

上信越自動車道
埋蔵文化財発掘調査報告書 6

——長野市内 その4 ——

松 原 遺 跡

古代・中世

図 版 編

2 0 0 0

日 本 道 路 公 団
長 野 県 教 育 委 員 会
長 野 県 埋 蔵 文 化 財 セ ン タ ー

上信越自動車道

埋蔵文化財発掘調査報告書 6

——長野市内 その4——

松 原 遺 跡

古代・中世

図 版 編

2 0 0 0

日 本 道 路 公 団
長 野 県 教 育 委 員 会
長 野 県 埋 蔵 文 化 財 セ ン タ ー

例 言

1. 本書は長野県長野市松代町東寺尾字北堀他に所在する松原遺跡の発掘調査報告書のうち、古代・中世についての調査結果を収録したものである。
2. 本書は『上信越自動車道埋蔵文化財発掘調査報告書 6 長野市内 その4 松原遺跡―古代・中世―』全2分冊のうち、第2分冊 図版編である。
3. 調査は上信越自動車道建設工事に伴う事前の記録保存のための調査として、長野県教育委員会の委託を受け、県教育委員会の指導のもとに、財団法人長野県埋蔵文化財センター及び財団法人長野県文化振興事業団長野県埋蔵文化財センターが実施したものである。
4. 調査にあたっては以下の関係機関のご協力を得た。
長野県教育委員会文化財生涯学習課 日本道路公団名古屋建設局 日本道路公団東京第二建設局
長野市教育委員会 JAグリーン長野農協
5. 発掘調査から本書の刊行に至るまで多くの方々のご指導を賜り、ご協力を得た。第1分冊 本文編にお名前を掲げさせていただくが、厚く感謝申し上げたい。
6. 本遺跡の概要については、すでに当センター発行の『長野県埋蔵文化財センター年報』6～15で報告している。それらと本書での記述に若干の相違があるが、古代・中世に関してのものは、本書をもって最終的な報告とする。
7. 調査記録、出土遺物は報告書刊行後、長野県立歴史館に移管し保管する。
8. 編集は上田典男が行い、百瀬長秀が全体を校閲した。

凡 例

1. 本書に掲載した実測図等の縮尺は、特に断りのある場合を除いて下記のように統一してある。

(1) 遺構実測図

全体図	1 : 3000	遺構配置図	1 : 400
遺構実測図	1 : 120	住居址重複関係図	1 : 120

(2) 遺物実測図

土器・焼物・円筒形土製品	1 : 4	台石・凹石	1 : 4
土錘・用途不明土製品・文字関係資料	1 : 3	砥石・軽石製品	1 : 3
土製紡錘車・ミニチュア土器	1 : 2	石帯・石製紡錘車	1 : 2
金属製品・鑄造関係資料	1 : 3	石臼	1 : 6
銭貨拓影図	2 : 3	石塔類	1 : 8
鍛冶関係資料	1 : 4	骨角牙製品	1 : 2

(3) 遺構写真

縮尺不統一

(4) 遺物写真

土器（食膳具・小形甕）	1 : 3	土製品	1 : 3	石塔類	1 : 6
土器（上記以外の煮炊具・貯蔵具）	1 : 4	金属製品	1 : 2	文字関係資料	1 : 1

上記以外は実測図の縮尺に対応している。

2. 実測図中のスクリーントーンは、特に断りのある場合を除いて以下の事項を表している。

(1) 遺構実測図

- ①=被熱痕跡及び焼土堆積 ②=焼土・炭化物の分布範囲 ③=炭化物の分布範囲
- ④=灰の分布範囲 ⑤=柱痕跡 ⑥=近世以降の暗渠
- ⑦=近代以降の暗渠 ⑧=攪乱・トレンチ・後世の遺構などに破壊されている部分

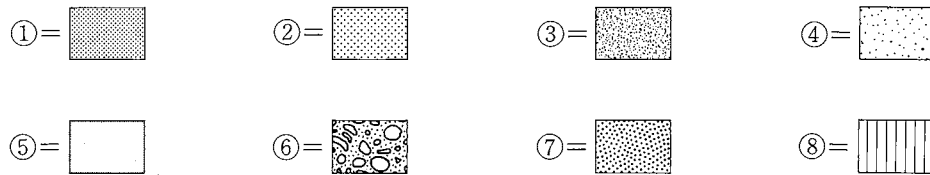

(2) 遺物実測図

古代土器

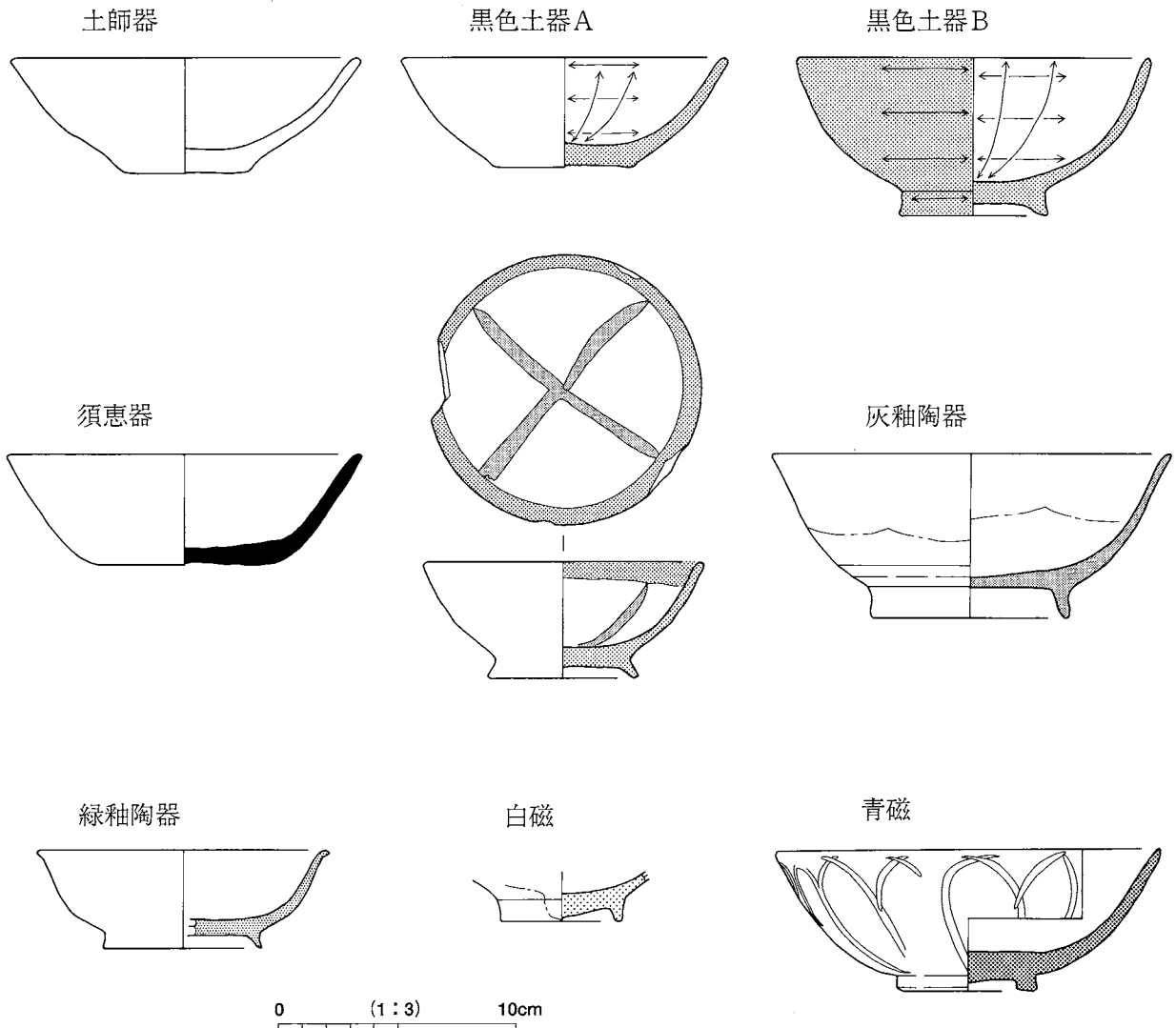

文字関係資料

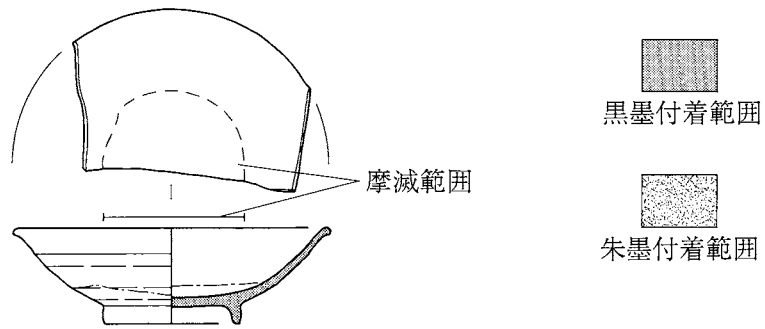

中世焼物

実測図の断面を、土師質－白抜き、須恵質－黒塗りで表す他、瓦質、陶器、磁器は以下のスクリーントーンで表した。また、国産陶磁器の釉薬の種類については以下のスクリーントーンで表した。ただし、灰釉については白抜きにした。なお、白磁・青磁については古代と同様に表した。

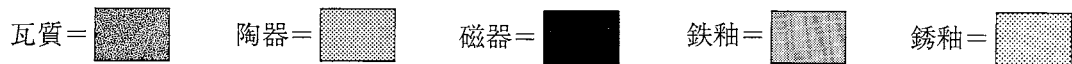

下記の遺物についてはそれぞれ以下のスクリーントーンで当該事項を表現している。

石器・石製品



金属製品



骨角牙製品



木製品

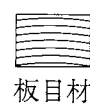
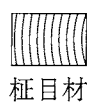

*各遺物の欠損及び剥落部、すずの付着範囲については、木製品を除いて共通のスクリーントーンで表した。



図 版 目 次

図版 1	遺跡全体図 (1:3000)	図版39	遺構実測図24
図版 2	遺構配置図割付図	図版40	遺構実測図25
図版 3	遺構配置図 1 (1:400)	図版41	遺構実測図26
図版 4	遺構配置図 2 (1:400)	図版42	遺構実測図27
図版 5	遺構配置図 3 (1:400)	図版43	遺構実測図28
図版 6	遺構配置図 4 (1:400)	図版44	遺構実測図29
図版 7	遺構配置図 5 (1:400)	図版45	遺構実測図30
図版 8	遺構配置図 6 (1:400)	図版46	遺構実測図31
図版 9	遺構配置図 7 (1:400)	図版47	遺構実測図32
図版10	遺構配置図 8 (1:400)	図版48	遺構実測図33
図版11	遺構配置図 9 (1:400)	図版49	遺構実測図34
図版12	遺構配置図10 (1:400)	図版50	遺構実測図35
図版13	遺構配置図11 (1:400)	図版51	遺構実測図36
図版14	遺構配置図12 (1:400)	図版52	遺構実測図37
図版15	1:120遺構実測図割付図	図版53	遺構実測図38
図版16	遺構実測図 1	図版54	遺構実測図39
図版17	遺構実測図 2	図版55	遺構実測図40
図版18	遺構実測図 3	図版56	遺構実測図41
図版19	遺構実測図 4	図版57	遺構実測図42
図版20	遺構実測図 5	図版58	遺構実測図43
図版21	遺構実測図 6	図版59	遺構実測図44
図版22	遺構実測図 7	図版60	遺構実測図45
図版23	遺構実測図 8	図版61	遺構実測図46
図版24	遺構実測図 9	図版62	遺構実測図47
図版25	遺構実測図10	図版63	遺構実測図48
図版26	遺構実測図11	図版64	遺構実測図49
図版27	遺構実測図12	図版65	遺構実測図50
図版28	遺構実測図13	図版66	遺構実測図51
図版29	遺構実測図14	図版67	遺構実測図52
図版30	遺構実測図15	図版68	遺構実測図53
図版31	遺構実測図16	図版69	遺構実測図54
図版32	遺構実測図17	図版70	遺構実測図55
図版33	遺構実測図18	図版71	遺構実測図56
図版34	遺構実測図19	図版72	遺構実測図57
図版35	遺構実測図20	図版73	遺構実測図58
図版36	遺構実測図21	図版74	遺構実測図59
図版37	遺構実測図22	図版75	遺構実測図60
図版38	遺構実測図23	図版76	遺構実測図61

図版77	遺構実測図62	図版117	竪穴住居址重複関係図10
図版78	遺構実測図63	図版118	古代土器実測図 1
図版79	遺構実測図64	図版119	古代土器実測図 2
図版80	遺構実測図65	図版120	古代土器実測図 3
図版81	遺構実測図66	図版121	古代土器実測図 4
図版82	遺構実測図67	図版122	古代土器実測図 5
図版83	遺構実測図68	図版123	古代土器実測図 6
図版84	遺構実測図69	図版124	古代土器実測図 7
図版85	遺構実測図70	図版125	古代土器実測図 8
図版86	遺構実測図71	図版126	古代土器実測図 9
図版87	遺構実測図72	図版127	古代土器実測図10
図版88	遺構実測図73	図版128	古代土器実測図11
図版89	遺構実測図74	図版129	古代土器実測図12
図版90	遺構実測図75	図版130	古代土器実測図13
図版91	遺構実測図76	図版131	古代土器実測図14
図版92	遺構実測図77	図版132	古代土器実測図15
図版93	遺構実測図78	図版133	古代土器実測図16
図版94	遺構実測図79	図版134	古代土器実測図17
図版95	遺構実測図80	図版135	古代土器実測図18
図版96	遺構実測図81	図版136	古代土器実測図19
図版97	遺構実測図82	図版137	古代土器実測図20
図版98	遺構実測図83	図版138	古代土器実測図21
図版99	遺構実測図84	図版139	古代土器実測図22
図版100	遺構実測図85	図版140	古代土器実測図23
図版101	遺構実測図86	図版141	古代土器実測図24
図版102	遺構実測図87	図版142	古代土器実測図25
図版103	遺構実測図88	図版143	古代土器実測図26
図版104	遺構実測図89	図版144	古代土器実測図27
図版105	遺構実測図90	図版145	古代土器実測図28
図版106	遺構実測図91	図版146	古代土器実測図29
図版107	遺構実測図92	図版147	古代土器実測図30
図版108	竪穴住居址重複関係図 1	図版148	古代土器実測図31
図版109	竪穴住居址重複関係図 2	図版149	古代土器実測図32
図版110	竪穴住居址重複関係図 3	図版150	古代土器実測図33
図版111	竪穴住居址重複関係図 4	図版151	古代土器実測図34
図版112	竪穴住居址重複関係図 5	図版152	古代土器実測図35
図版113	竪穴住居址重複関係図 6	図版153	古代土器実測図36
図版114	竪穴住居址重複関係図 7	図版154	古代土器実測図37
図版115	竪穴住居址重複関係図 8	図版155	古代土器実測図38
図版116	竪穴住居址重複関係図 9	図版156	古代土器実測図39

图版157 古代土器実测图40
图版158 古代土器実测图41
图版159 古代土器実测图42
图版160 古代土器実测图43
图版161 古代土器実测图44
图版162 古代土器実测图45
图版163 古代土器実测图46
图版164 古代土器実测图47
图版165 古代土器実测图48
图版166 古代土器実测图49
图版167 古代土器実测图50
图版168 古代土器実测图51
图版169 古代土器実测图52
图版170 古代土器実测图53
图版171 古代土器実测图54
图版172 古代土器実测图55
图版173 古代土器実测图56
图版174 古代土器実测图57
图版175 古代土器実测图58
图版176 古代土器実测图59
图版177 古代土器実测图60
图版178 古代土器実测图61
图版179 古代土器実测图62
图版180 古代土器実测图63
图版181 古代土器実测图64
图版182 古代土器実测图65
图版183 古代土器実测图66
图版184 古代土器実测图67
图版185 古代土器実测图68
图版186 古代土器実测图69
图版187 古代土器実测图70
图版188 古代土器実测图71
图版189 古代土器実测图72
图版190 古代土器実测图73
图版191 古代土器実测图74
图版192 古代土器実测图75
图版193 古代土器実测图76
图版194 古代土器実测图77
图版195 古代土器実测图78
图版196 古代土器実测图79

图版197 古代土器実测图80
图版198 古代土器実测图81
图版199 古代土器実测图82
图版200 古代土器実测图83
图版201 古代土器実测图84
图版202 古代土器実测图85
图版203 古代土器実测图86
图版204 古代土器実测图87
图版205 古代土器実测图88
图版206 古代土器実测图89
图版207 古代土器実测图90
图版208 古代土器実测图91
图版209 古代土器実测图92
图版210 古代土器実测图93
图版211 古代土器実测图94
图版212 古代土器実测图95
图版213 古代土器実测图96
图版214 古代土器実测图97
图版215 古代土器実测图98
图版216 古代土器実测图99
图版217 古代土器実测图100
图版218 古代土器実测图101
图版219 古代土器実测图102
图版220 古代土器実测图103
图版221 古代土器実测图104
图版222 古代土器実测图105
图版223 古代土器実测图106
图版224 古代土器実测图107
图版225 古代土器実测图108
图版226 古代土器実测图109
图版227 古代土器実测图110
图版228 古代土器実测图111
图版229 古代土器実测图112
图版230 古代土器実测图113
图版231 古代土器実测图114
图版232 古代土器実测图115
图版233 古代土器実测图116
图版234 古代土器実测图117
图版235 古代土器実测图118
图版236 古代土器実测图119

- 図版237 古代土器実測図120
 図版238 古代土器実測図121
 図版239 古代土器実測図122
 図版240 古代土器実測図123
 図版241 古代土器実測図124
 図版242 古代土器実測図125
 図版243 古代土器実測図126
 図版244 古代土器実測図127
 図版245 古代土器実測図128
 図版246 古代土製品実測図 1
 図版247 古代土製品実測図 2
 図版248 古代土製品実測図 3
 図版249 古代土製品実測図 4
 図版250 古代土製品実測図 5
 図版251 古代石器・石製品実測図 1
 図版252 古代石器・石製品実測図 2
 図版253 古代石器・石製品実測図 3
 図版254 古代石器・石製品実測図 4
 図版255 古代石器・石製品実測図 5
 図版256 古代石器・石製品実測図 6
 図版257 古代石器・石製品実測図 7
 図版258 古代石器・石製品実測図 8
 図版259 古代石器・石製品実測図 9
 図版260 古代石器・石製品実測図10
 図版261 古代石器・石製品実測図11
 図版262 古代金属製品実測図 1
 図版263 古代金属製品実測図 2
 図版264 古代金属製品実測図 3
 図版265 古代金属製品実測図 4
 図版266 古代金属製品実測図 5
 図版267 古代金属製品実測図 6
 図版268 古代金属製品実測図 7
 図版269 古代金属製品実測図 8
 図版270 古代骨角牙製品実測図 1
 図版271 古代骨角牙製品実測図 2
 図版272 古代骨角牙製品実測図 3
 図版273 古代骨角牙製品実測図 4
 図版274 古代骨角牙製品実測図 5
 図版275 古代木製品実測図 1
 図版276 古代木製品実測図 2
 図版277 古代木製品実測図 3
 図版278 古代木製品実測図 4
 図版279 古代木製品実測図 5
 図版280 古代木製品実測図 6
 図版281 古代木製品実測図 7
 図版282 古代木製品実測図 8
 図版283 古代木製品実測図 9
 図版284 古代木製品実測図10
 図版285 古代木製品実測図11
 図版286 古代木製品実測図12
 図版287 古代木製品実測図13
 図版288 古代木製品実測図14
 図版289 古代木製品実測図15
 図版290 古代木製品実測図16
 図版291 古代木製品実測図17
 図版292 古代鍛冶・鑄造関係資料 1
 図版293 古代鍛冶・鑄造関係資料 2
 図版294 古代鍛冶・鑄造関係資料 3
 図版295 古代鍛冶・鑄造関係資料 4
 図版296 古代鍛冶・鑄造関係資料 5
 図版297 古代鍛冶・鑄造関係資料 6
 図版298 古代鍛冶・鑄造関係資料 7
 図版299 古代文字関係資料 1
 図版300 古代文字関係資料 2
 図版301 古代文字関係資料 3
 図版302 古代文字関係資料 4
 図版303 古代文字関係資料 5
 図版304 古代文字関係資料 6
 図版305 古代文字関係資料 7
 図版306 古代文字関係資料 8
 図版307 古代文字関係資料 9
 図版308 古代文字関係資料10
 図版309 古代文字関係資料11
 図版310 古代文字関係資料12
 図版311 古代文字関係資料13
 図版312 古代文字関係資料14
 図版313 古代文字関係資料15
 図版314 古代文字関係資料16
 図版315 古代文字関係資料17
 図版316 中世焼物実測図 1

図版317	中世焼物実測図 2	図版328	中世石塔類実測図 3
図版318	中世焼物実測図 3	図版329	中世石塔類実測図 4
図版319	中世焼物実測図 4	図版330	中世石塔類実測図 5
図版320	中世焼物実測図 5	図版331	中世金属製品実測図 1
図版321	中世焼物実測図 6	図版332	中世金属製品実測図 2
図版322	中世石器・石製品実測図 1	図版333	中世金属製品実測図 3
図版323	中世石器・石製品実測図 2	図版334	中世木製品実測図 1
図版324	中世石器・石製品実測図 3	図版335	中世木製品実測図 2
図版325	中世石器・石製品実測図 4	図版336	中世木製品実測図 3
図版326	中世石塔類実測図 1	図版337	中世木製品実測図 4
図版327	中世石塔類実測図 2		

写真図版目次

PL 1	遺跡上空空中写真	PL25	古代土器 2
PL 2	遺跡遠景・基本層序	PL26	古代土器 3
PL 3	松原 1号墳 (全景・石室内)	PL27	古代土器 4
PL 4	松原 1号墳 (墳丘)	PL28	古代土器 5
PL 5	松原 1号墳 (墳丘・遺物出土状況)	PL29	古代土器 6
PL 6	松原 2・3号墳	PL30	古代土器 7
PL 7	松原 1号墳出土土器 1	PL31	古代土器 8
PL 8	松原 1号墳出土土器 2	PL32	古代土器 9
PL 9	松原 1号墳出土金属製品 1	PL33	古代土器10
PL10	松原 1号墳出土金属製品 2	PL34	古代土器11
PL11	松原 1号墳出土金属製品 3	PL35	古代土器12
PL12	松原 1号墳出土玉類・2号墳出土 金属製品	PL36	古代土器13
PL13	古代竪穴住居址 1	PL37	古代土器14
PL14	古代竪穴住居址 2	PL38	古代土器15
PL15	古代竪穴住居址 3	PL39	古代土器16
PL16	古代竪穴住居址 4	PL40	古代土器17
PL17	古代竪穴住居址 5	PL41	古代土器18
PL18	古代竪穴住居址 6・掘立柱建物址	PL42	古代土器19
PL19	古代道路址・溝址	PL43	古代土器20
PL20	古代墓址	PL44	古代土器21
PL21	古代井戸址・土坑	PL45	古代土器22
PL22	古代土坑・河川址・築状遺構	PL46	古代土器23
PL23	古代築状遺構	PL47	古代土器24
PL24	古代土器 1	PL48	古代土器25
		PL49	古代土器26

PL50	古代土器27	PL90	古代土器67
PL51	古代土器28	PL91	古代土器68
PL52	古代土器29	PL92	古代土器69
PL53	古代土器30	PL93	古代土製品 1
PL54	古代土器31	PL94	古代土製品 2
PL55	古代土器32	PL95	古代土製品 3
PL56	古代土器33	PL96	古代土製品 4
PL57	古代土器34	PL97	古代土製品 5
PL58	古代土器35	PL98	古代石器・石製品 1
PL59	古代土器36	PL99	古代石器・石製品 2
PL60	古代土器37	PL100	古代石器・石製品 3
PL61	古代土器38	PL101	古代石器・石製品 4
PL62	古代土器39	PL102	古代石器・石製品 5
PL63	古代土器40	PL103	古代金属製品 1
PL64	古代土器41	PL104	古代金属製品 2
PL65	古代土器42	PL105	古代金属製品 3
PL66	古代土器43	PL106	古代金属製品 4
PL67	古代土器44	PL107	古代金属製品 5
PL68	古代土器45	PL108	古代金属製品 6
PL69	古代土器46	PL109	古代金属製品 7
PL70	古代土器47	PL110	古代骨角牙製品 1
PL71	古代土器48	PL111	古代骨角牙製品 2
PL72	古代土器49	PL112	古代木製品 1
PL73	古代土器50	PL113	古代木製品 2
PL74	古代土器51	PL114	古代木製品 3
PL75	古代土器52	PL115	古代木製品 4
PL76	古代土器53	PL116	古代木製品 5
PL77	古代土器54	PL117	古代木製品 6
PL78	古代土器55	PL118	古代木製品 7
PL79	古代土器56	PL119	古代木製品 8
PL80	古代土器57	PL120	古代木製品 9
PL81	古代土器58	PL121	古代木製品10
PL82	古代土器59	PL122	古代木製品11
PL83	古代土器60	PL123	古代木製品12
PL84	古代土器61	PL124	古代木製品13
PL85	古代土器62	PL125	古代木製品14
PL86	古代土器63	PL126	古代木製品15
PL87	古代土器64	PL127	古代木製品16
PL88	古代土器65	PL128	古代木製品17
PL89	古代土器66	PL129	古代鍛冶・鑄造関係資料 1

PL130	古代鍛冶・鑄造關係資料 2	PL152	中世石器・石製品 1
PL131	古代文字關係資料 1	PL153	中世石器・石製品 2
PL132	古代文字關係資料 2	PL154	中世石塔類 1
PL133	古代文字關係資料 3	PL155	中世石塔類 2
PL134	古代文字關係資料 4	PL156	中世石塔類 3
PL135	古代文字關係資料 5	PL157	中世石塔類 4
PL136	古代文字關係資料 6	PL158	中世石塔類 5
PL137	古代文字關係資料 7	PL159	中世石塔類 6
PL138	古代文字關係資料 8	PL160	中世石塔類 7
PL139	古代文字關係資料 9	PL161	中世石塔類 8
PL140	中世溝址・墓址 1	PL162	中世石塔類 9
PL141	中世墓址 2	PL163	中世石塔類 10
PL142	中世墓址 3・井戸址 1	PL164	中世石塔類 11
PL143	中世井戸址 2・土坑	PL165	中世石塔類 12
PL144	斜面部中世墓址群 1	PL166	中世金屬製品 1
PL145	斜面部中世墓址群 2	PL167	中世金屬製品 2
PL146	斜面部中世墓址群 3	PL168	中世金屬製品 3
PL147	中世焼物 1	PL169	中世木製品 1
PL148	中世焼物 2	PL170	中世木製品 2
PL149	中世焼物 3	PL171	中世木製品 3
PL150	中世焼物 4	PL172	中世木製品 4
PL151	中世焼物 5	PL173	中世木製品 5

実測図版

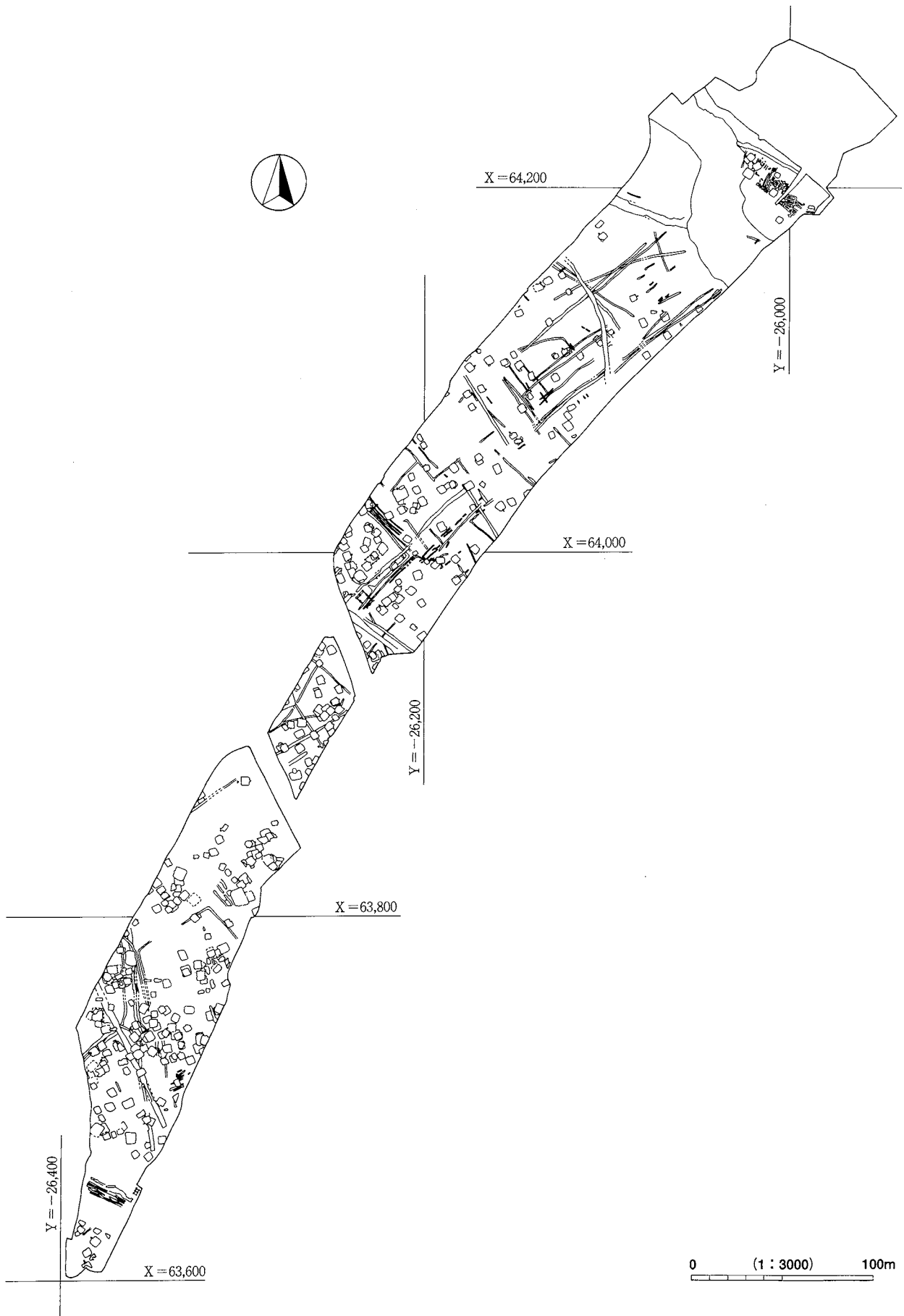

図版 2 遺構配置図割付図

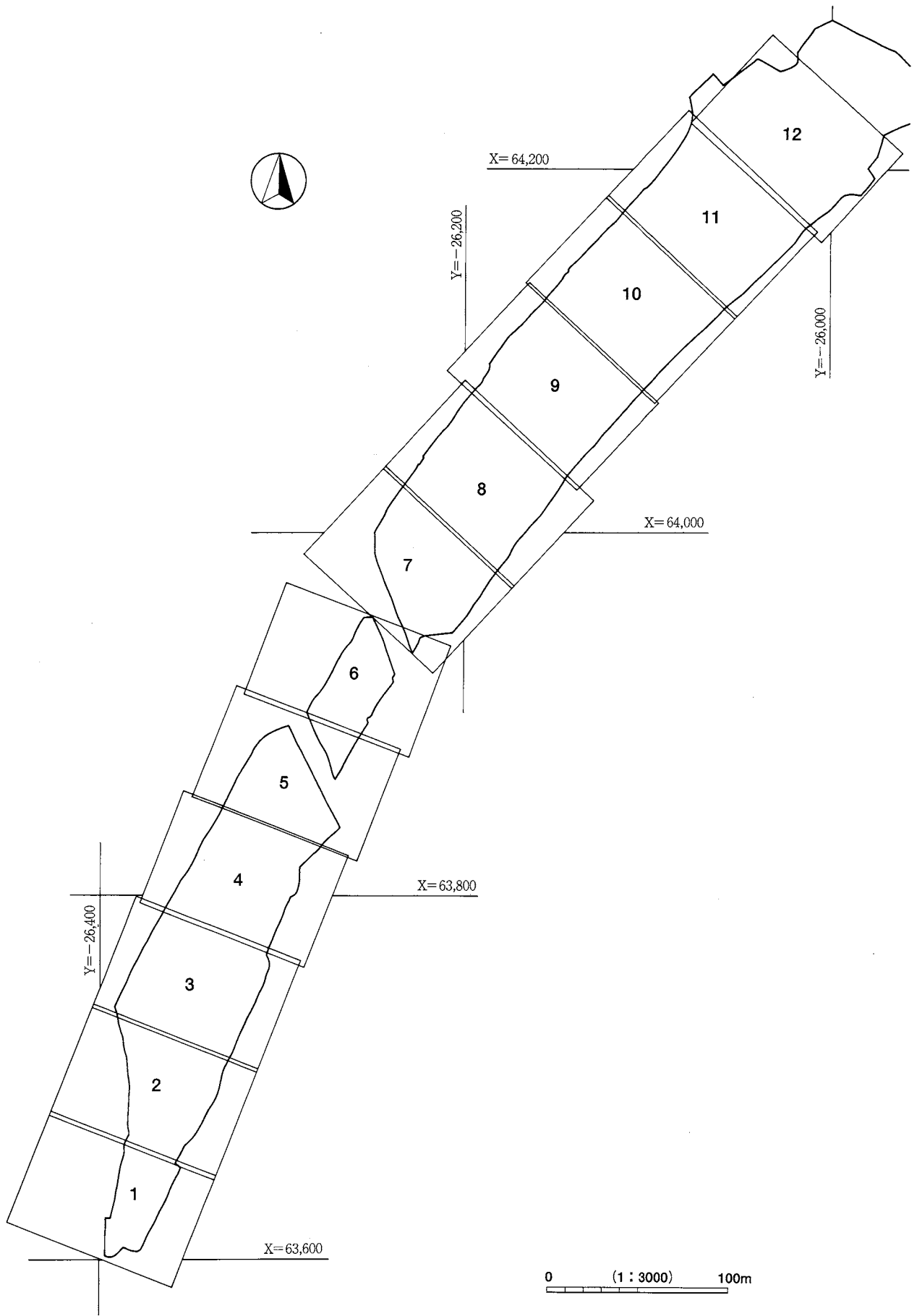

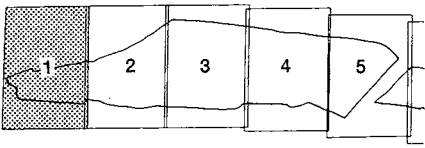

IUP

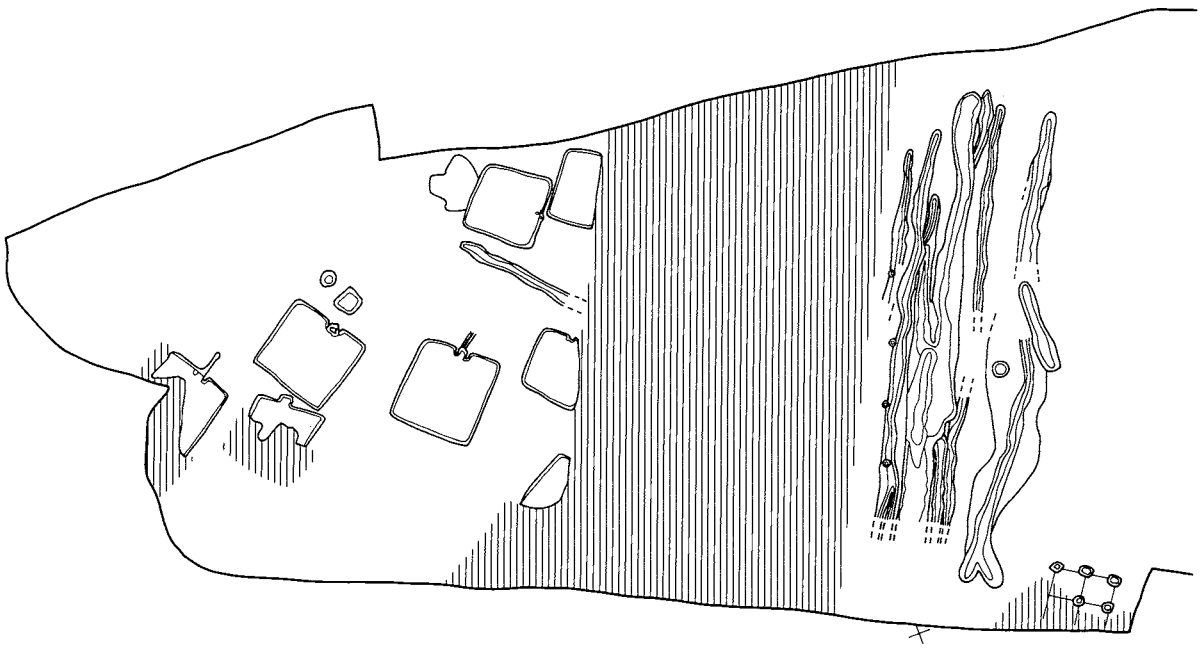

+

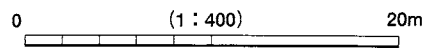

図版4 遺構配置図2 (1:400)

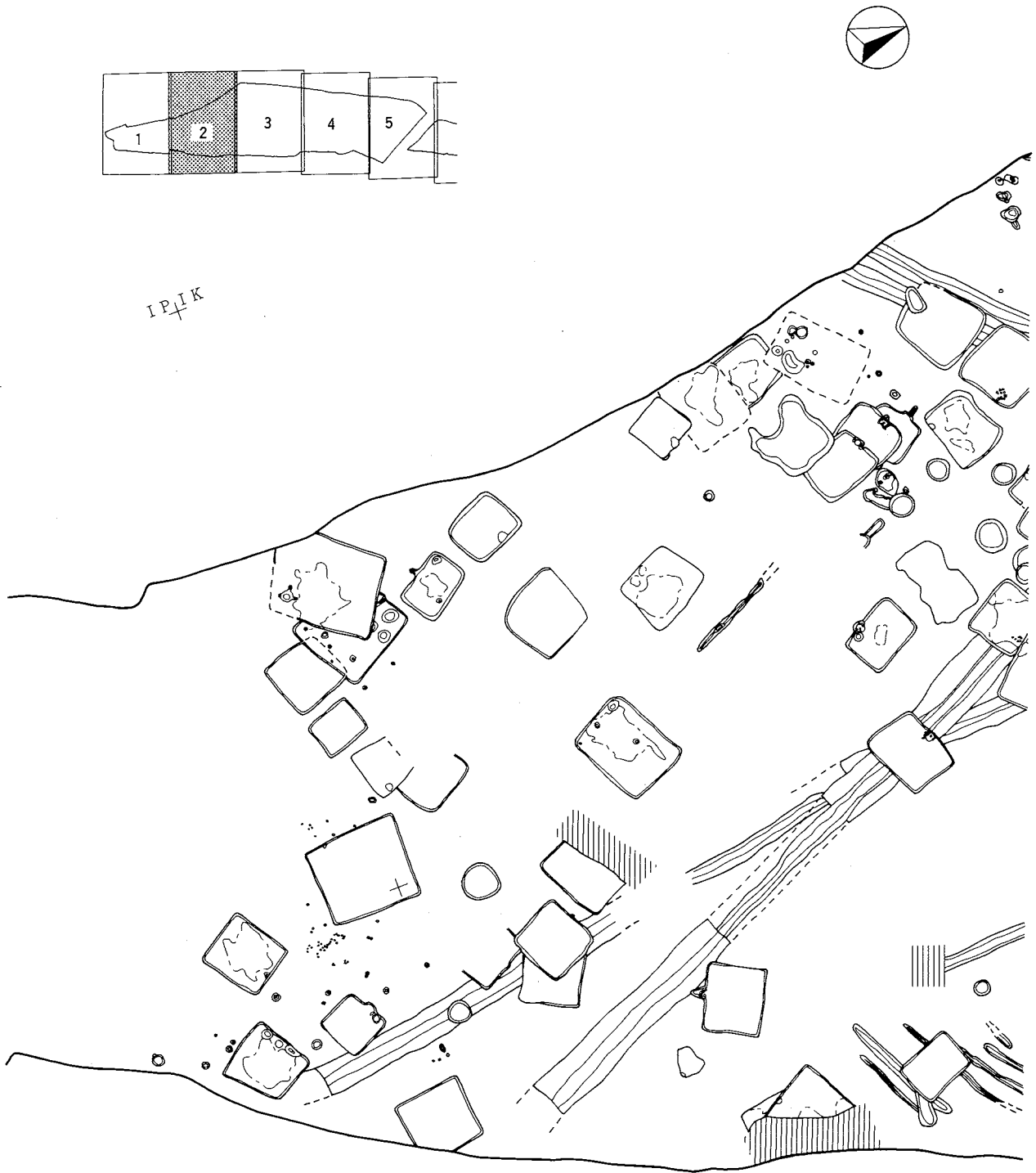

0 (1:400) 20m

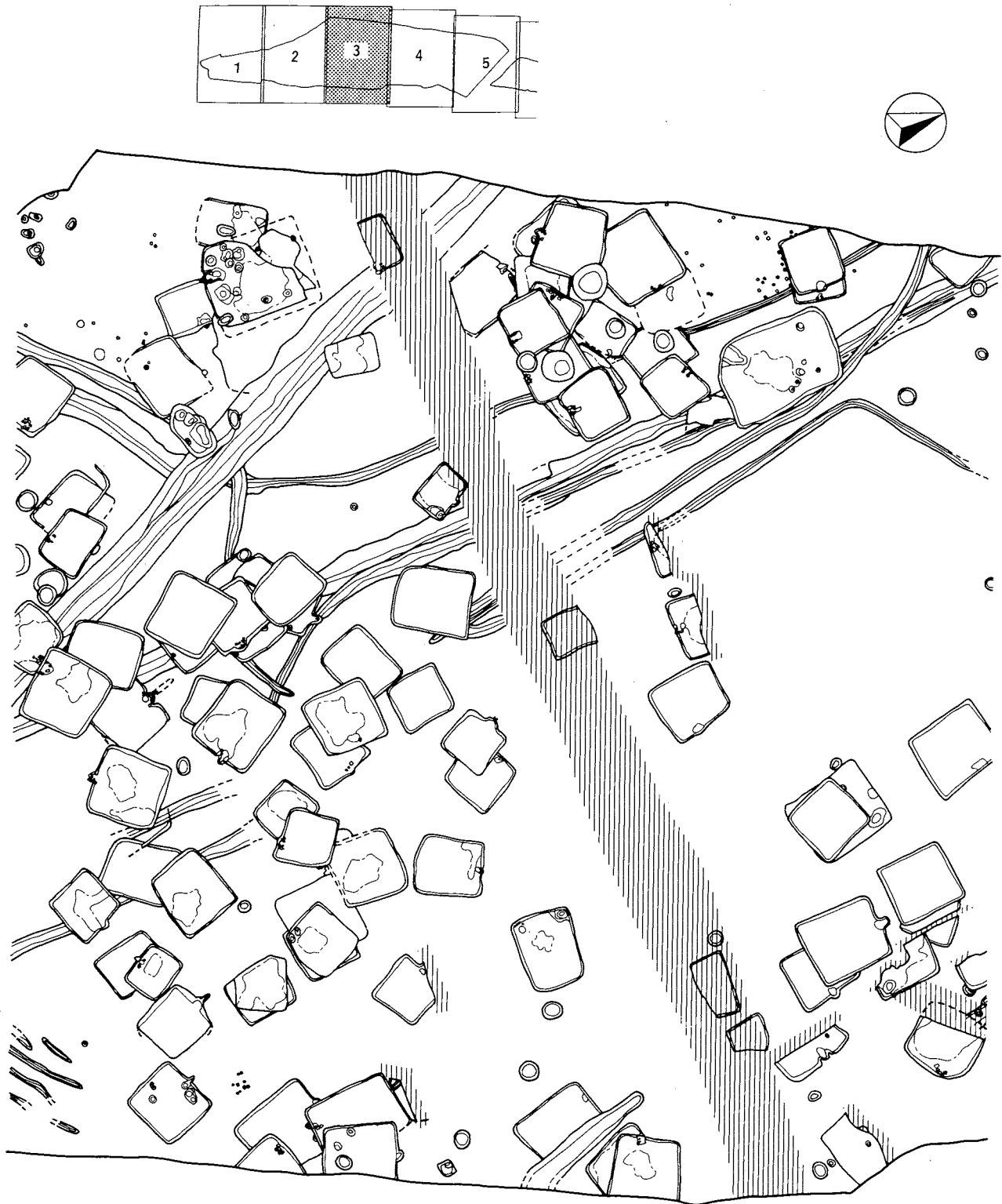

I L I G
+ H

0 (1:400) 20m

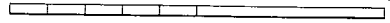

図版 6 遺構配置図 4 (1:400)

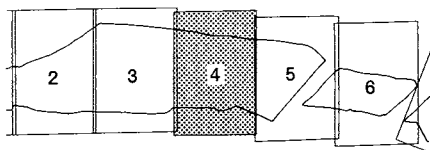
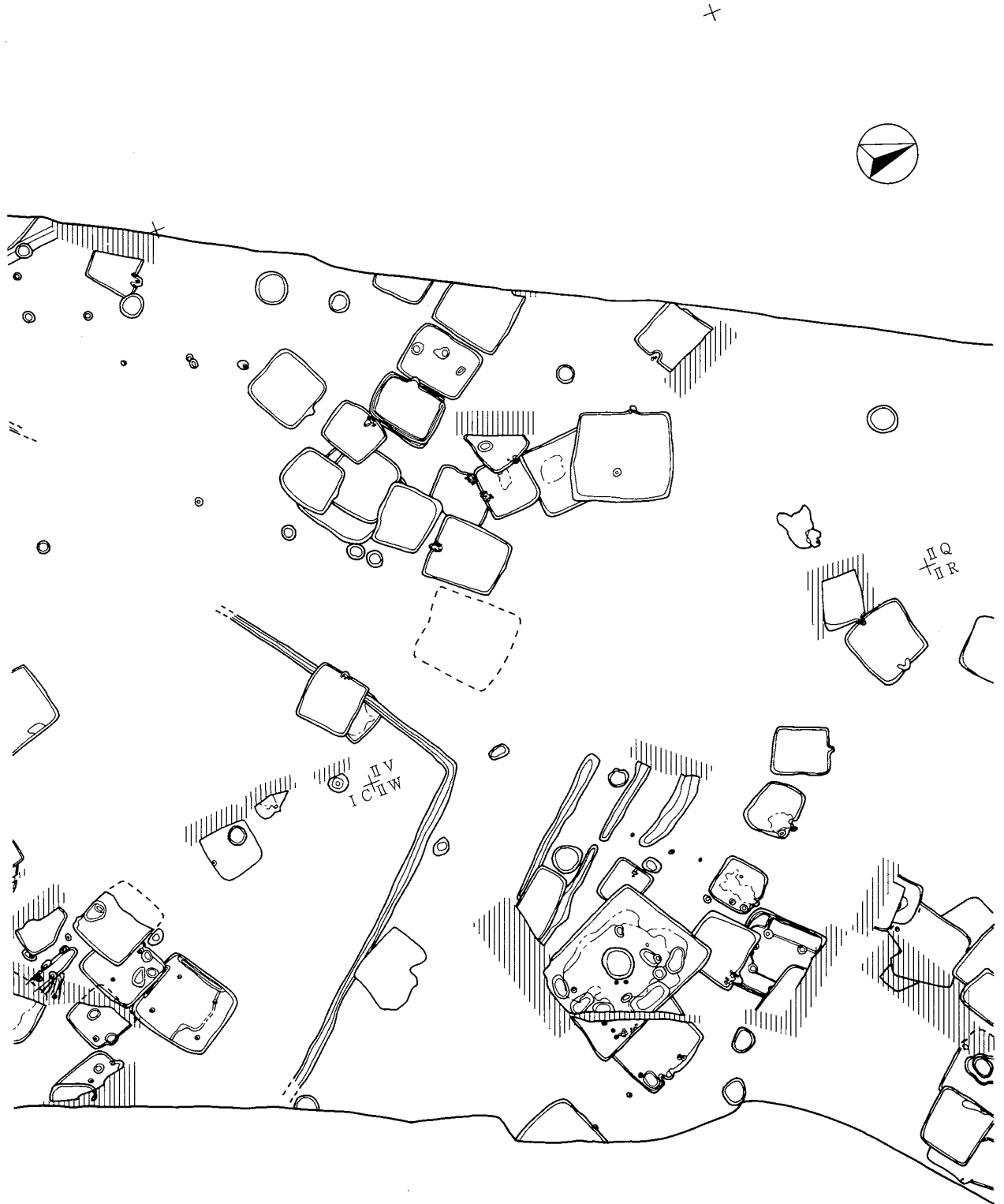

0 (1:400) 20m

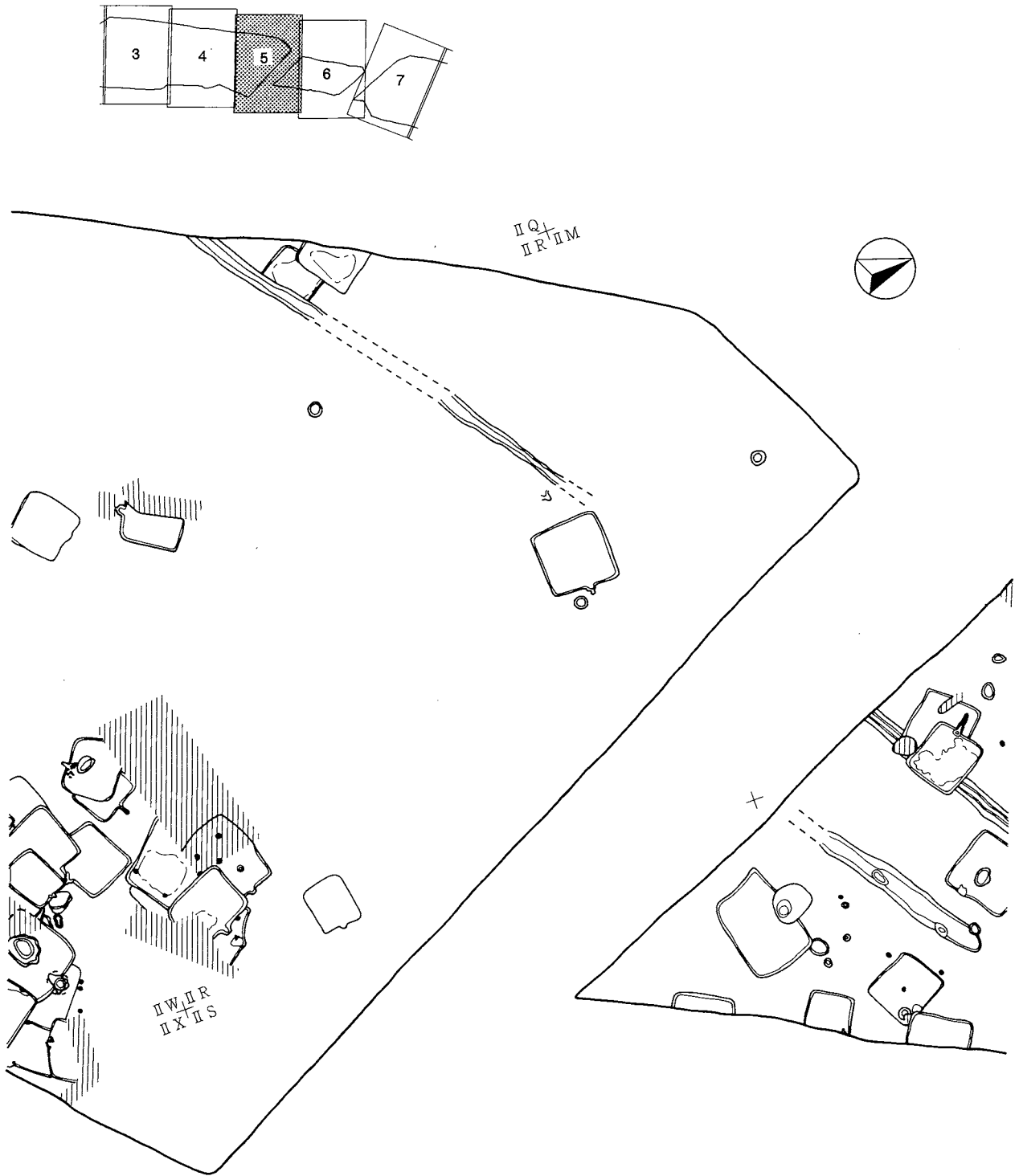

0 (1:400) 20m

図版 8 遺構配置図 6 (1 : 400)

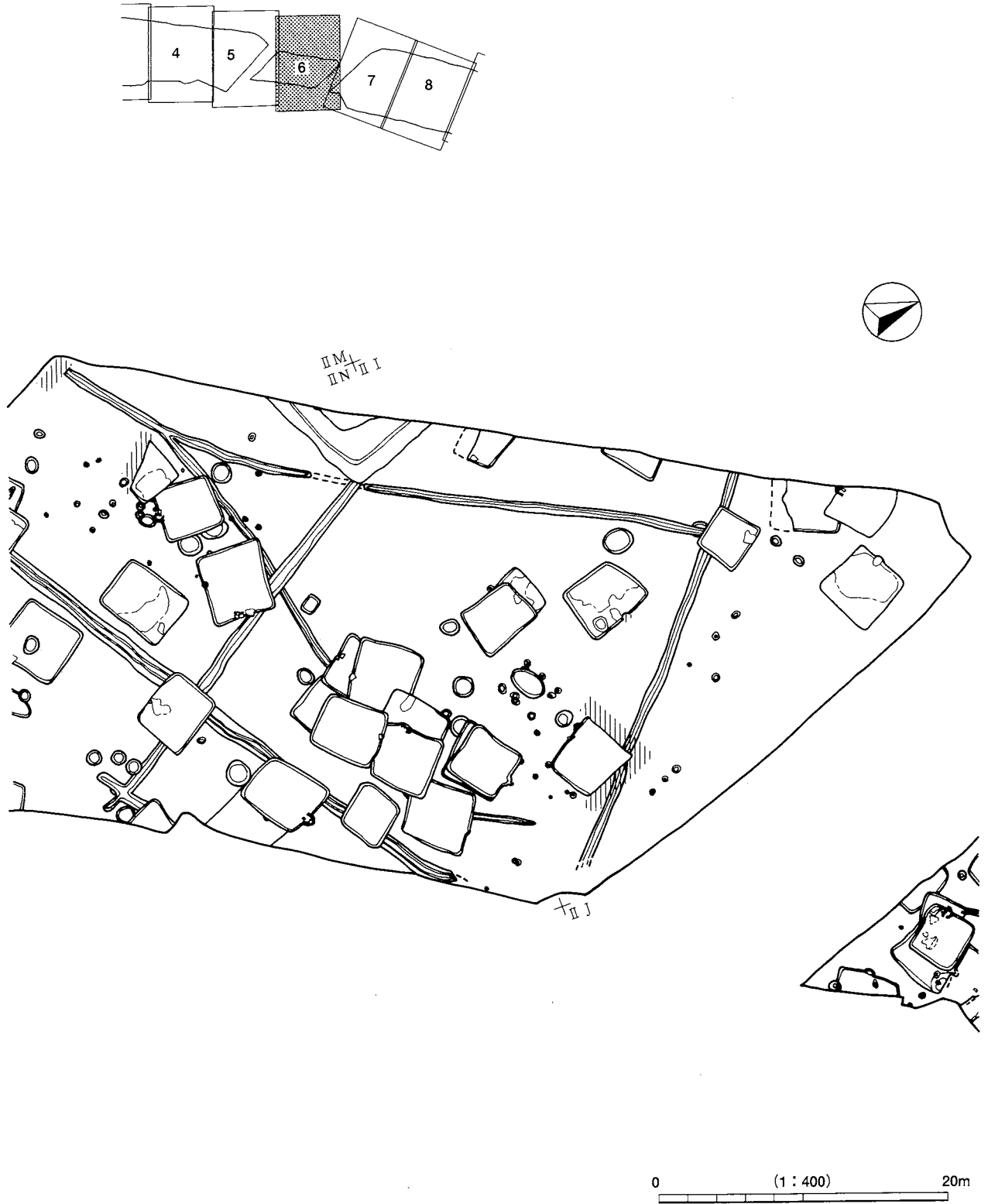

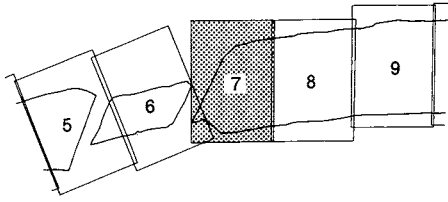

0 (1 : 400) 20m

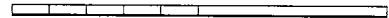

図版10 遺構配置図8 (1:400)



0 (1:400) 20m

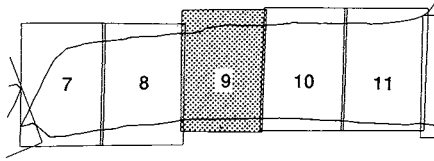

0 (1:400) 20m

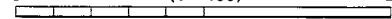

図版12 遺構配置図10 (1:400)

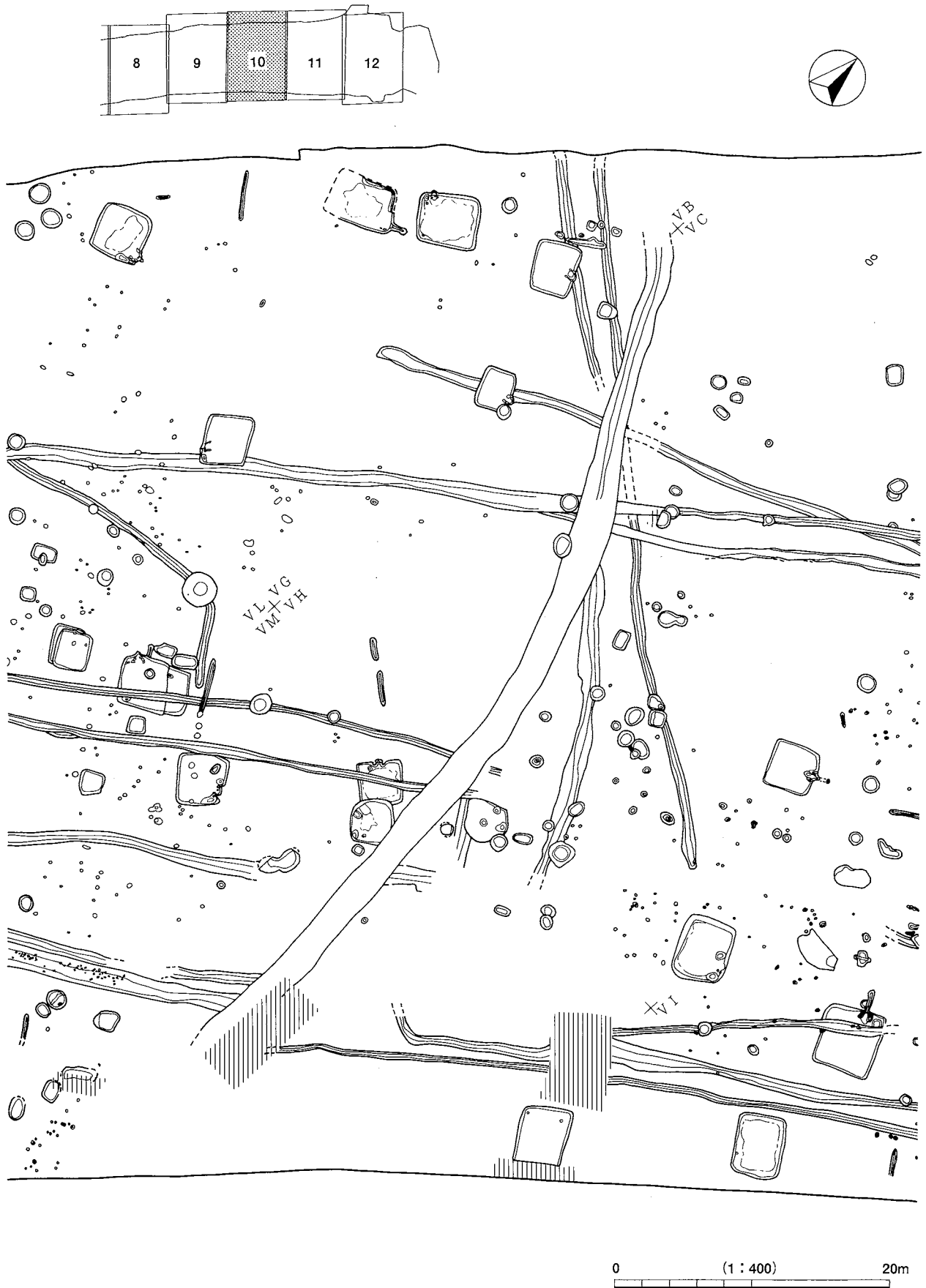



図版14 遺構配置図12 (1:400)

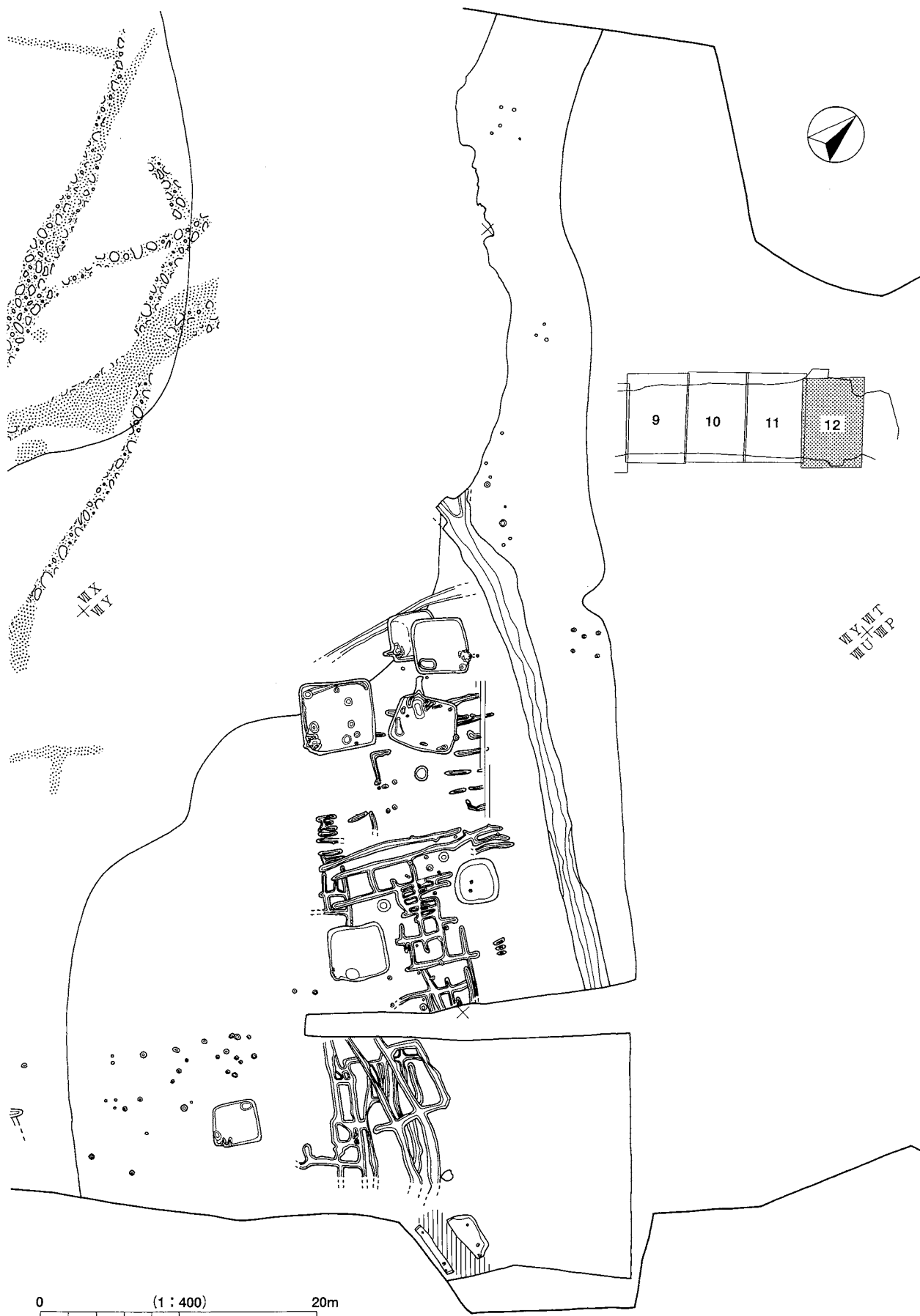

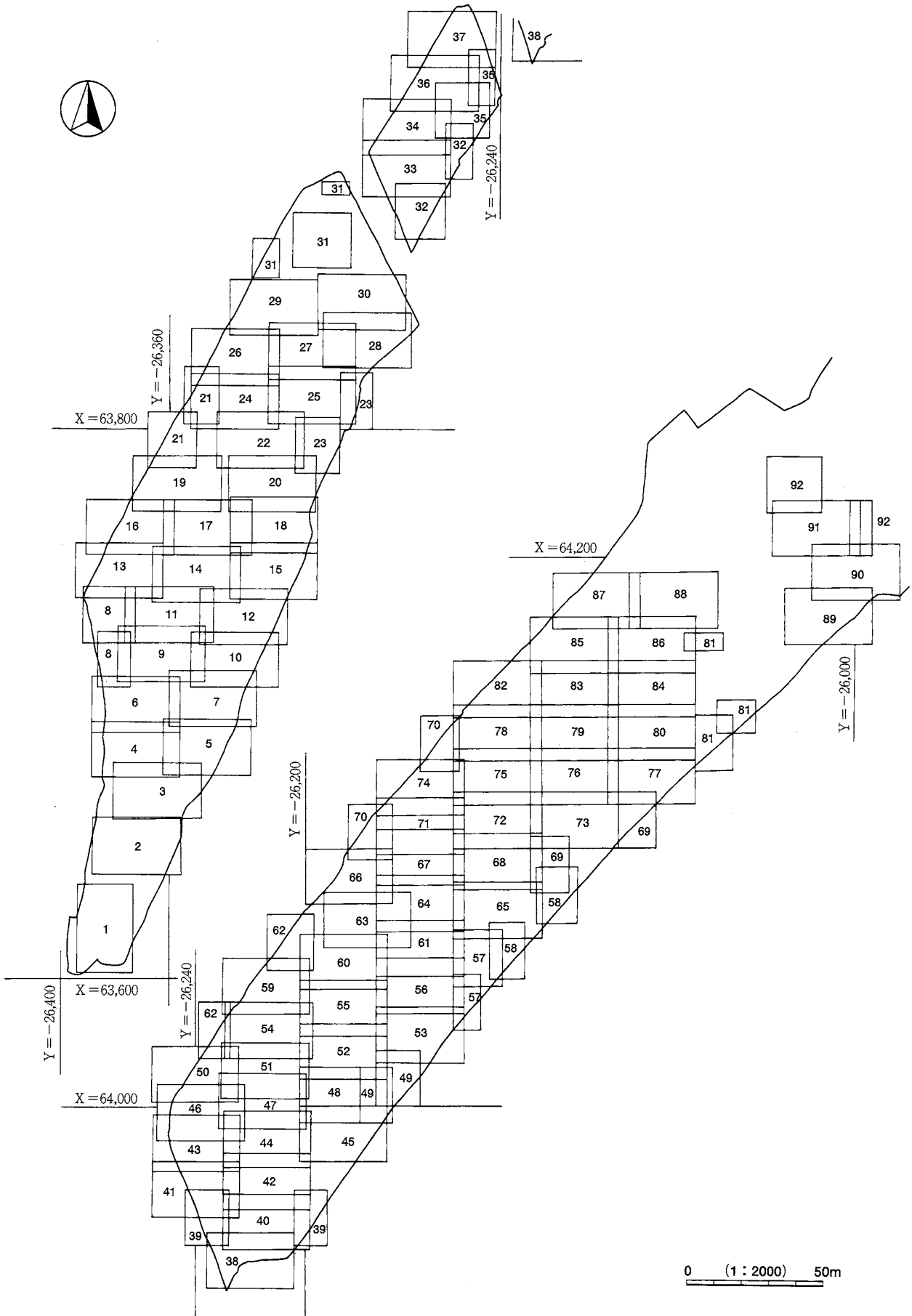

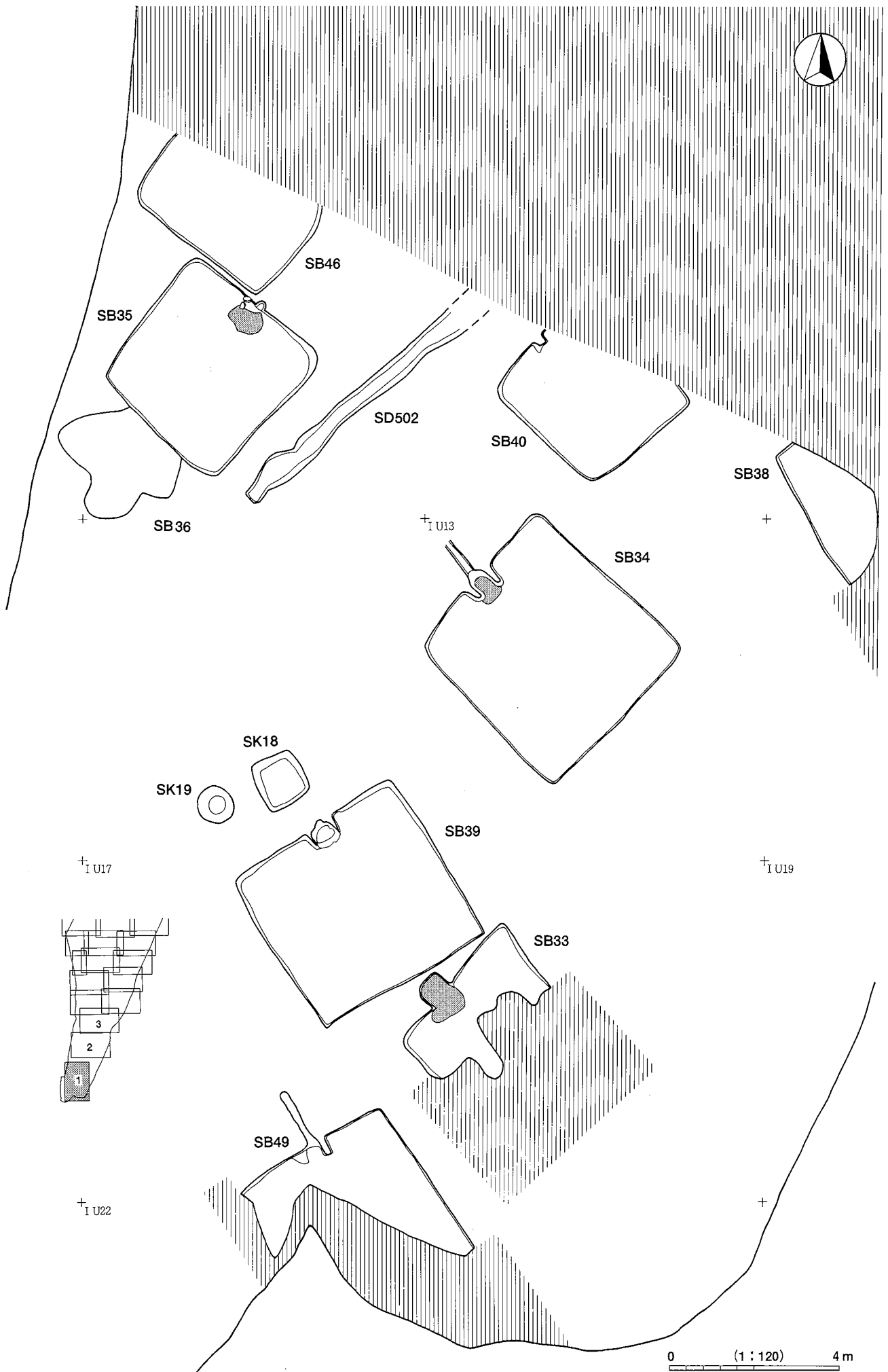

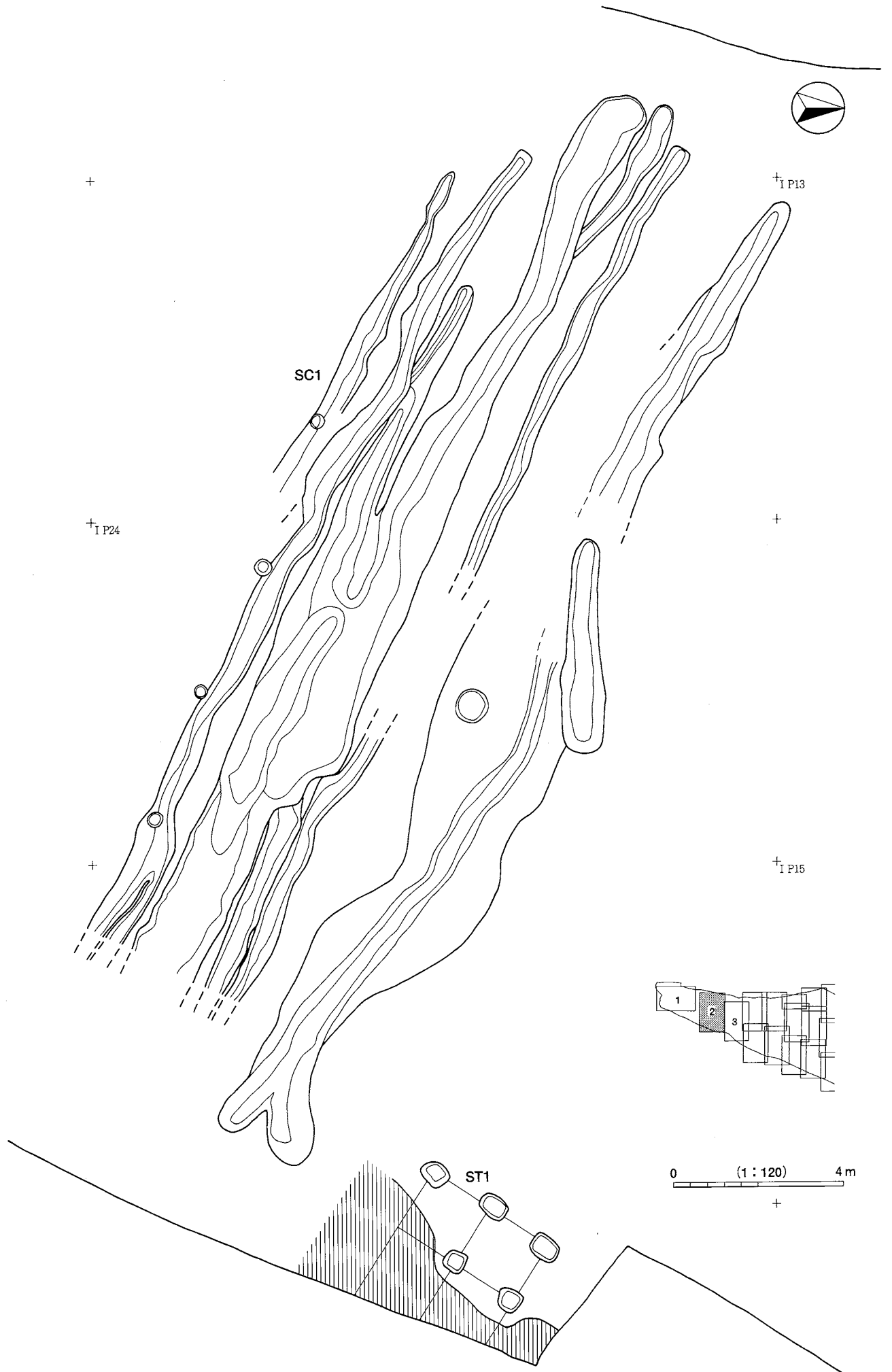

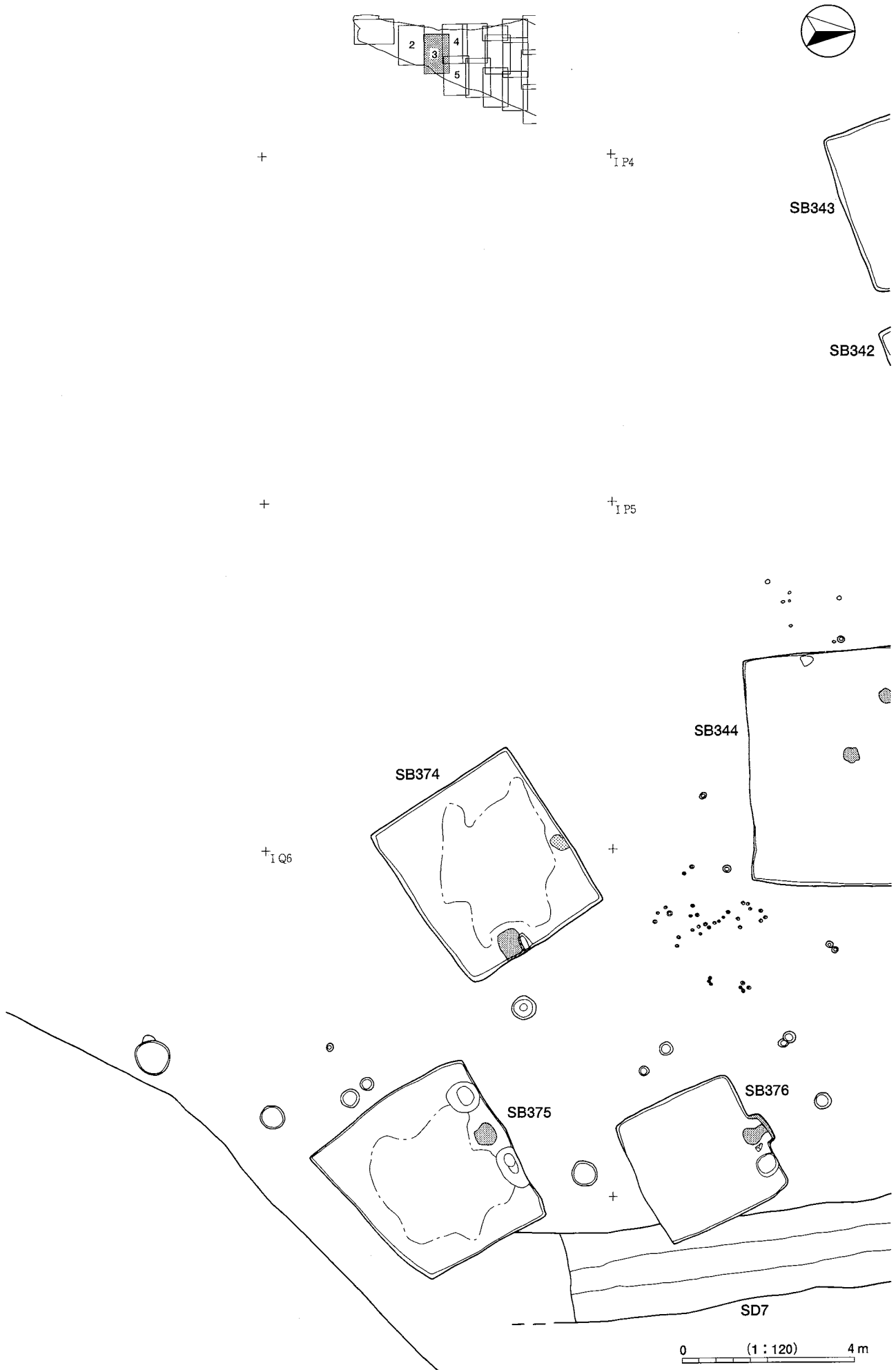

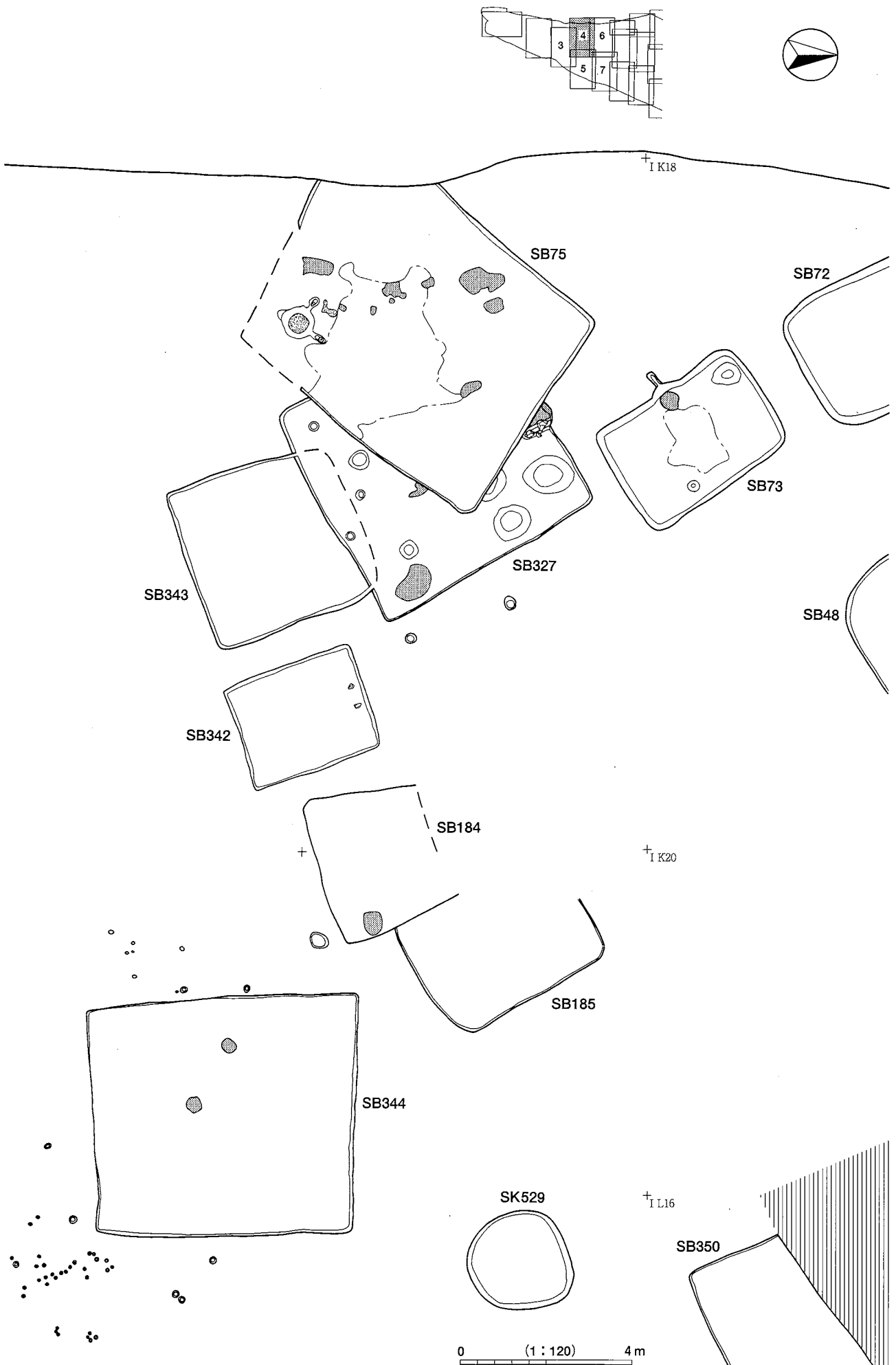

図版20 遺構実測図 5

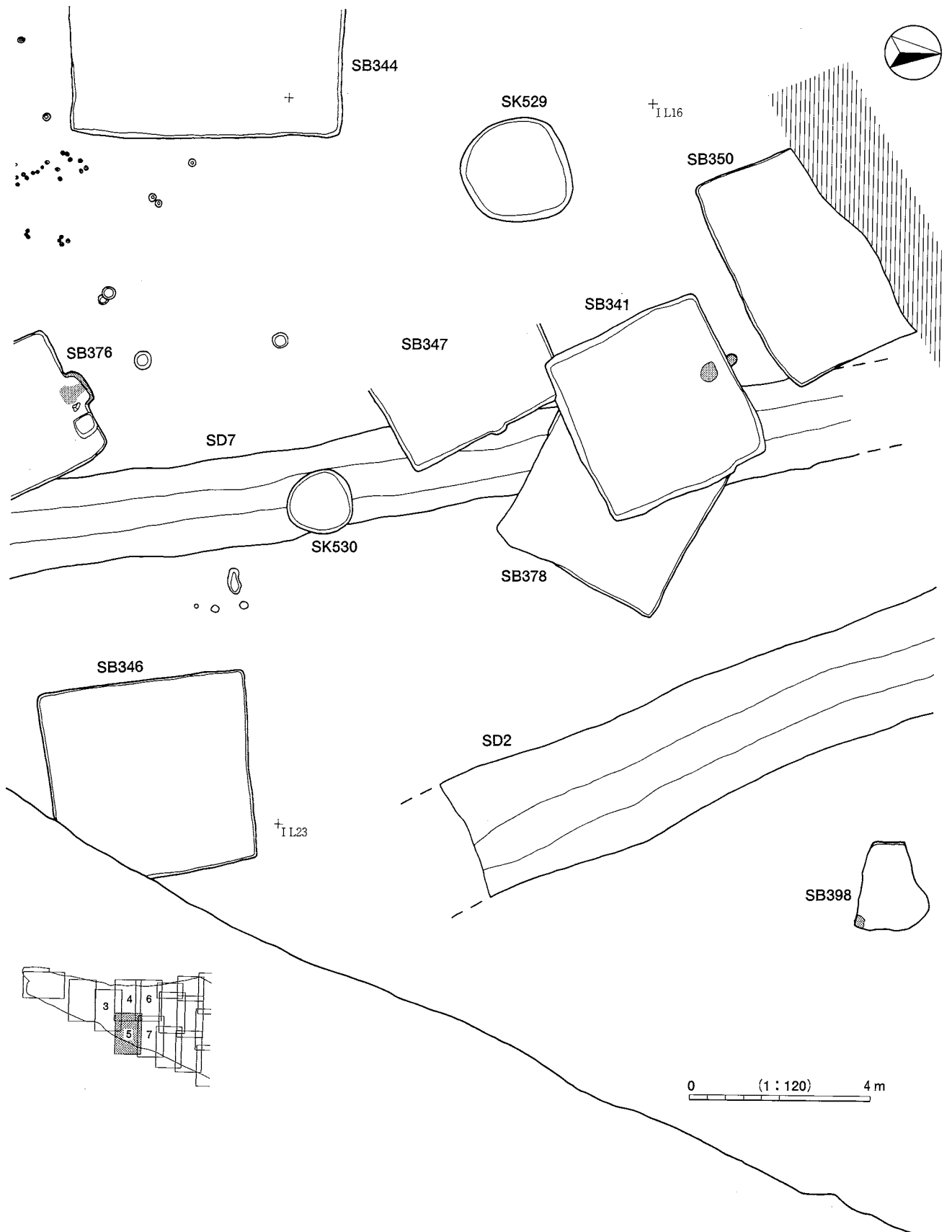

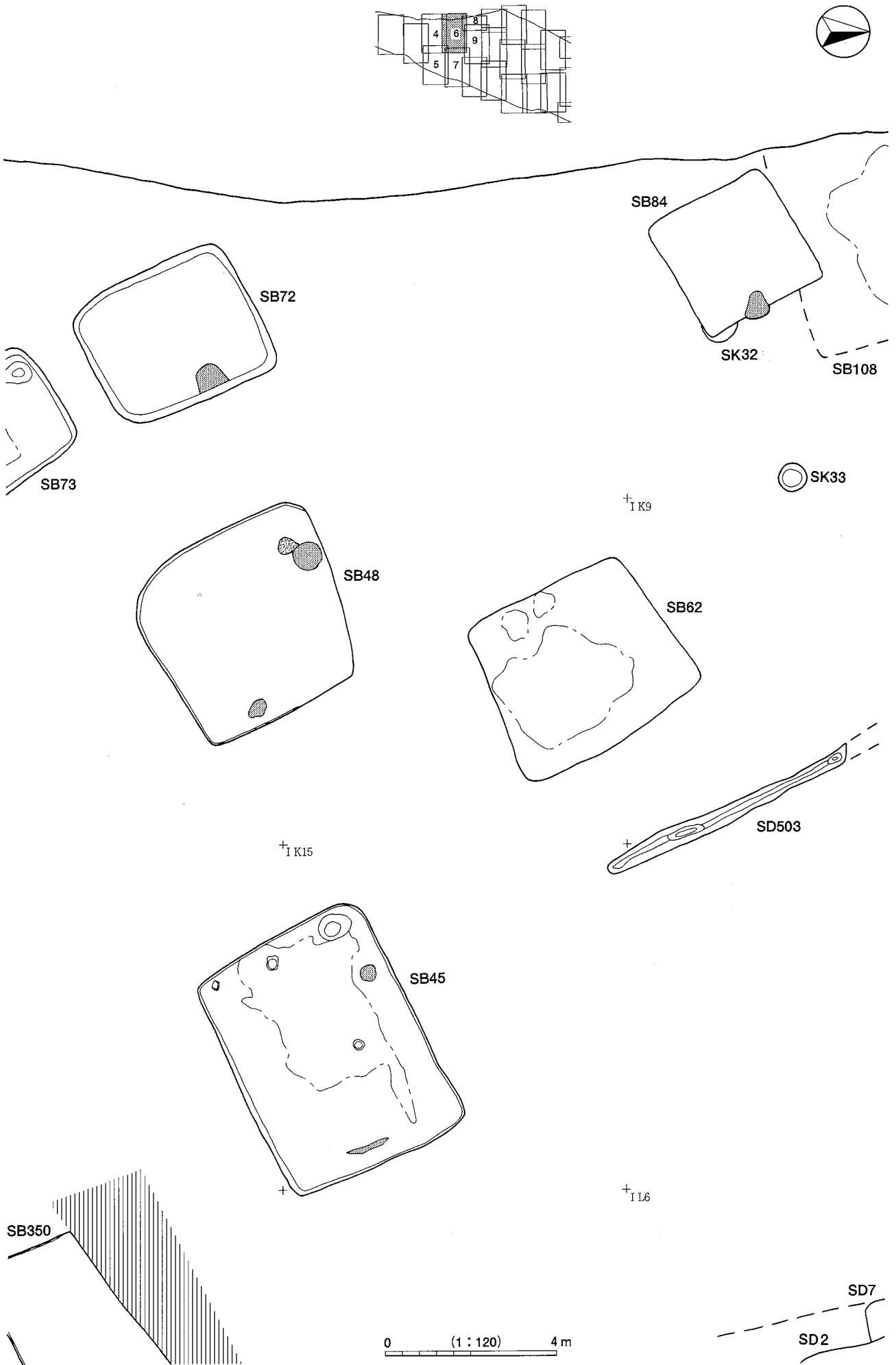

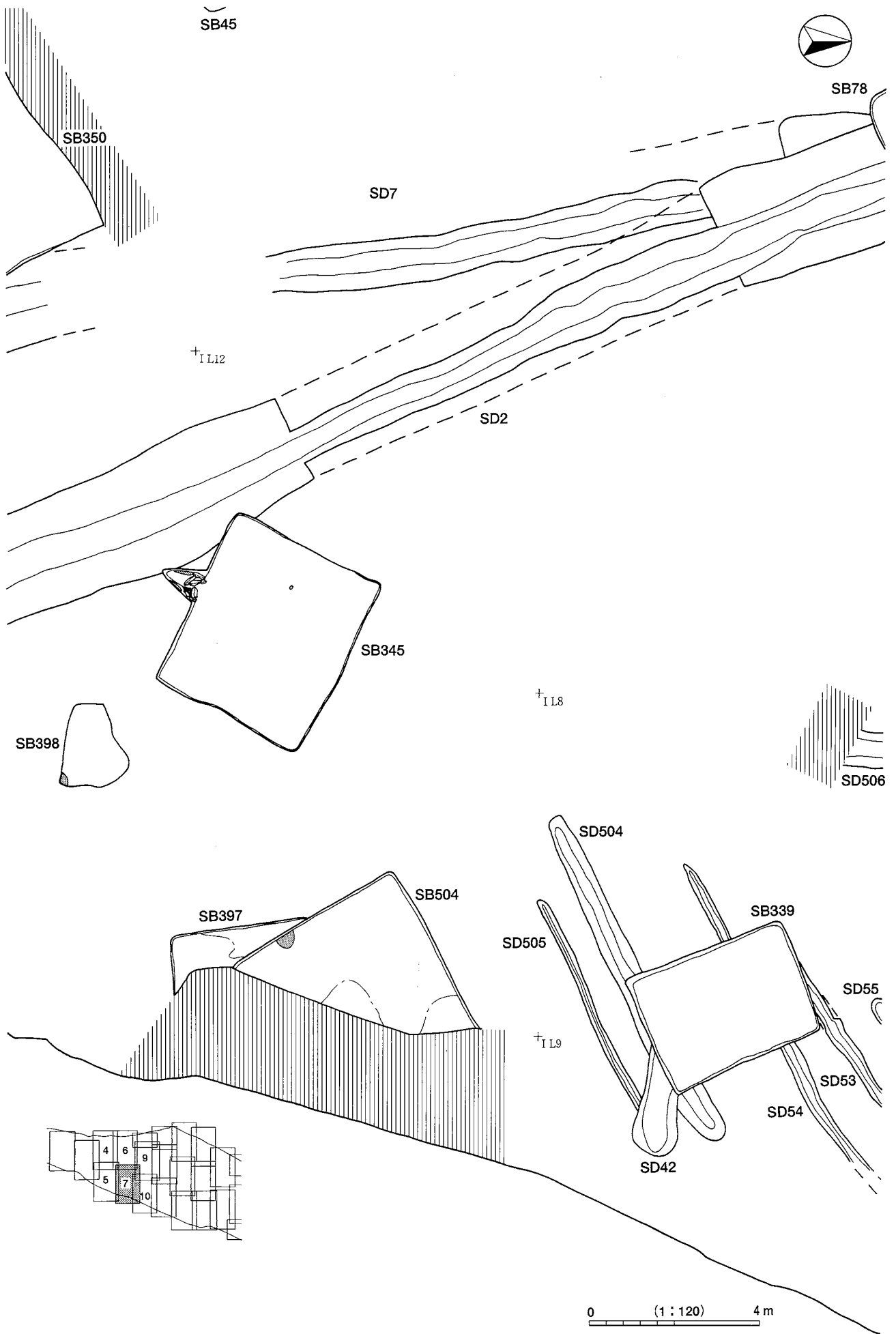

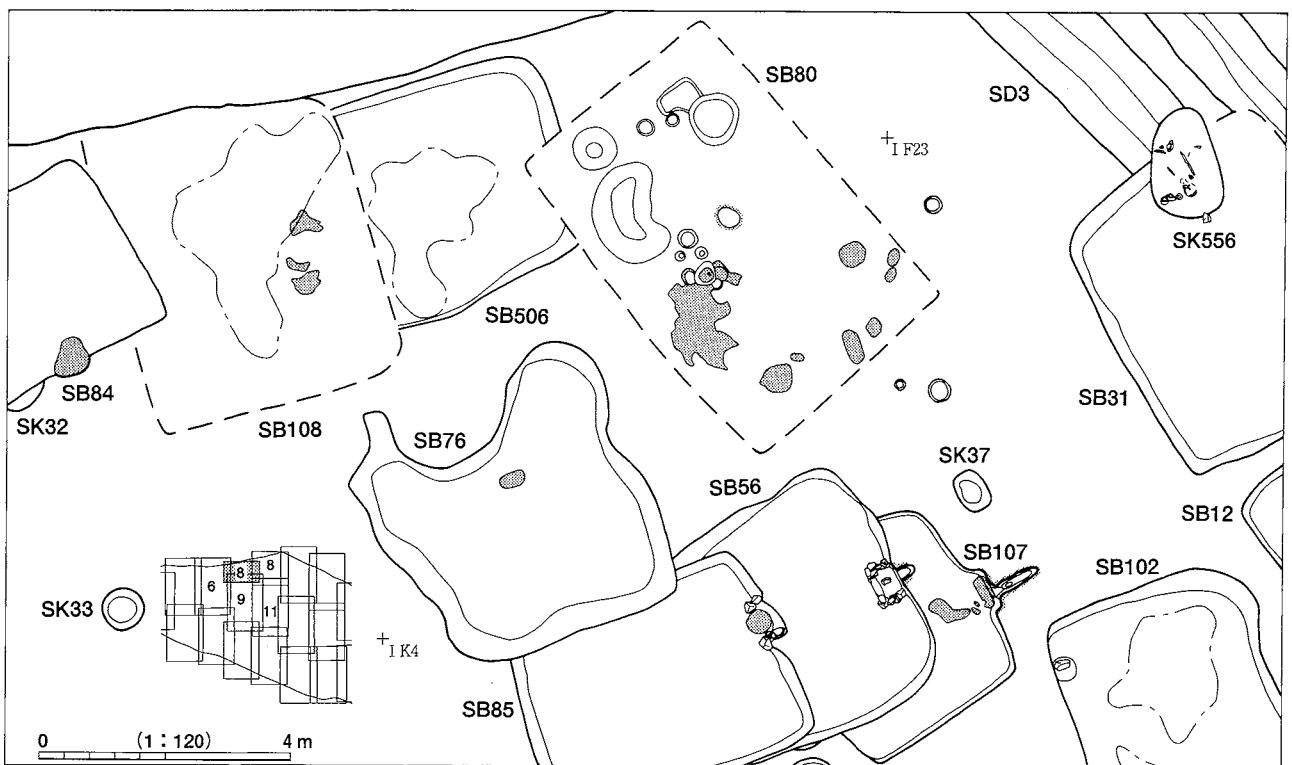
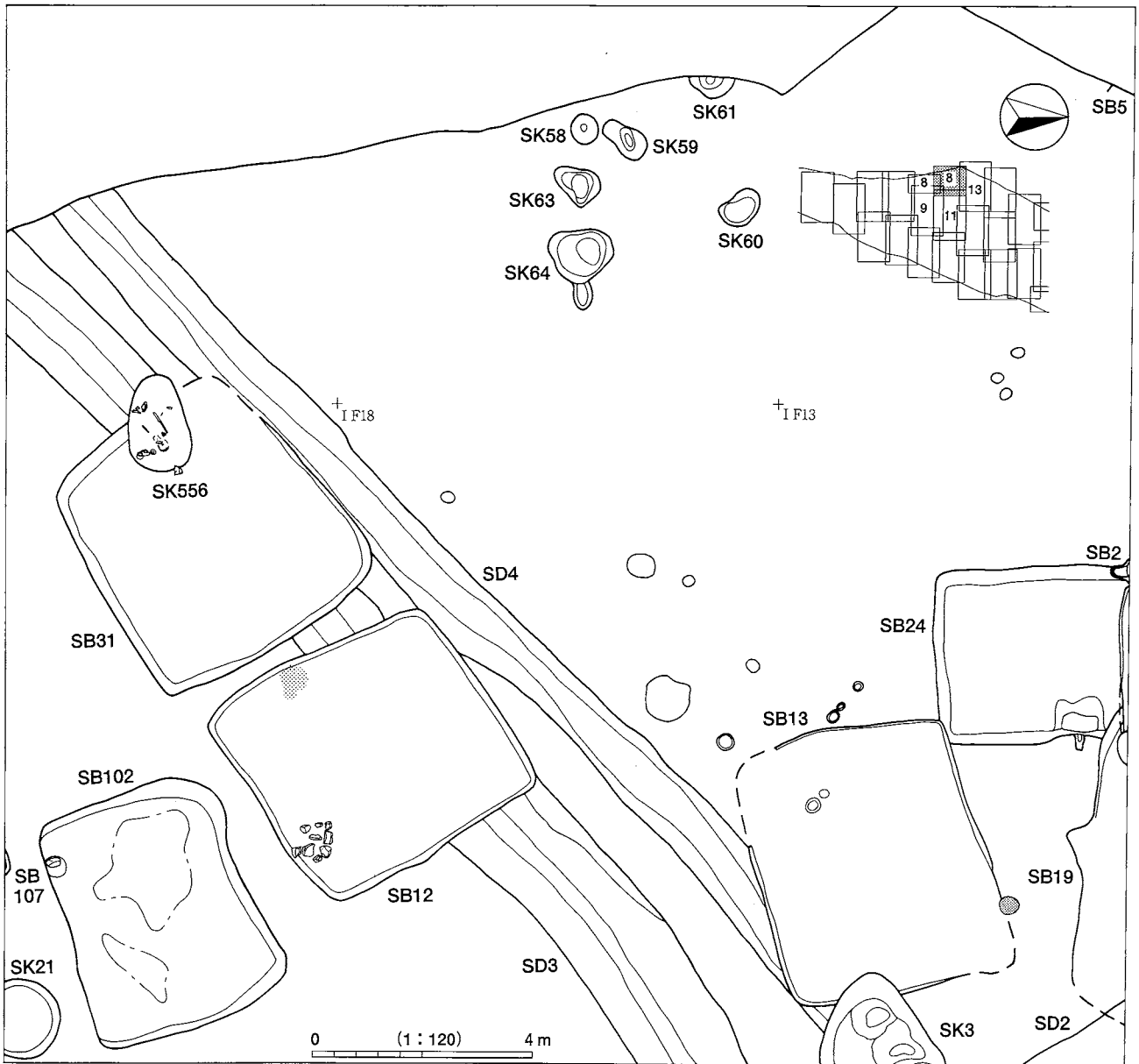

図版24 遺構実測図 9

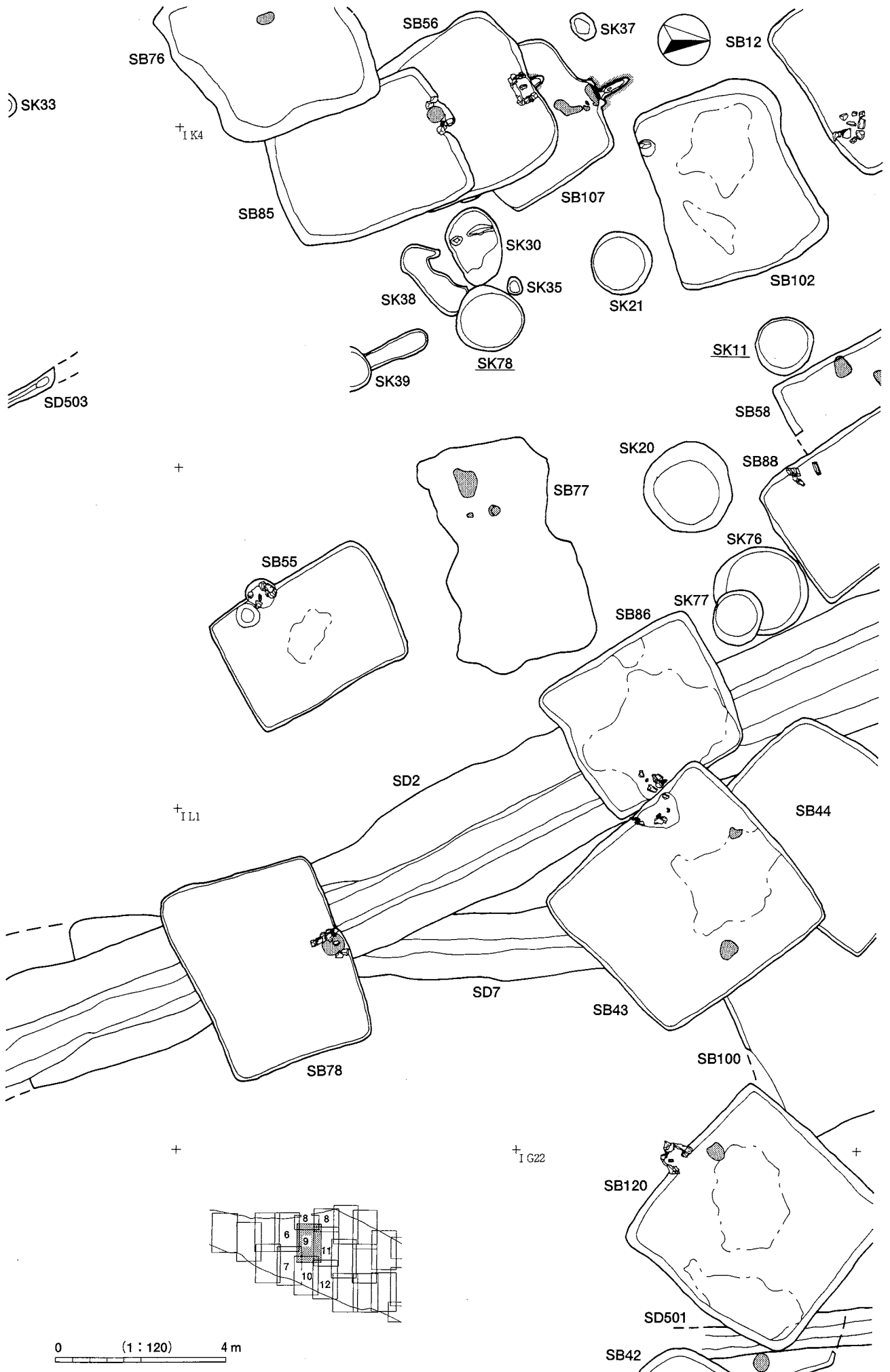

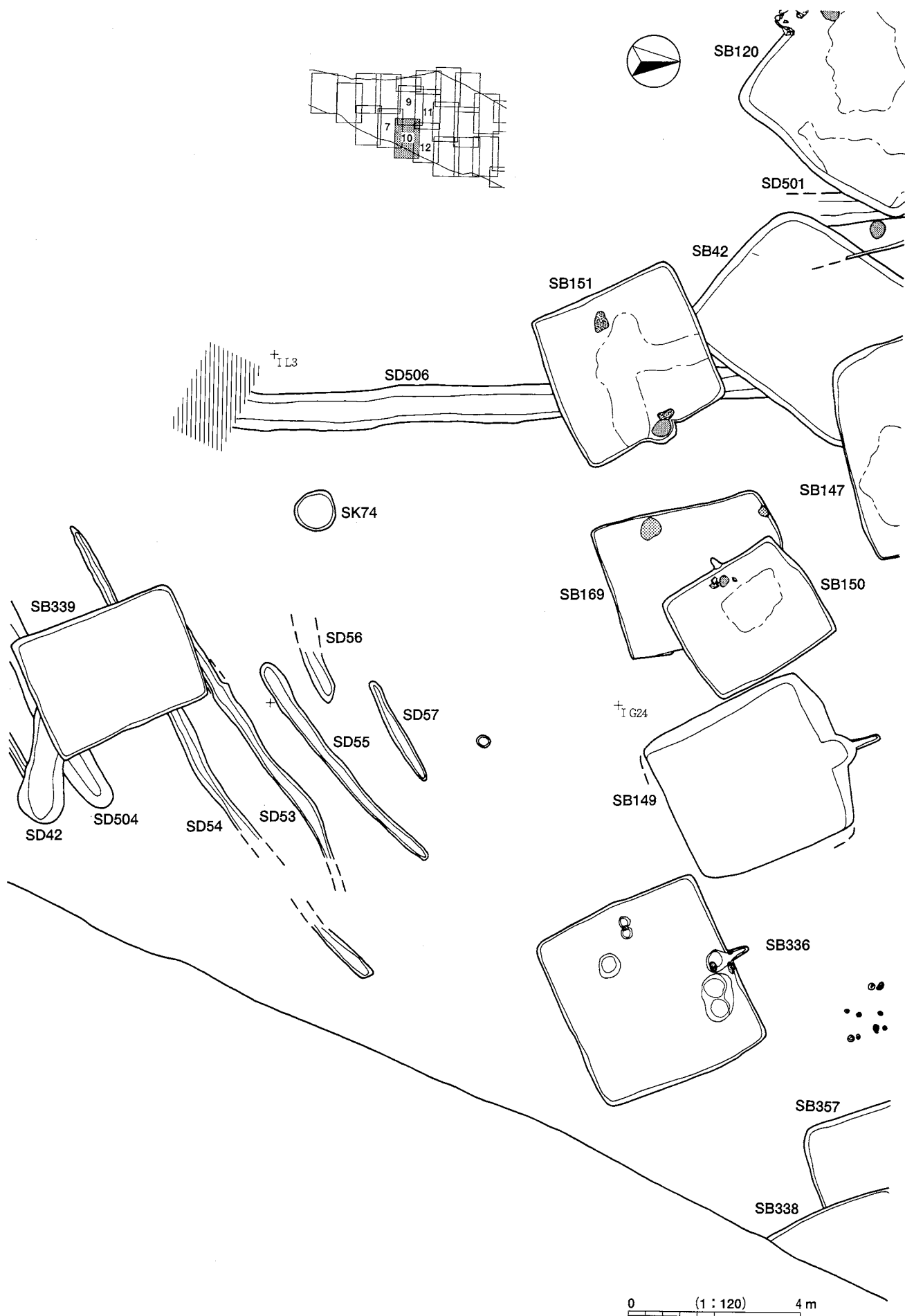

図版26 遺構実測図11

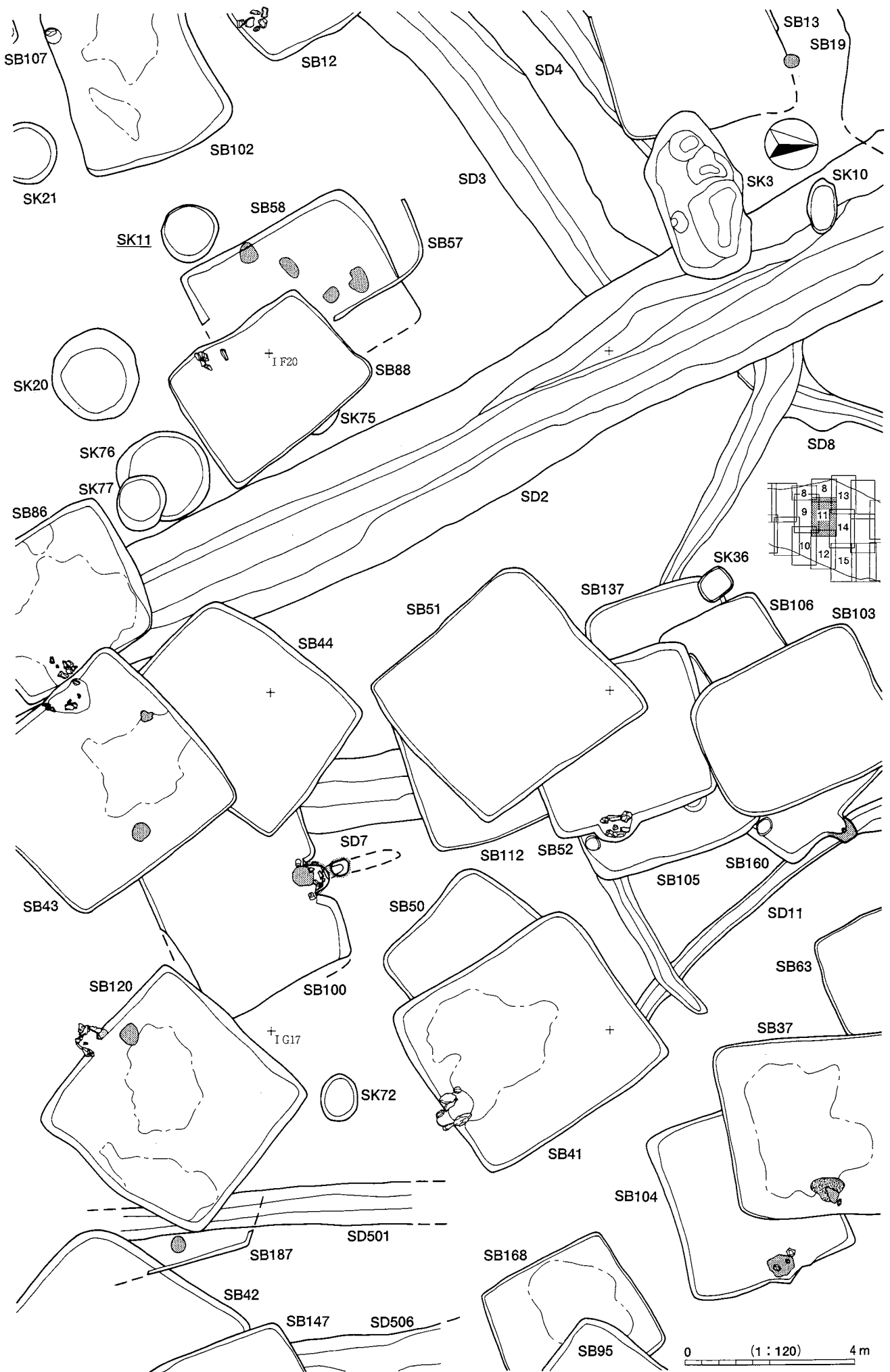

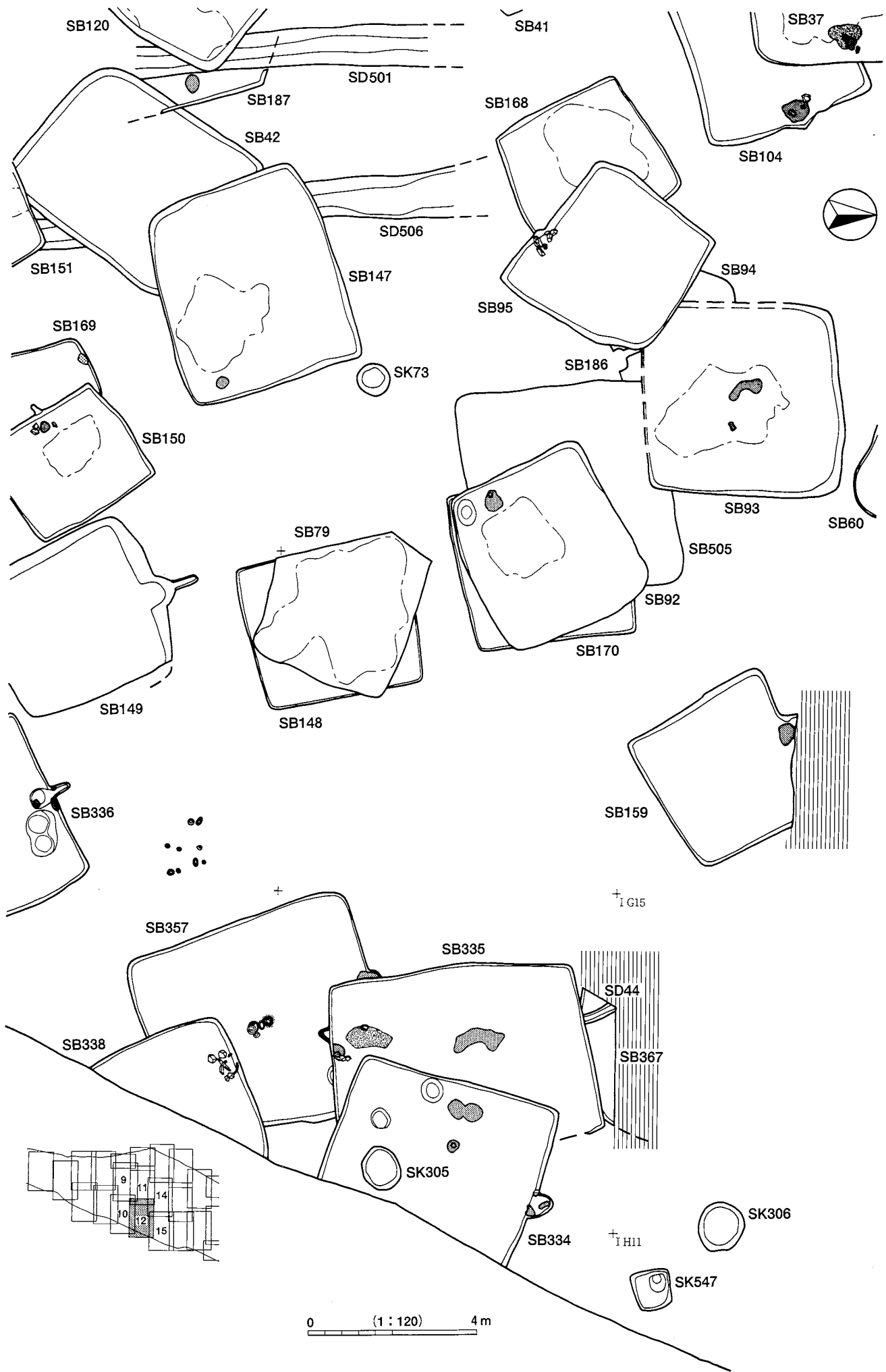

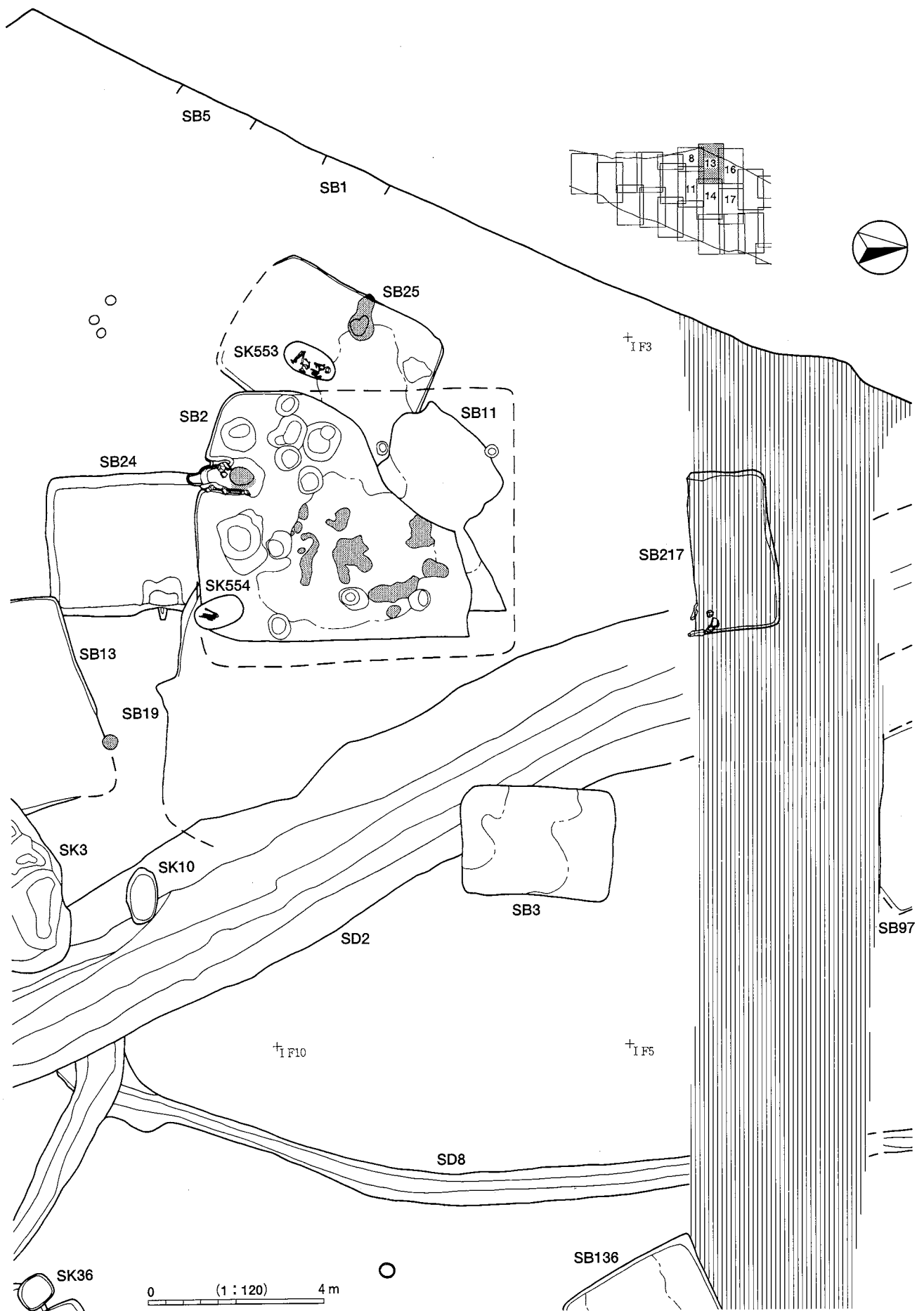

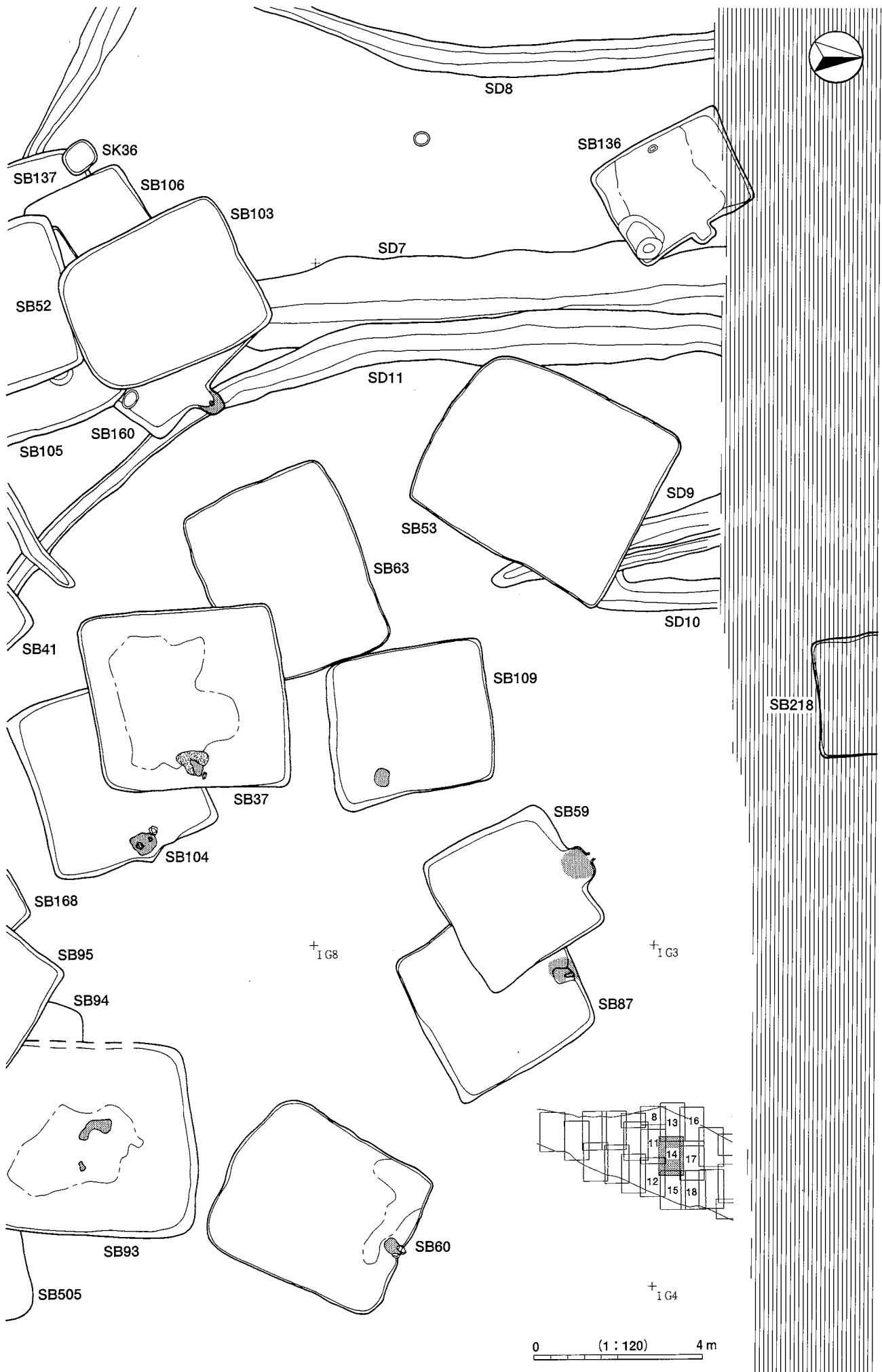

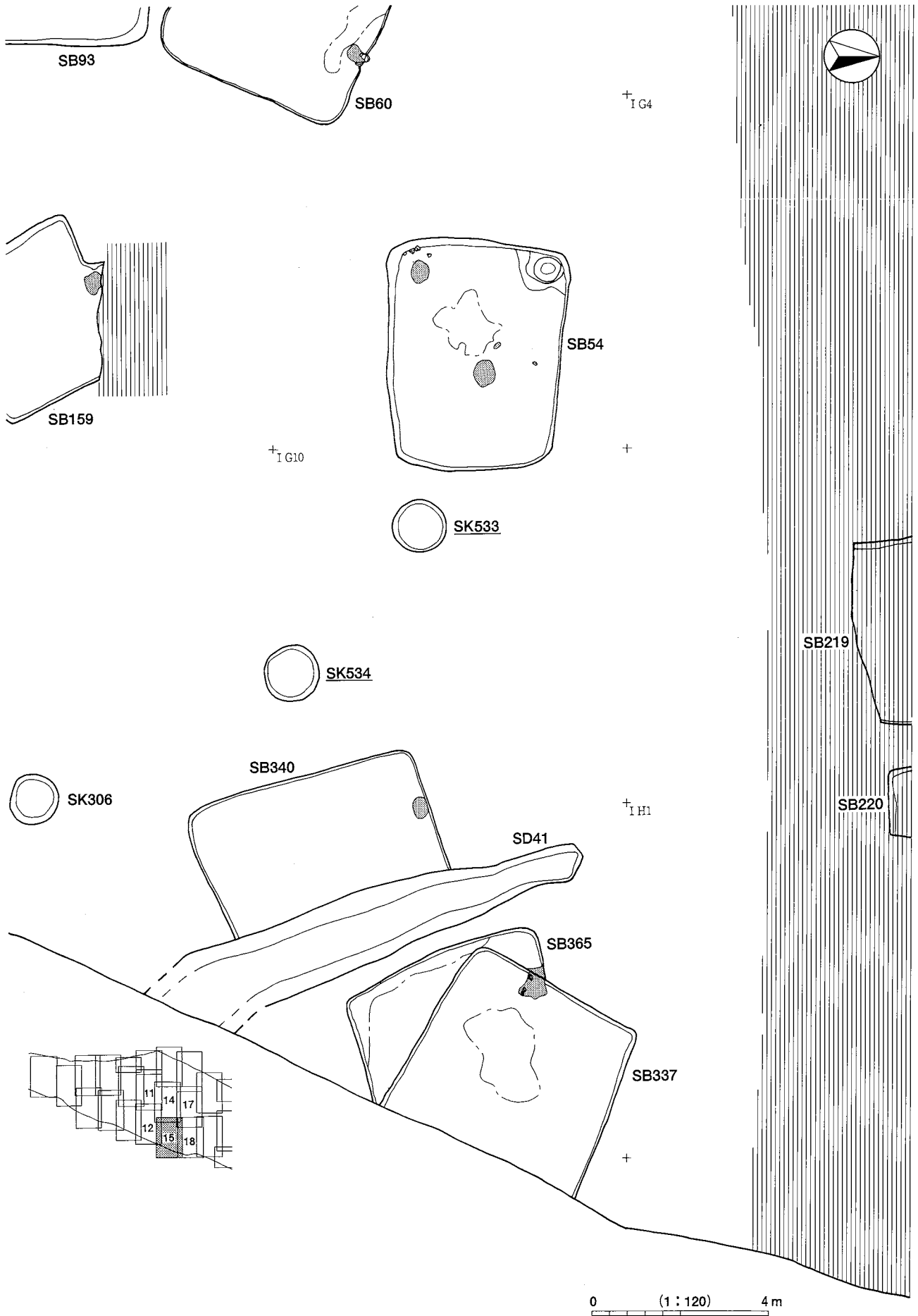

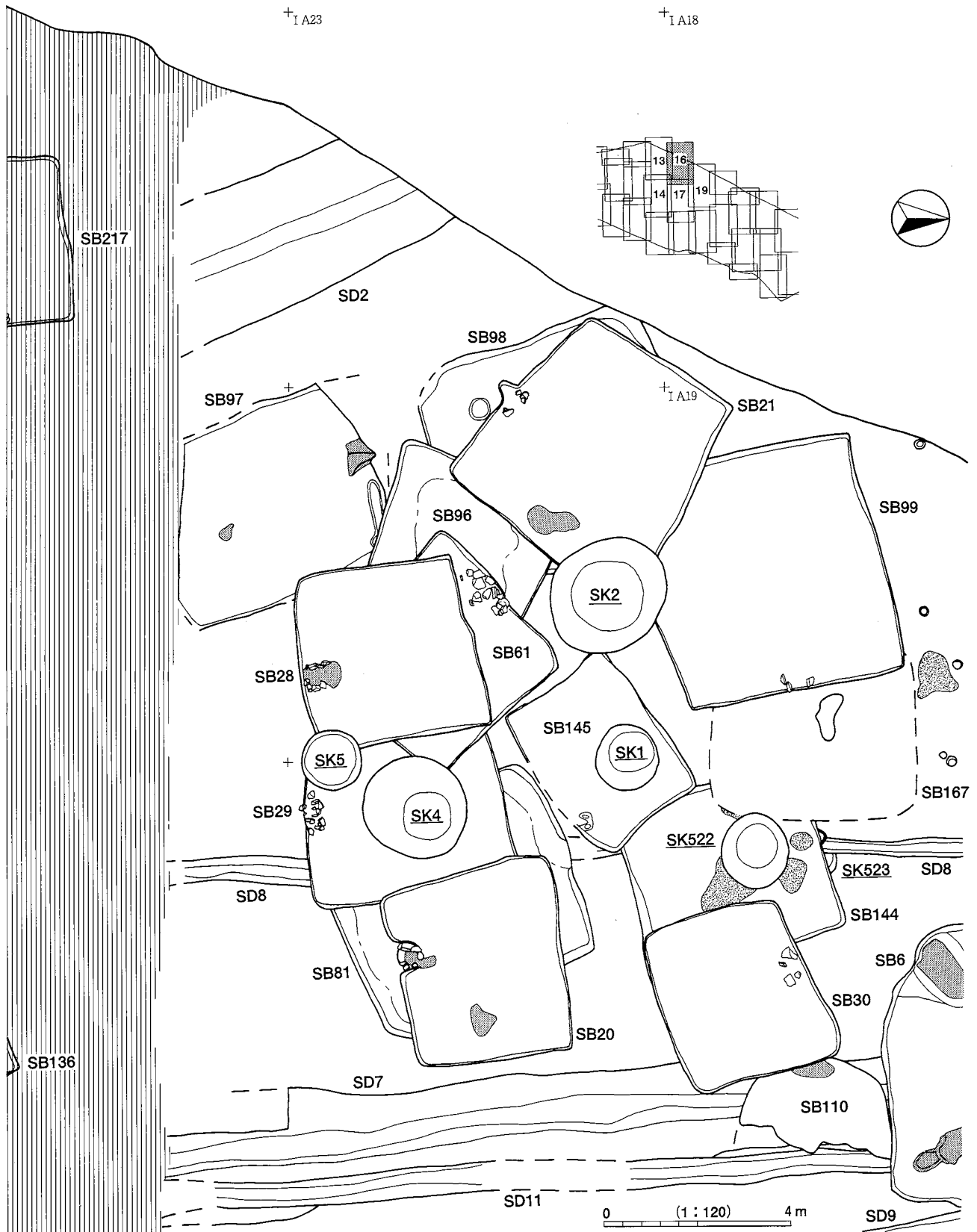

図版32 遺構実測図17

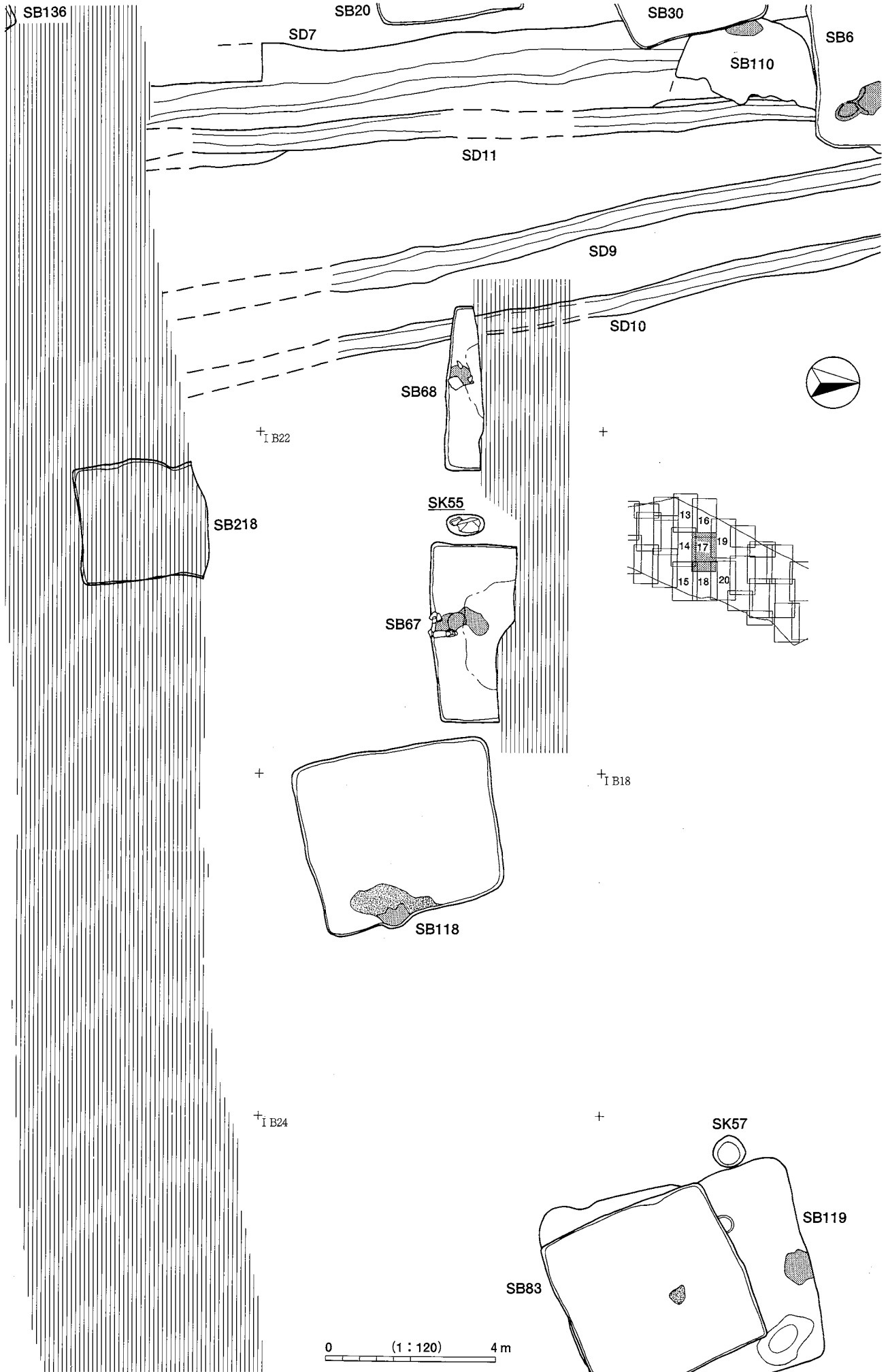

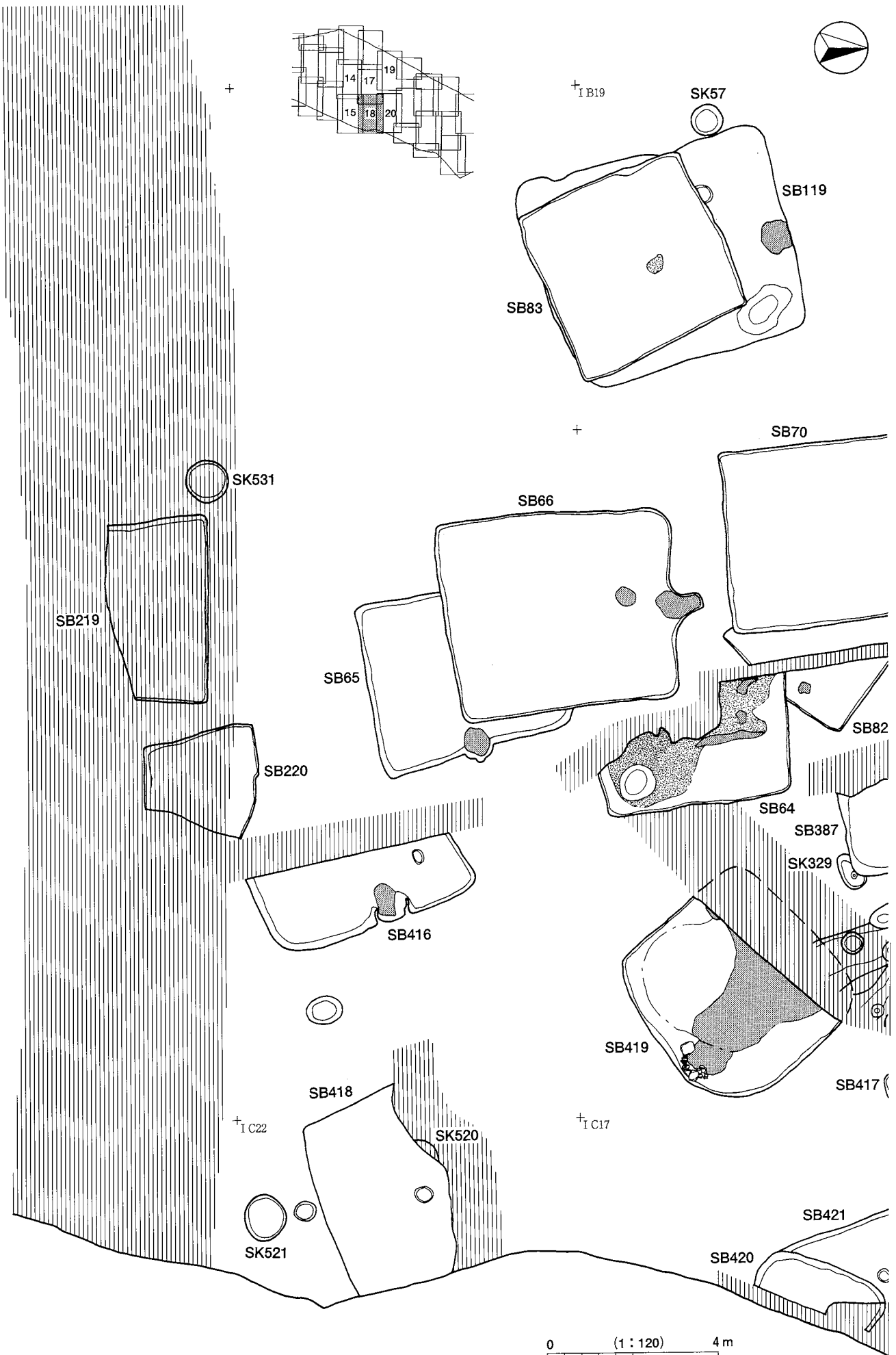

図版34 遺構実測図19

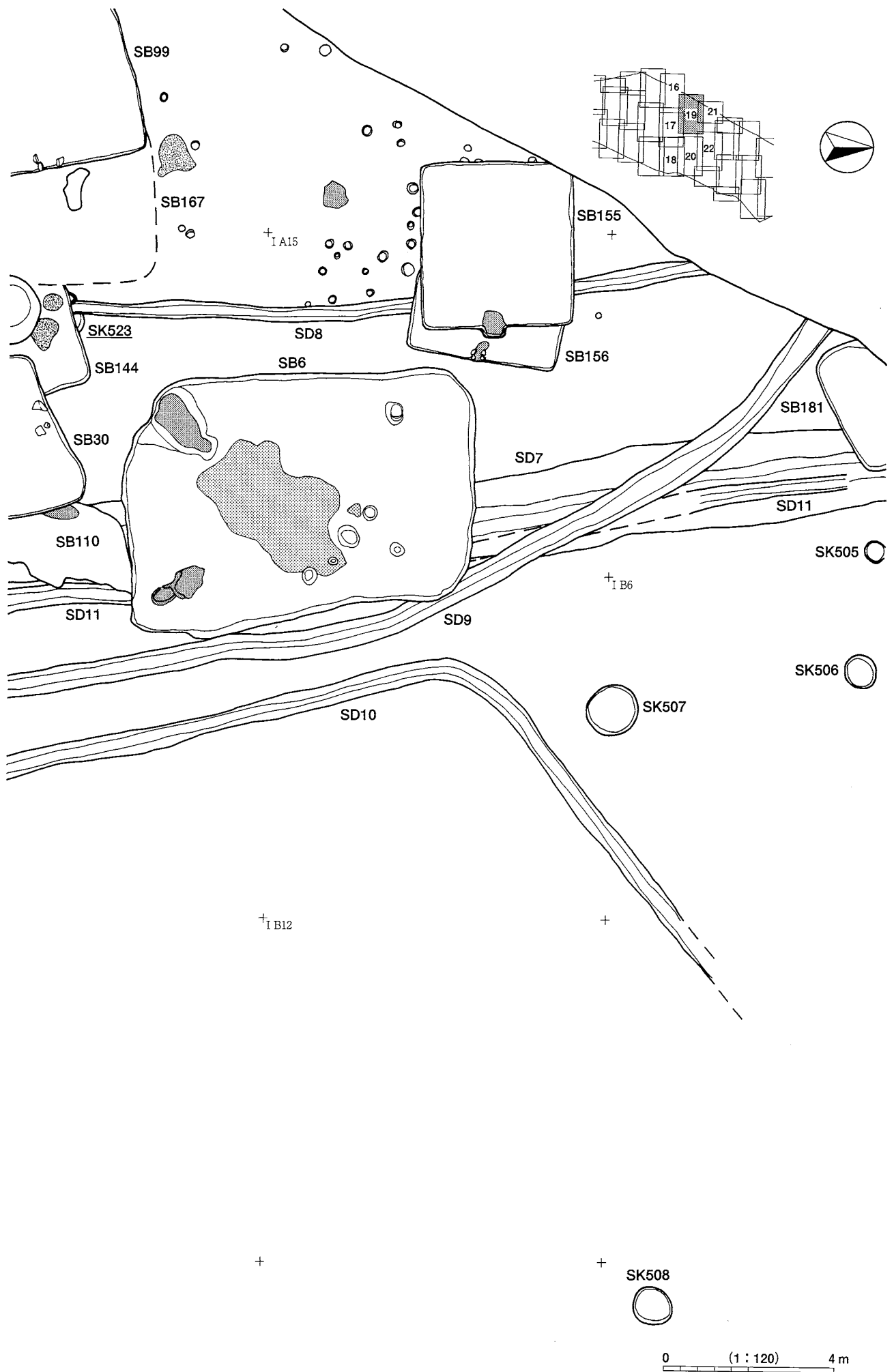

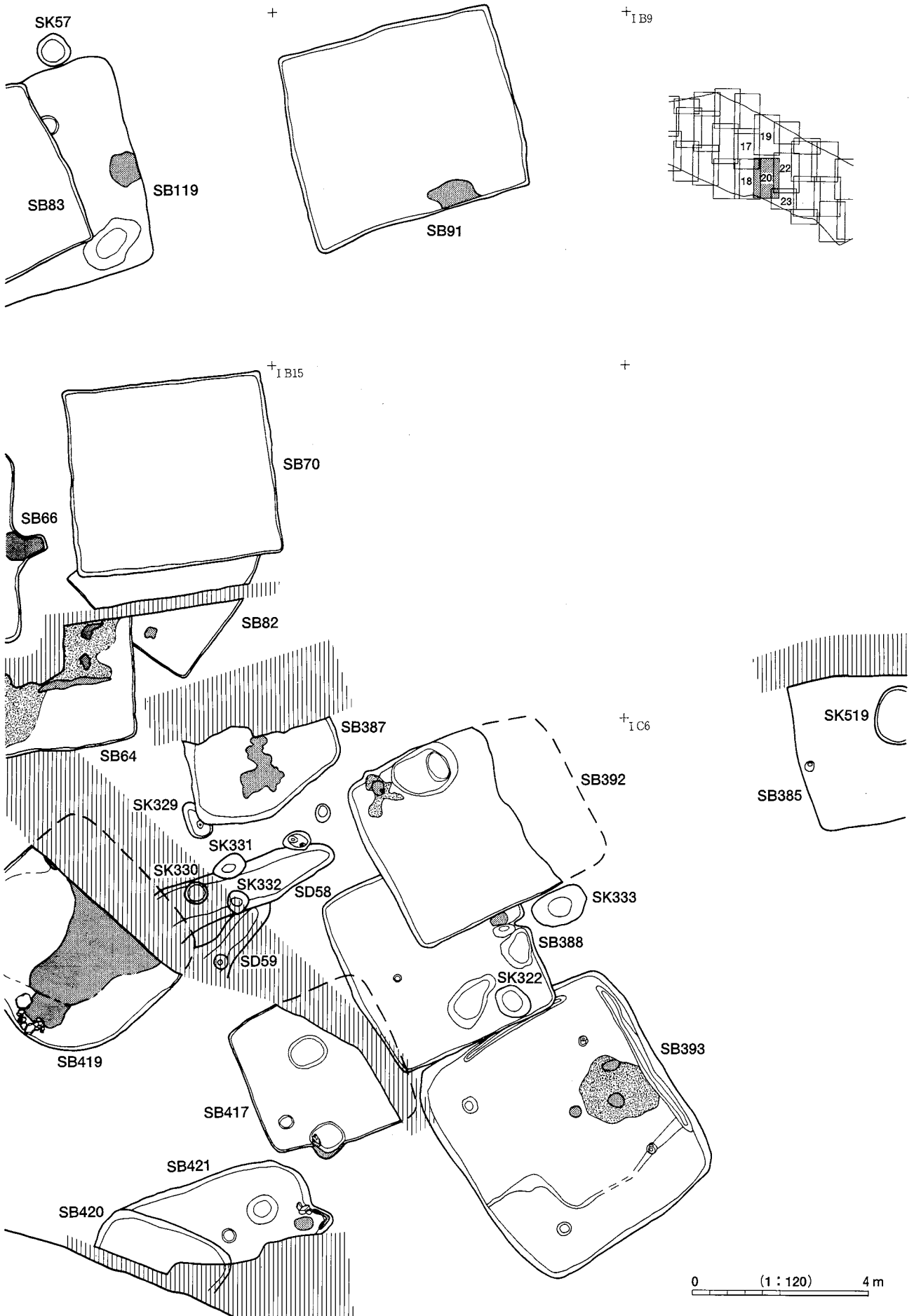

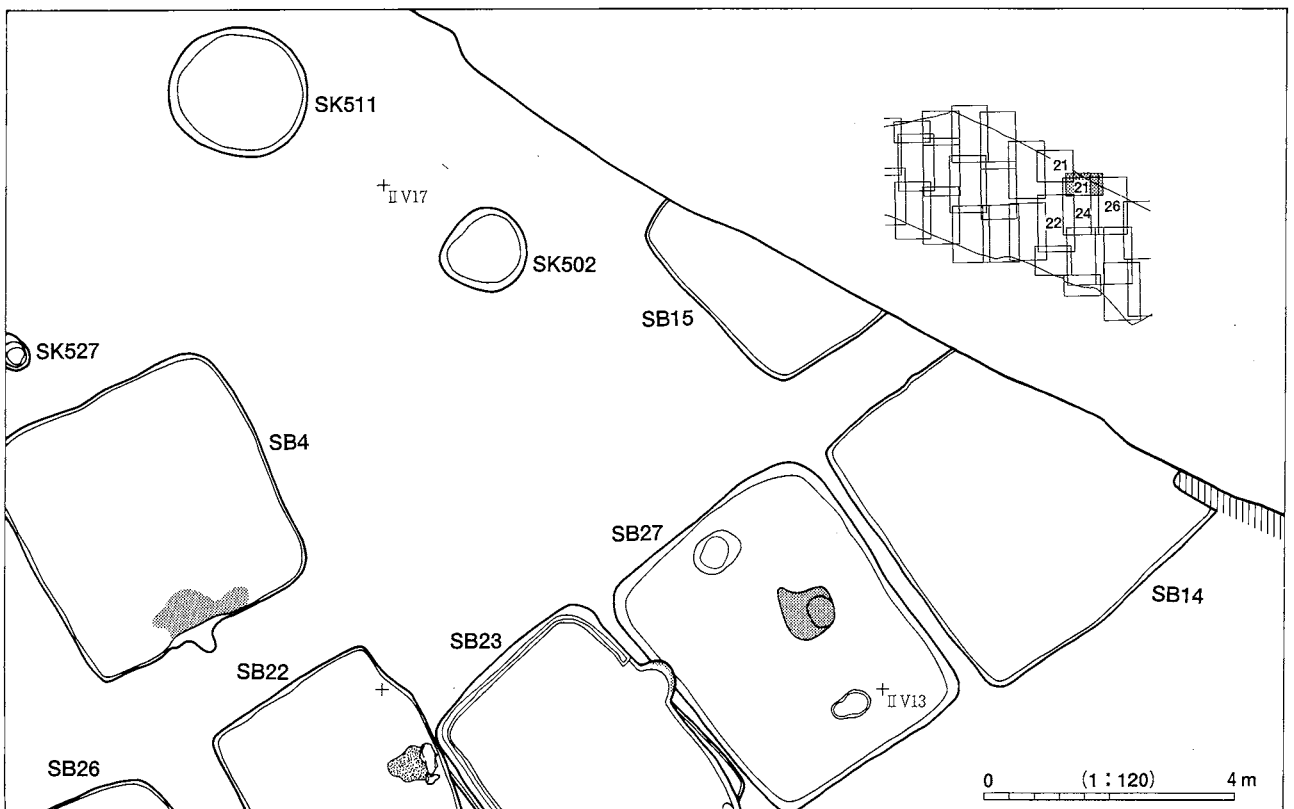
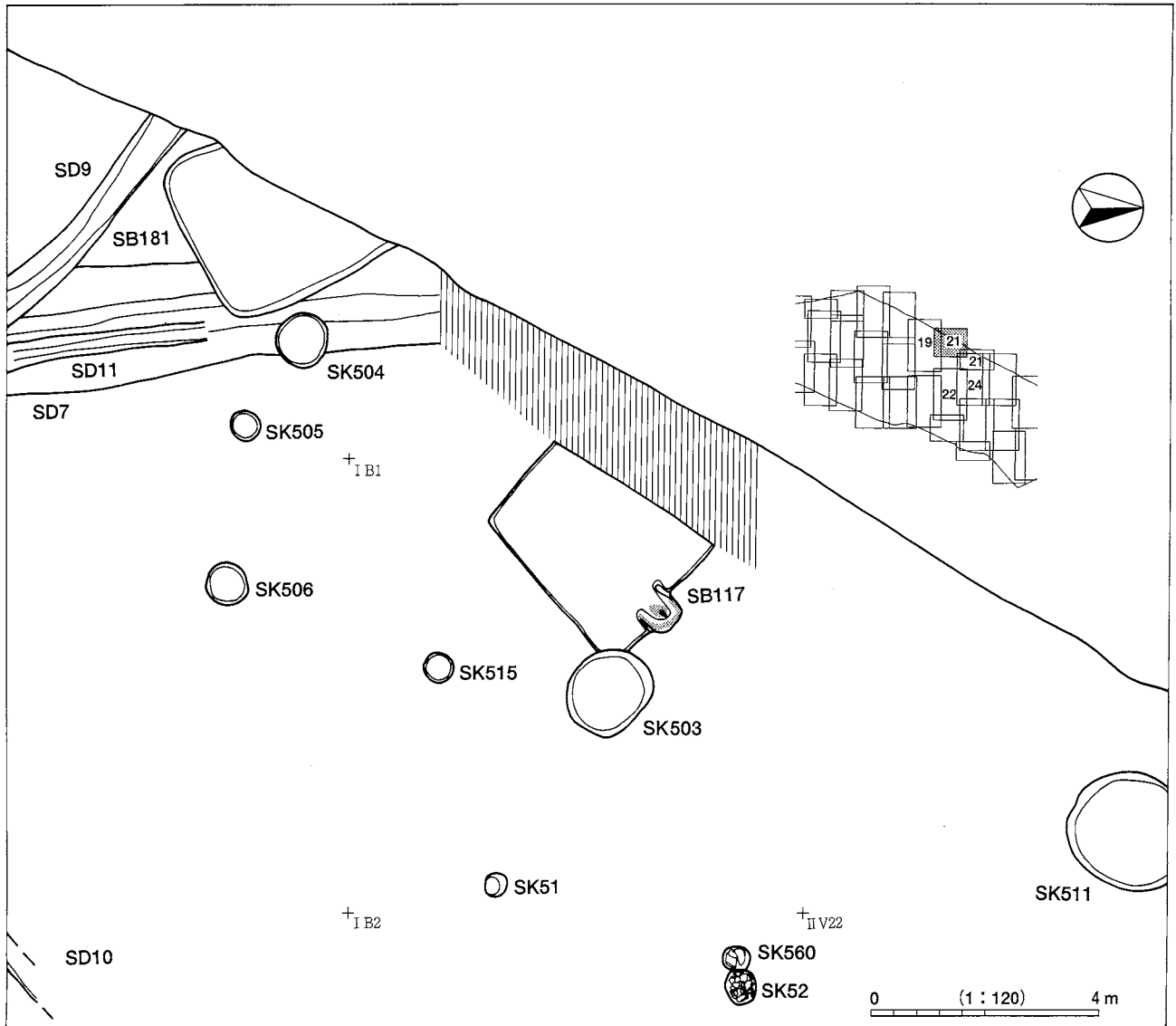

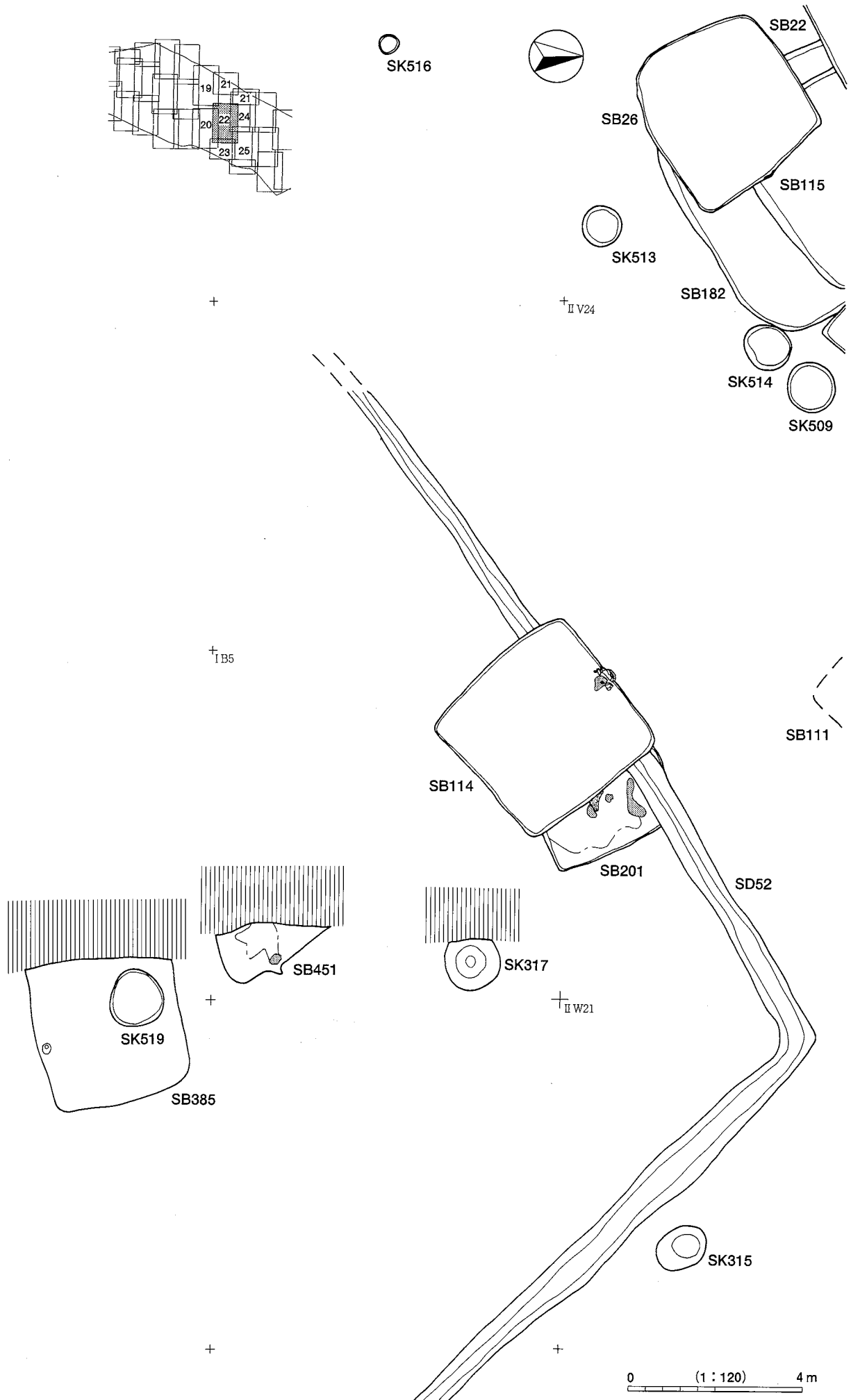

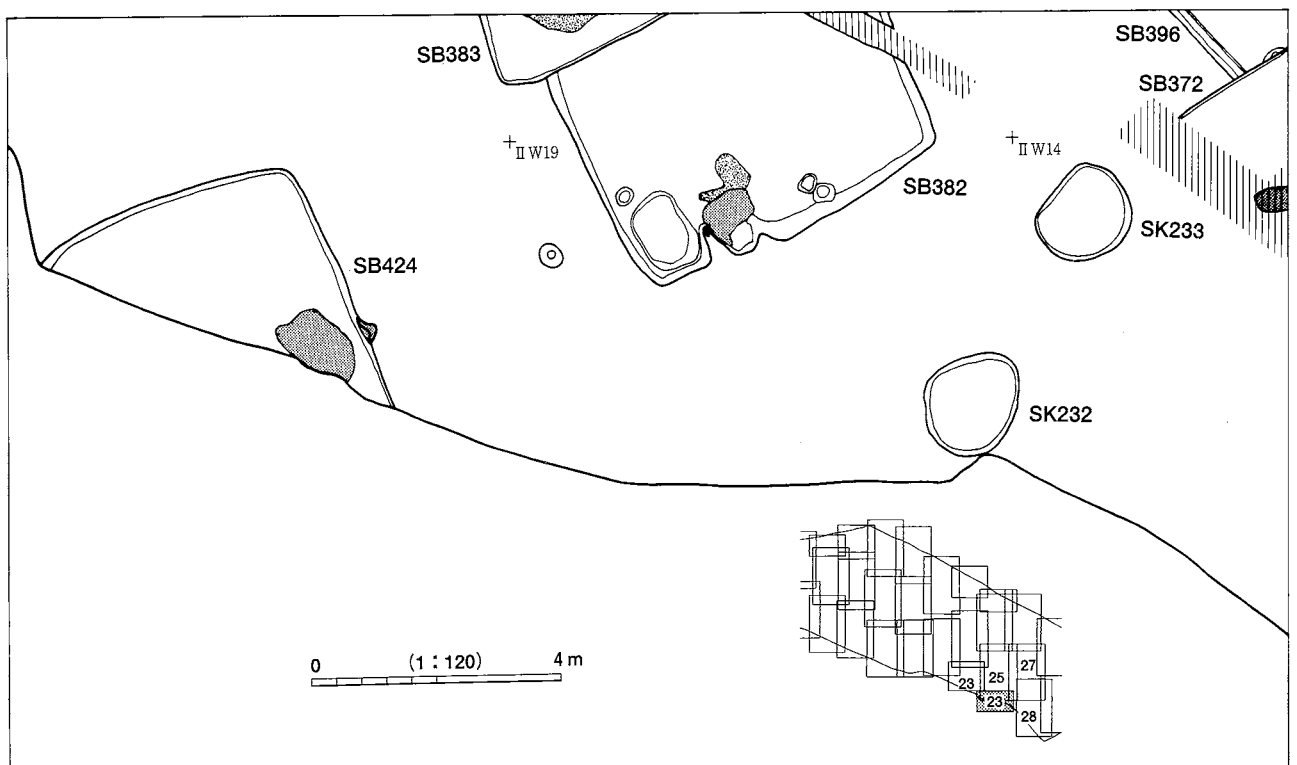
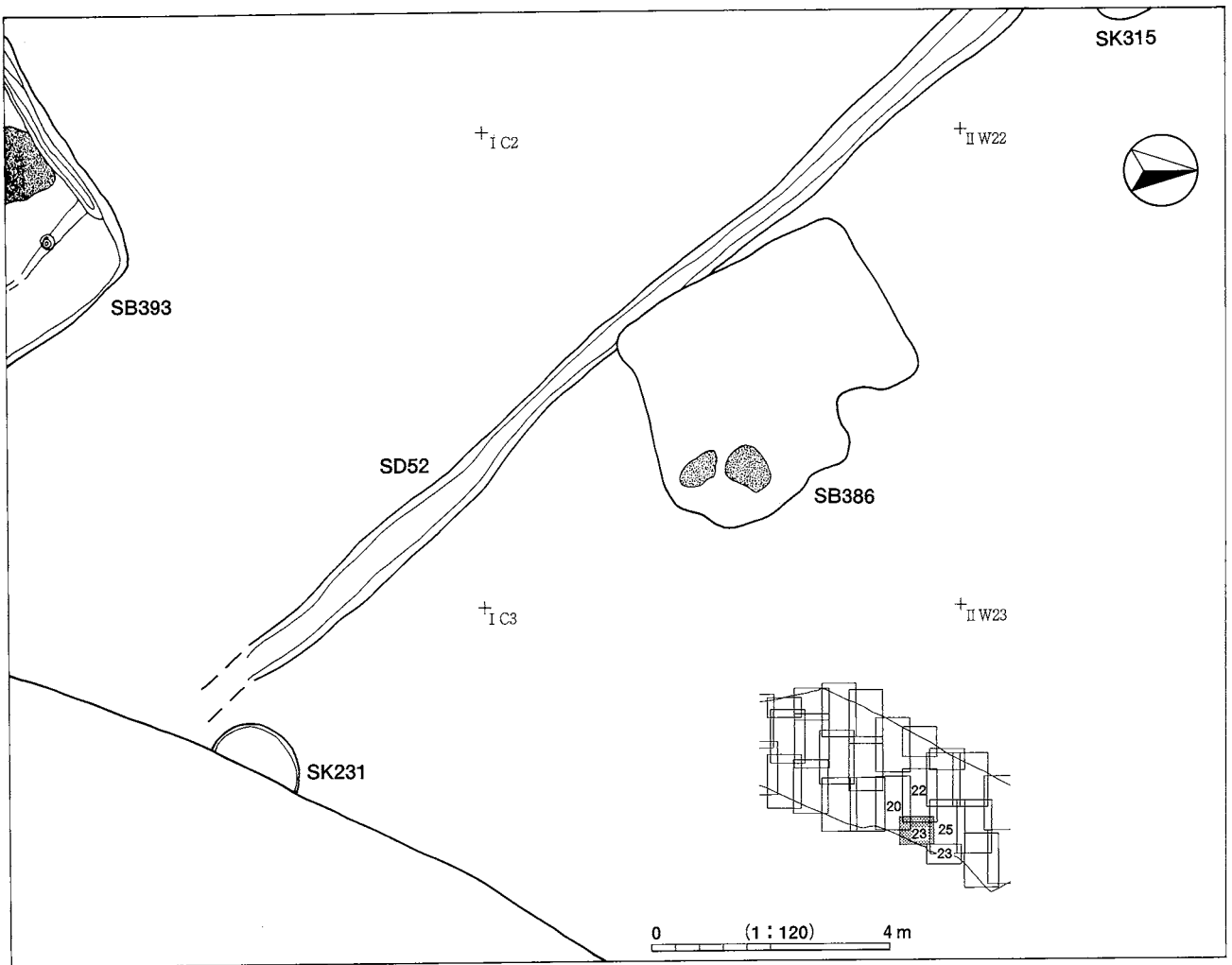

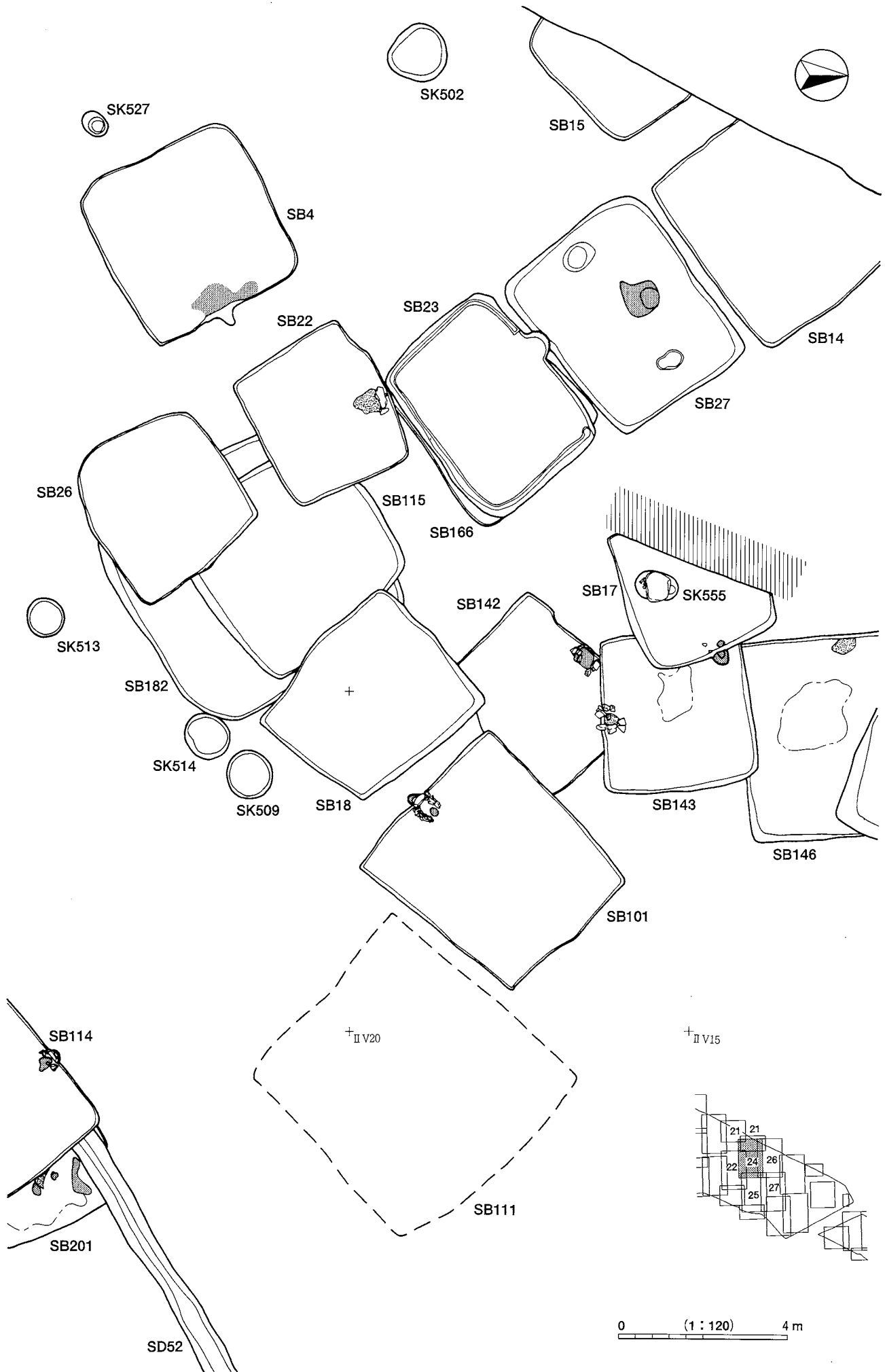

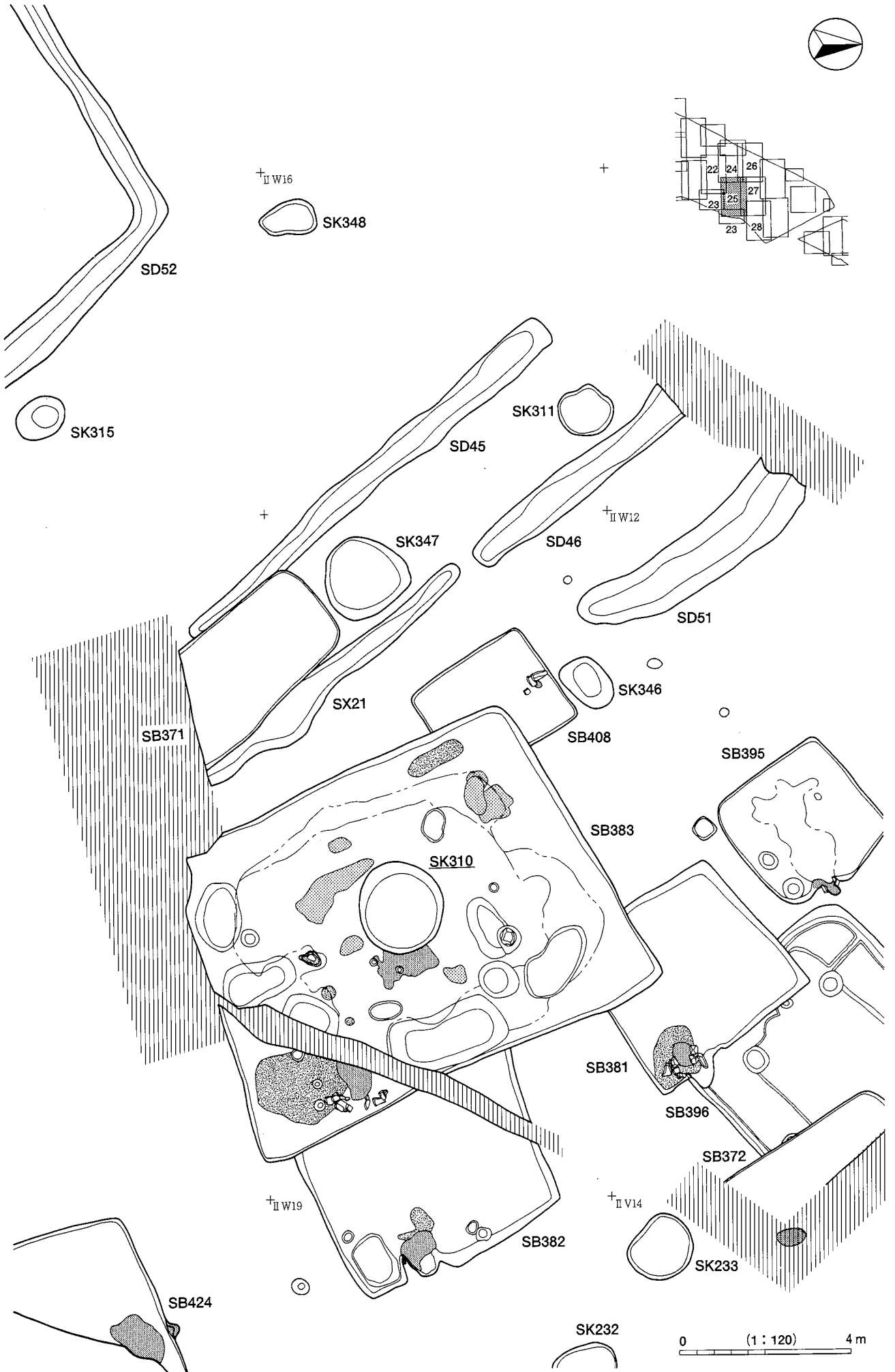
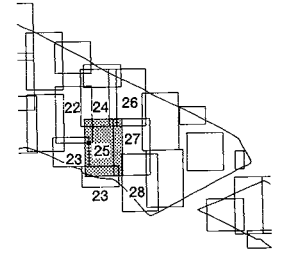

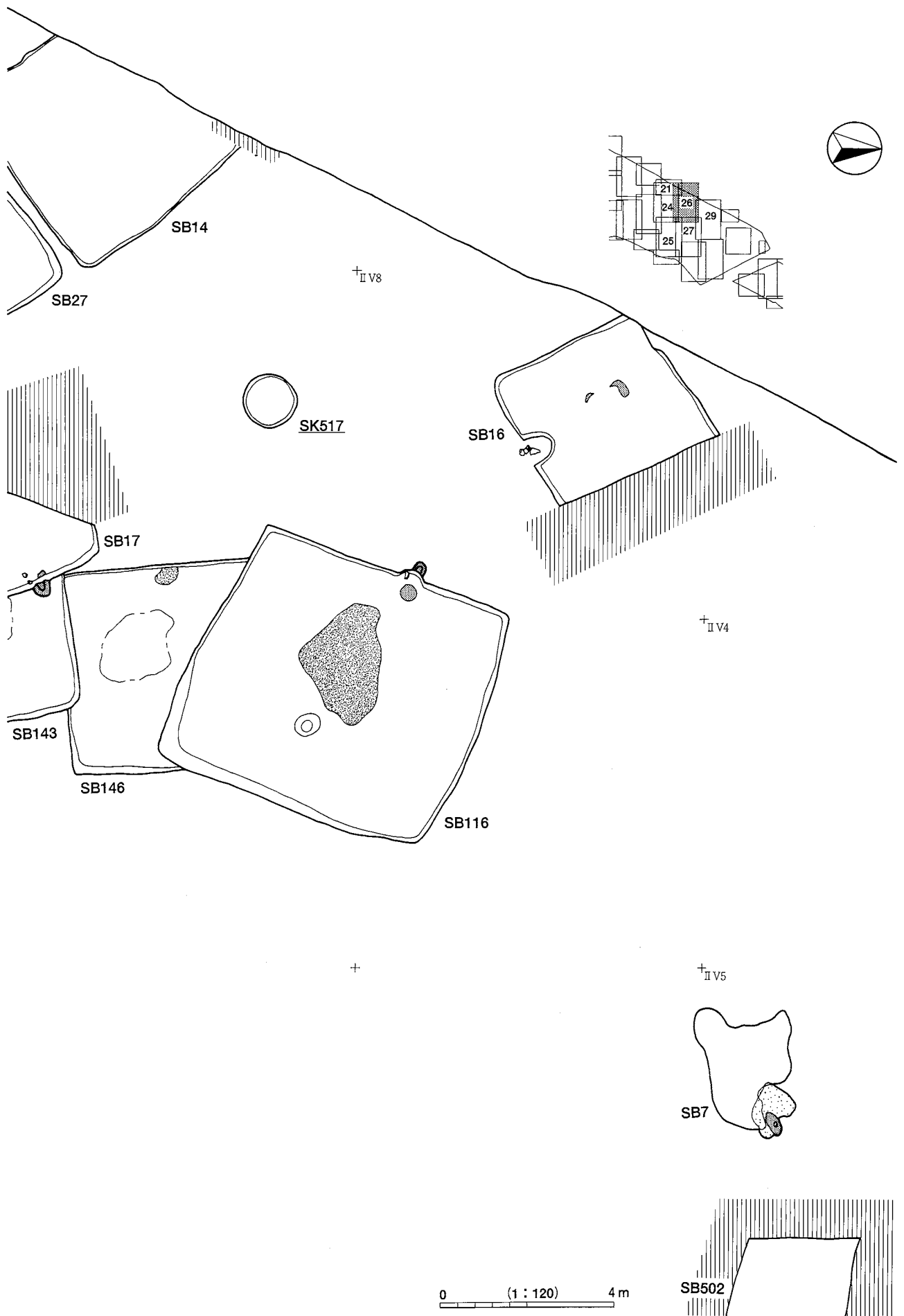

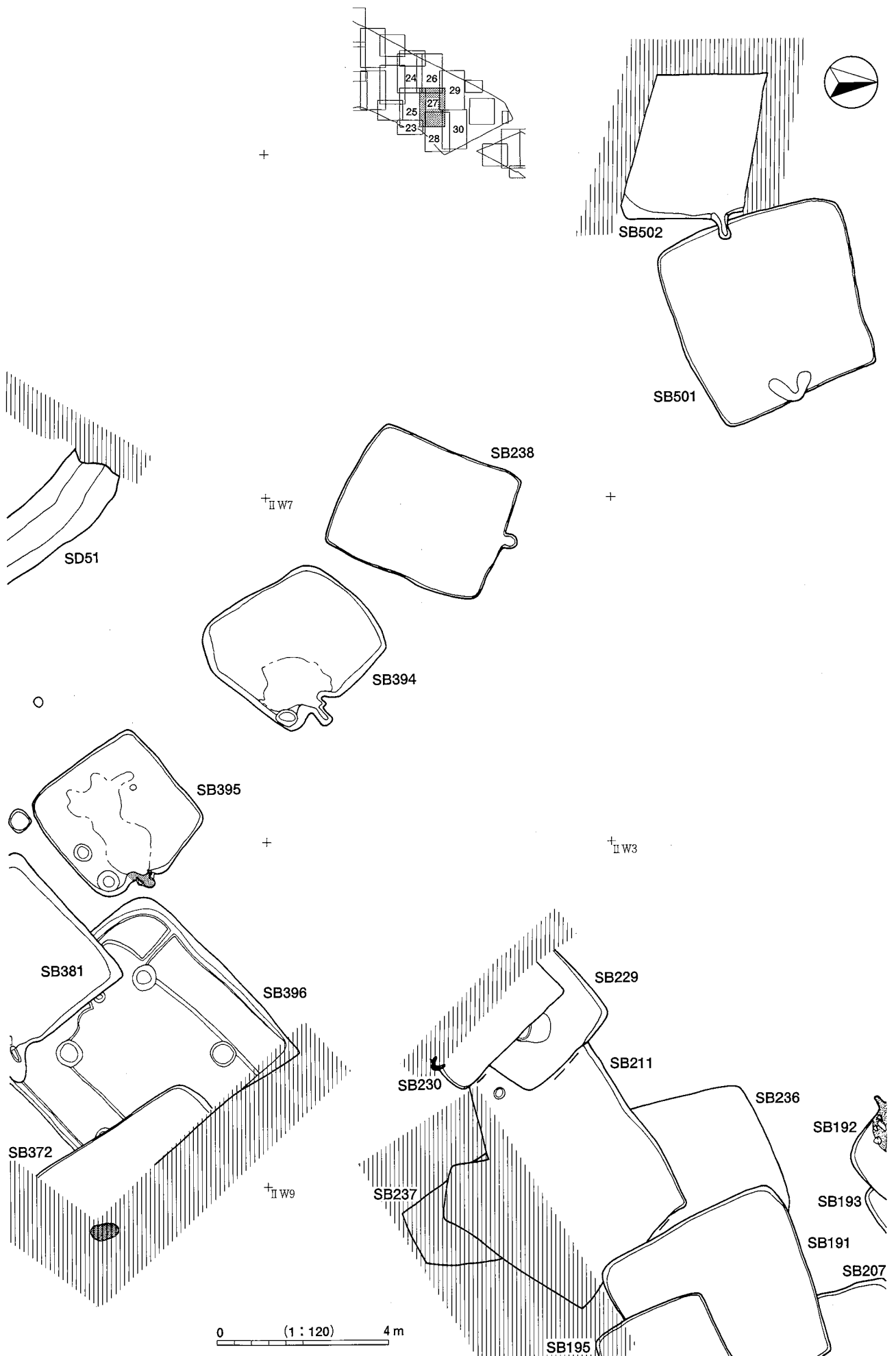

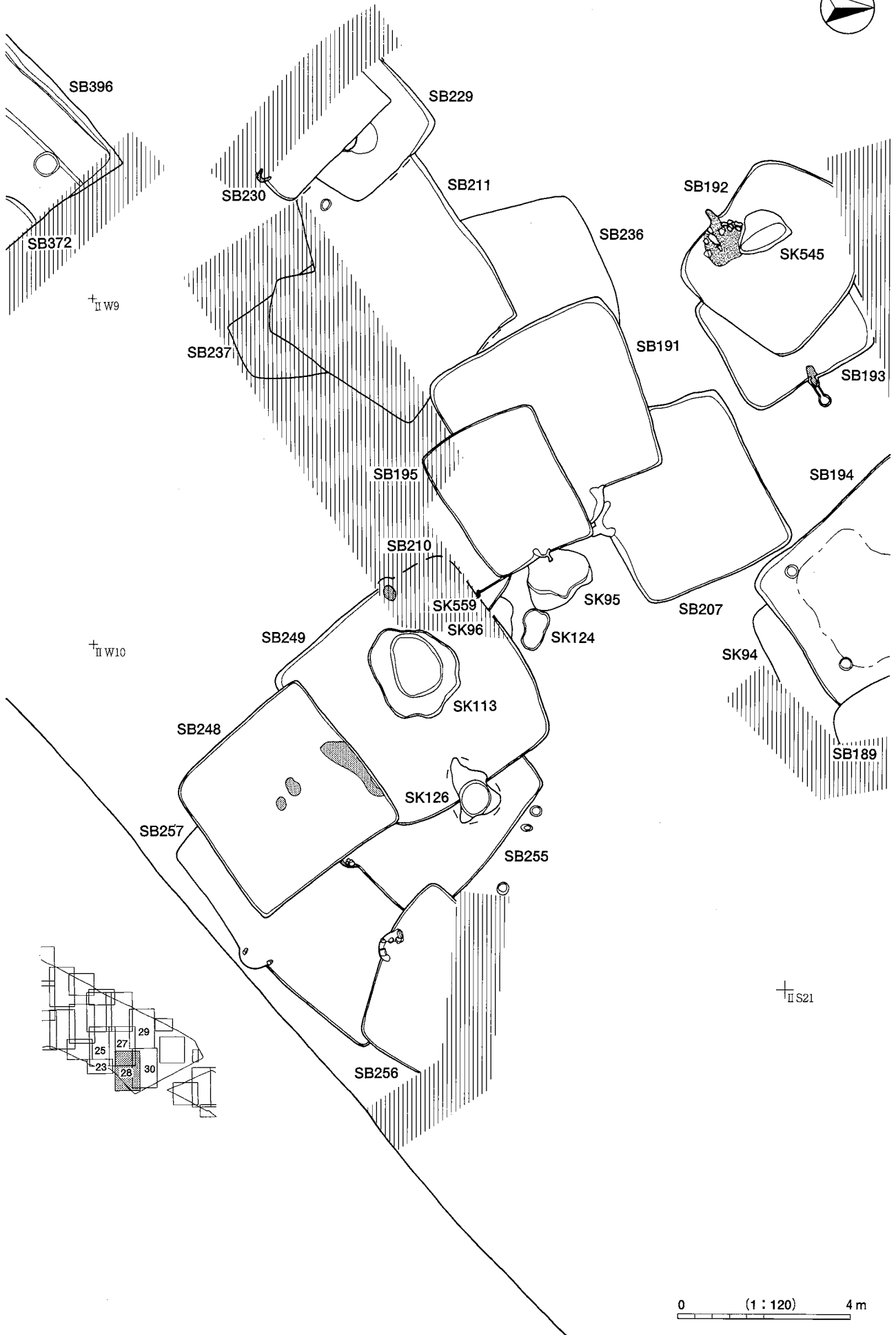

0 (1:120) 4m

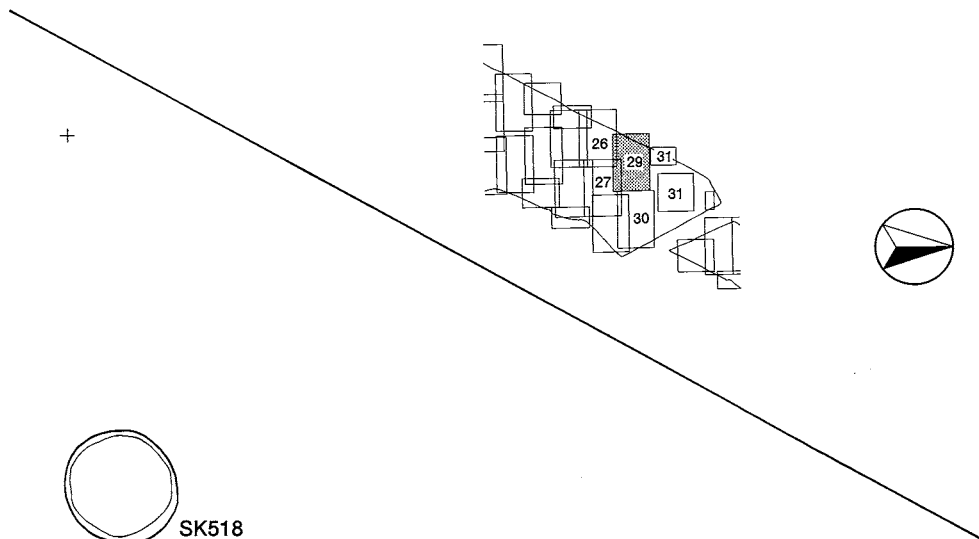

†_{II}Q25

+

)
)
)

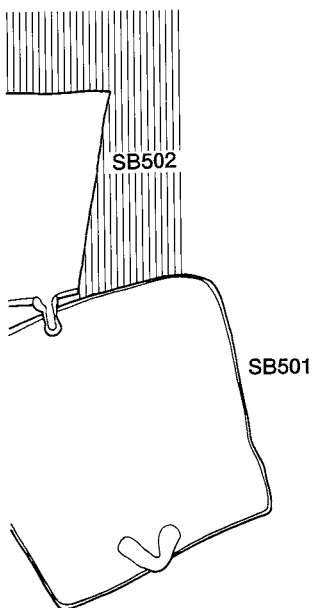

†_{II}R21

†_{II}R16

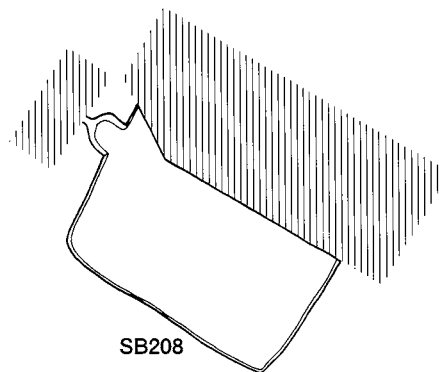
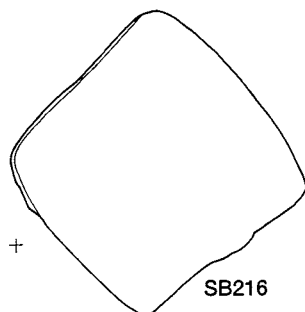

0 (1 : 120) 4 m

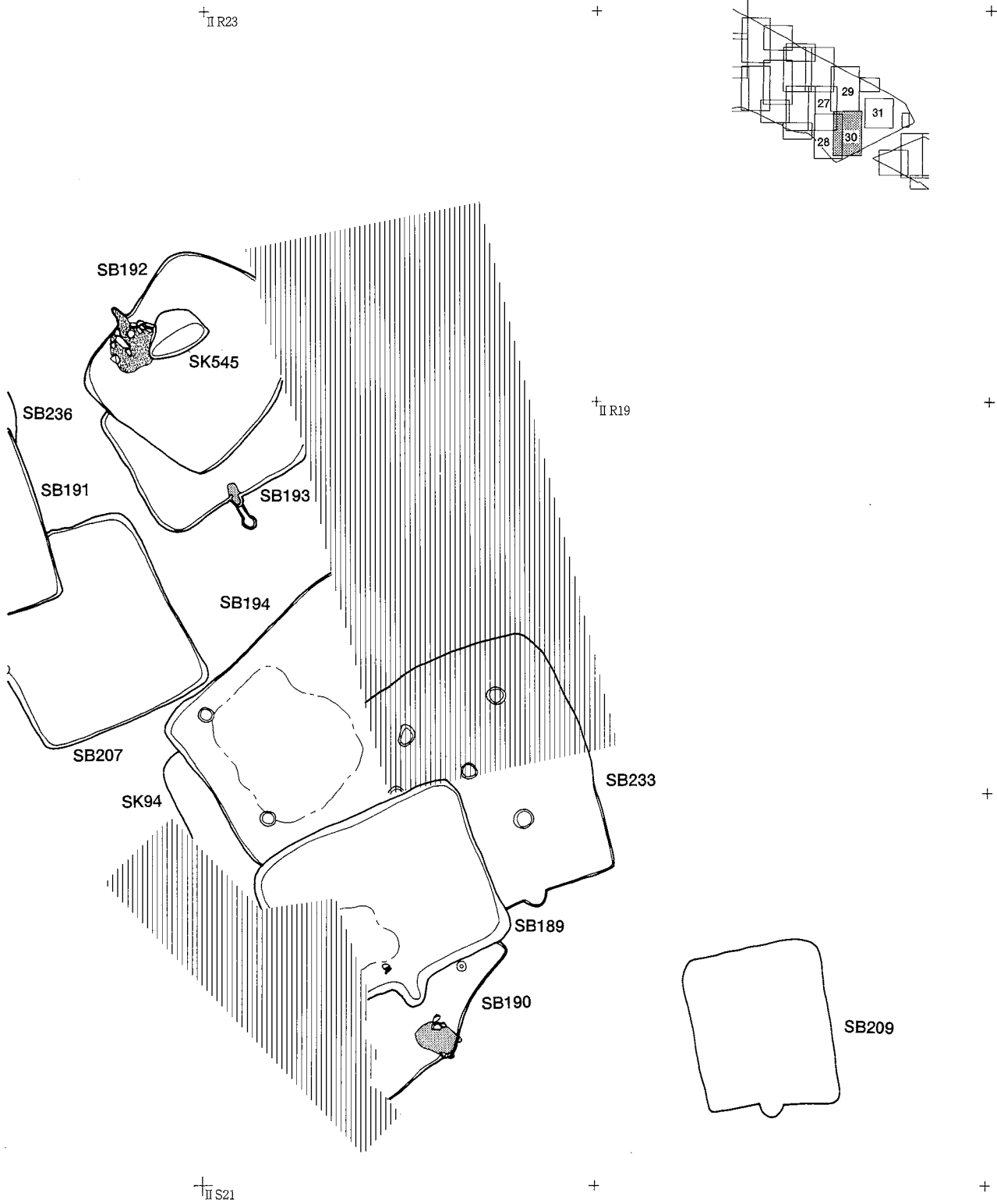

0 (1:120) 4 m

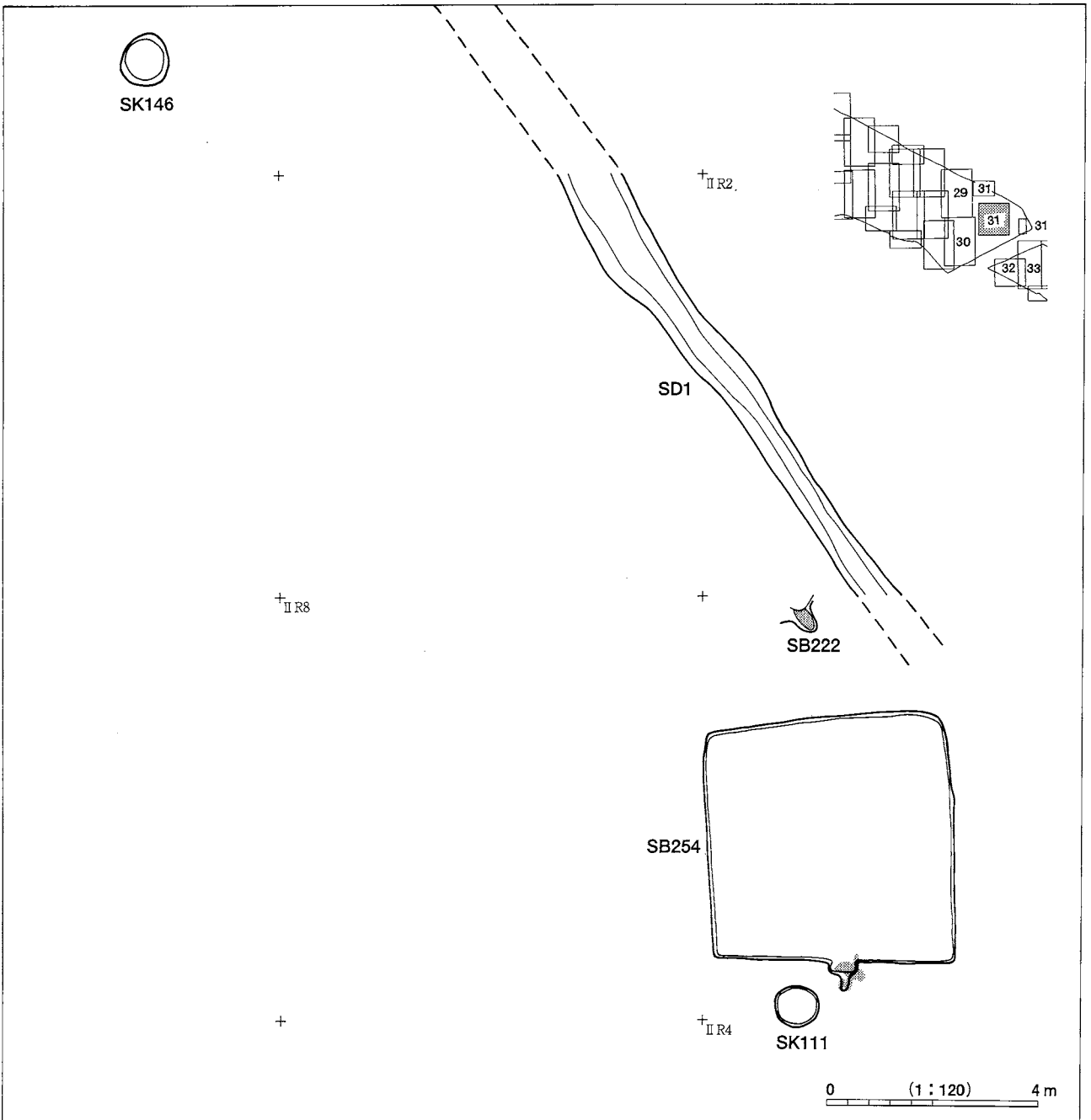
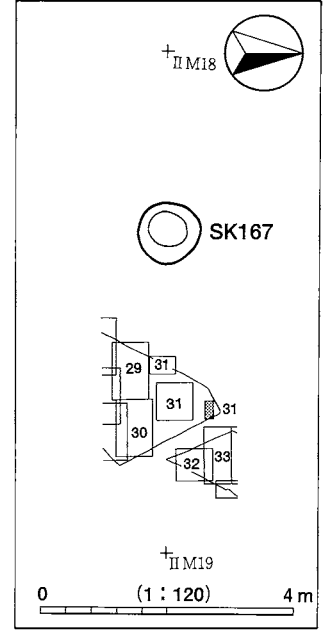
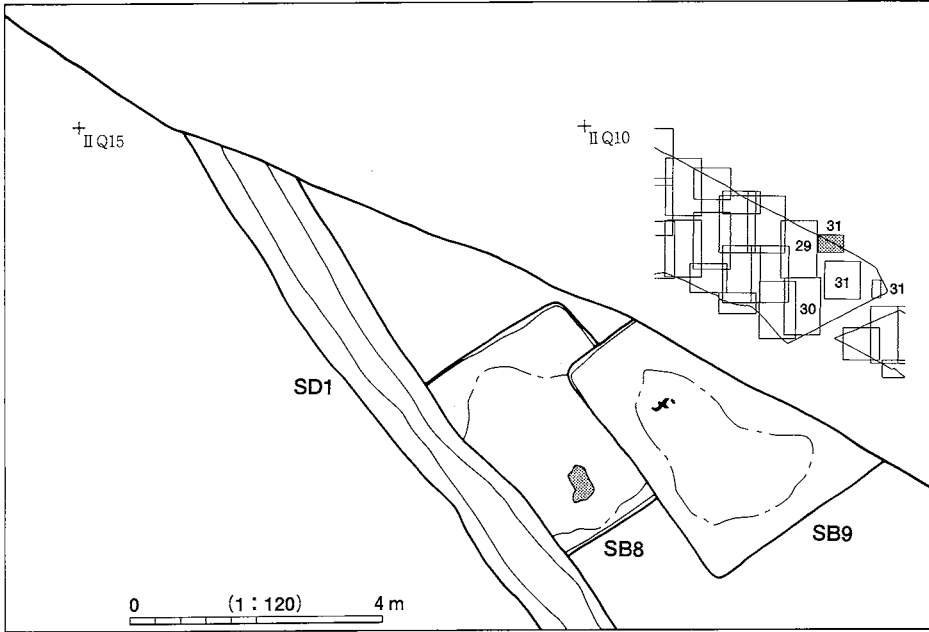

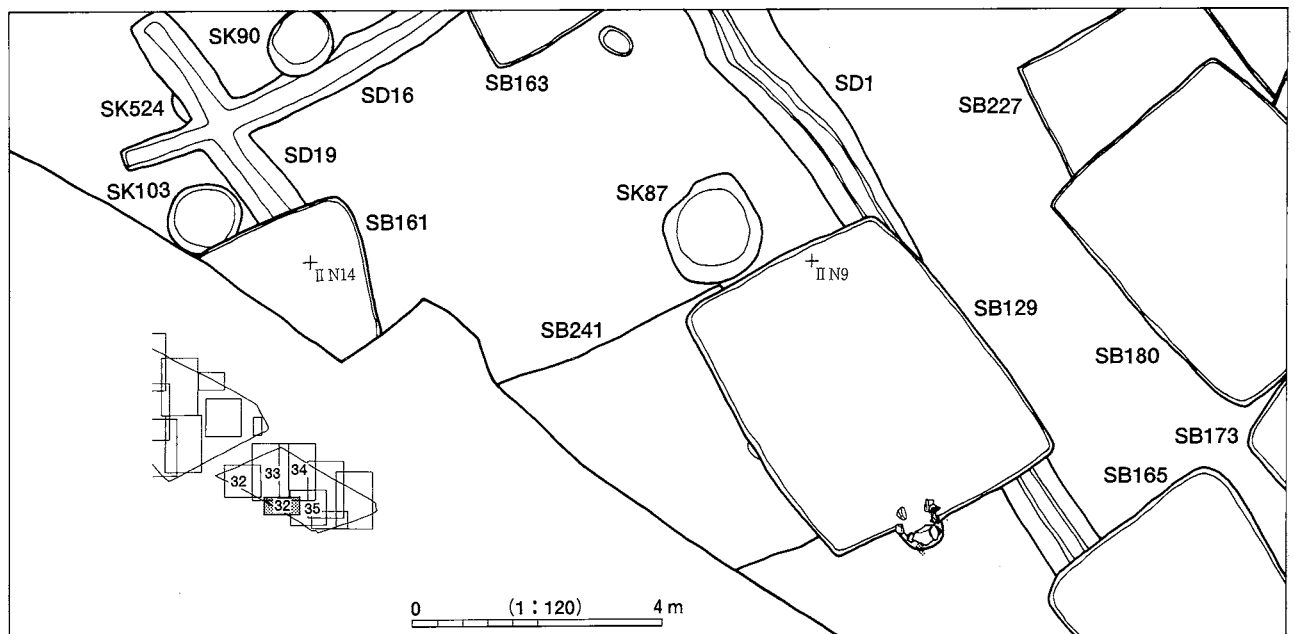
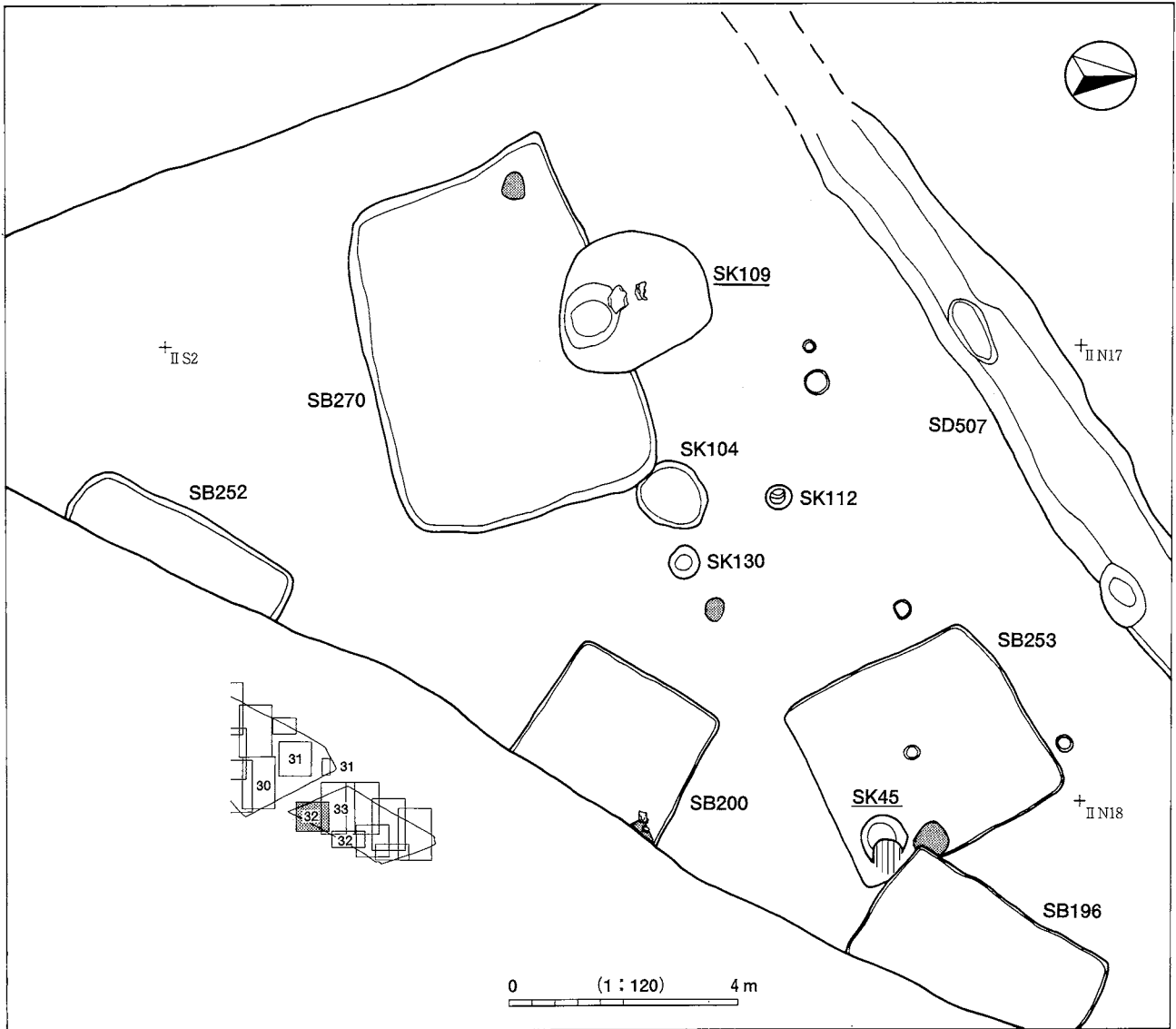

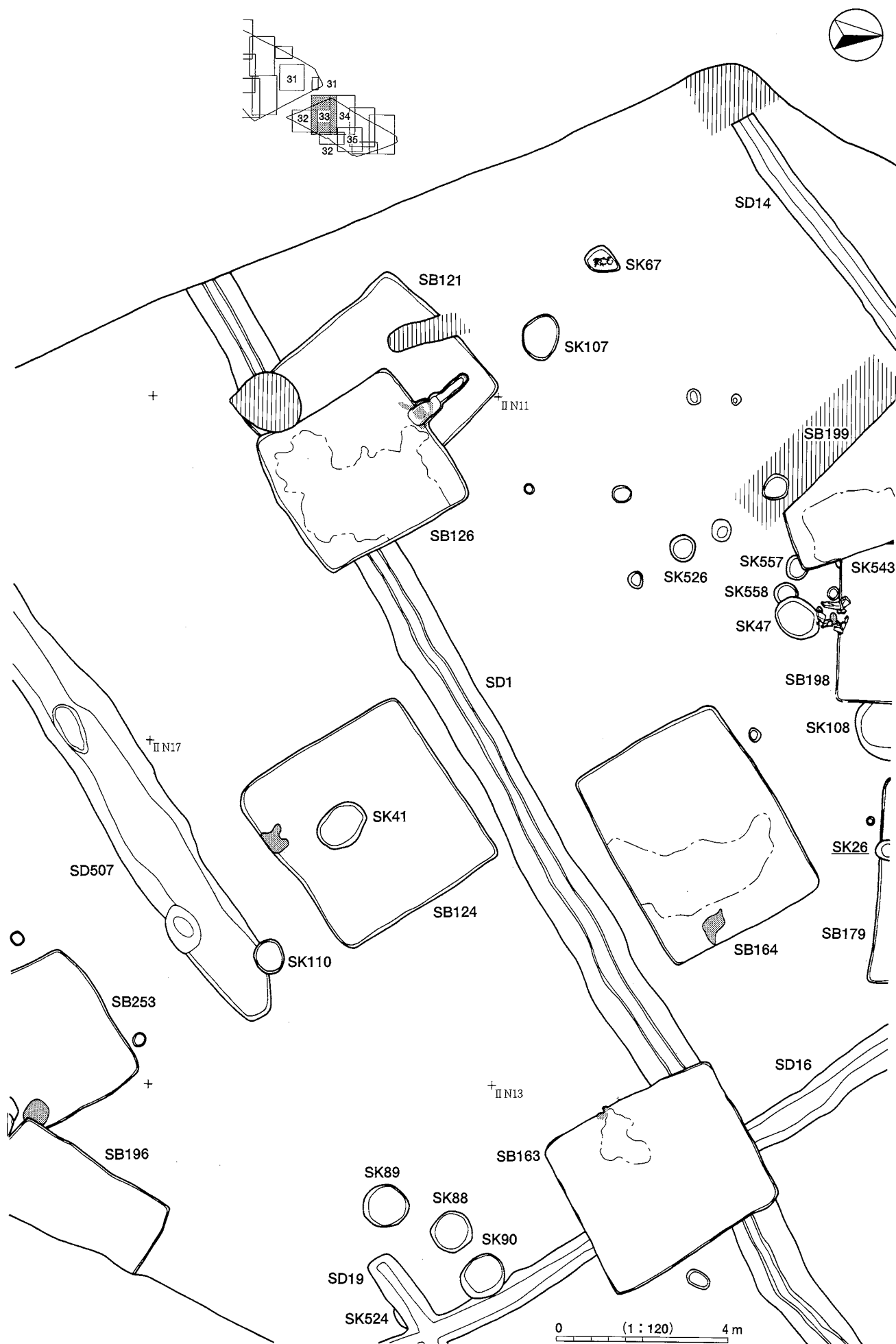

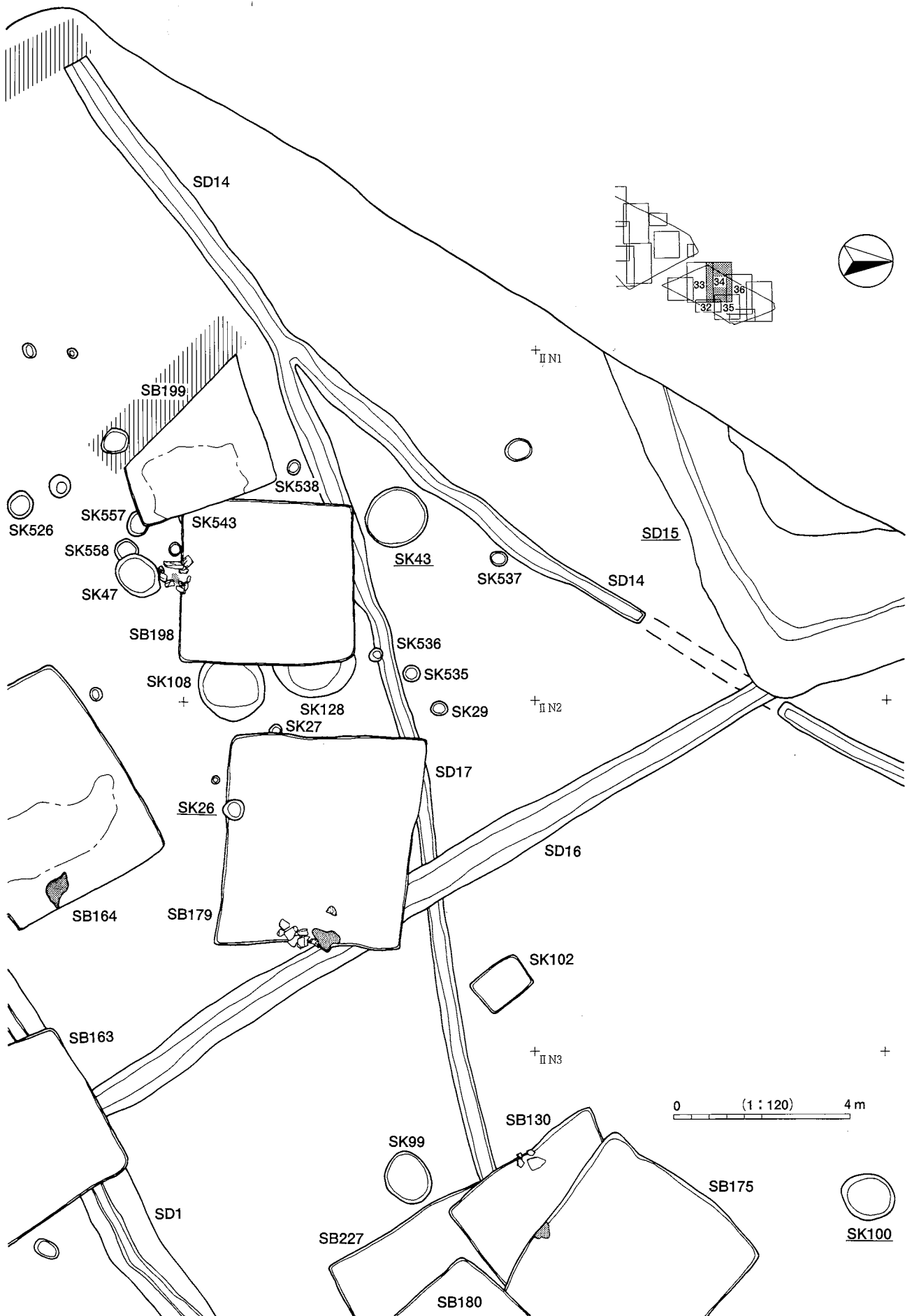

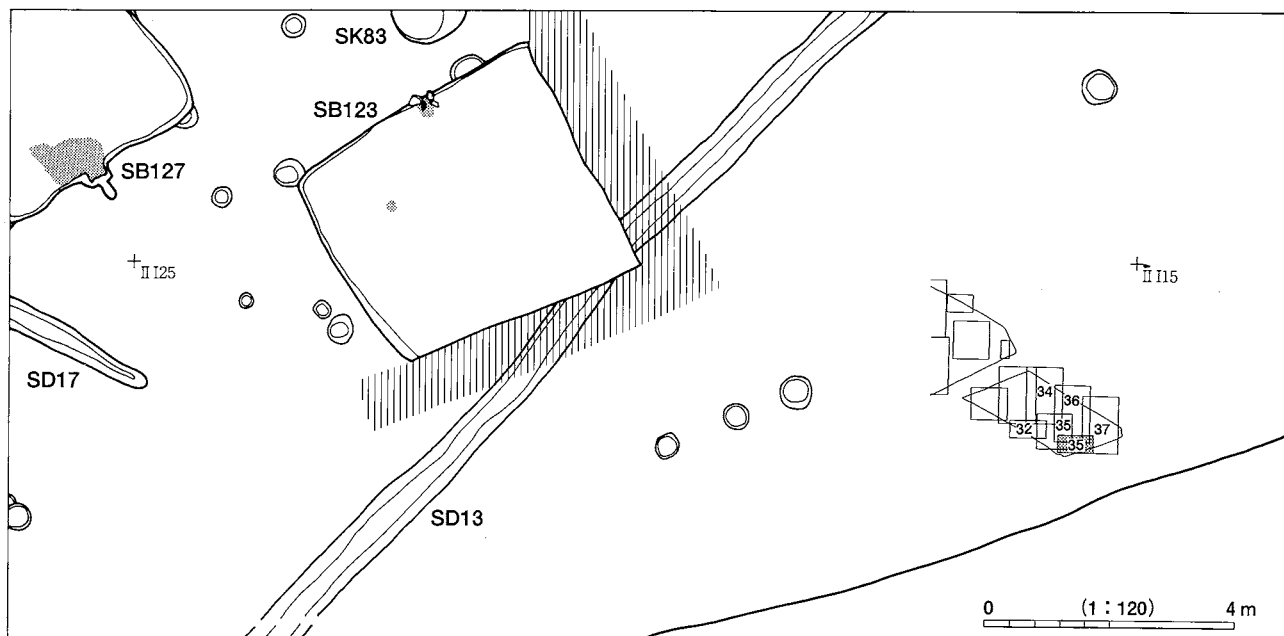
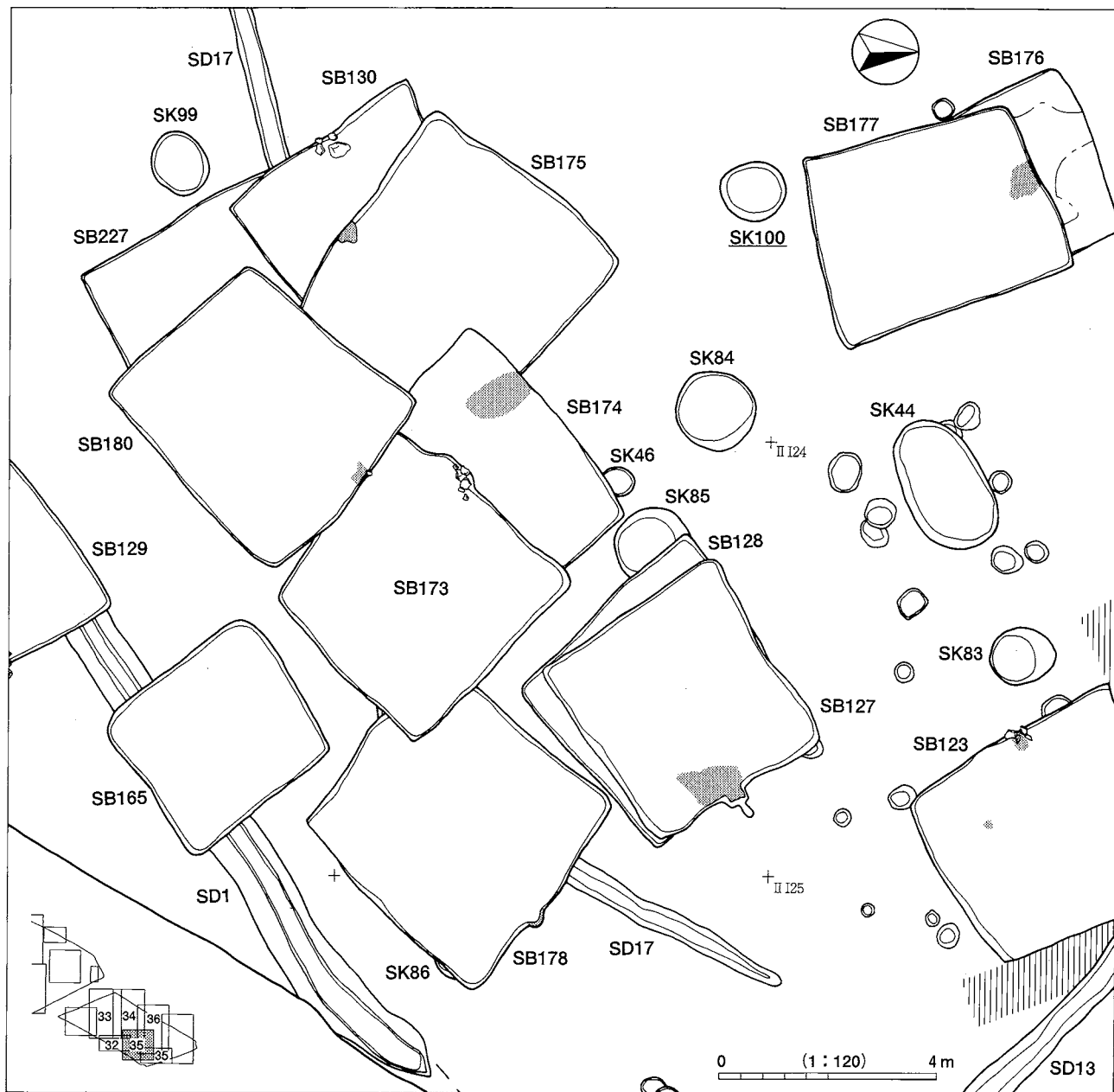

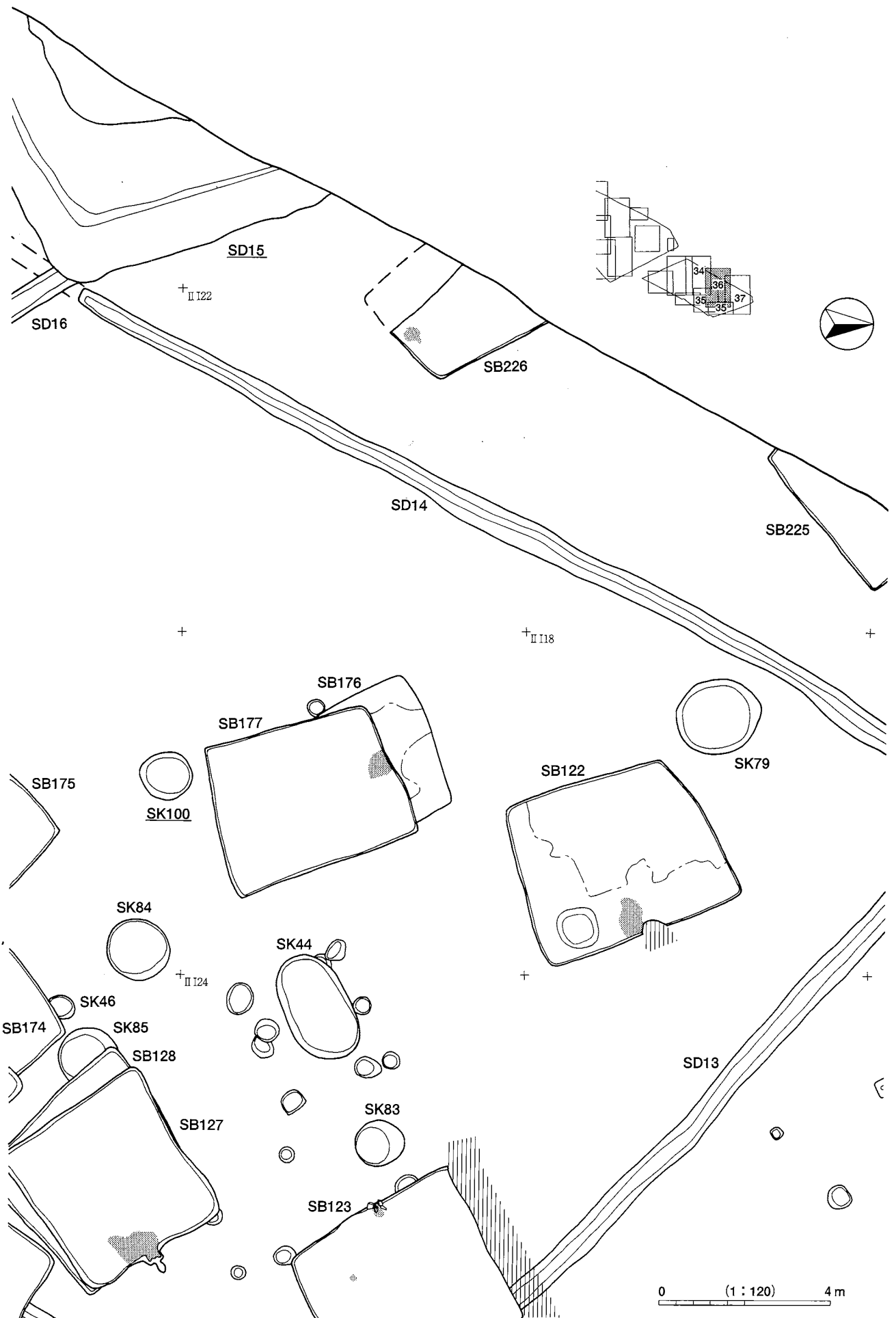

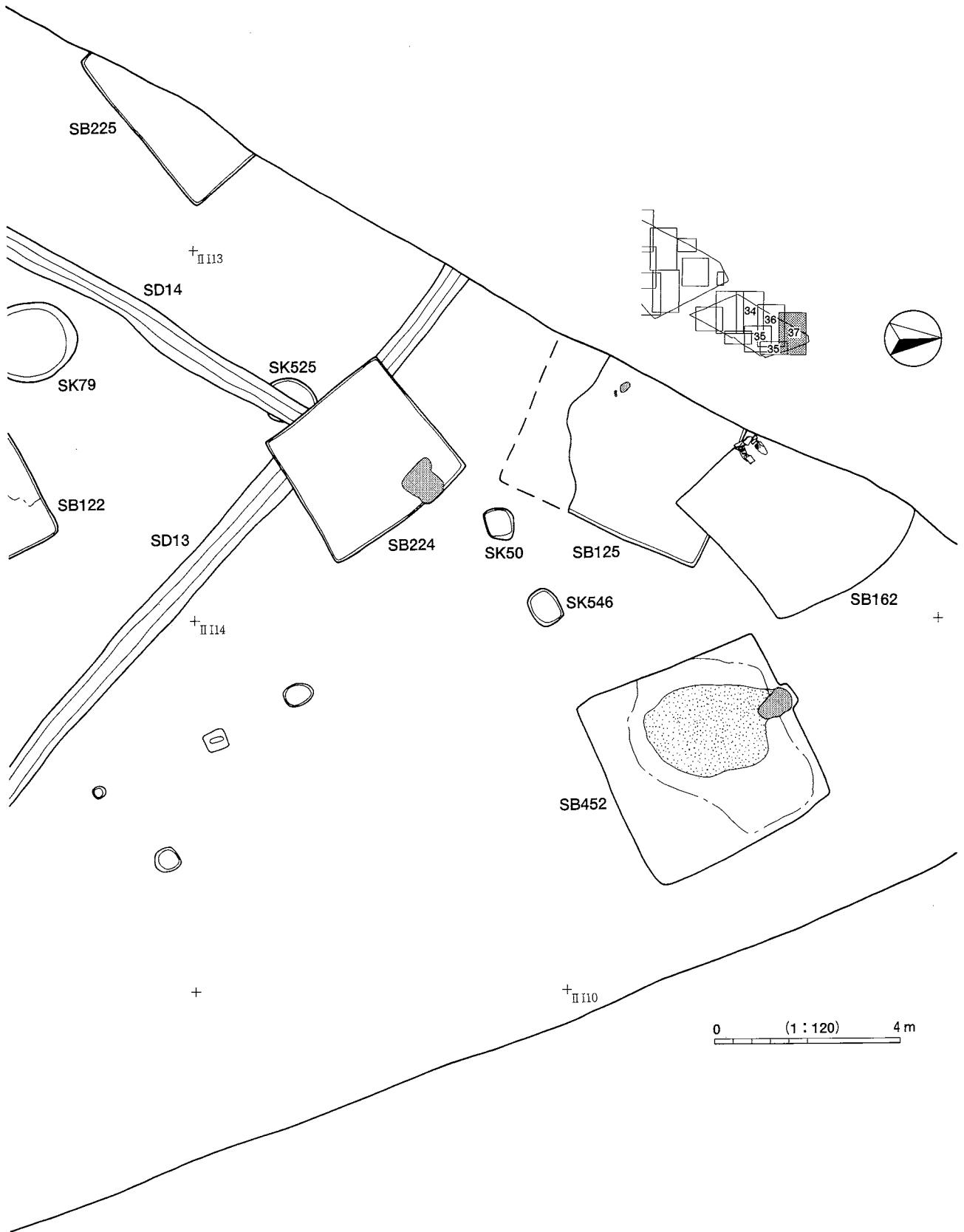

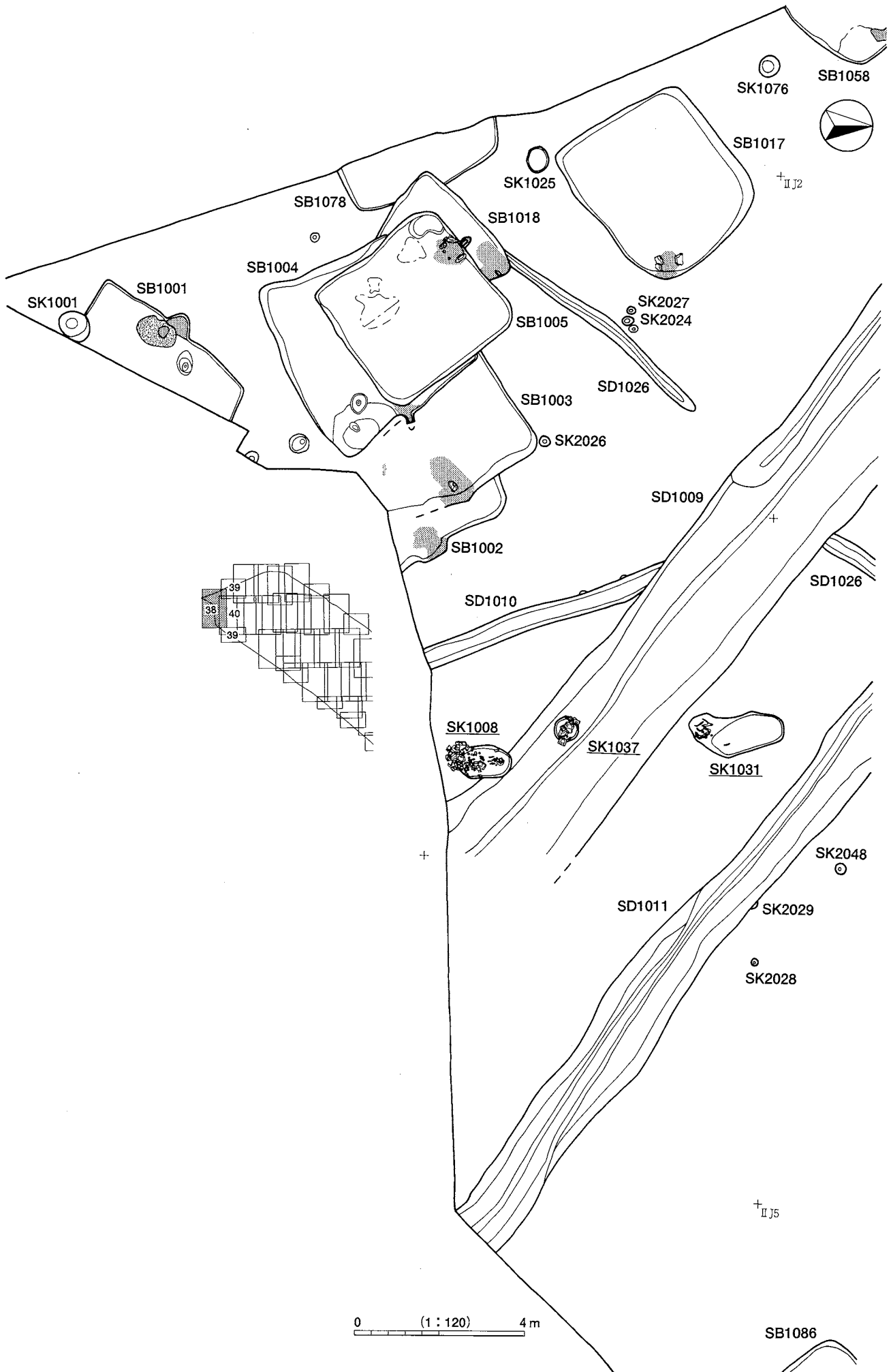

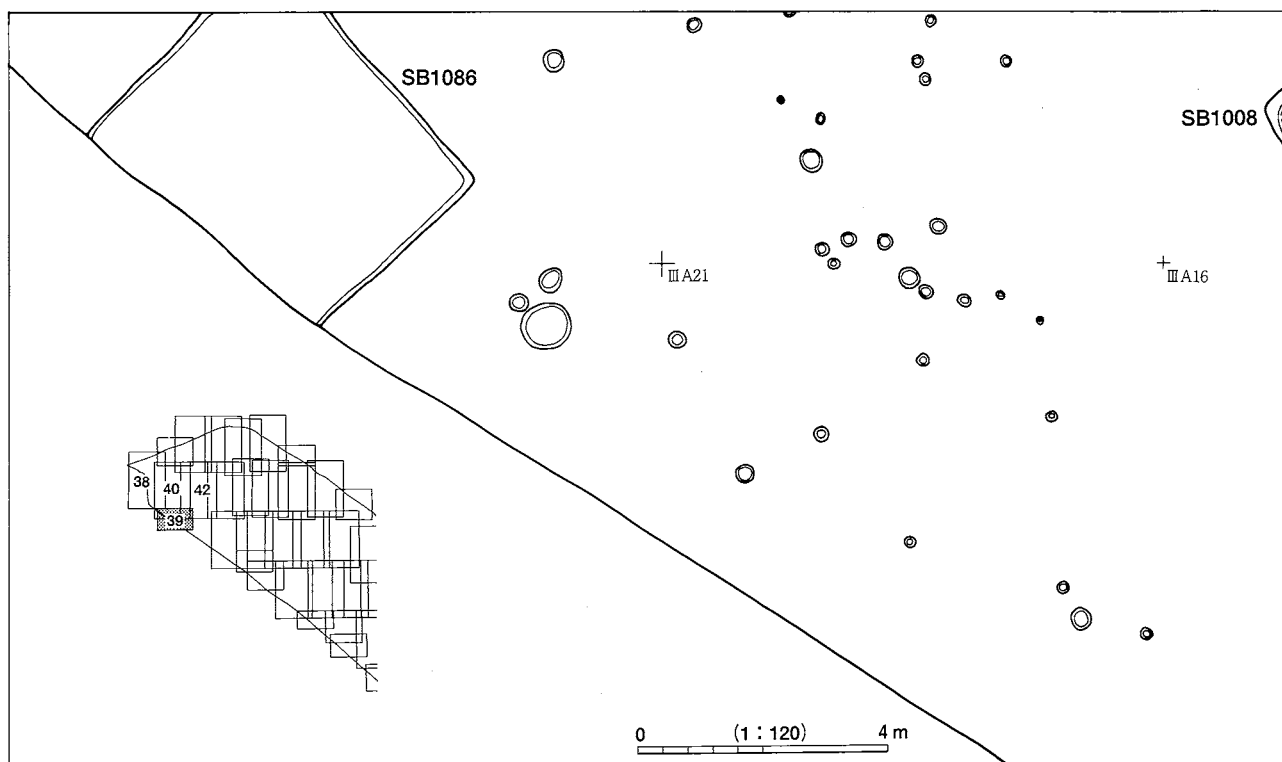
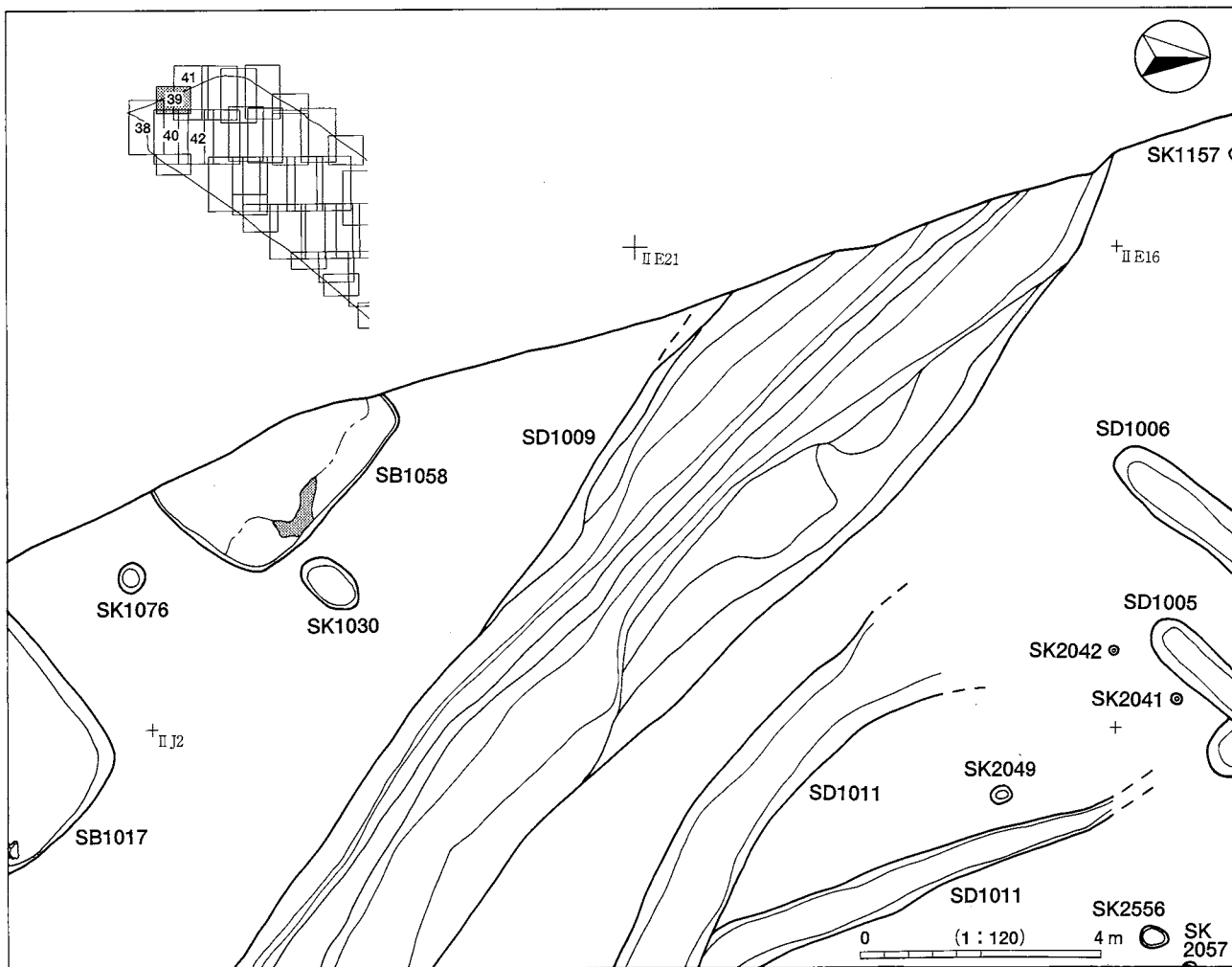

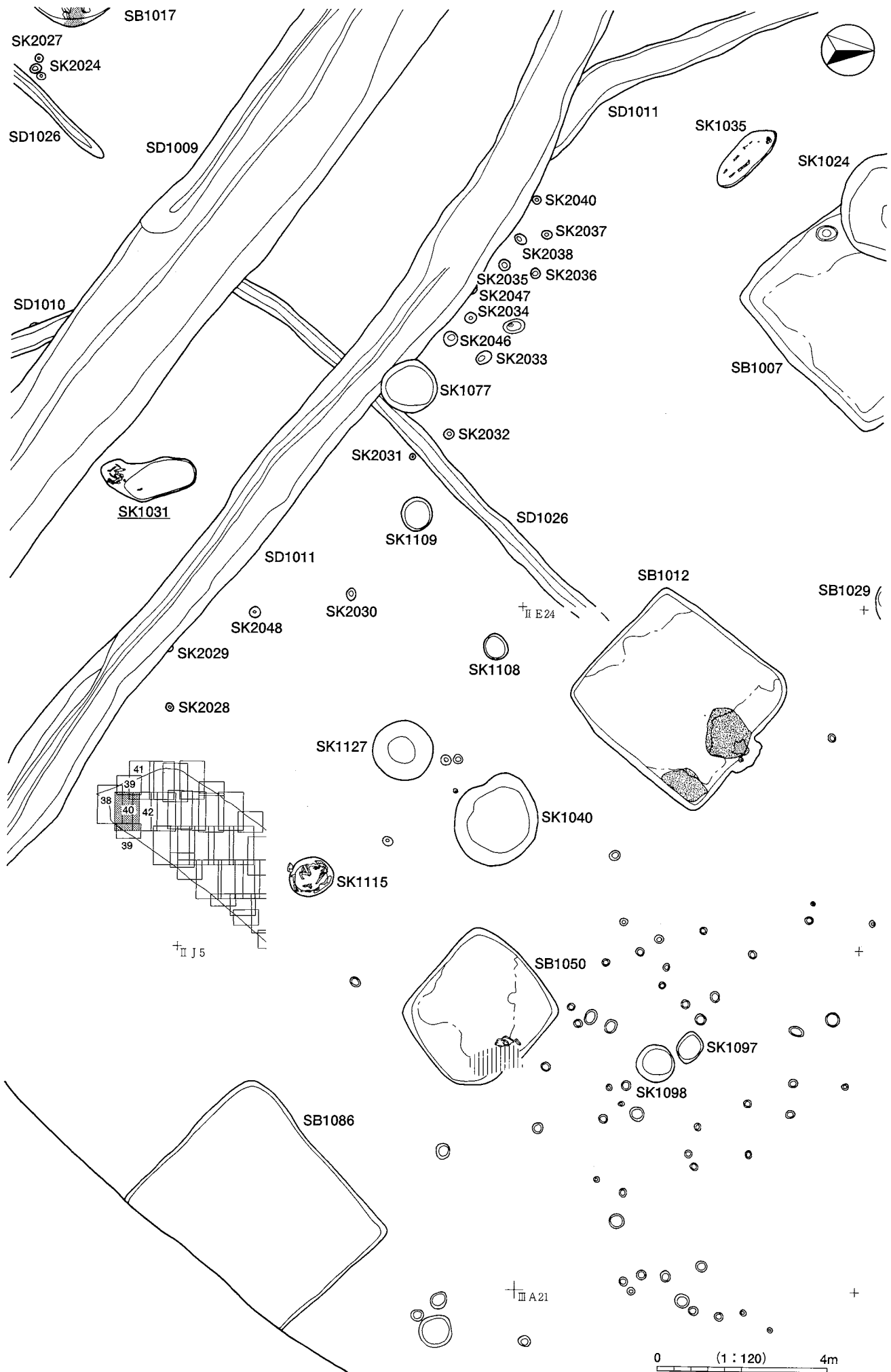

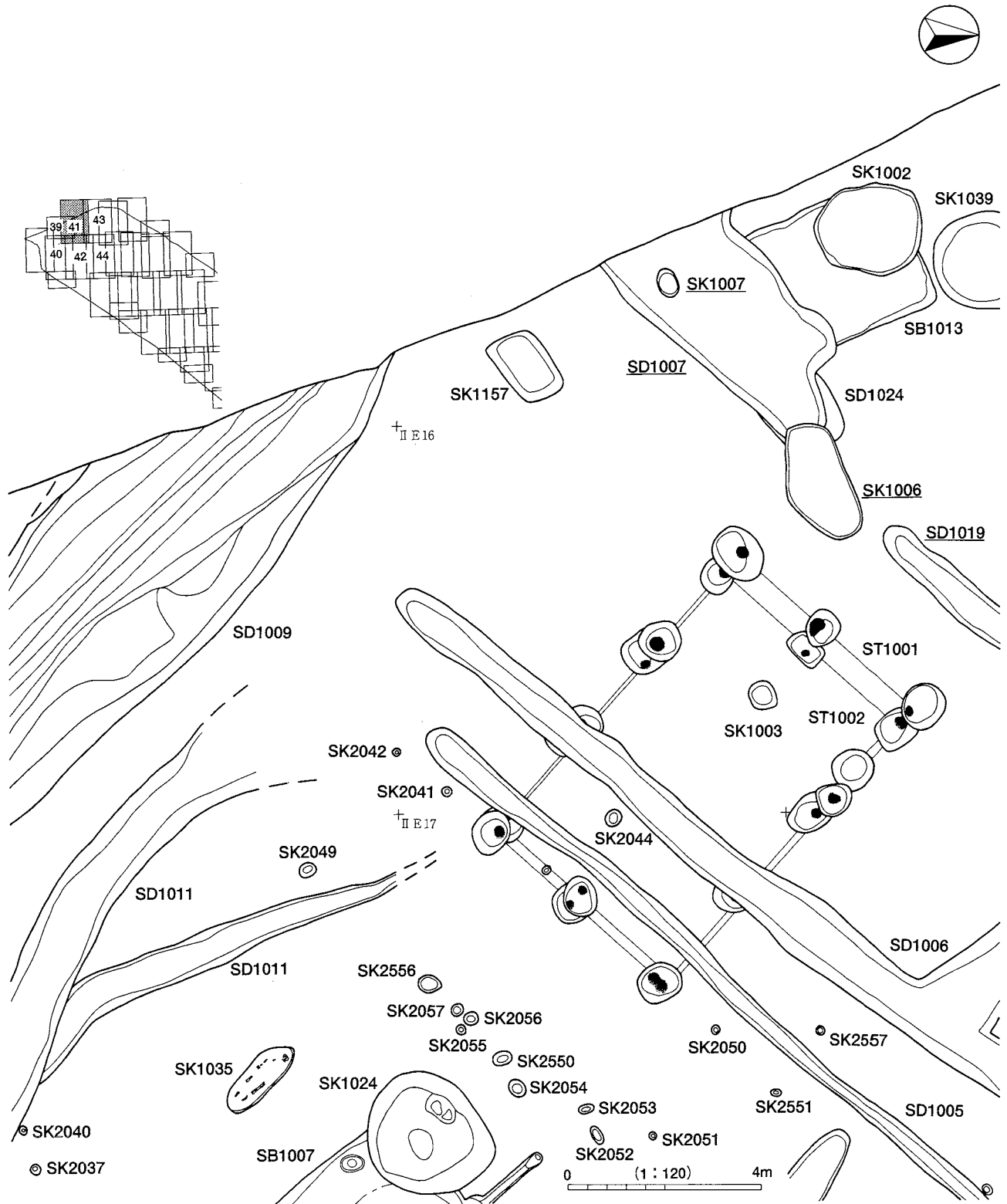

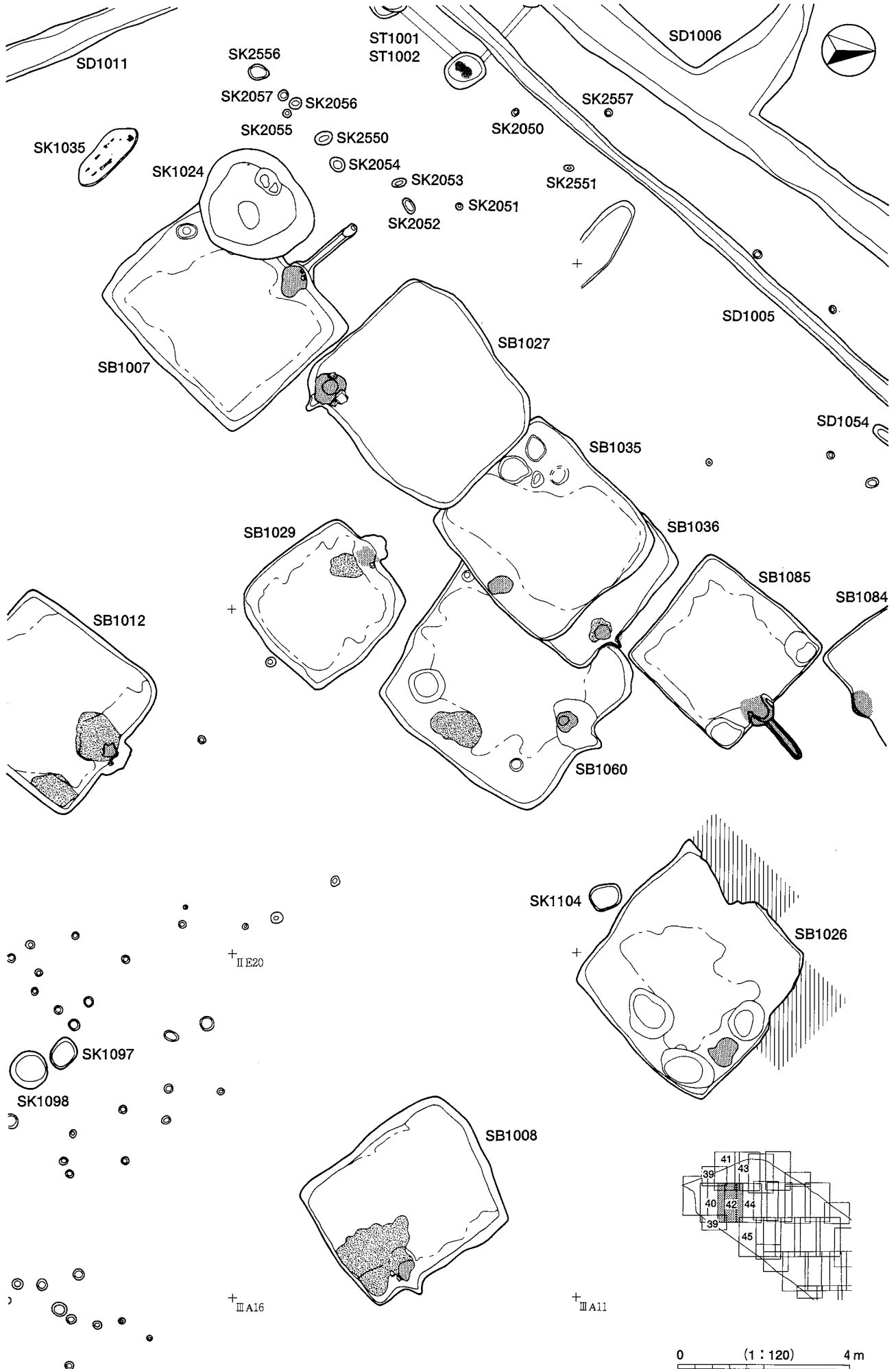

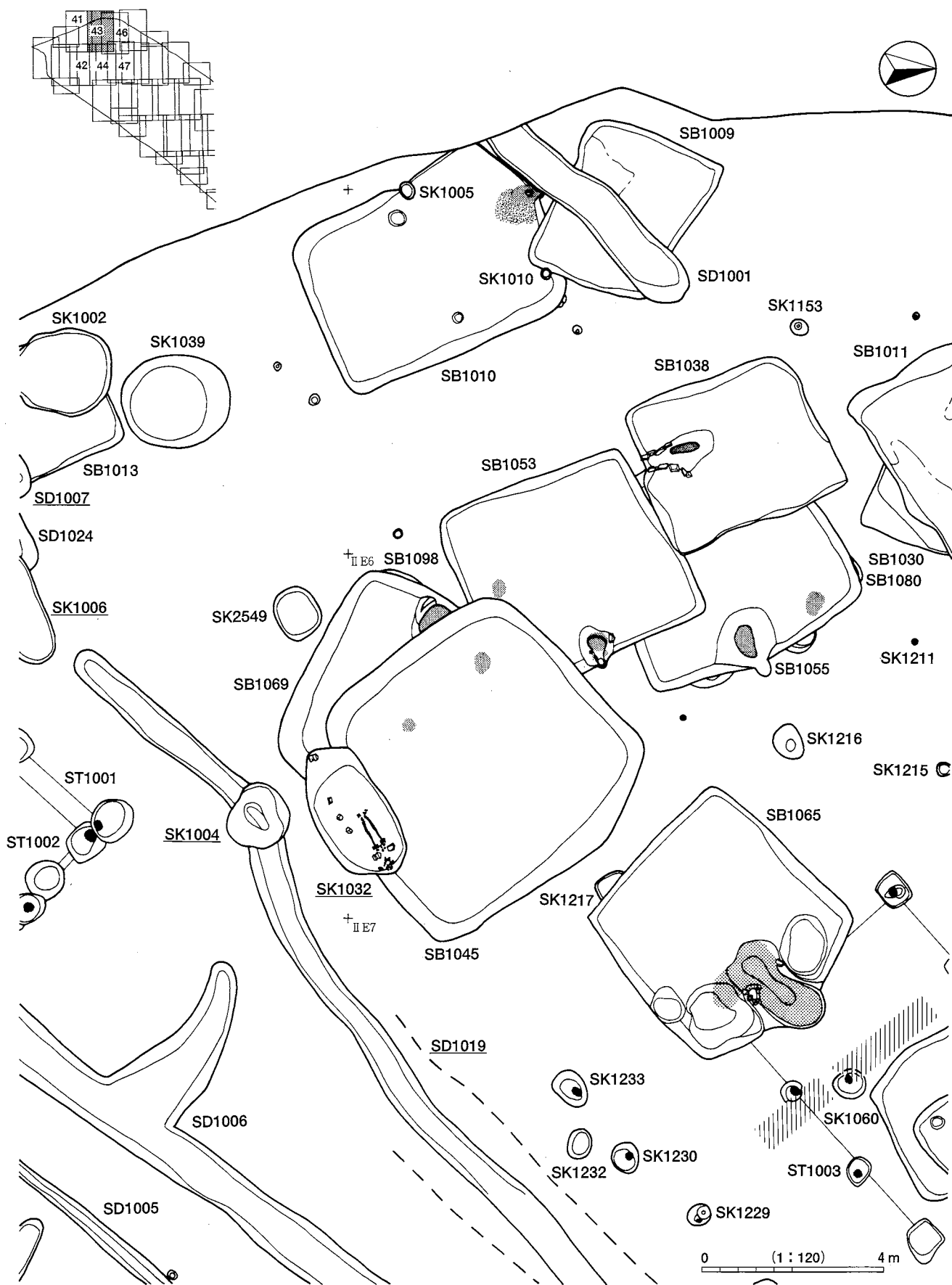

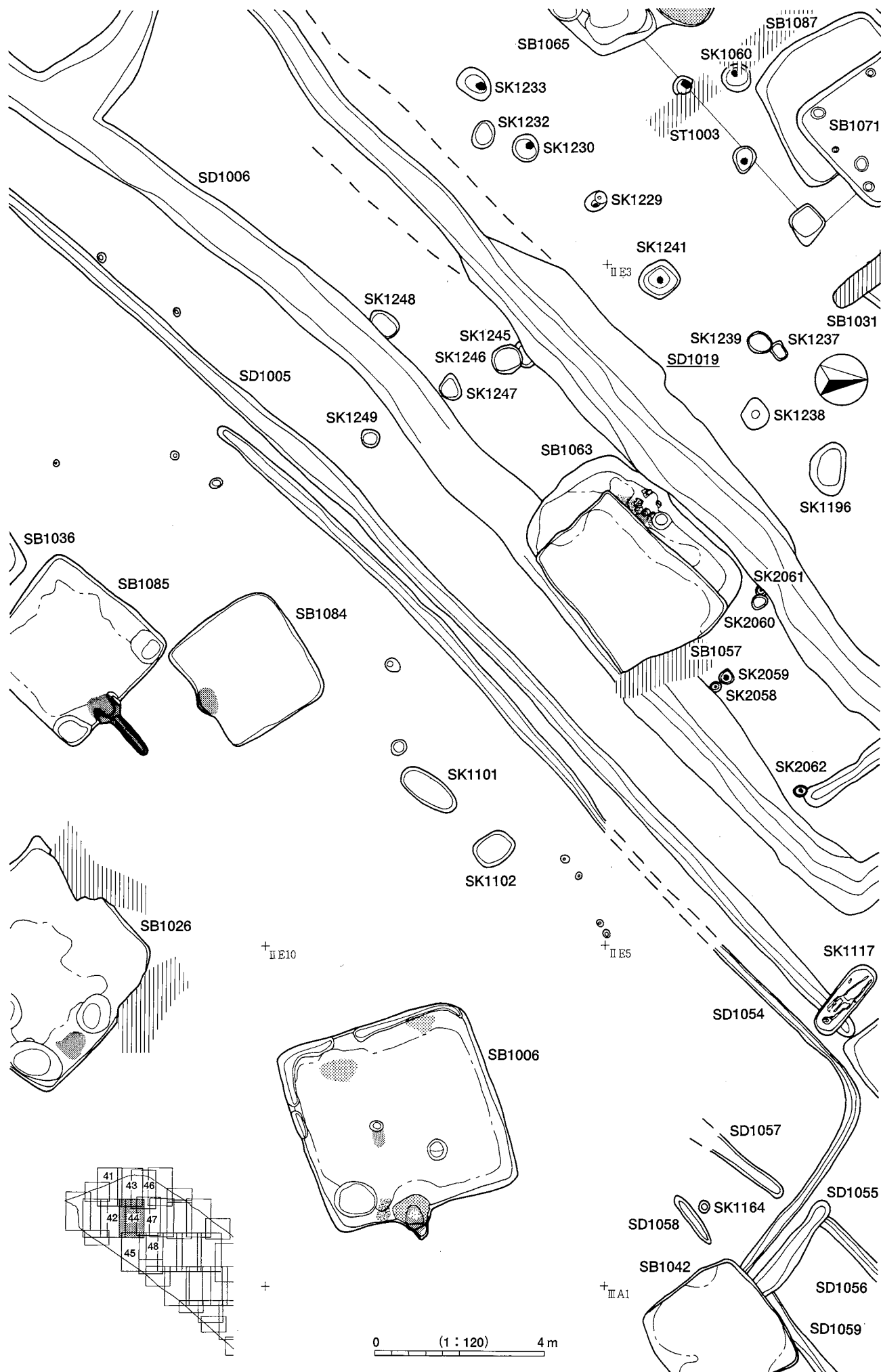

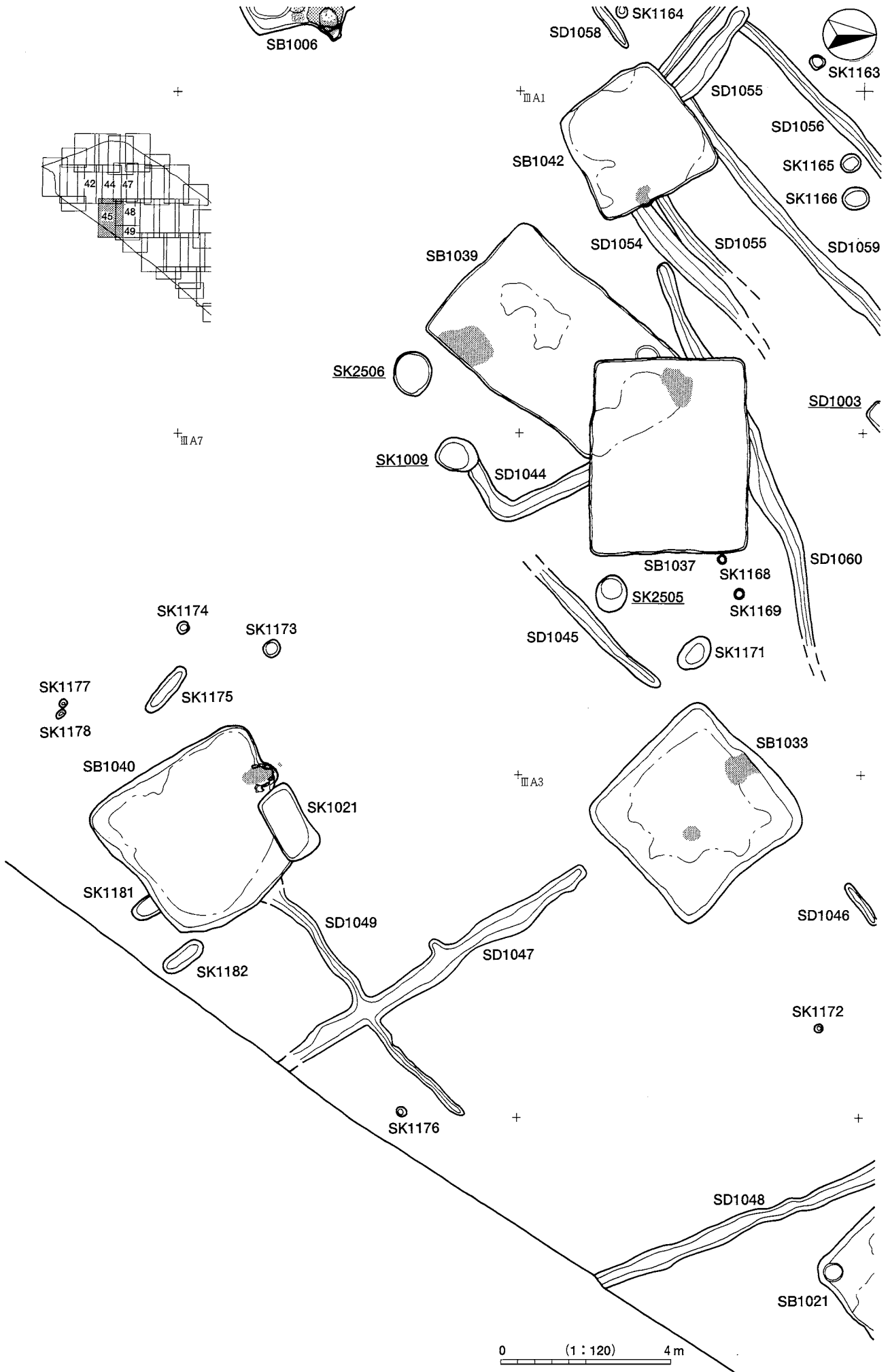

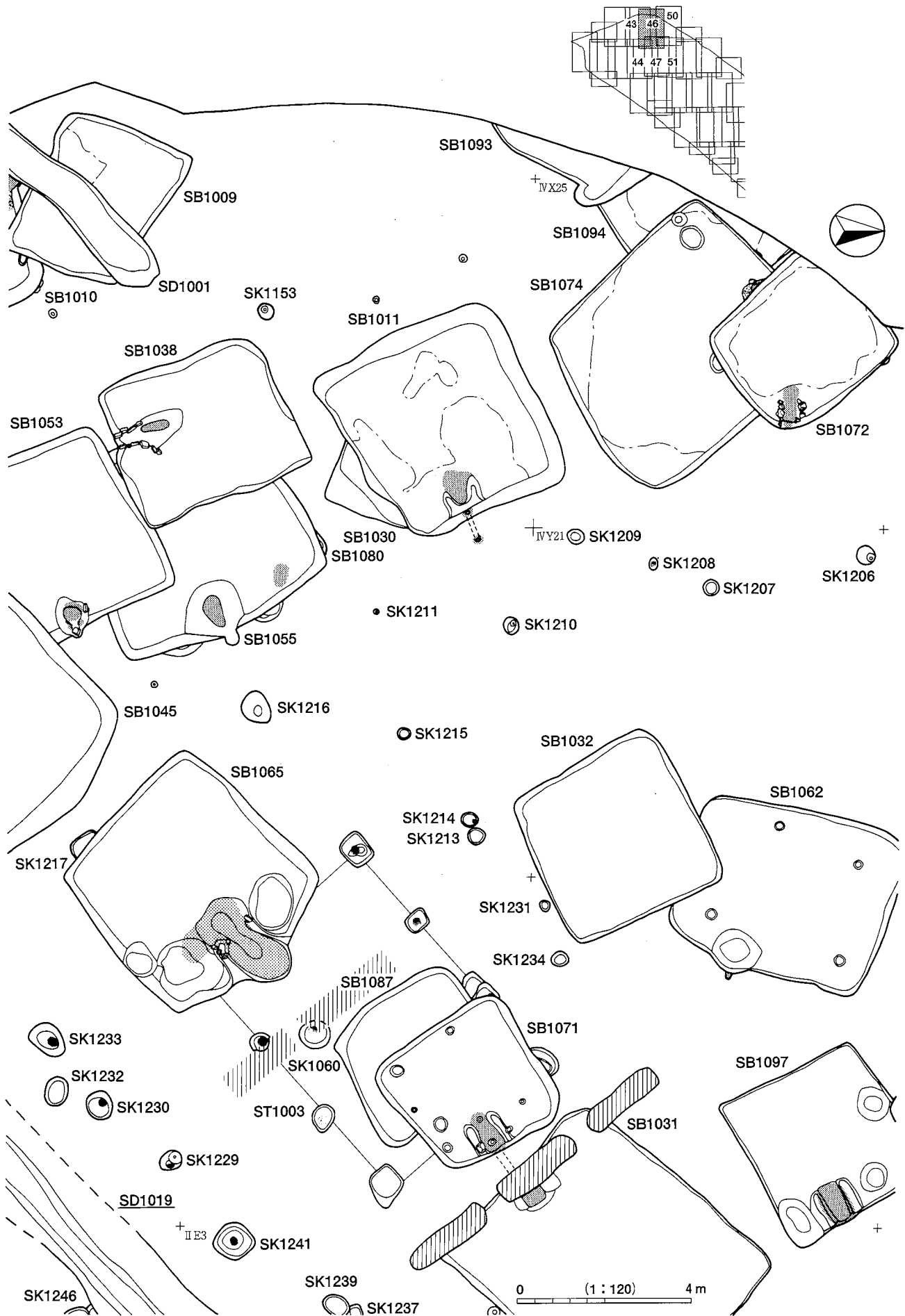

図版62 遺構実測図47

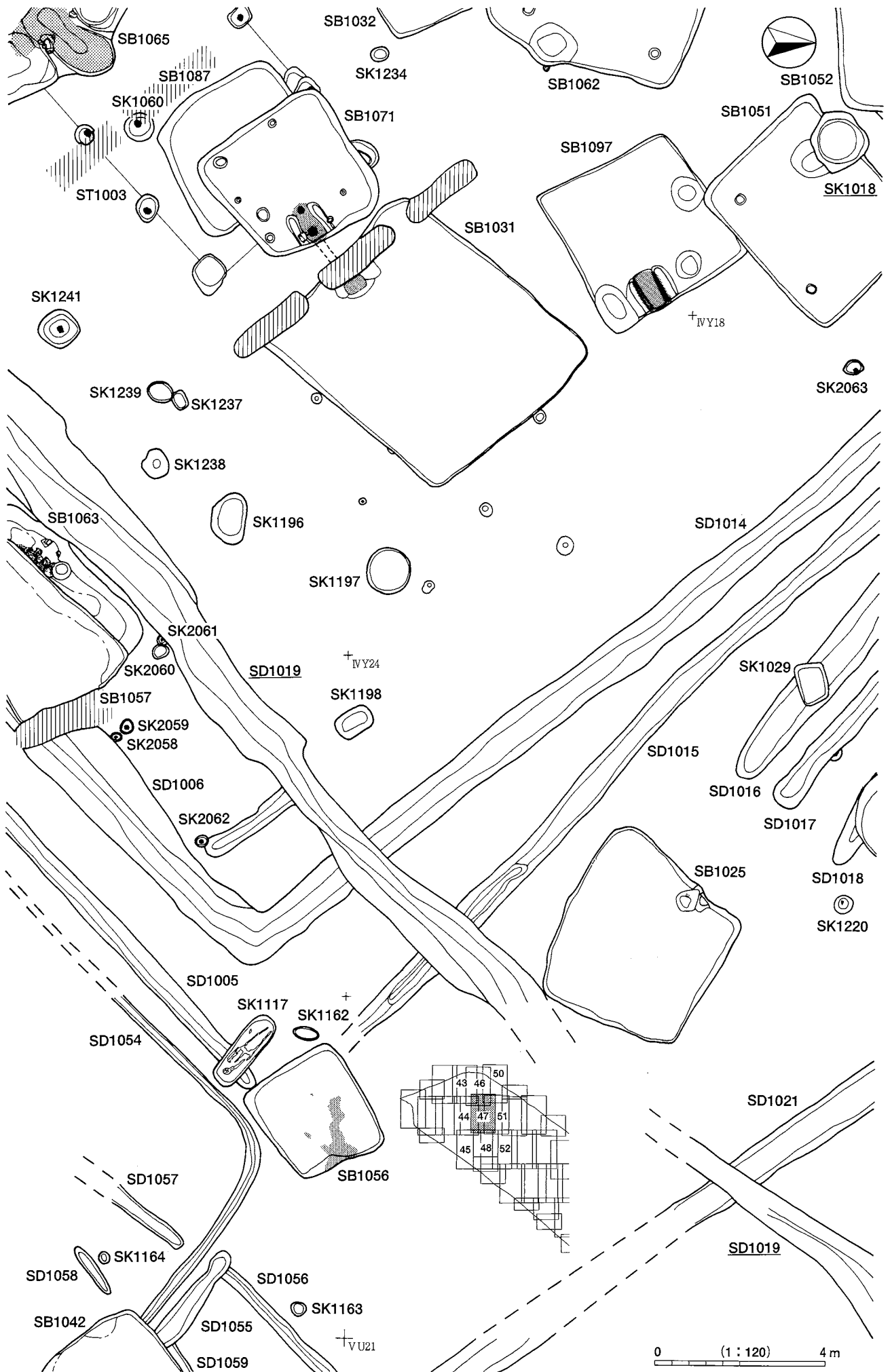

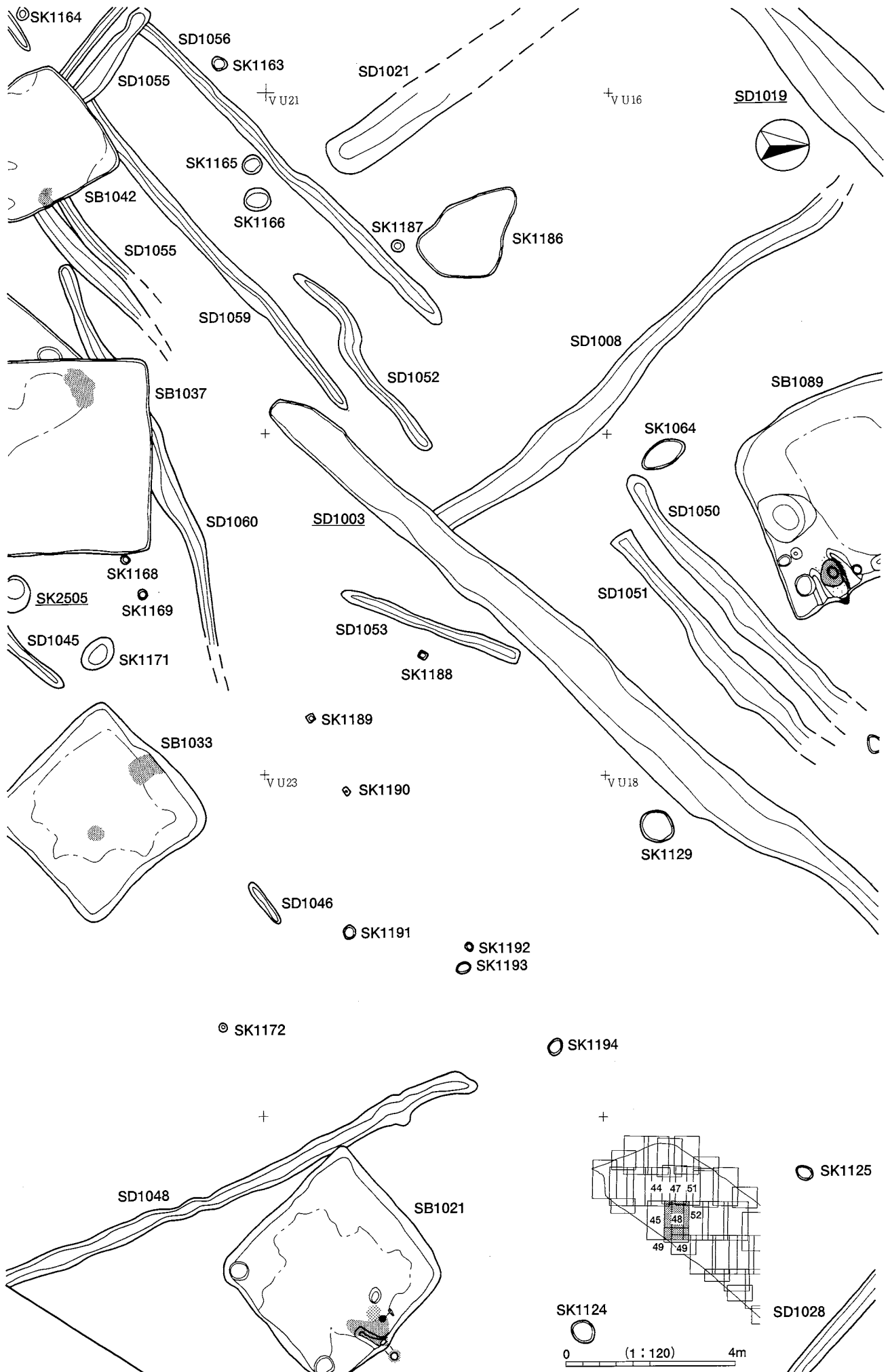

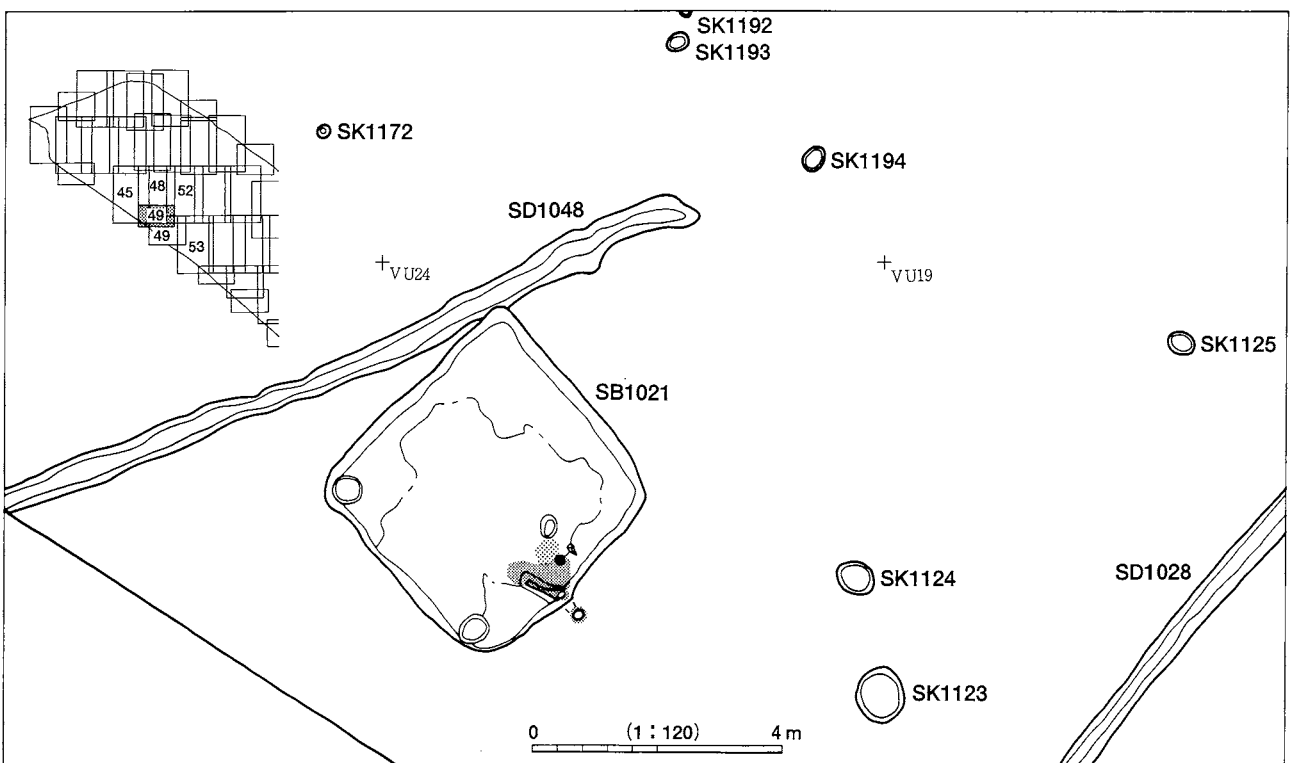
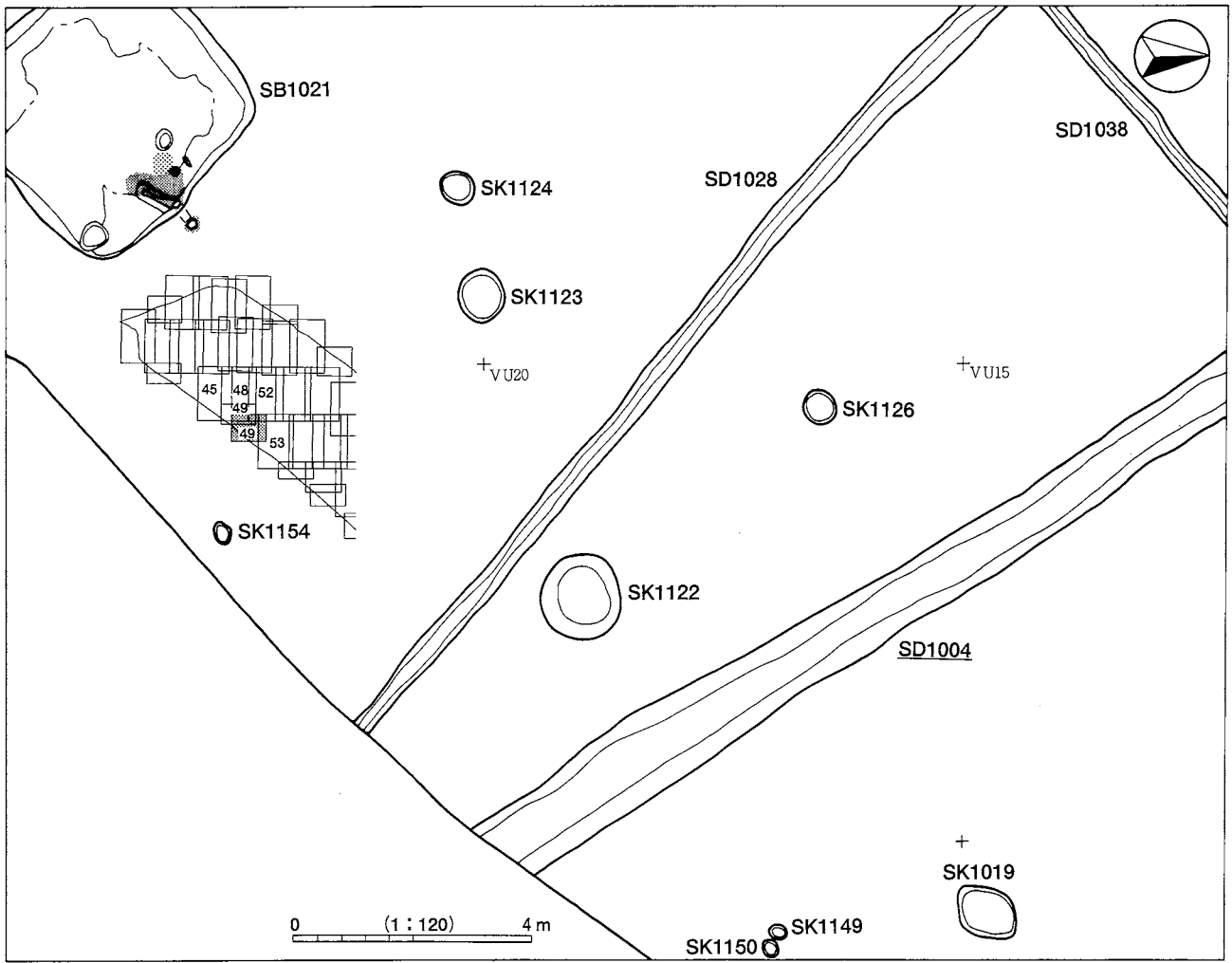

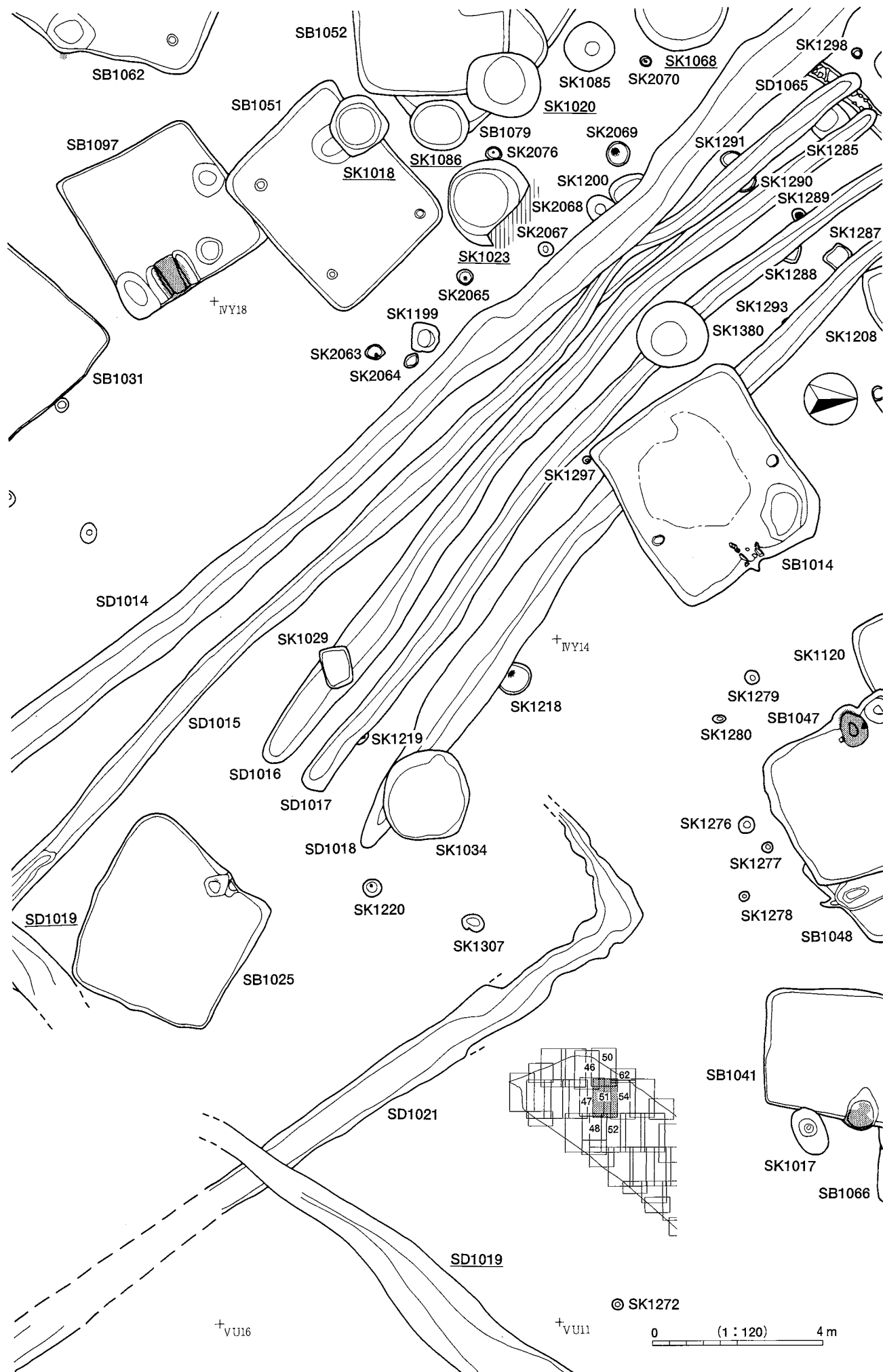

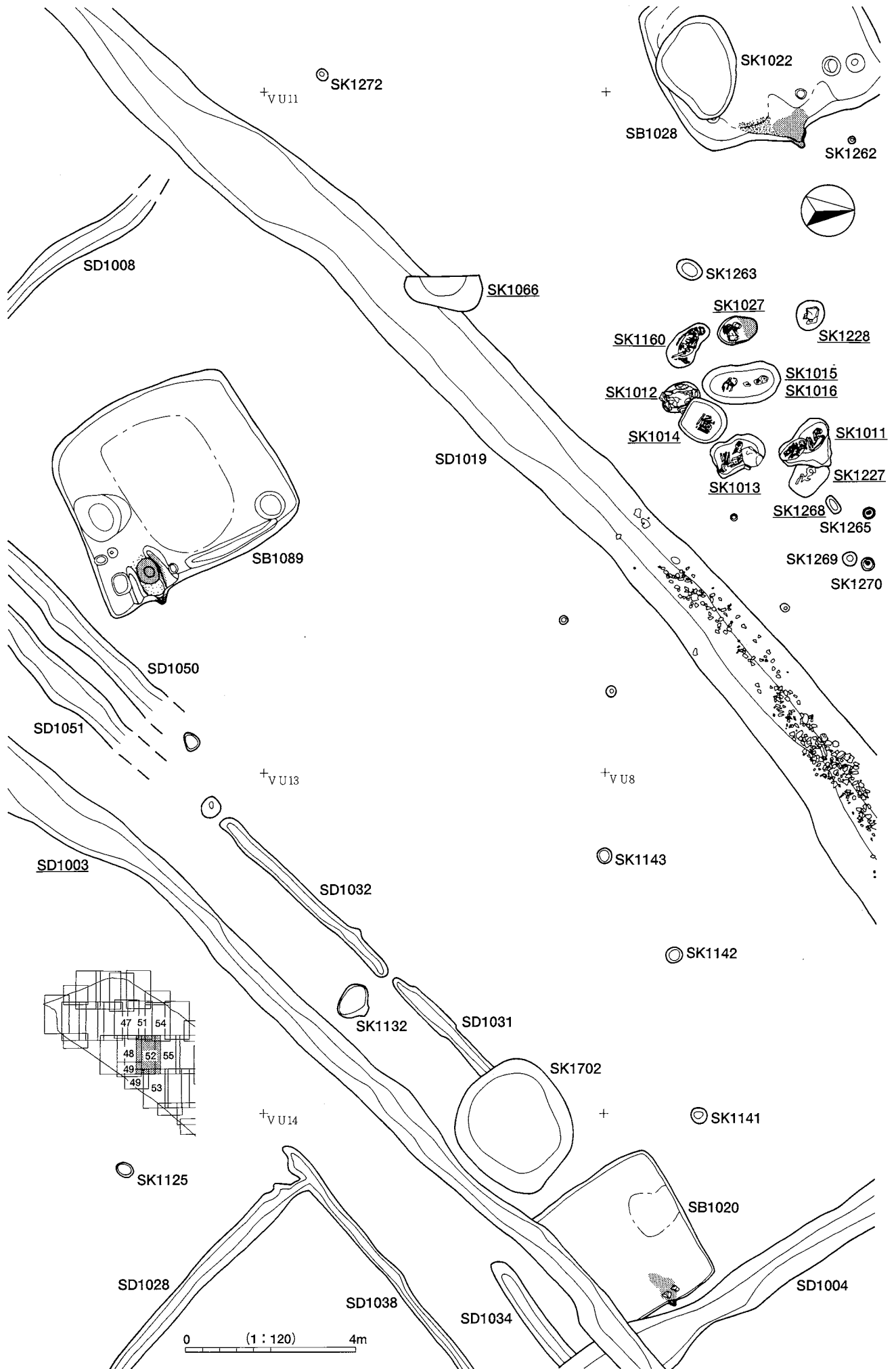

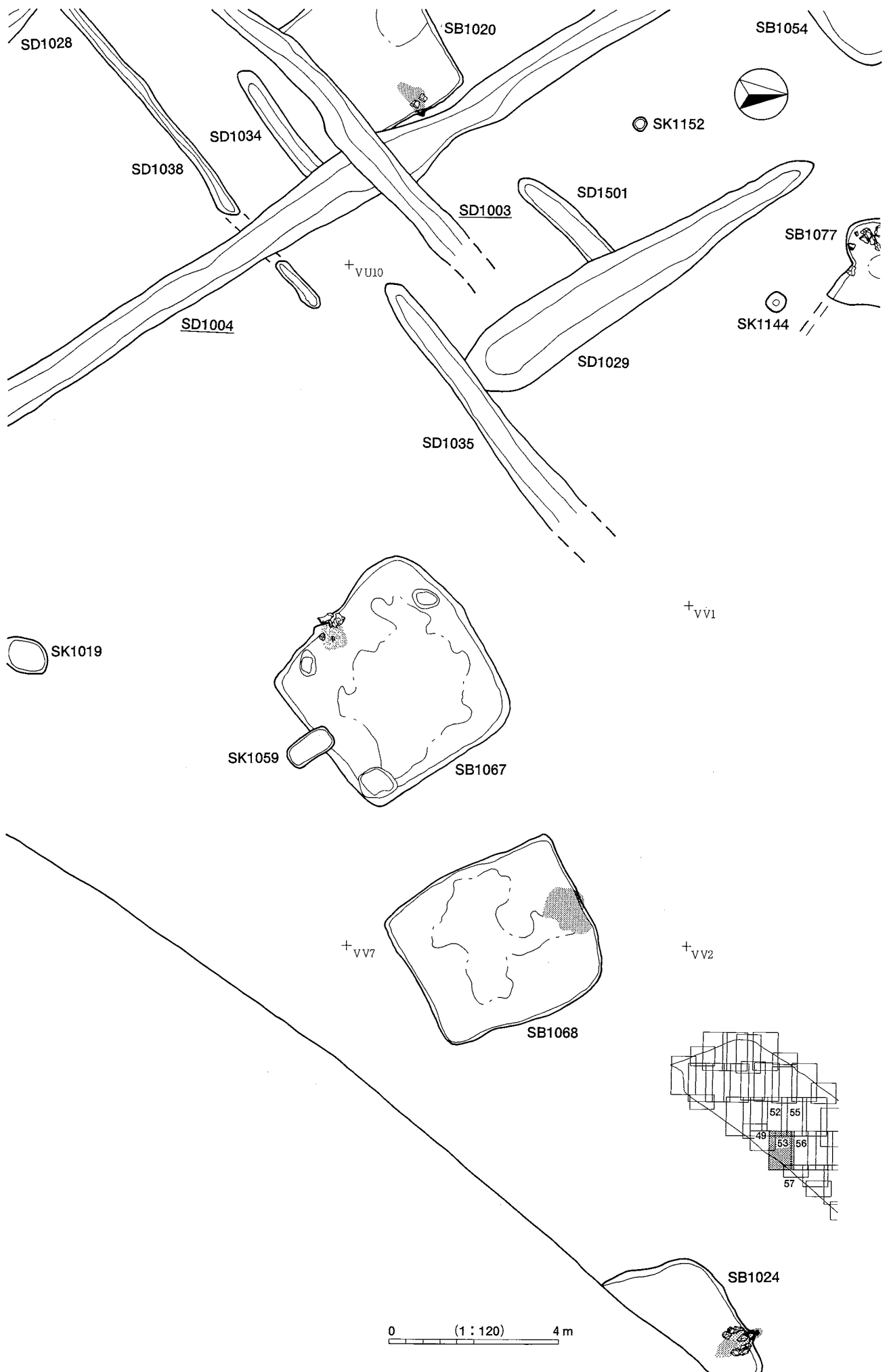

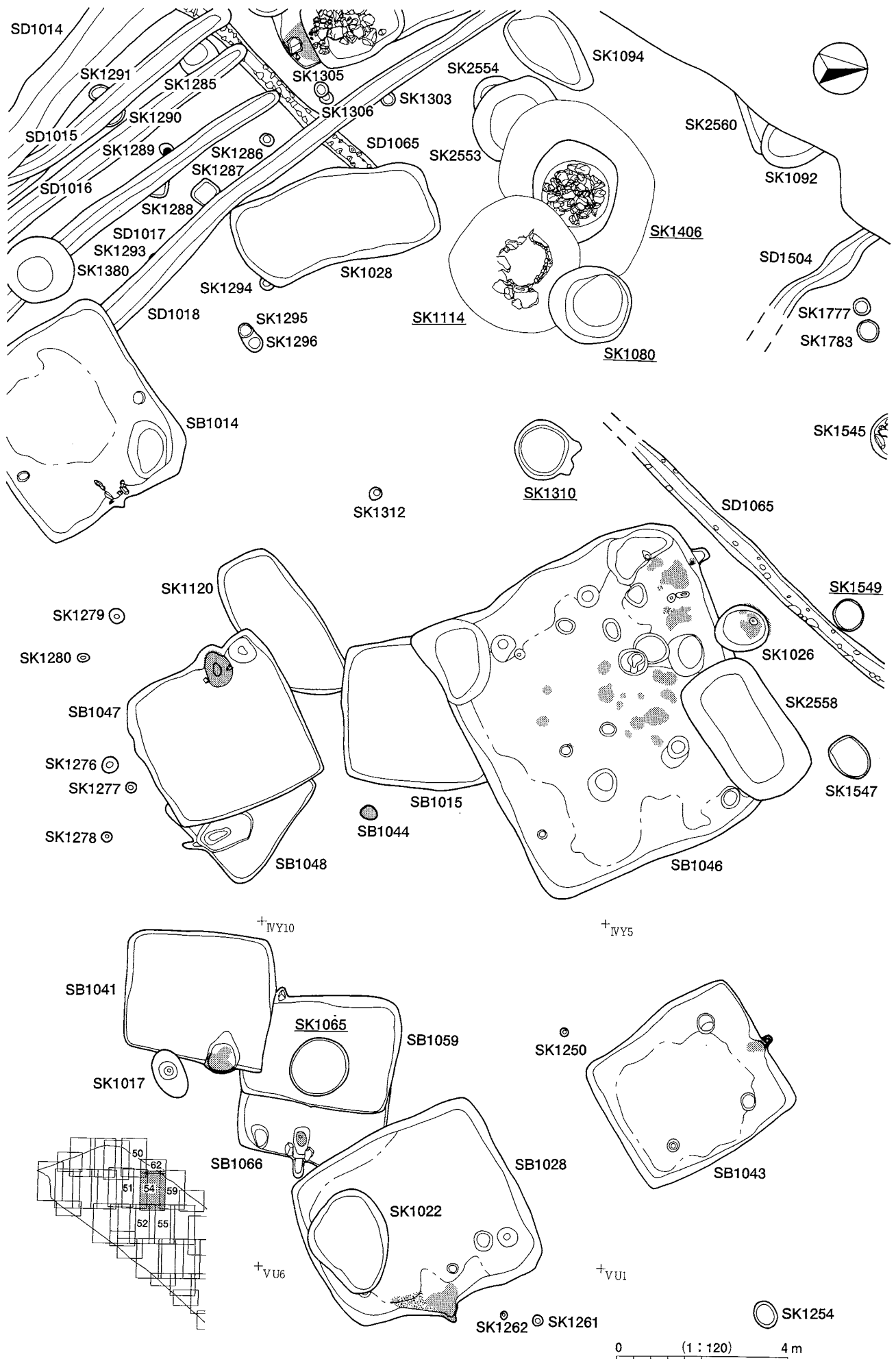

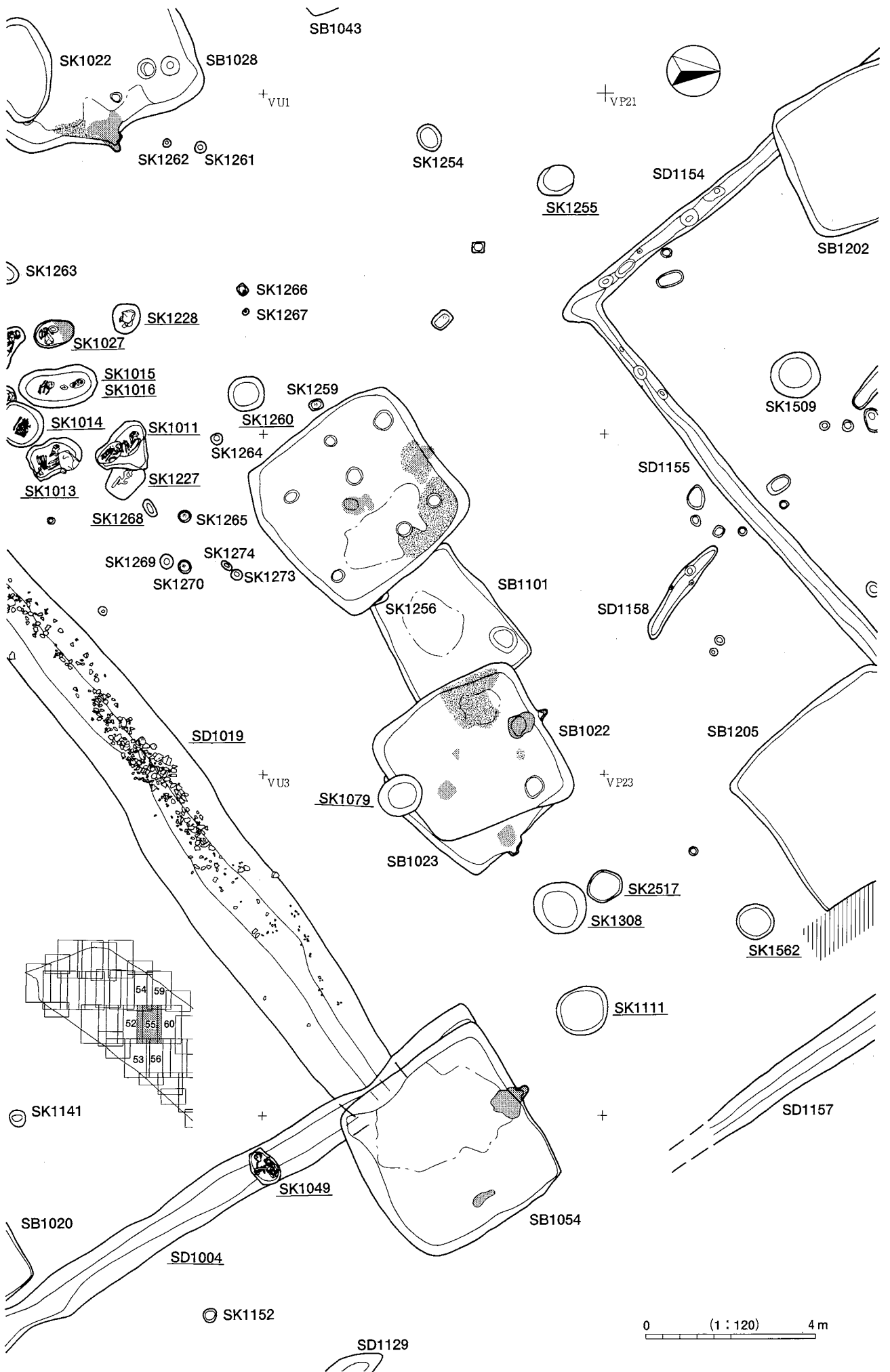

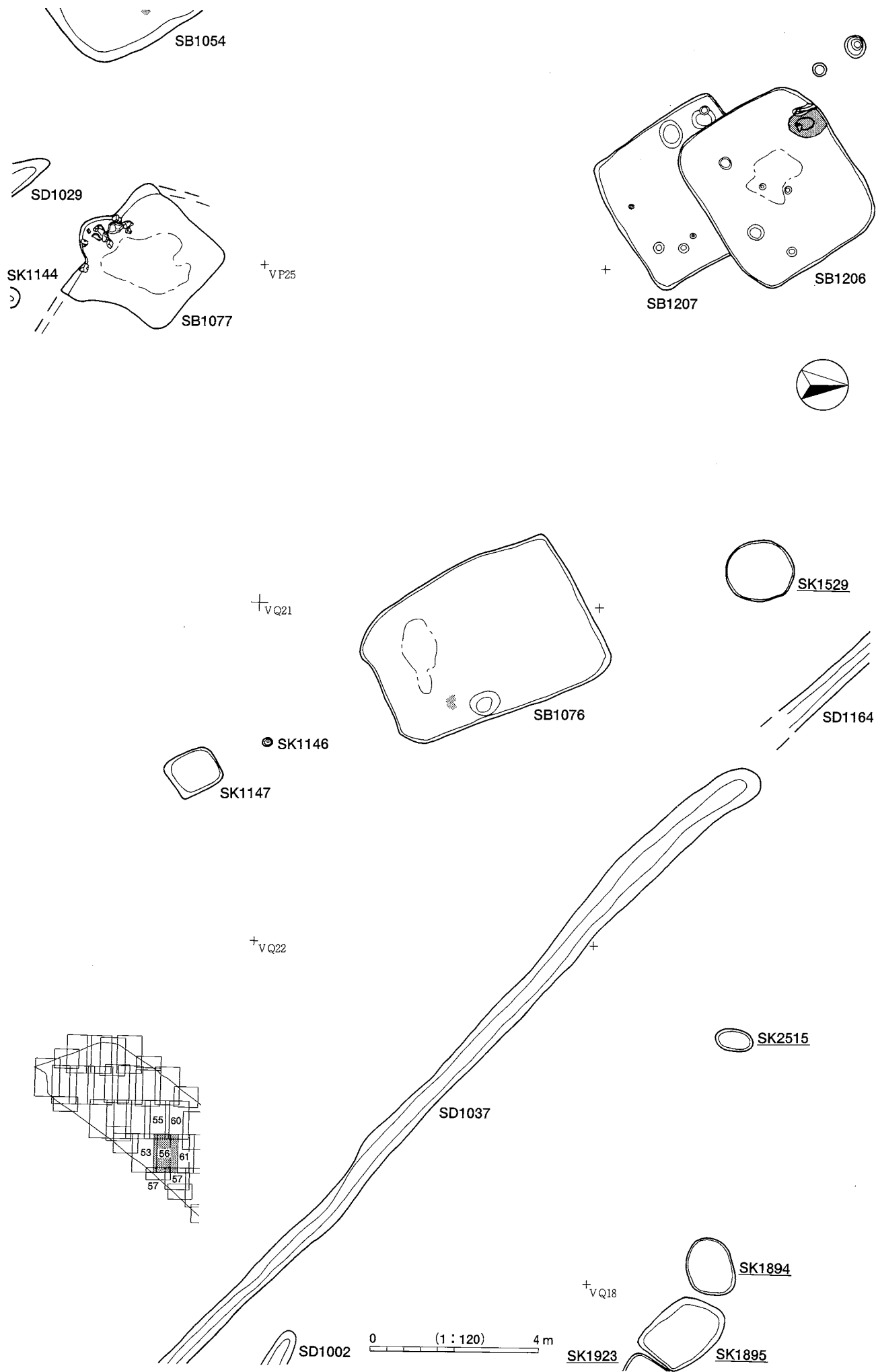

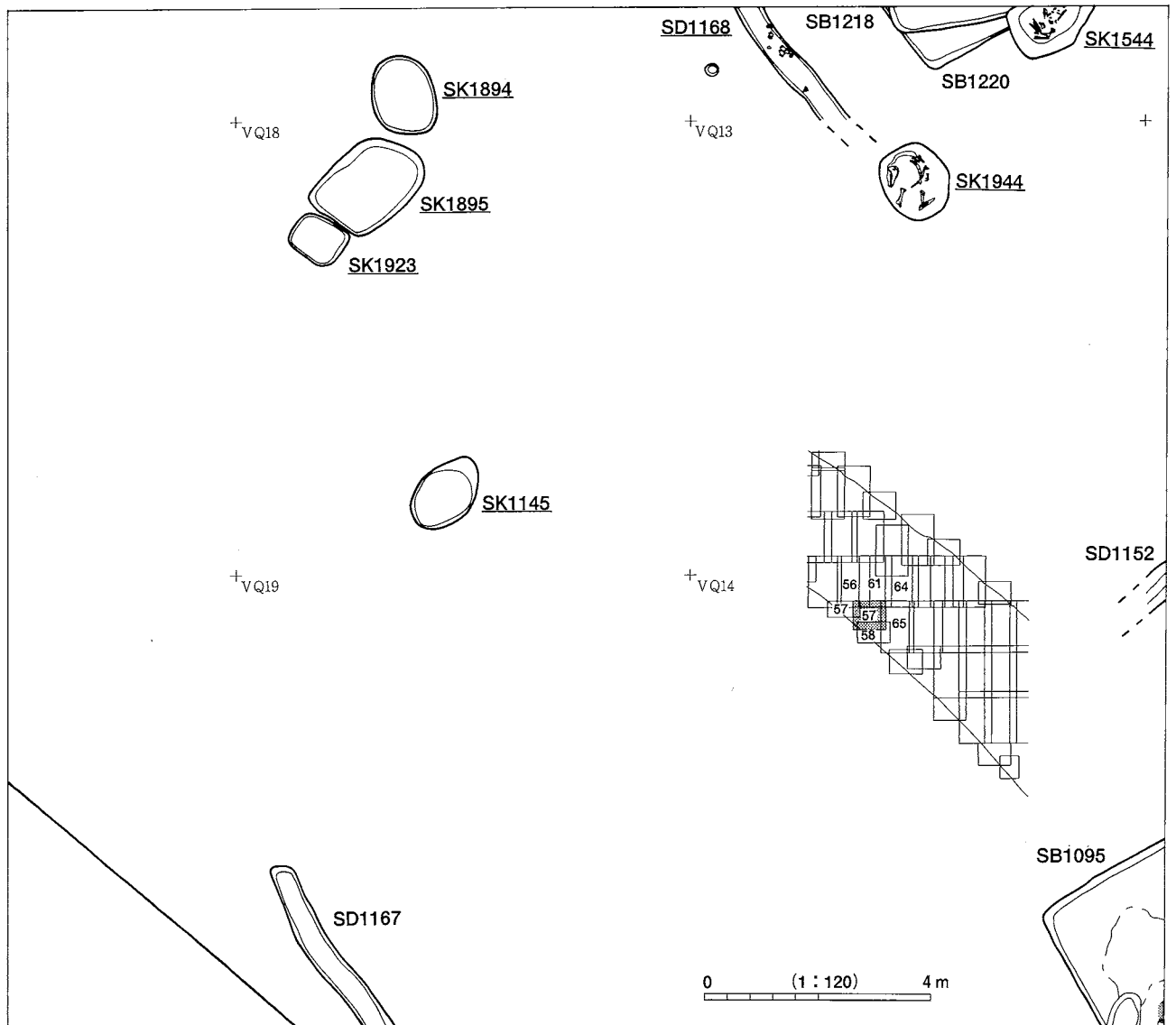
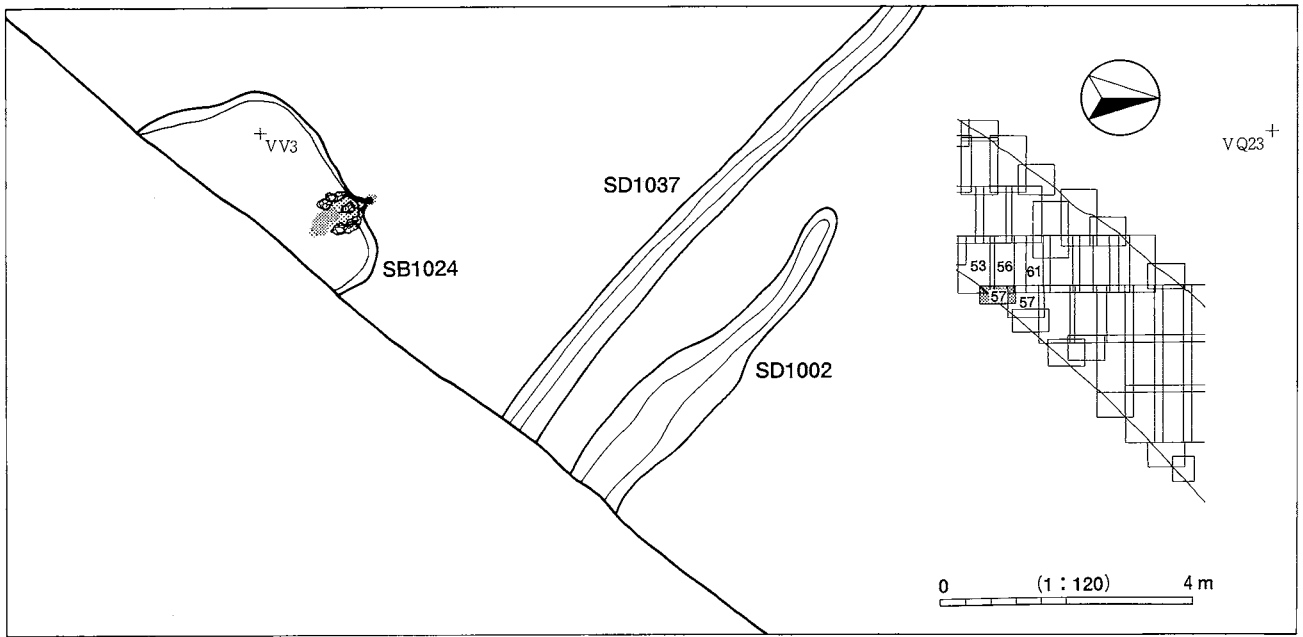

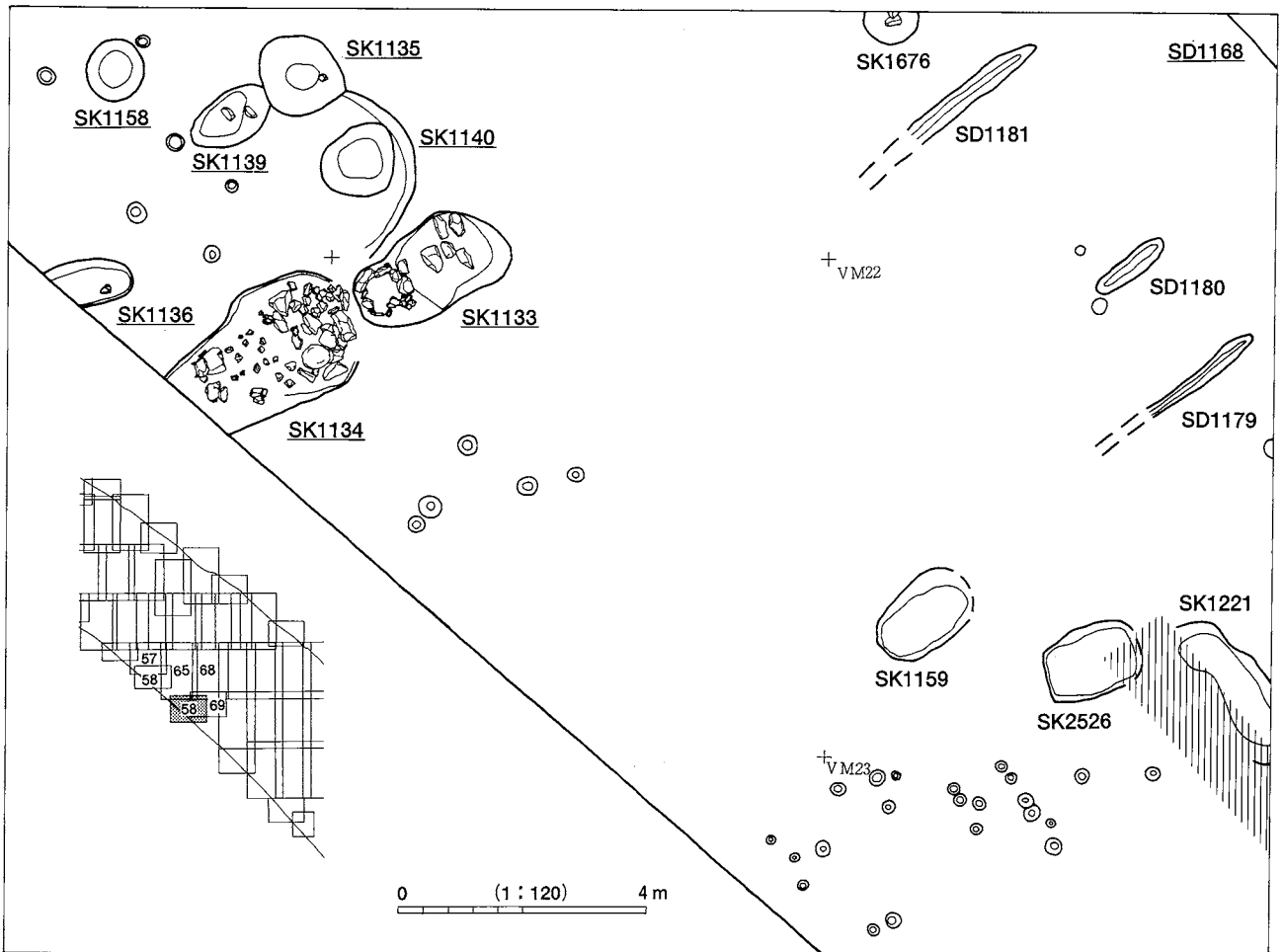
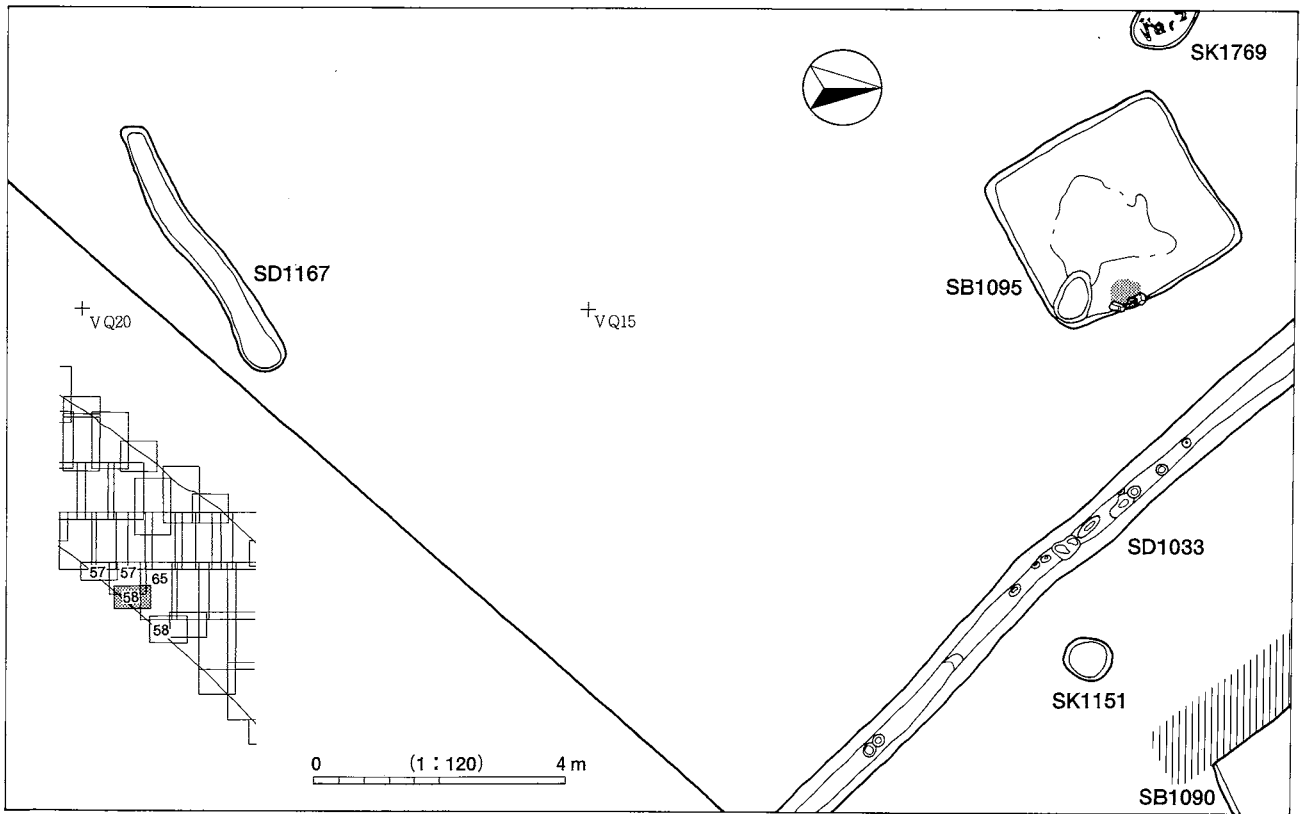

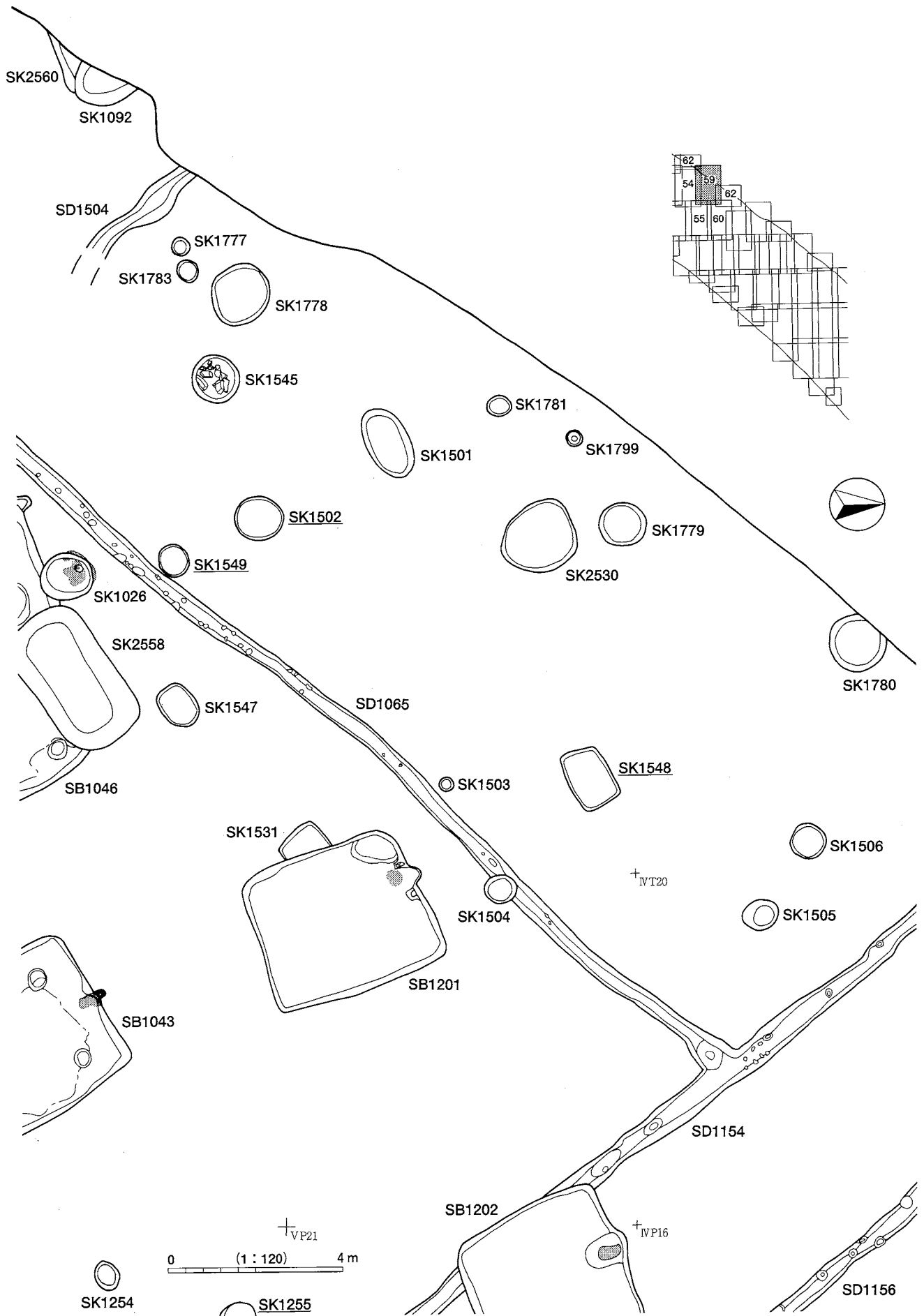

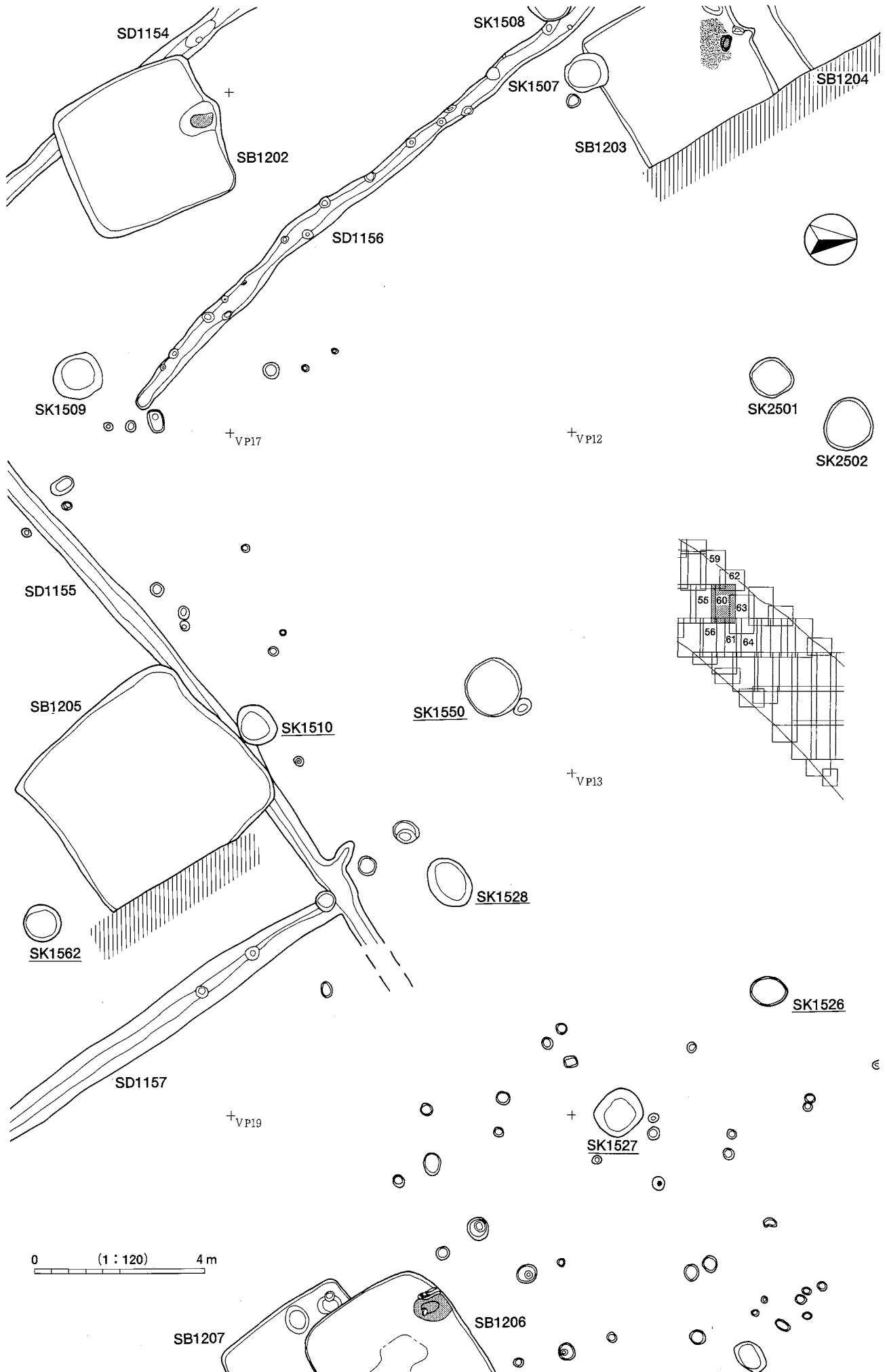

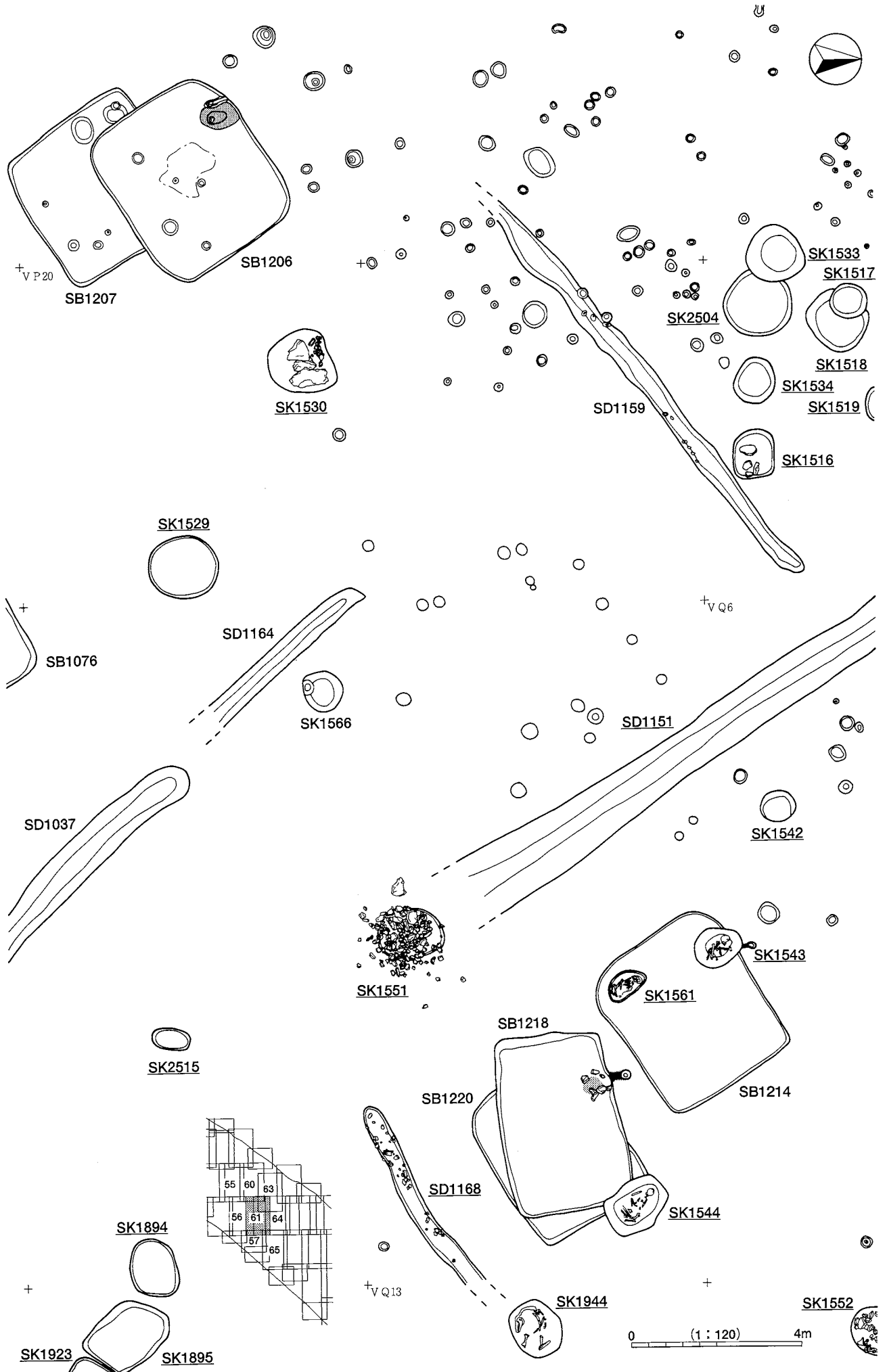

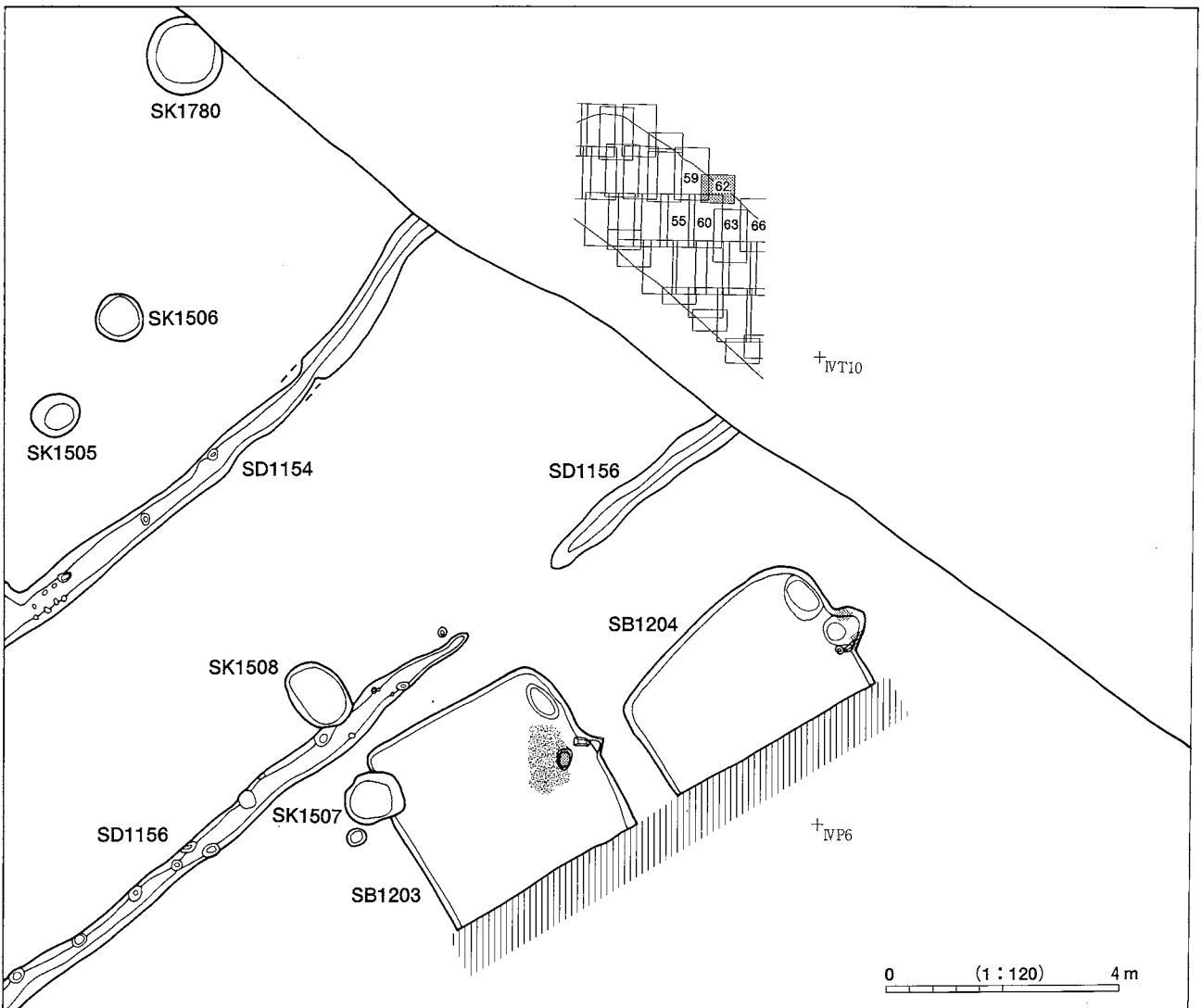
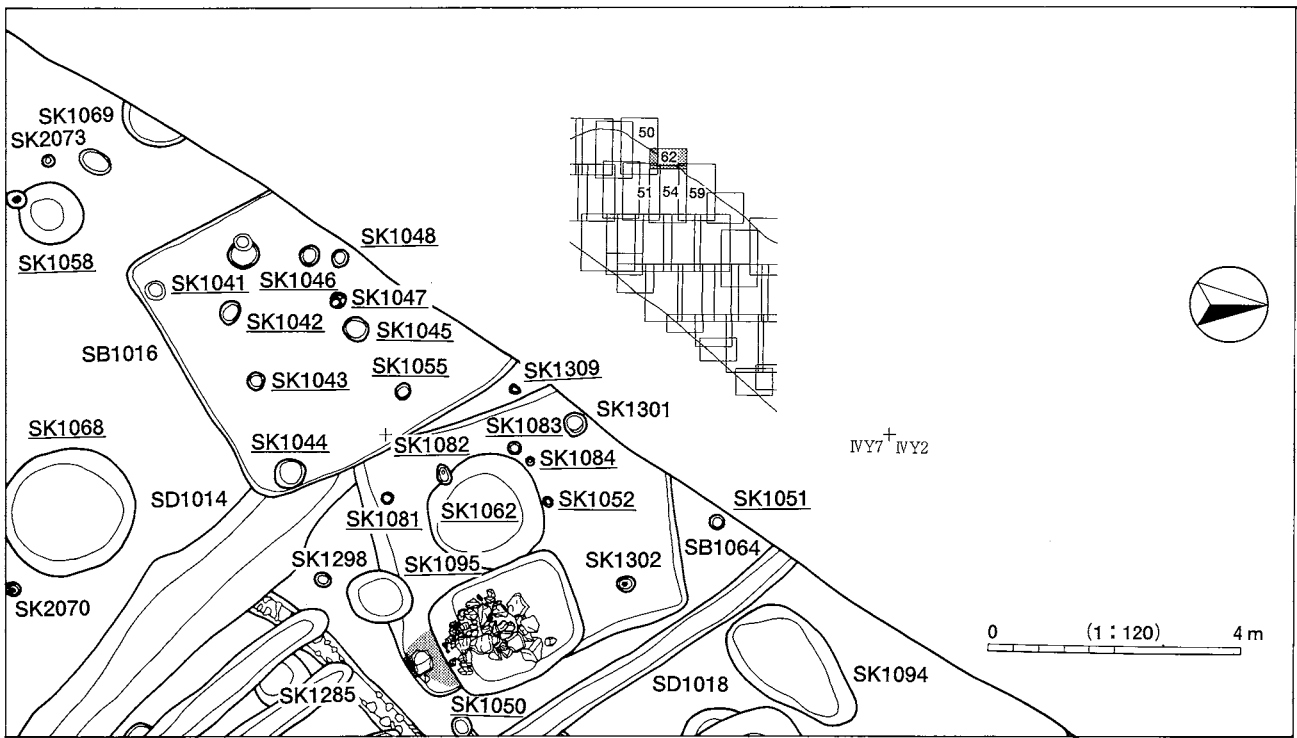

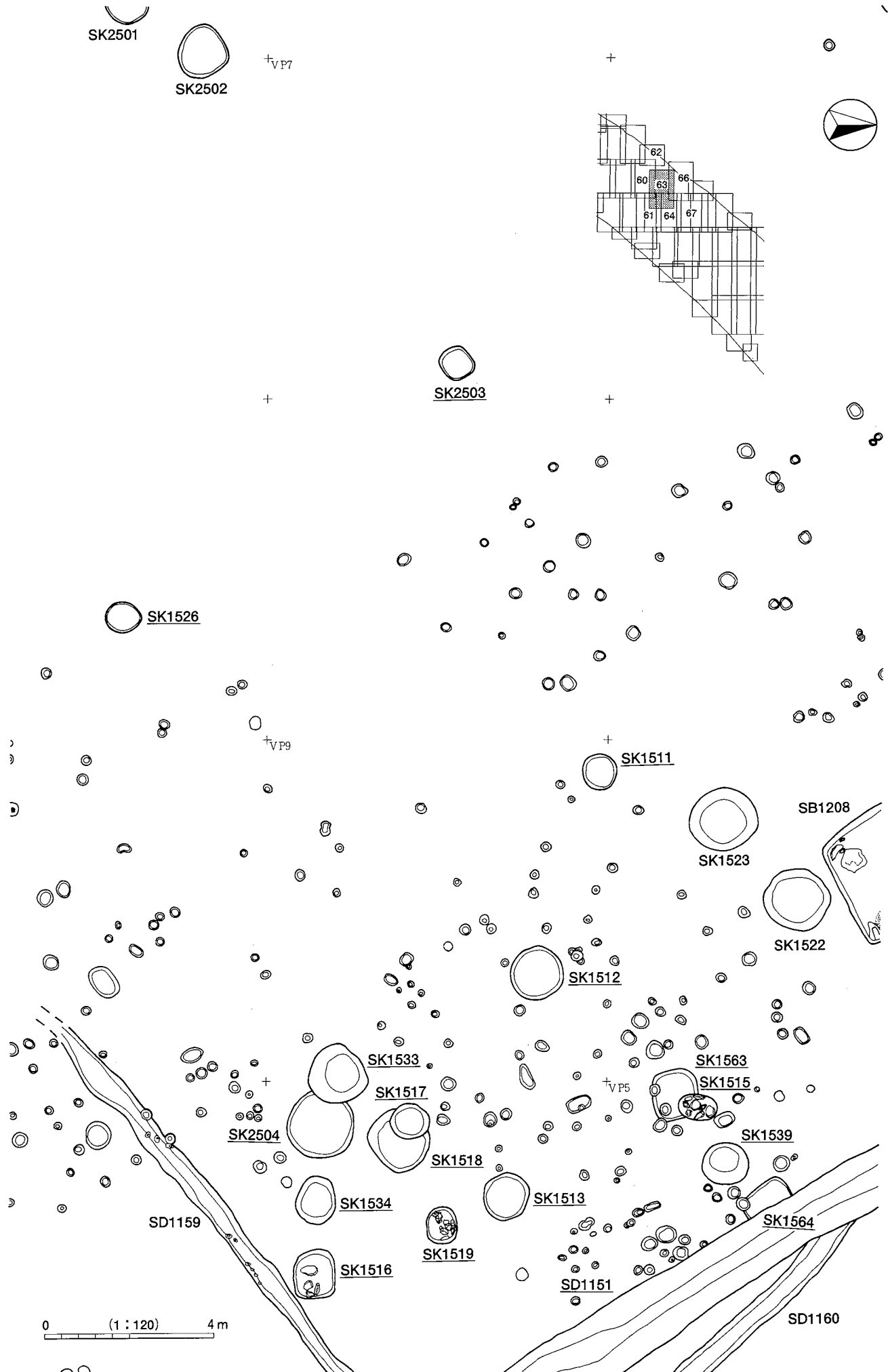

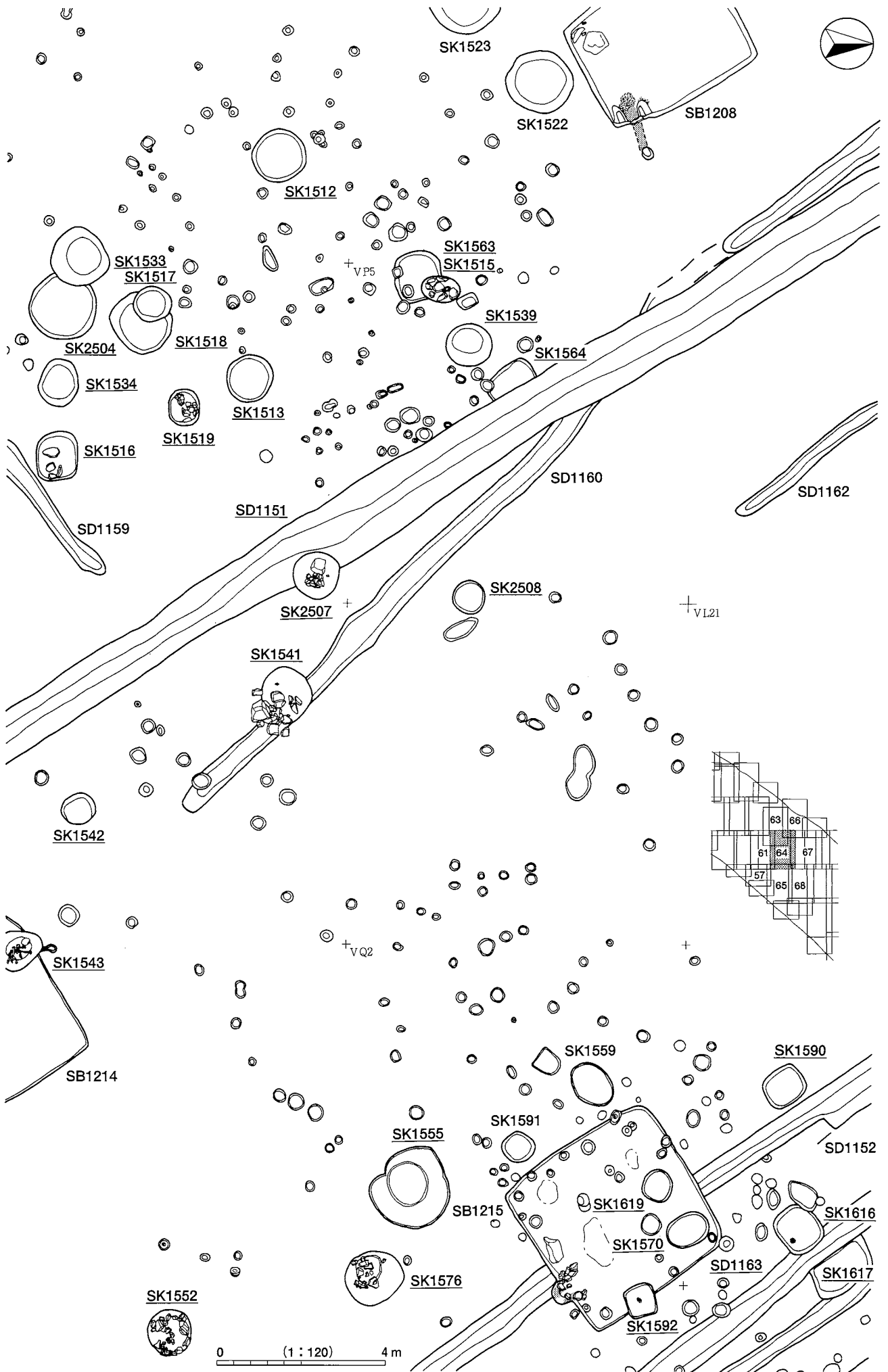

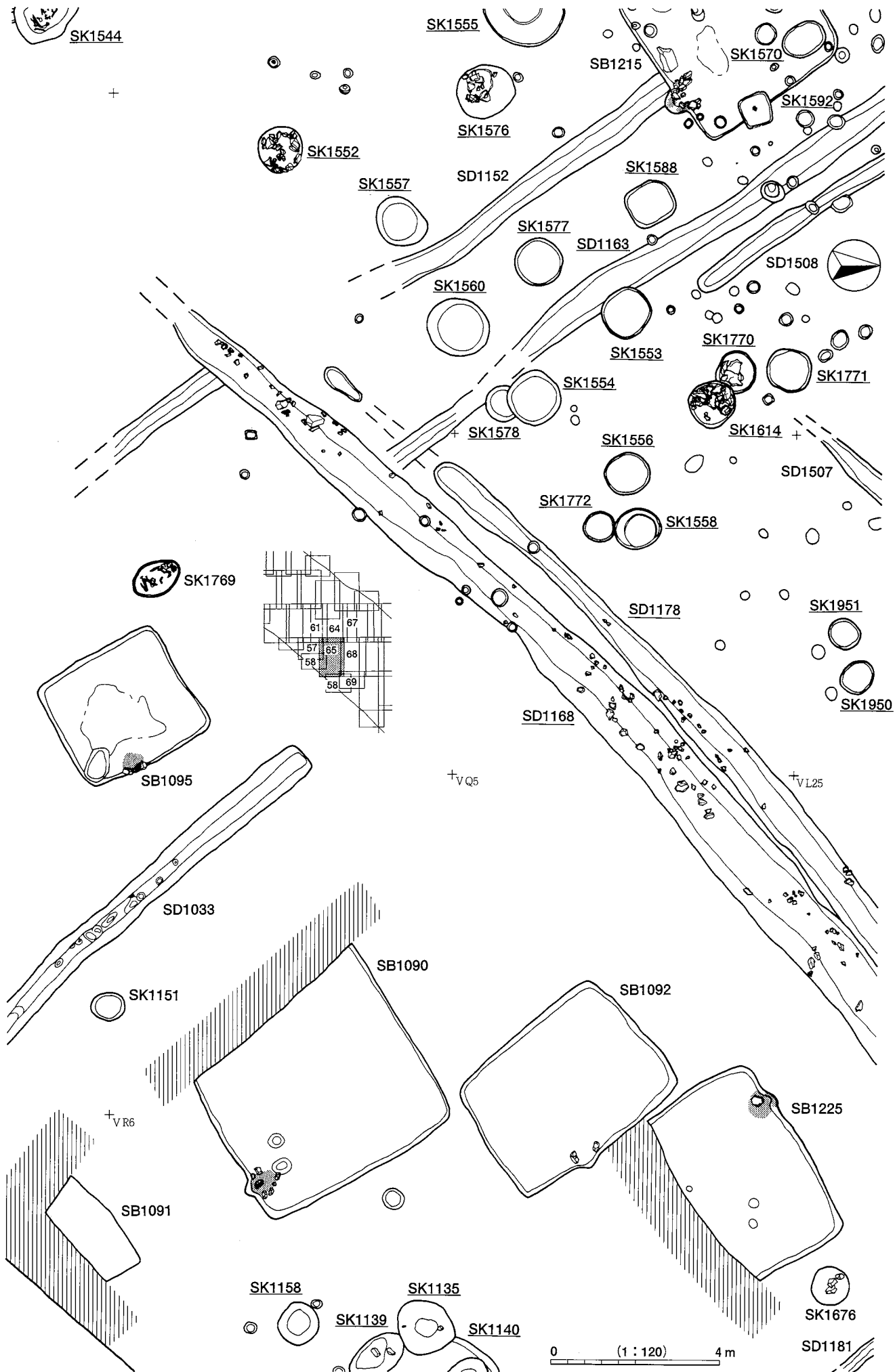

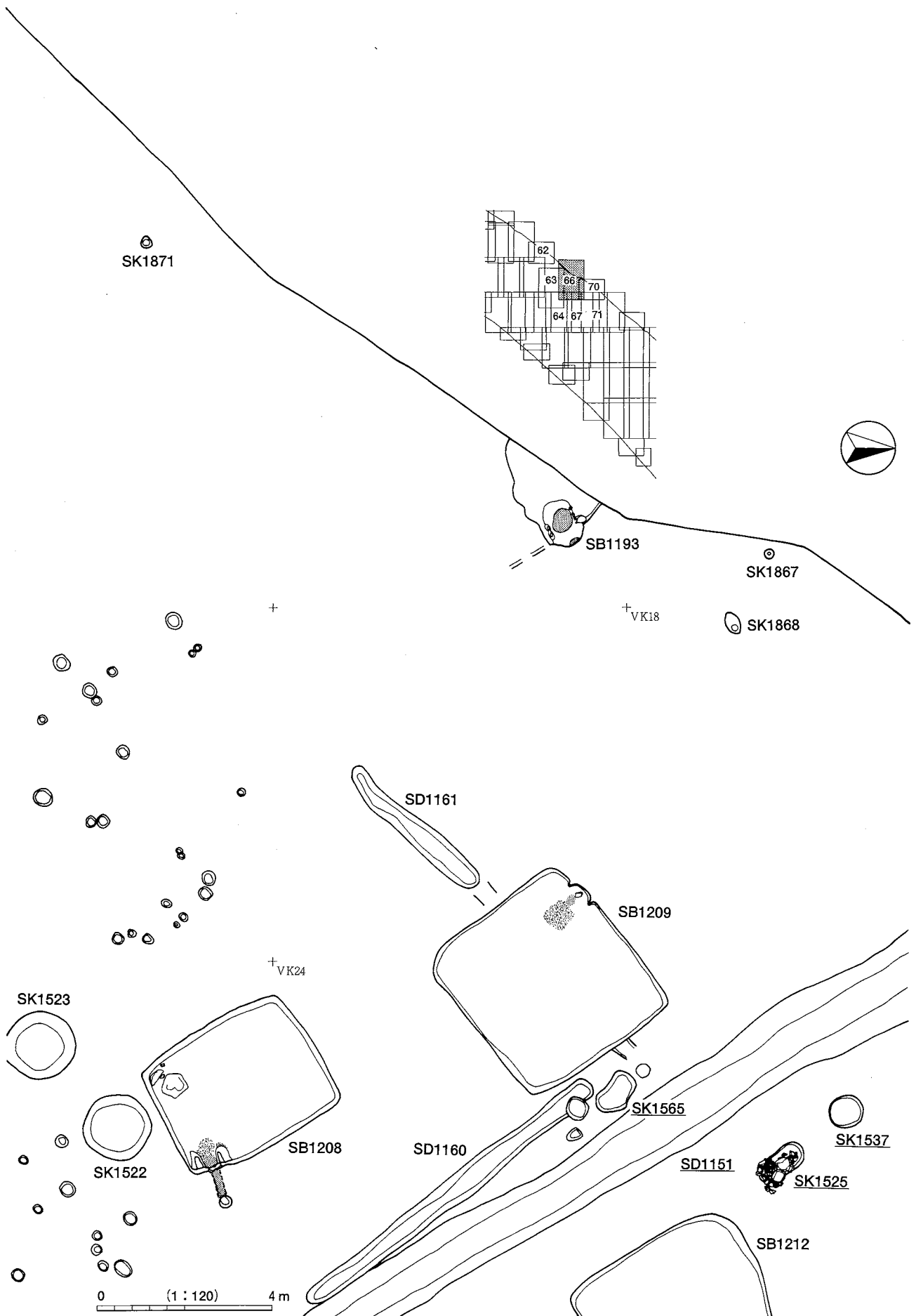

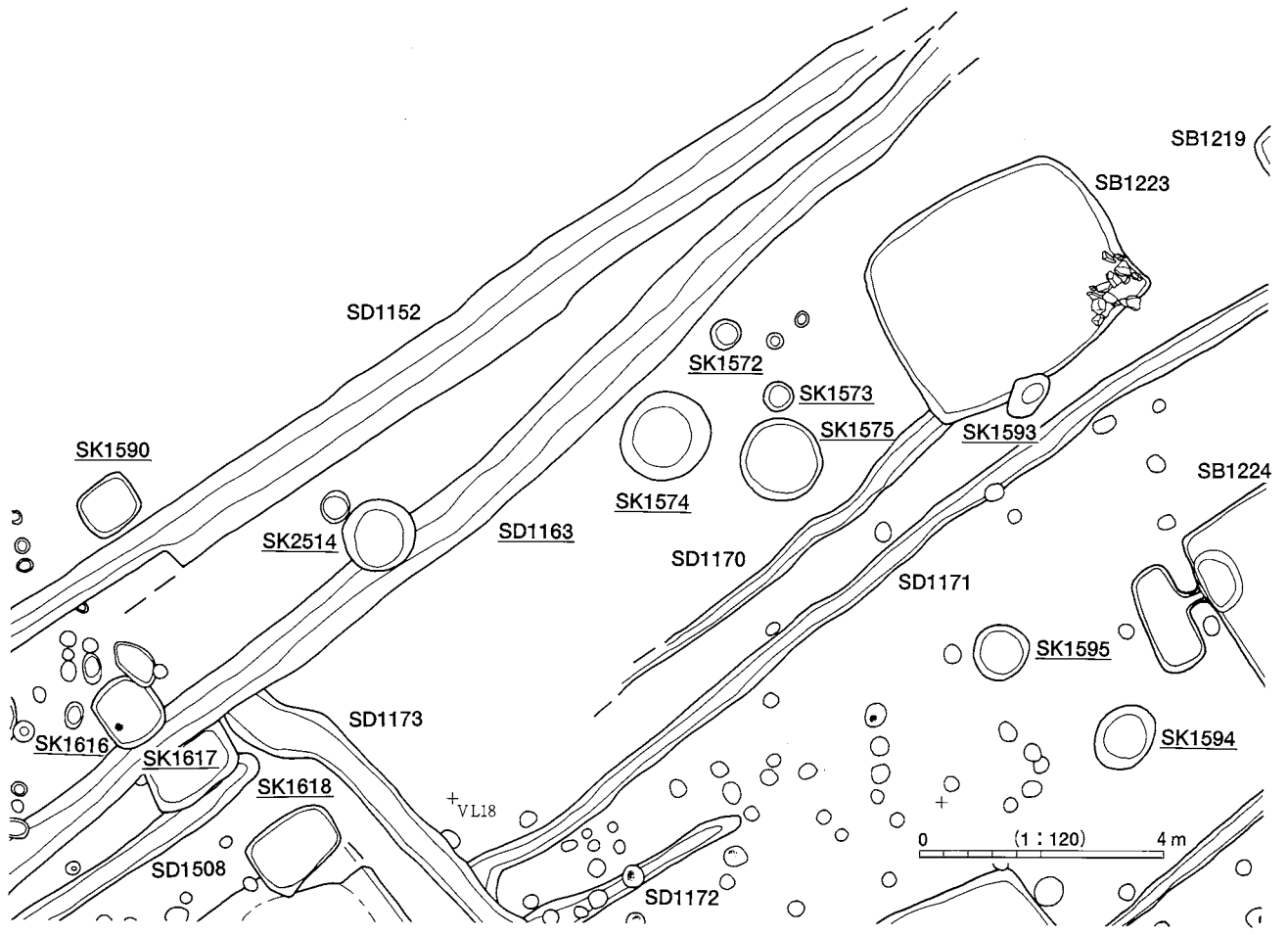
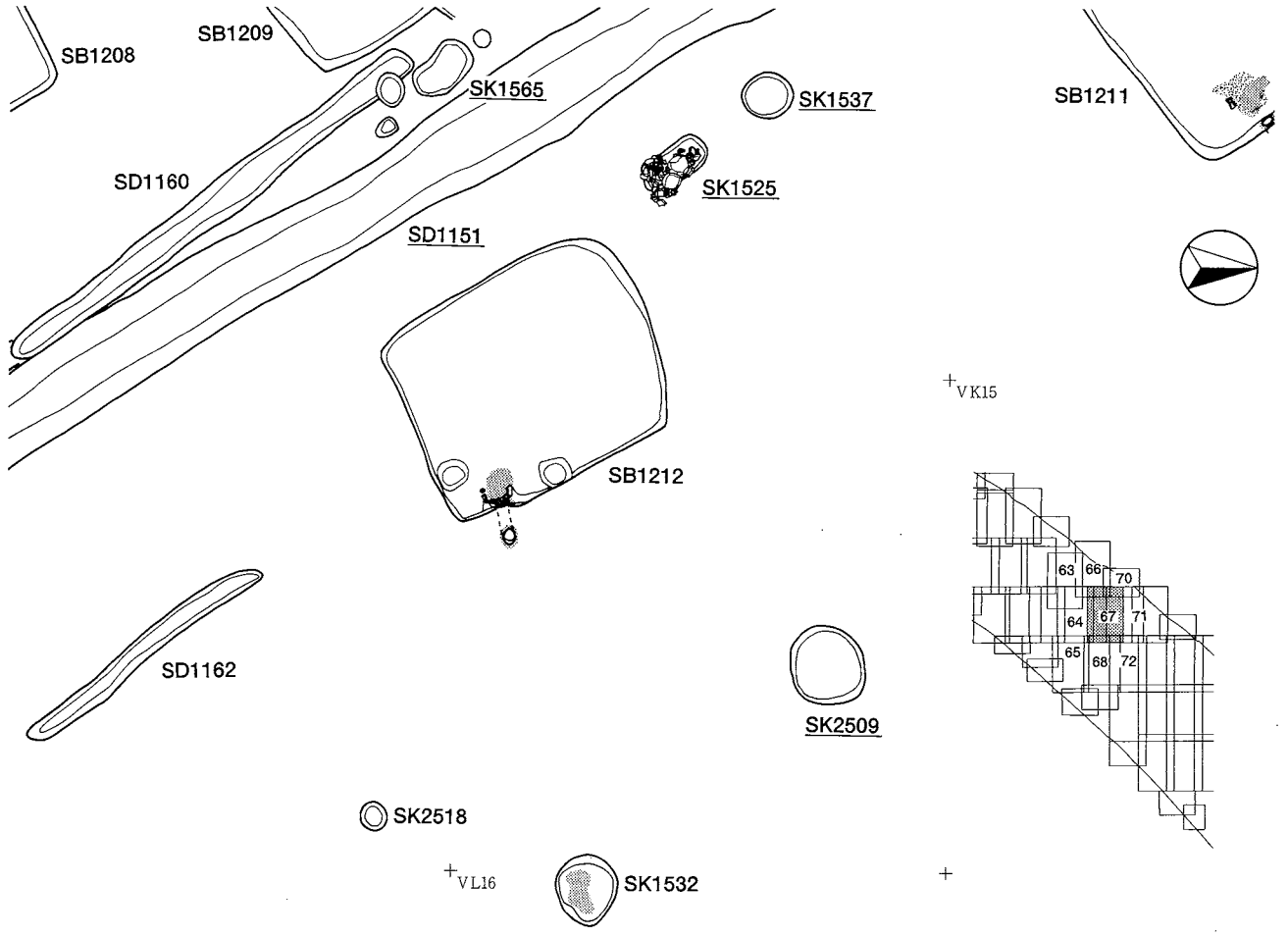

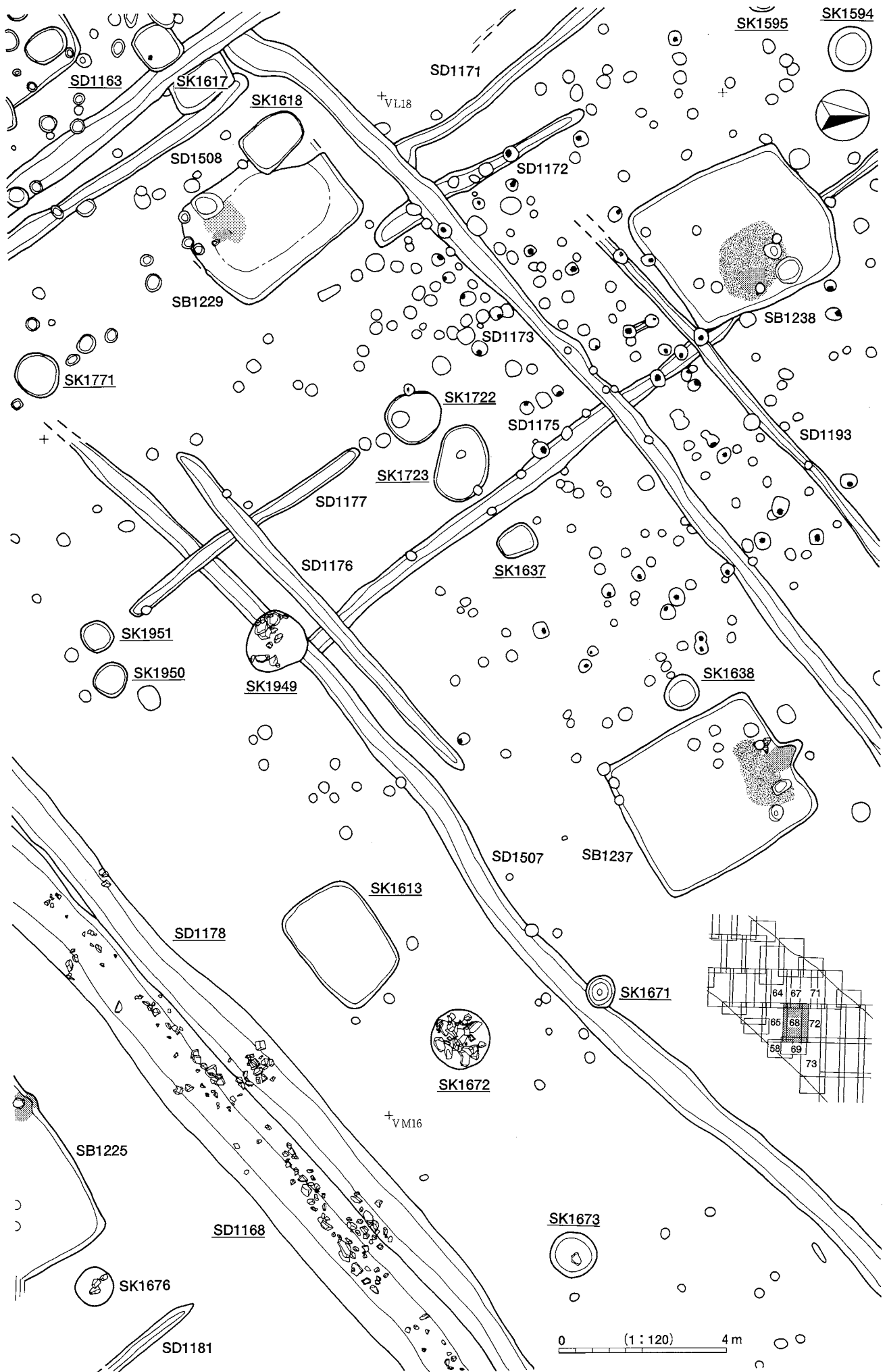

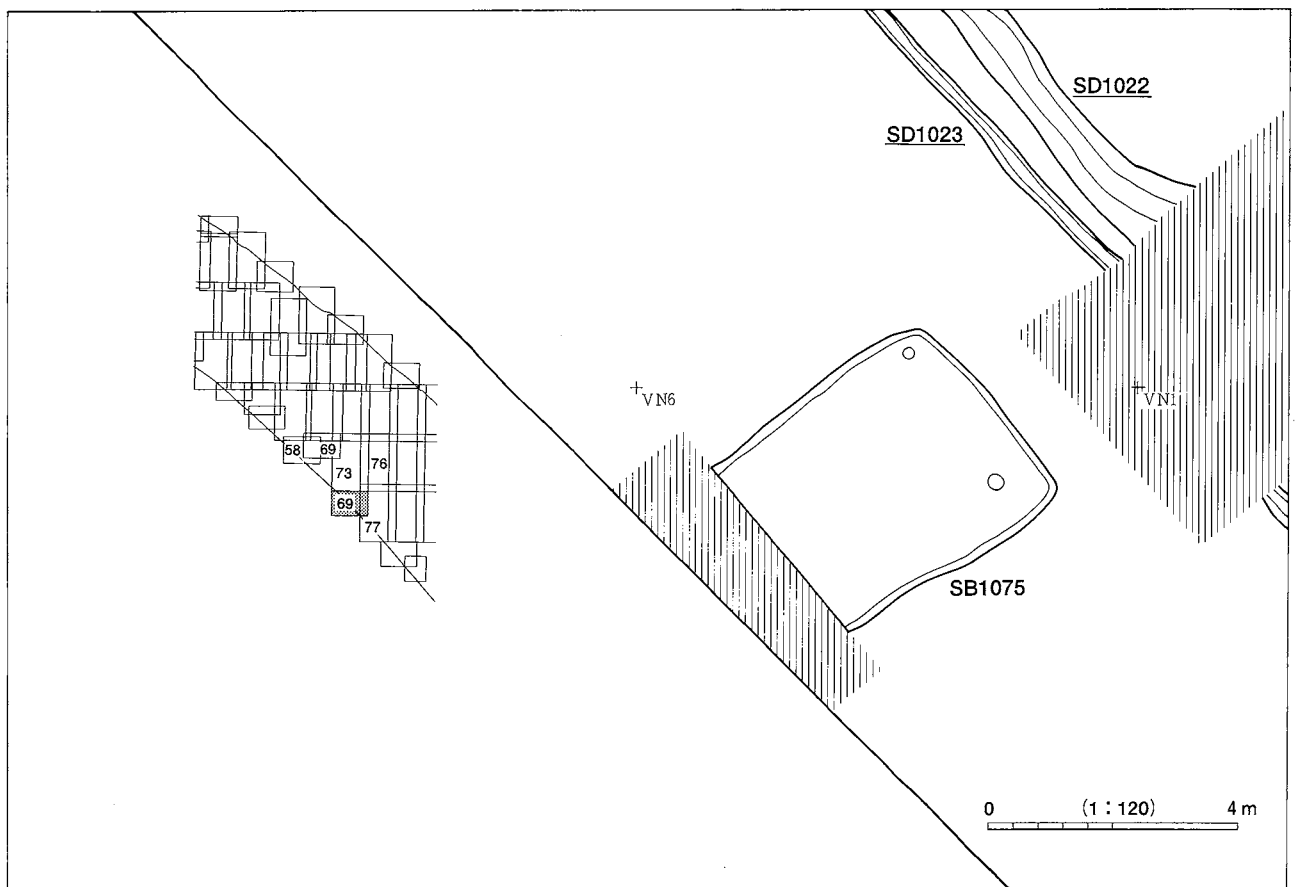
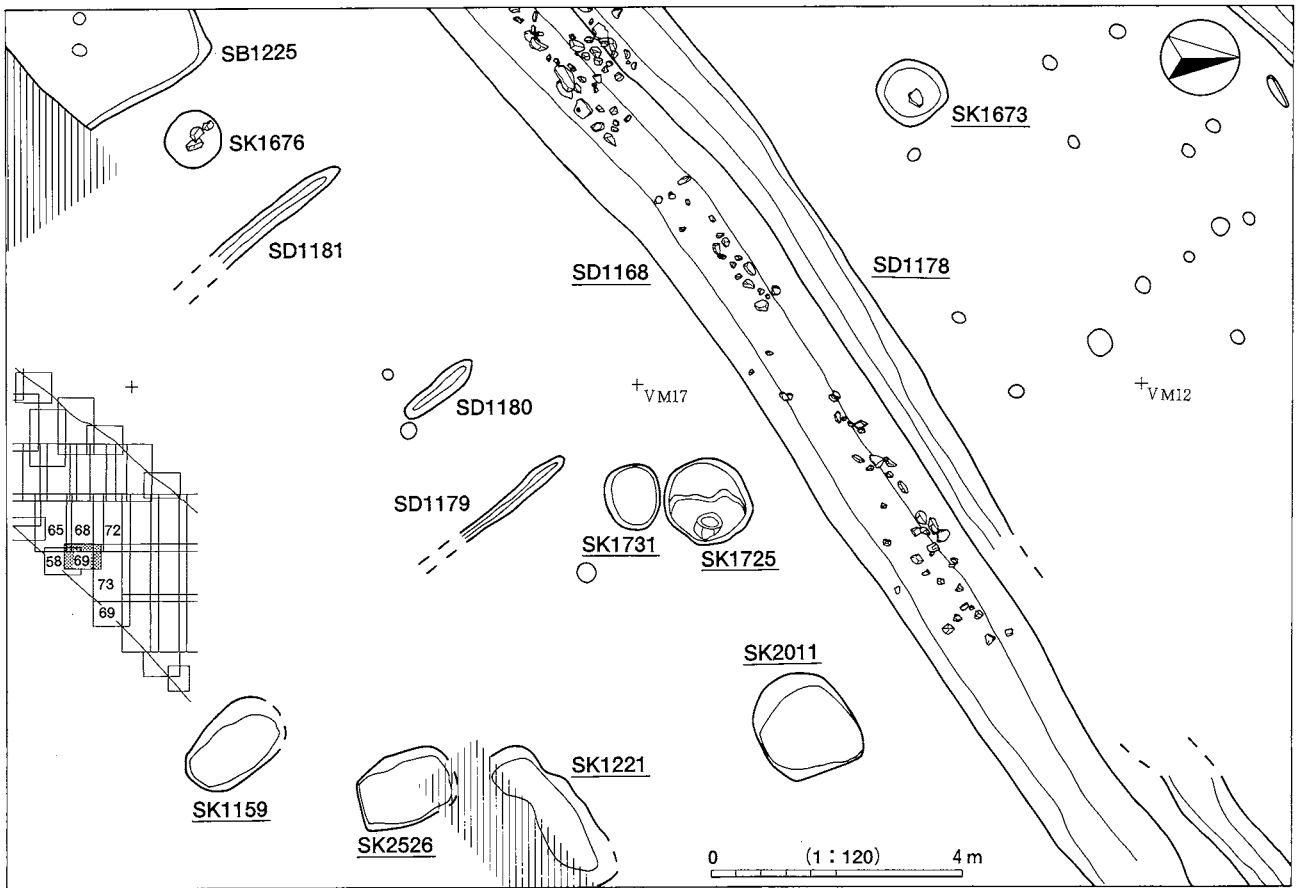

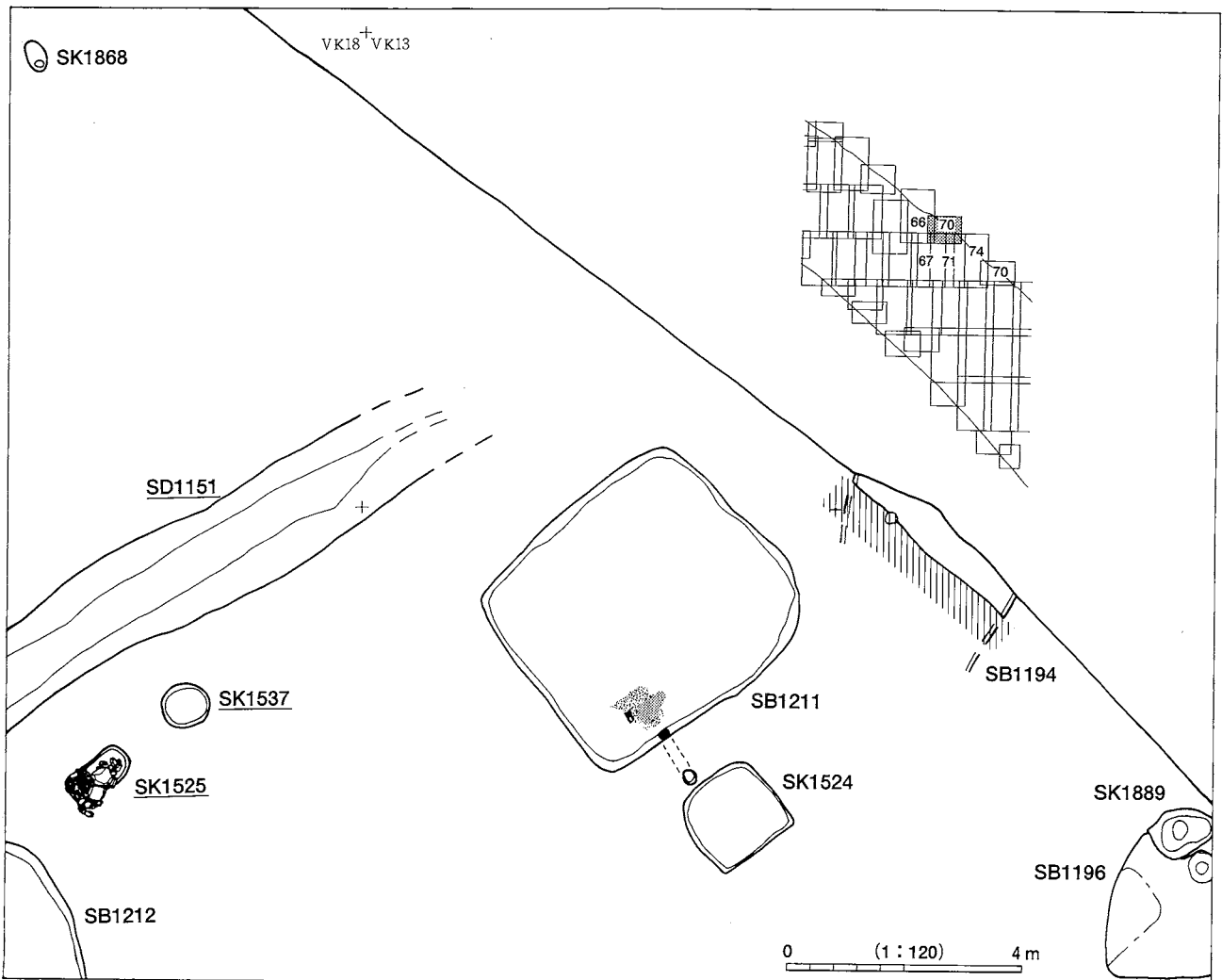
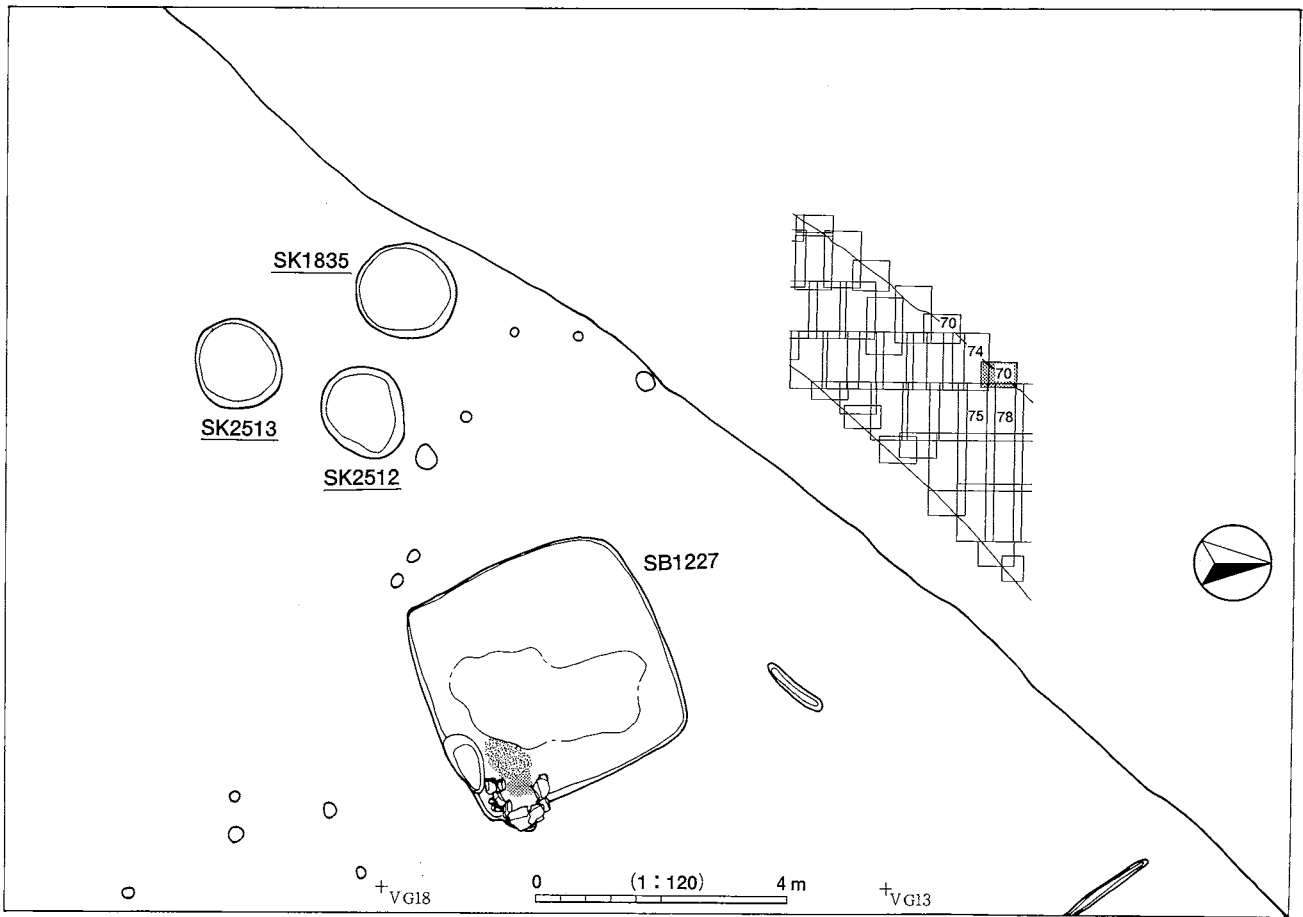

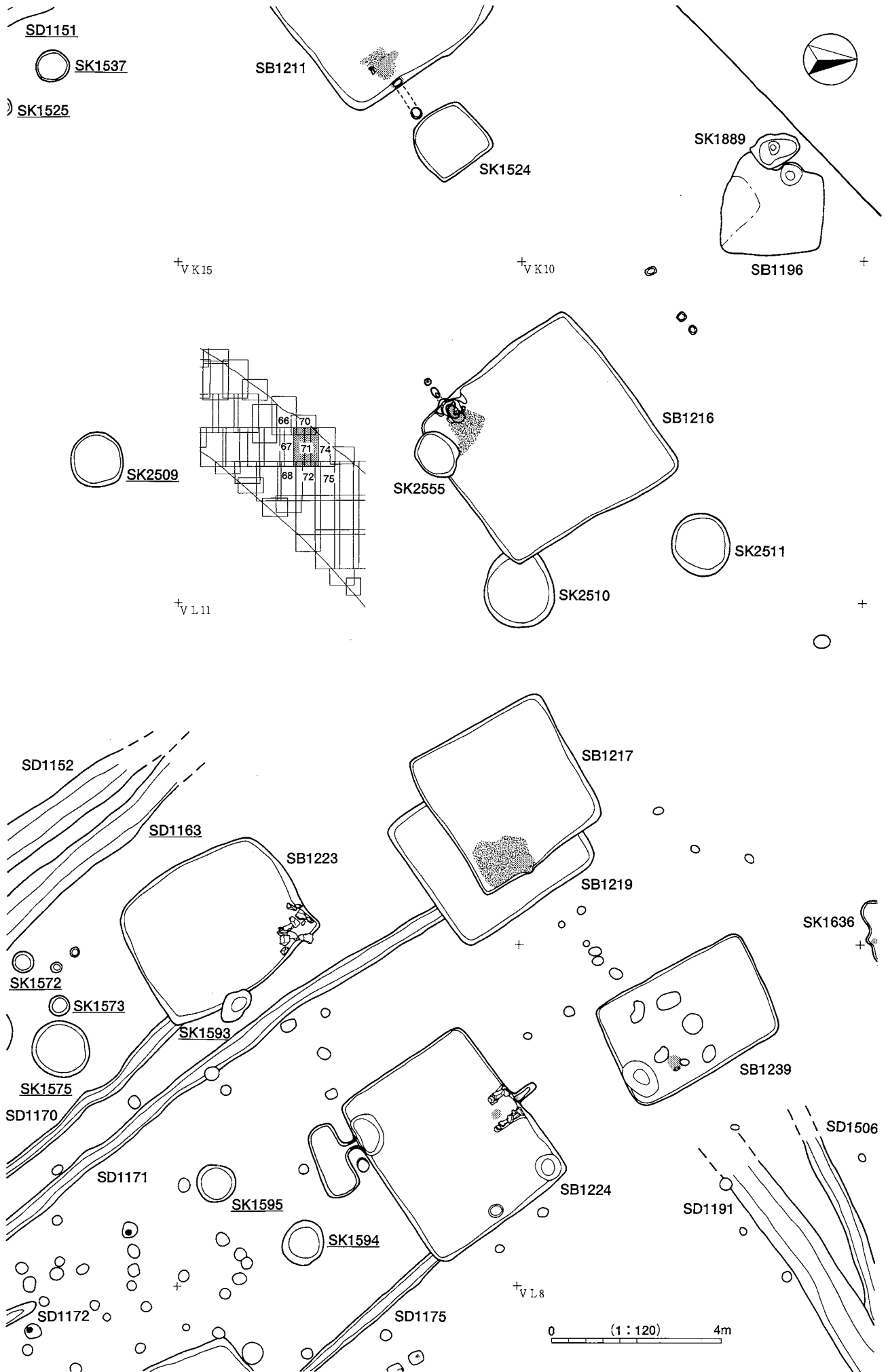

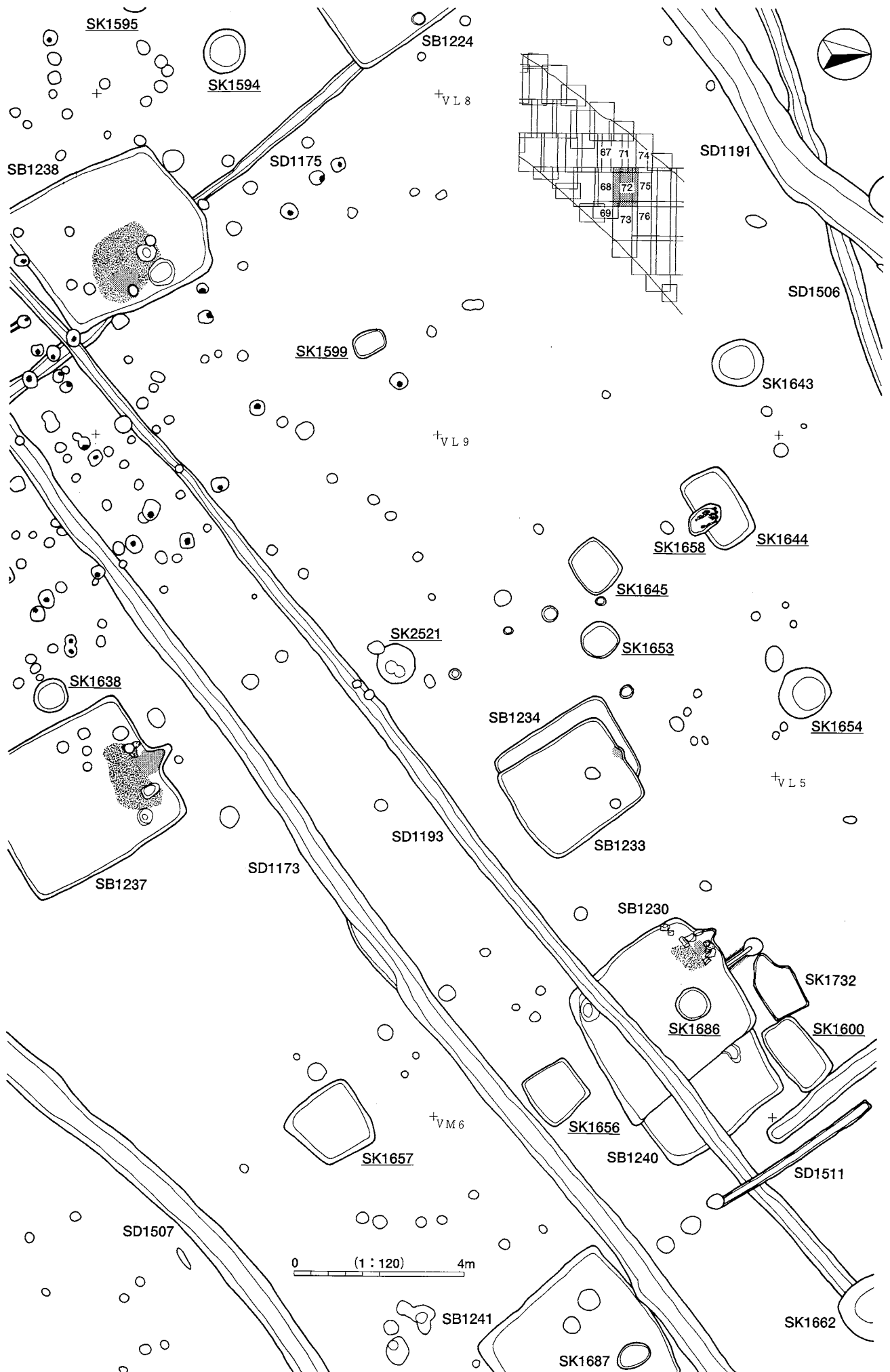

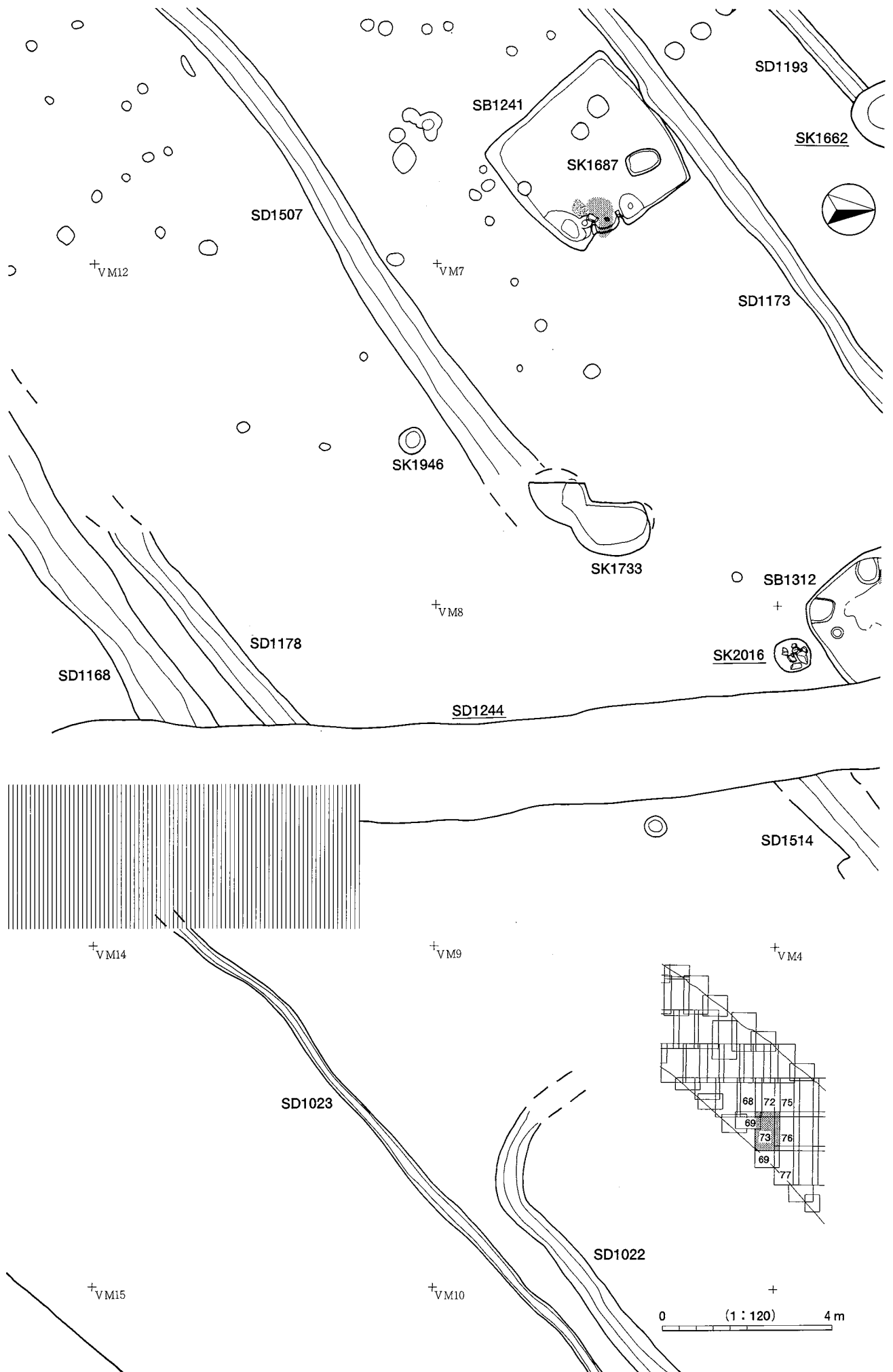

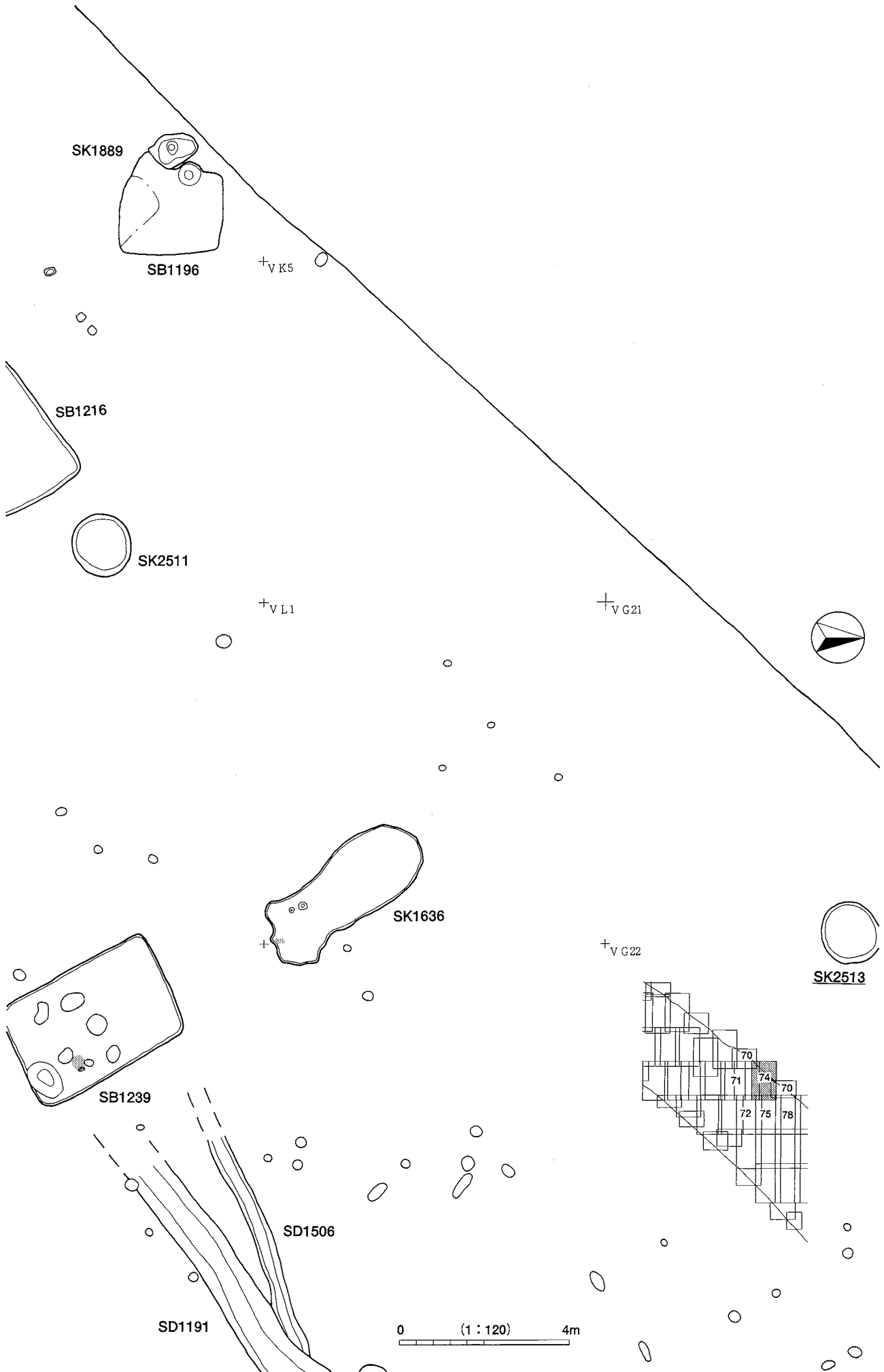

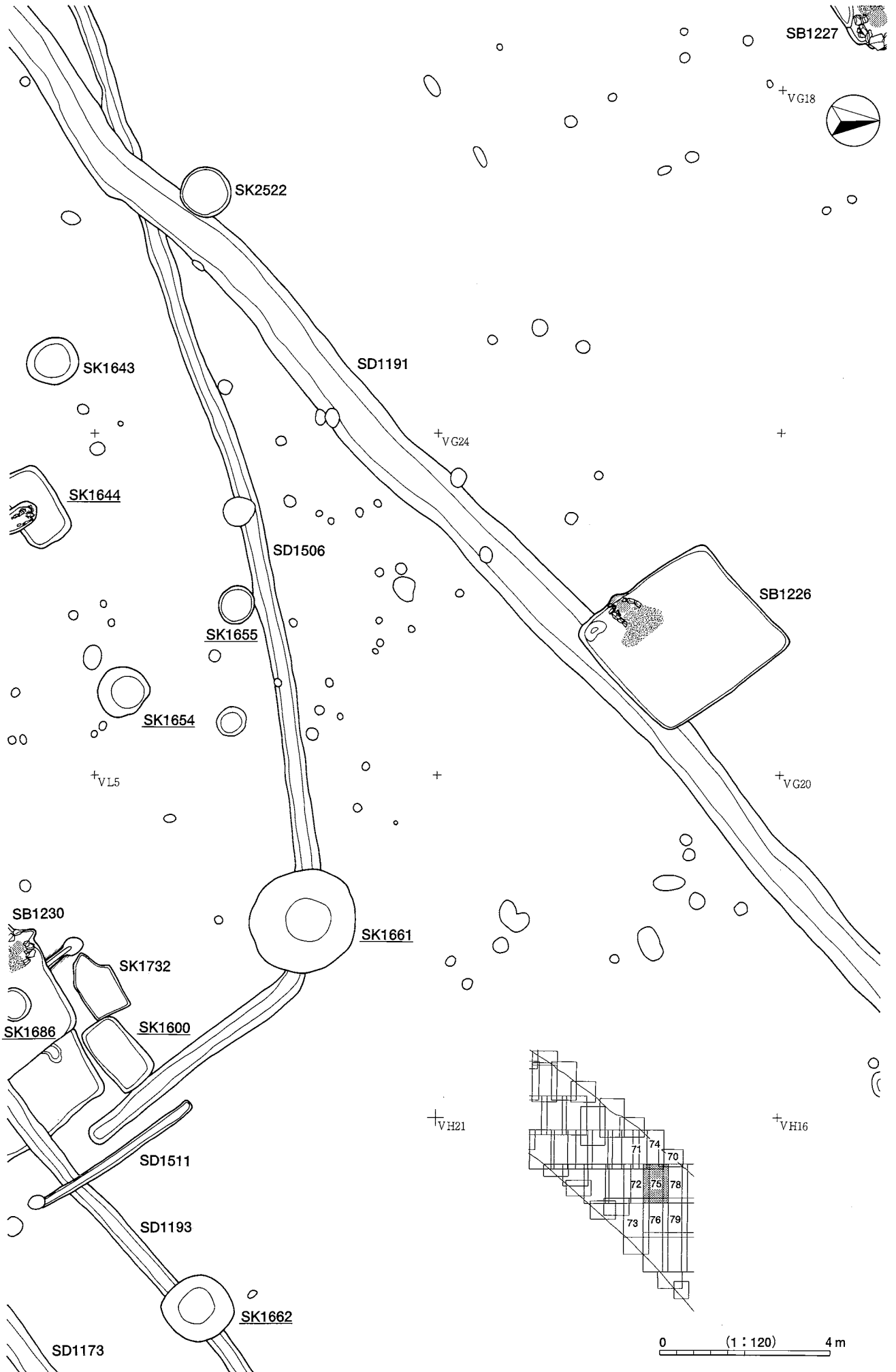

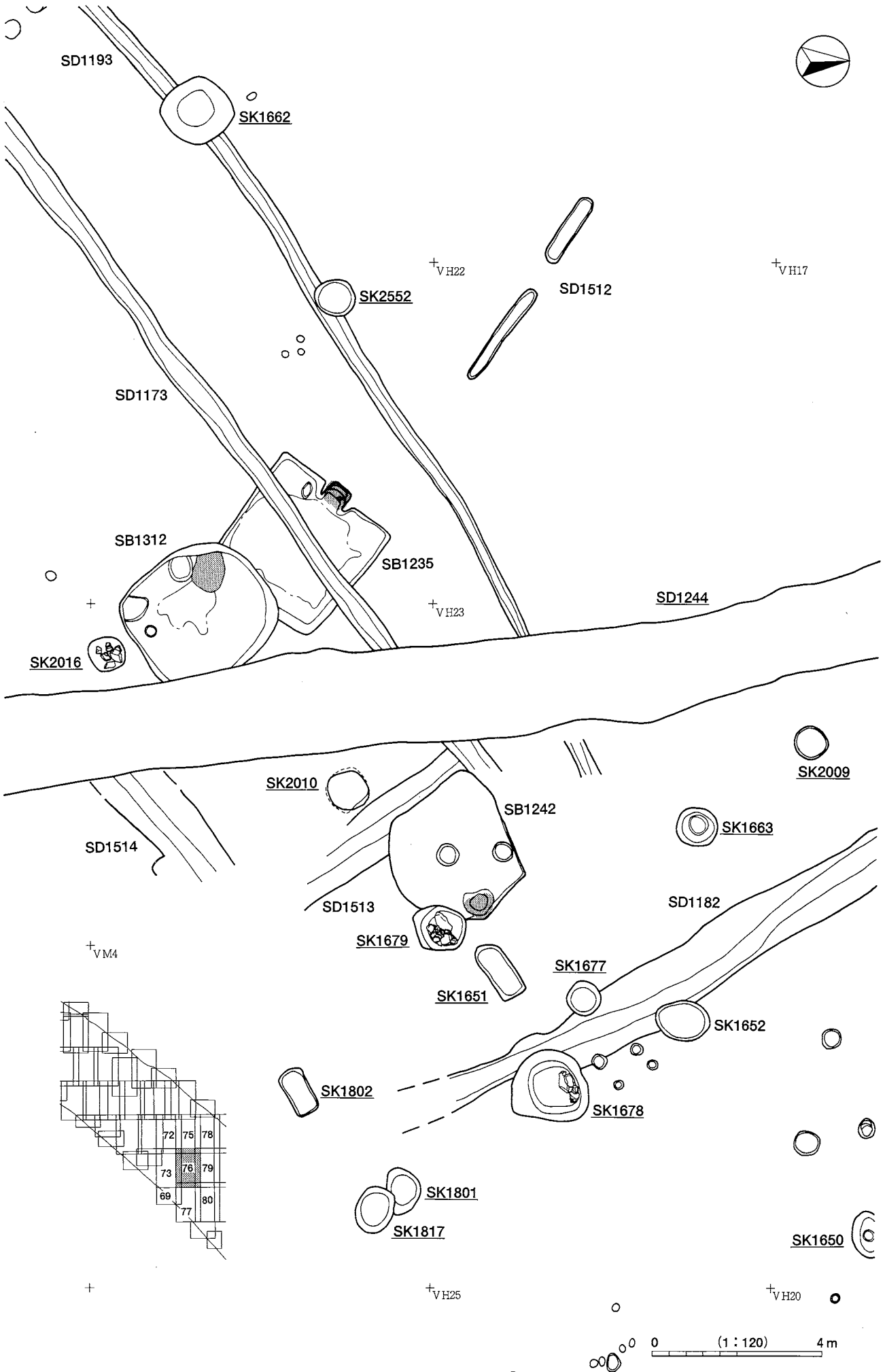

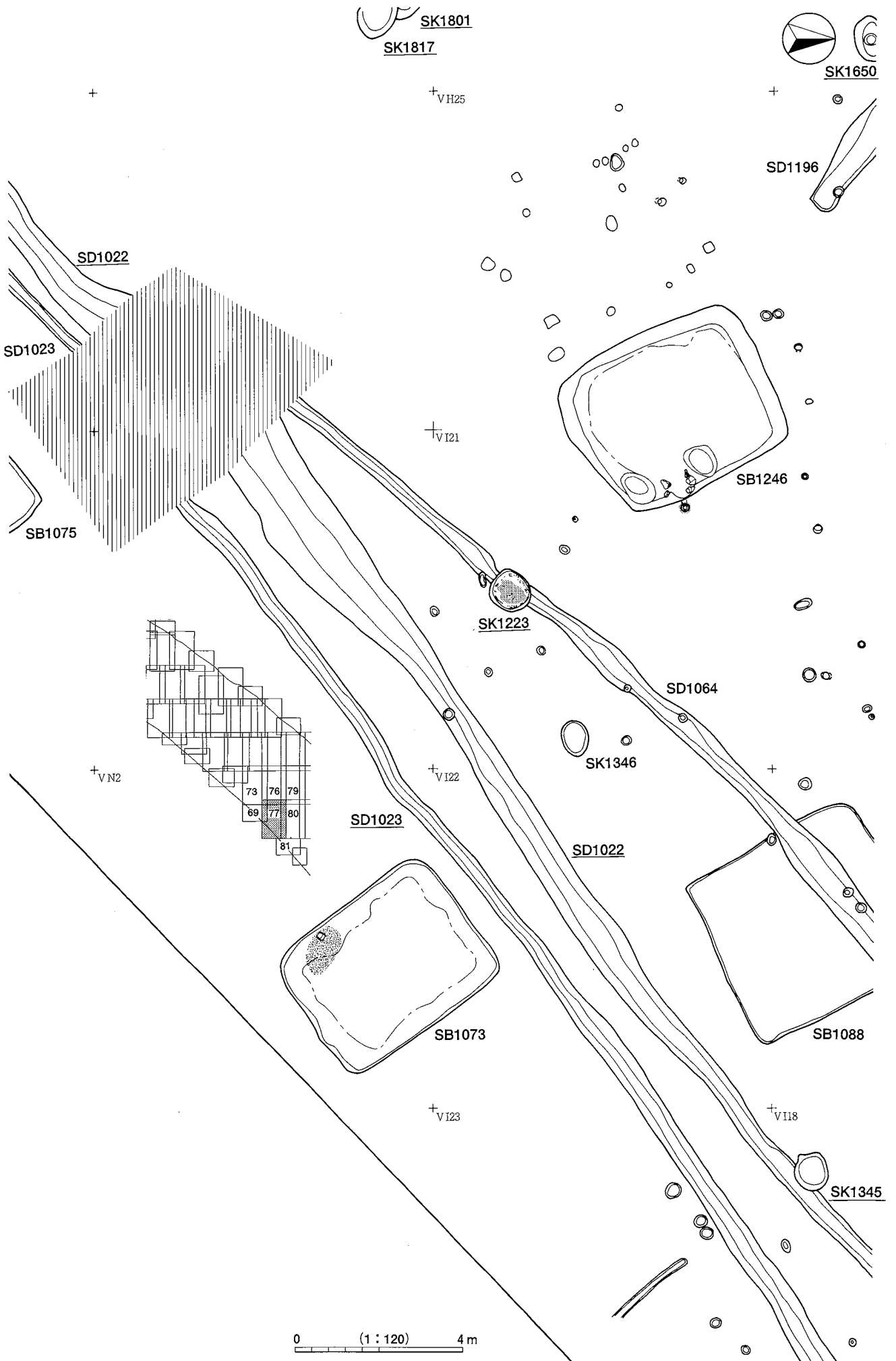

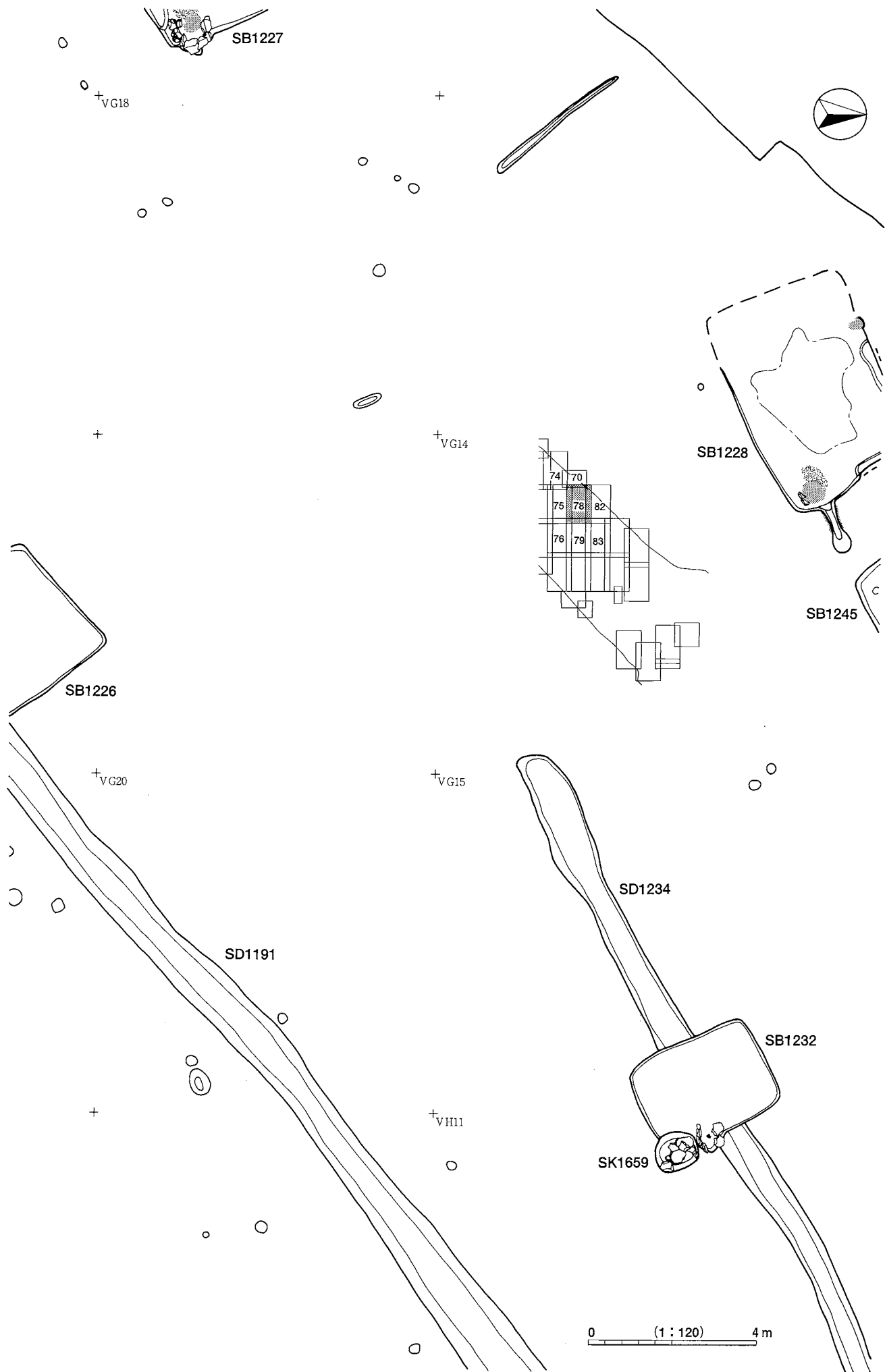

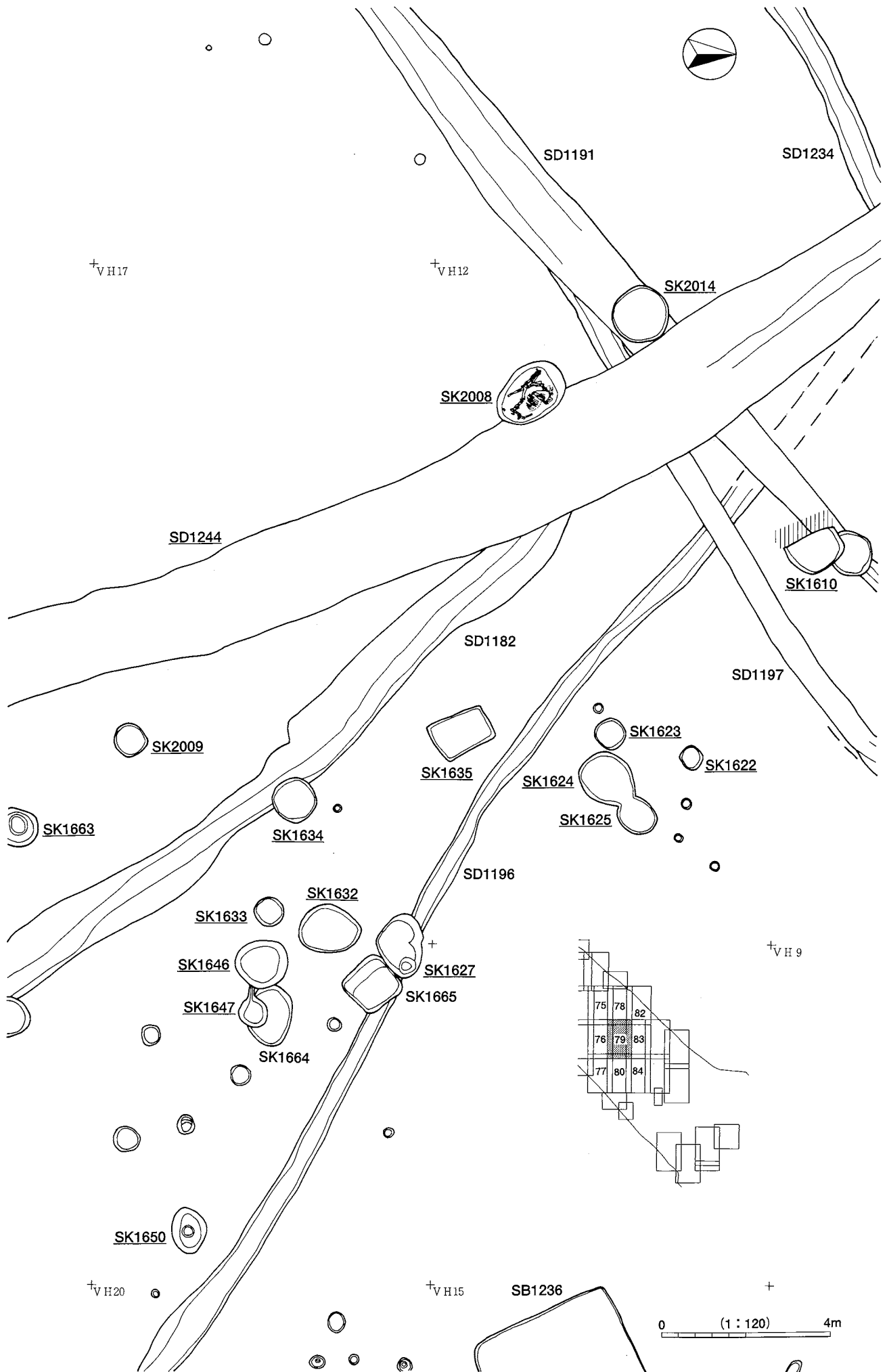

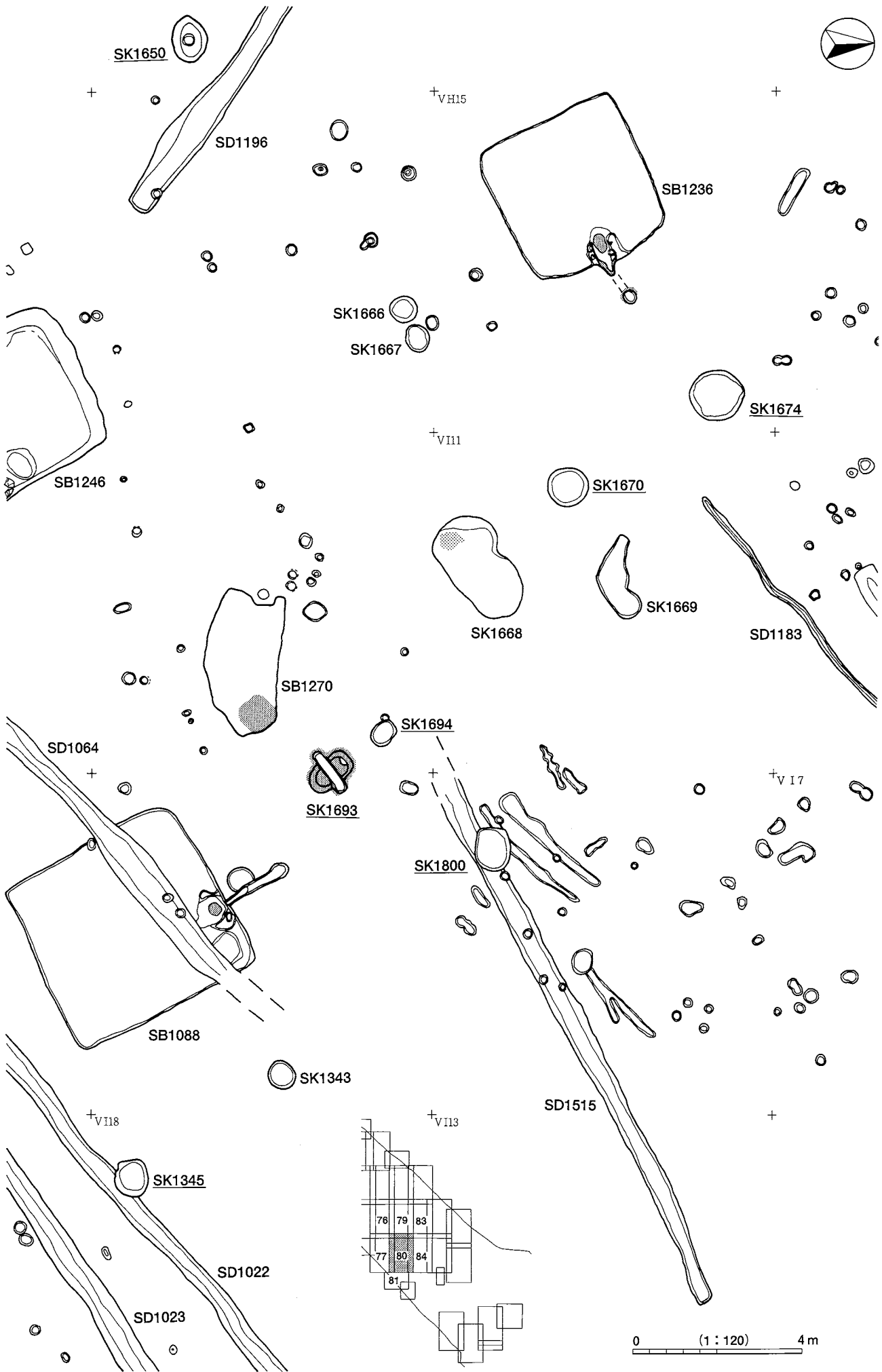

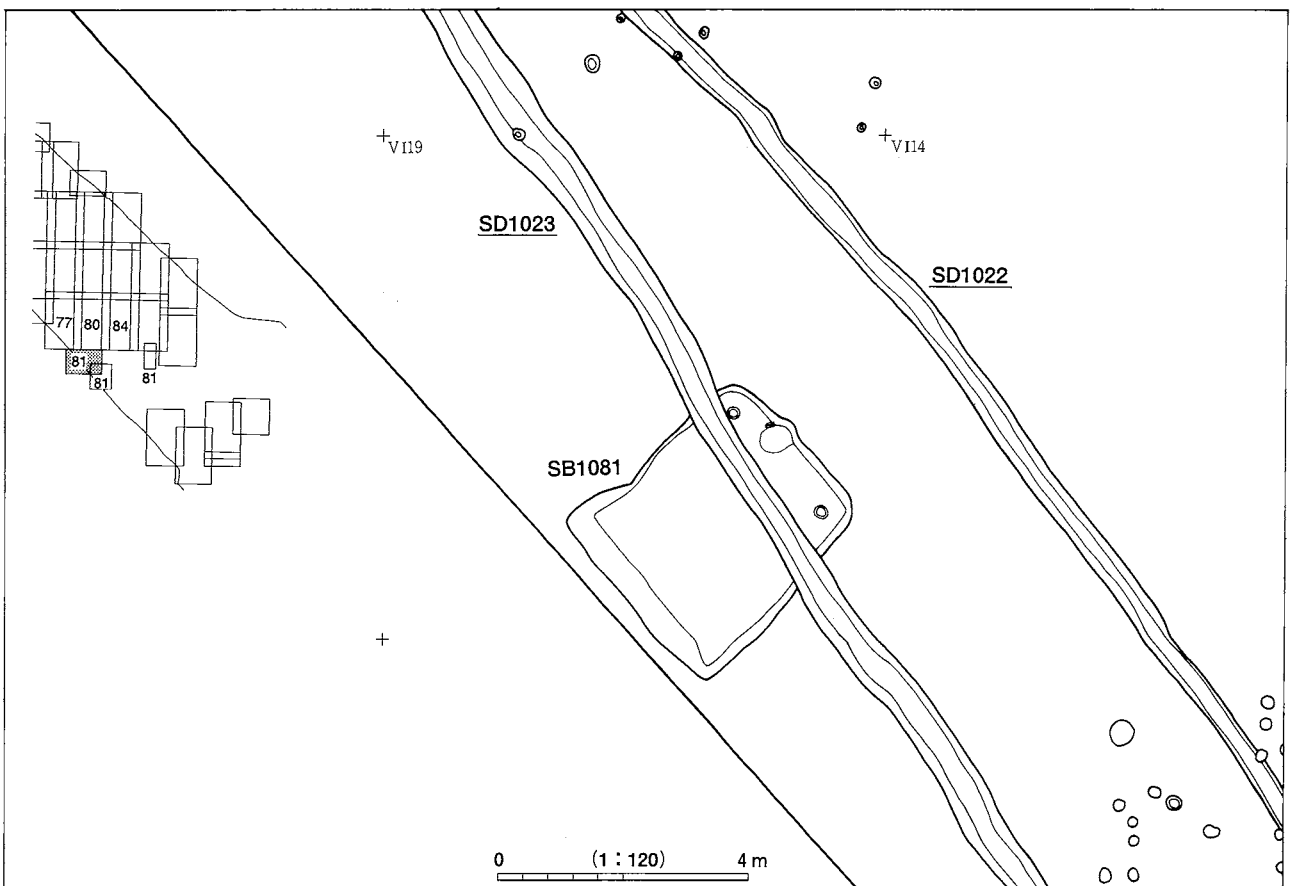
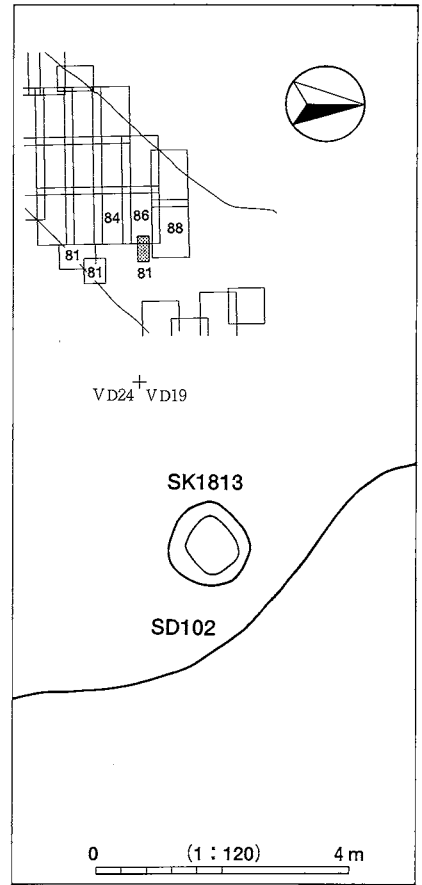
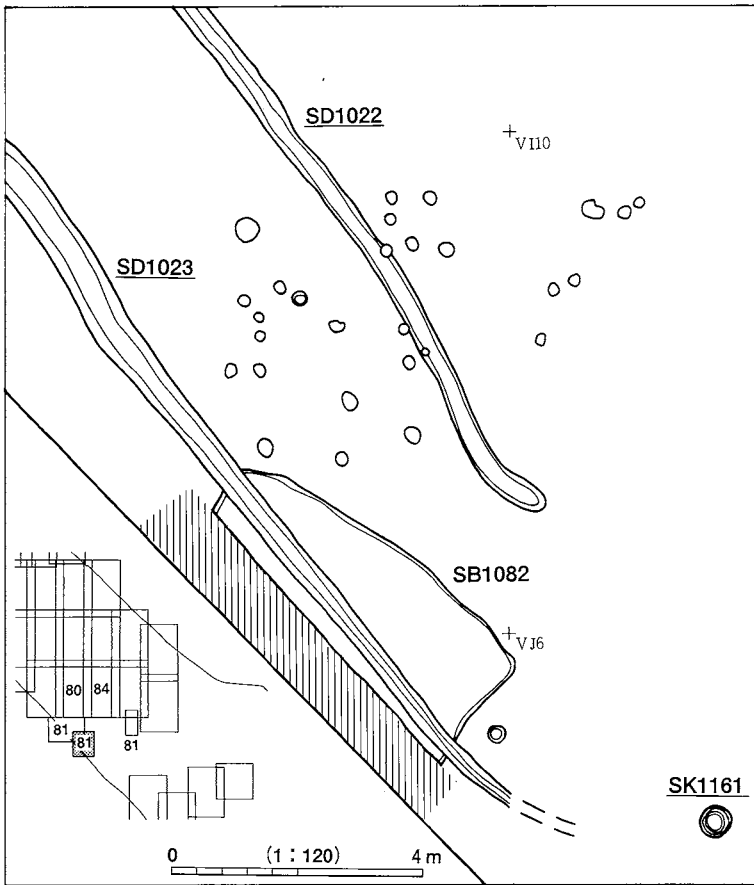

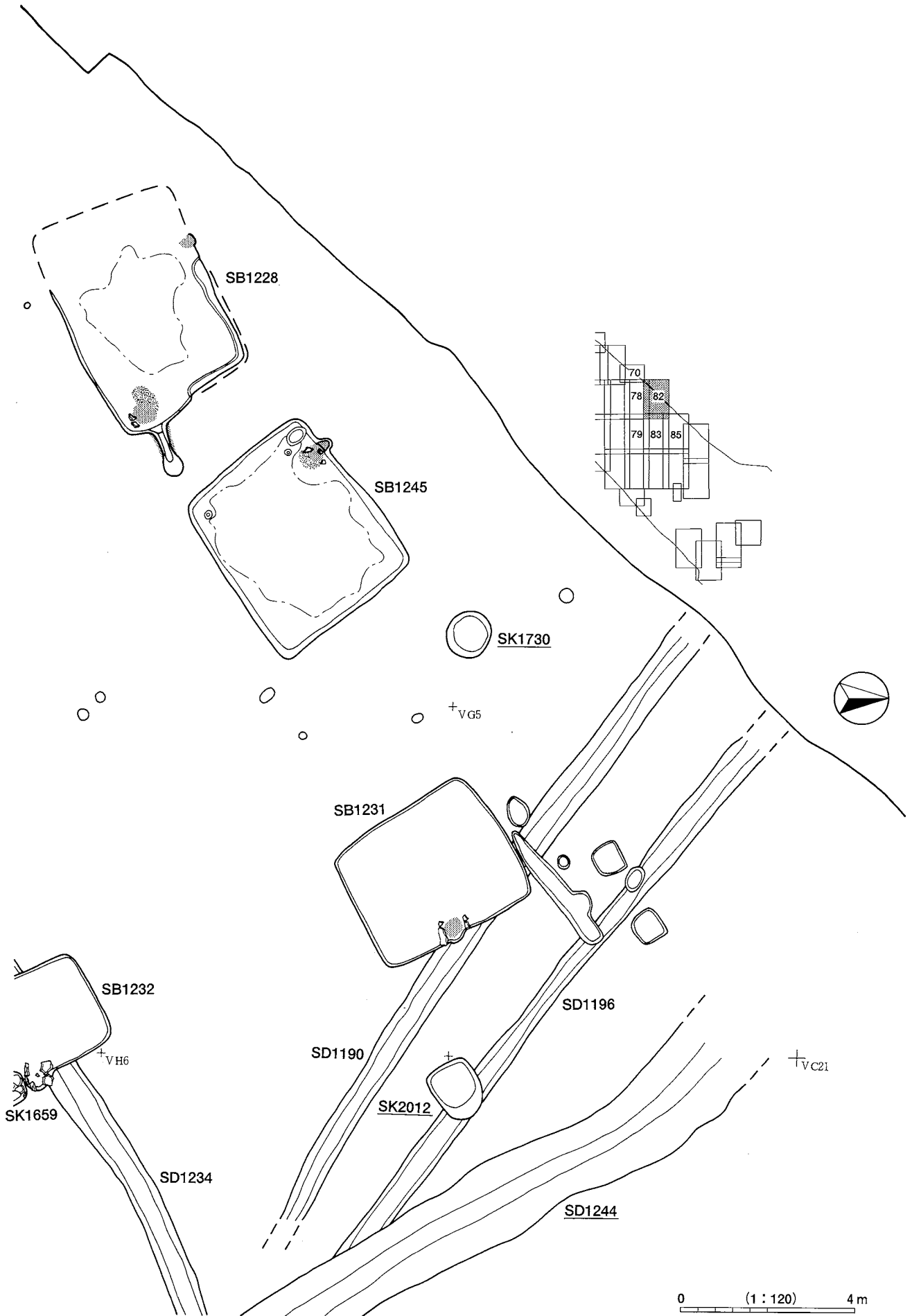

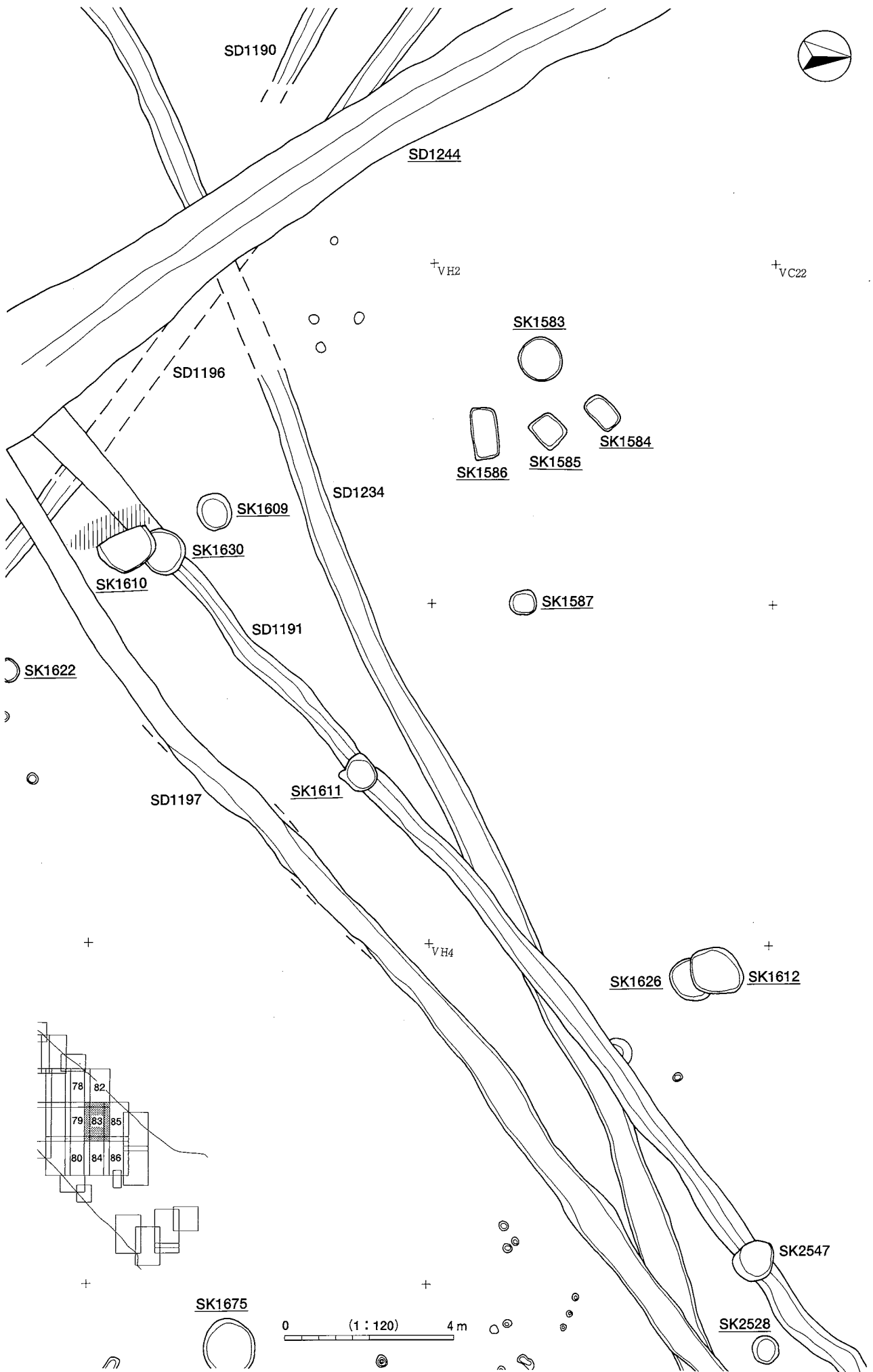

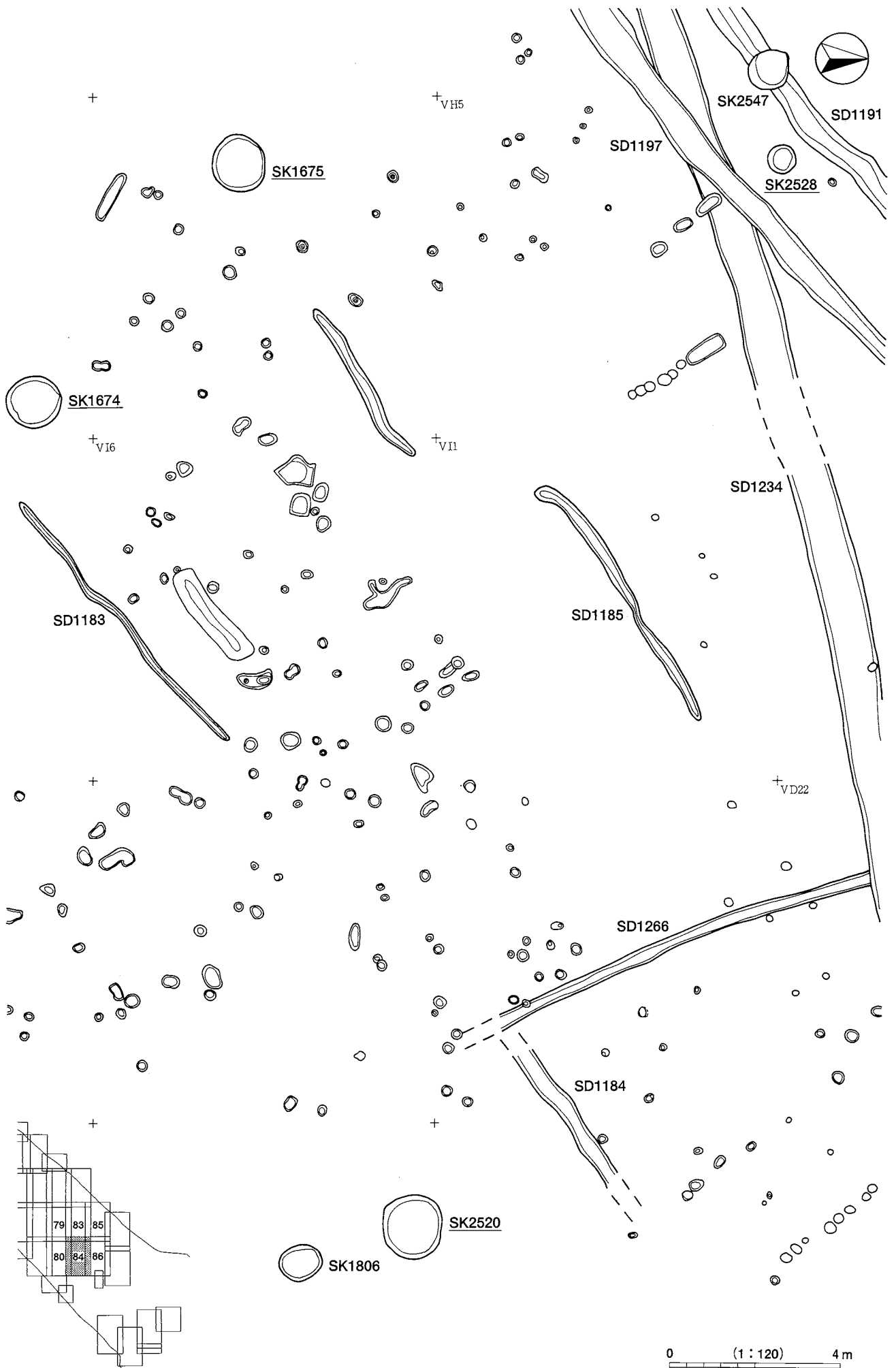

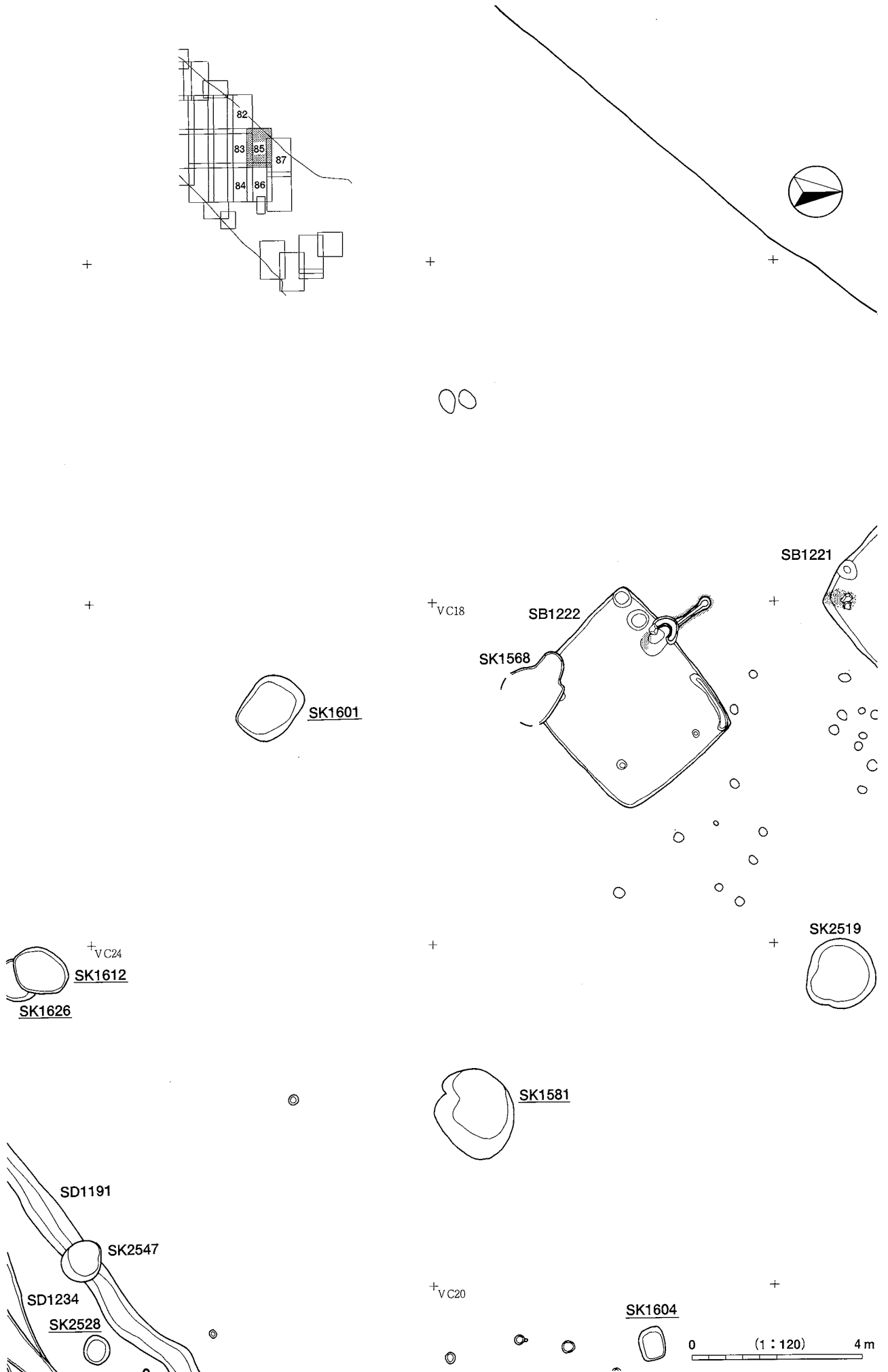

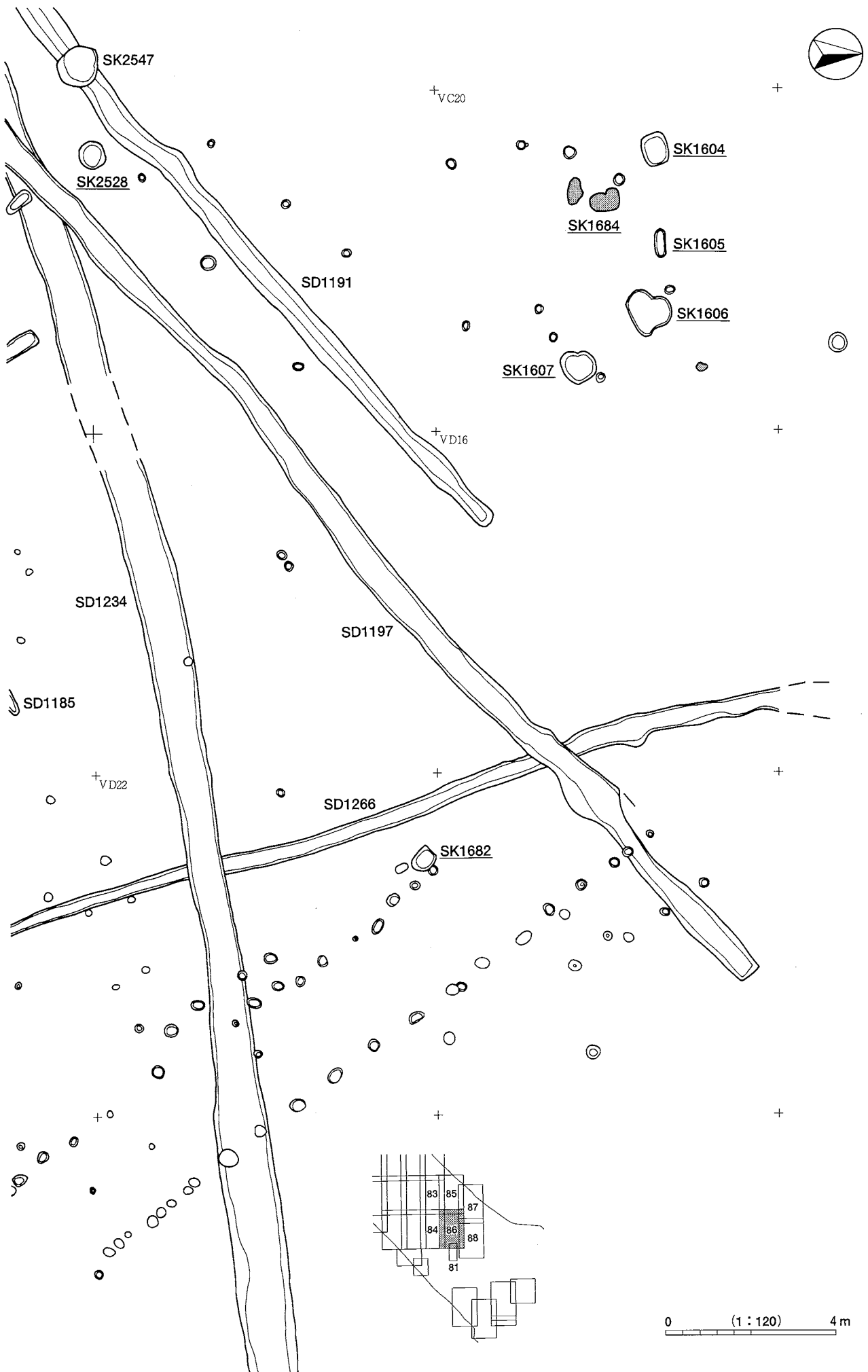

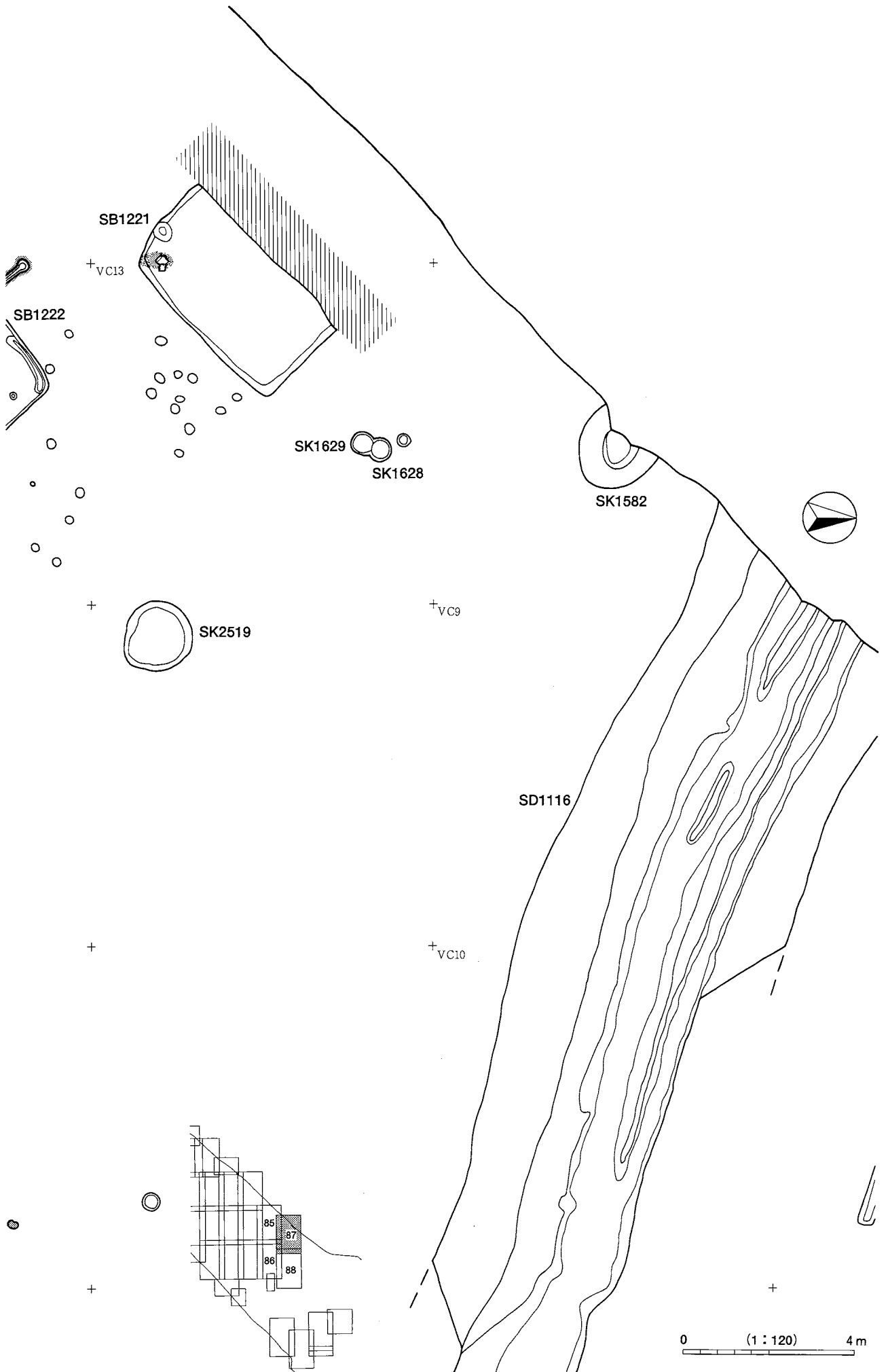

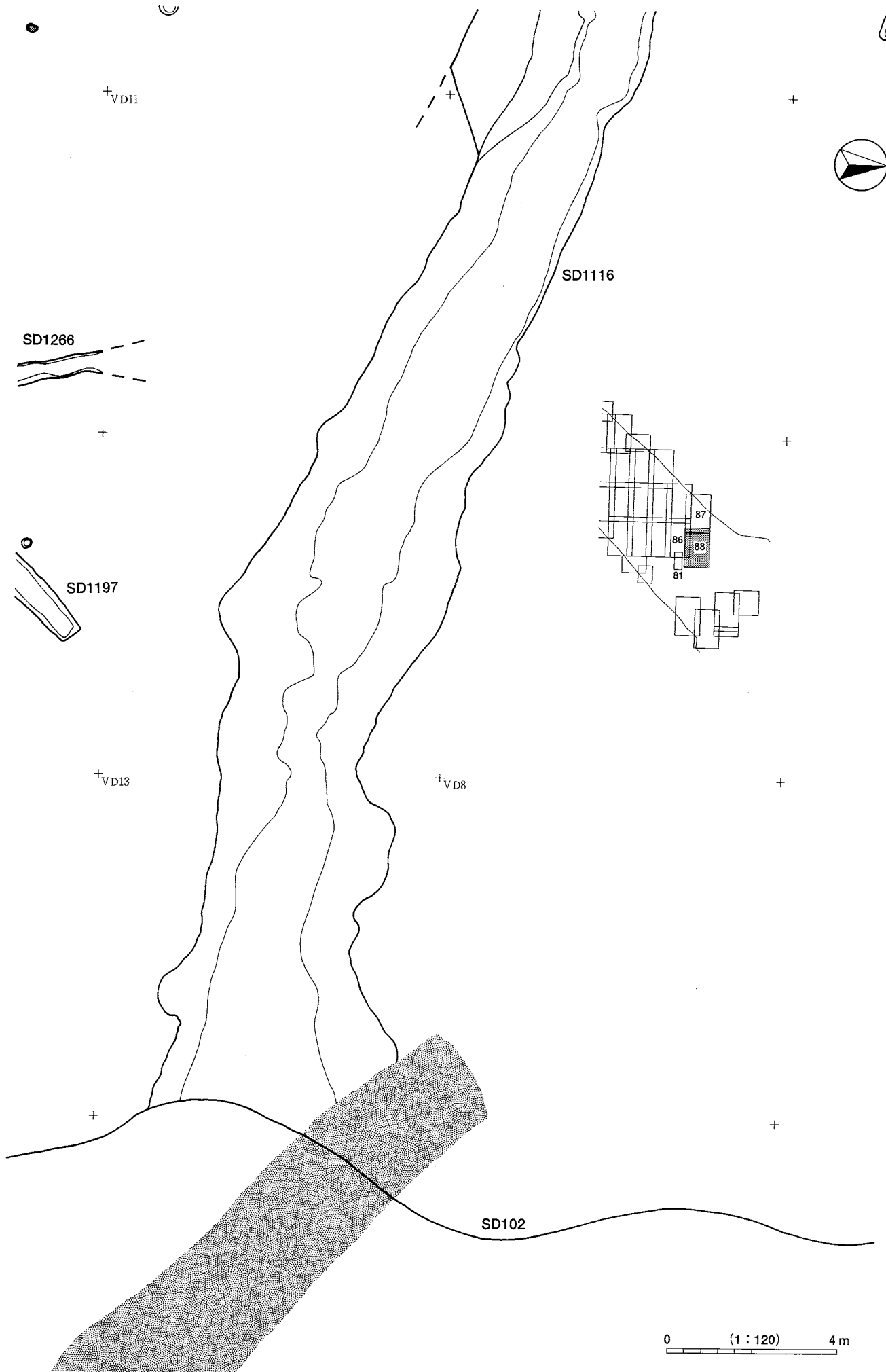

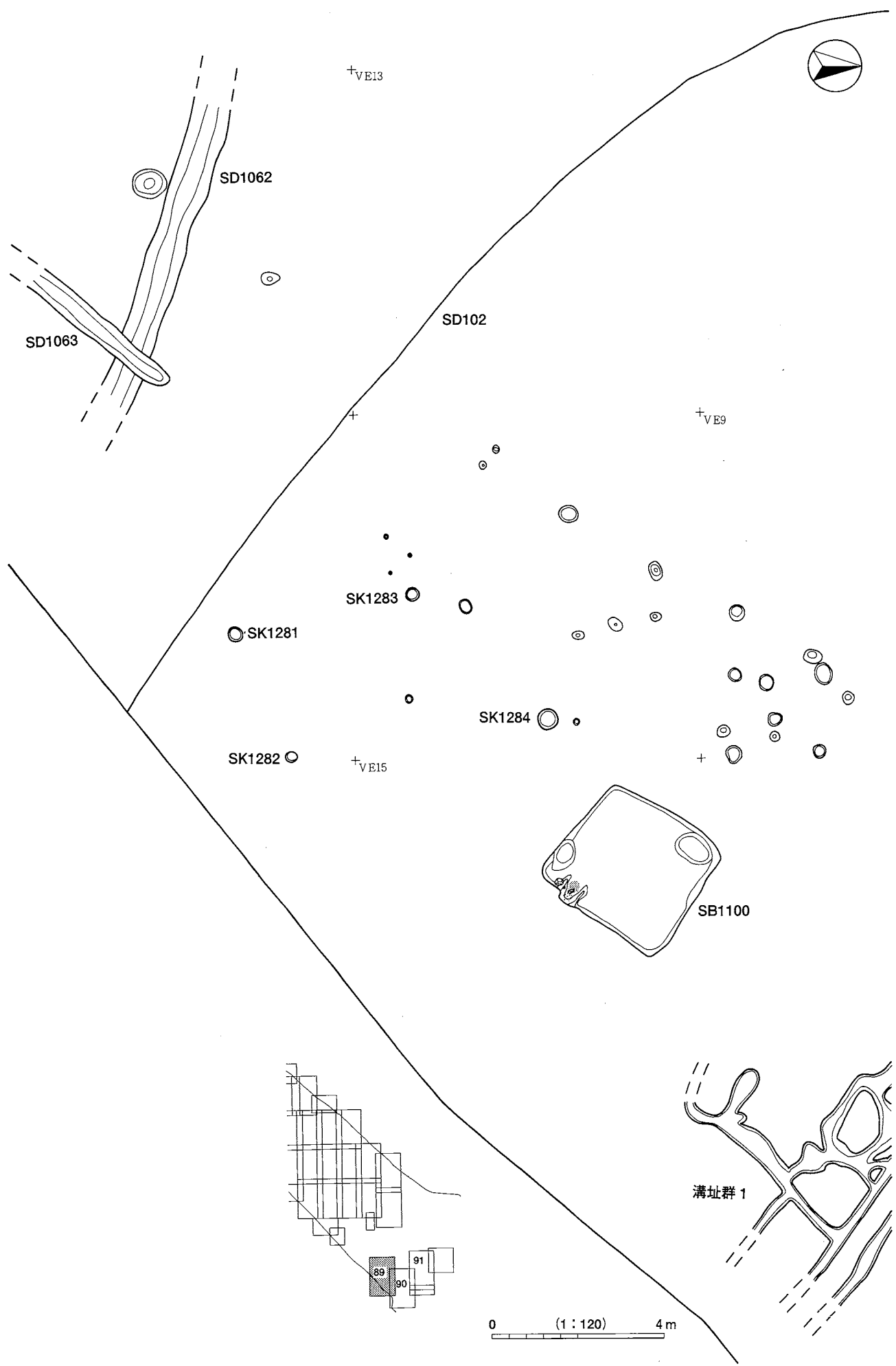

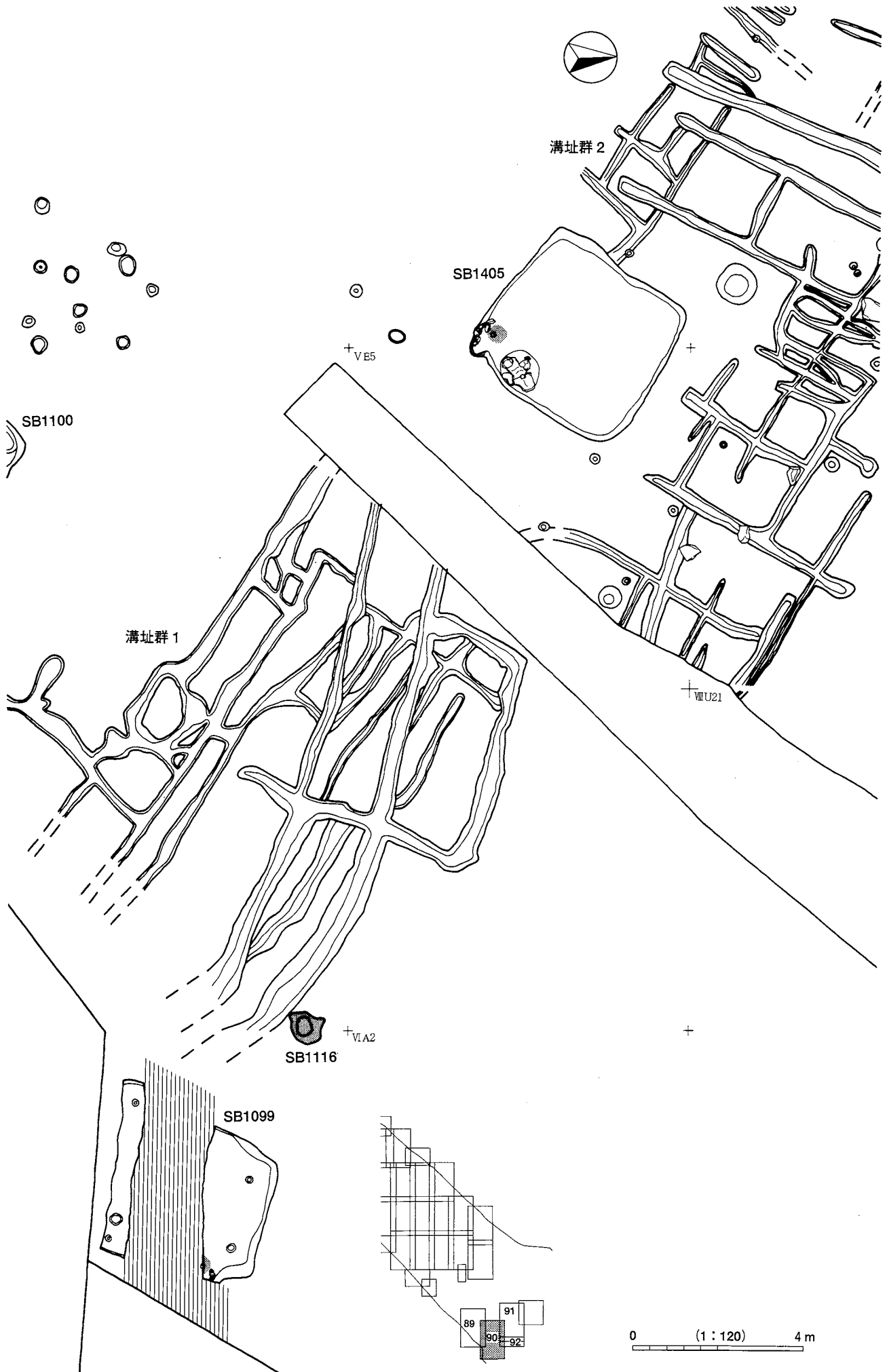

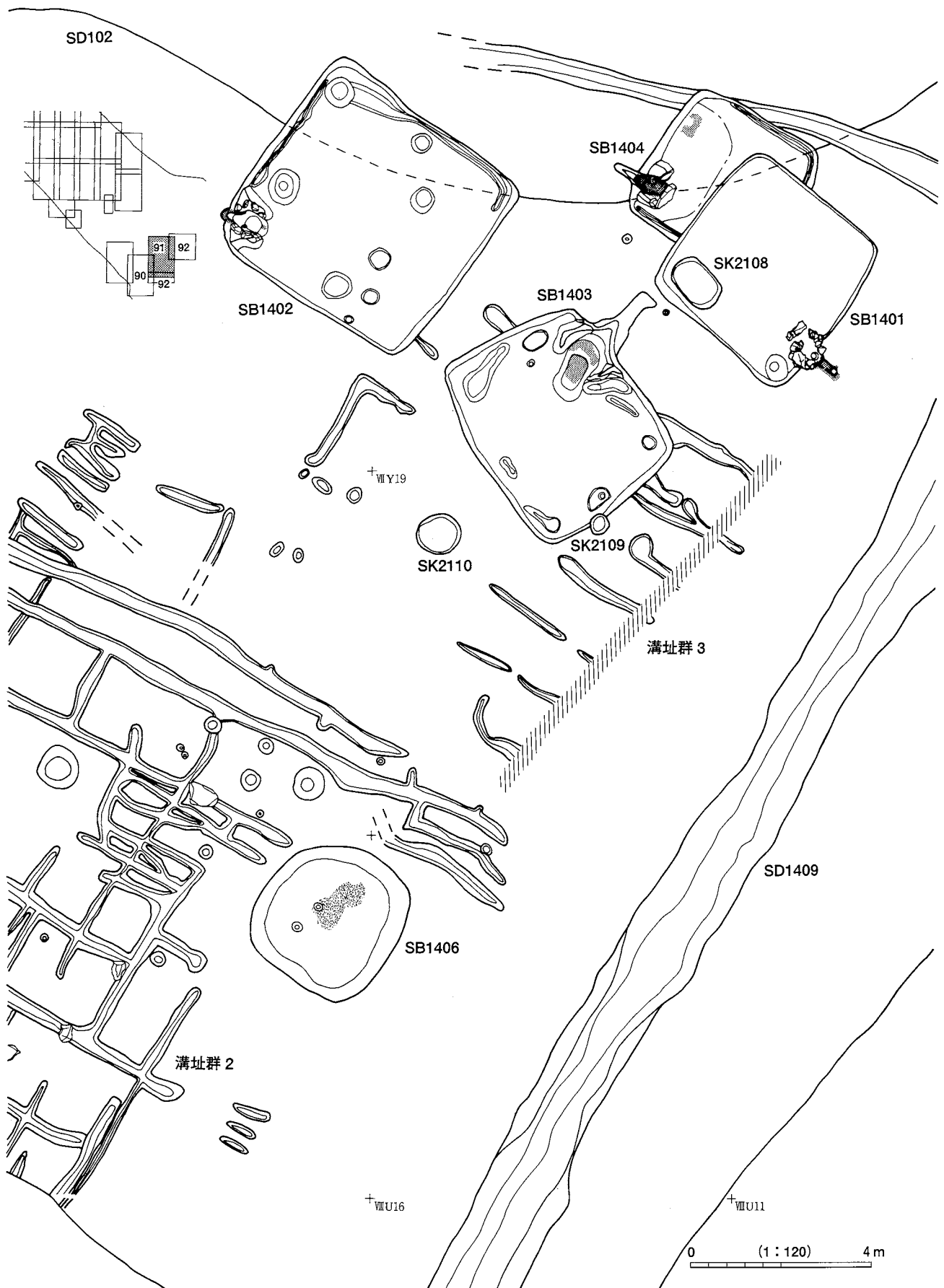

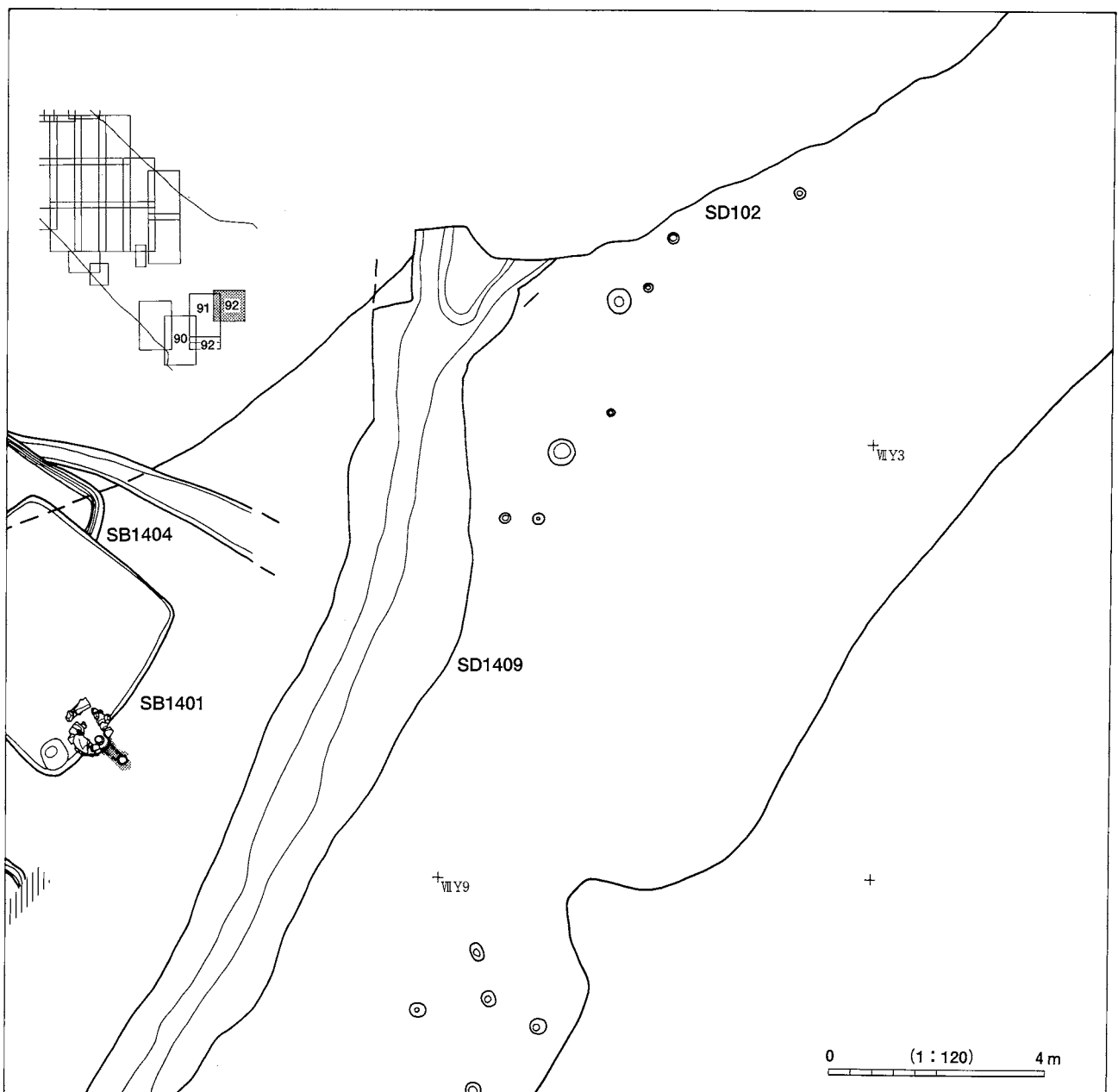
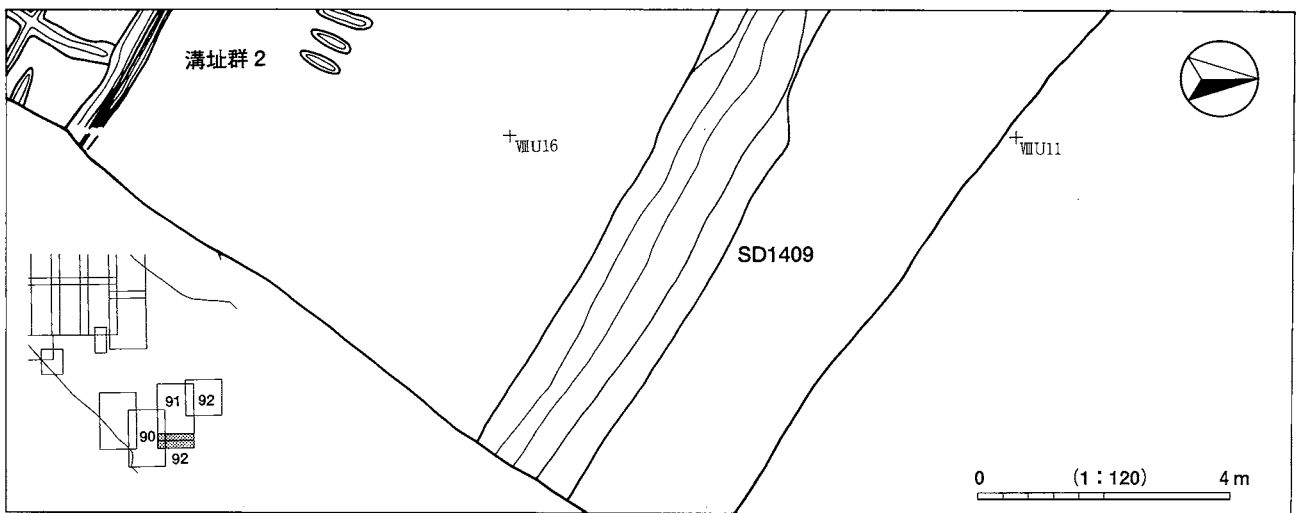

図版108 竪穴住居址重複関係図 1

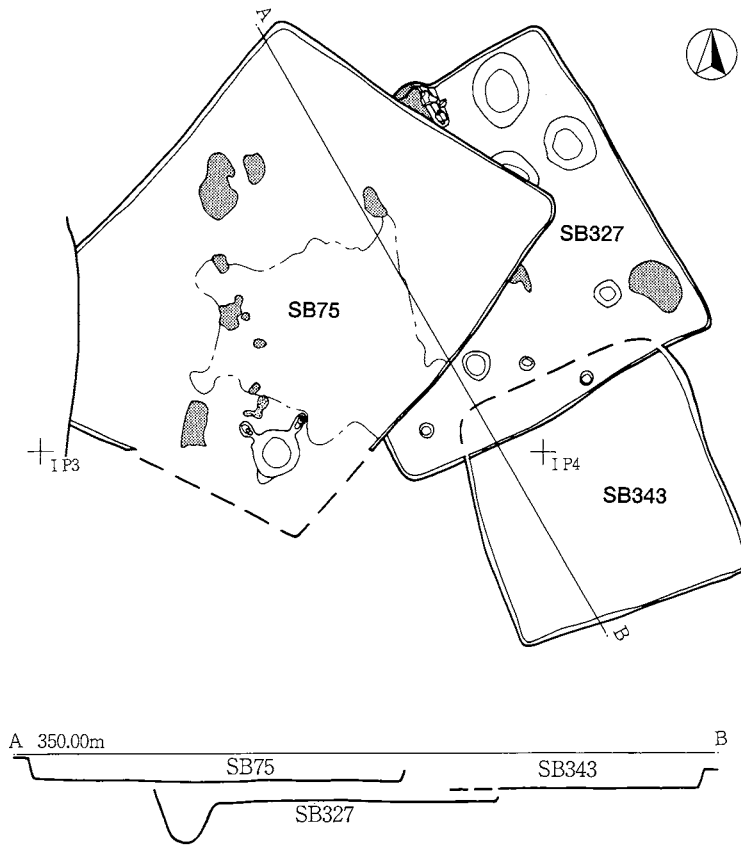
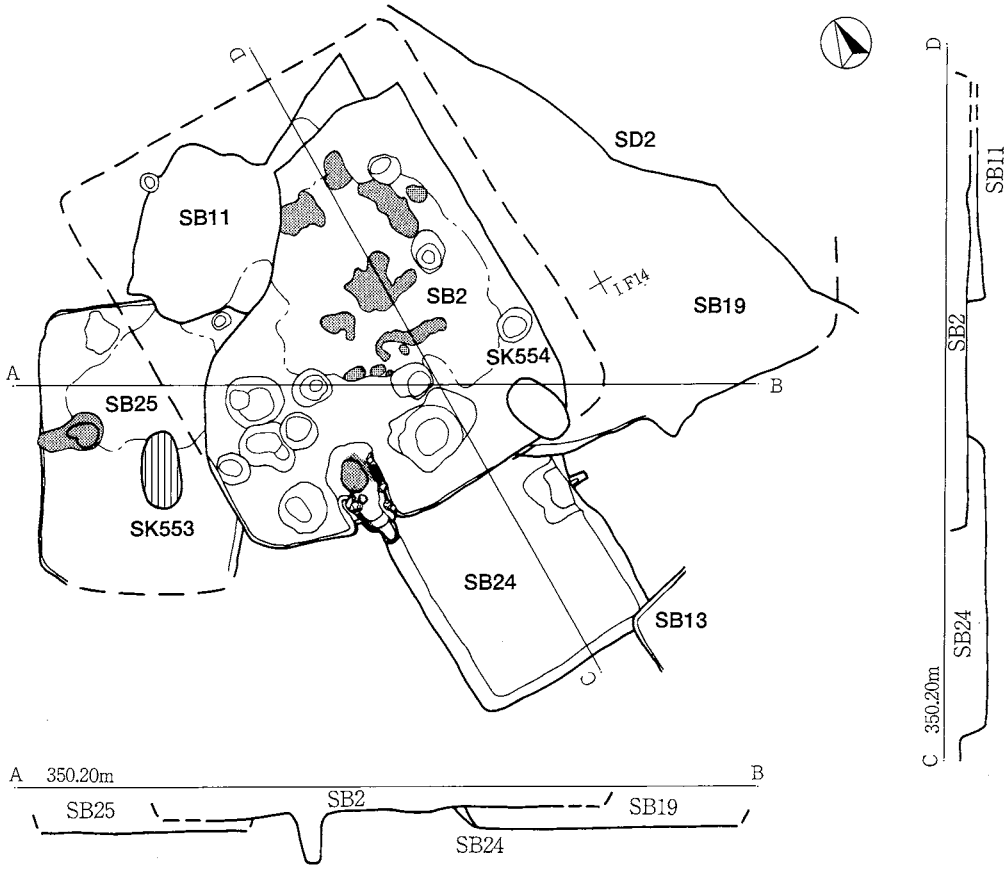

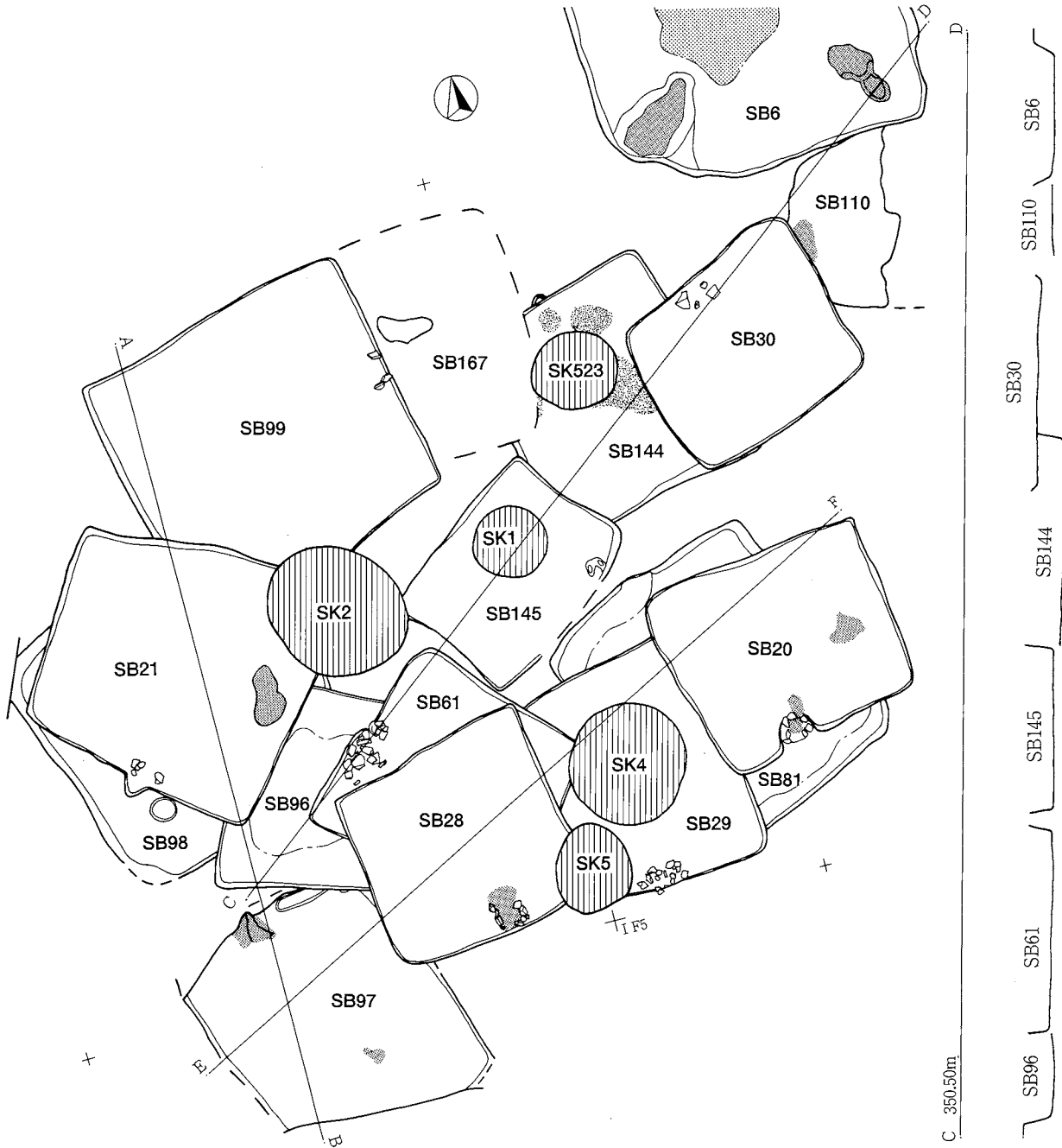

A 350.50m B

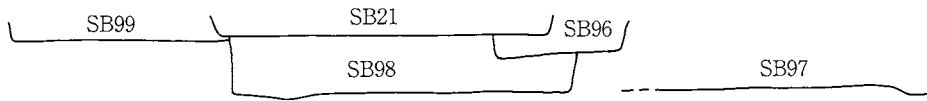

E 350.50m F

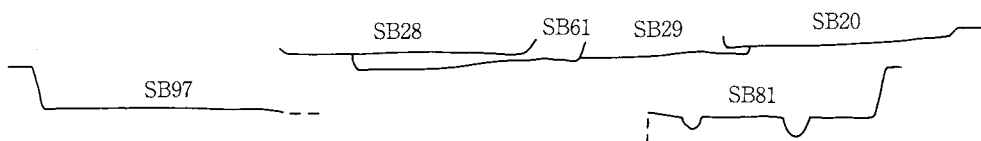

図版110 竪穴住居址重複関係図3

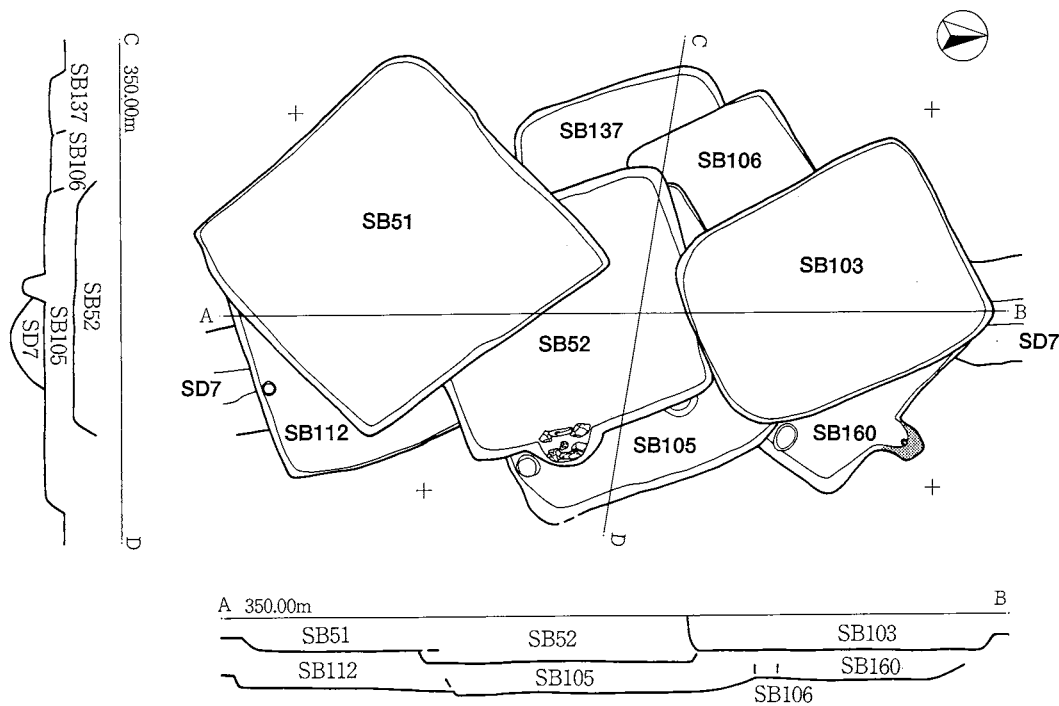
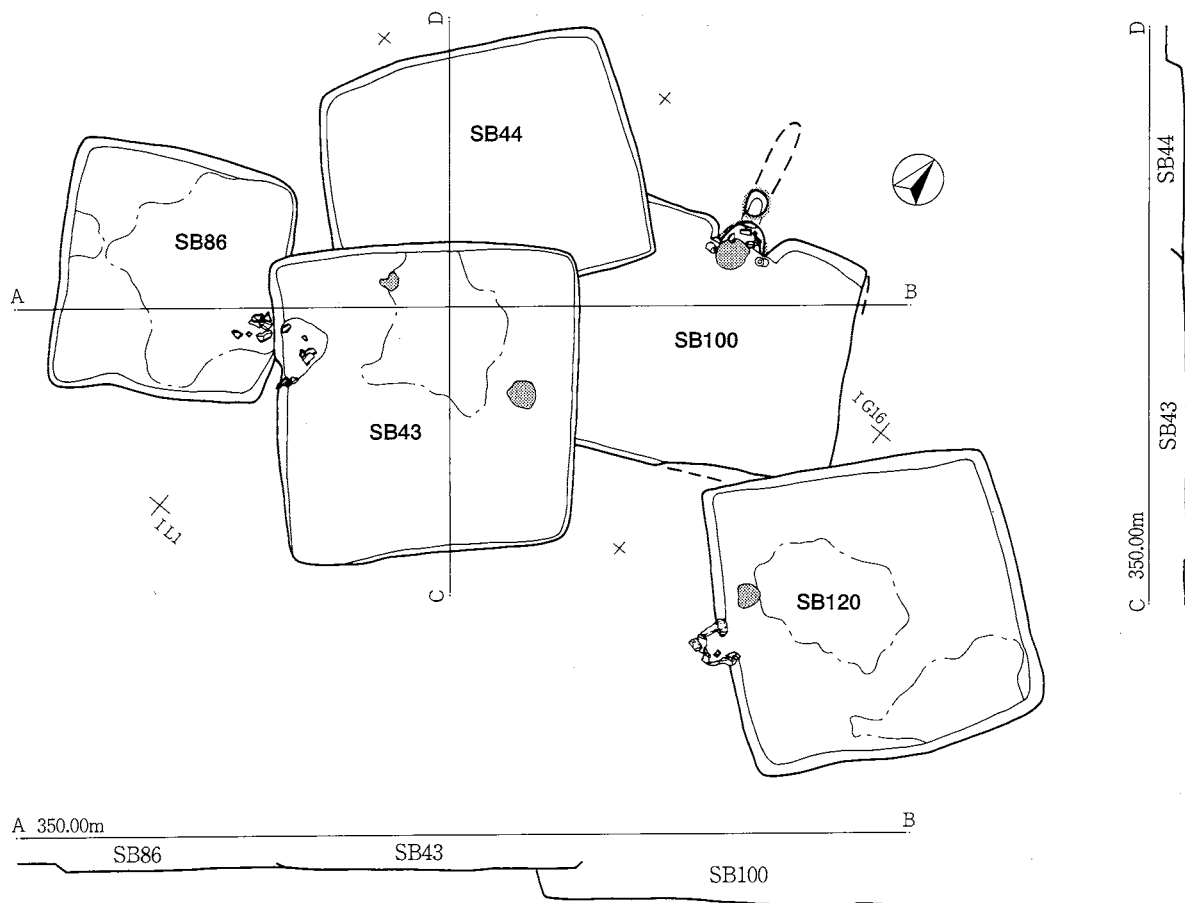

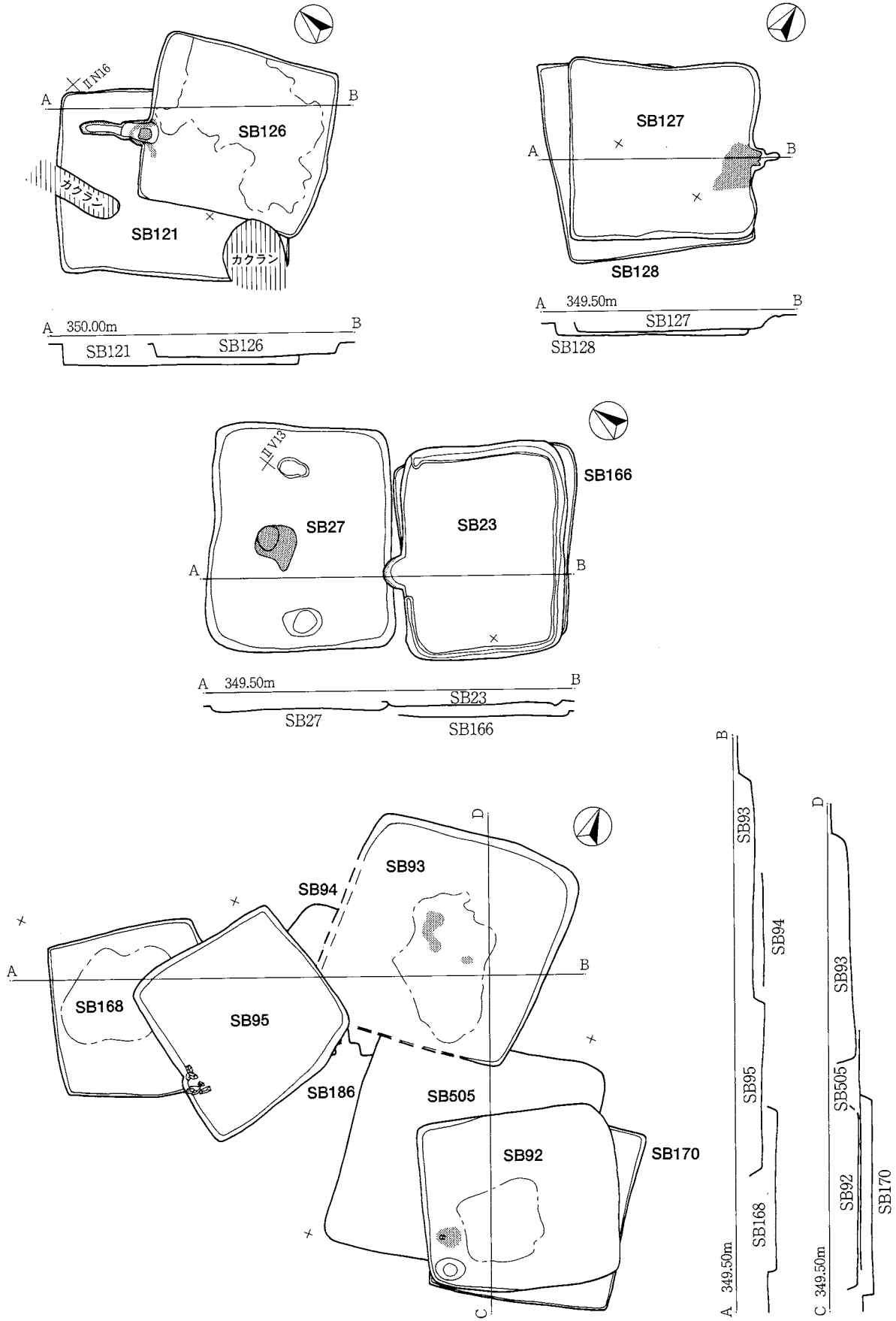

図版112 竪穴住居址重複関係図 5

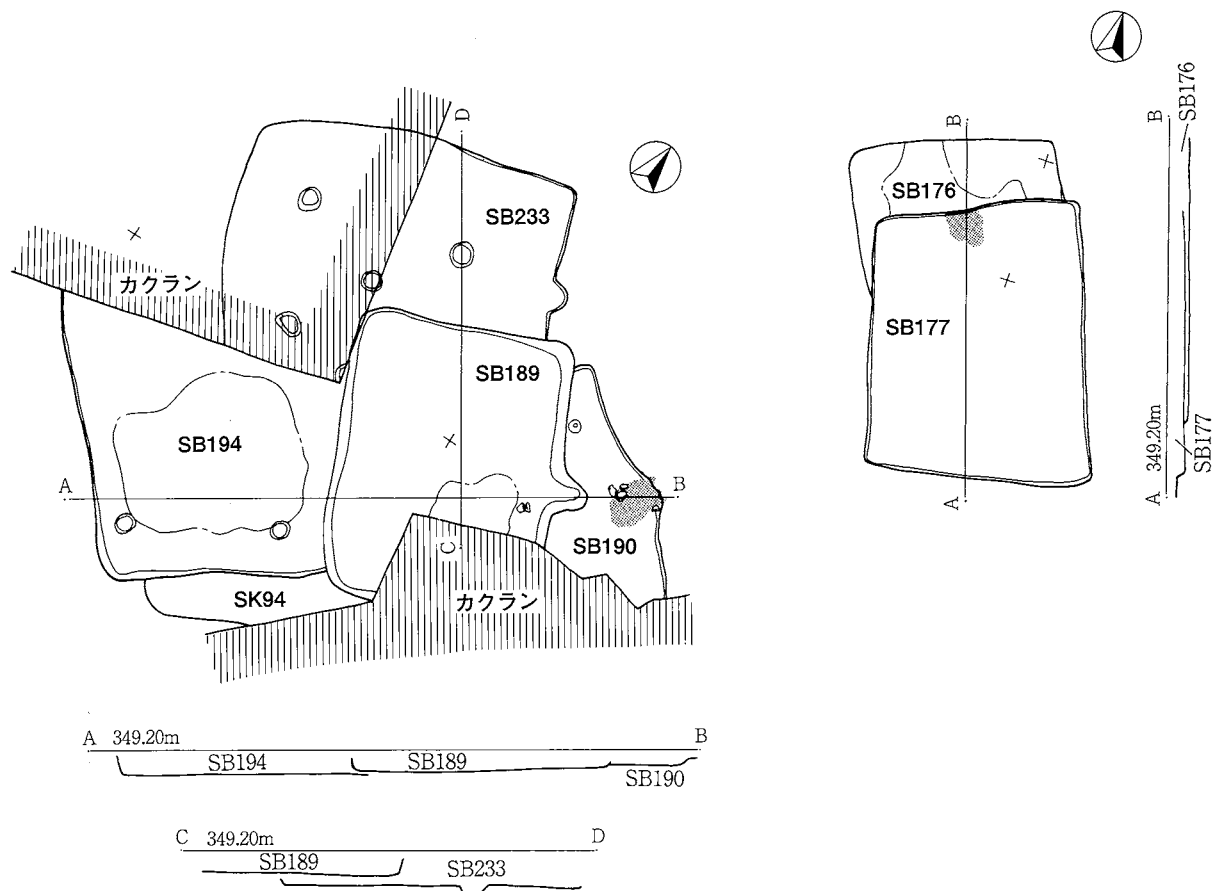
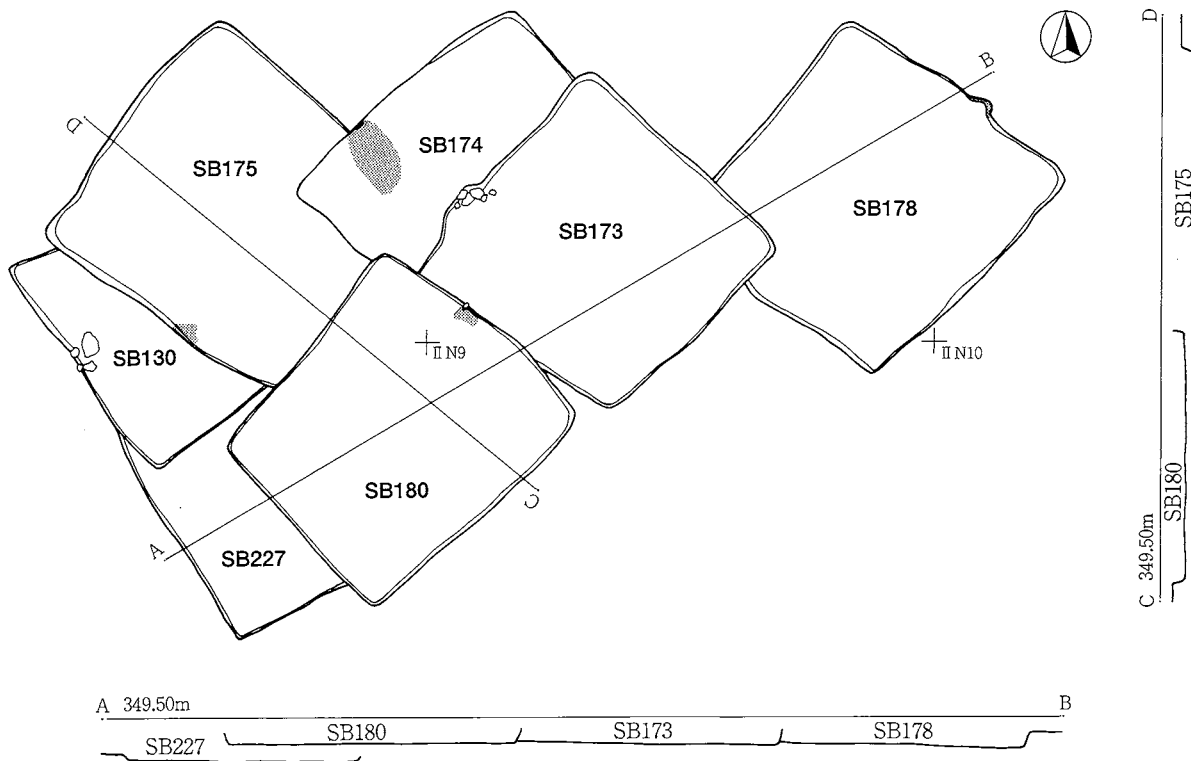

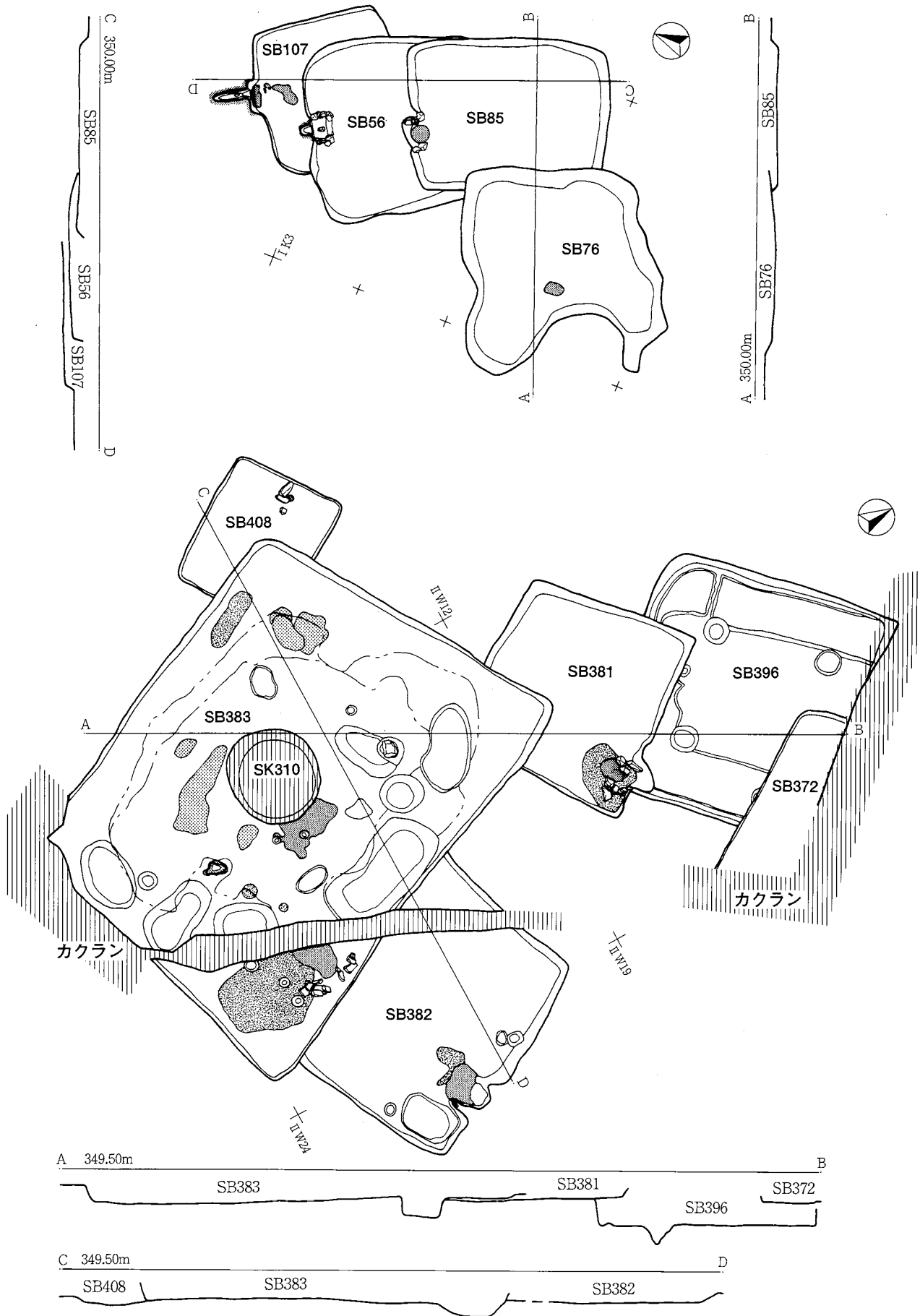

図版114 竪穴住居址重複関係図 7

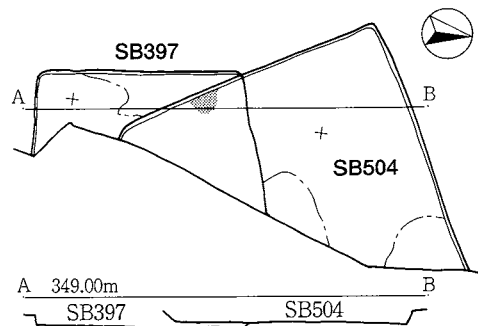
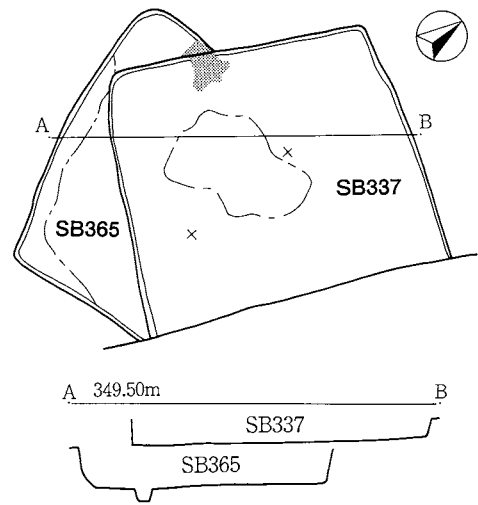
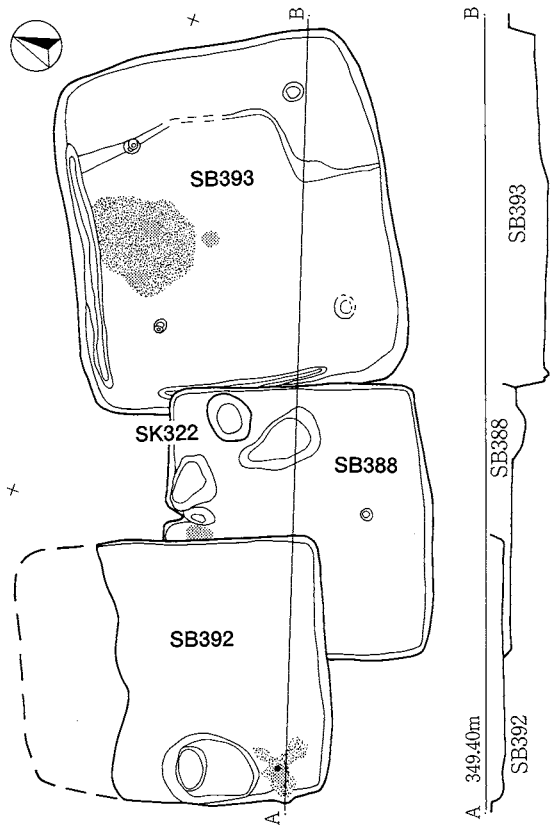
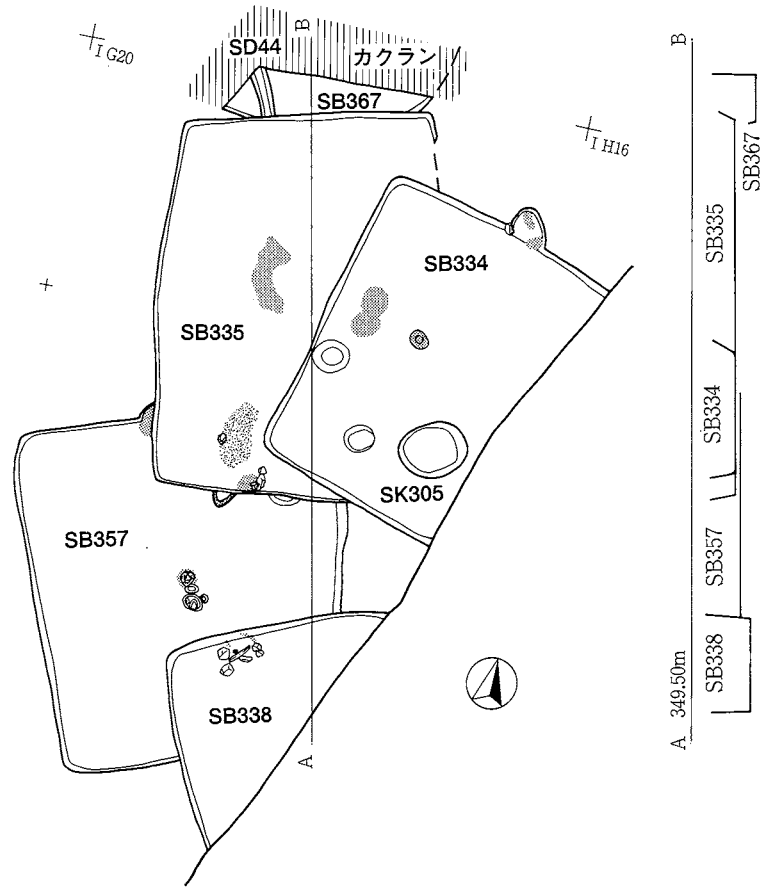
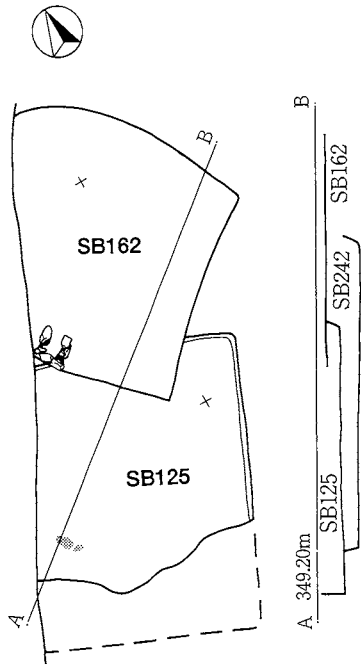

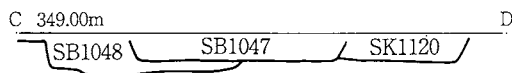
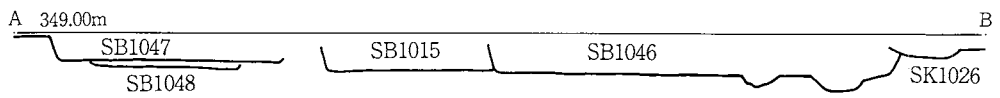
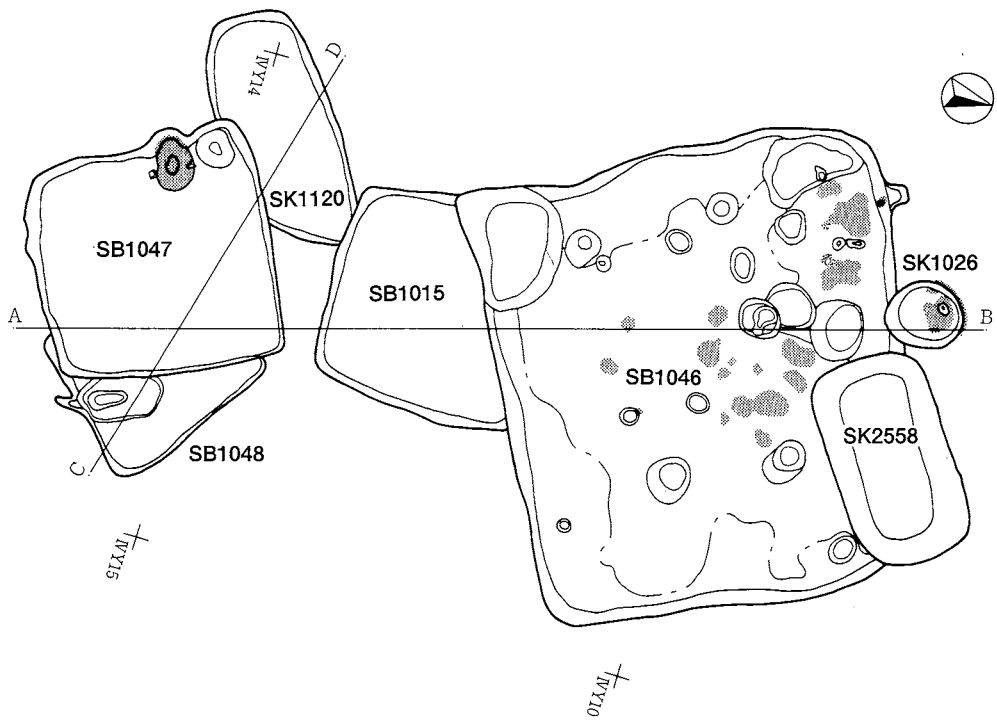
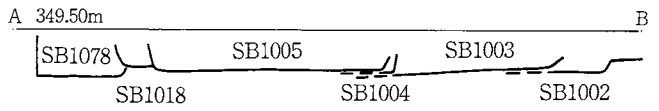
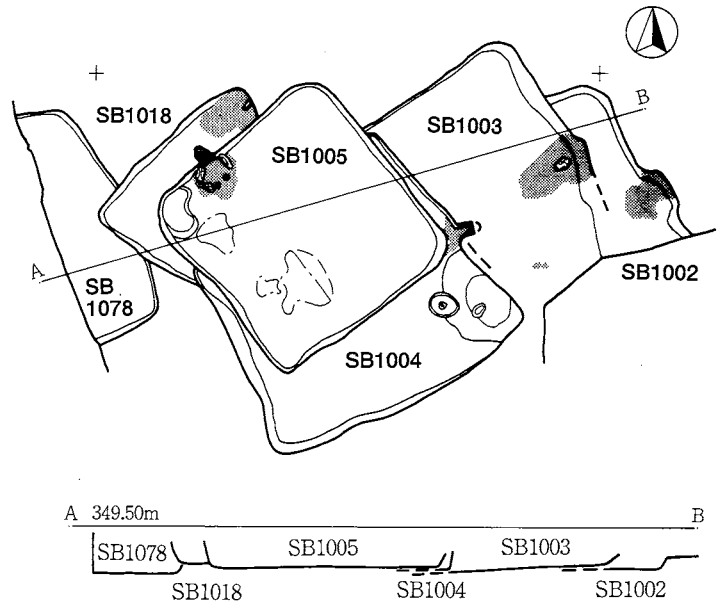
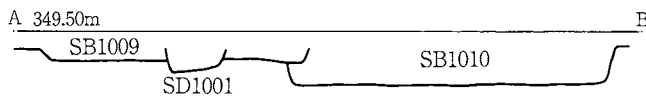
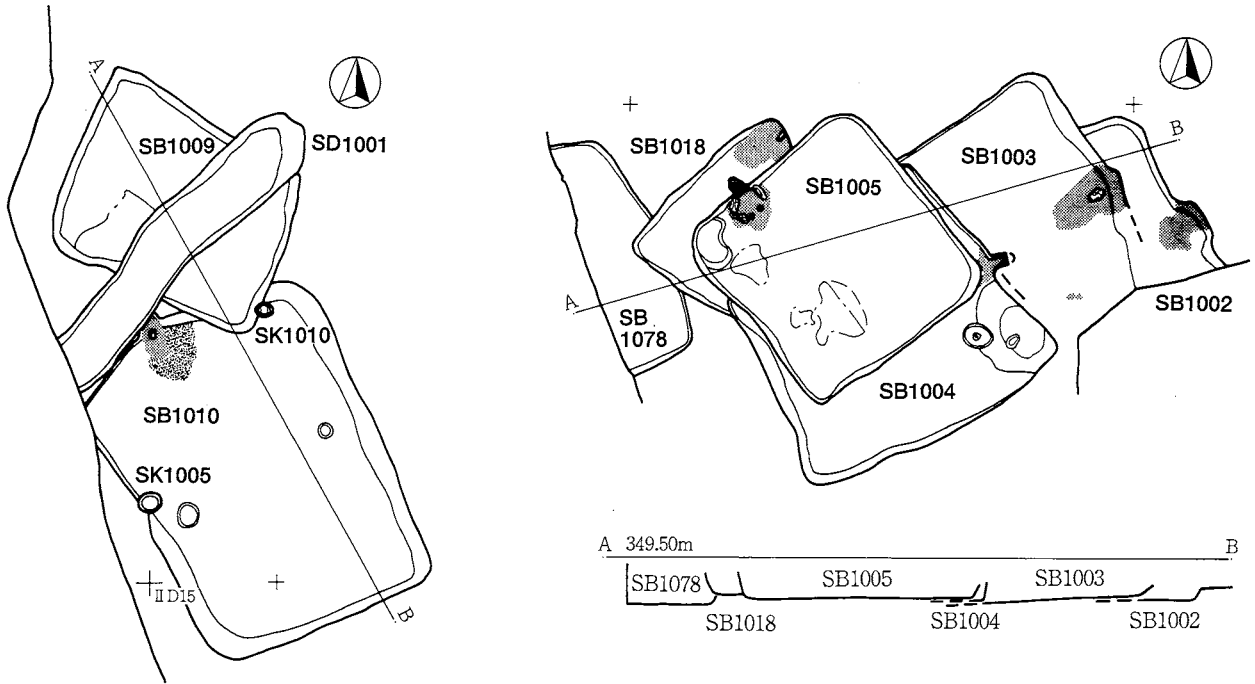

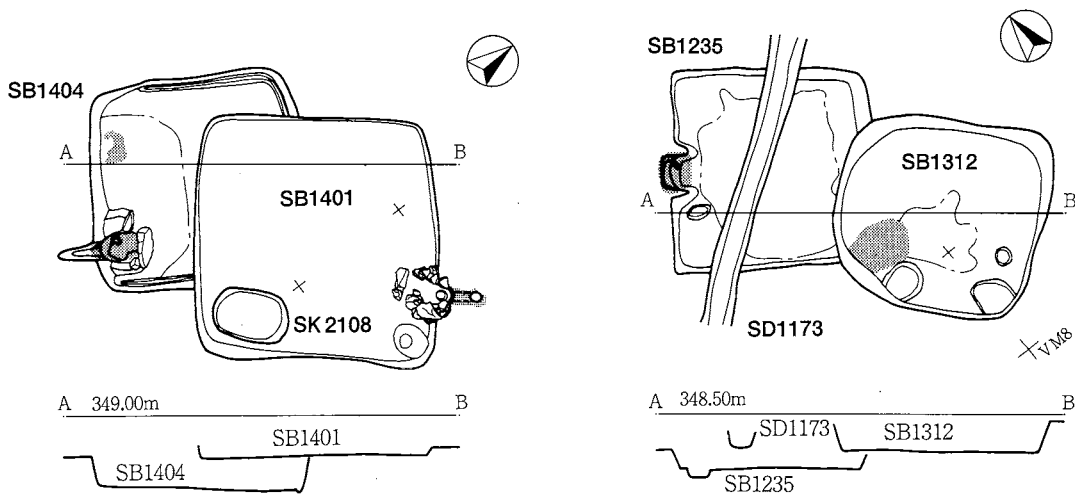
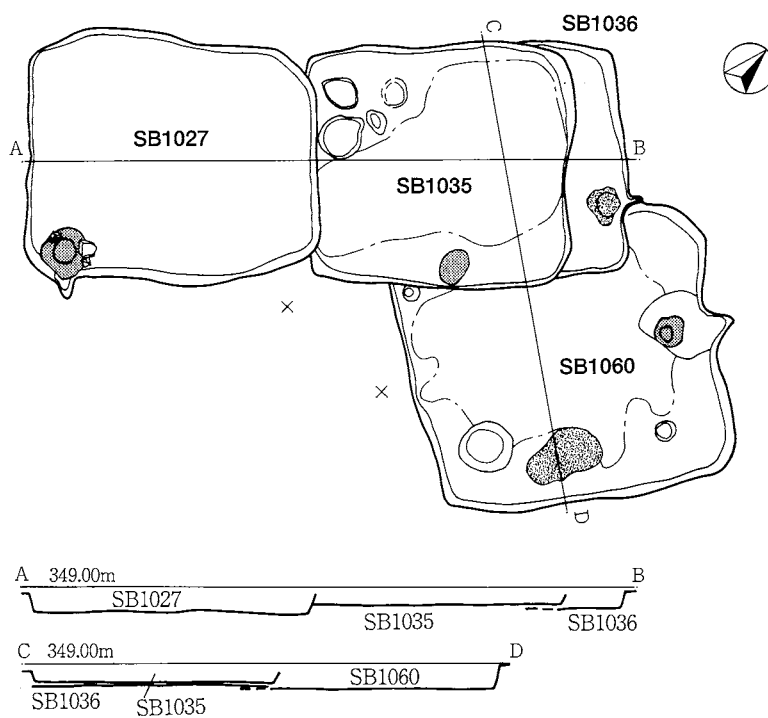
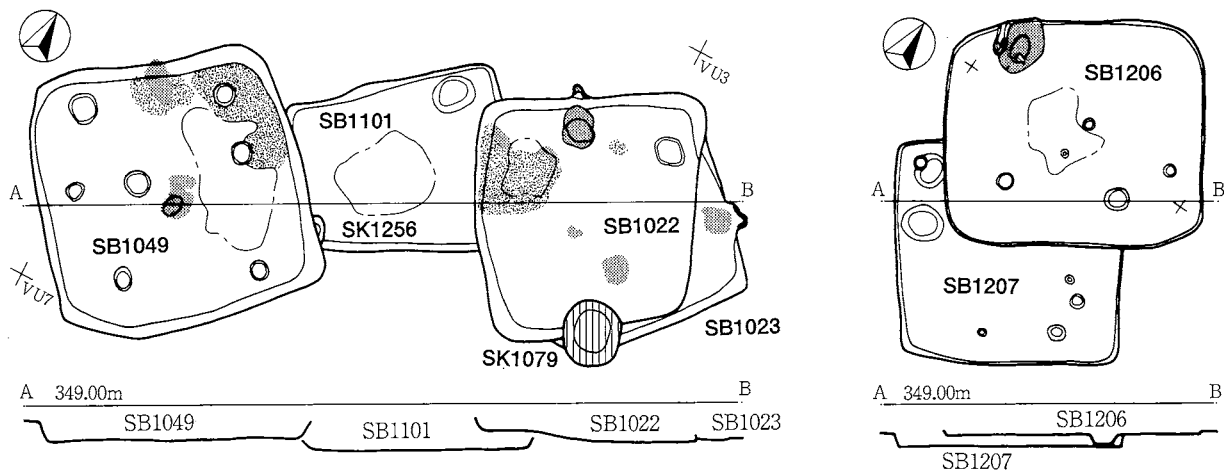

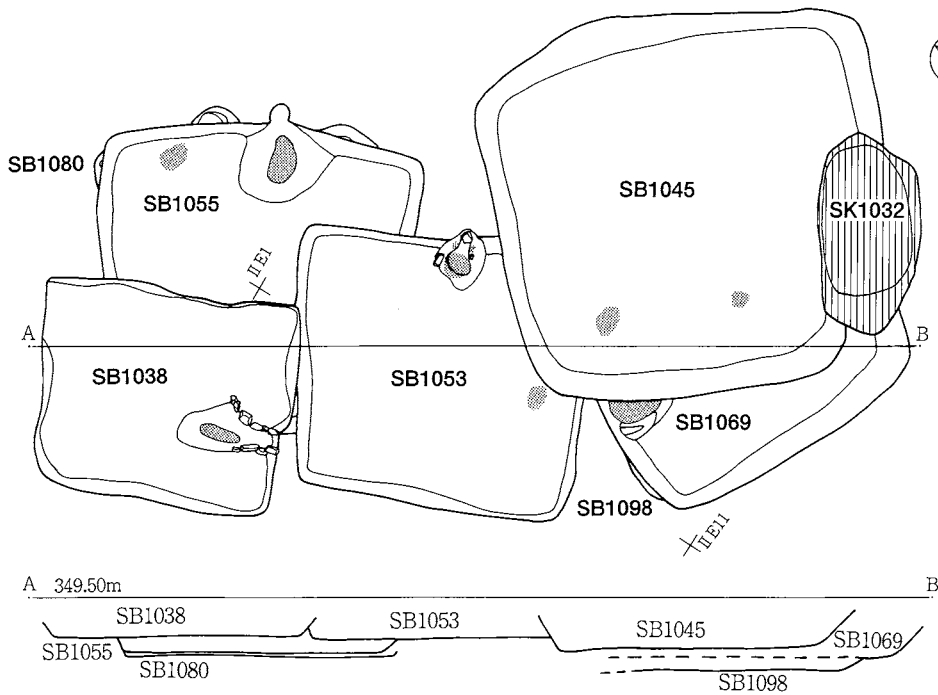
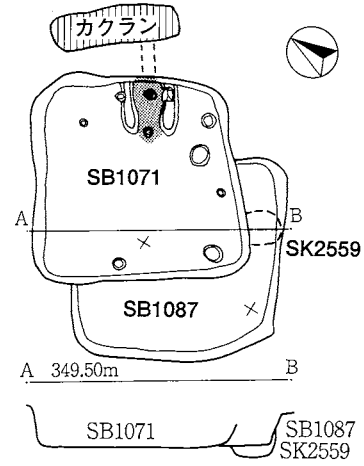
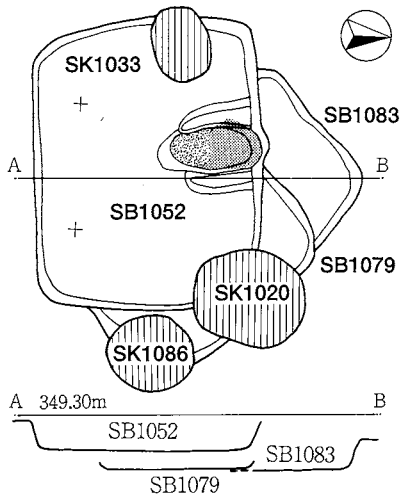
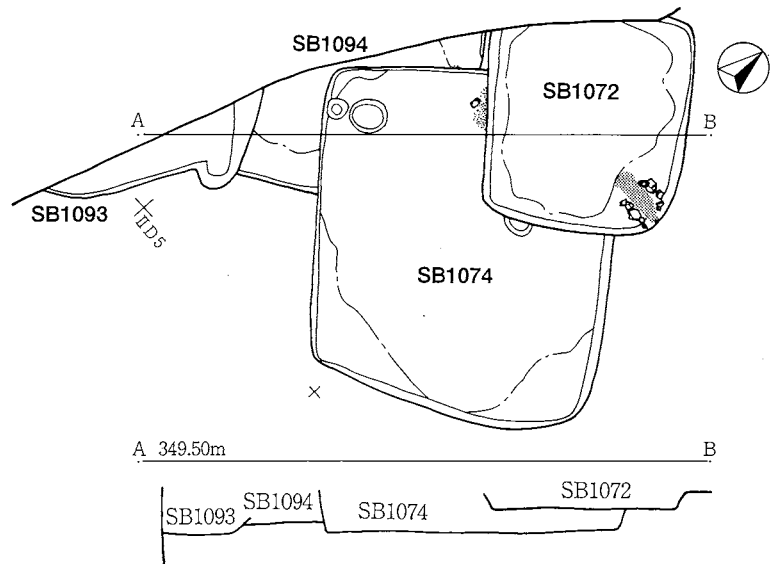
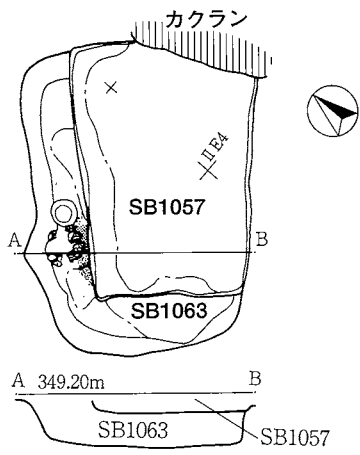

SB2 (1~8)

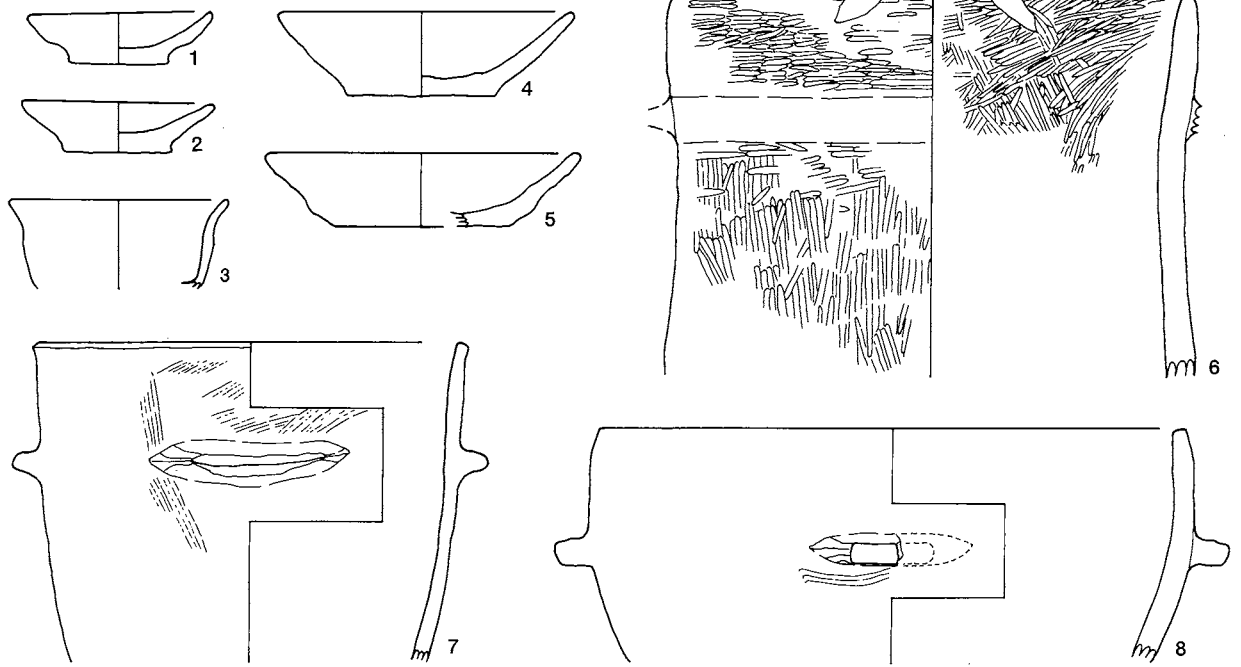

SB6 (1~23)

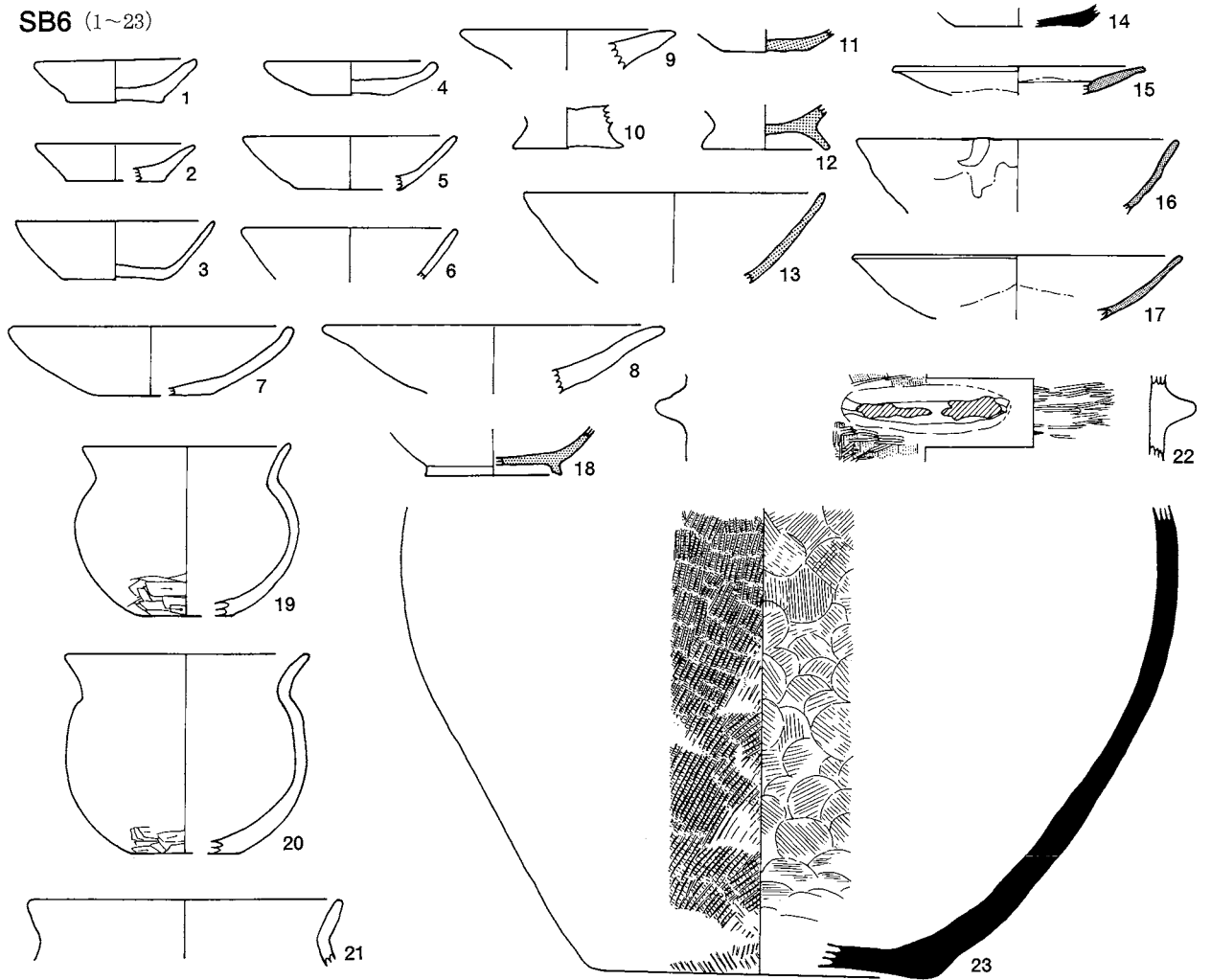

SB7 (1~29)

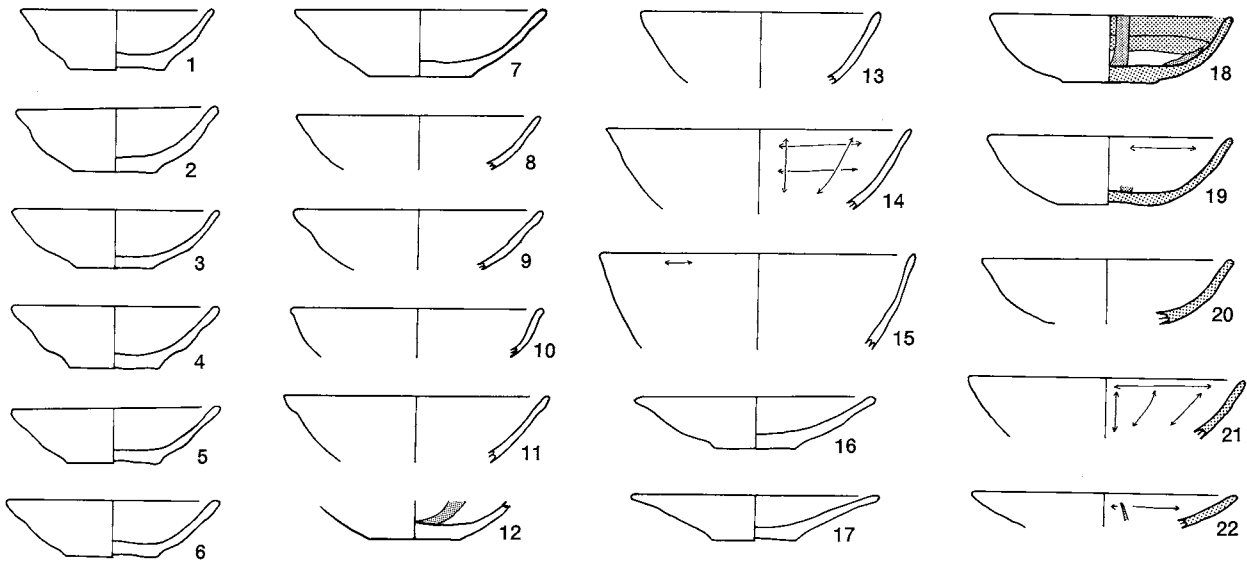

SB12

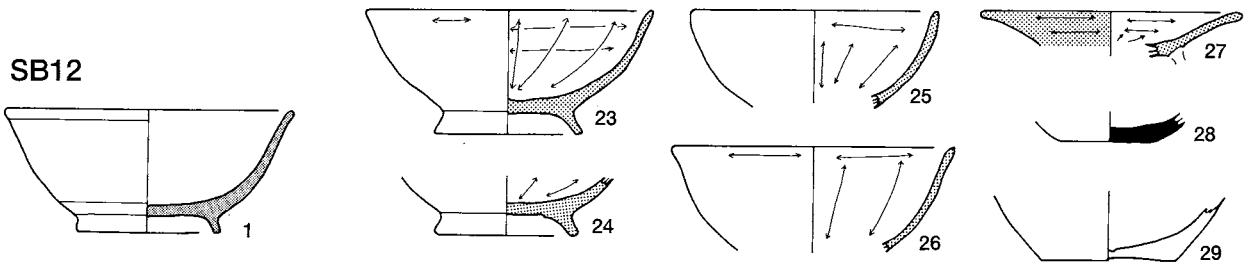

SB16 (1~24)

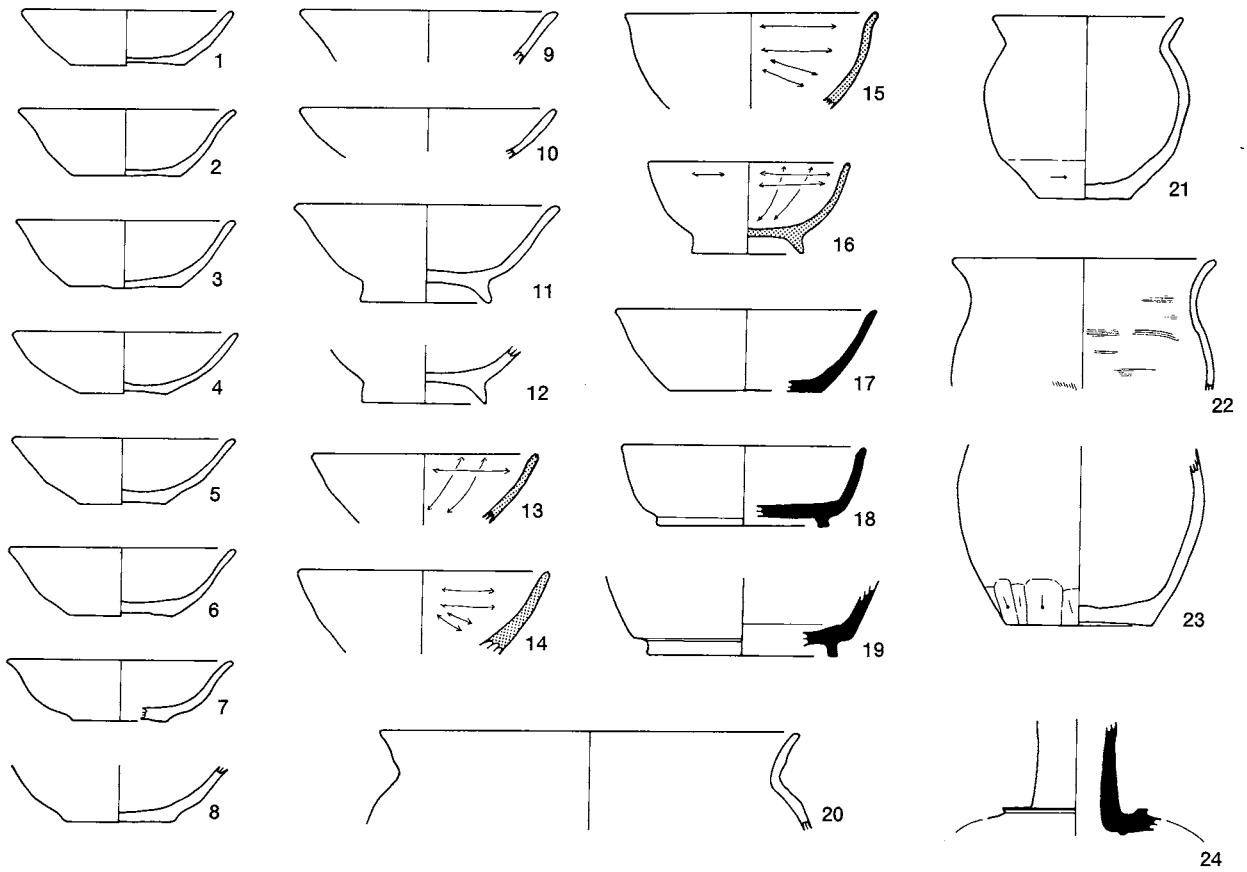

SB18 (1~22)

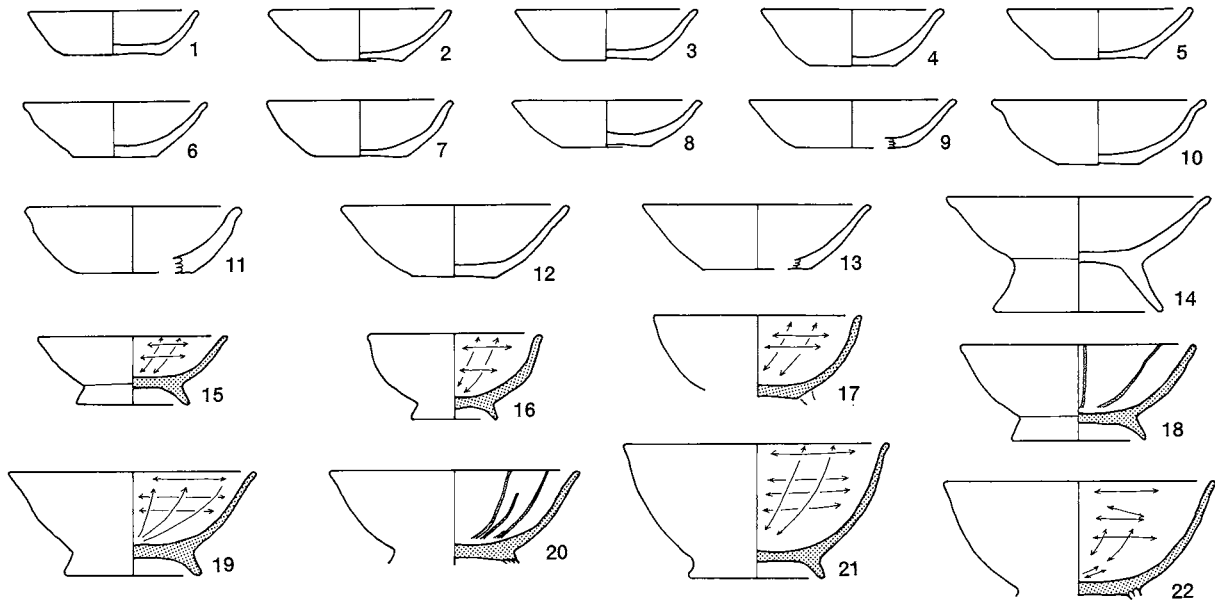

SB22 (1~14)

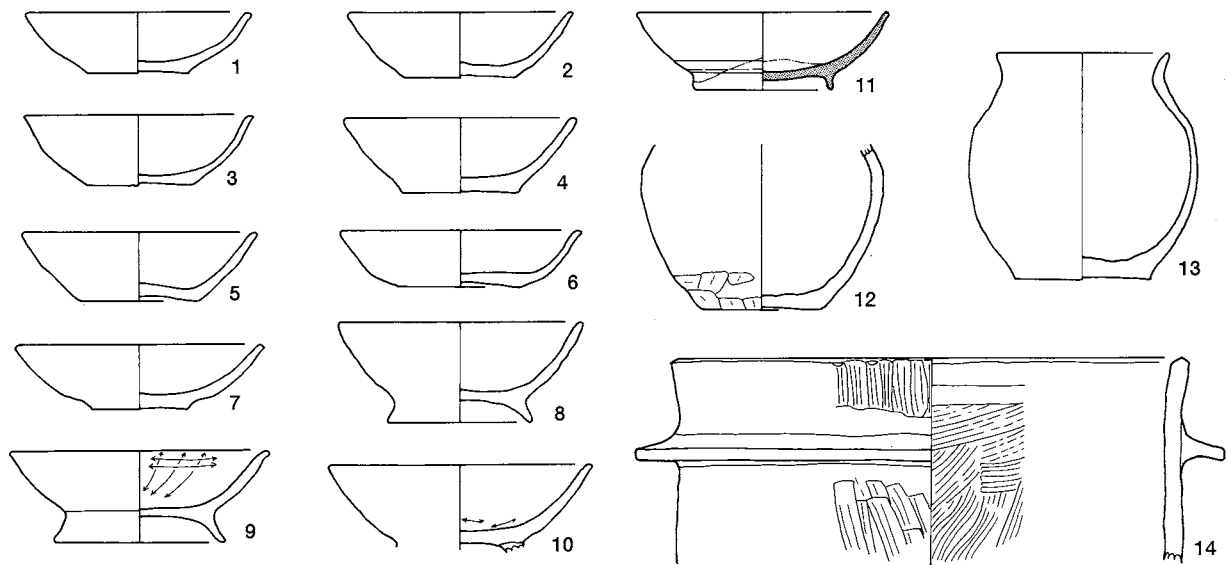

SB25 (1~9)

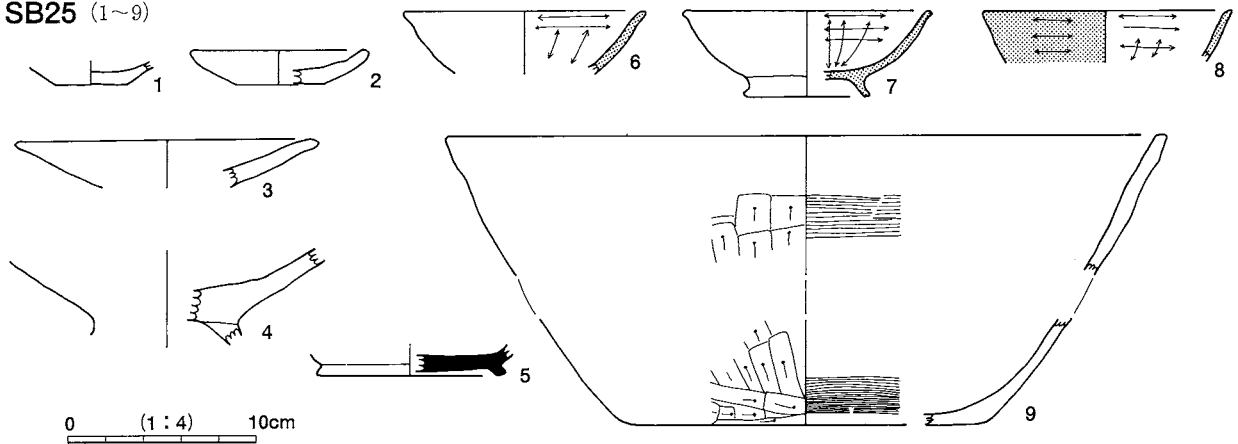

0 (1:4) 10cm

SB29 (1~20)

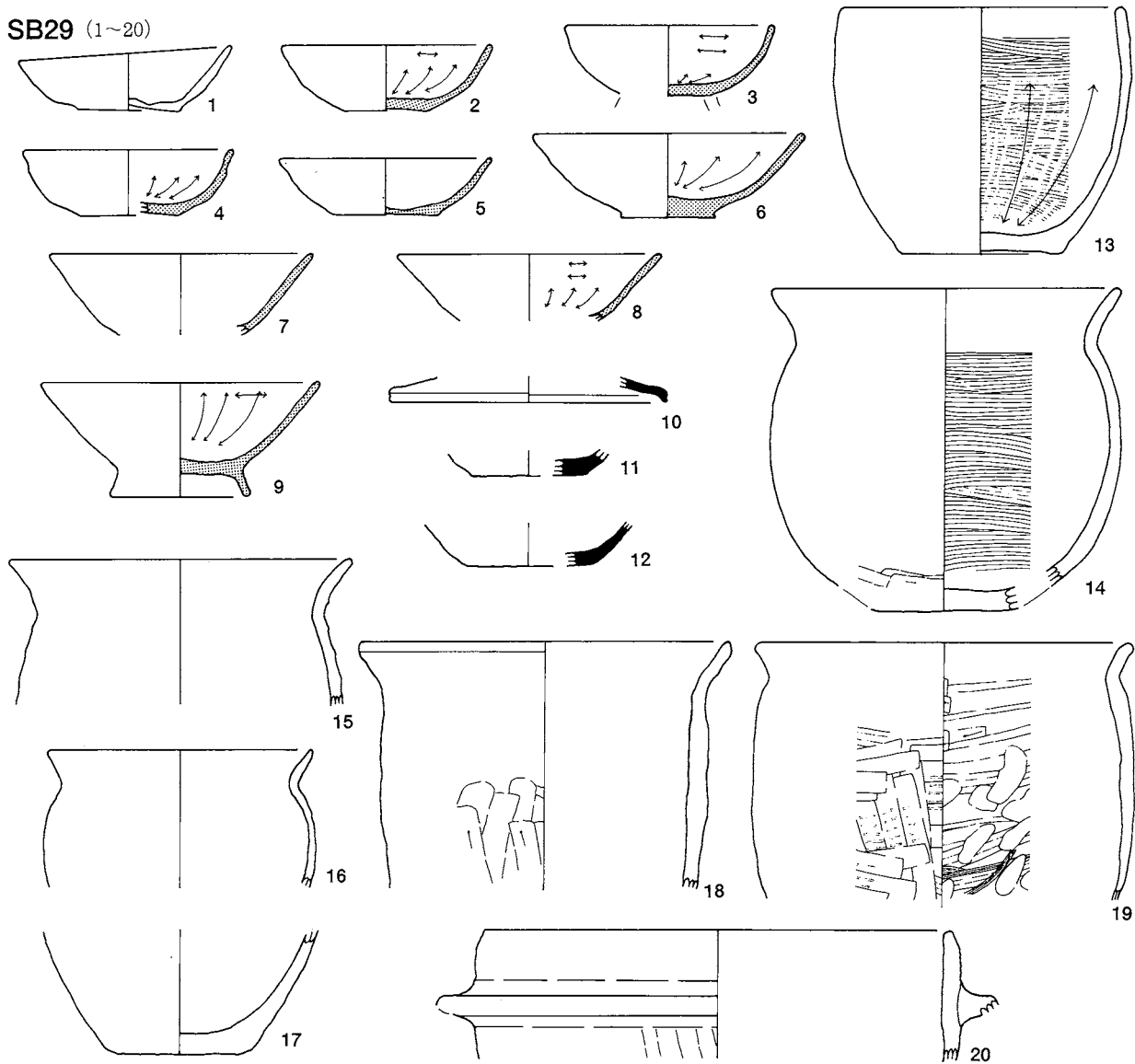

SB31 (1~23)

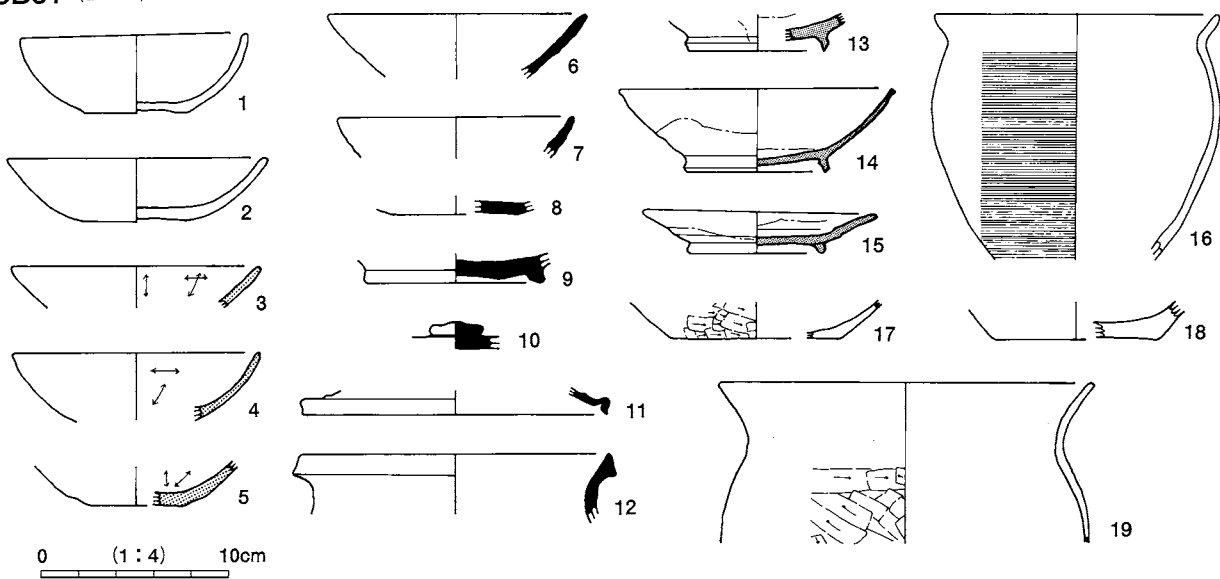

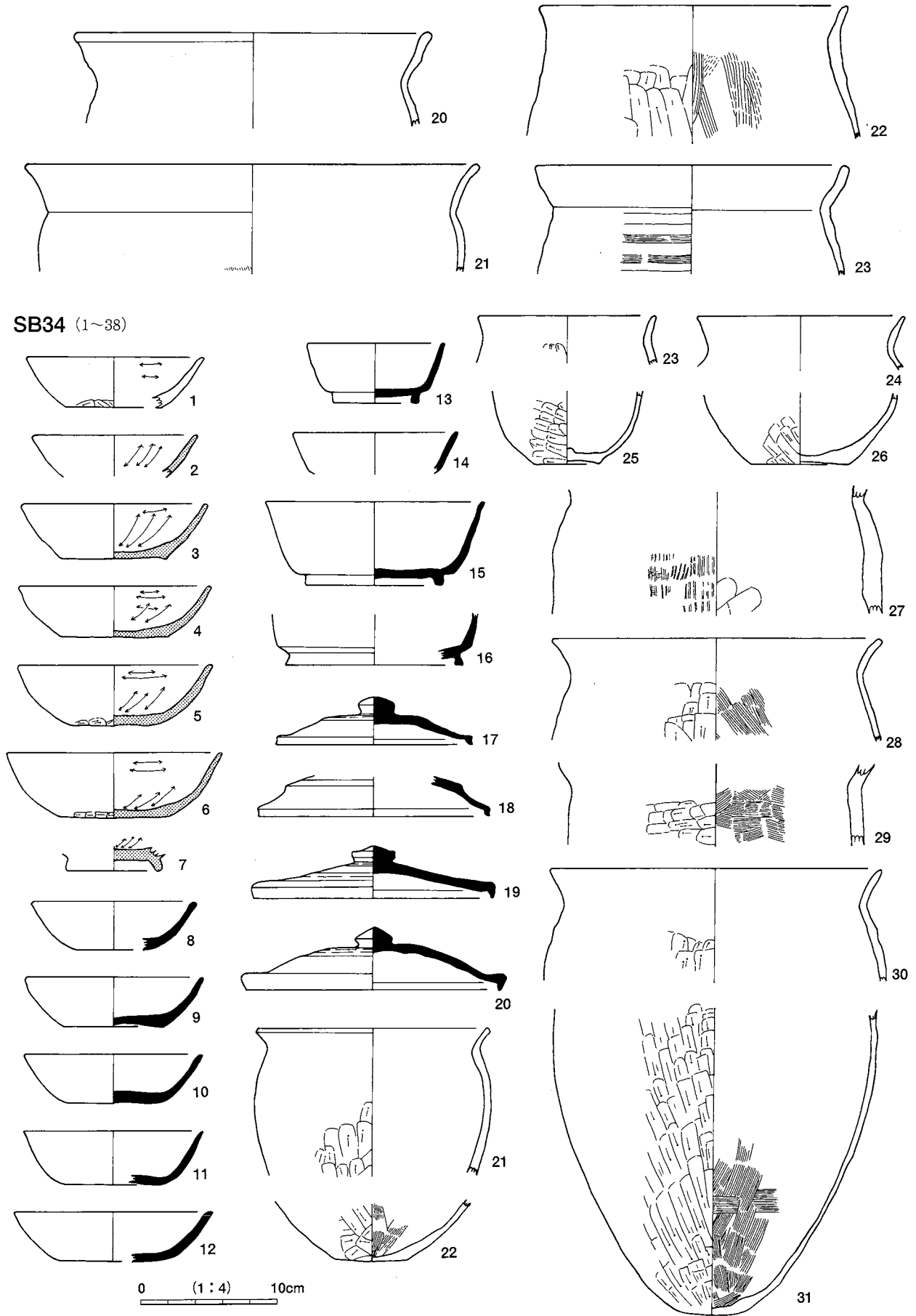

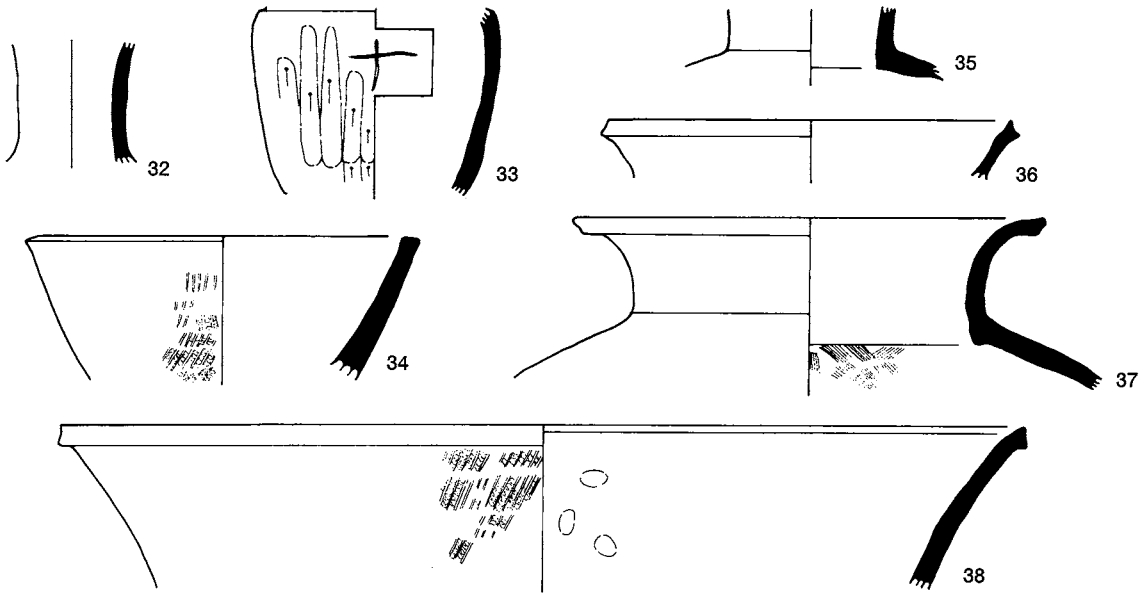

SB35 (1~29)

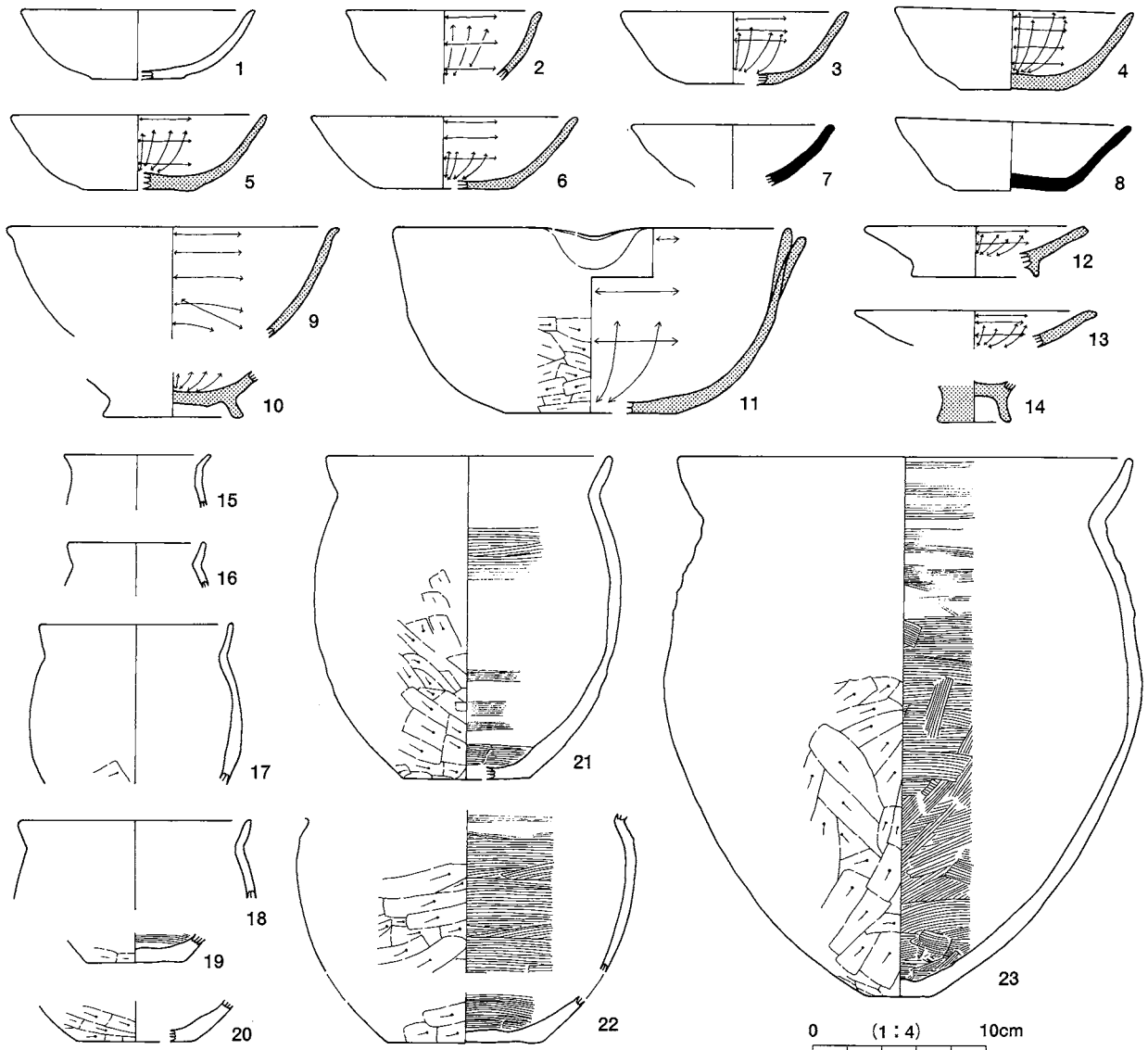

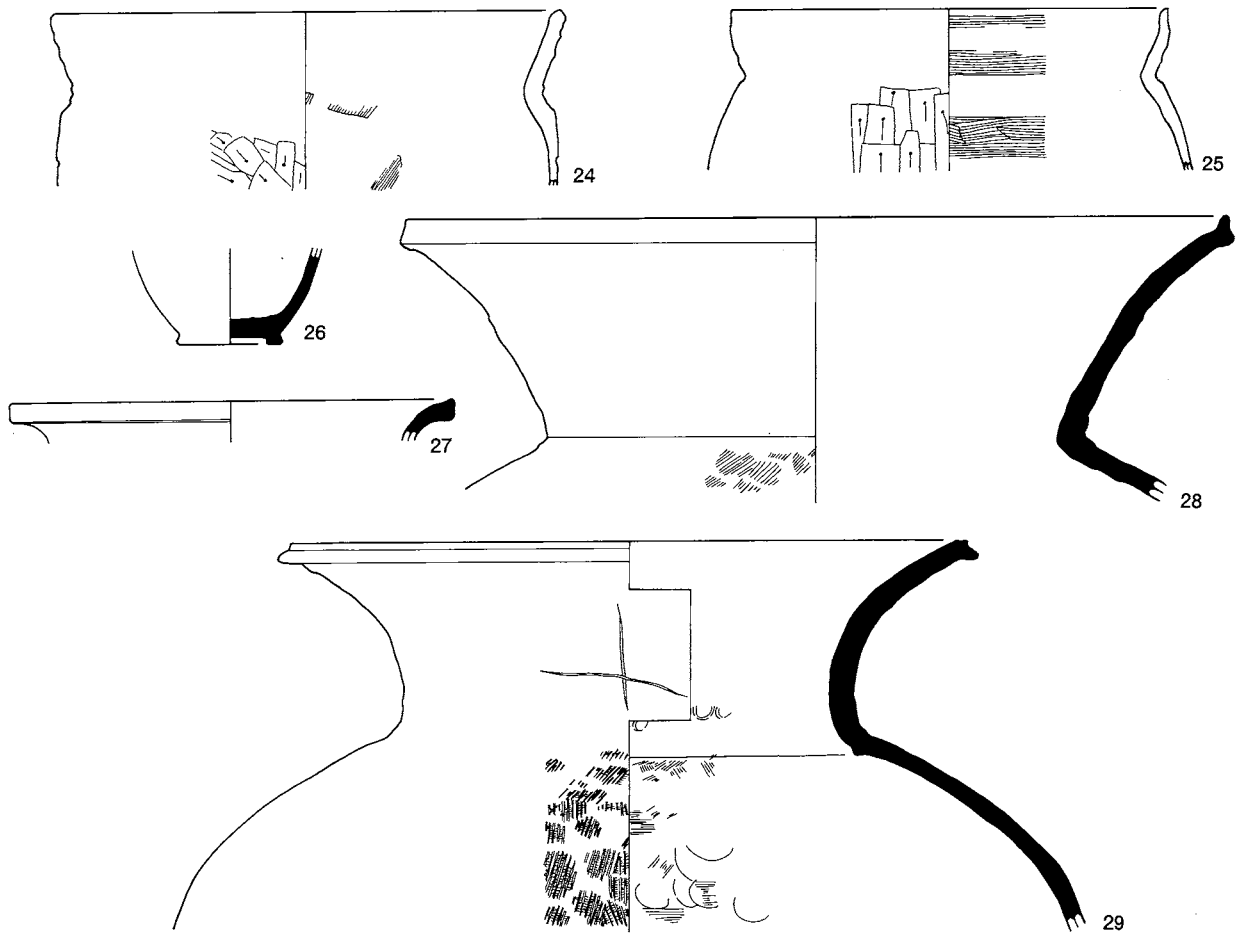

SB37

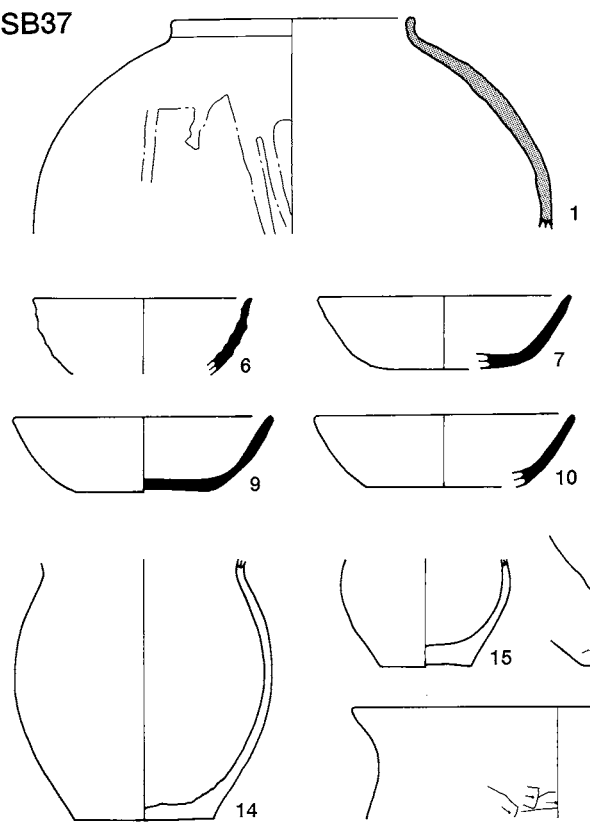

SB38 (1~19)

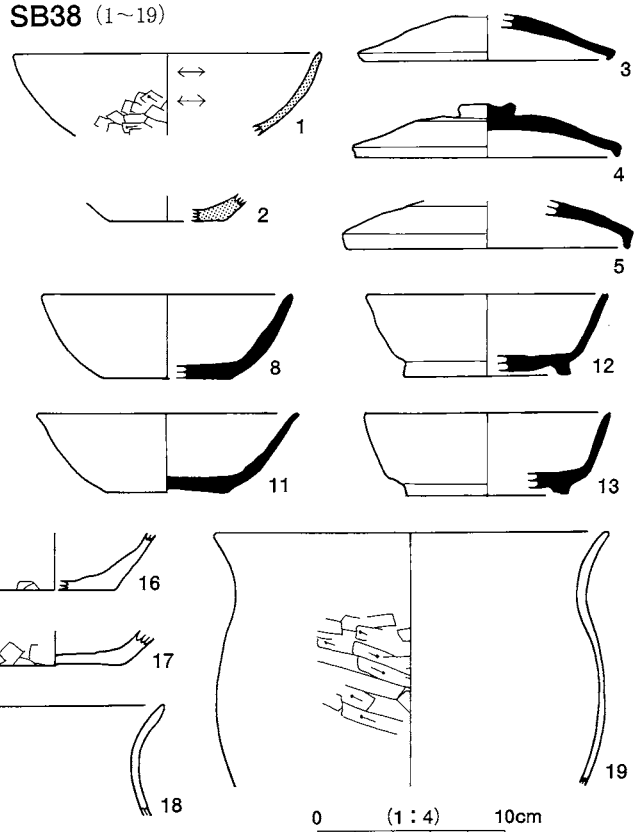

SB39 (1~6)

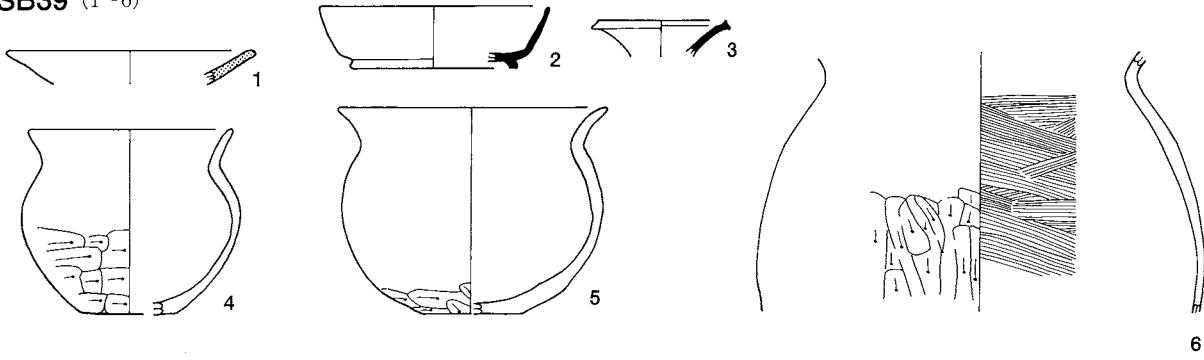

SB40 (1~19)

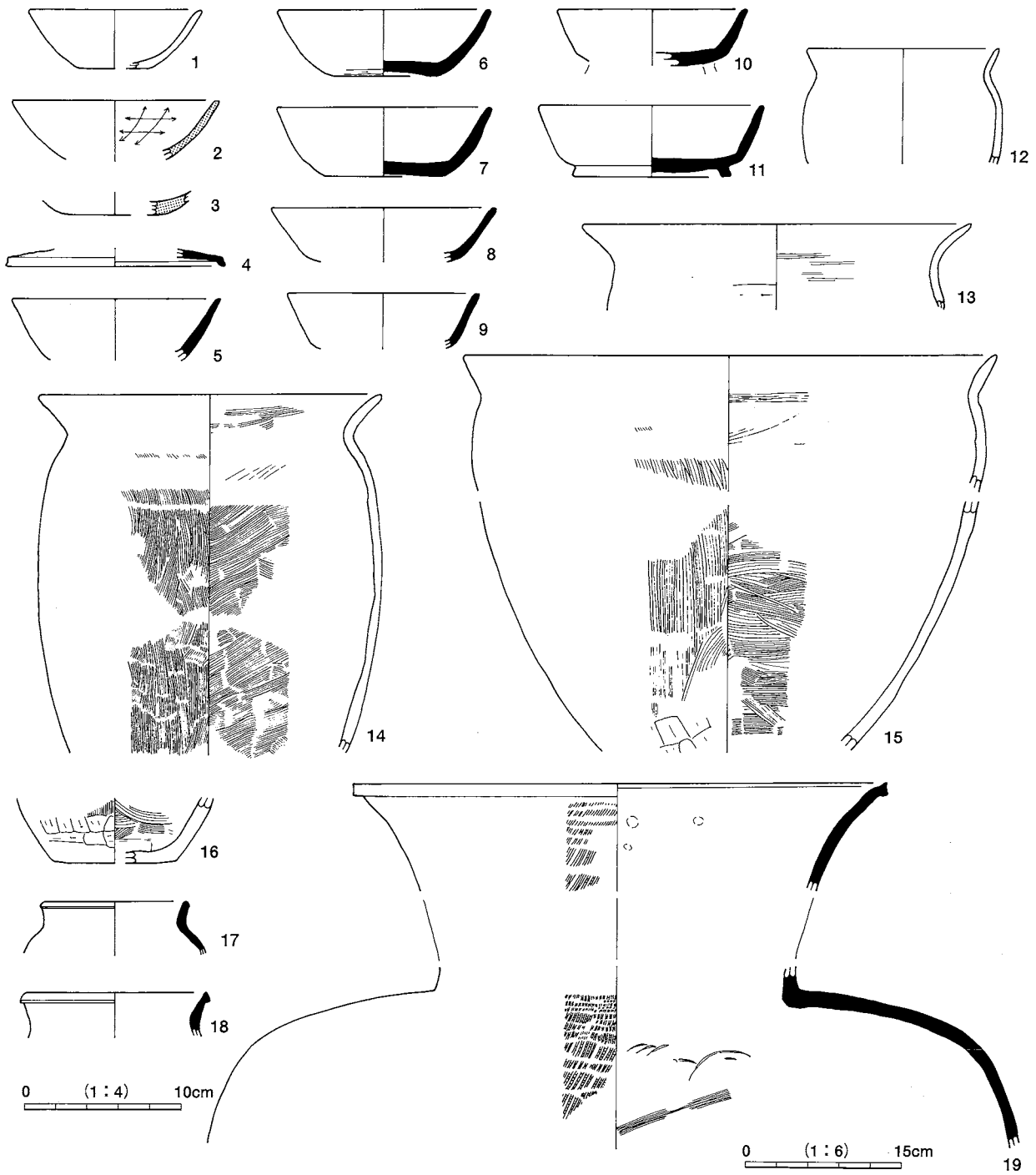

SB41 (1~5)

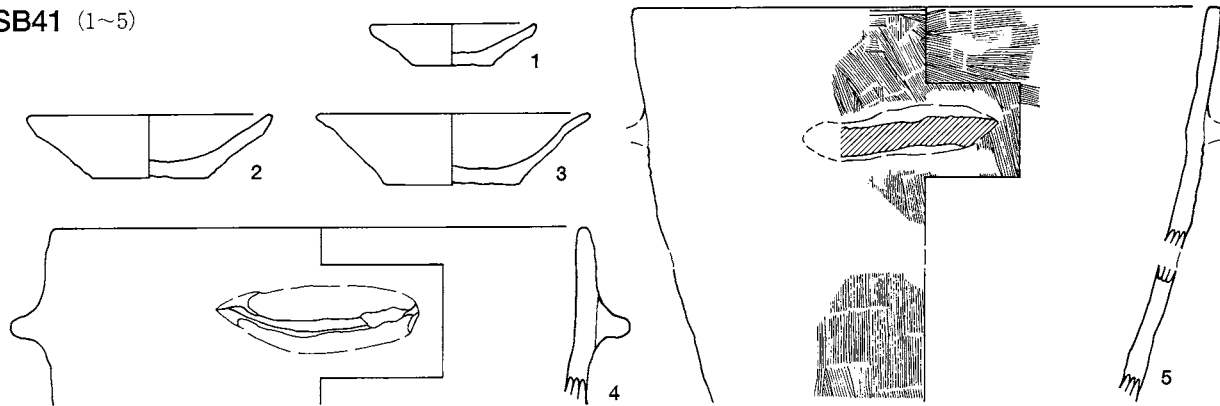

SB43 (1~10)

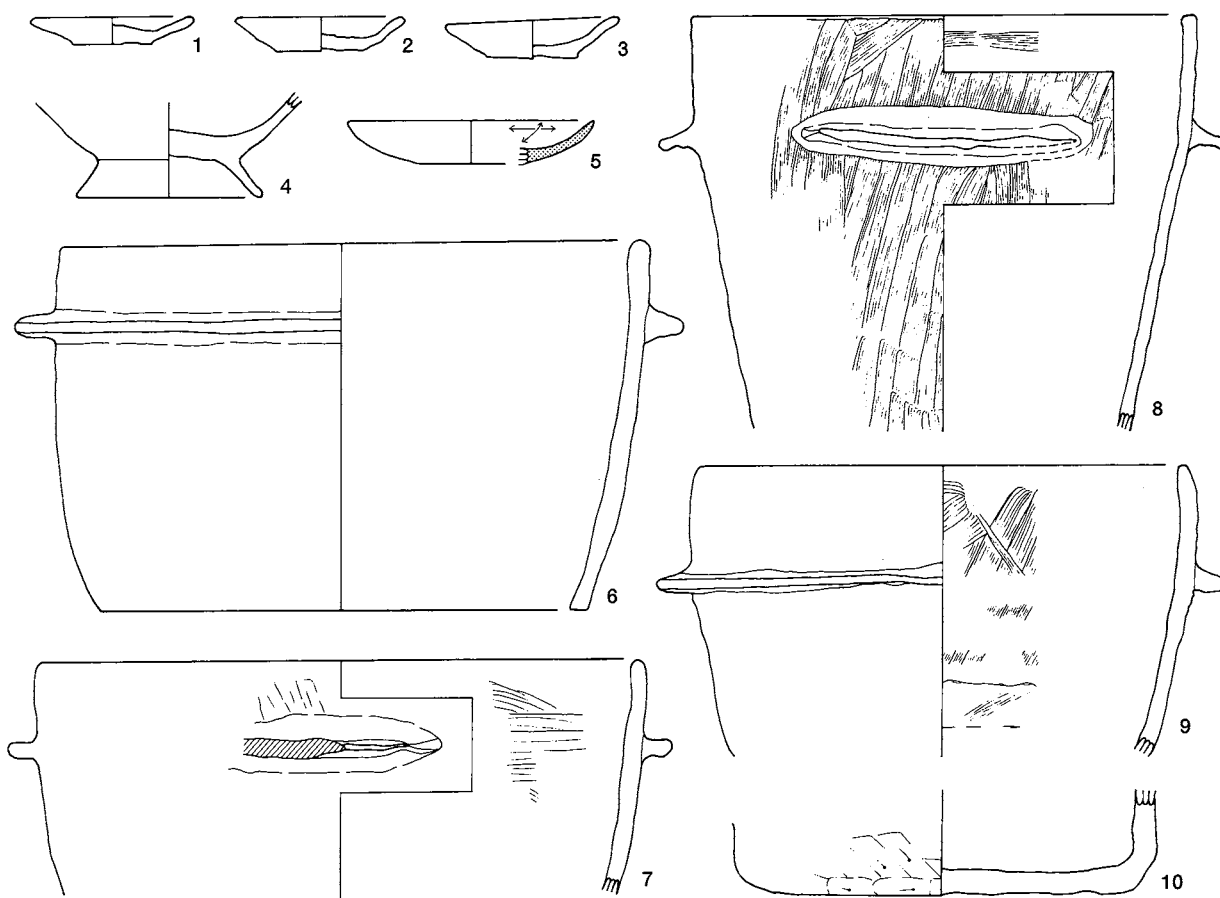

SB45 (1~3)

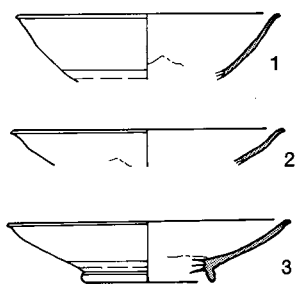

SB48 (1~22)

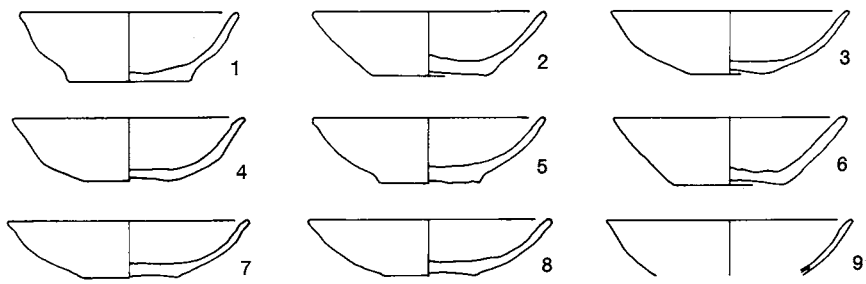

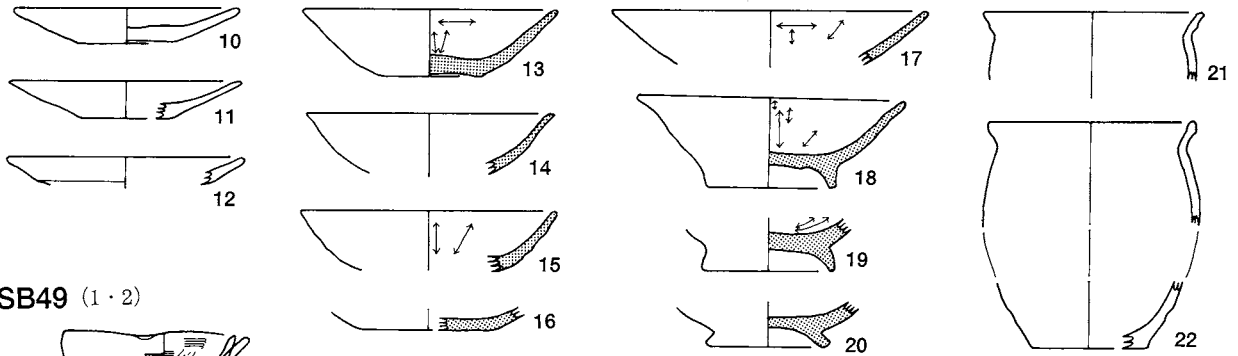

SB49 (1・2)

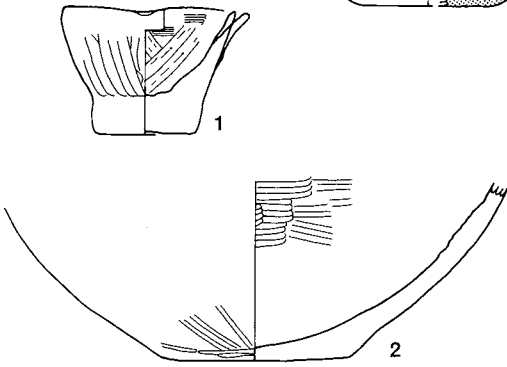

SB54 (1~4)

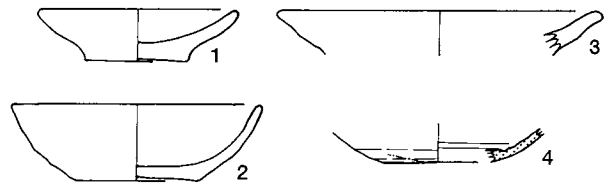

SB56 (1~21)

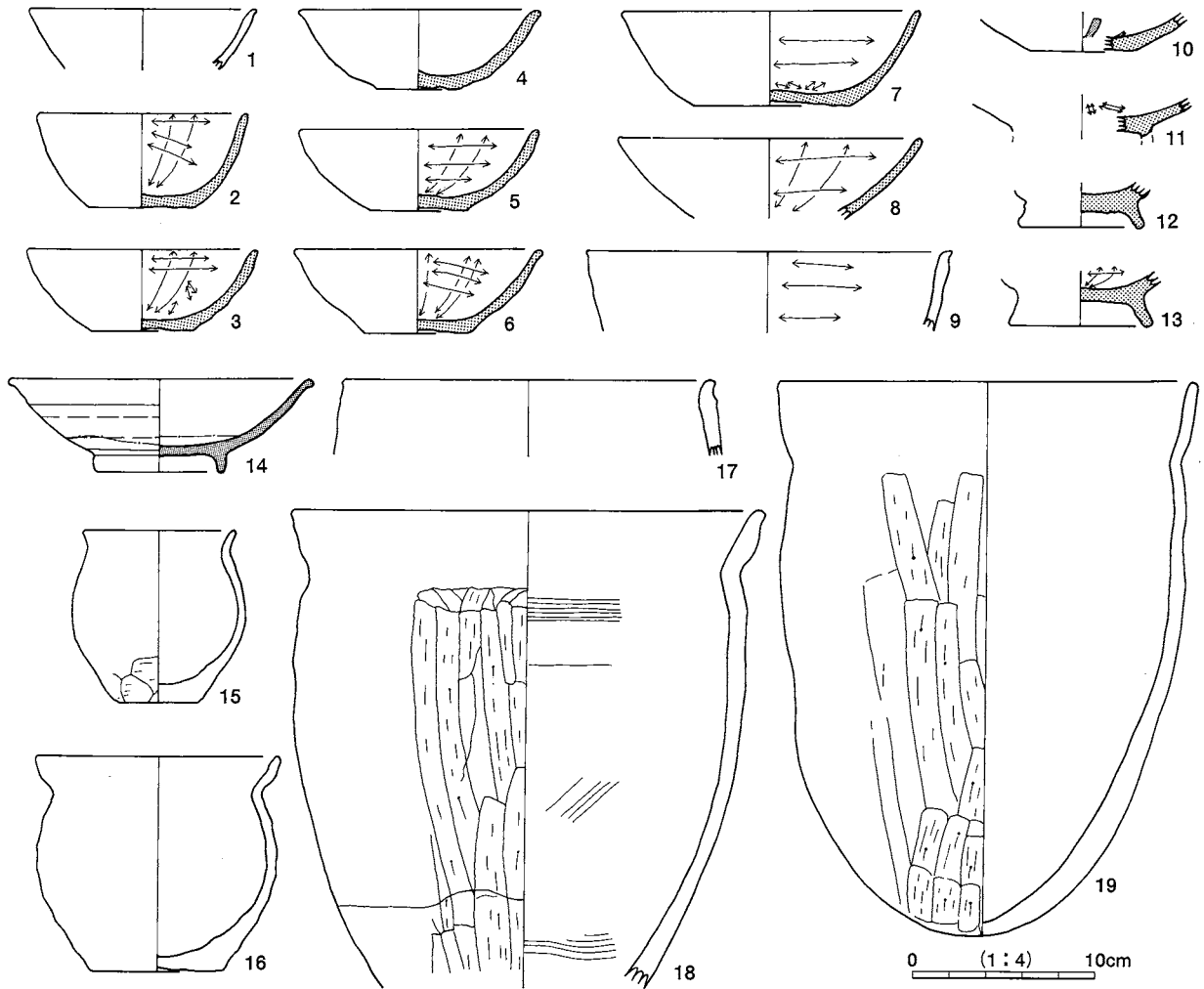

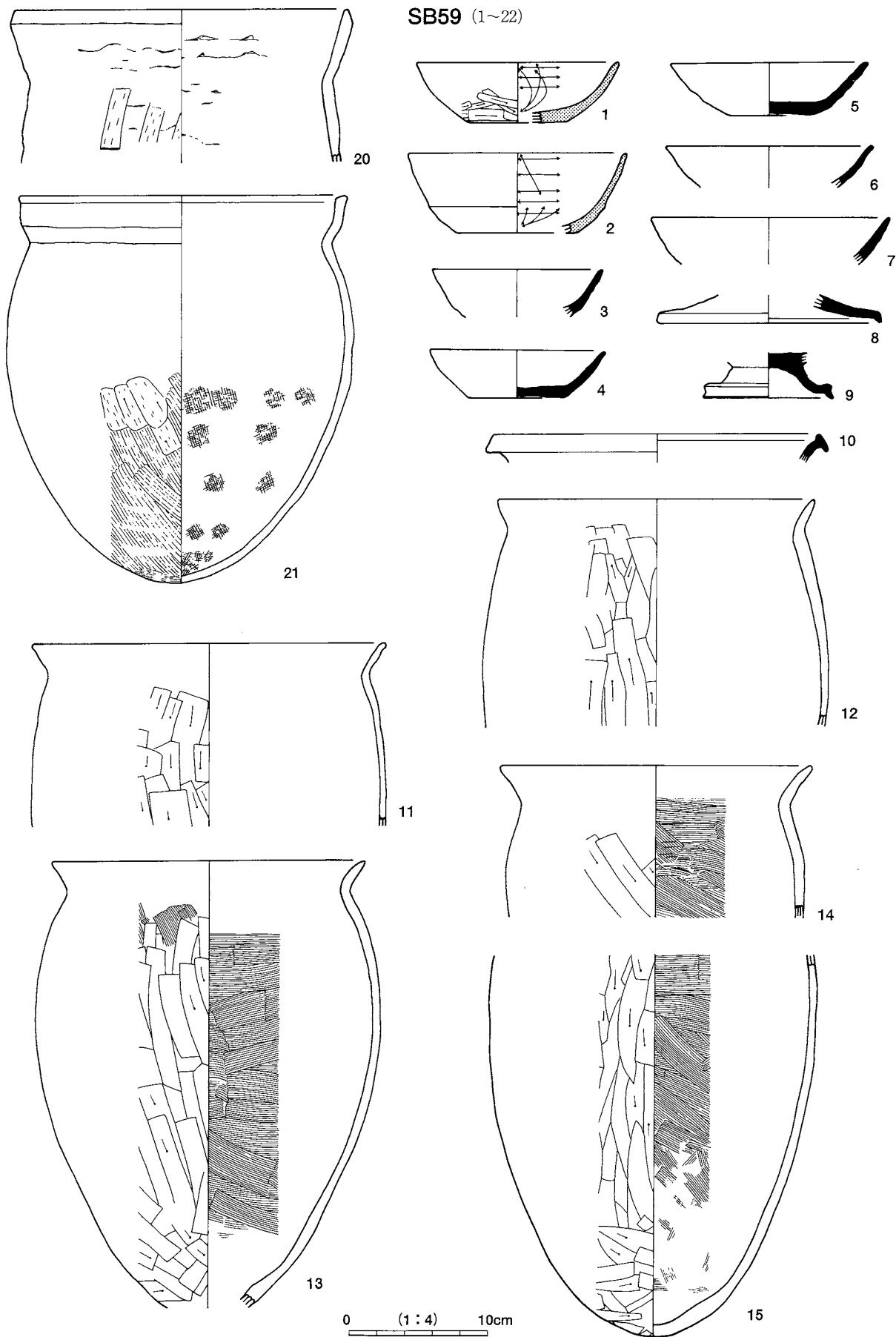

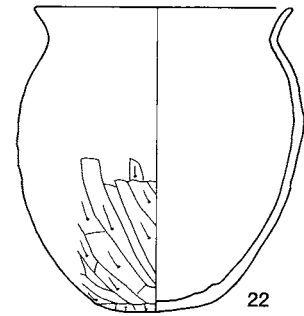
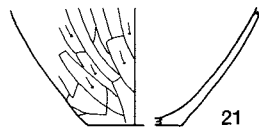
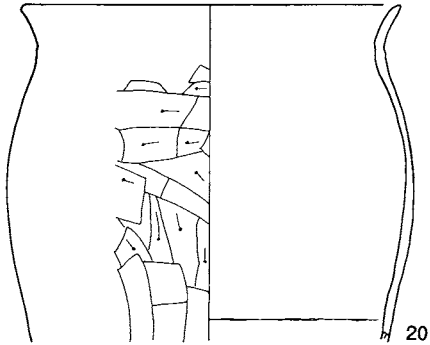
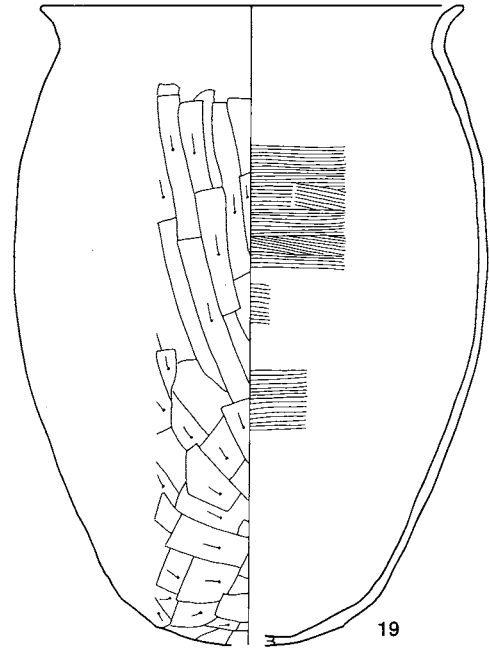
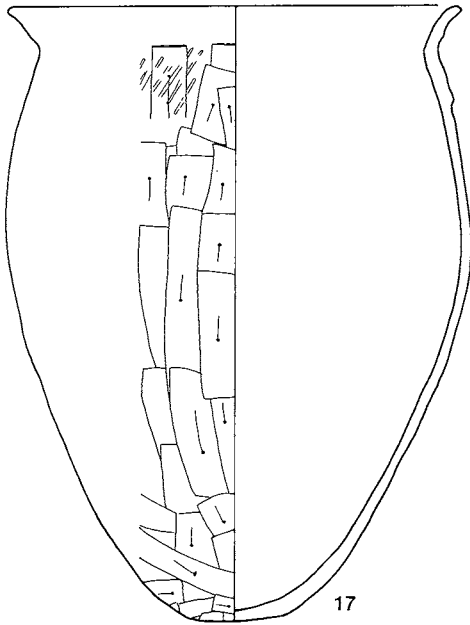
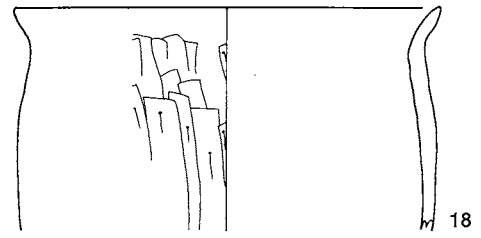
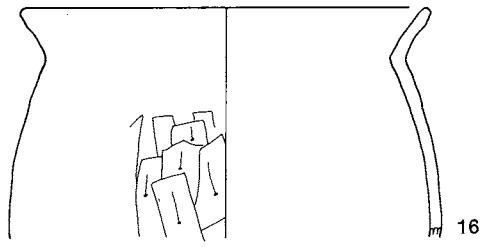

SB60 (1~3)

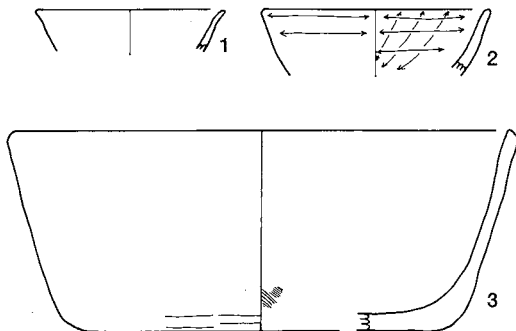

0 (1:4) 10cm

SB64

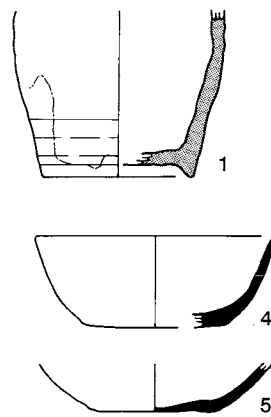

SB65 (1~14)

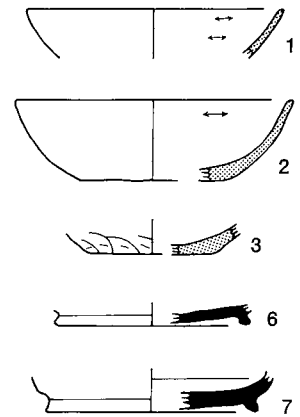

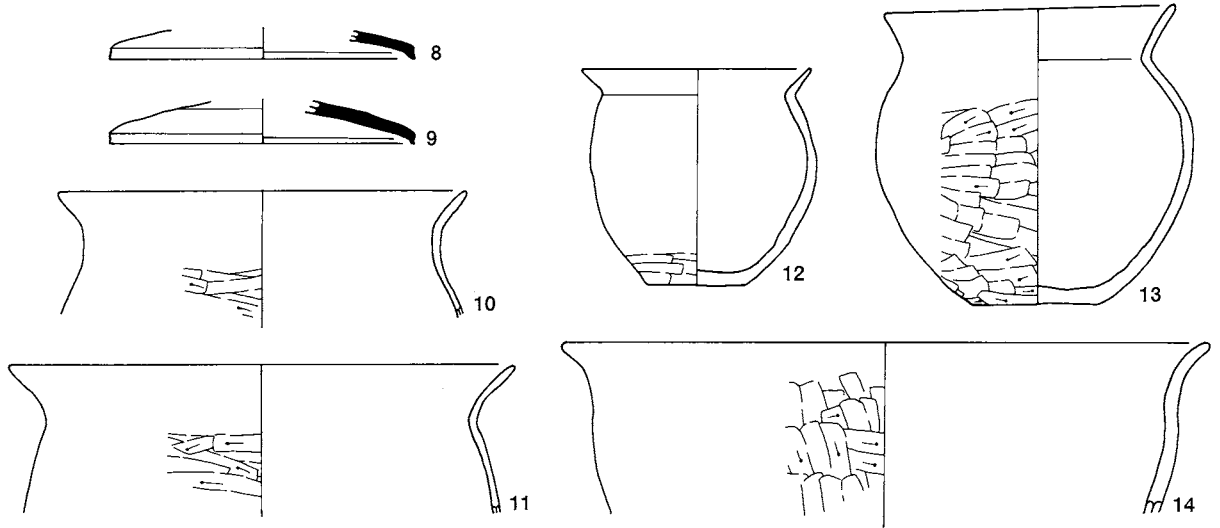

SB70 (1~13)

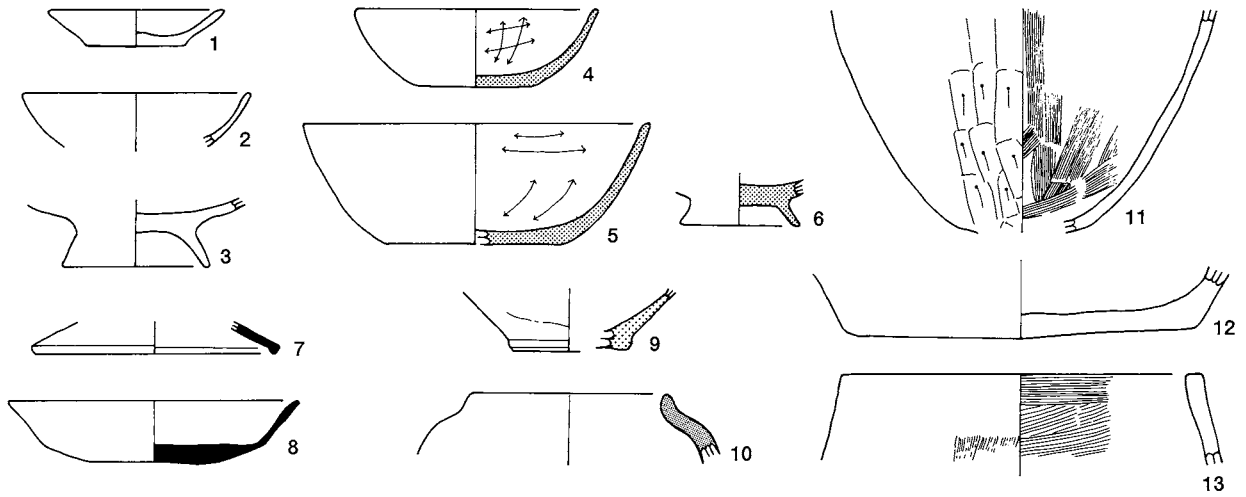

SB76 (1~12)

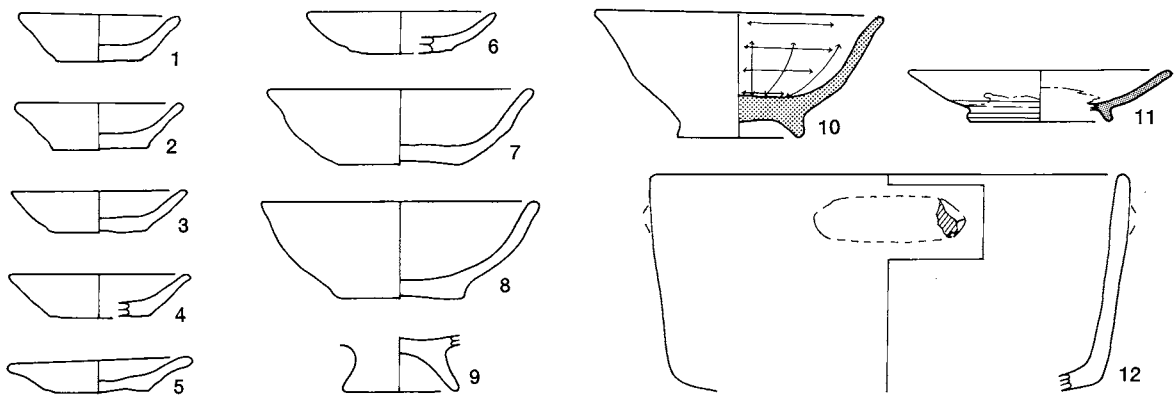

SB72 (1~3)

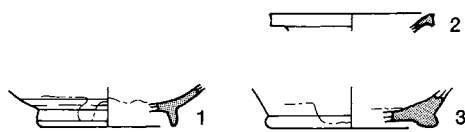

SB77 (1~6)

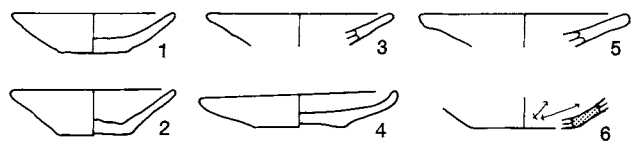

SB78 (1~11)

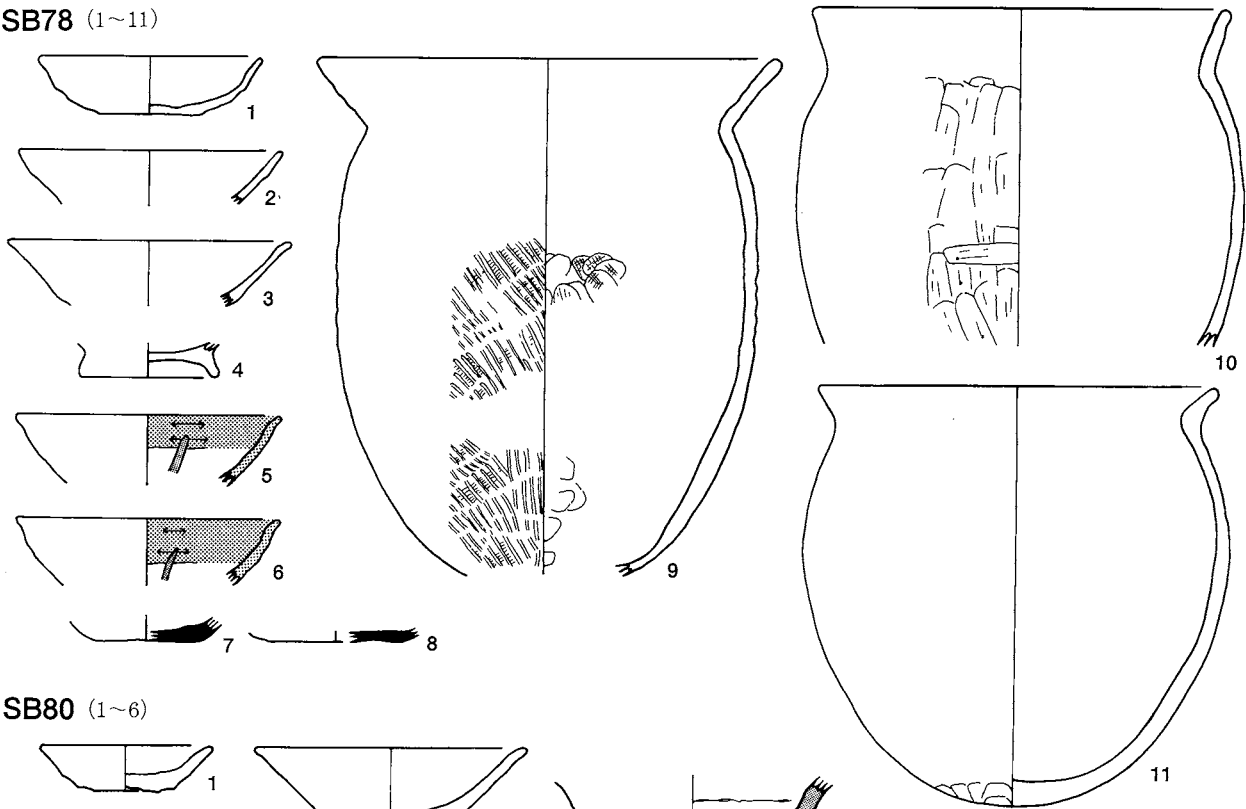

SB80 (1~6)

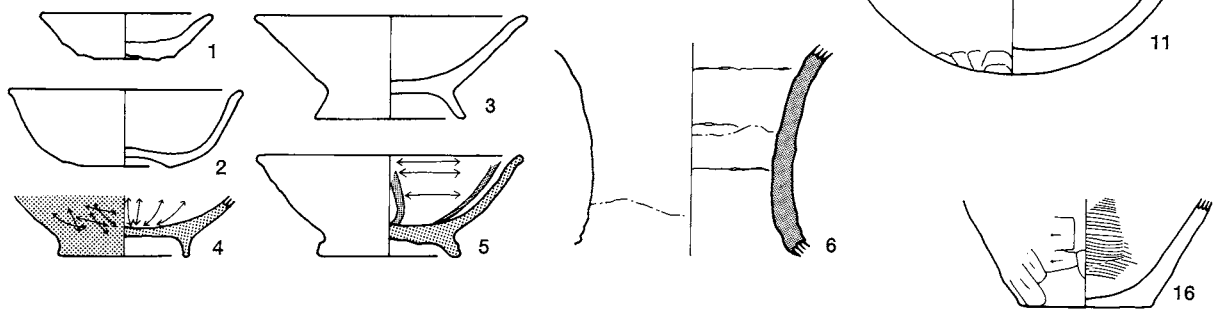

SB81 (1~19)

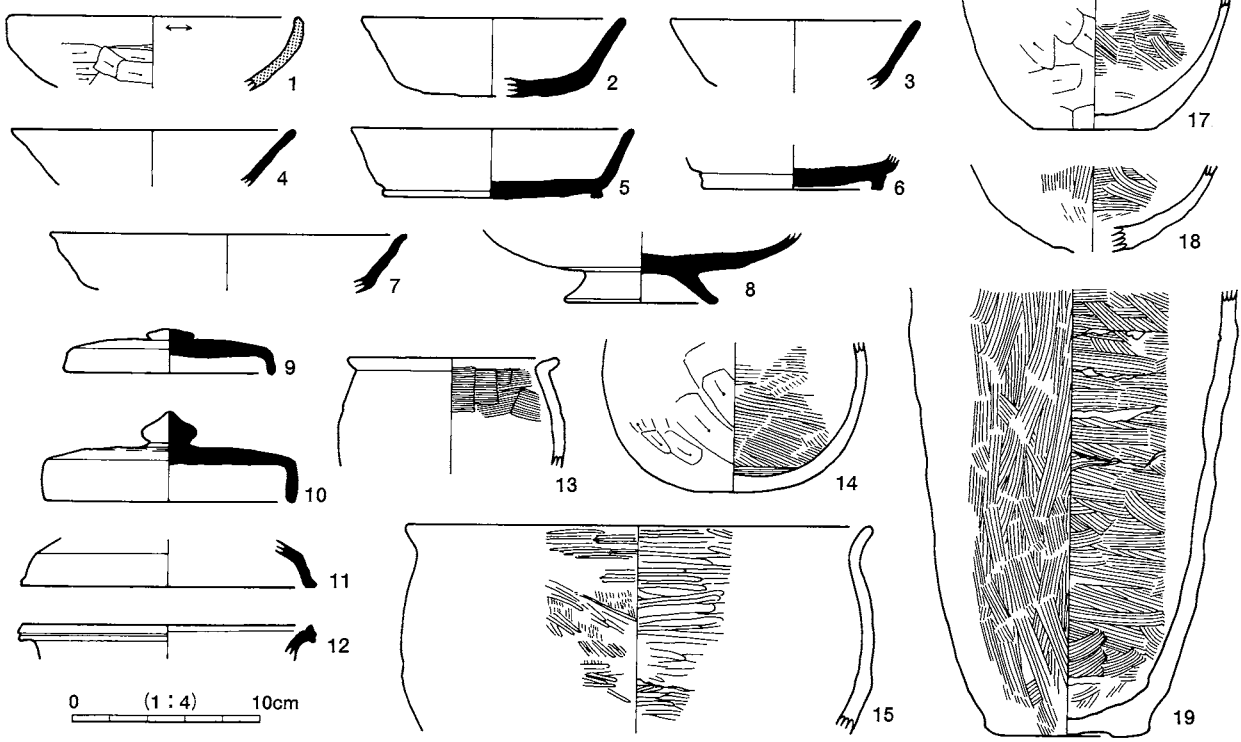

0 (1:4) 10cm

SB83 (1~4)

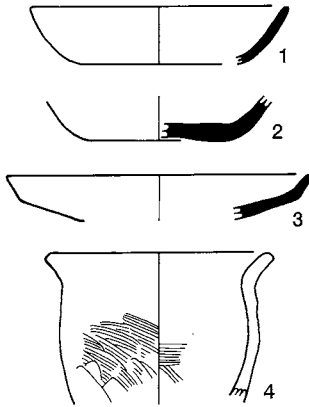

SB85 (1·2)

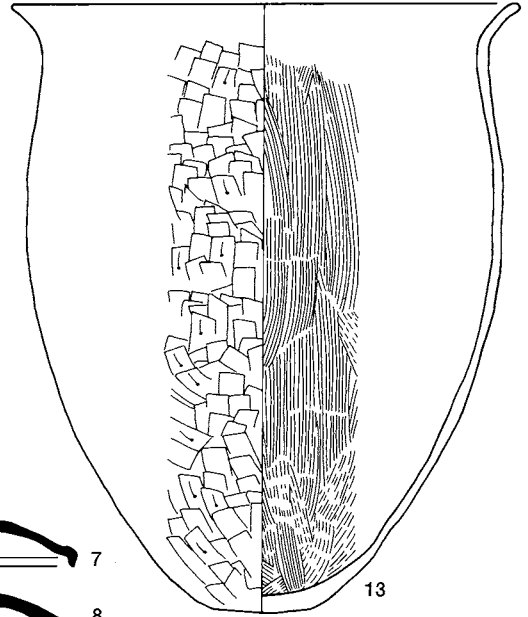
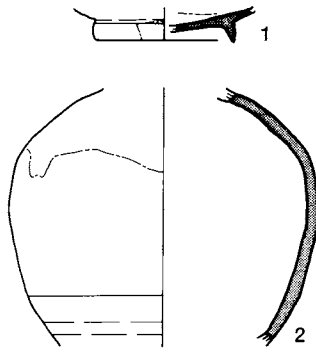

SB87 (1~15)

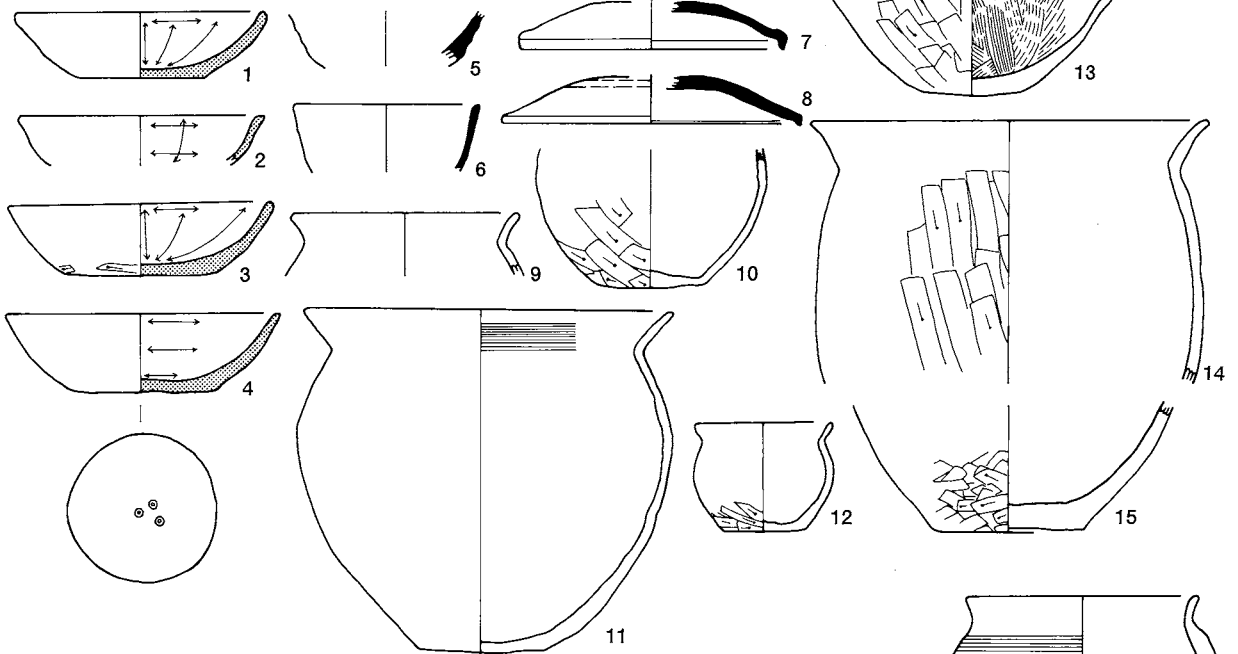

SB88 (1~12)

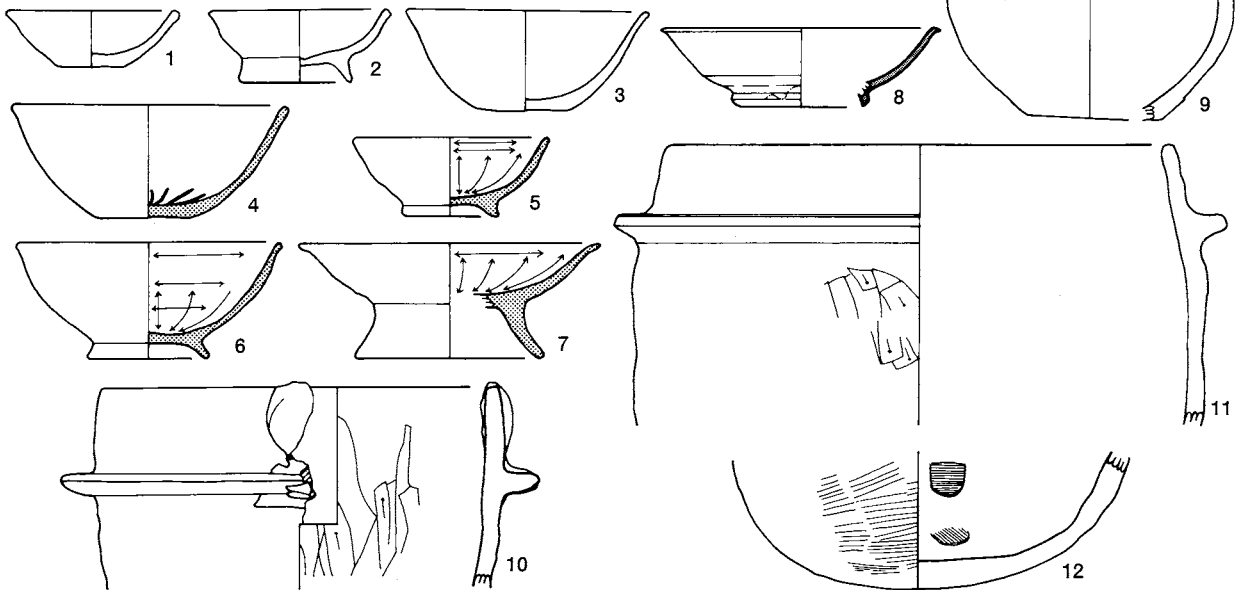

SB91 (1~5)

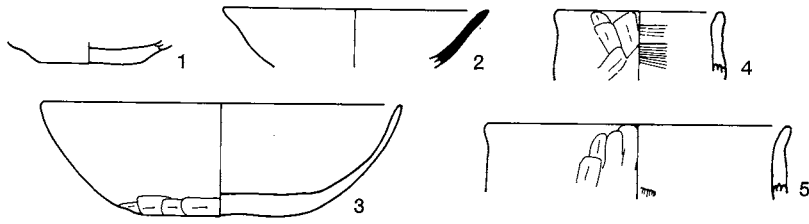

SB93



SB95



SB92 (1~36)

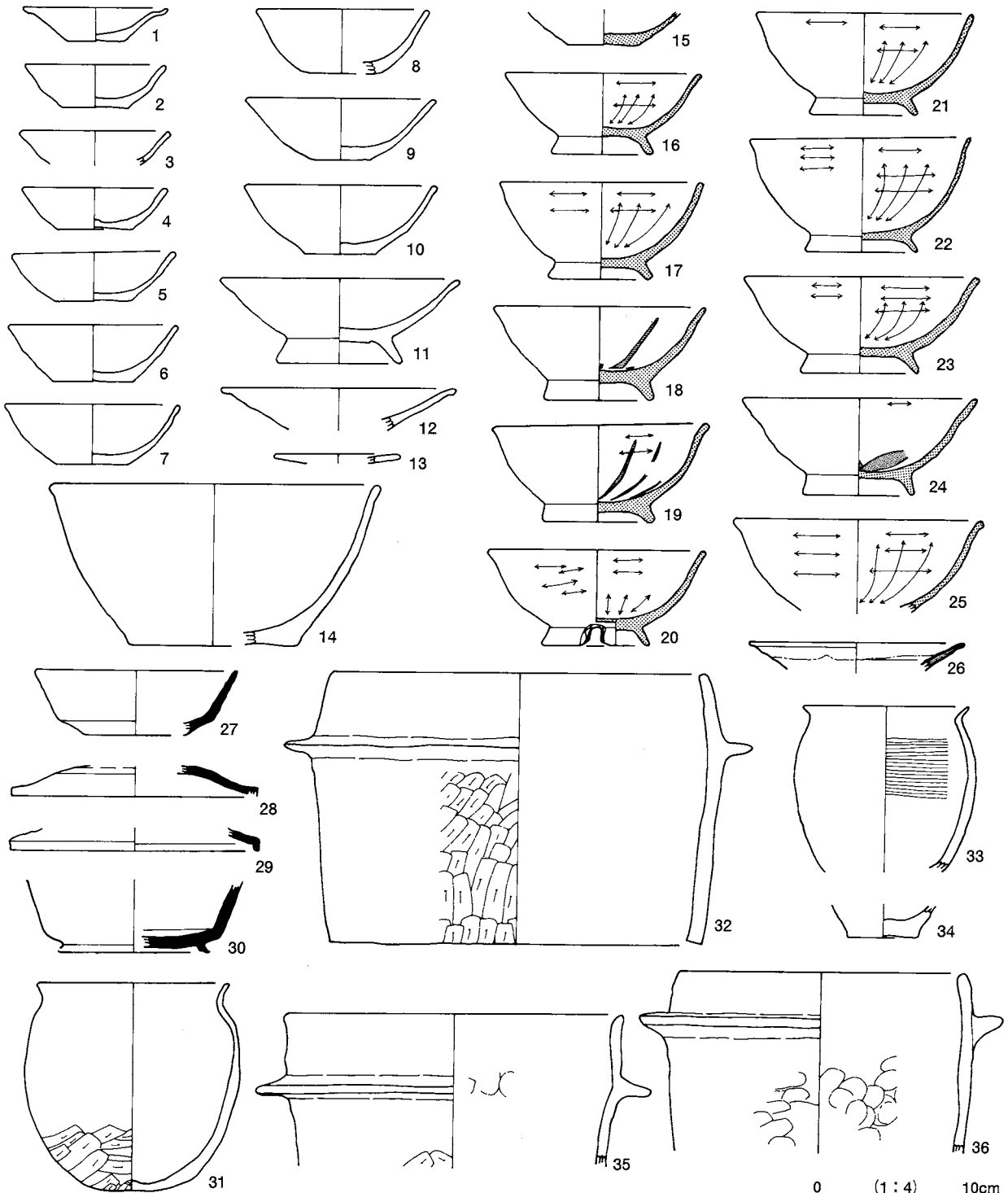

0 (1:4) 10cm

SB97 (1~16)

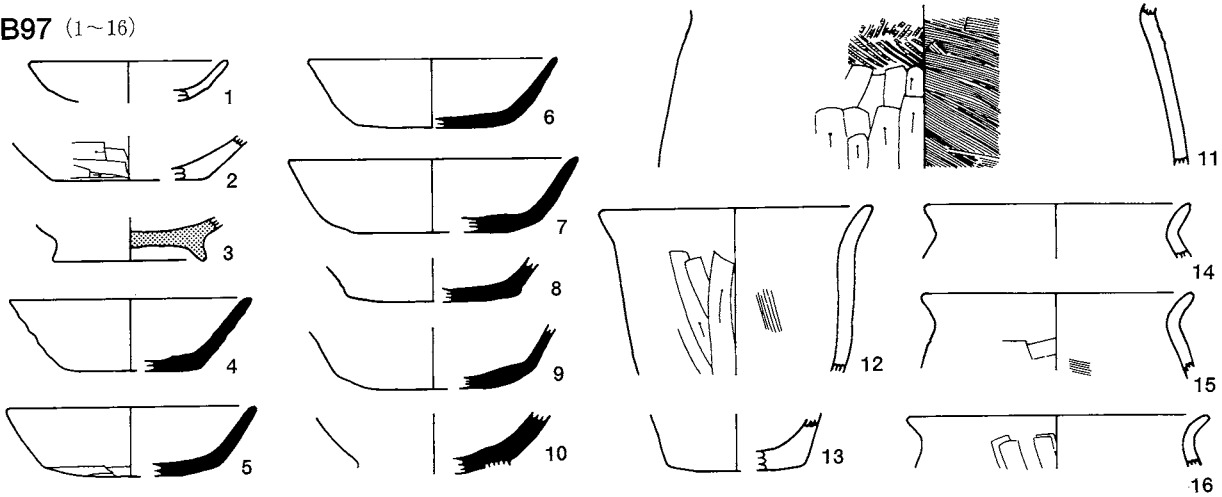

SB98 (1~32)

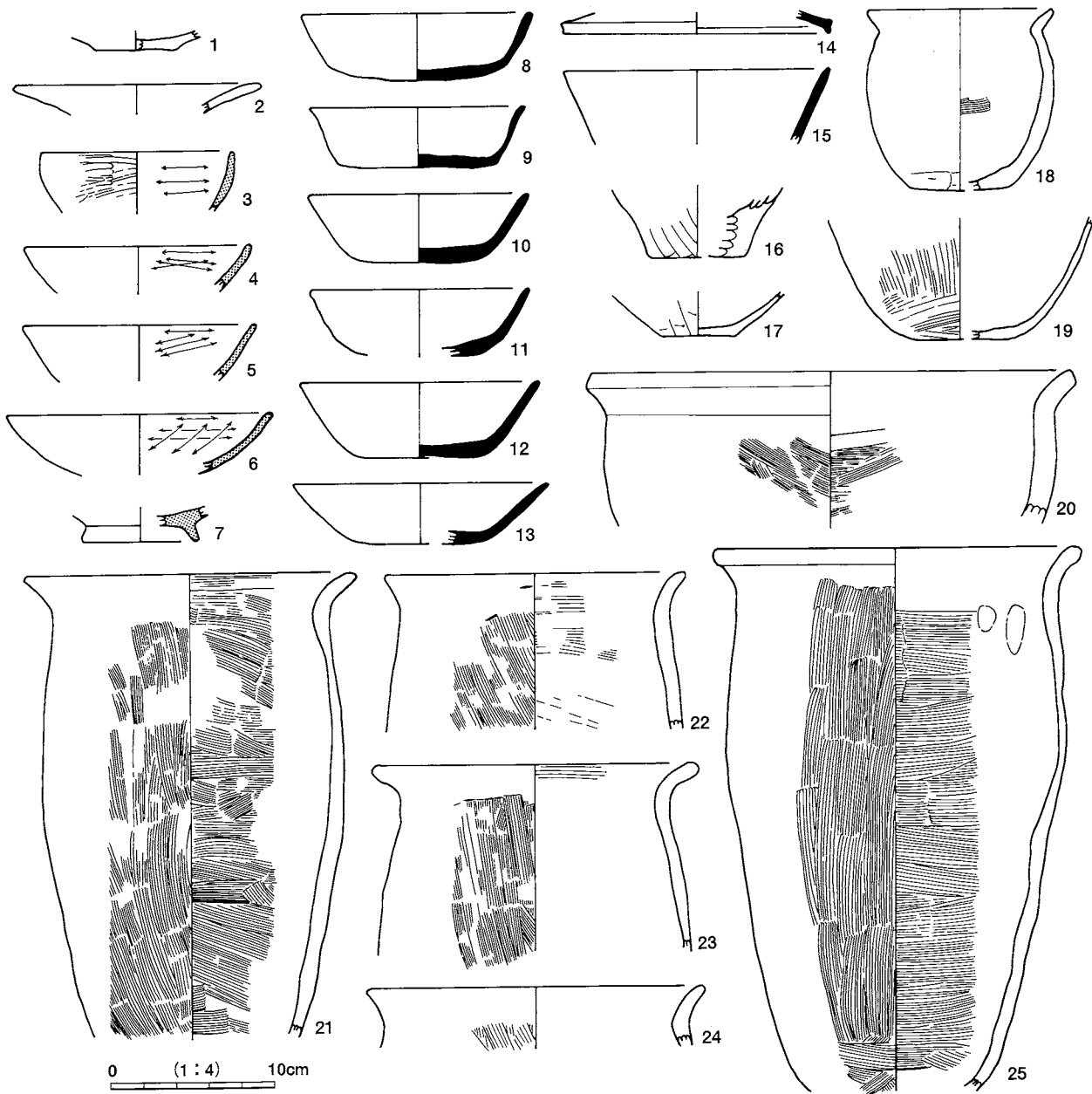

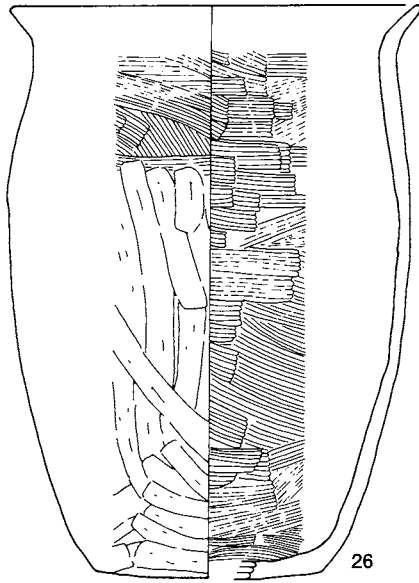

26

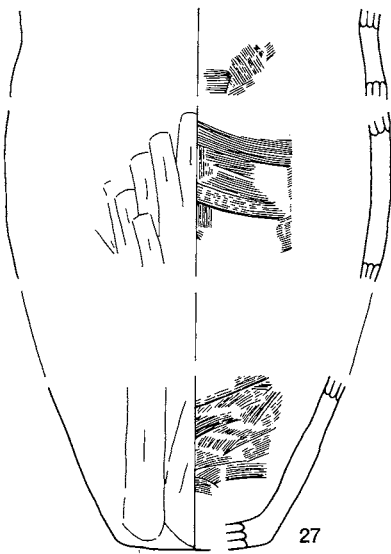

27

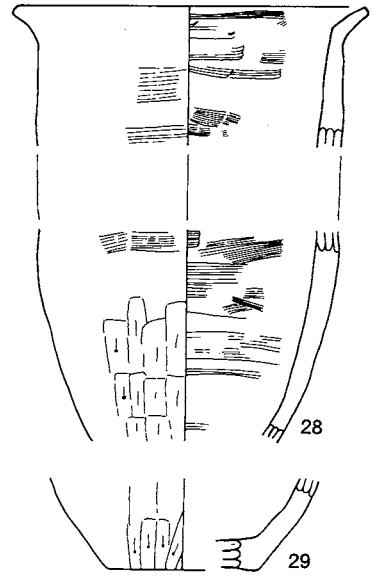

28

29

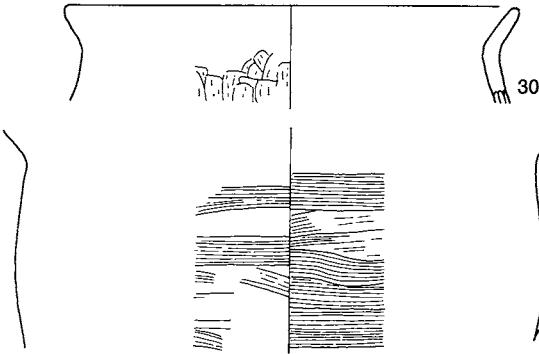

30



31

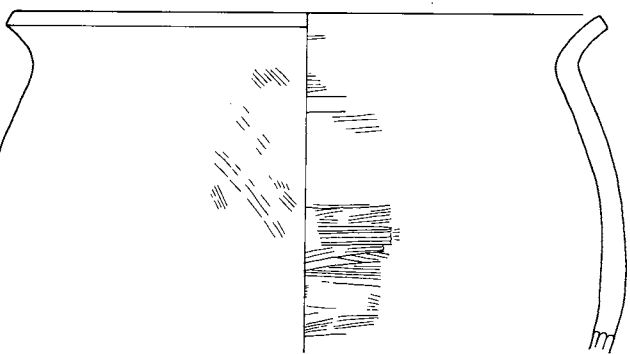

32

SB99 (1~19)

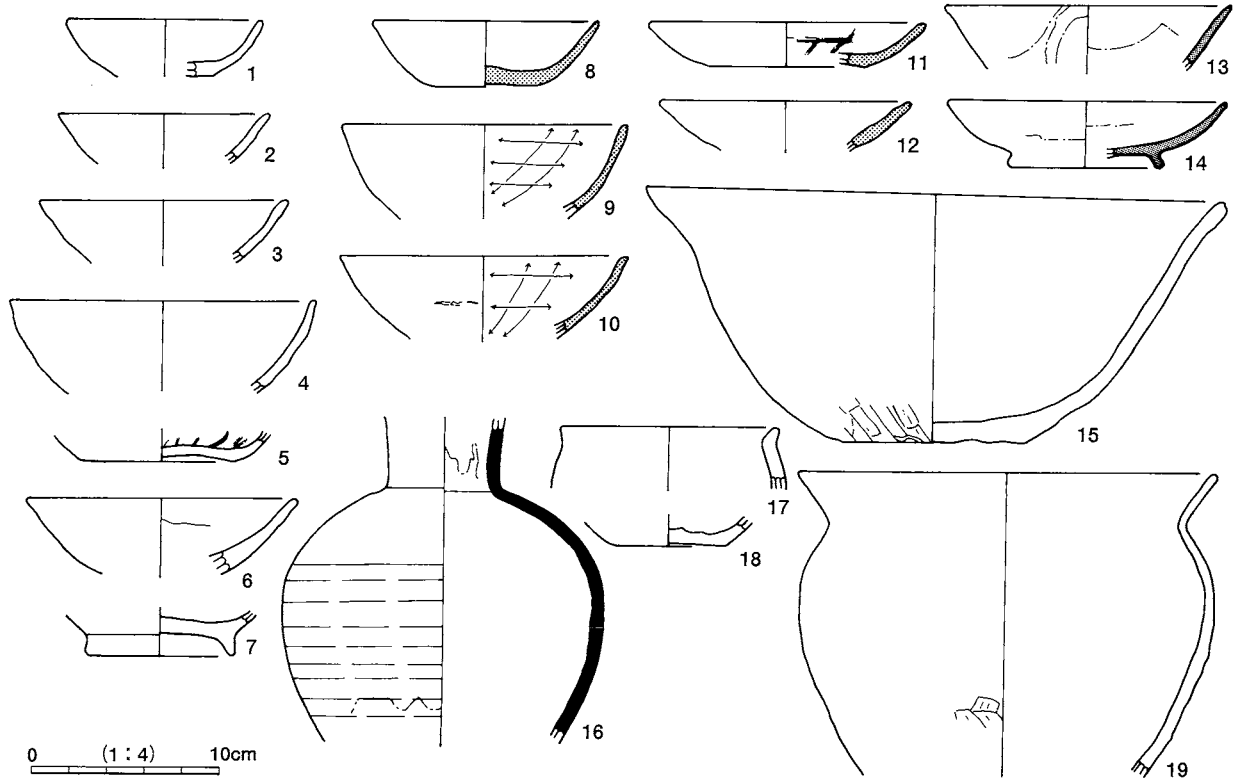

0 (1:4) 10cm

SB100 (1~24)

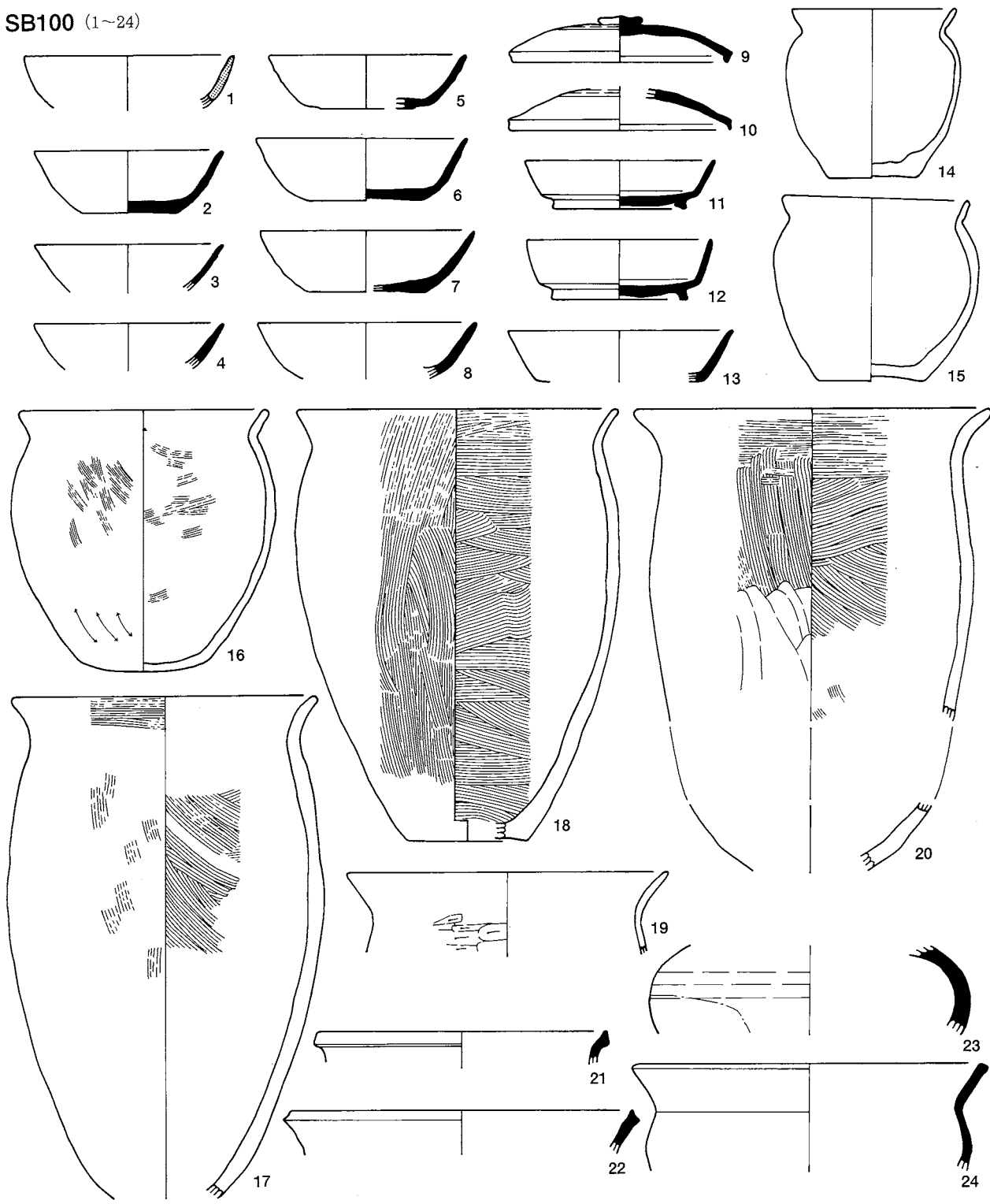

SB101 (1~51)

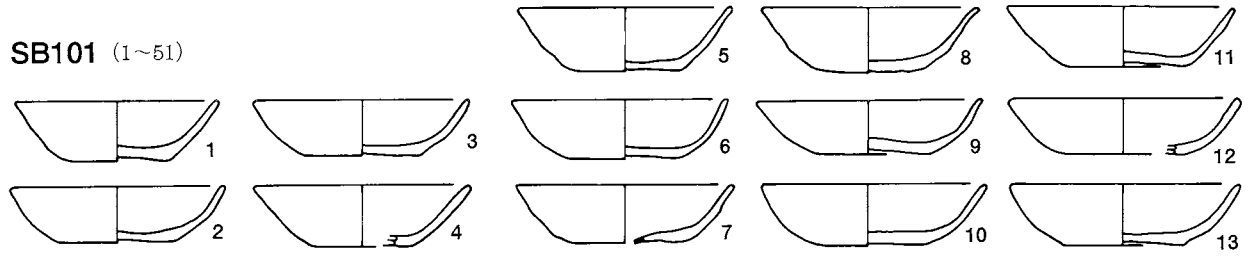

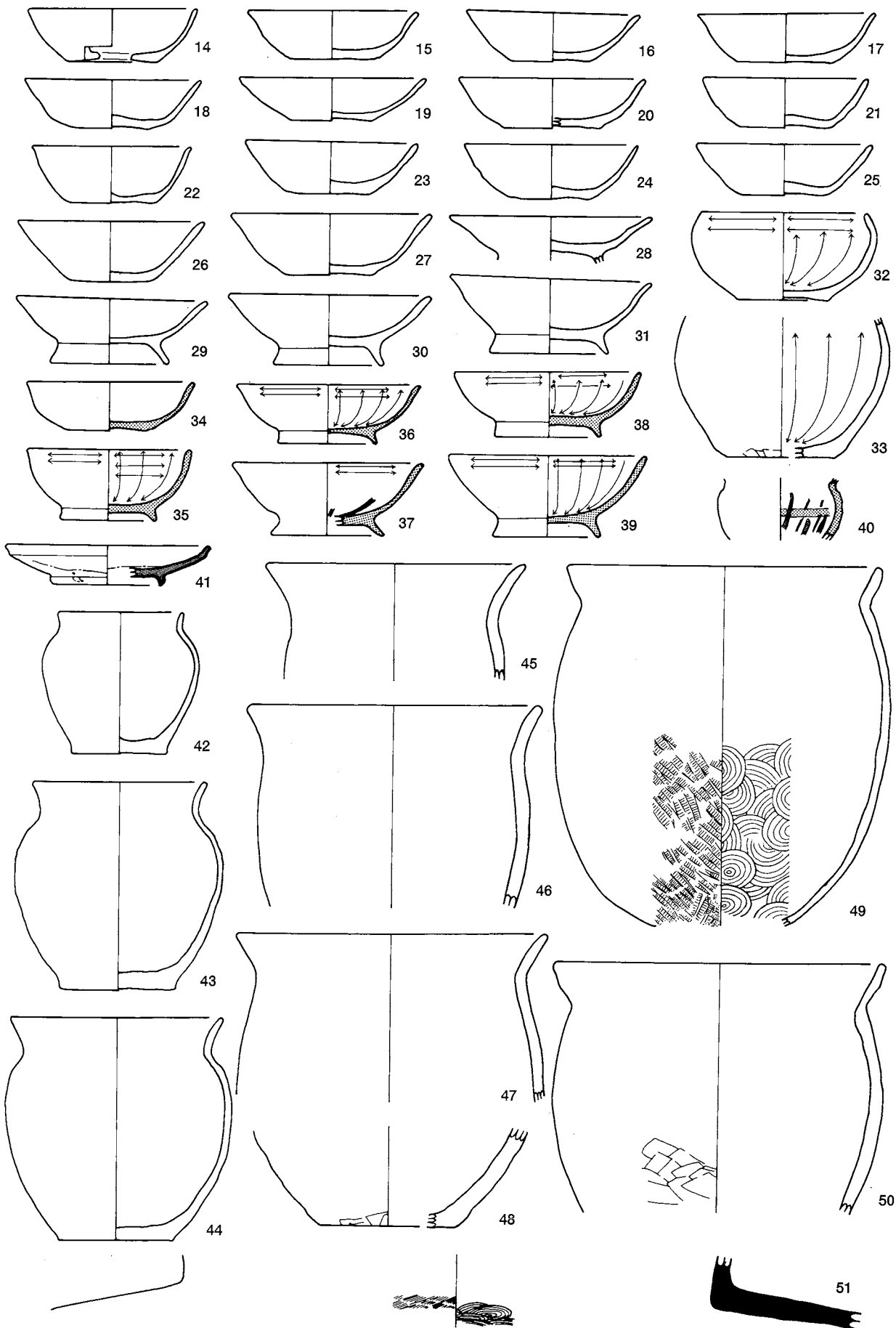

SB102 (1~6)

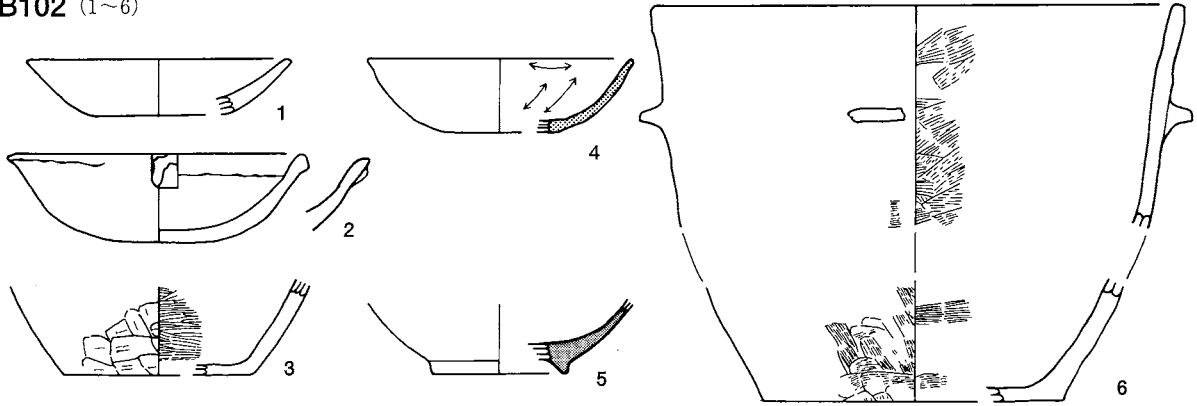

SB104 (1~14)

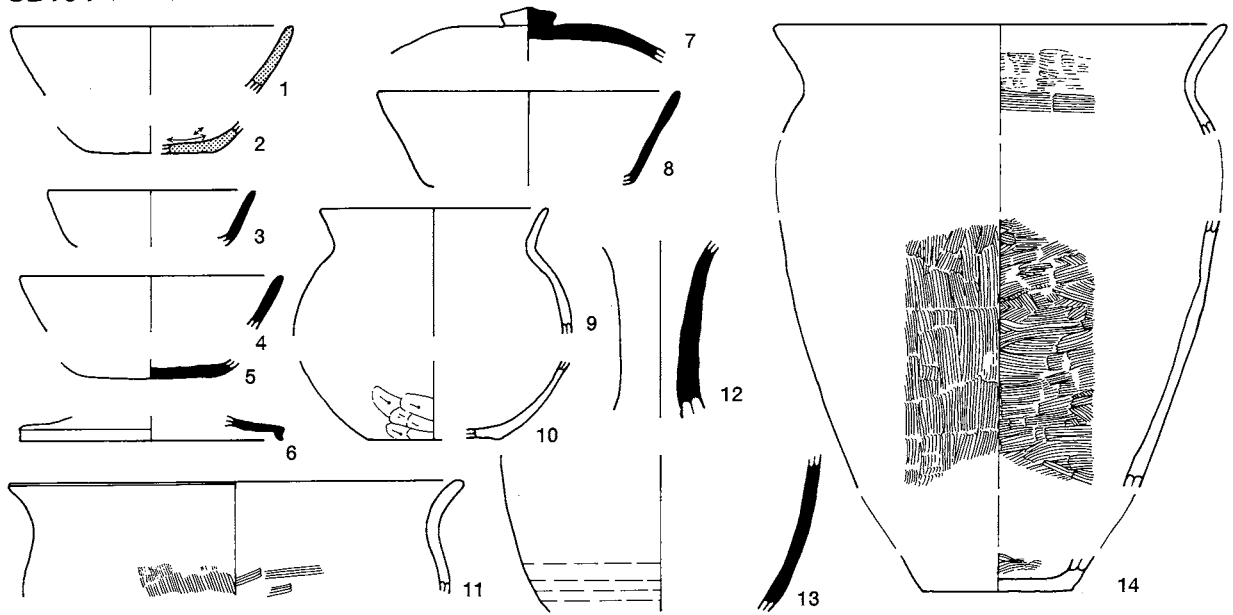

SB105 (1~33)

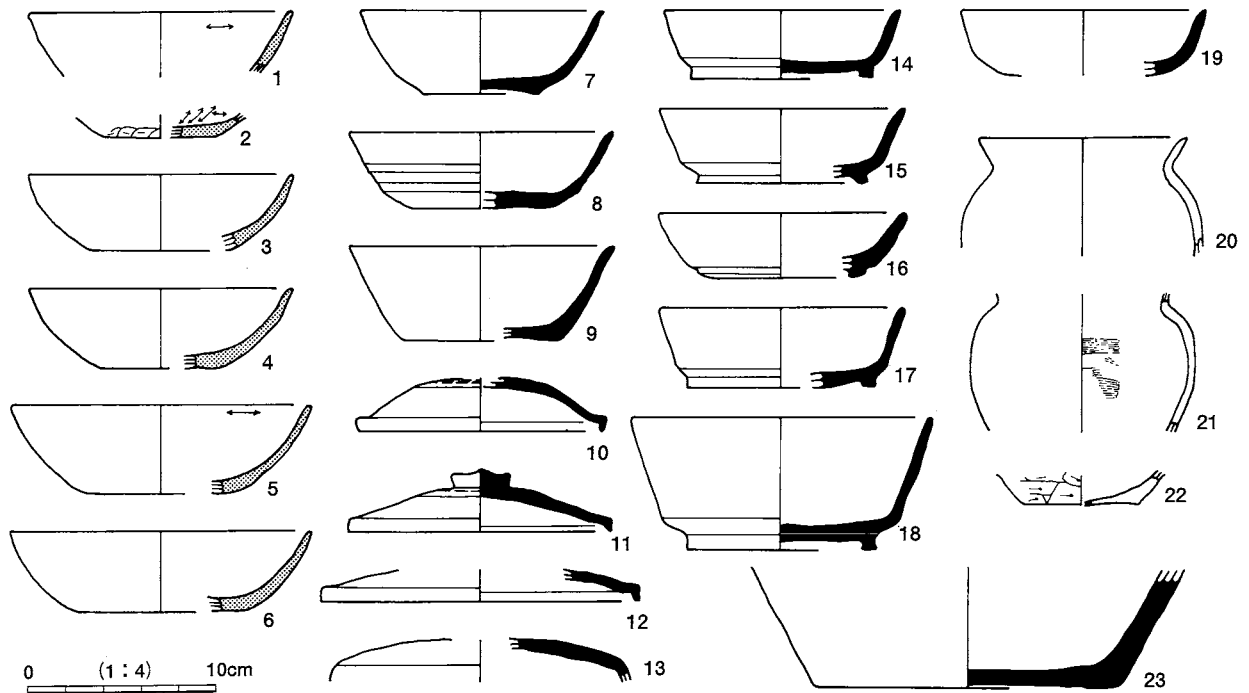

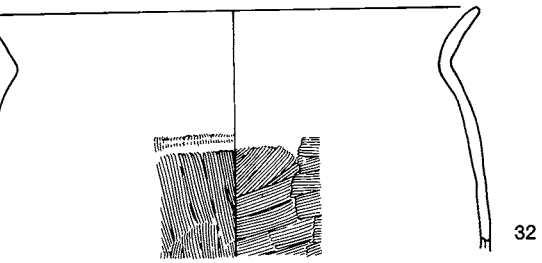
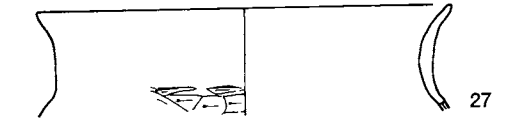
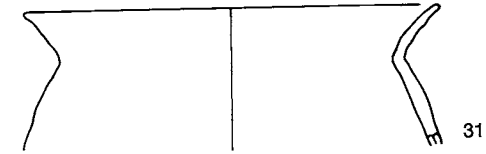
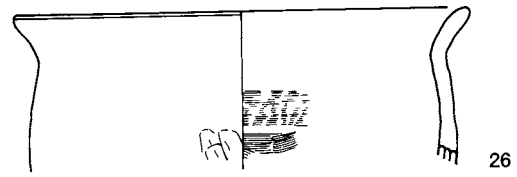
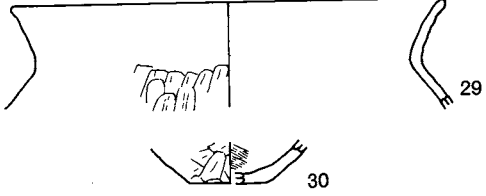
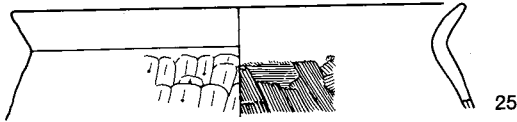
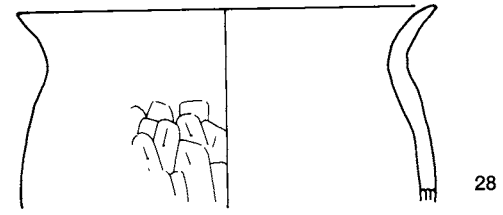
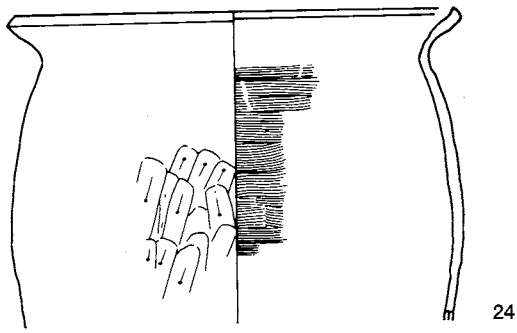

SB108

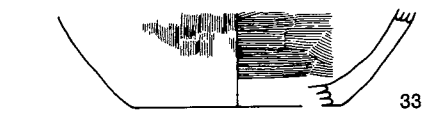
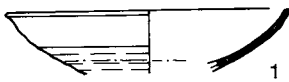

SB111 (1~20)

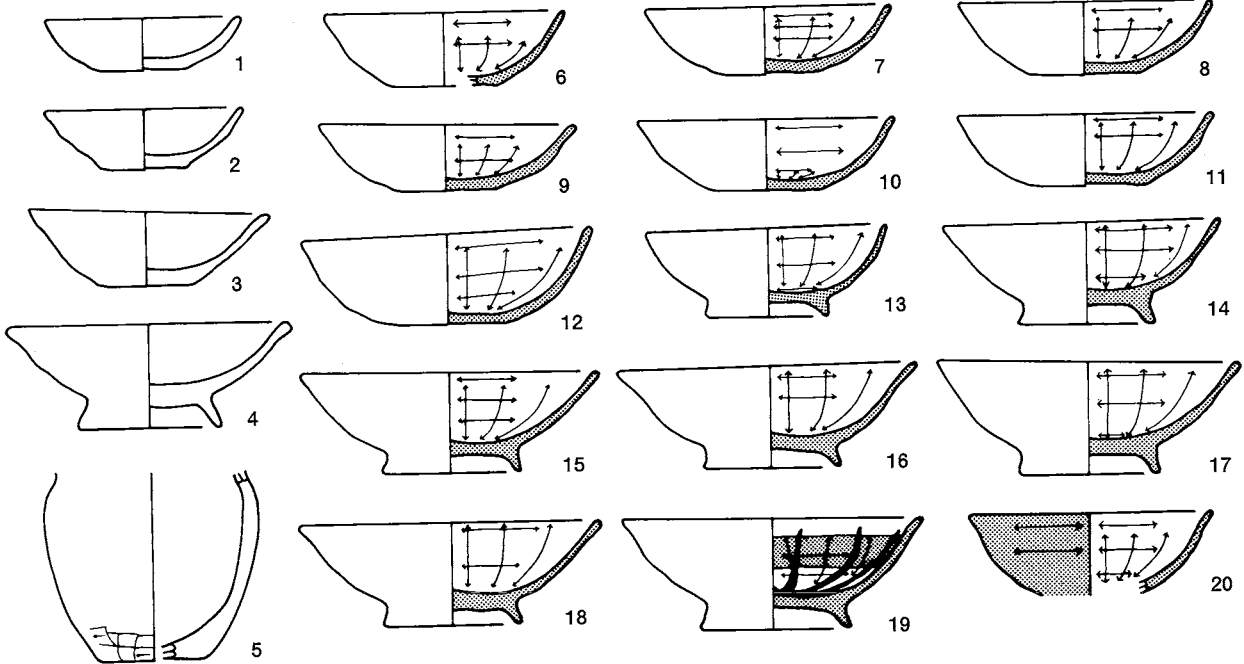

0 (1:4) 10cm

SB114 (1~42)

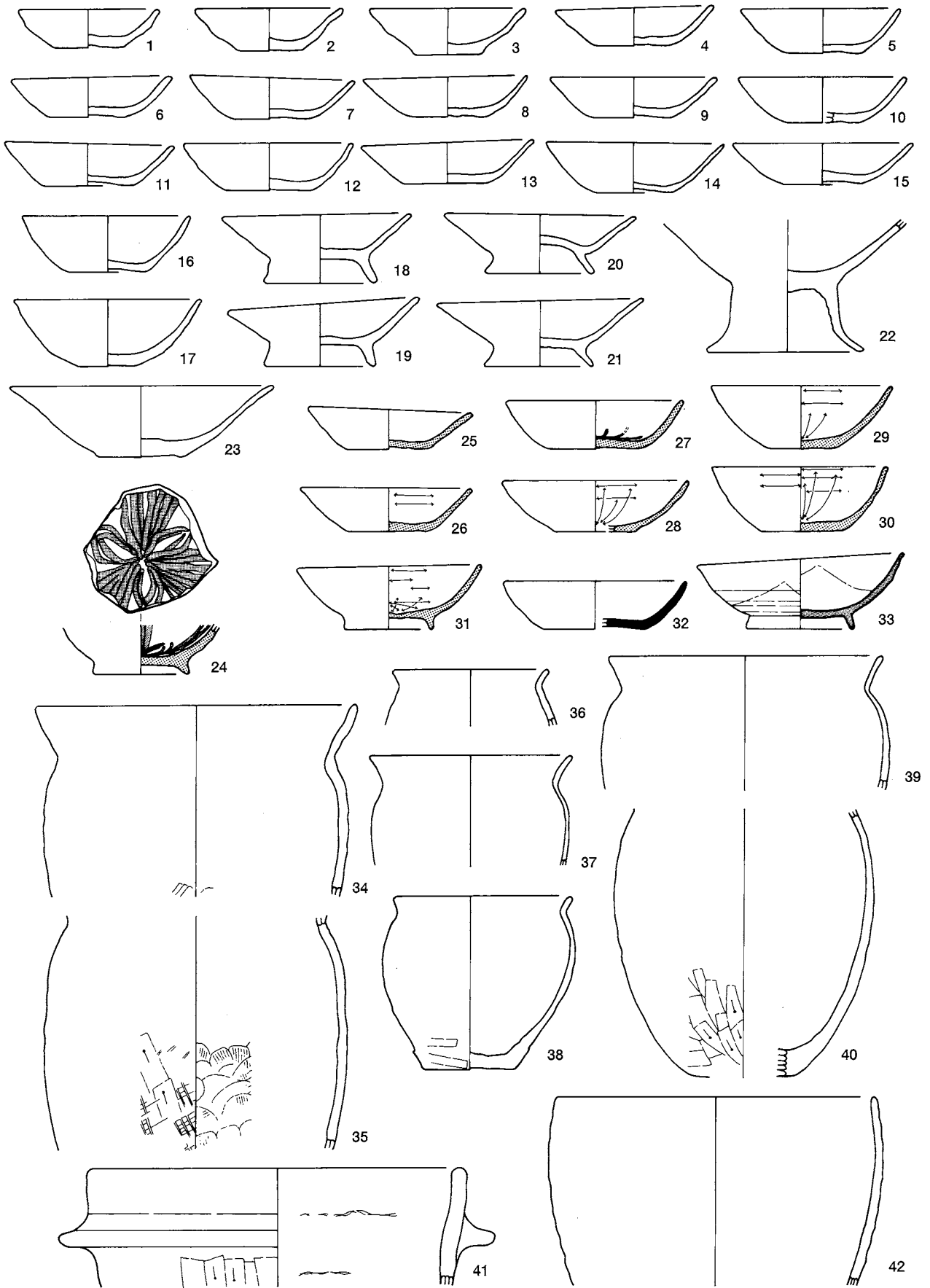

SB116 (1~87)

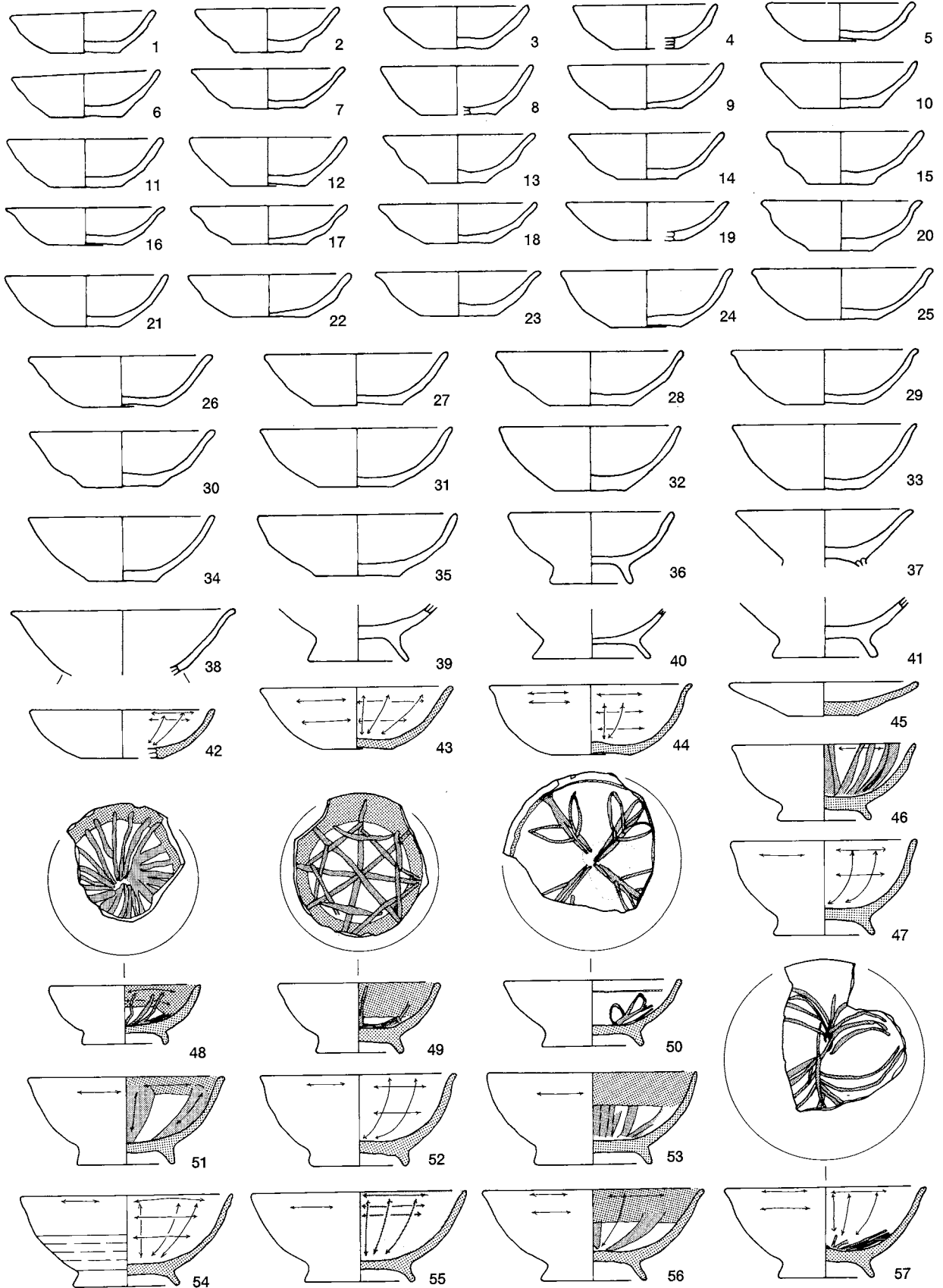

0 (1:4) 10cm

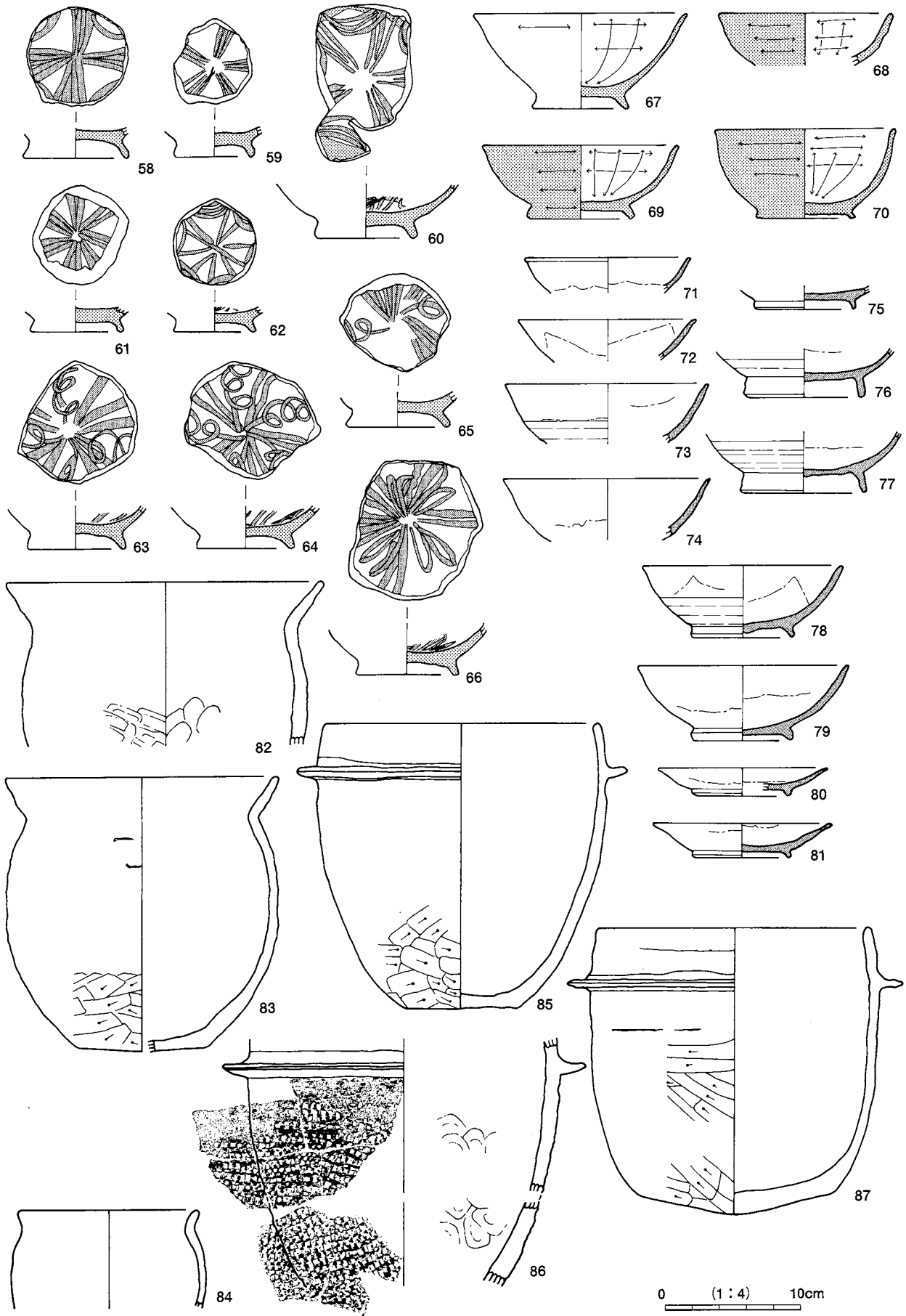

SB117 (1-2)

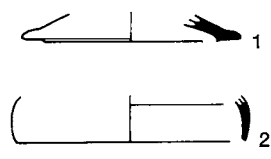

SB121 (1-16)

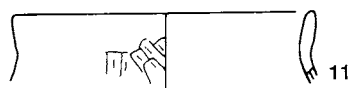
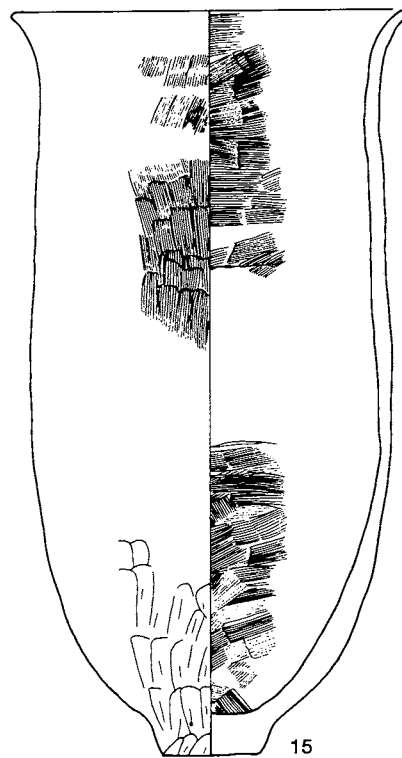
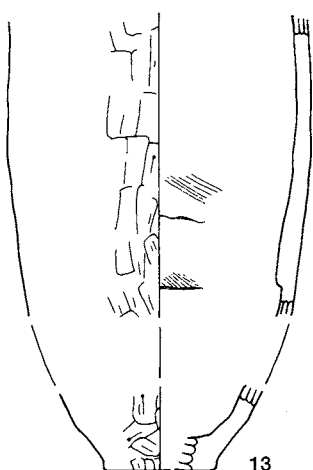
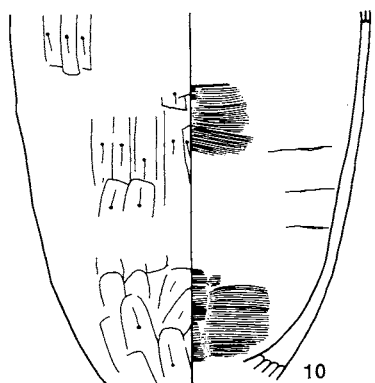
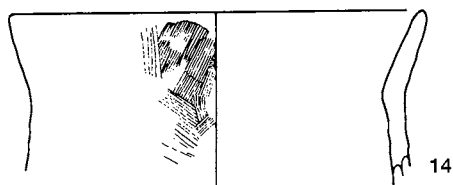
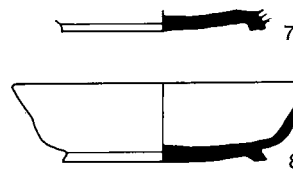
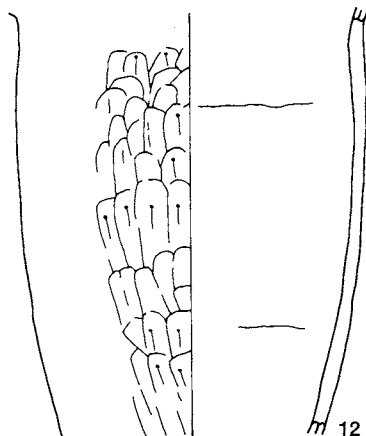
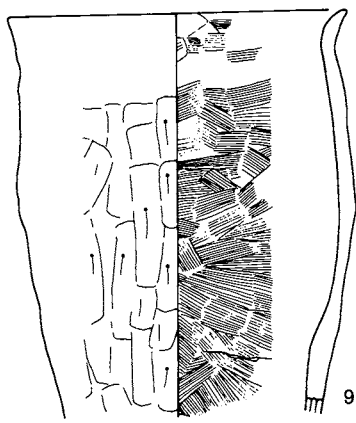
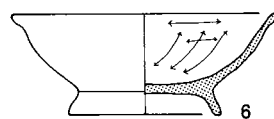
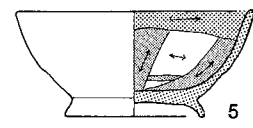
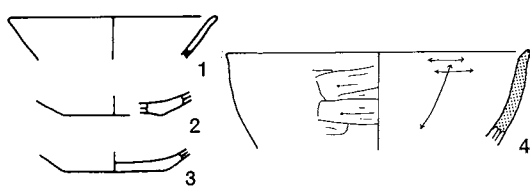

SB122 (1-47)

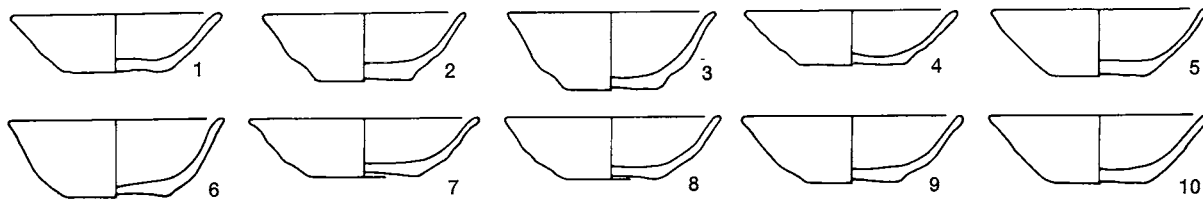

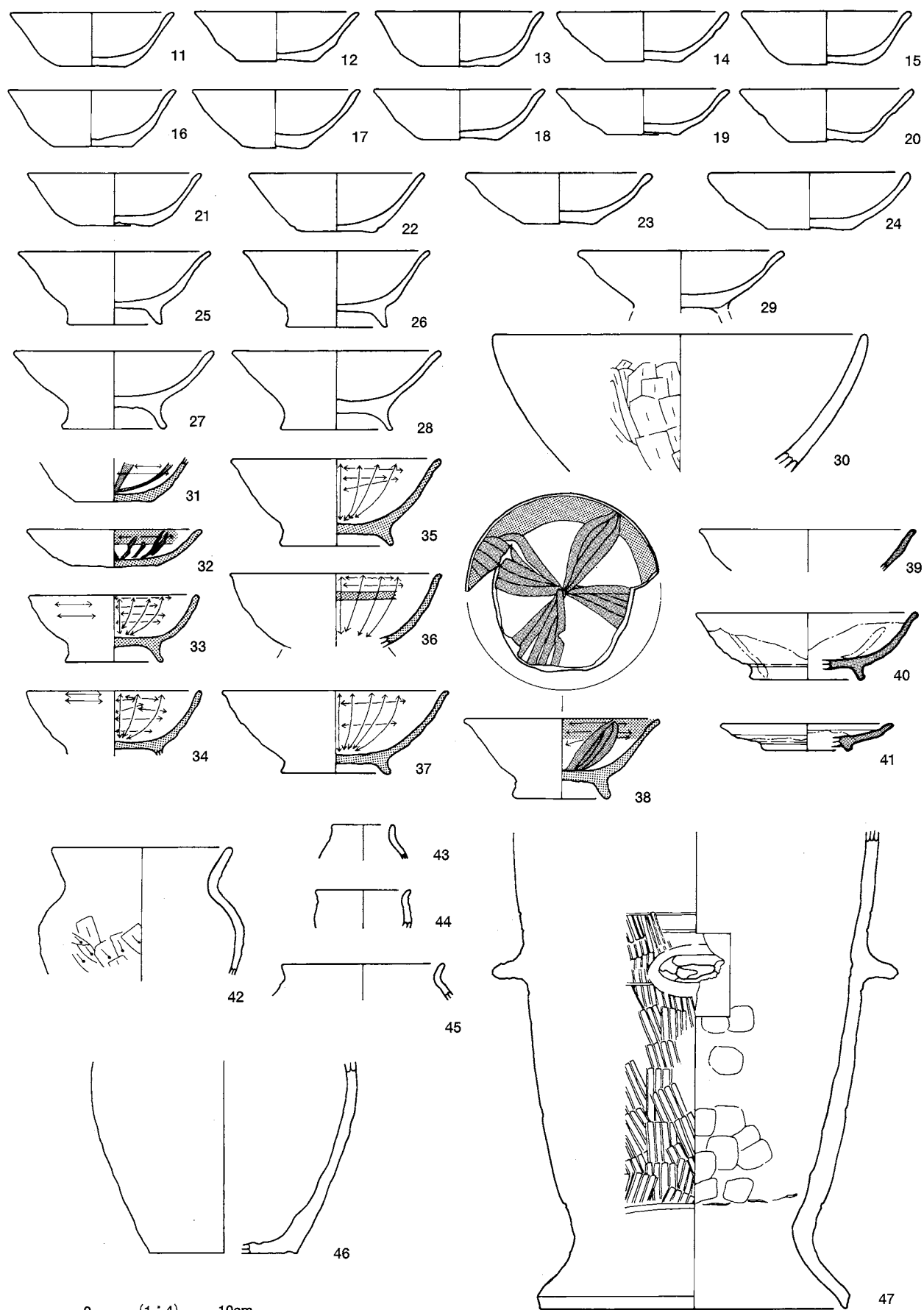

0 (1:4) 10cm

SB123 (1~35)

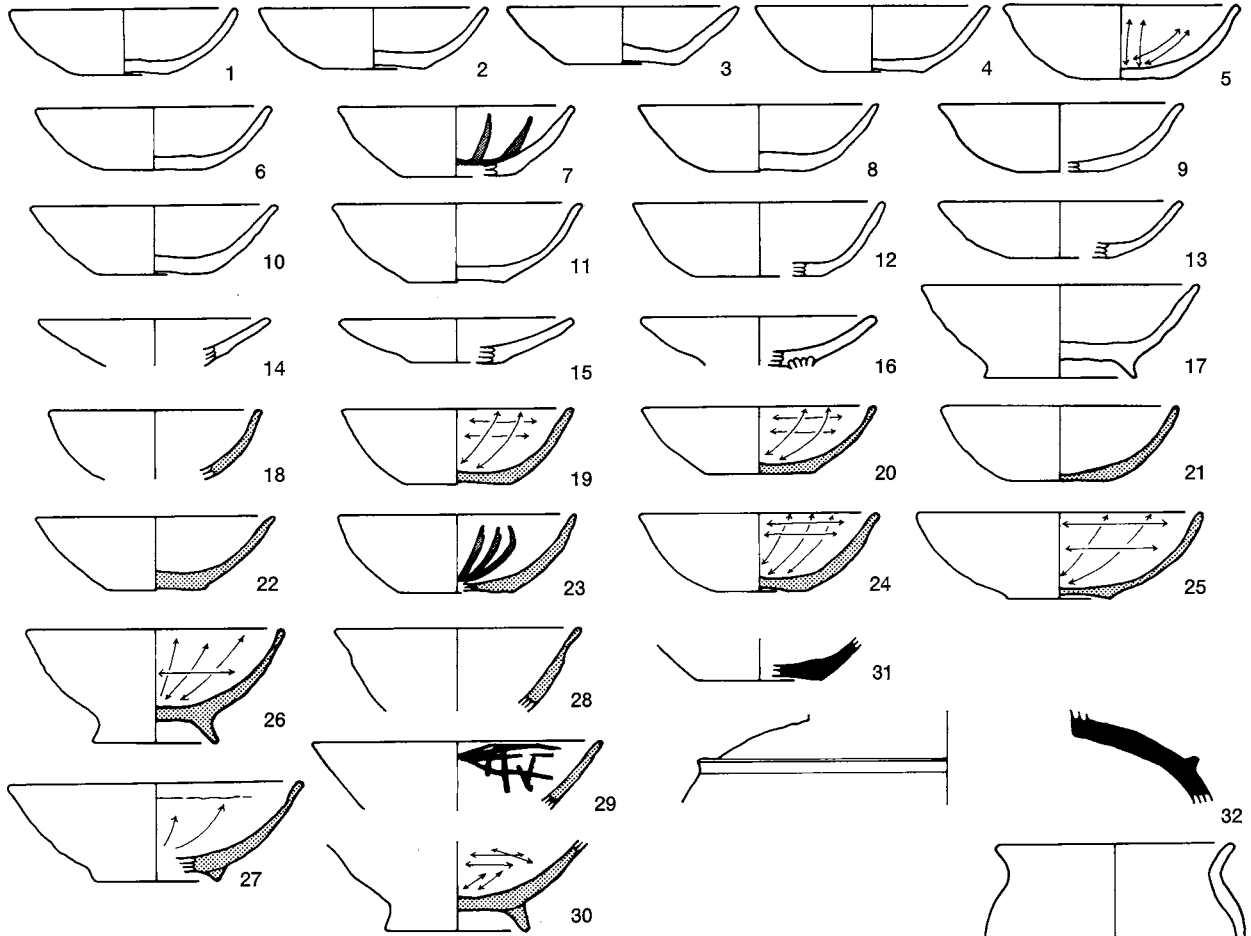

SB124 (1・2)



SB125 (1~28)

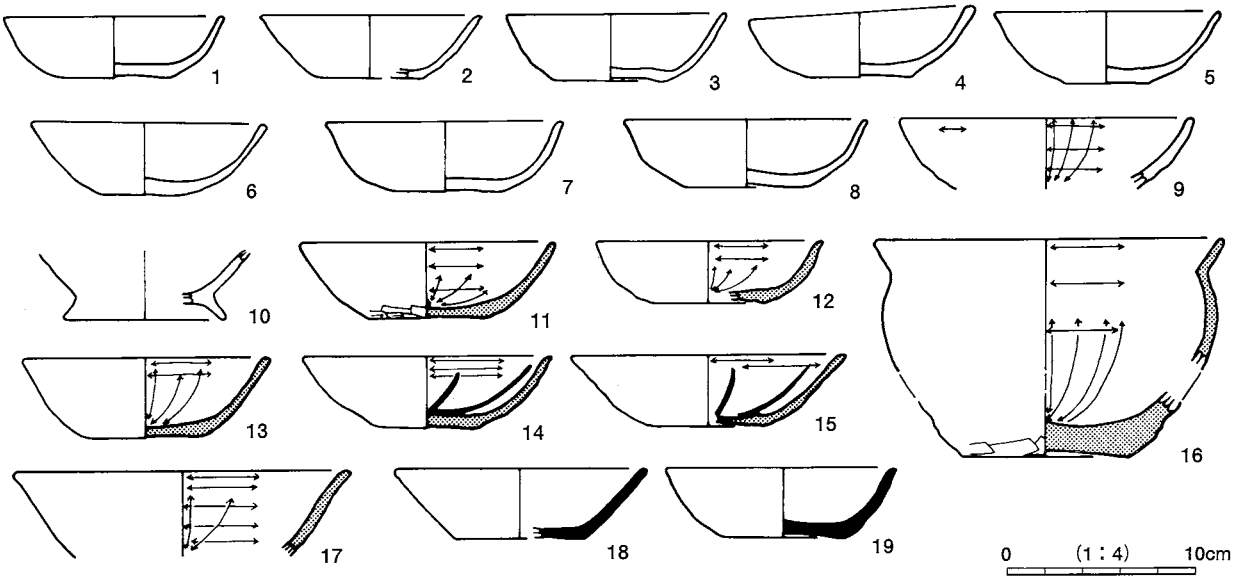

0 (1:4) 10cm

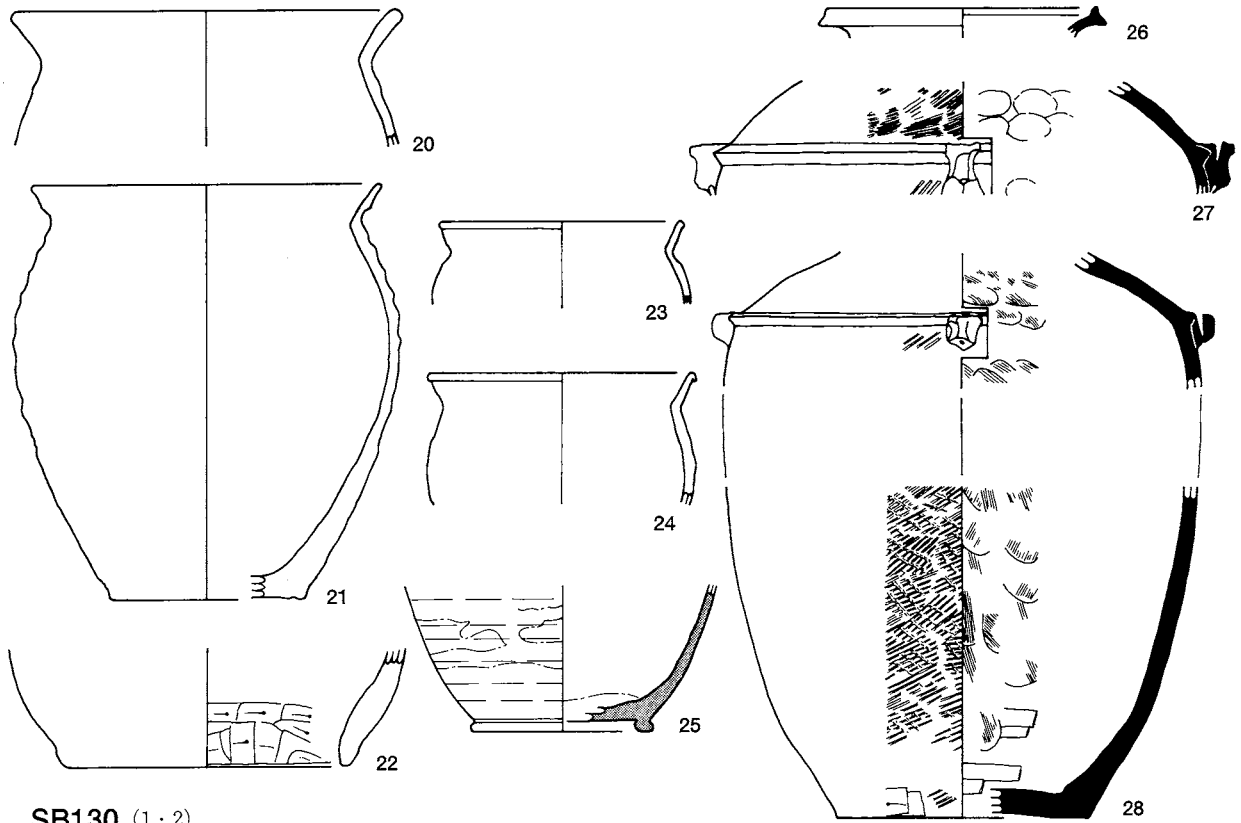

SB130 (1·2)



SB136 (1~5)

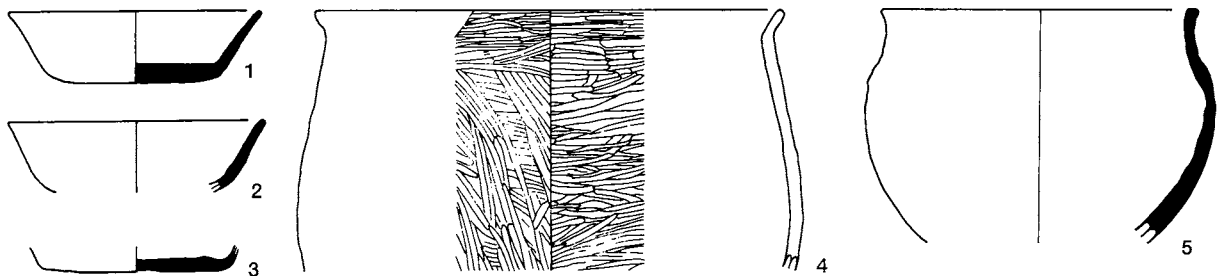

SB142 (1~20)

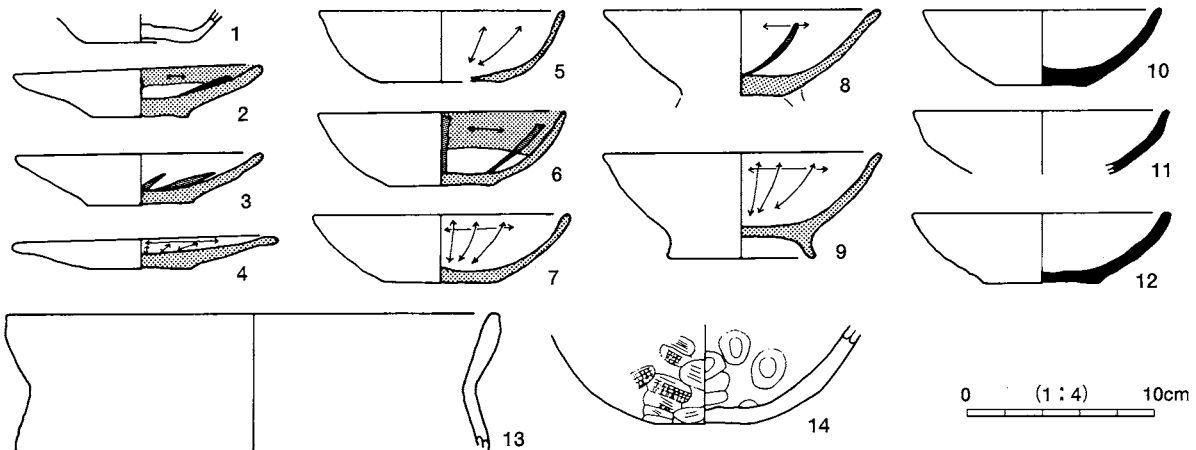

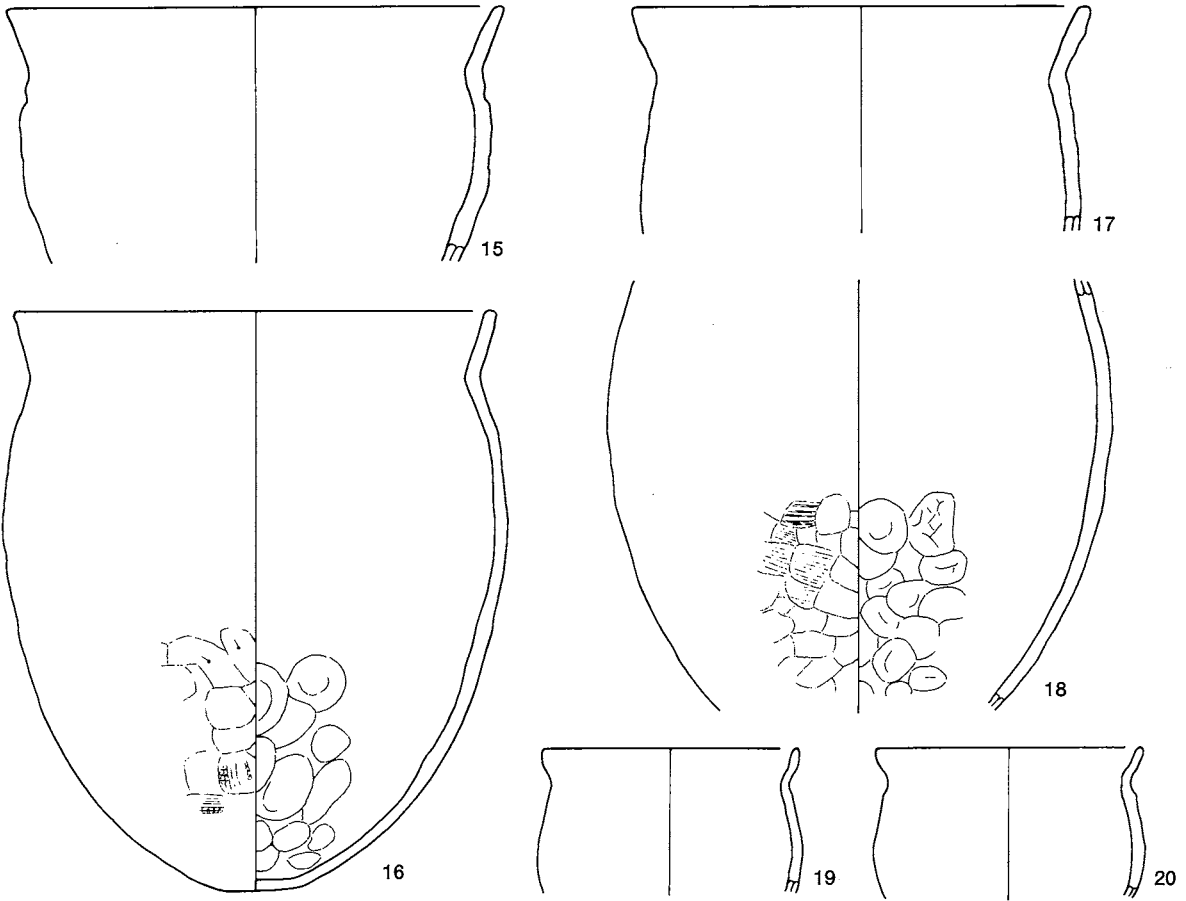

SB145 (1・2)

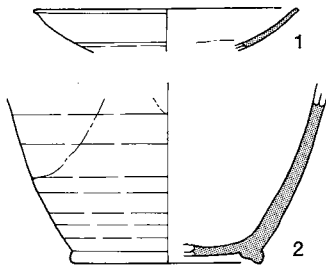

SB146 (1~3)

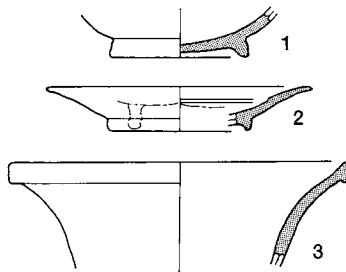

SB147

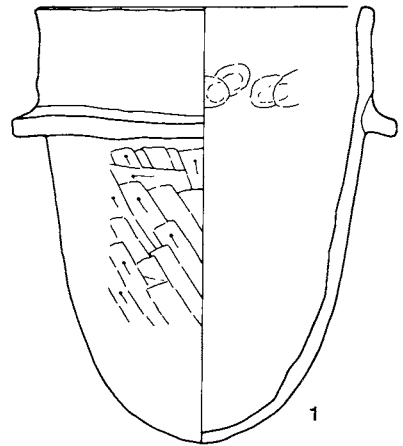

SB149 (1~16)

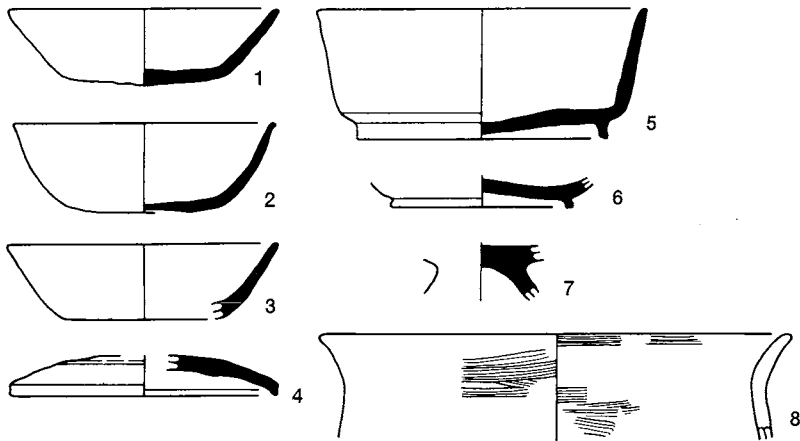

SB148

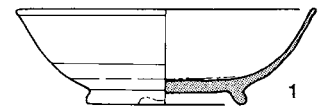

0 (1:4) 10cm

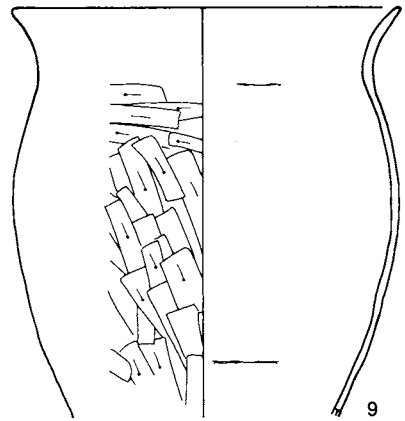

9

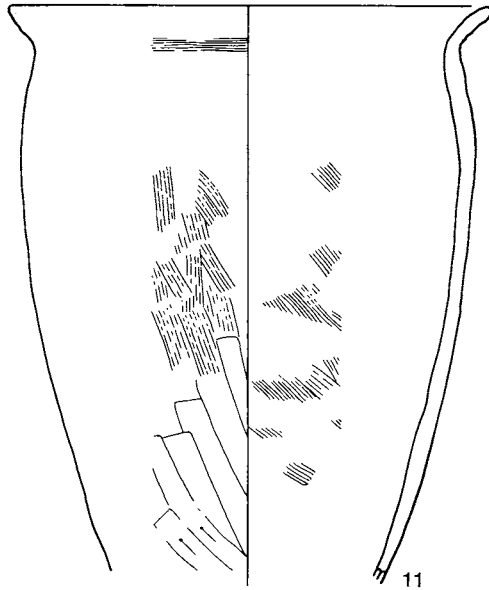

11

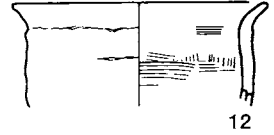

12

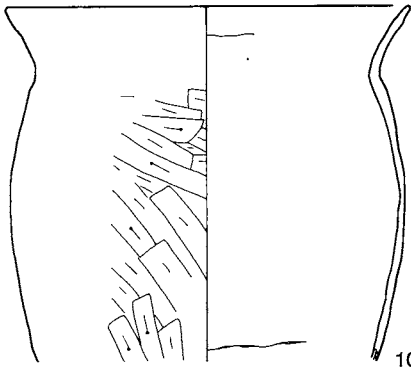

10

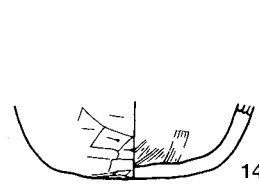

14

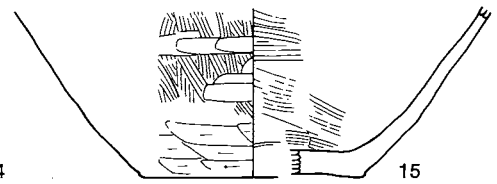

15

SB160 (1·2)

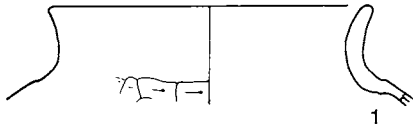

1



16

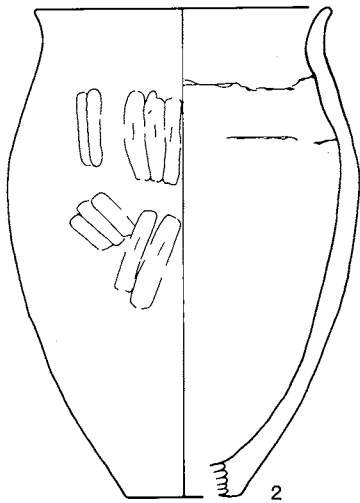

2

SB163 (1~14)

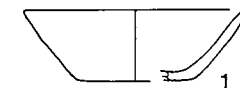

1

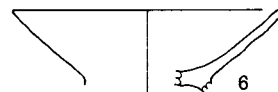

6



11



2



7

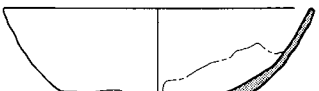

12

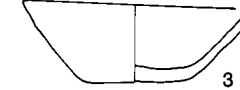

3

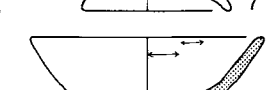

8

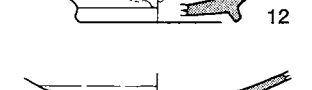

13

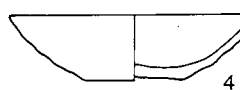

4



9



14



5

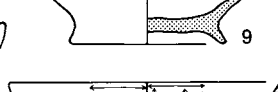

10



14

0 (1:4) 10cm

SB165 (1・2)

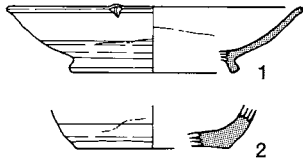

SB168 (1~14)

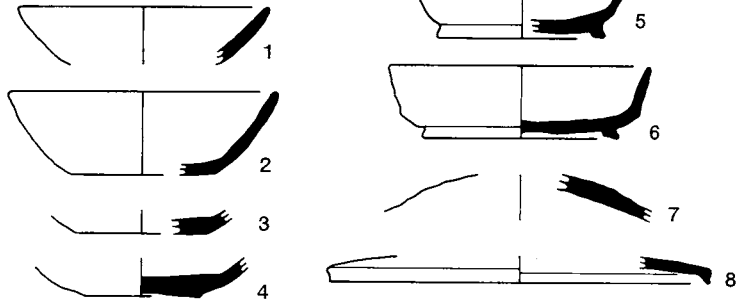

SB167

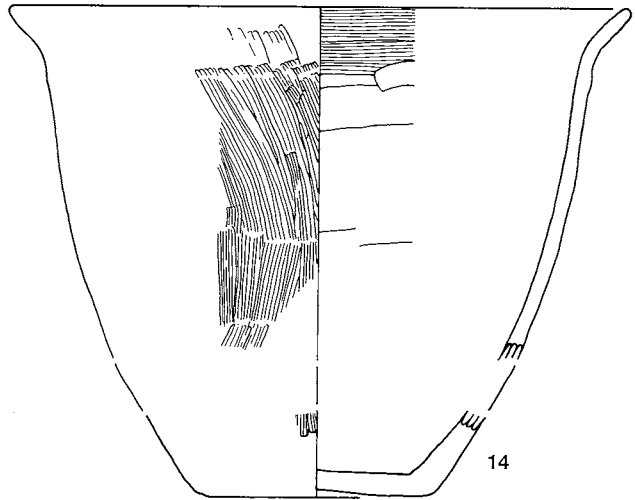
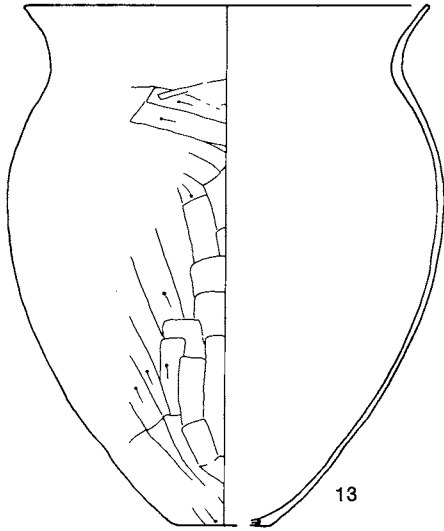
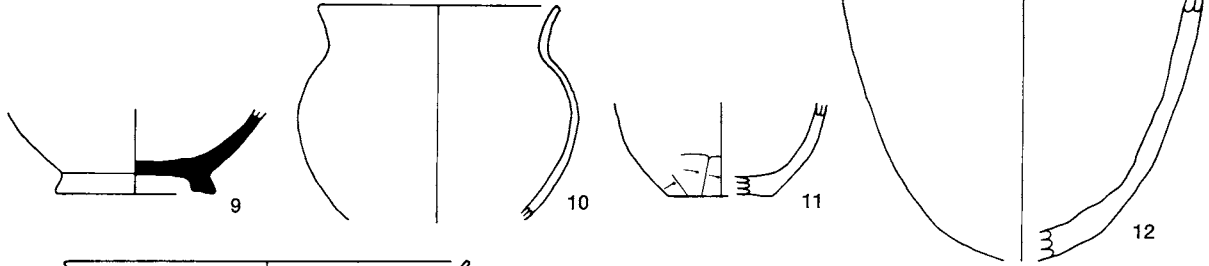
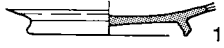

SB183 (1~5)

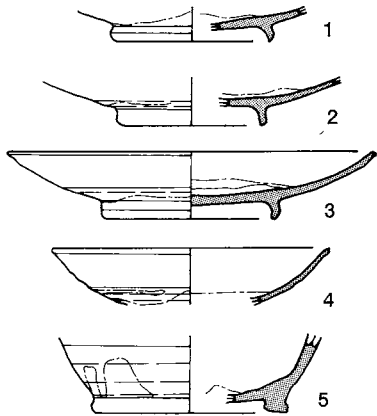

SB185 (1~6)

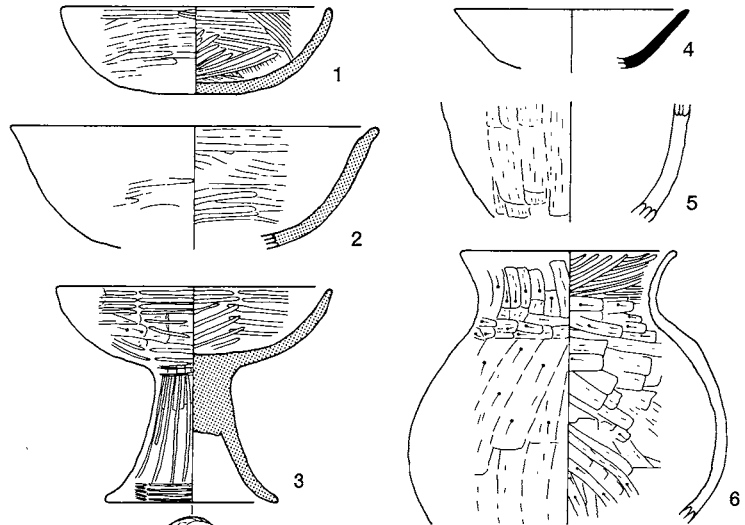

SB187

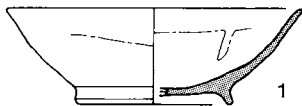

0 (1:4) 10cm

SB189 (1~58)

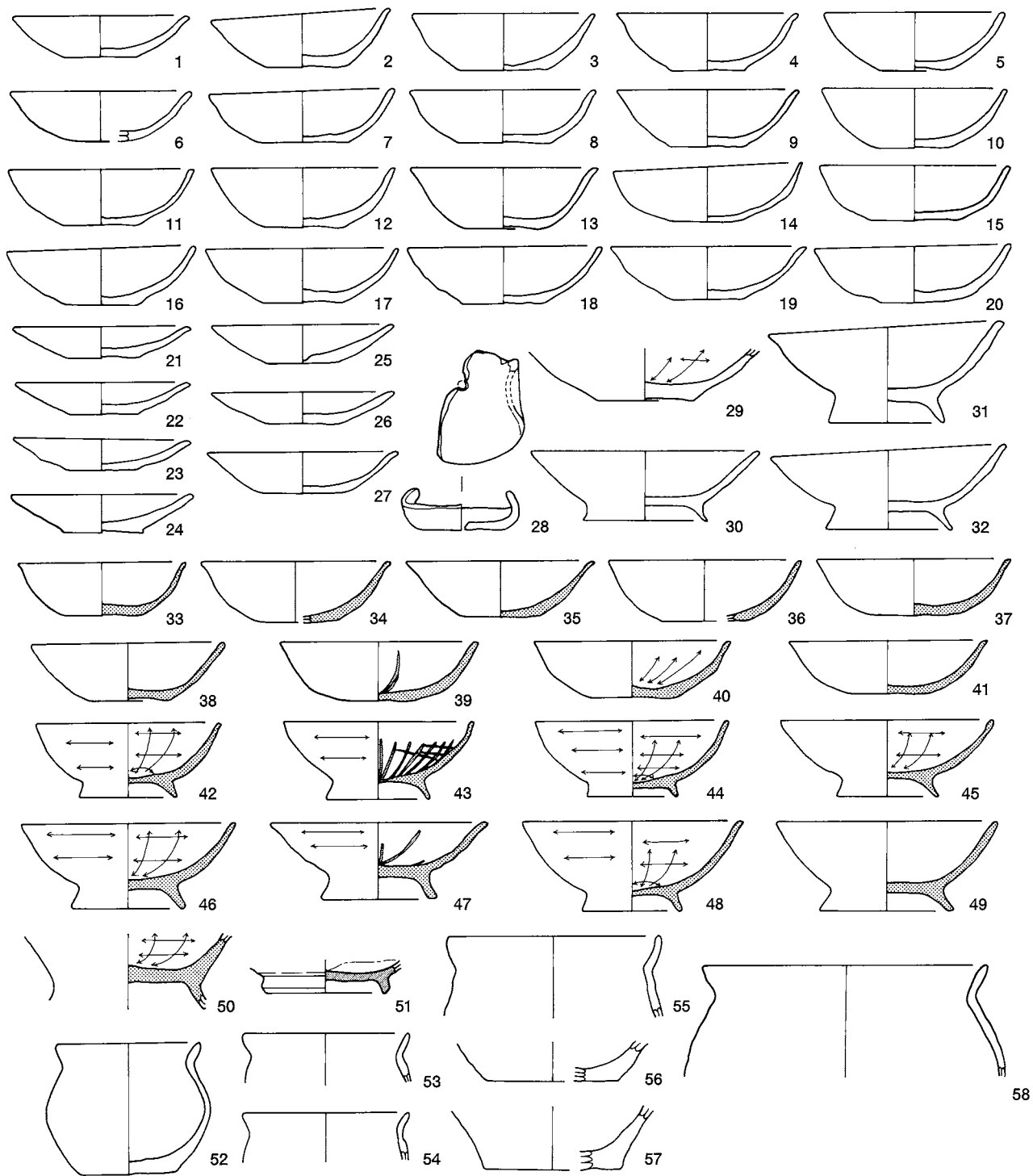

SB191 (1~26)

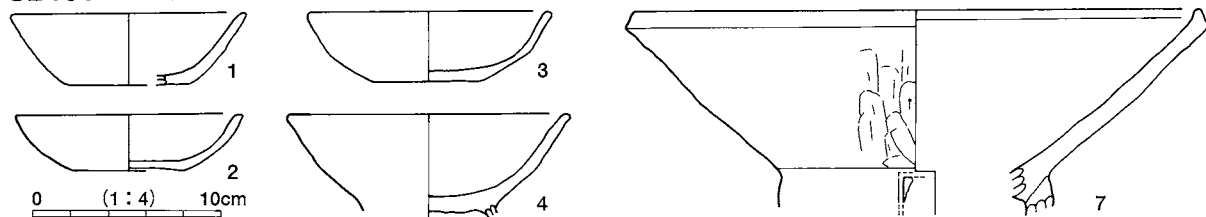

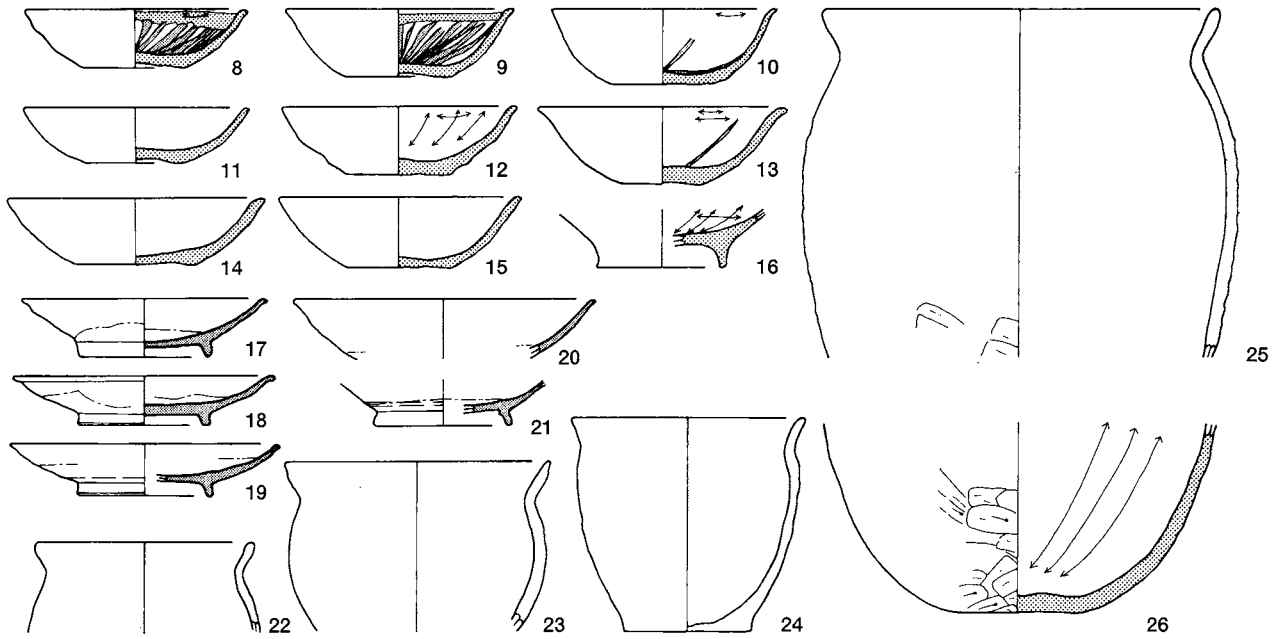

SB192 (1~21)

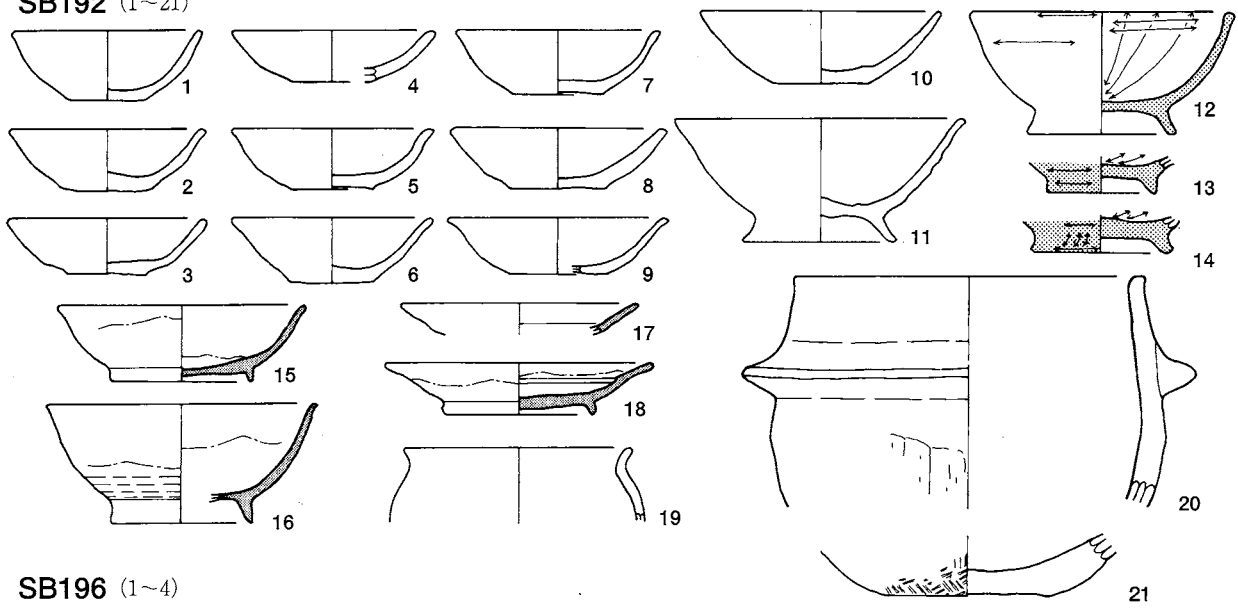

SB196 (1~4)

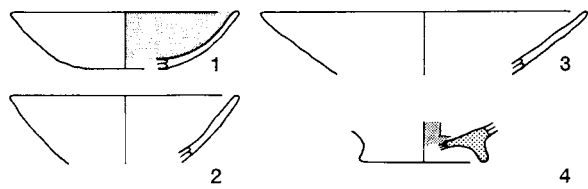

SB198 (1~11)

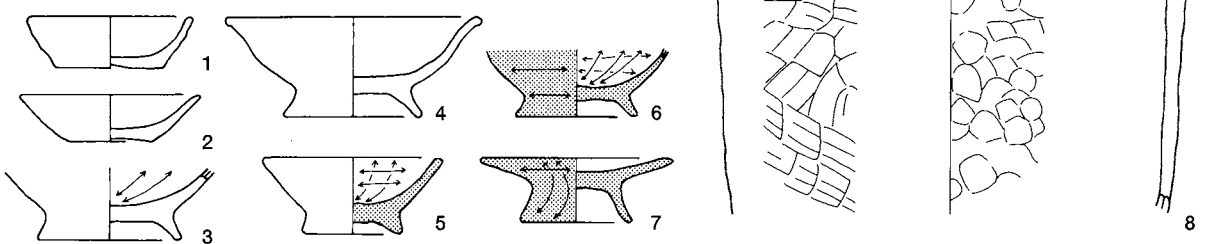

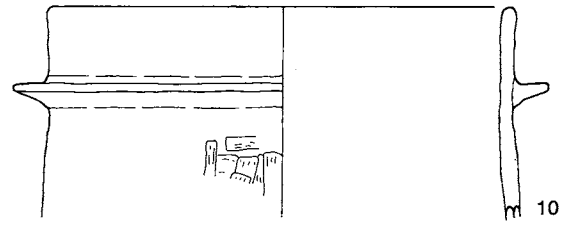
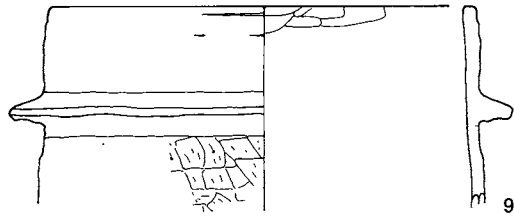

SB200 (1·2)

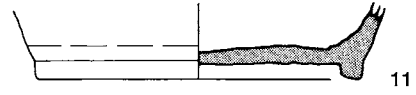
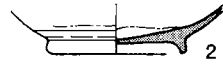
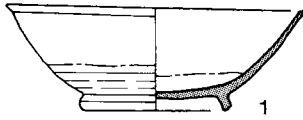

SB210 (1~41)

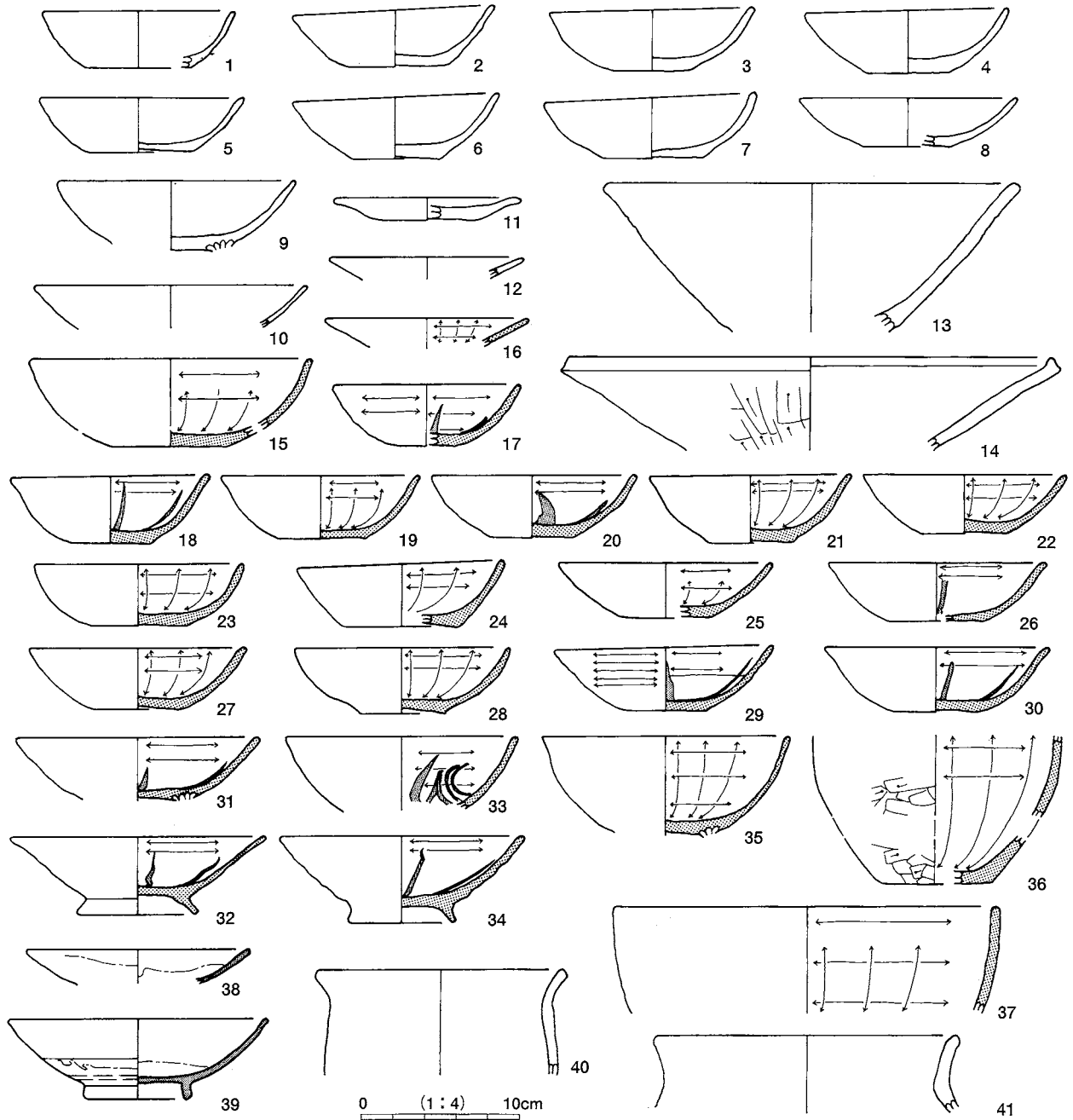

SB216 (1~23)

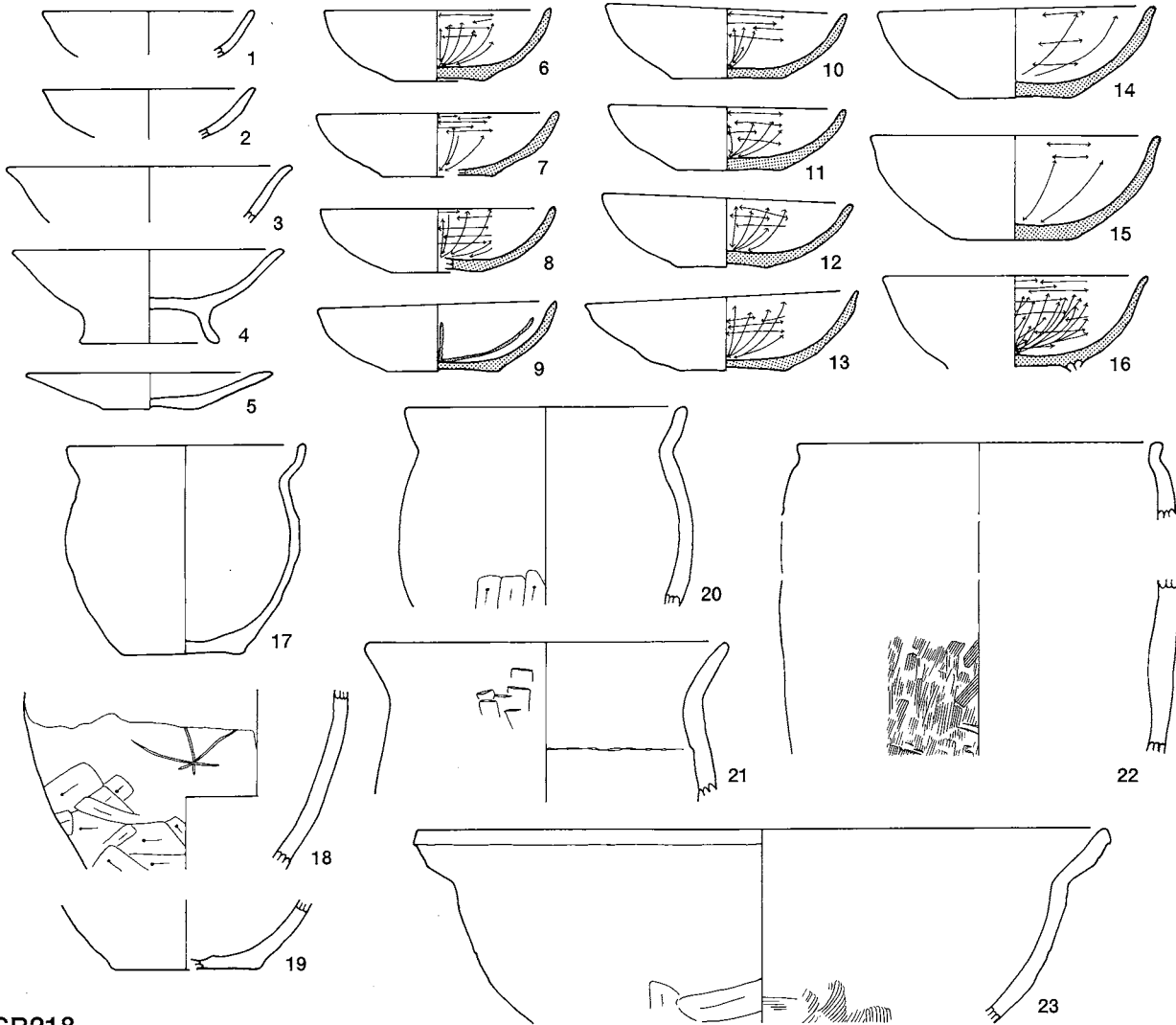

SB218

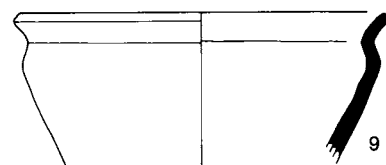

SB219 (1~10)

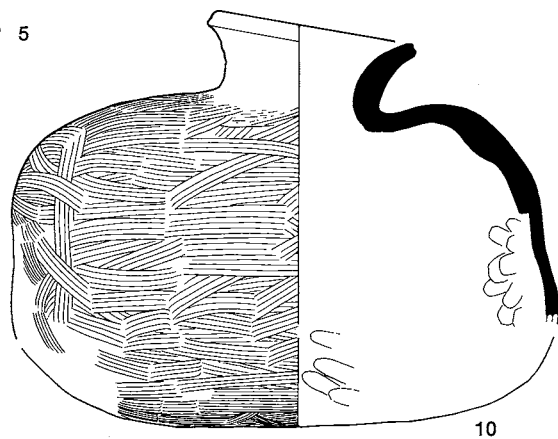
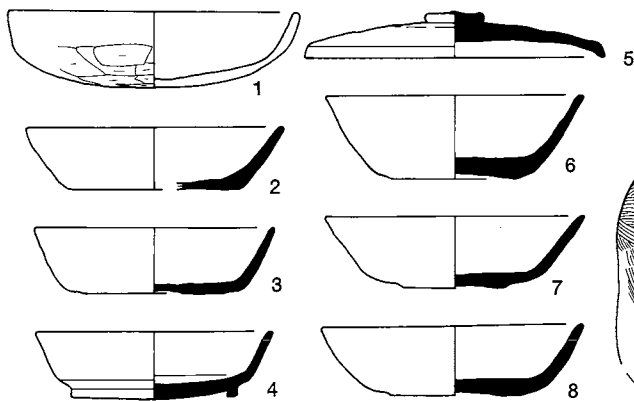

0 (1:4) 10cm

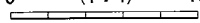

SB224

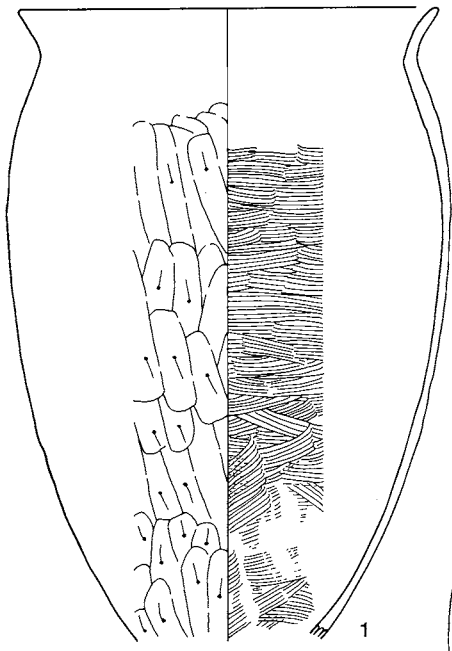

SB227 (1~10)

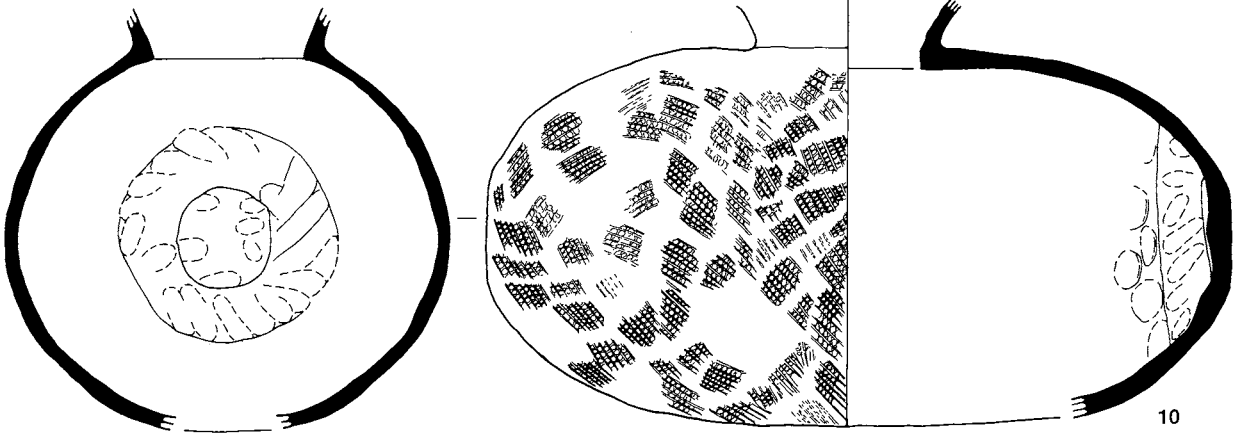
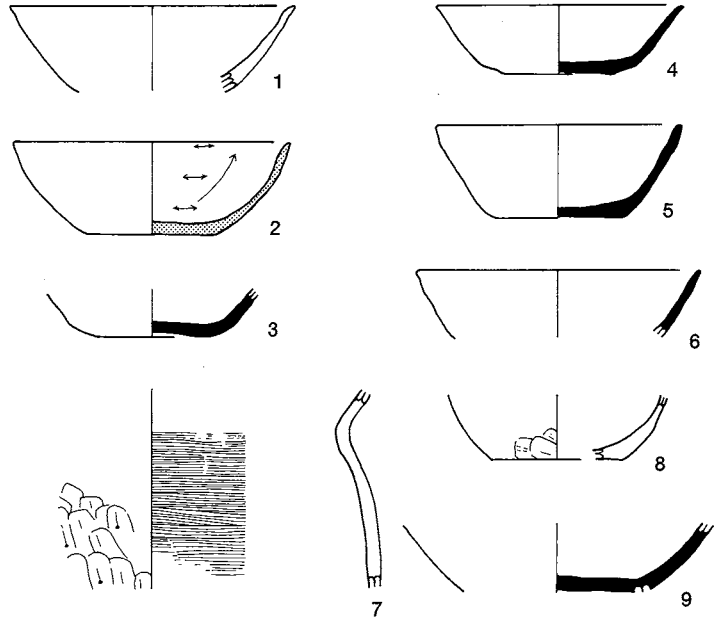

SB242 (1~8)

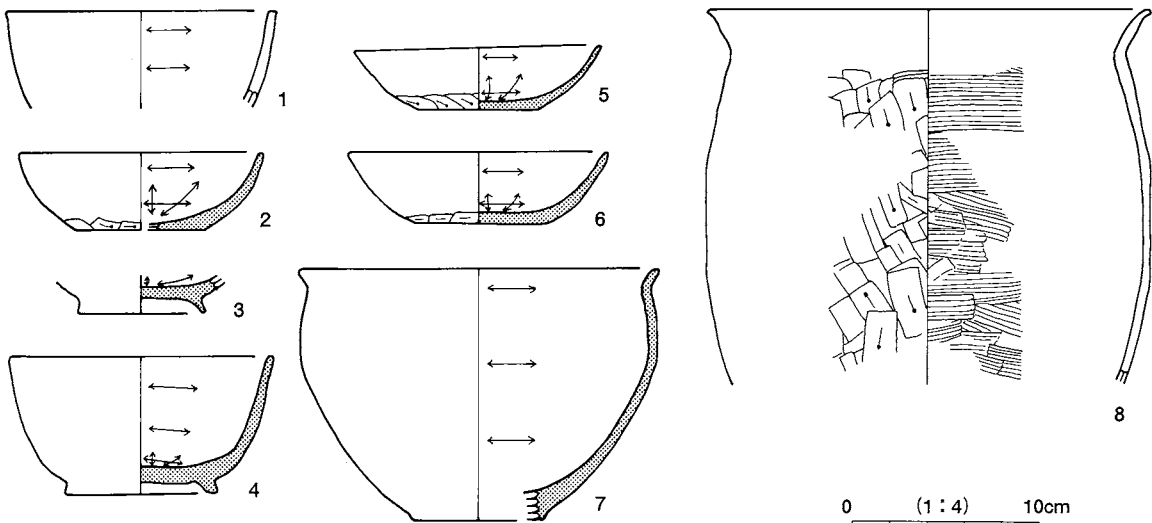

SB249

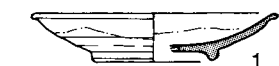

1

SB255 (1~34)



1



2



3



4

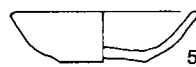

5



6



7

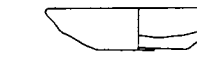

8

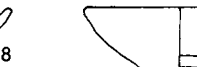

9

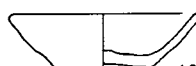

10

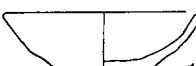

11

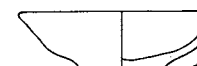

12



13



14



15

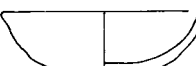

16



17



18



19

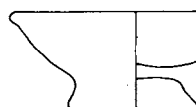

20

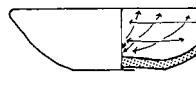

24

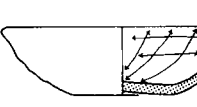
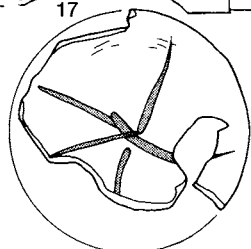

27



21

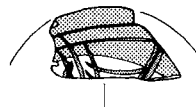

25

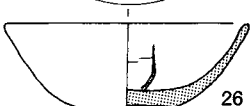

26

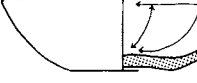

28



22



29

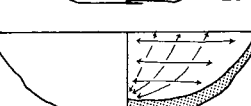

31



32

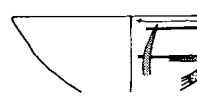

23

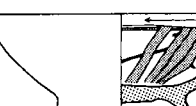

30



33



34

SB257

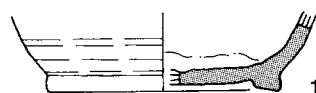

1

SB270



1

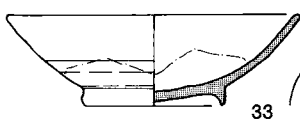

33

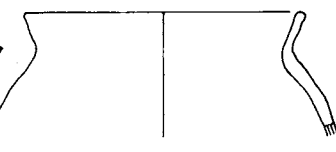

34

SB327 (1~44)

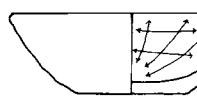

1

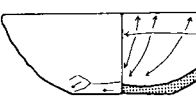

2

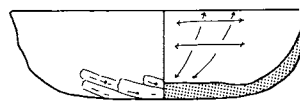

3

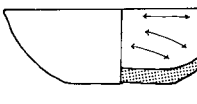

4

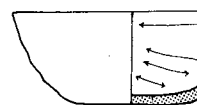

5

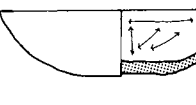

6

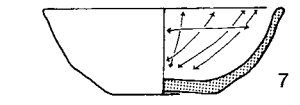

7

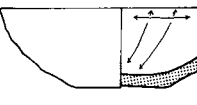

8

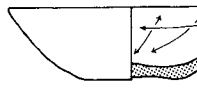

9

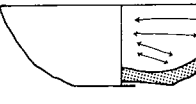

10

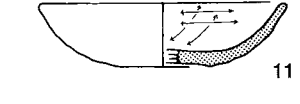

11

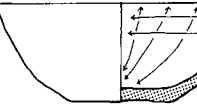

12

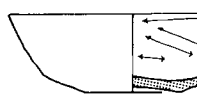

13

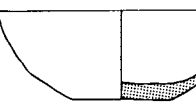

14

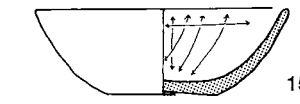

15

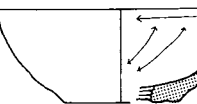

16

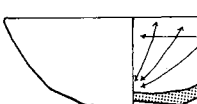

17

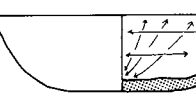

18

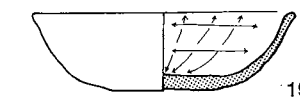

19

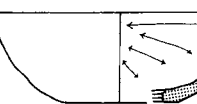

20

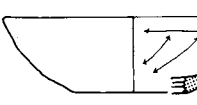

21

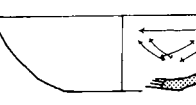

22

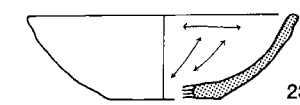

23

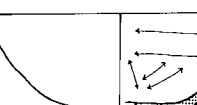

24

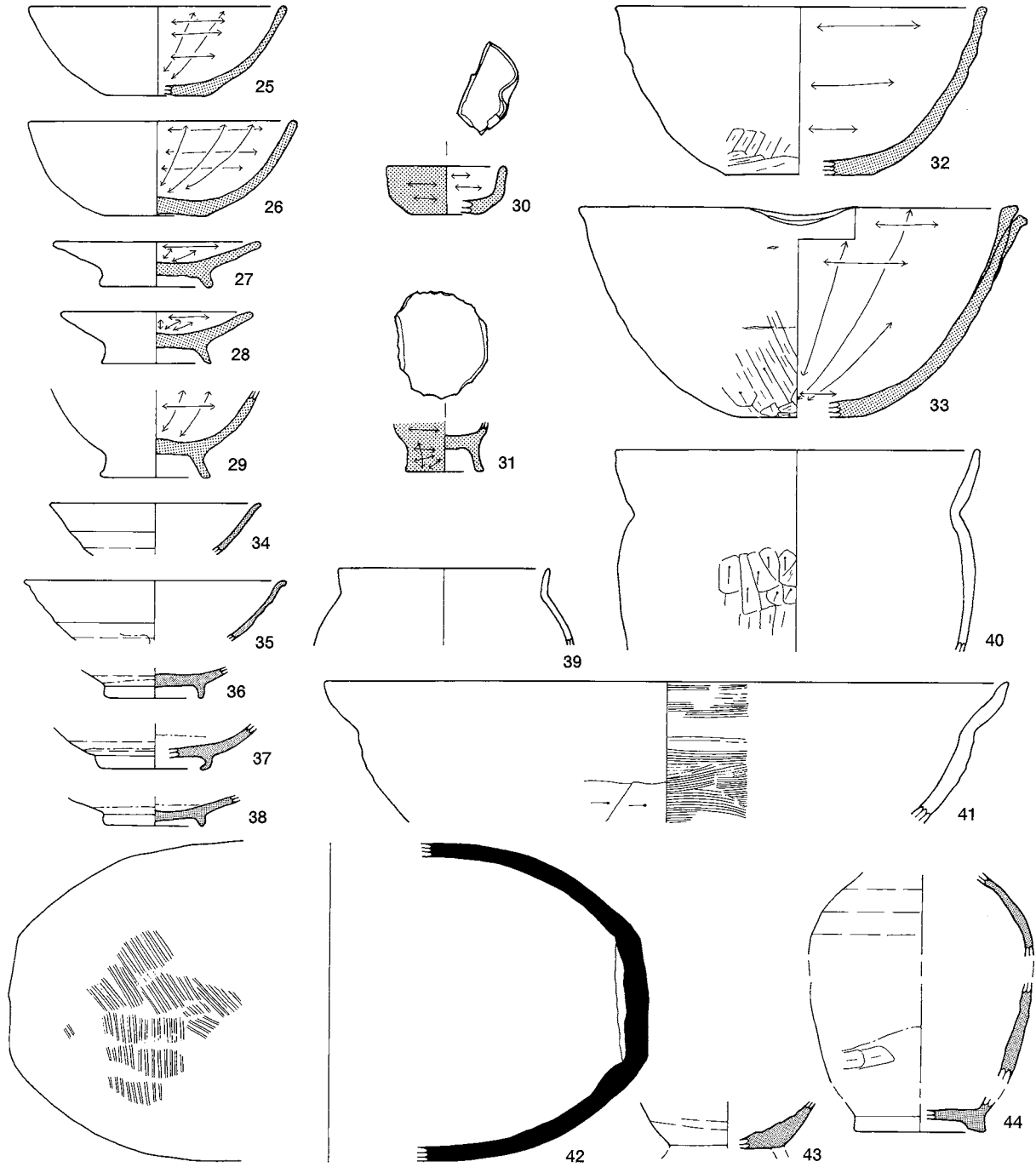

SB336 (1~18)

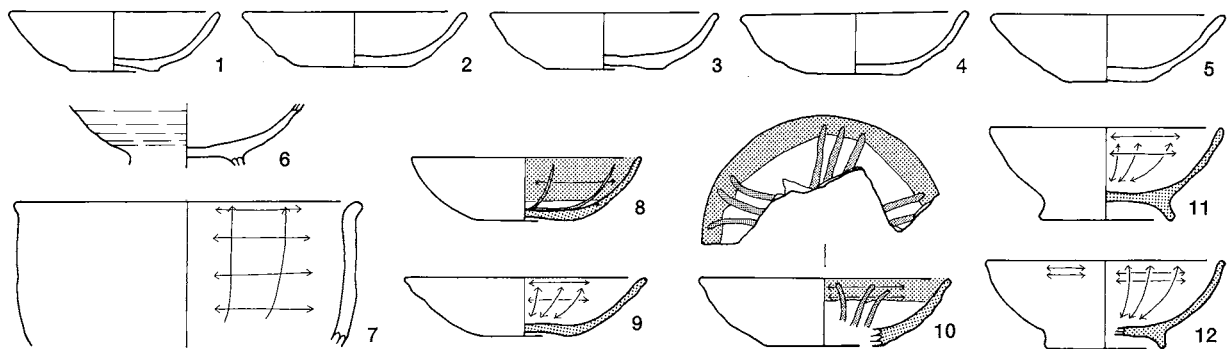

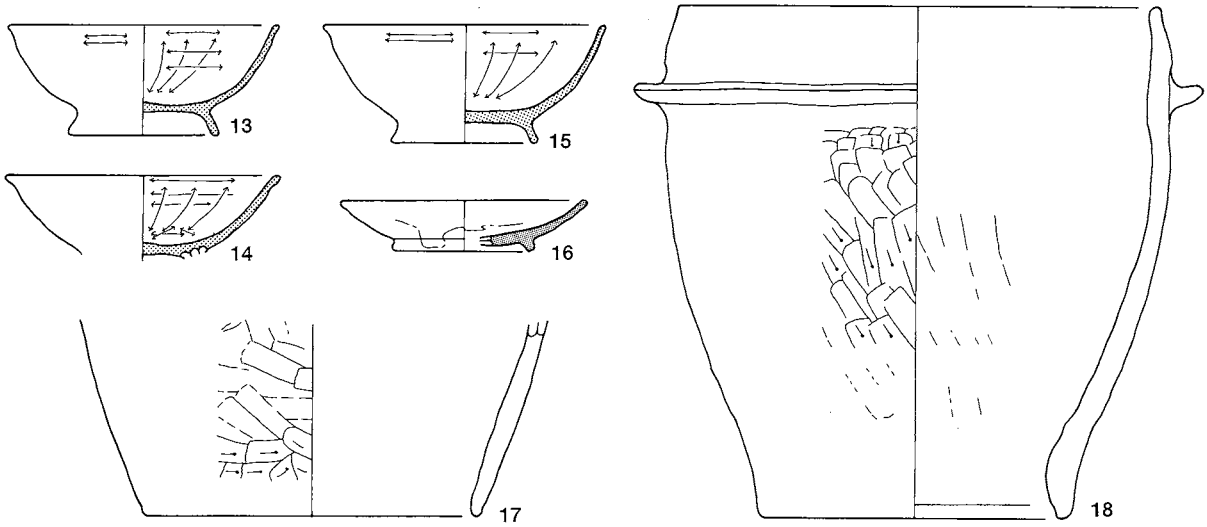

SB338 (1~44)

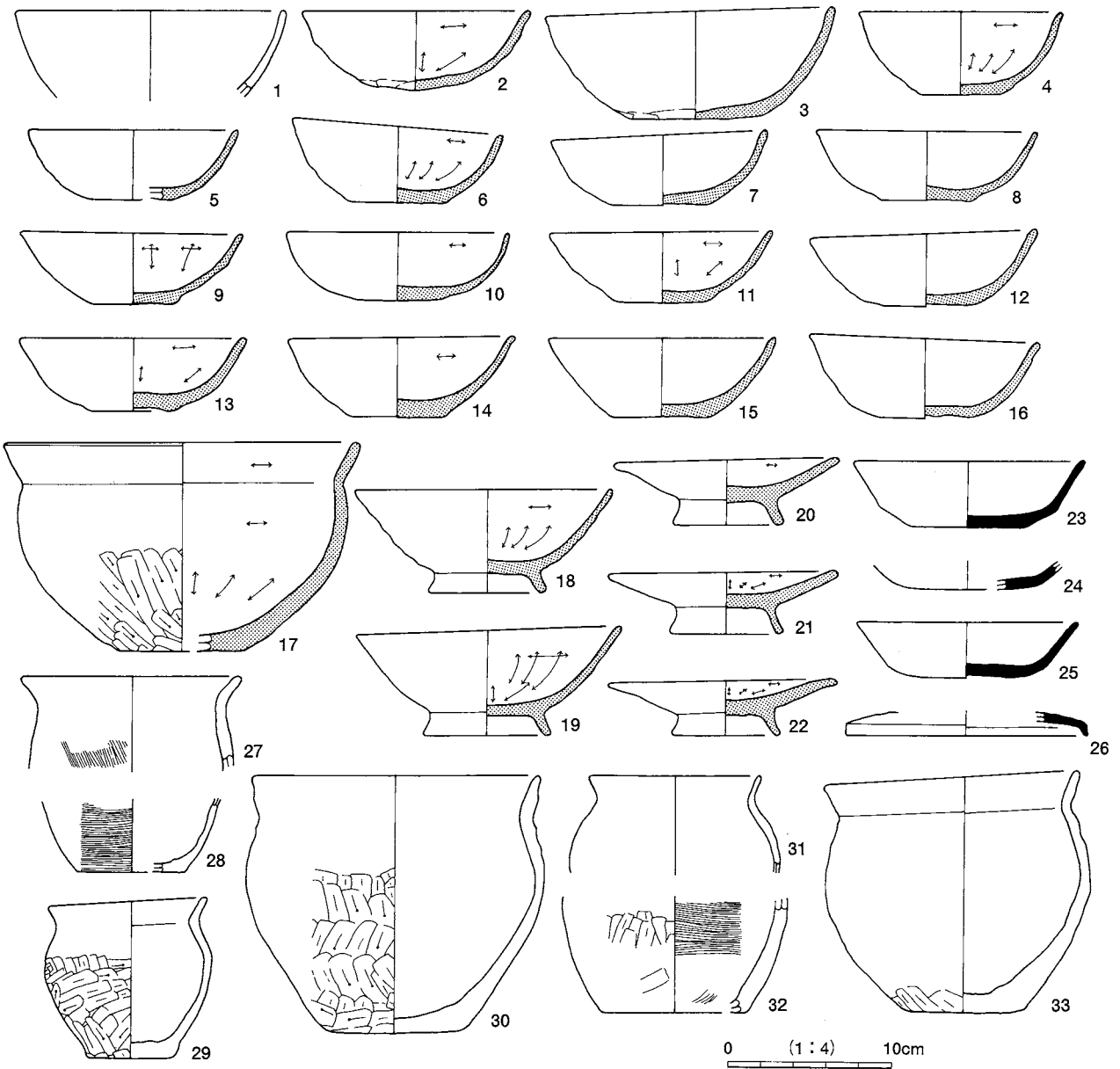

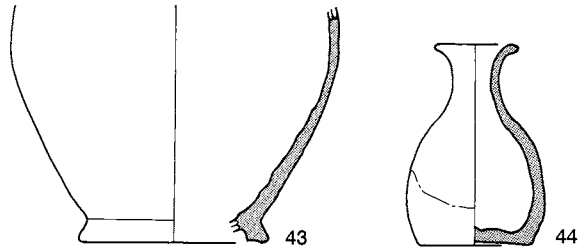
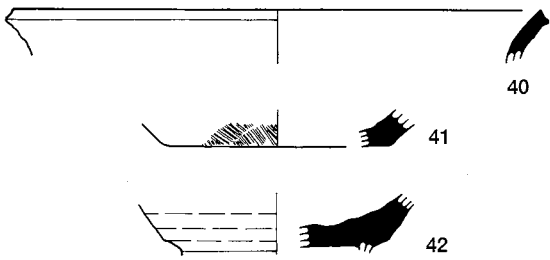
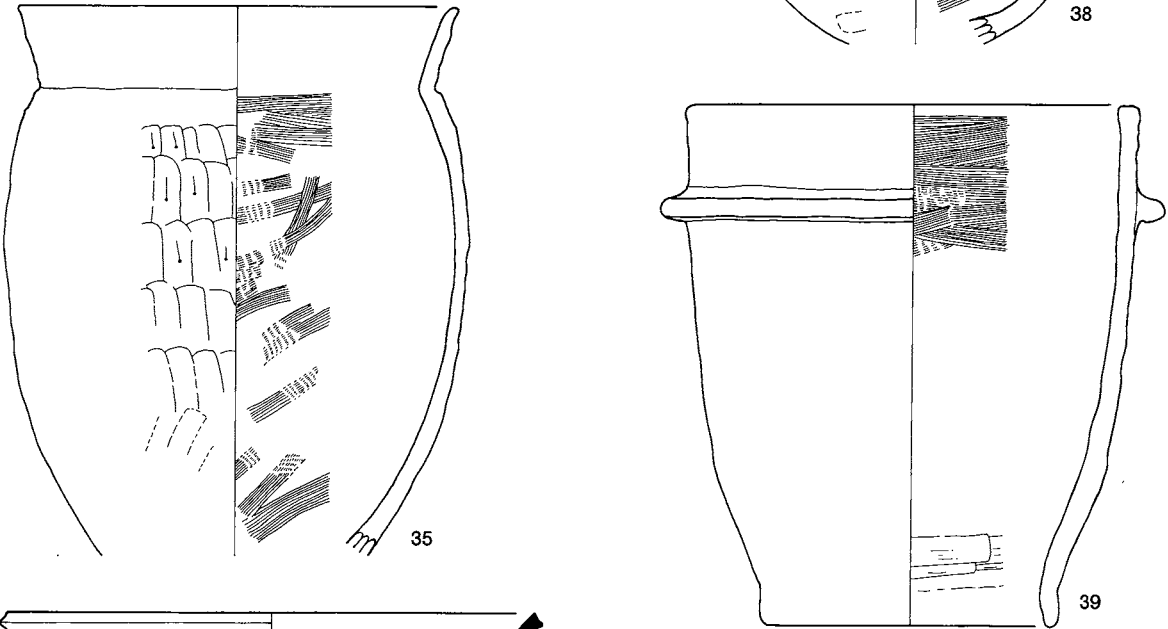
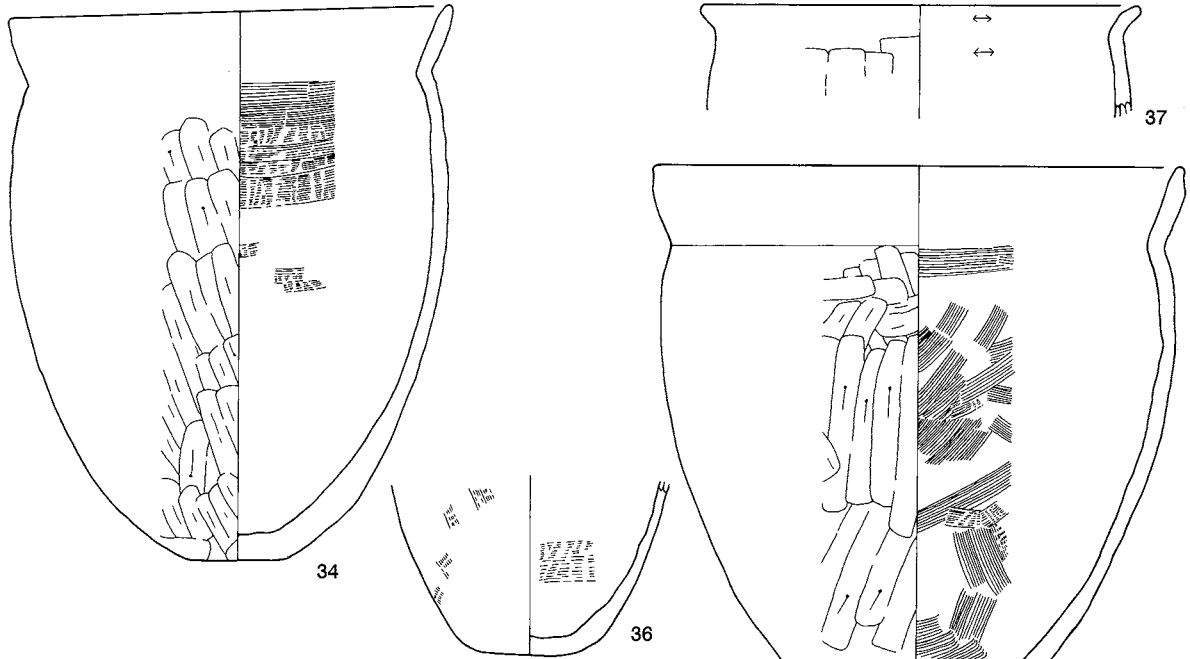

SB343 (1·2)

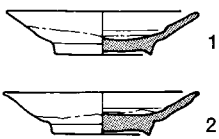

SB345

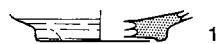

0 (1:4) 10cm

SB357 (1~6)

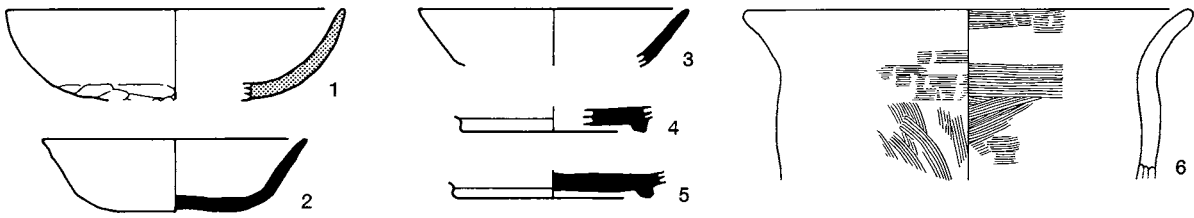

SB374 (1~10)

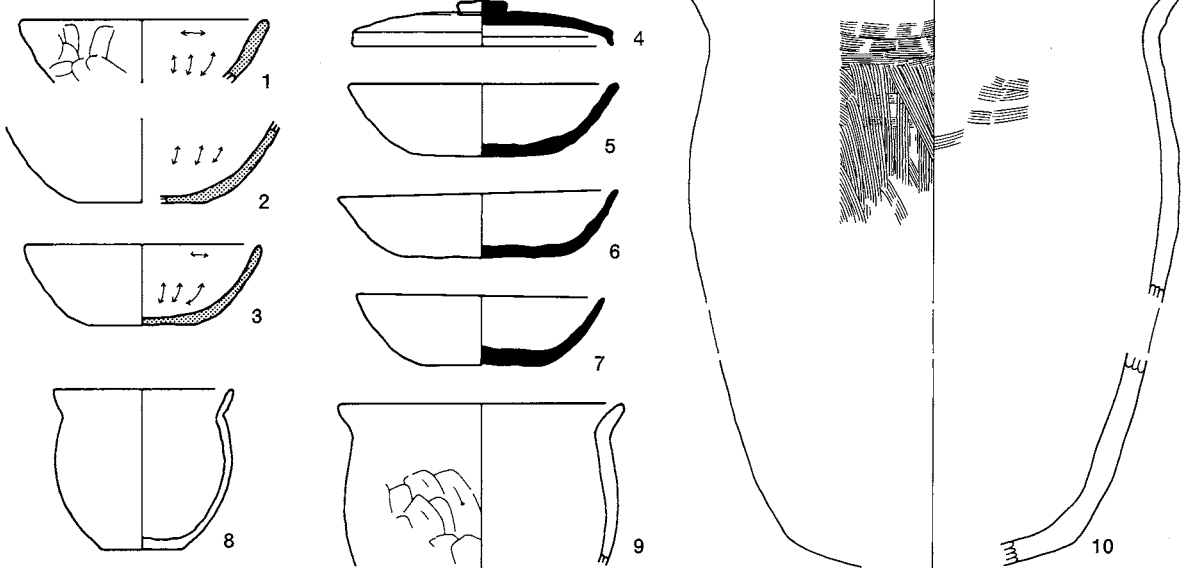

SB375 (1~8)

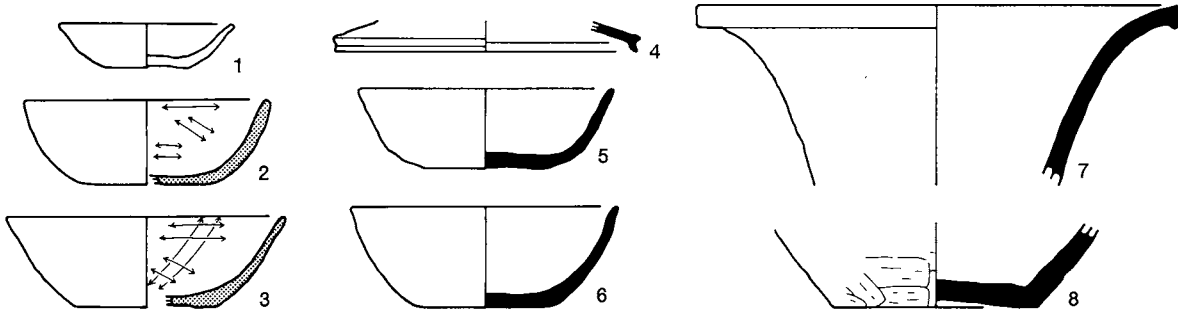

SB378

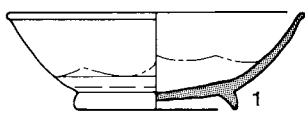

SB382 (1~56)

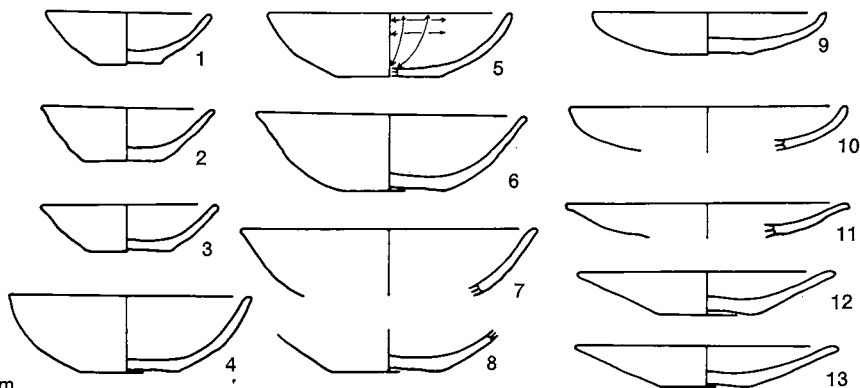

SB381 (1·2)

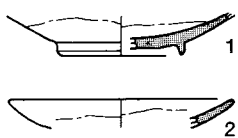

0 (1:4) 10cm

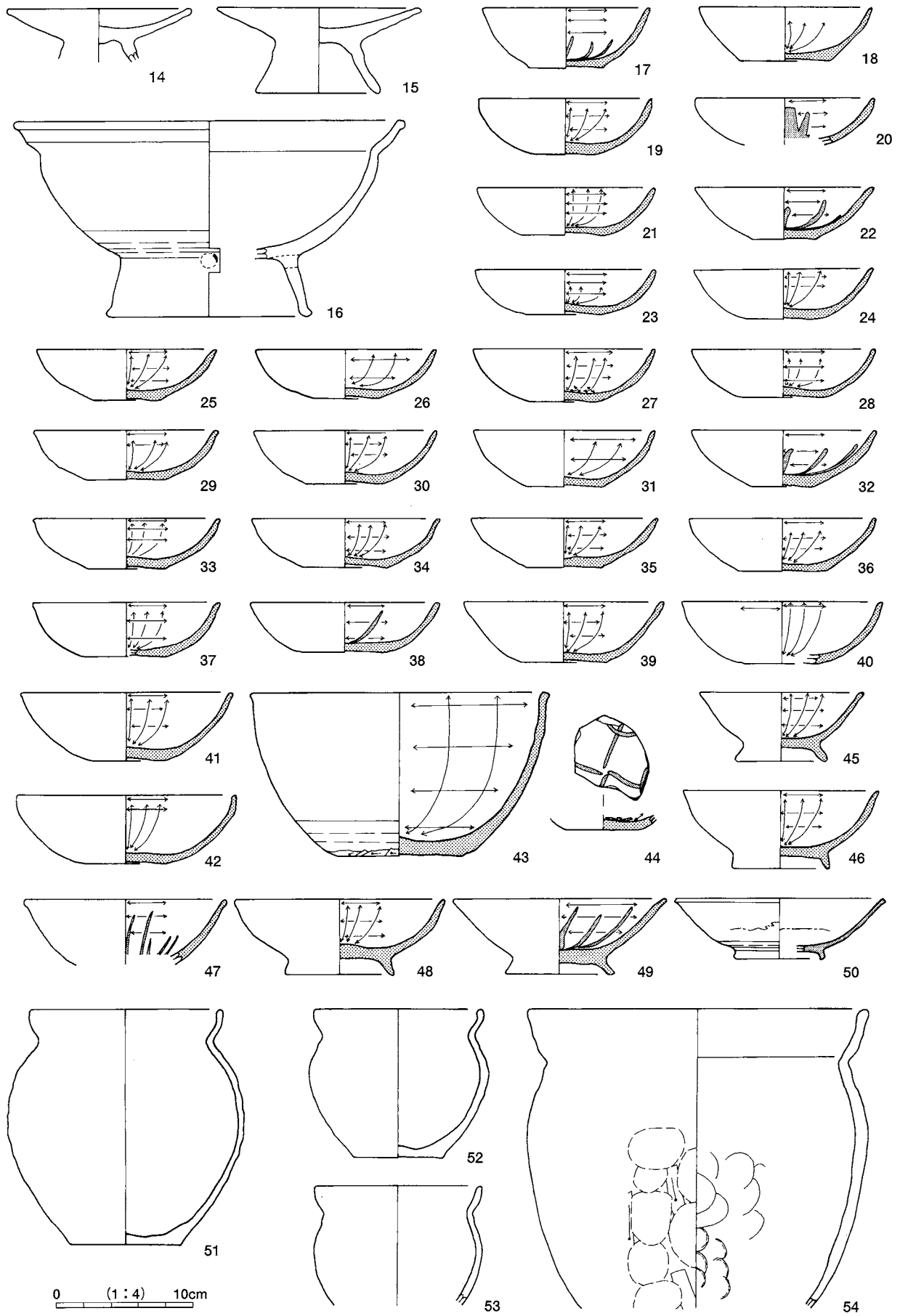

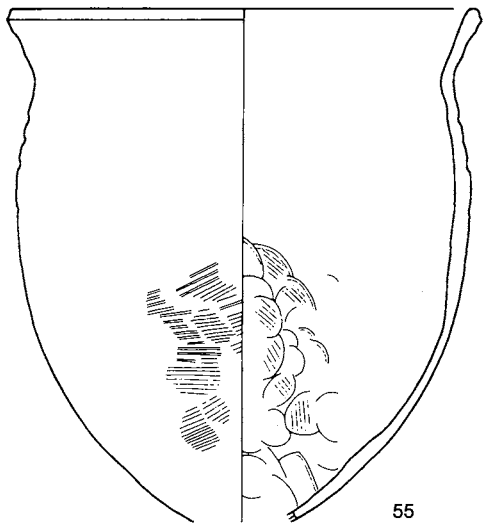

55

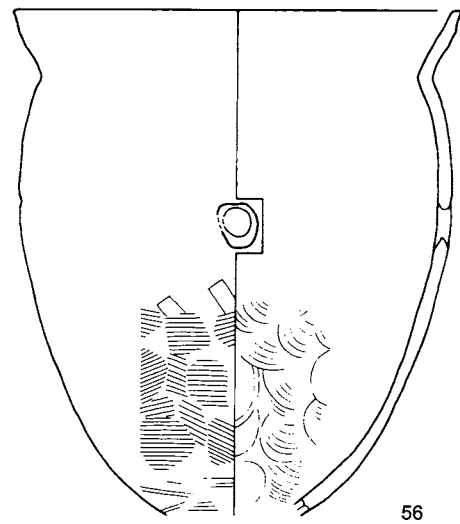

56

SB383 (1~211)

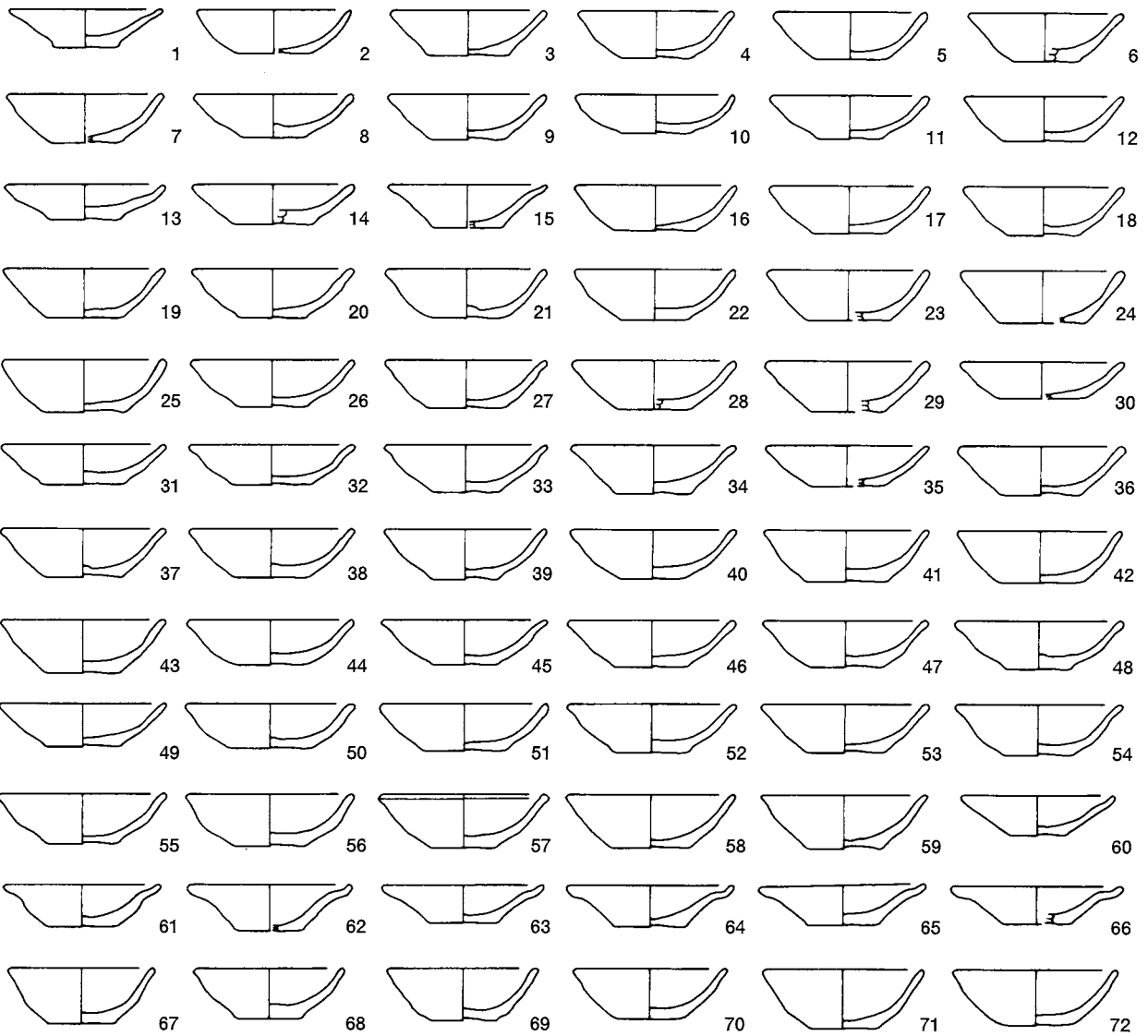

0 (1:4) 10cm

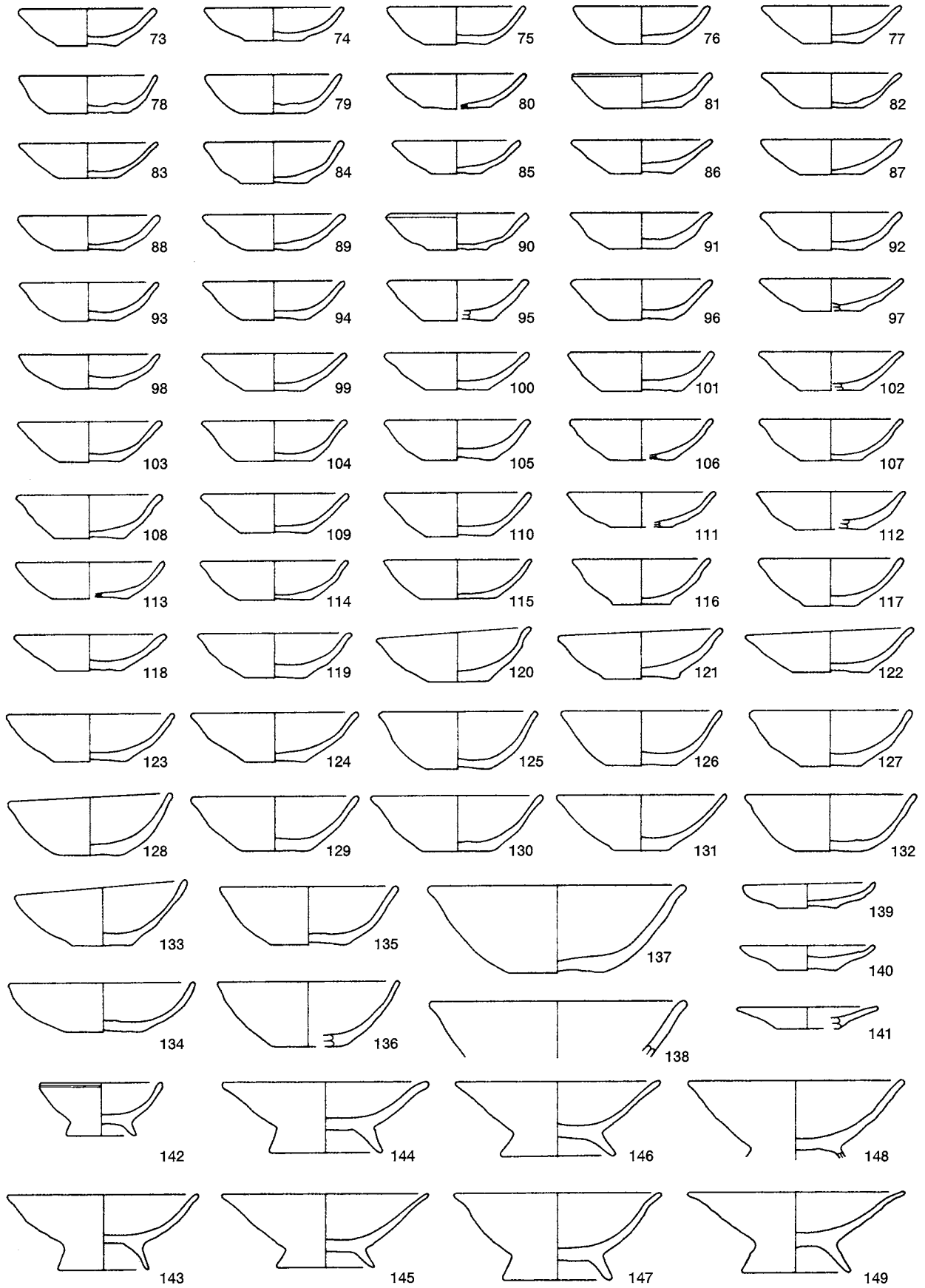

0 (1:4) 10cm

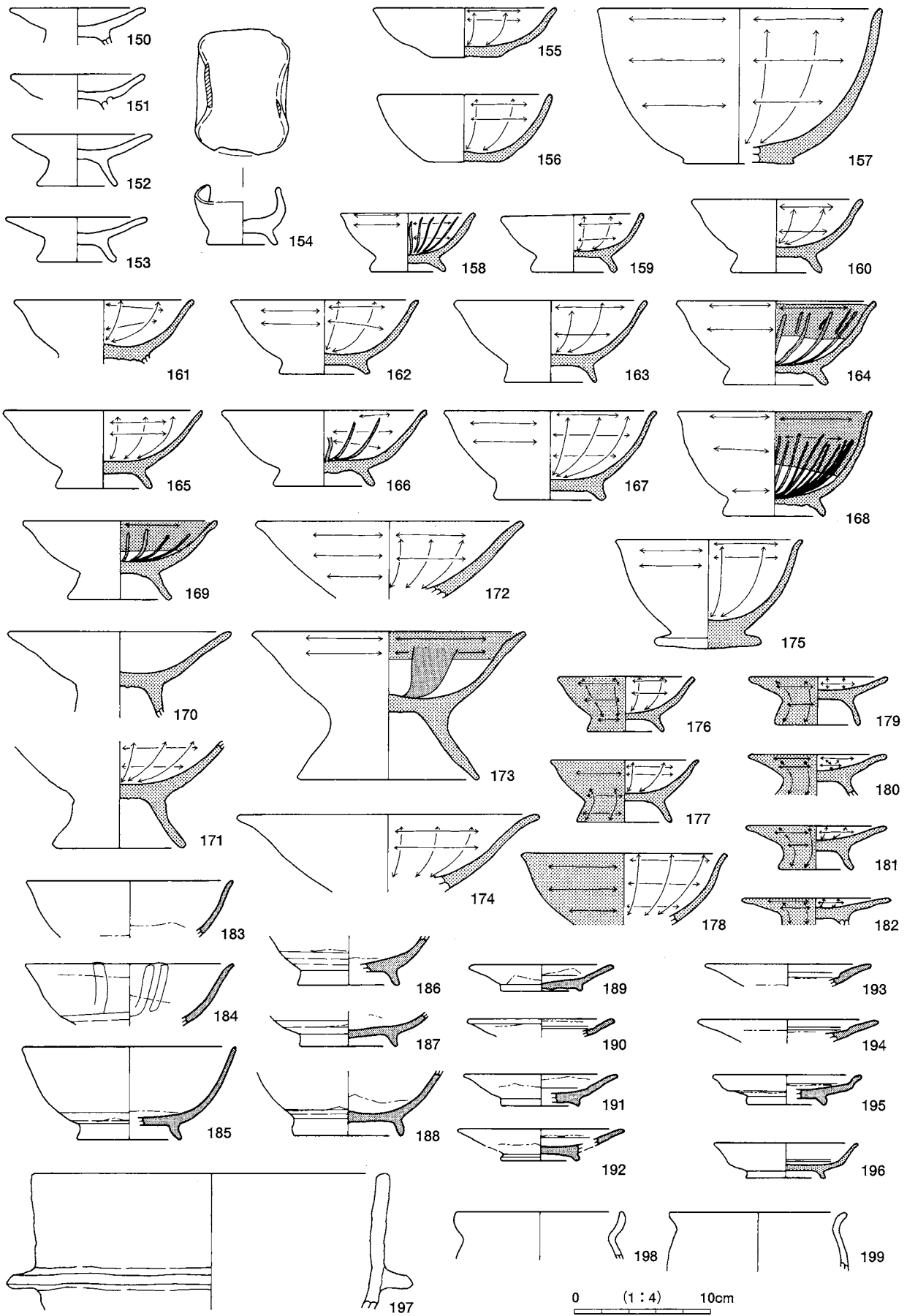

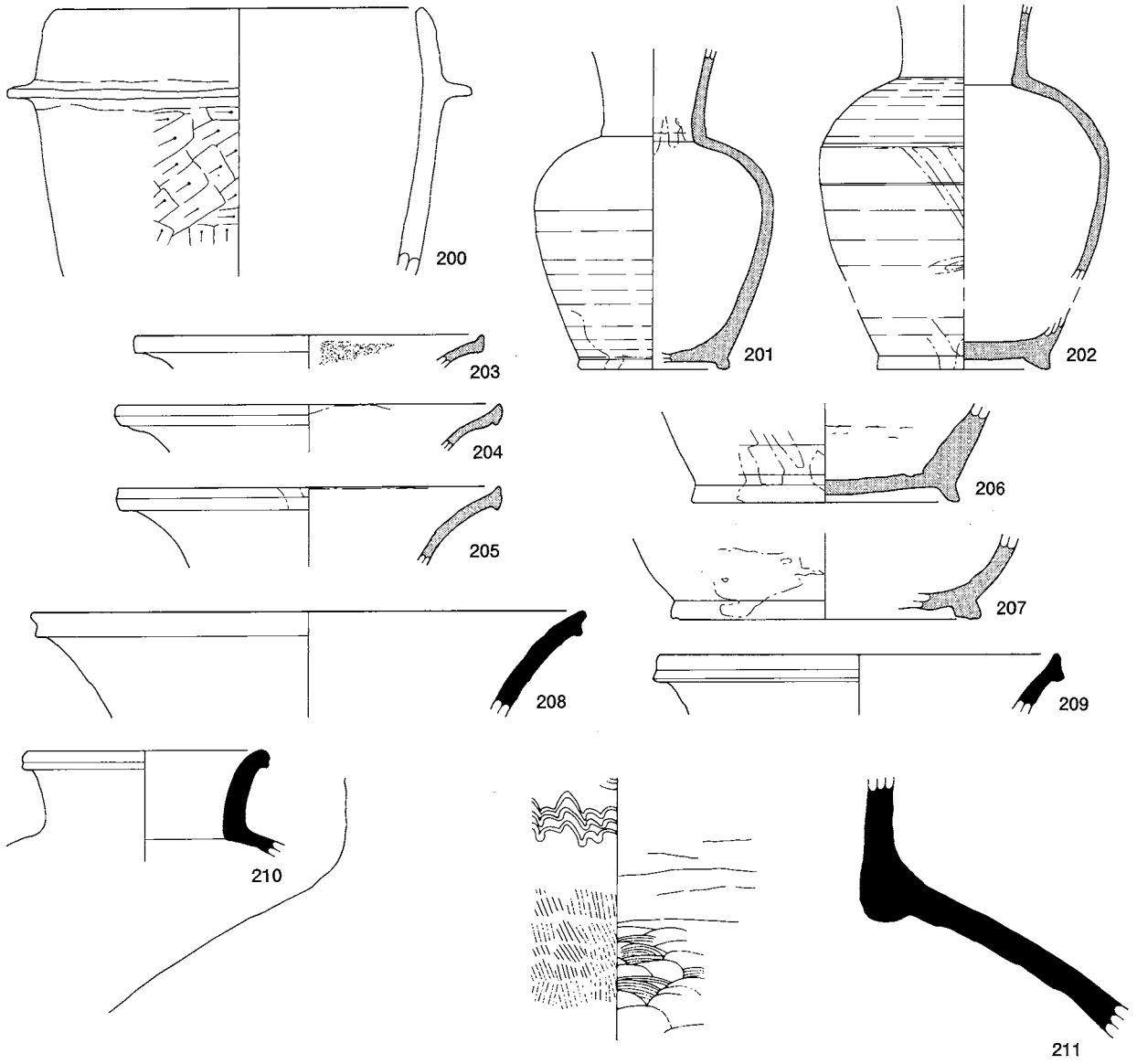

SB388 (1~20)

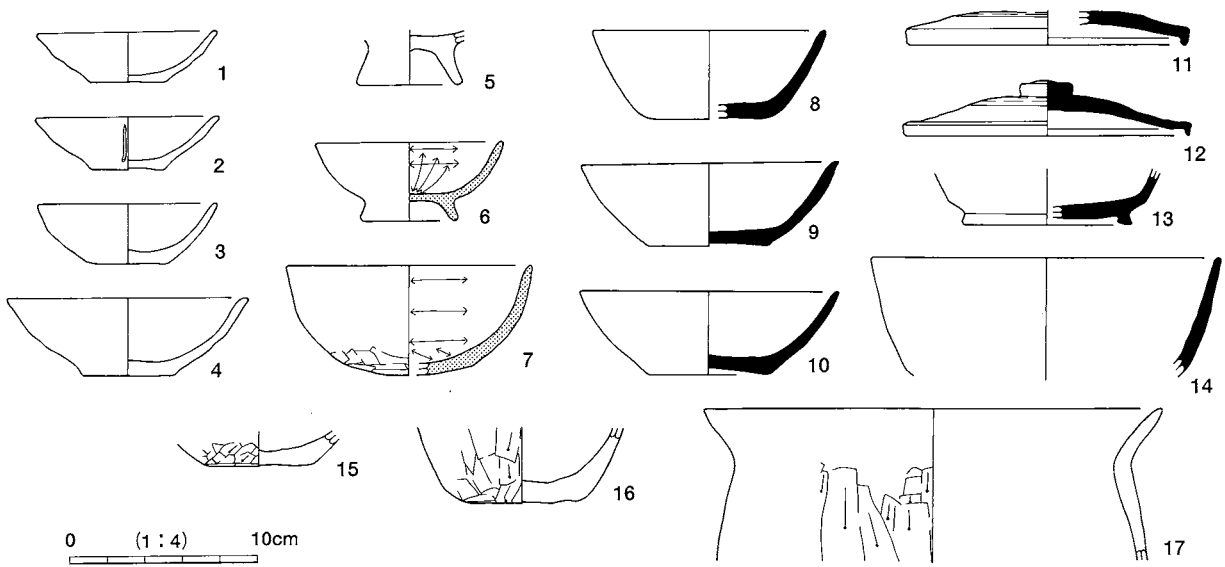

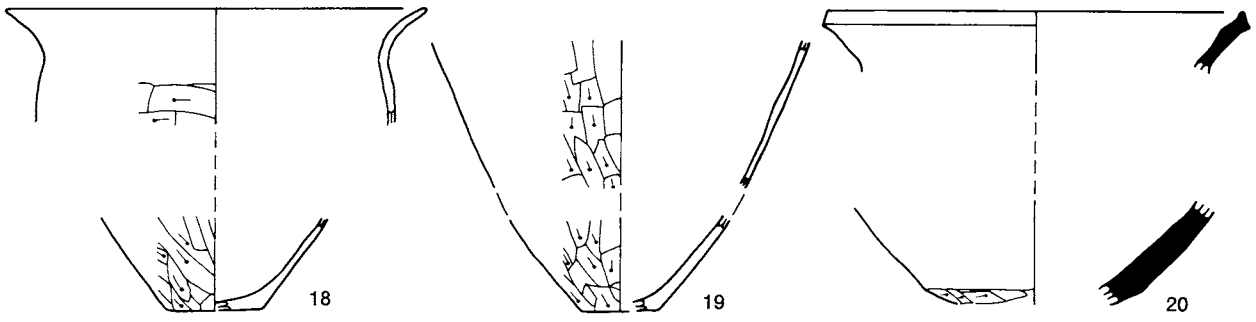

SB395 (1~15)

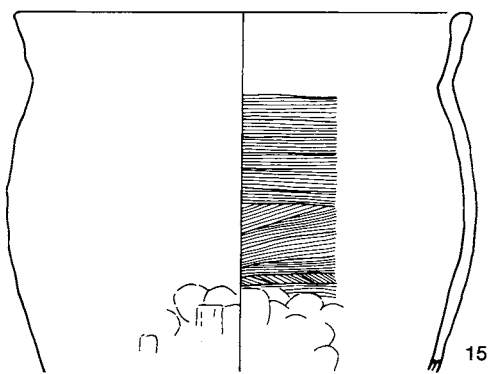
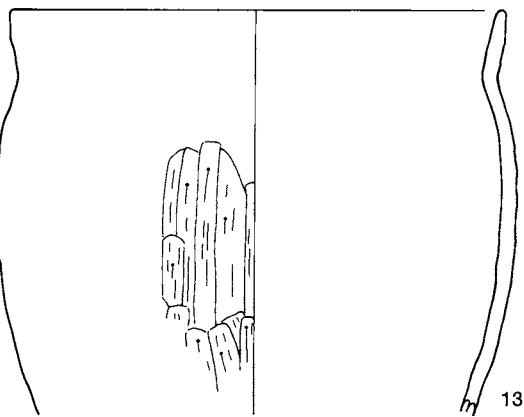
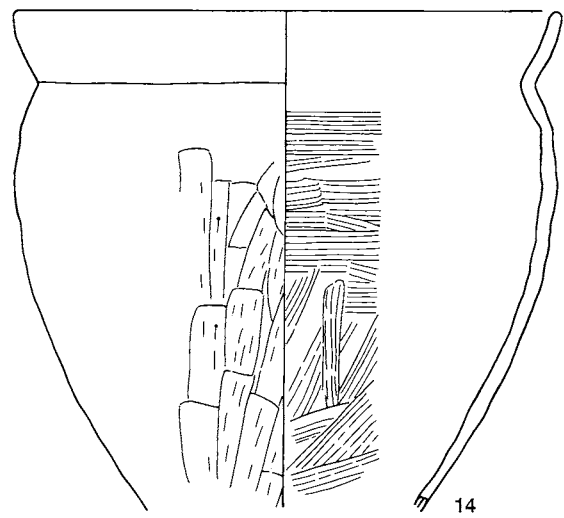
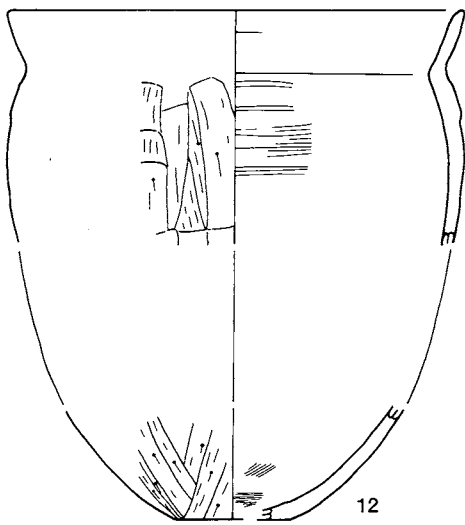
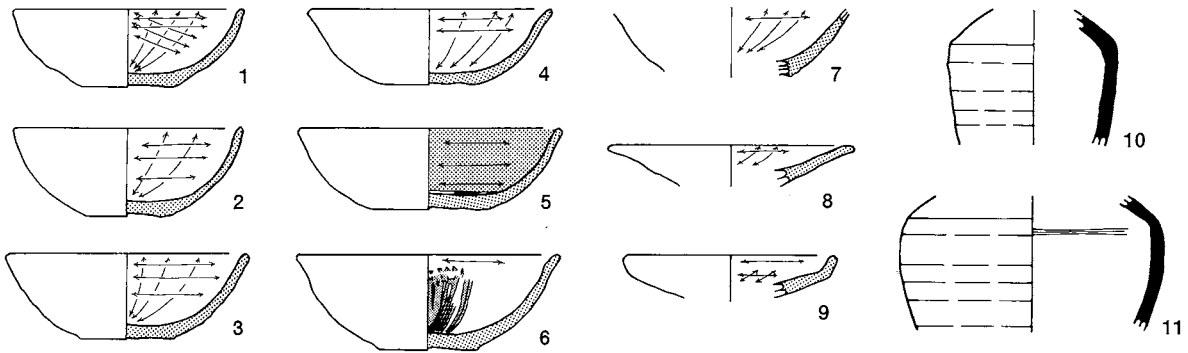

0 (1:4) 10cm

SB416 (1~10)

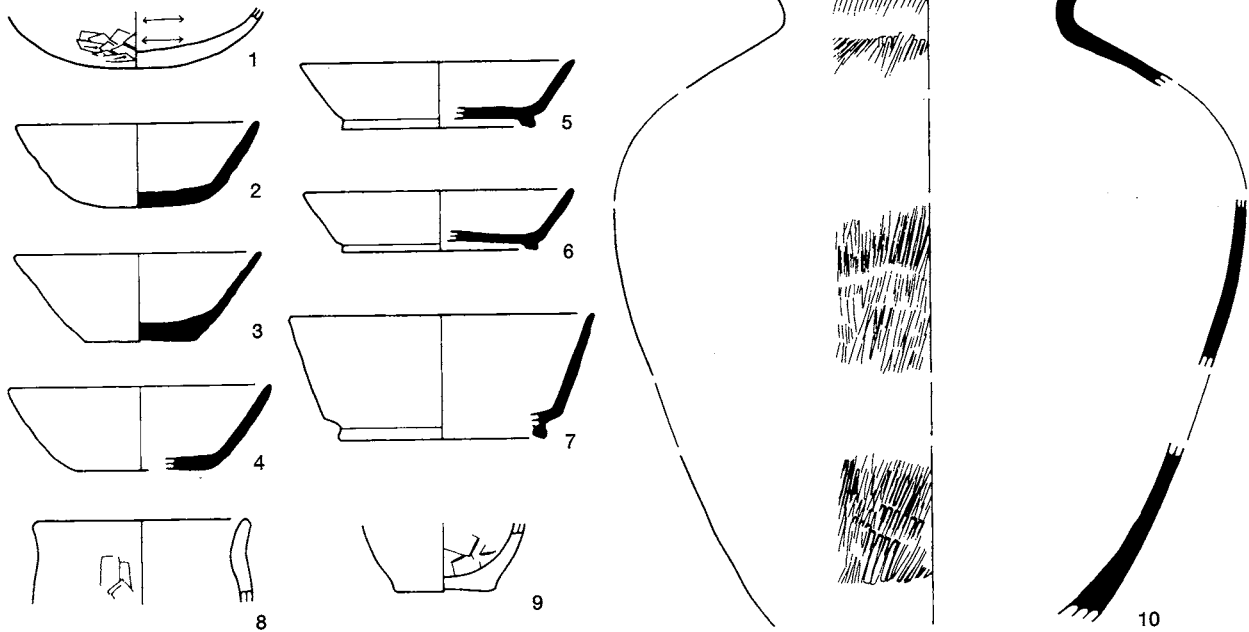

SB421 (1~59)

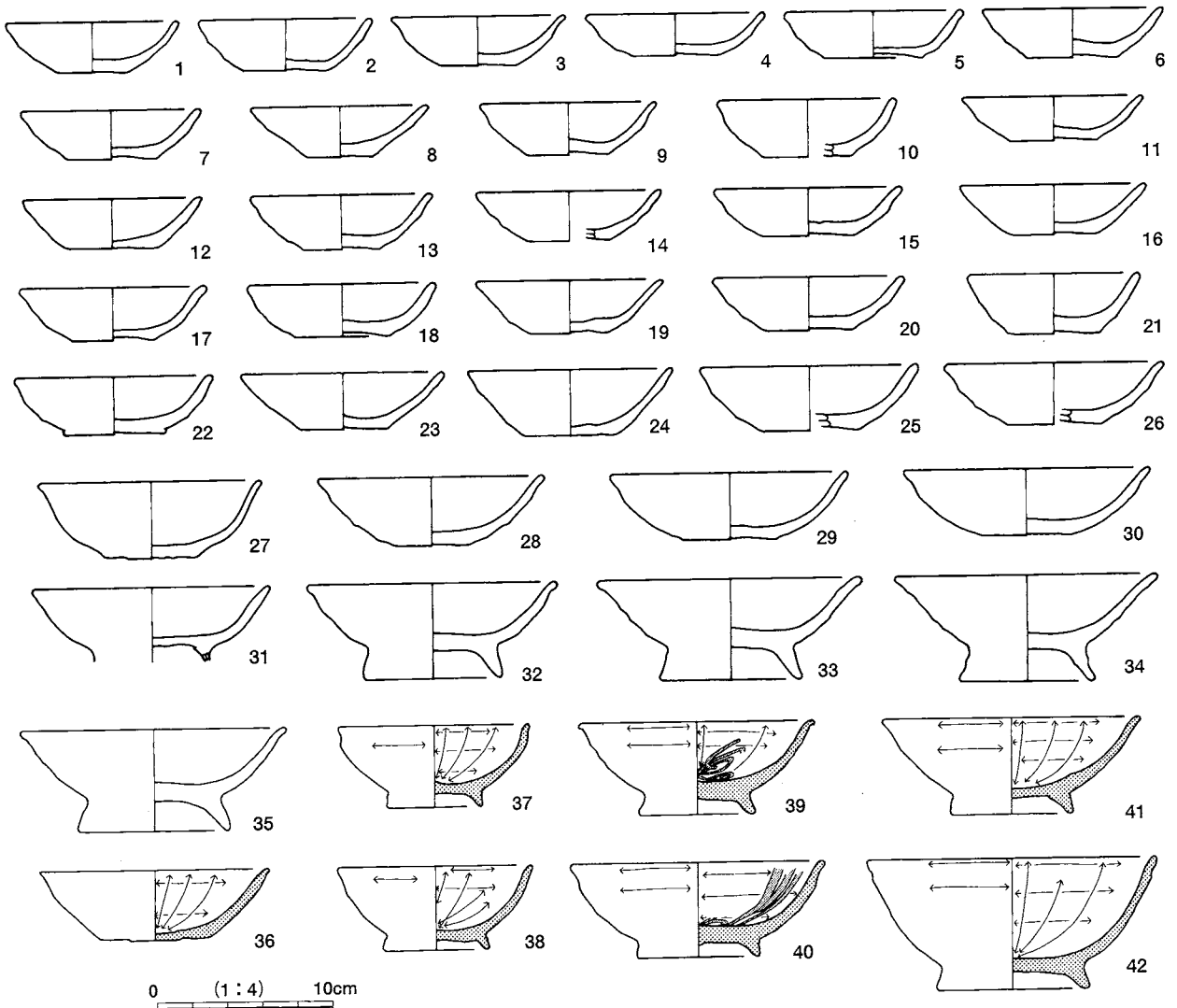

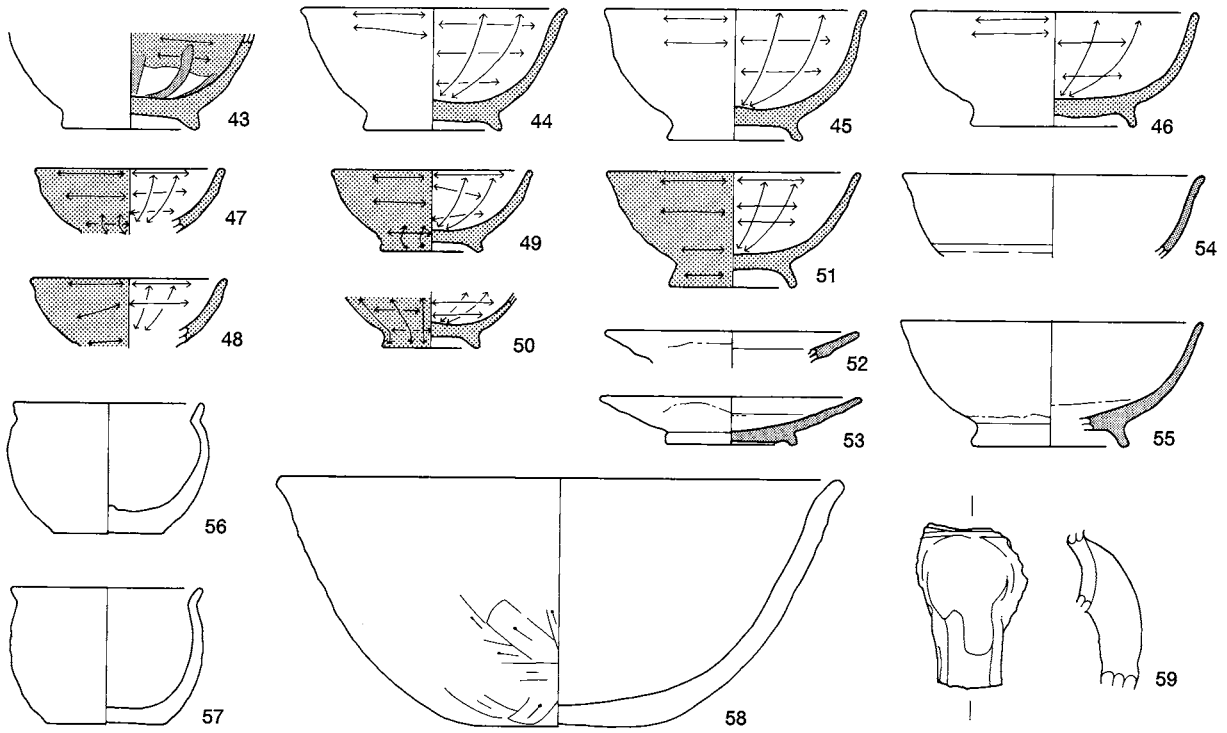

SB504 (1・2)

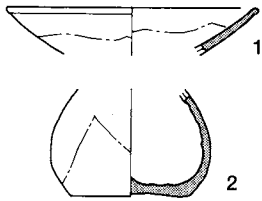

SB1002 (1~23)

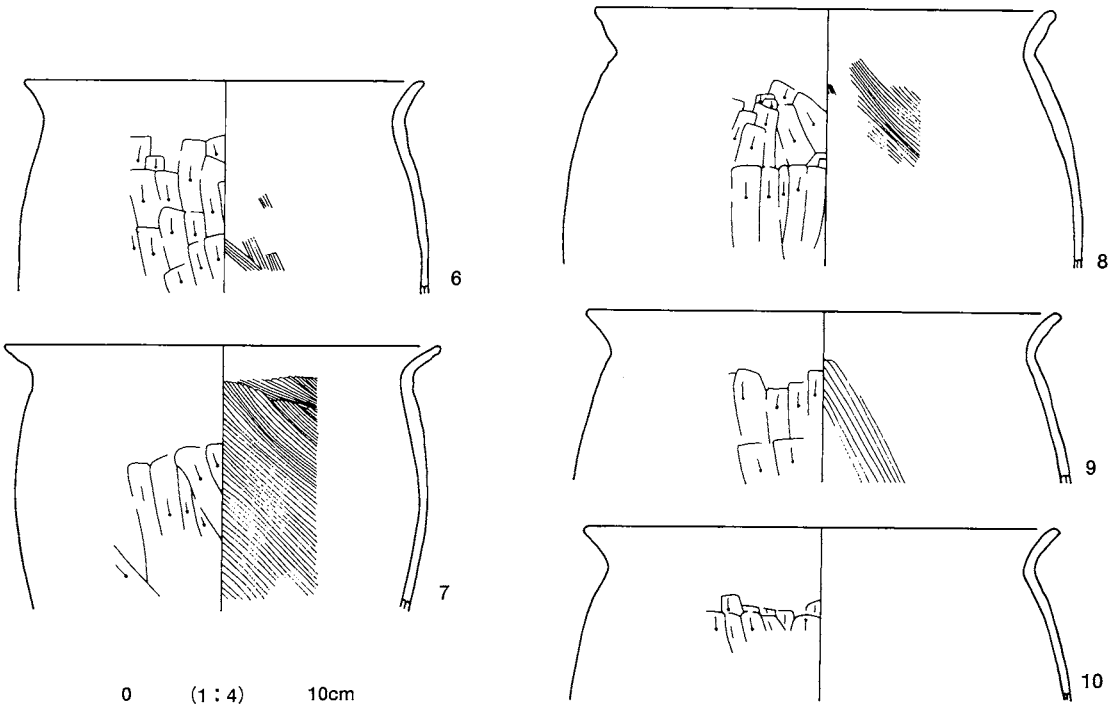
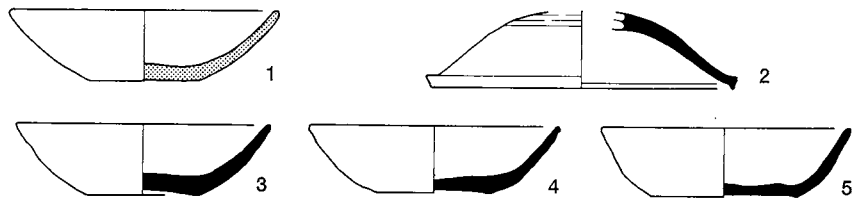

0 (1:4) 10cm

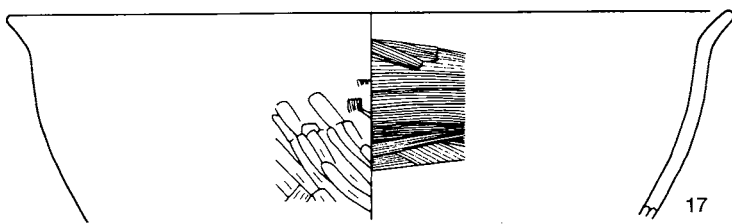
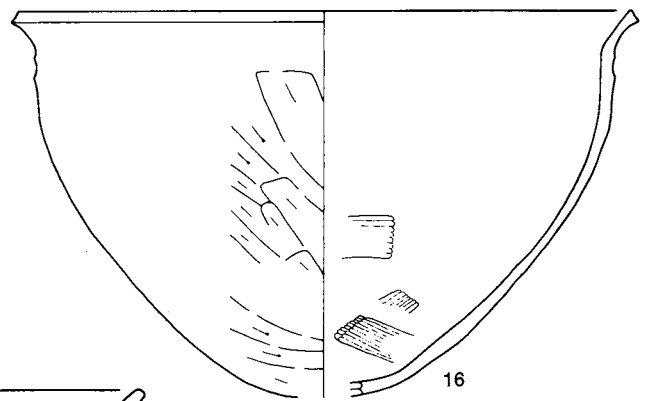
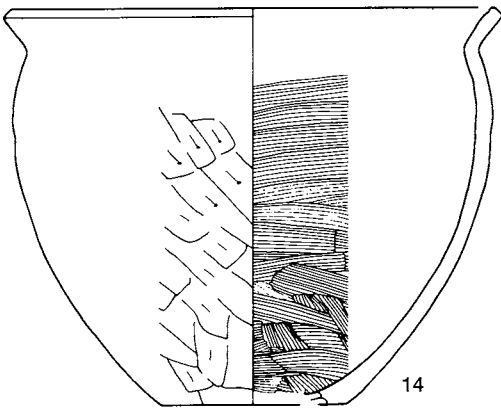
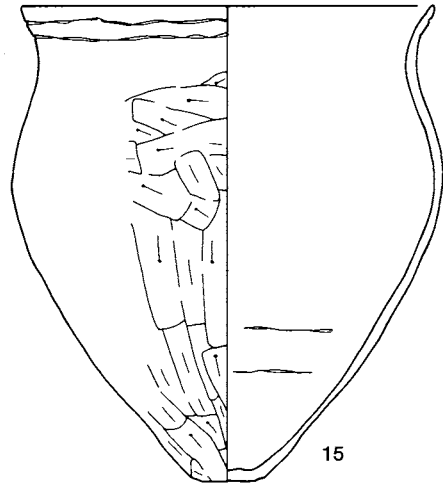
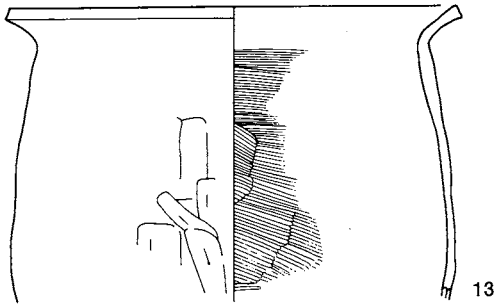
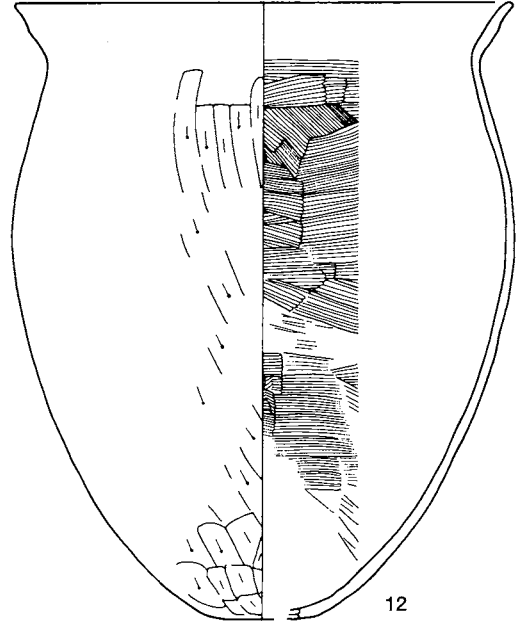
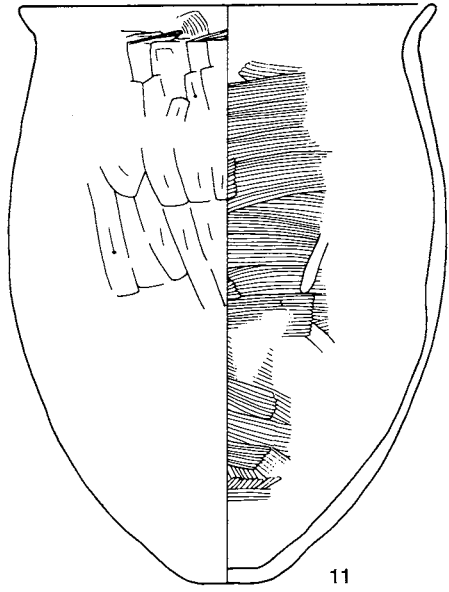

0 (1:4) 10cm

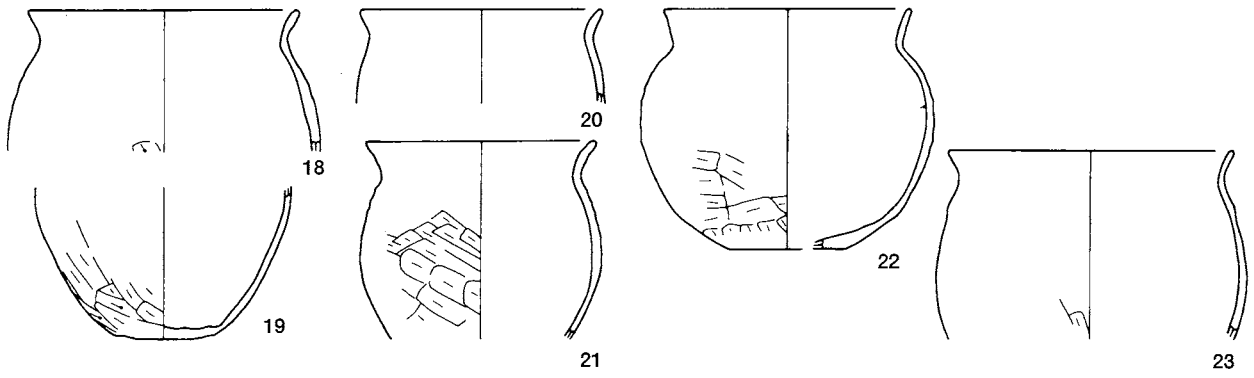

SB1005 (1~56)

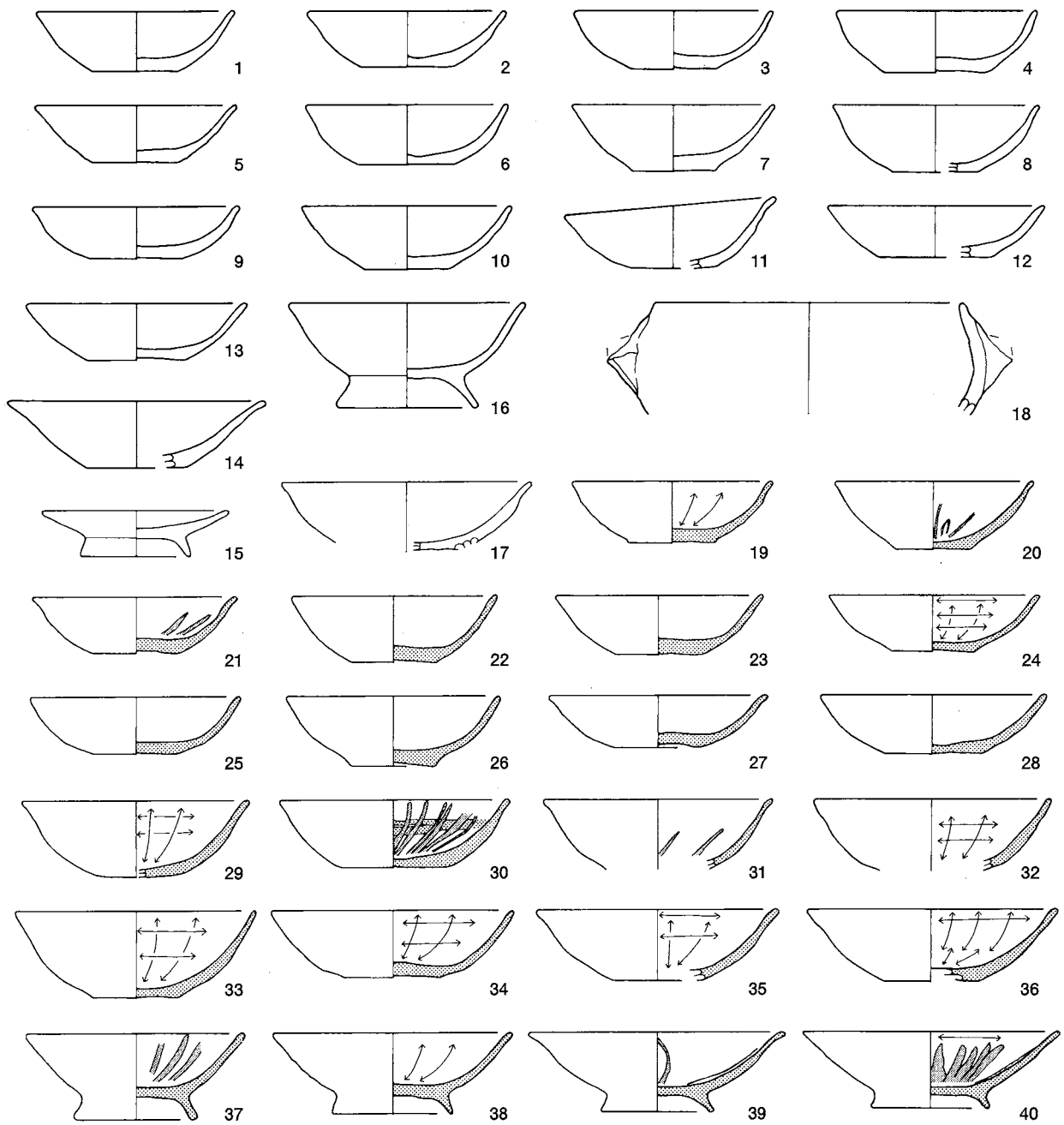

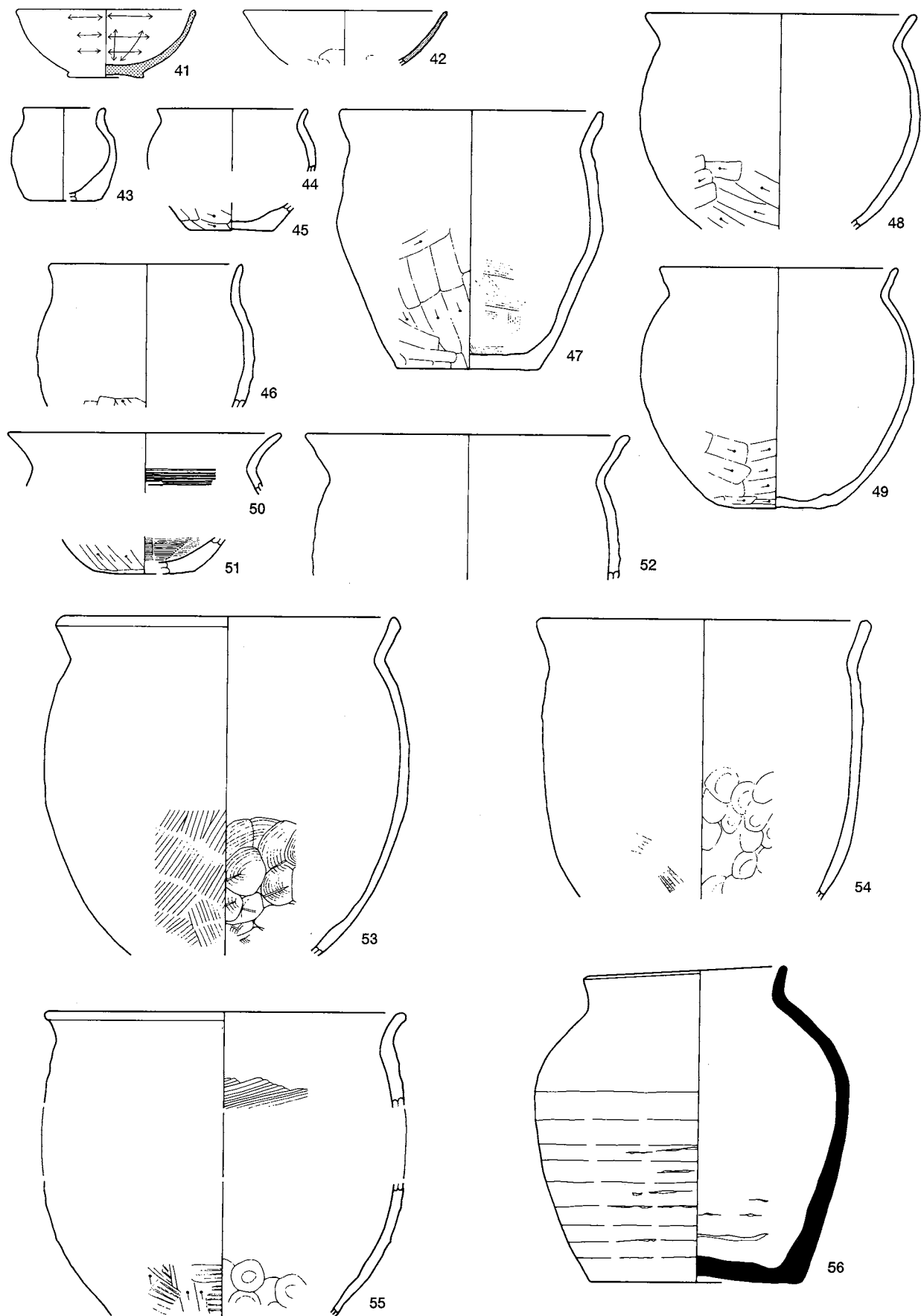

SB1006 (1~14)

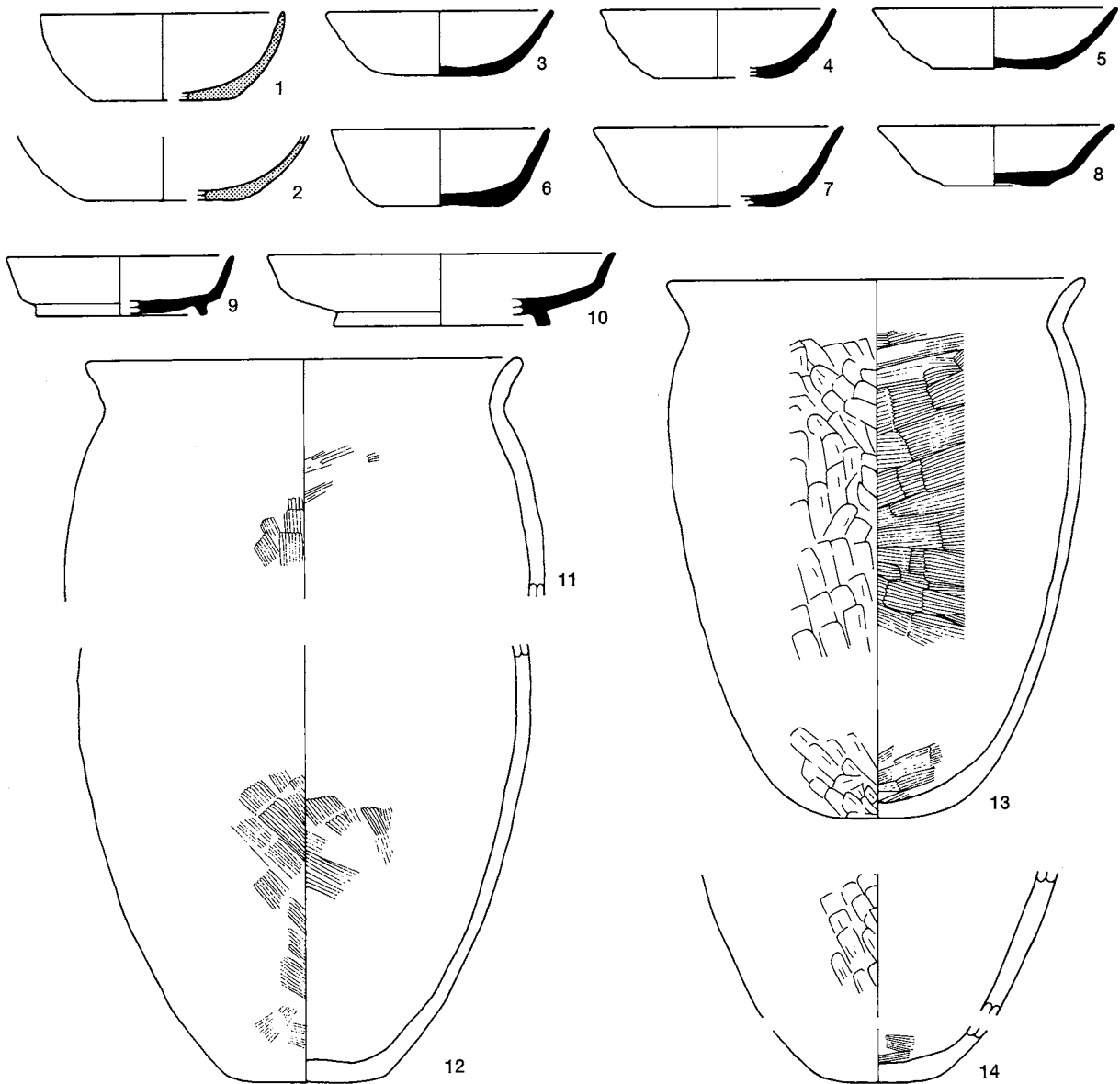

SB1008 (1~38)

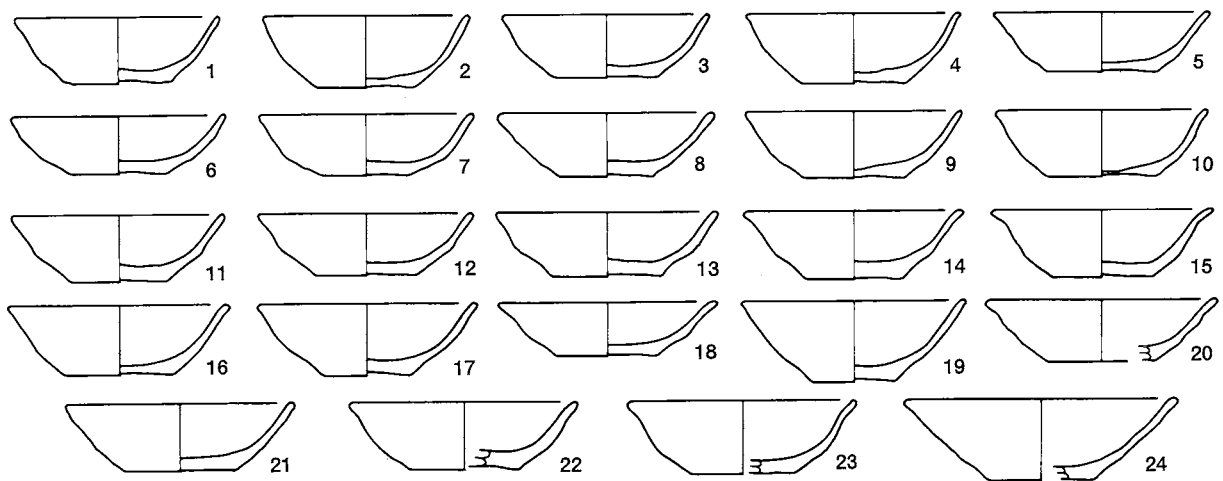

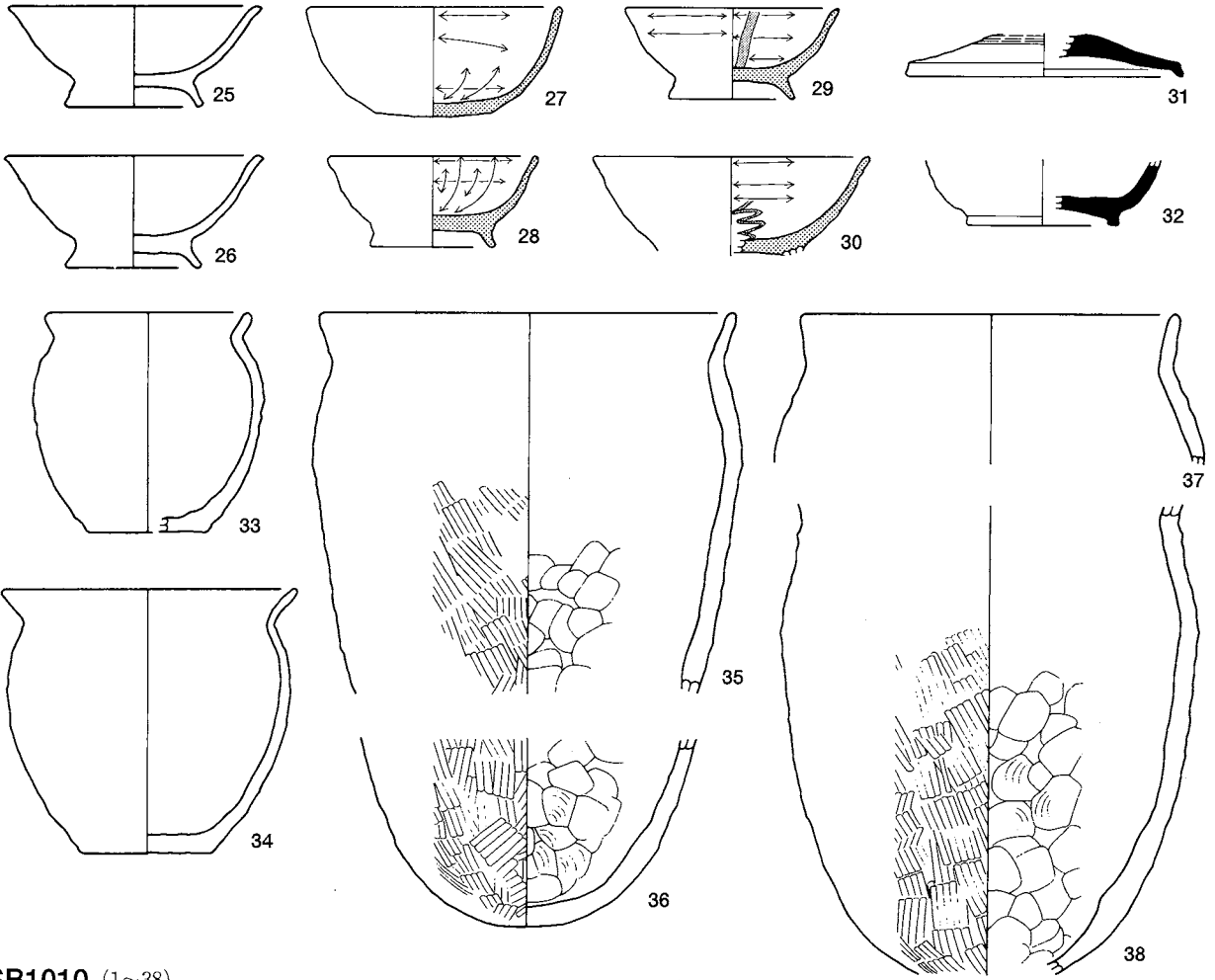

SB1010 (1~38)

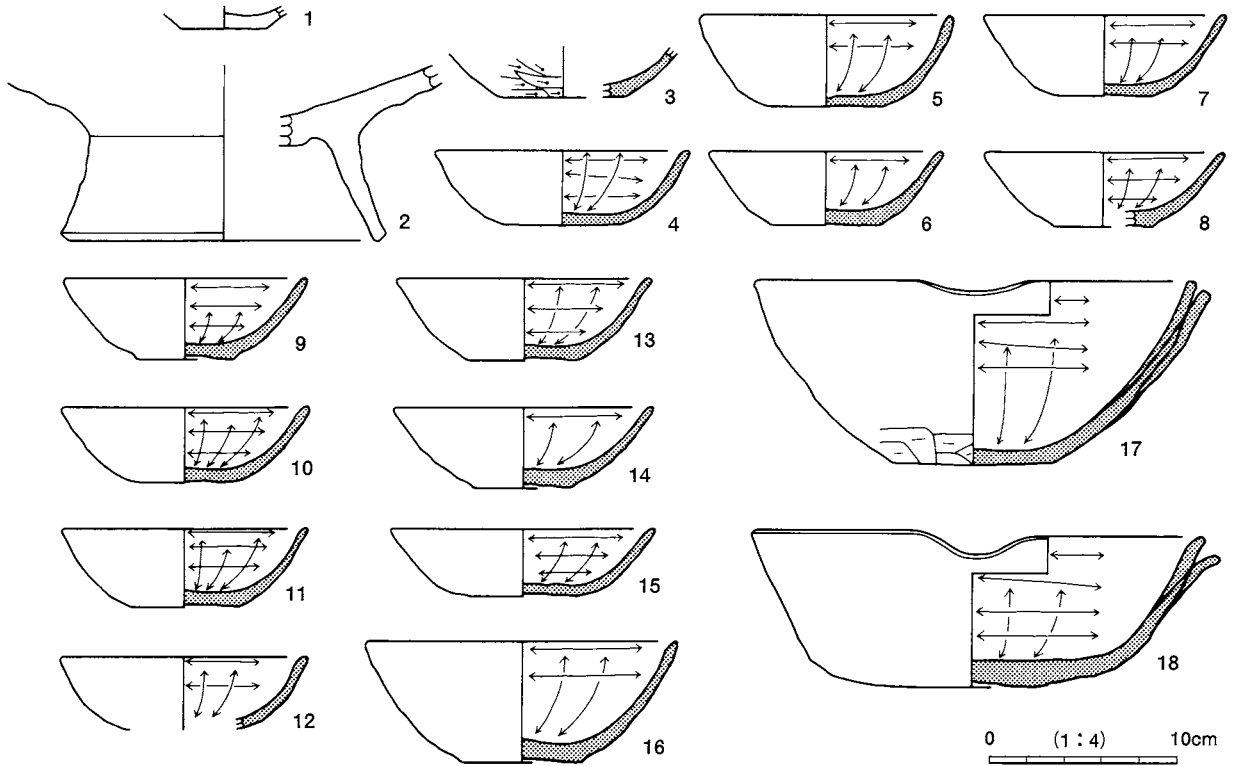

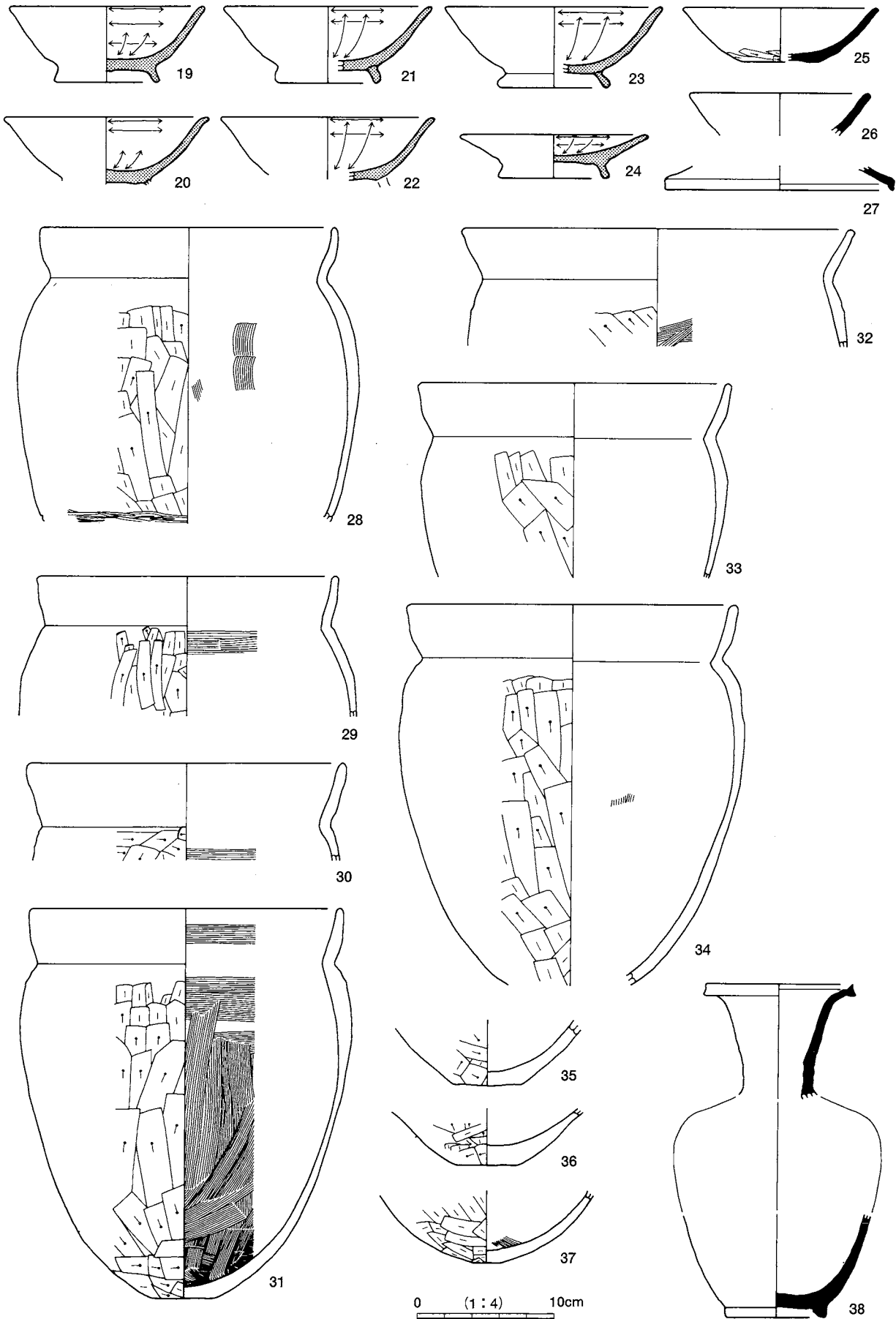

SB1011 (1~73)

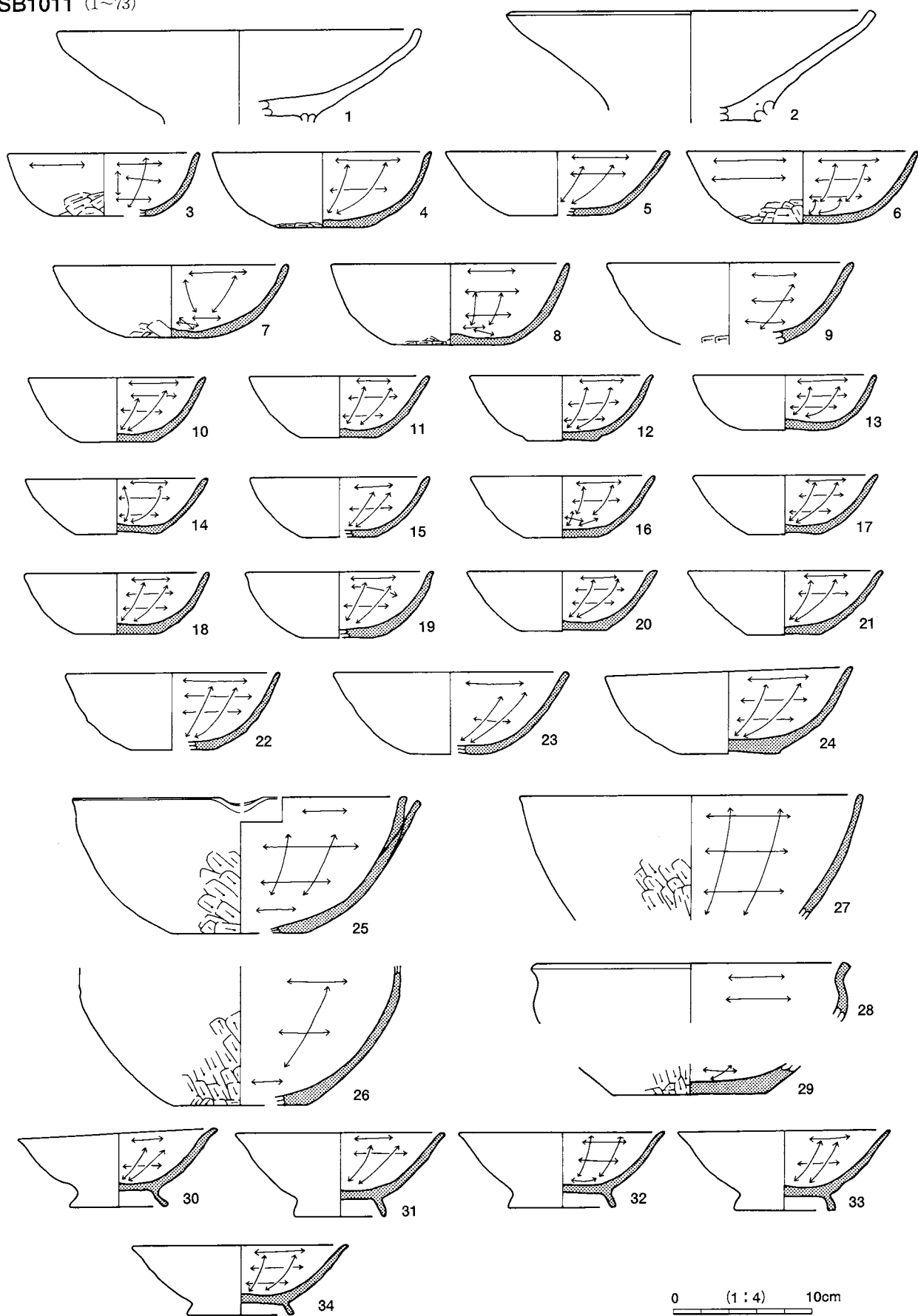

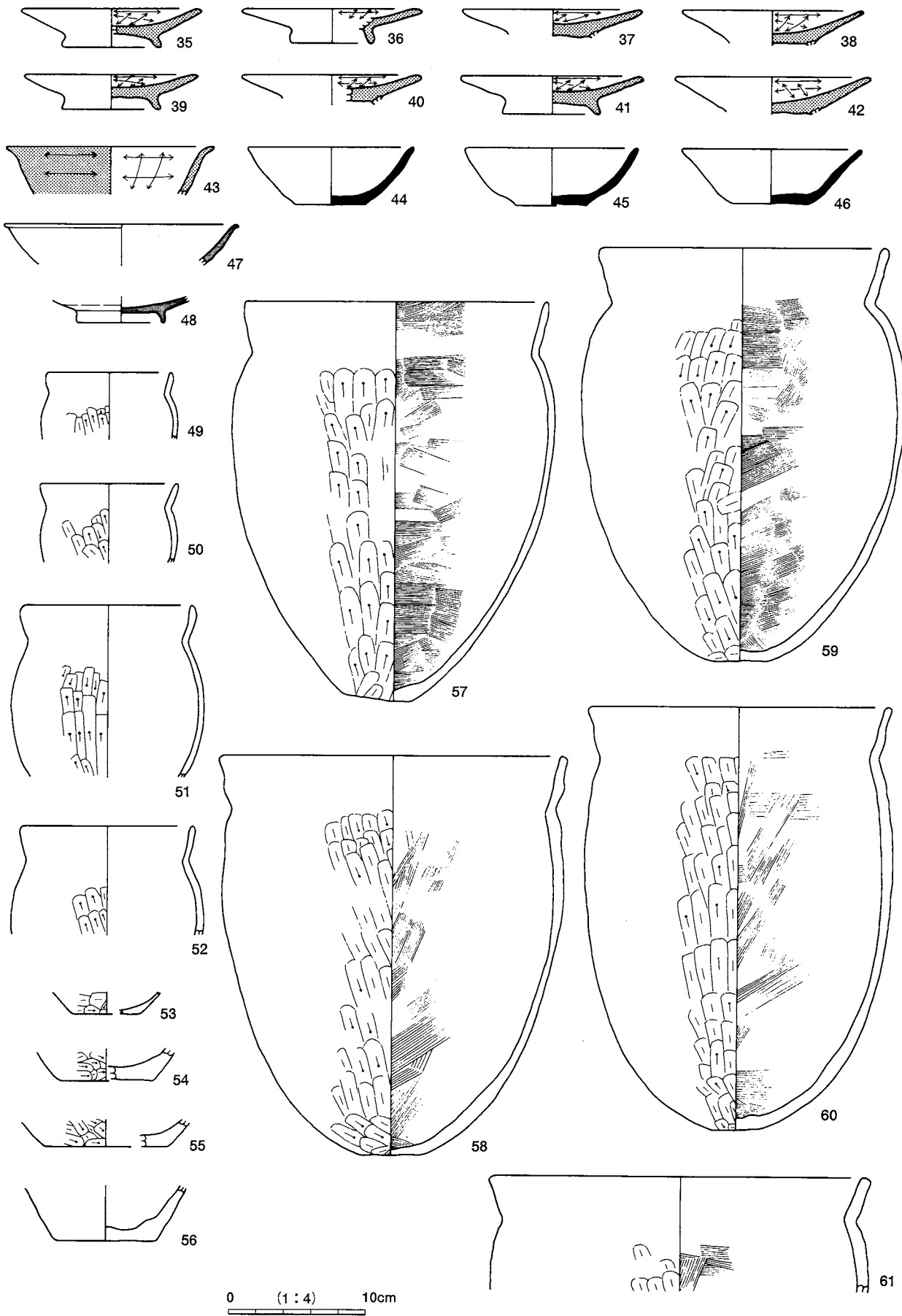

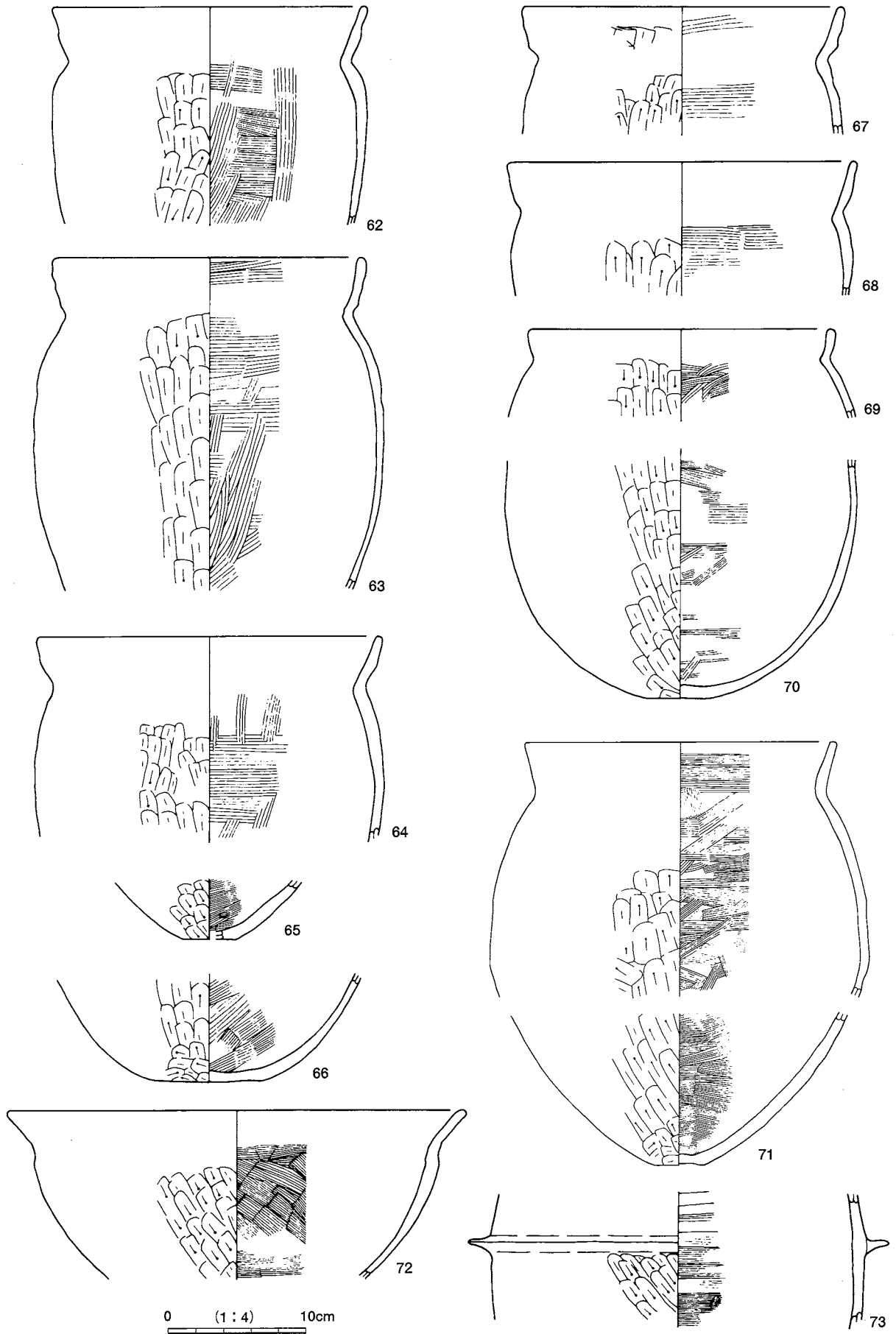

SB1014

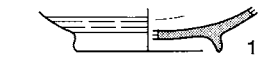

SB1017 (1~31)

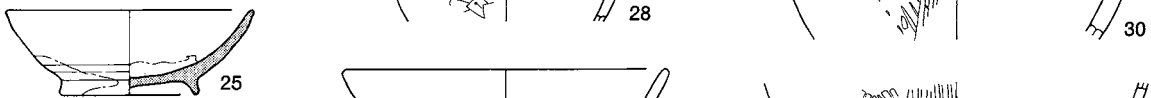
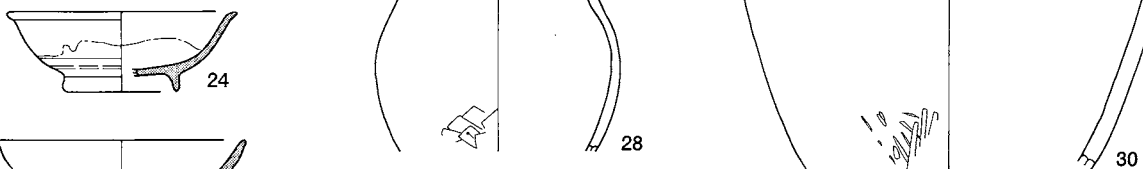
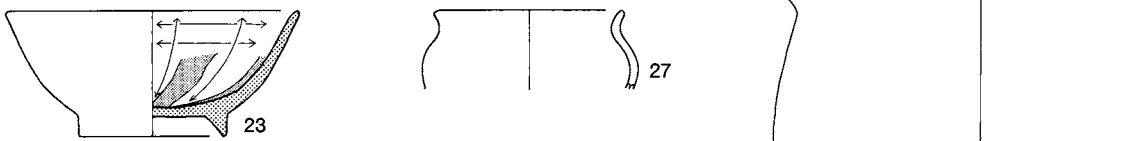
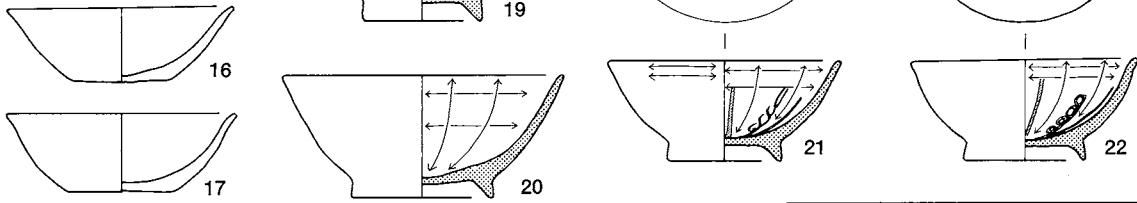
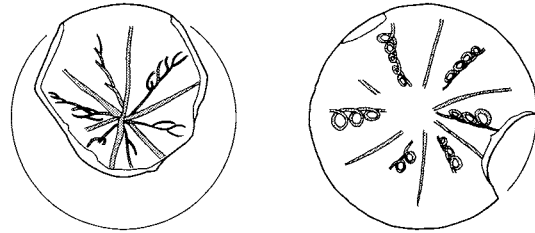
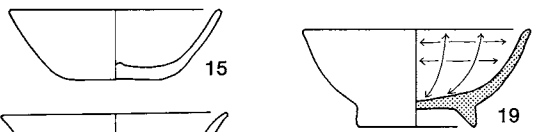
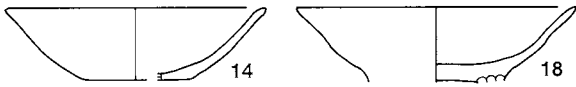
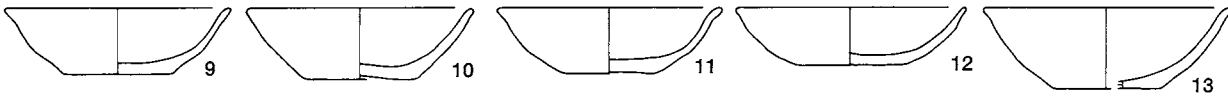
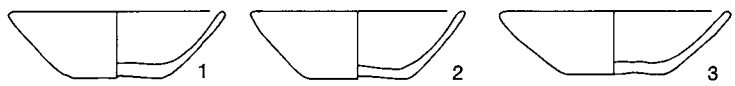

SB1020 (1~14)

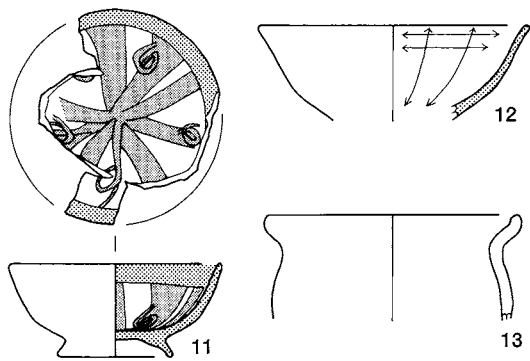
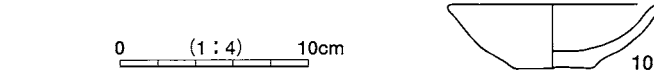
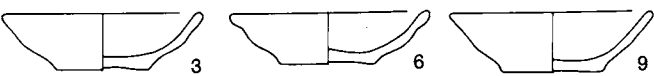
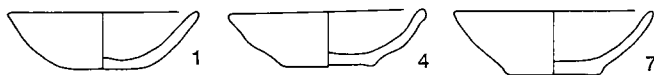

0 (1:4) 10cm

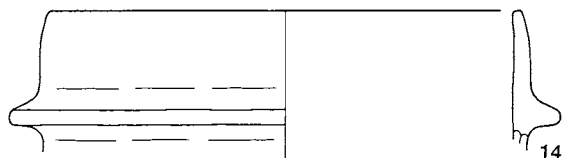

SB1022

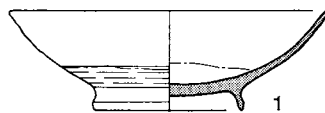

SB1024 (1~17)

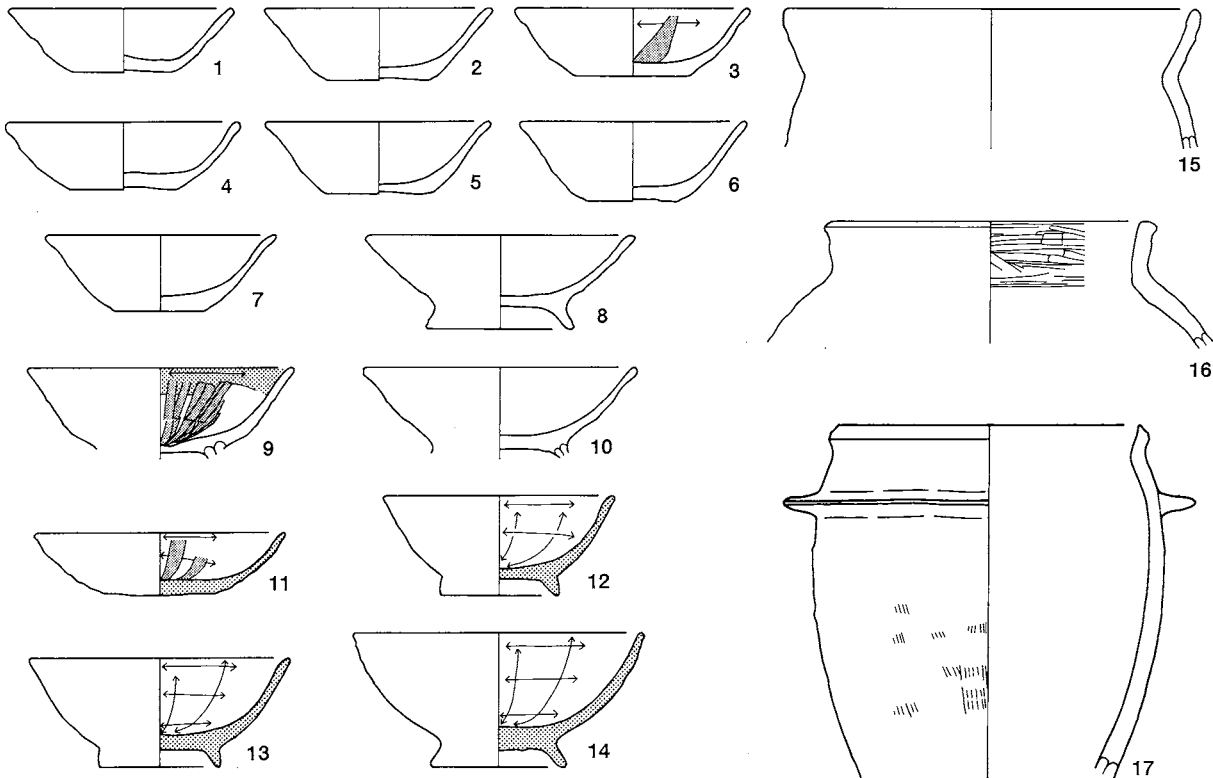

SB1026 (1~25)

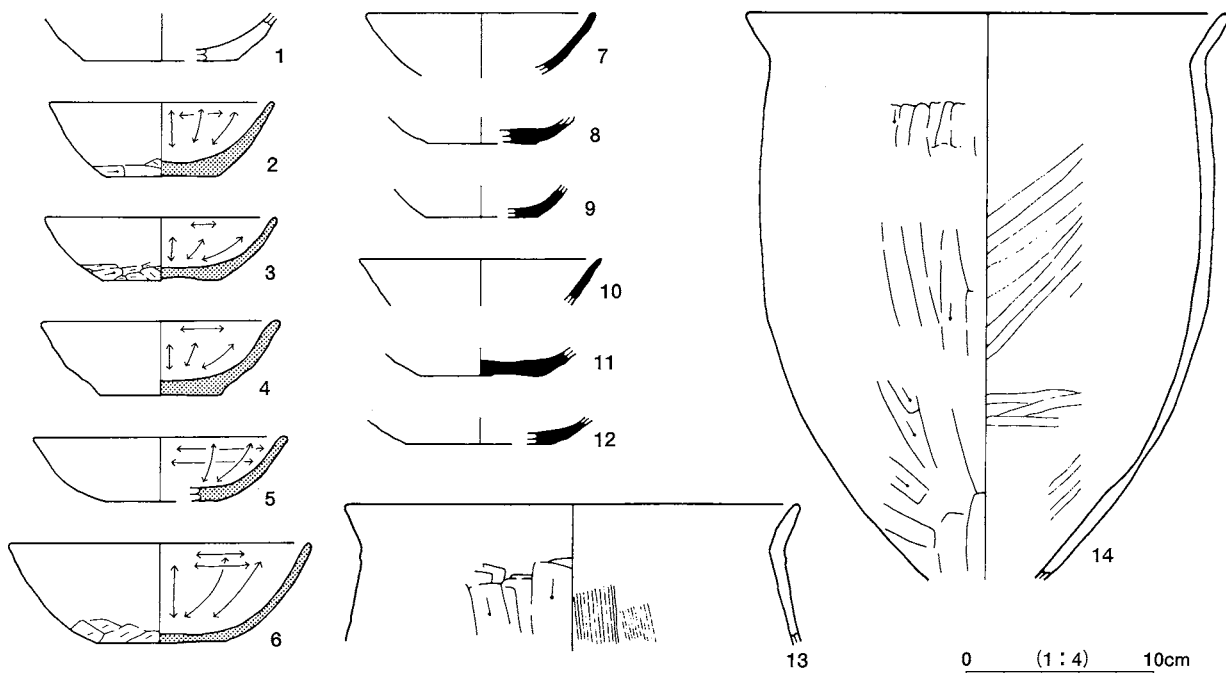

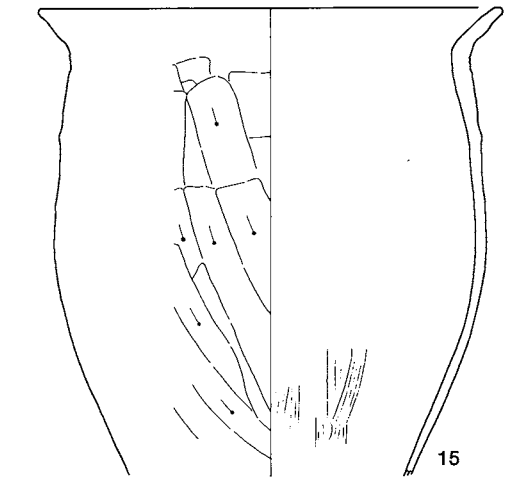

15

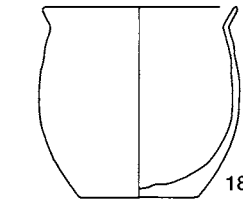

18

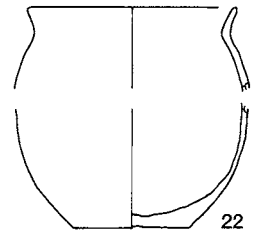

22

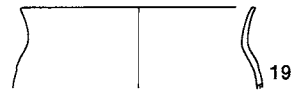

19

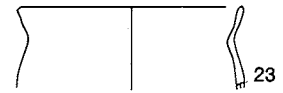

23

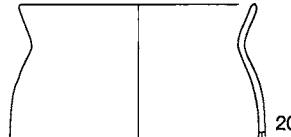

20

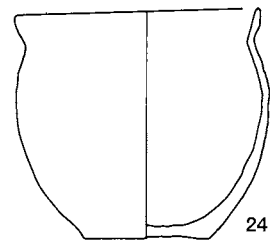

24

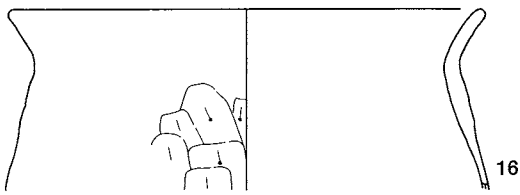

16

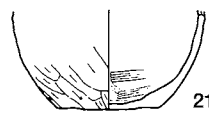

21

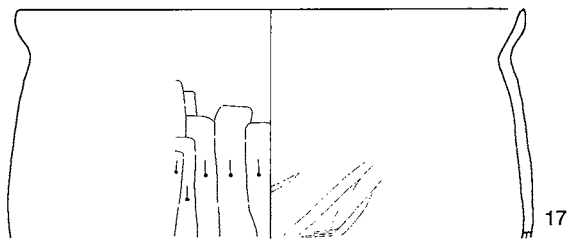

17

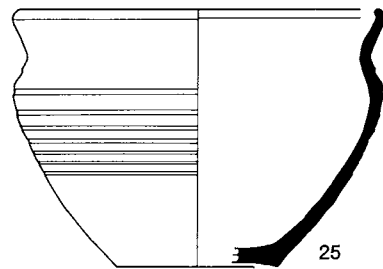

25

SB1029 (1~5)



2

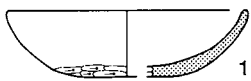

1

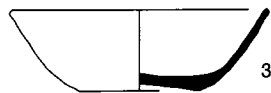

3

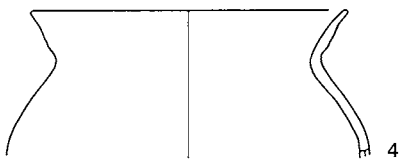

4

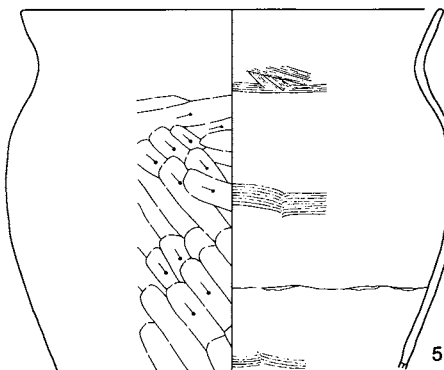

5

SB1030 (1~20)

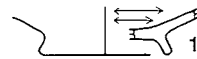

1

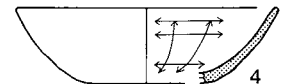

4

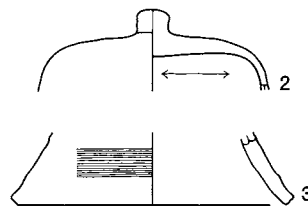

2

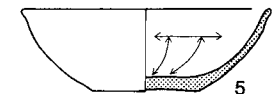

5

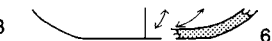

6

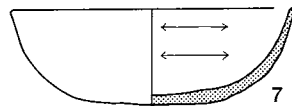

7

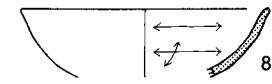

8

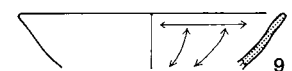

9

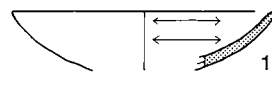

10

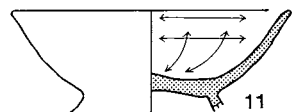

11

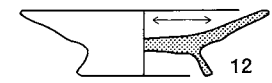

12

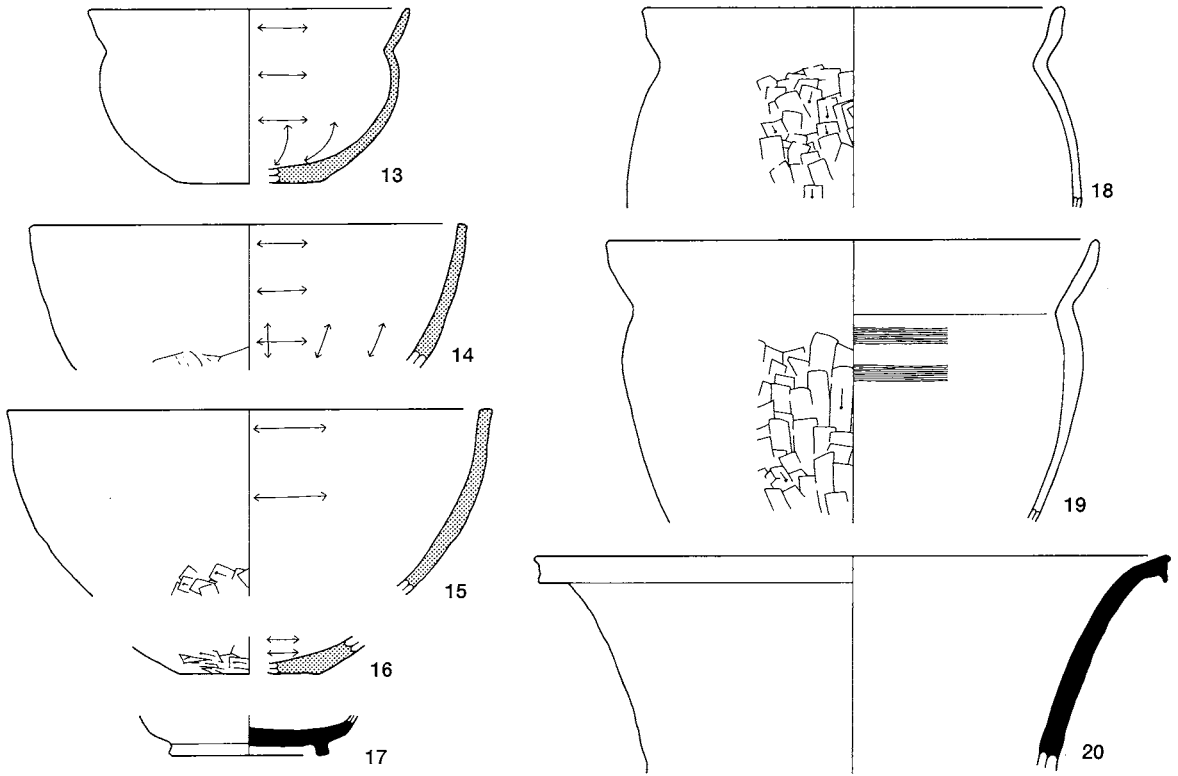

SB1033 (1·2)

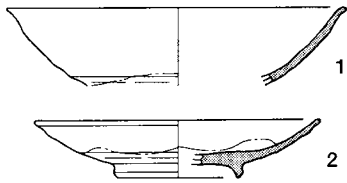

SB1038 (1~14)

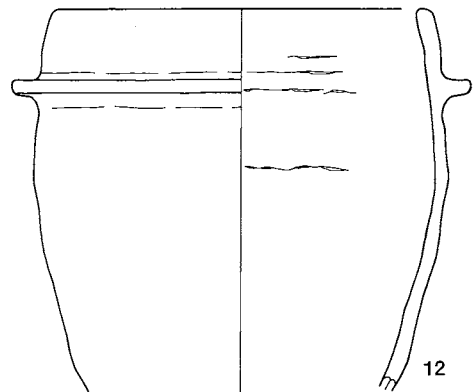
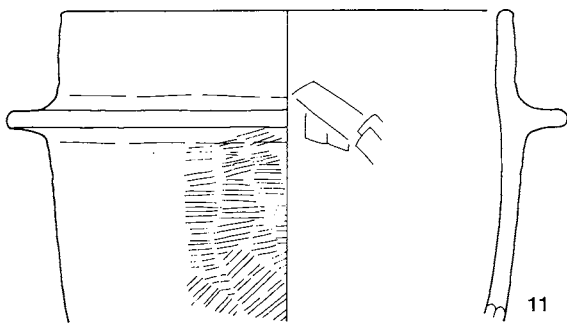
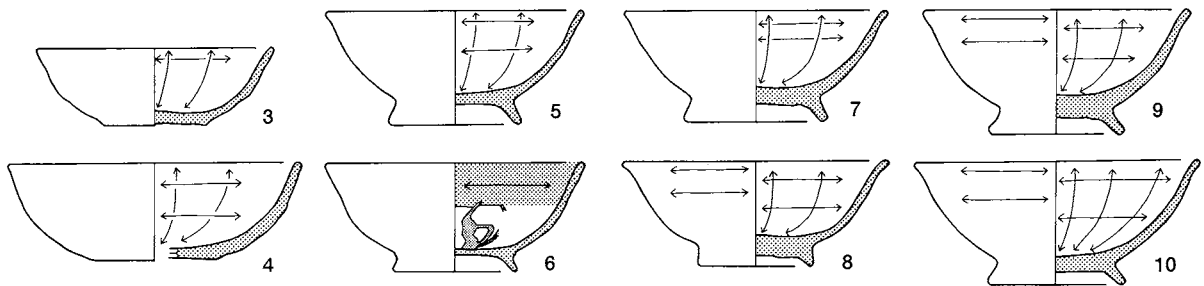

0 (1:4) 10cm

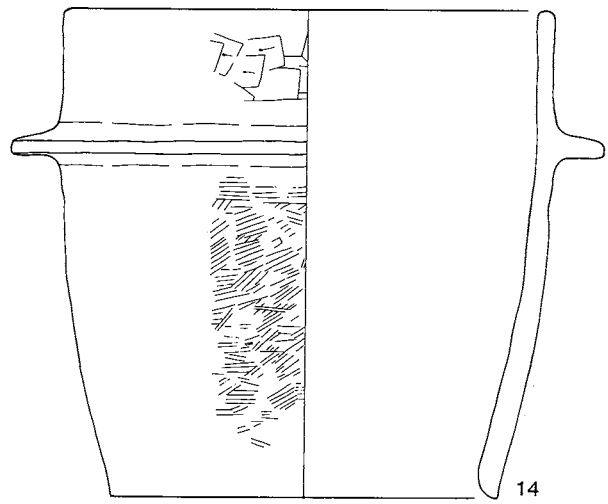
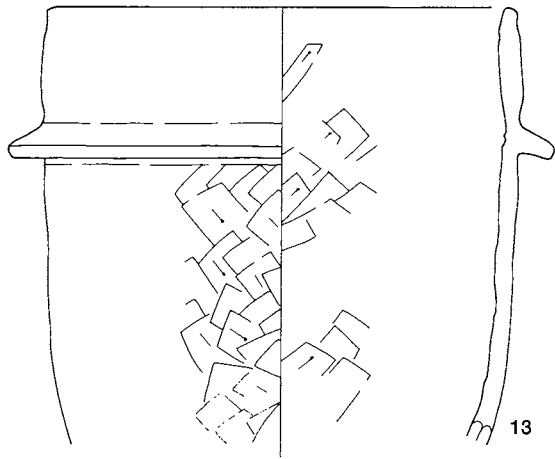

SB1039 (1~27)

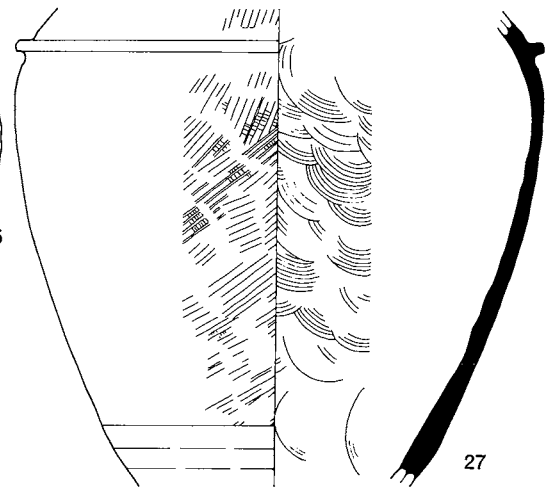
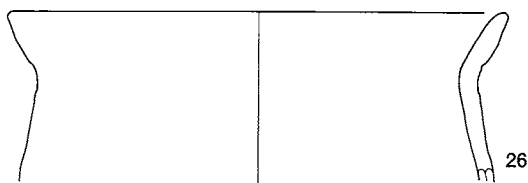
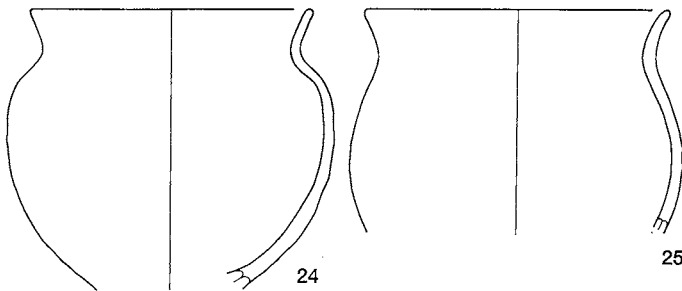
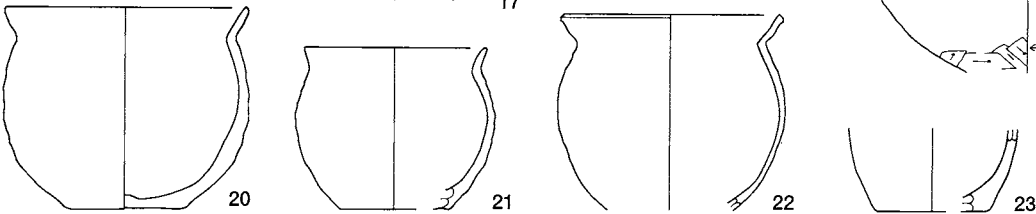
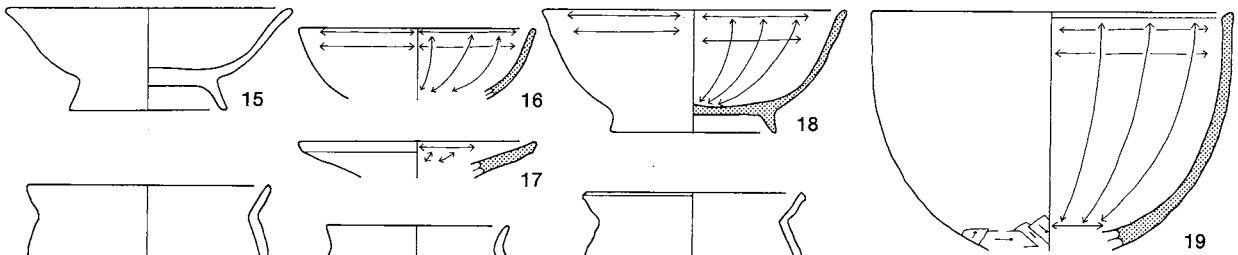
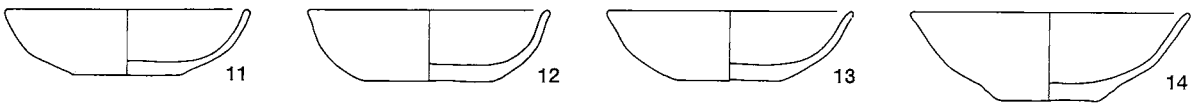

SB1041

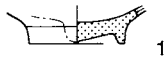

SB1045 (1·2)

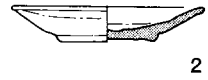

SB1046 (1~157)

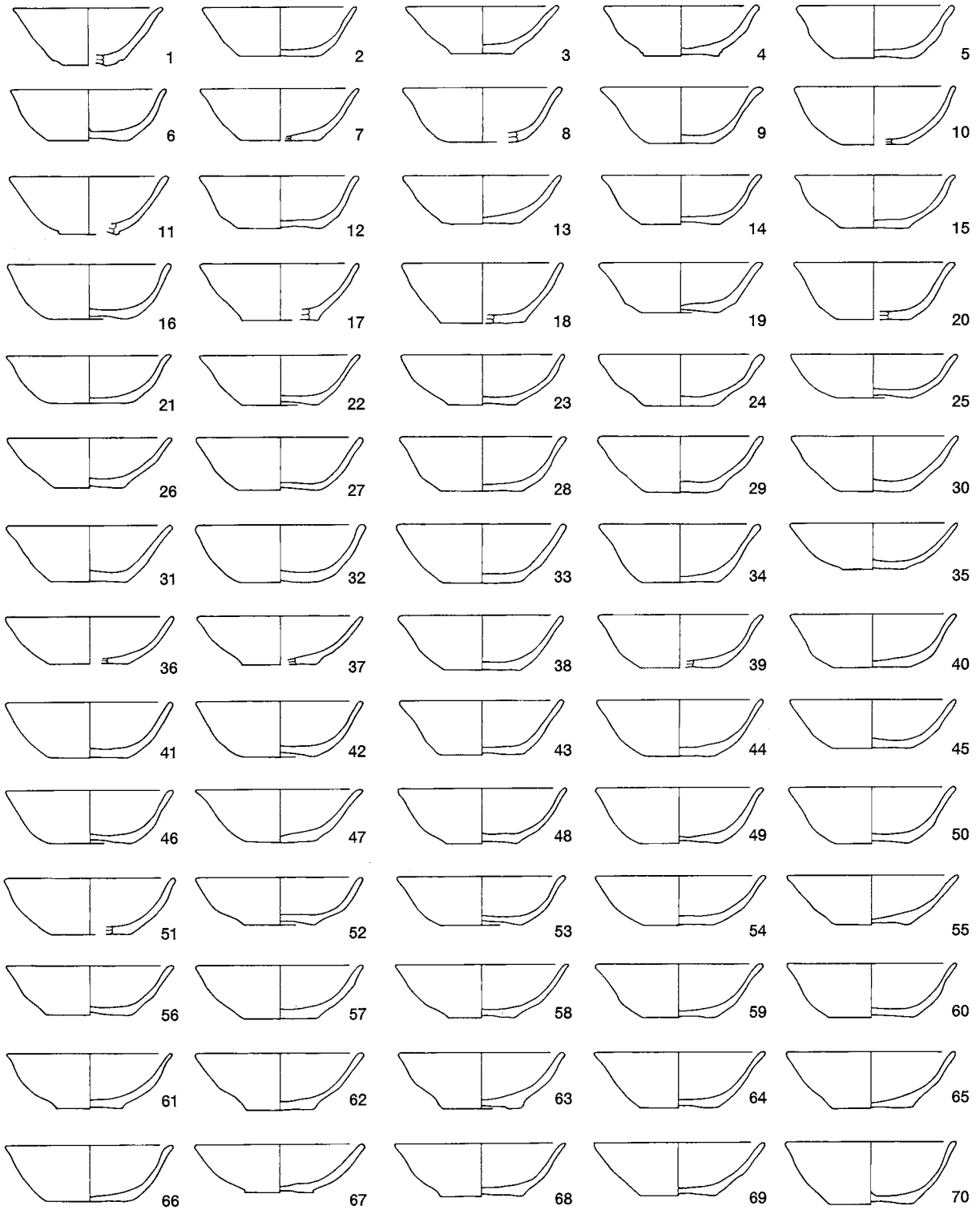

0 (1:4) 10cm

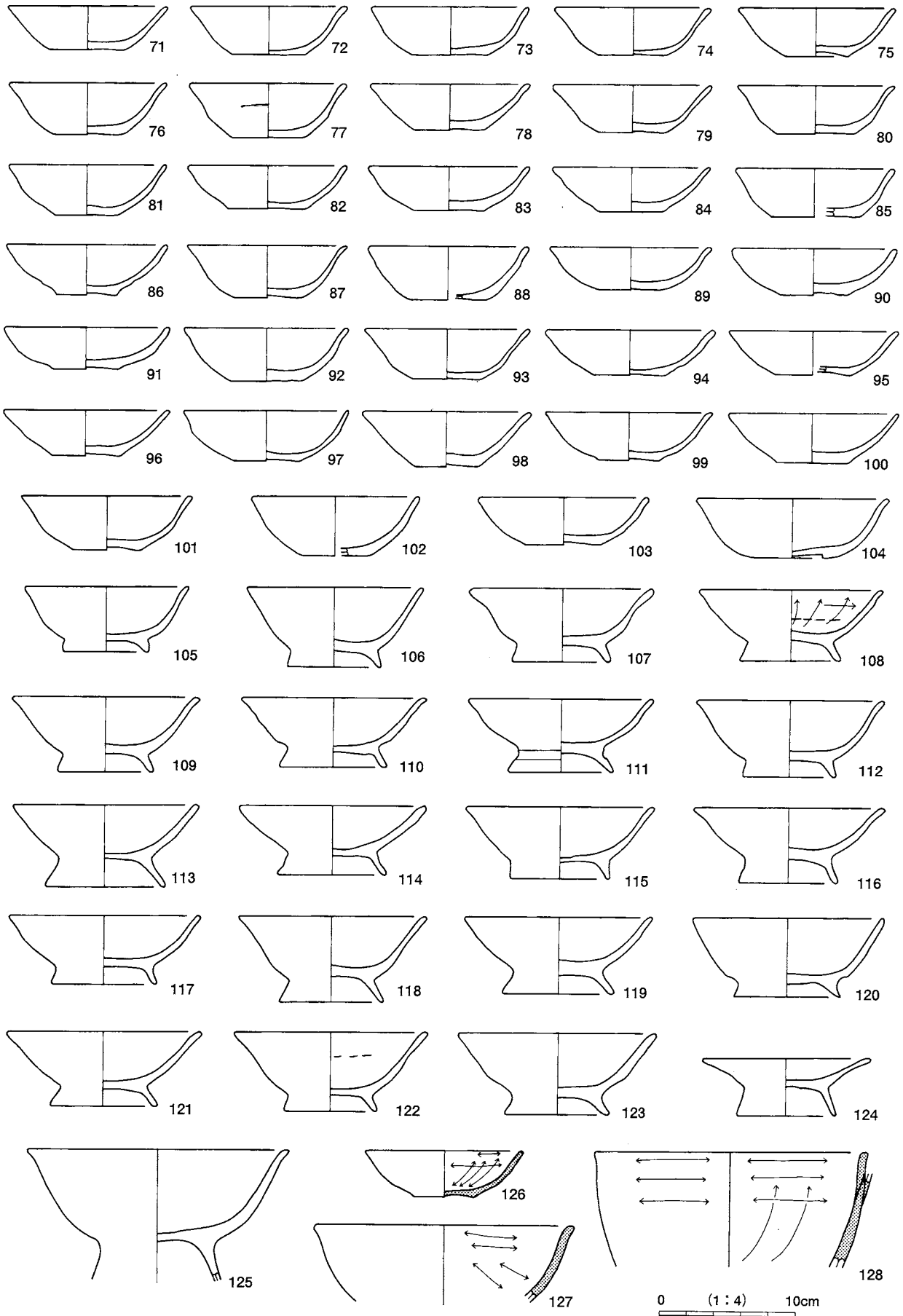

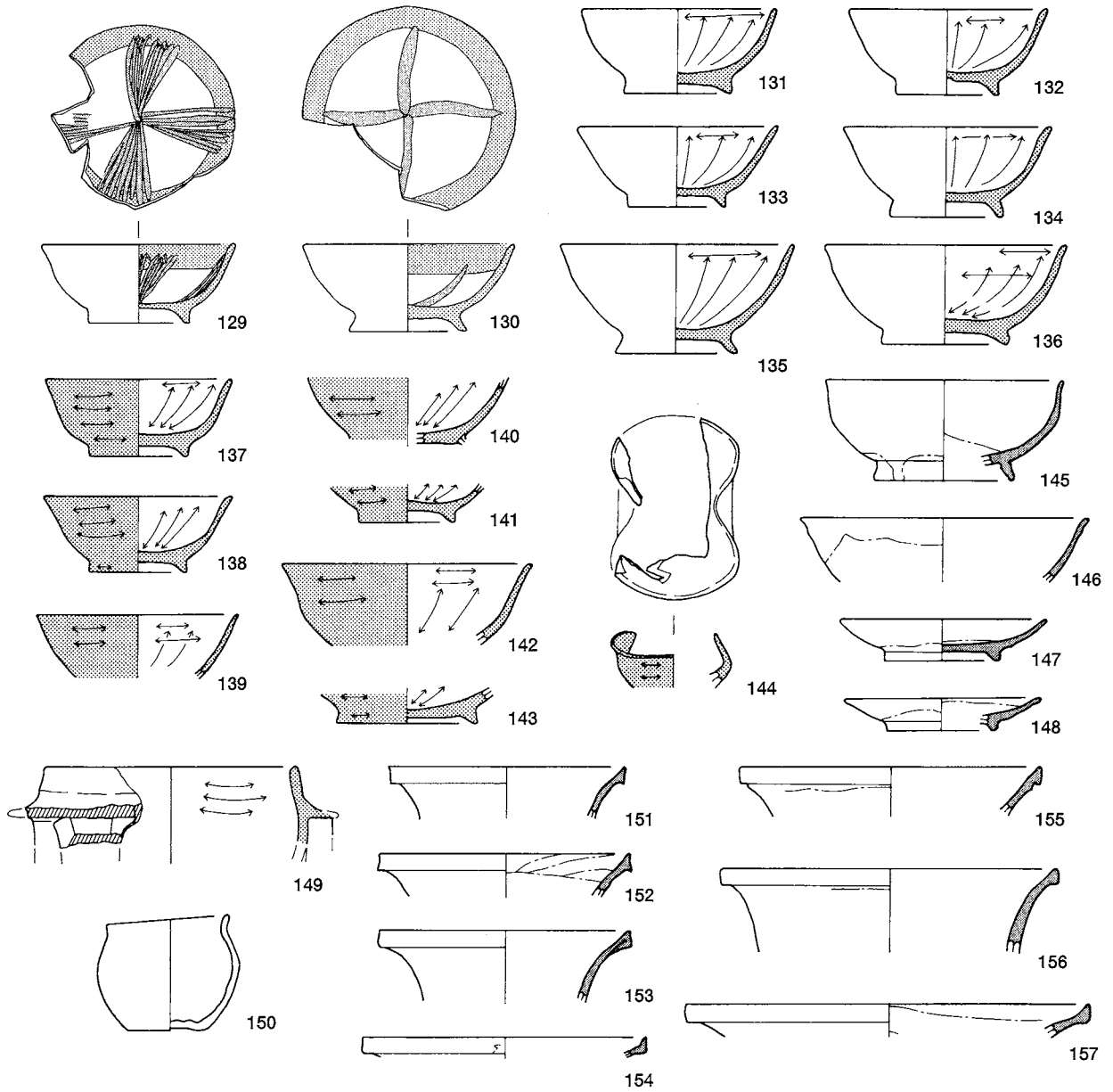

SB1047



SB1051 (1~28)

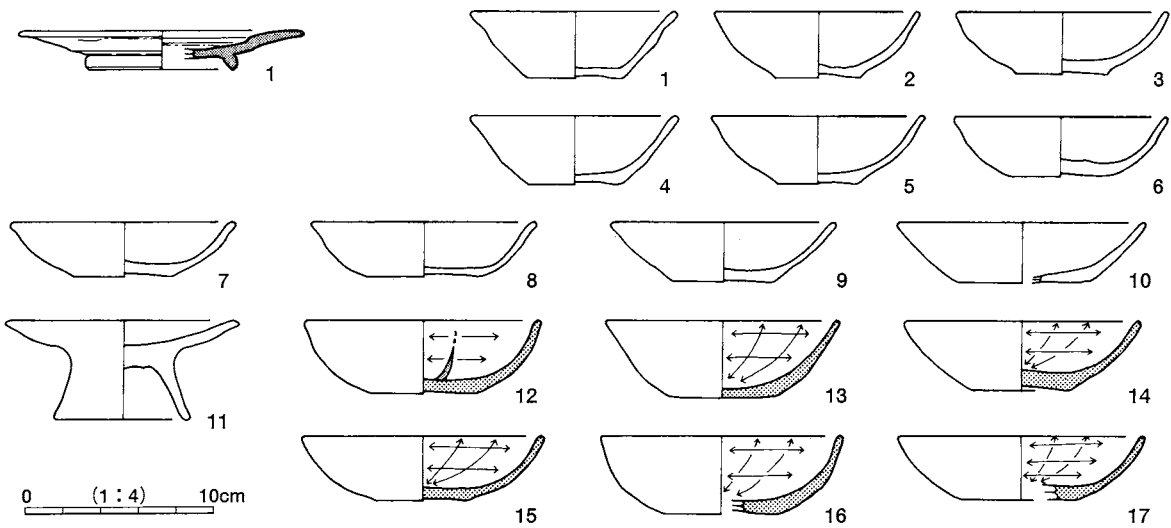

0 (1:4) 10cm

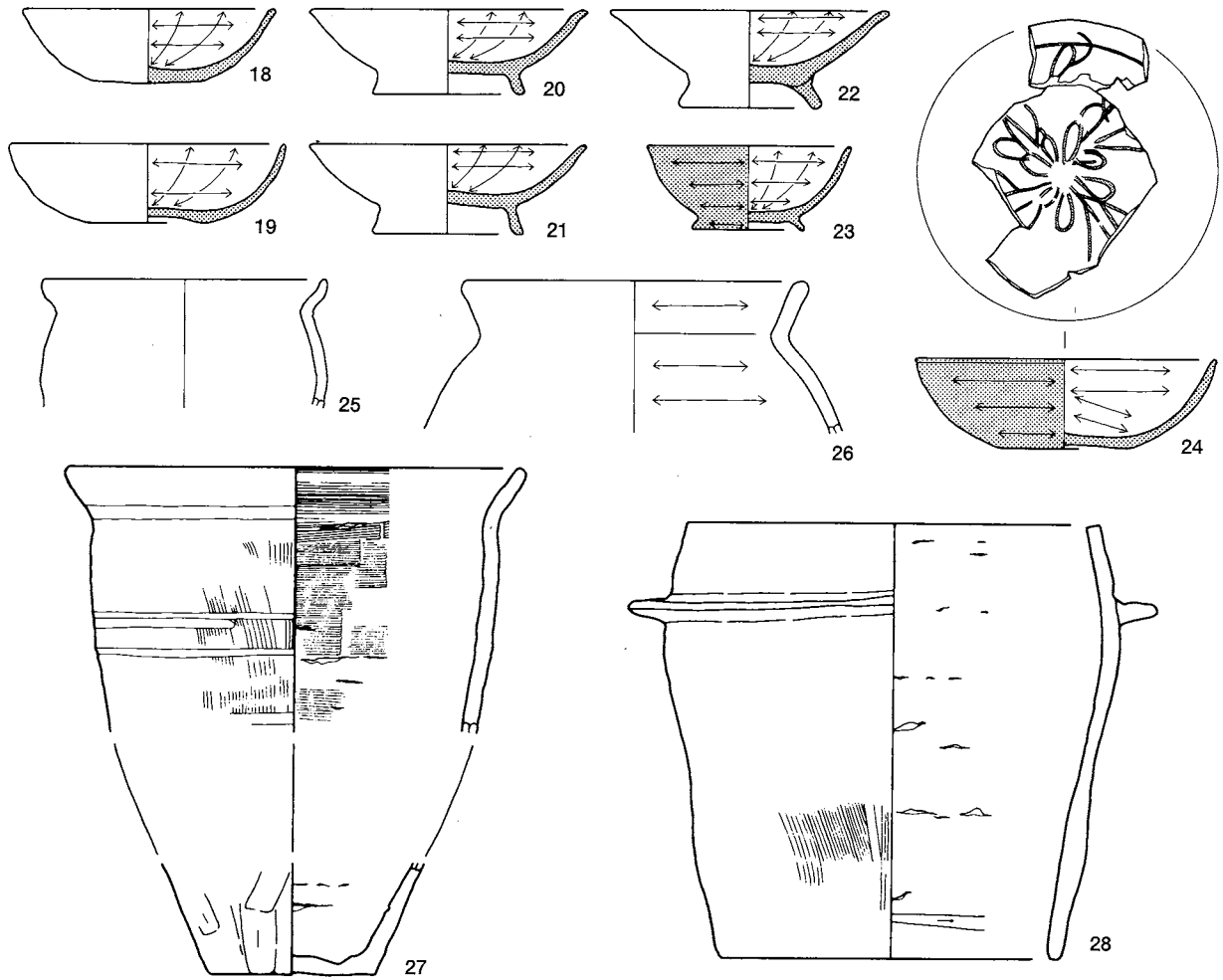

SB1052 (1~22)

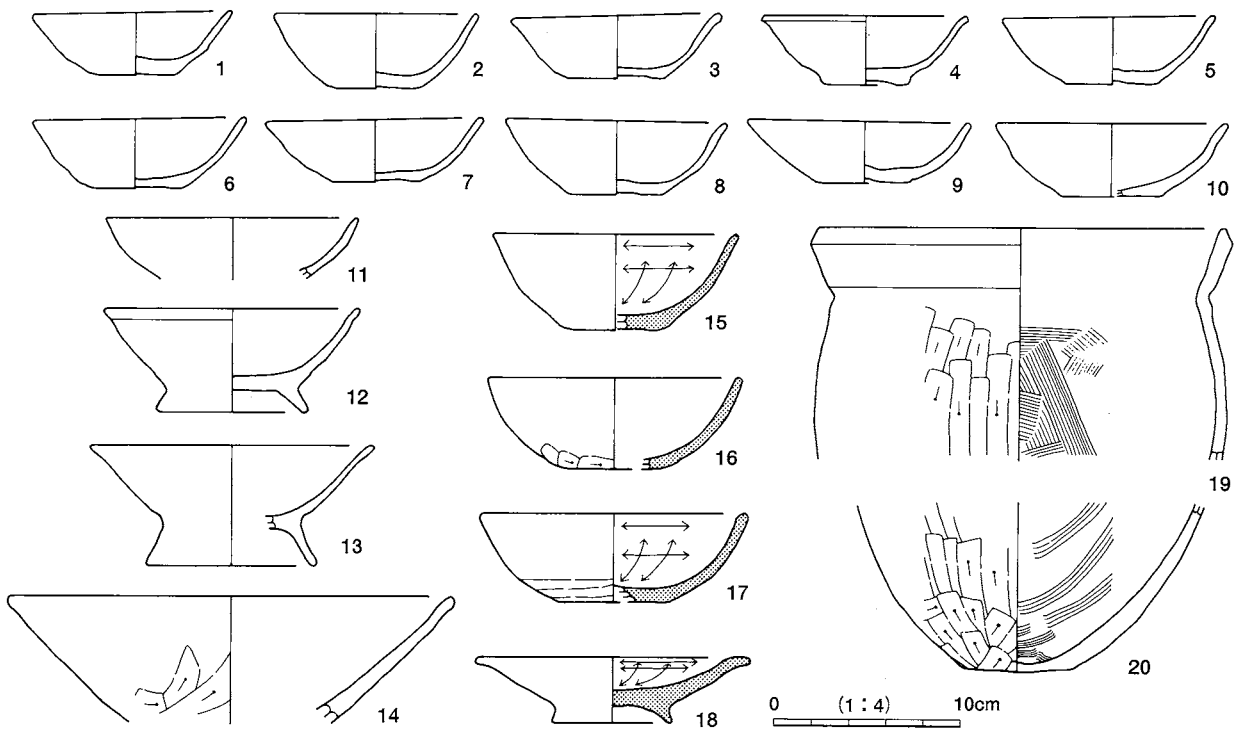

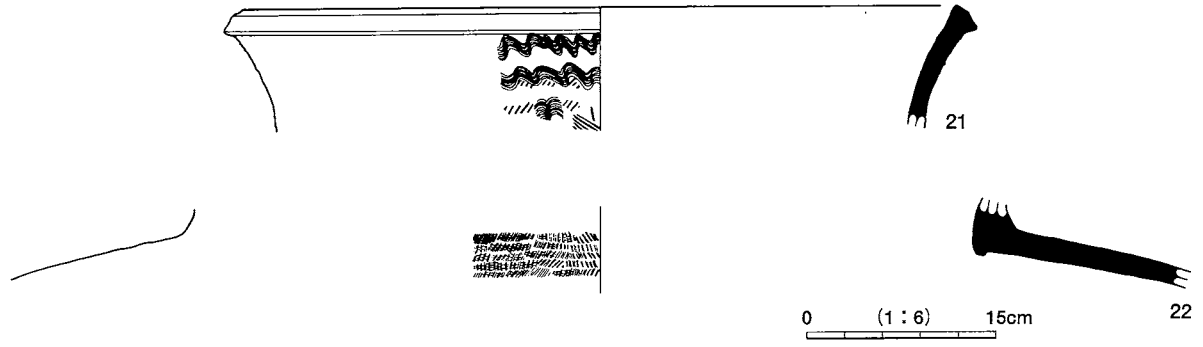

SB1059 (1~4)

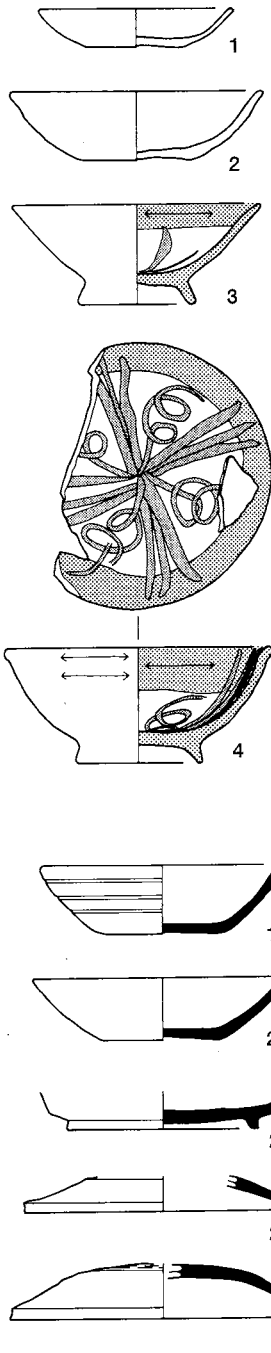

SB1060 (1~48)

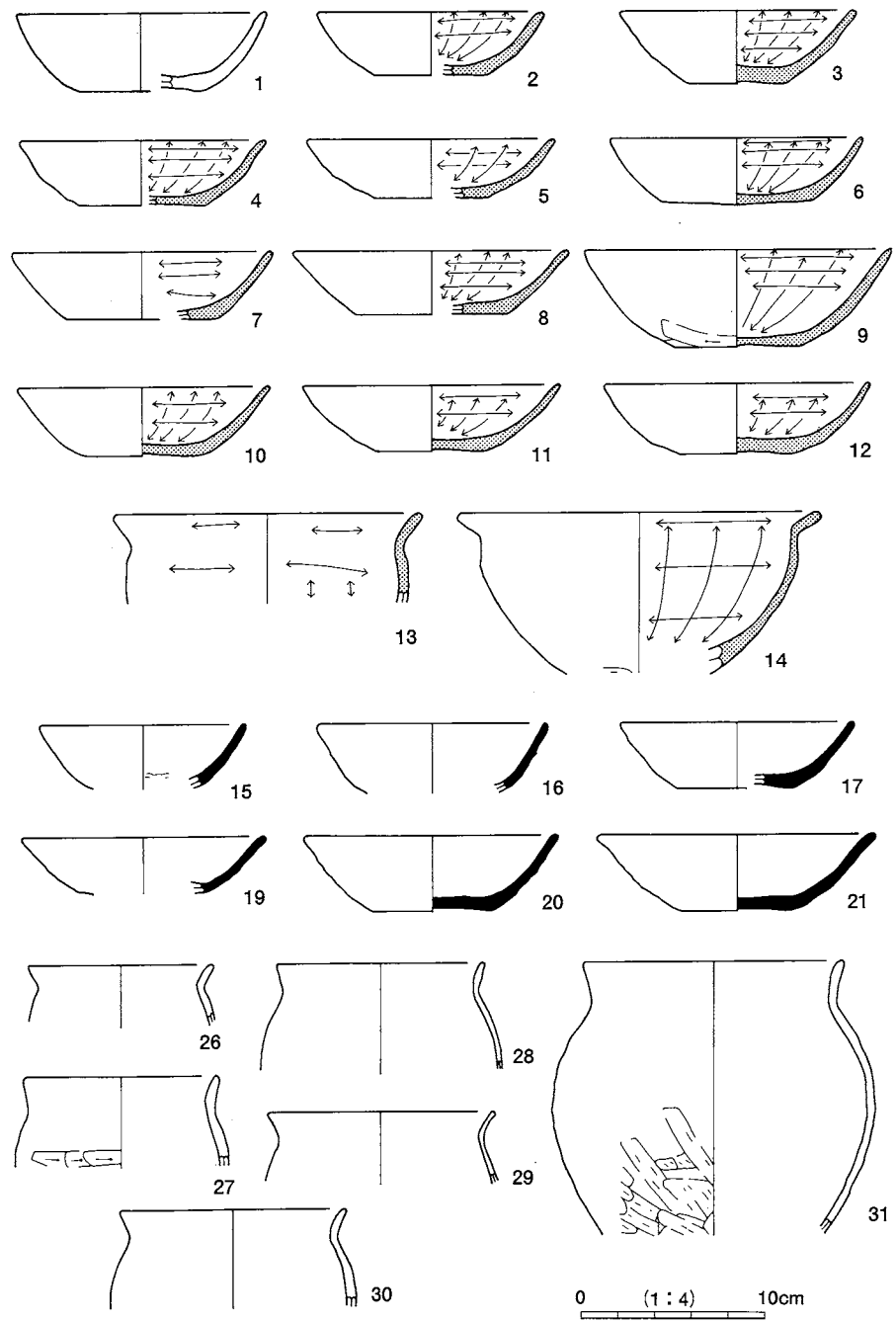

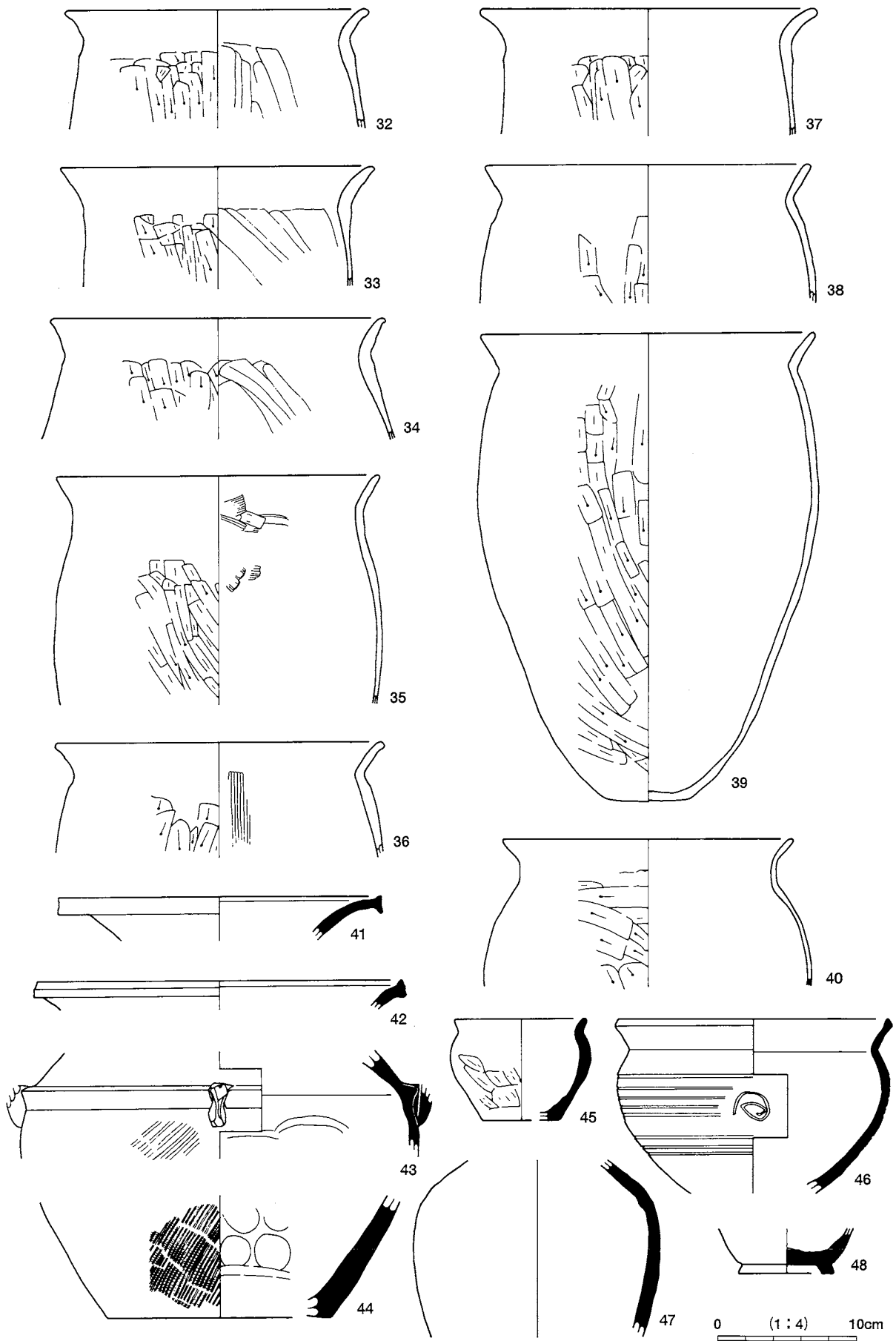

SB1063 (1~19)

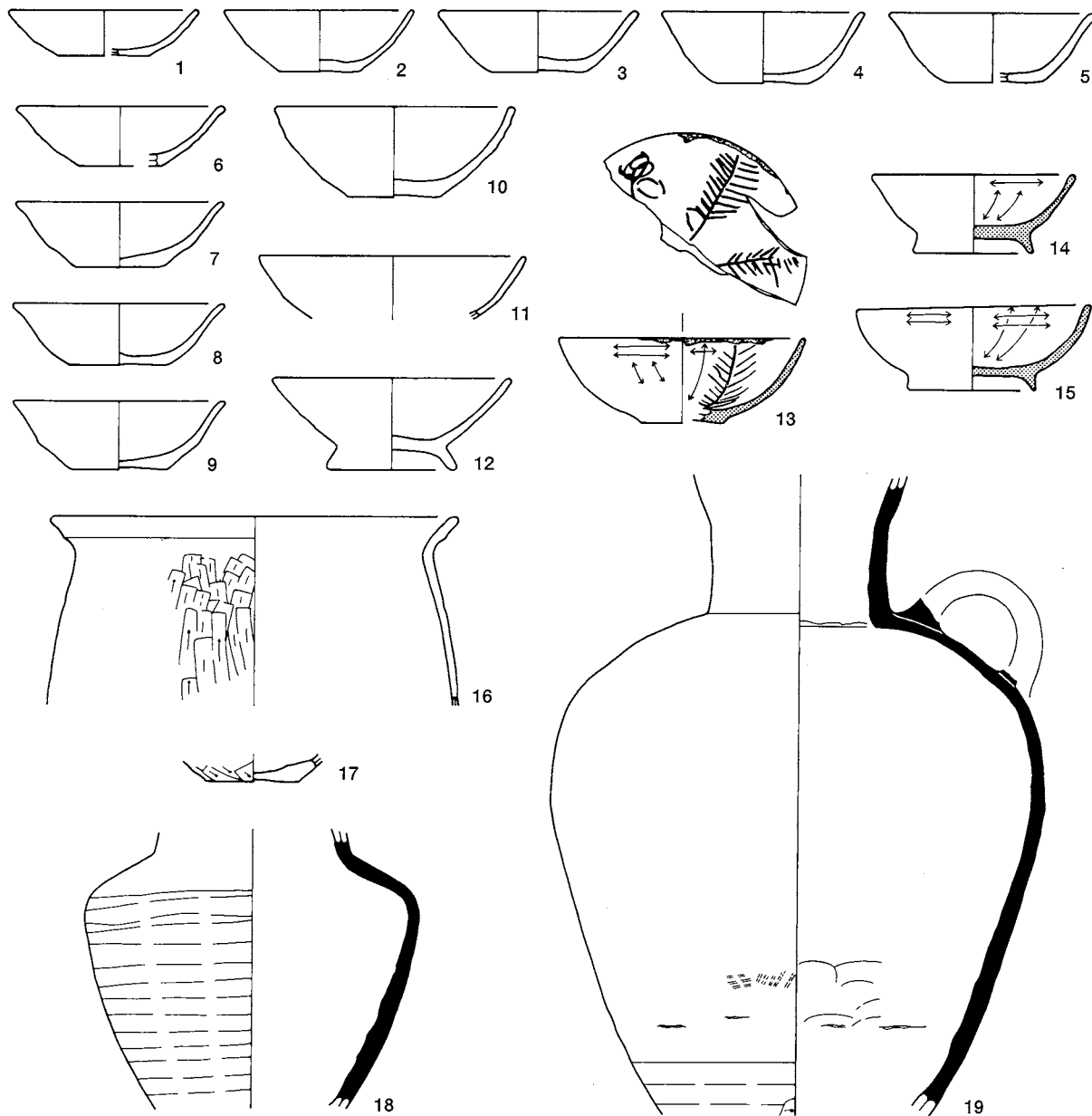

SB1065 (1~72)

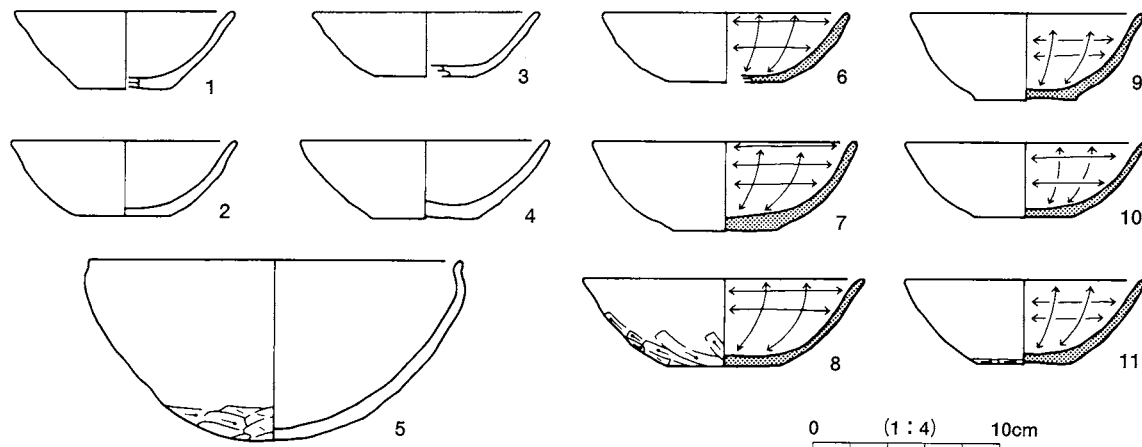

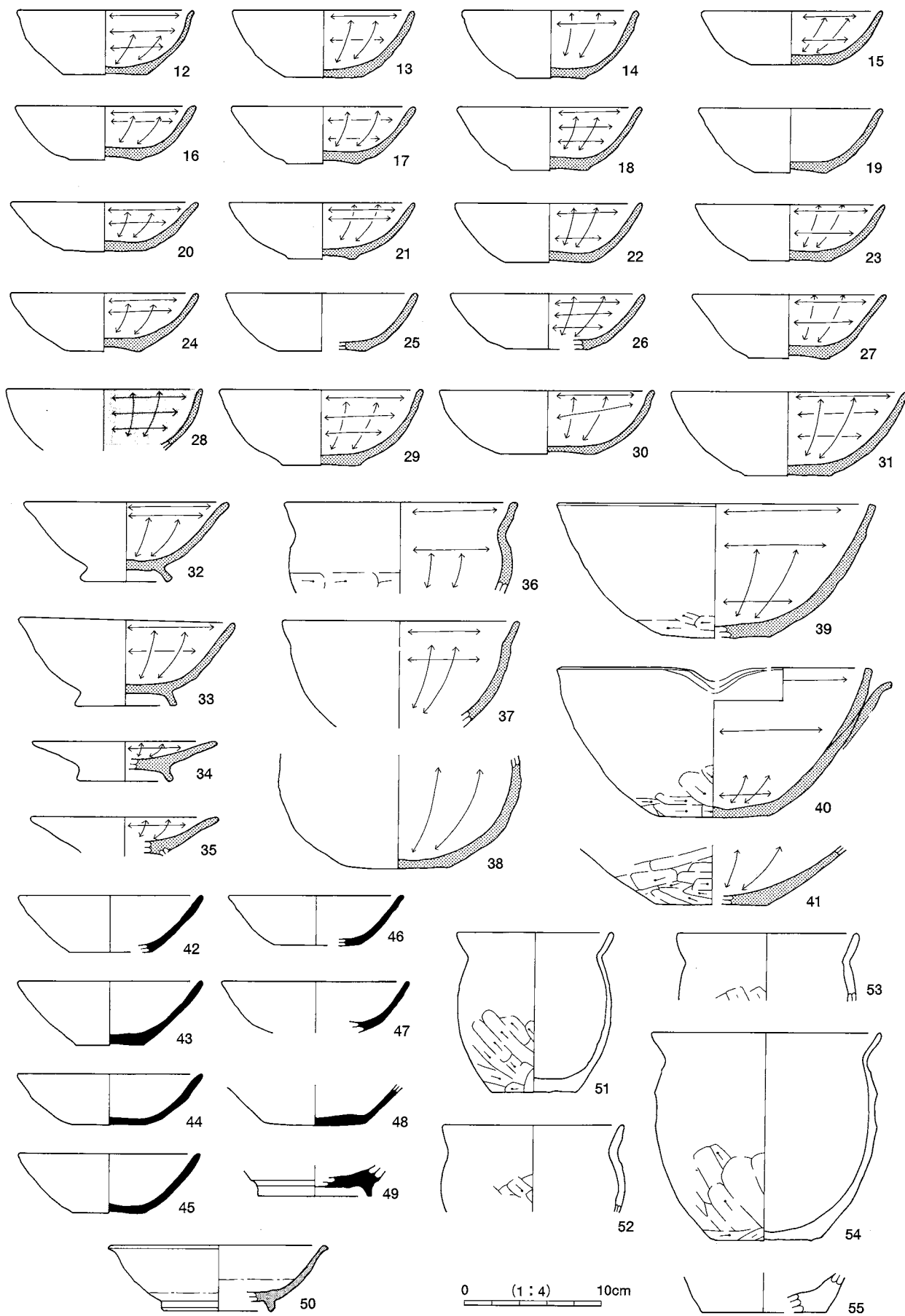

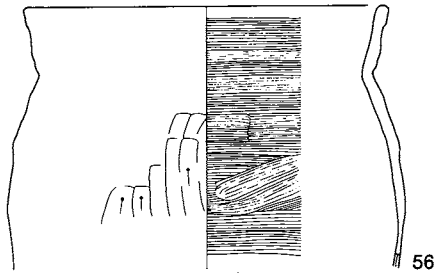

56

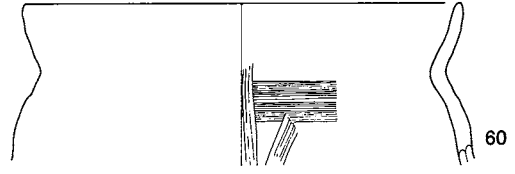

60

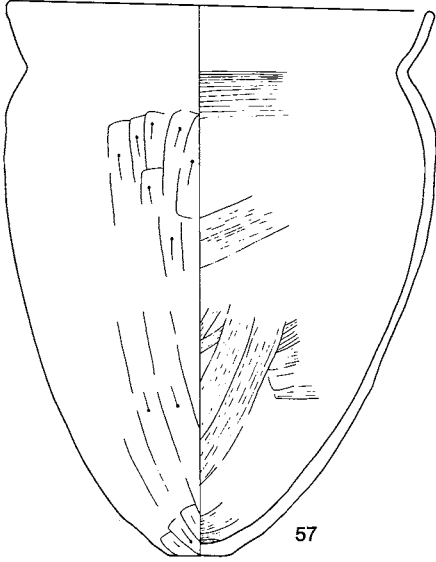

57

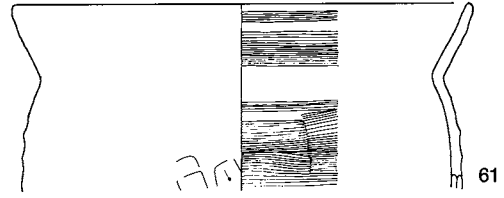

61

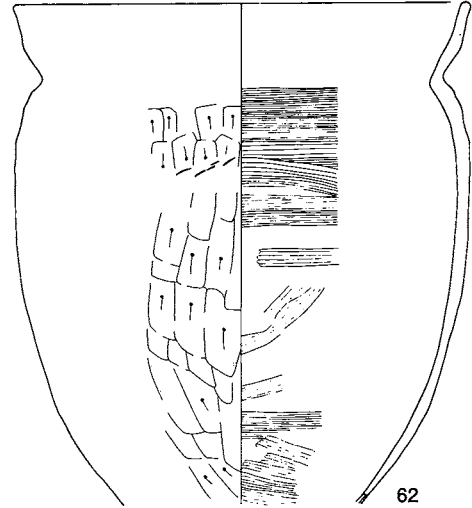

62

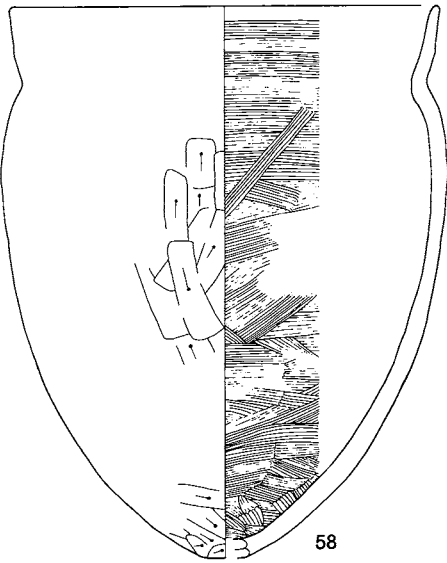

58

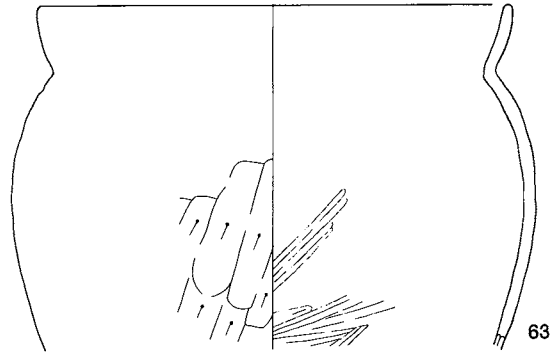

63

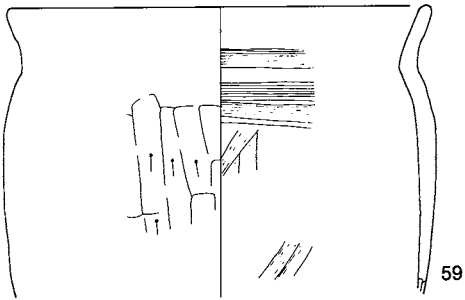

59

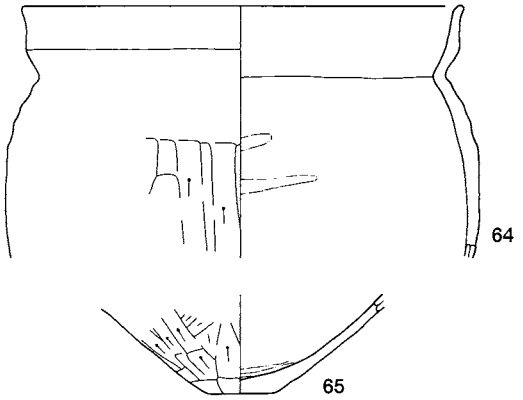

64

0 (1:4) 10cm



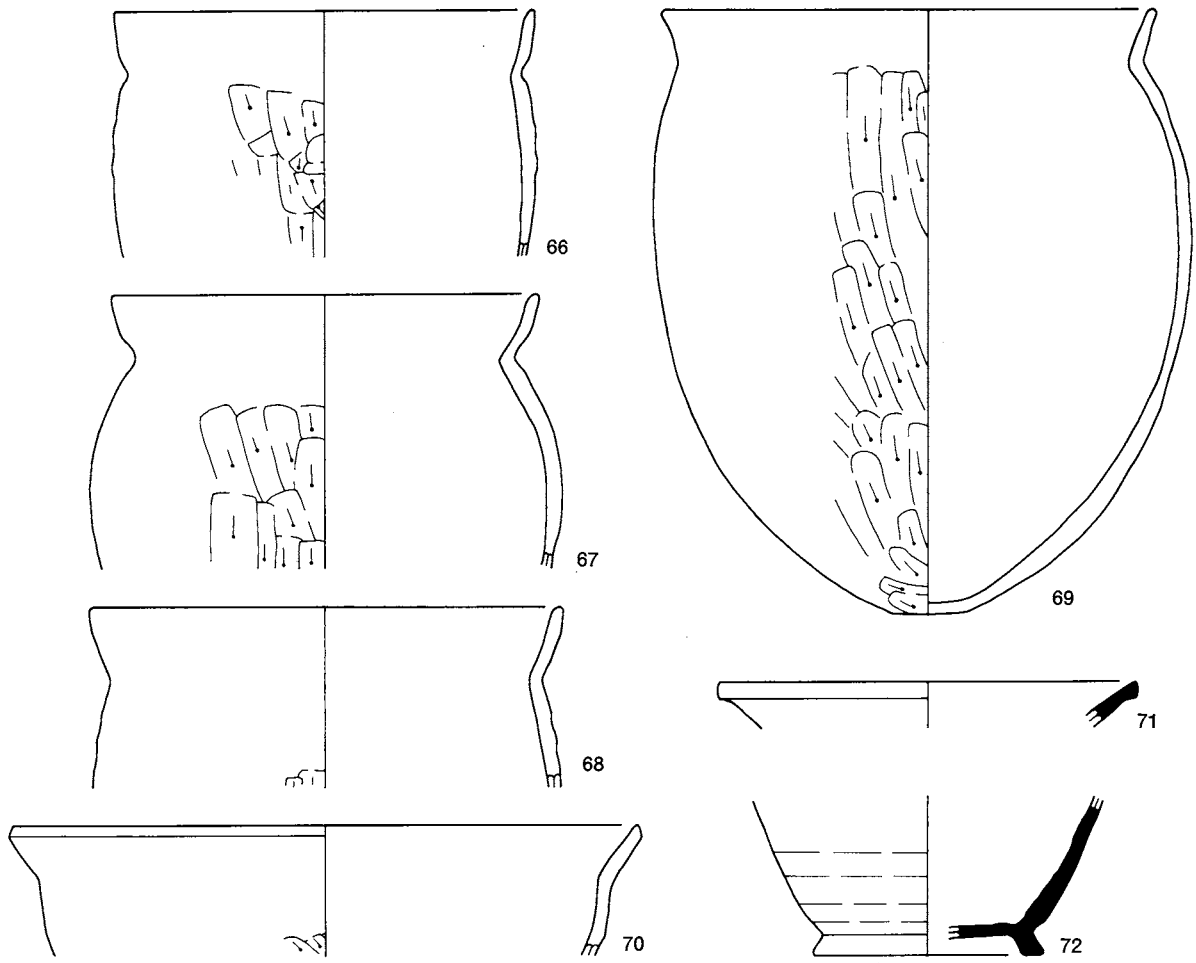

SB1067 (1~47)

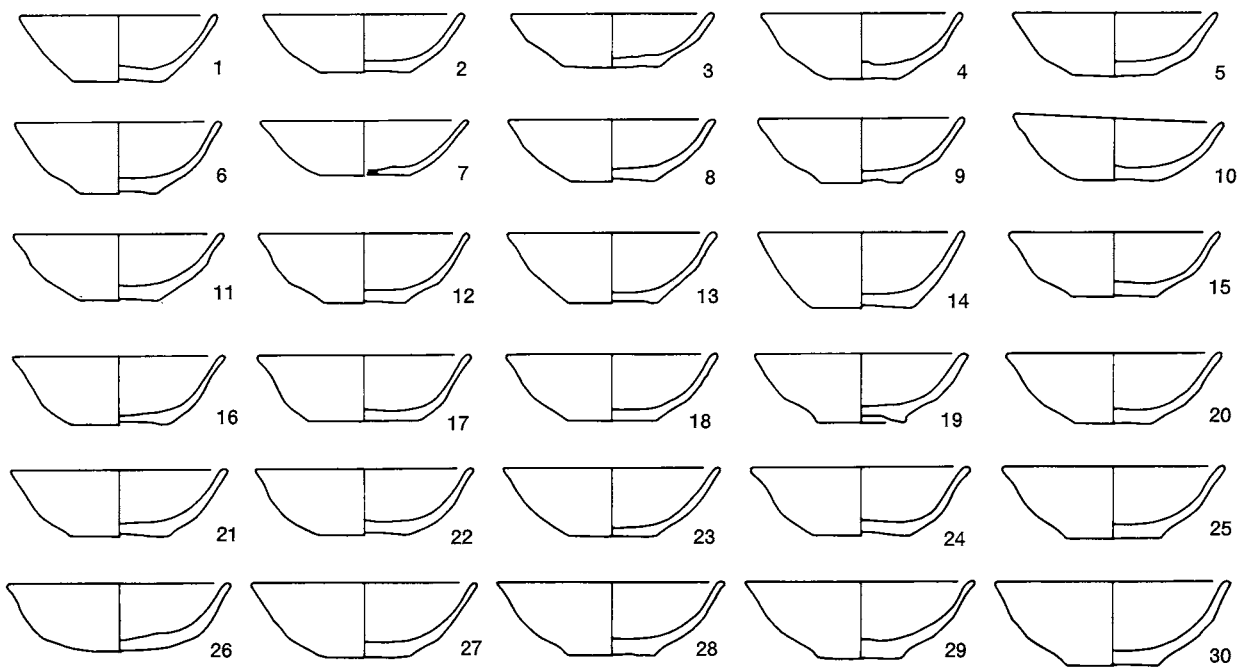

0 (1:4) 10cm

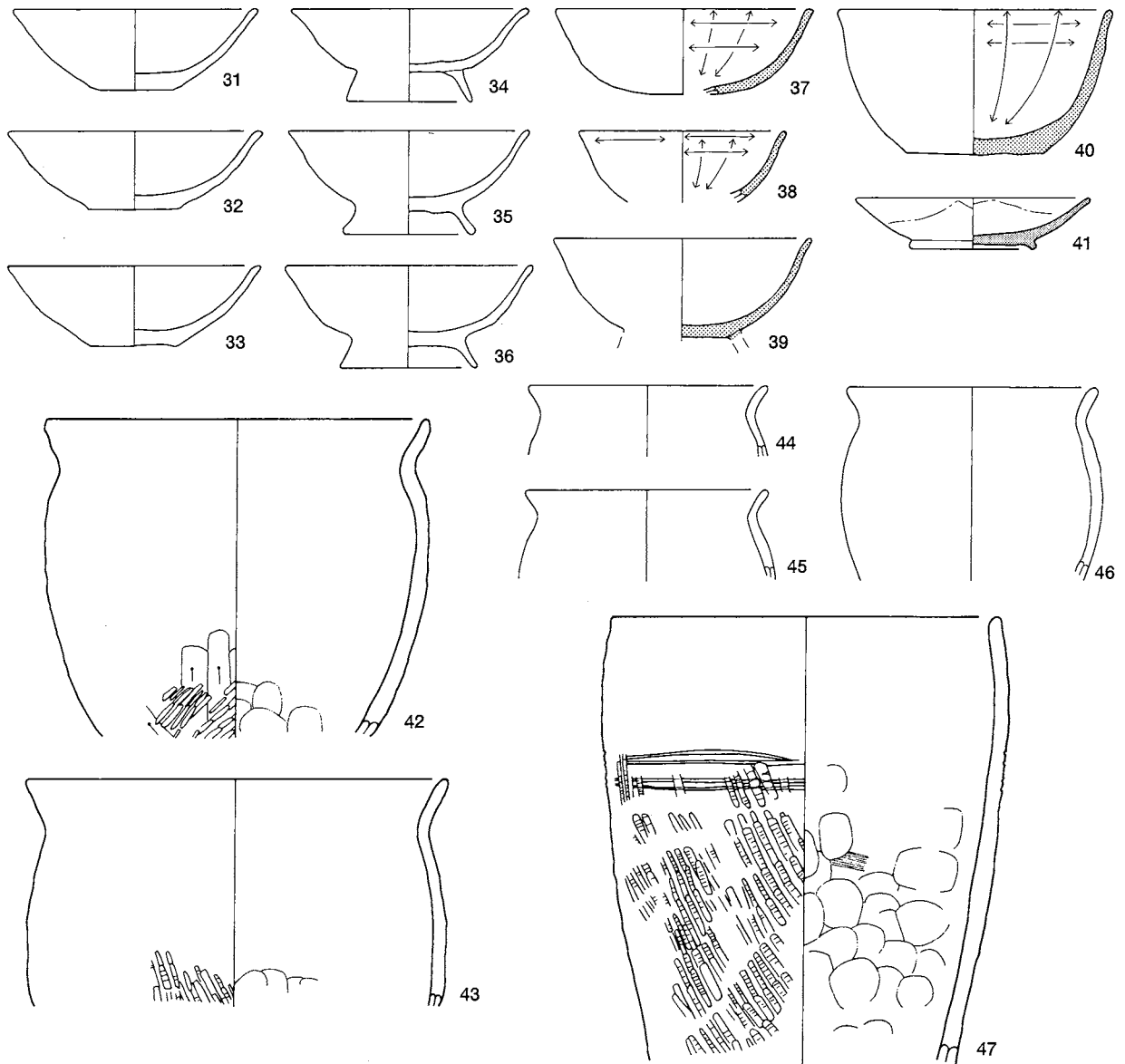

SB1070 (1~19)

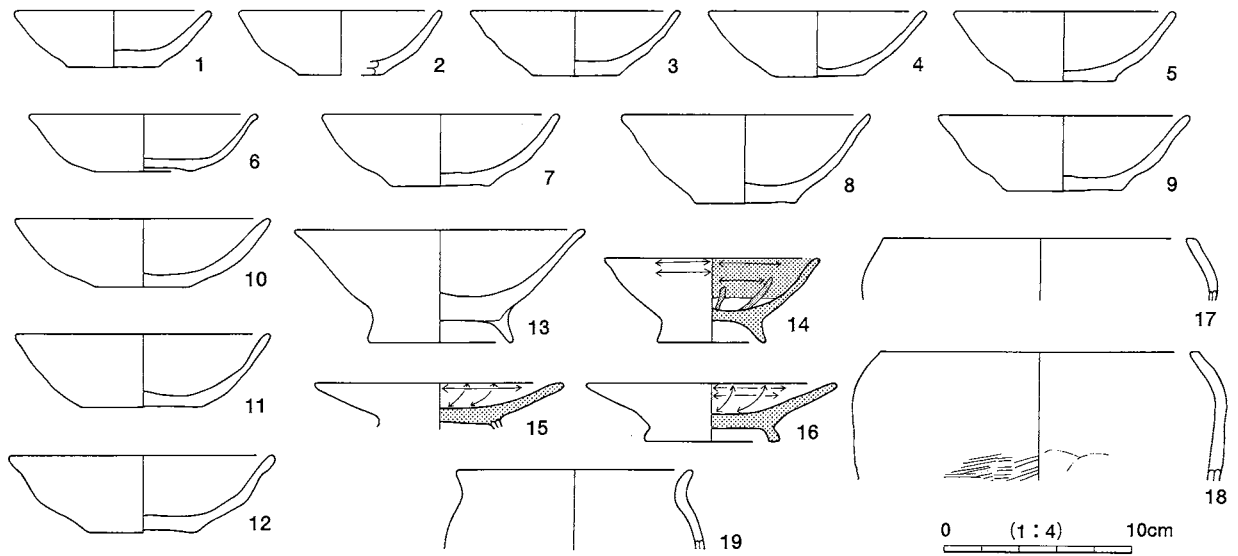

SB1071 (1~18)

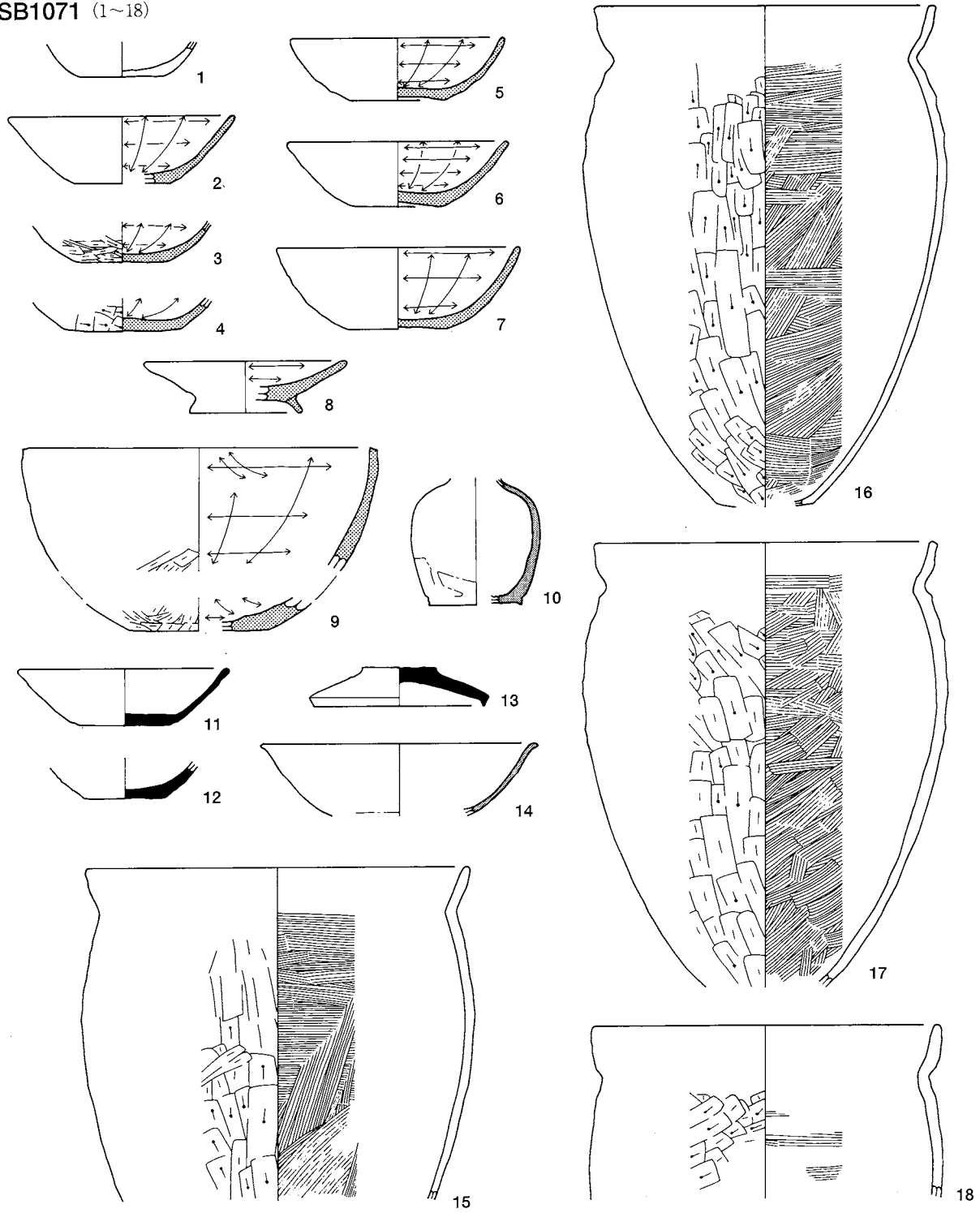

SB1074 (1~73)

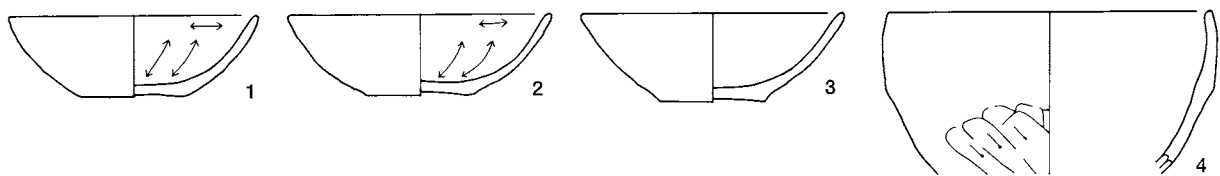

0 (1:4) 10cm

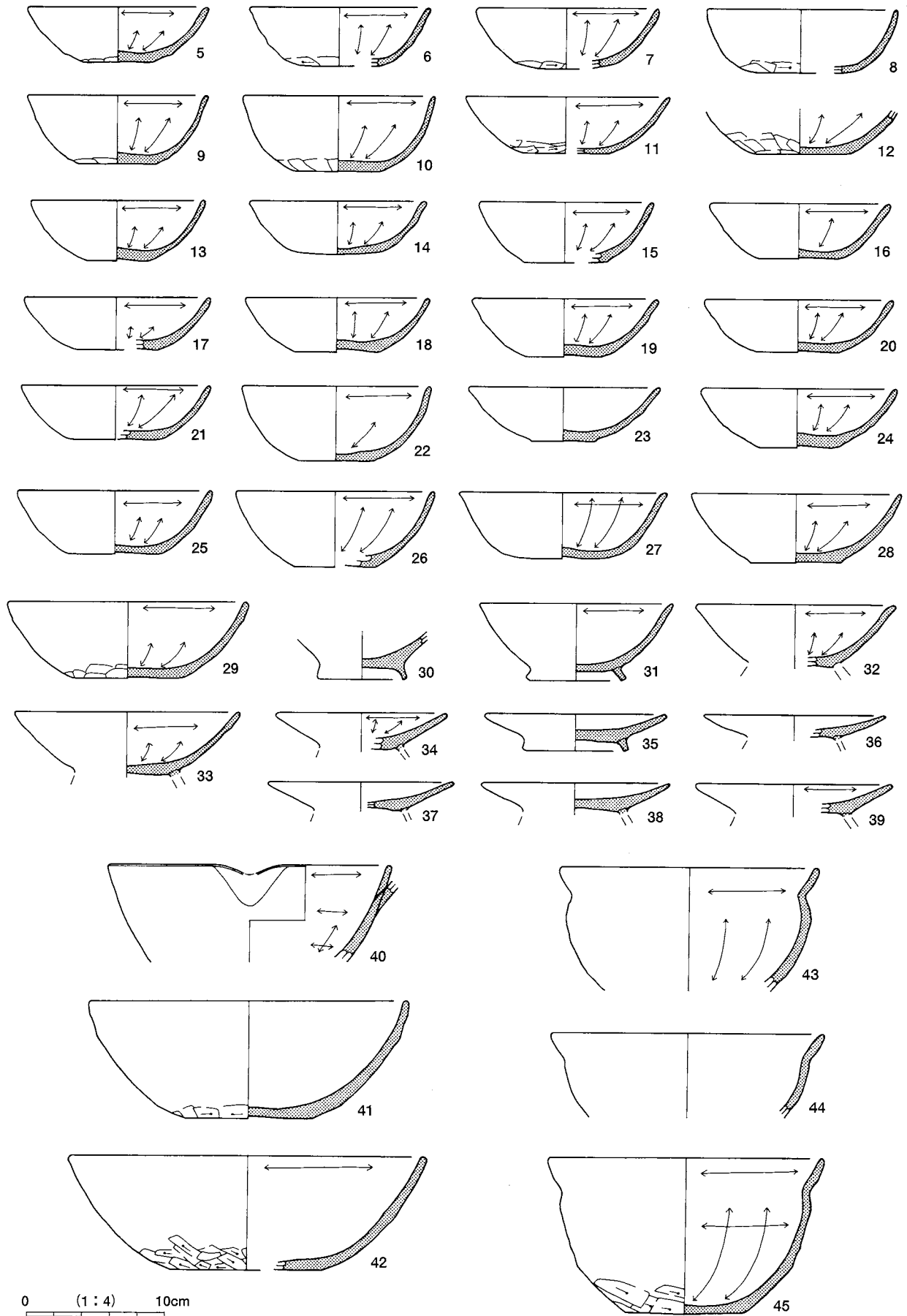

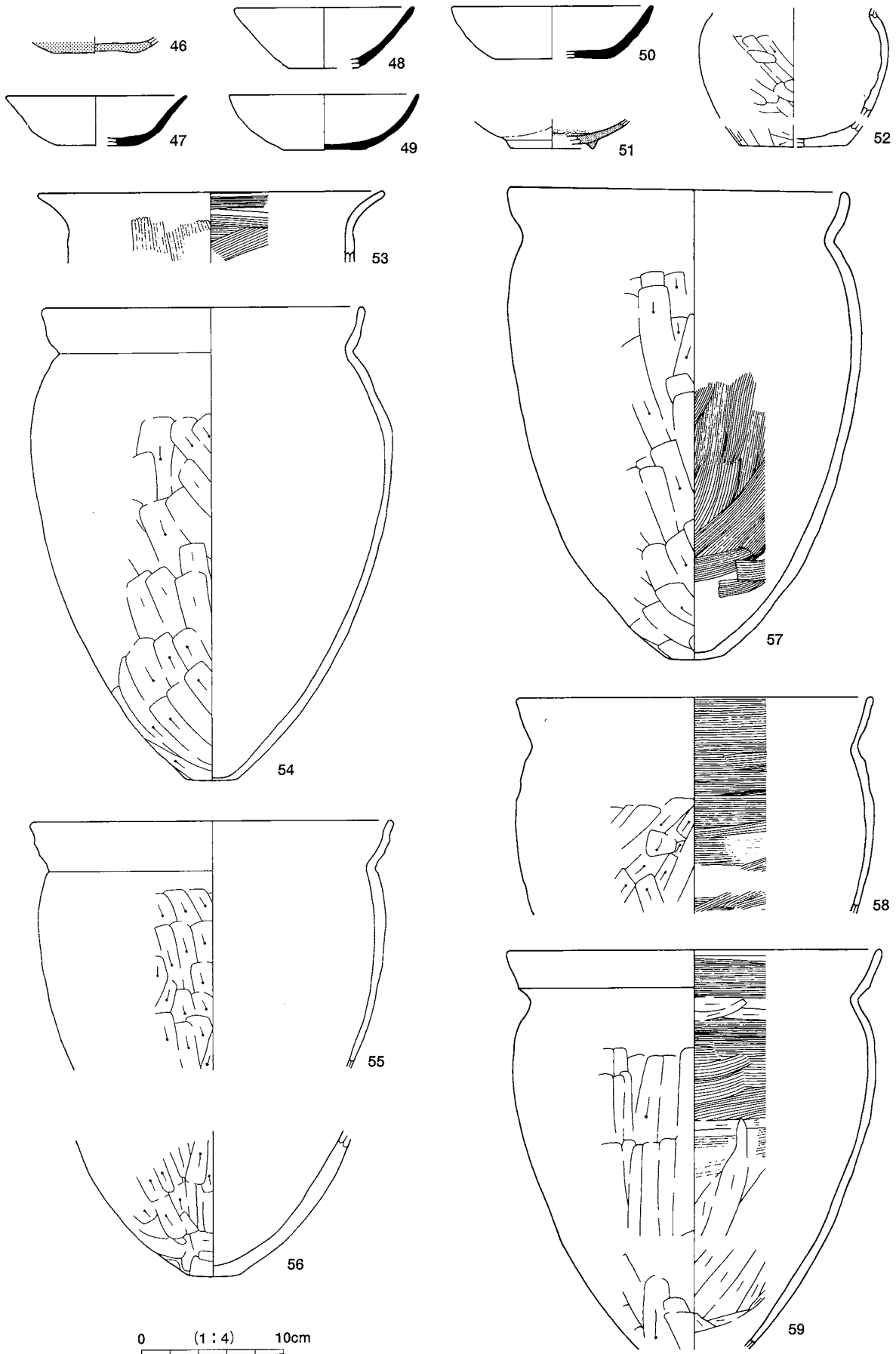

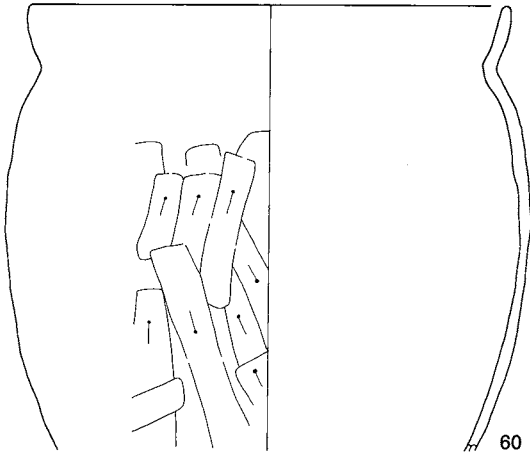

60

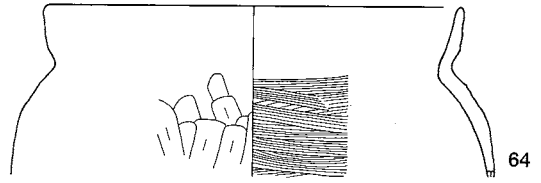

64

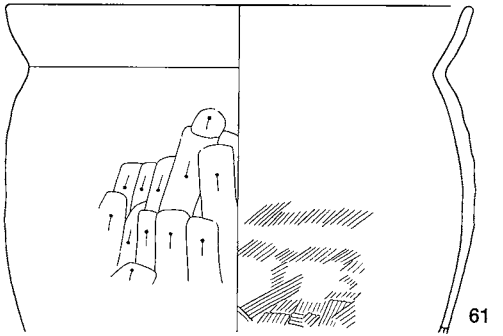

61

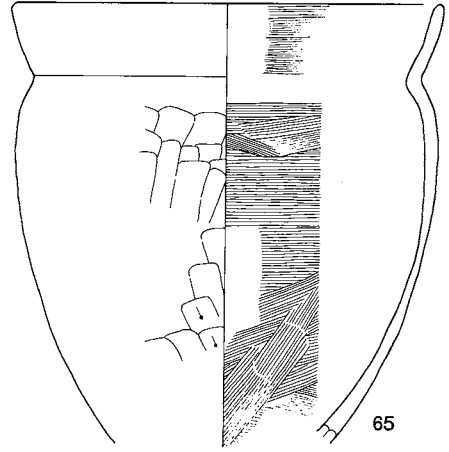

65

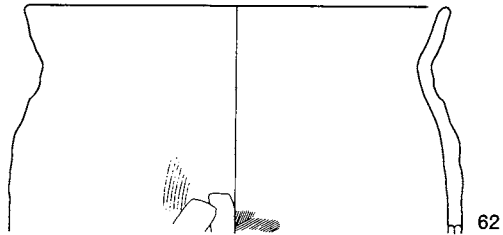

62

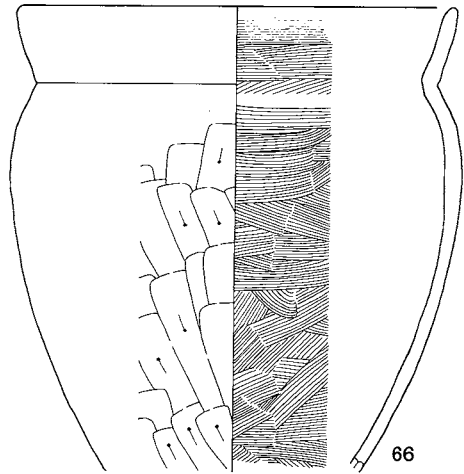

66

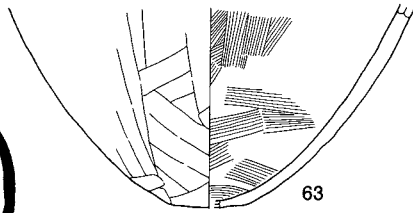

63

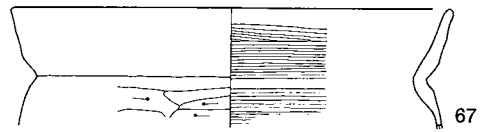

67

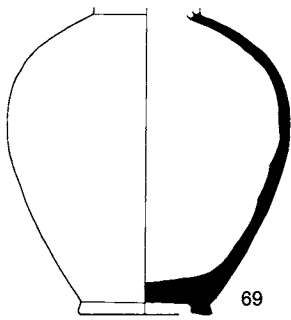

69

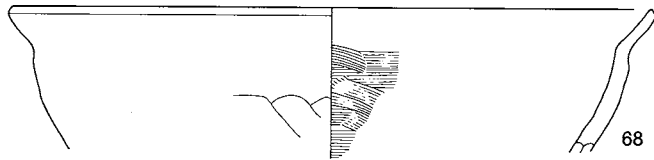

68

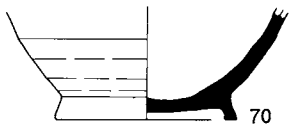

70

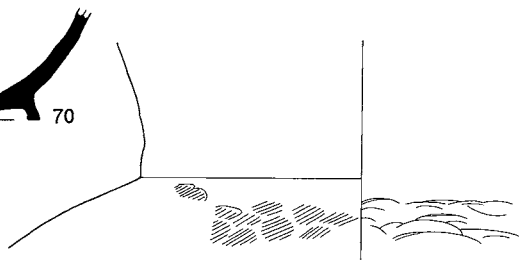

71

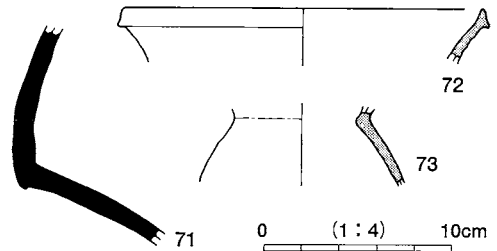

72

73

0 (1:4) 10cm

SB1076 (1~26)

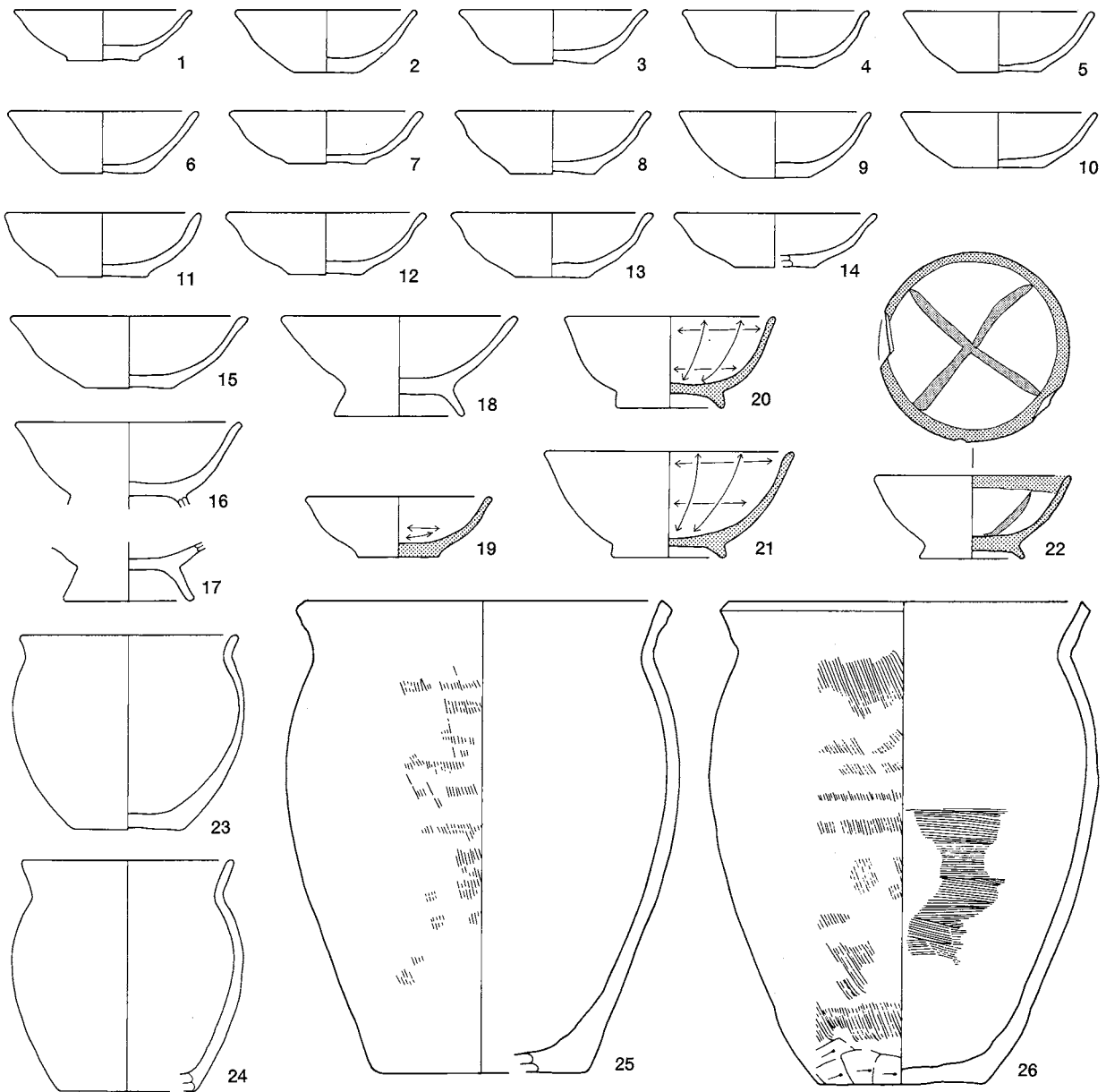

SB1080 (1~47)

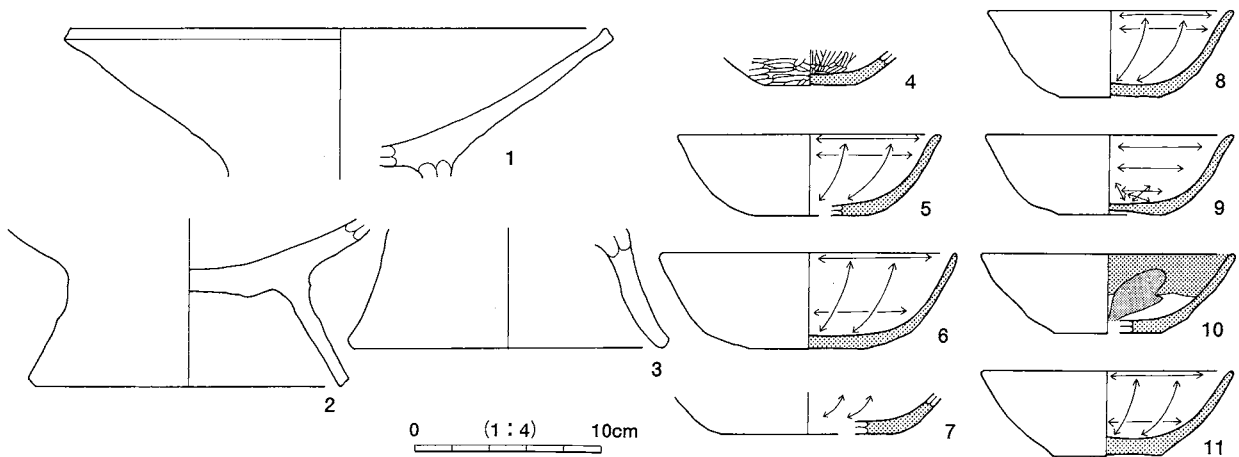

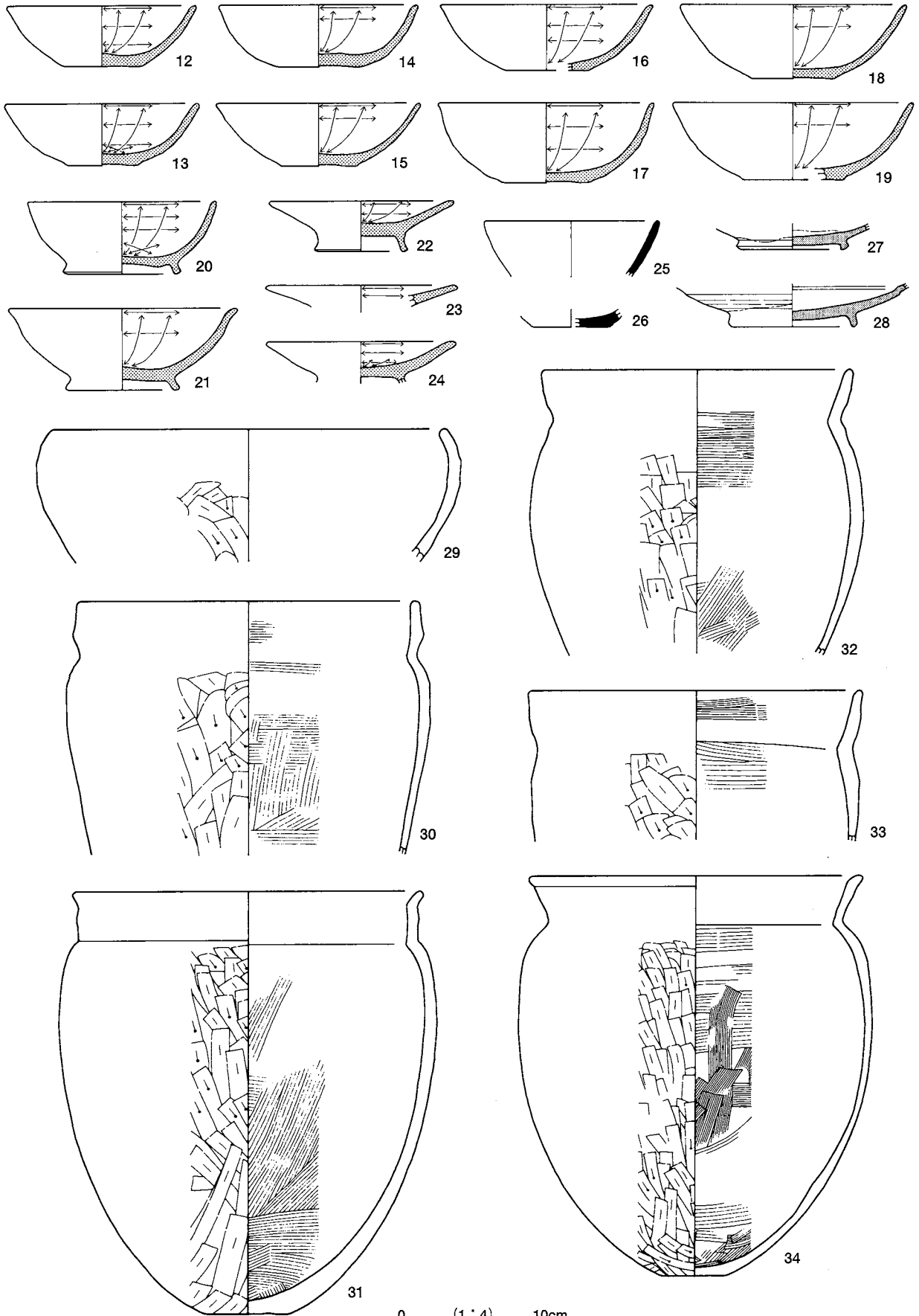

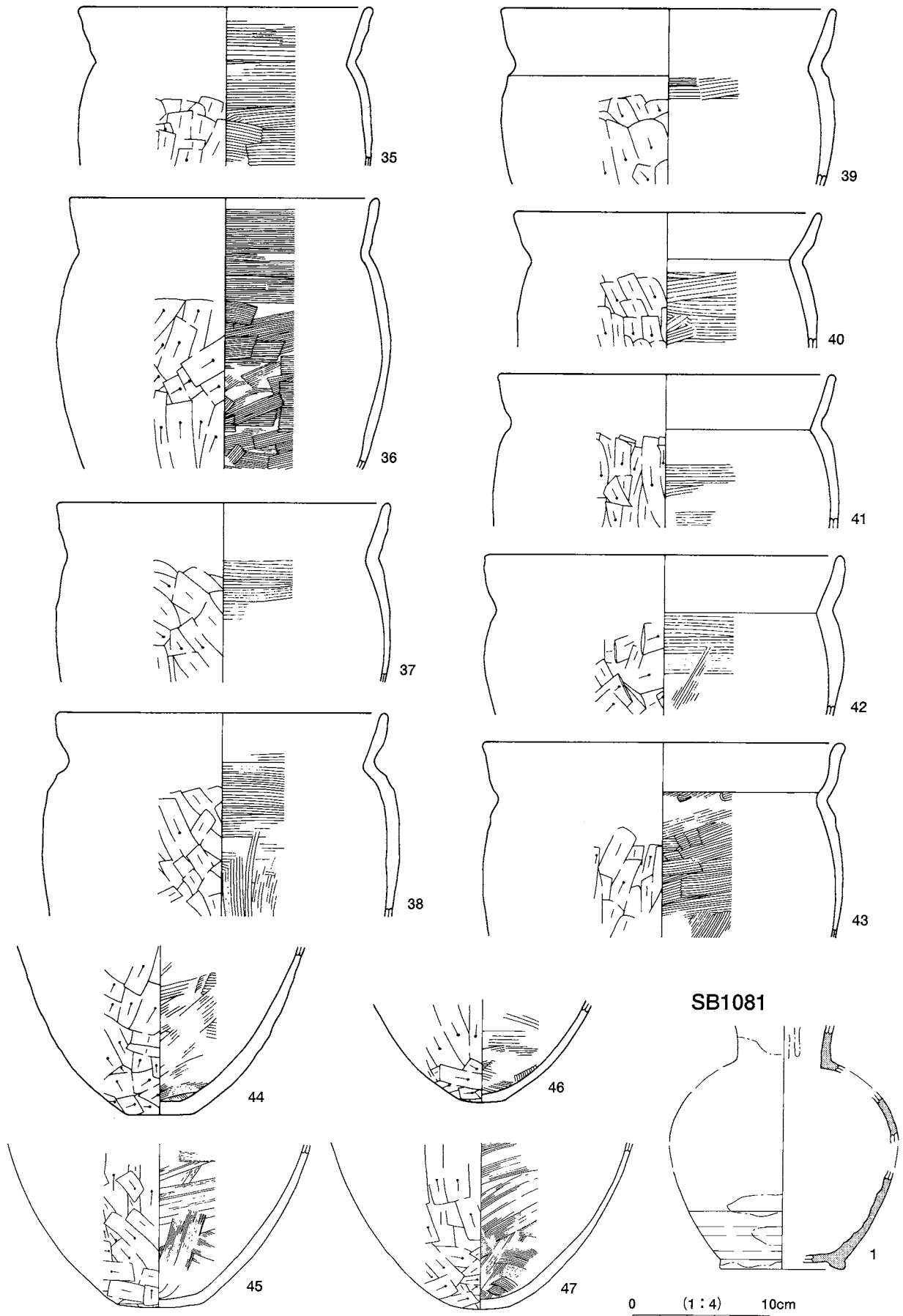

SB1084 (1~6)

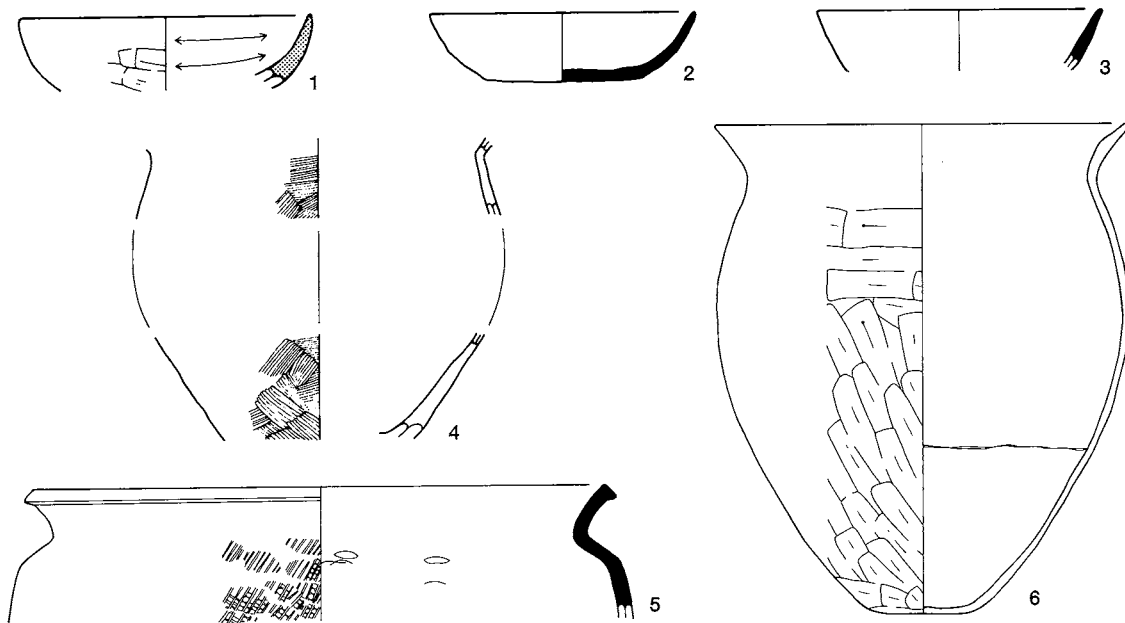

SB1085 (1~7)

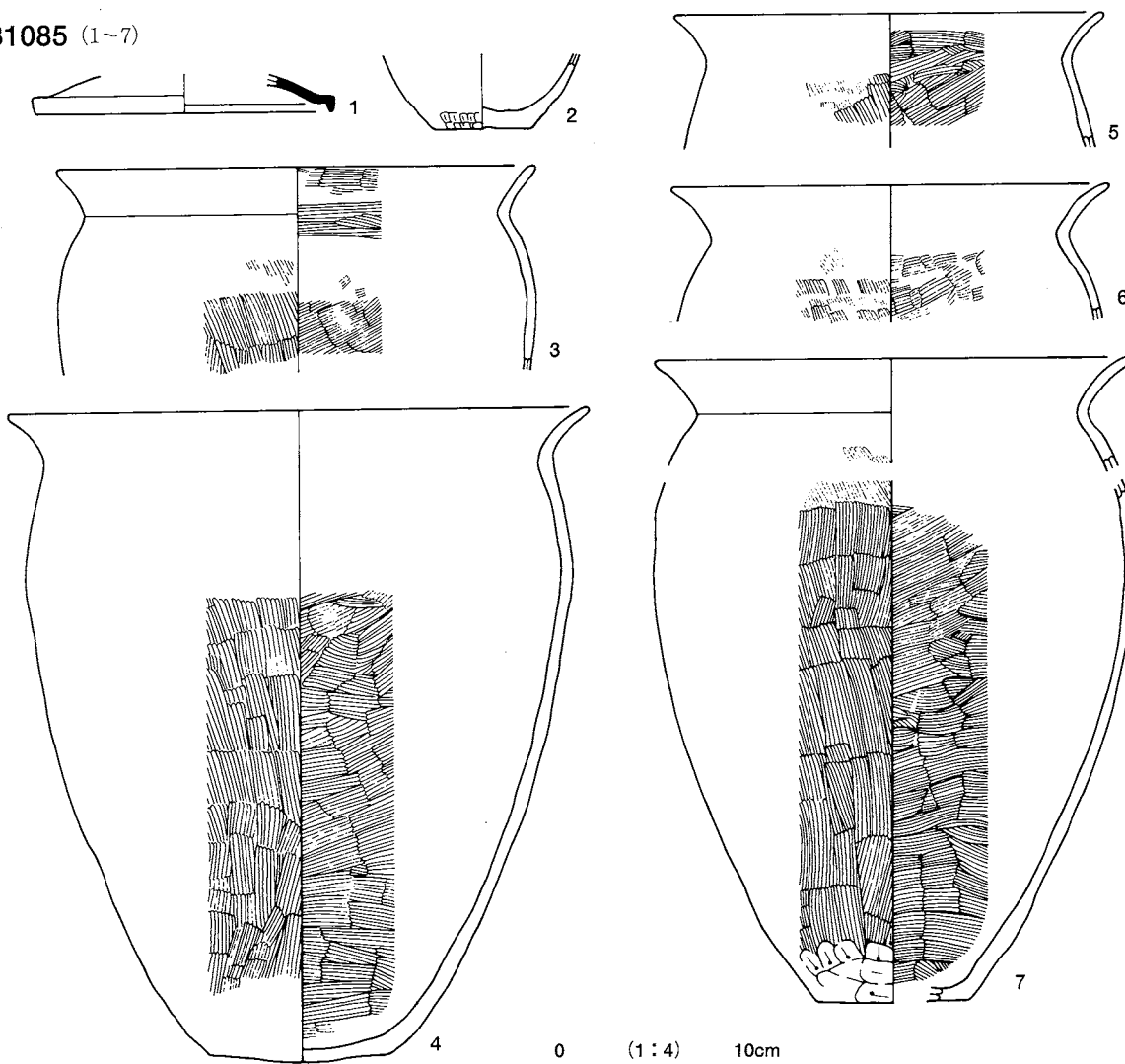

SB1086 (1~22)

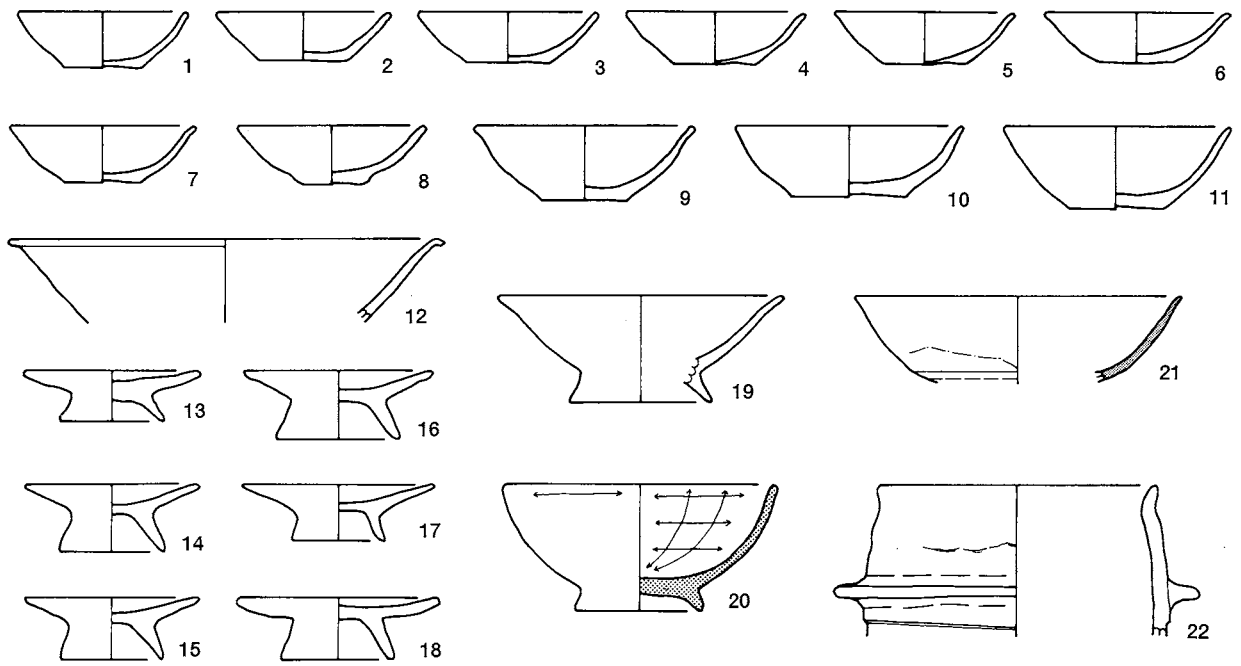

SB1088 (1~19)

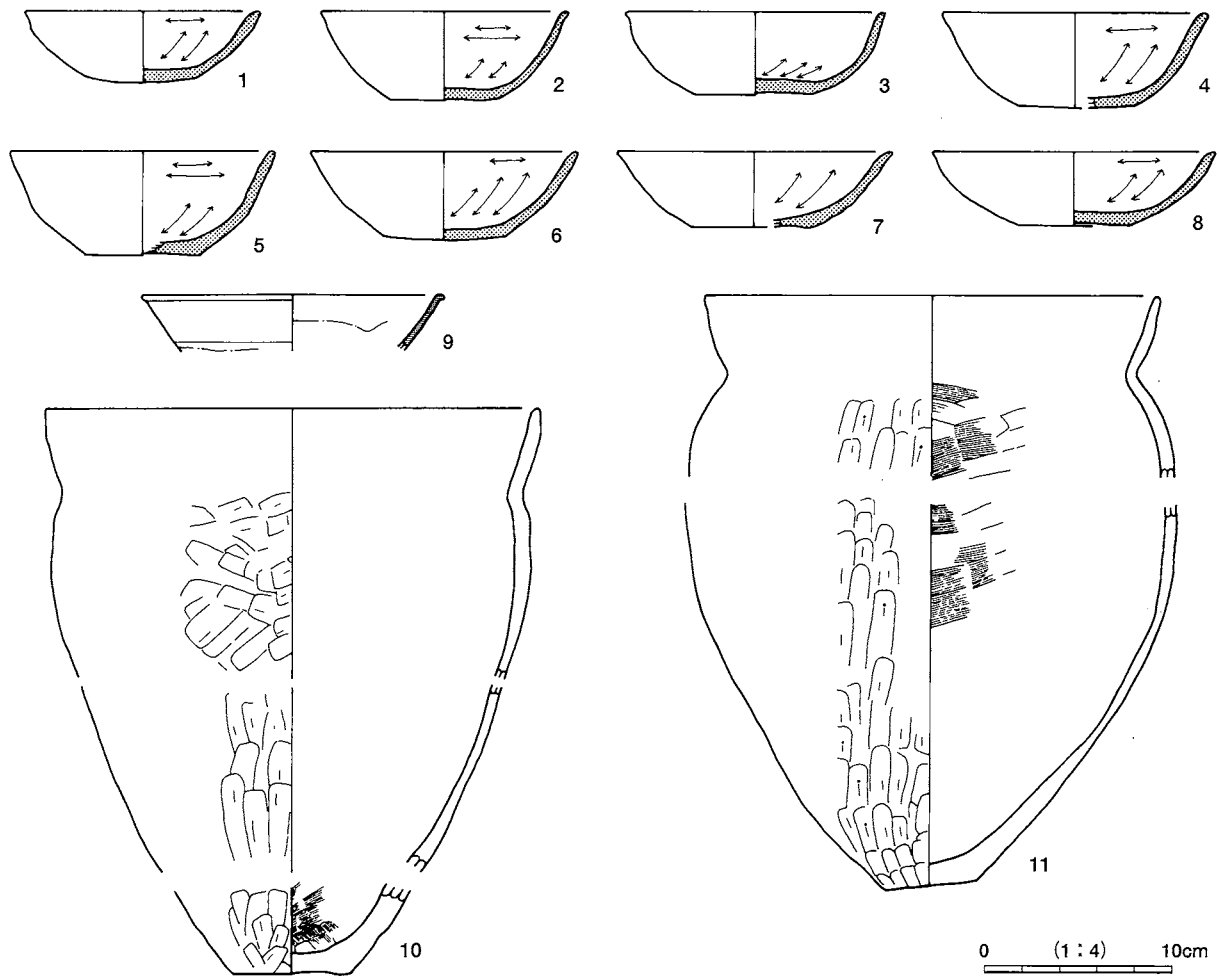

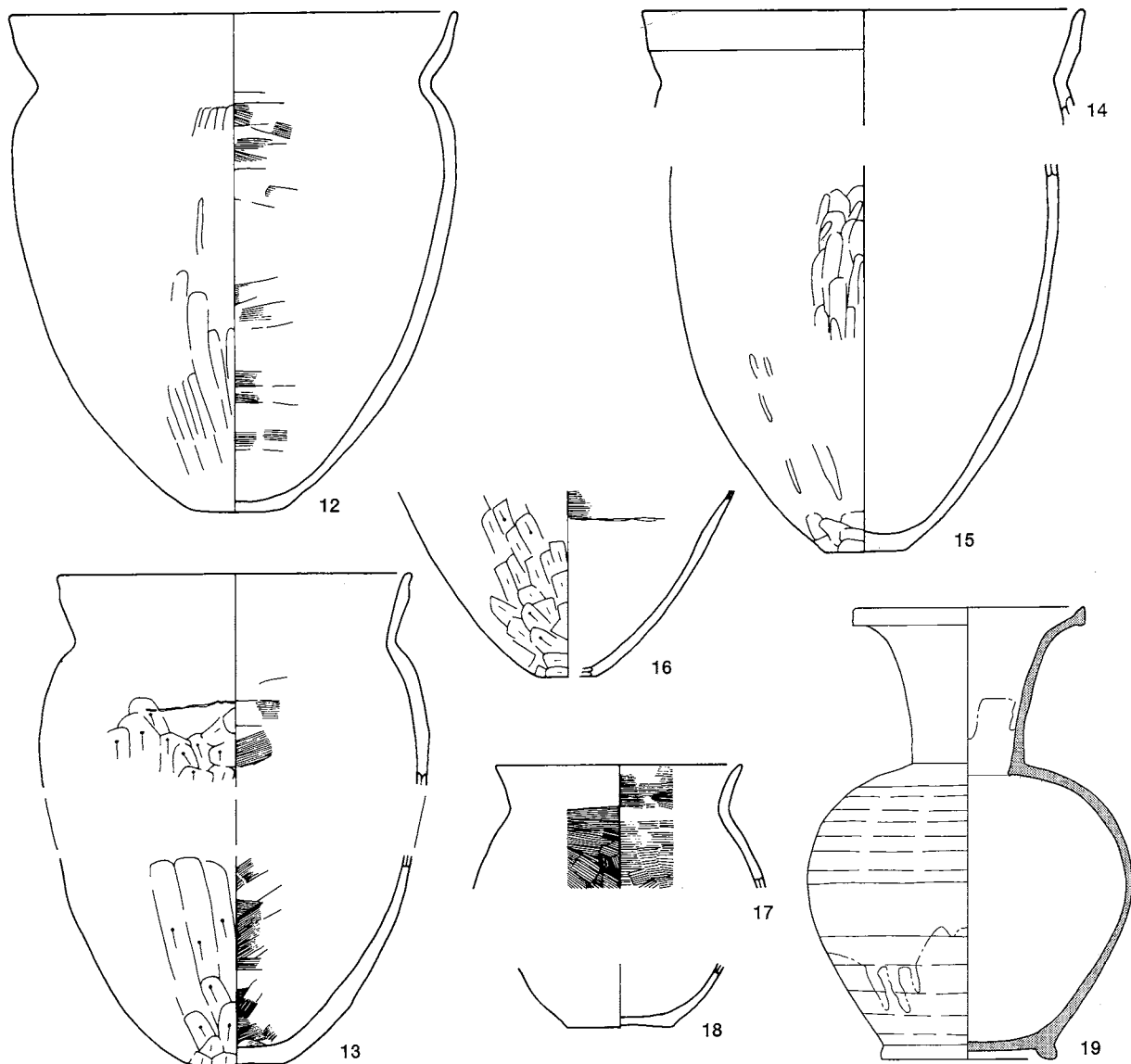

SB1089 (1~15)

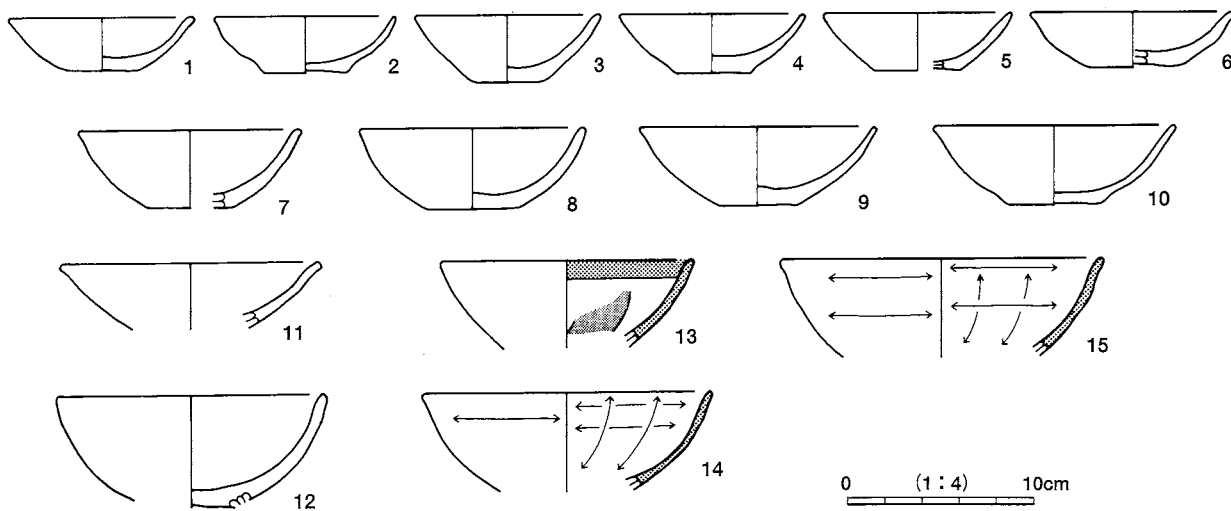

SB1090 (1~26)

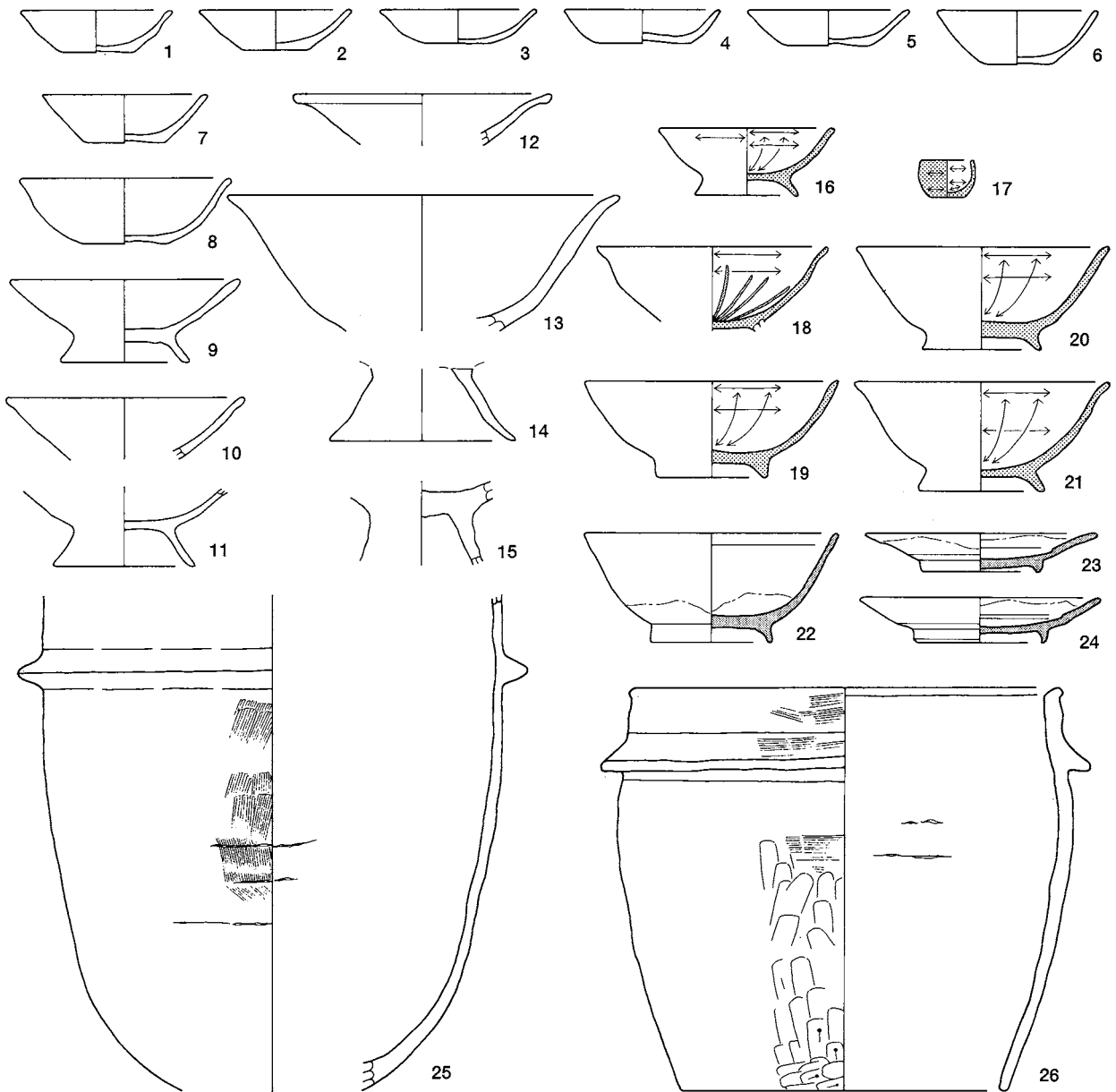

SB1092 (1~12)

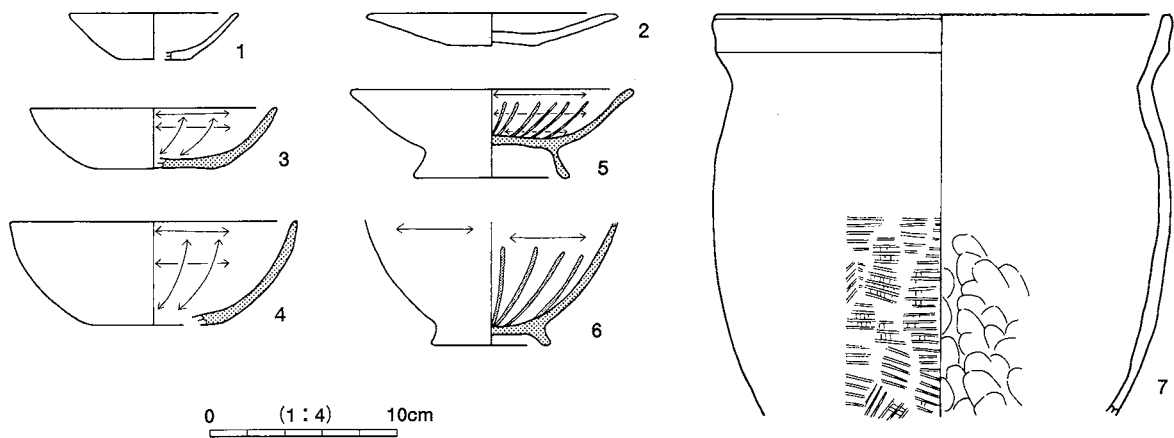

0 (1:4) 10cm

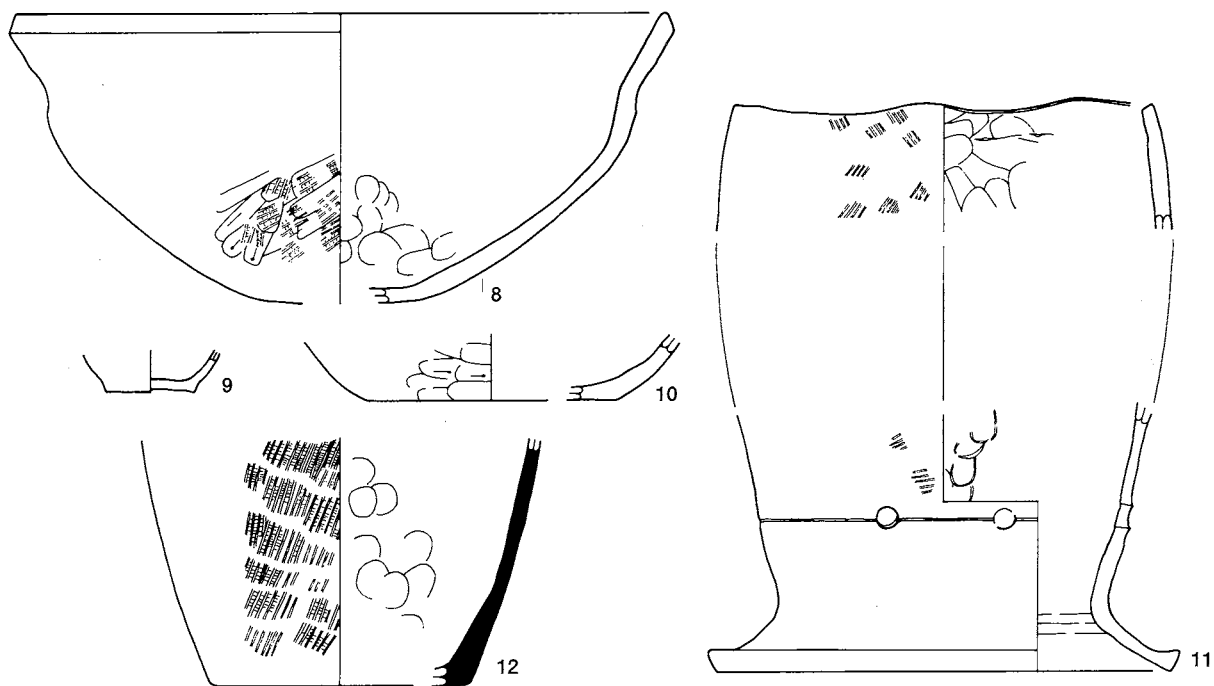

SB1093 (1~10)

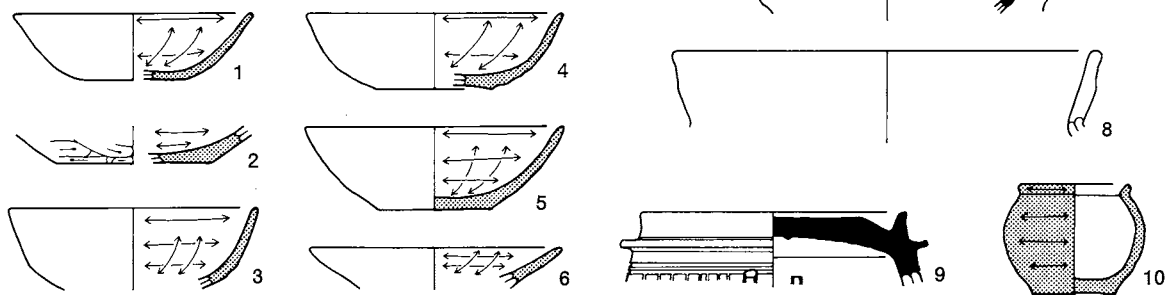

SB1095 (1~27)

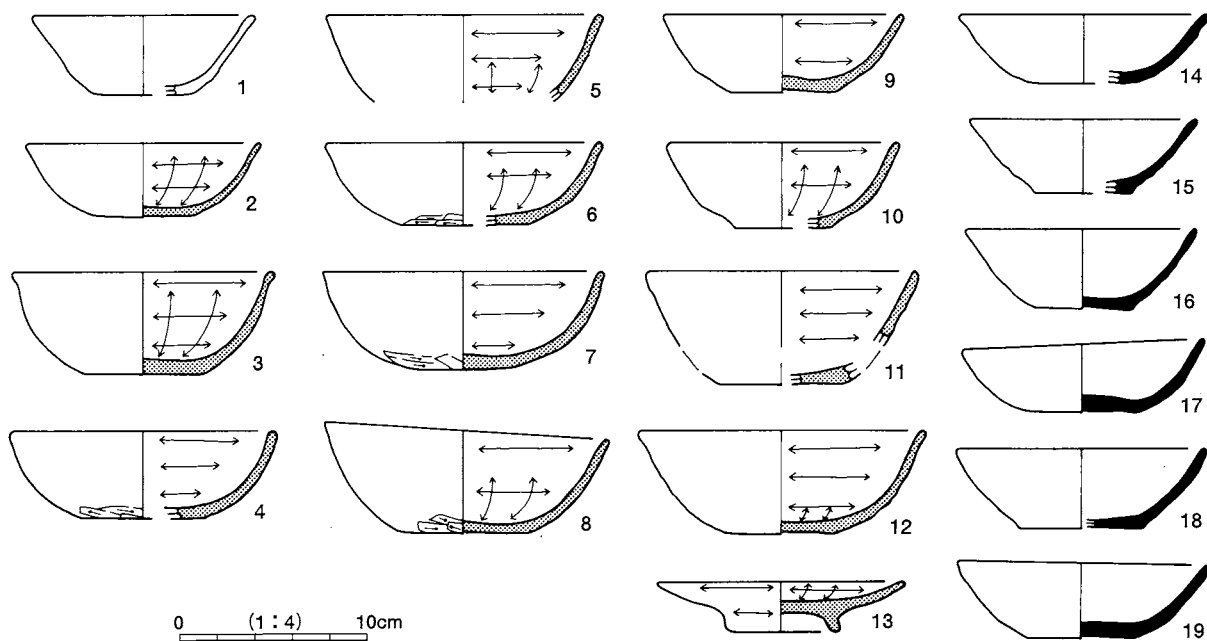

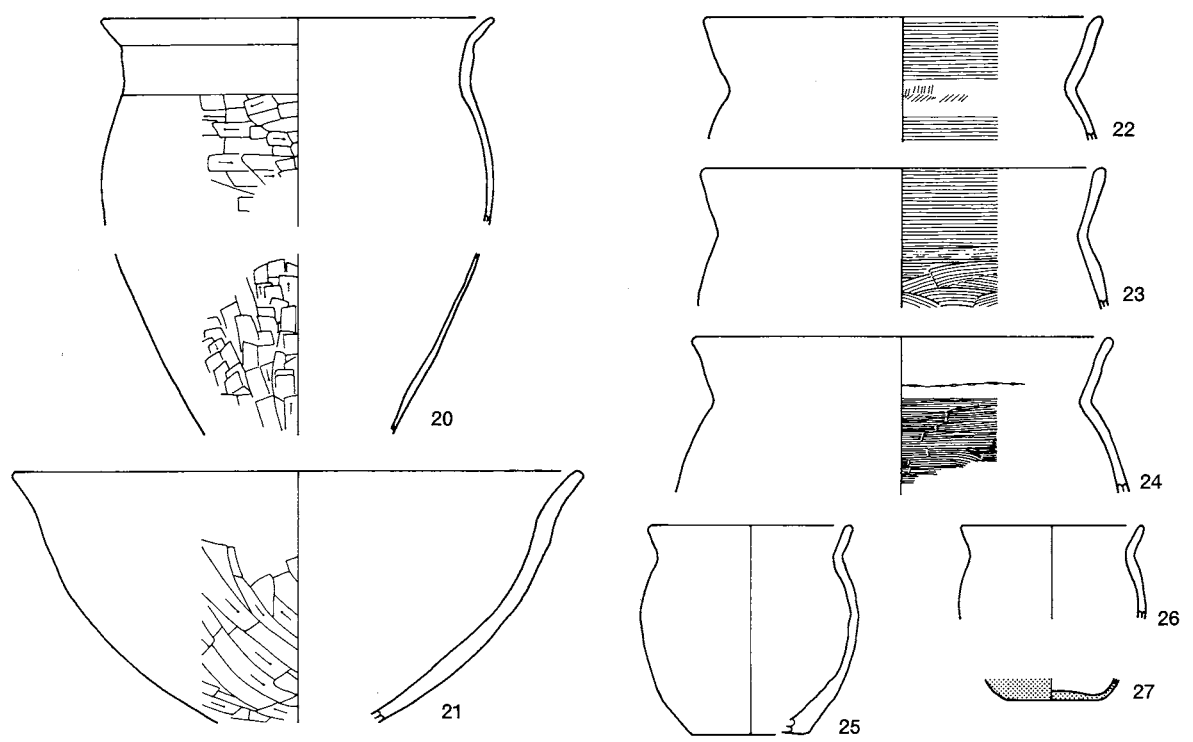

SB1098 (1~15)

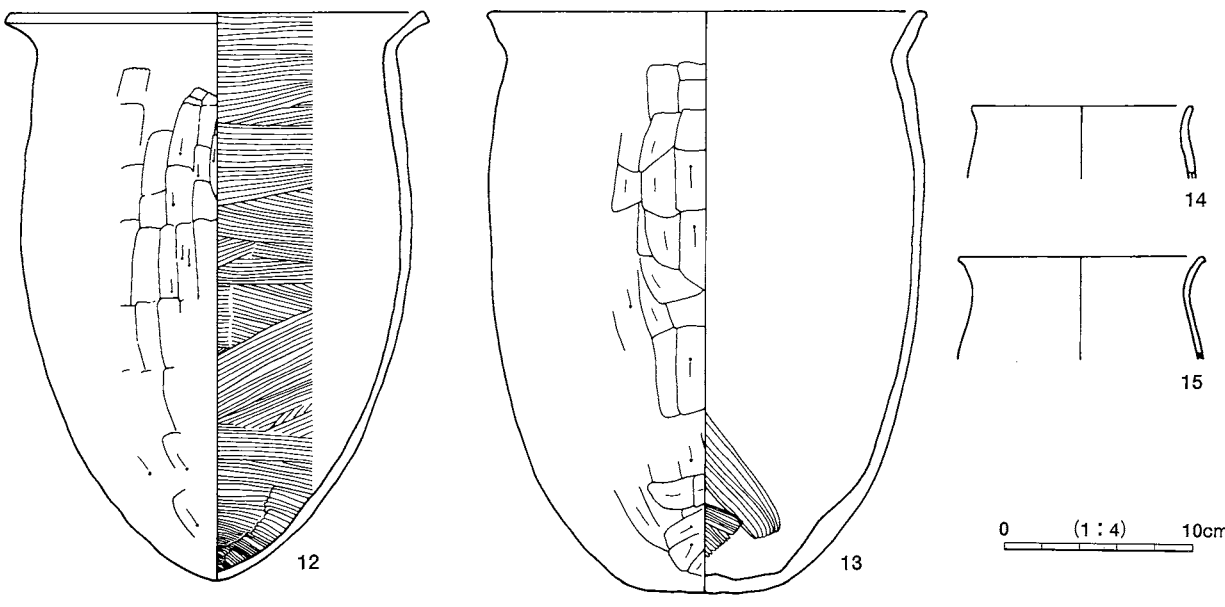
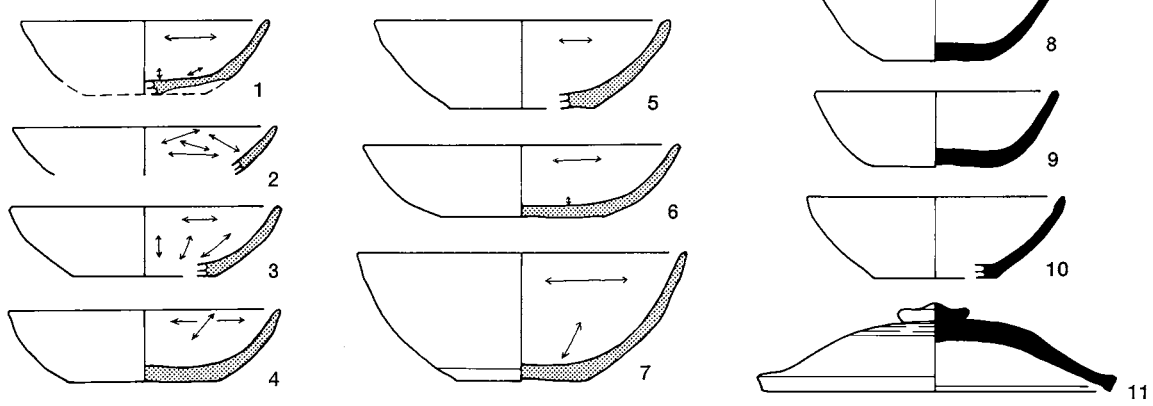

0 (1:4) 10cm

SB1100 (1·2)

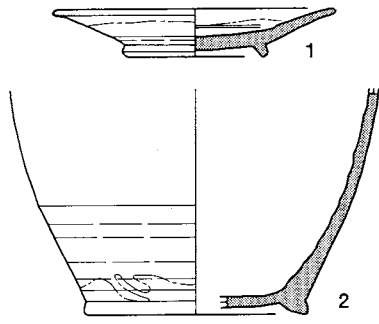

SB1101 (1~11)

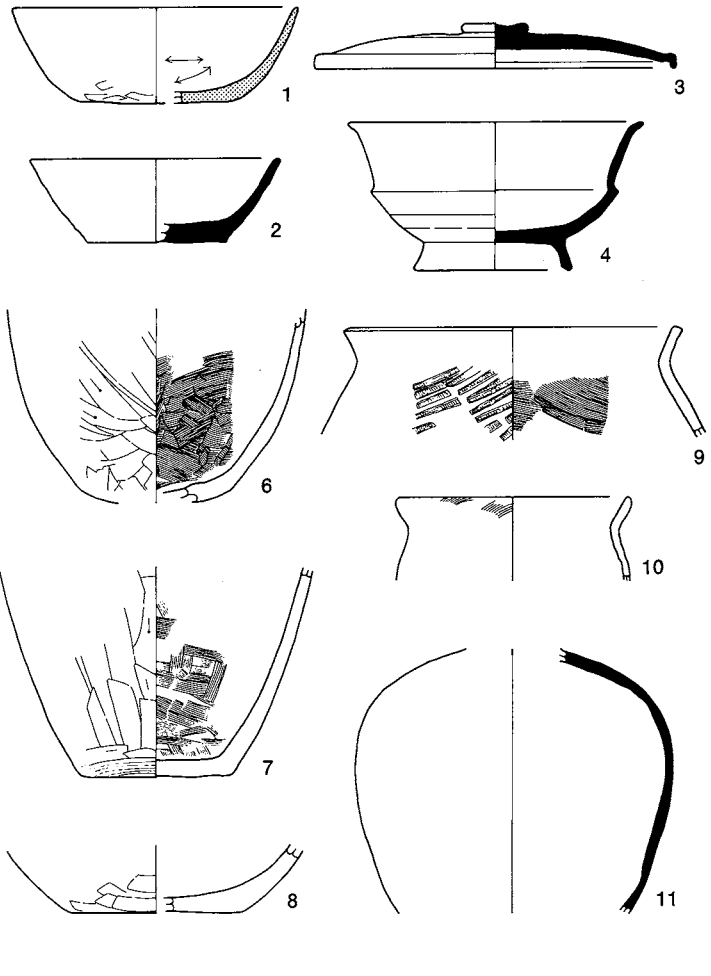

SB1194 (1~15)

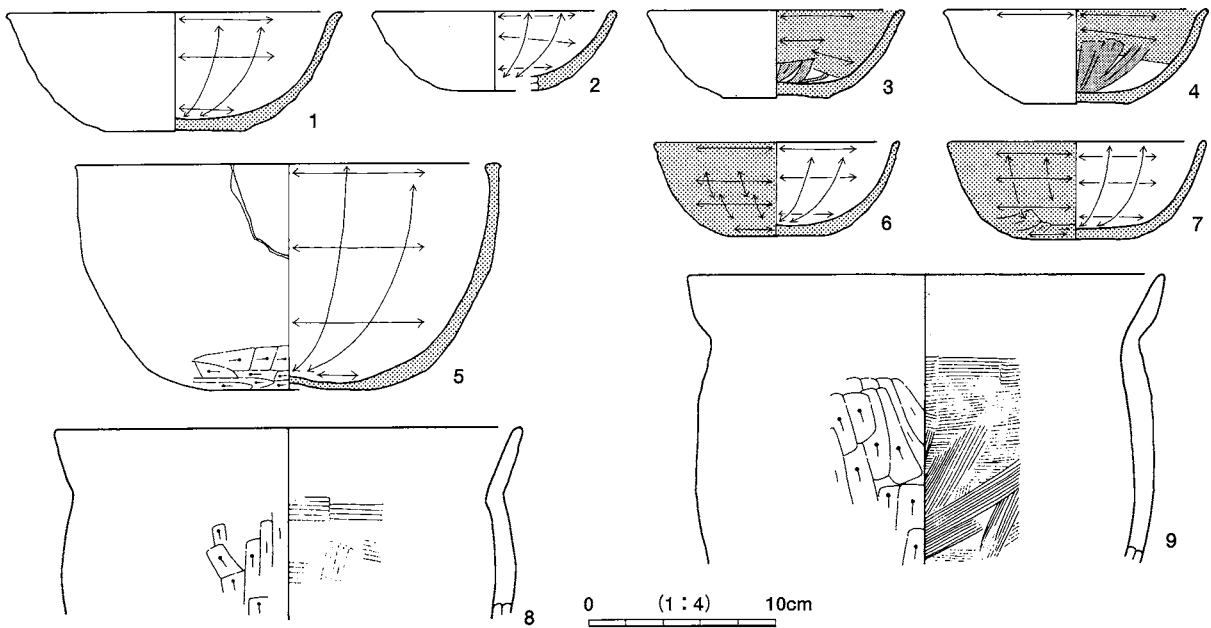

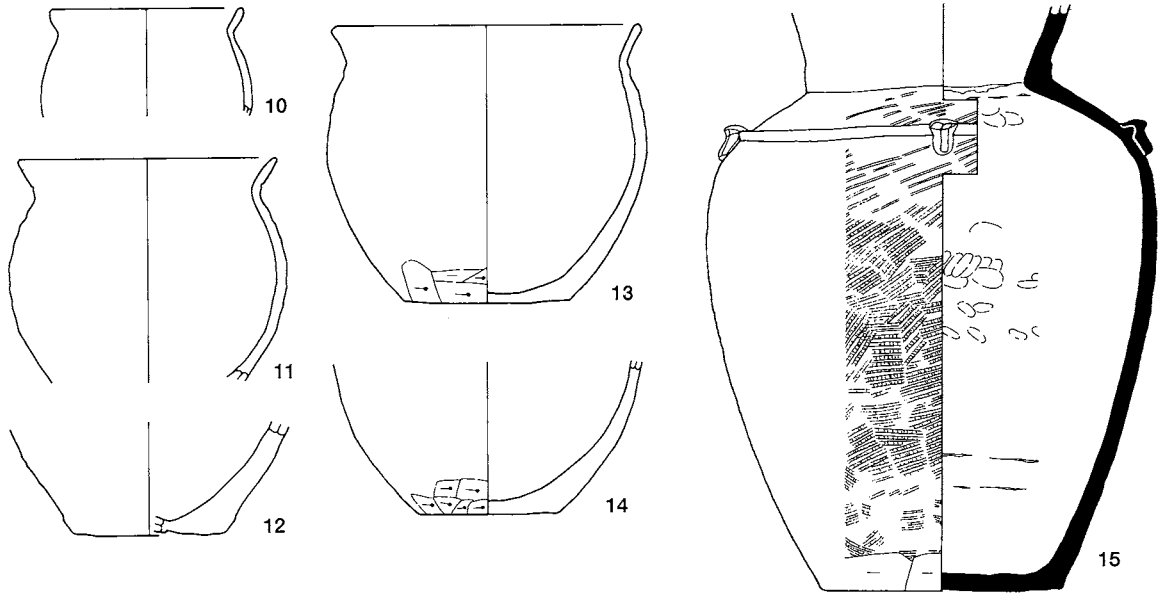

SB1201 (1~29)

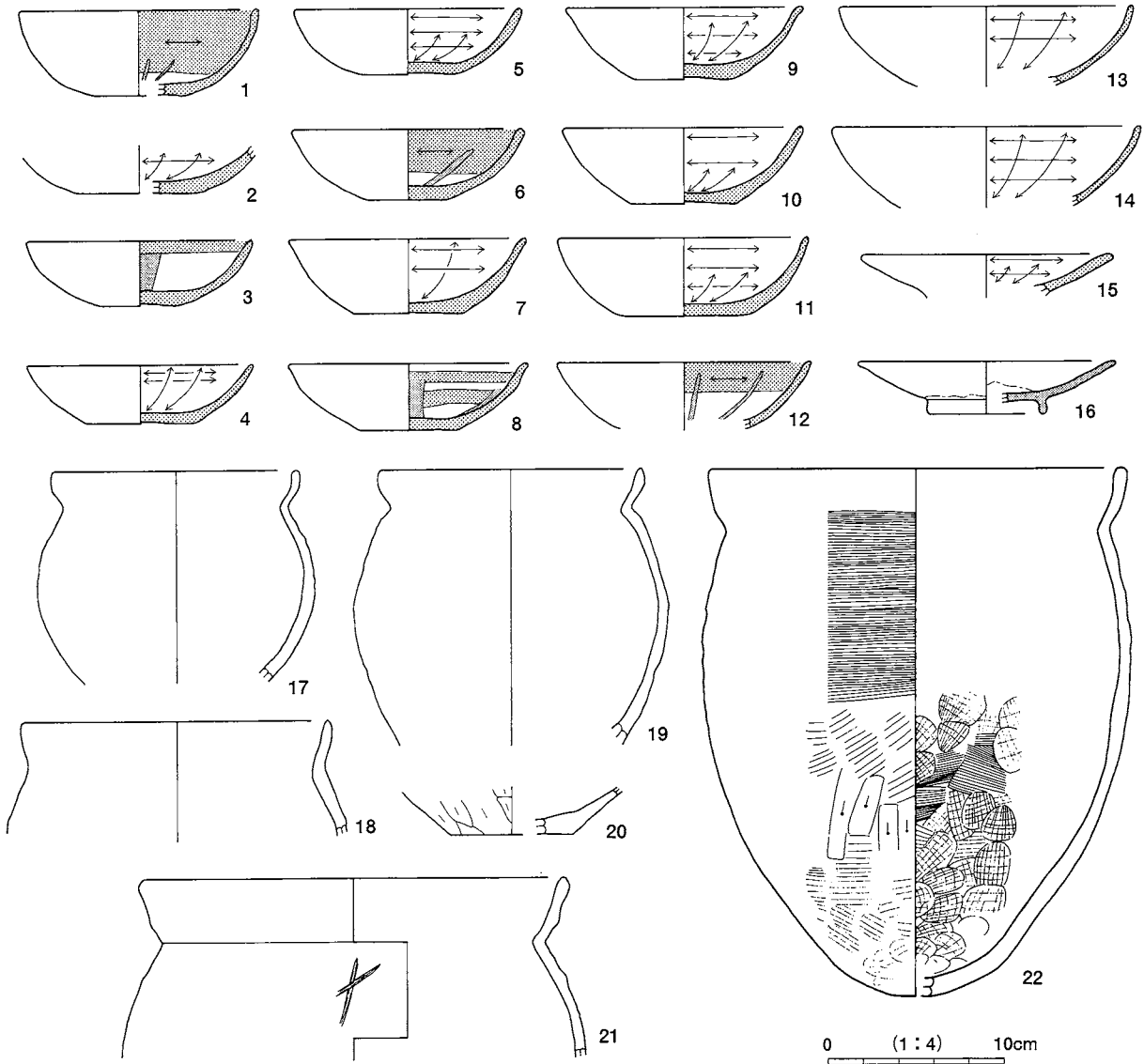

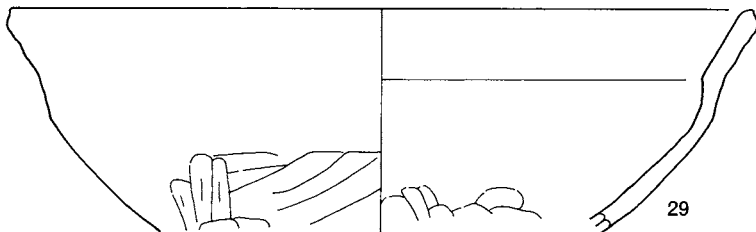
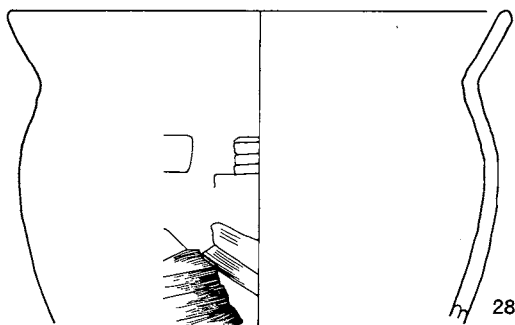
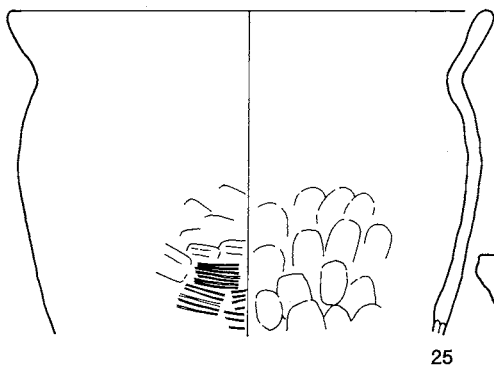
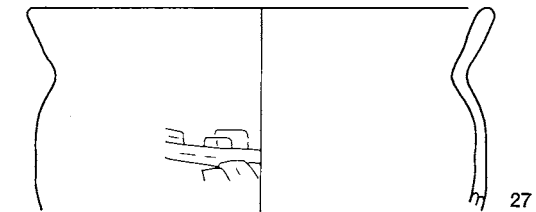
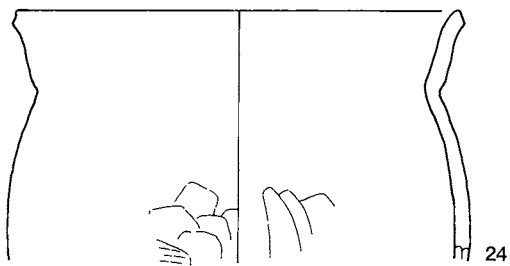
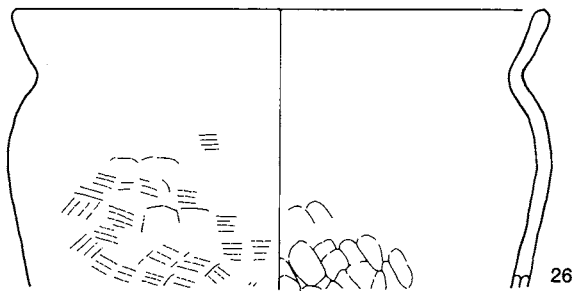
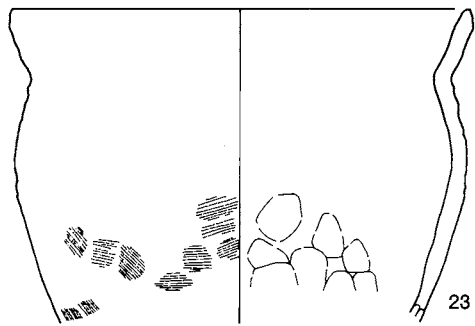

SB1204

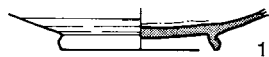

SB1205 (1-2)

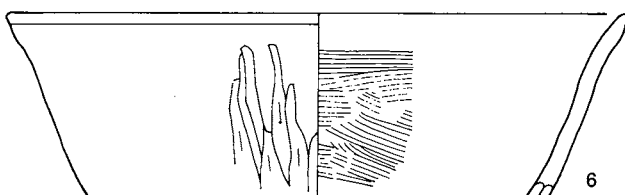
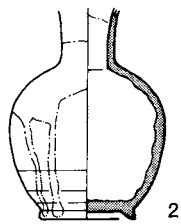
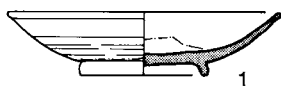

SB1207 (1~9)

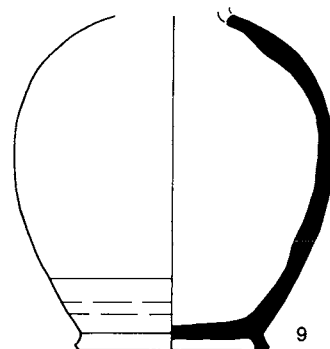
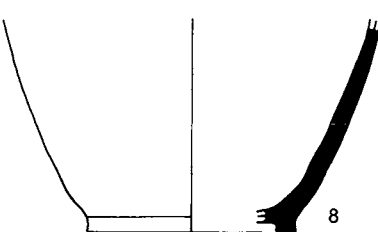
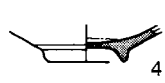
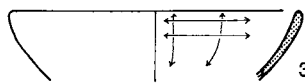
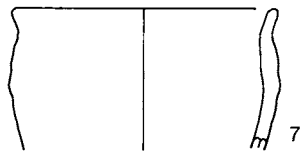
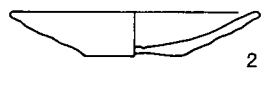
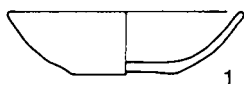

0 (1:4) 10cm

SB1208 (1~9)

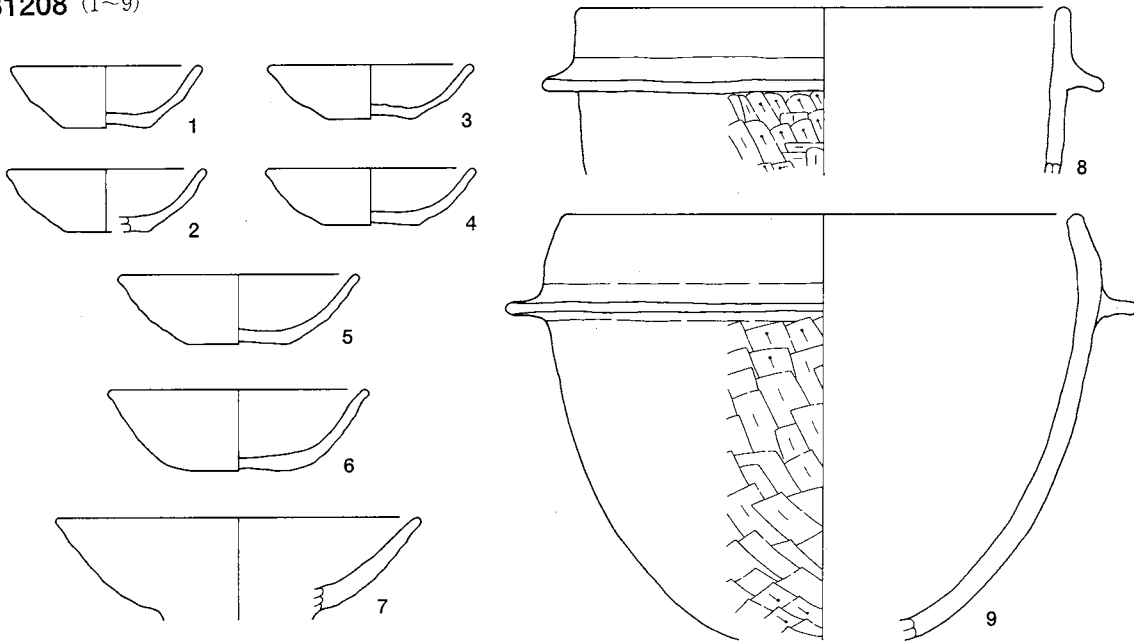

SB1209 (1~20)

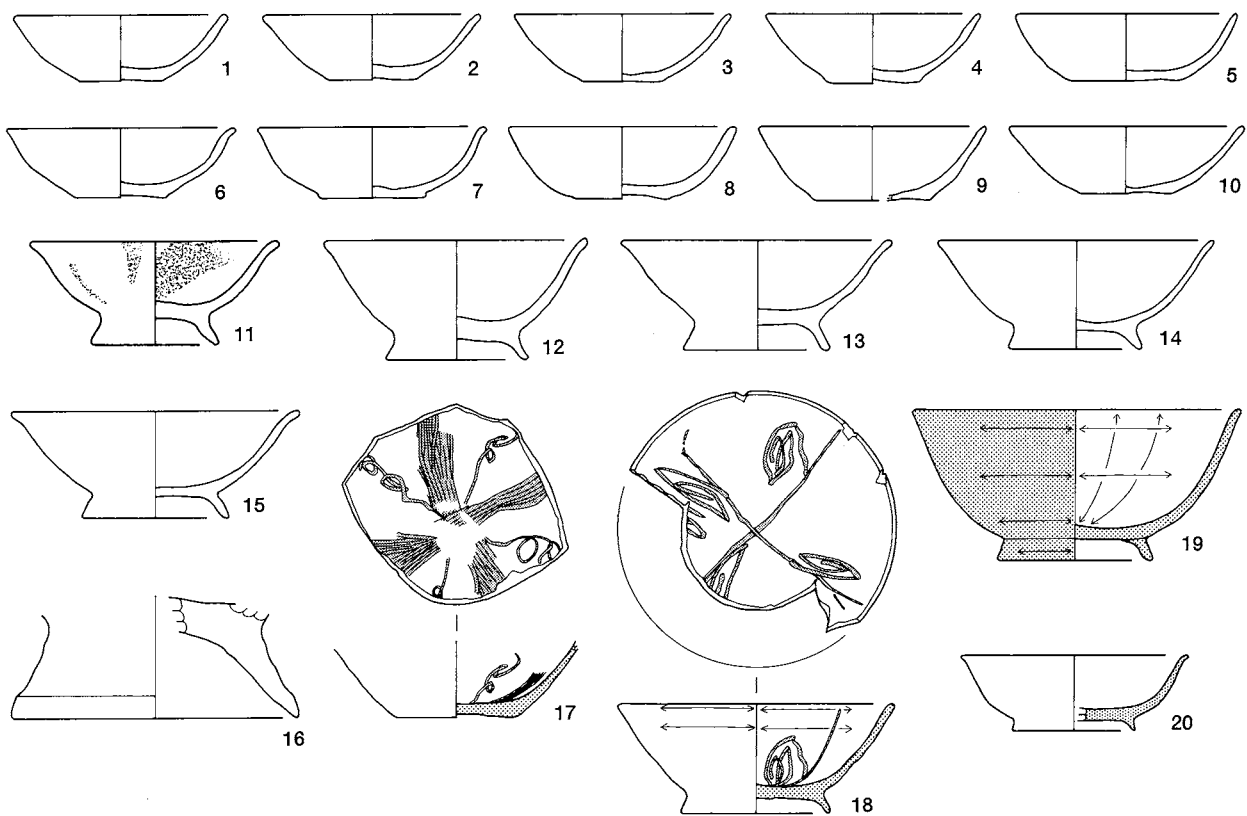

SB1211

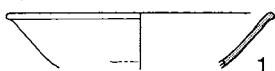

SB1213



0 (1:4) 10cm



SB1212 (1~8)

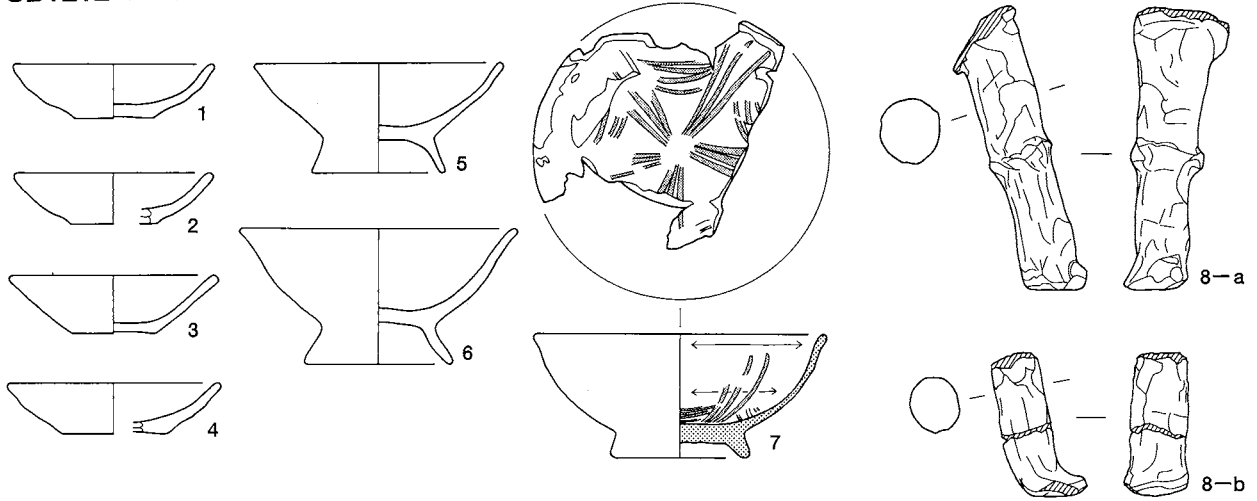

SB1216 (1~13)

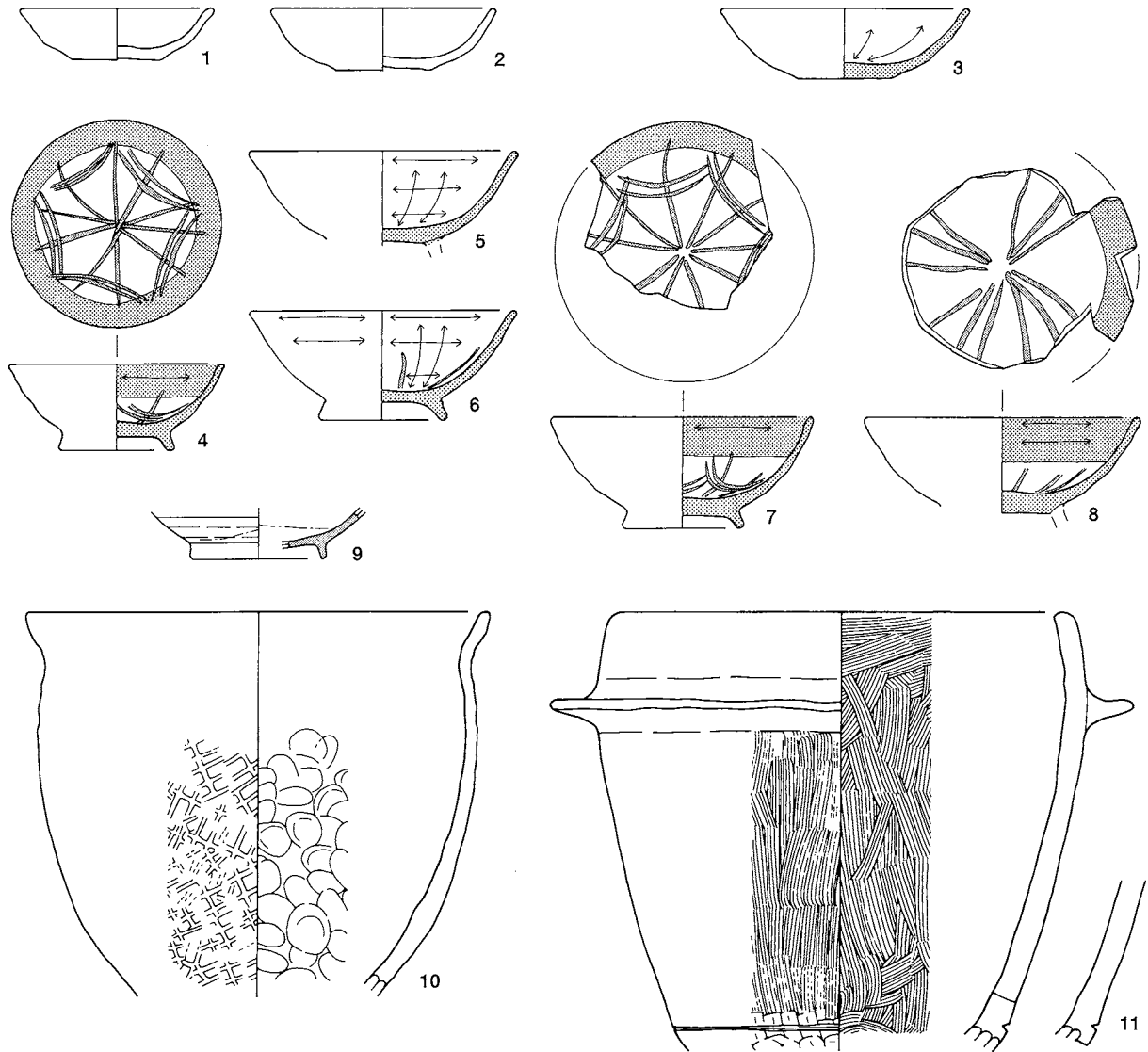

0 (1:4) 10cm

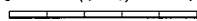

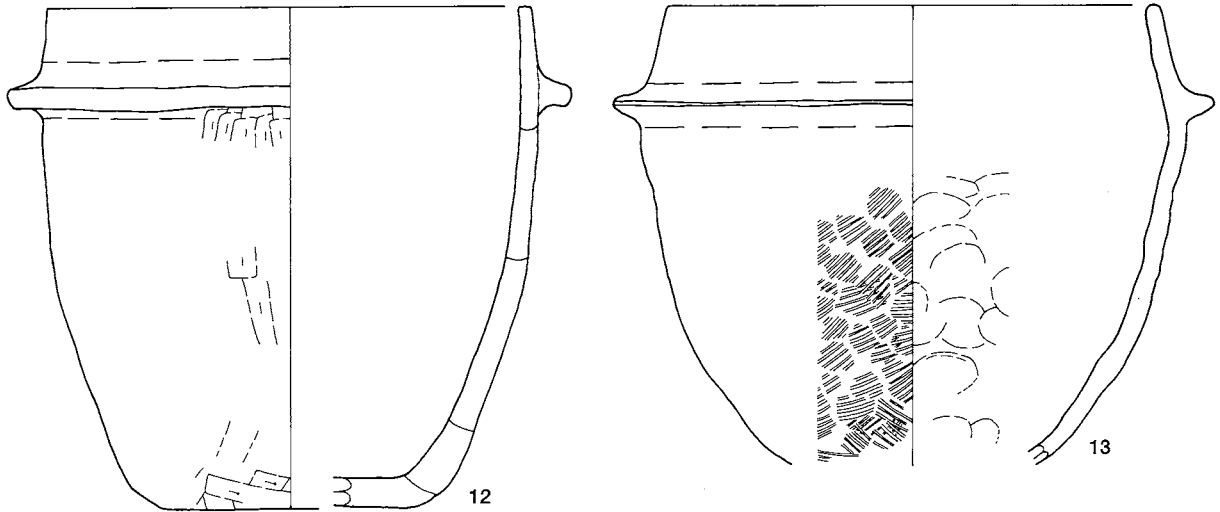

SB1217 (1~16)

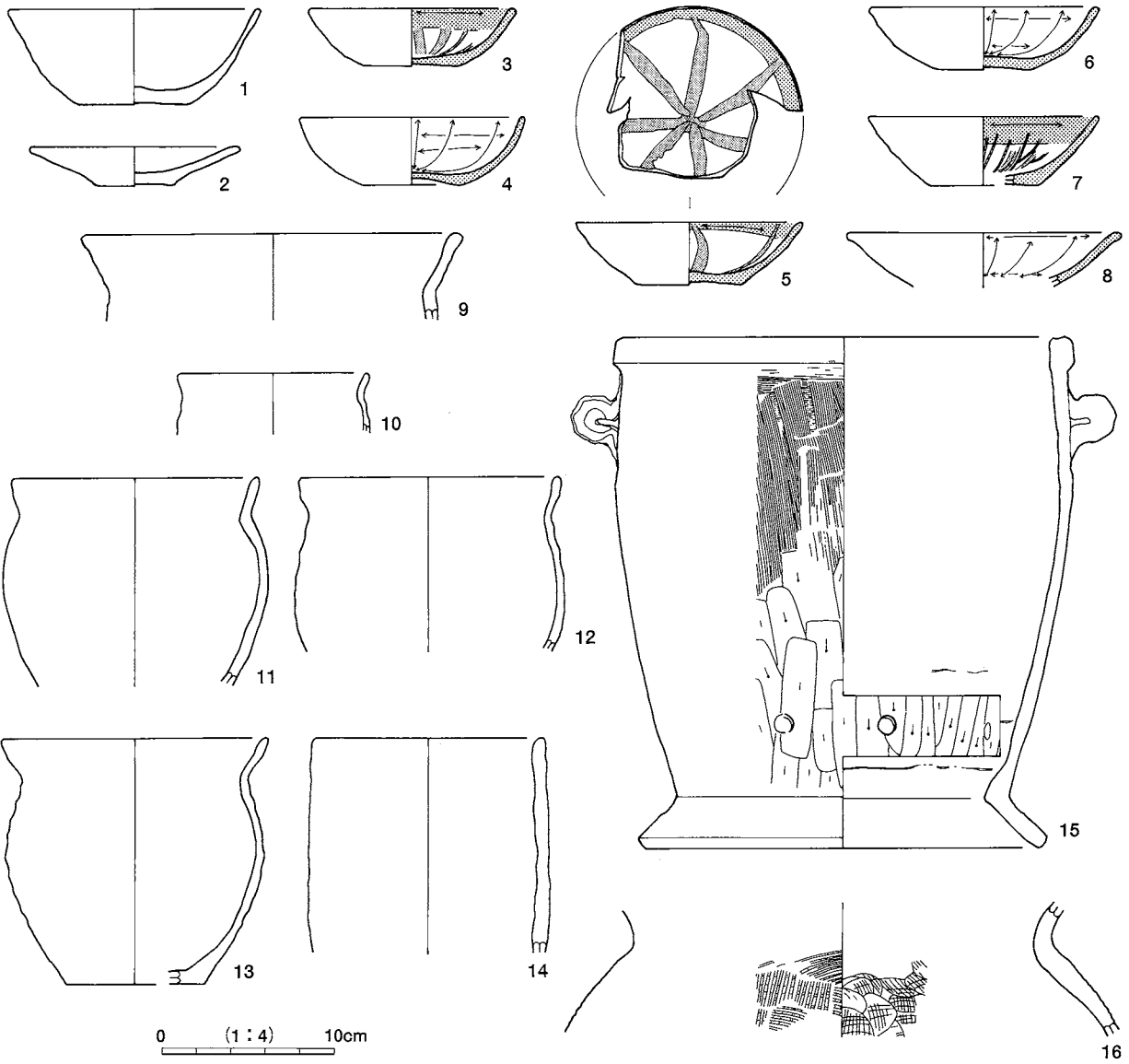

SB1218 (1~14)

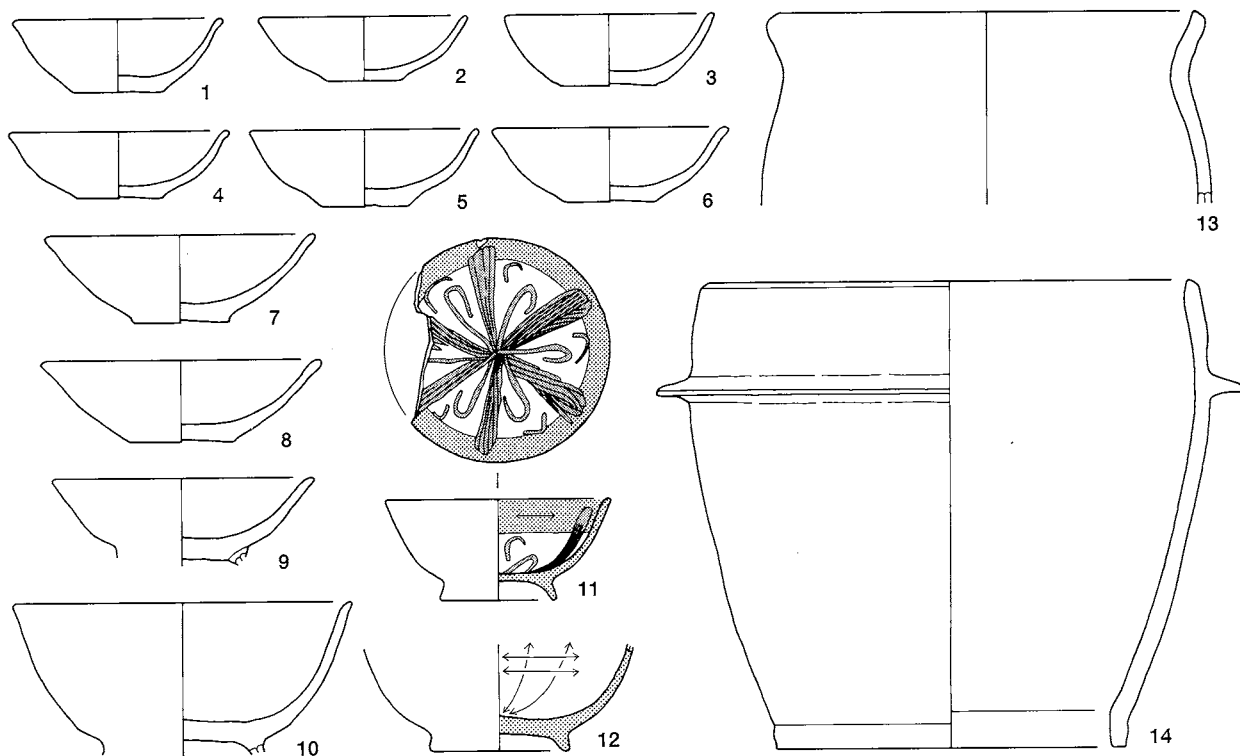

SB1219 (1~9)

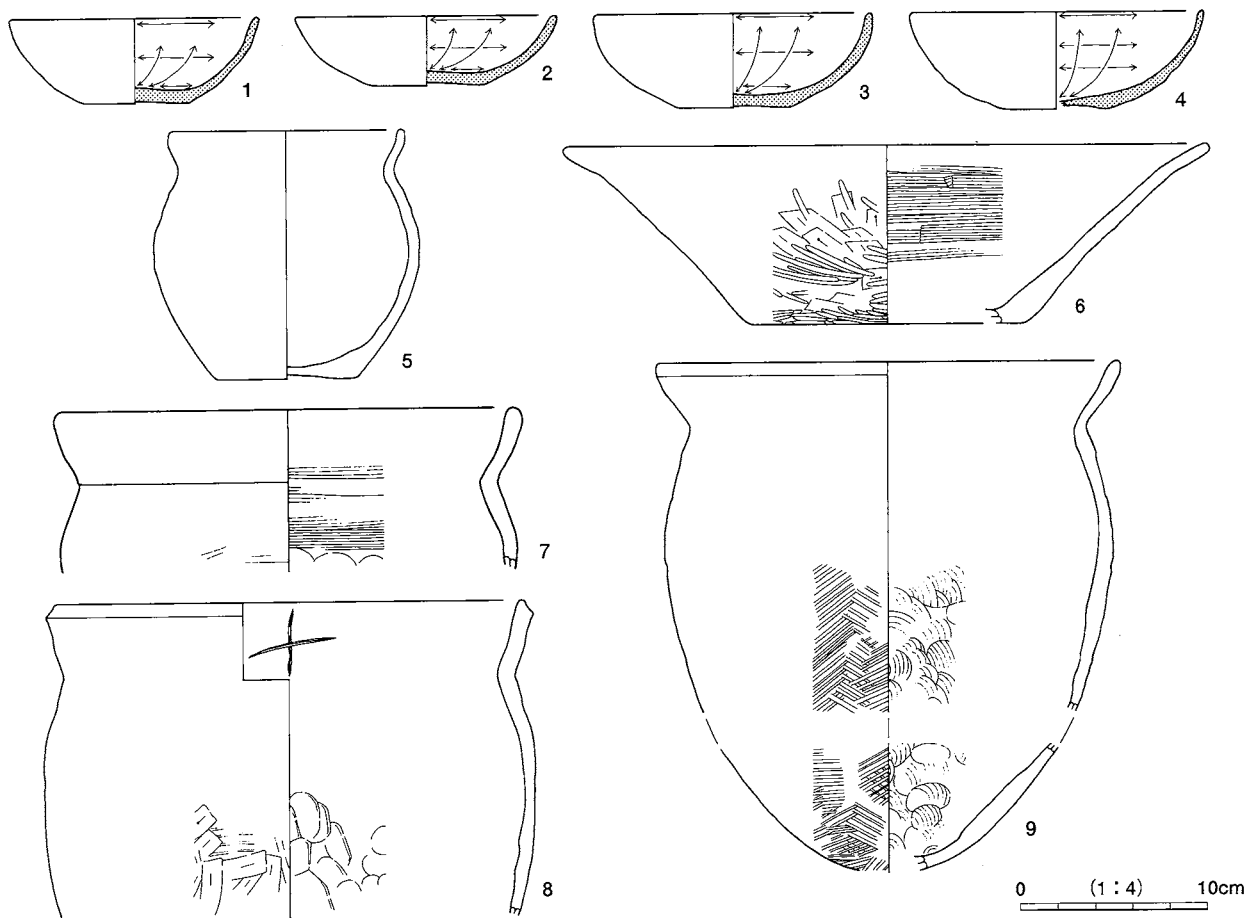

SB1222 (1~28)

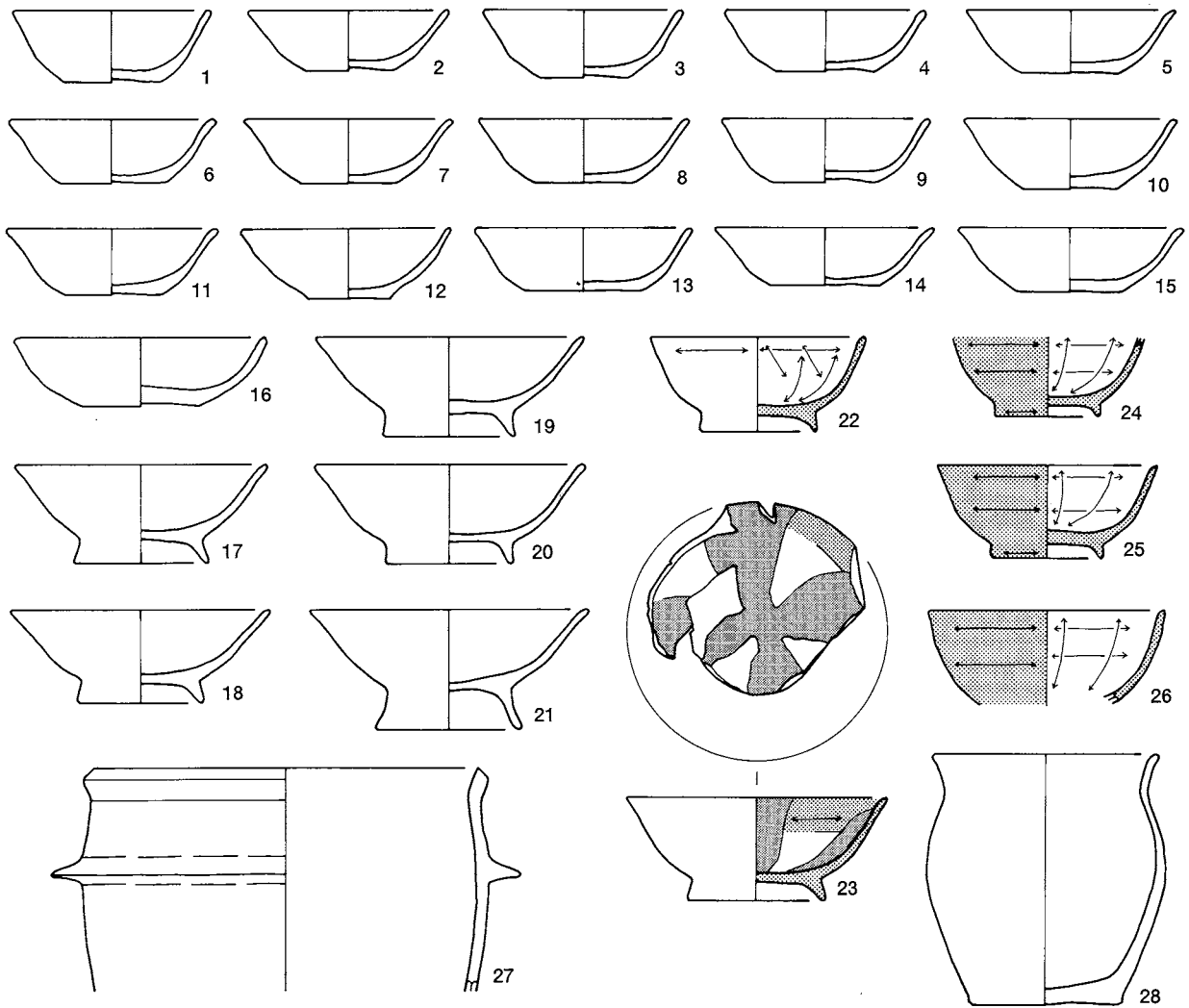

SB1224 (1~44)

SB1223

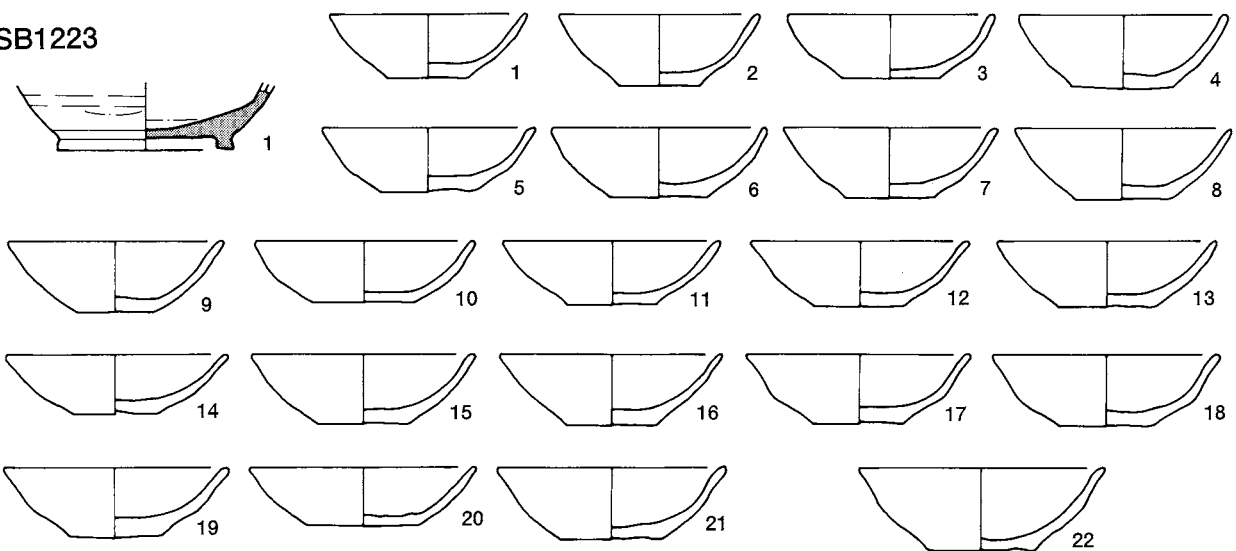

0 (1:4) 10cm

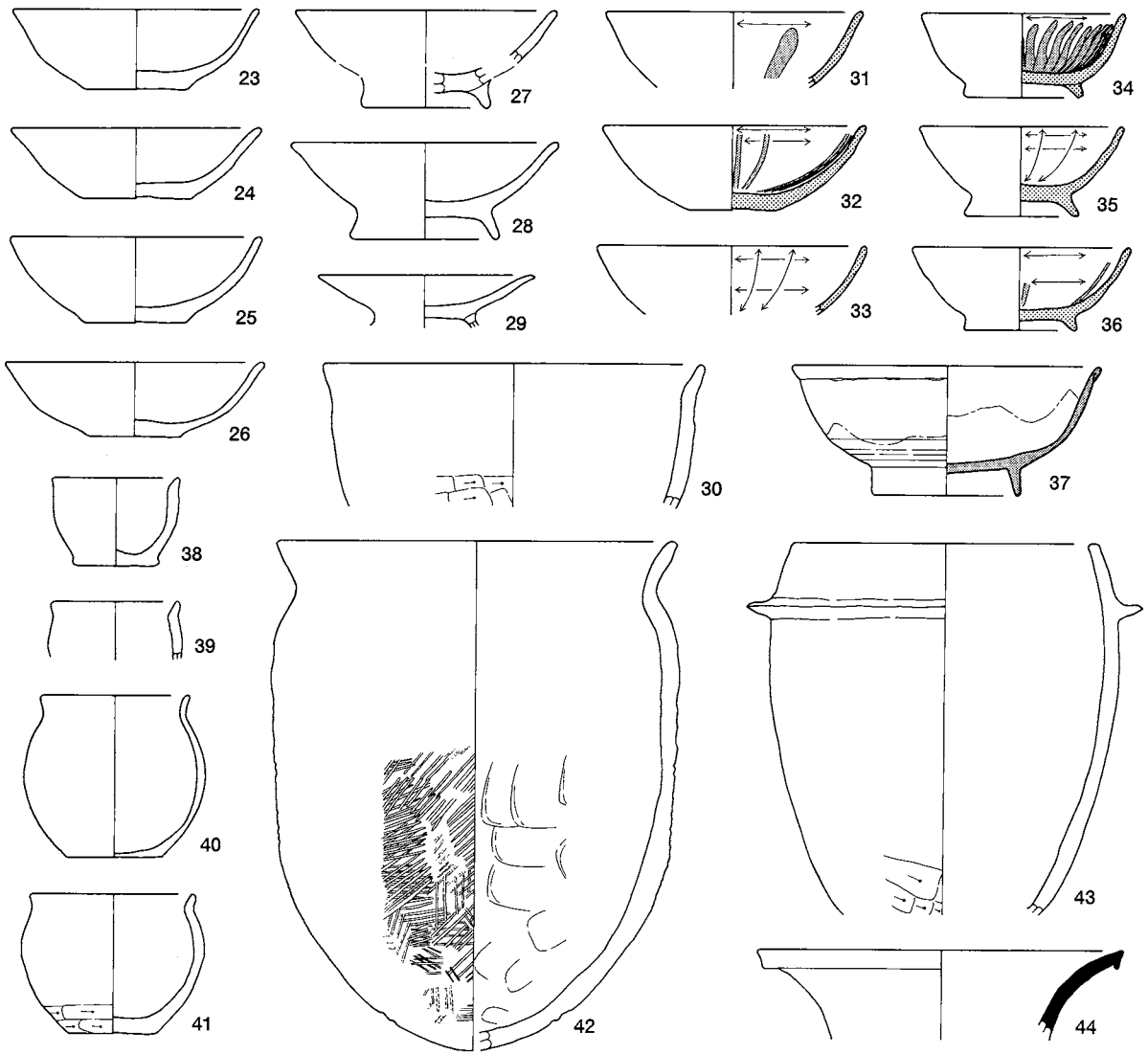

SB1225



SB1228

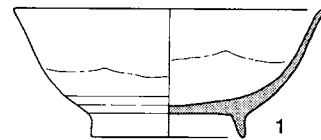

SB1226 (1~29)

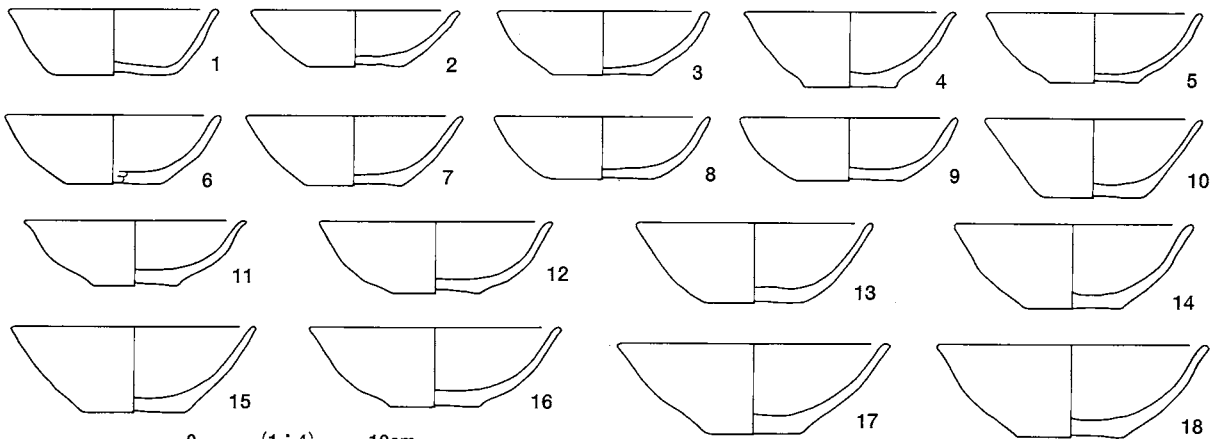

0 (1:4) 10cm

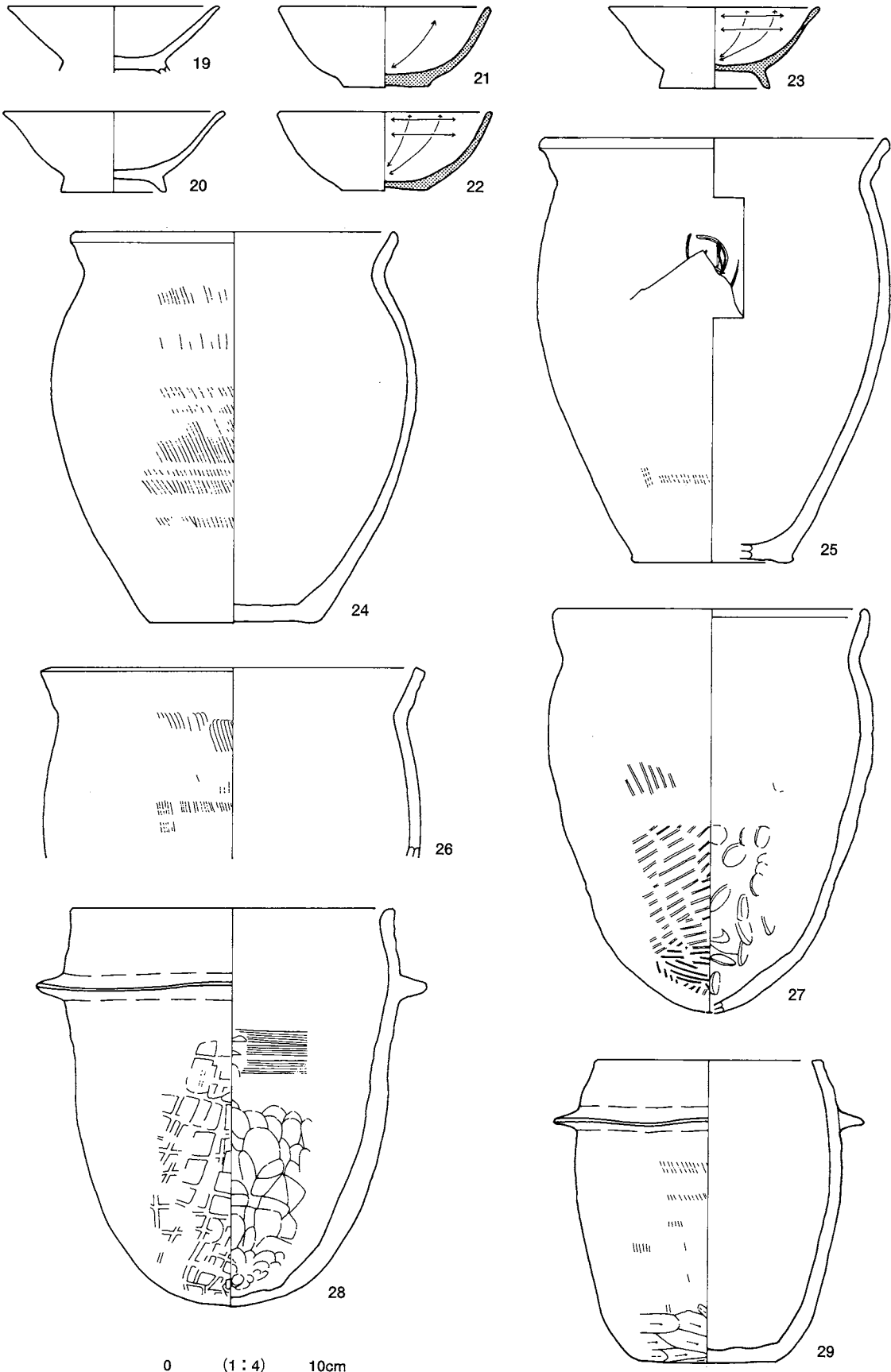

SB1230 (1~4)

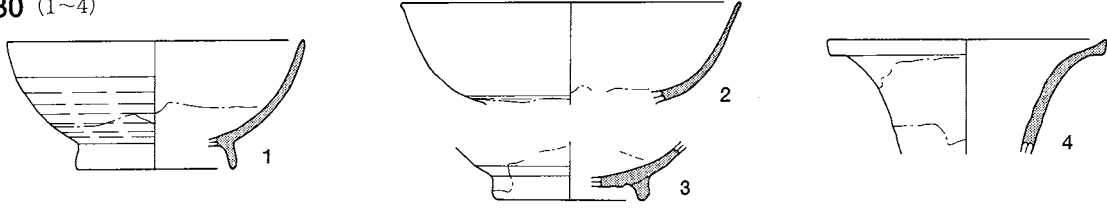

SB1231 (1~24)

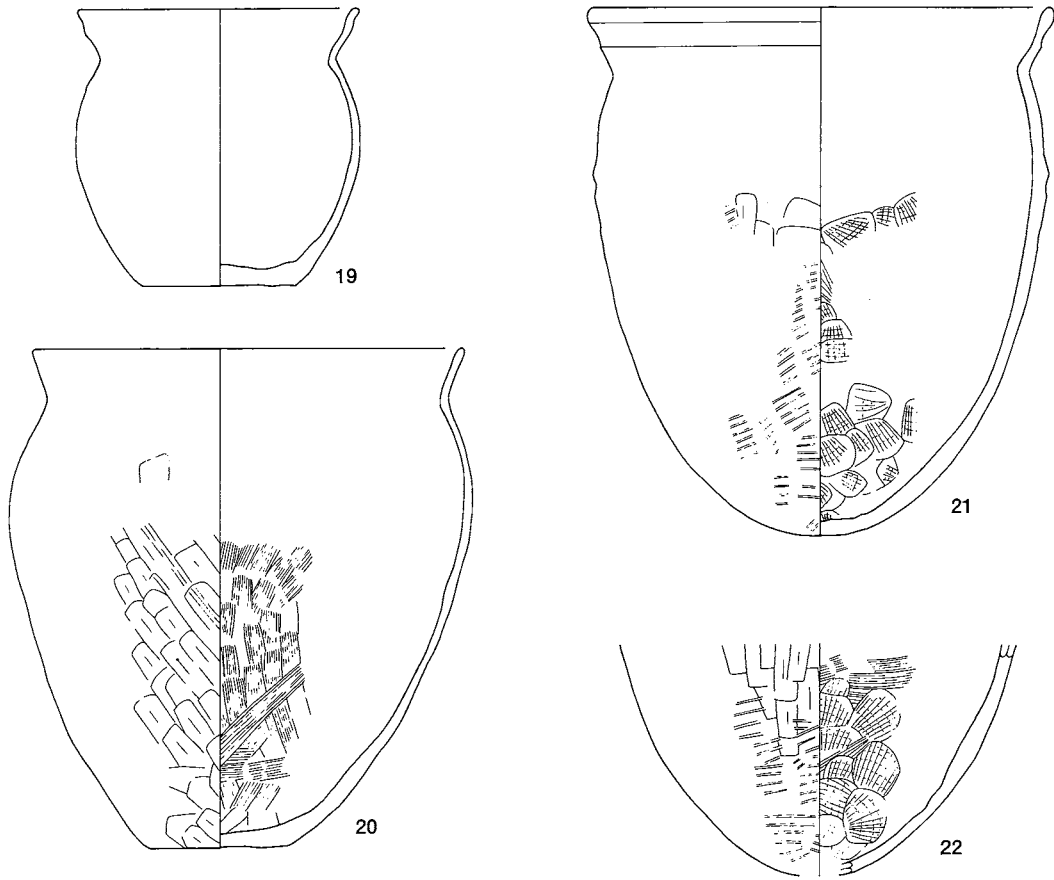
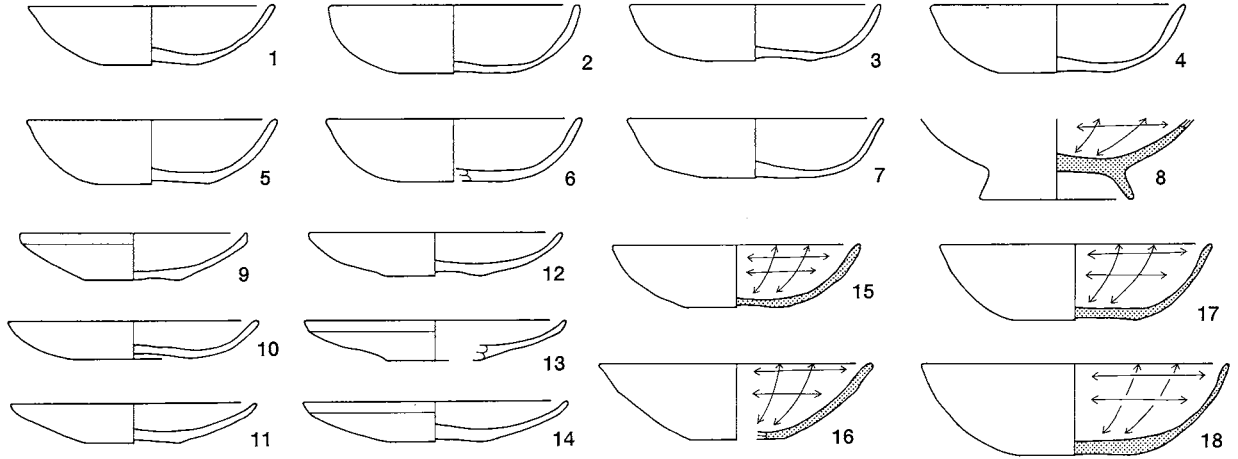

0 (1:4) 10cm

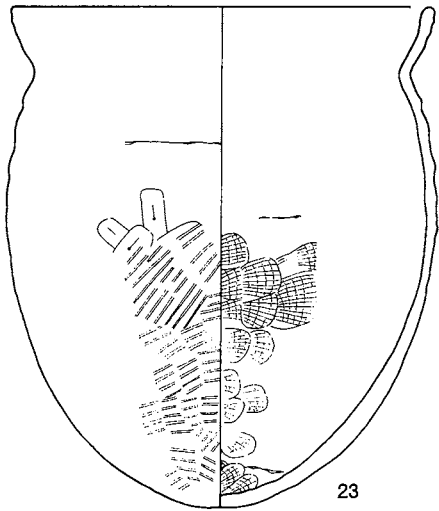

23

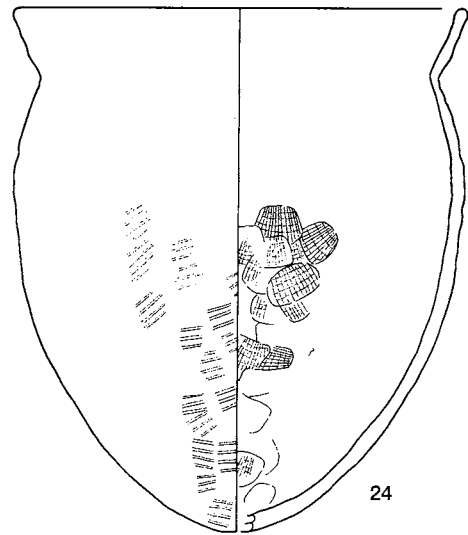

24

SB1235 (1~4)

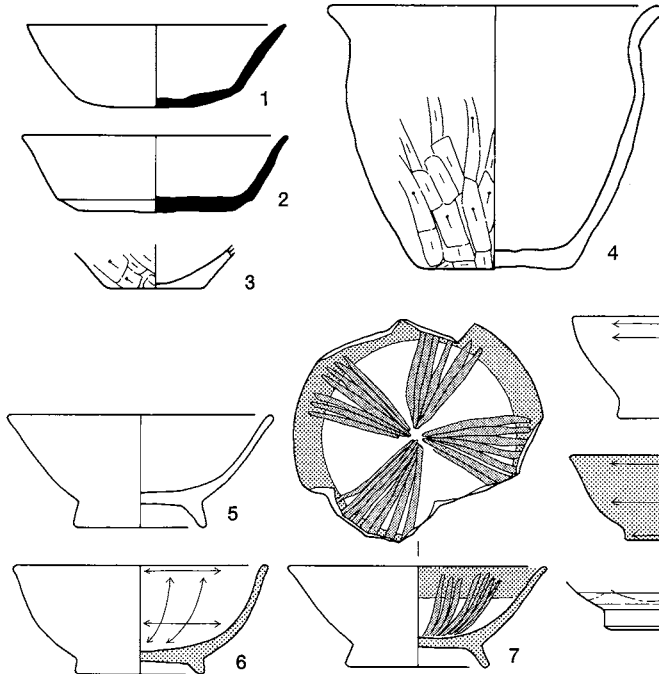

SB1236 (1~13)

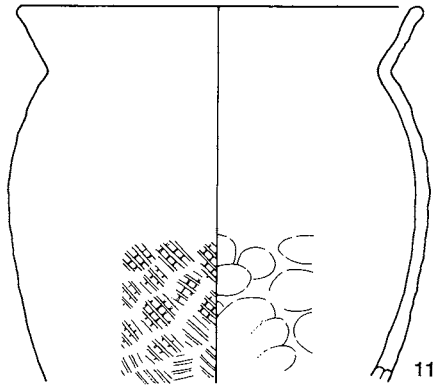
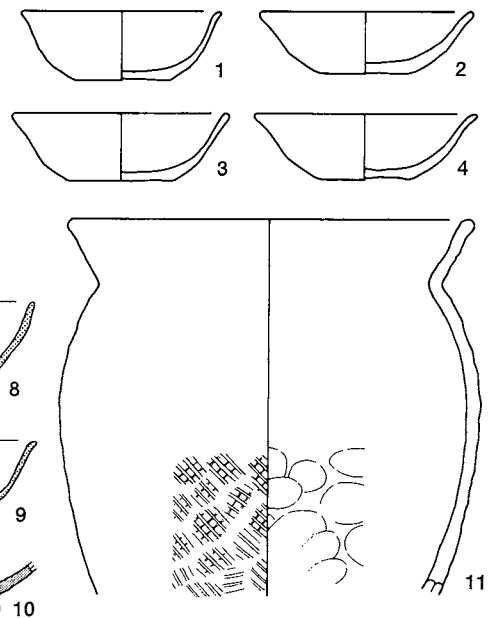

11

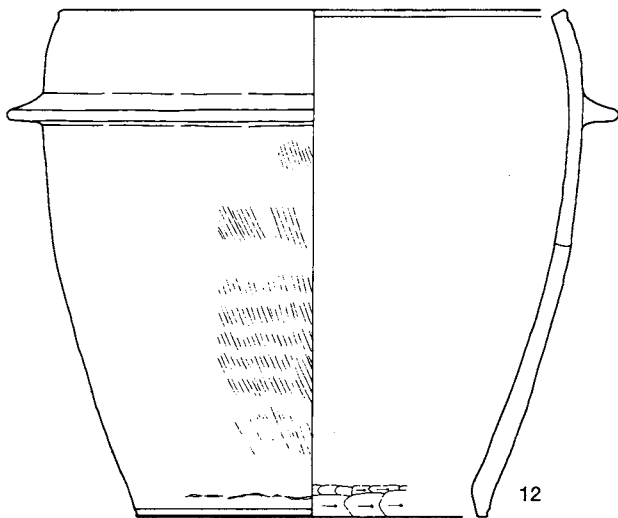

12

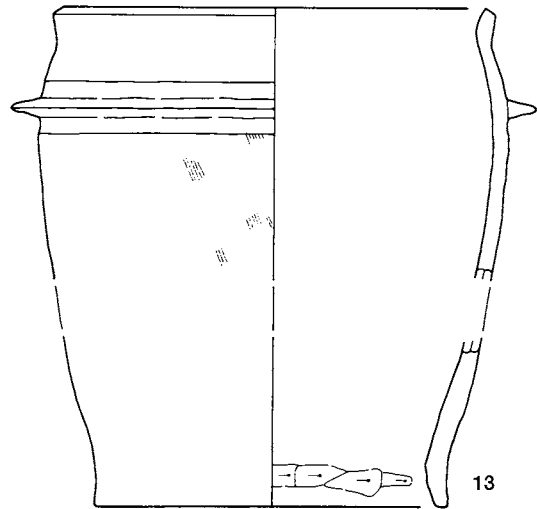

13

0 (1:4) 10cm

SB1237 (1~23)

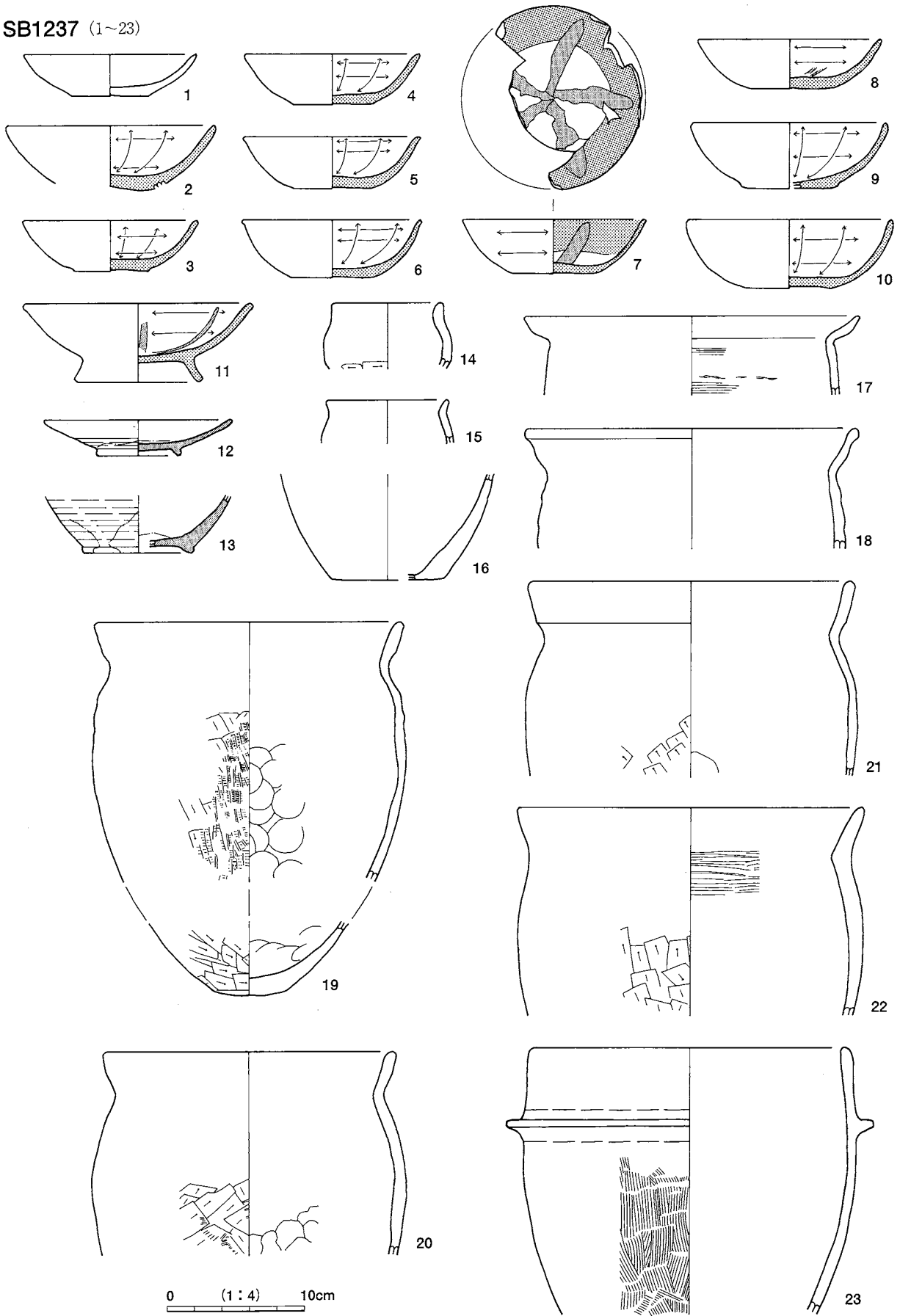

SB1238 (1・2)

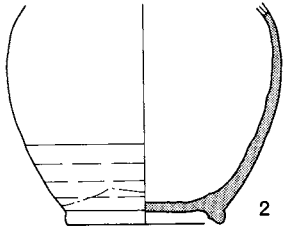
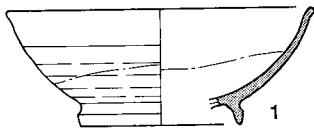

SB1241

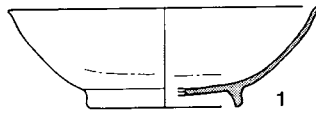

SB1246 (1~27)

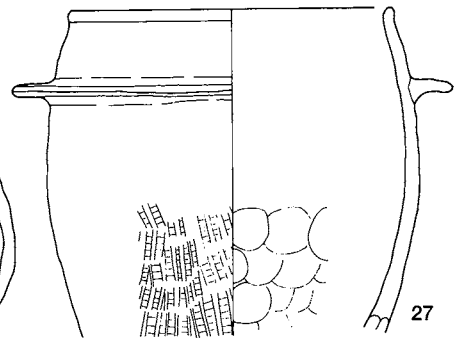
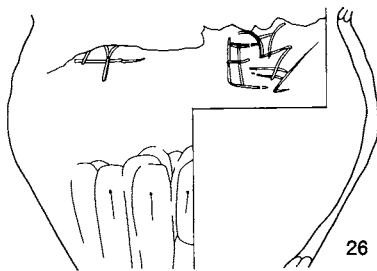
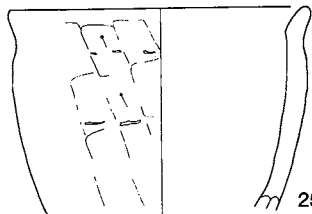
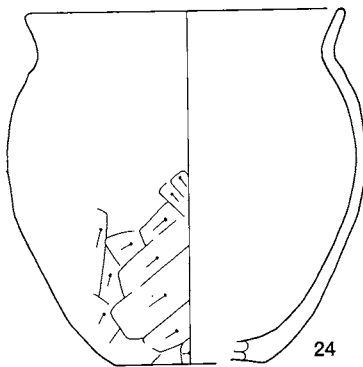
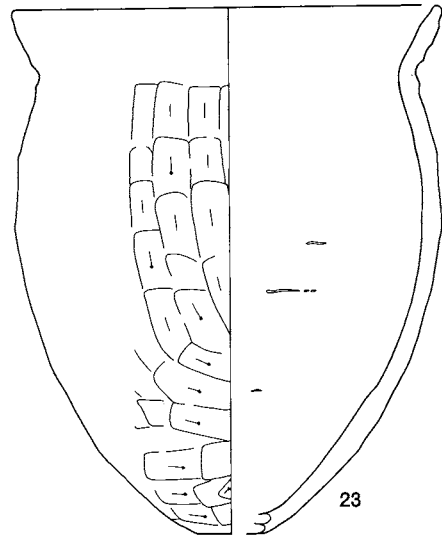
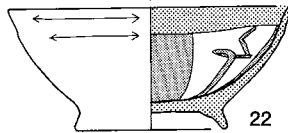
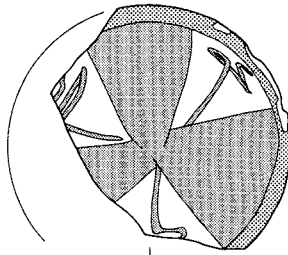
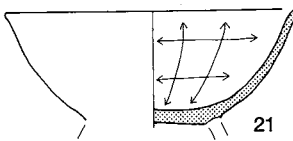
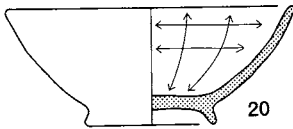
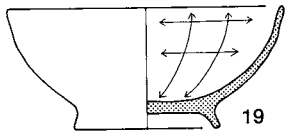
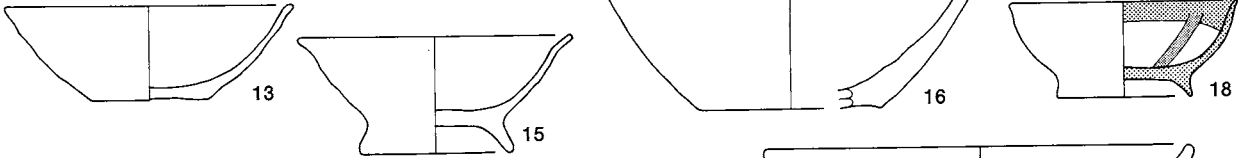
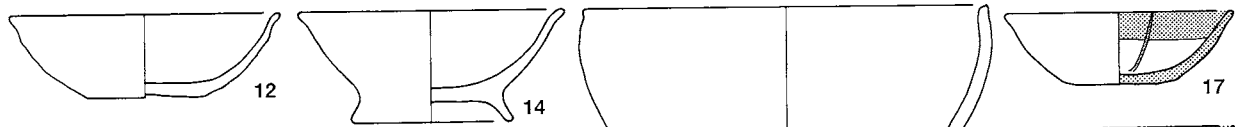
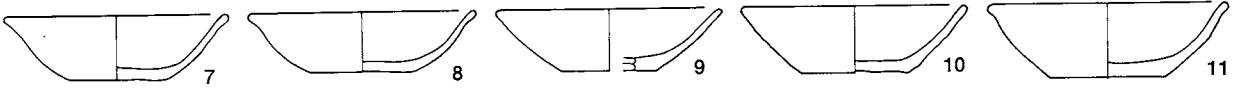
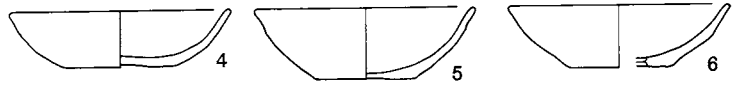
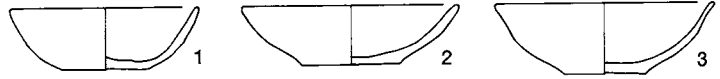

0 (1:4) 10cm

SB1312 (1~27)

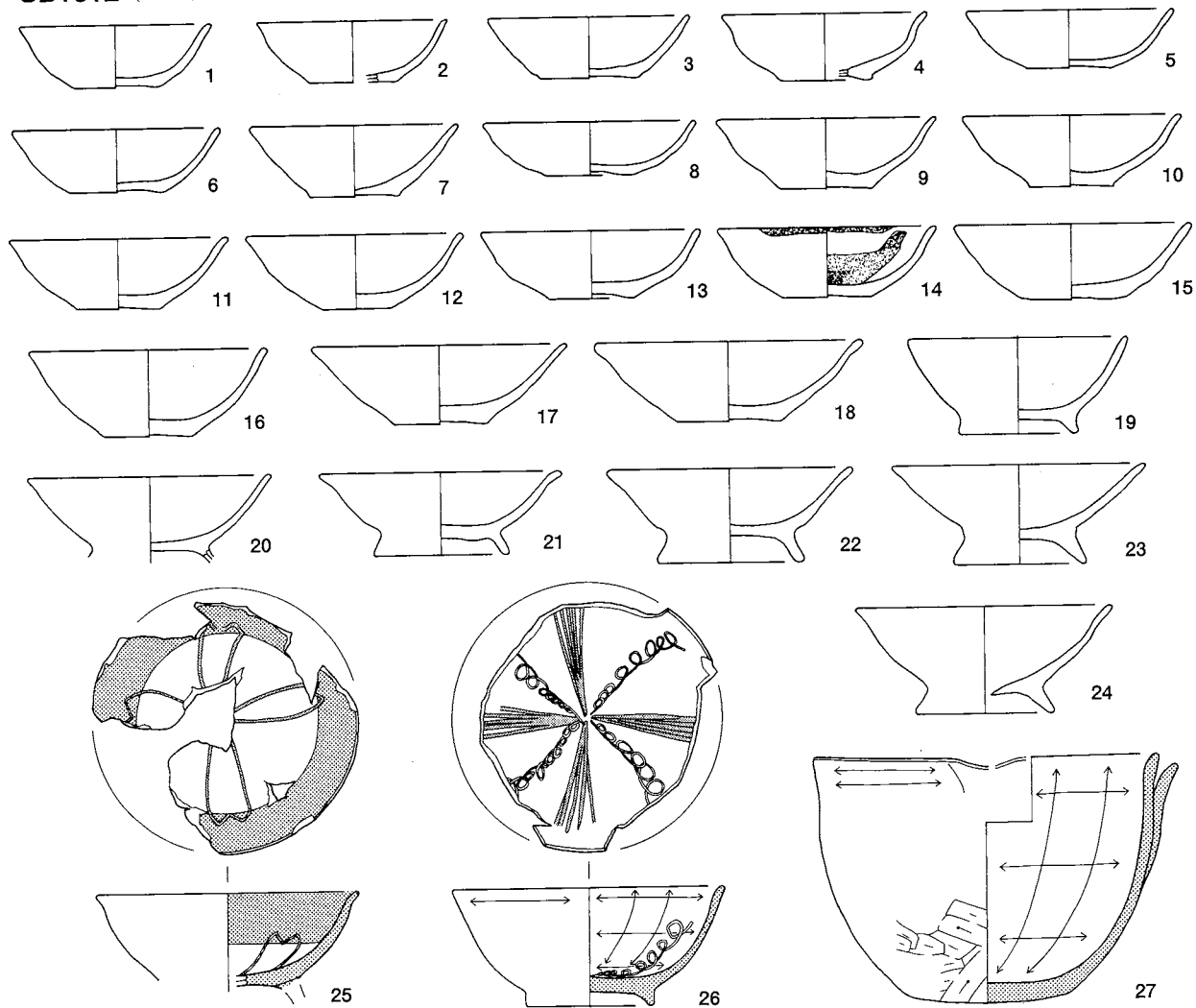

SB1401 (1~29)

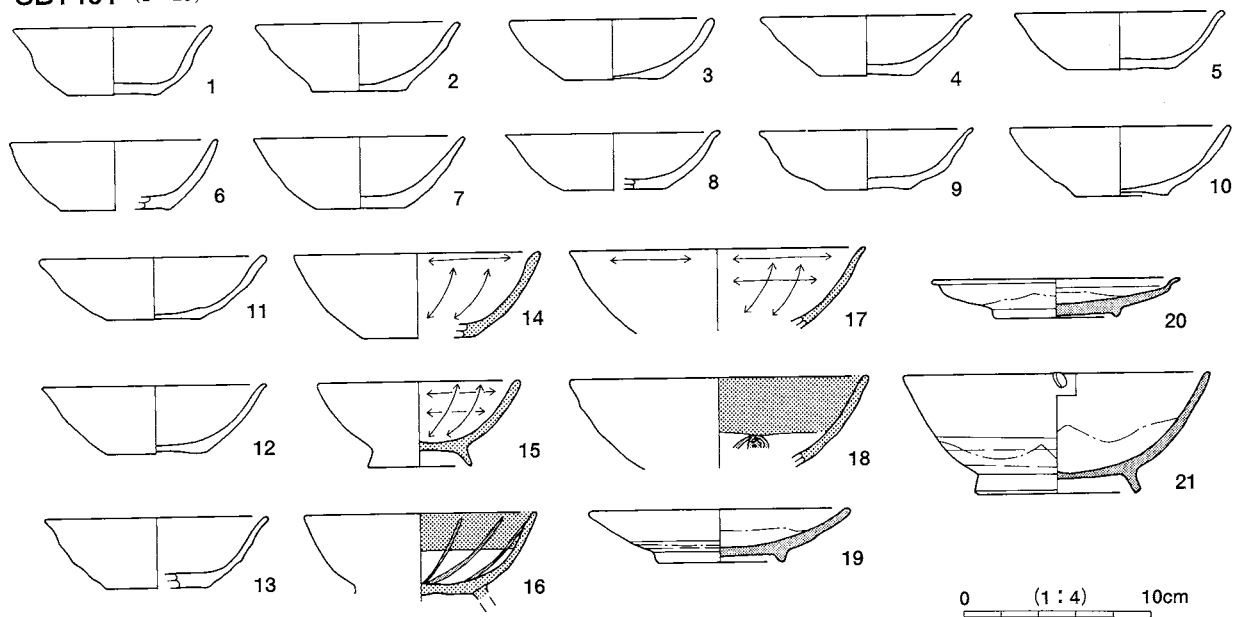

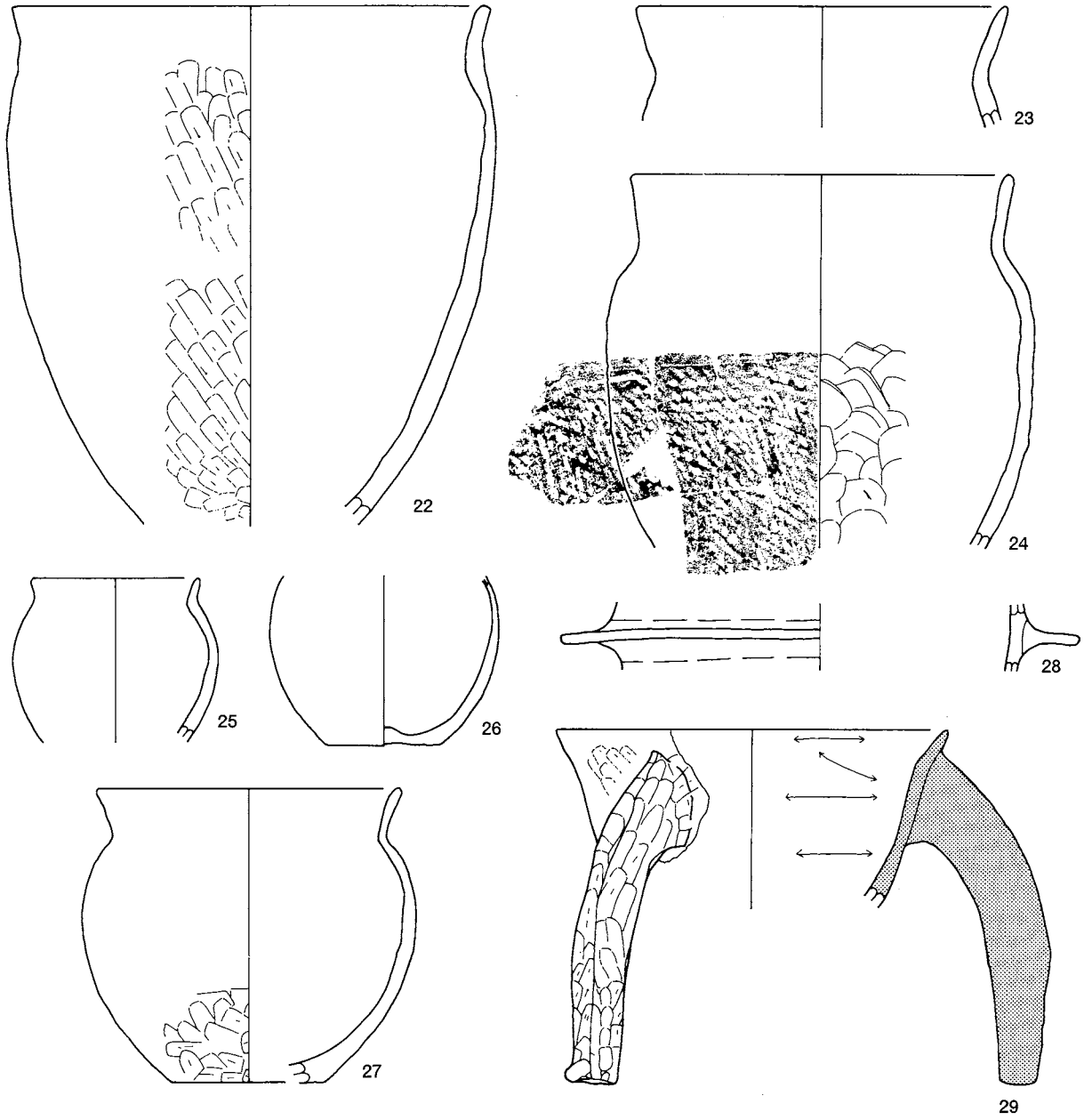

SB1402 (1~46)

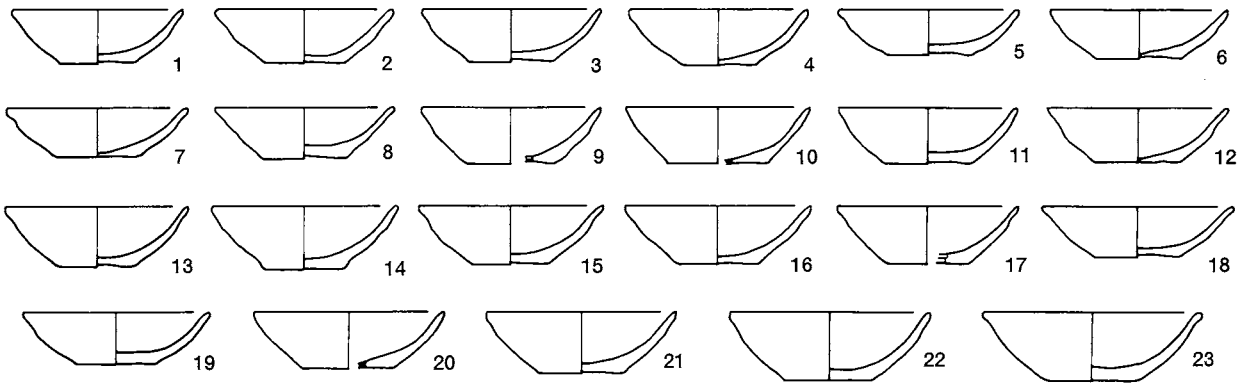

0 (1:4) 10cm

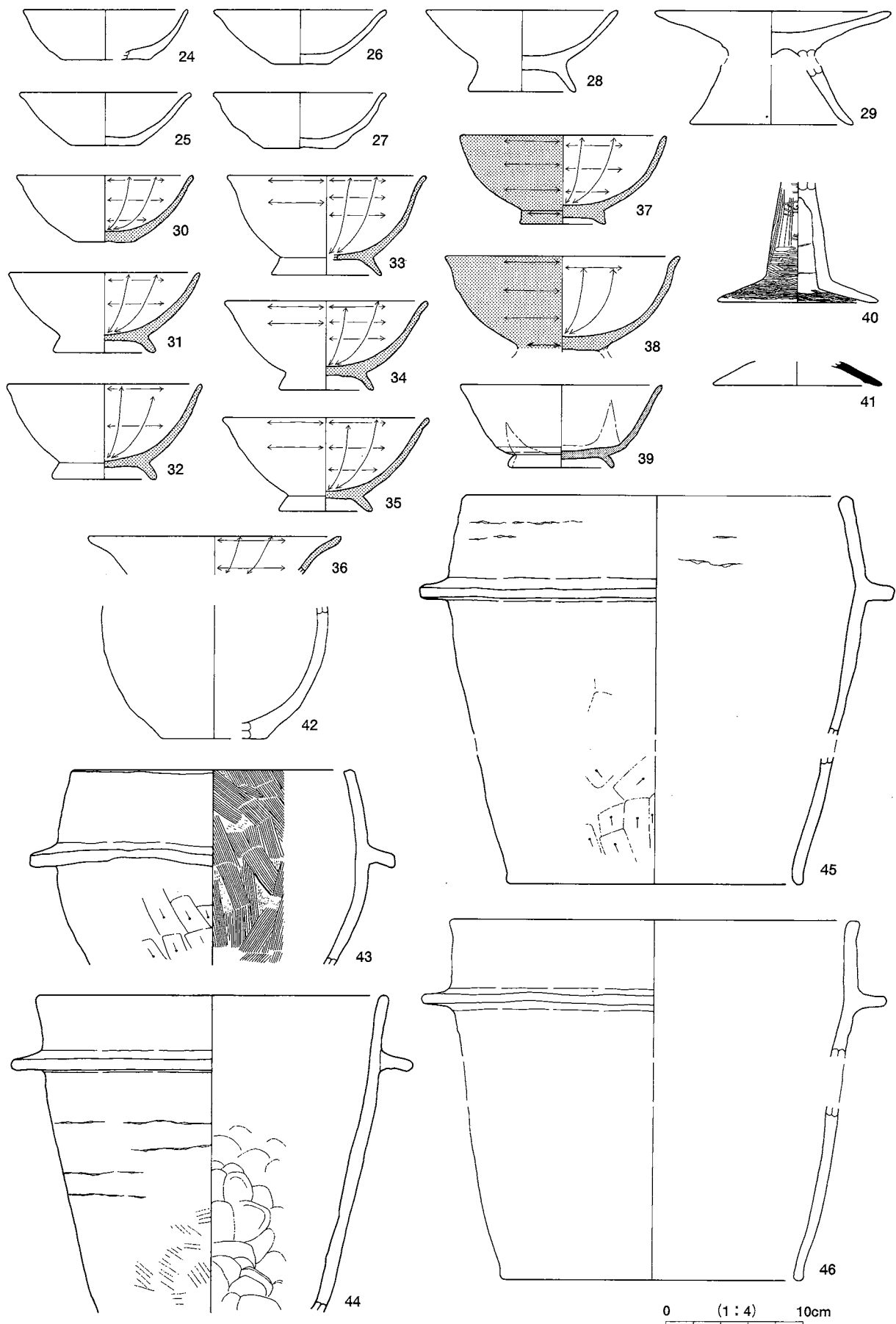

SB1403 (1~3)

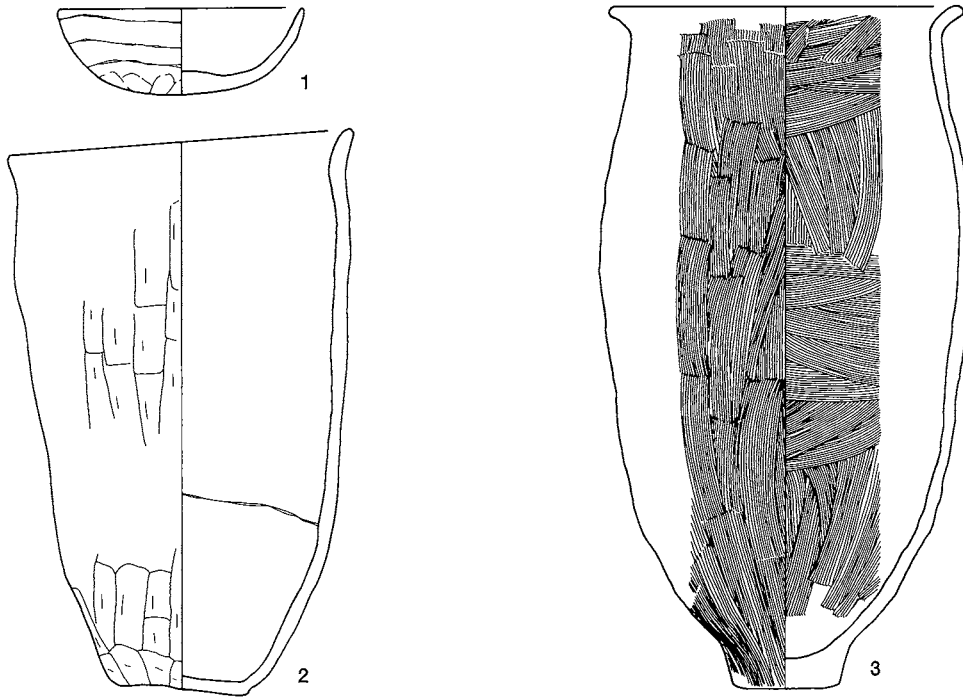

SB1404 (1~4)

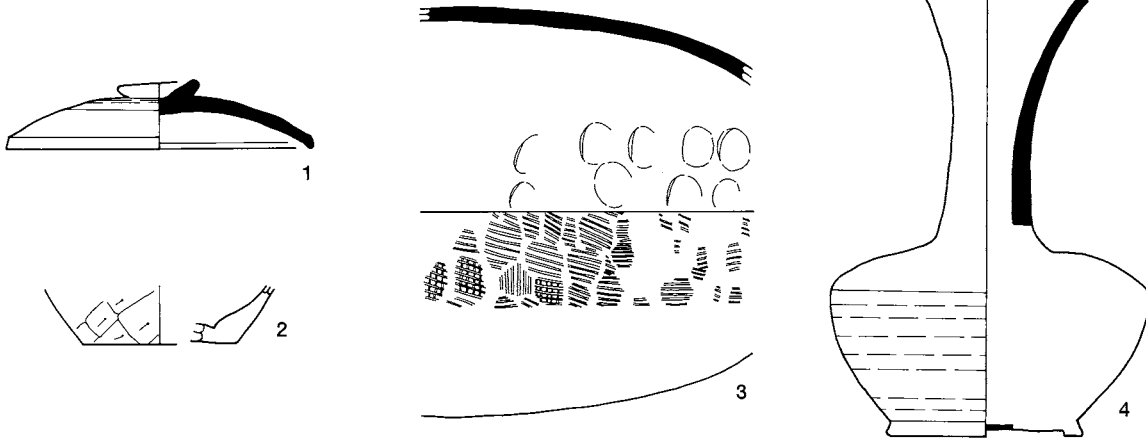

SB1405 (1~26)

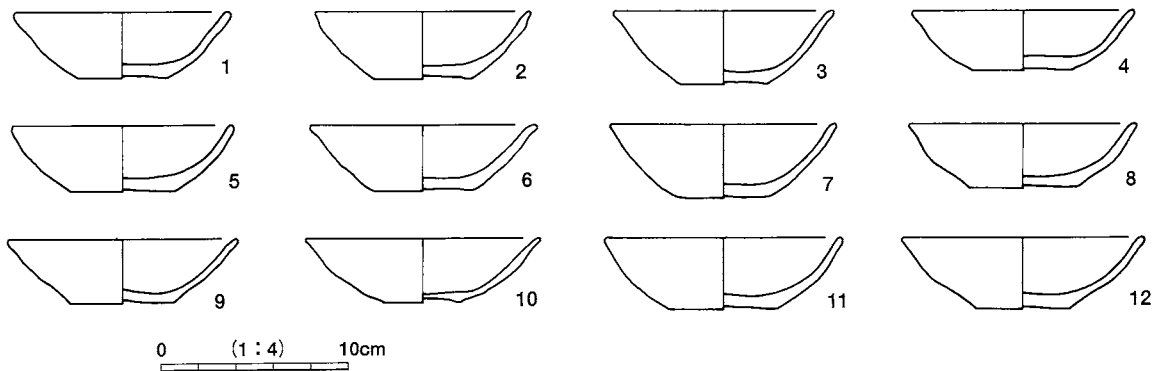

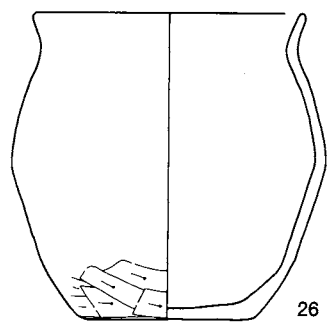
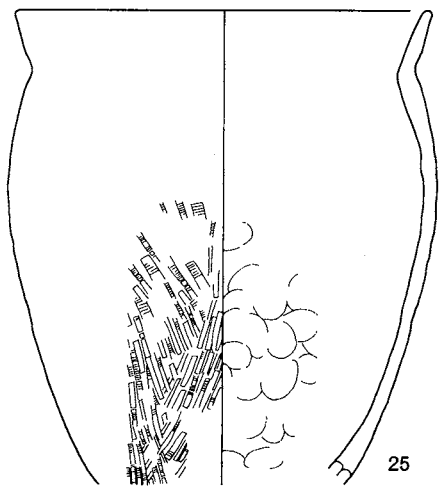
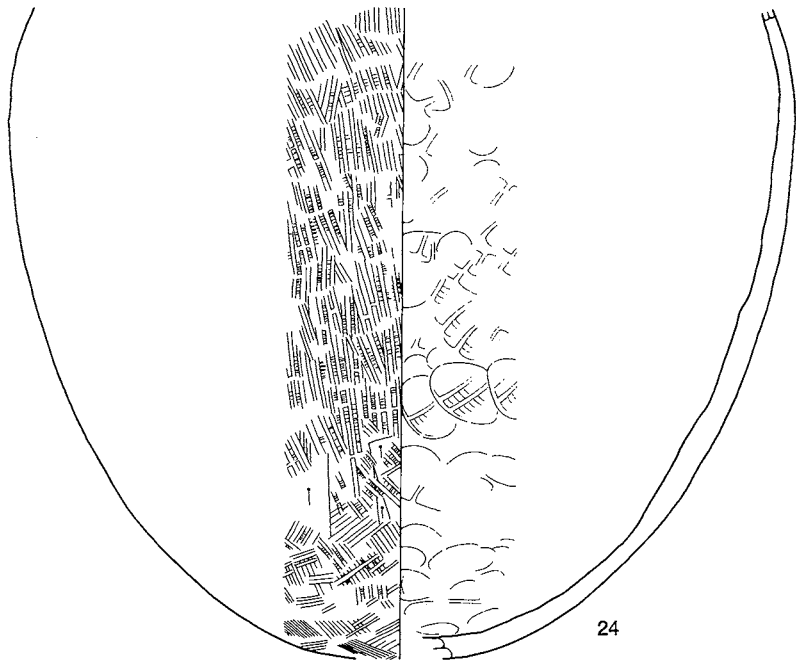
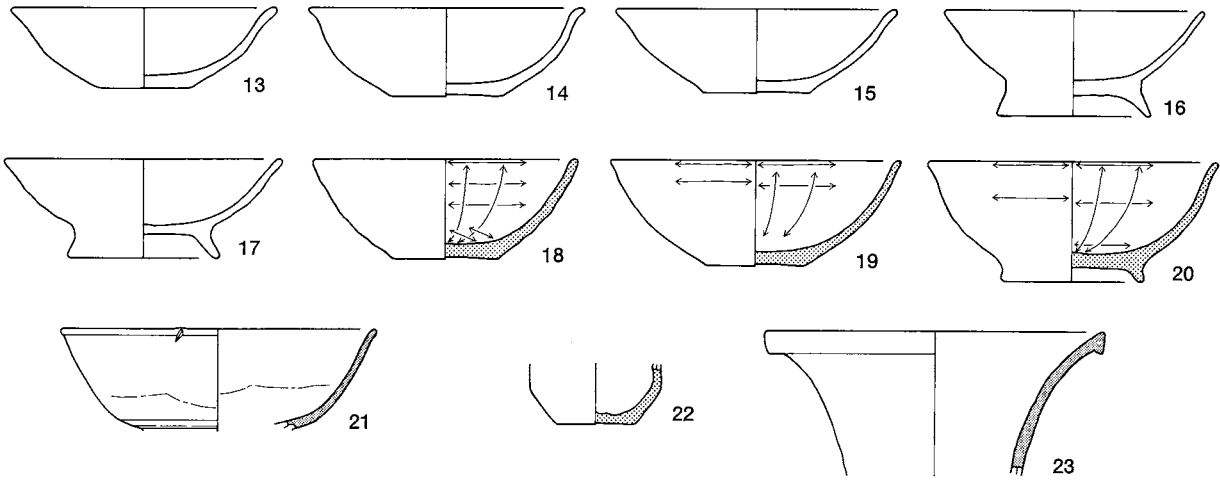

0 (1:4) 10cm

SD1 (1~4)

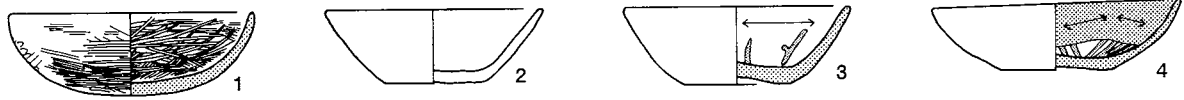

SD2 (1~54)

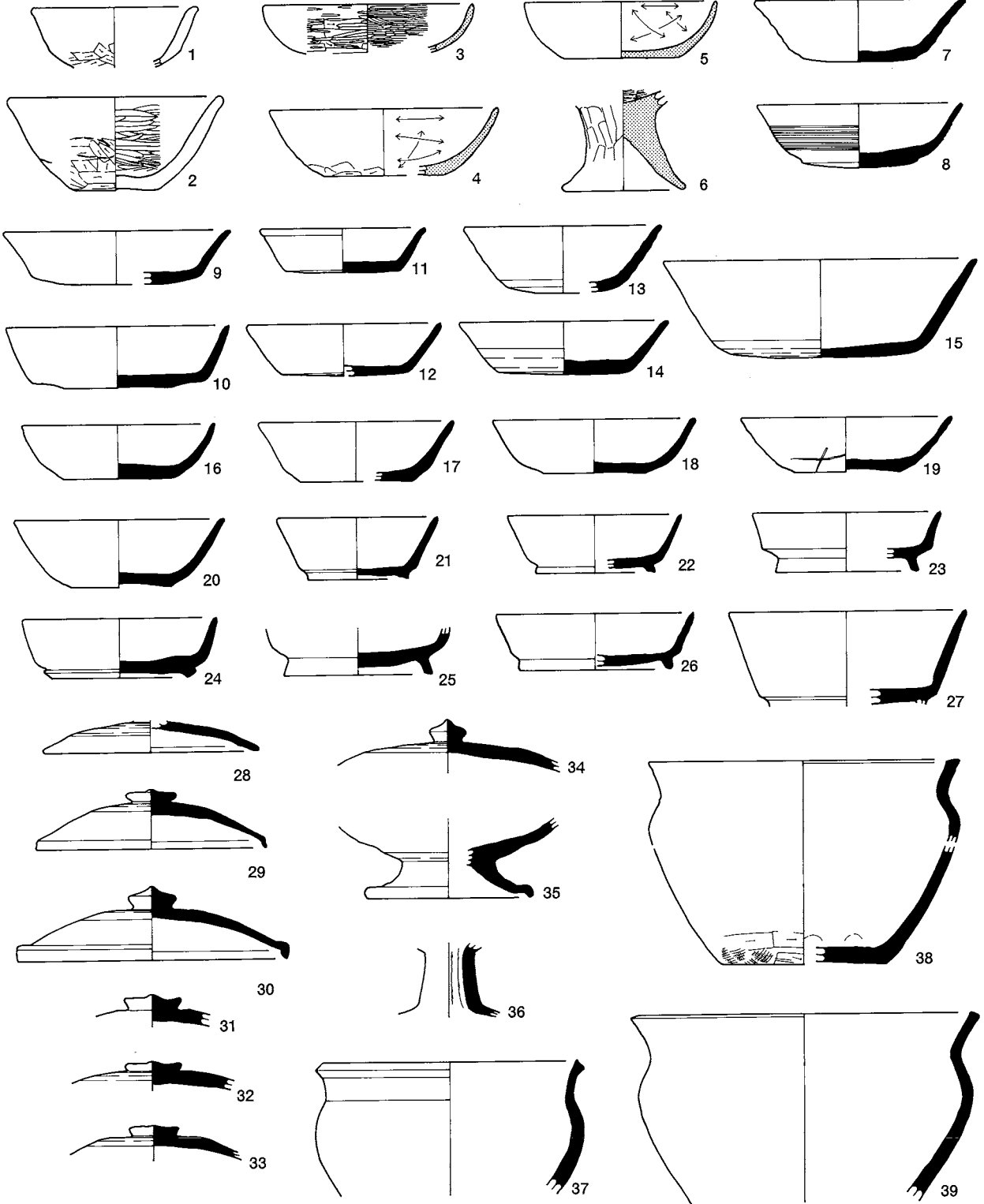

0 (1:4) 10cm

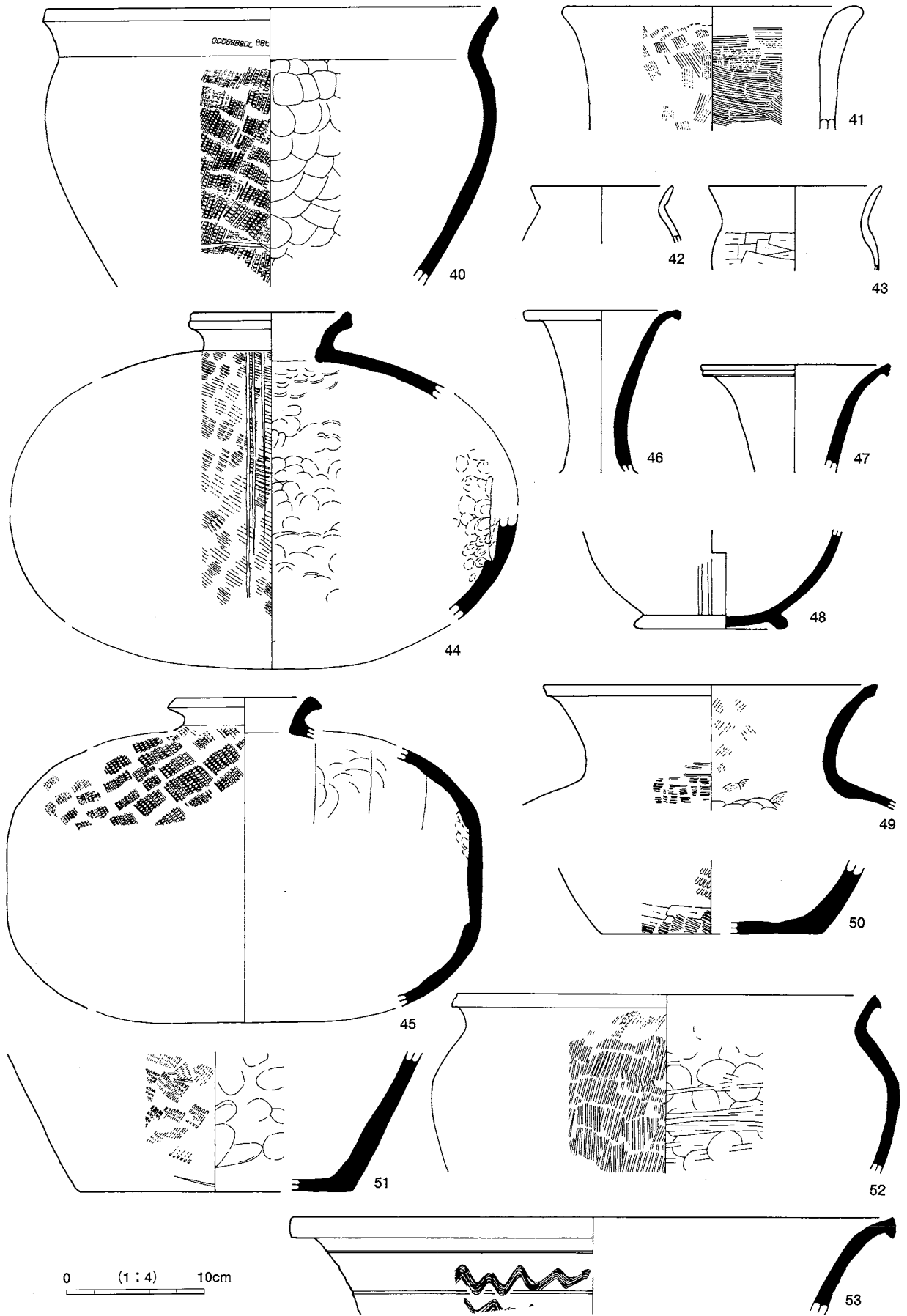

SD3 (1~17)

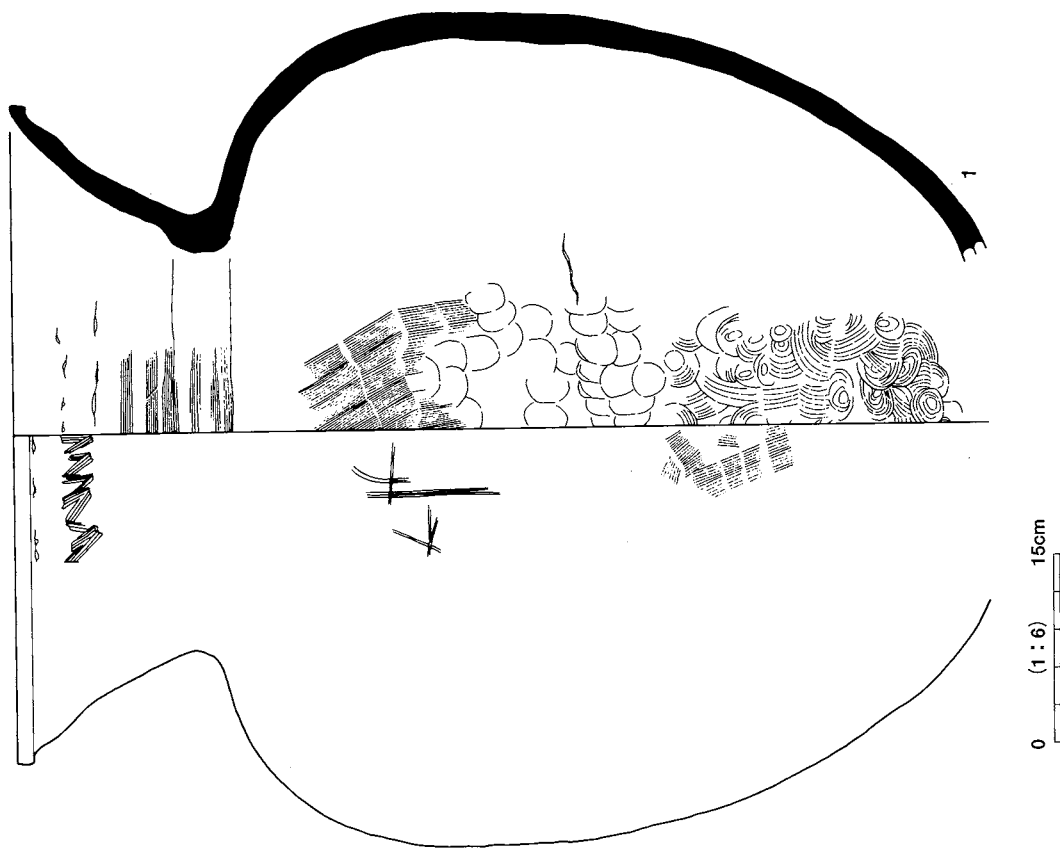

SD2

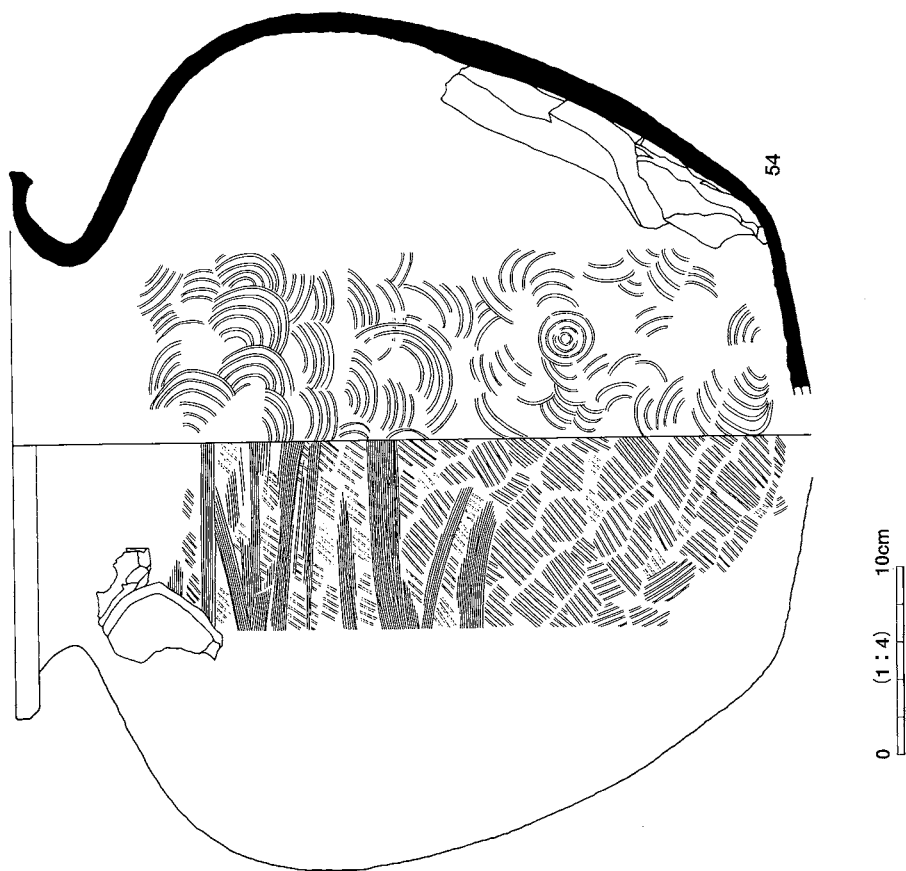

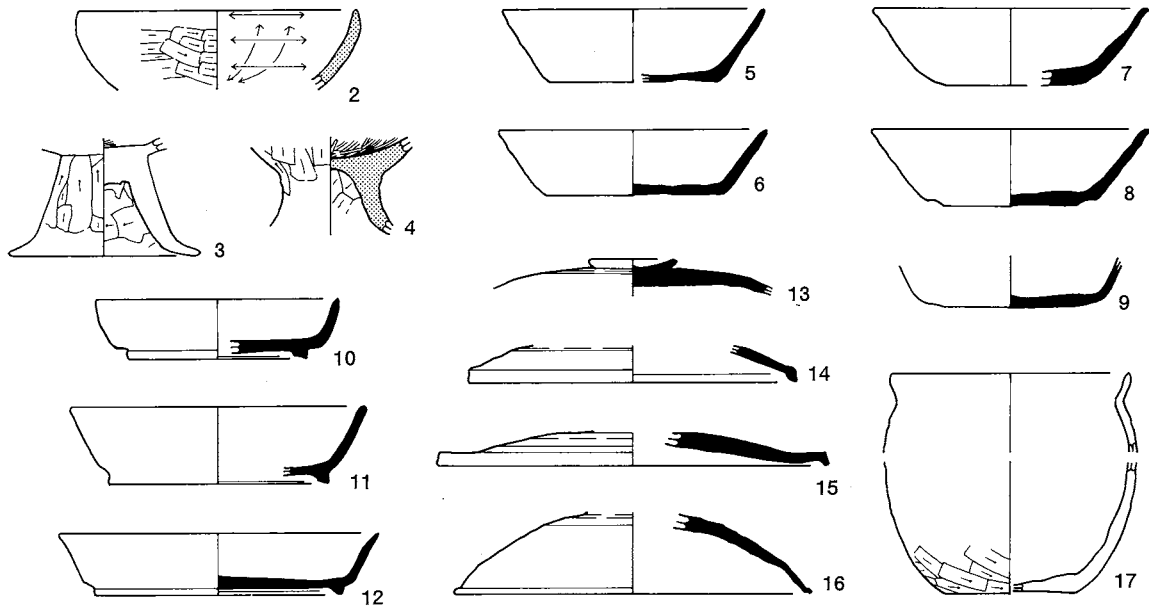

SD9



SD10 (1~3)

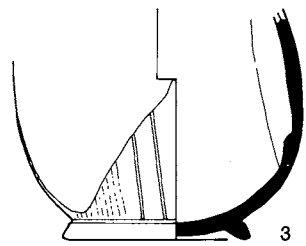
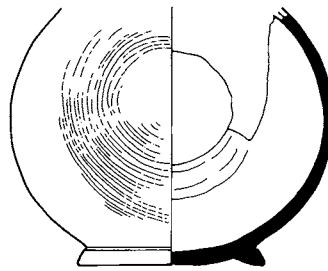
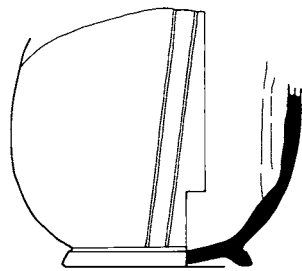
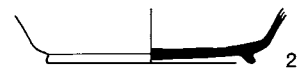

SD18 (1·2)

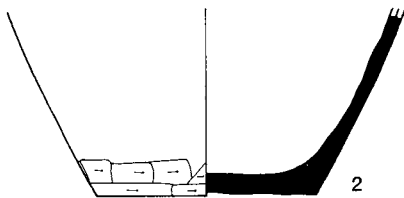
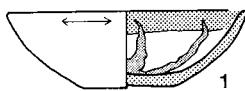

SD45 (1~7)

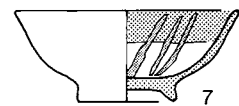
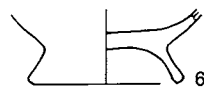
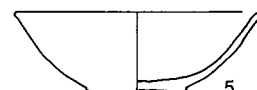
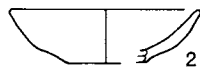
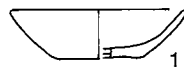

SD24

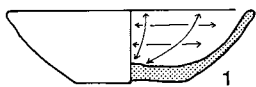

SD46 (1~6)

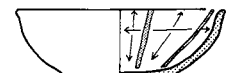
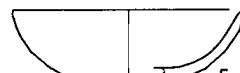
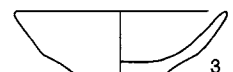

0 (1:4) 10cm

SD51

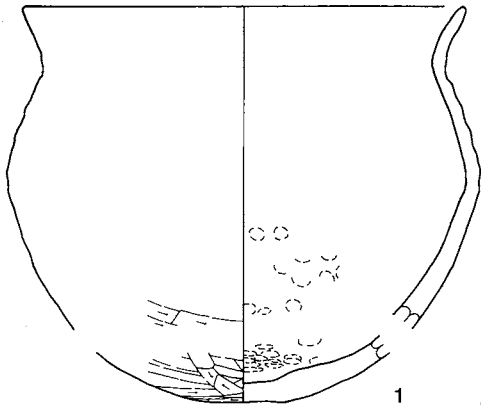

SD58 (1~6)

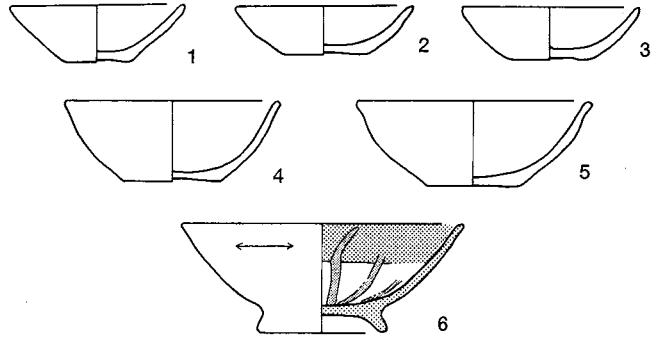

SD53

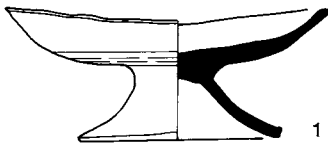

SD1001 (1~13)

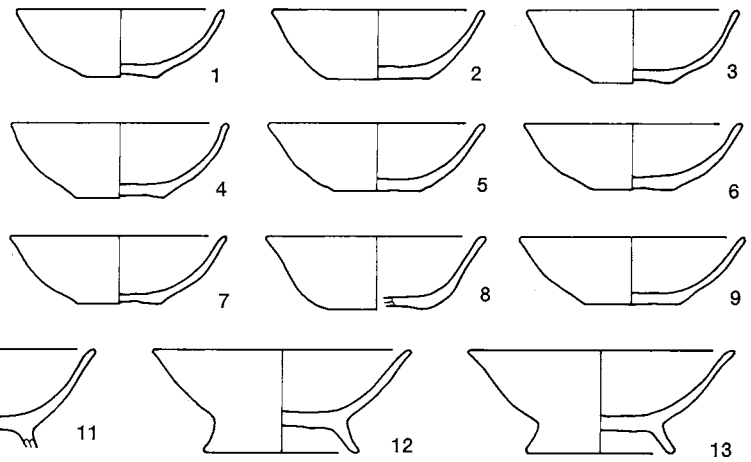

SD1009 1層 (1~14)

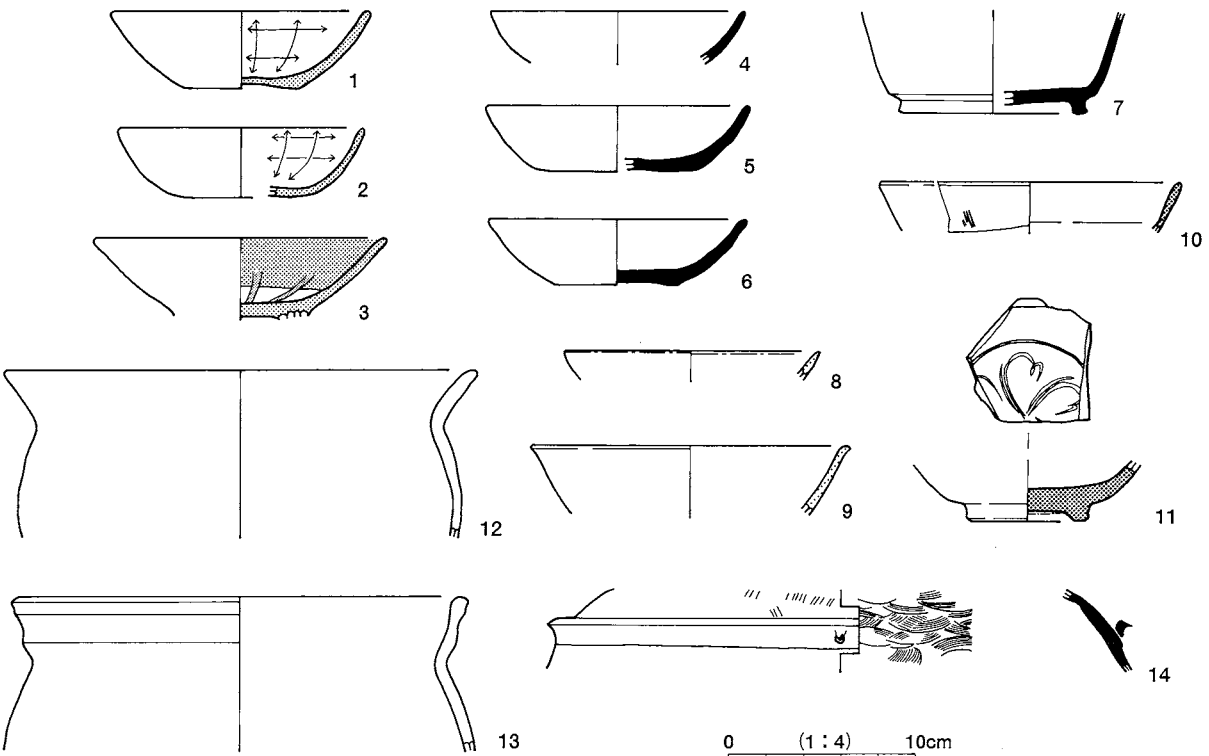

SD1009 2層 (15~38)

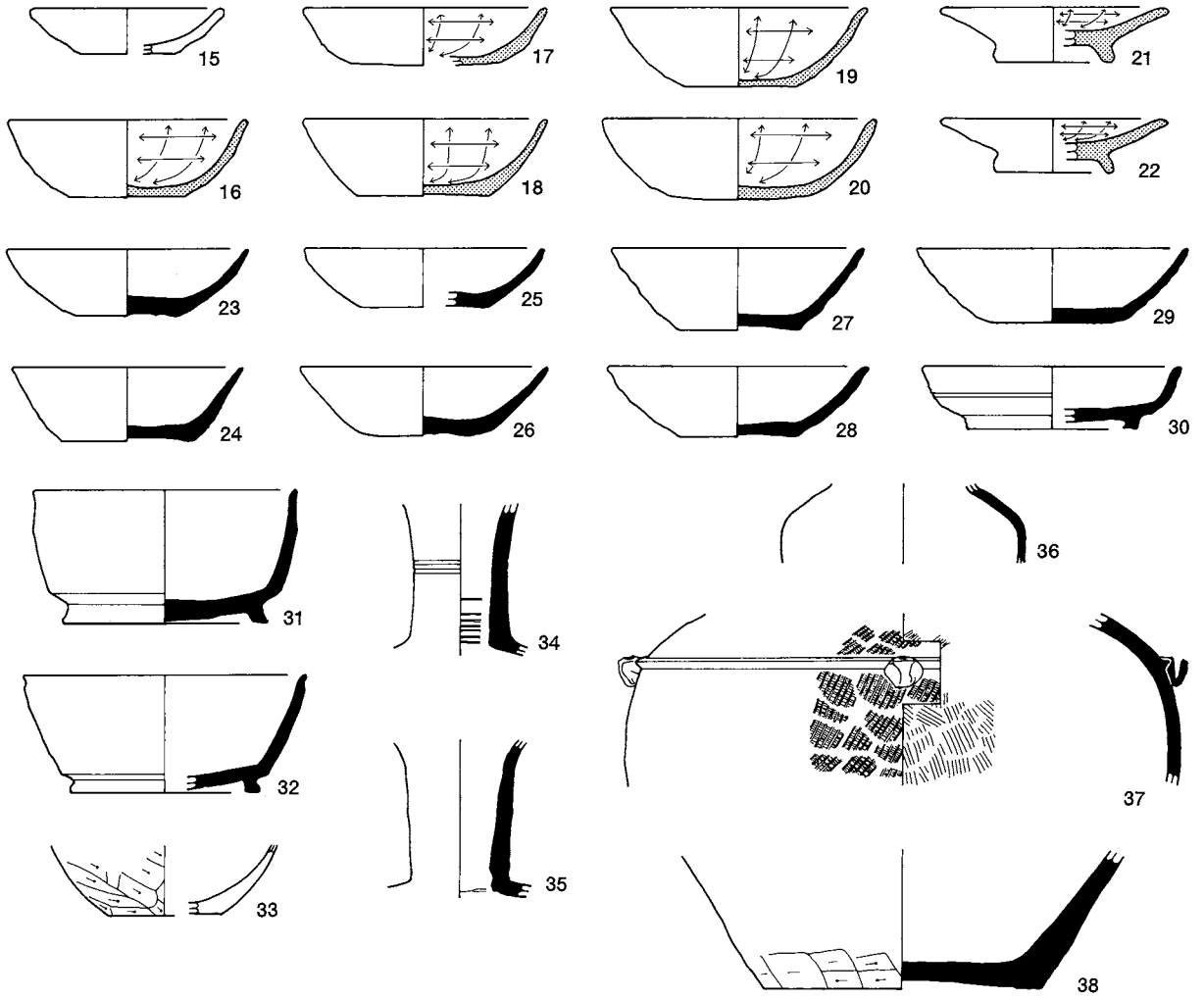

SD1009 3層 (39・40)



SD1009 覆土一括 (41~46)

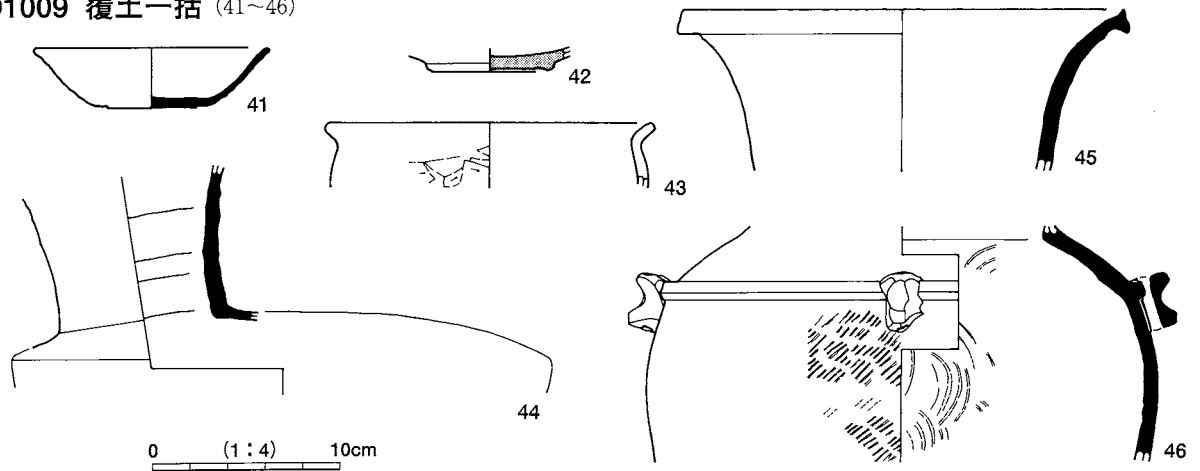

SD1014

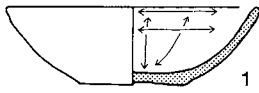

SD1015 (1・2)

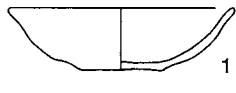

SD1018 (1・2)



SD1152 (1・2)

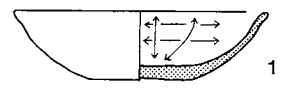

SD1016

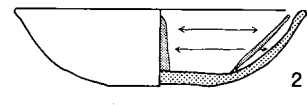
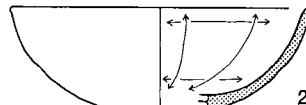
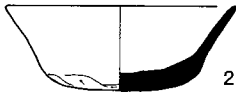
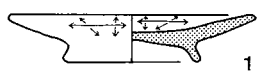

SD1021 (1~8)

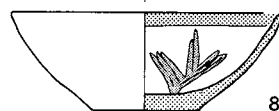
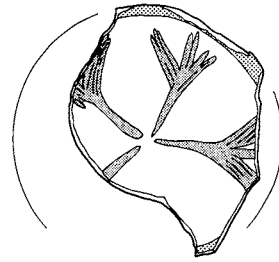
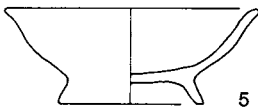
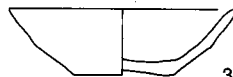
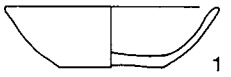

SD1173 (1~3)

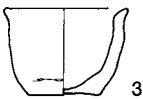
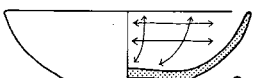
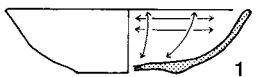

SD1191

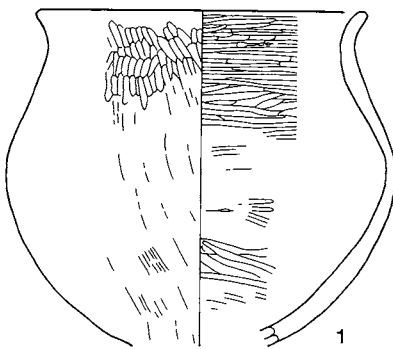

SD1409 (1・2)

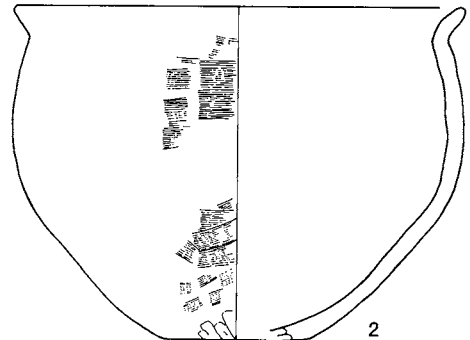
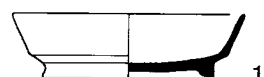

SC1 (1~20)

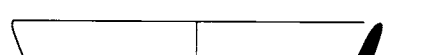
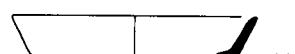
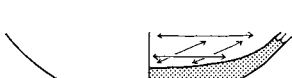
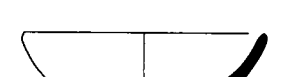
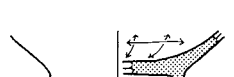
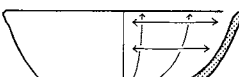

0 (1:4) 10cm

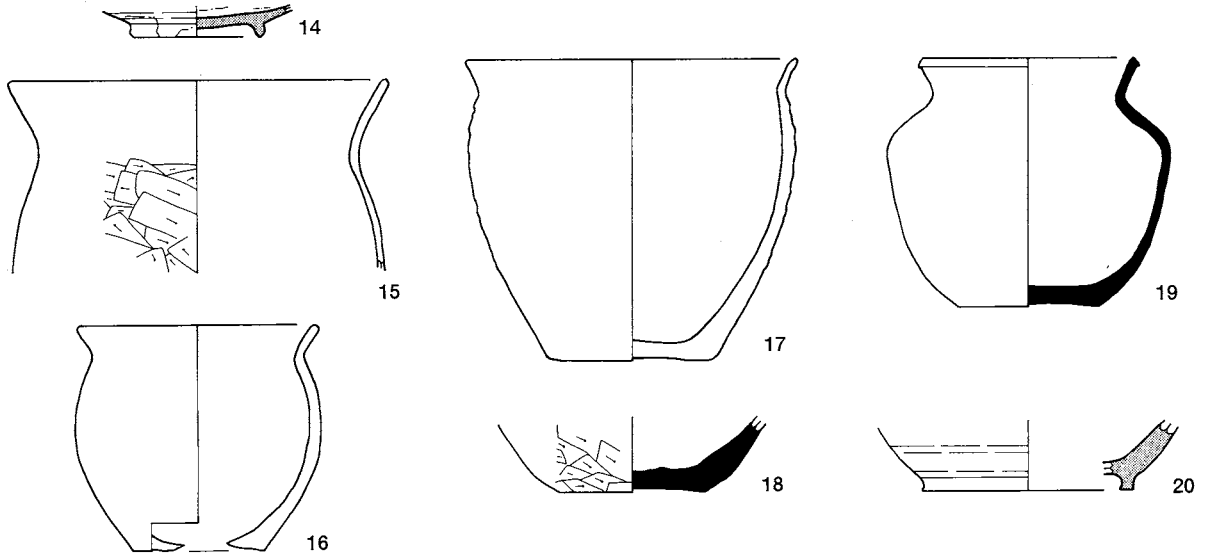

SK556 (1~3)

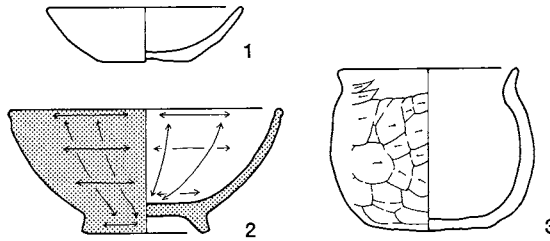

SK1035



SK1094

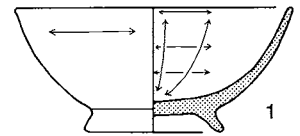

SK1117

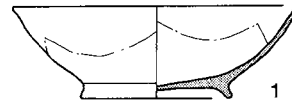

SK1226 (1~5)

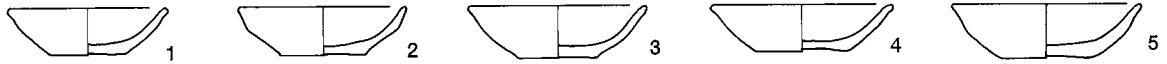

SK76 (1·2)

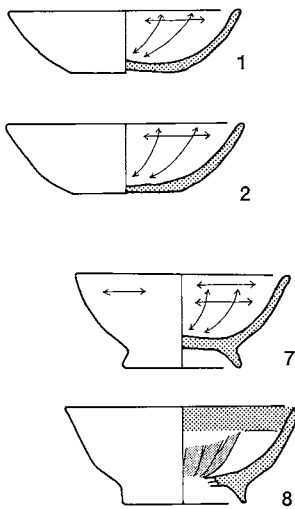

SK84 (1~17)

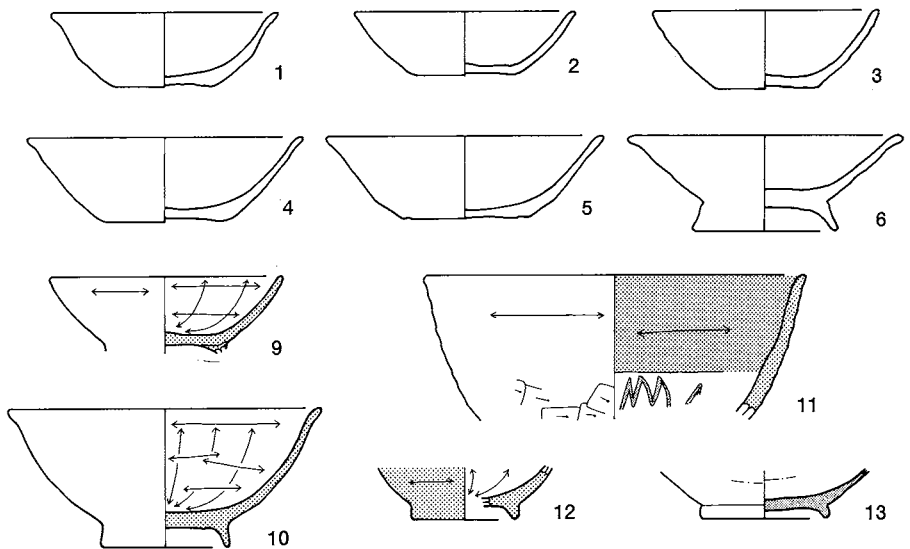

0 (1:4) 10cm

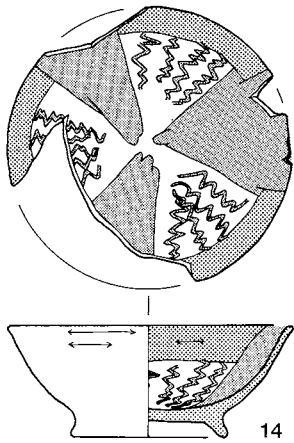

SK146

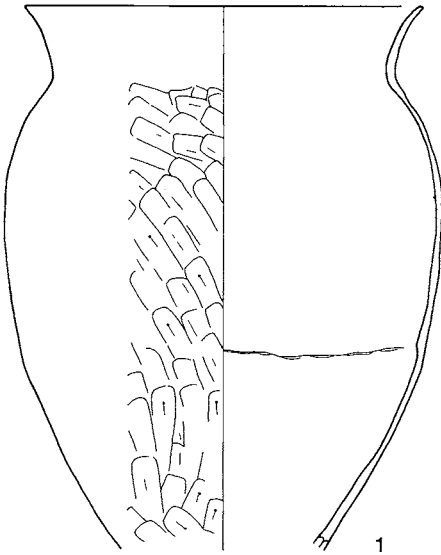

SK111 (1・2)

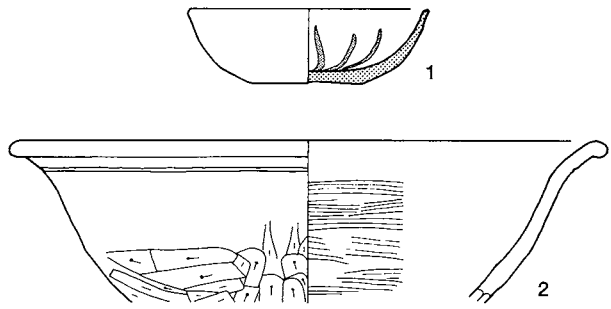

SK128 (1・2)

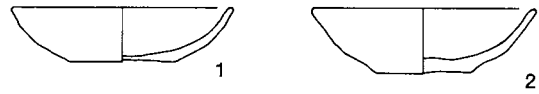

SK502 (1~22)

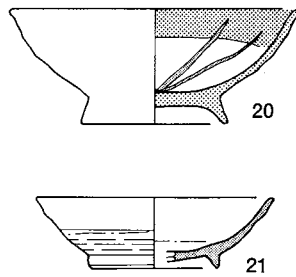
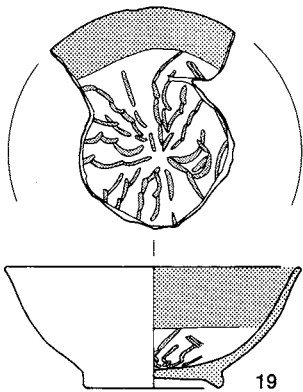
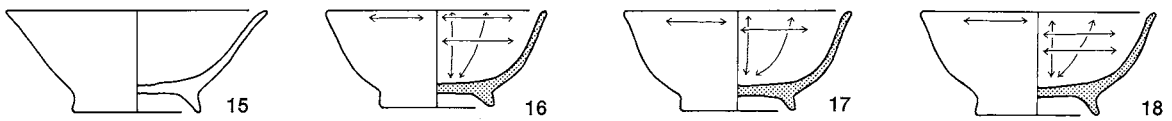
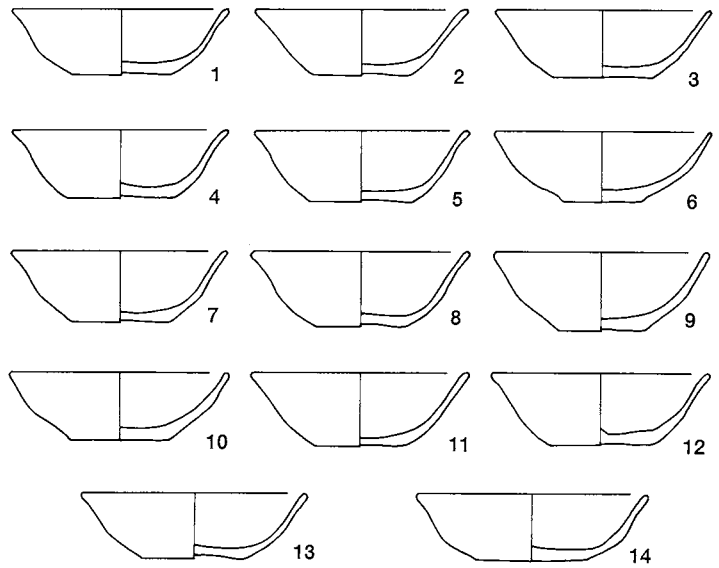

0 (1:4) 10cm

SK504 (1·2)

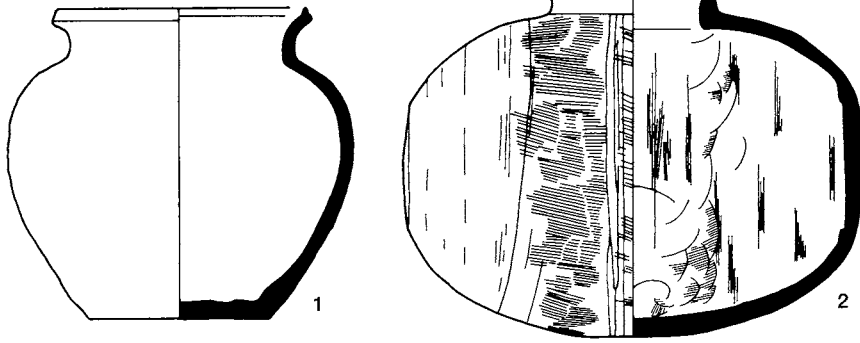

SK509 (1·2)

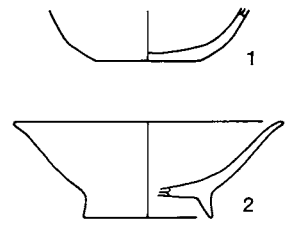

SK505 (1~3)

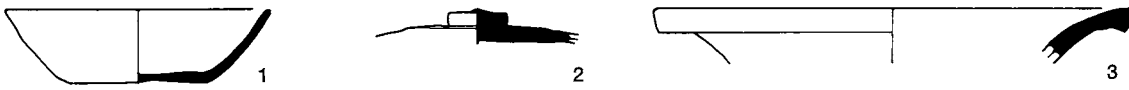

SK515

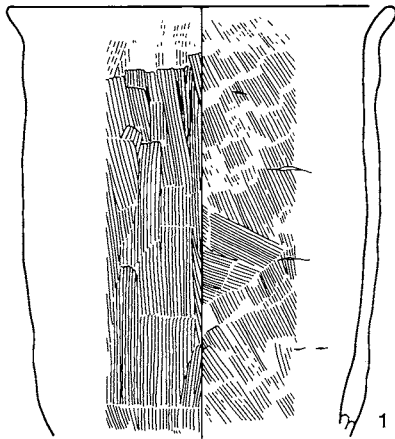

SK522 (1~6)

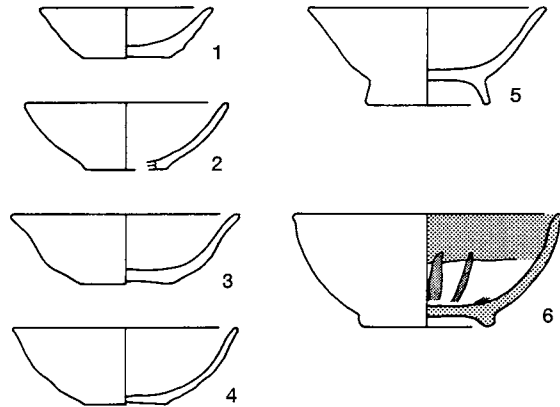

SK1034 (1~36)

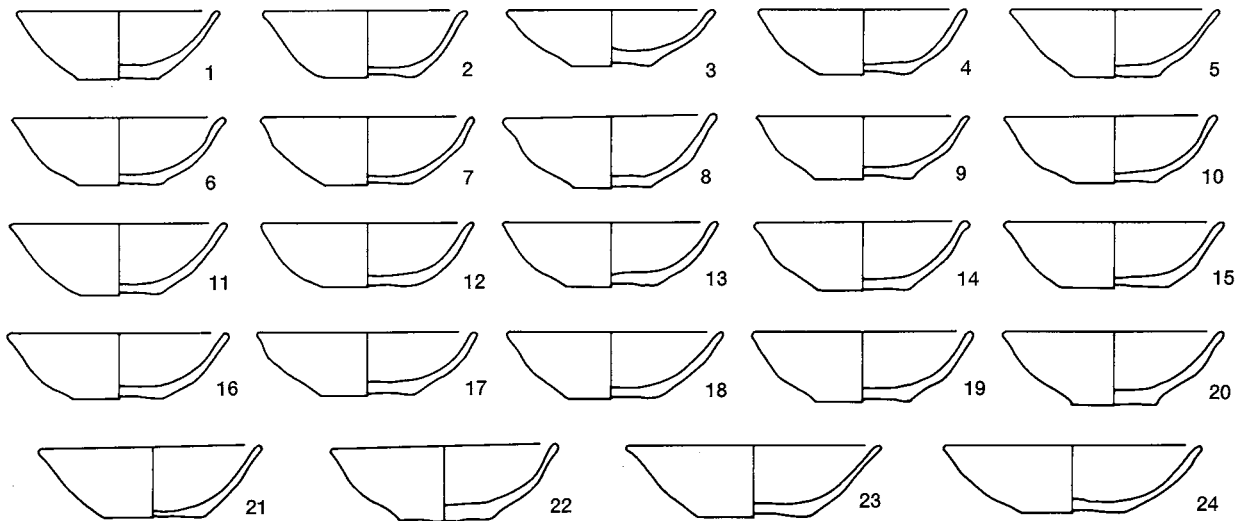

0 (1:4) 10cm

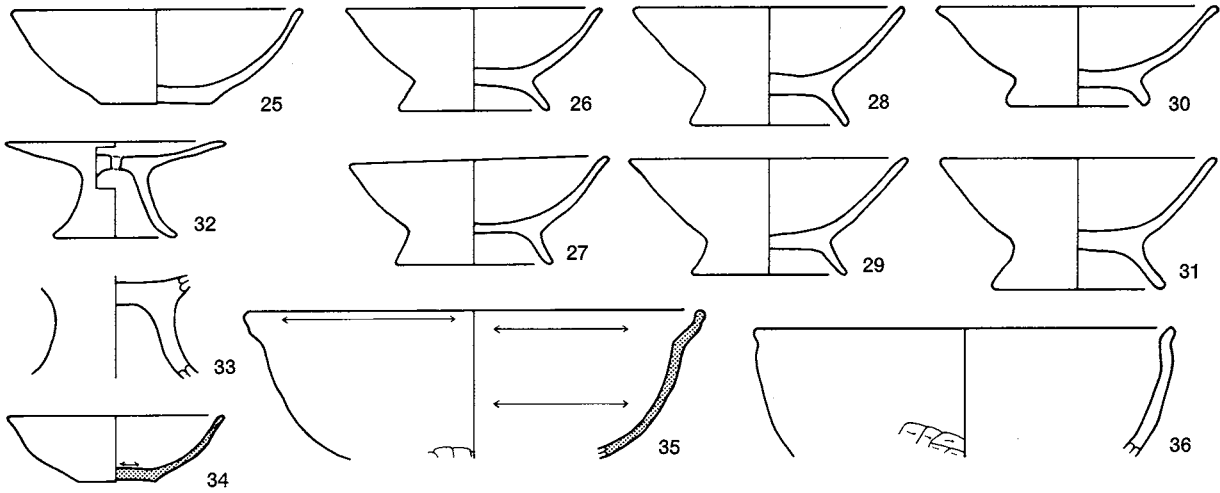

SK1127 (1・2)

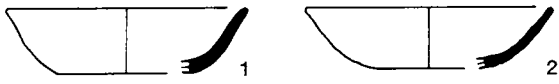

SK1676

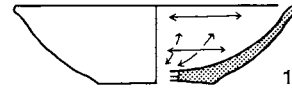

SK2511 (1~3)

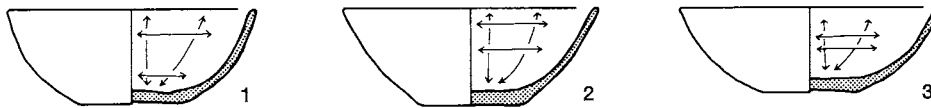

SK3 (1~7)

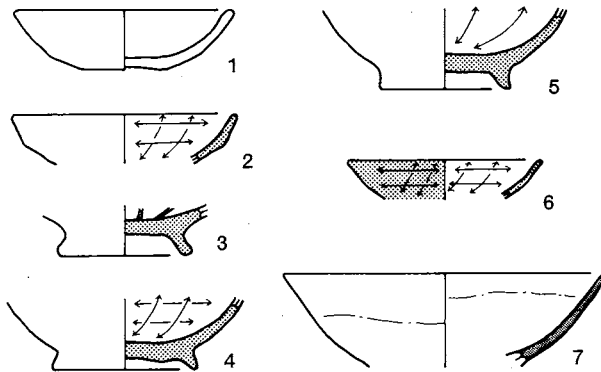

SK26

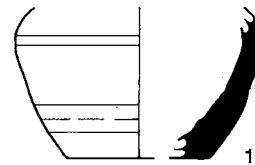

SK19 (1~3)

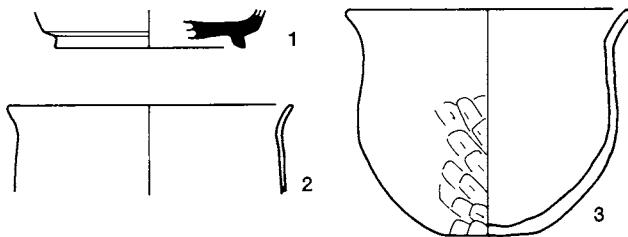

SK30 (1~3)

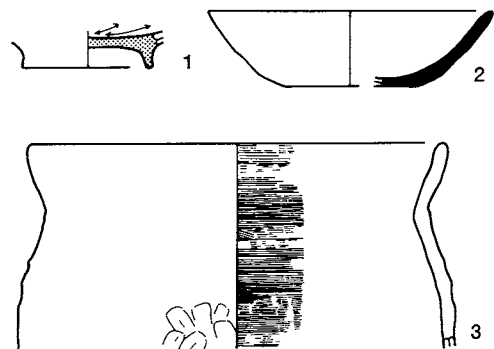

0 (1:4) 10cm

SK32 (1・2)

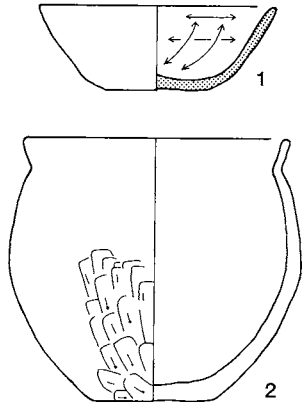

SK33 (1~4)

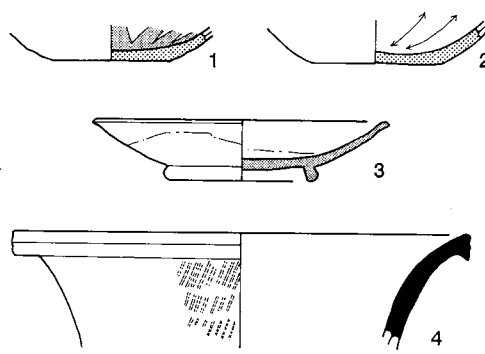

SK36 (1・2)

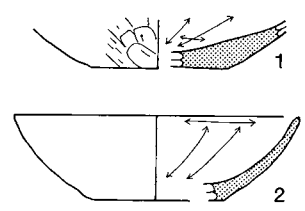

SK44

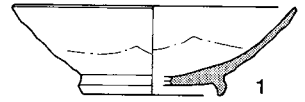

SK47 (1~11)

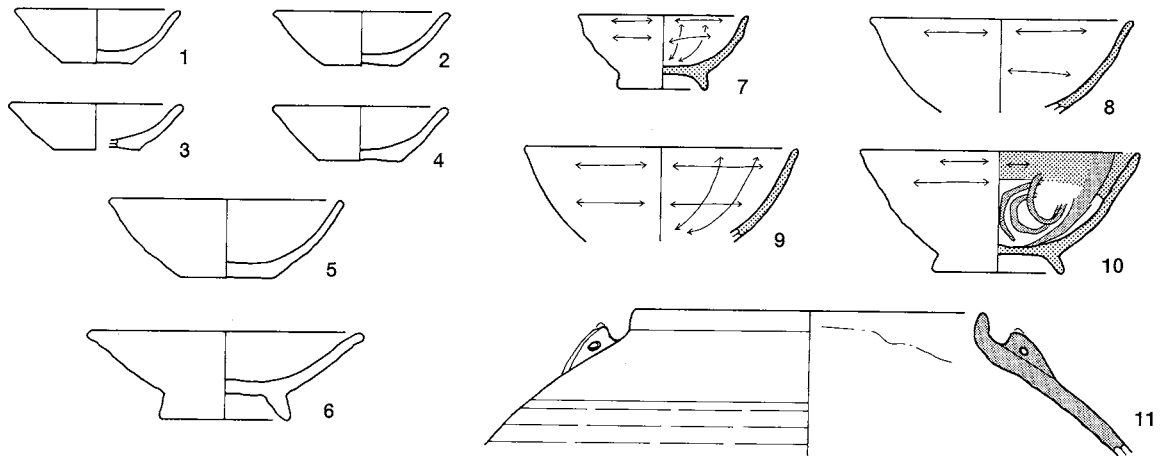

SK51 (1~12)

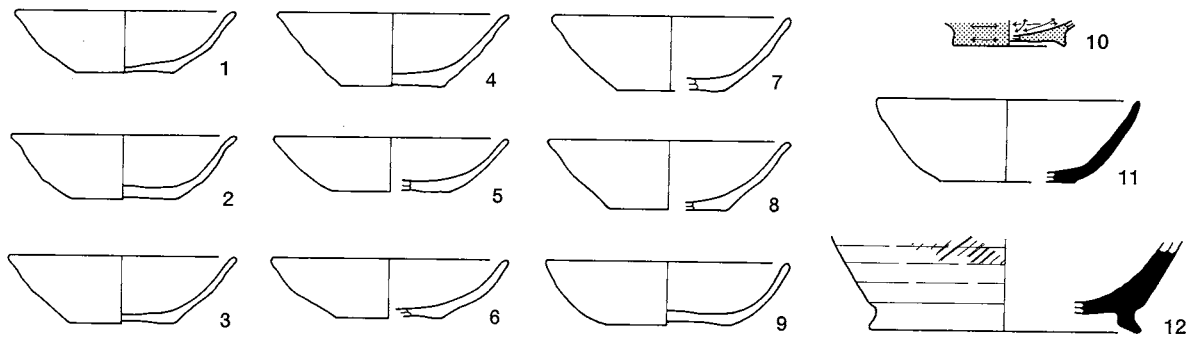

SK52 (1~4)

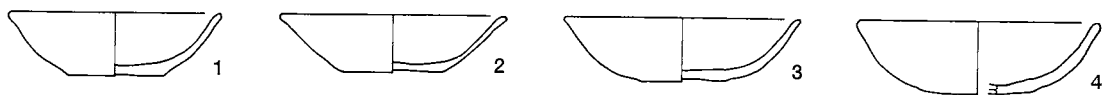

SK532

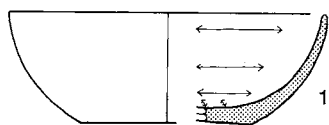

SK94 (1~17)

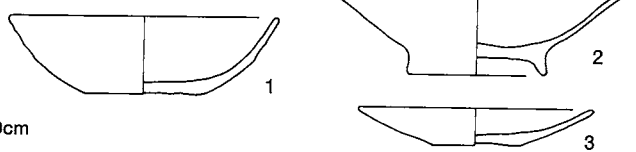

0 (1:4) 10cm

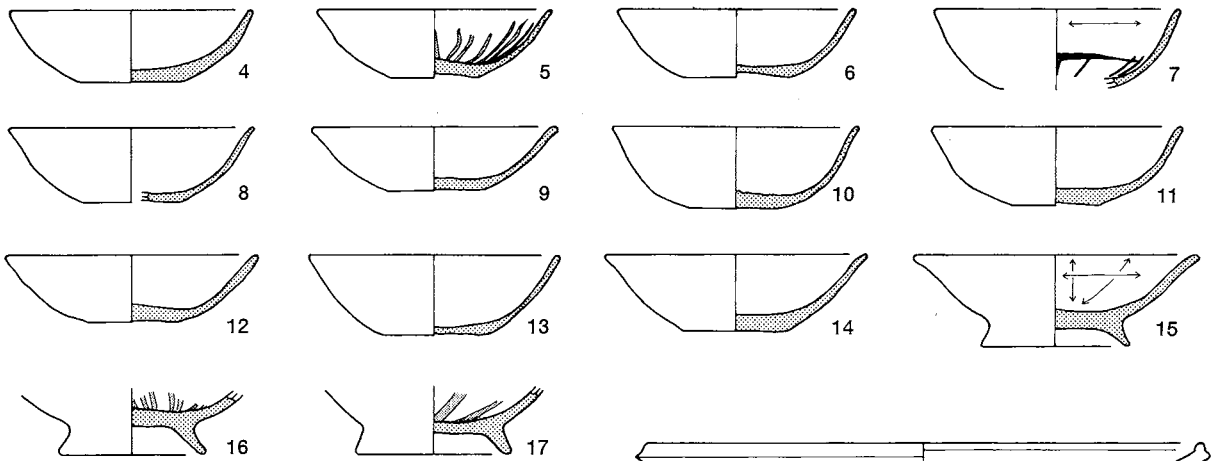

SK95 (1~9)

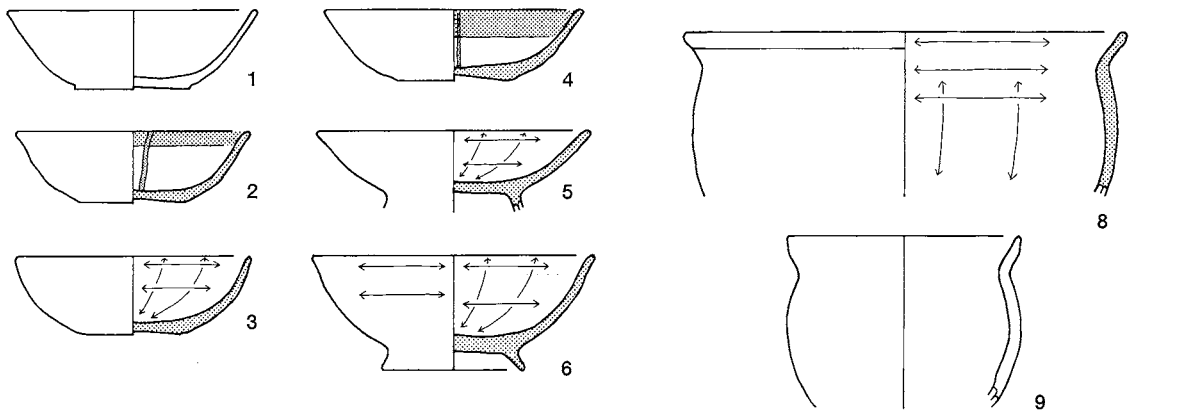

SK113 (1~13)

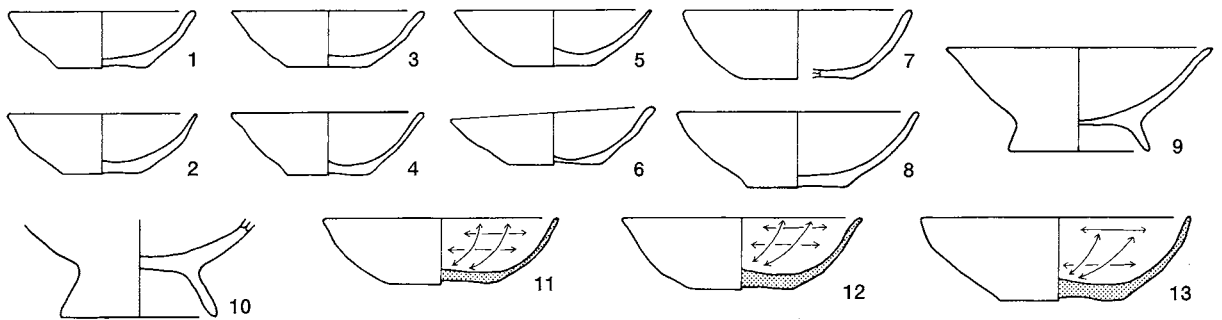

SK124 (1~3)

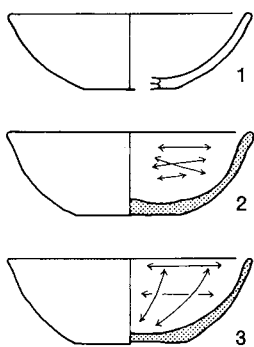

SK126 (1~5)

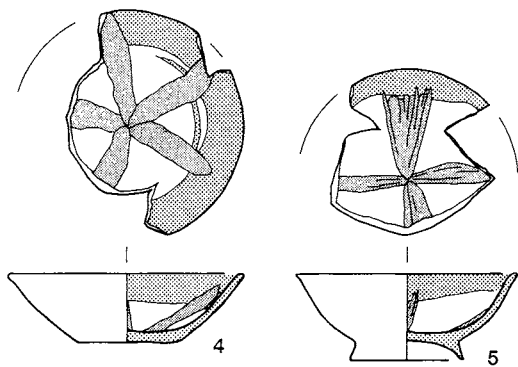
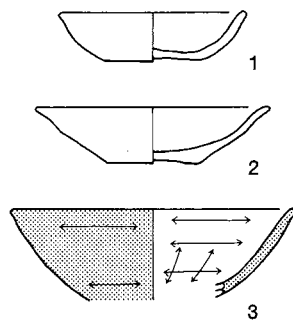

0 (1:4) 10cm

SK123 (1~52)

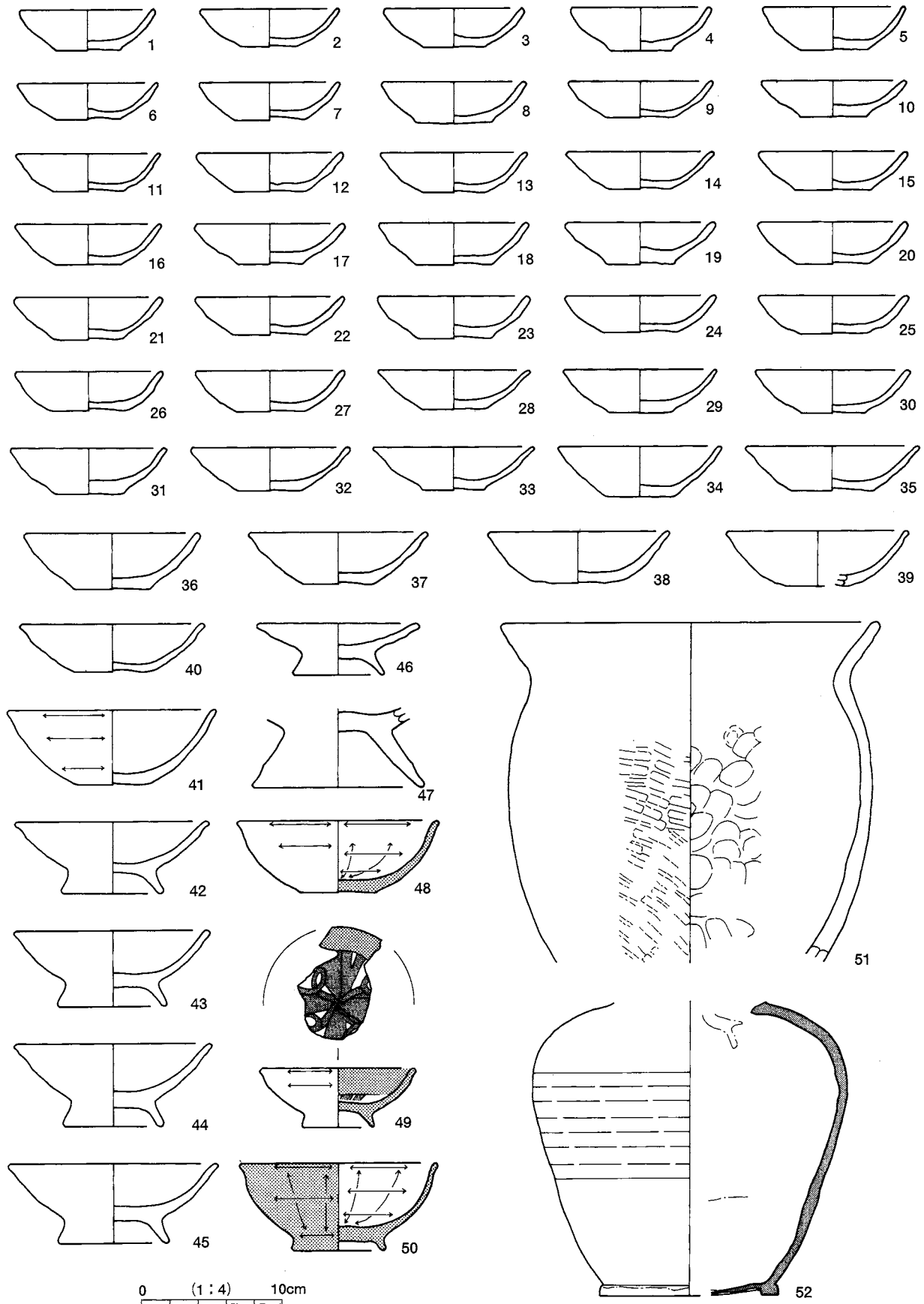

SK130 (1~7)

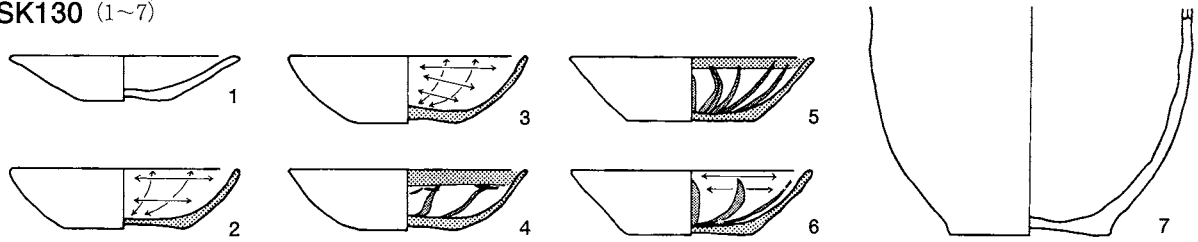

SK231 (1~27)

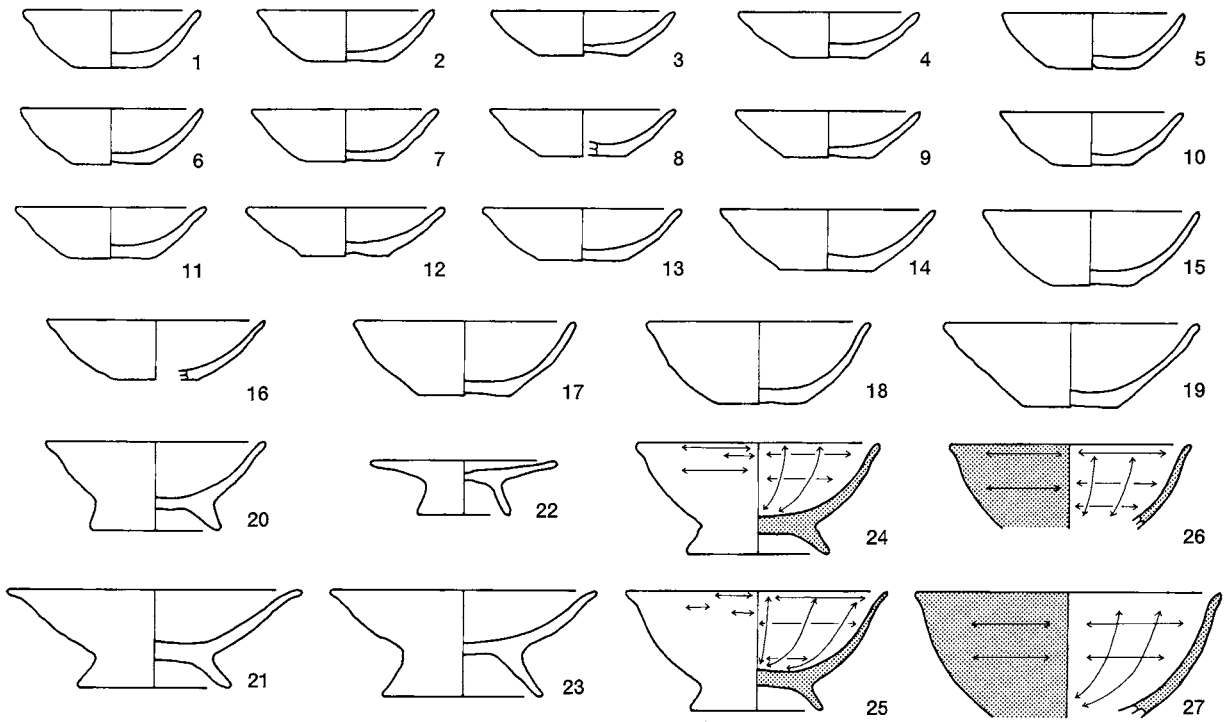

SK232

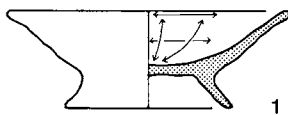

SK233

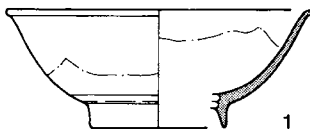

SK348

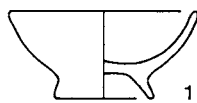

SK347 (1~6)

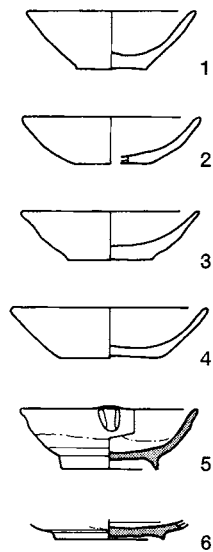

SK349 (1~7)

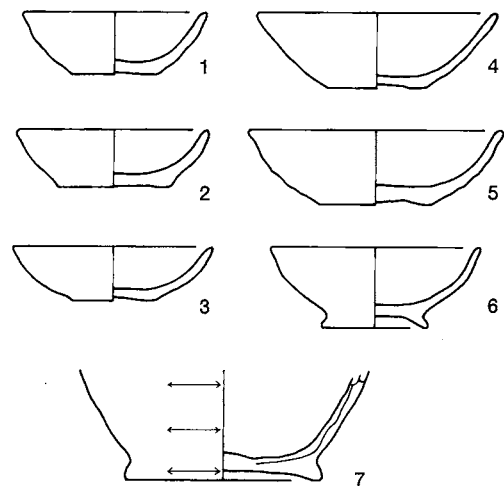

0 (1:4) 10cm

SK1001

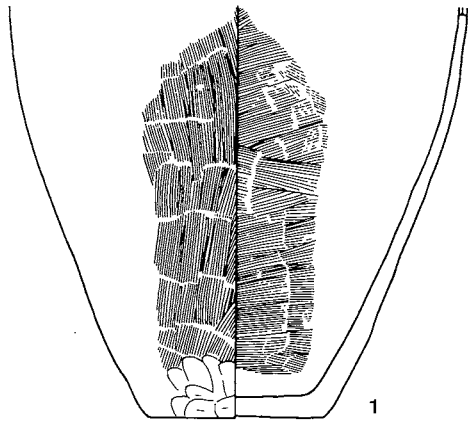

SK1021 (1~4)

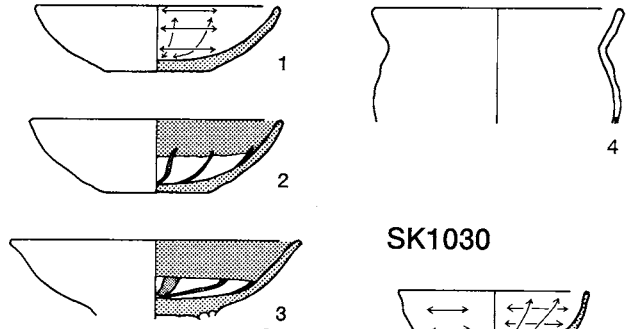

SK1030

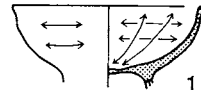

SK1028 (1~15)

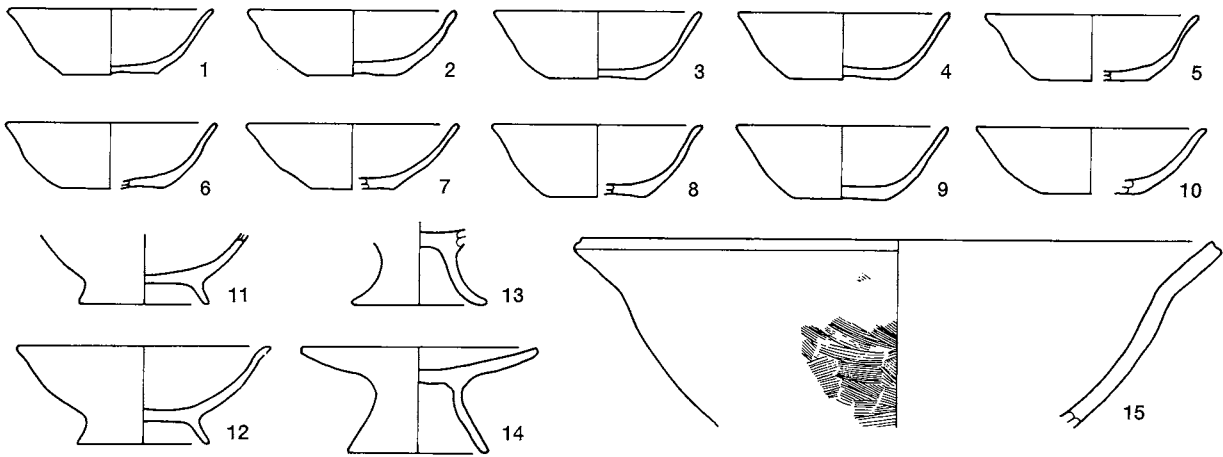

SK1040 (1~7)

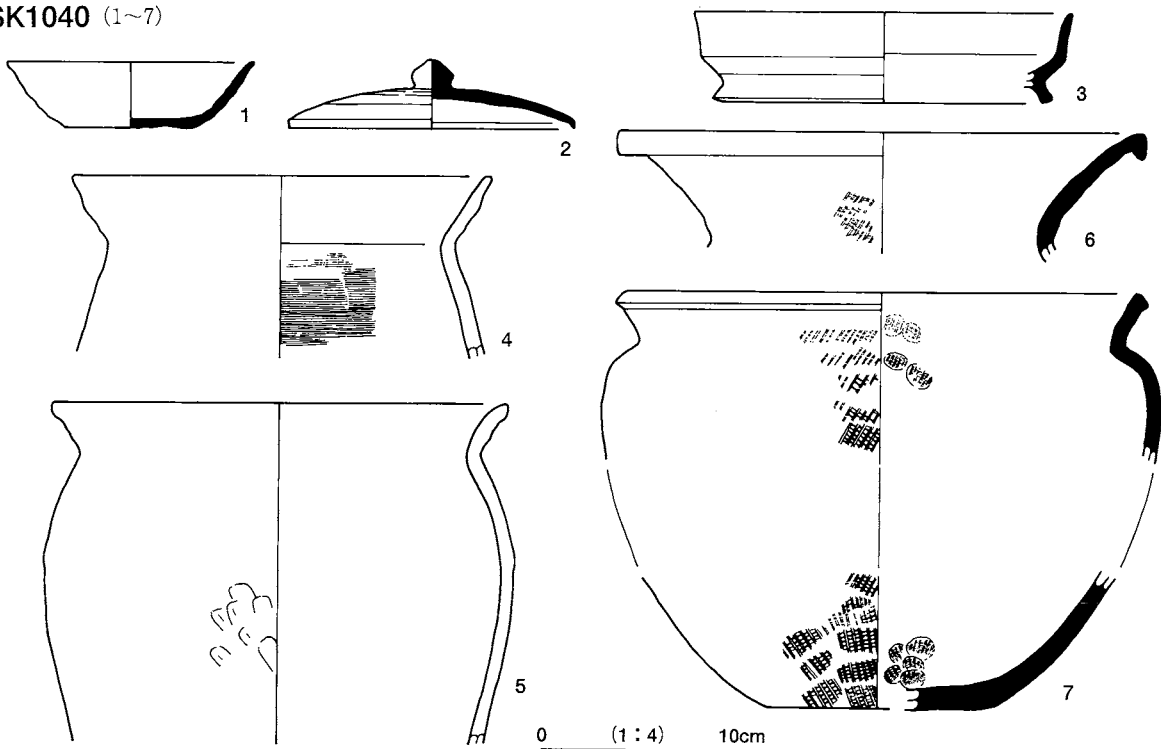

SK1064

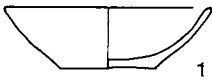

SK1120 (1・2)

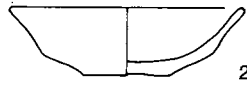
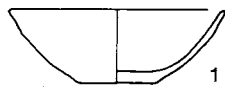

SK1636 (1~5)

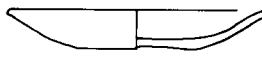
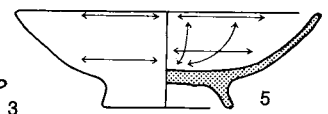
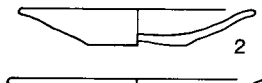
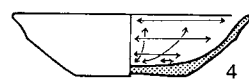

SK1092 (1・2)

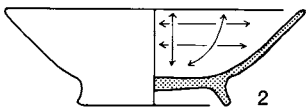
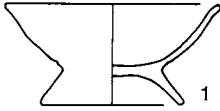

SK1501

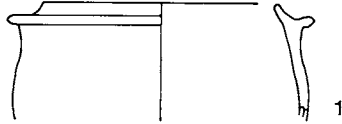

SK1524

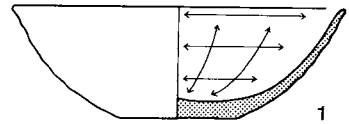

SK1659 (1~3)

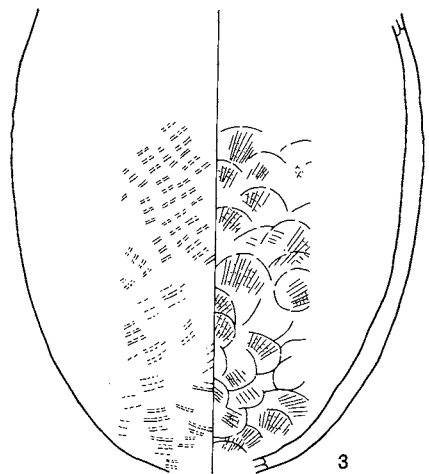
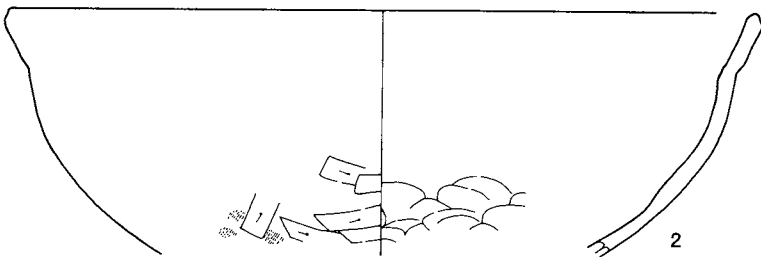
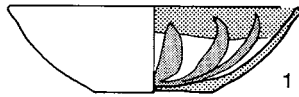

SK1733 (1~10)

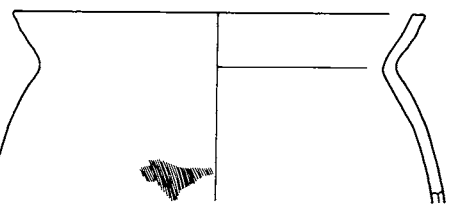
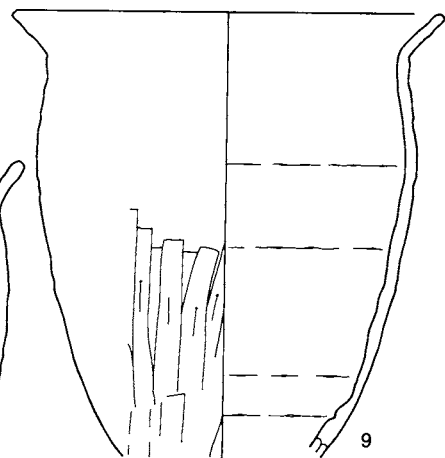
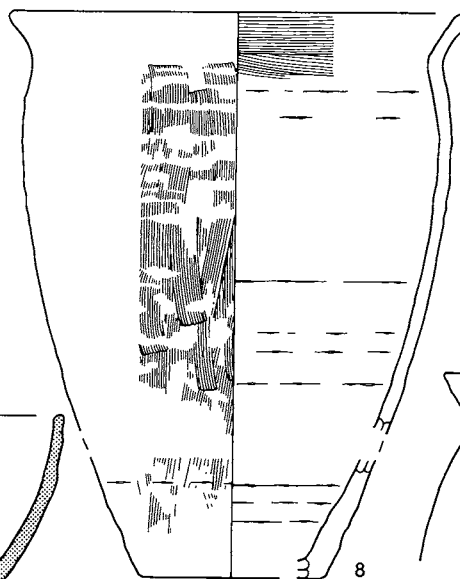
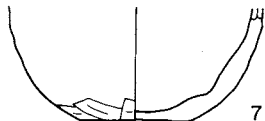
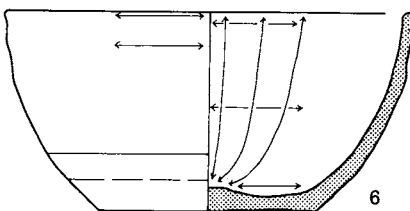
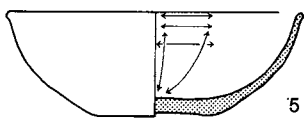
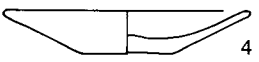
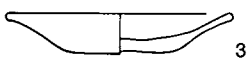
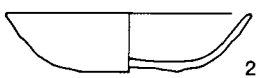
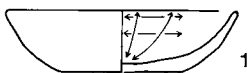

0 (1:4) 10cm

SK1889 (1·2)

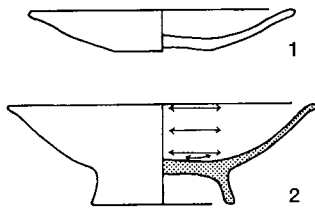

SK2108 (1~5)

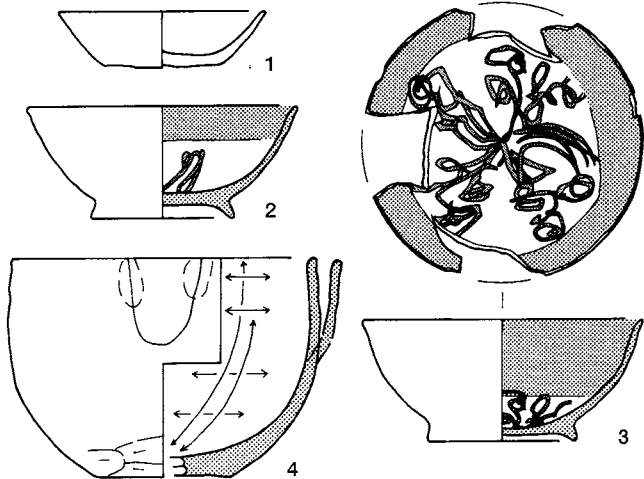

SK2558 (1~4)

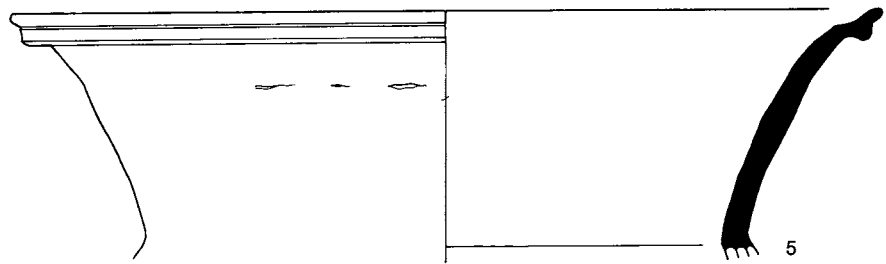
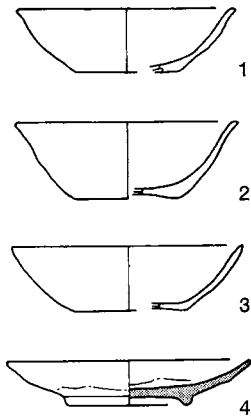

SD102 VD区 (1~36)

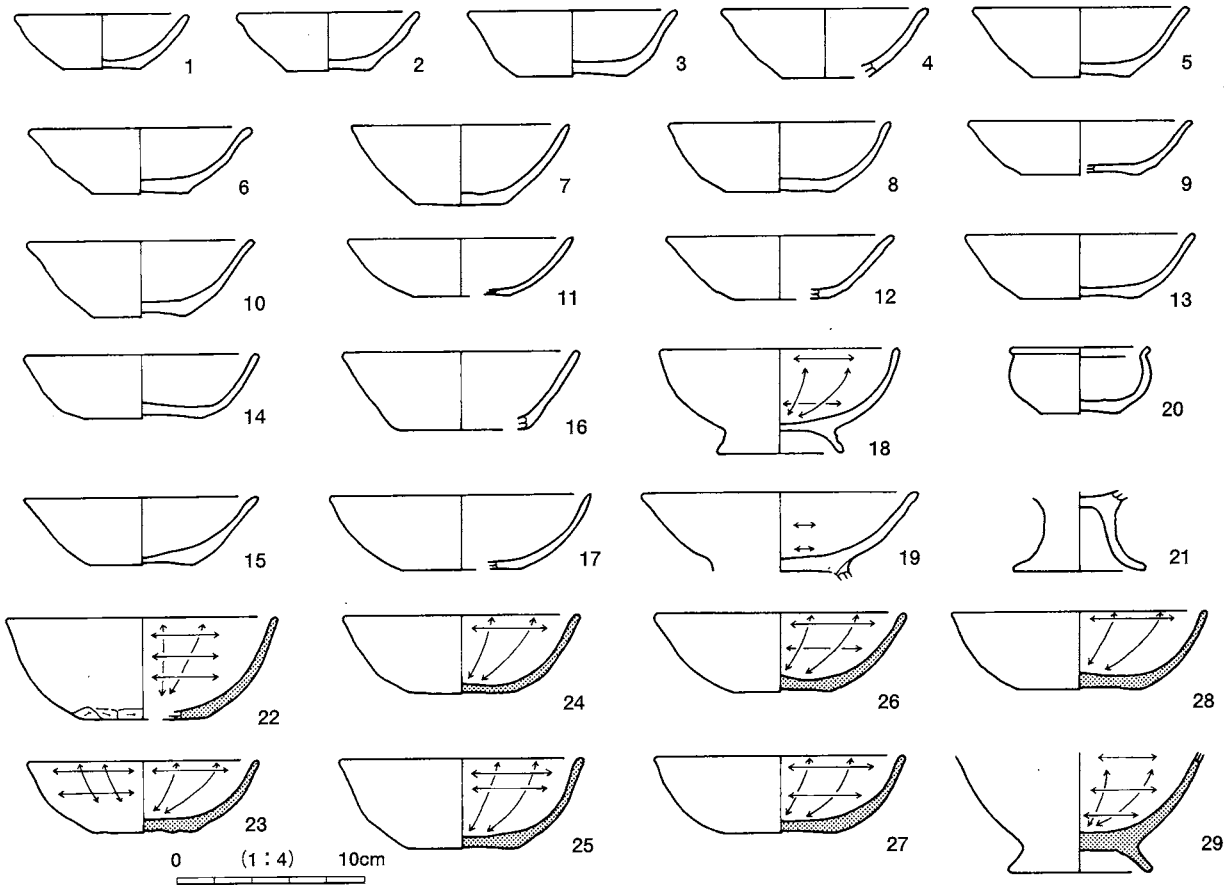

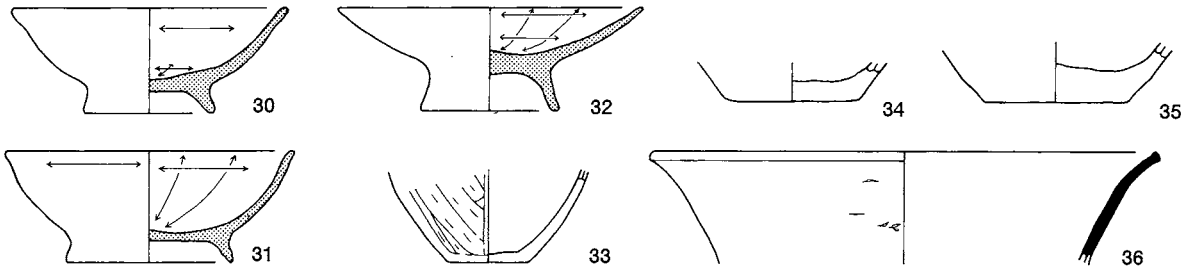

SD102 VE区 (37~61)

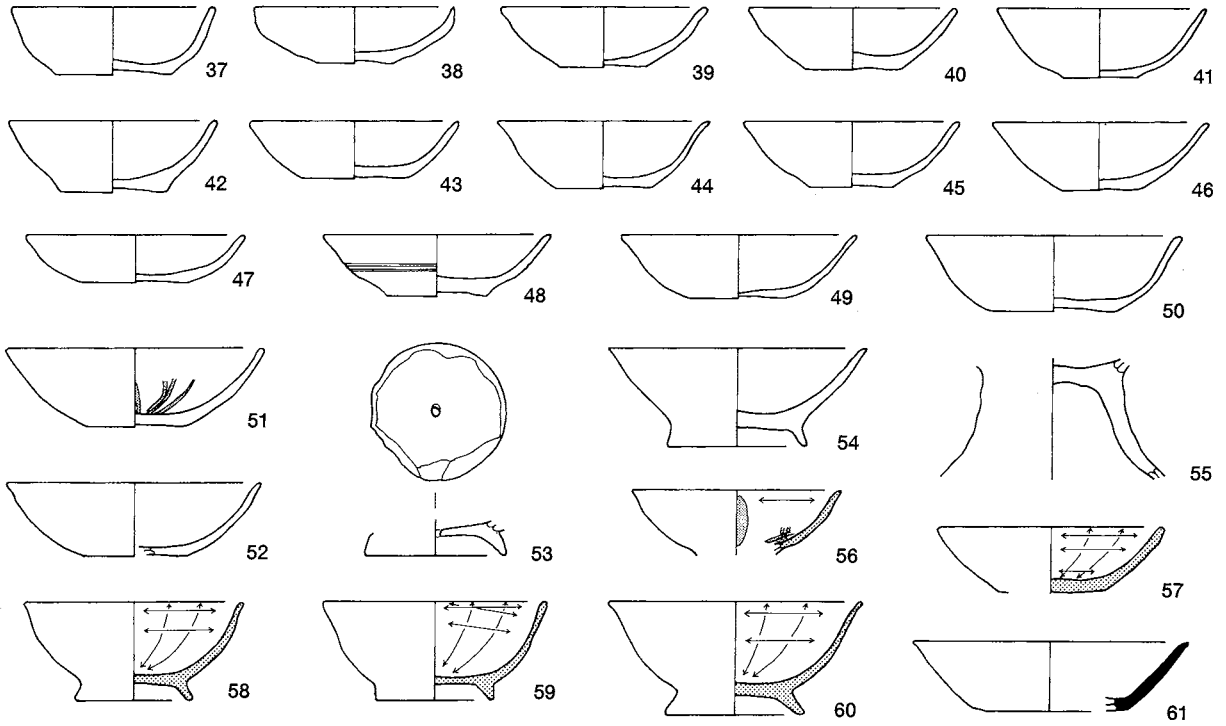

SD102 VJ区 (62~69)

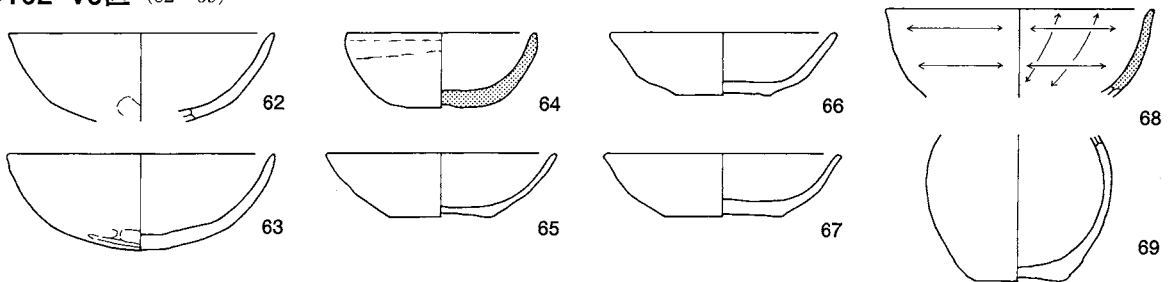

SD102 VIX区 (70~90)

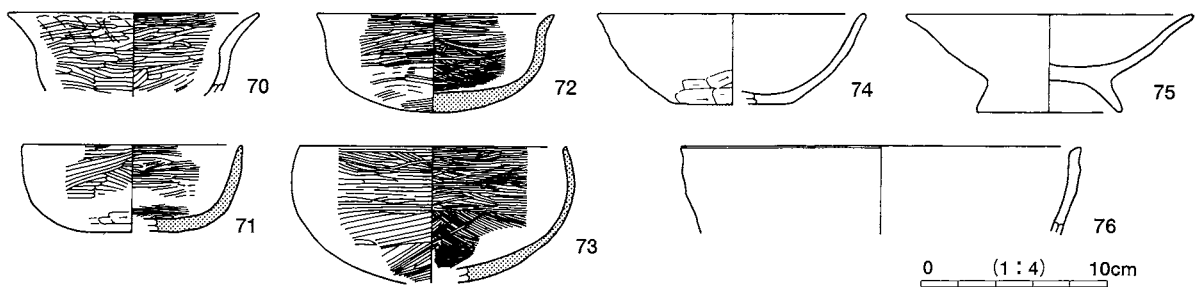

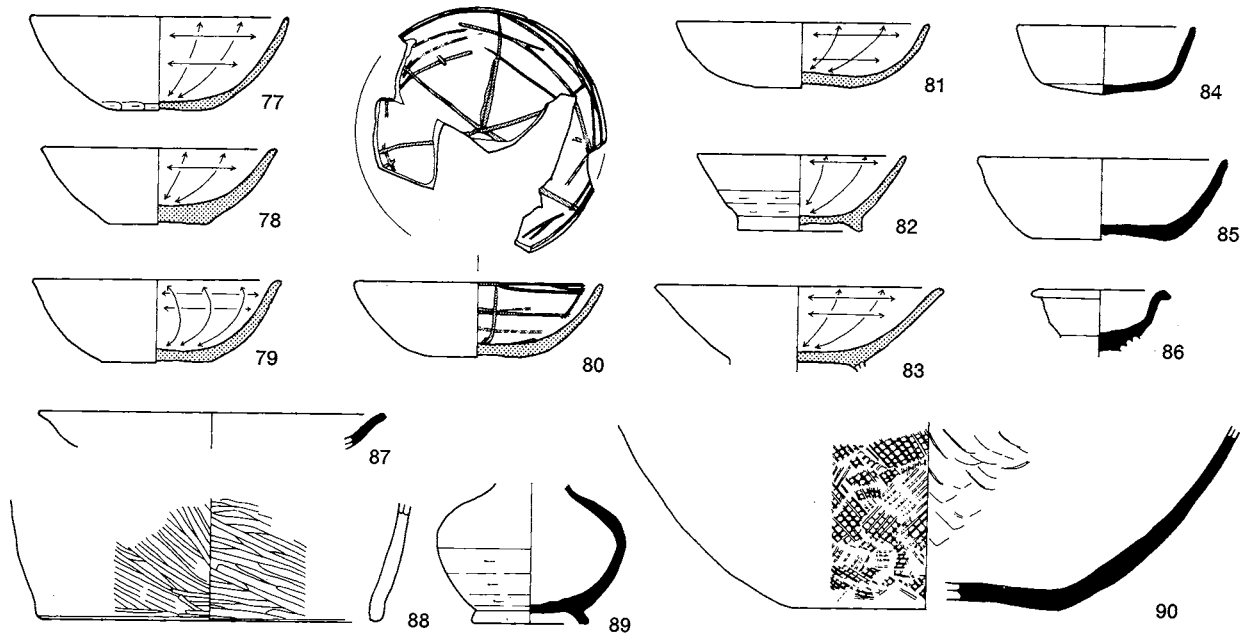

SD102 VII区 (91~103)

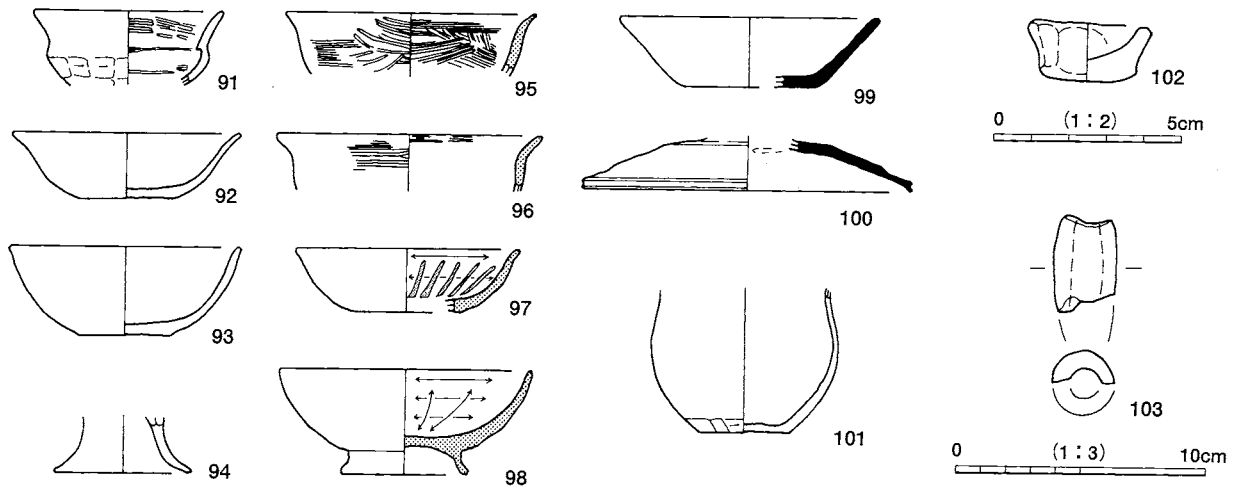

SD102 覆土一括 (104~112)

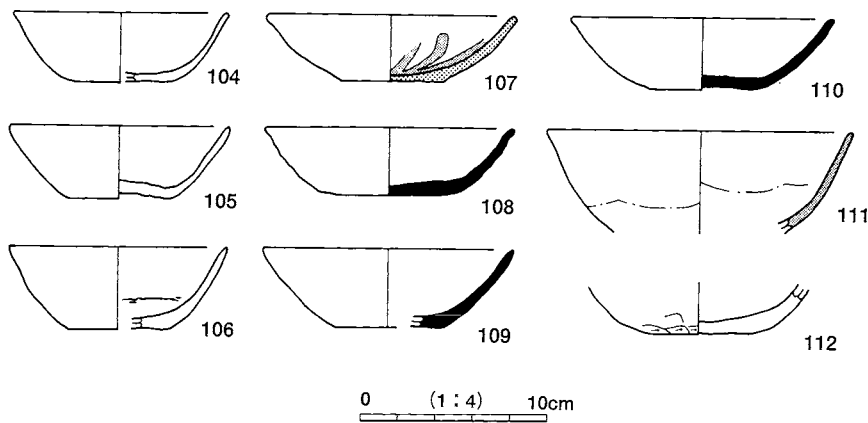

SD102 ヤナ (113~115)

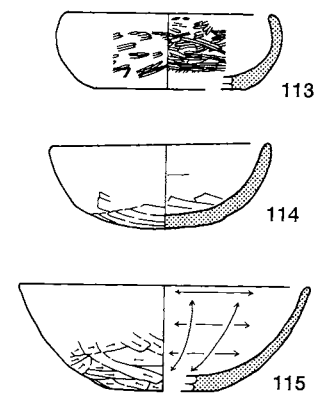

遺構外 (1~32)

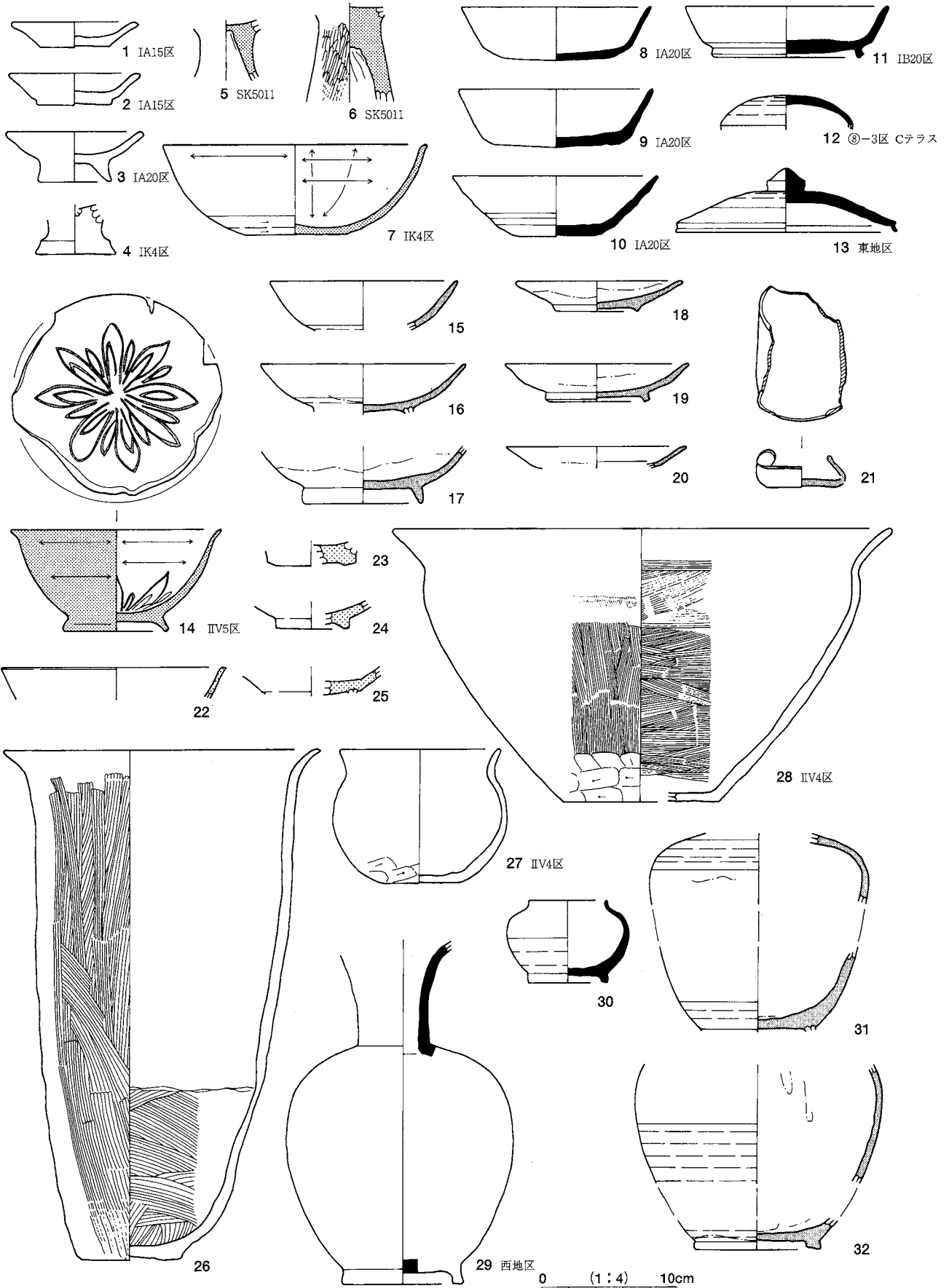

円筒形土製品 (1~15)

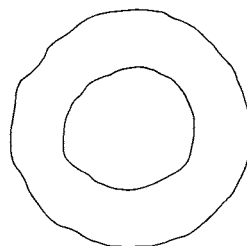
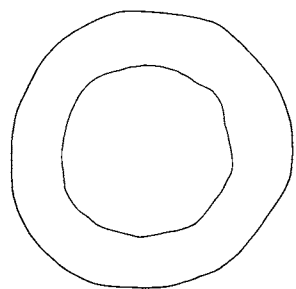
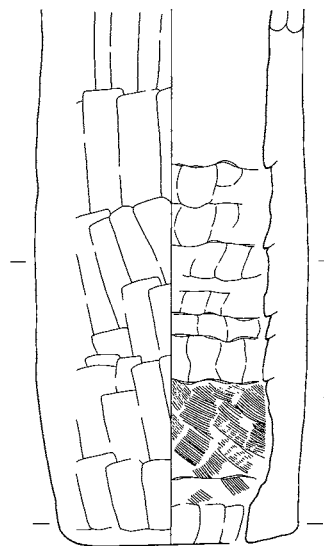
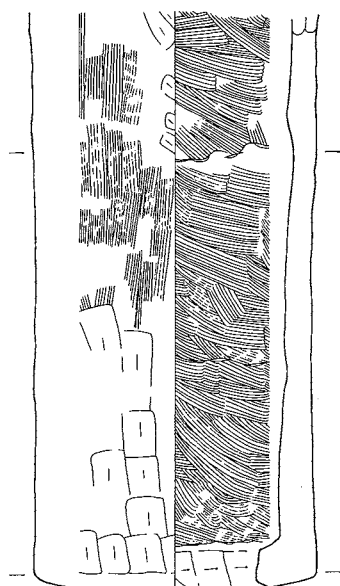
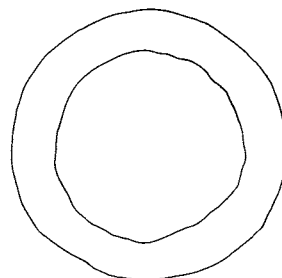
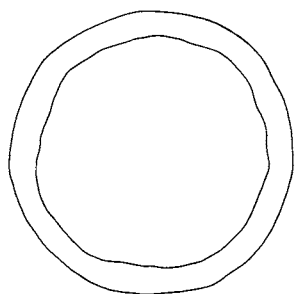
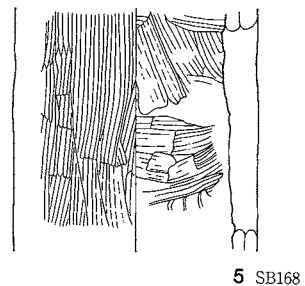
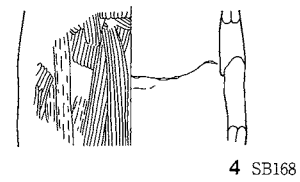
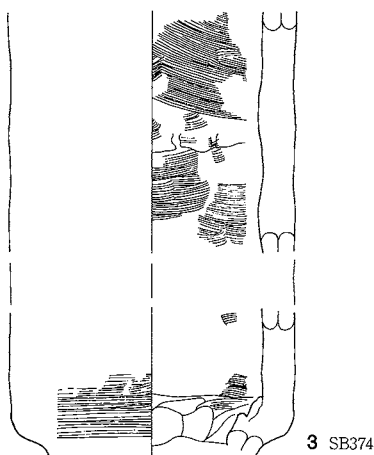
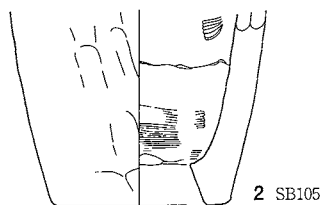

0 (1:4) 10cm

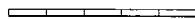

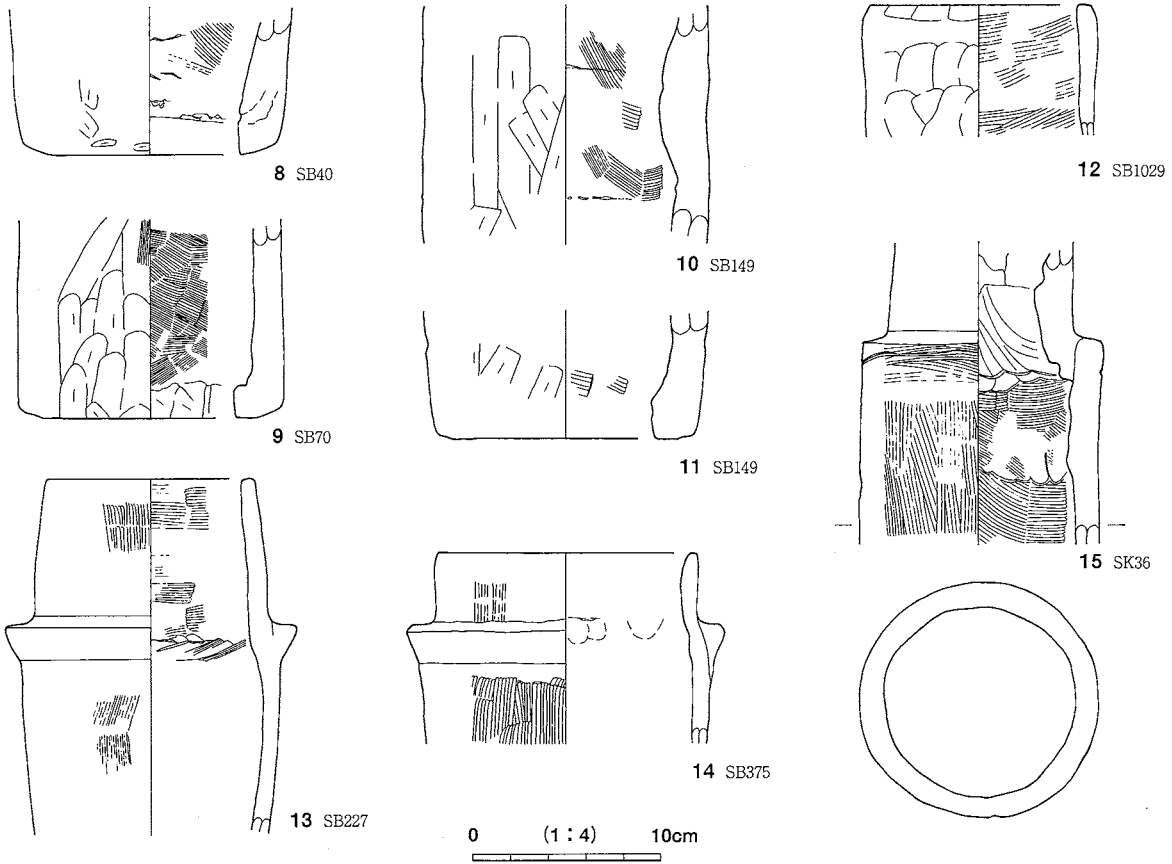

土錘 (1~40)

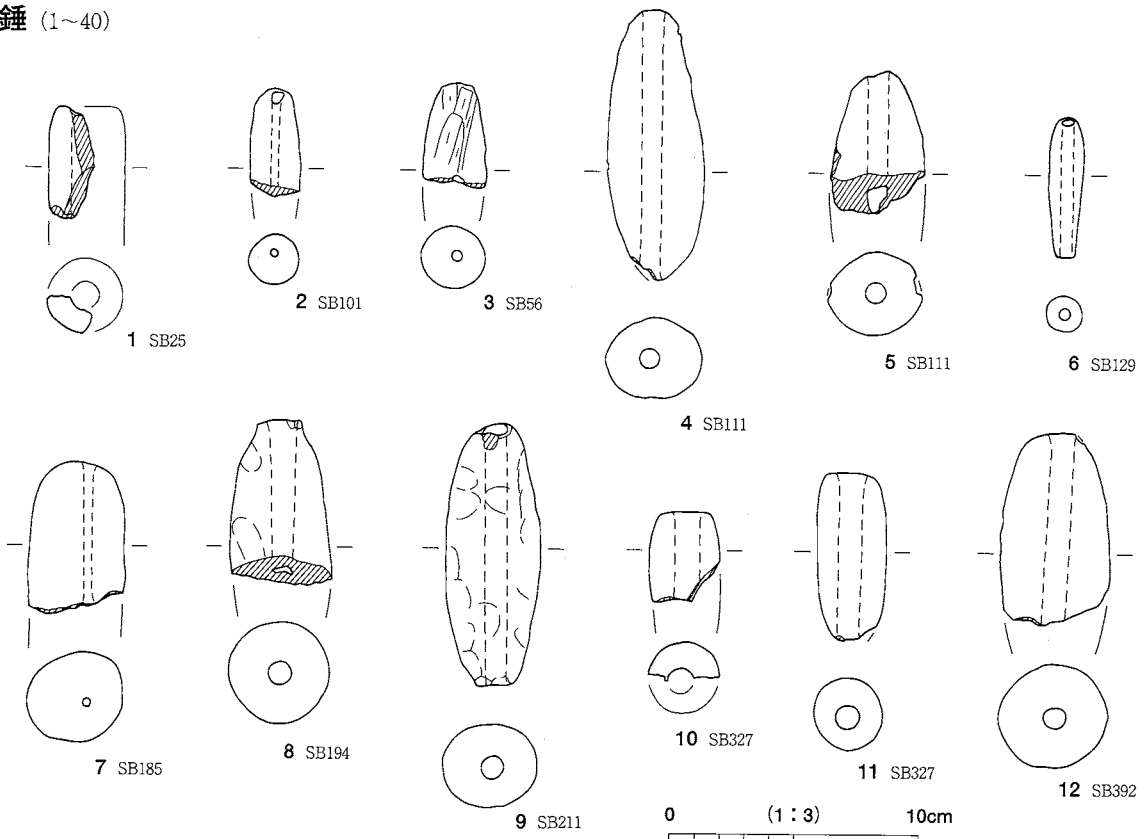

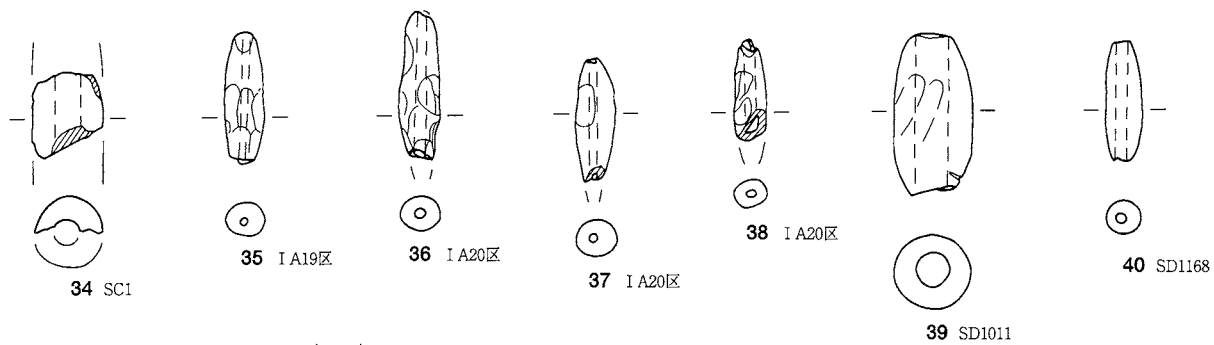
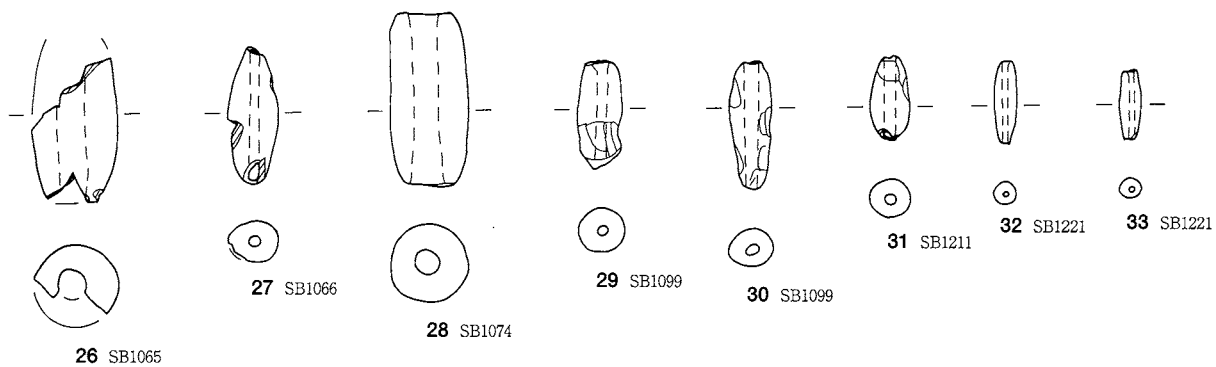
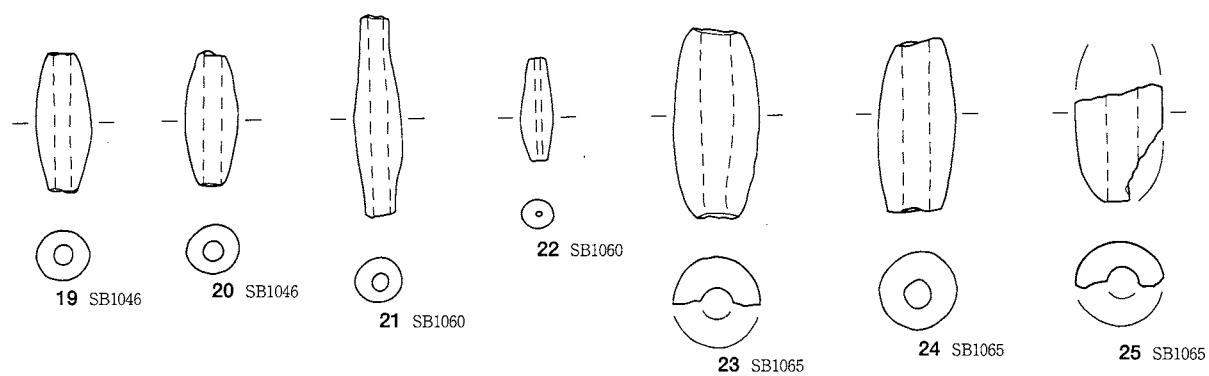
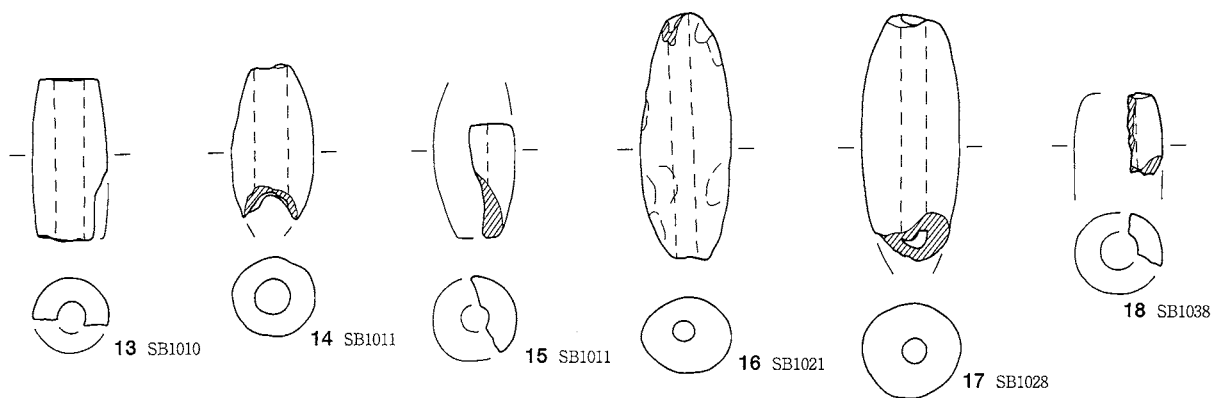

0 (1:3) 10cm

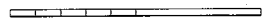

土製紡錘車・有孔土製円板 (1~3)

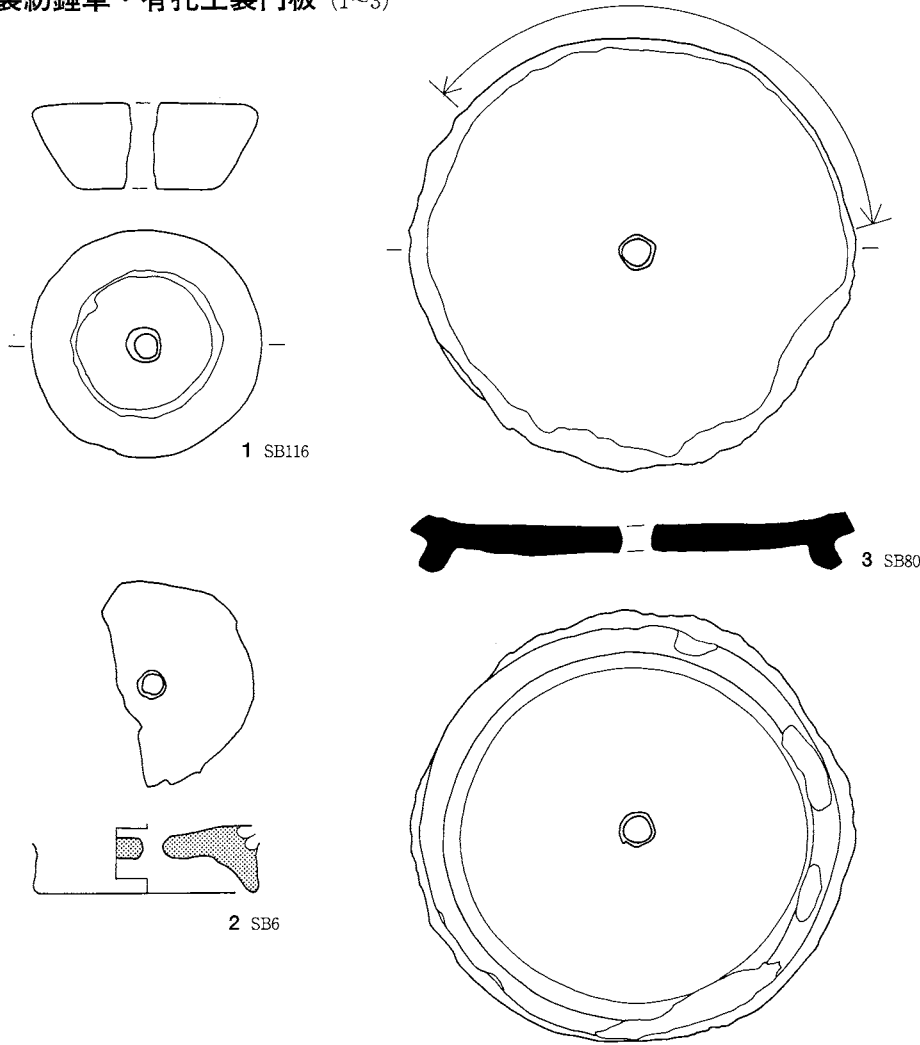

0 (1:2) 5cm

球状土製品 (1・2)

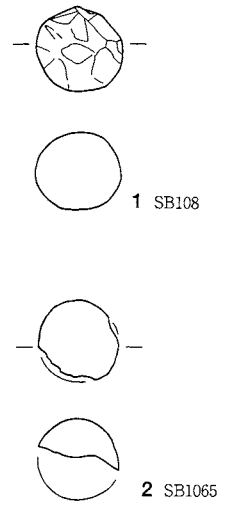

円柱状土製品 (1・2)

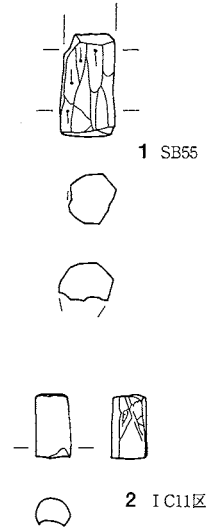

用途不明土製品 (1~7)

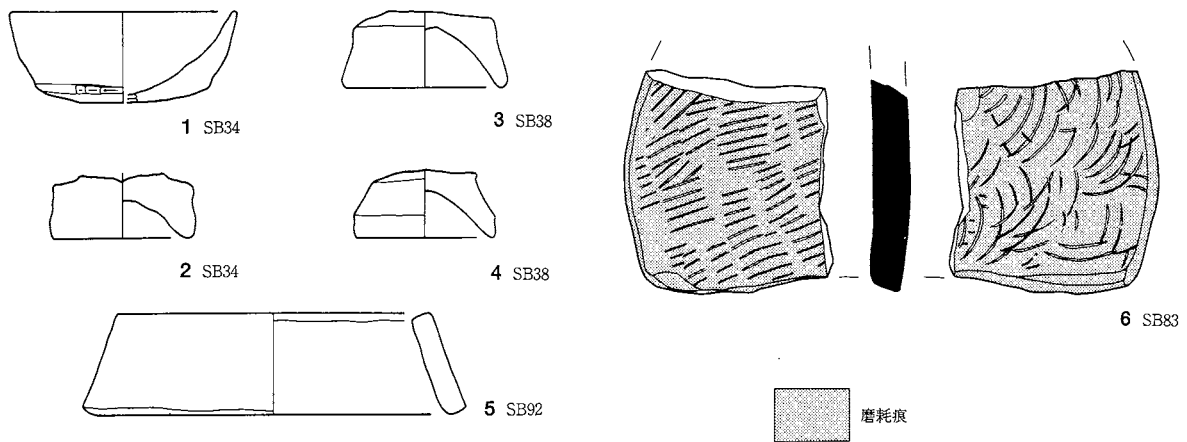

0 (1:3) 10cm

■ 磨耗痕

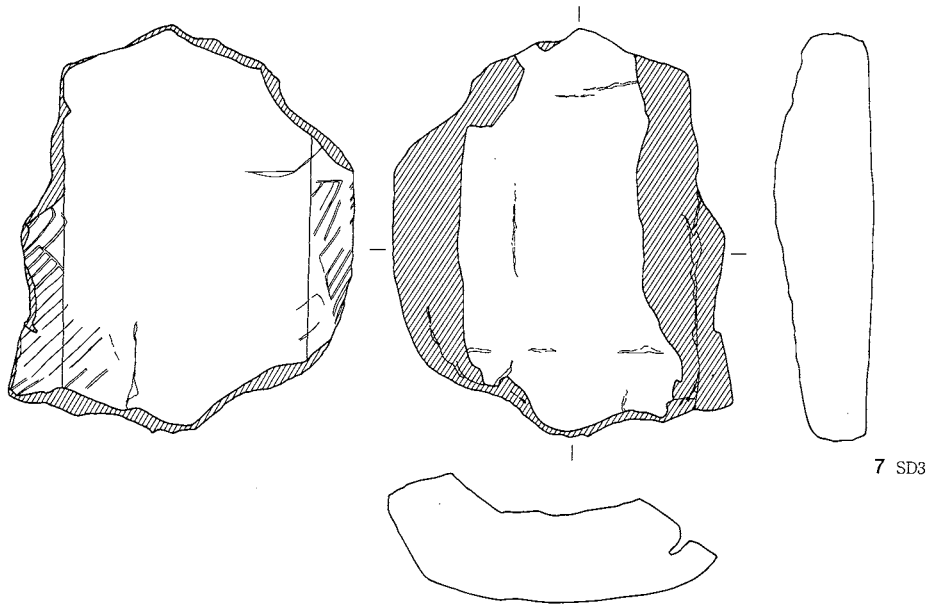

7 SD3

0 (1:3) 10cm

ミニチュア土器 (1~12)

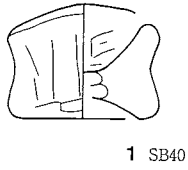

1 SB40

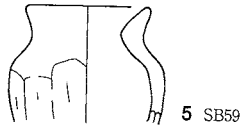

5 SB59

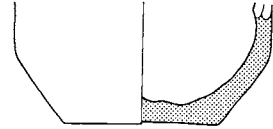

9 SB1405-22

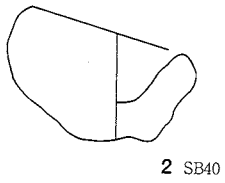

2 SB40

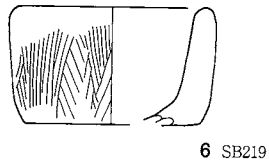

6 SB219

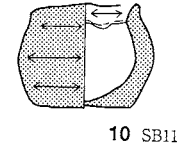

10 SB11

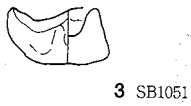

3 SB1051

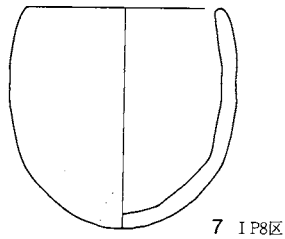

7 IP8区

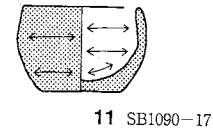

11 SB1090-17

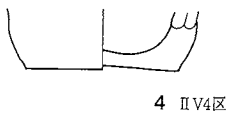

4 II V4区

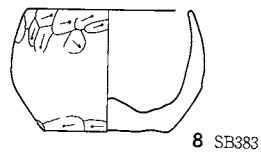

8 SB383

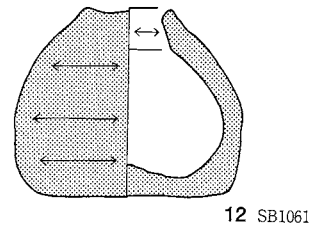

12 SB1061

0 (1:2) 5cm

石帯 (1・2)

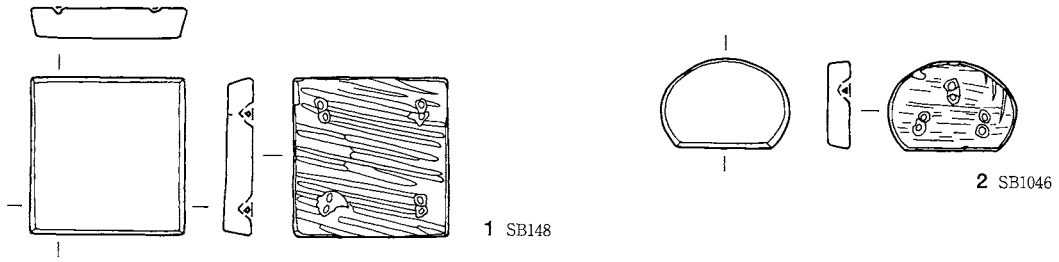

基石状石製品 (1~10)

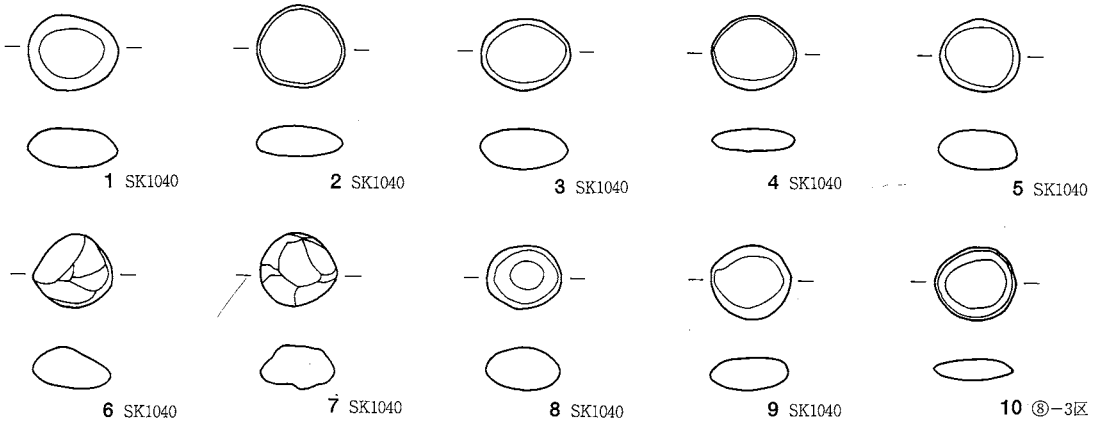

紡錘車

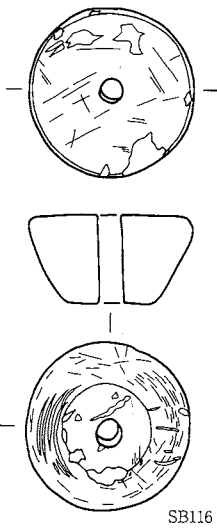

用途不明石製品 (1~4)

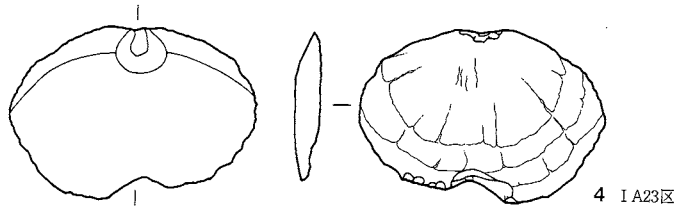
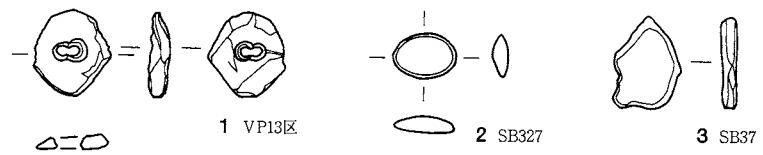

0 (1:2) 5cm

編物石 (1~6)

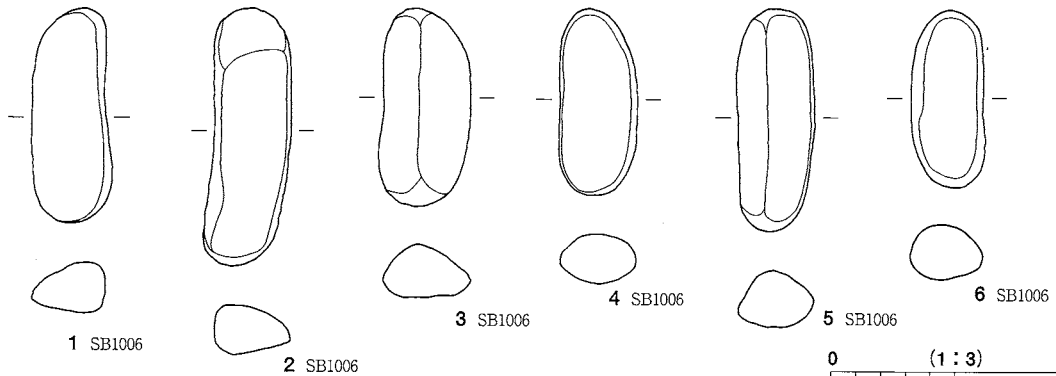

0 (1:3) 10cm

砥石 (1~58)

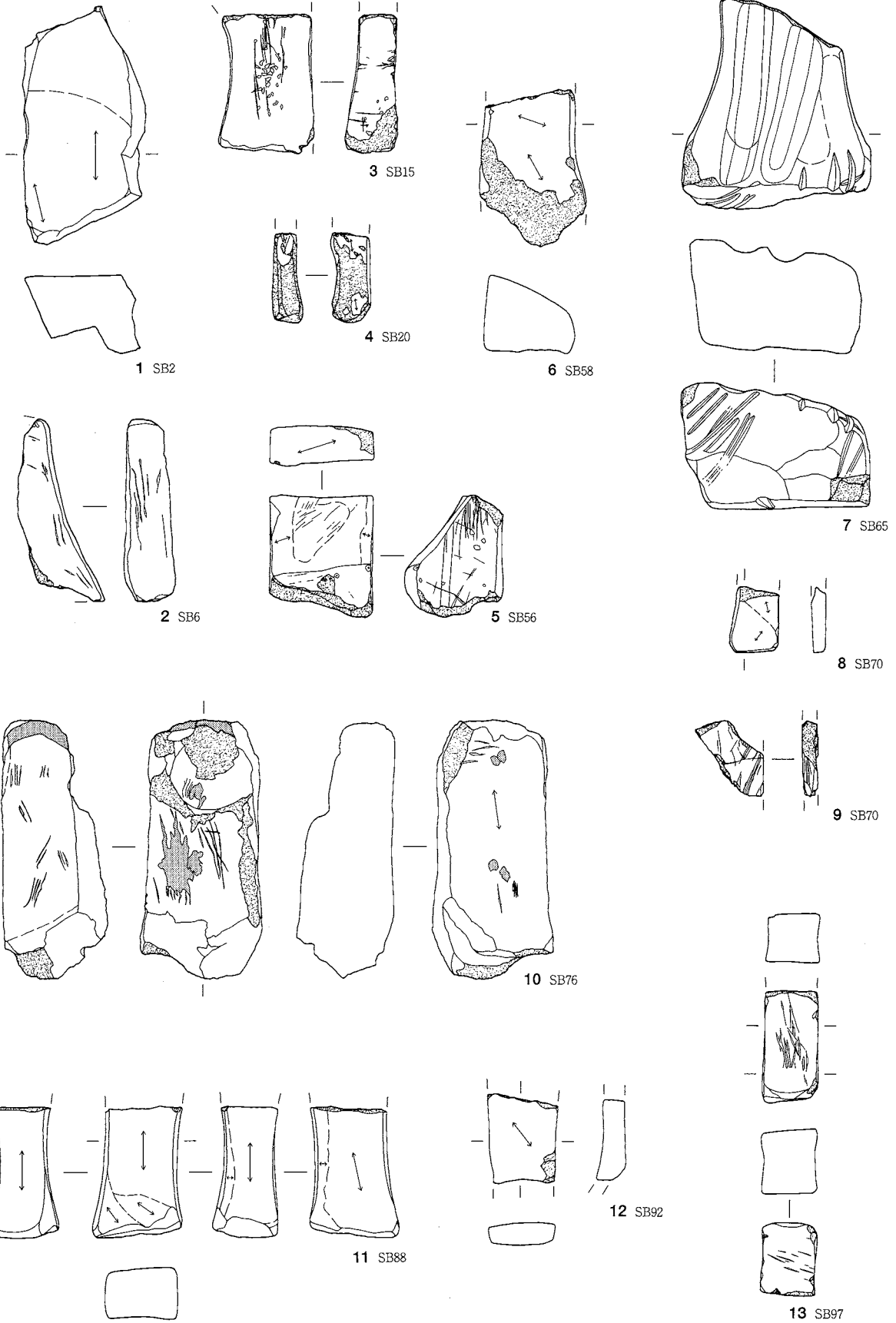

0 (1:3) 10cm

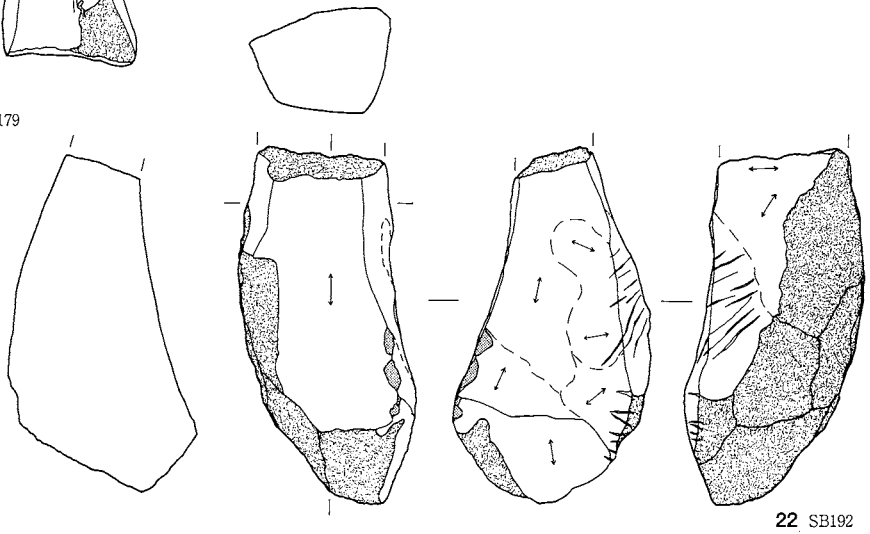
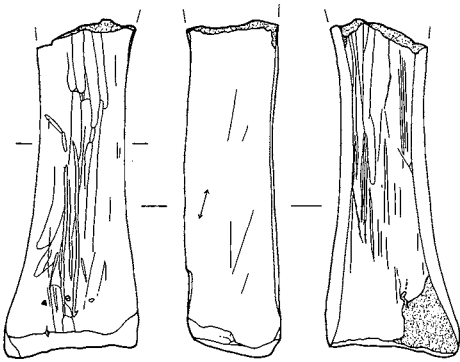
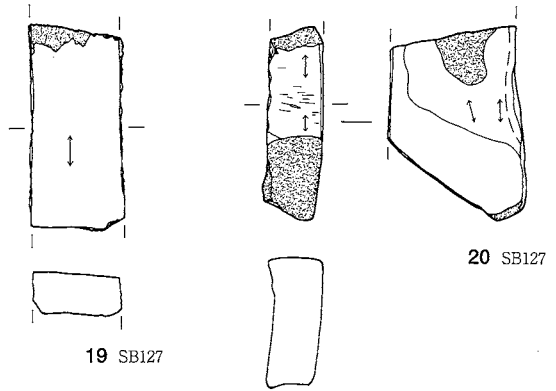
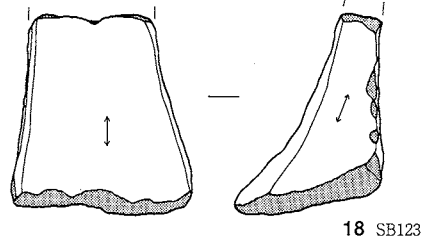
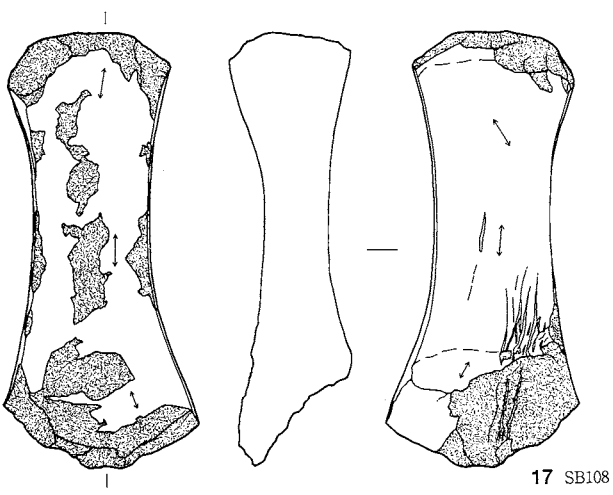
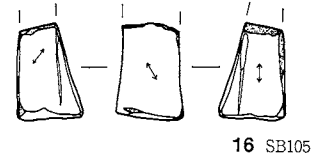
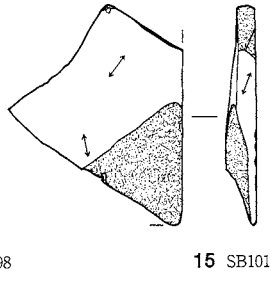
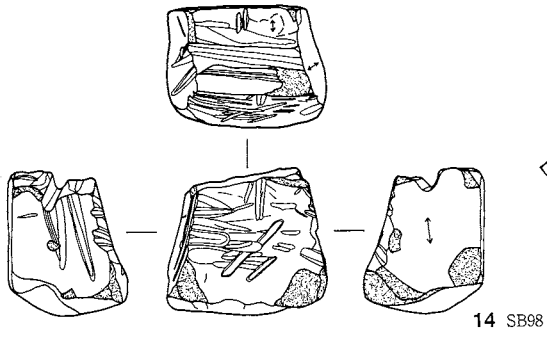

0 (1:3) 10cm

22 SB192

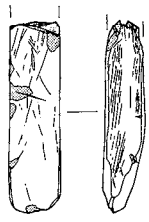

23 SB193

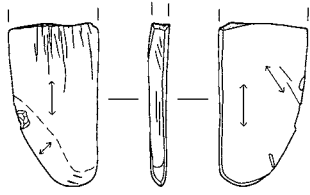

24 SB194

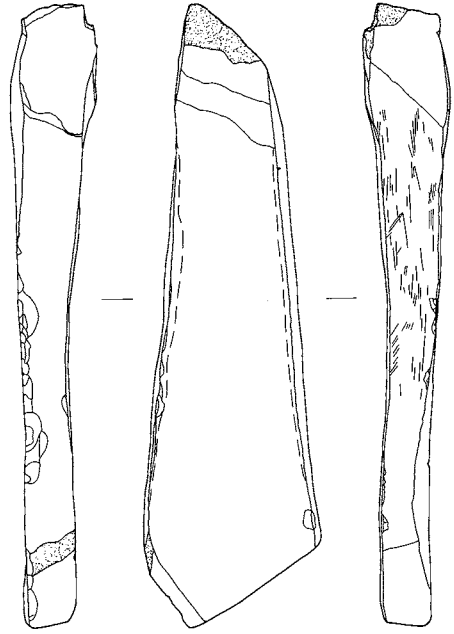

31 SB502

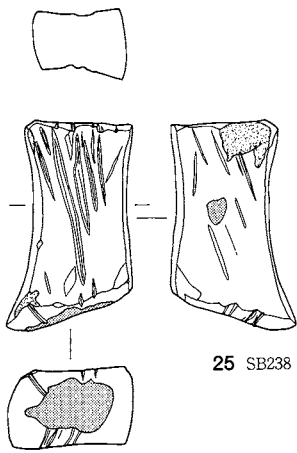

25 SB238

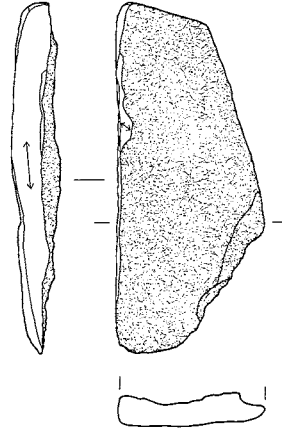

26 SB343

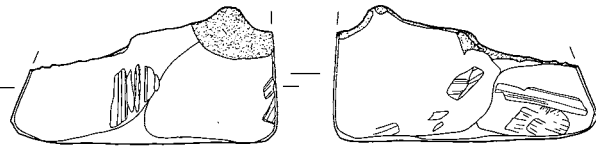

27 SB334

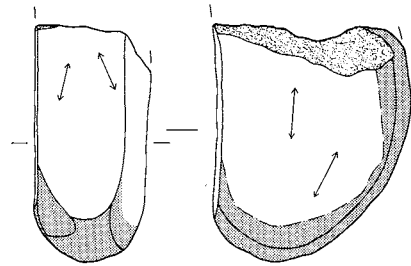

32 SB1005

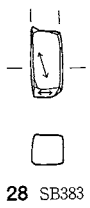
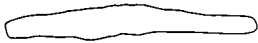

28 SB383

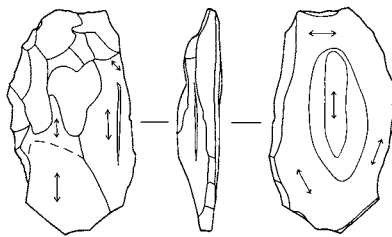

29 SB383

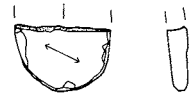
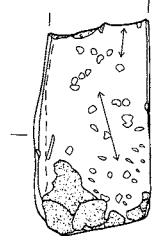
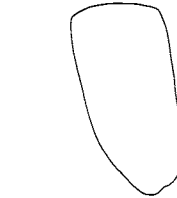

34 SB1046

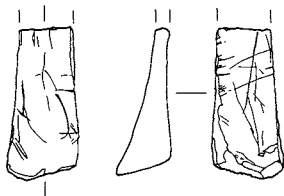

30 SB385



33 SB1045

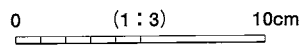

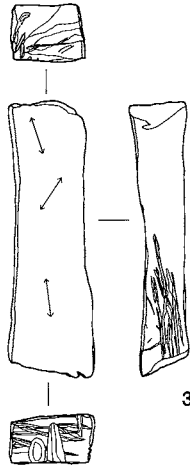

35 SB1049

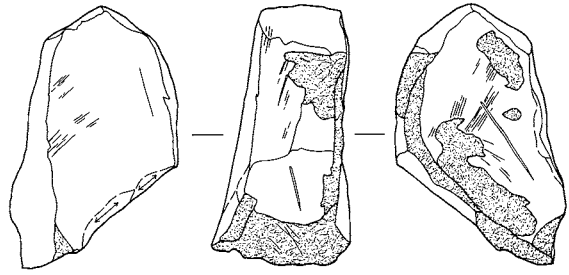

36 SB1067

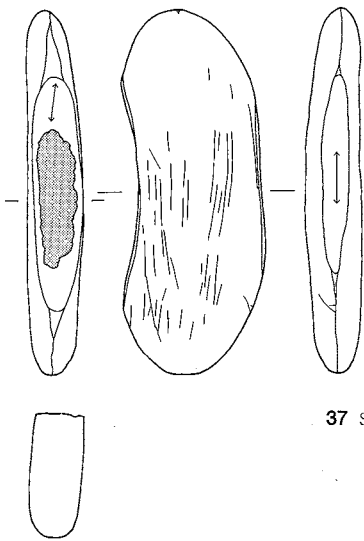

37 SB1208

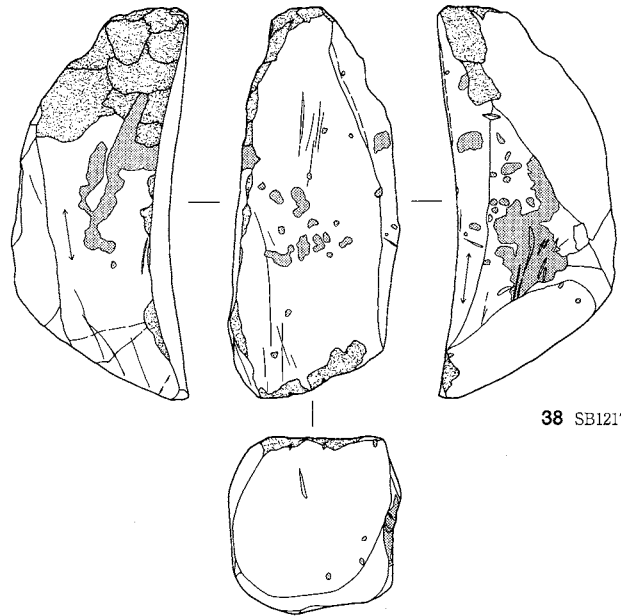

38 SB1217

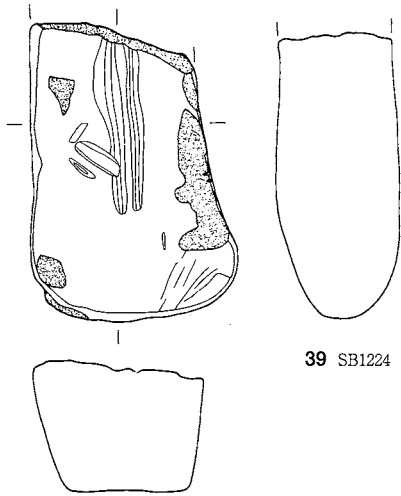

39 SB1224

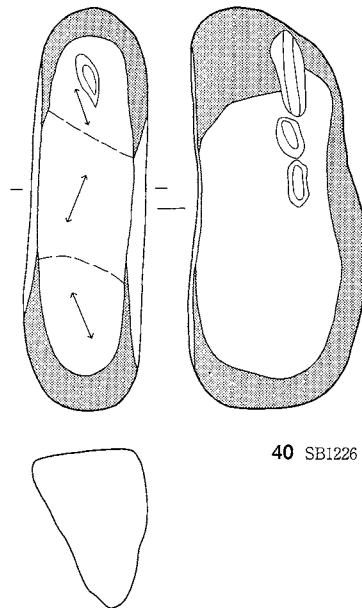

40 SB1226

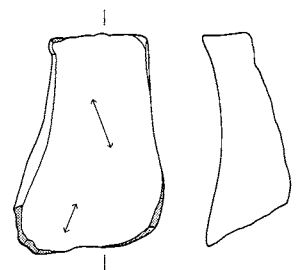

41 SB1226

0 (1:3) 10cm

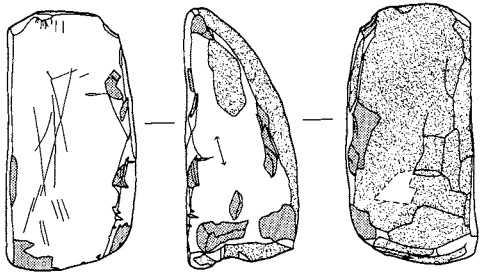

42 SB1230

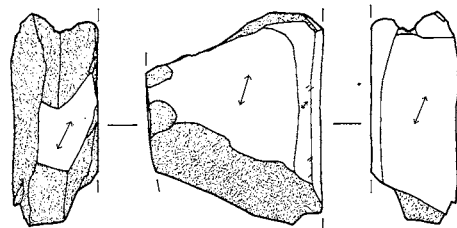

43 SB1230

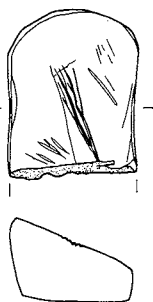
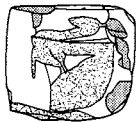

44 SB1233

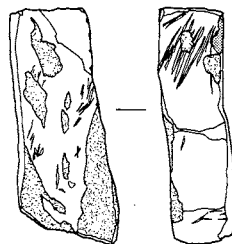

45 SB1241



46 SB1241

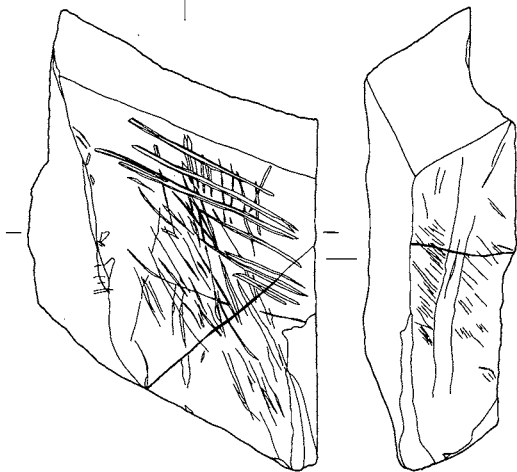

47 SB1245

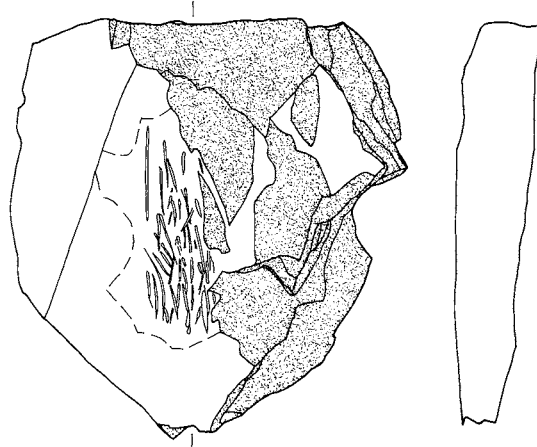

48 SB1312

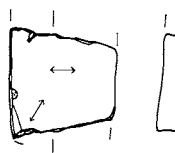
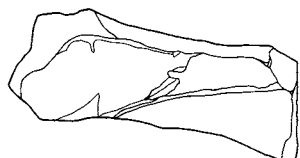
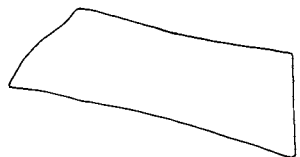

49 SB1312

0 (1 : 3) 10cm

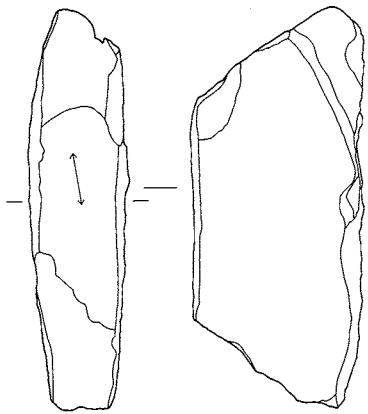

50 ST1008

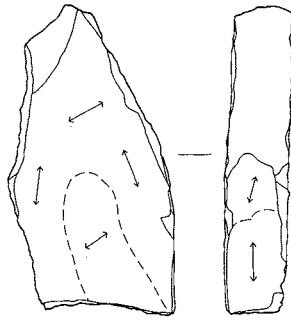

51 SK36

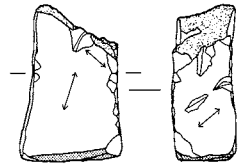

52 SK38

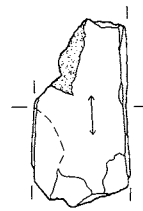

53 SK347



54 SK1121

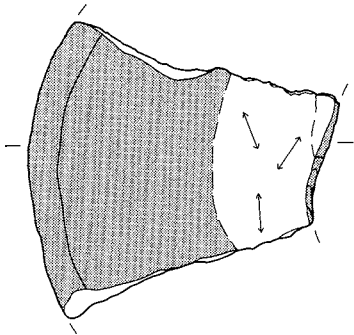
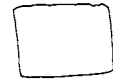

55 IF10区

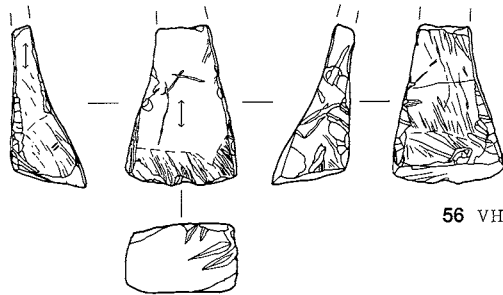
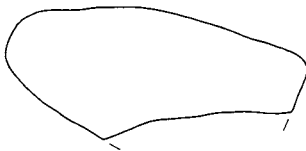

56 VH15区

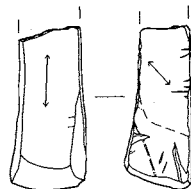

57 V16区

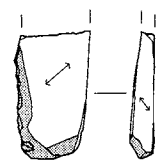

58 ㊦区

0 (1:3) 10cm

台石・凹石 (1~11)

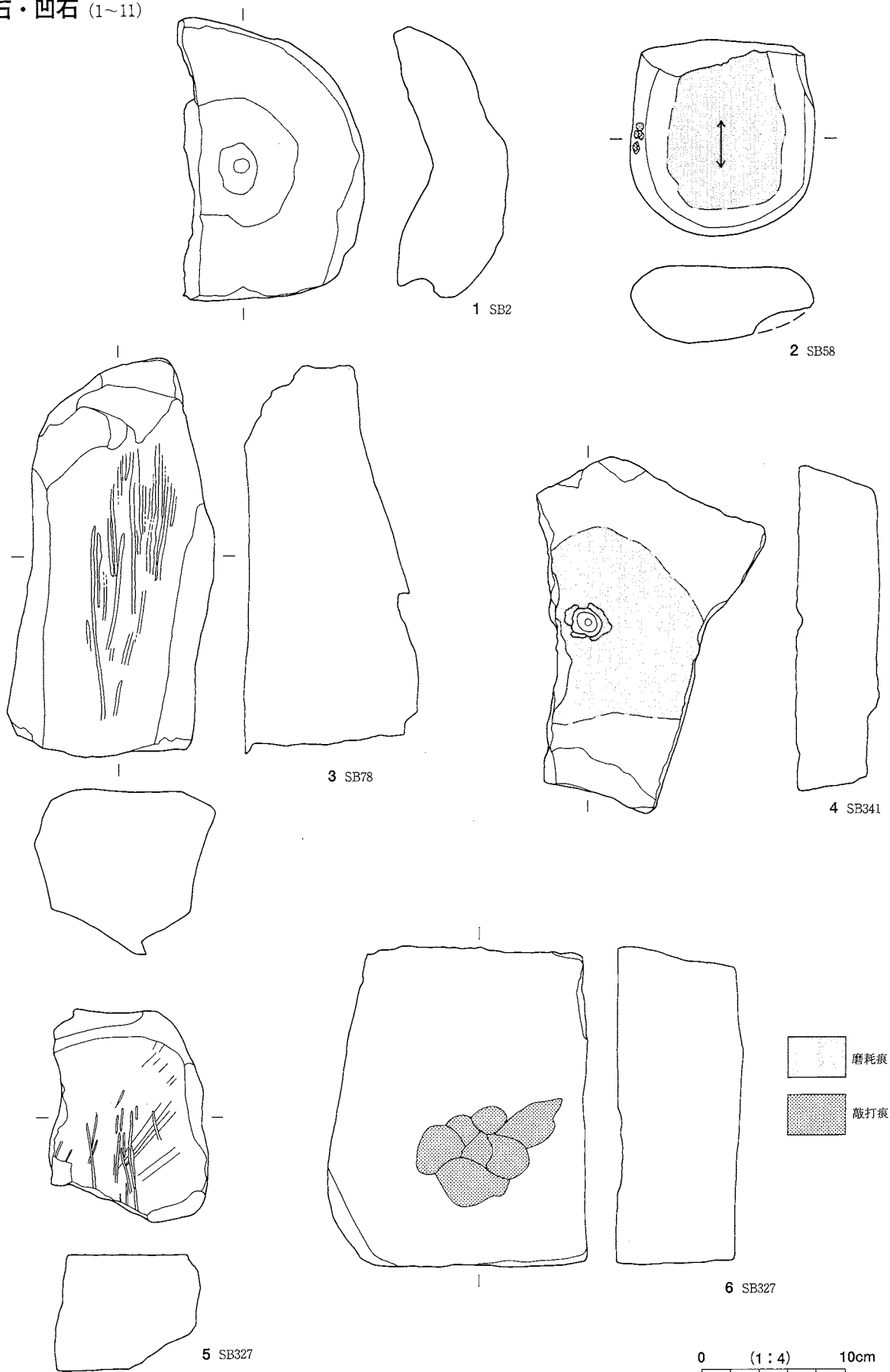

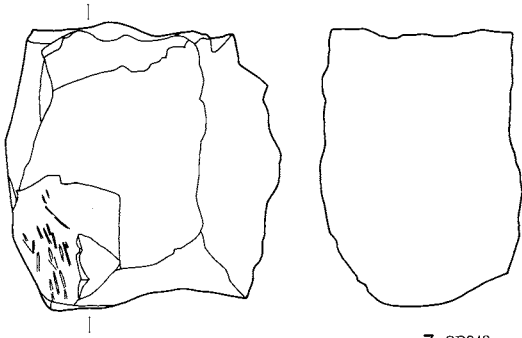

7 SB343

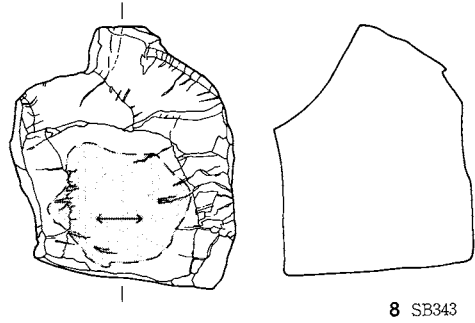

8 SB343

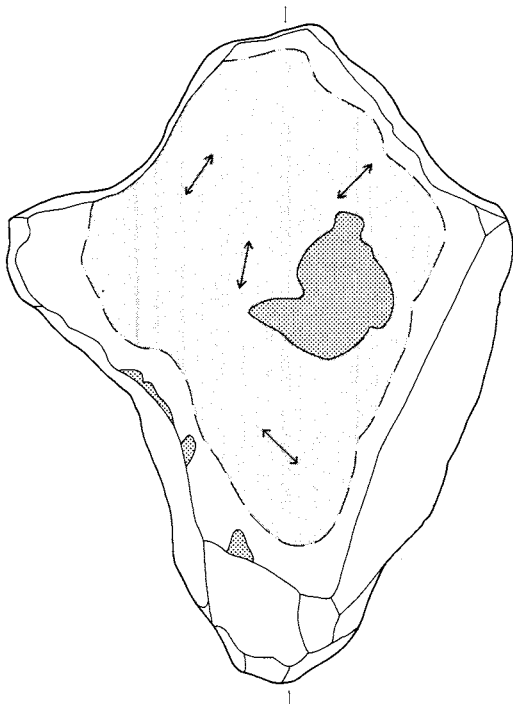

9 SB375

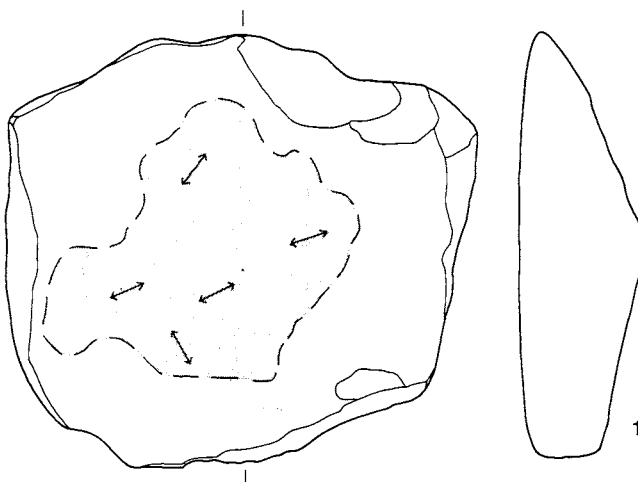
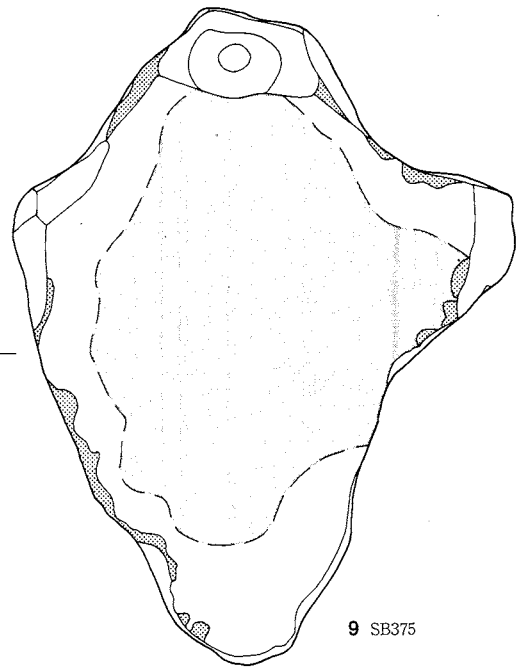
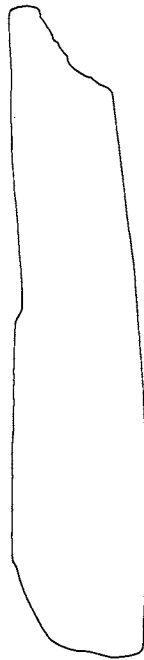

10 ST1008

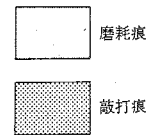

0 (1:4) 10cm

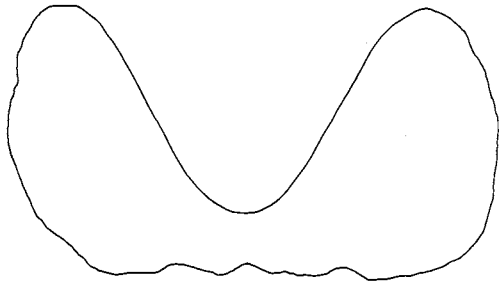
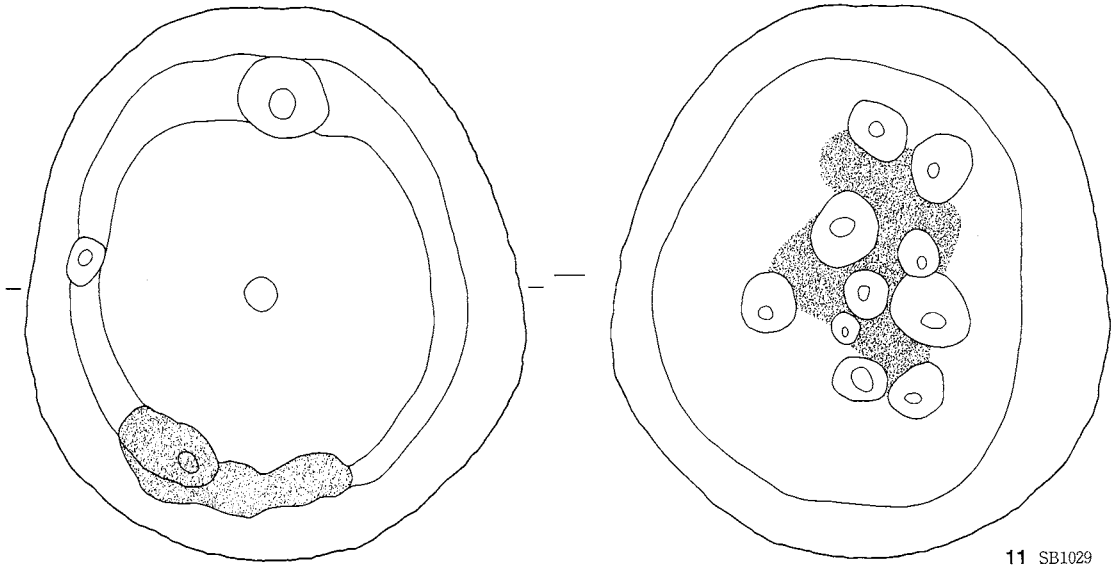

軽石製品 (1~26)

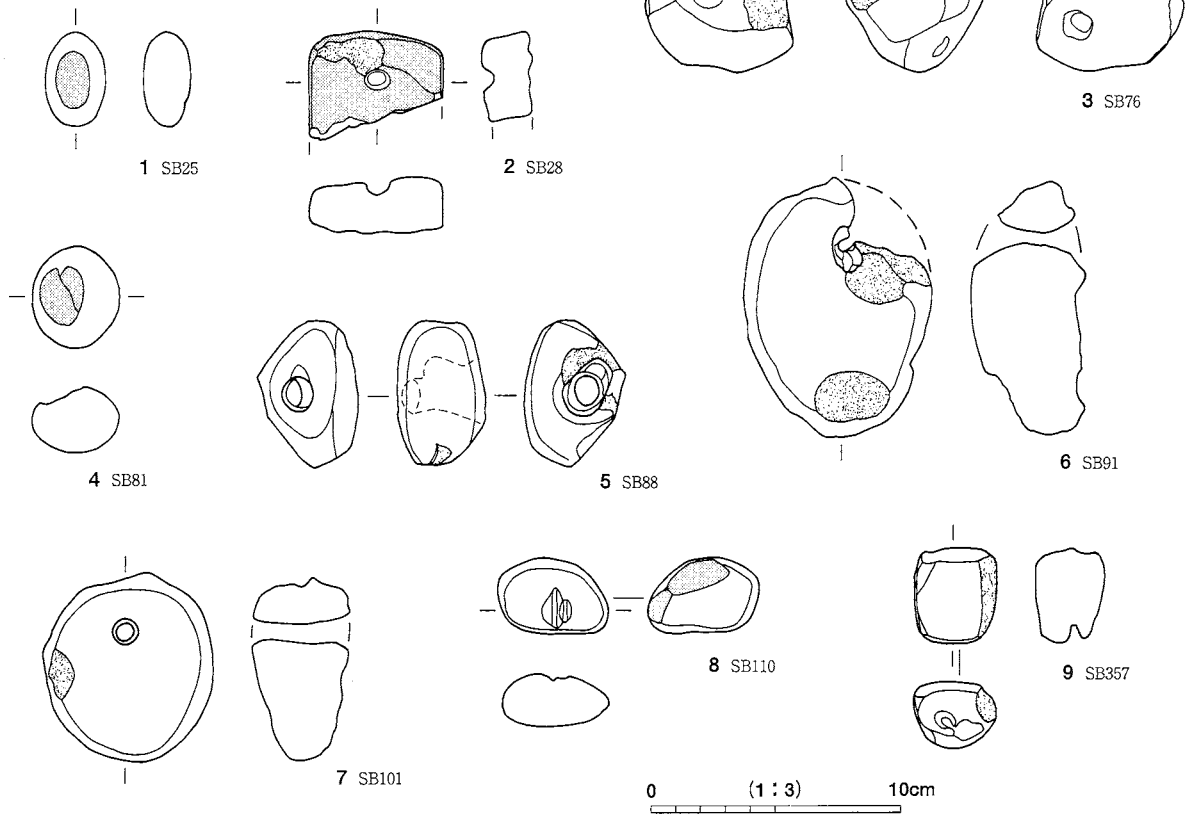

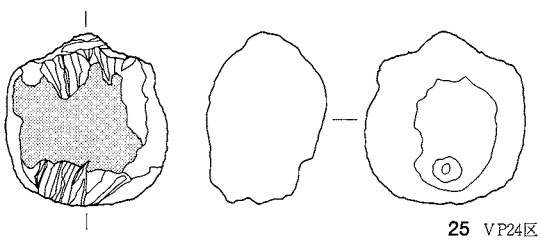
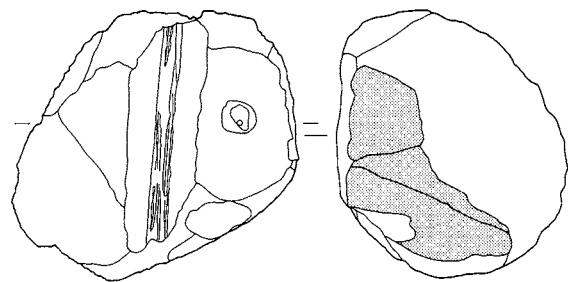
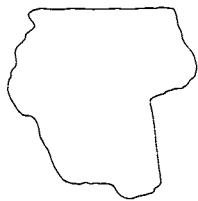
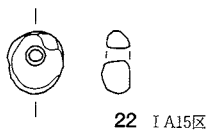
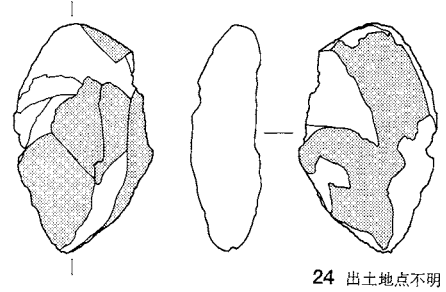
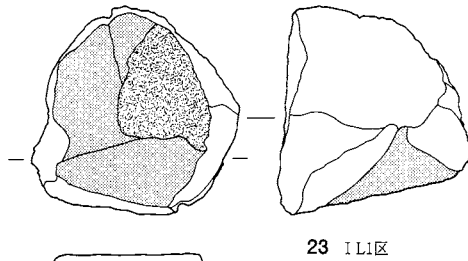
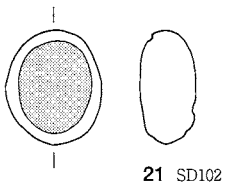
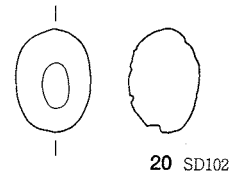
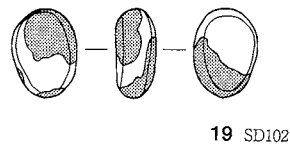
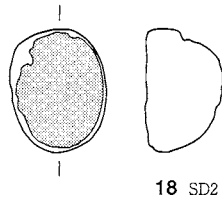
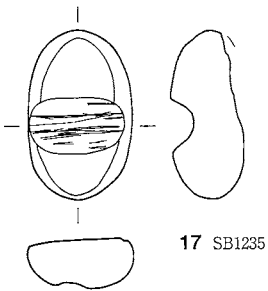
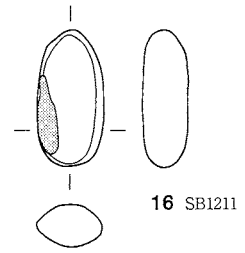
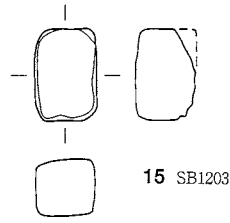
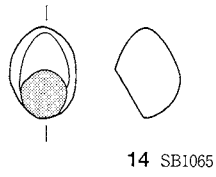
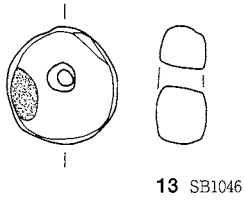
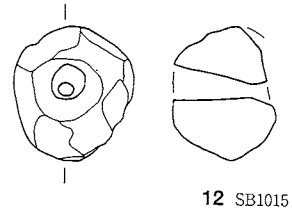
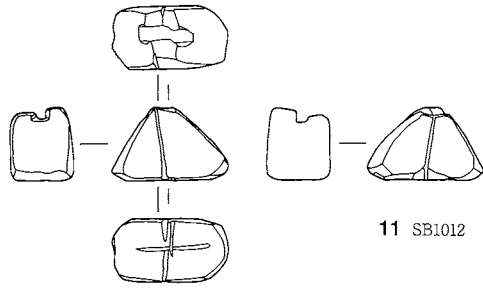
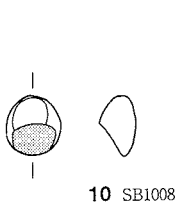

0 (1:3) 10cm

鉄製品 (1~239)

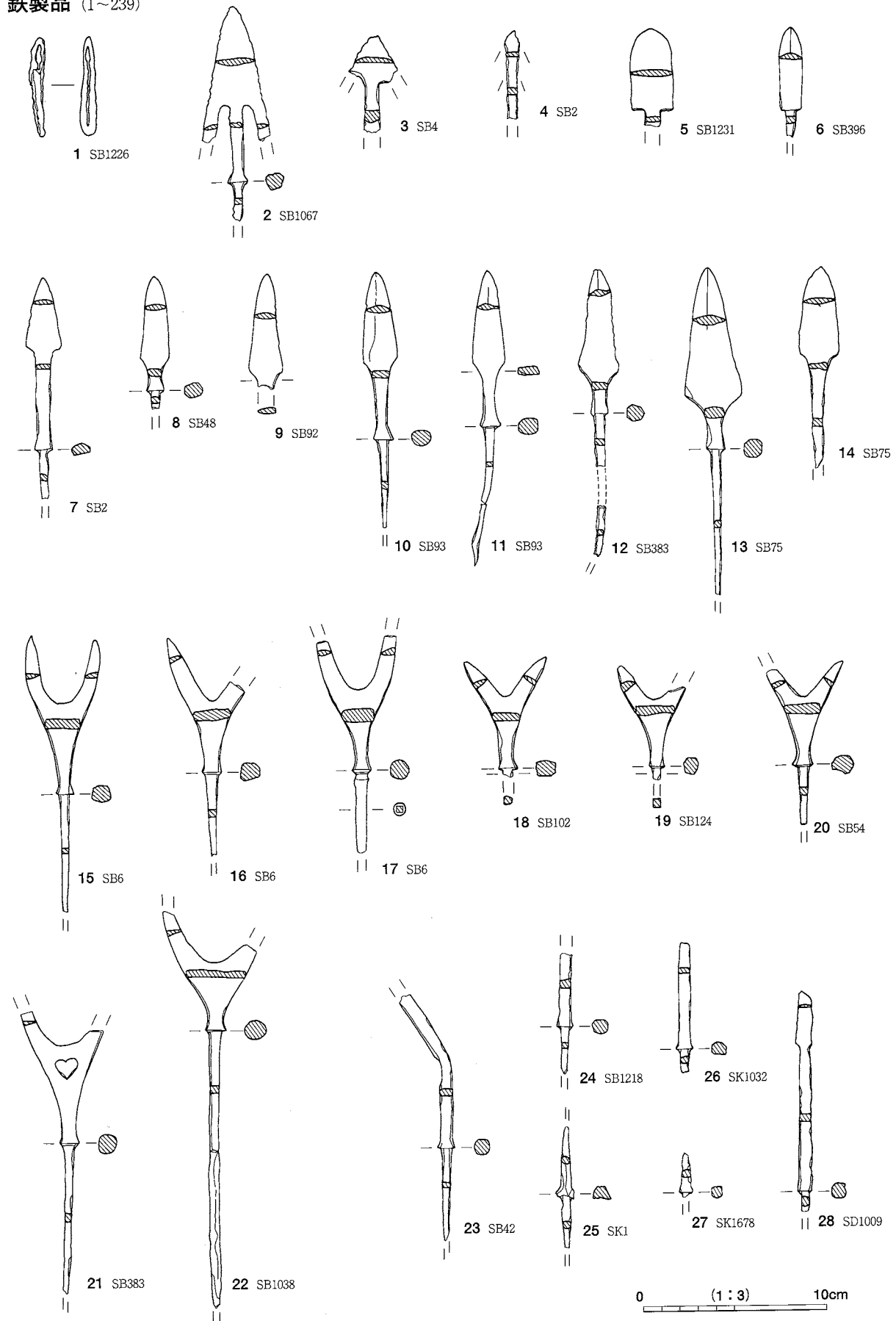

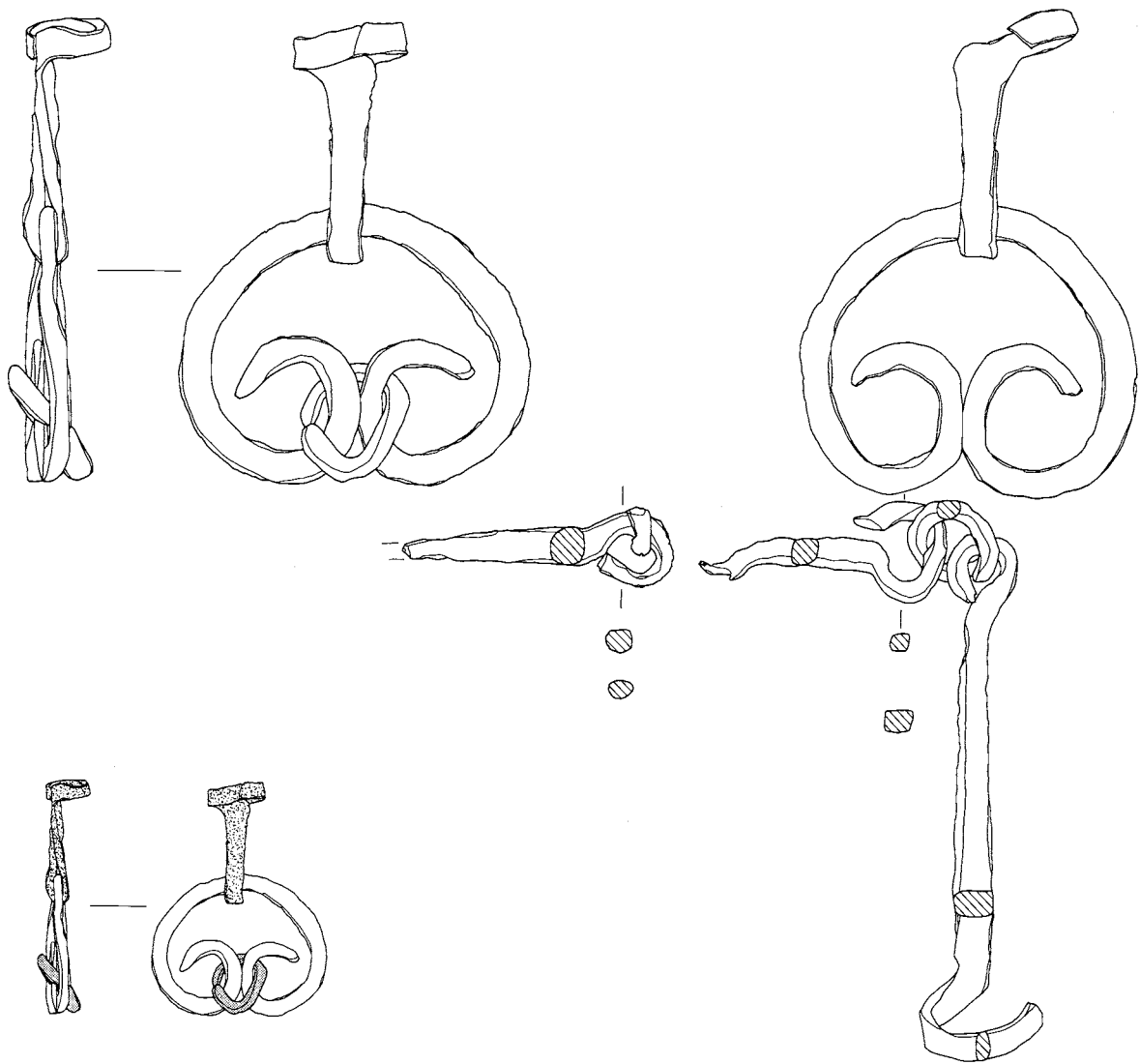

※ スクリーントーンの違いは
鍛鉄の違い・組み合わせを示す。

29 SK19

0 (1:2) 5cm

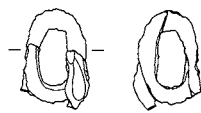

30 SB383

30 SB383

0 (1:3) 10cm

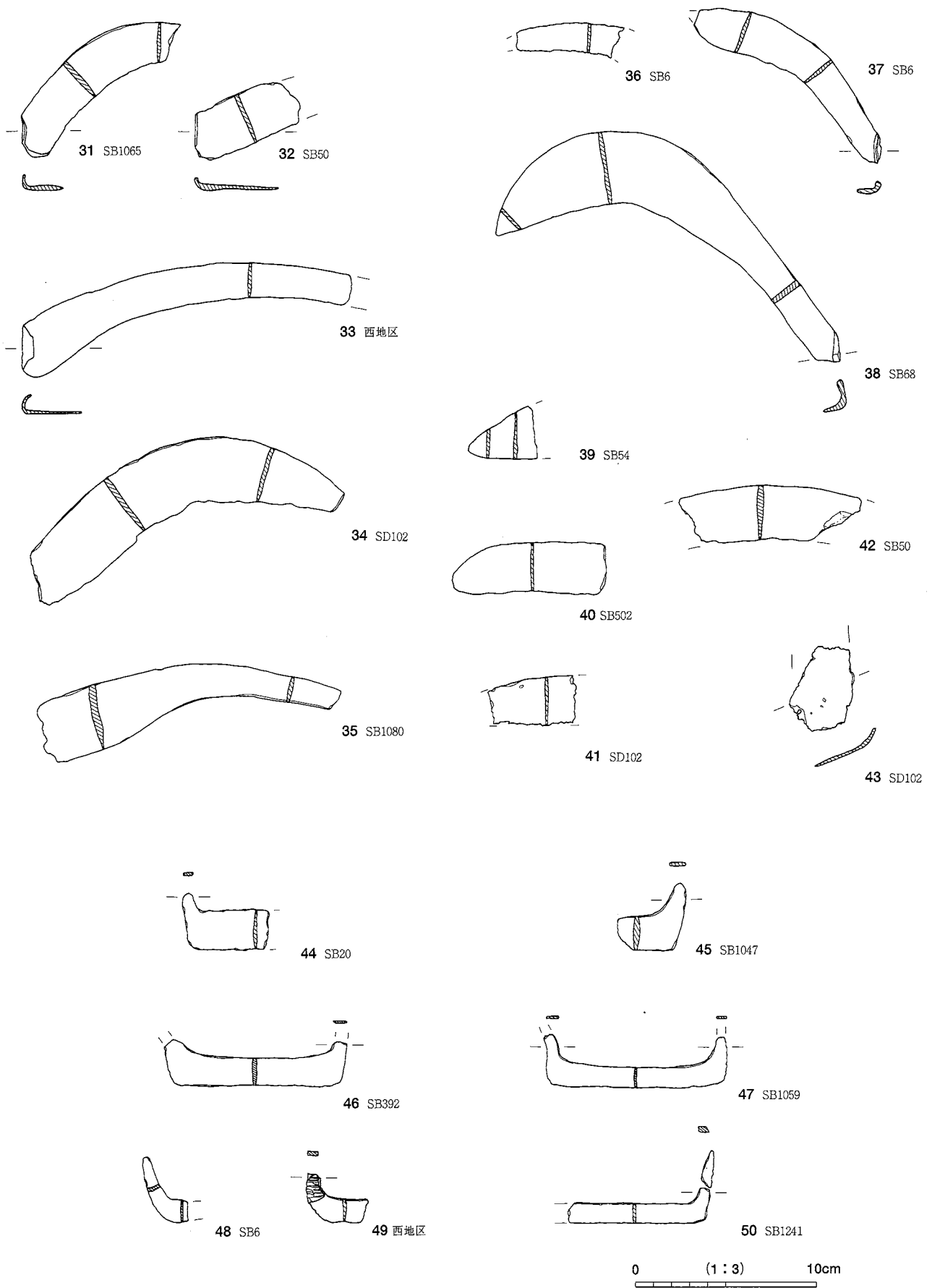

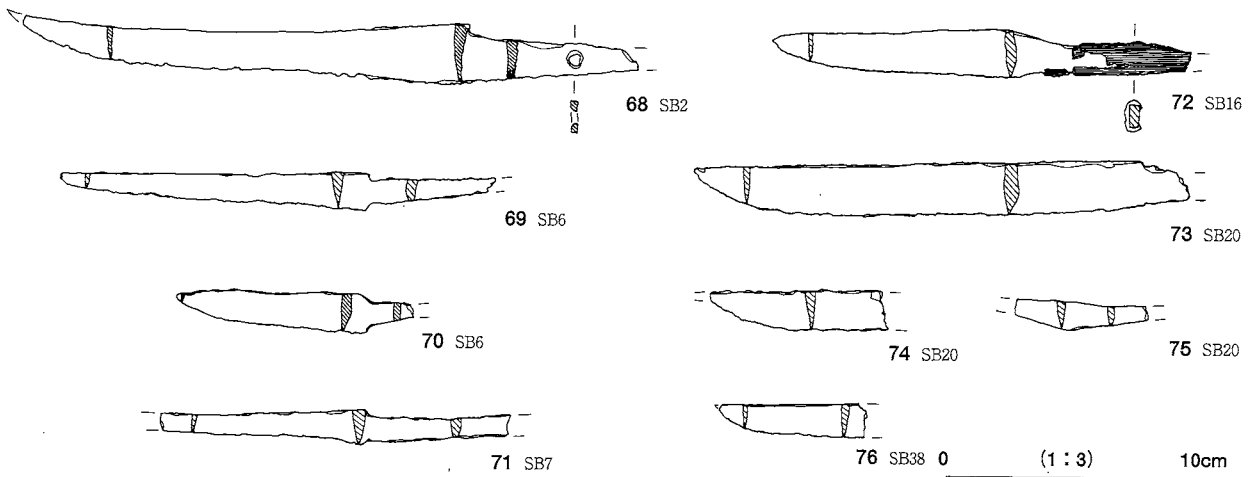
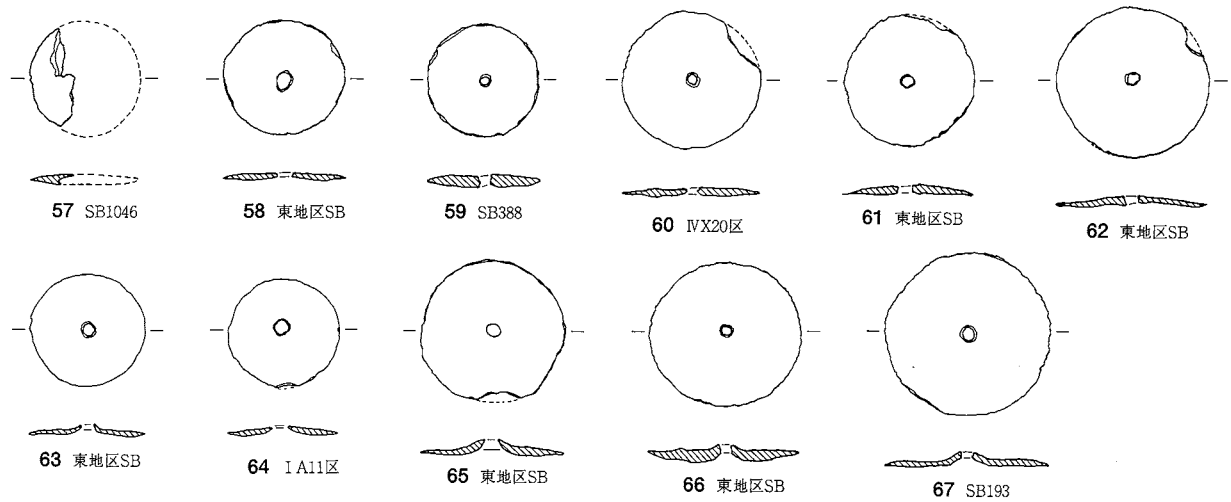
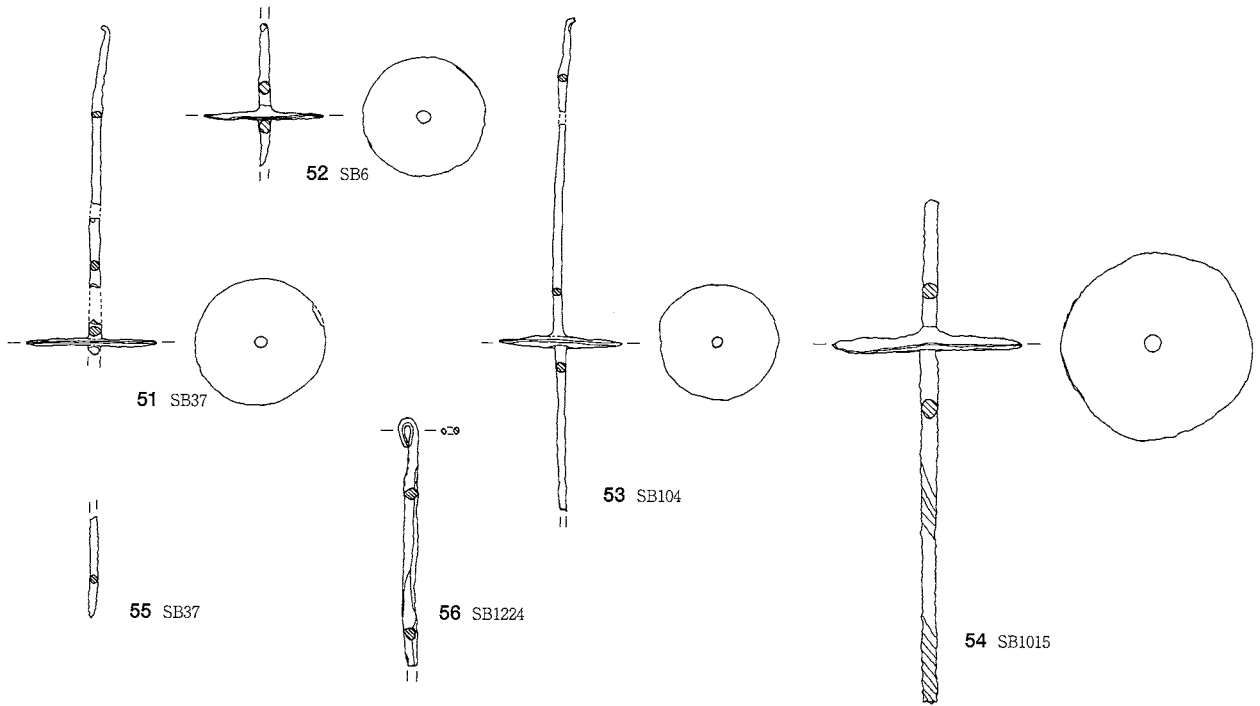

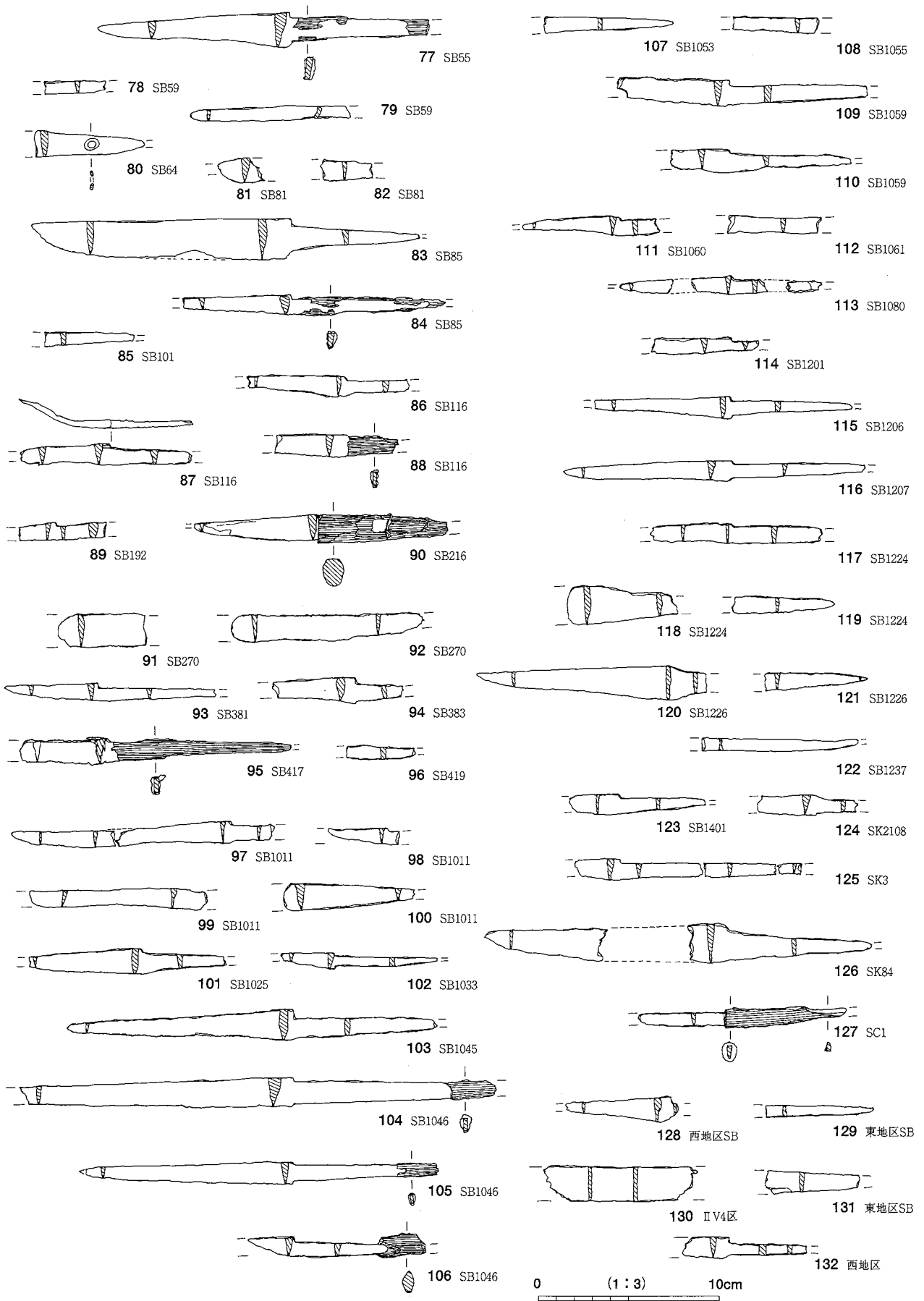

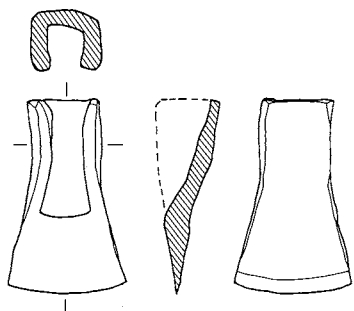

133 SB80

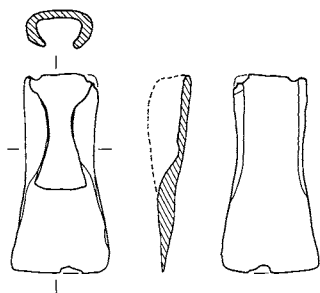

134 SD102VJ1区

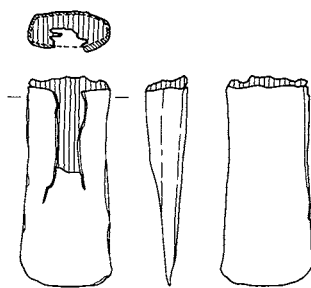

135 SD102VII4区

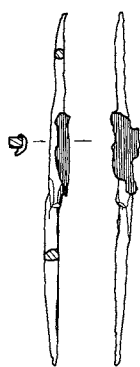

136 出土地点不明



137 SB13

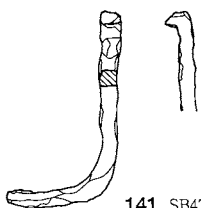

141 SB47

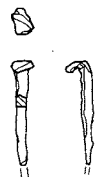

143 SB371



138 SB29

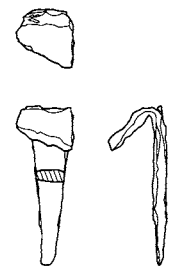

142 SB149

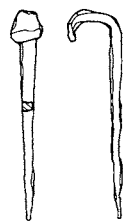

144 SB371

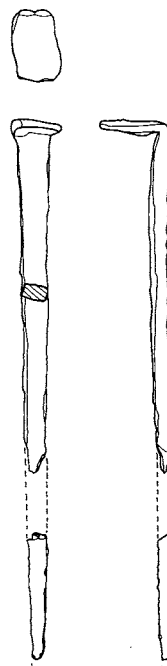

145 SB383

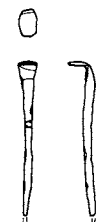

146 SB383



139 SB35



140 SB66



147 SB383

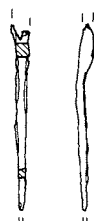

149 SB1024



151 SB1207



153 SB1207



155 SB1207

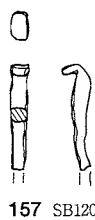

157 SB1207



148 SB383



150 SB1092



152 SB1207

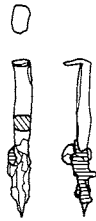

154 SB1207

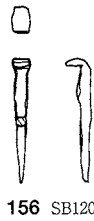

156 SB1207



158 SB1207



160 SB1225



162 東地区

150 SB1092

0 (1:3) 10cm

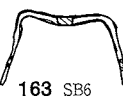

163 SB6

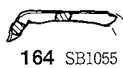

164 SB1055



161 SB1225

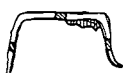

165 SB1207

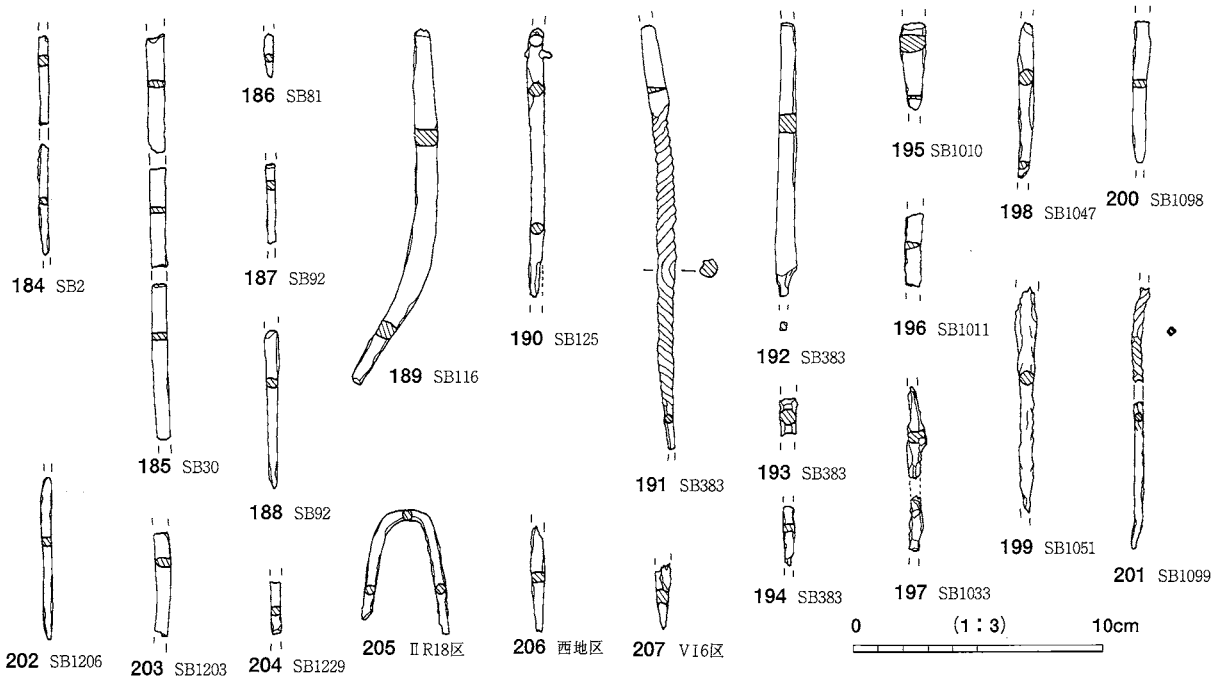
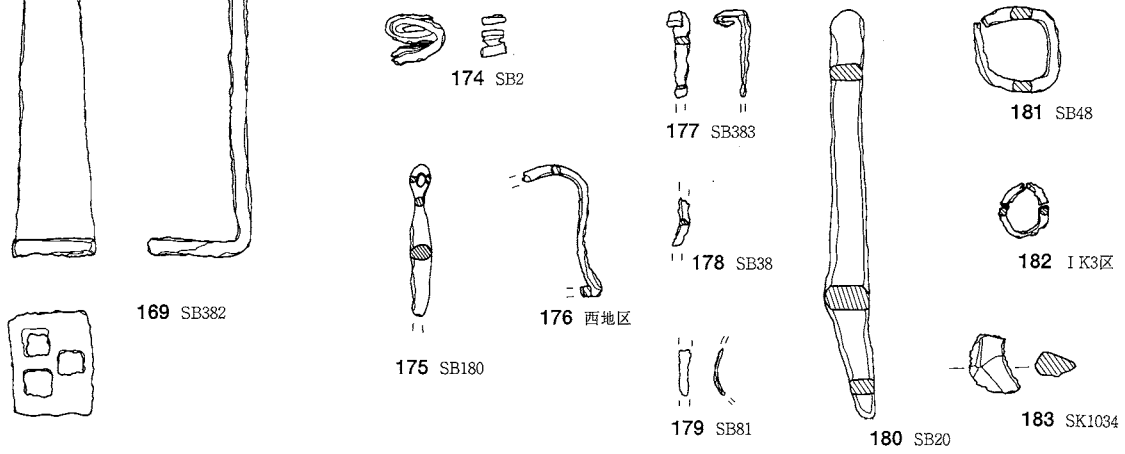
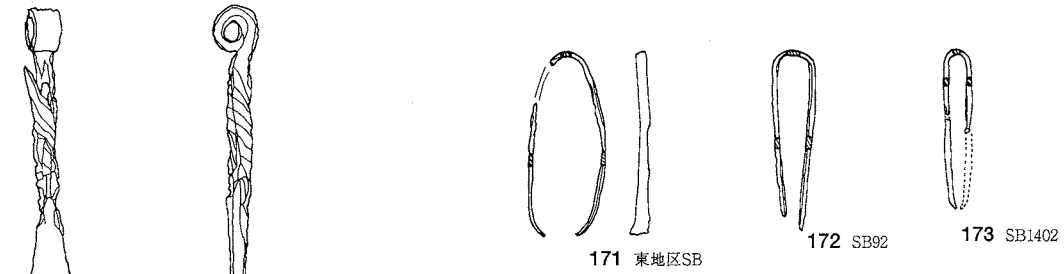
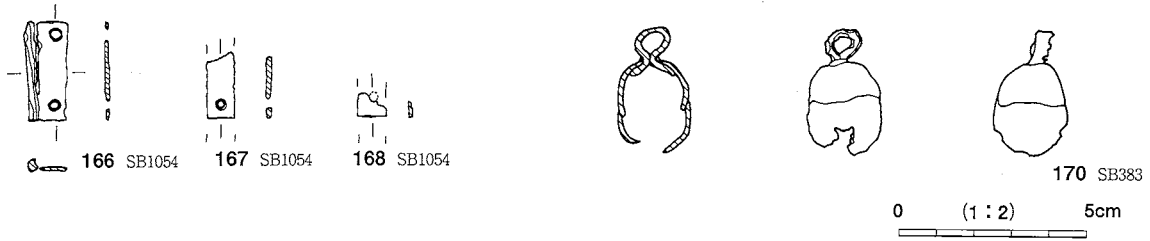

銅製品 (1~6)

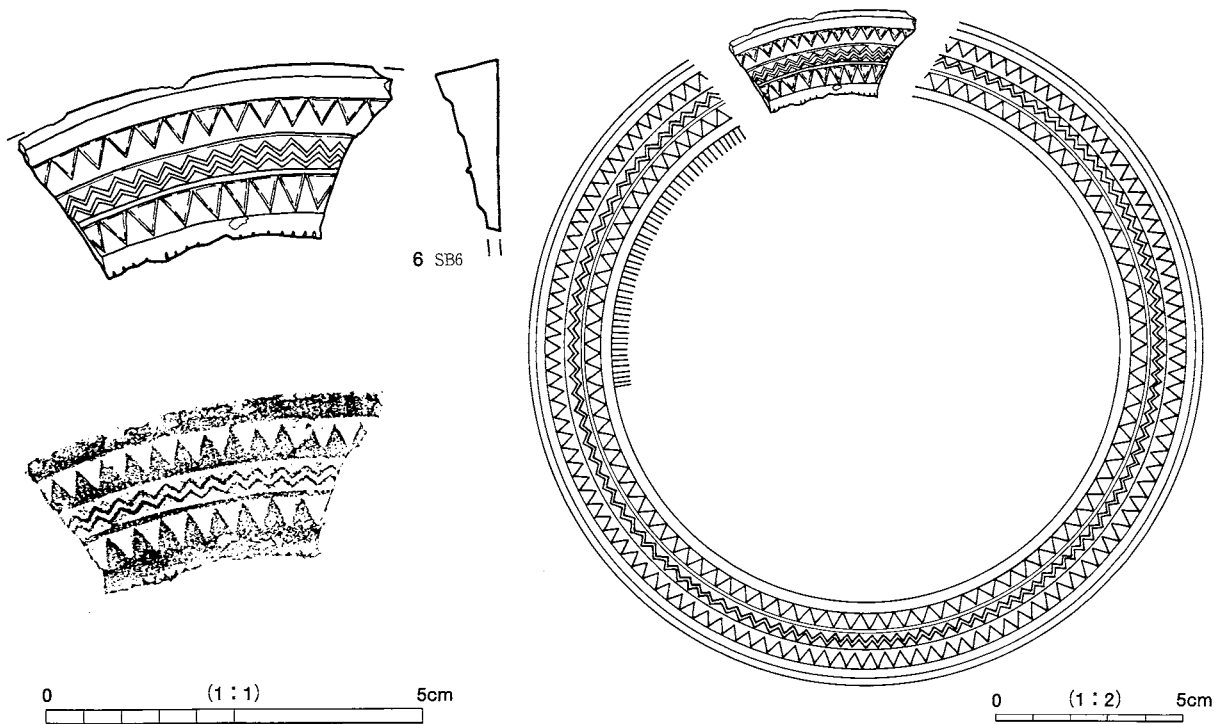
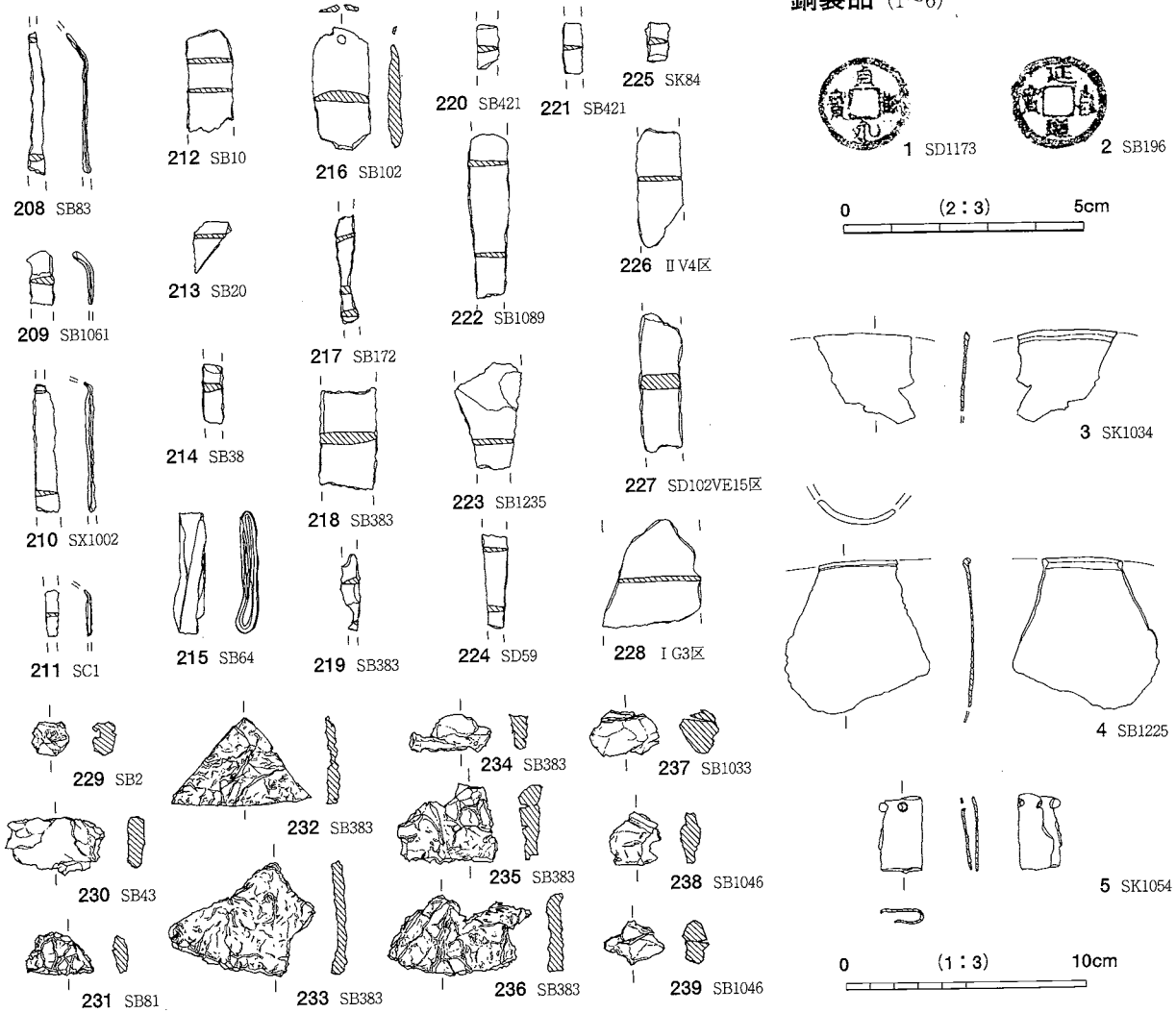

弭

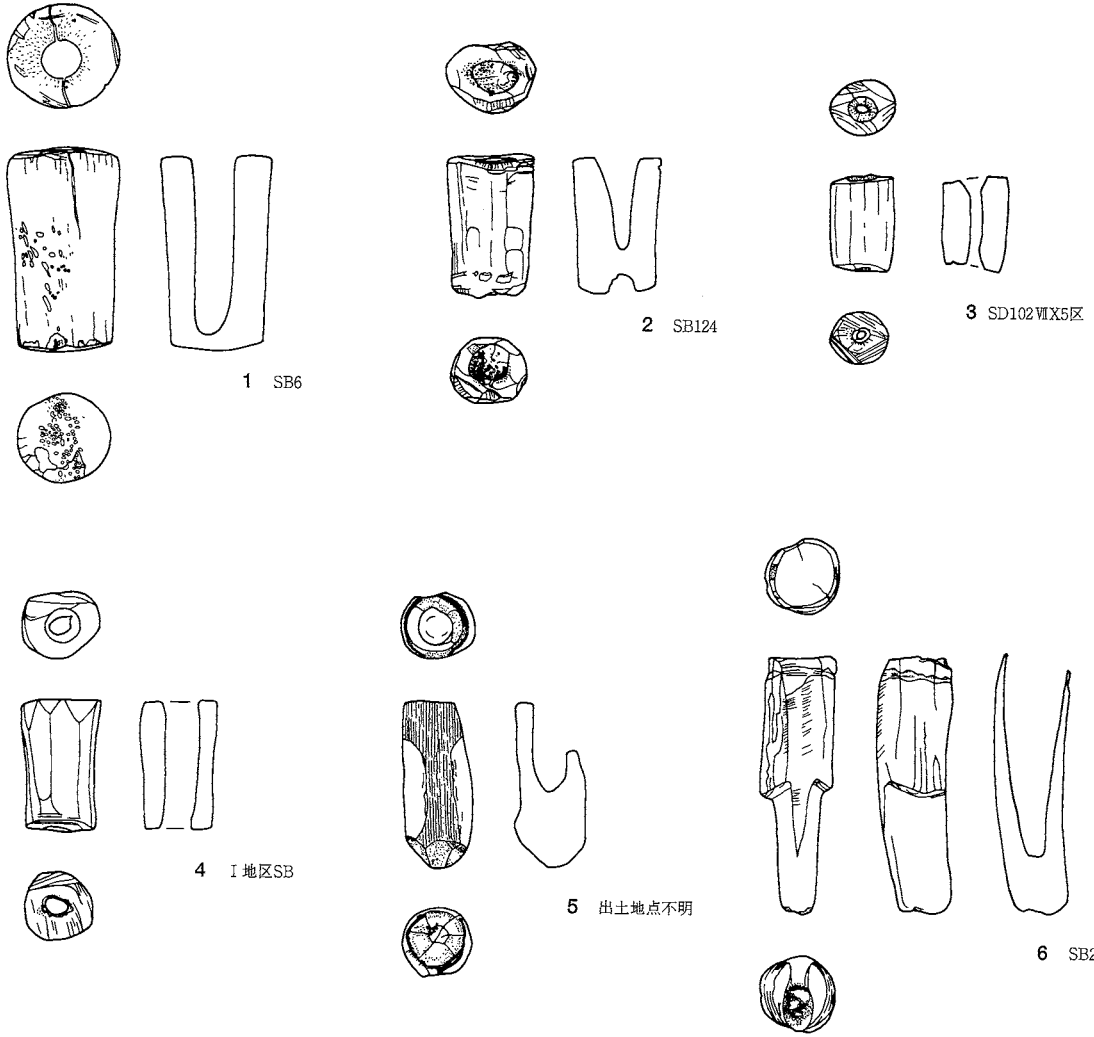

刀子柄

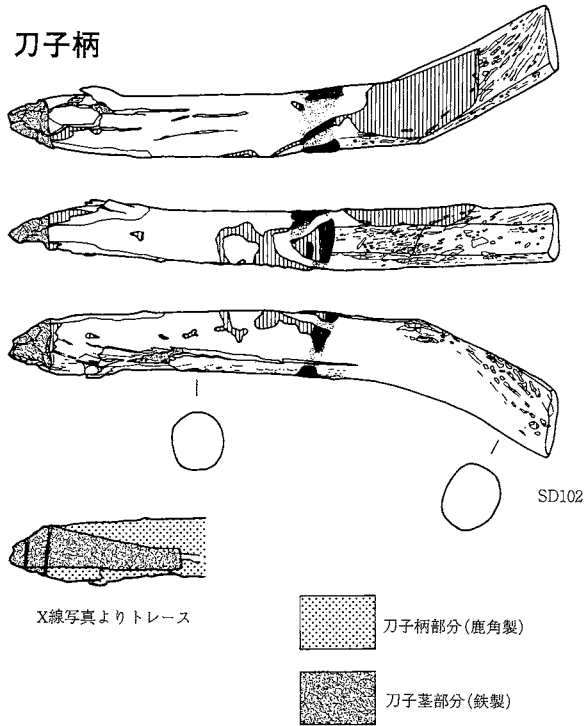

刺突具

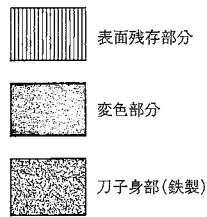
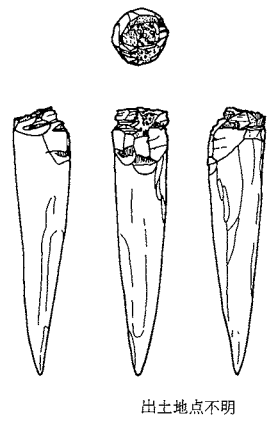

X線写真よりトレース

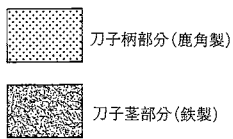

0 (1:2) 5cm



装飾品 (1~5)

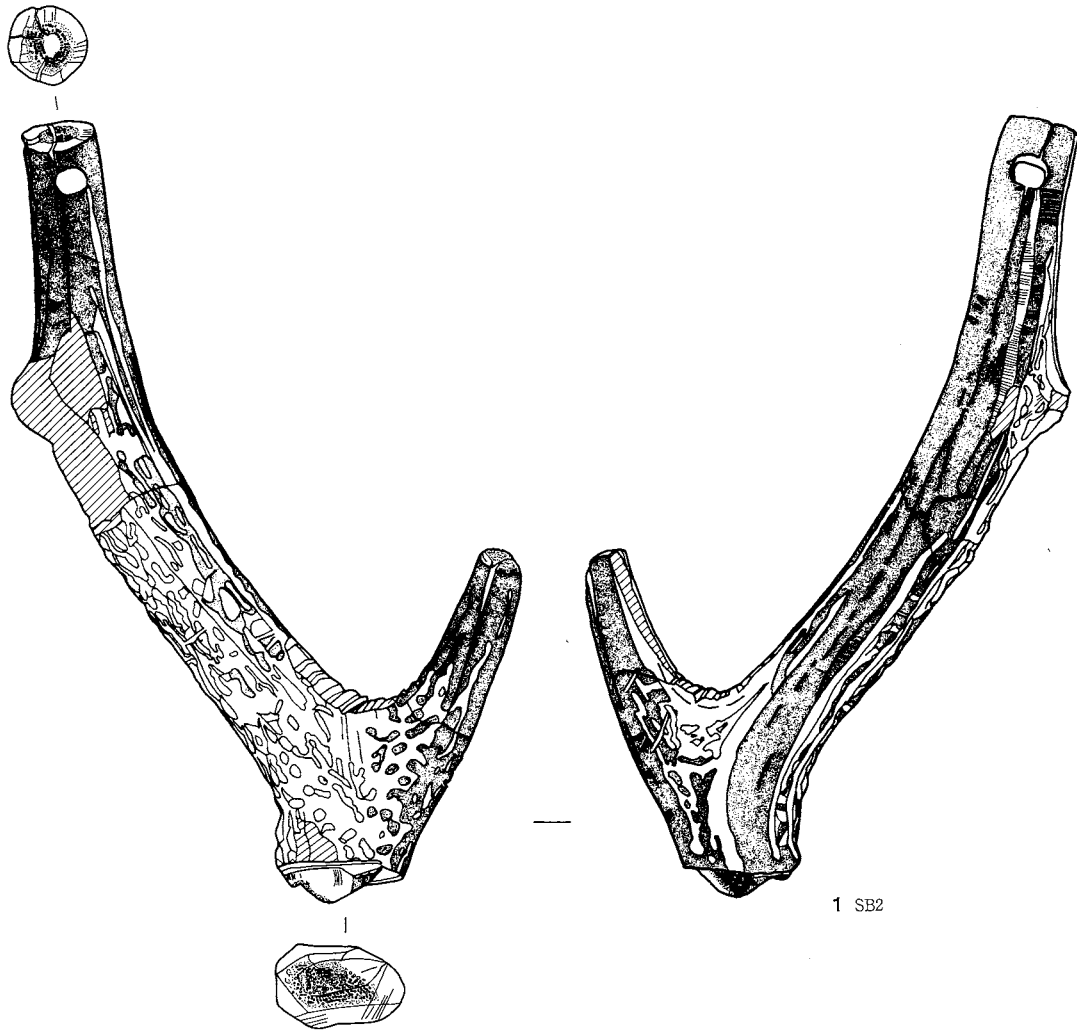

1 SB2

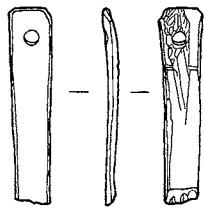

2 SB327



3 SB327

0 (1:2) 5cm



4 SB1045

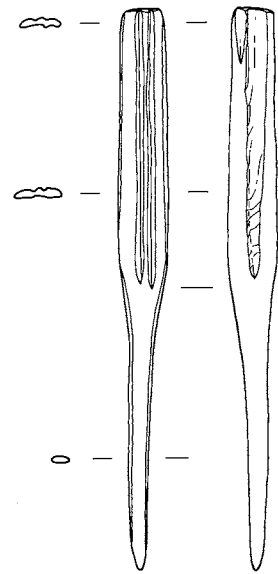

5 SK1039

0 (1:2) 5cm



サイコロ

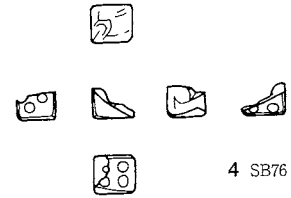
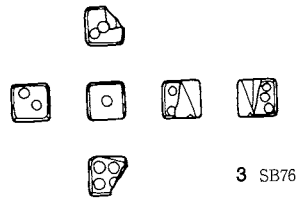
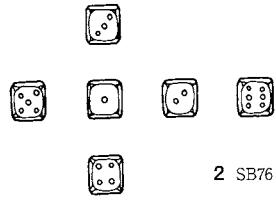
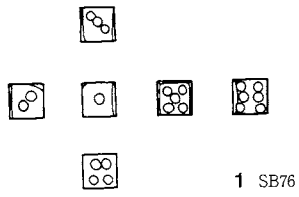

0 (1:1) 2.5cm

卜骨

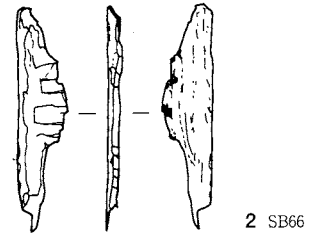
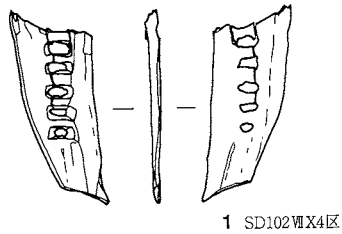

製品素材 (1~15)

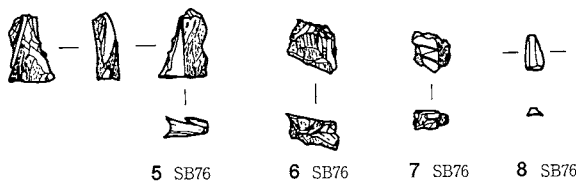
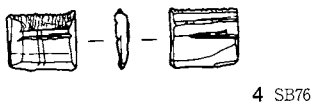
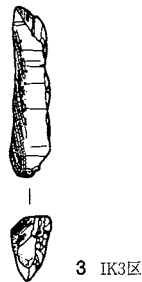
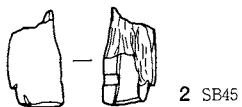
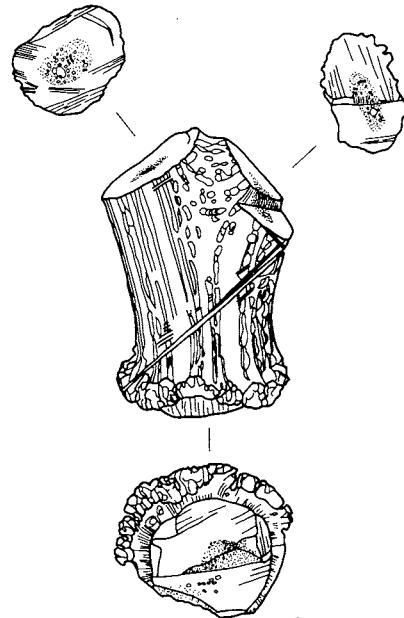
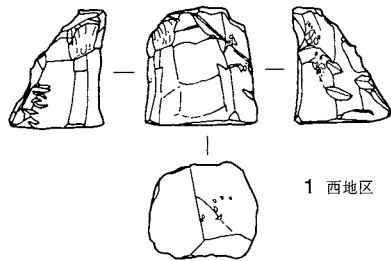

0 (1:2) 5cm

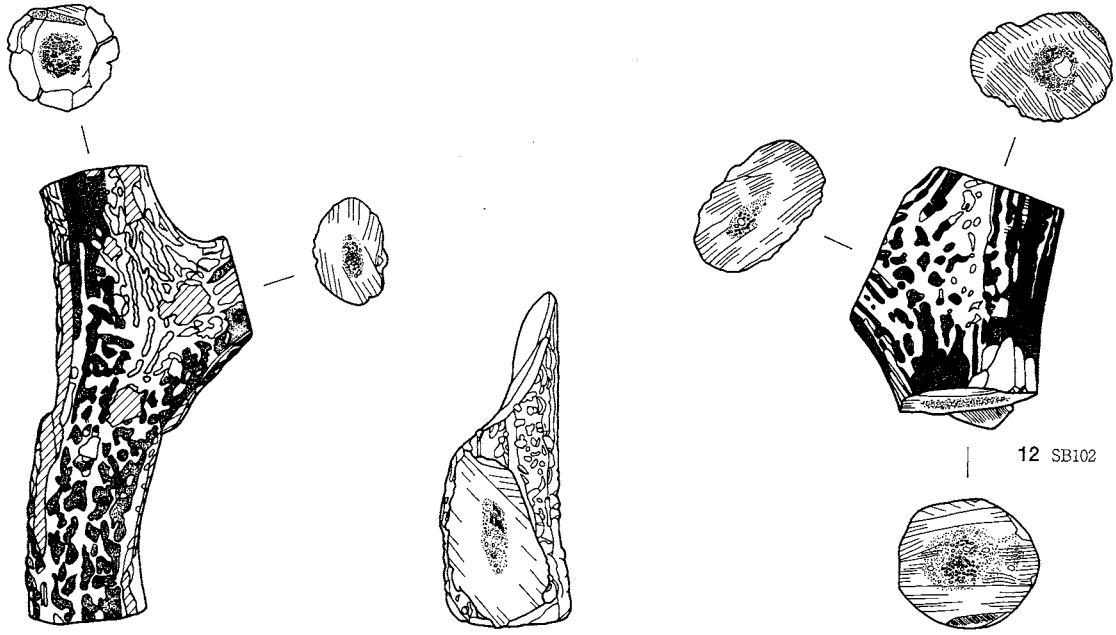

10 SB102

11 SB102C区

12 SB102

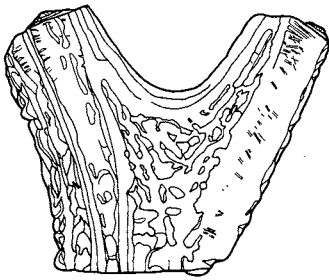
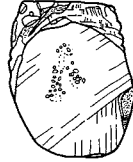
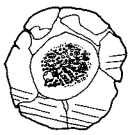

14 SB1048

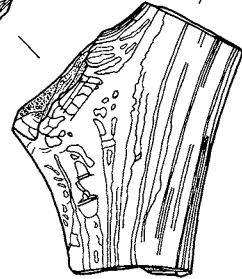
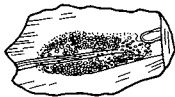

13 SB102C区

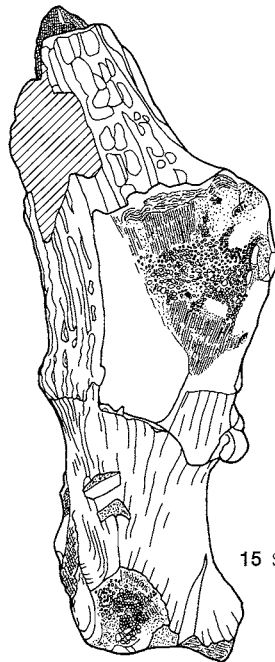

15 SD21F20区

0 (1:2) 5cm

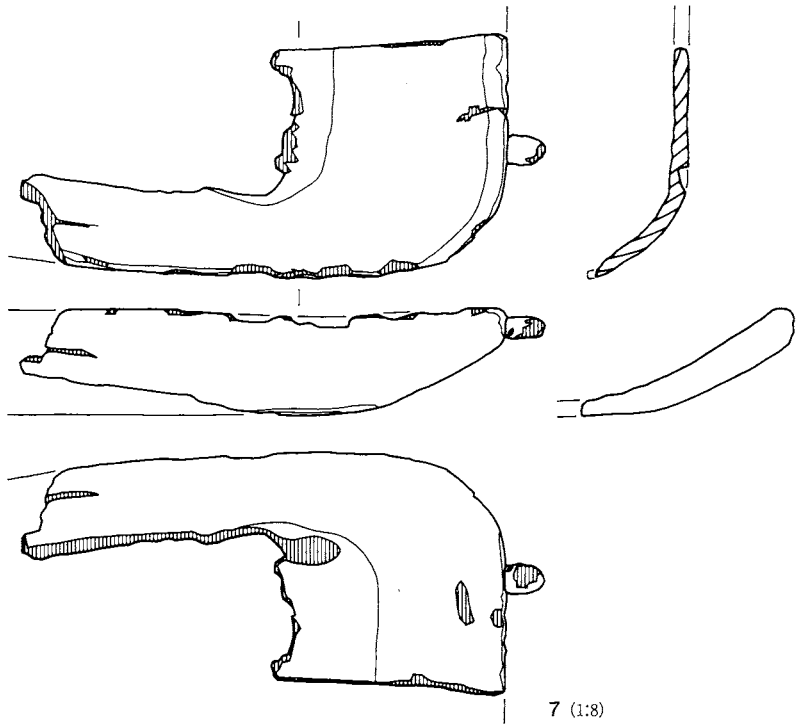
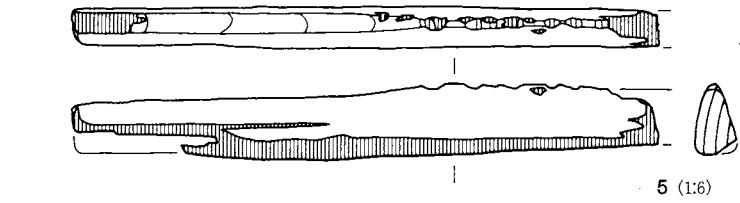
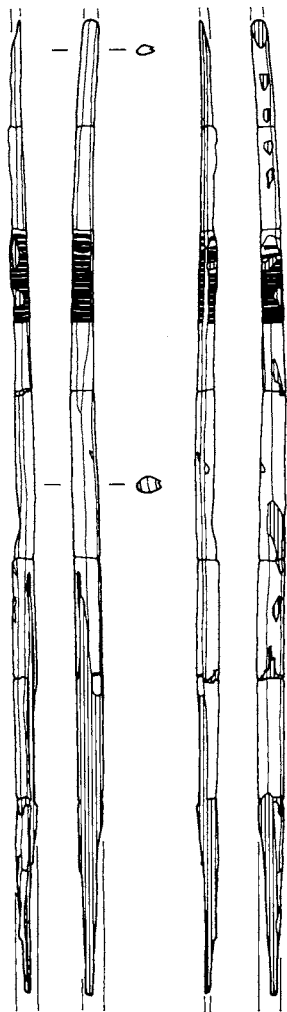
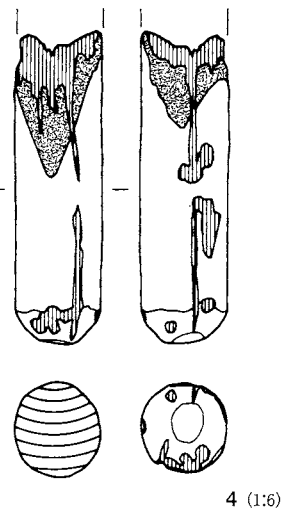
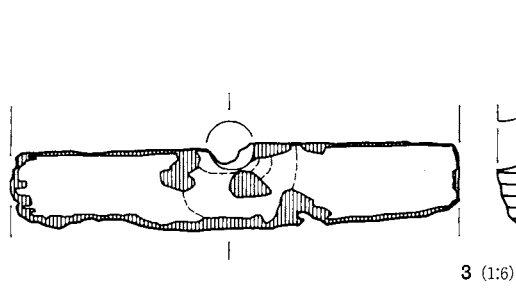
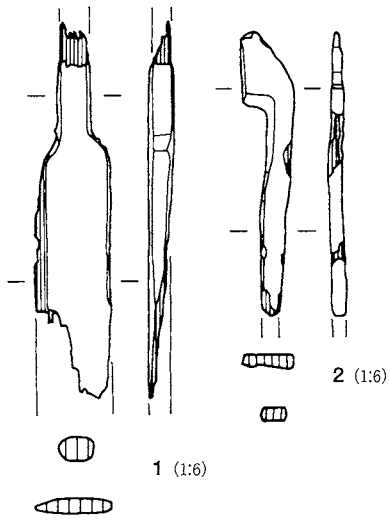

6 (1:6)

7 (1:8)

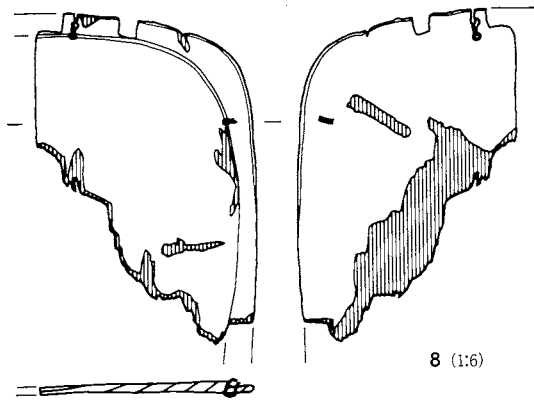

8 (1:6)

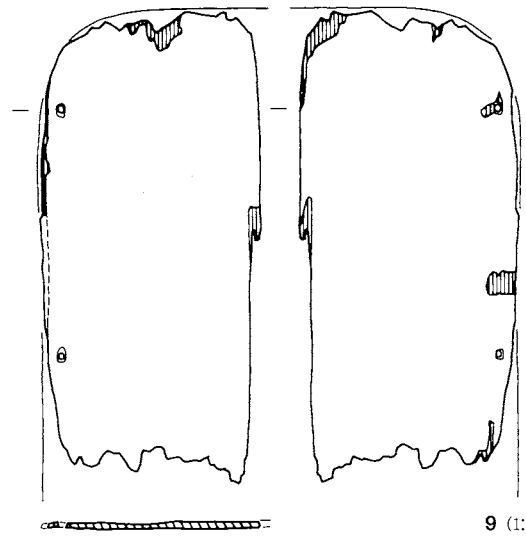

9 (1:6)

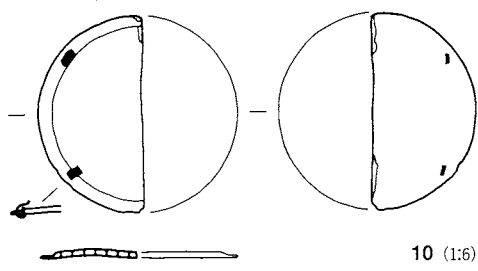

10 (1:6)

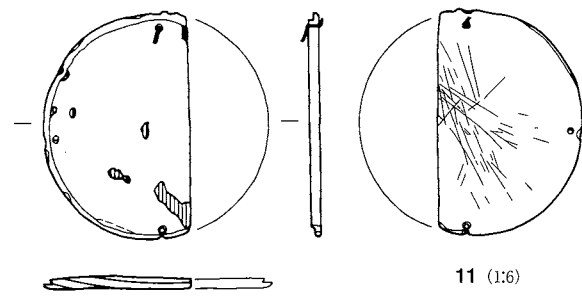

11 (1:6)

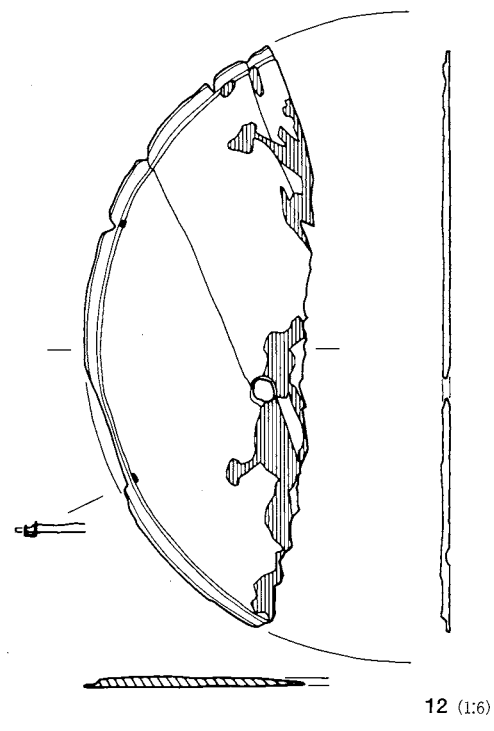

12 (1:6)

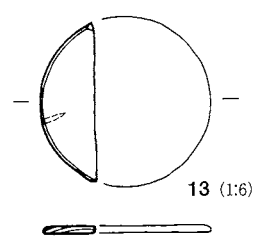

13 (1:6)

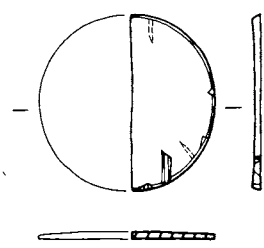

14 (1:6)

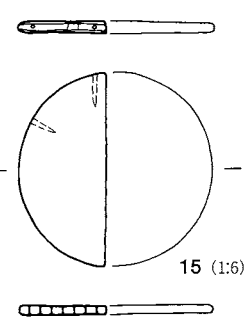

15 (1:6)

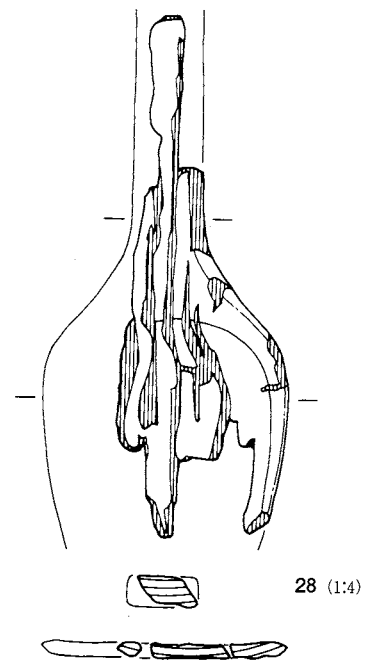
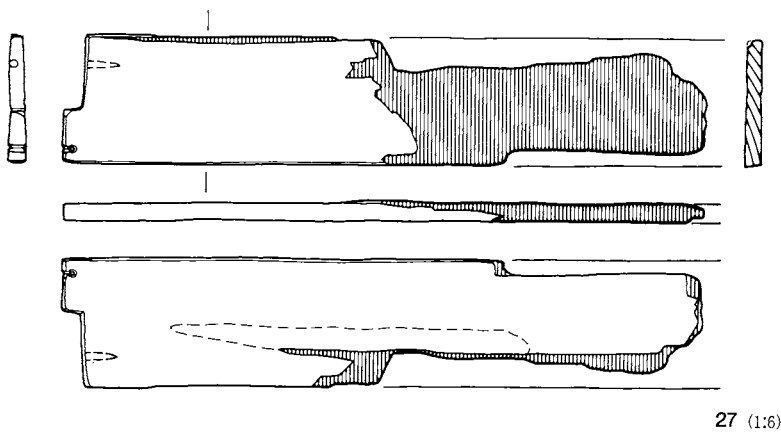
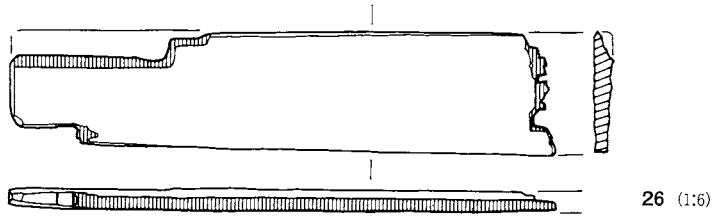
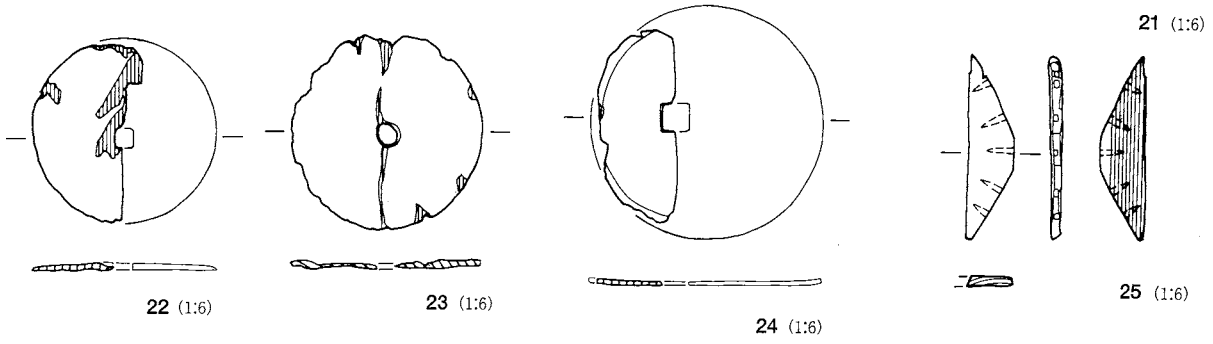
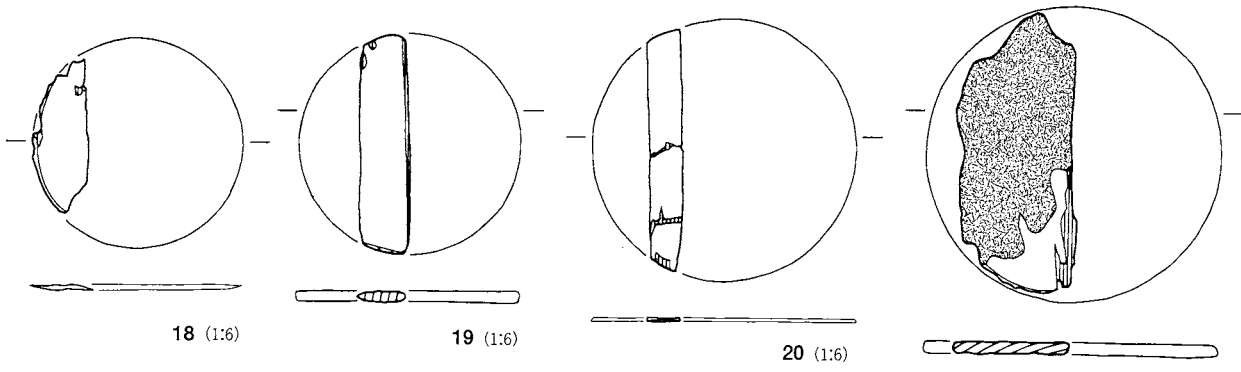
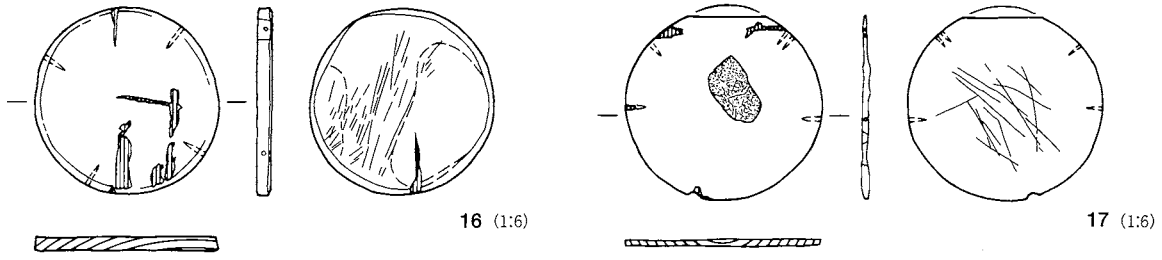

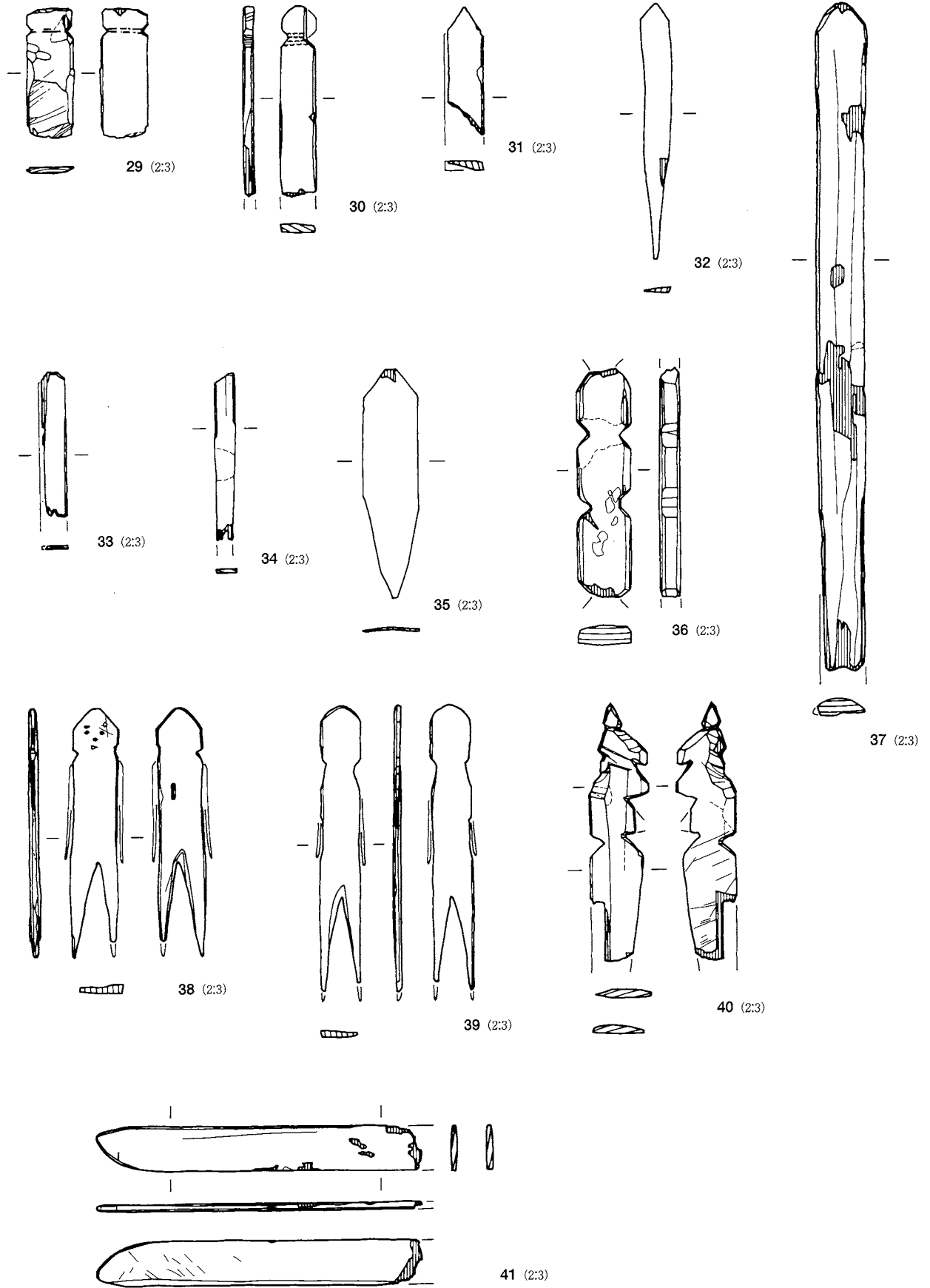

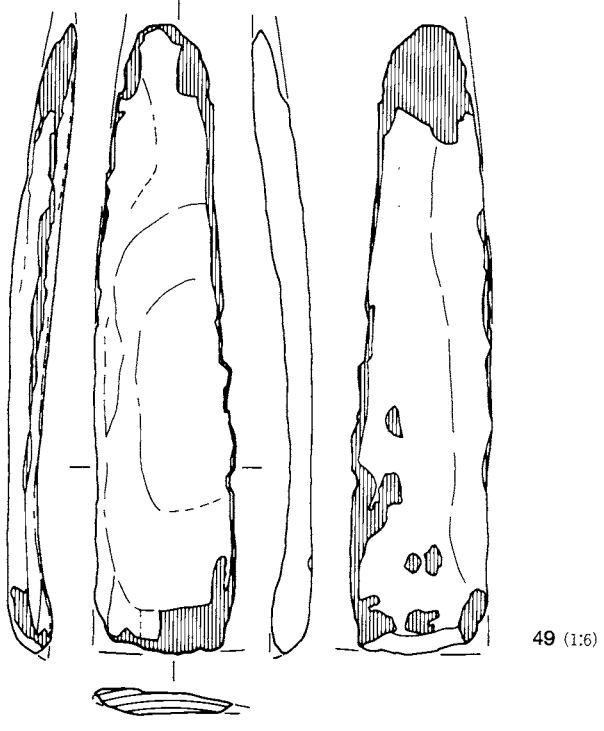
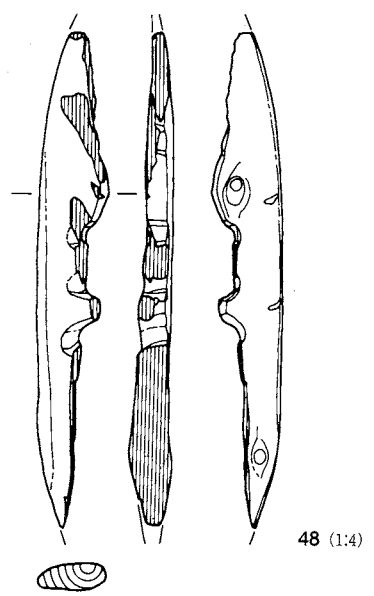
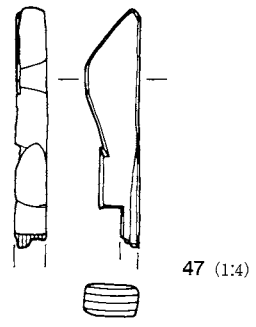
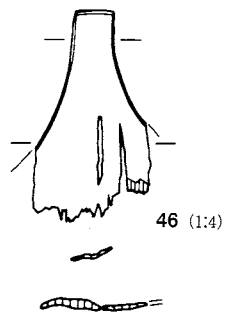
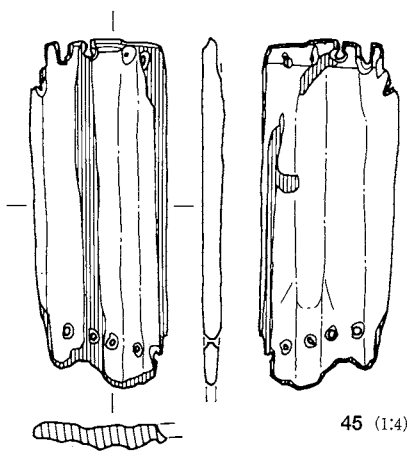
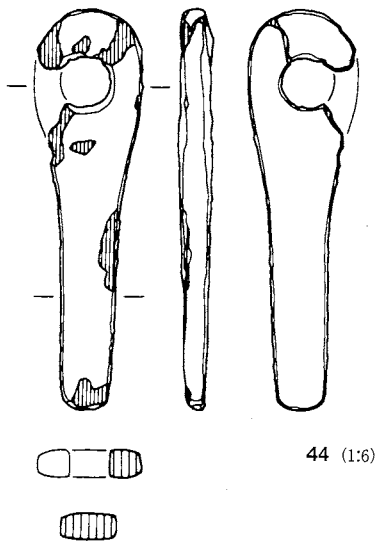
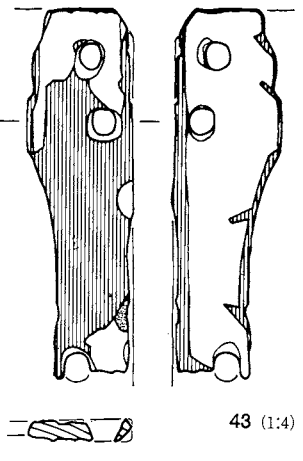
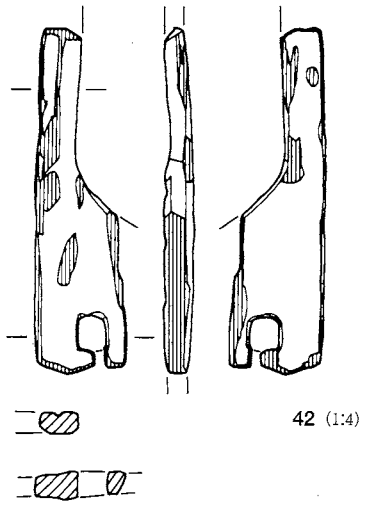

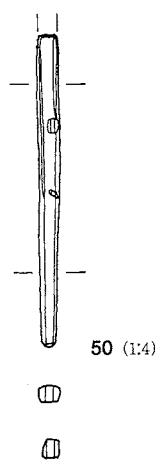

50 (1:4)

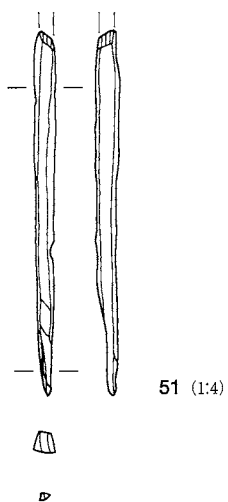

51 (1:4)

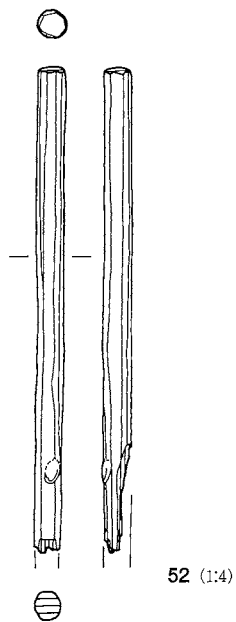

52 (1:4)

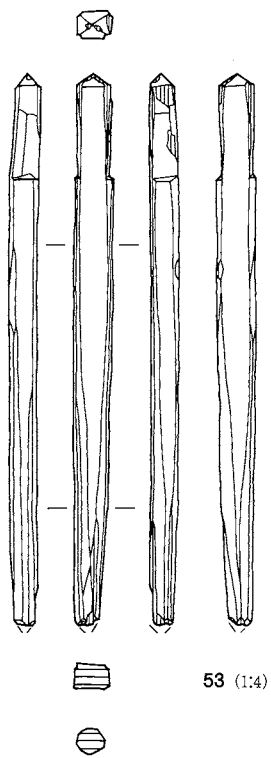

53 (1:4)

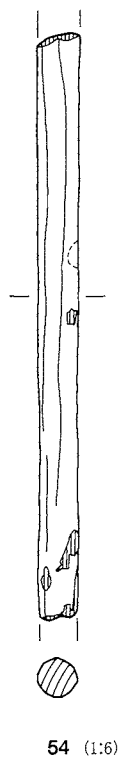

54 (1:6)

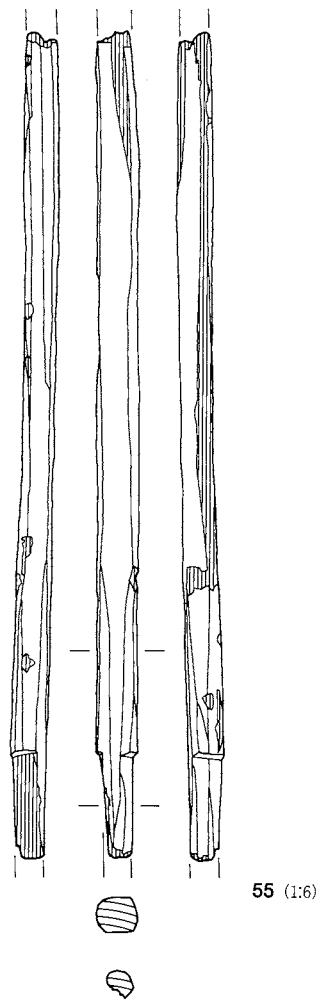

55 (1:6)

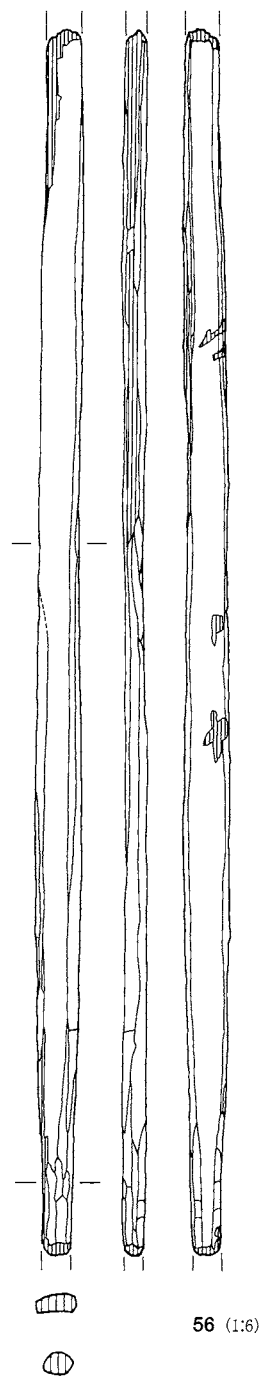

56 (1:6)

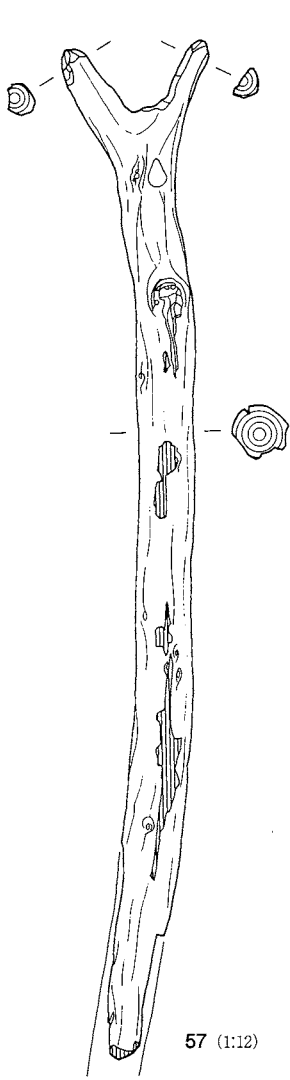

57 (1:12)

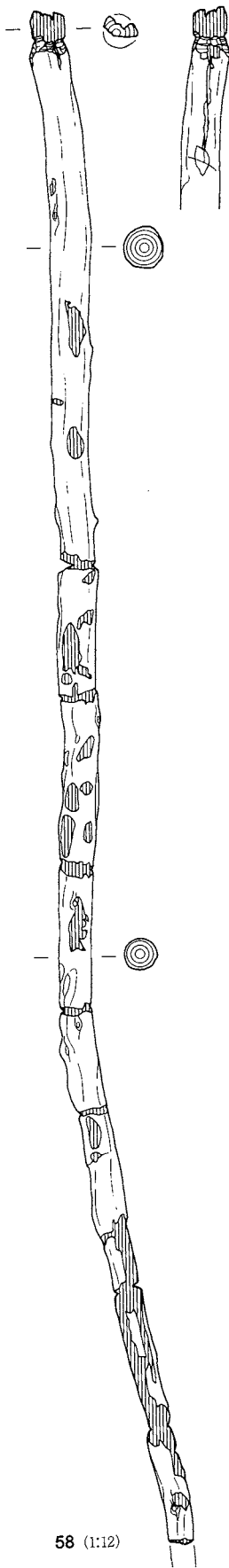

58 (1:12)

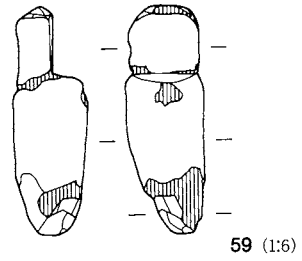

59 (1:6)

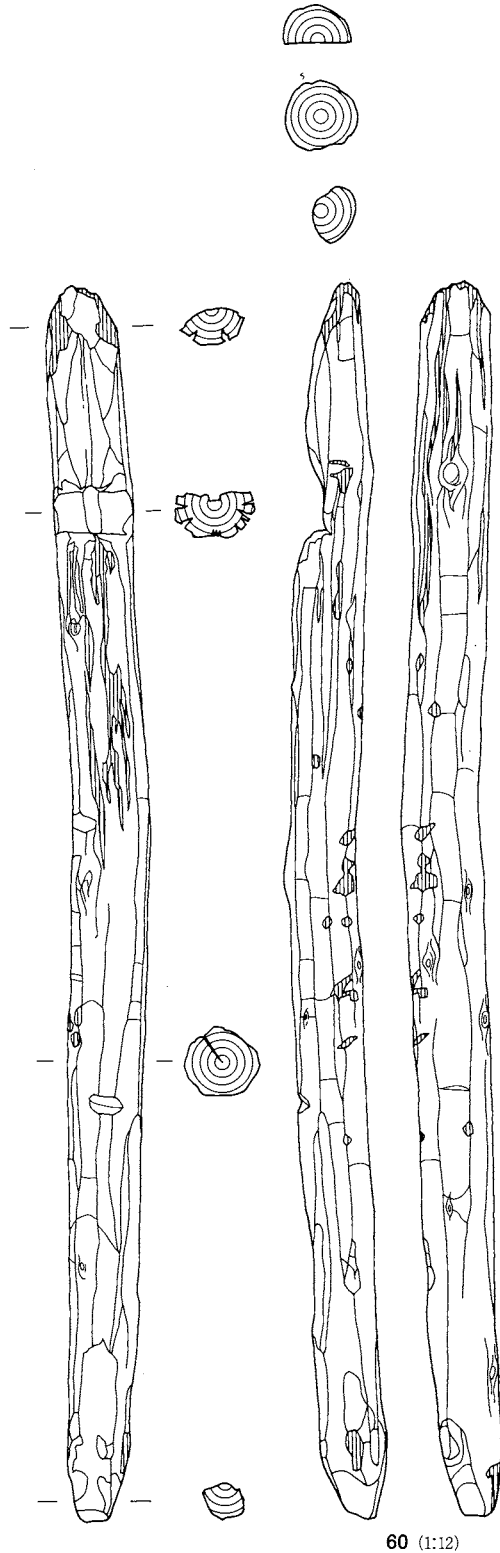

60 (1:12)

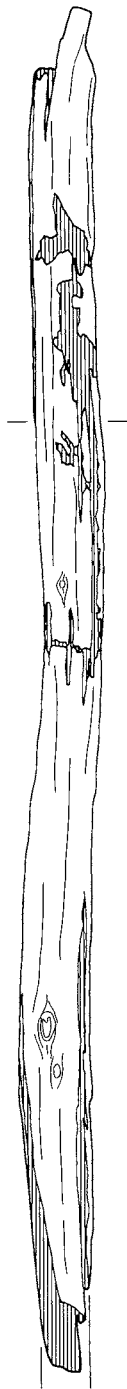
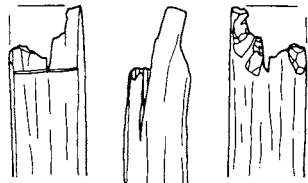

61 (1:16)

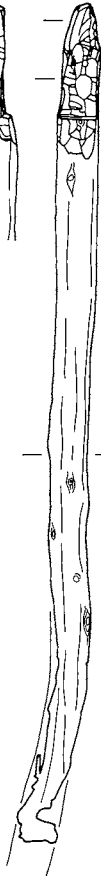
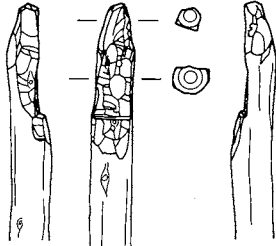

62 (1:12)



63 (1:12)



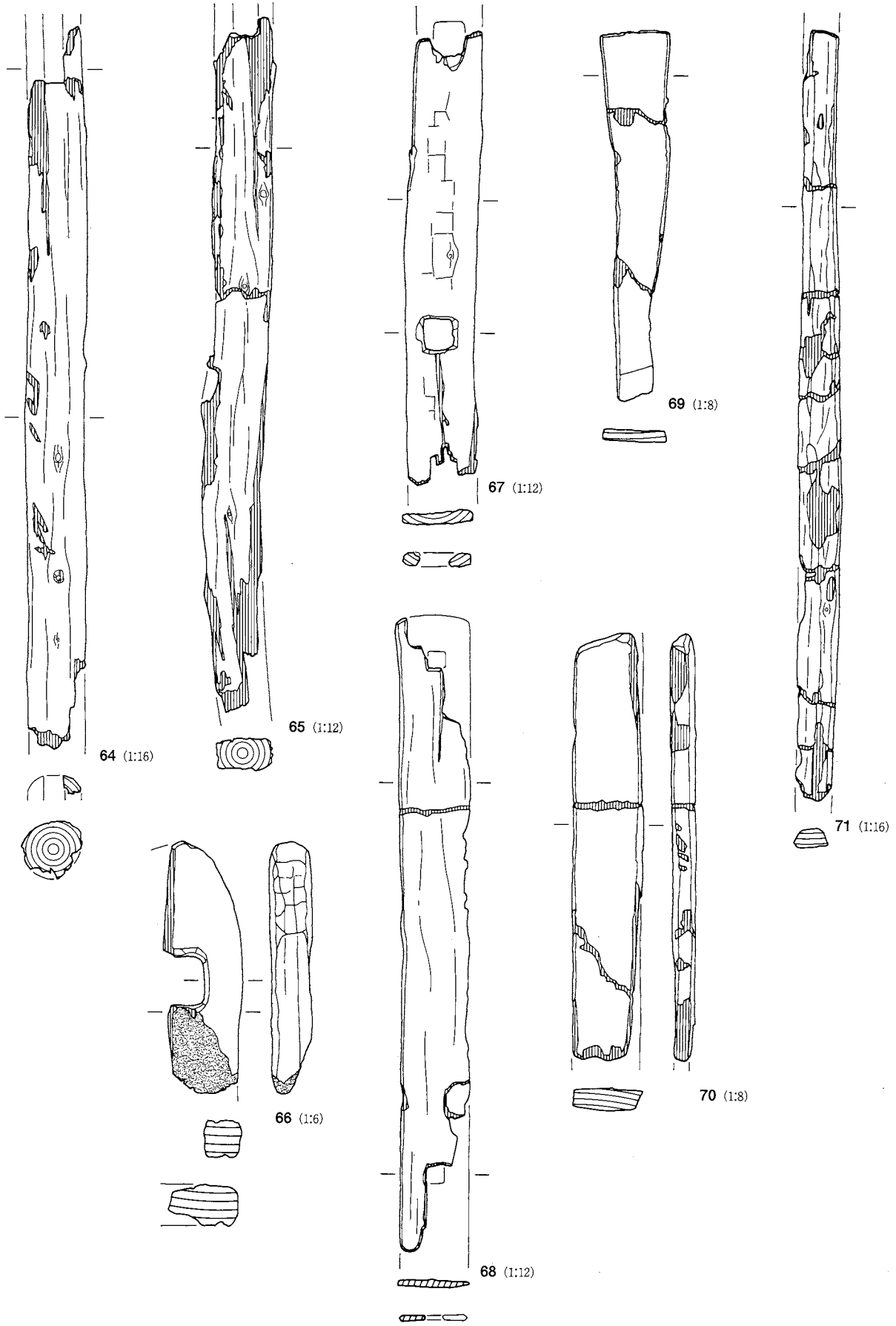

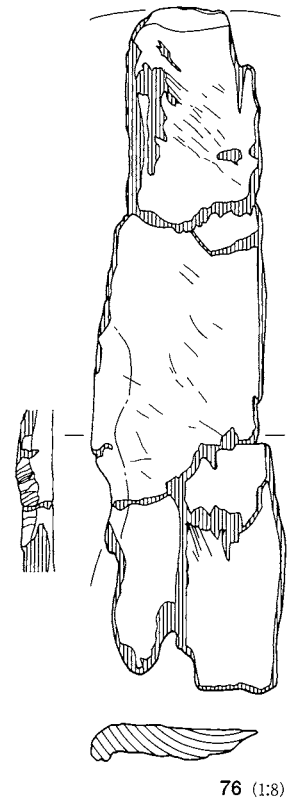
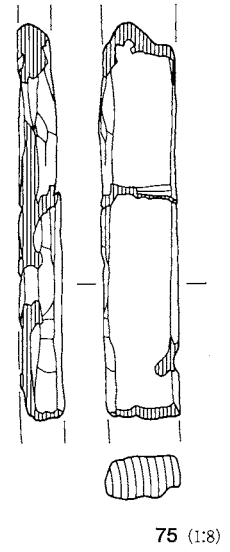
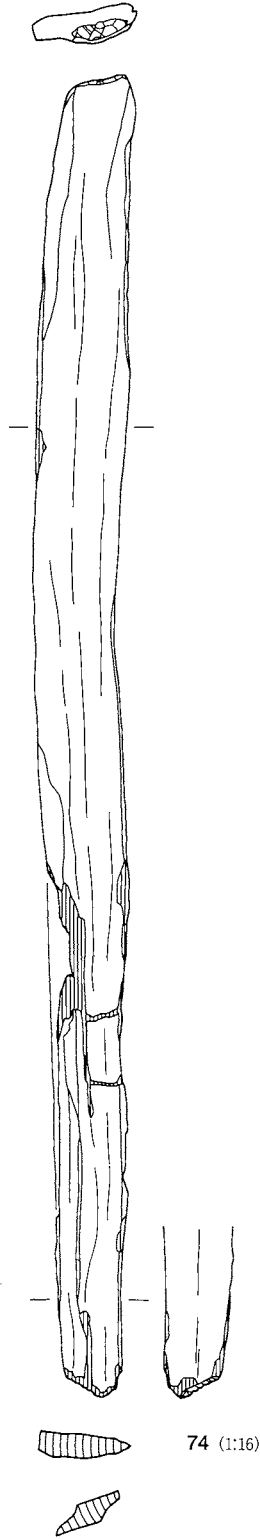
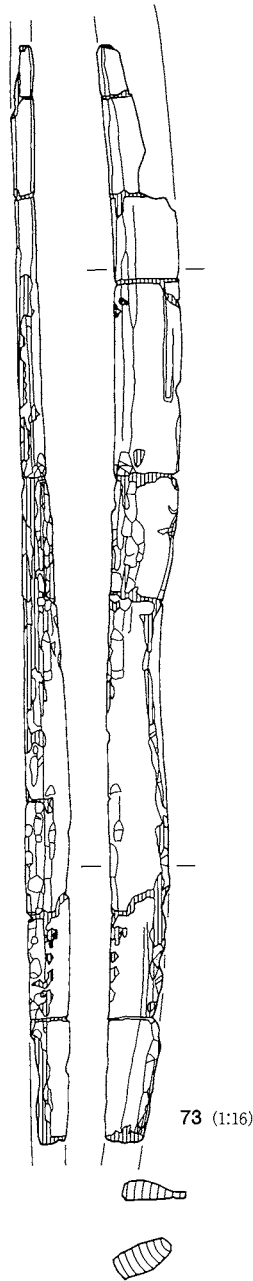
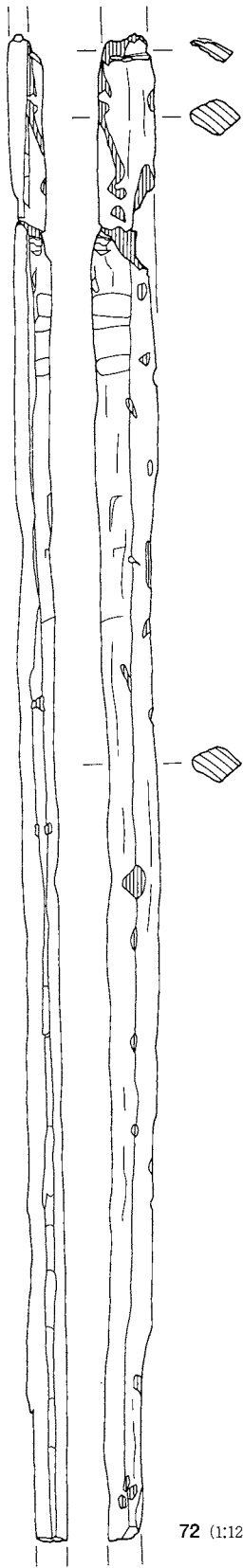

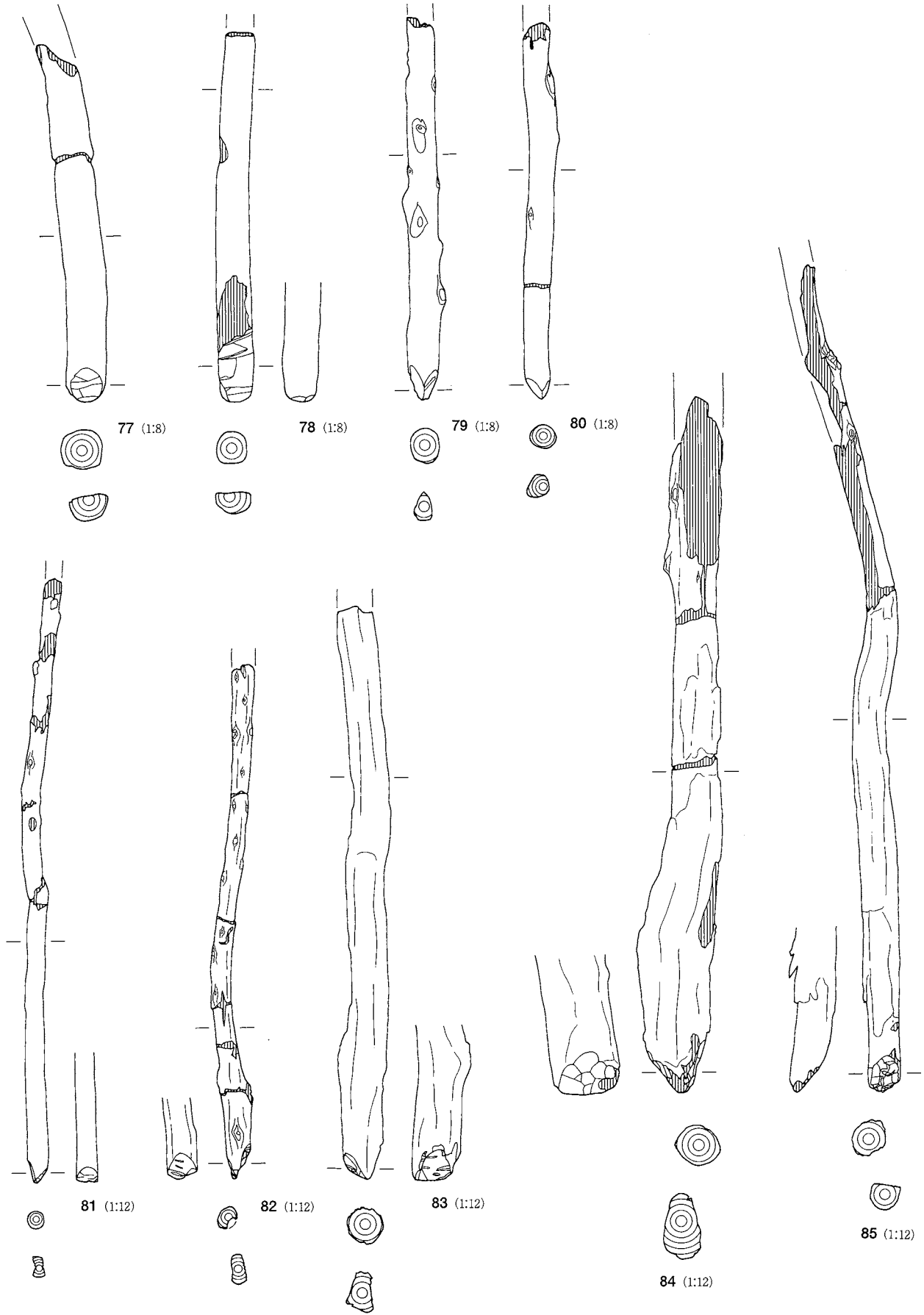

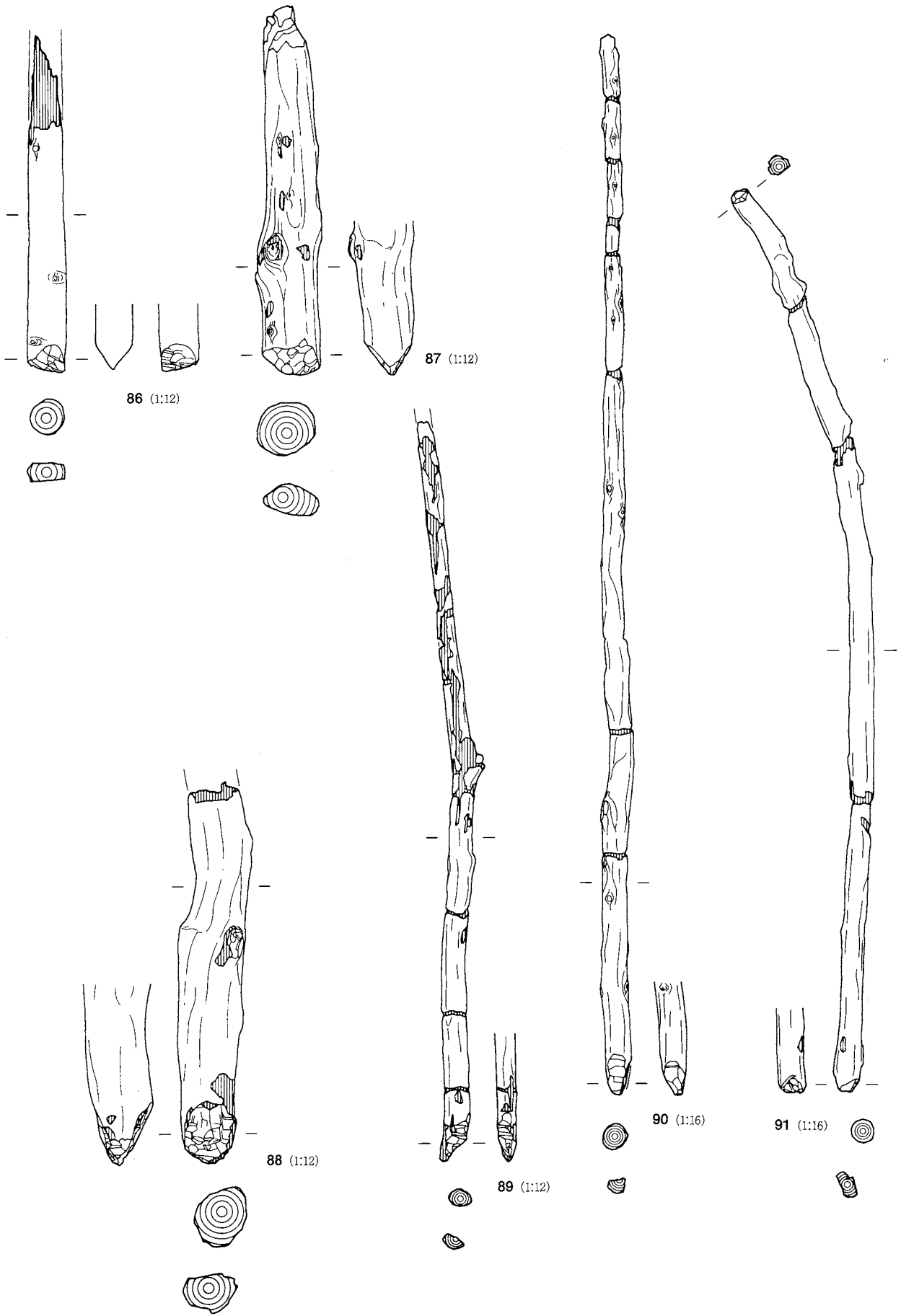

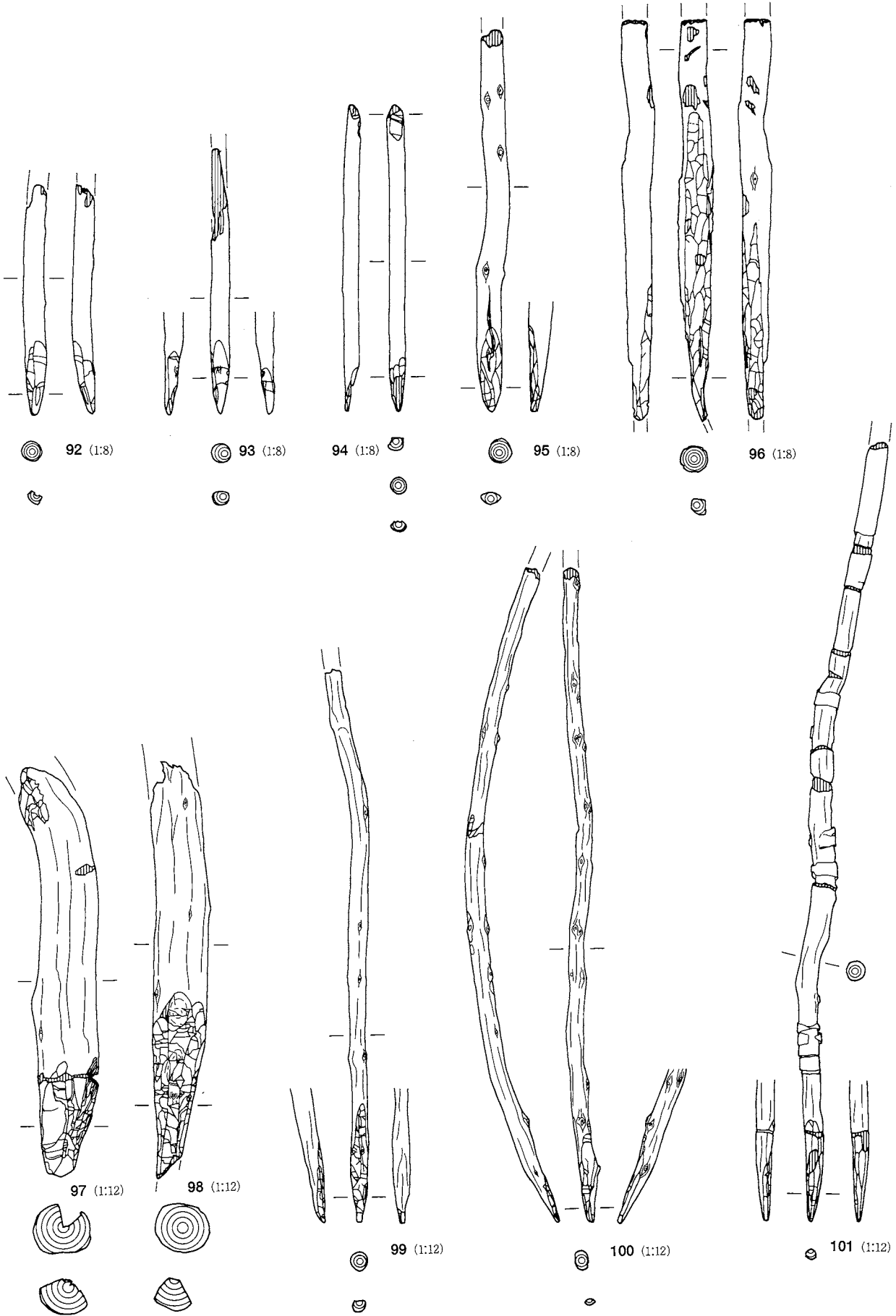

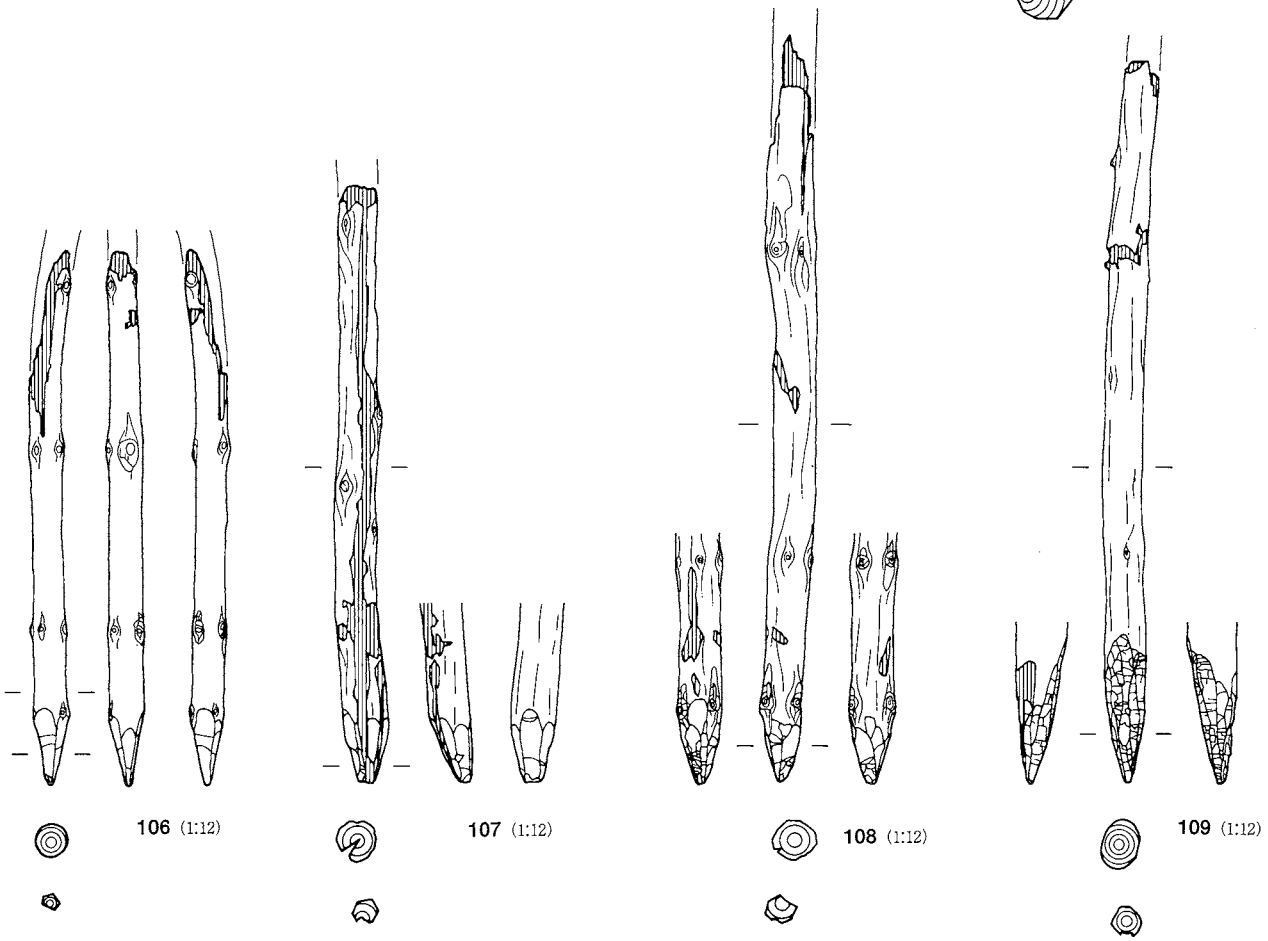
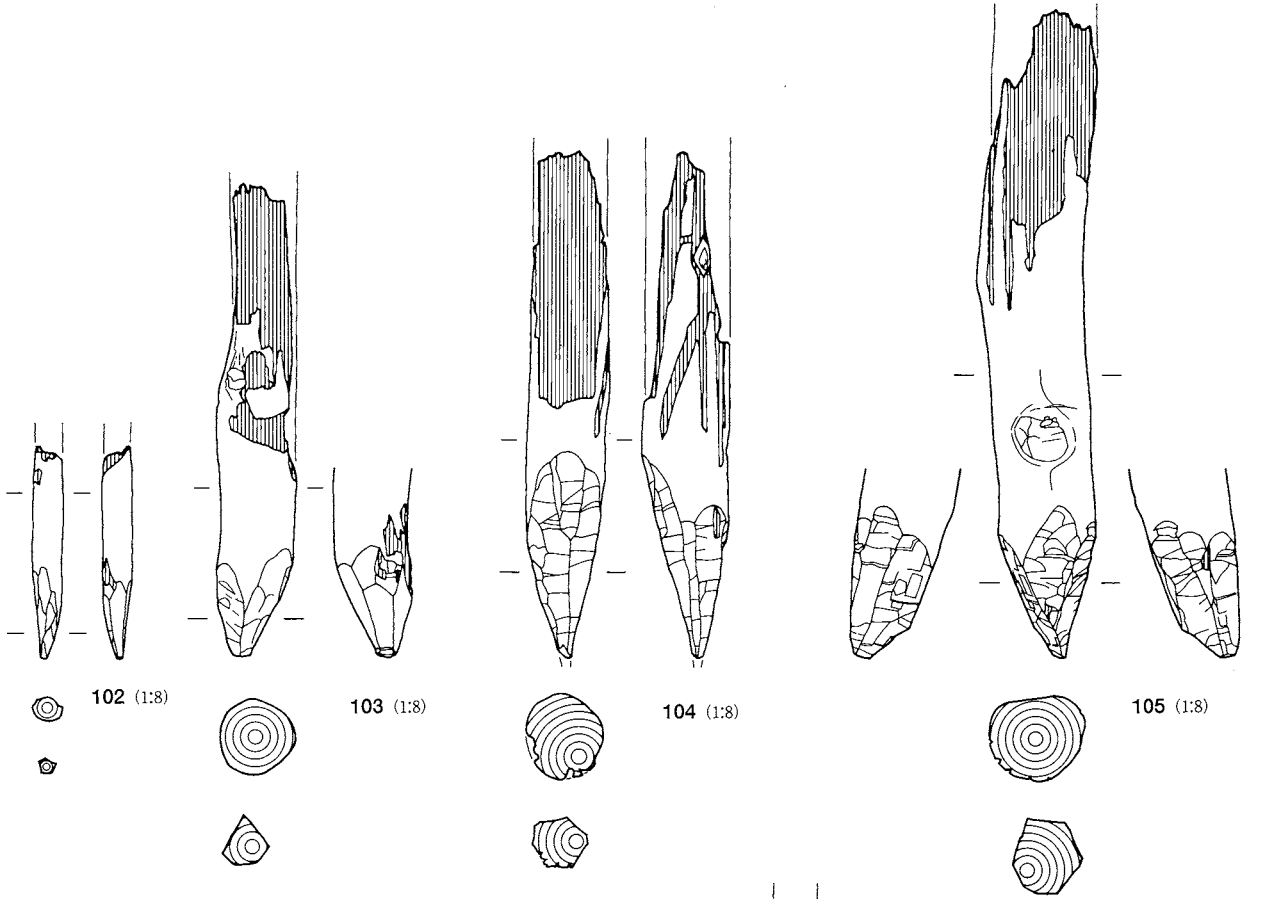

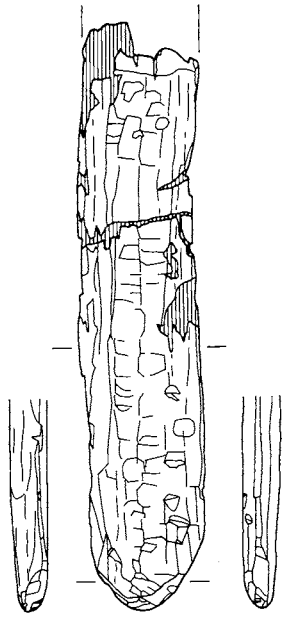

110 (1:12)

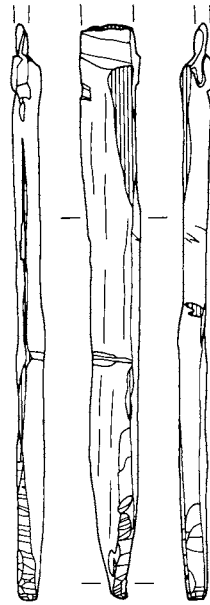

111 (1:12)

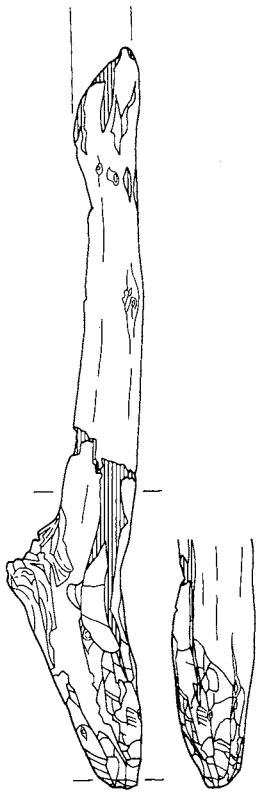

112 (1:12)



113 (1:12)

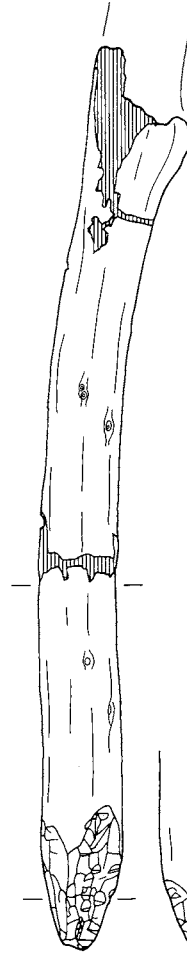

114 (1:12)

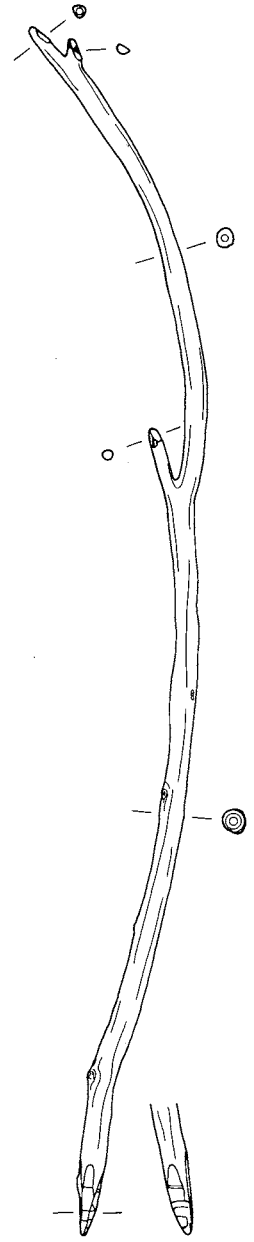

115 (1:12)



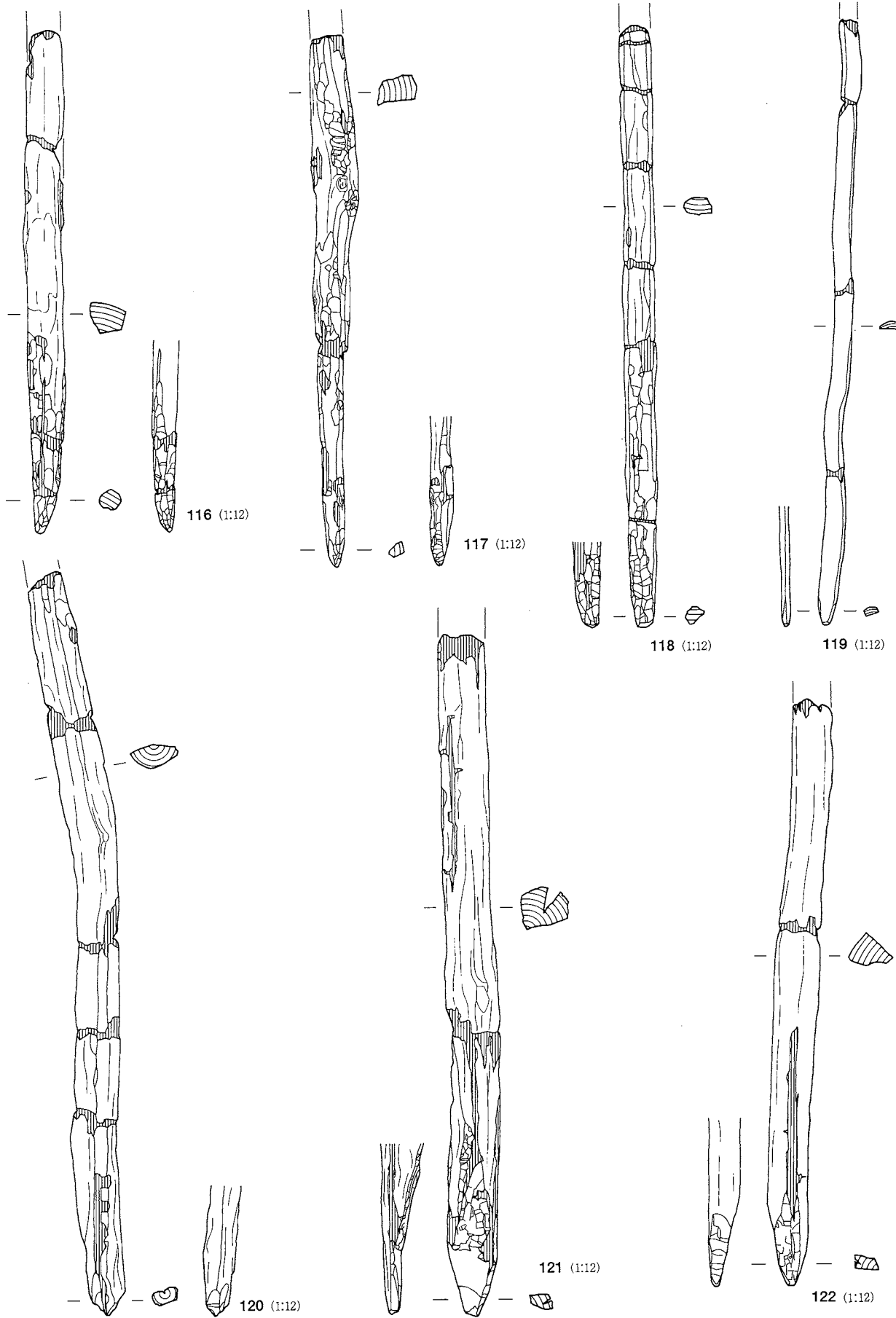

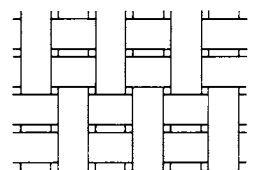
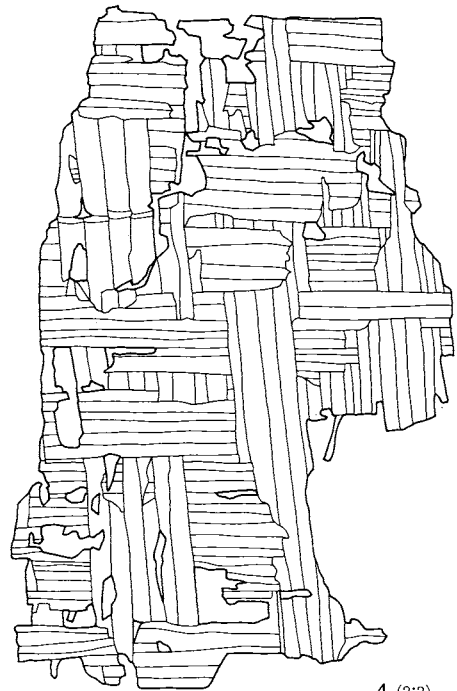
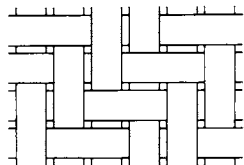
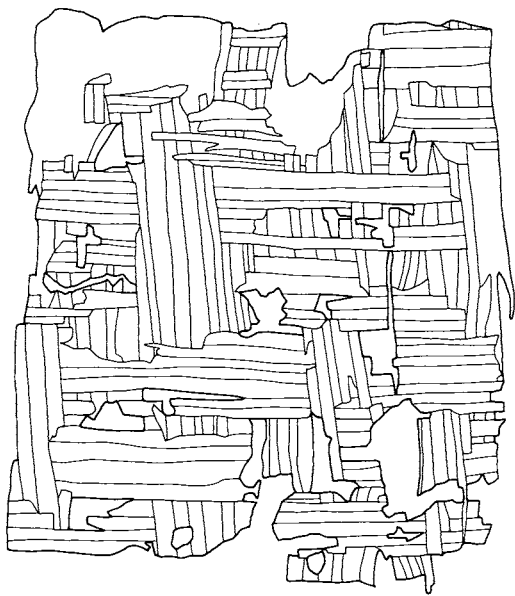
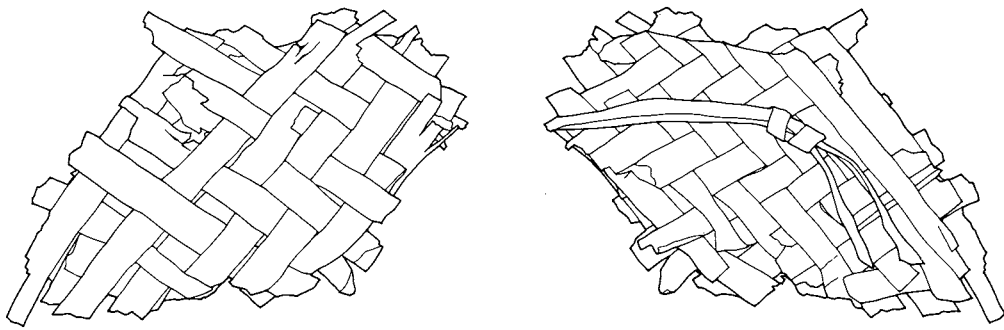
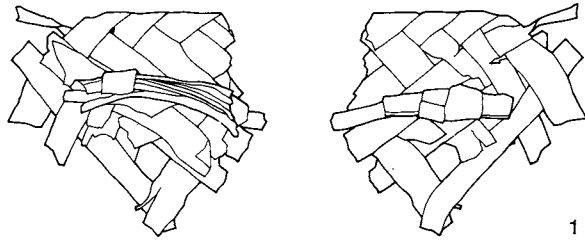

鉄塊 (1~4)

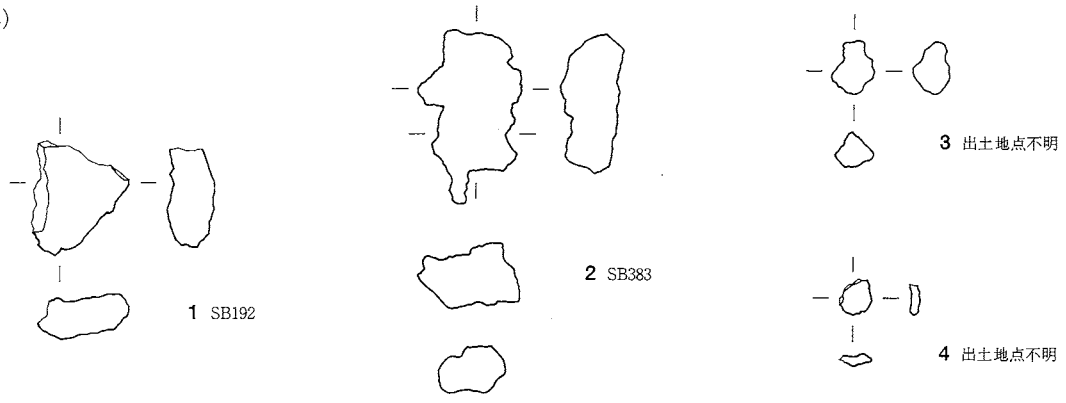

流動滓 (1~5)

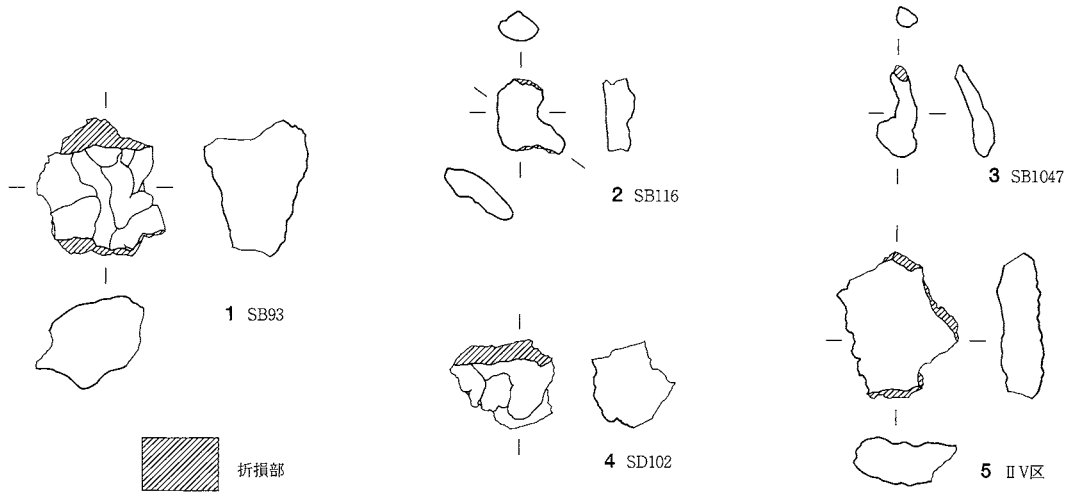

椀形滓 (1~45)

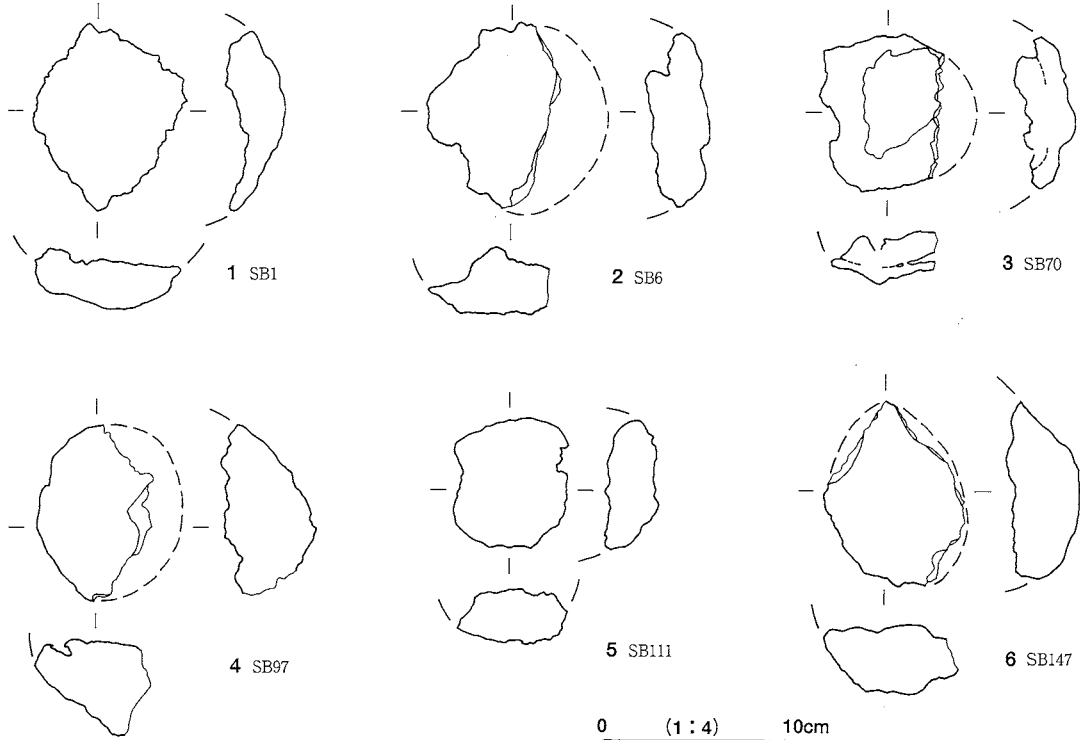

0 (1:4) 10cm

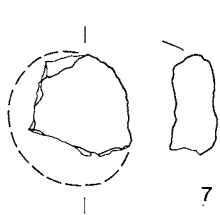

7 SB173

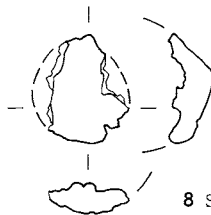

8 SB178

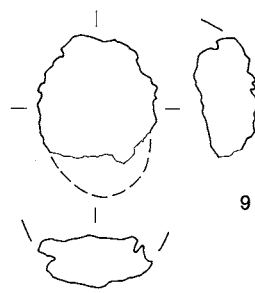

9 SB191

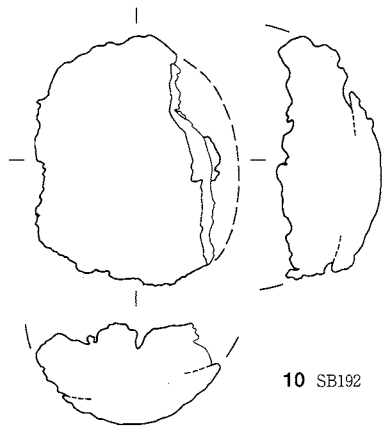

10 SB192

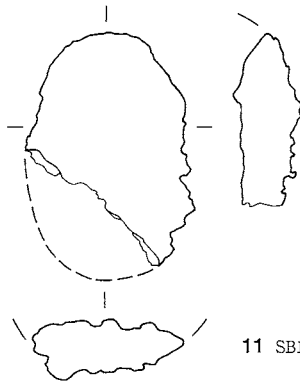

11 SB192

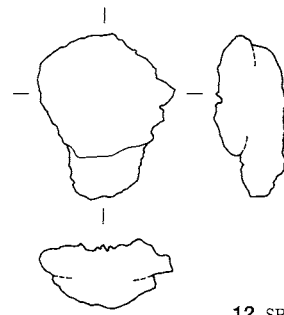

12 SB210

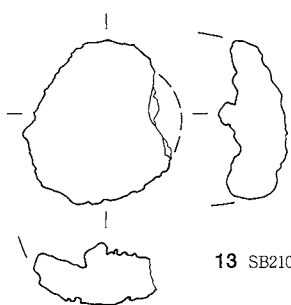

13 SB210

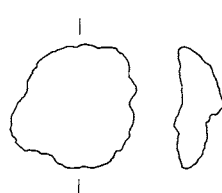

14 SB408

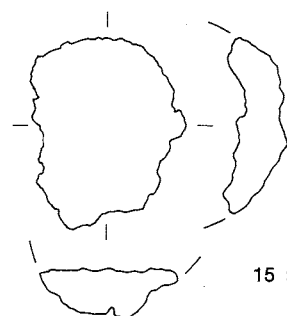

15 SB1014

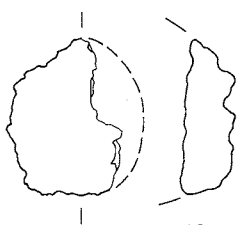

16 SB1028

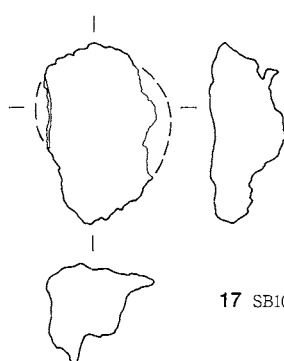

17 SB1047

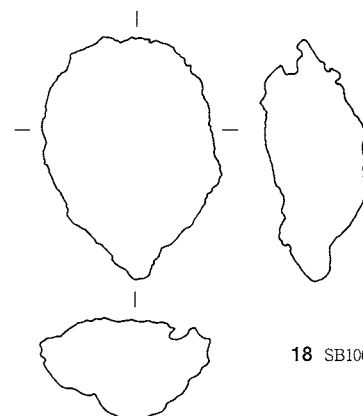

18 SB1067

0 (1:4) 10cm

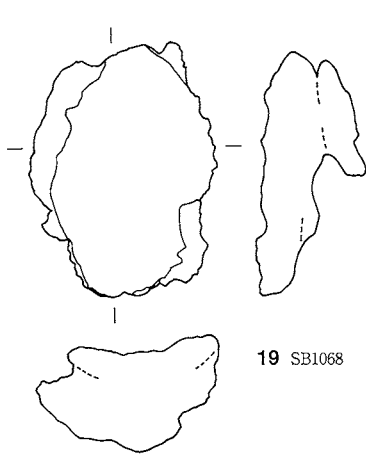

19 SB1068

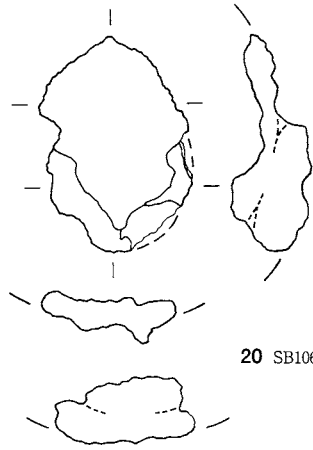

20 SB1068

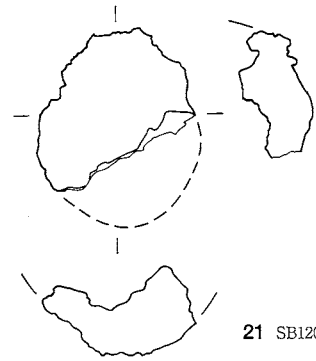

21 SB1208

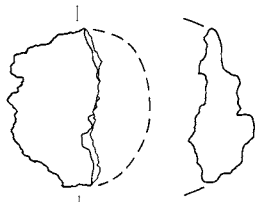

22 SB1236

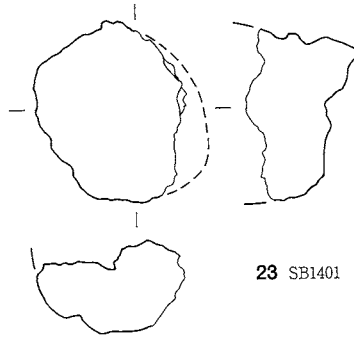

23 SB1401

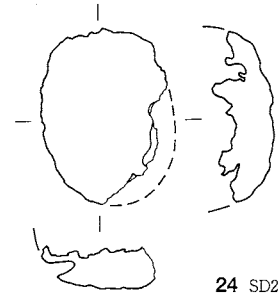

24 SD2

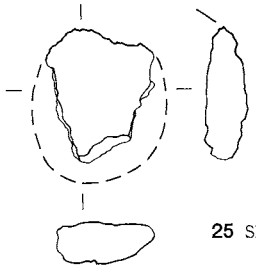

25 SD2

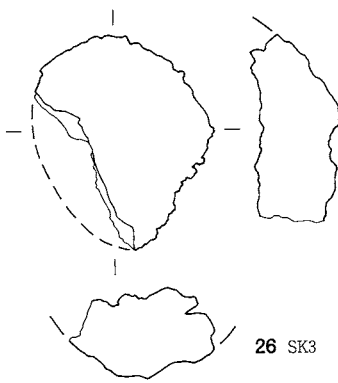

26 SK3

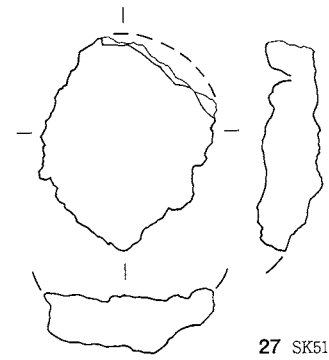

27 SK51

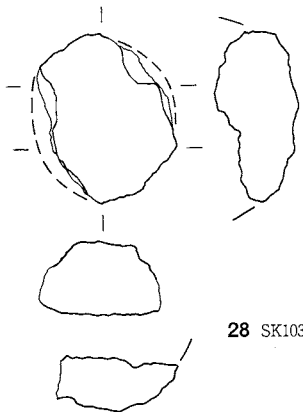

28 SK1034

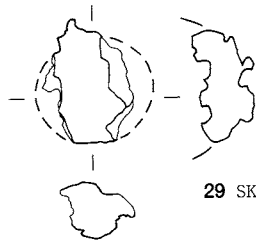

29 SK1733

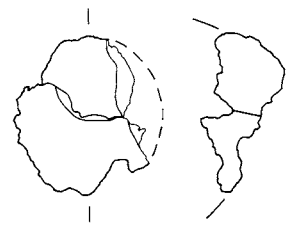

30 I A15区

0 (1:4) 10cm

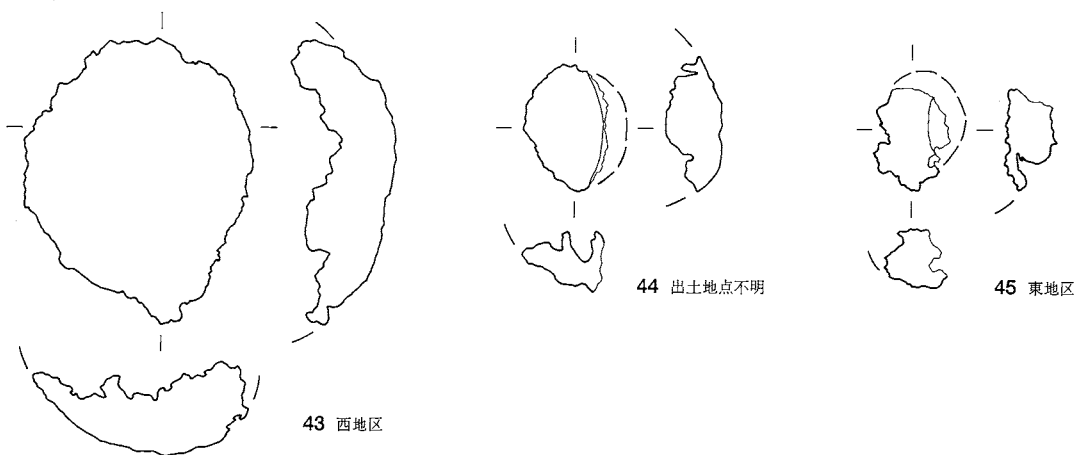
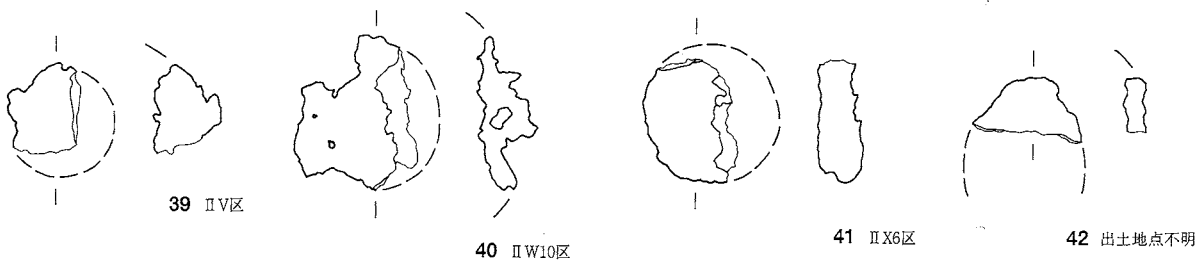
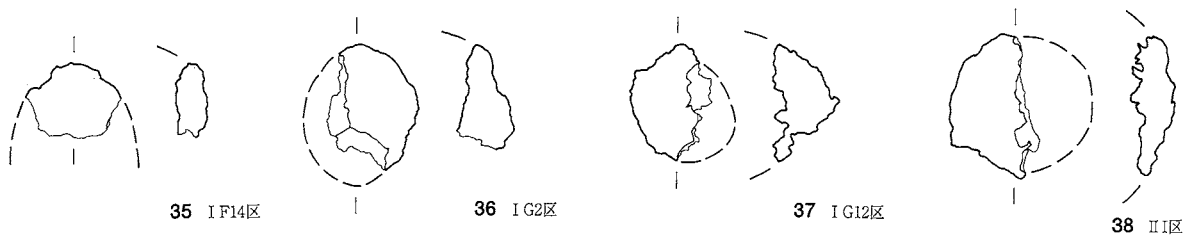
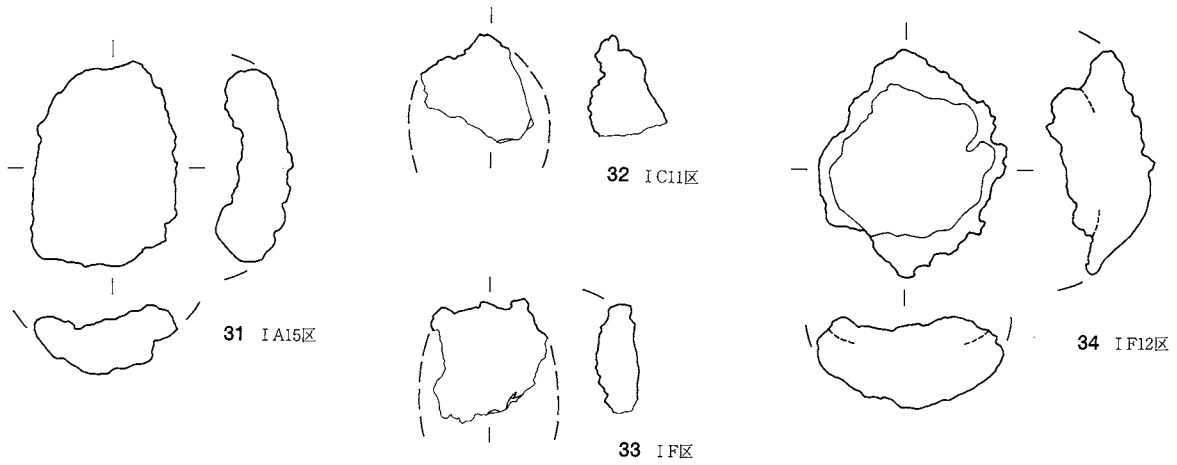

0 (1:4) 10cm

羽口 (1~10)

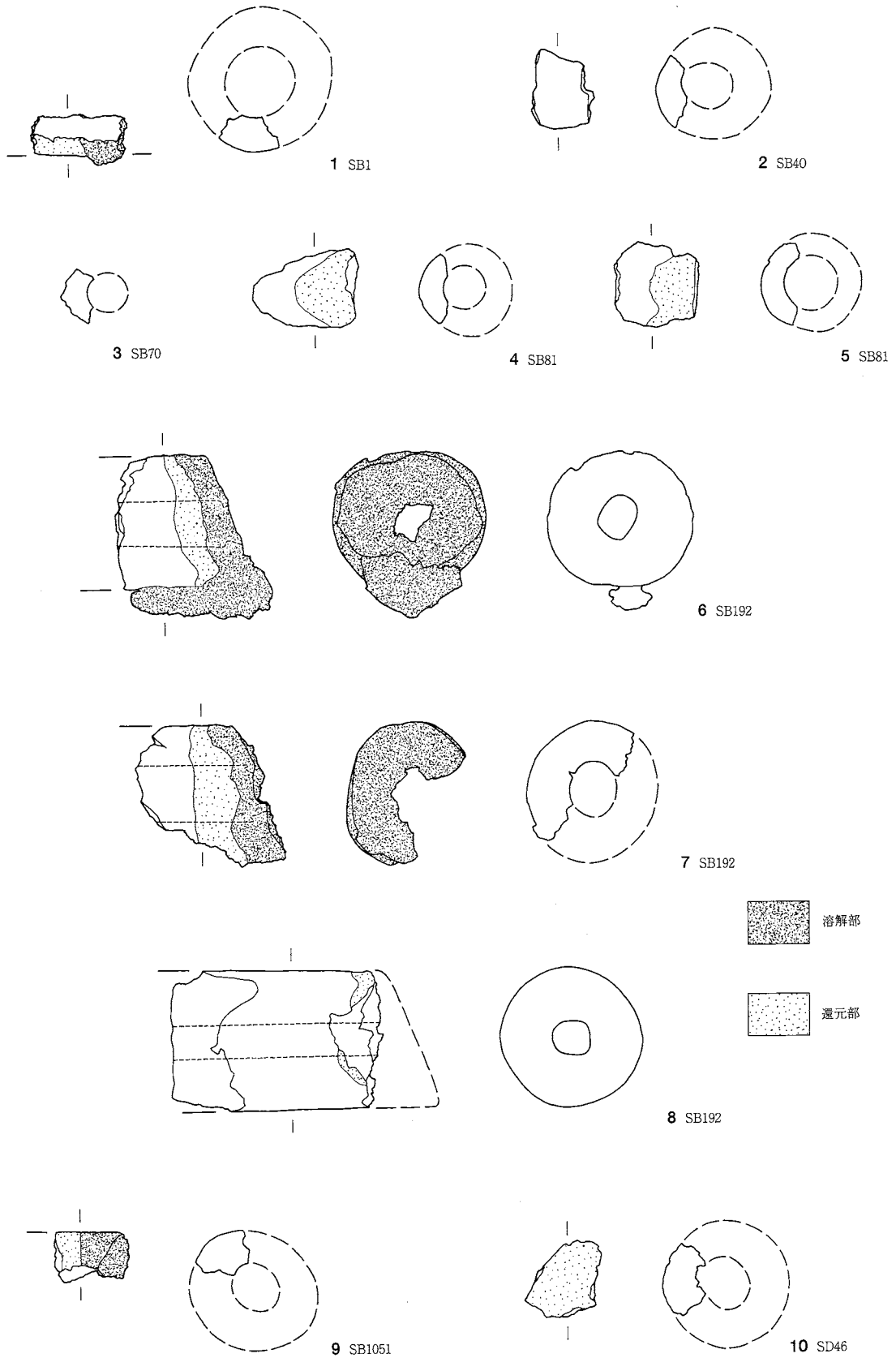

炉壁 (1~3)

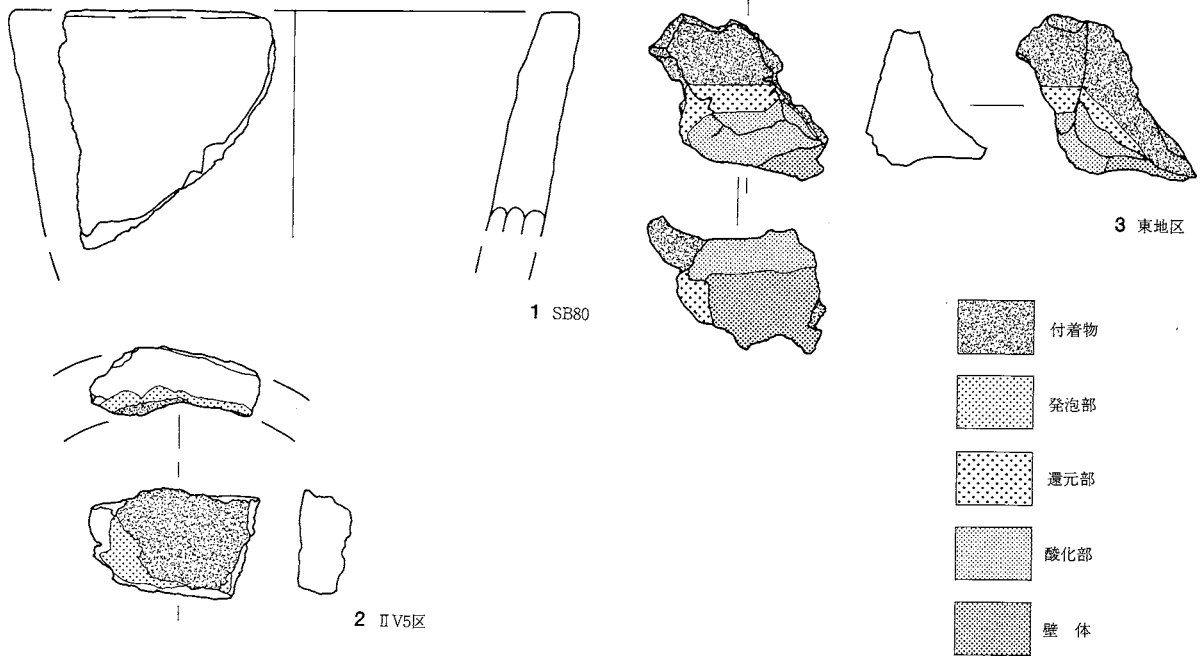

壁体 (1~3)

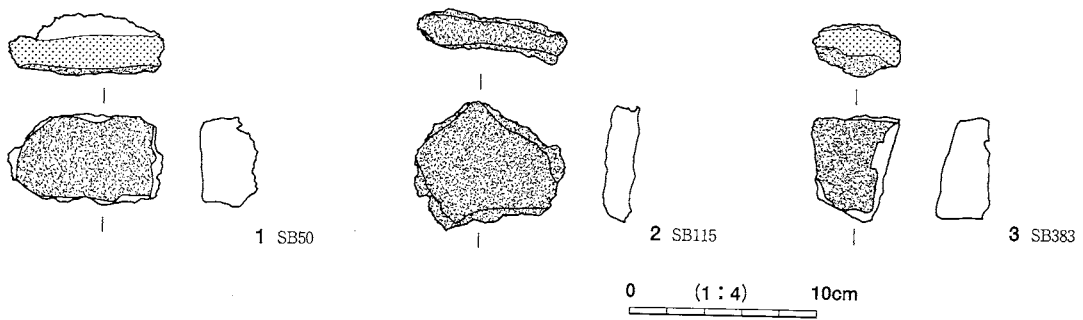

鑄型 (1~5)

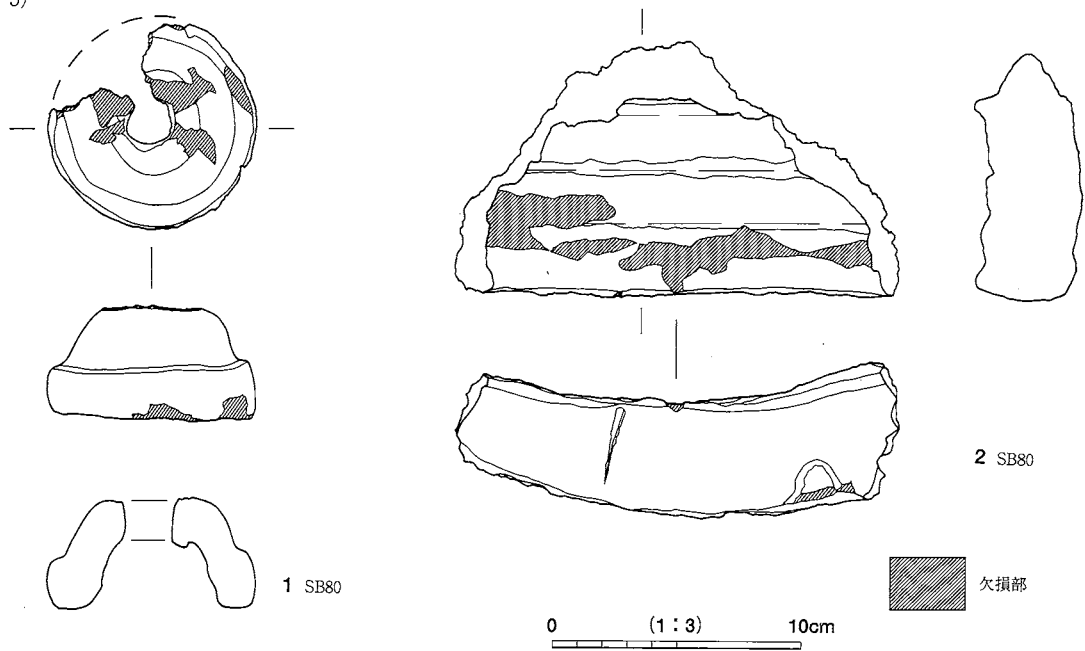



3 SB80

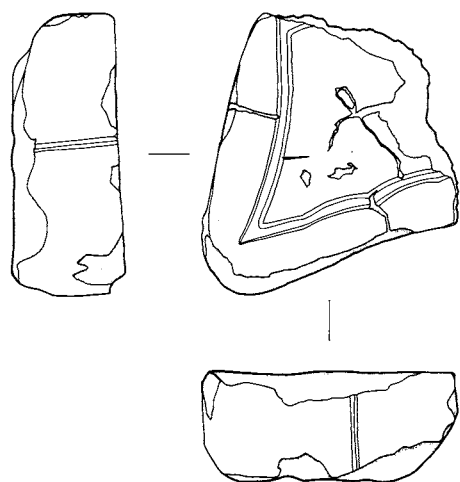

4 SB80



欠損部

0 (1:3) 10cm

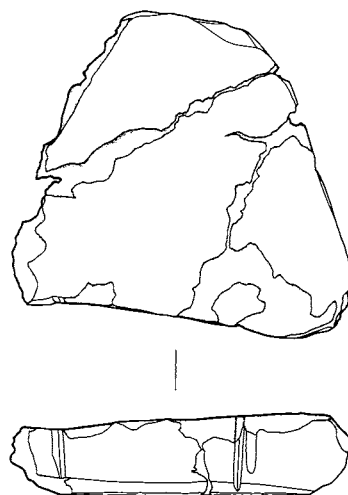

5 SB80

墨書土器 (1~142)

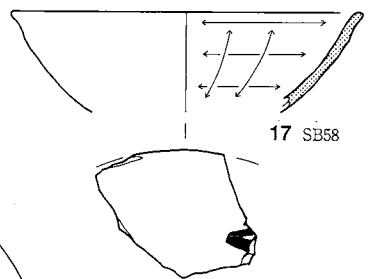
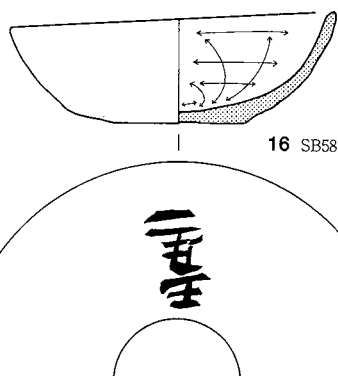
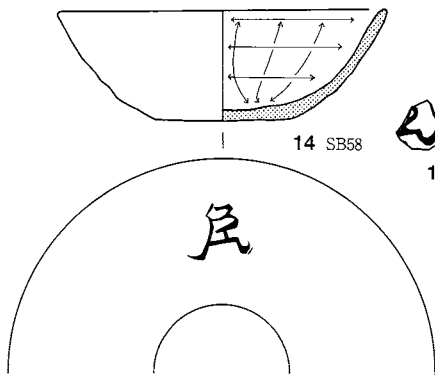
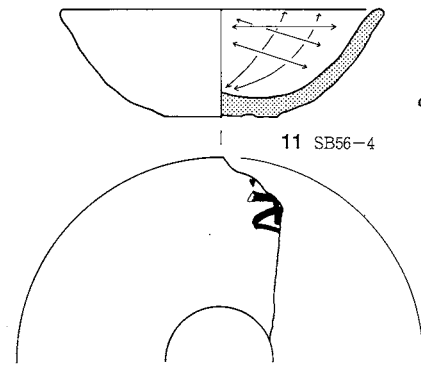
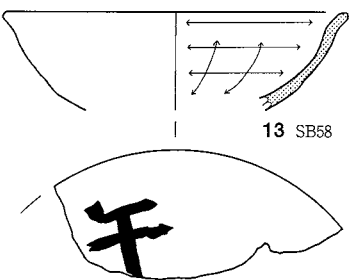
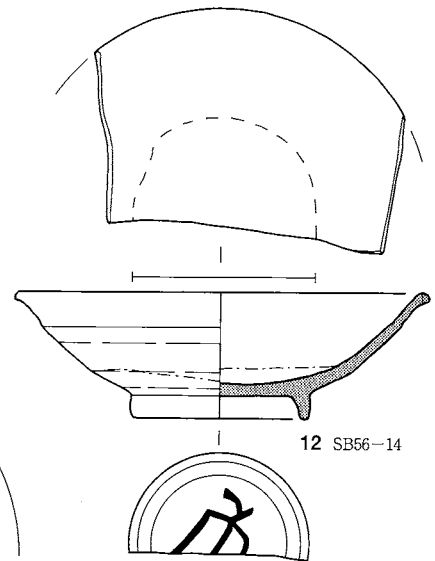
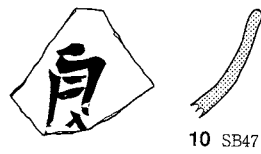
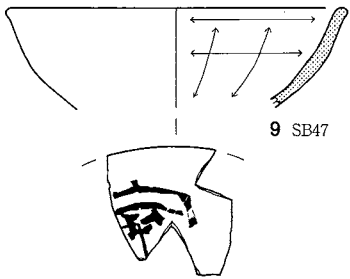
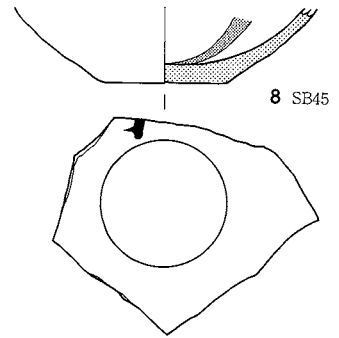
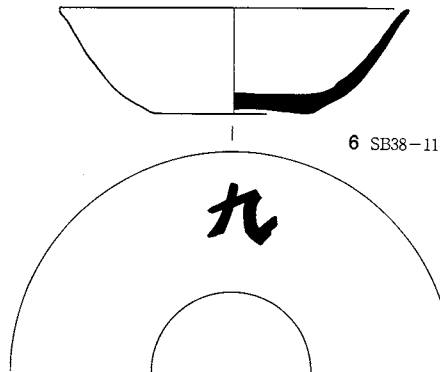
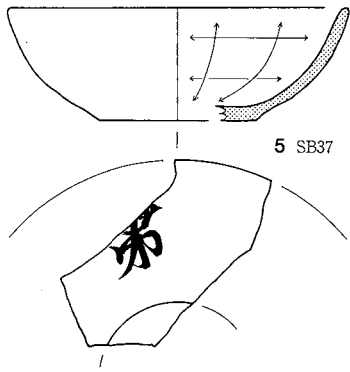
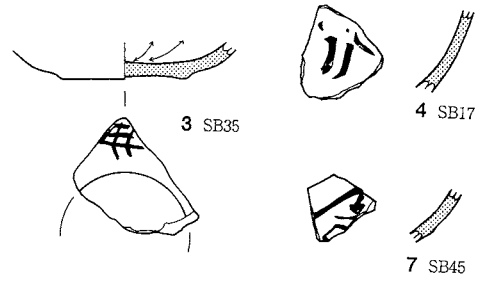
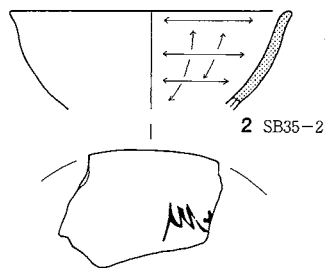
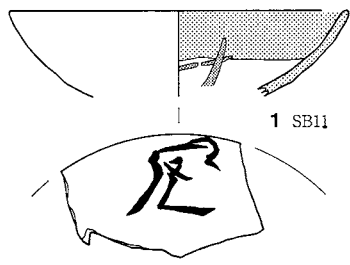

0 (1:3) 10cm

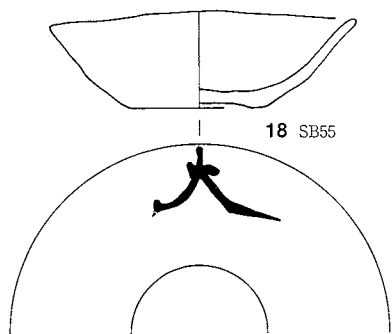

18 SB55

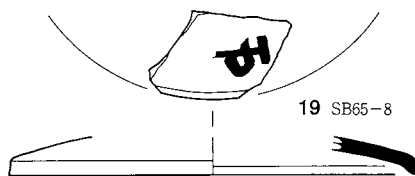

19 SB65-8

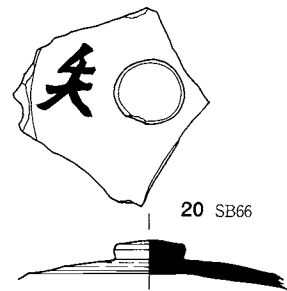

20 SB66

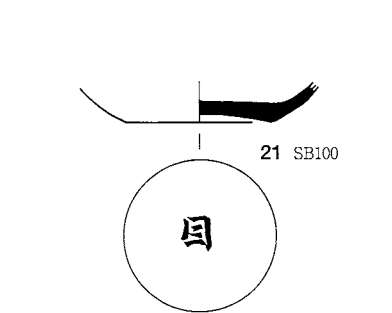

21 SB100

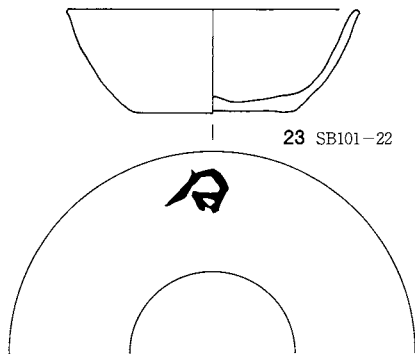

23 SB101-22

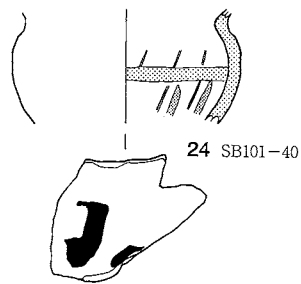

24 SB101-40

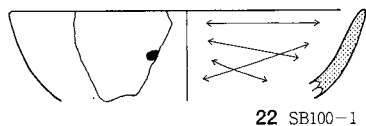

22 SB100-1

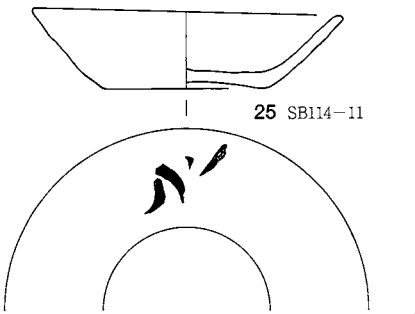

25 SB114-11

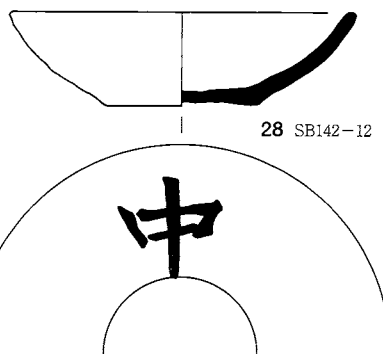

28 SB142-12

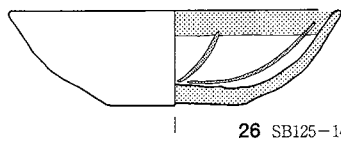

26 SB125-14

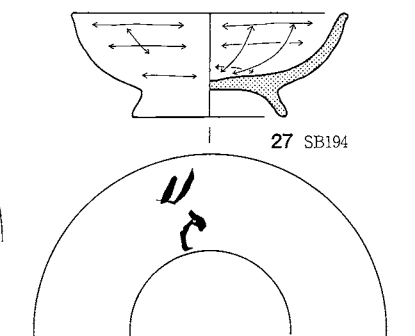

27 SB194

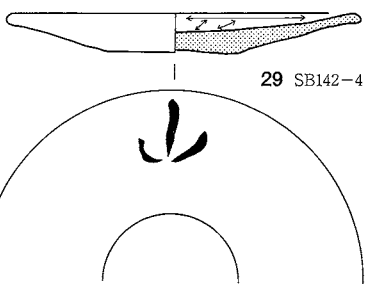

29 SB142-4

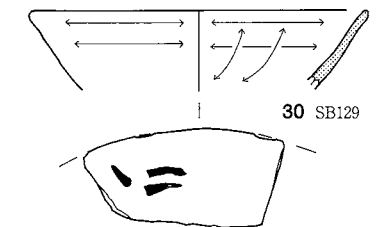

30 SB129

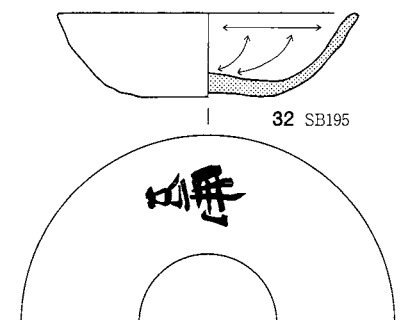

32 SB195

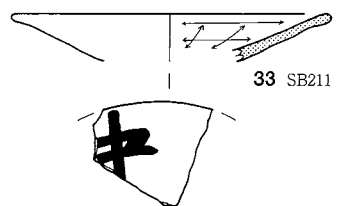

33 SB211



31 SB179

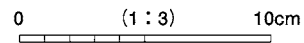

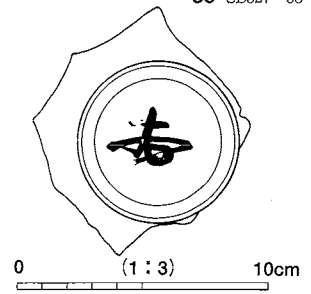
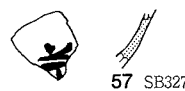
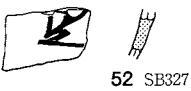
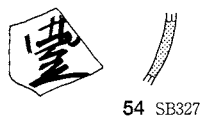
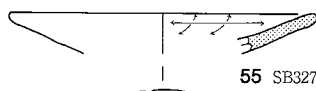
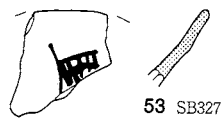
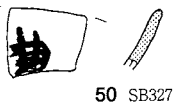
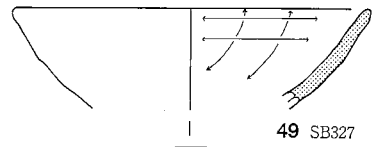
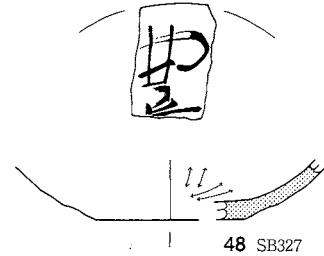
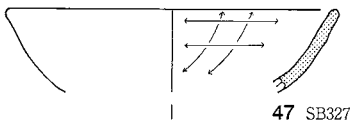
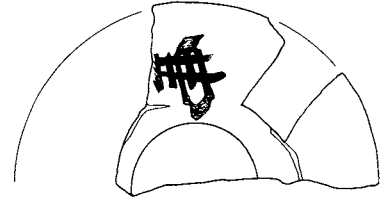
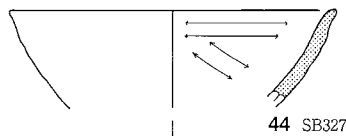
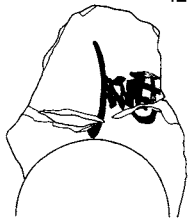
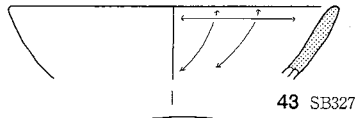
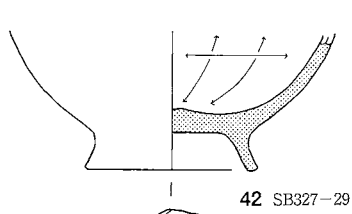
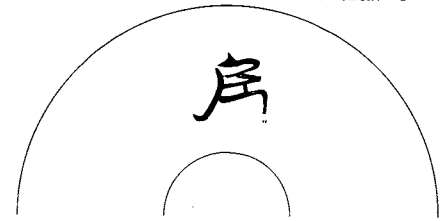
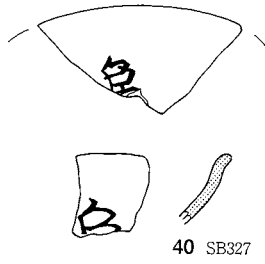
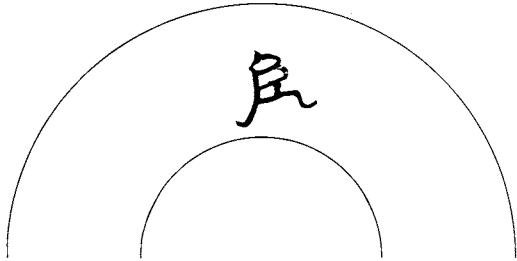
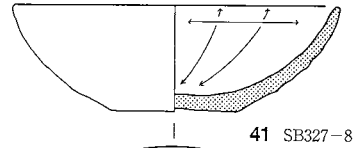
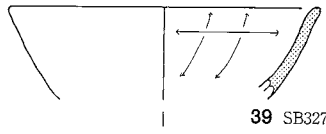
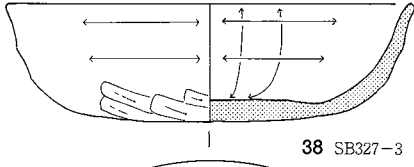
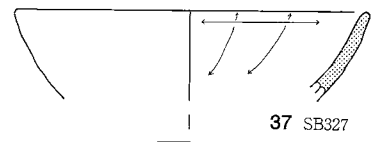
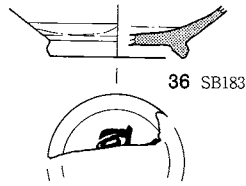
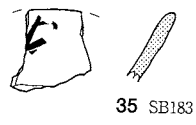
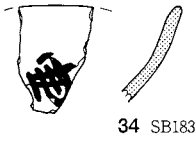

0 (1:3) 10cm

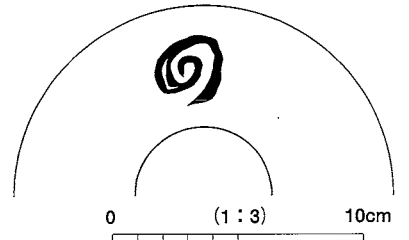
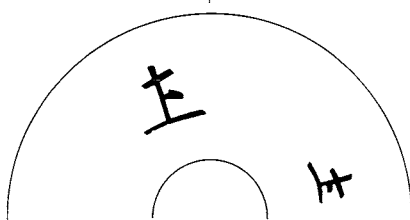
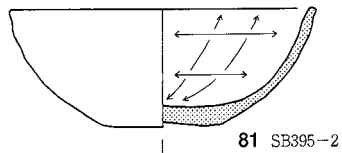
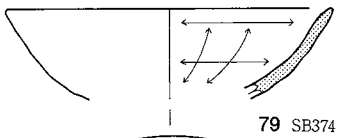
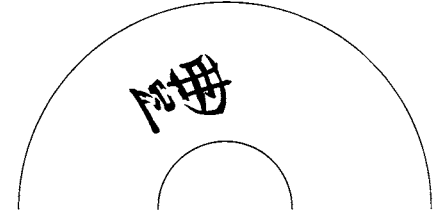
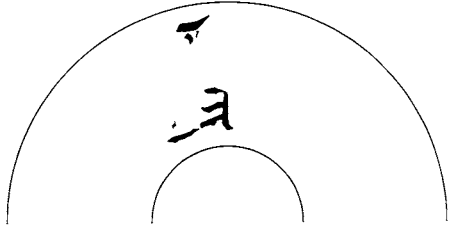
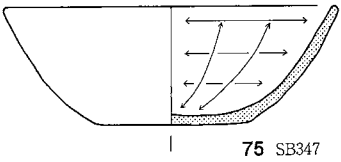
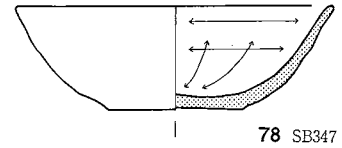
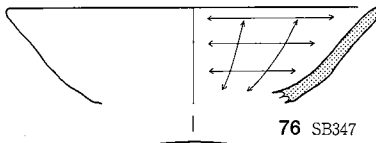
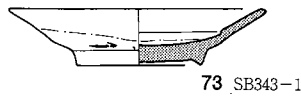
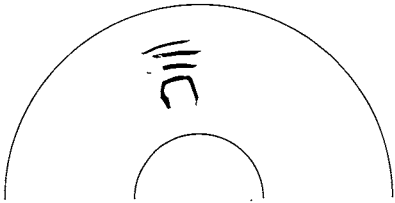
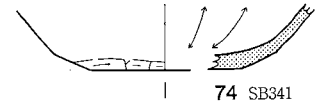
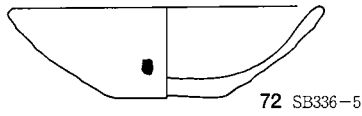
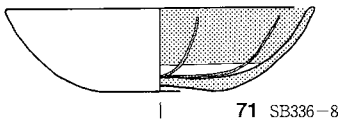
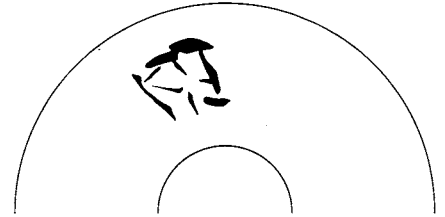
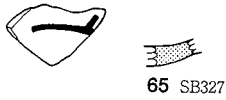
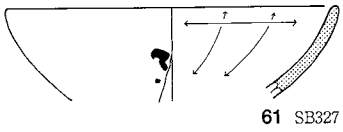
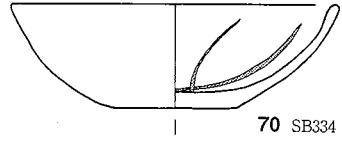
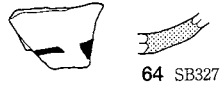
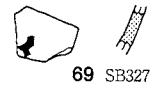
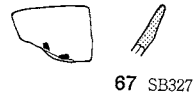
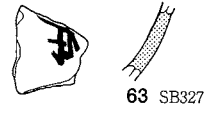
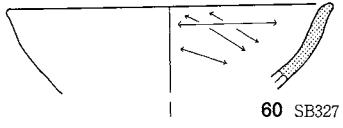
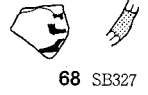
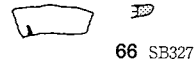
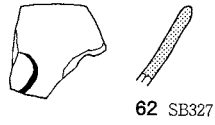
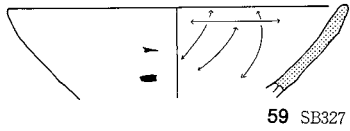

0 (1:3) 10cm

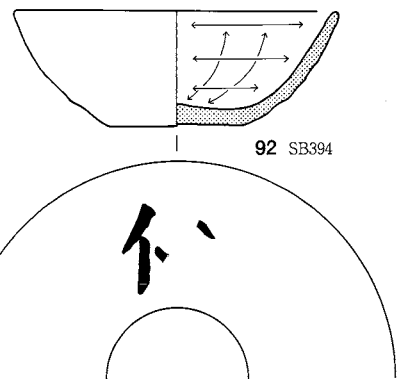
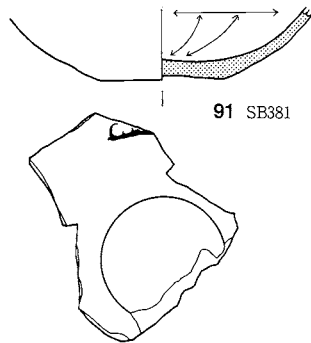
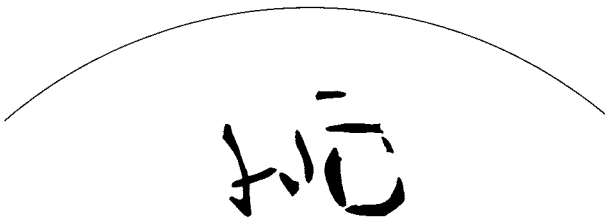
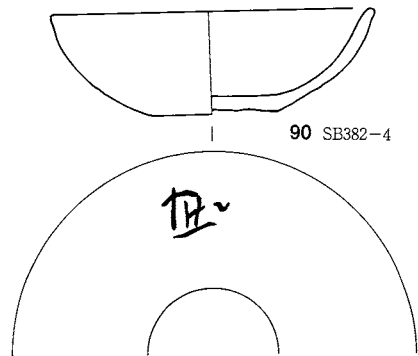
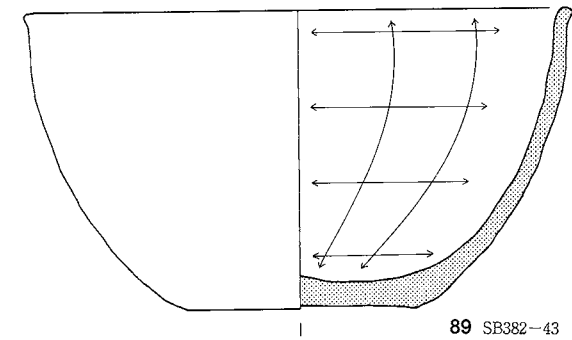
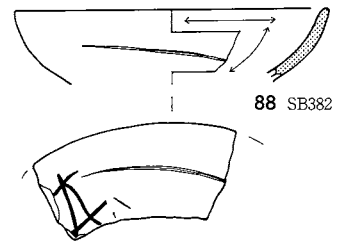
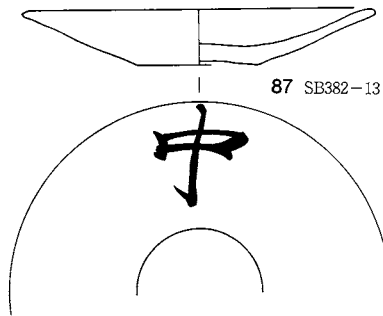
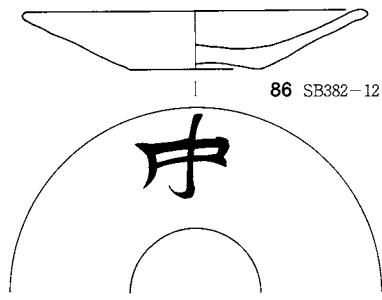
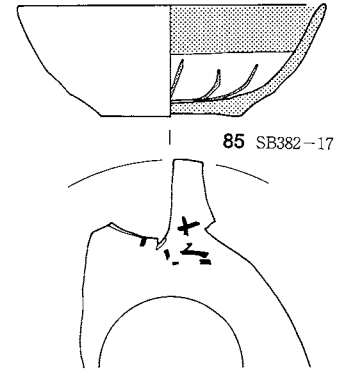
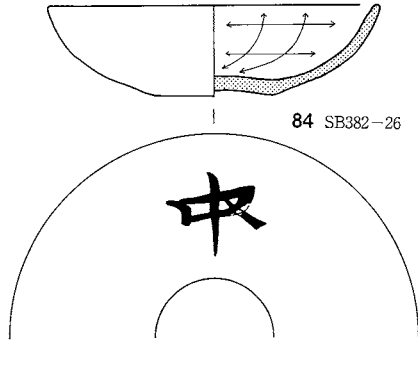
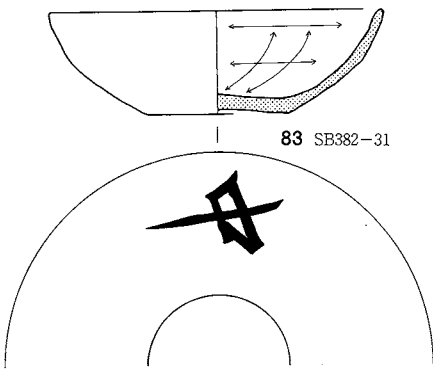

0 (1:3) 10cm

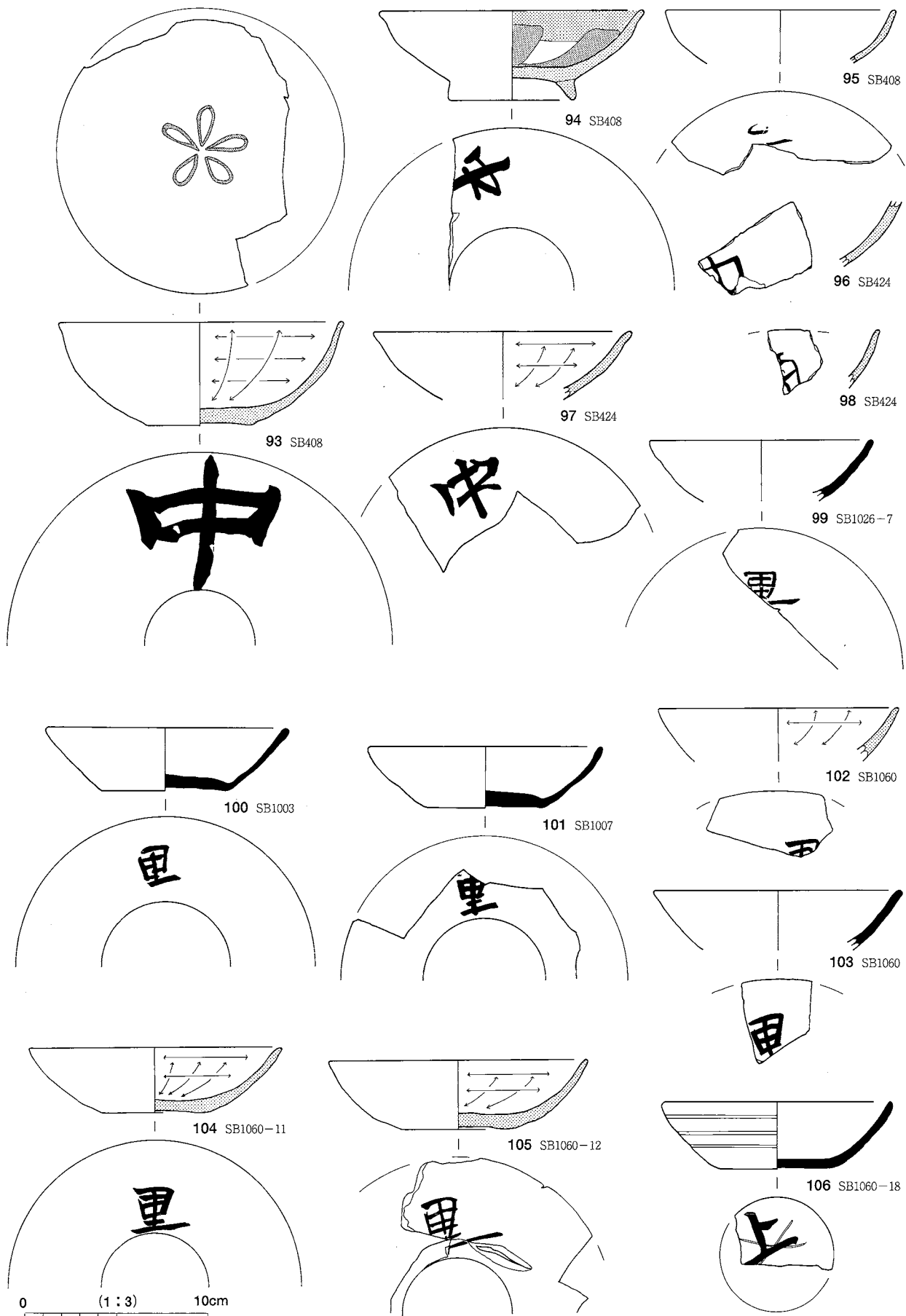

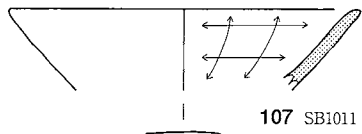

107 SB1011

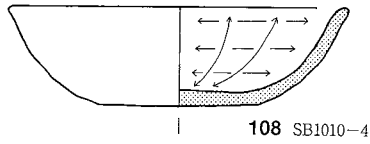

108 SB1010-4

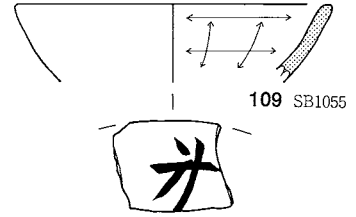

109 SB1055

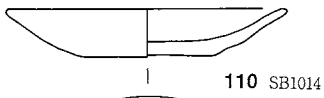

110 SB1014

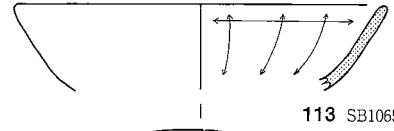
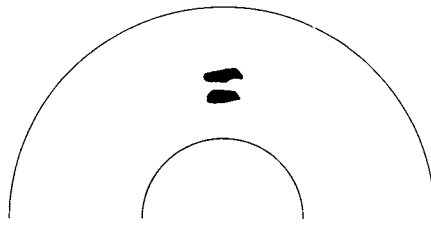

113 SB1065

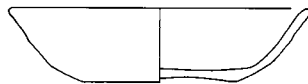
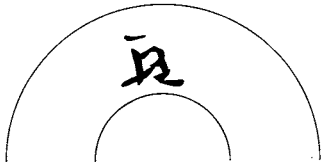

112 SB1051-8

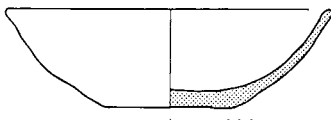

111 SB1040

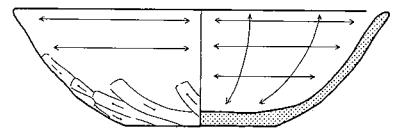
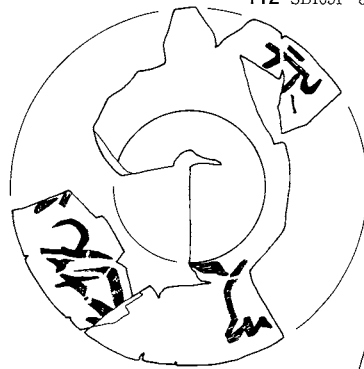

114 SB1065-8

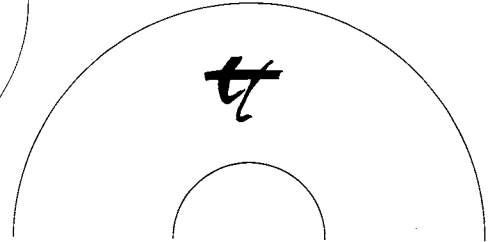
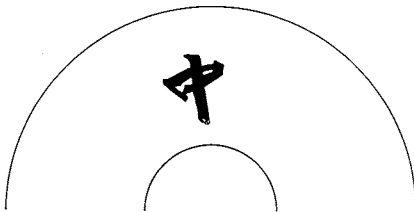

115 SB1098-11

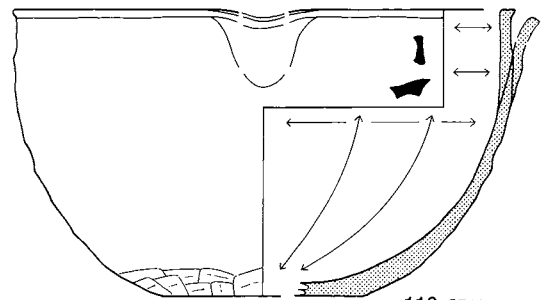

116 SB1050



117 SB1076



119 SB1038



120 SB1047

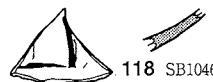

118 SB1046

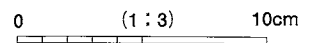

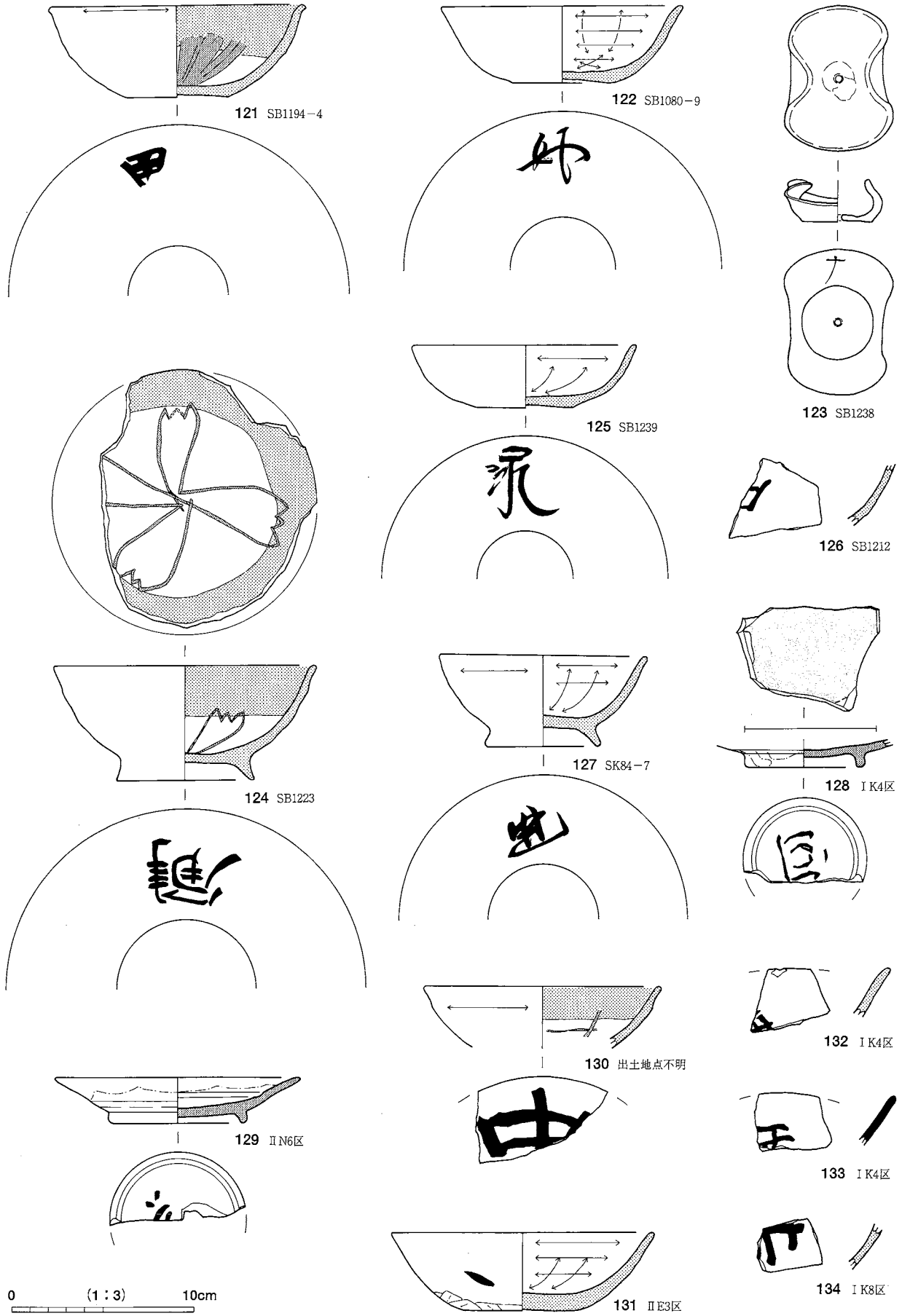

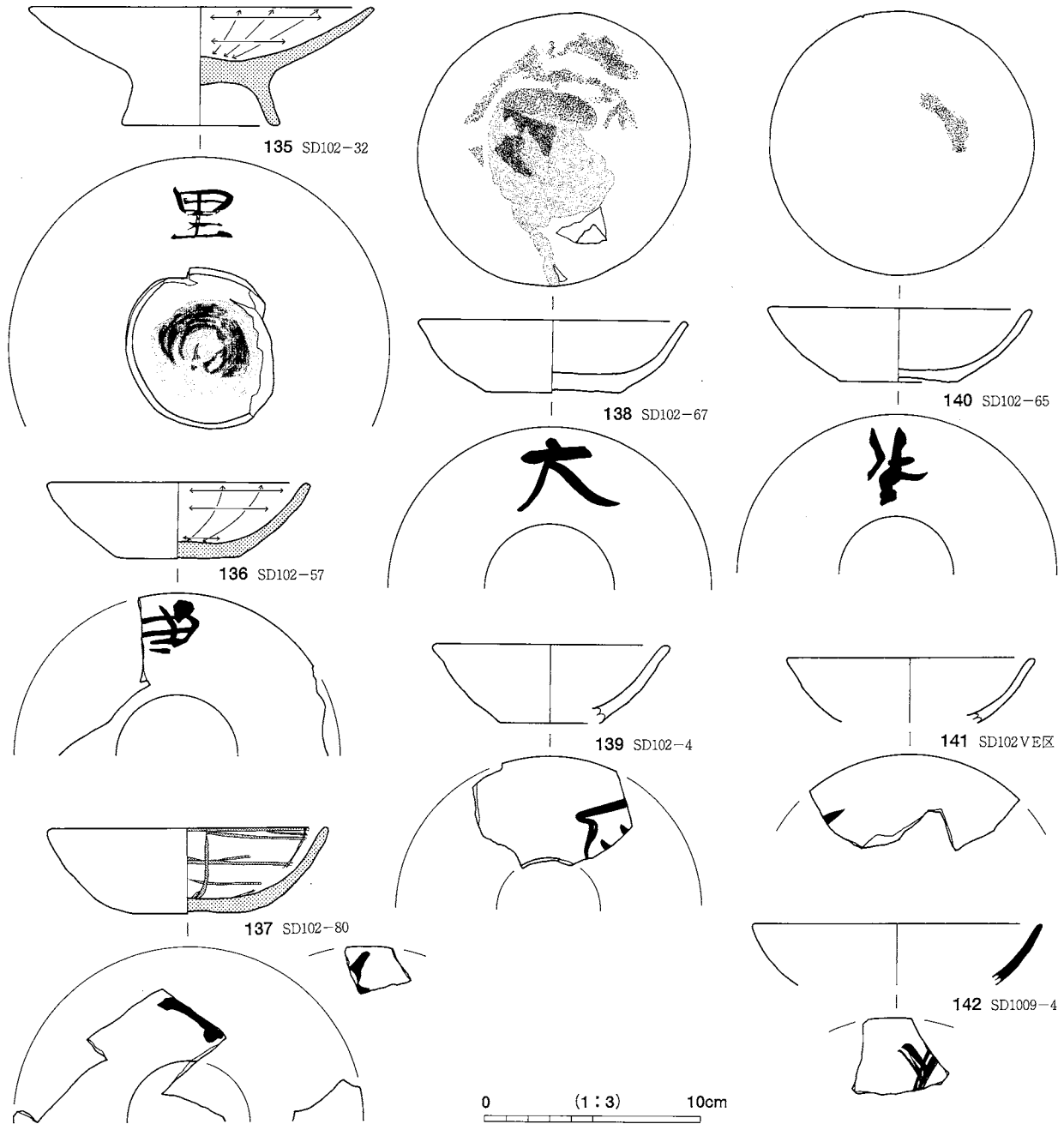

籀書・刻印・刻書土器 (143~167)

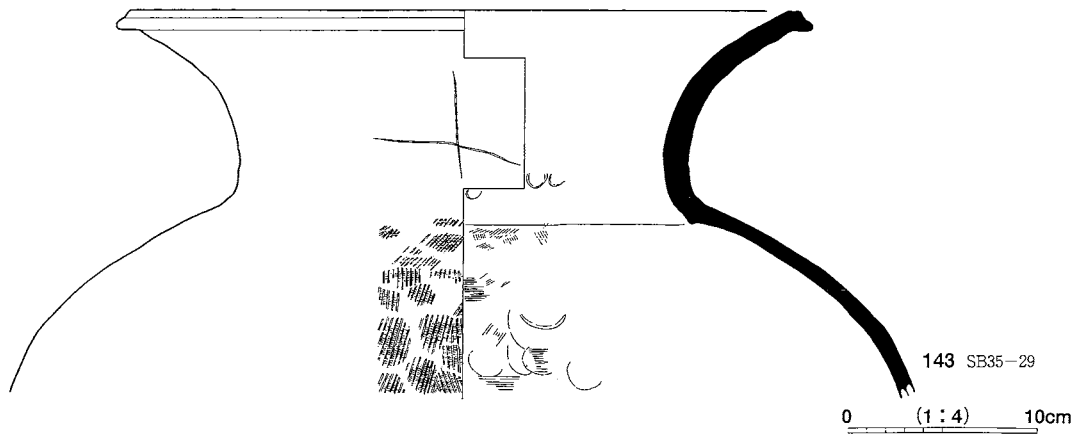

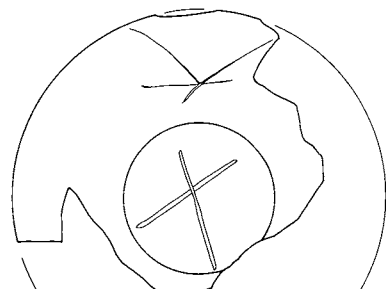
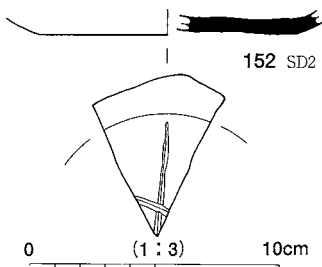
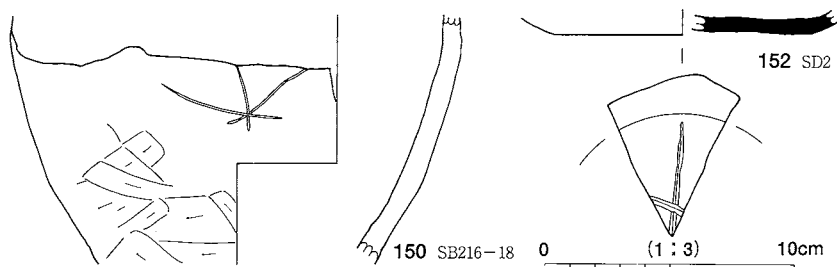
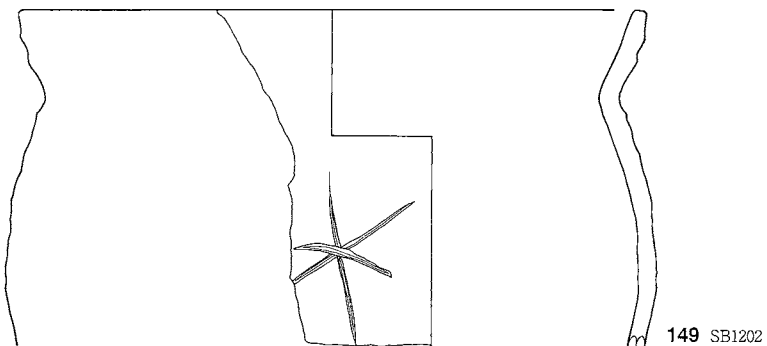
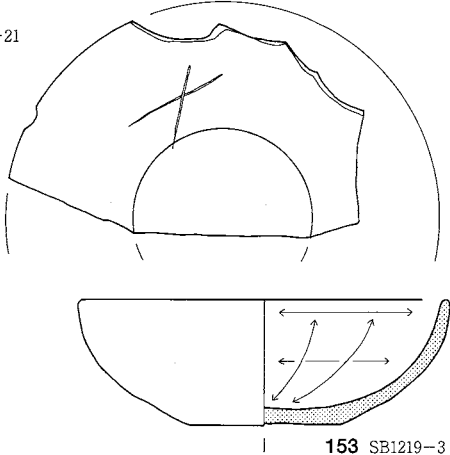
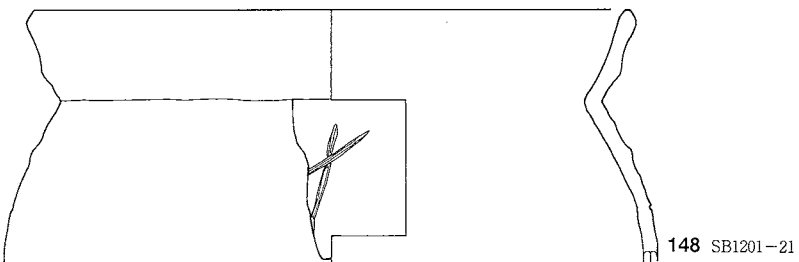
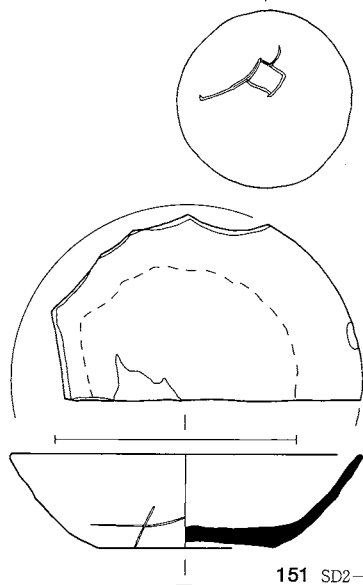
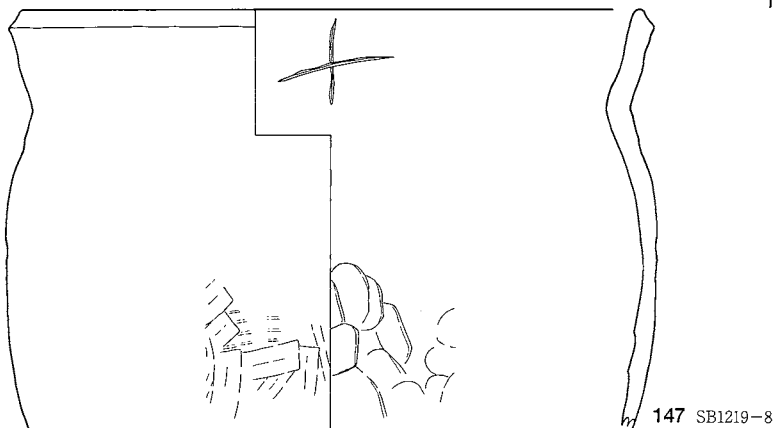
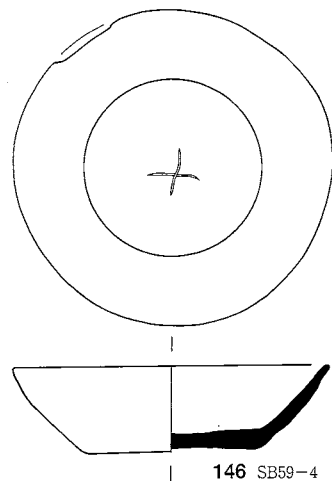
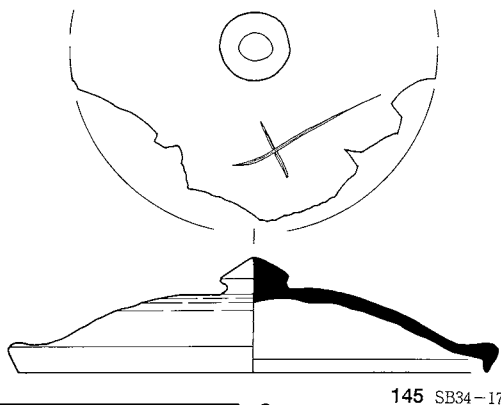
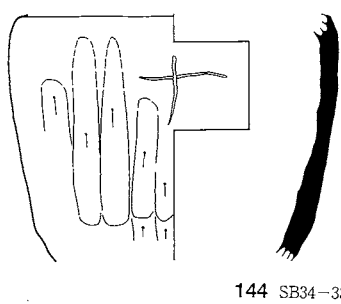

0 (1:3) 10cm

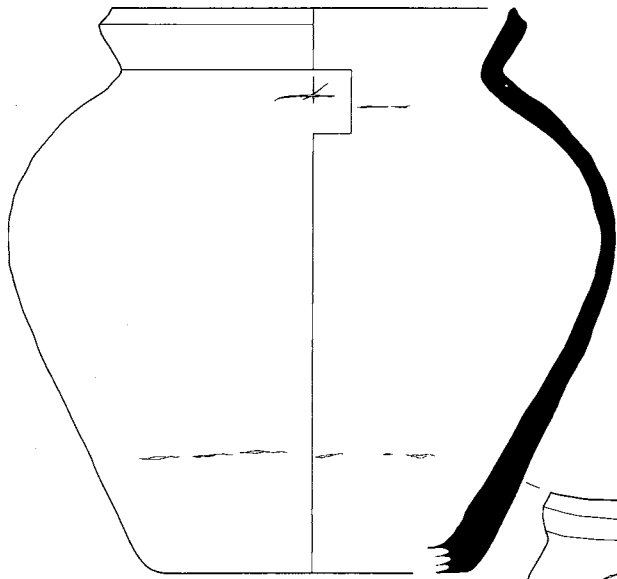

154 SB1011

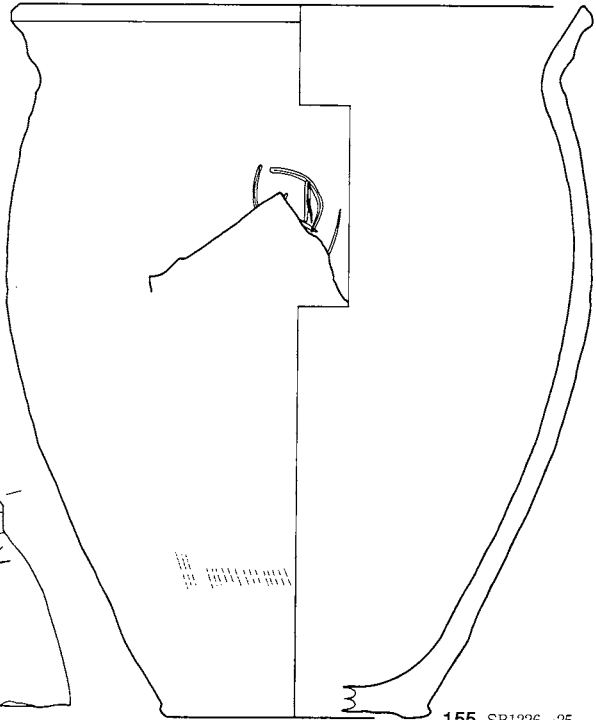

155 SB1226-25

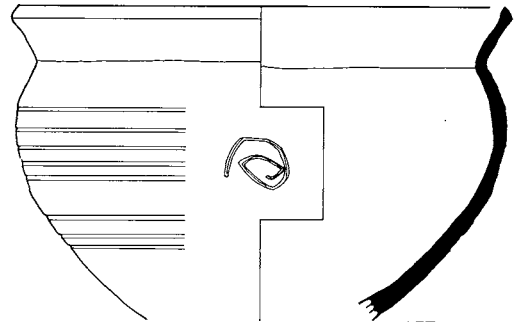
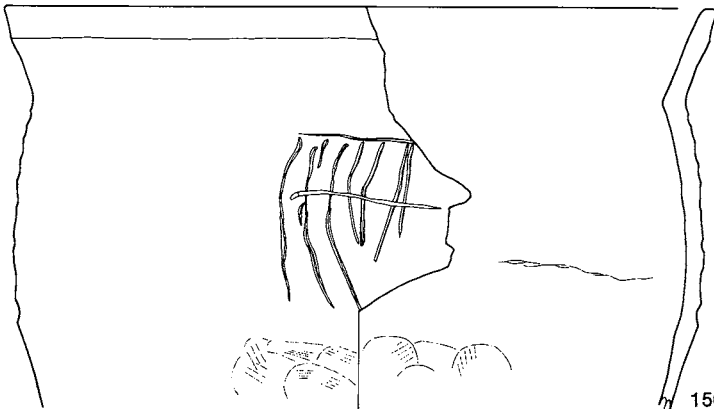

156 SB143

157 SB1060-46

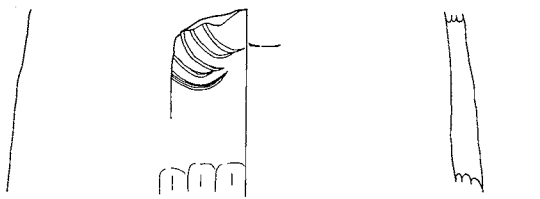

158 SB395



160 SK52

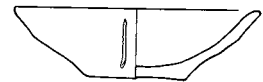

163 SB388-2

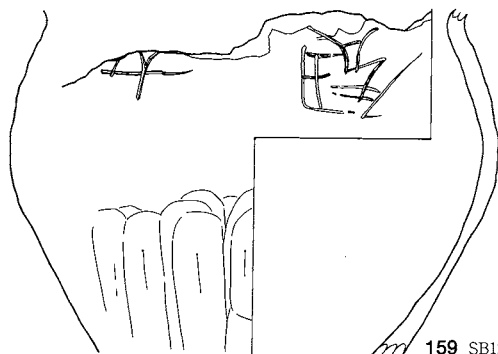
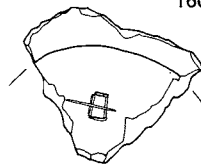

159 SB1246-26

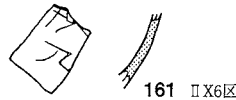

161 II X6区



164 SB124-1

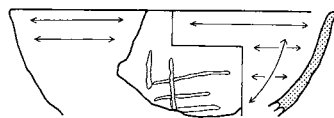

162 SB1099

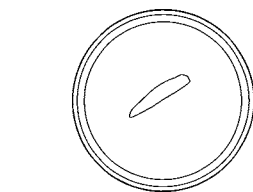

0 (1:3) 10cm

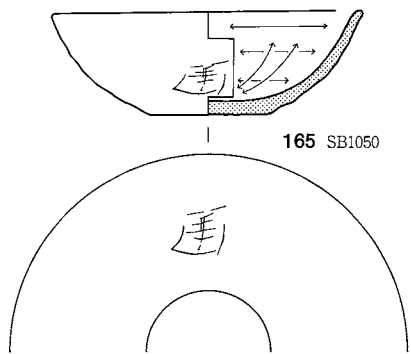

165 SB1050

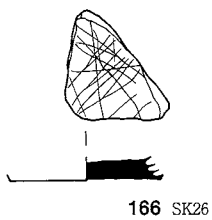

166 SK26

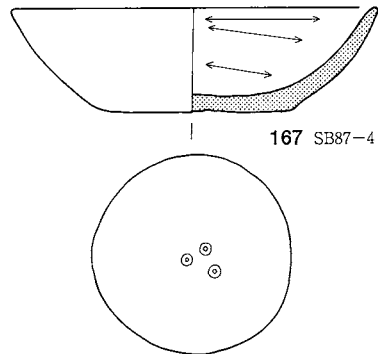

167 SB87-4

陶硯・転用硯 (168~231)

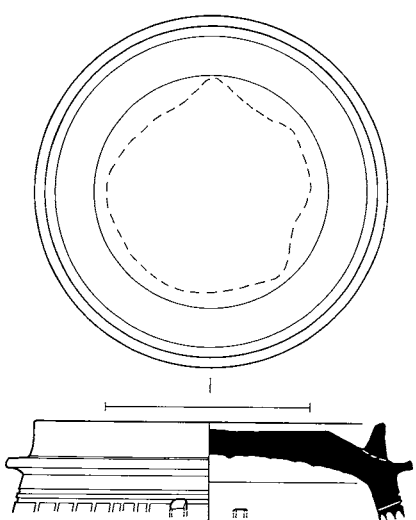

168 SB1093-9

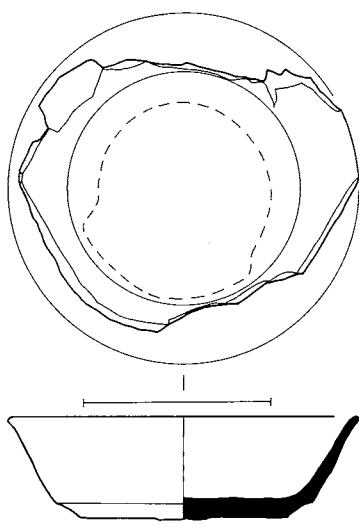

169 SB1235-2

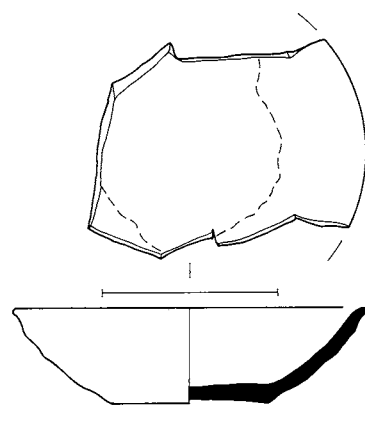

170 SD1009 2層-28

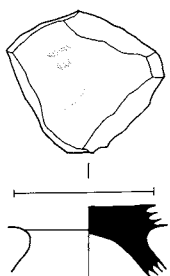

171 SB149-7

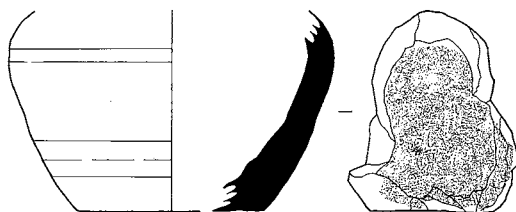

172 SK26-1

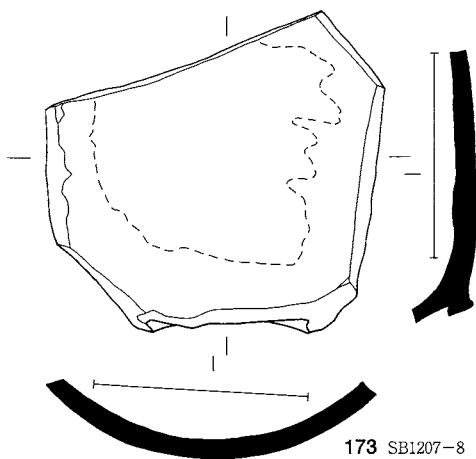
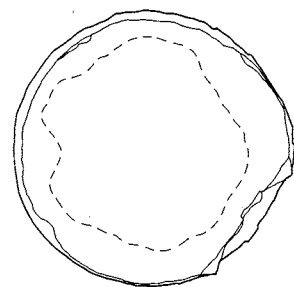

174 SB383



175 SB121-7

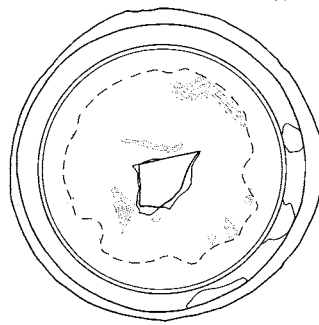

173 SB1207-8

0 (1:3) 10cm

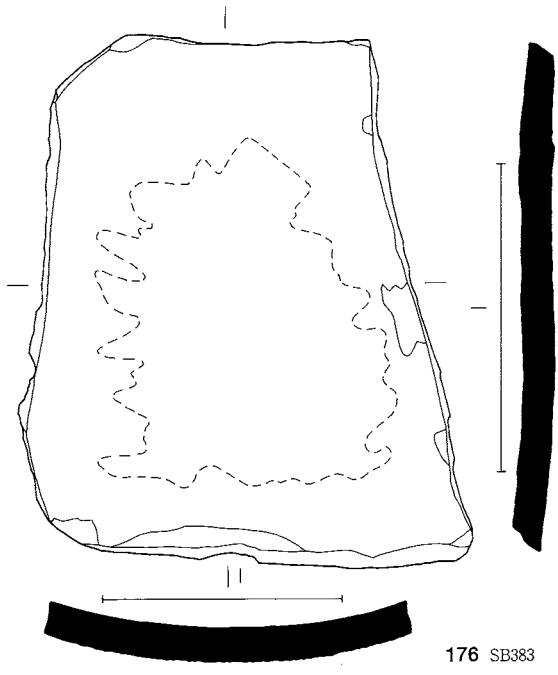

176 SB383

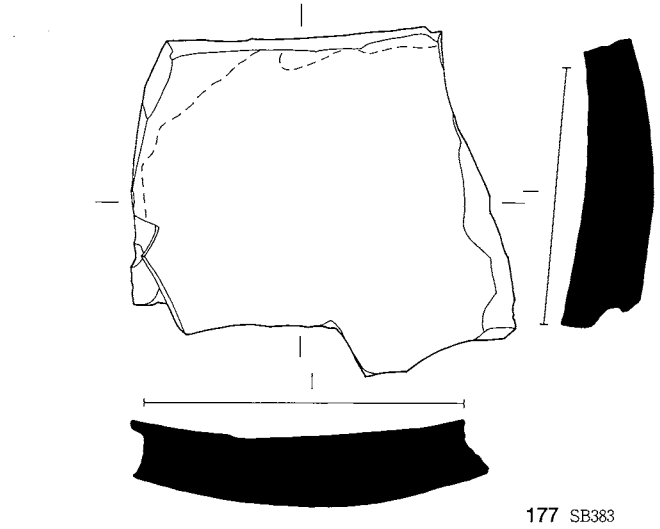

177 SB383

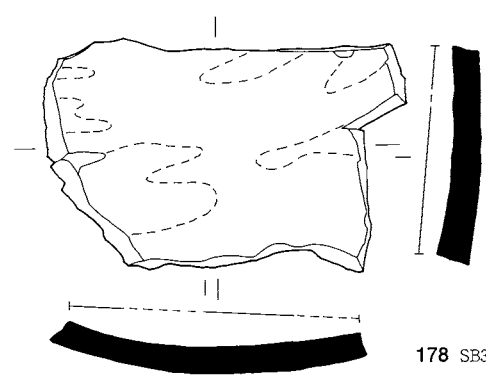

178 SB333

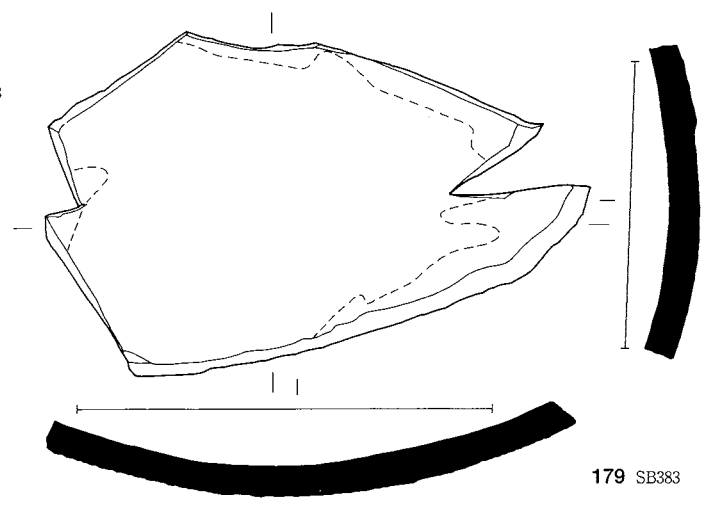

179 SB383

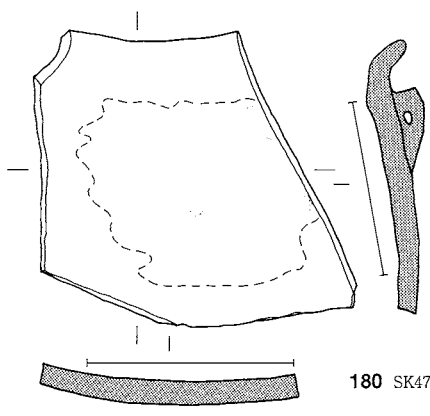

180 SK47-11

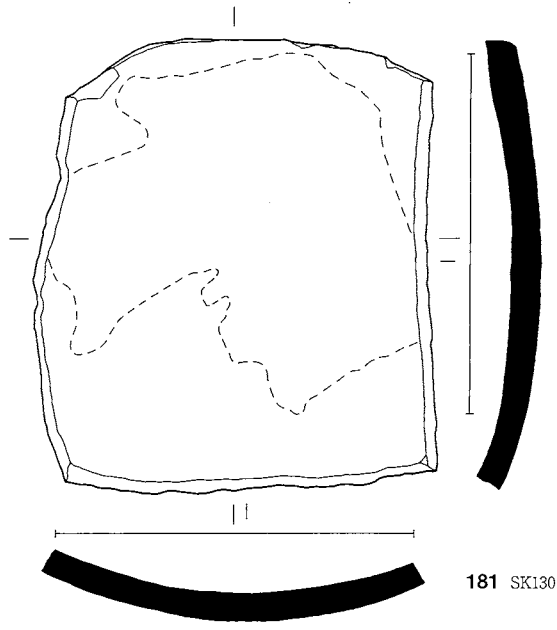

181 SK130

0 (1:3) 10cm

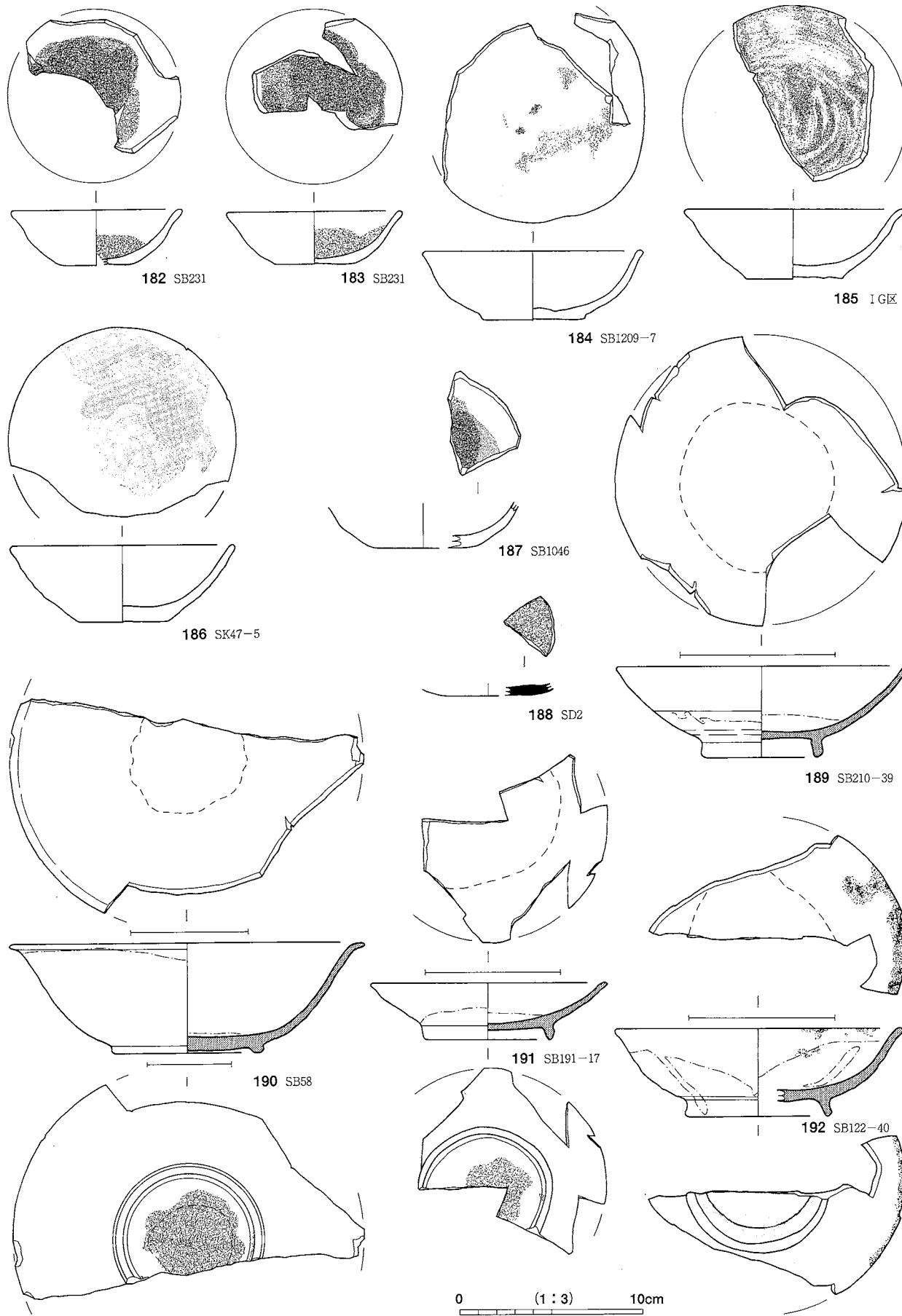

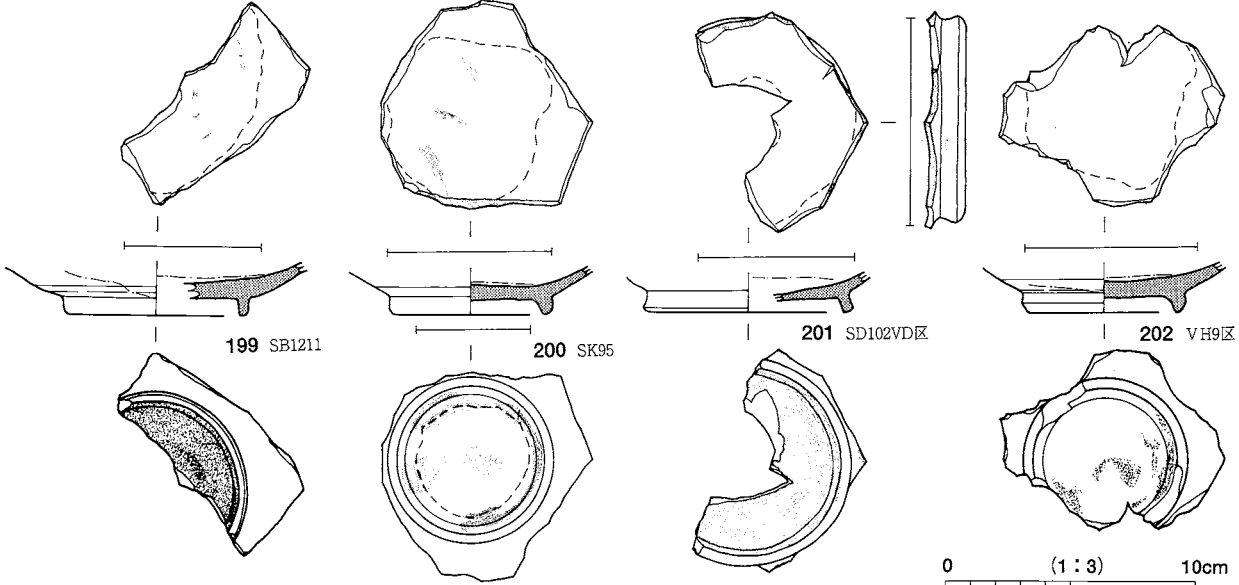
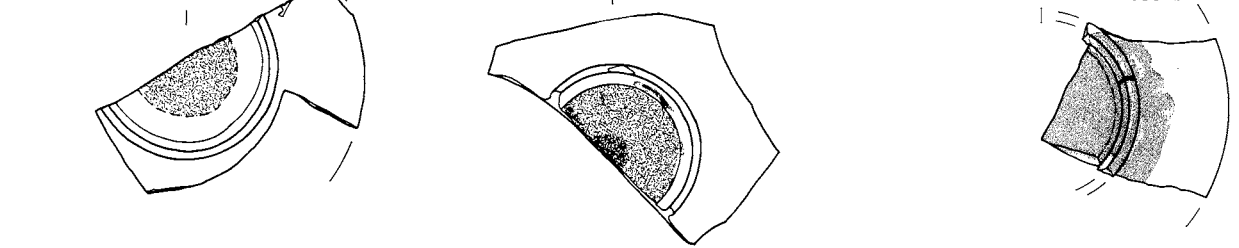
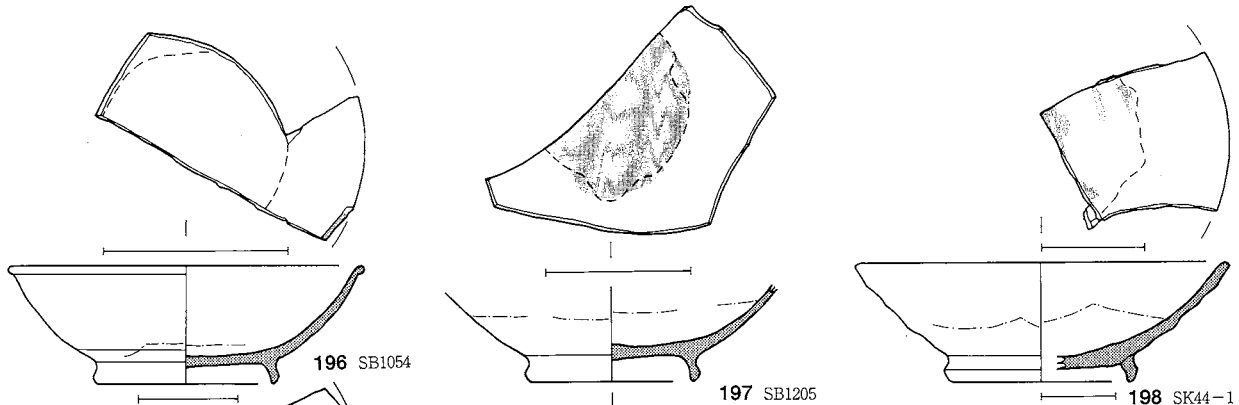
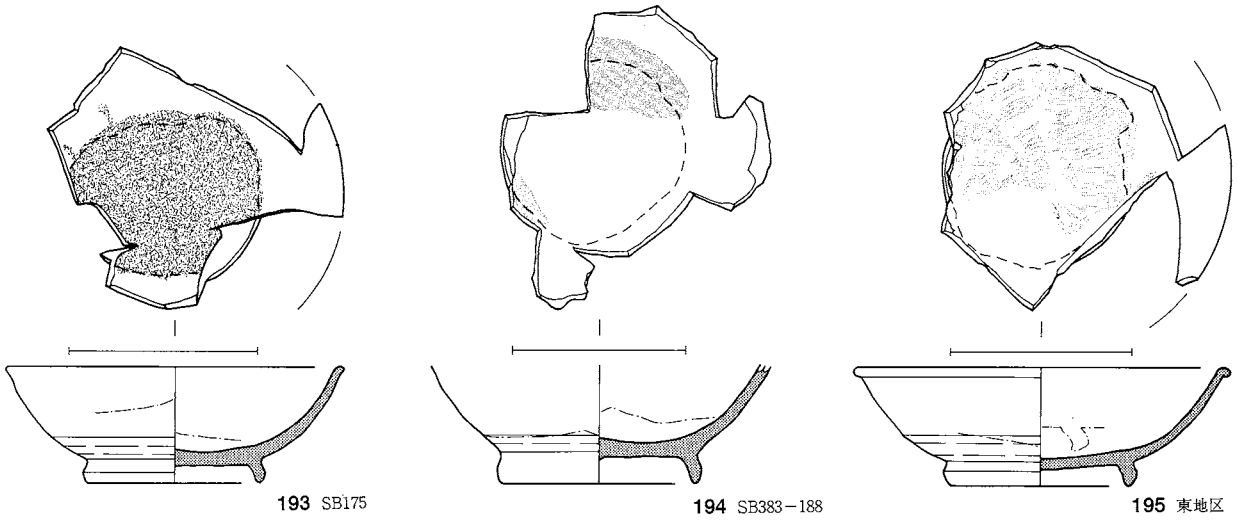

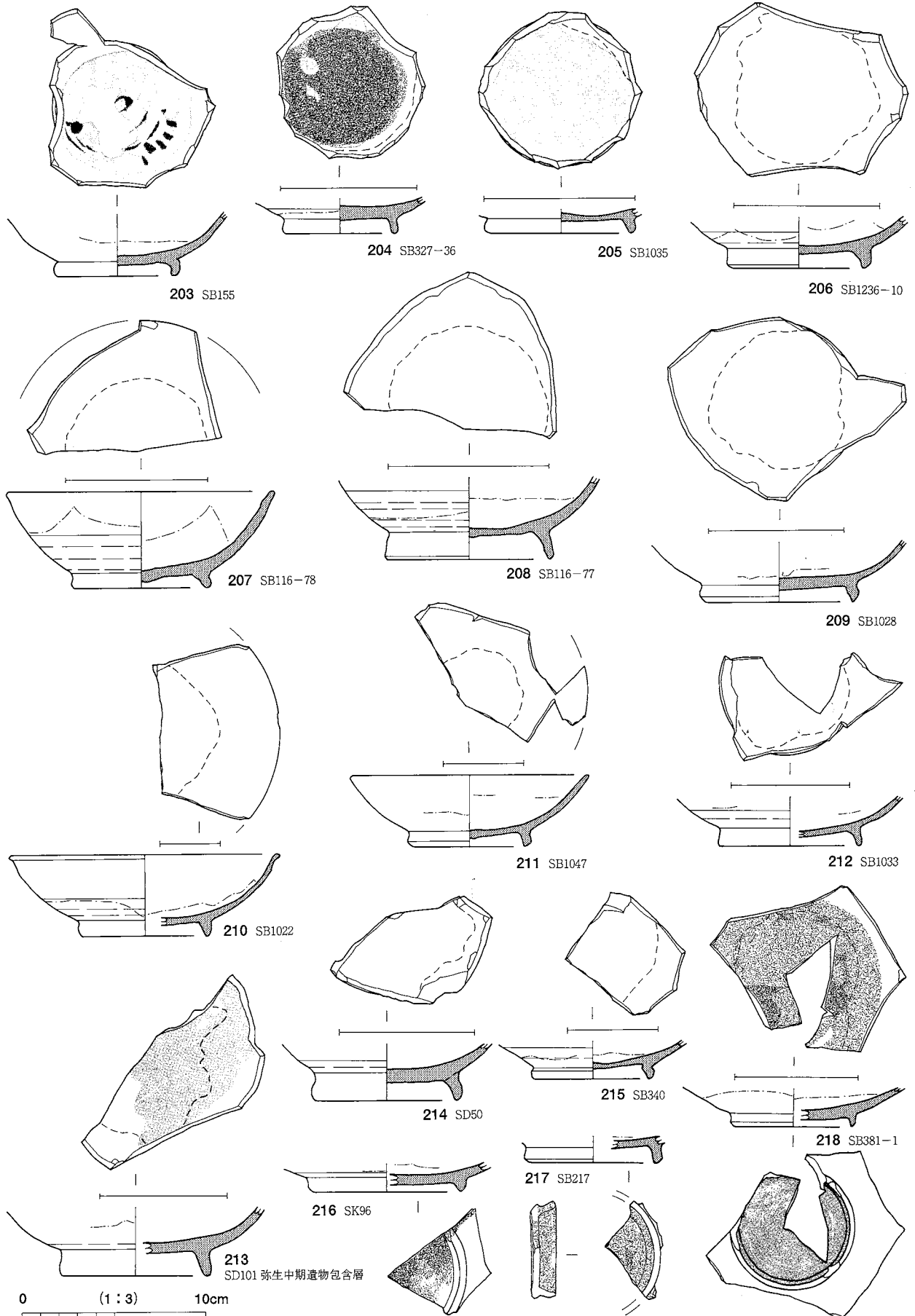

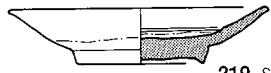
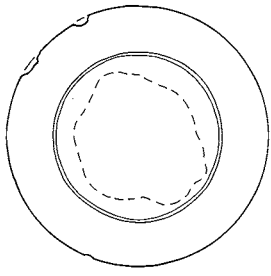

219 SB343-2

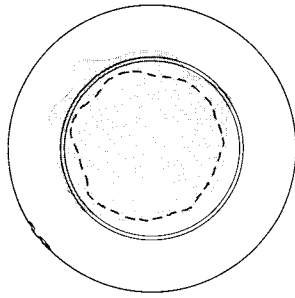

220 SB1027

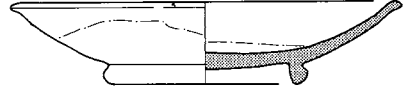
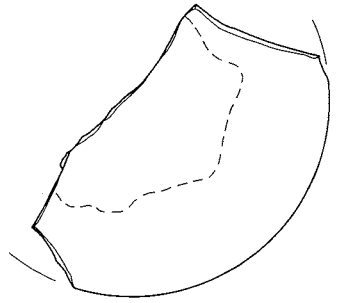

221 SK33-3

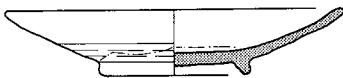
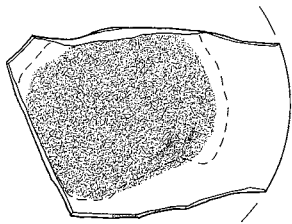

222 SB1237-12

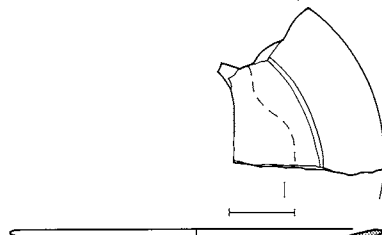

223 SB238

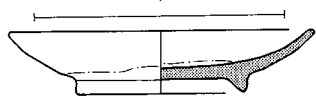
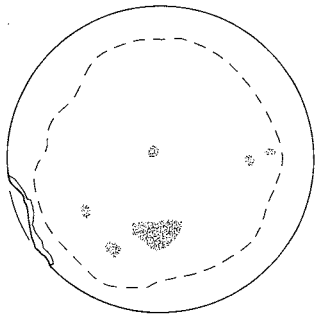
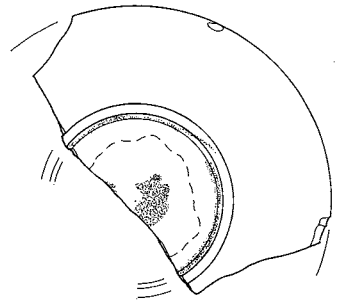

224 SB1046-147

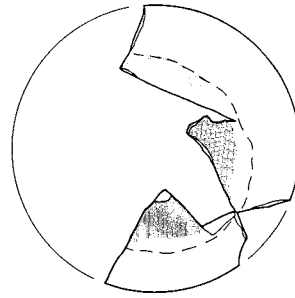

225 SB1046-148

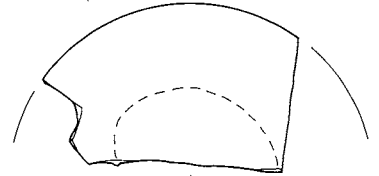

226 SB1201-16

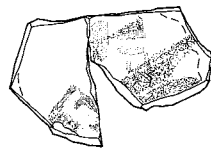

228 SB1009覆土一括-42

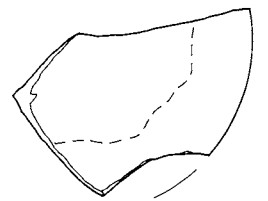

230 SB1401-19

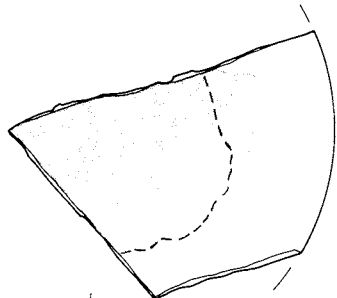

227 SB183-3

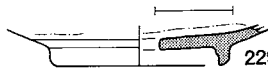
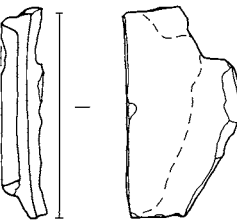

229 SD102

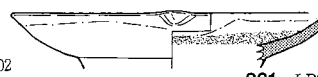

231 I B21区

0 (1:3) 10cm

SD15 (1~4)

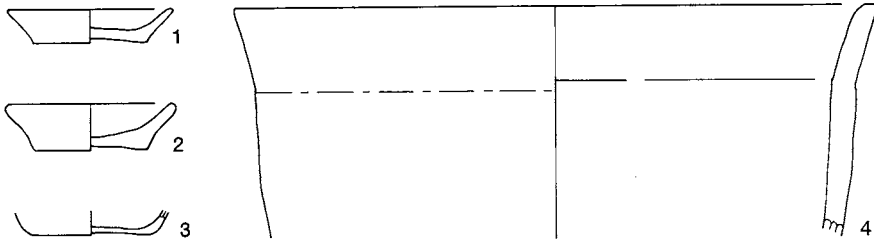

SD1003

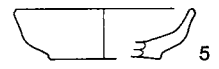

SD1004



SD1151

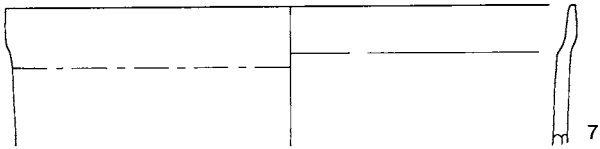

SD1178 (8·9)

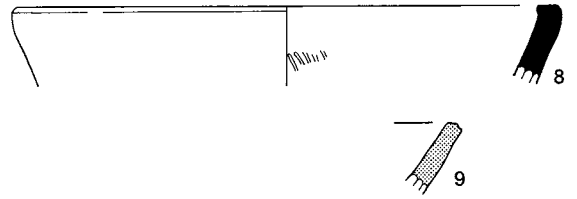

SD1187

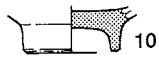

SD1244 (11·12)



SD1019 · SX1001 (13~21)

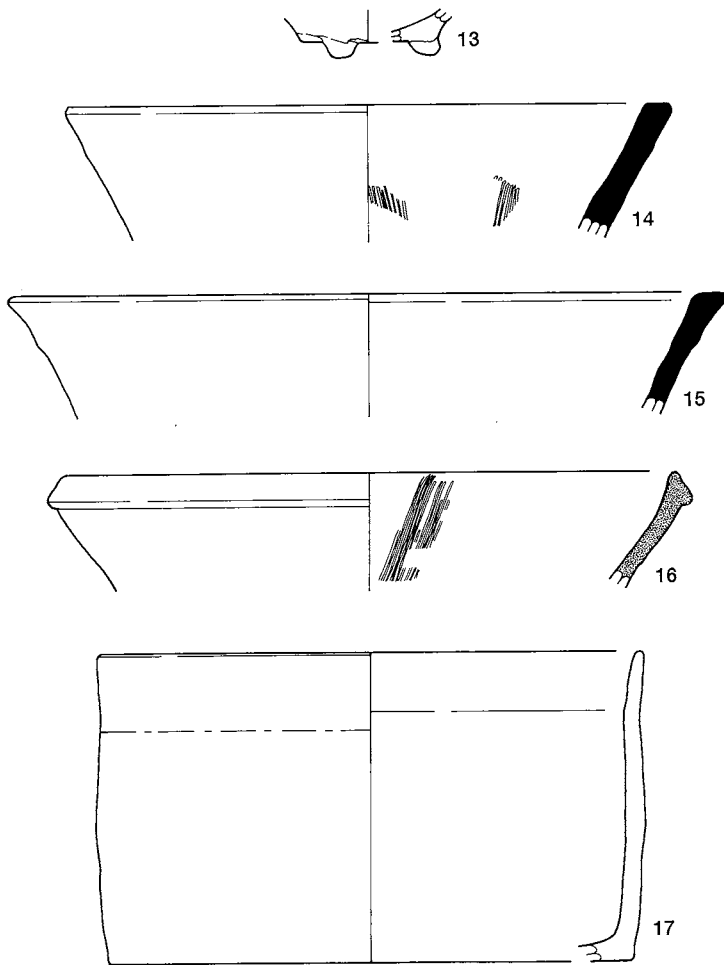

SD1168 (22~25)

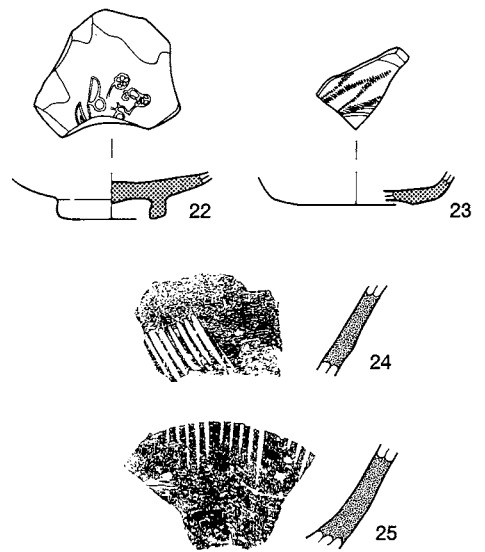

0 (1:4) 10cm

平坦部中世墓址
SK1014

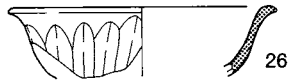

26

斜面部中世墓址群周辺出土 (27~36)

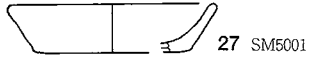

27 SM5001

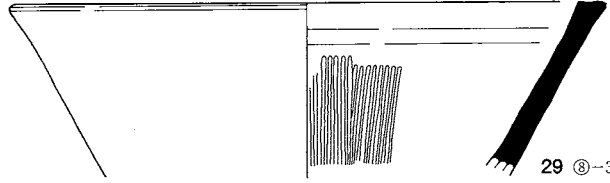

29 ㊸-3区

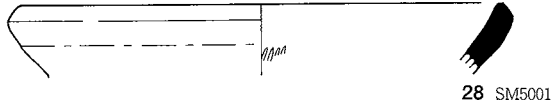

28 SM5001

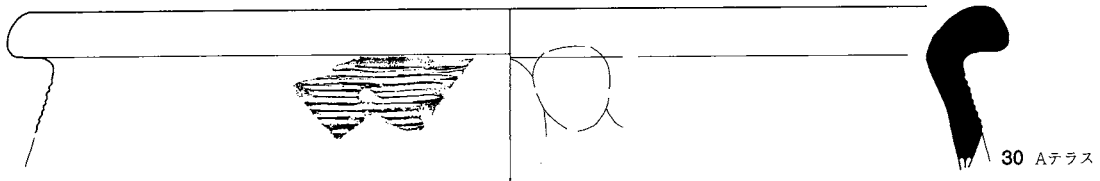

30 Aテラス

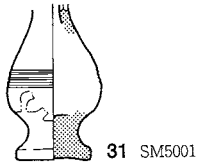

31 SM5001

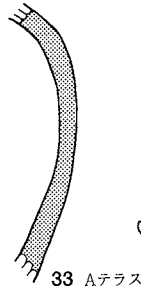
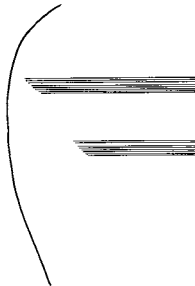

33 Aテラス

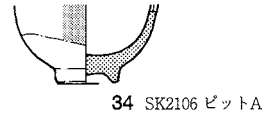

34 SK2106 ビットA

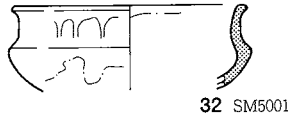

32 SM5001

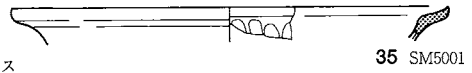

35 SM5001

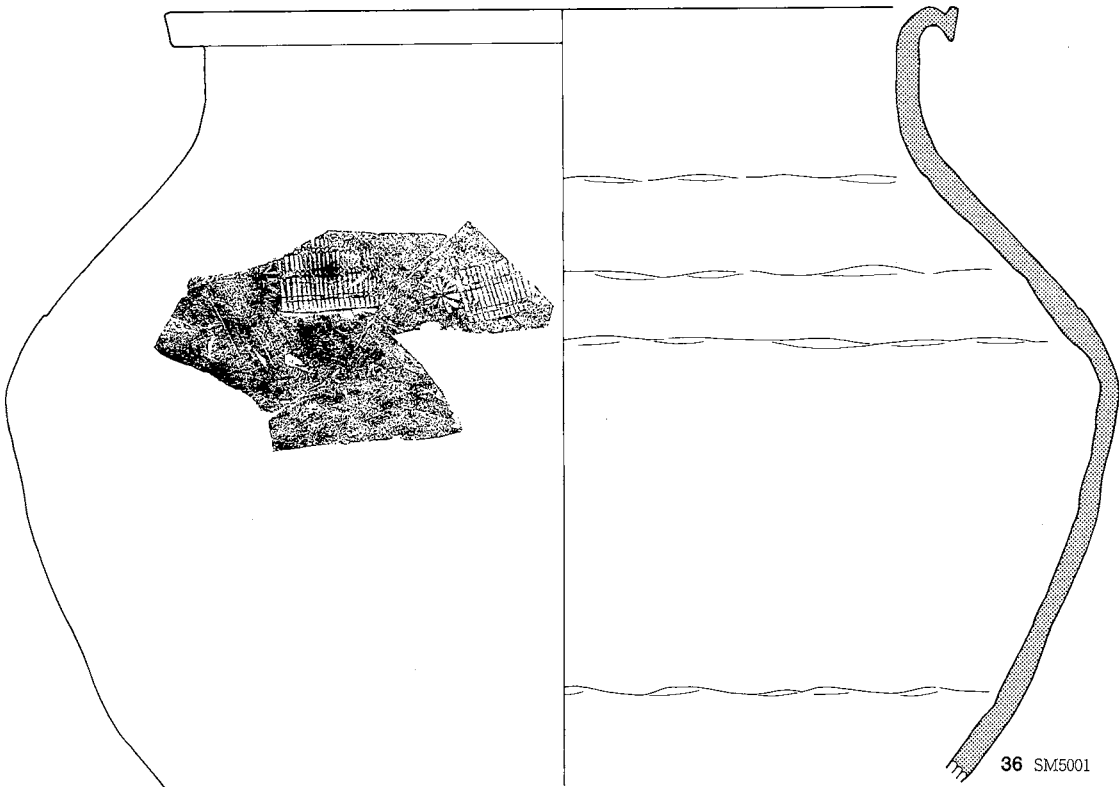

36 SM5001

0 (1:4) 10cm

SK523

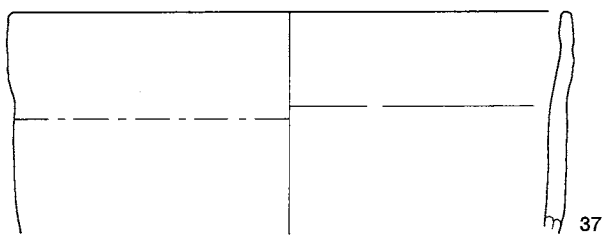

SK1255

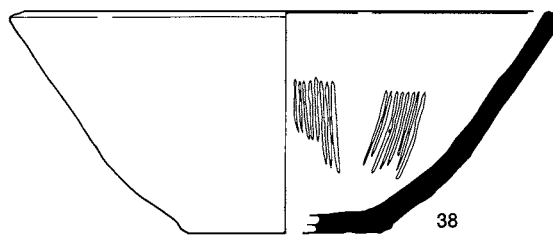

SK2

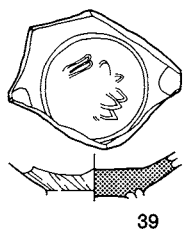

SK1541 (53・54)

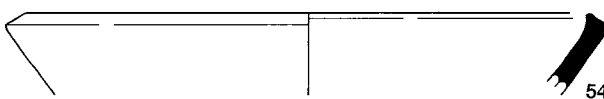
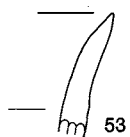

SK533

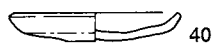

SK1655

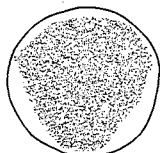

SK1562

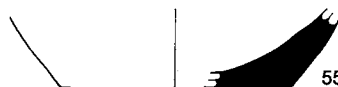

SK1560

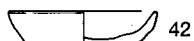
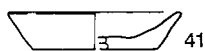

SK1574

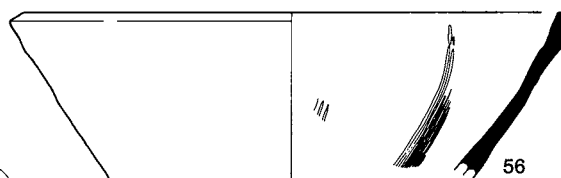

SK1550 (43~51)

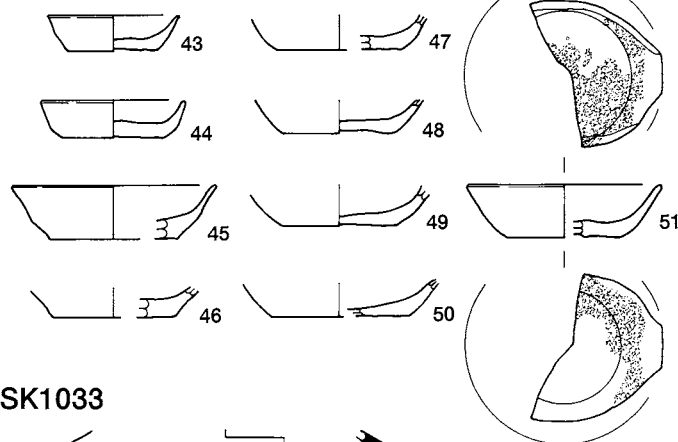

SK2513



SK1033

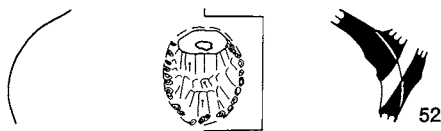

SK1080

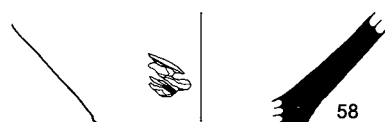

SK45

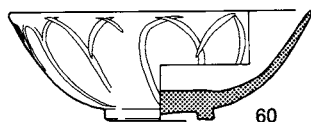

SK1053

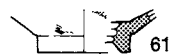

SK1533



SK1004



SK1133

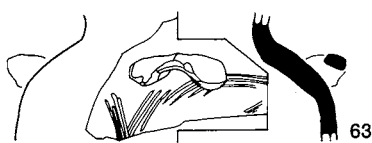

SK1221

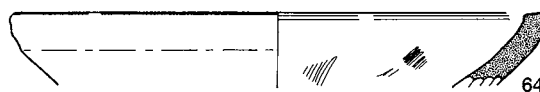

0 (1:4) 10cm

SK1581

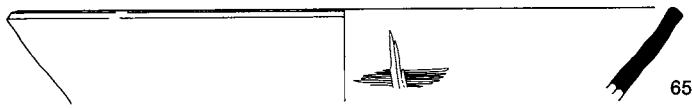

SK1646

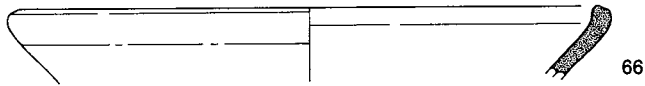

SK1607



SK1613

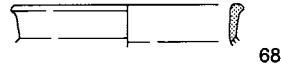

SK1637



SK1644 (70・71)

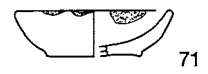
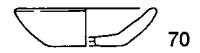

SK1650

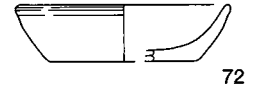

遺構外出土焼物 (古代遺構出土焼物も含む)

カワラケ (73~77)

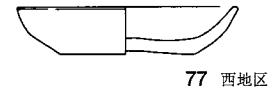
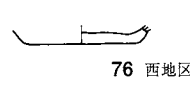
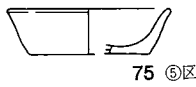
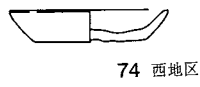
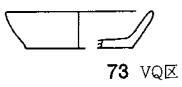

内耳鍋 (78~84)

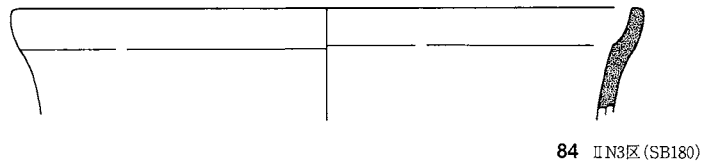
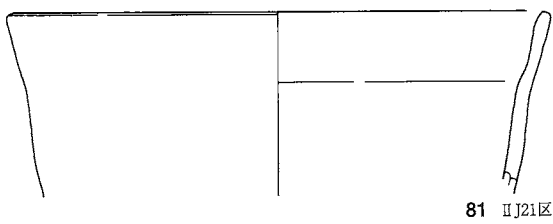
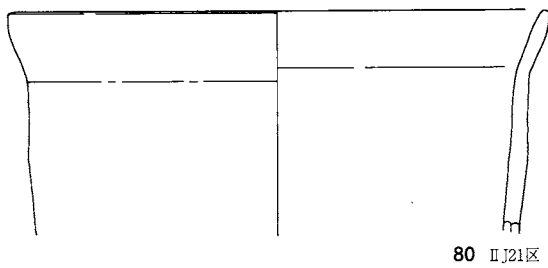
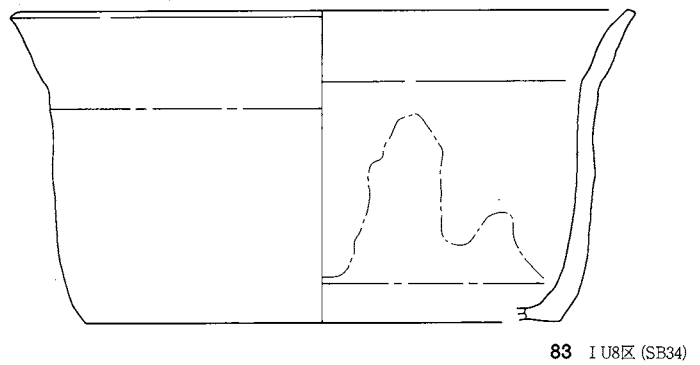
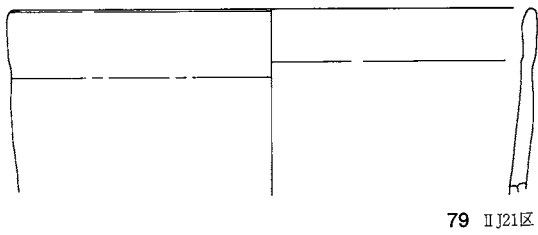
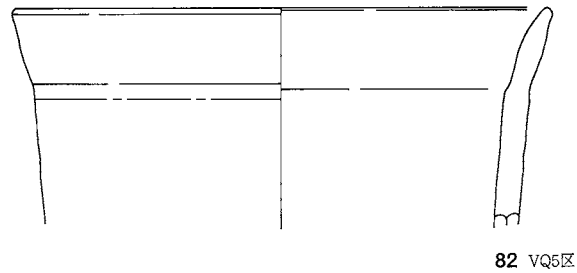

0 (1:4) 10cm

在地産播鉢 (85~92)

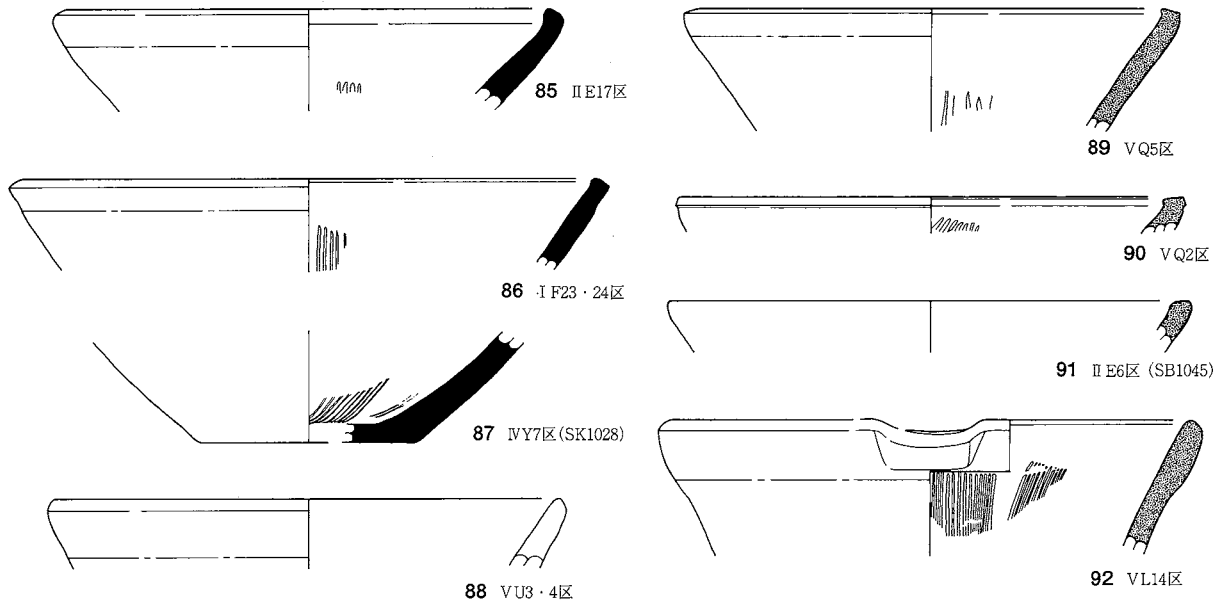

珠洲産鉢 (93~101)

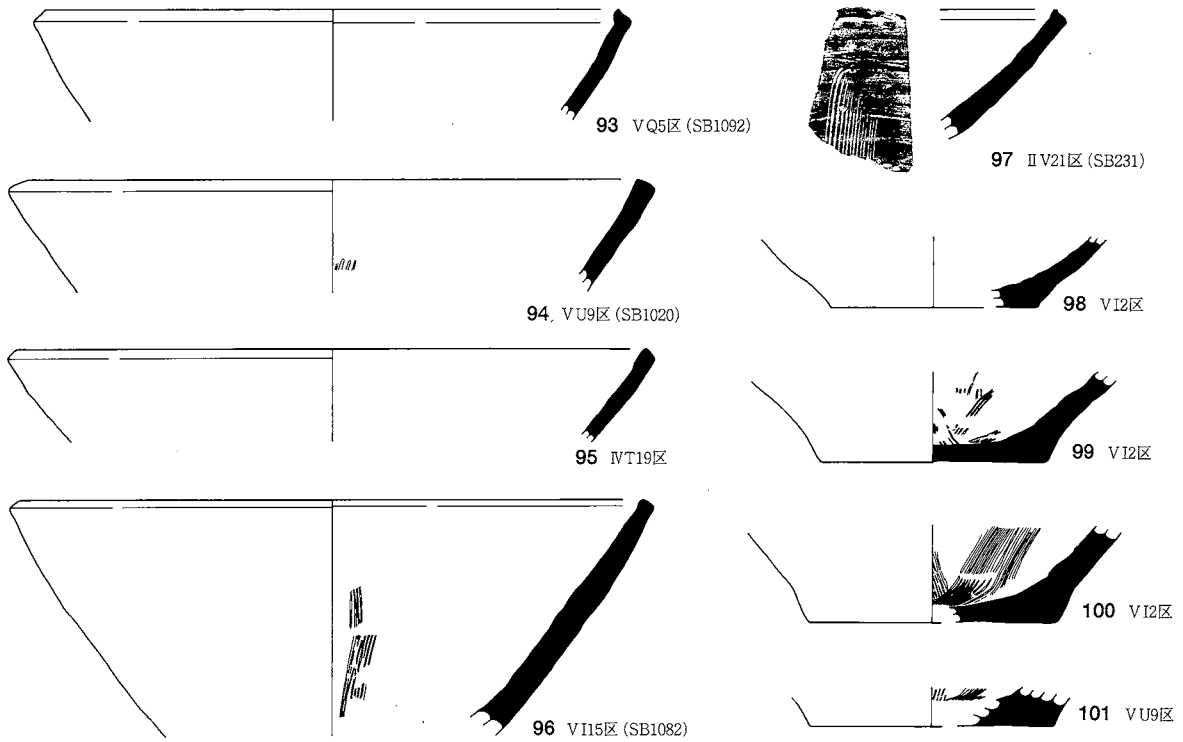

古瀬戸 (102~106)

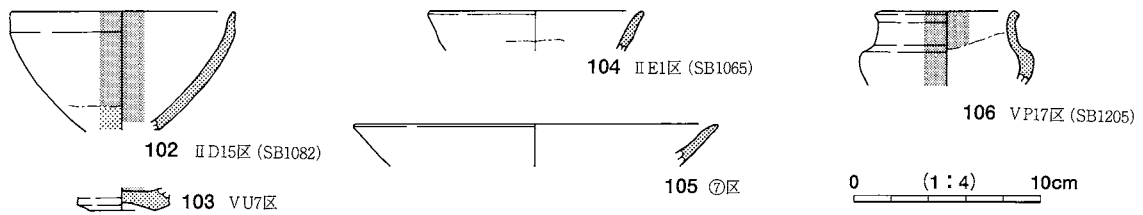

山茶碗系コネ鉢

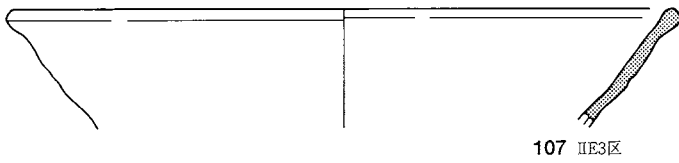

常滑コネ鉢 (108・109)

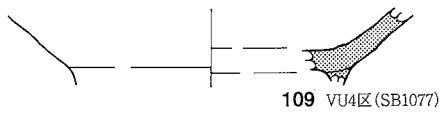
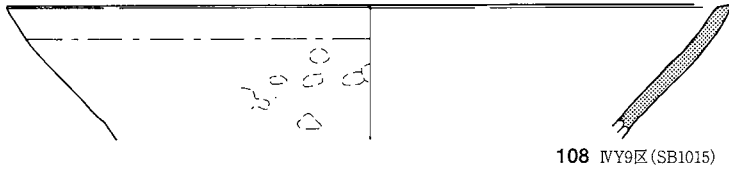

越中瀬戸 (117~119)

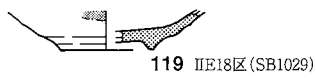
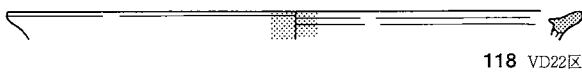
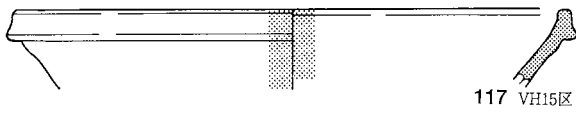

中国陶磁器 (110~116)

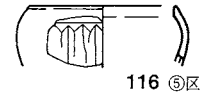
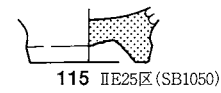
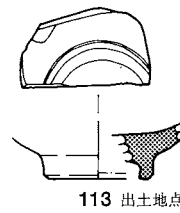
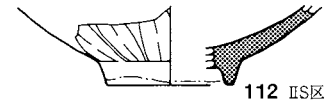
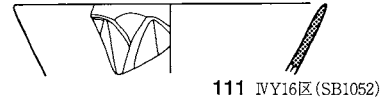
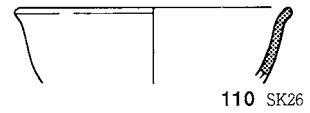

信楽



0 (1:4) 10cm

土製品 (1~5)

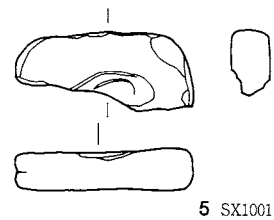
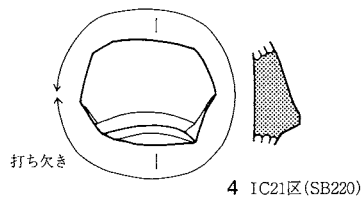
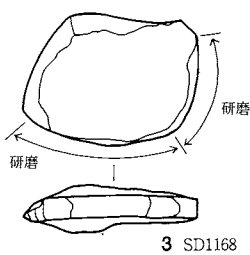
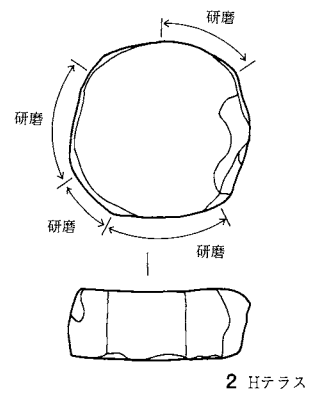
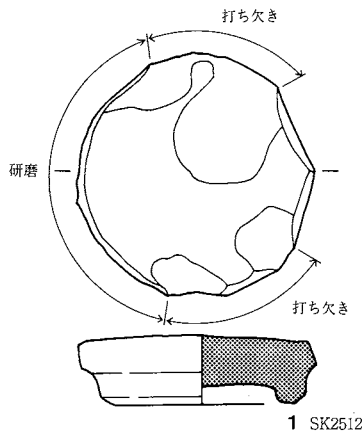

0 (1:2) 5cm

砥石 (1~6)

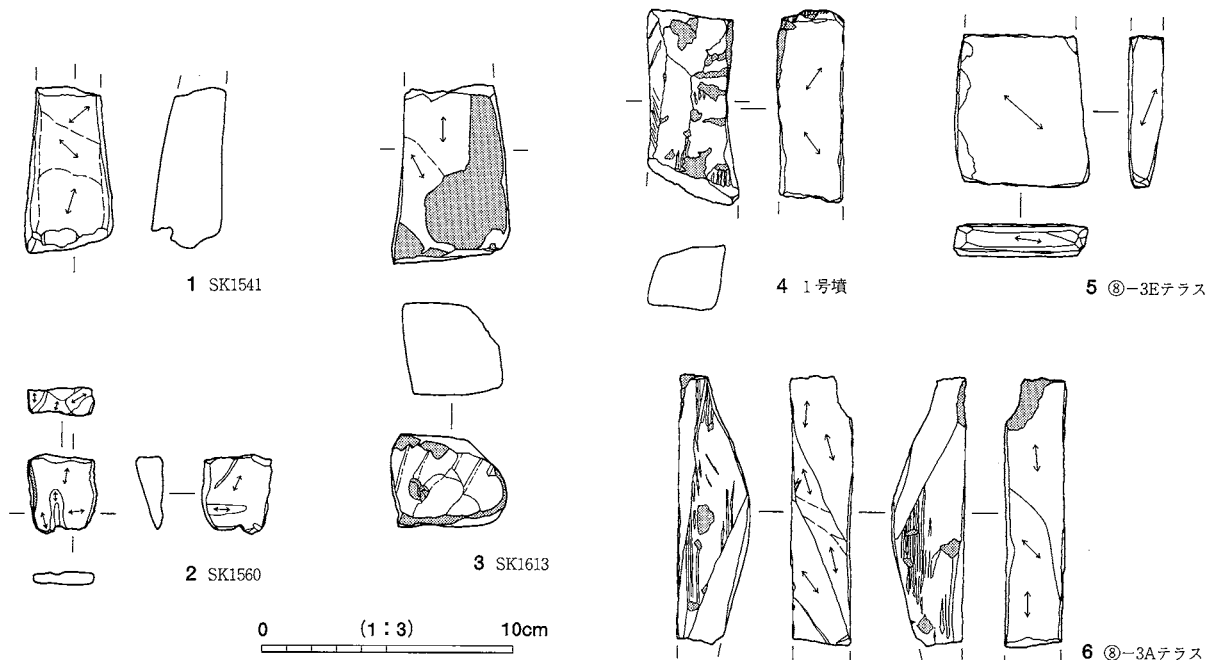

台石・凹石 (1~6)

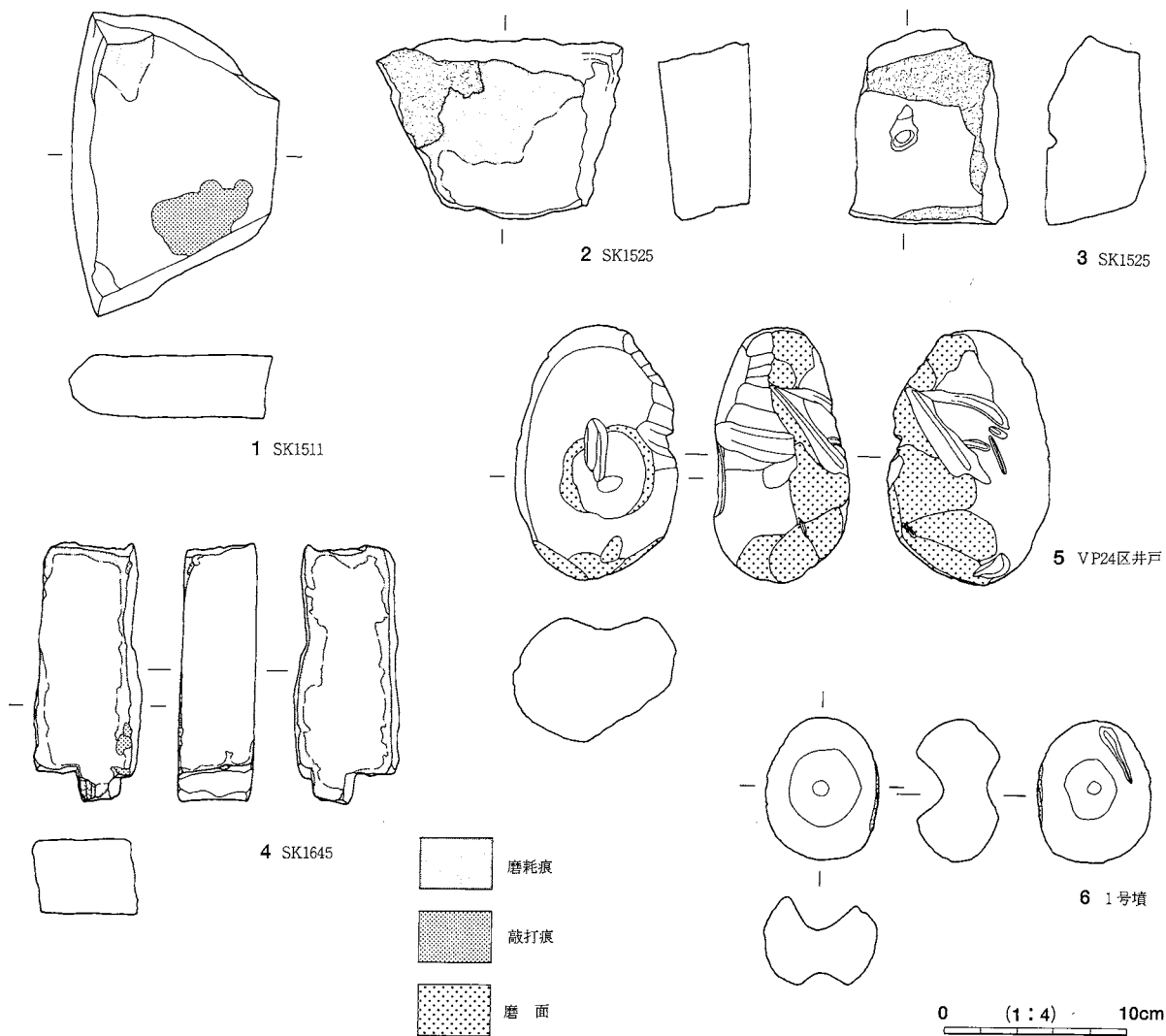

軽石製品 (1~5)

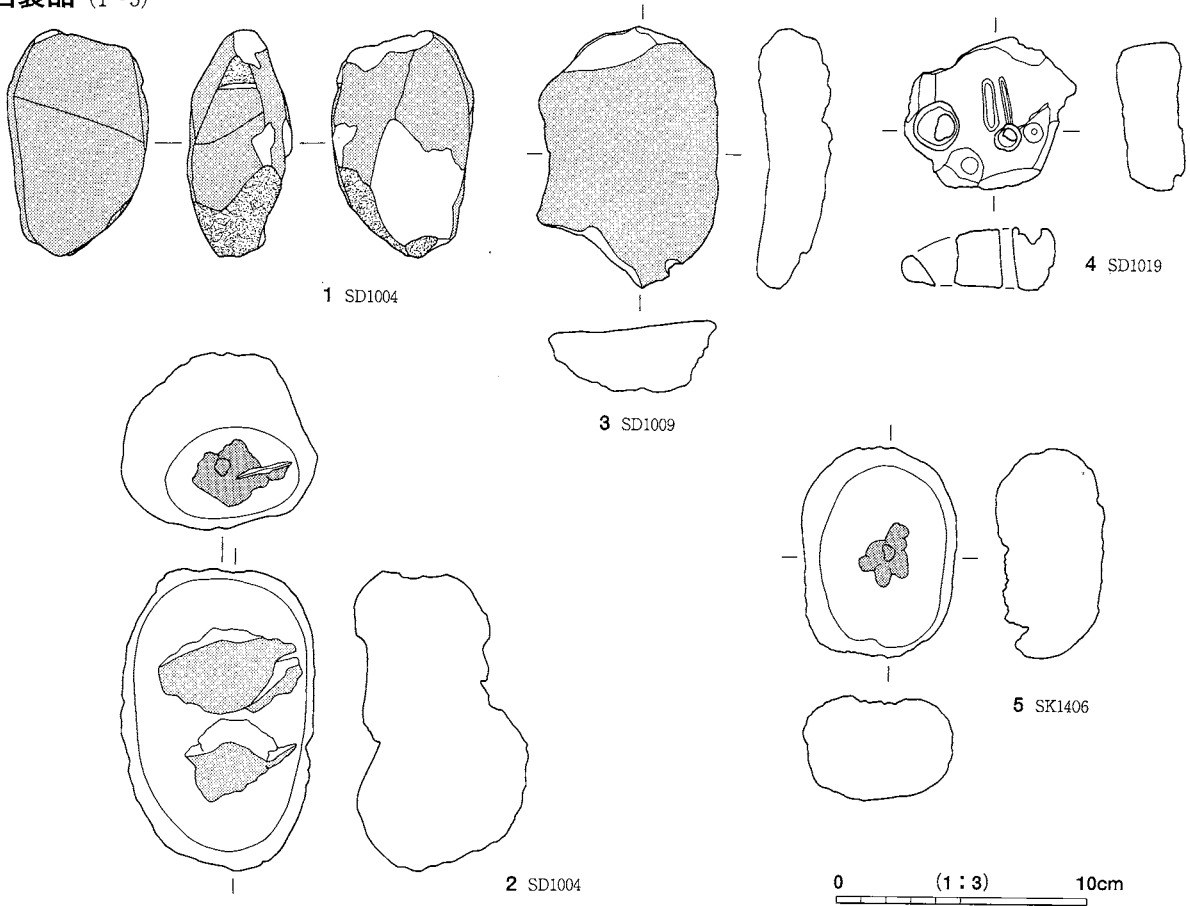

石臼・茶臼 (1~10)

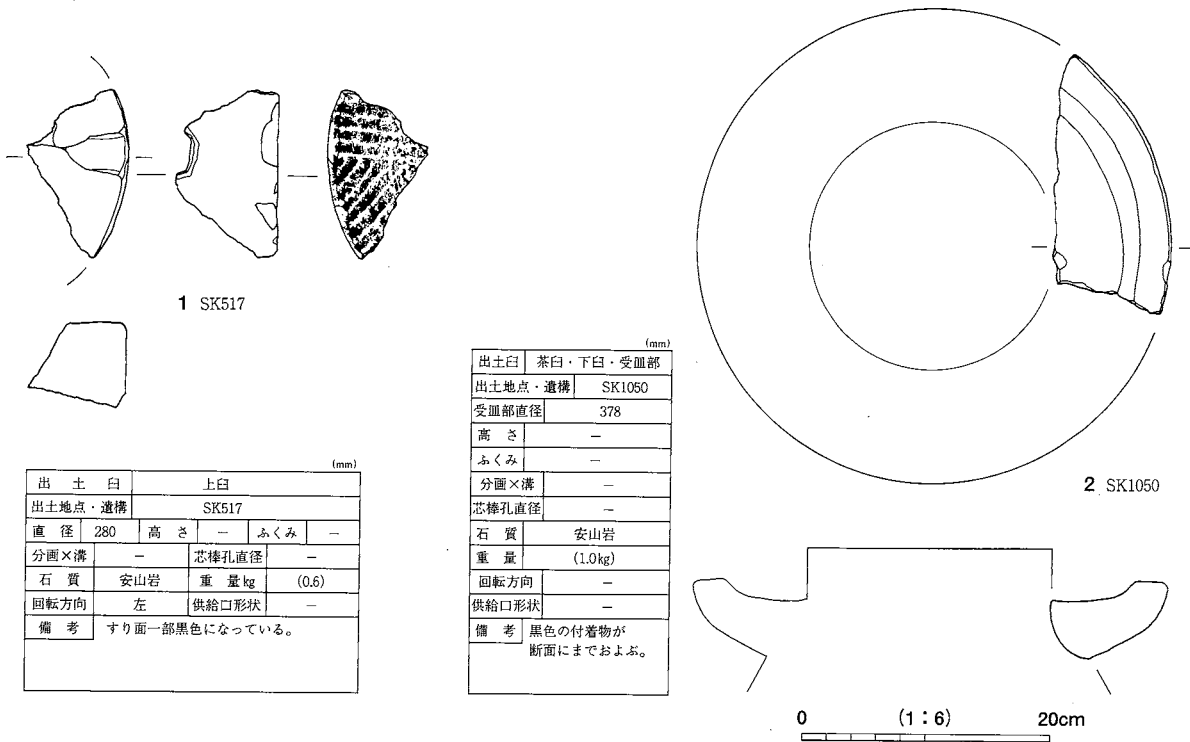

出土臼		上臼			
出土地点・遺構 SK517					
直径	280	高さ	—	ふくみ	—
分画×溝	—	芯棒孔直径	—		
石質	安山岩	重量kg	(0.6)		
回転方向	左	供給口形状	—		
備考	すり面一部黒色になっている。				

茶臼・下臼・受皿部	
出土地点・遺構 SK1050	
受皿部直径	378
高さ	—
ふくみ	—
分画×溝	—
芯棒孔直径	—
石質	安山岩
重量	(1.0kg)
回転方向	—
供給口形状	—
備考	黒色の付着物が断面にまでおよぶ。

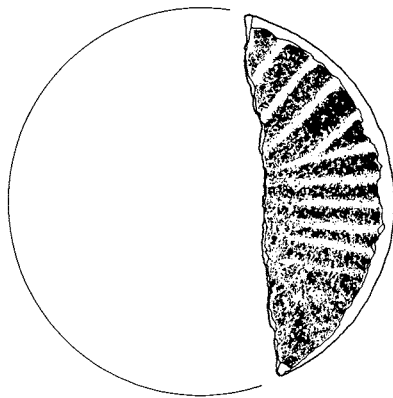
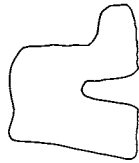
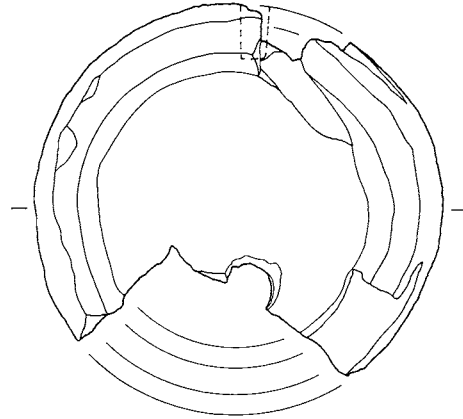
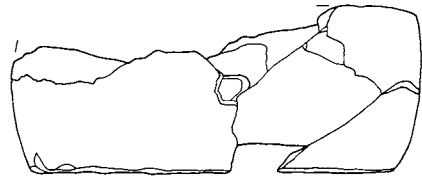
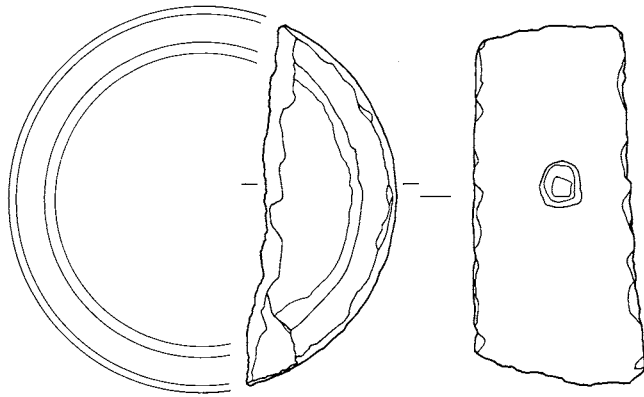

3 SK1541

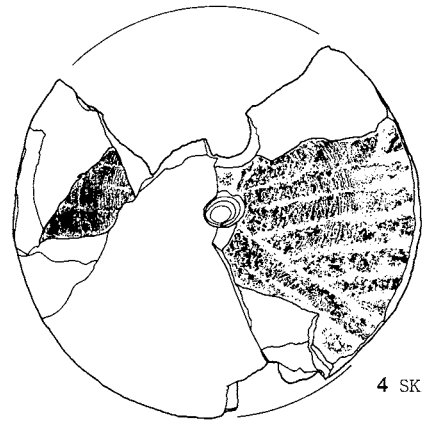

4 SK1541

(mm)

出土日	上白		
出土地点・遺構	SK1541		
直径	(306)	高さ	134・123
分画×溝	(6×6)	芯棒孔直径	ふくみ
石質	安山岩	重量kg	(4.3)
回転方向	左	供給口形状	-
備考			

(mm)

出土日	上白		
出土地点・遺構	SK1541		
直径	324	高さ	135・102
分画×溝	8×6	芯棒孔直径	(27)
石質	安山岩	重量kg	(10.6)
回転方向	左	供給口形状	隅丸方形
備考	8分画は交わった角度より出した。		

0 (1:6) 20cm

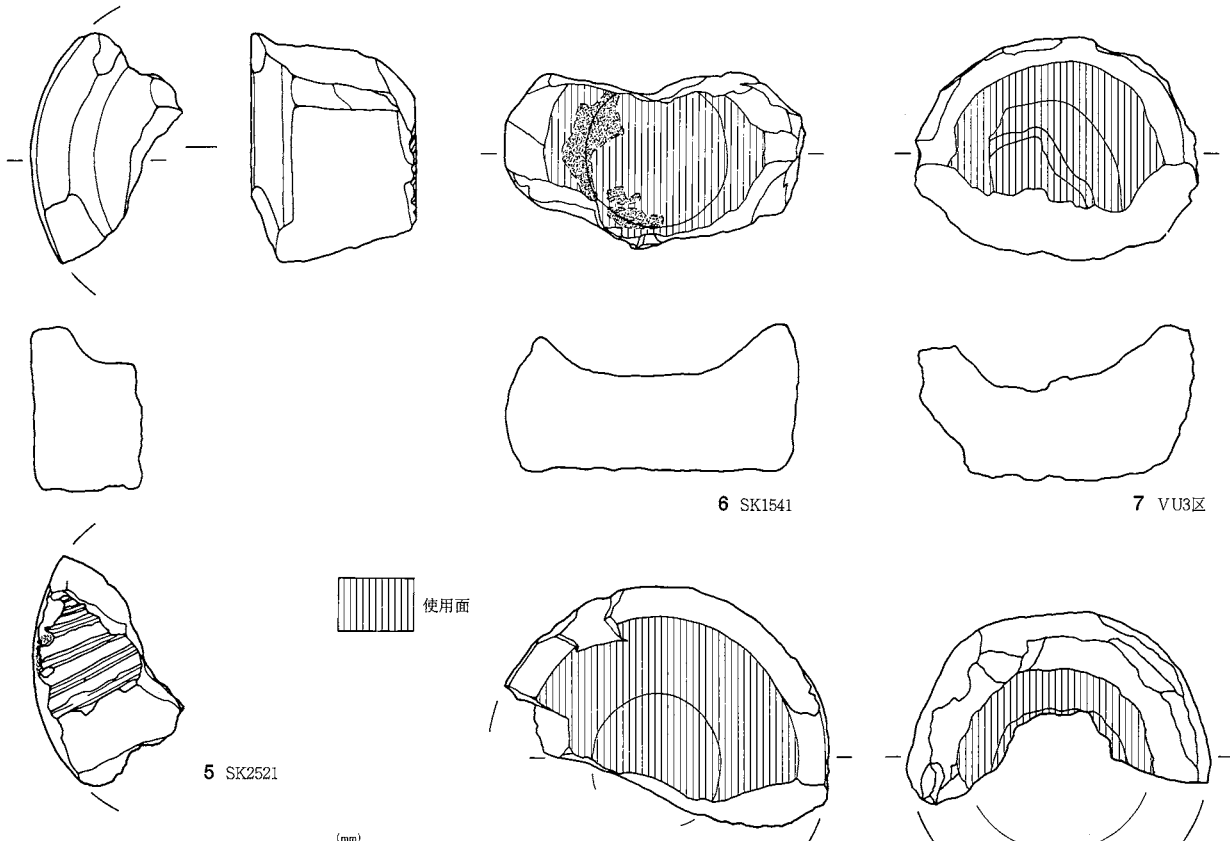

(mm)

出土白	上白		
出土地点・遺構	SK2521		
直径	(290)	高さ	(130)
分画×溝	—	芯棒孔直径	—
石質	安山岩	重量kg	(2.8)
回転方向	—	供給口形状	—
備考	一部すず付着。		

挿図番号	出土地点・遺構	石質	直径mm	高さmm	深さmm	重量kg
6	SK1541	安山岩	(234)	(116)	(45)	(3.7)
備考	内面敲打痕あり。底面敲打痕あり。 内面に黒色部分あり。					

挿図番号	出土地点・遺構	石質	直径mm	高さmm	深さmm	重量kg
7	VU3区	安山岩	(218)	122	52	(4.6)
備考	内面2段底で敲打痕あり。 外面・底部全て敲打痕あり。					

挿図番号	出土地点・遺構	石質	直径mm	高さmm	深さmm	重量kg
8	VP24区	安山岩	(268)	(146)	77	(5.4)
備考	内面敲打痕あり。底部不明。 外面敲打による粗仕上げ。					

挿図番号	出土地点・遺構	石質	直径mm	高さmm	深さmm	重量kg
9	VP24区	安山岩	240	(103)	84	(2.5)
備考	内面にノミ痕あり					

挿図番号	出土地点・遺構	石質	直径mm	高さmm	深さmm	重量kg
10	㊸-3b区	安山岩	—	124	66	(4.75)
備考	内面にノミ痕あり。片口の未成品か？					

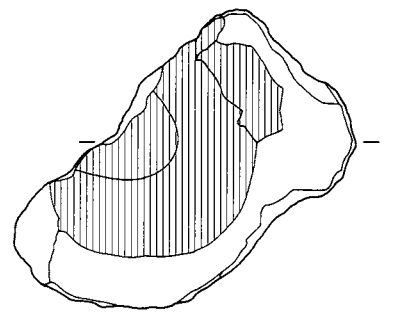

10 ㊸-3b区

0 (1:6) 20cm



五輪塔 空風輪

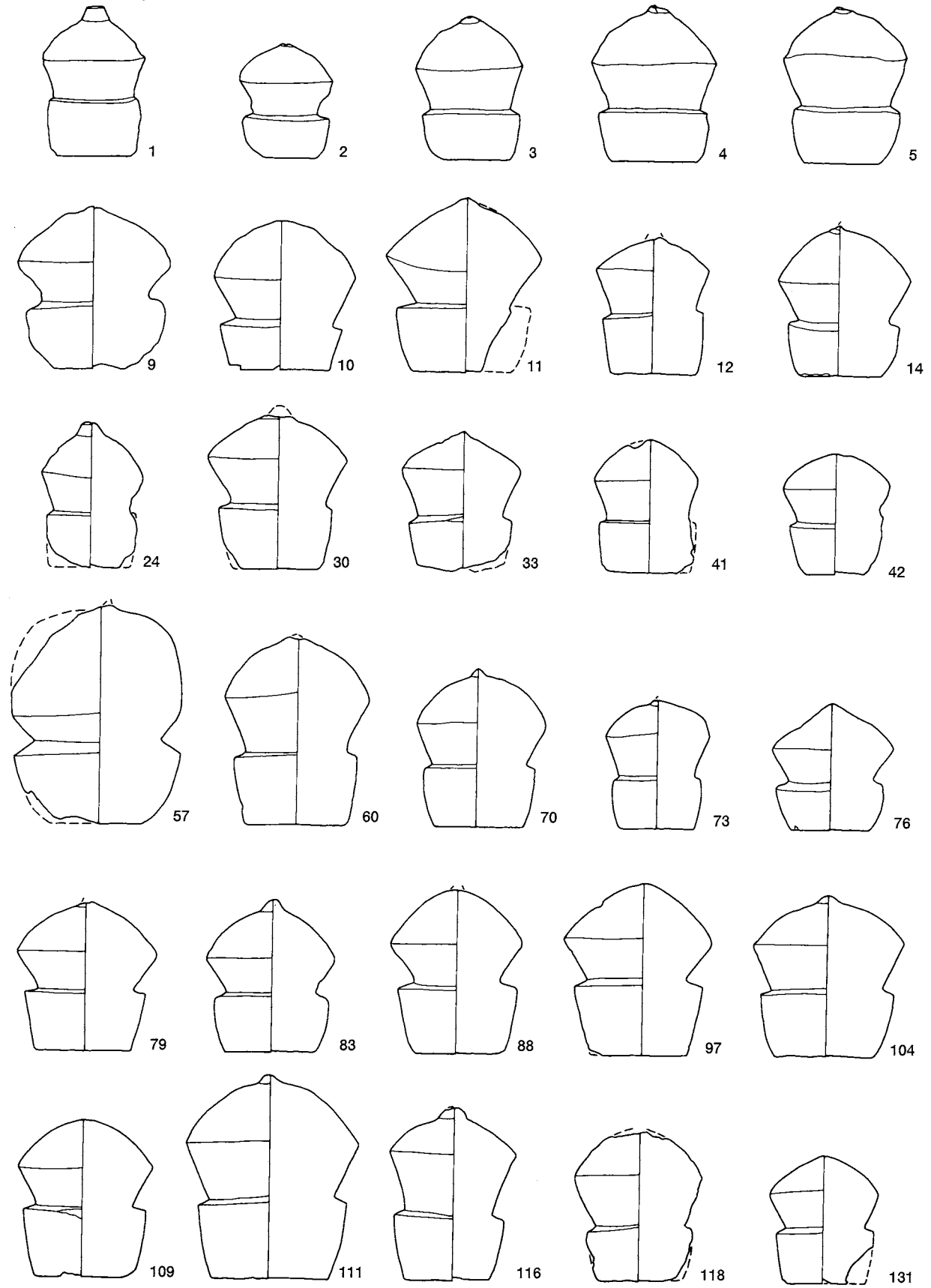

0 (1 : 8) 20cm

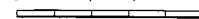

五輪塔 火輪

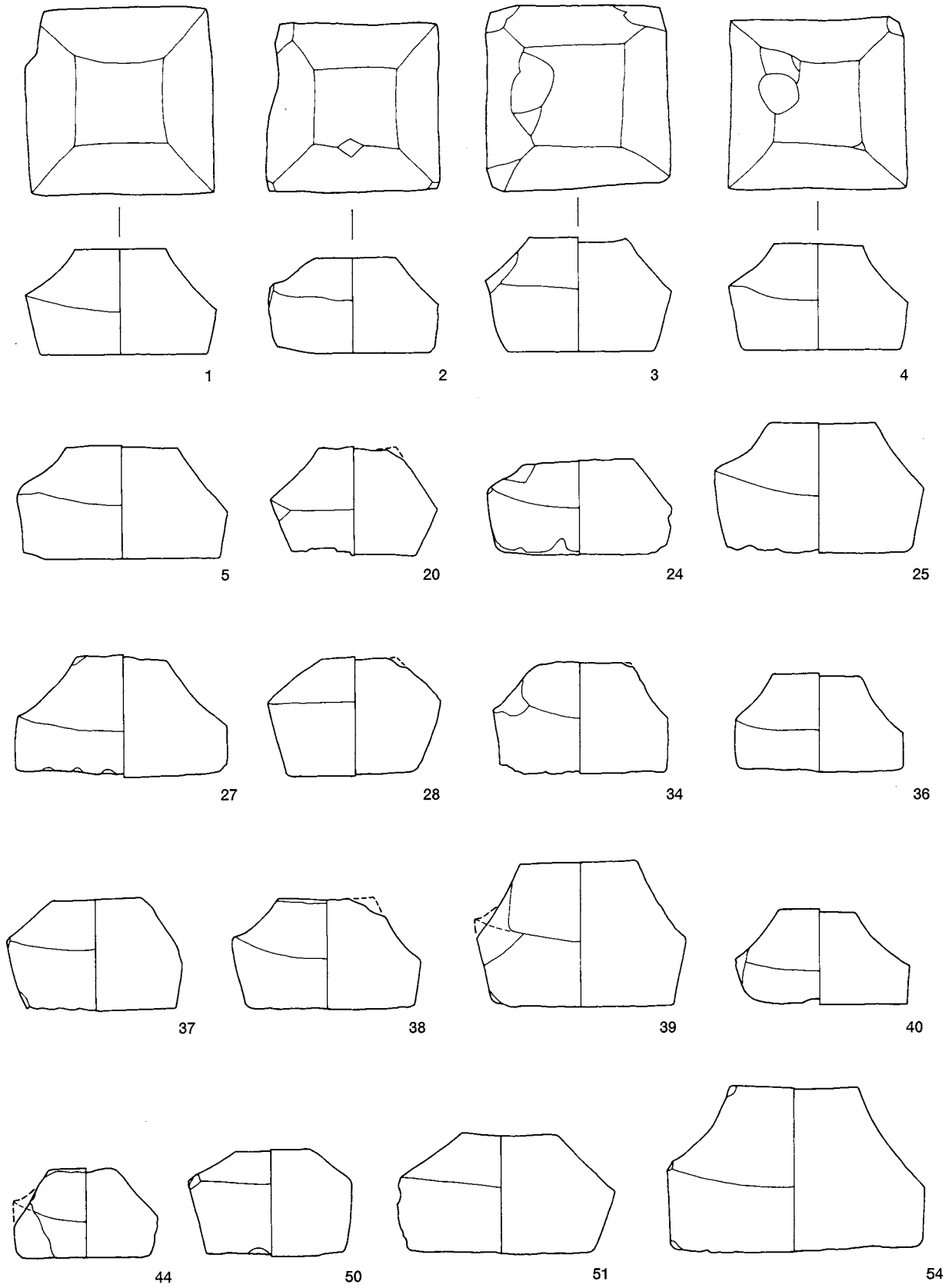

0 (1:8) 20cm

五輪塔 水輪

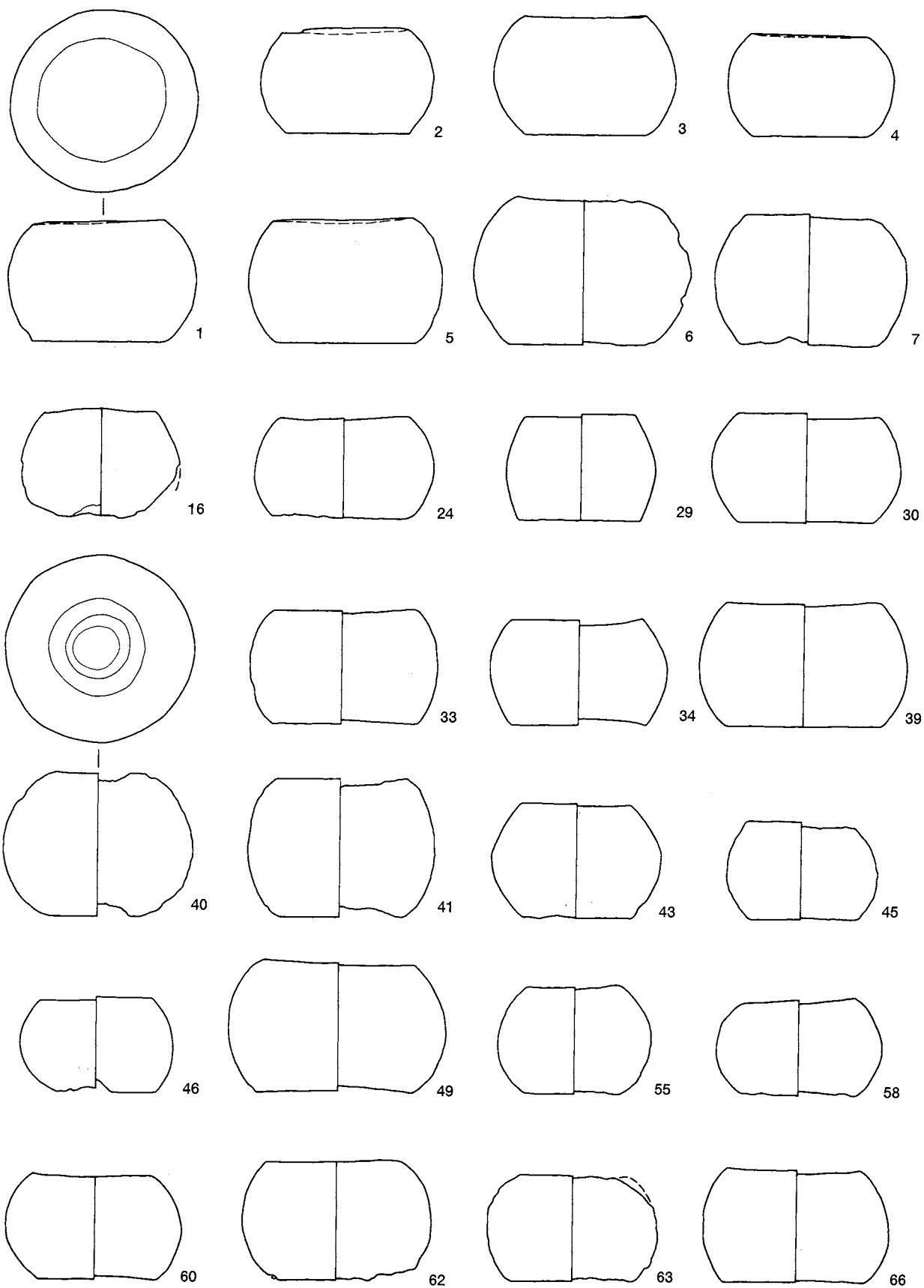

0 (1:8) 20cm

五輪塔 地輪

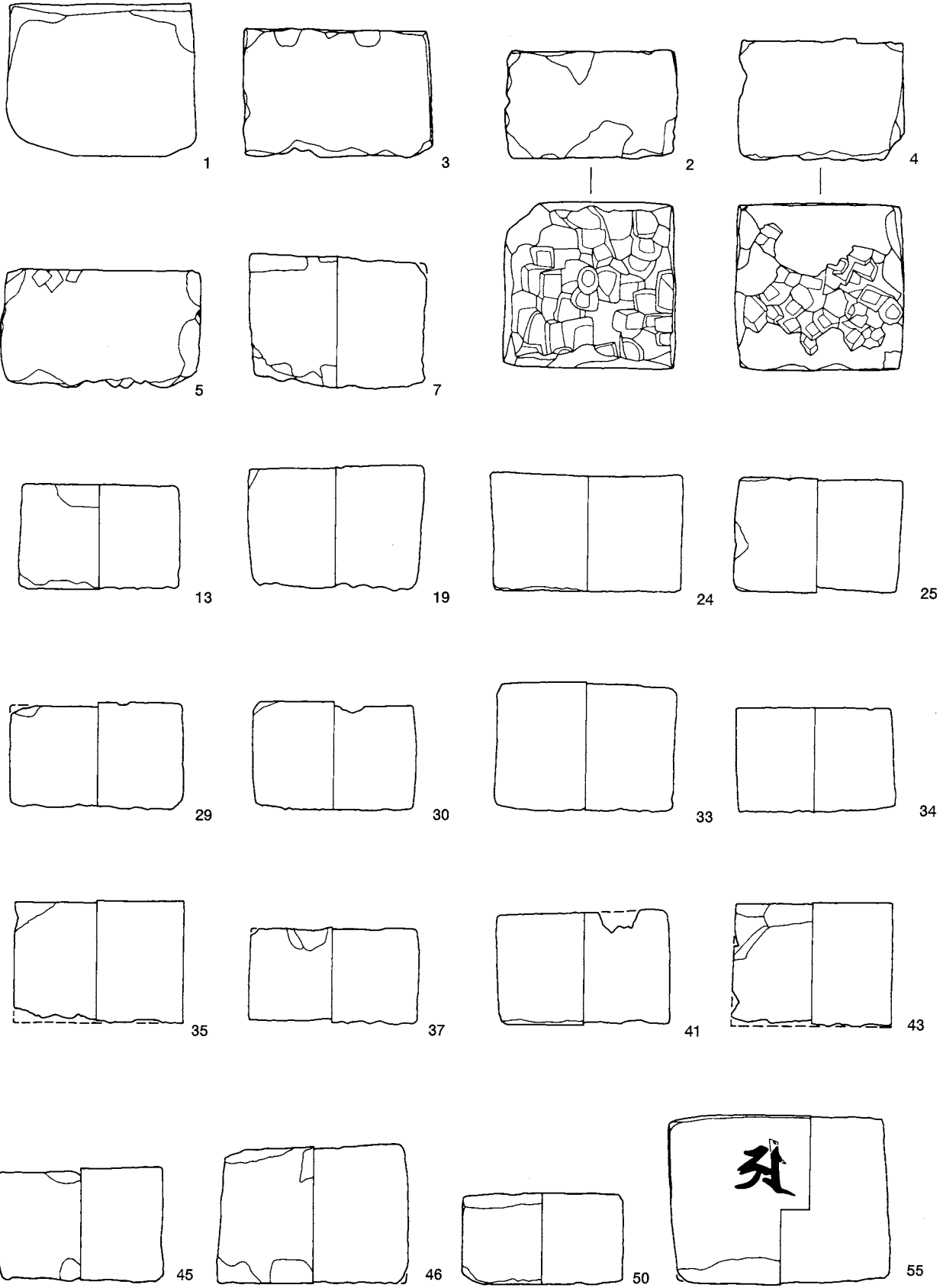

0 (1:8) 20cm

その他の石塔類 (1~18)

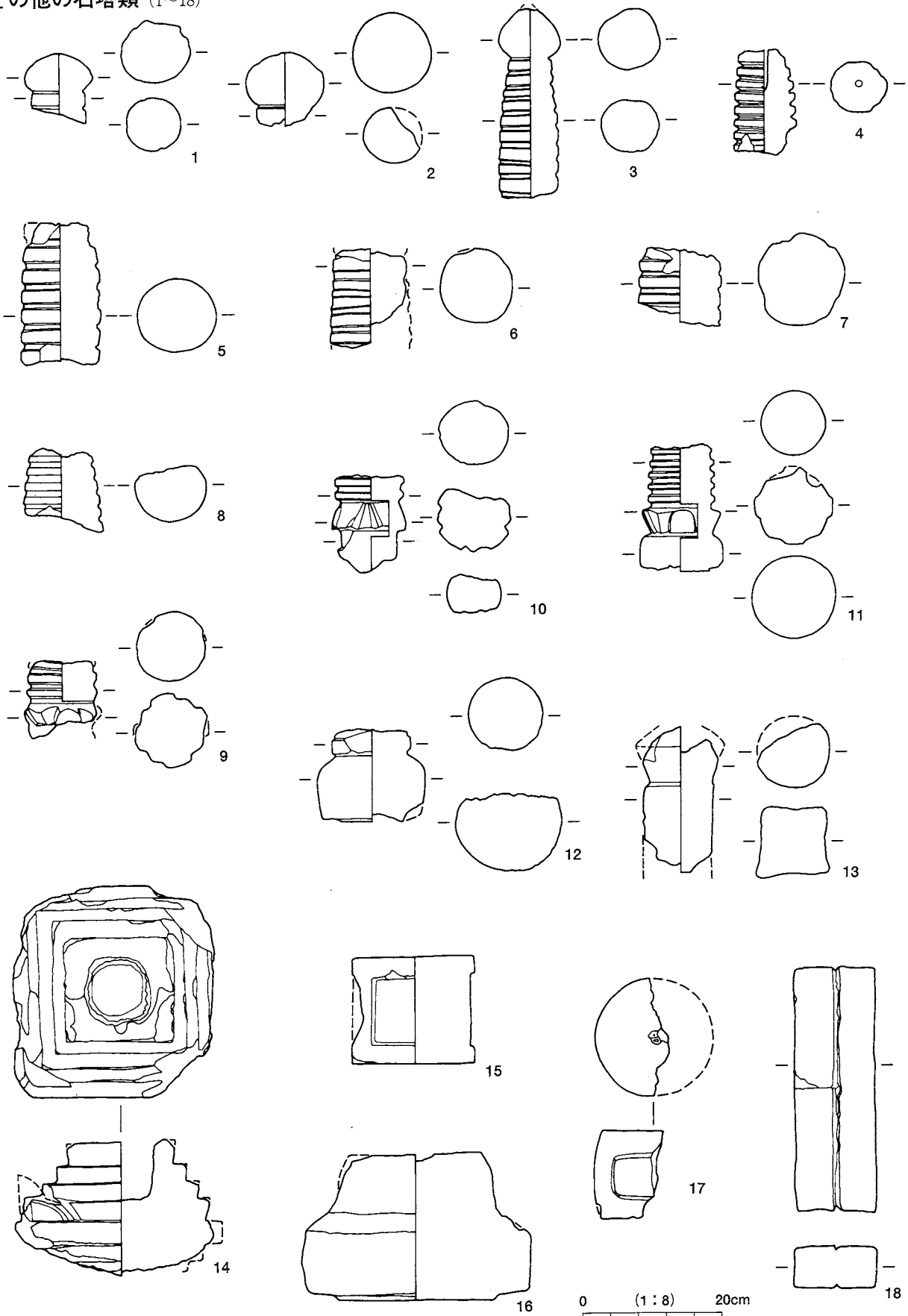

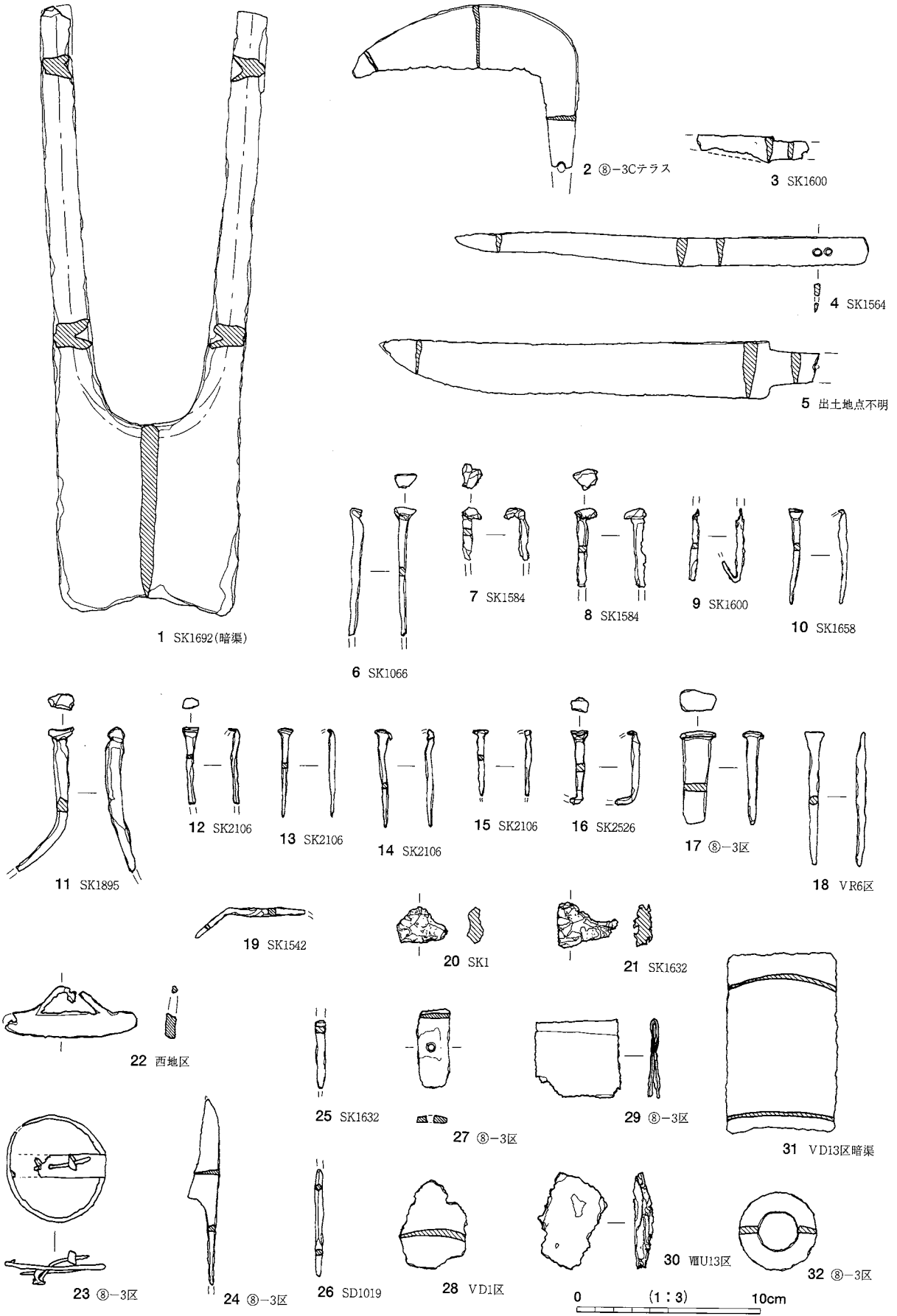

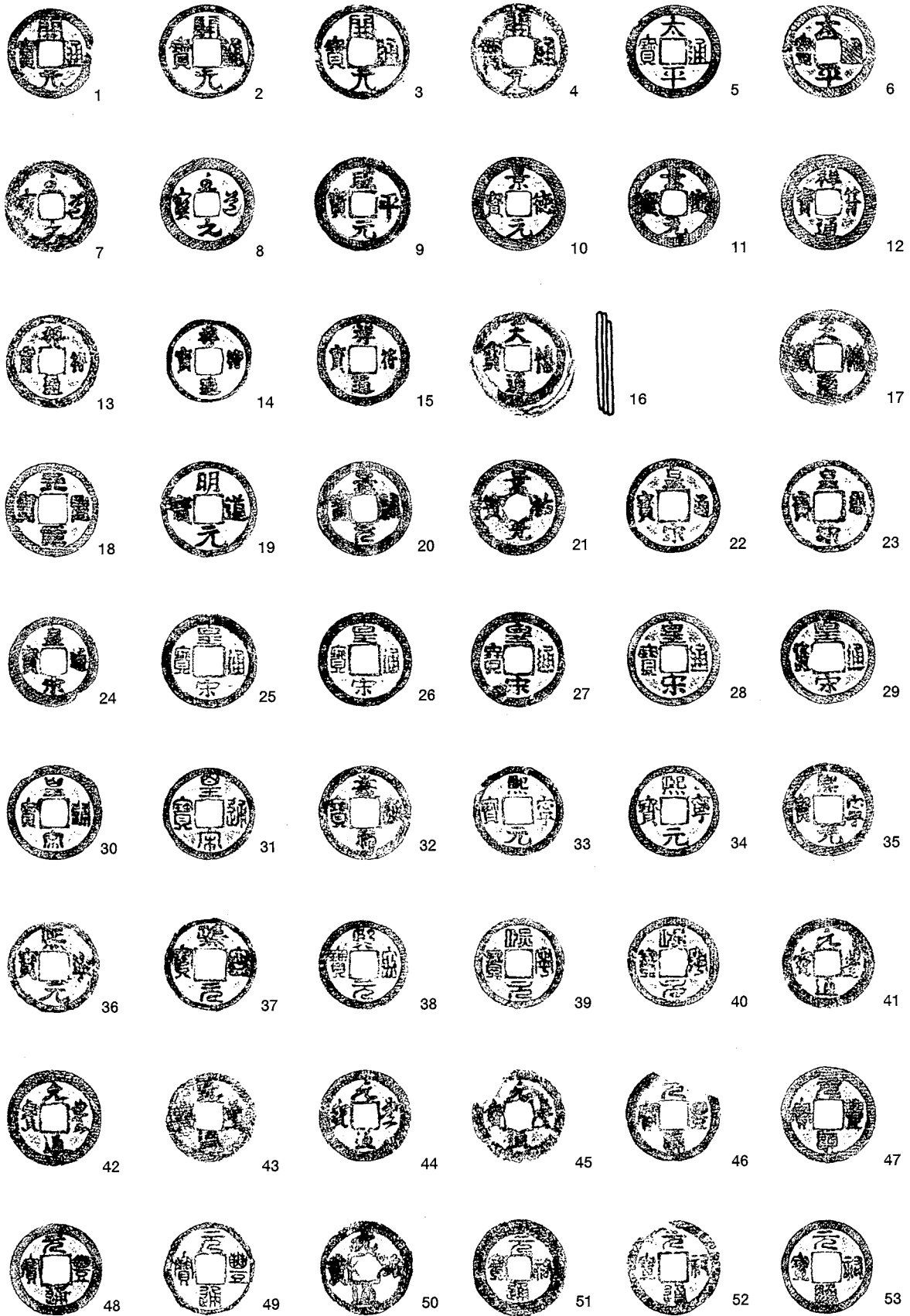

0 (2:3) 5cm

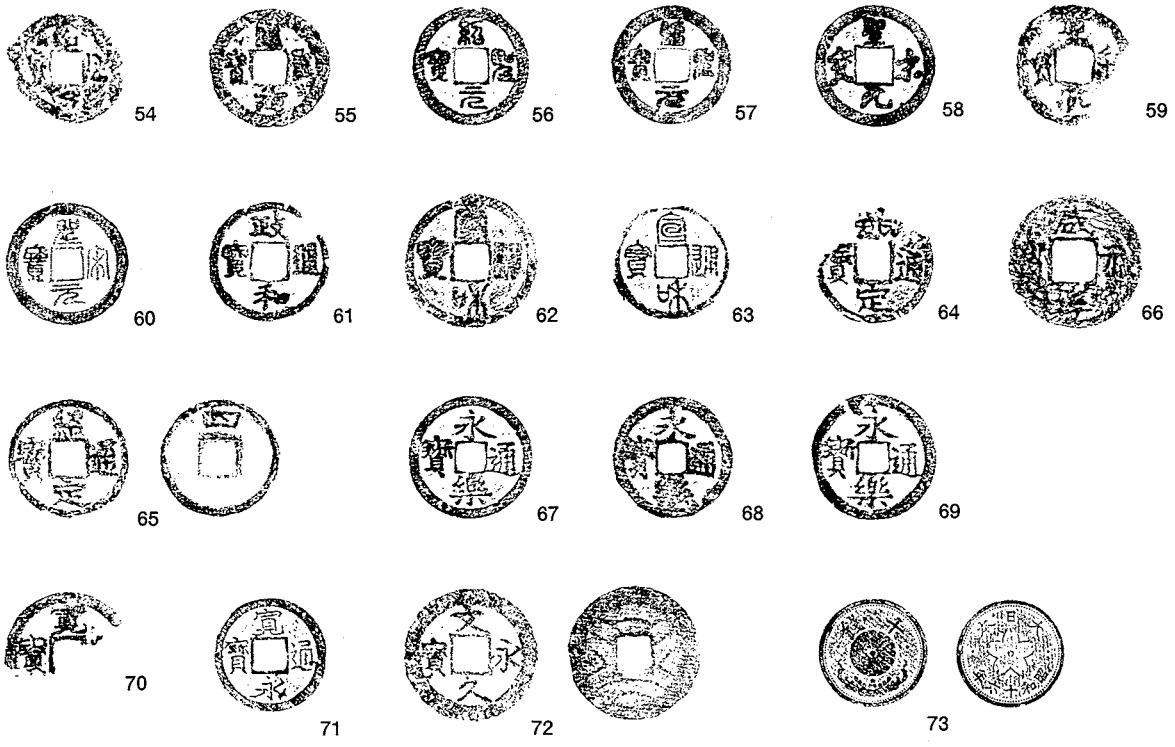

0 (2:3) 5cm

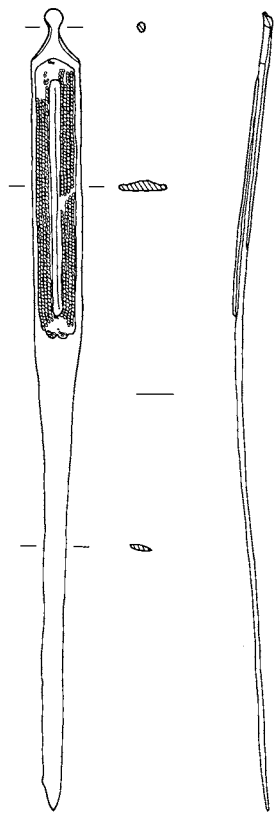

1 SK1066

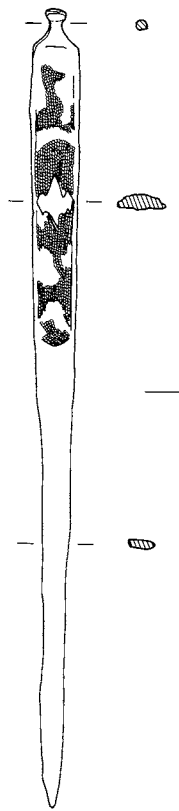

2 SK1066

0 (1:2) 5cm

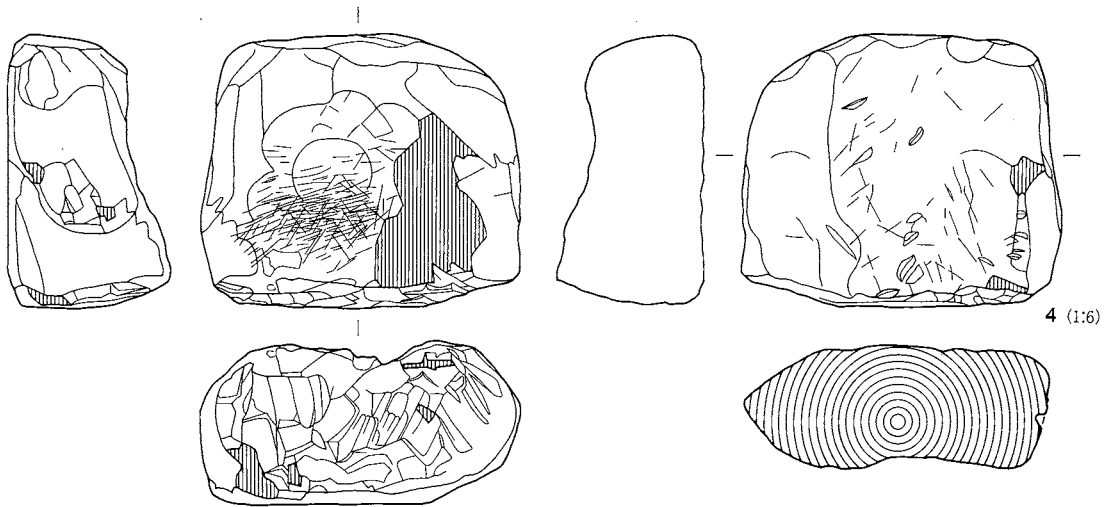
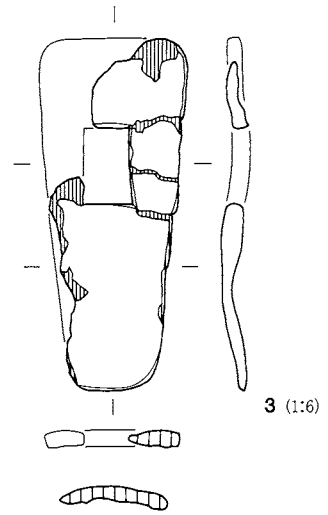
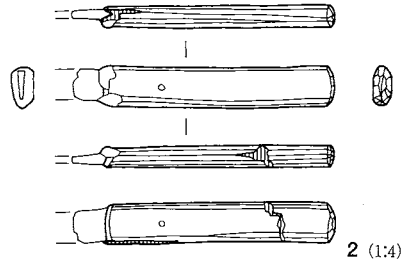
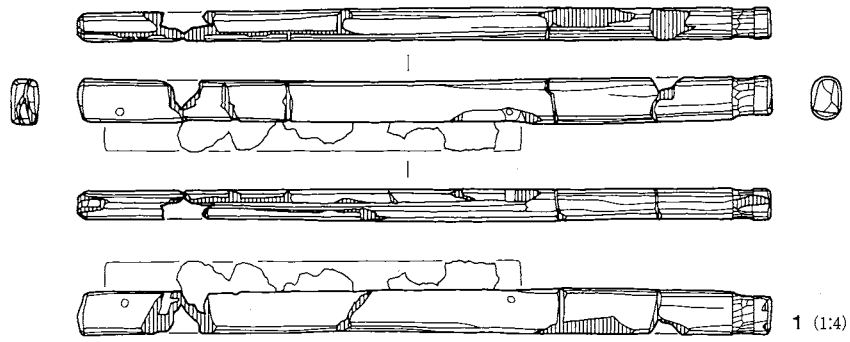

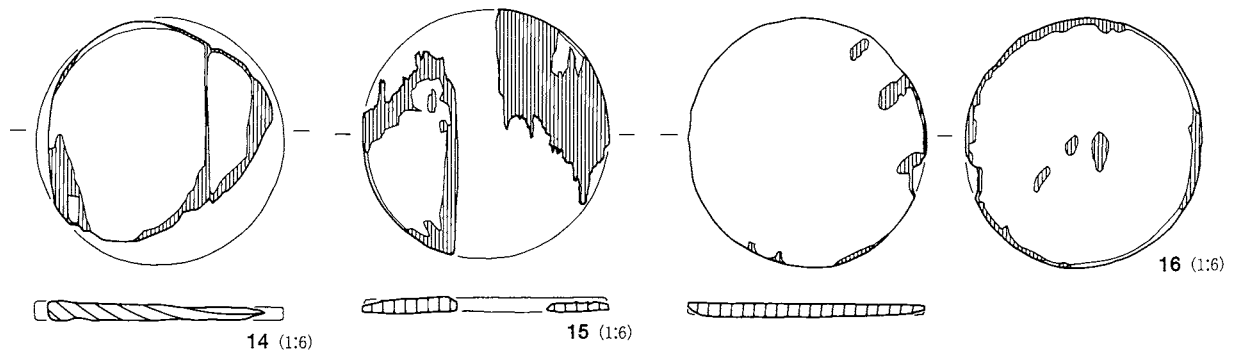
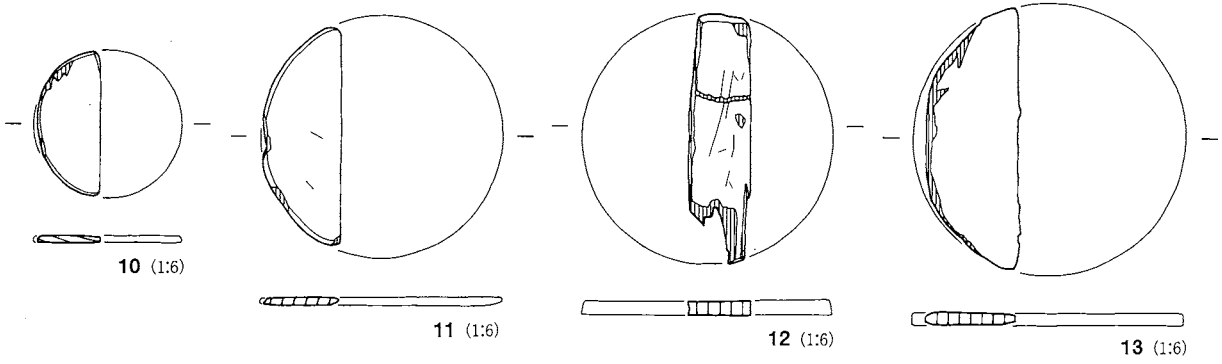
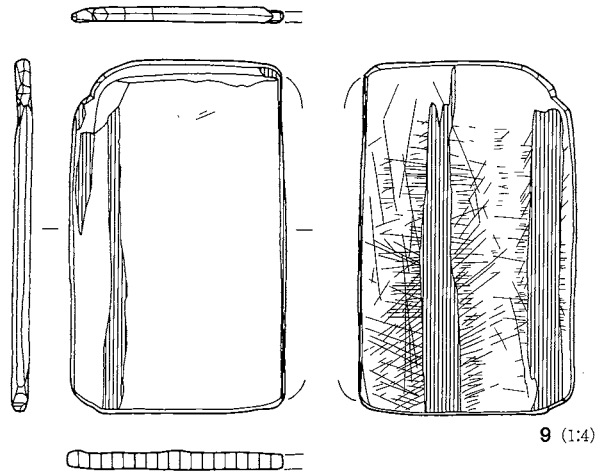
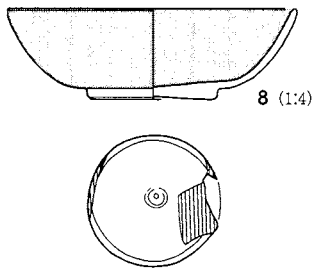
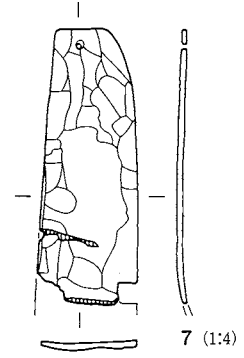
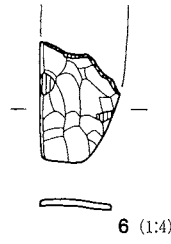
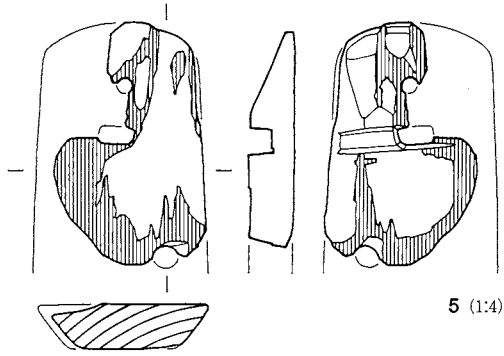

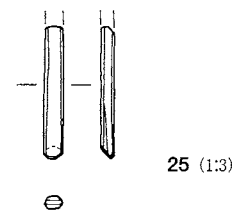
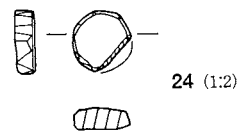
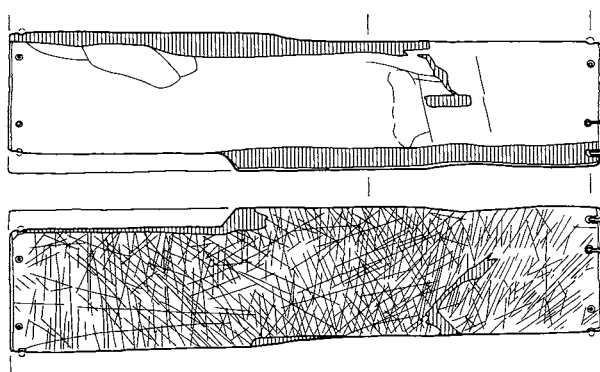
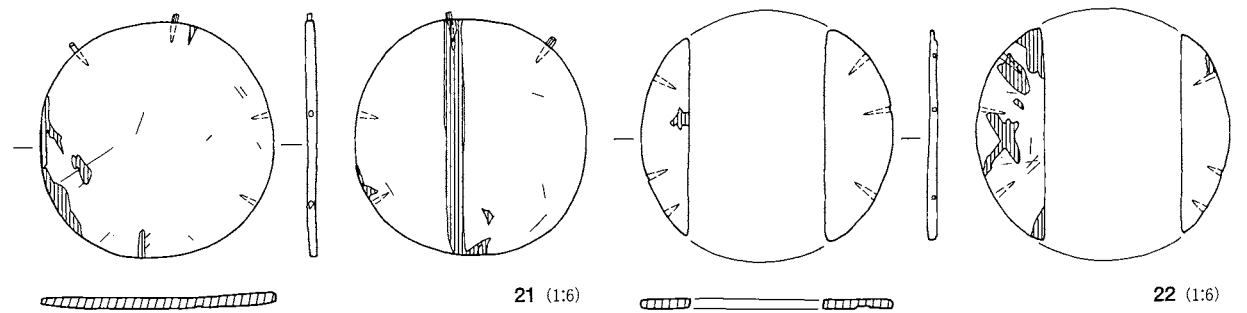
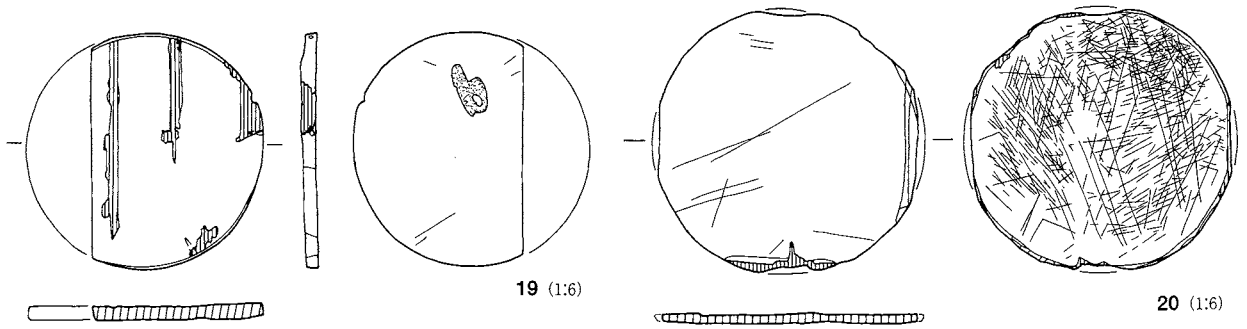
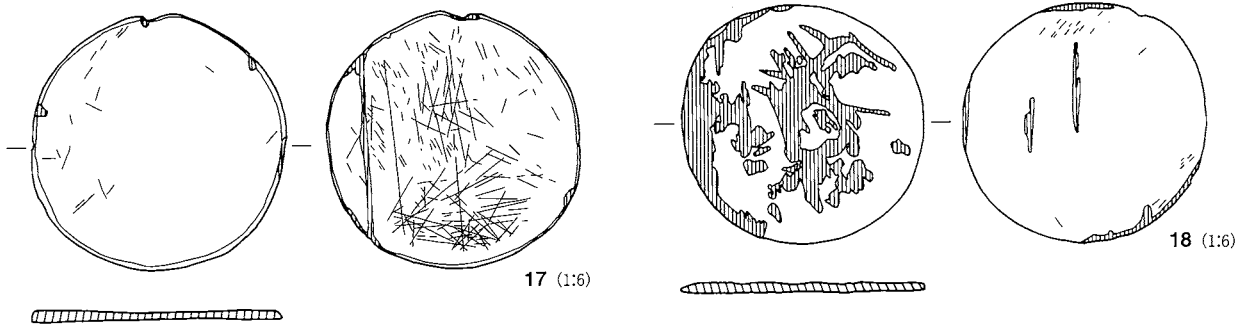

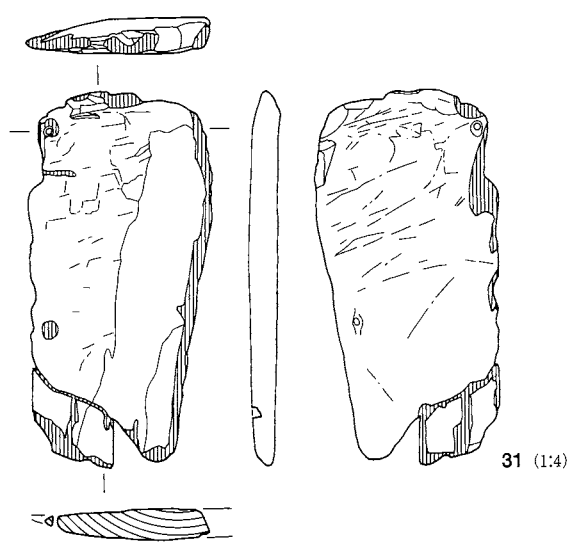
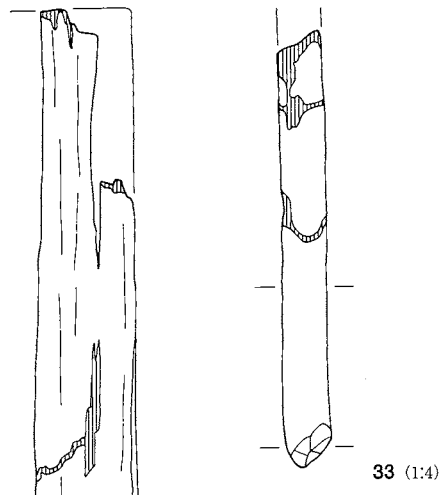
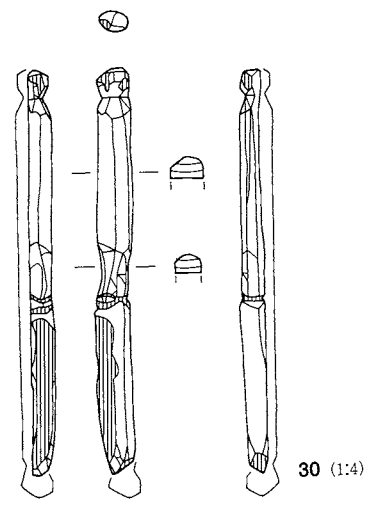
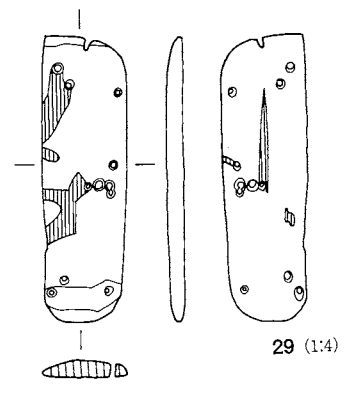
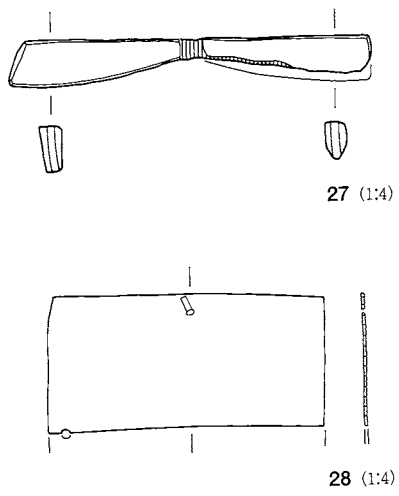
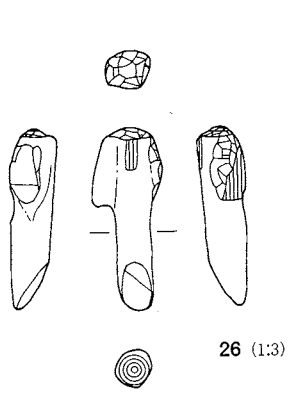

写 真 图 版

遺跡上空空中写真
(昭和40年撮影)





遺跡遠景
(地蔵峠上空より)

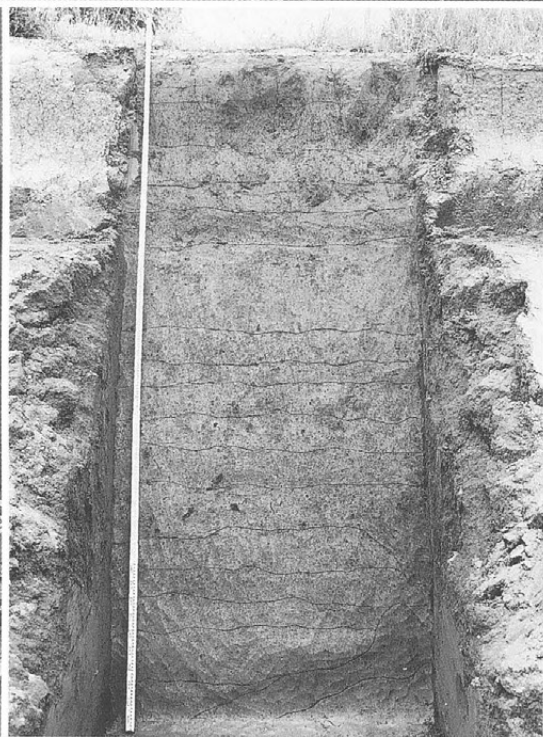

左：遺跡遠景
(長野IC上空より)
右：⑦区基本層序

完掘状況
(斜面下方より)



玄室内床面

2: 床面の小角礫
礫敷き状況

3: 床面下の大角
礫・礫敷き状況
と排水施設天井
部(奥壁側より)

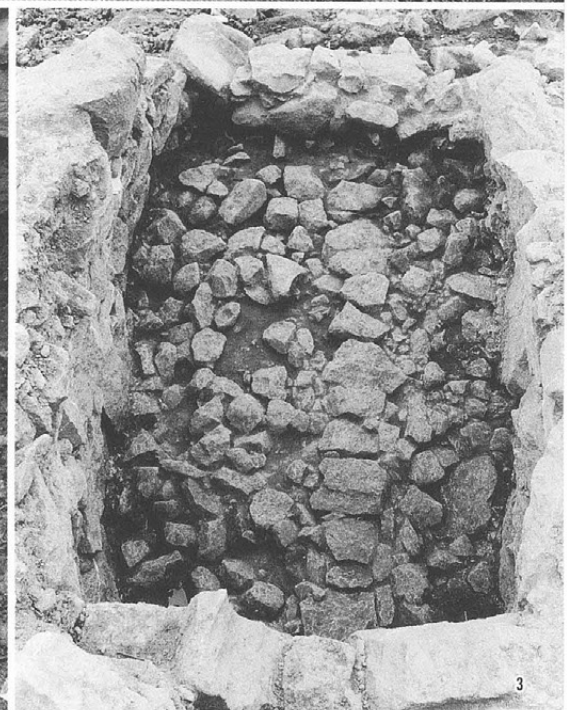

排水施設

4: 框石と羨道部

5: 床面下礫敷き除
去後





6



7

6：玄室左側壁
7：奥壁左コーナーとその裏込め



8



9

8：玄室右側壁
9：奥壁右コーナーとその裏込め

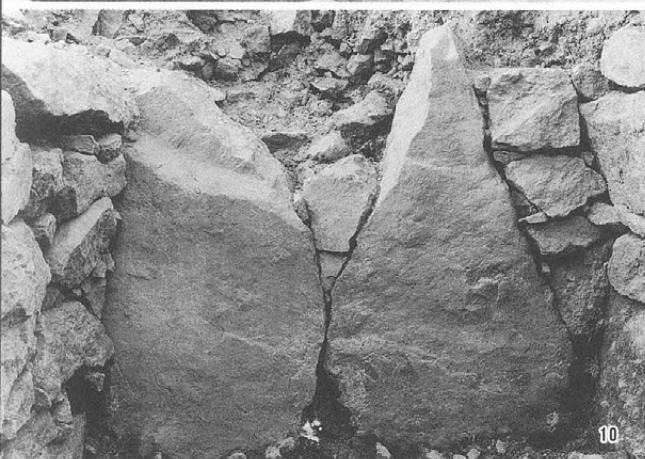

10



11

10：玄室奥壁
11：玄室及びその裏込め状況



12



13

石室構築掘り方
12：石室及びその裏込め状況
13：裏込め除去後の石室と掘り方



14

石室構築掘り方
石室除去後

玄室に直交する墳丘断面
15: 左側壁側
16: 右側壁側



外護列石及び内回りの列石
17: 右側面より
18: 左側面より



外護列石及び内回りの列石
(墳丘背面より)
19: 左側
20: 右側



21: 石室裏込めと内
内回りの列石
22: 高杯
出土状況



須恵器大甕出土状況
23: 口縁部出土状況
24: 口縁部除去後

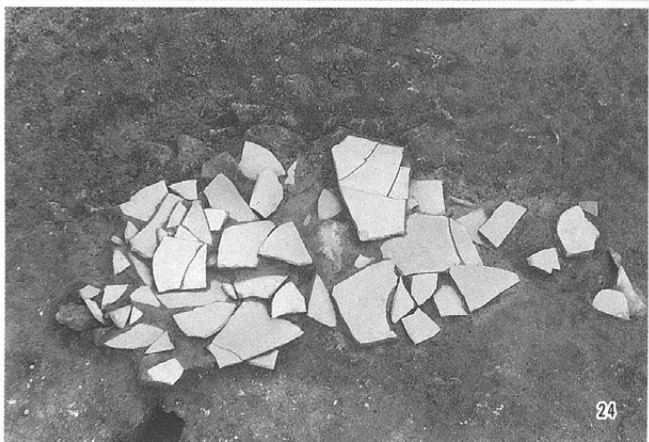



25



26

松原 2号墳
排水施設残存状況



27



28

松原 3号墳 玄室
奥壁残存状況



29

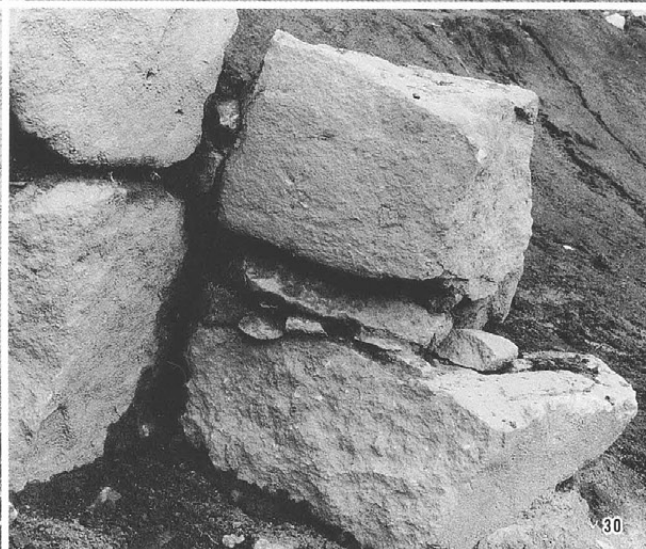

30

松原 3号墳 玄室
奥壁及び側壁
29：左コーナー
30：右コーナー



31



32

松原 3号墳
31：石室構築掘り方
32：玄室内床面鉄刀
出土状況

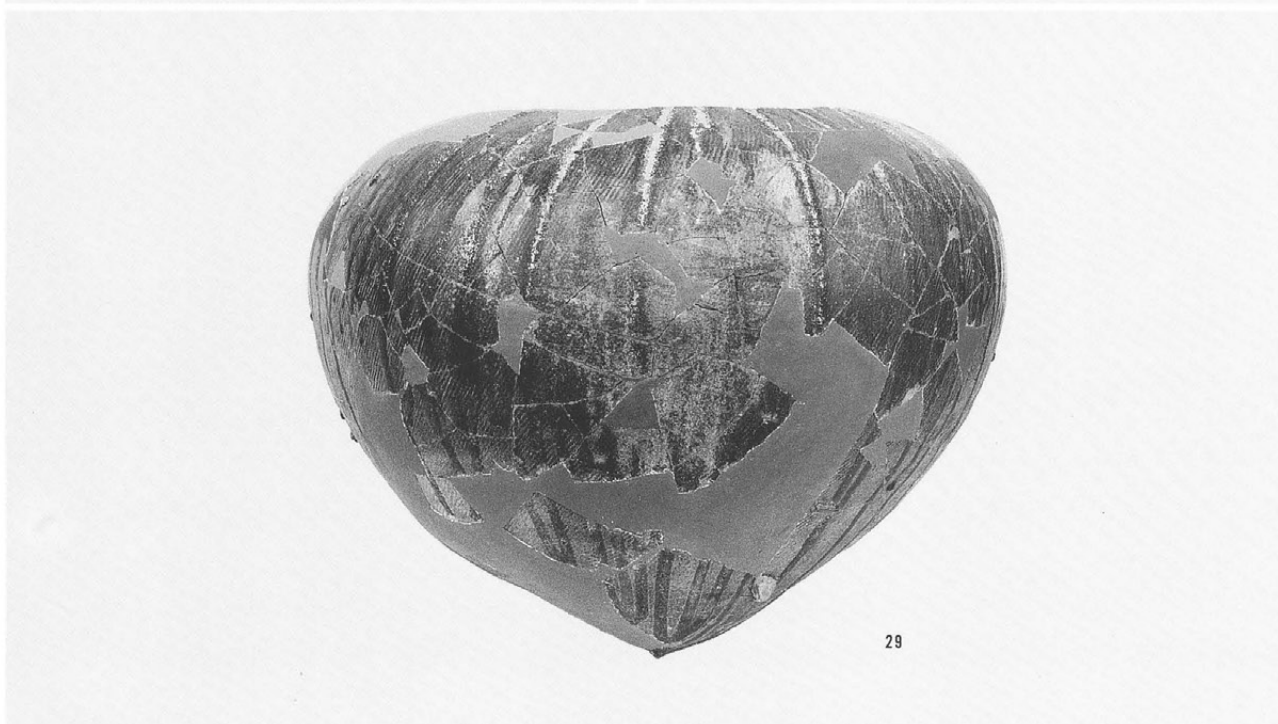
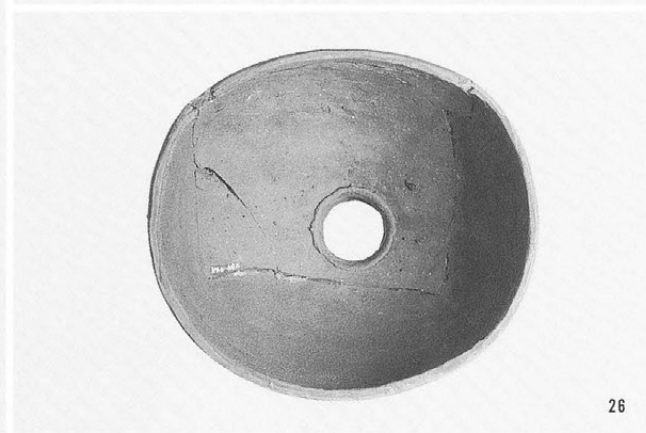



左：直刀
右上：刀装具
右中：鉄鏃
右下：両頭金具

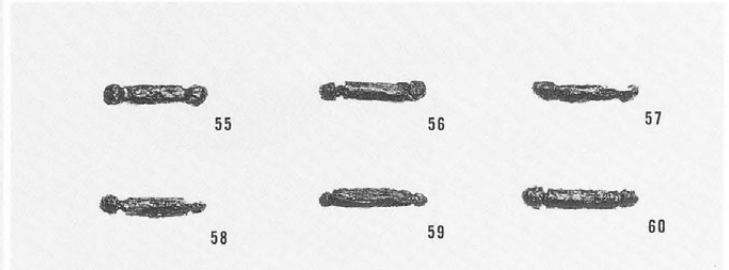
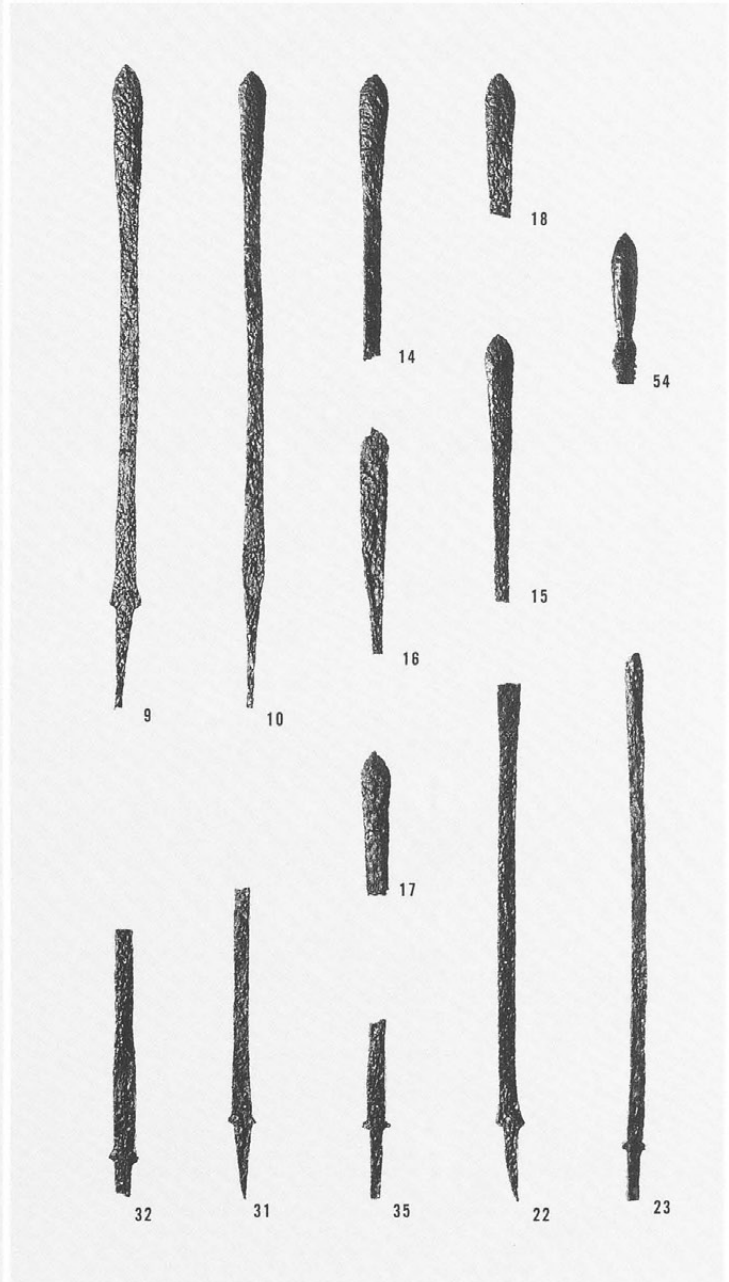
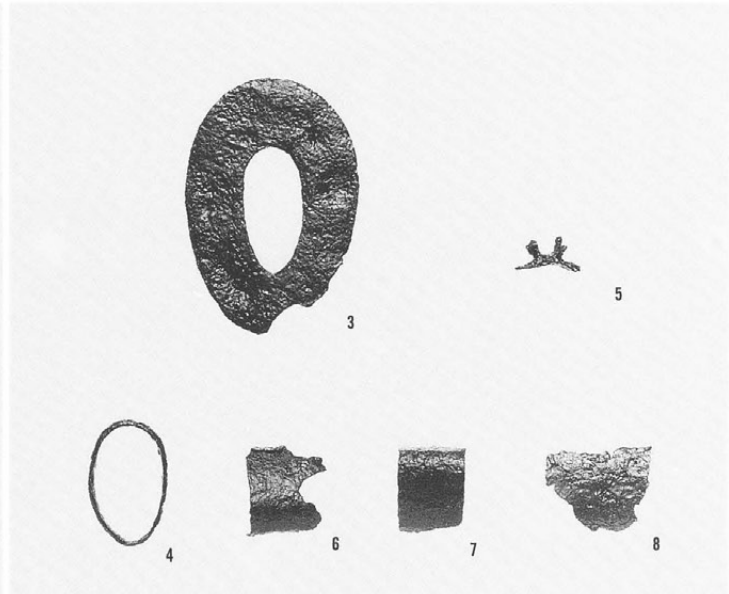
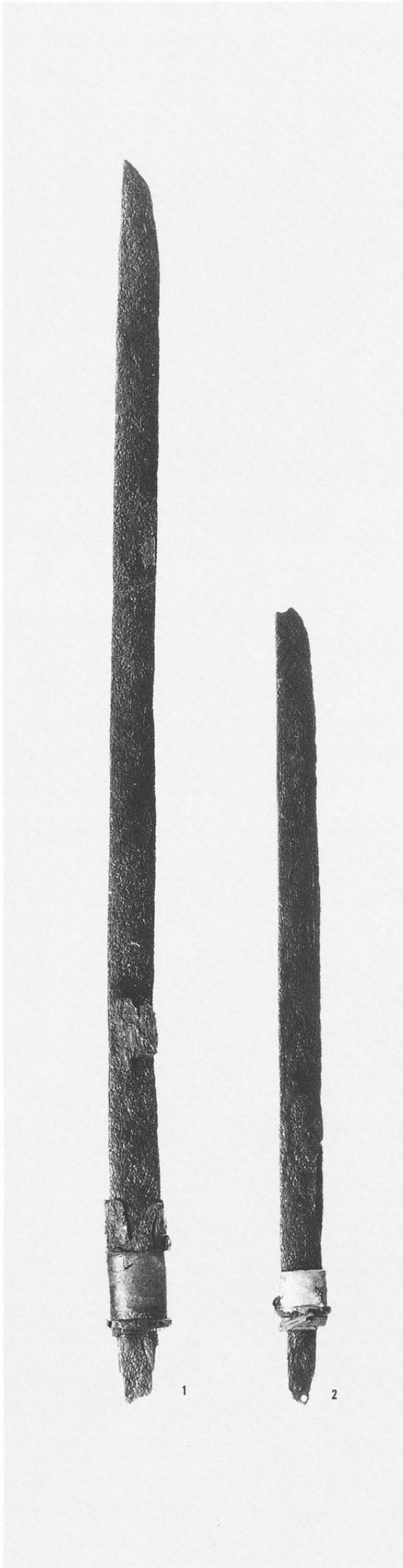

素環鏡板付轡

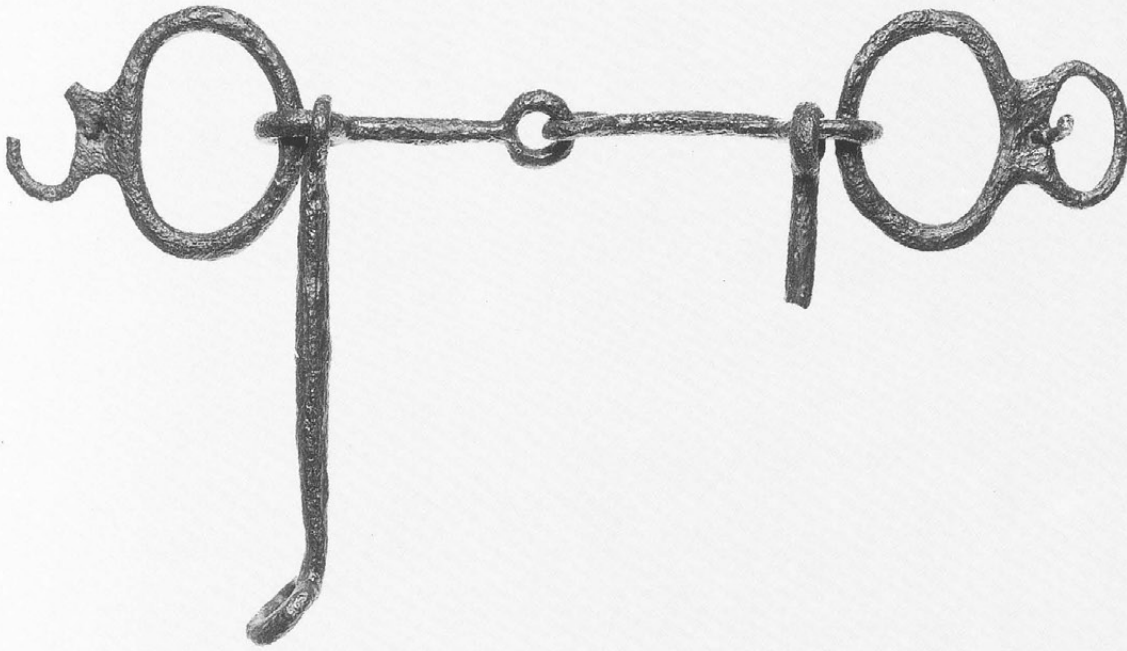

61

素環鏡板付轡

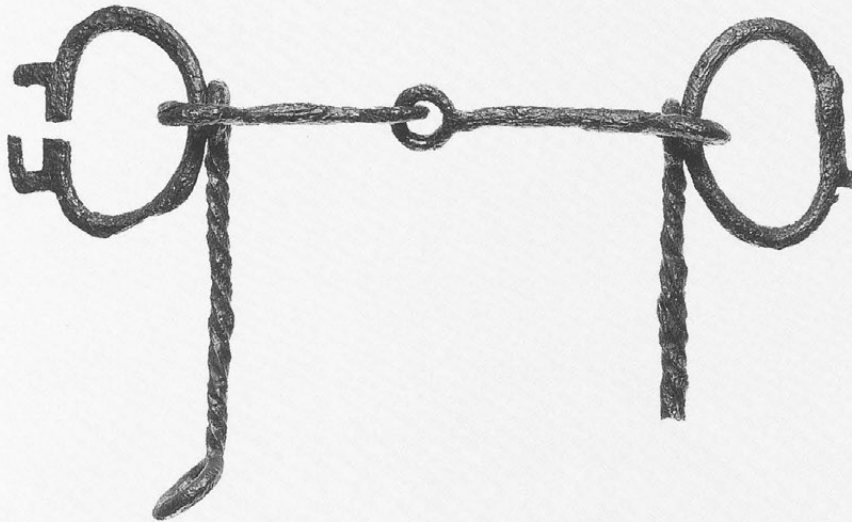

62

金銅製鞍金具



64

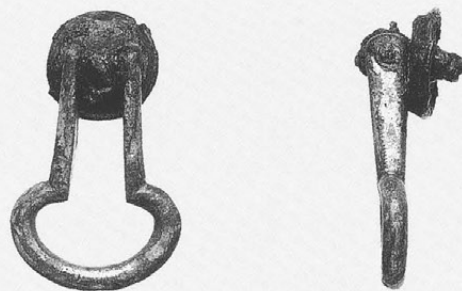

65

金銅製飾金具

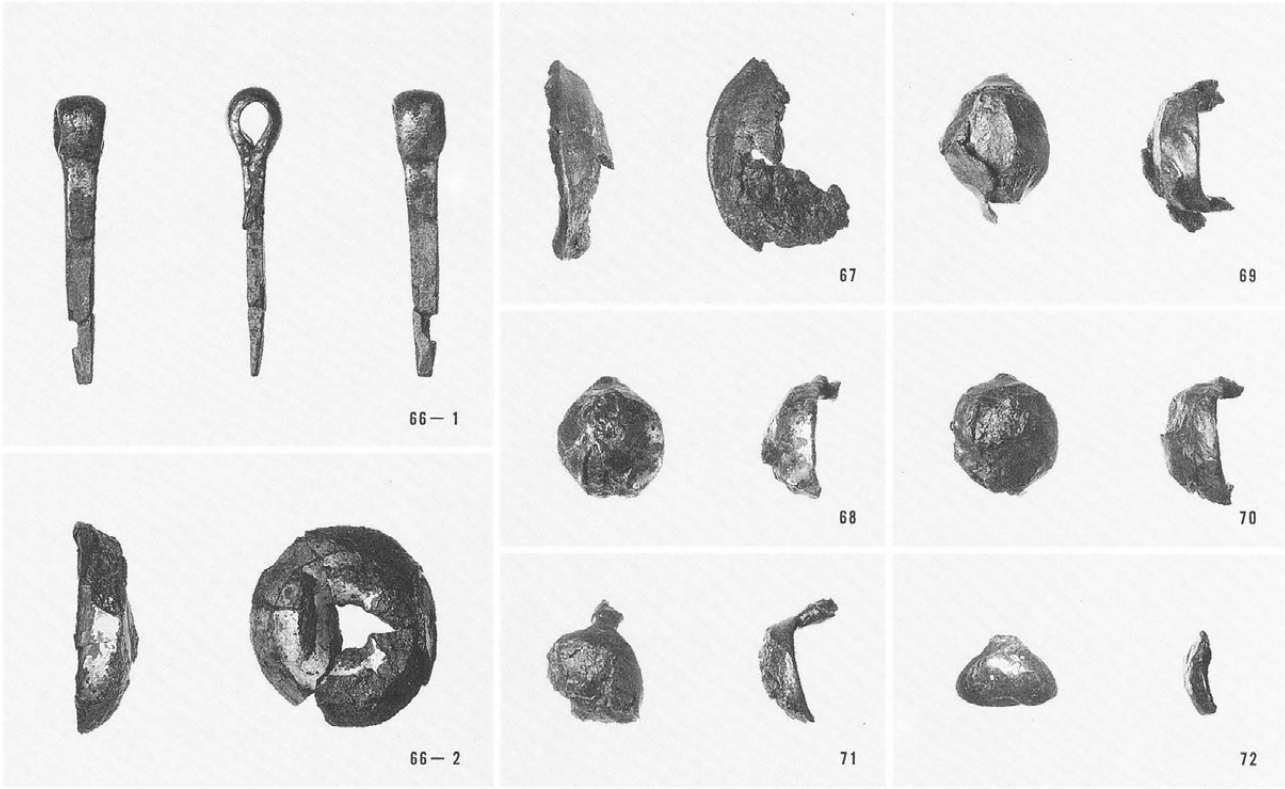

釘等鉄製品

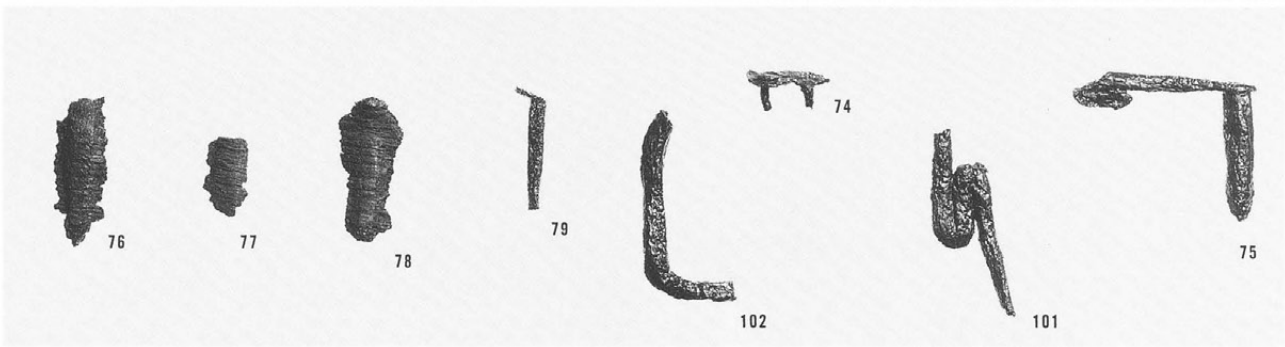

鉄釧



耳環

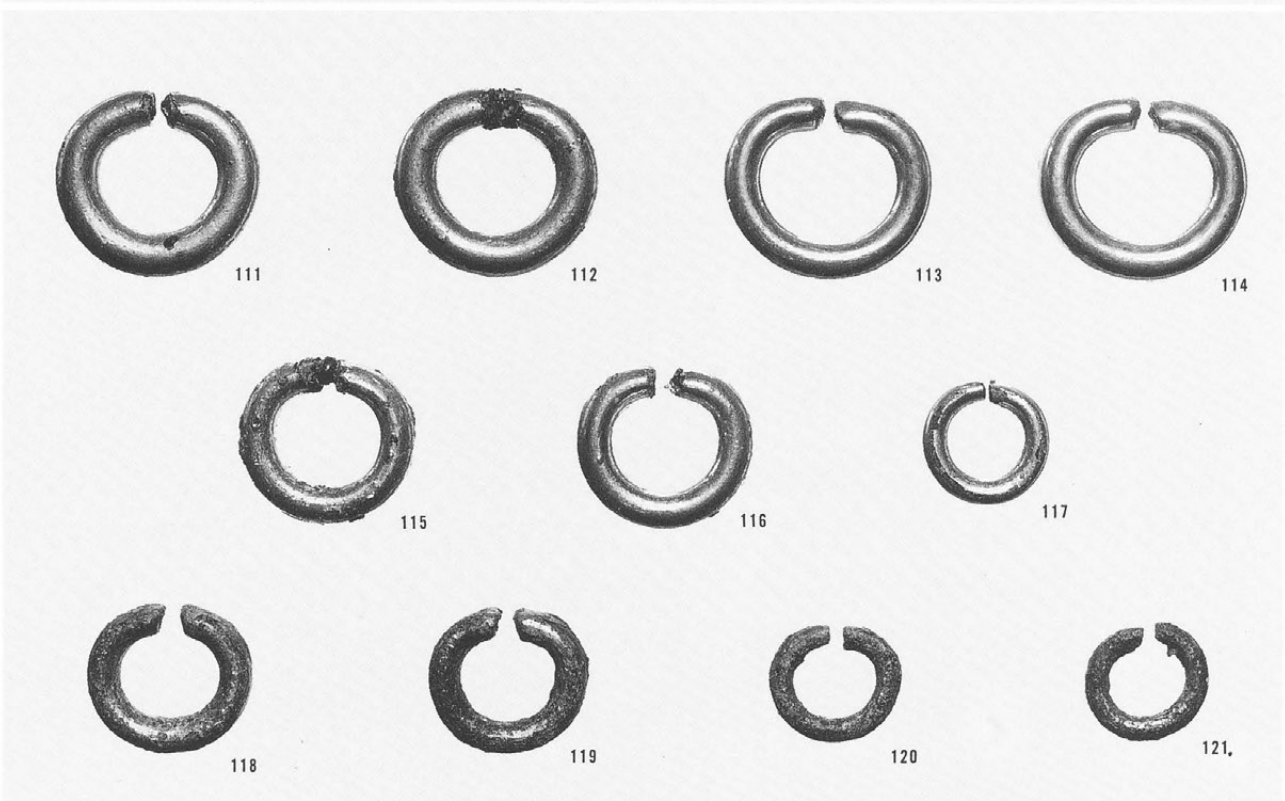

勾玉・平玉・管玉

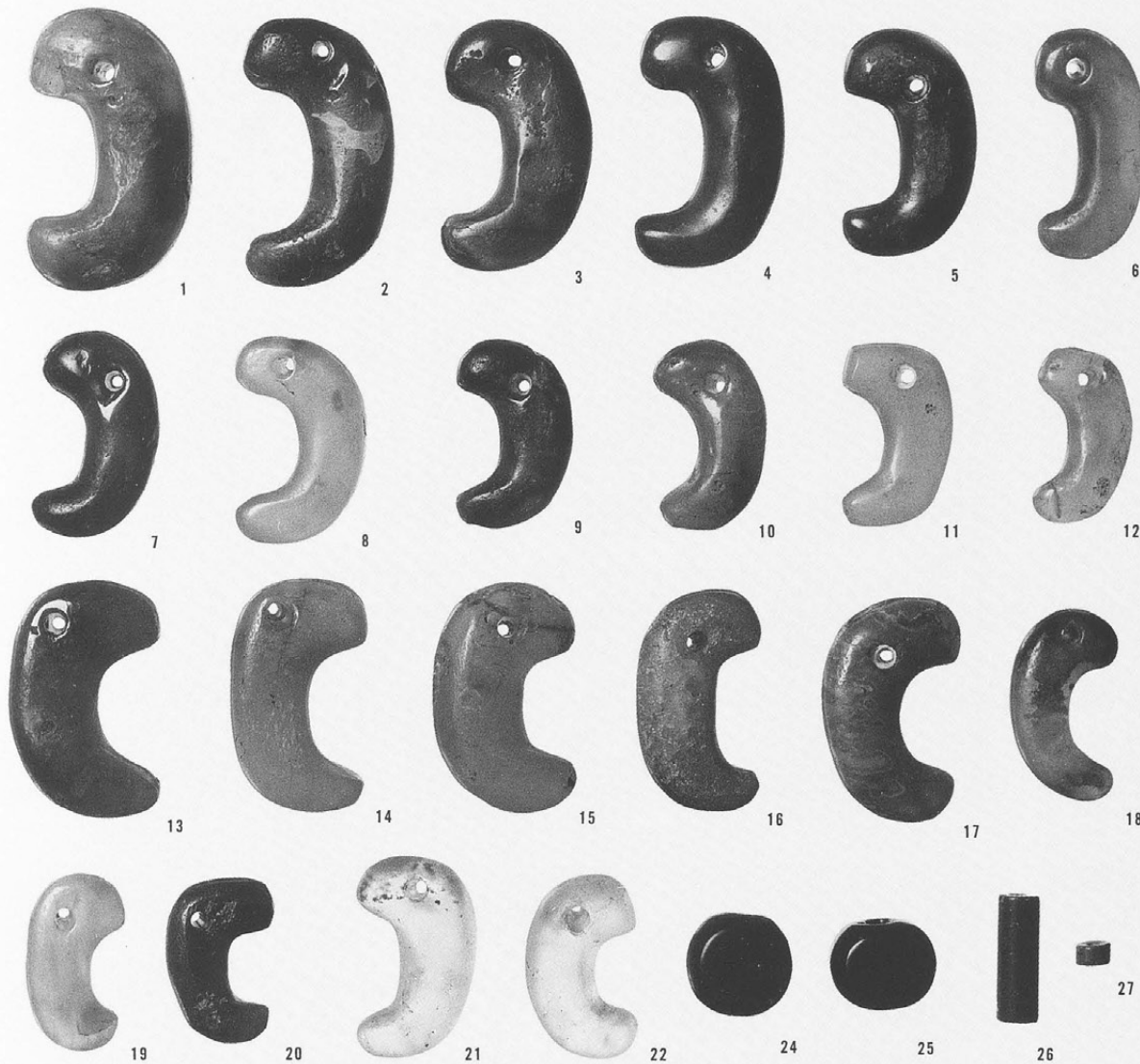

石製丸玉とガラス玉類

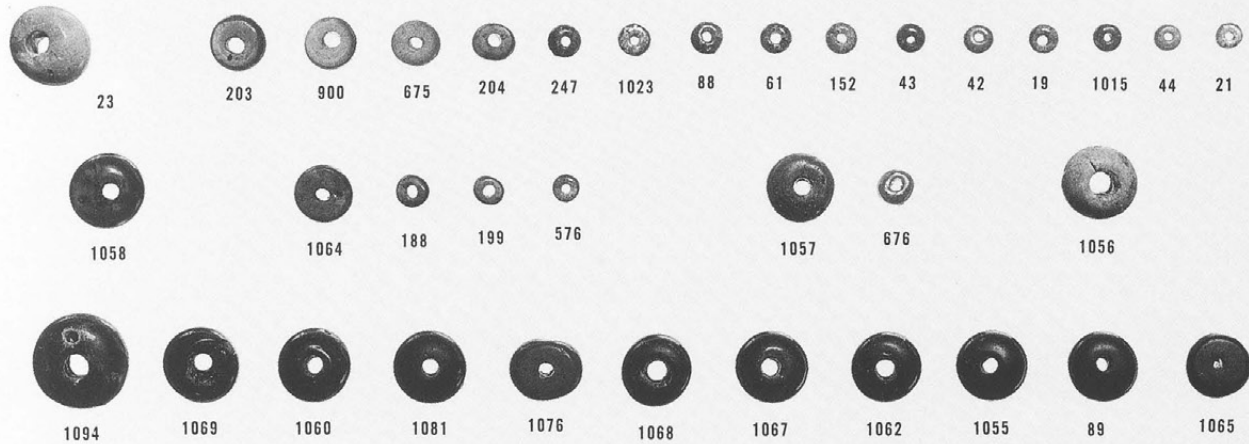

2・3 号墳出土金属製品

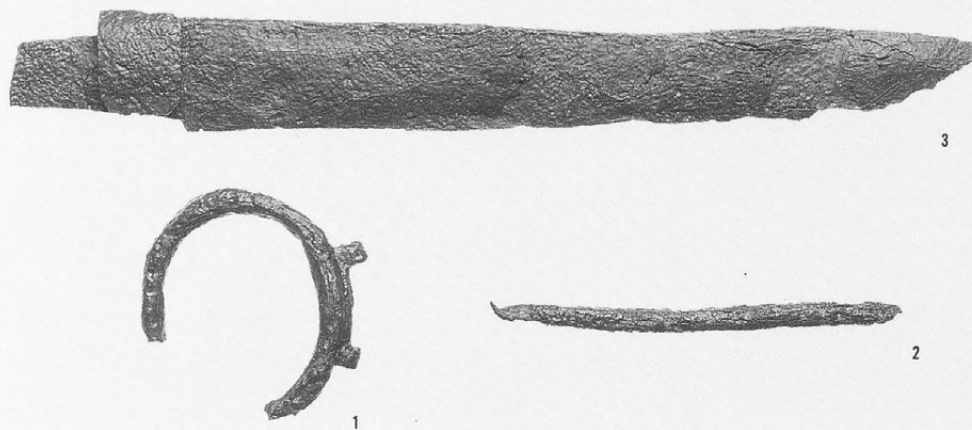

SB 6

左：完掘
右：鍛冶炉



SB41

左：完掘
右：カマド

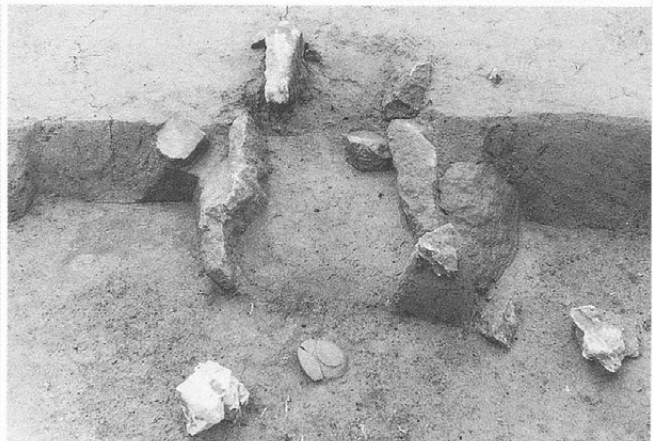
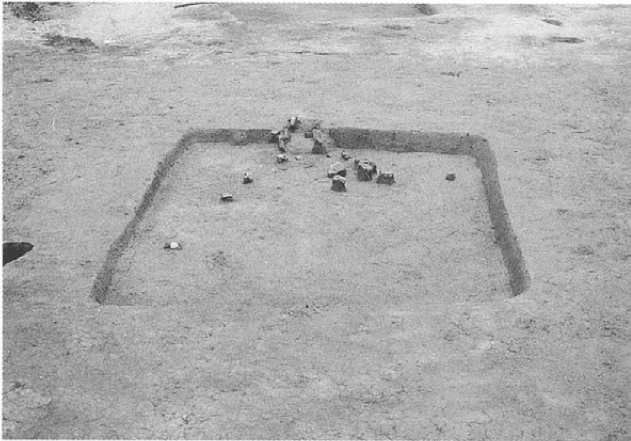

SB52カマド

左：石組み
右：天井石除去後

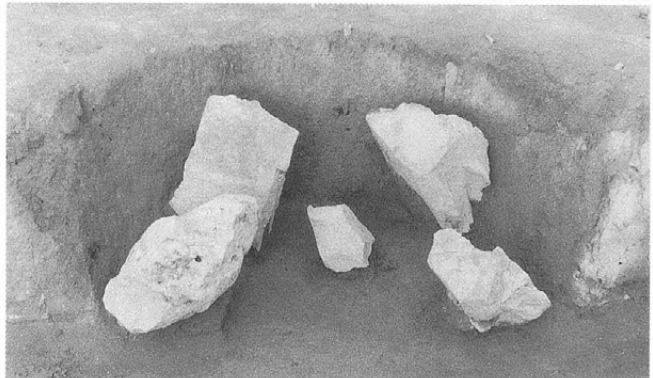

SB56カマド

左：燃焼部より
右：煙道部より



左：SB56カマド脇
遺物出土状況

右：SB58
遺物出土状況





左：SB59・87
遺物出土状況
右：SB76
遺物出土状況



SB80
左：全景
右：P5・6 鑄型等
出土状況

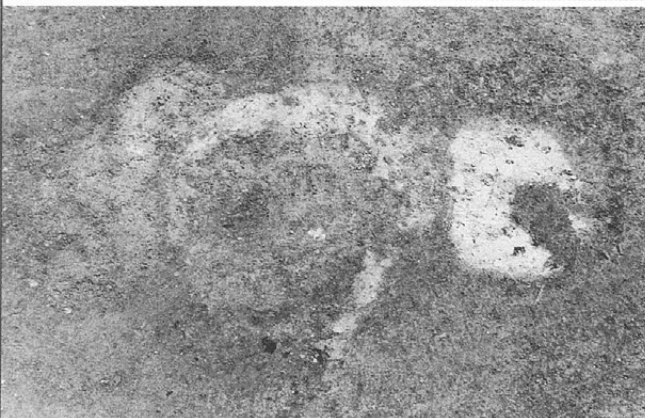

左：P7～9 検出状況
右：P7～9 断面

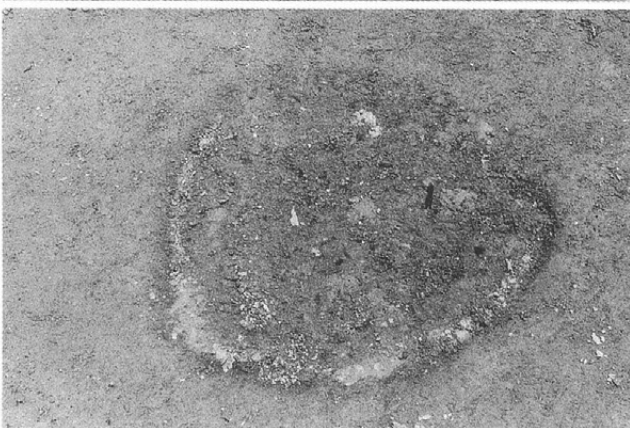

左：P7～9 完掘
右：P1 検出状況



SB81
左：完掘
右：床面中央鍛冶炉

左：SB92
遺物出土状況
右：SB98完掘



SB100カマド
左：遺物出土状況
右：完掘

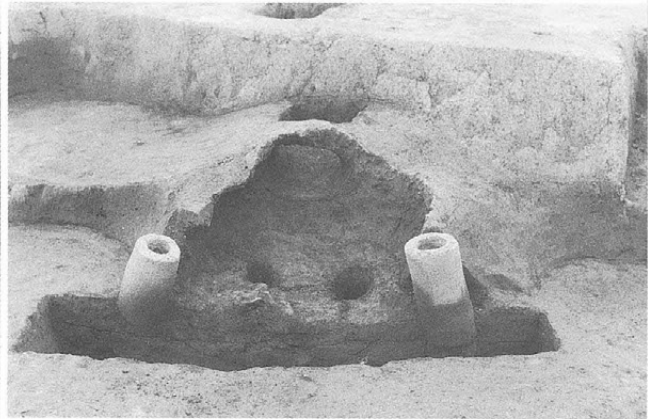

左：SB101カマド
遺物出土状況
右：SB104紡錘車
出土状況



左：SB105・106等
住居址重複状況
右：SB109
遺物出土状況



左：SB114カマド
遺物出土状況
右：SB150完掘

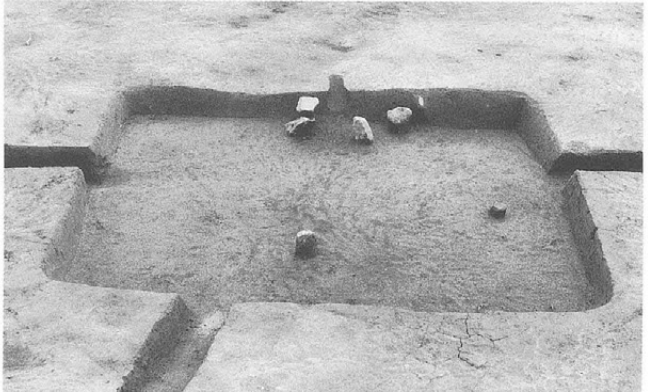



左：SB192カマド
右：SB198カマドとSK47



左：SB327カマド
右：SB335内鍛冶炉

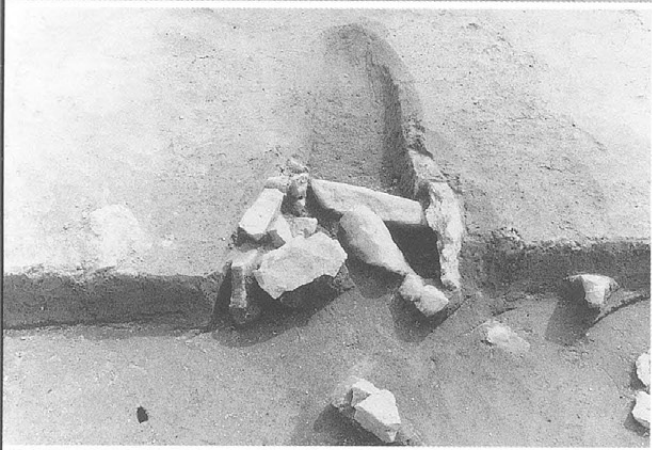

左：SB345カマド
右：SB1006完掘



SB1017
左：完掘
右：カマド遺物出土状況

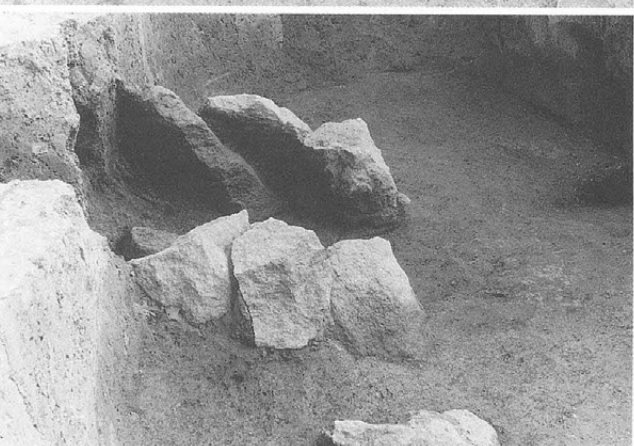

SB1024カマド
左：燃焼部側より
右：左側より

左：SB1038
遺物出土状況
右：SB1043完掘

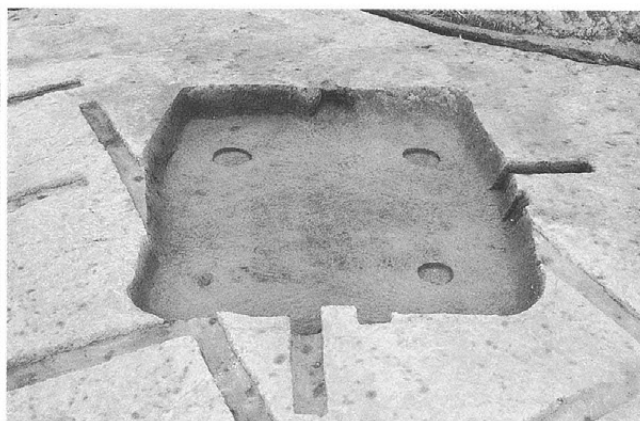

SB1046
左：完掘
右：石帯出土状況

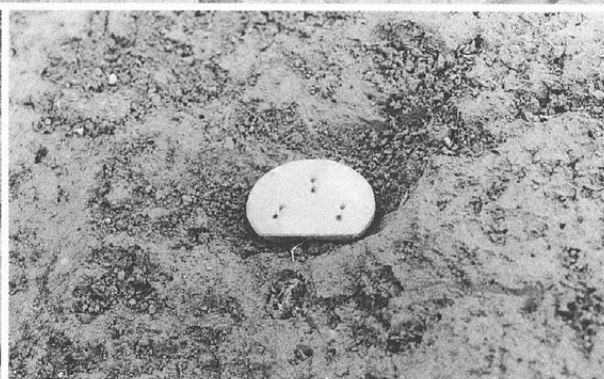

SB1046
左：カマド脇遺物
出土状況
右：東壁際遺物出
土状況



左：SB1066
カマド
右：SB1072
獣骨出土状況

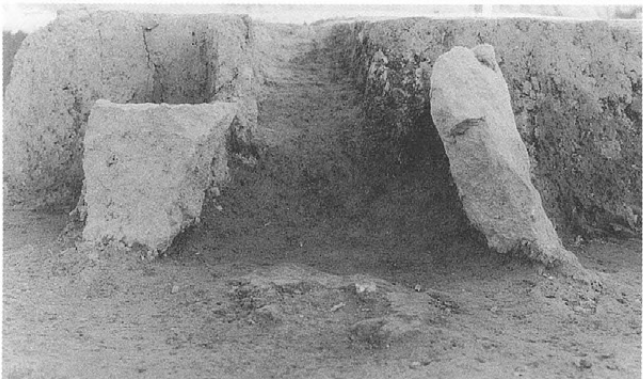

左：SB1085
完掘
右：SB1097
完掘



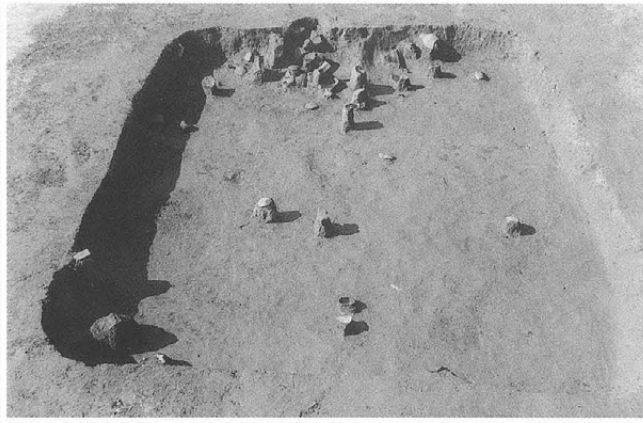

左：SB1100
遺物出土状況
右：SB1201
遺物出土状況



SB1207
左：炭化物等出土状況
右：鉄釘出土状況

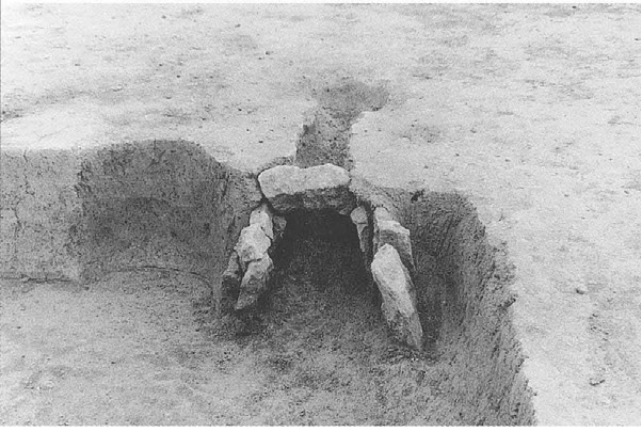

左：SB1208カマド
右：SB1222カマド



左：SB1223カマド
右：SB1226カマド
遺物出土状況



掘立柱建物址
左：ST1001・1002
右：ST1003