

443~450
SK2159



443



446



448



444



445



447

SK2172



449

SK2179



450

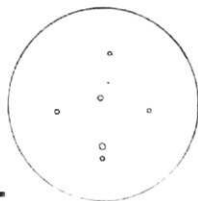

452~460

SD2201

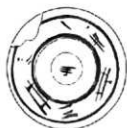

SD3201

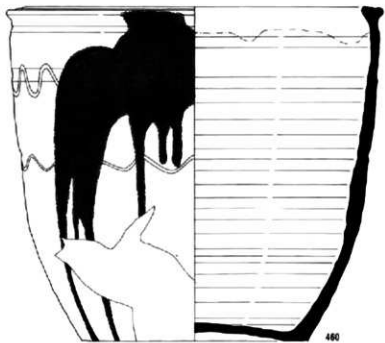

461~478
SD332/2

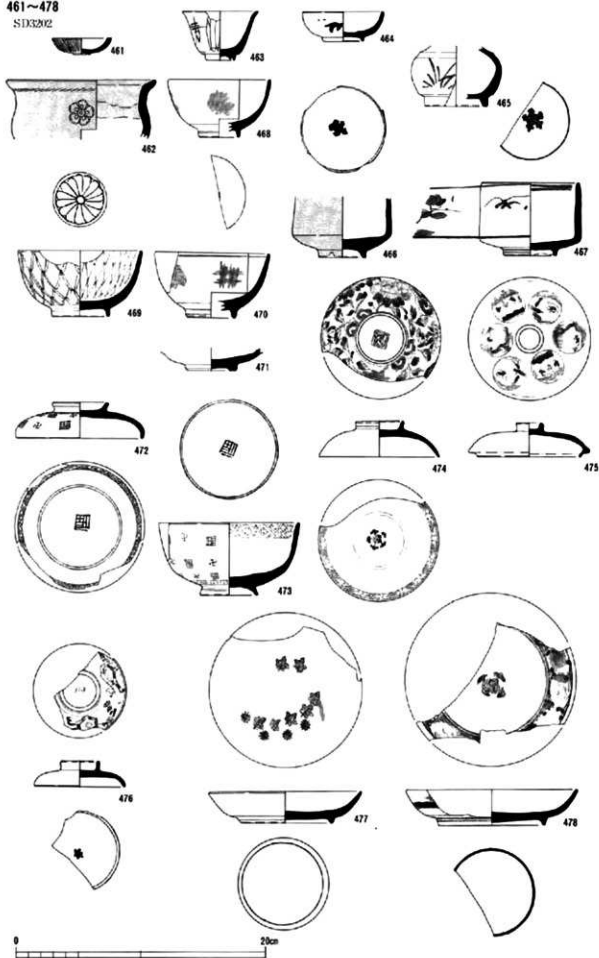

SD3202

479~497

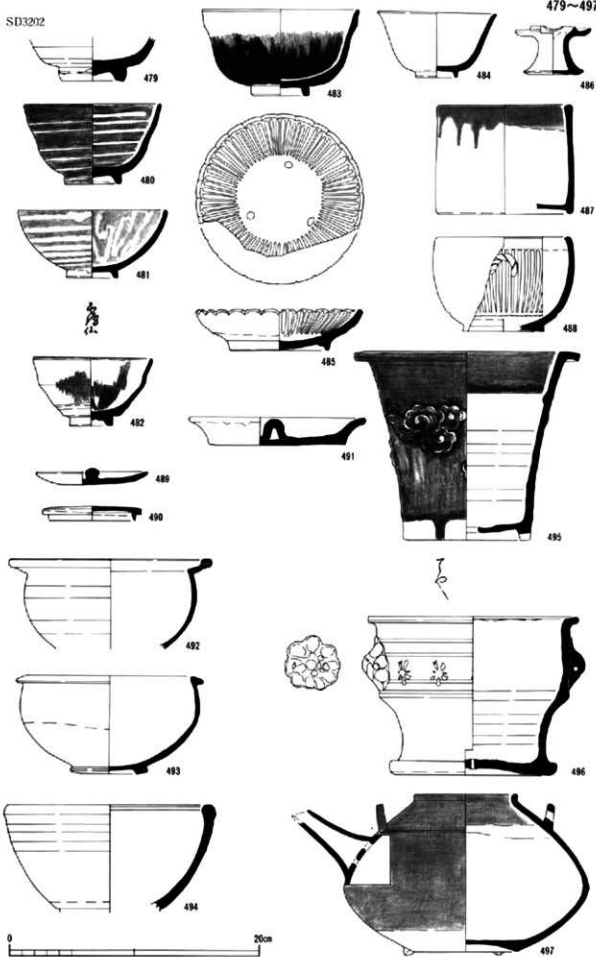

498~504
SD3202

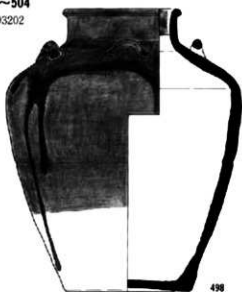

498

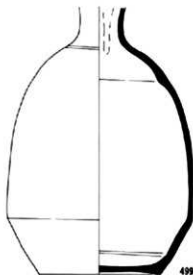

499

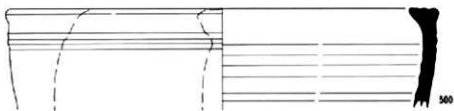

500



501



502



503



504

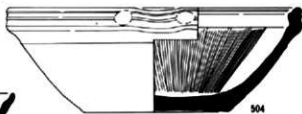

20cm

SD3202

505~514

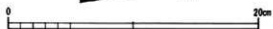
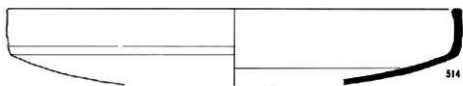
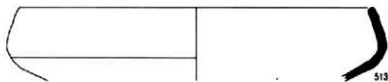
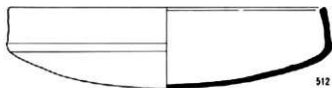
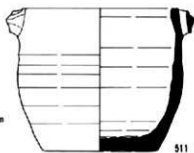
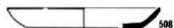
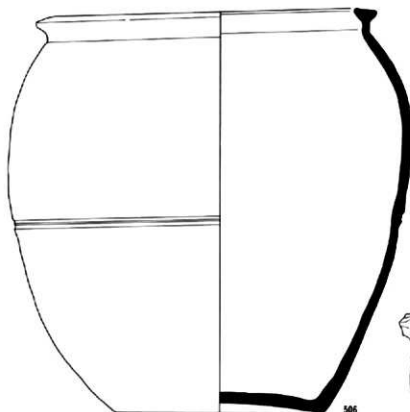
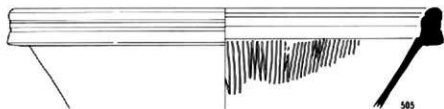

515~530

SK3208



515



516



517



518



519



520

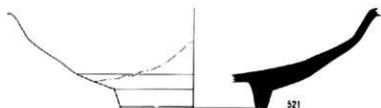

521



522

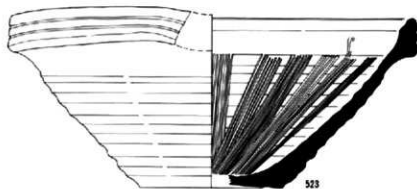

523



524



527



529

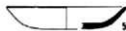

525

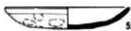

528



530



526

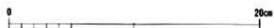

20cm

SG3201

531~552

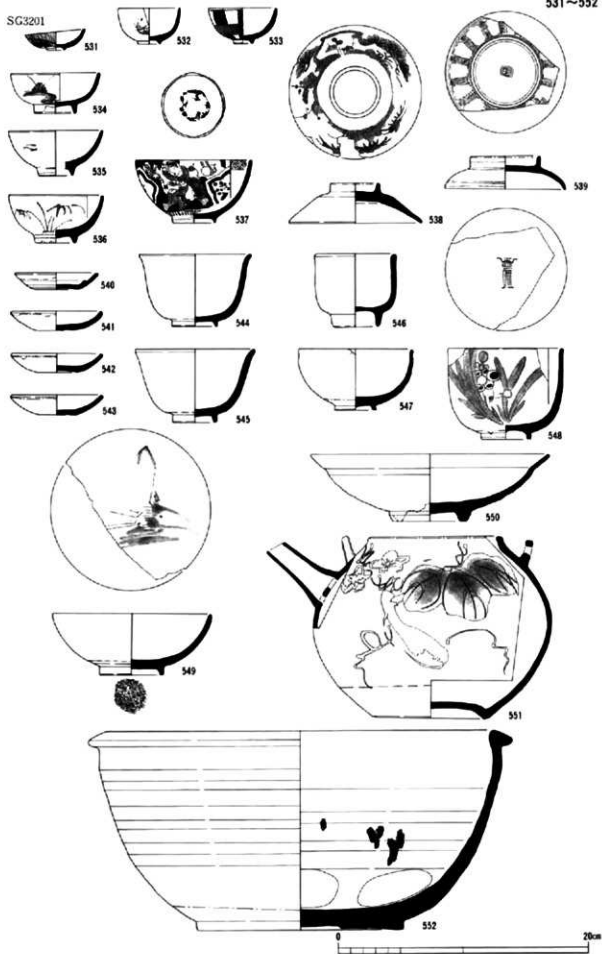

553~556

SG3201

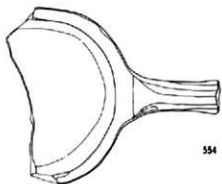
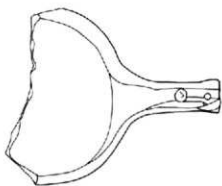
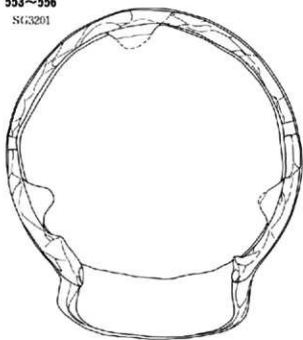

554

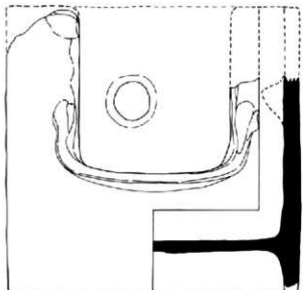

553

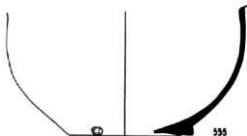

555

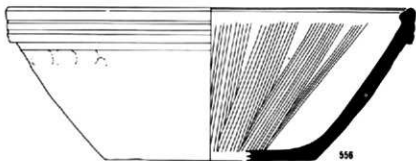

556



SG3201



557



558



559



560



561

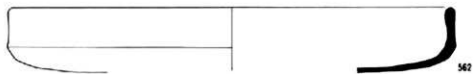

562

SX4002



563

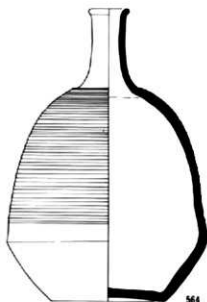

564

SK3201

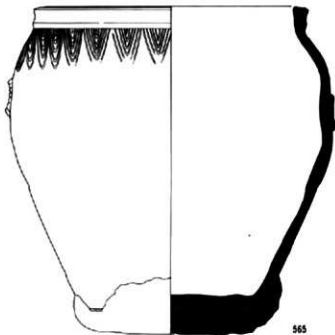

565

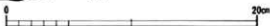

556~581

SD2321

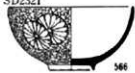

566

圖



567



568

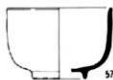

570



569

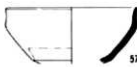

571

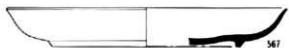

567



567



574



572



575



572



573



576

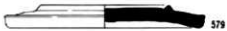

579



577

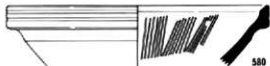

580



578



581



582~590

SD2321

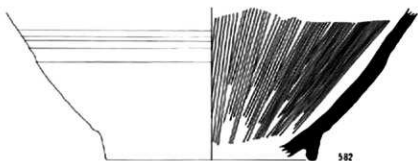

582



583

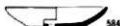

584



585

SD2301



586

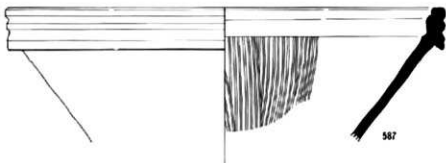

587

SD2304



588



589

SD2303



590

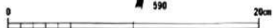

591~606

SD2310



591

※



593

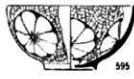

595



598



592



594



596



599



597



600

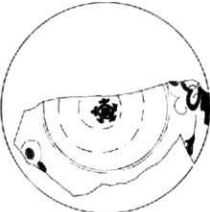
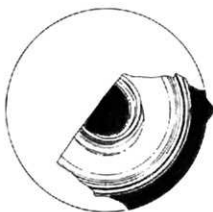

601



604



603



602



605

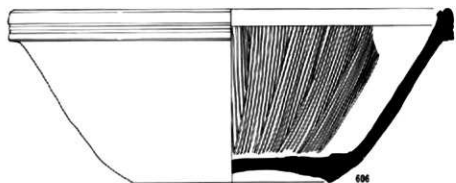

606

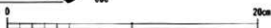

SD2310

607~613

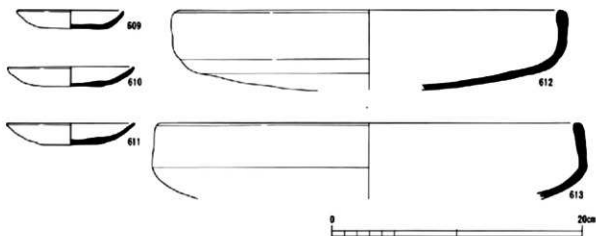
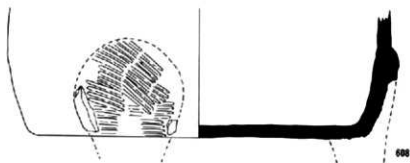
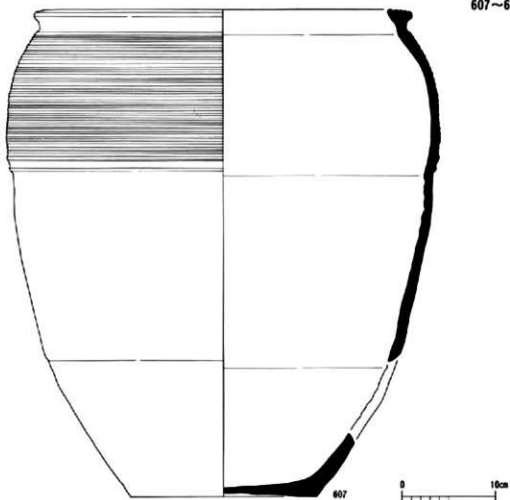

614~619
SD2305

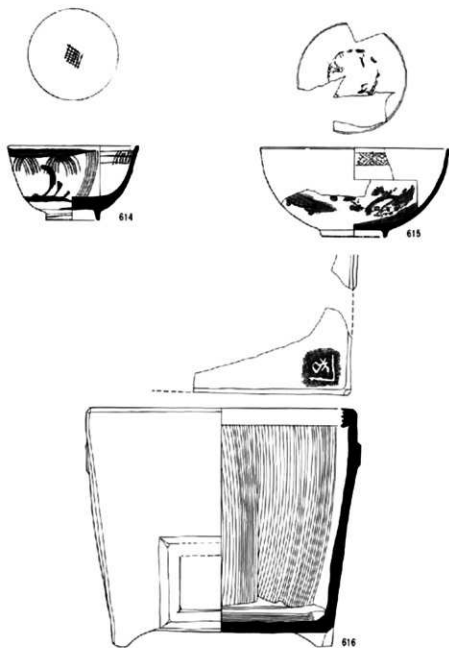

SD2306



SK2315

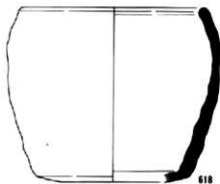

SD2403



620



621

622~642

SD2401



622

SD2402



624



SD2404



625



626



628



629



630

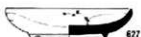

627



631



633

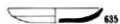

635



632



636



634



637

SK2417



638



639



640



641



642

20cm

643~665

SD3501

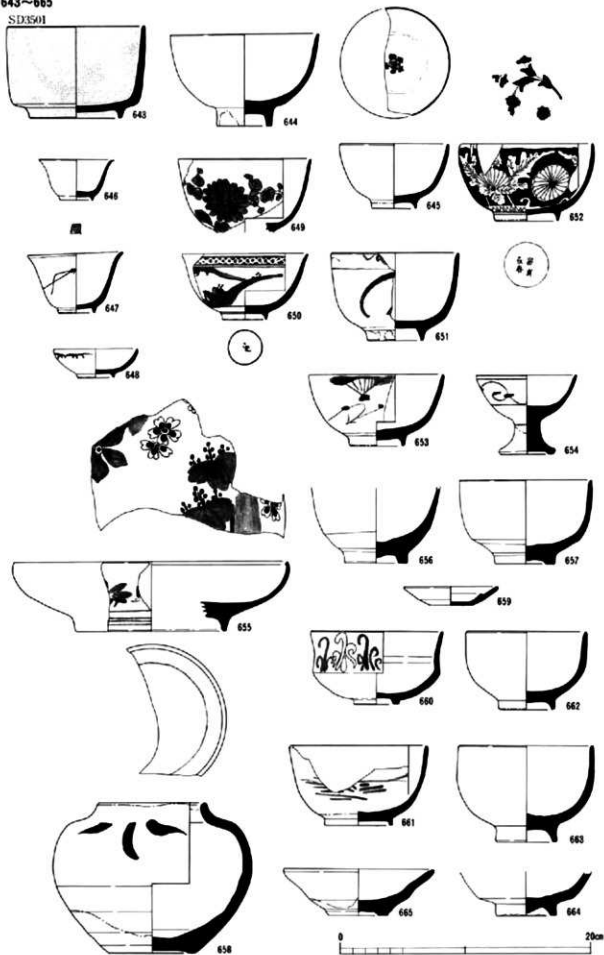

SD3501

666~670



671~673
SD3501

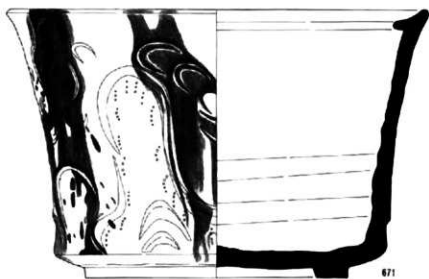

671

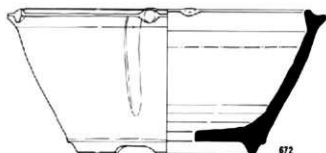

672

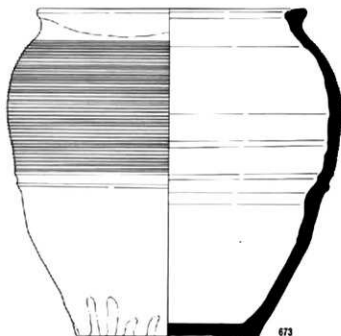

673



SD3601

674~678

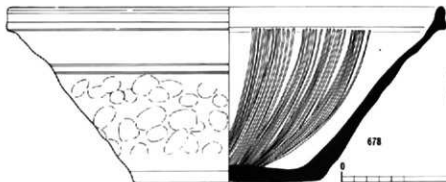
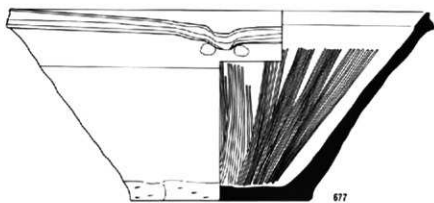
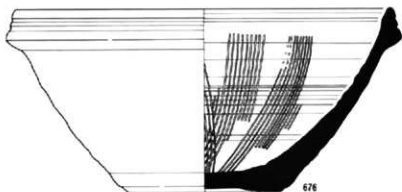
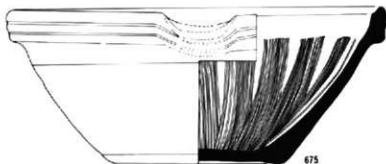
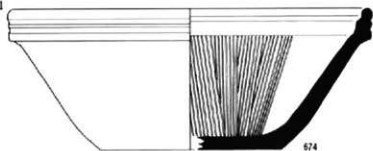

0 20cm

679~704

SD3501

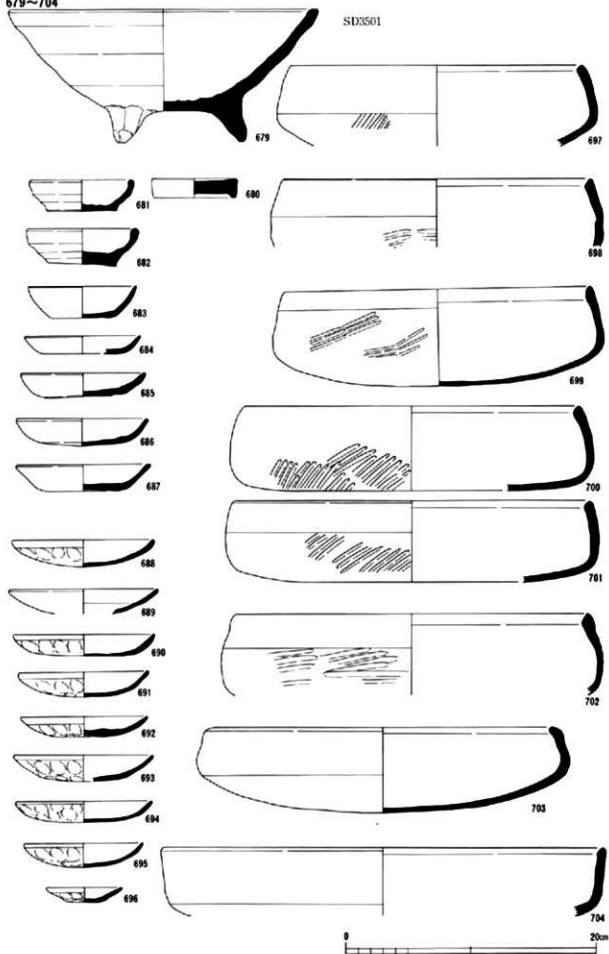

SD2501

705~714

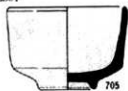

705

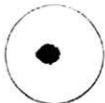

706

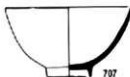

707

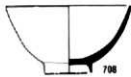

708



709



711



710



712



713



714



715~719

SD2501

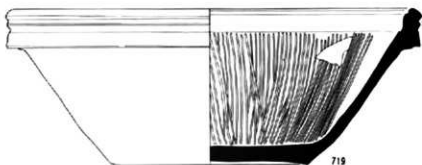
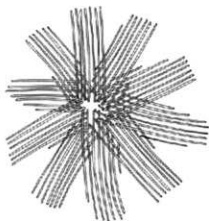
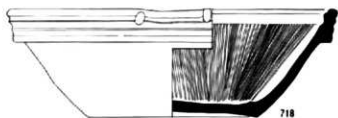
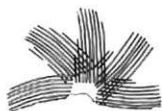
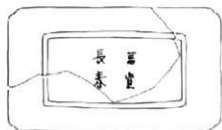
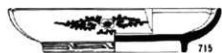
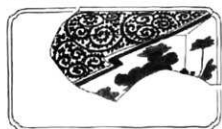

720~728

SD2502

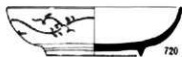
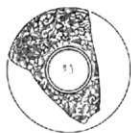

721

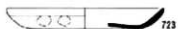
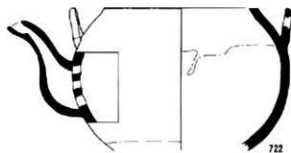
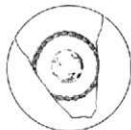

723

722

SD2503



724

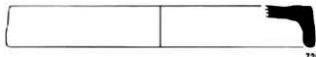

725

SF2501



726



727

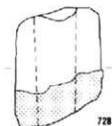

728

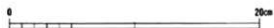

729~743

SK2501

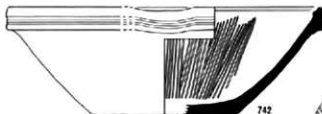
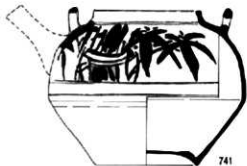
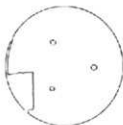
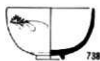

20cm

743

SK2501

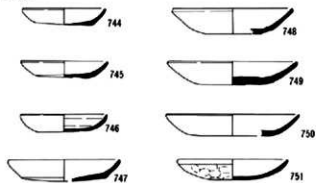

744~760

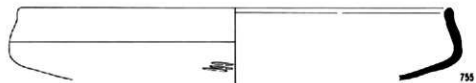
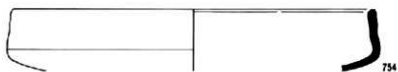
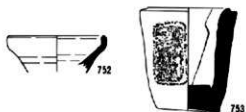

SG3501



SD2506



761~767
SK2503

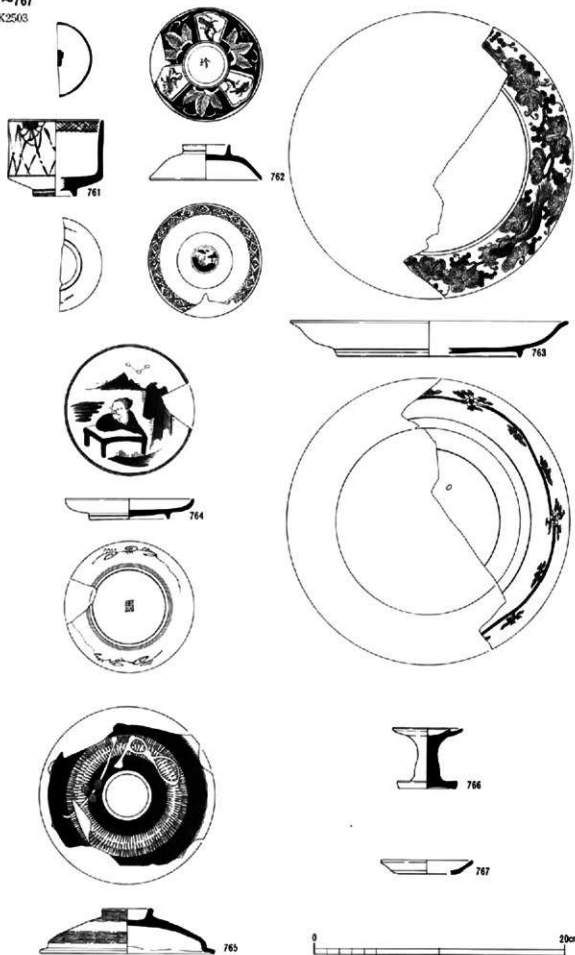

SK2502

768~796

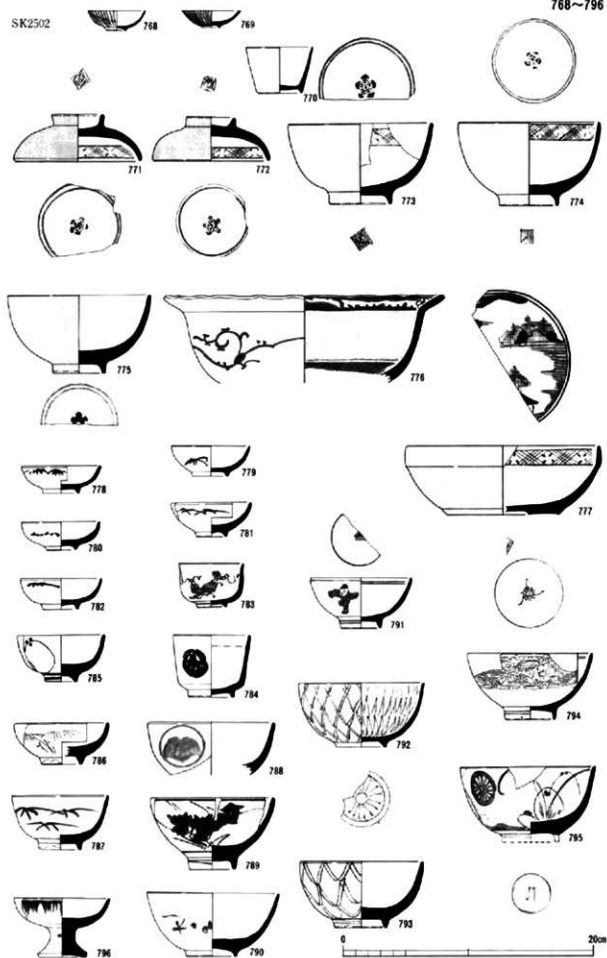

797~809

SK2502

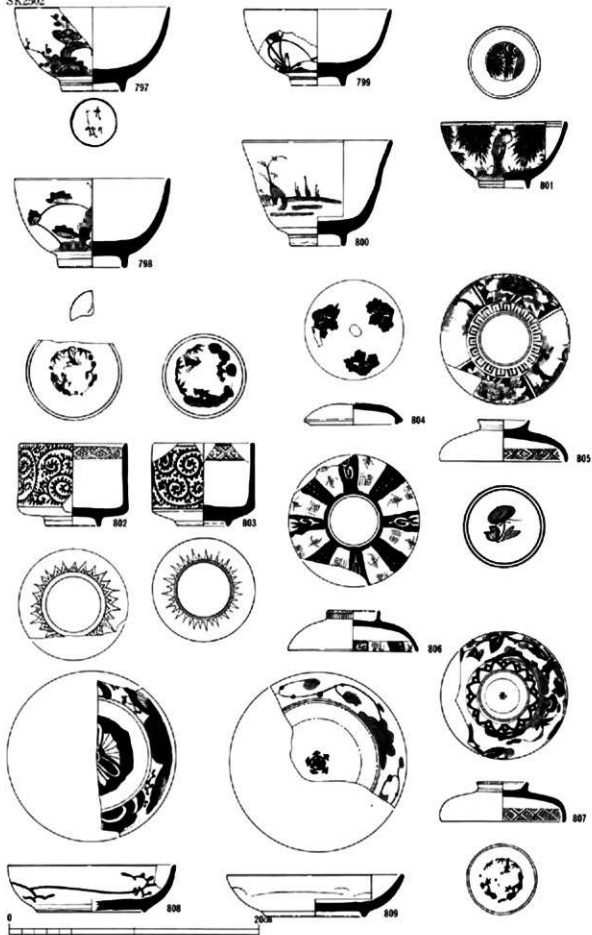

810~823

SK2502

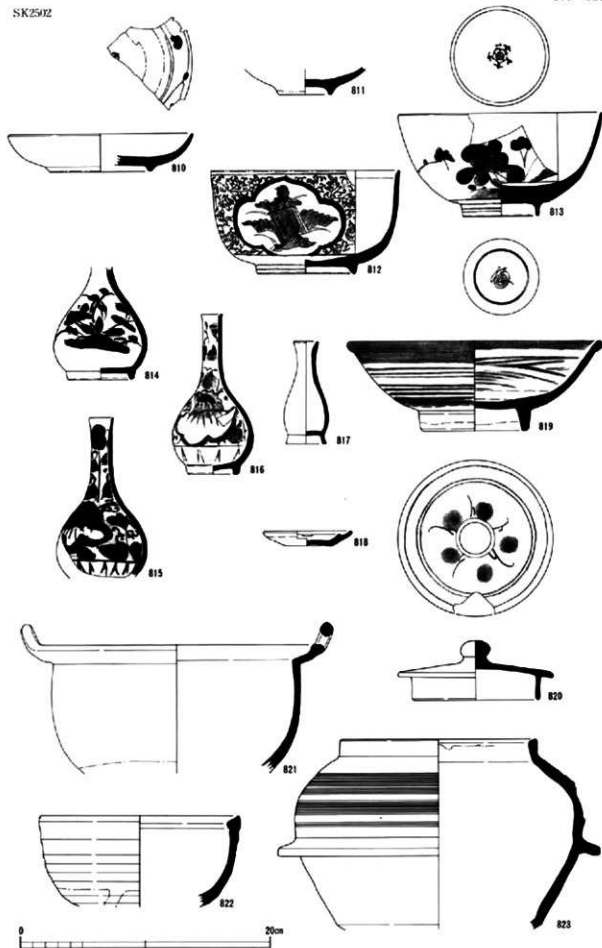

824・825

SK2502

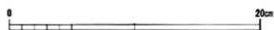
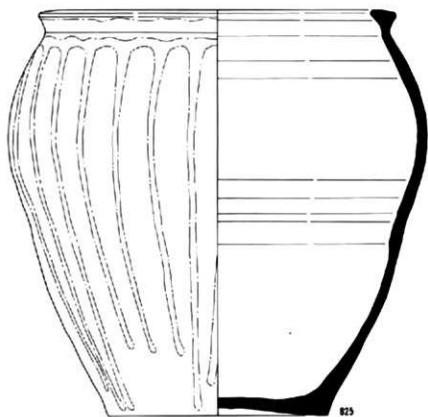
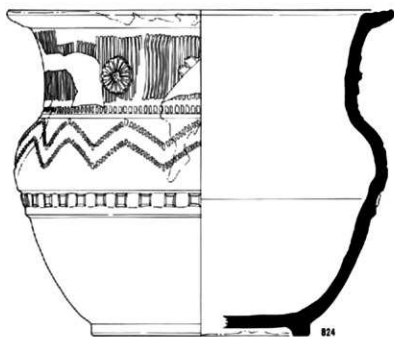

SK2502

826~828

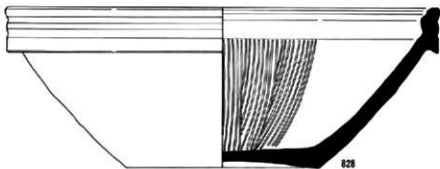
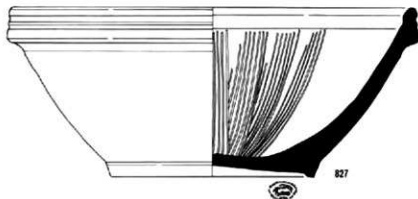
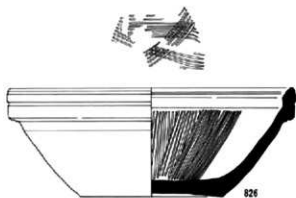

829~851
SK2502

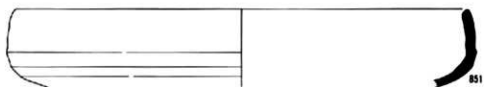
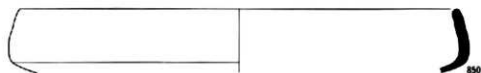
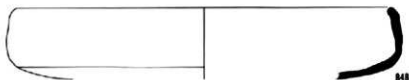
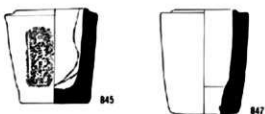
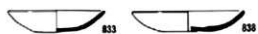
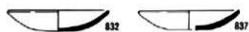

852~863

SD2505

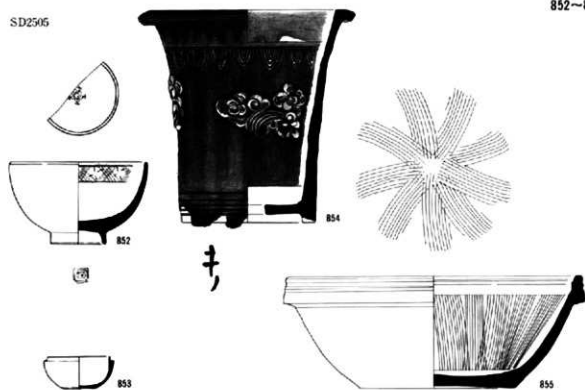

SG2501

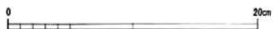
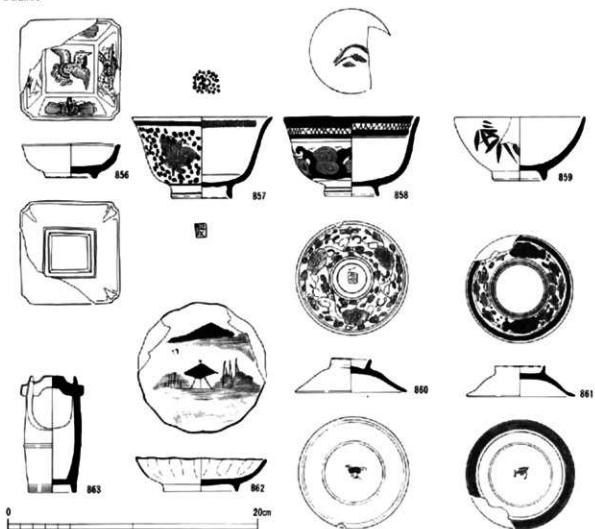

864~875

SD33505



864



866



869



867

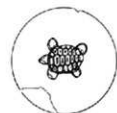

865



868



870

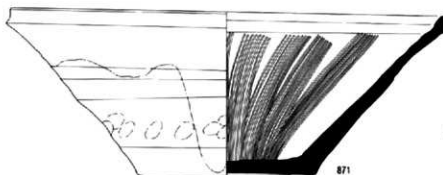

871

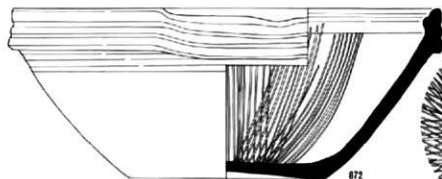

872



873

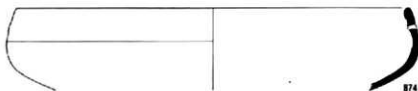

874



875



SK3506

876~899

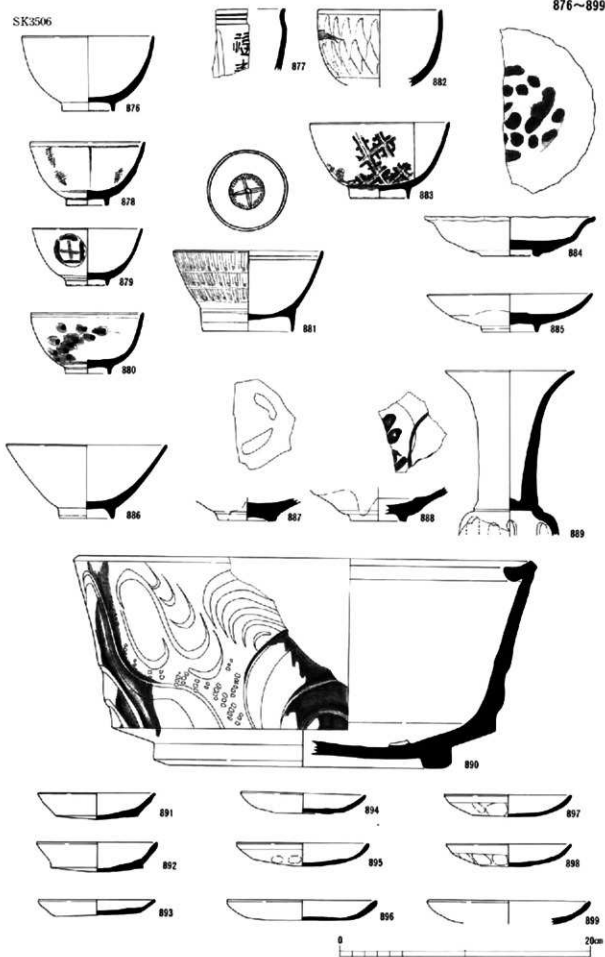

900~909
SK3506

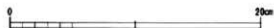
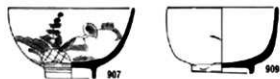
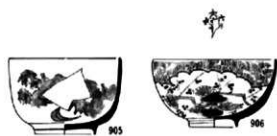
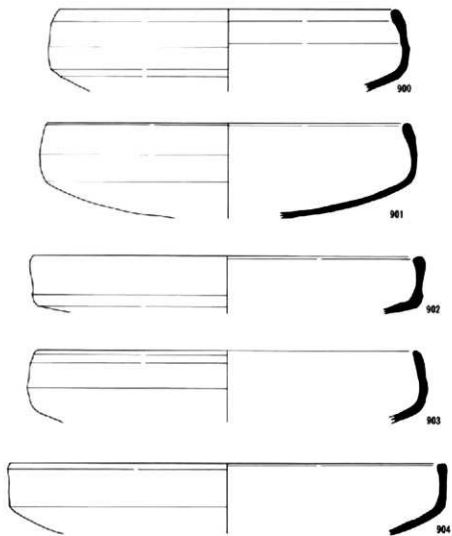

SK3518

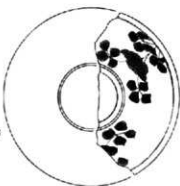
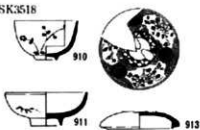

910~923

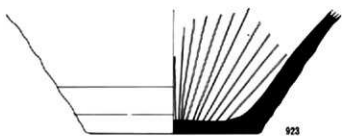
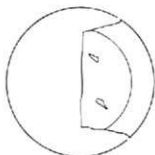
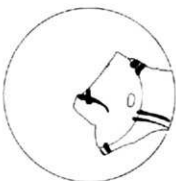
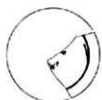
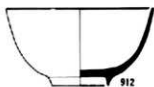

924~930
SK3518

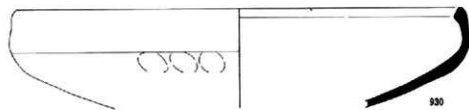
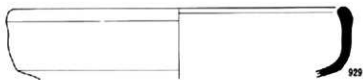
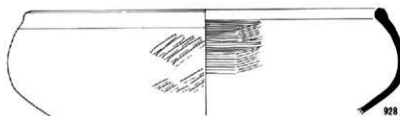
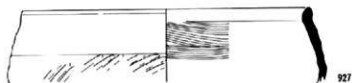
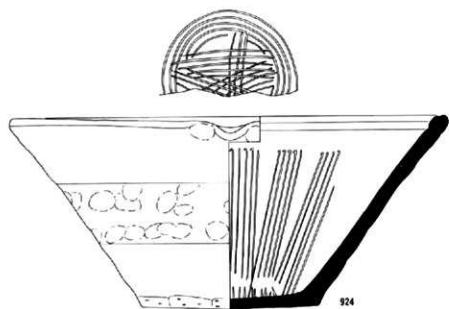

SK3523



931

SK3528

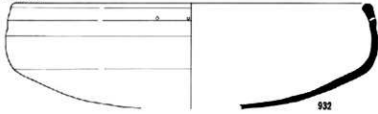

932

931~939

SK3533

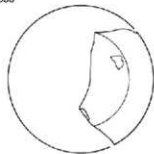

933



934



935



936

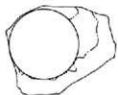

937

SK3534



938

SK3536

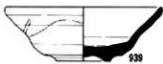
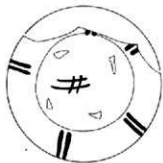

939

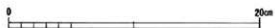

940~943
SK2505

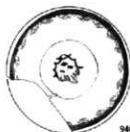

940

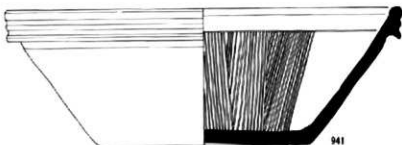

941

その他



942

SK2506

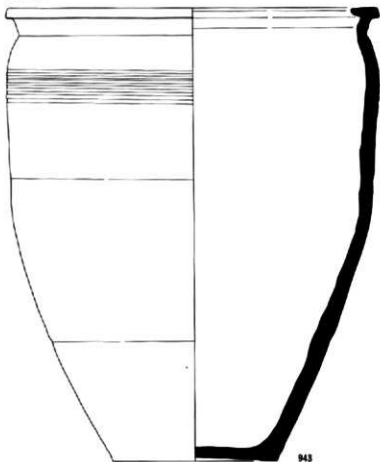

943

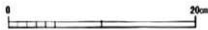

SK2504(水琴窟)

944・945

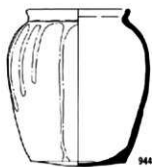

944

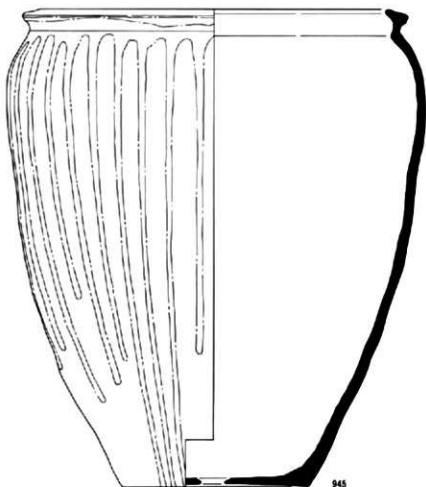

945



946~957

土製品

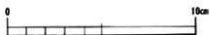

958~963

土製品

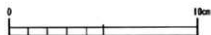
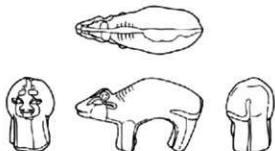
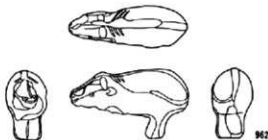
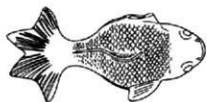
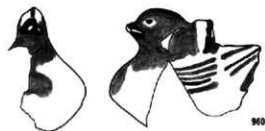
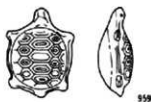

964~985

土製品



965

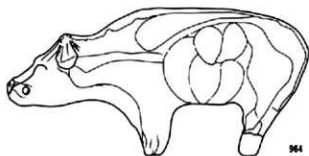
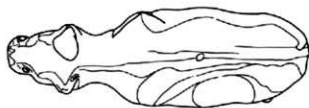

964



966



967



968



969



971



970



972



973



974



975



976



977



978



979



980



981



982



983



984



985



上製品

986~996

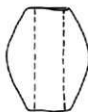
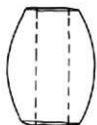
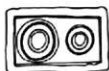

997~1004

新瓦瓦



997

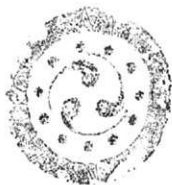

998



999



1000



1001



1002



1003



1004



1005~1012

軒瓦



1005

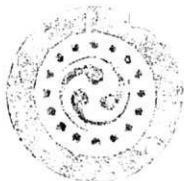

1006



1007



1008



1009



1010



1011



1012



1013~1020

杆九瓦

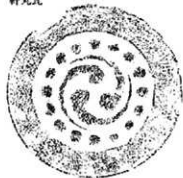

1013



1014

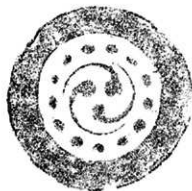

1015



1016



1017



1018



1019



1020



軒丸瓦

1021~1026

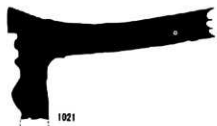
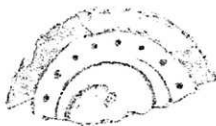

1021



1022



1023



1024



1025



1026

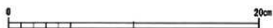

1027~1032

軒半瓦



1033~1038

軒平瓦

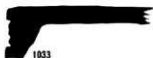

1033



1034



1035



1036



1037



1038



1039~1060

汽車土瓶

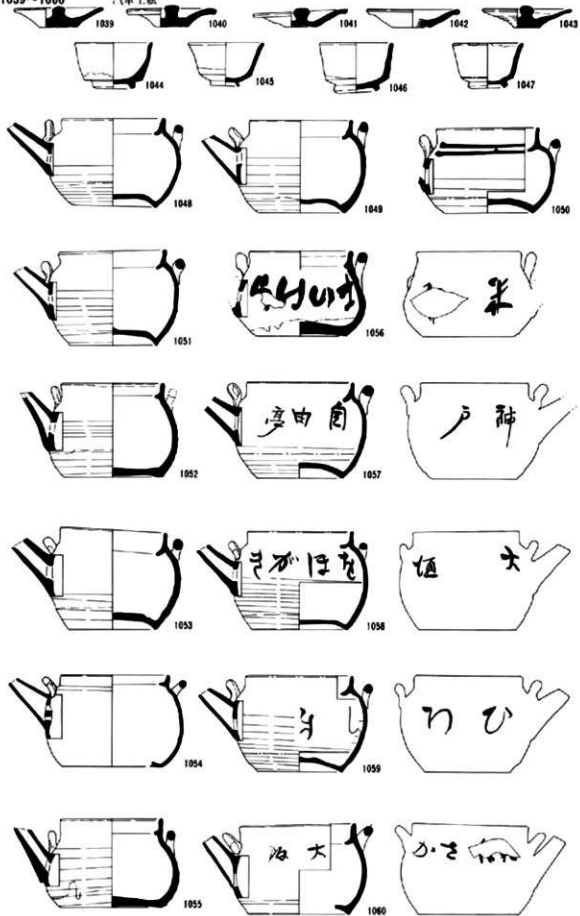

1061~1076

ガラス製品

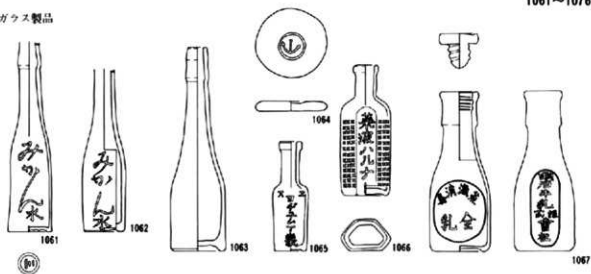

弥生土器

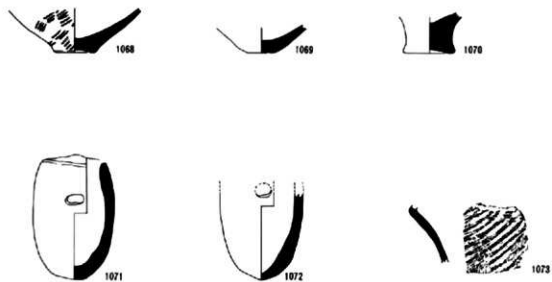

須恵器



W1~W21

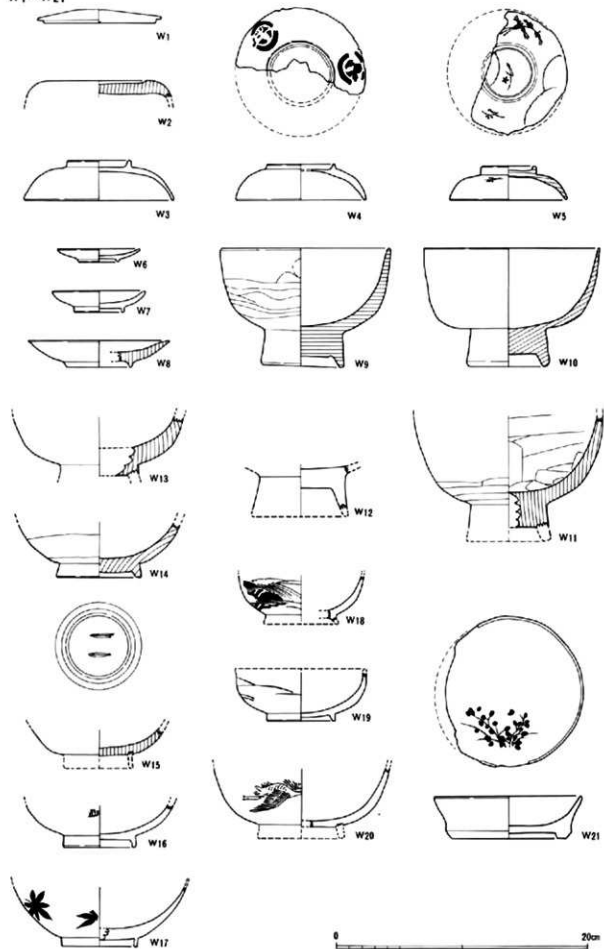

0 20cm

W22~W28

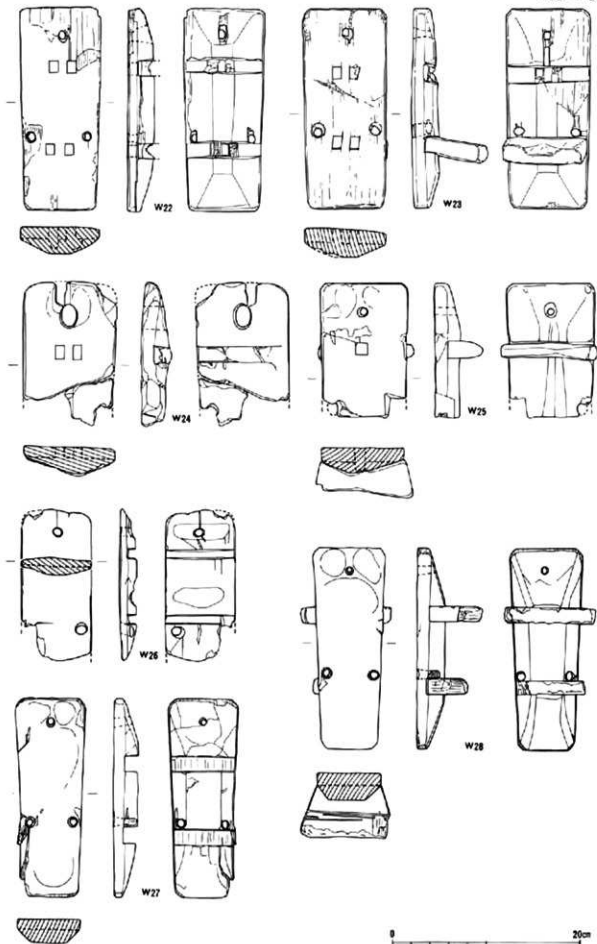

0 20cm

W29~W35

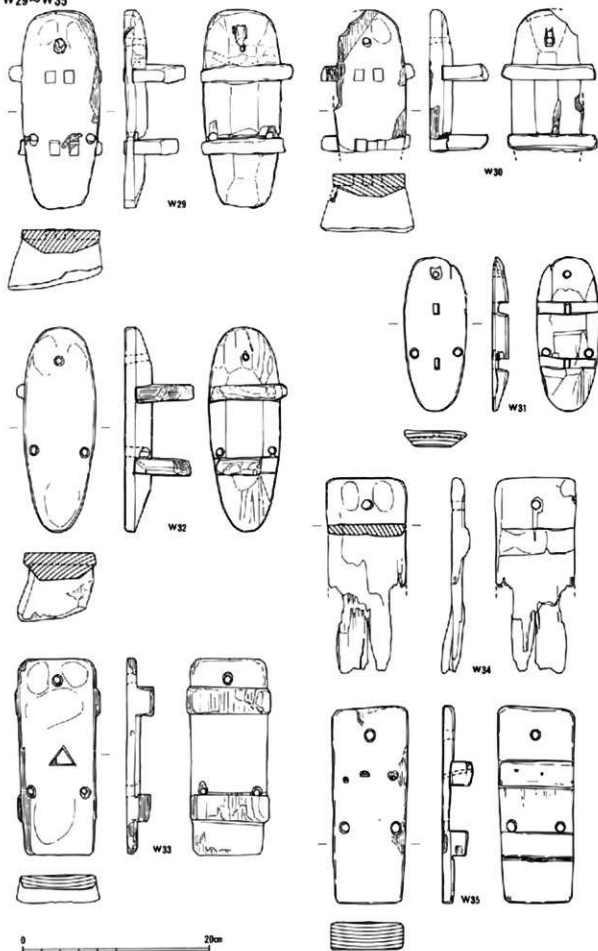

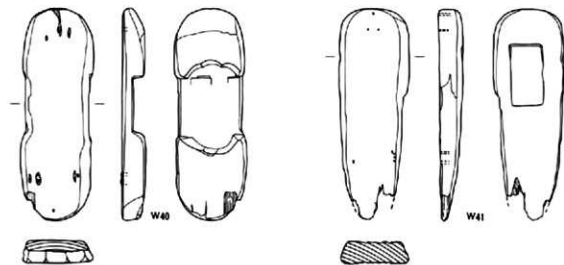
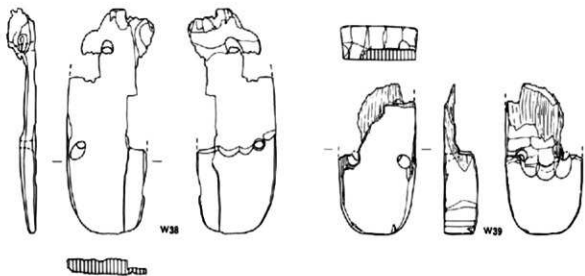
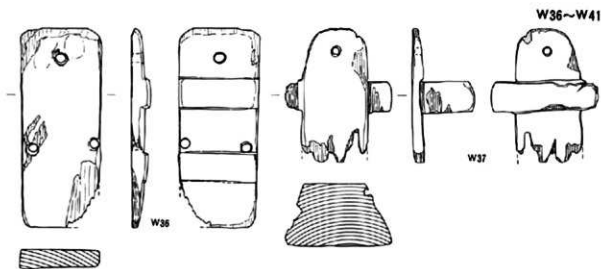

0 20cm

W42~W56

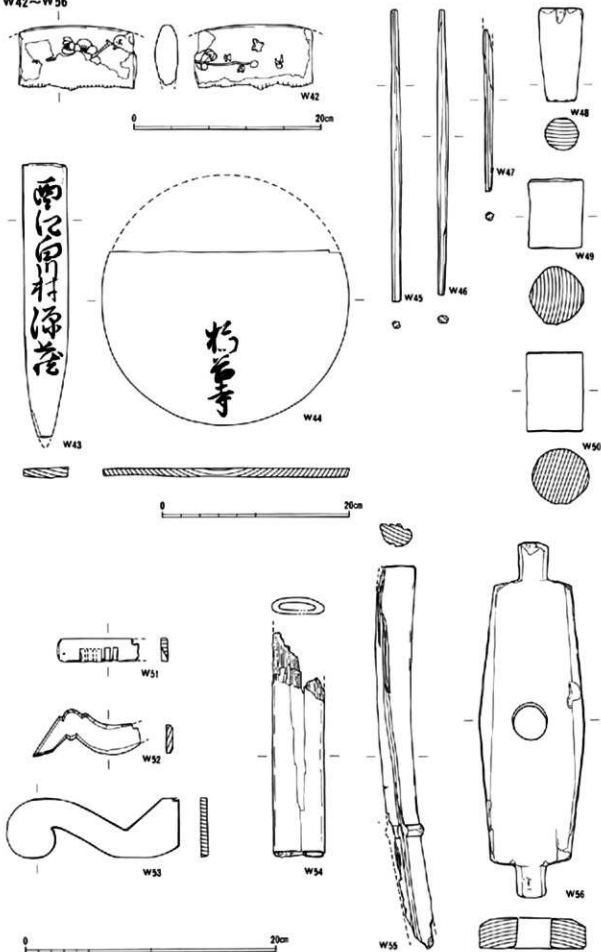

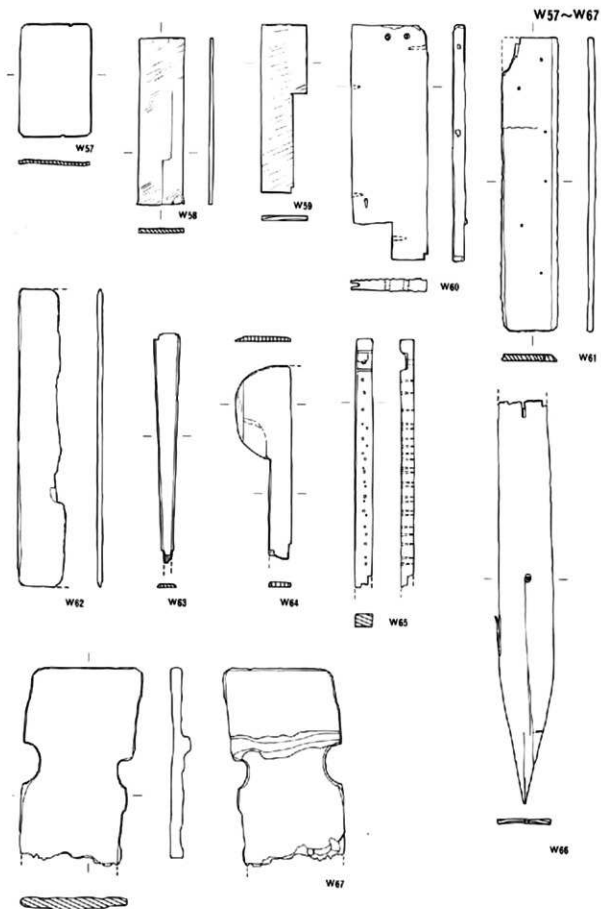

0 20cm

W69~W73

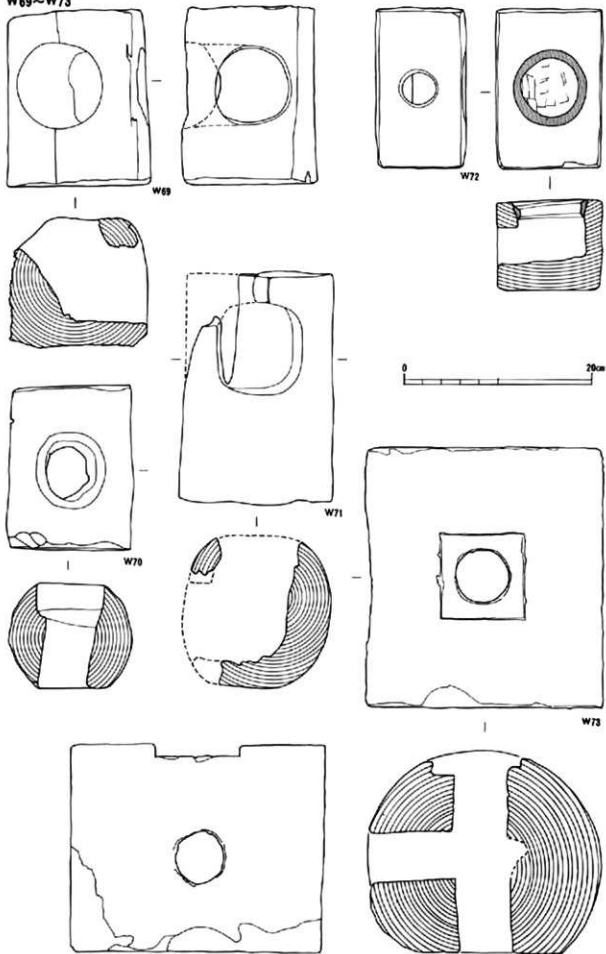

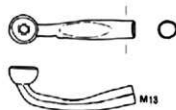
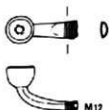
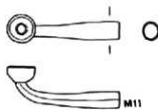
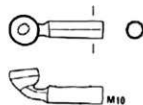
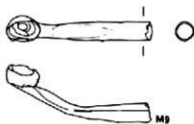
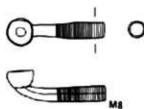
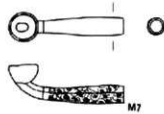
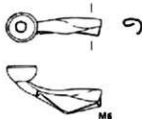
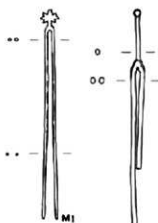

M14~M29

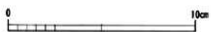
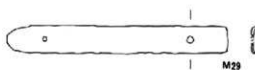
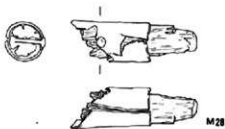
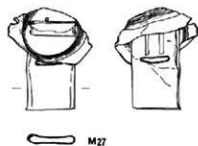
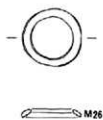
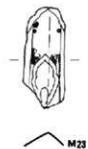
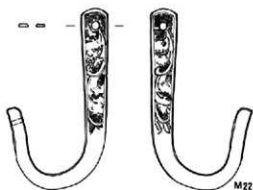
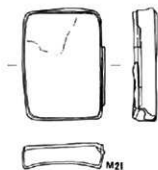

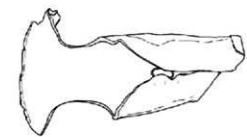

M30

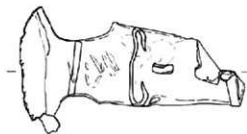

M34

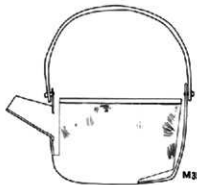
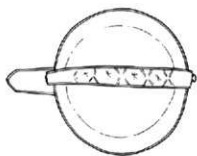

M35



M30~M36

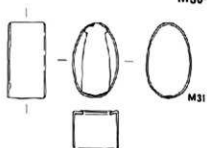

M31



M32

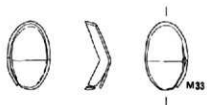

M33



M36



M37~M44

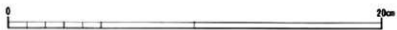

M45~M51

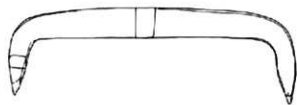
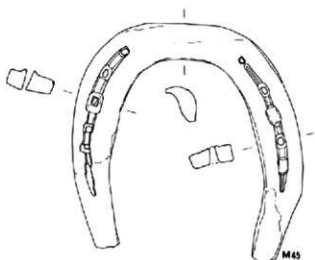
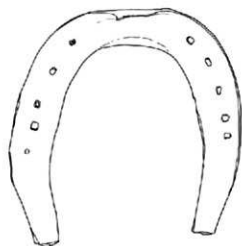

M46

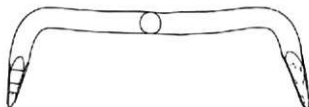

M47

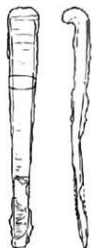

M48

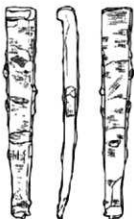

M49

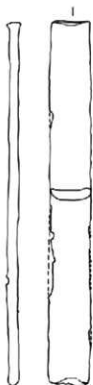

M50



M51



M52~M82

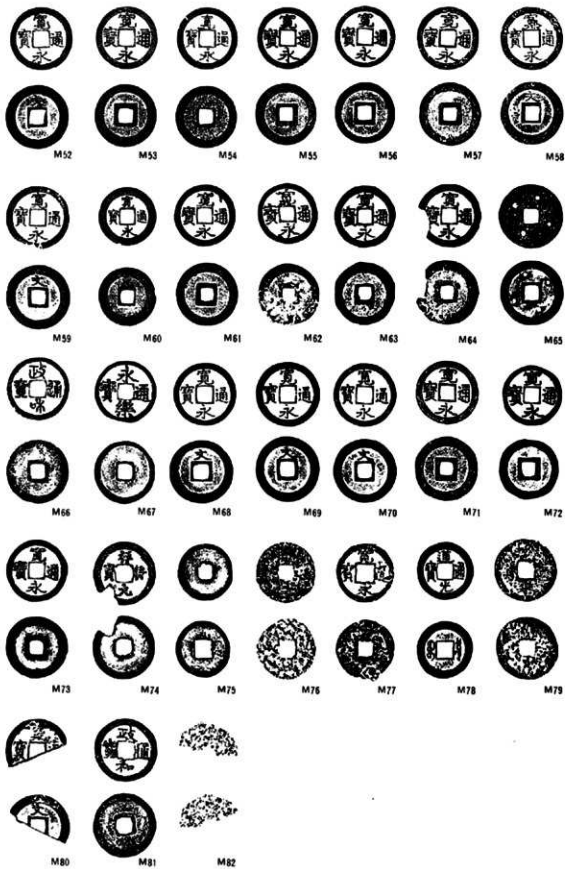

S1~S10

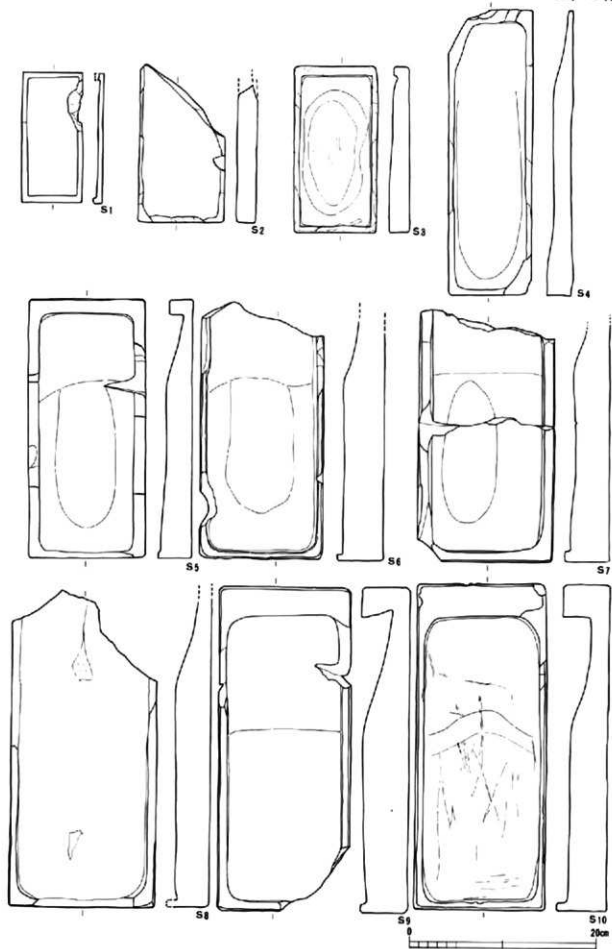

S11~S14

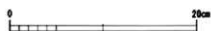
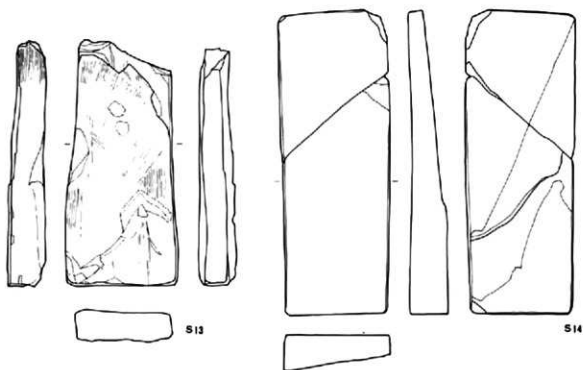
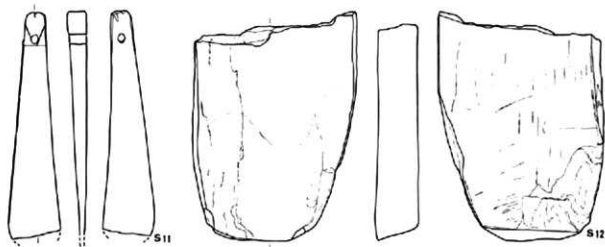

S15-S16

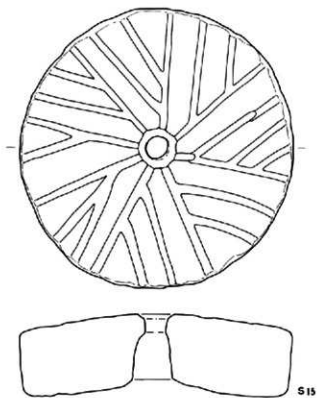

S15

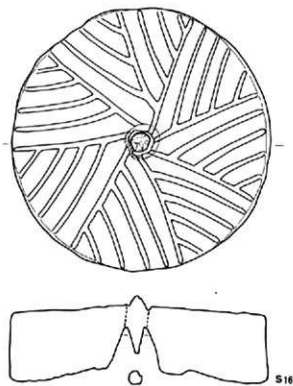

S16

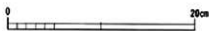

遺構図版



明石城跡航空写真（1980年撮影）



1. 発掘調査前の東中ノ町地区
(駅前駐車場 東から)

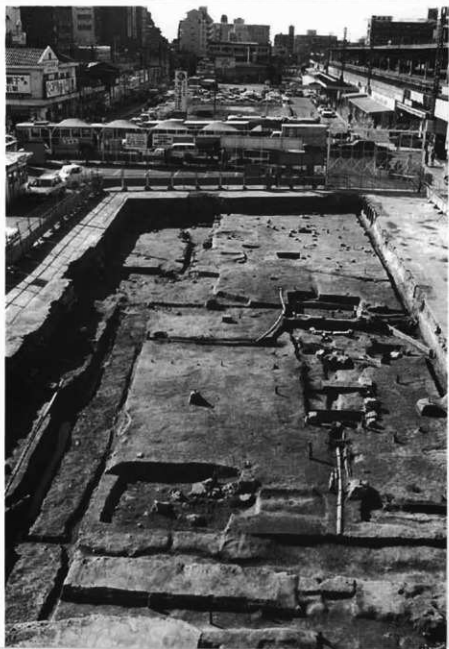

2. 東中ノ町地区全景と中ノ町地区を望む



1. 東中ノ町地区全景（東から）



2. 東中ノ町地区全景（東から）



1. SB3001 (建物跡)



2. SD2012 (石組溝) と
SD2013



3. SD2013 土層断面



1. SE3001 検出状態
2. SE3001 断面



1. SG2001
(池状遺構) 全景



2. SG2001



3. SG2001の水位調整施設



1. SW1001 (水道)

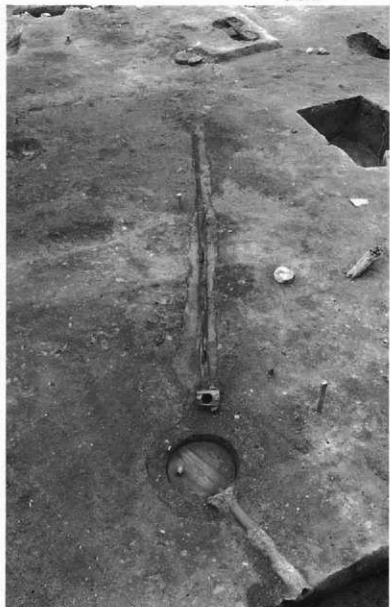

2. SW2001 (水道)



3. SW2001の罫

1. SK2001 (漆喰土坑) と
SK2002 (焼土坑)



2. SK2002 埋土断面

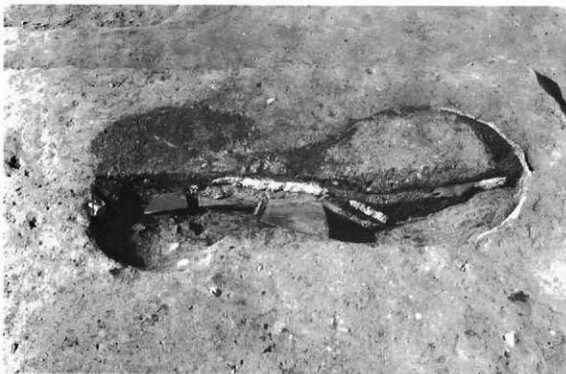

3. SK2002

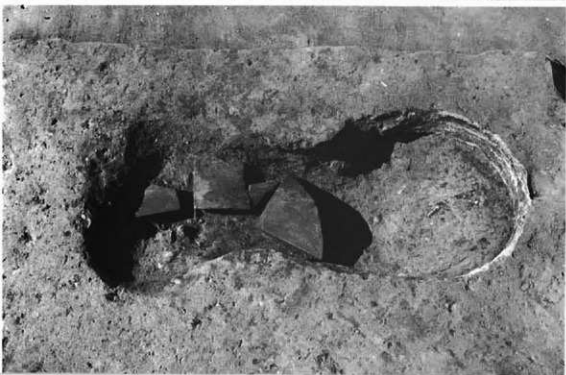

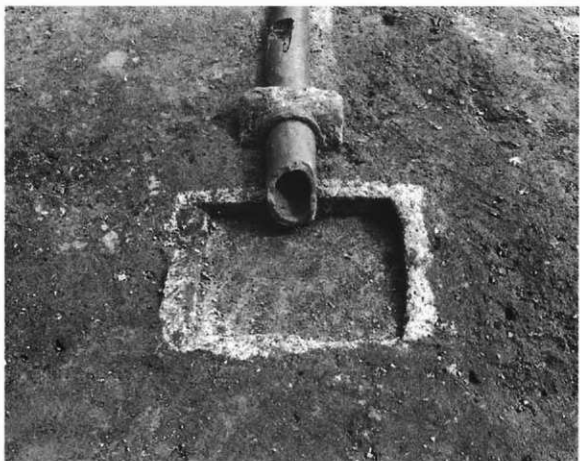
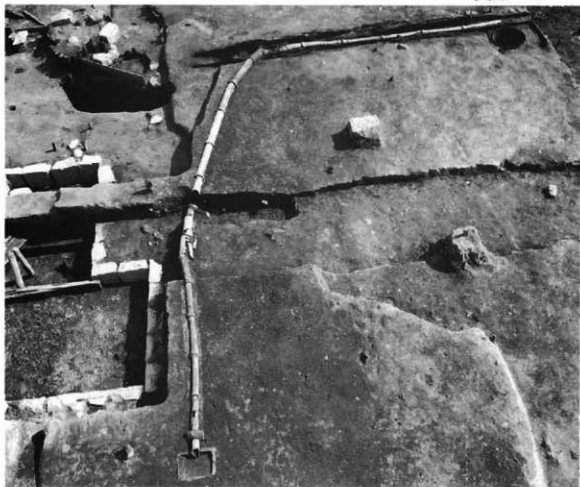

1. SP2001 (排水用土管)

2. SP2001の漆喰塗り集水樹



1. SG2002 (池状遺構)



2. SK3001 (煙桶)



3. SK2011

東中ノ町地区



1. SD2002と土層断面
鉄道のバラス敷きが見える



2. 7トレンチ付近地層断面

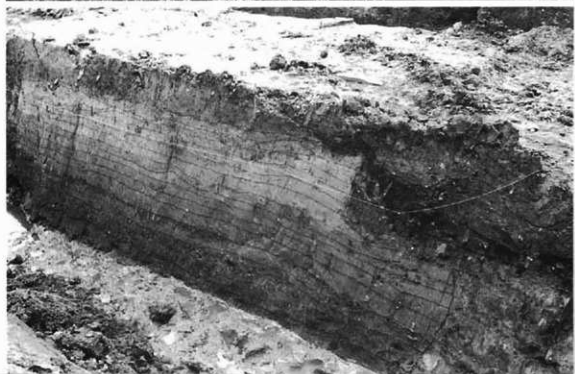

3. 下層の地層
(D2-D4間)



1. 中ノ町A地区から東中ノ町地区を望む



2. A地区全景(西から)

1. A地区屋敷境溝と築地跡



2. SA3102 (築地の基礎)





1. A地区西半部（南東から）
2. SX2101（石敷遺構）

1. SE2101 (井戸)



2. SE2102 (井戸)



3. SK2124 (土坑)





1. SG2101 (池) (南西から)

2. SG2101 (池) (南東から)



1. B地区上層全景（西から）
2. B地区下層全景（西から）



1. SD2201 (水路)



2. SD2201



3. SD2201 の堰

1. SA2201 (石列)



2. SD3202



3. 下層遺構面 (北から)

