

図面56 窪地西岸出土墨書土器2

深田遺跡

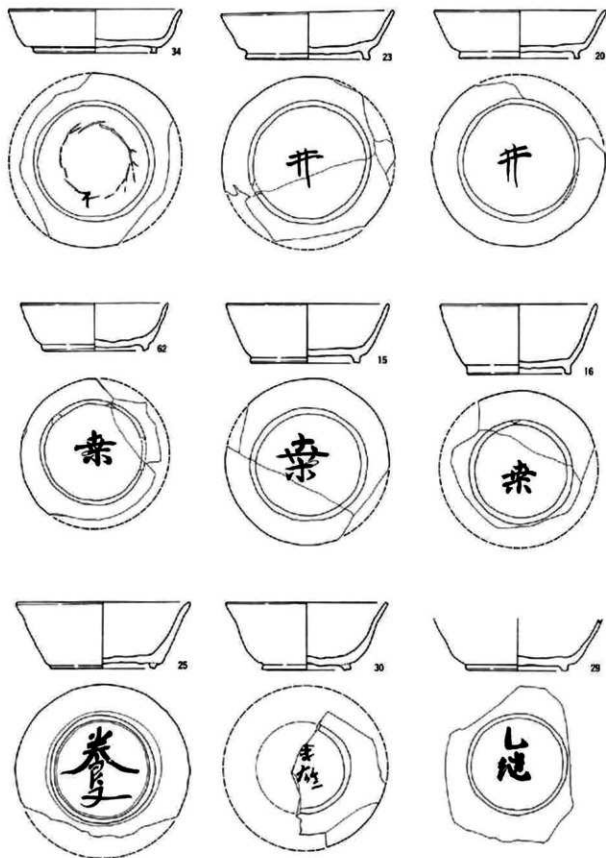

0 15cm

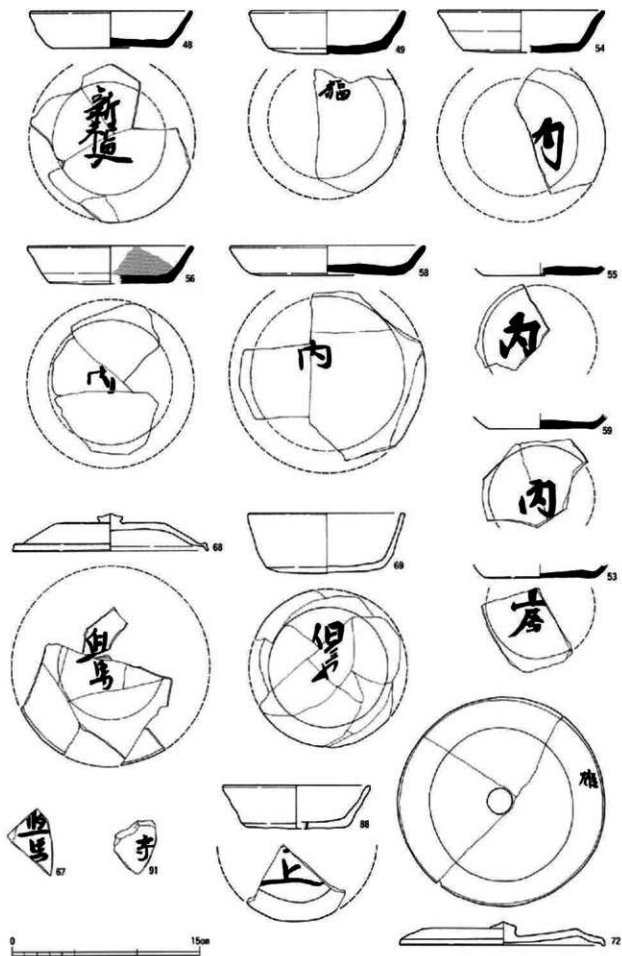

図面58 窪地東岸出土墨書土器 2

深田遺跡

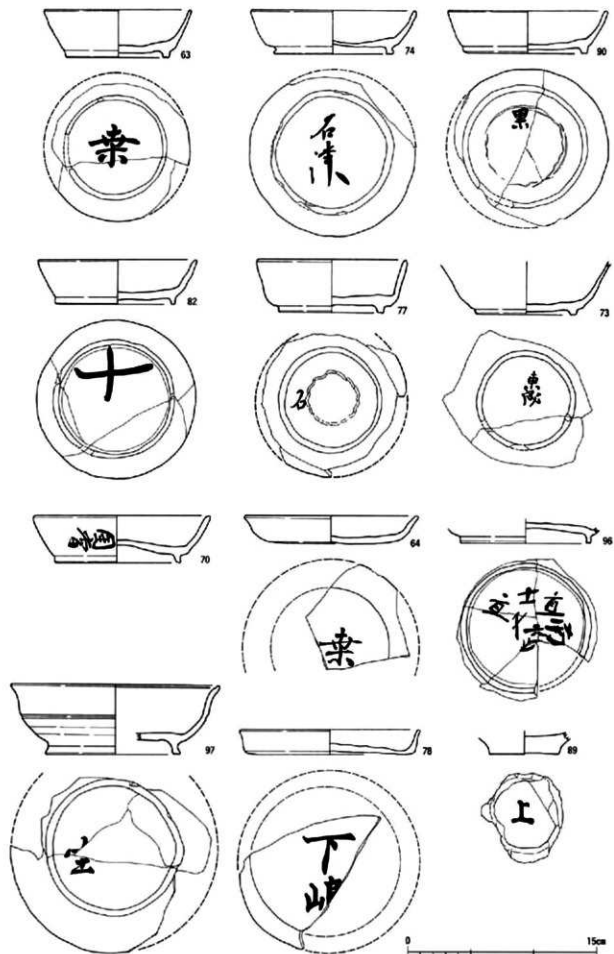

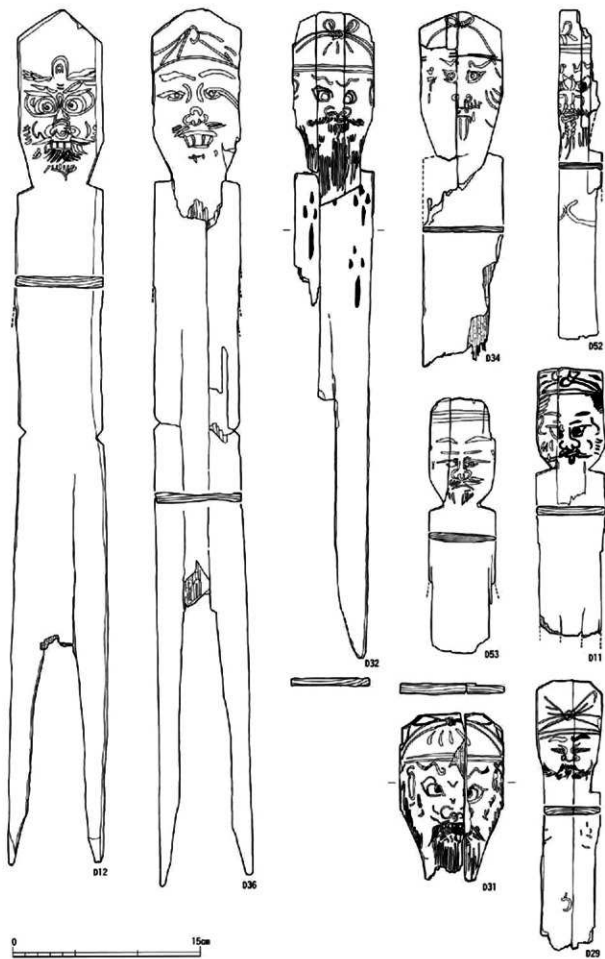

図面60 窪地西岸出土木製品2 (人形・馬形)

深田遺跡

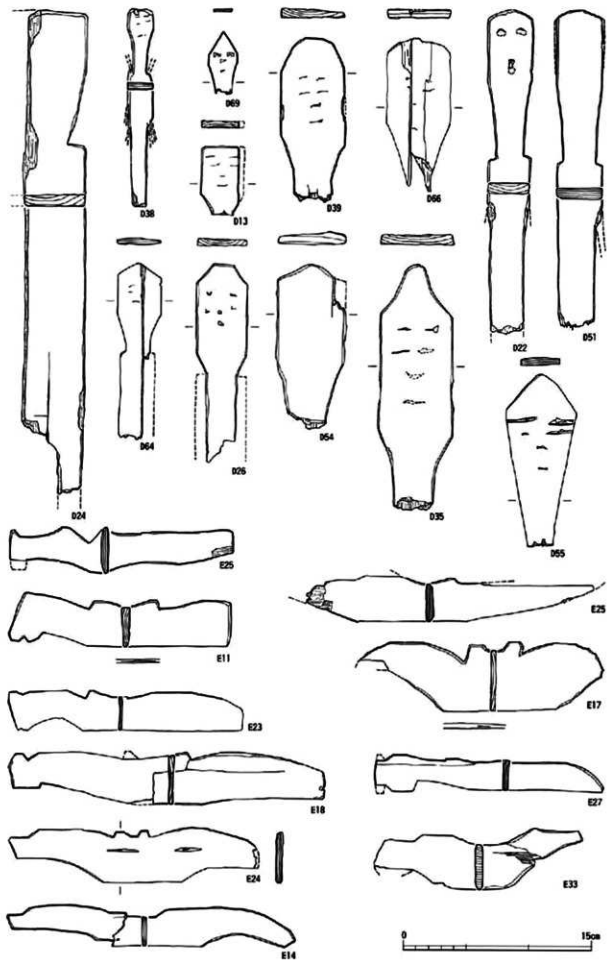

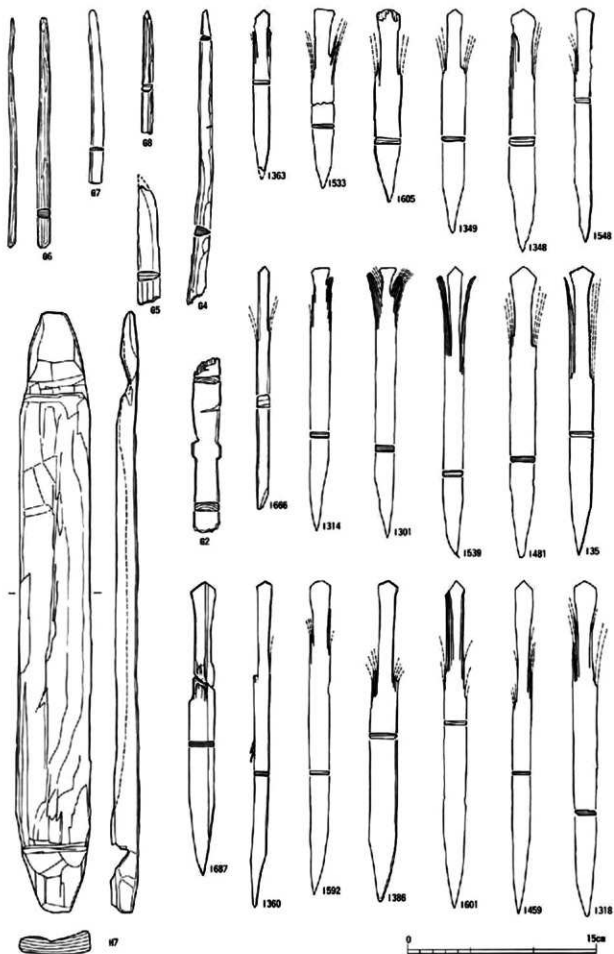

図面62 窪地西岸出土木製品 4 (斎串)

柴田繁雄

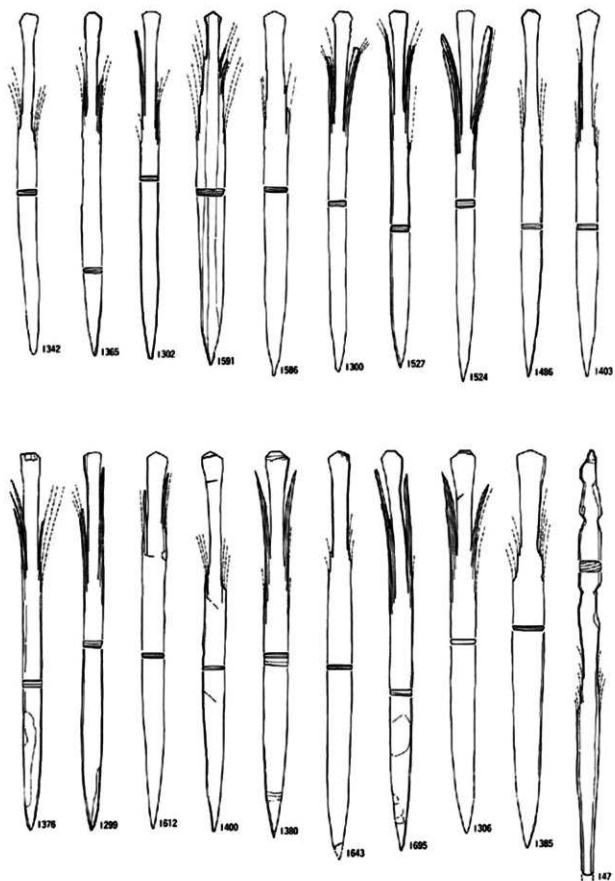

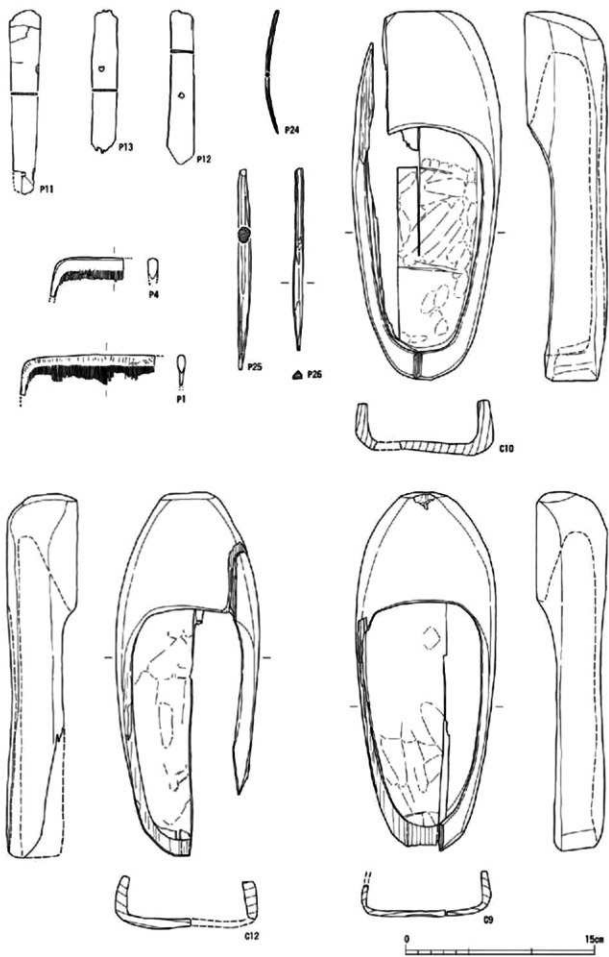



図面64 窪地西岸出土木製品6 (木履・下駄)

深田遺跡

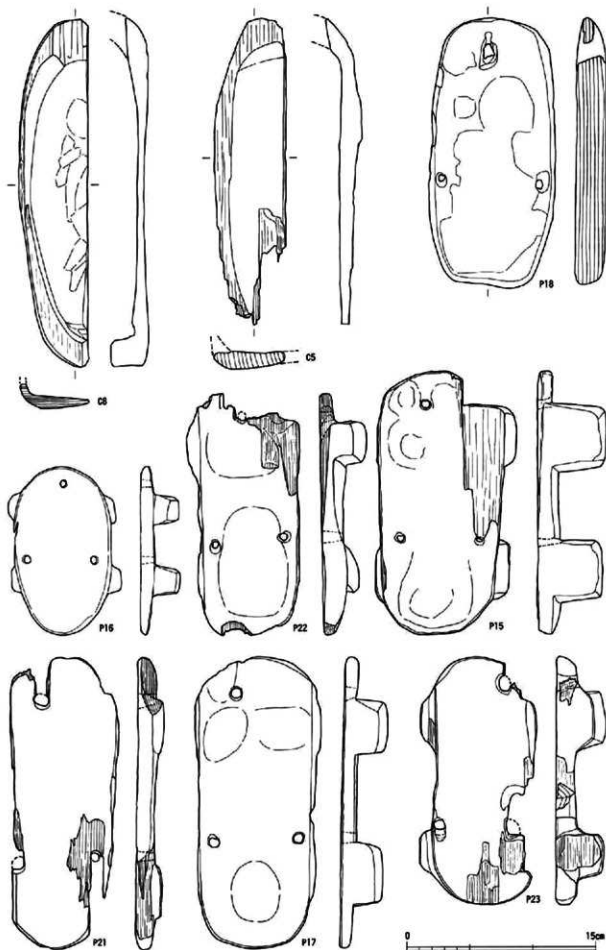

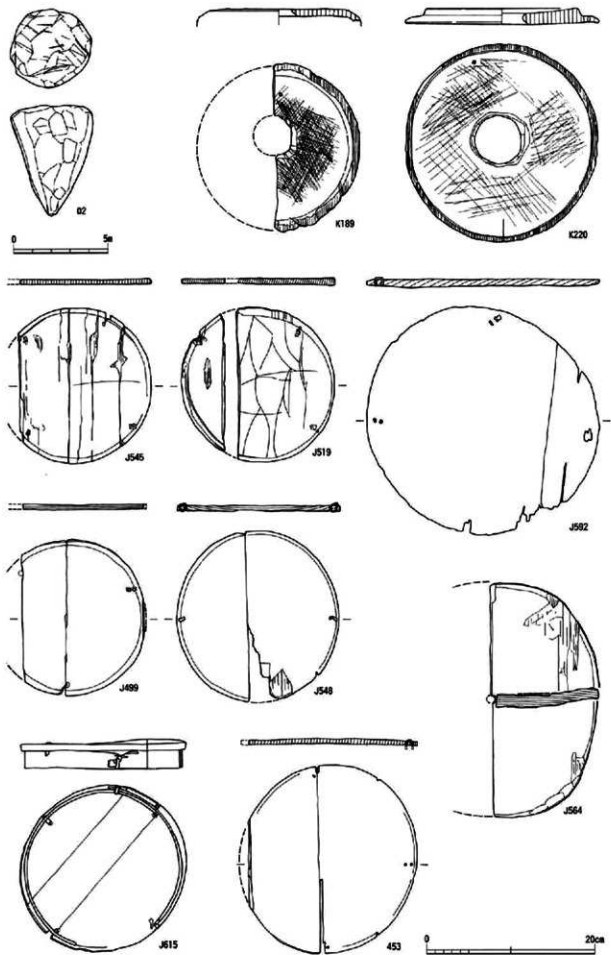

図面66 窪地西岸出土木製品 8 (撈物A)

深田達雄

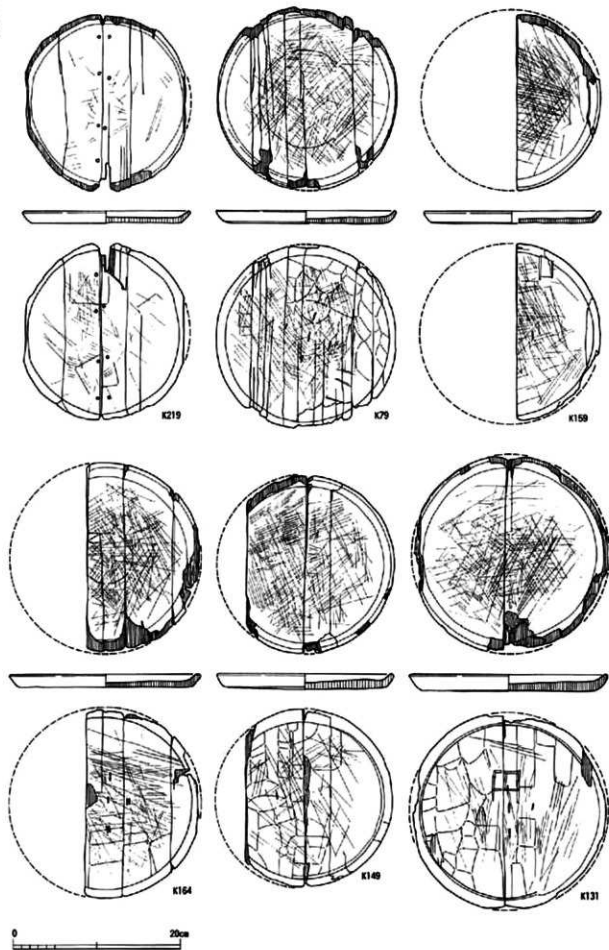

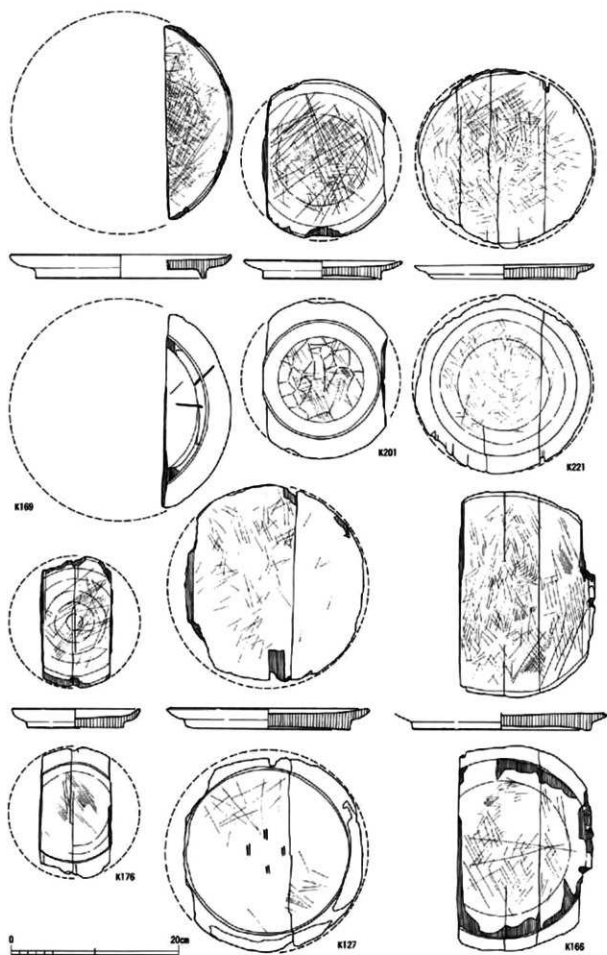

図面68 窪地西岸出土木製品10 (撓物B)

深田遺跡

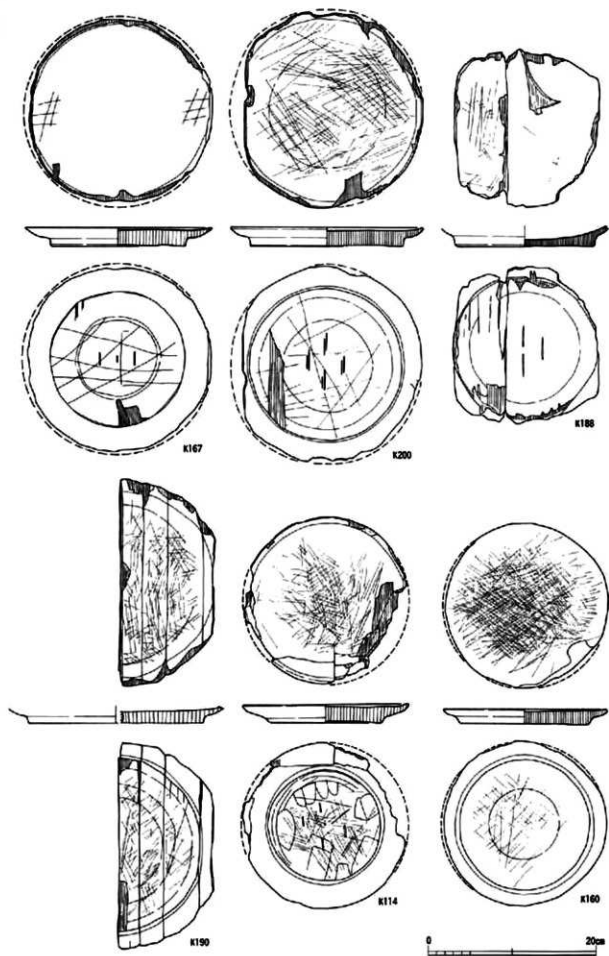

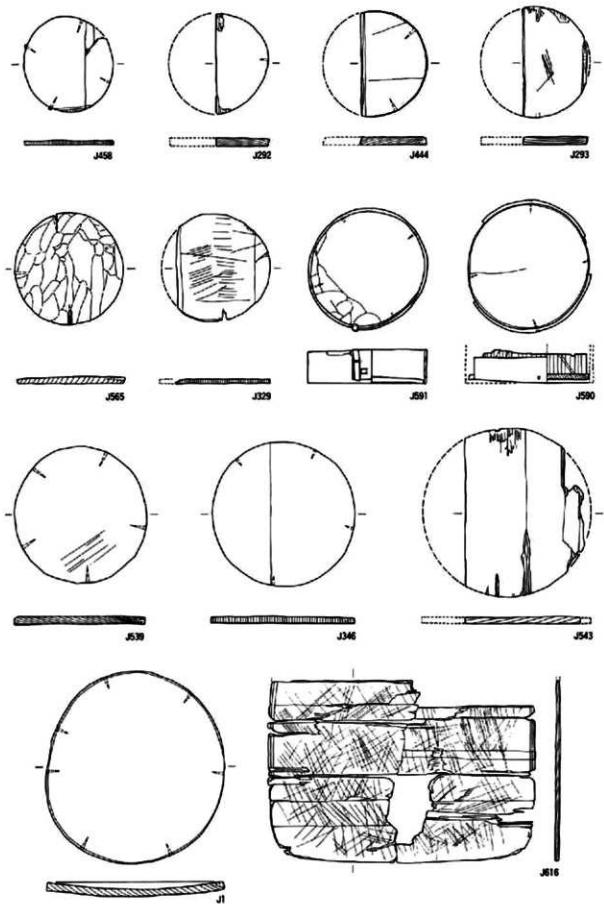

0 20cm

図面70 窪地西岸出土木製品12(箱・刺物・柄・栓)

深田遺跡

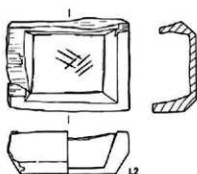
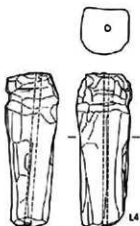
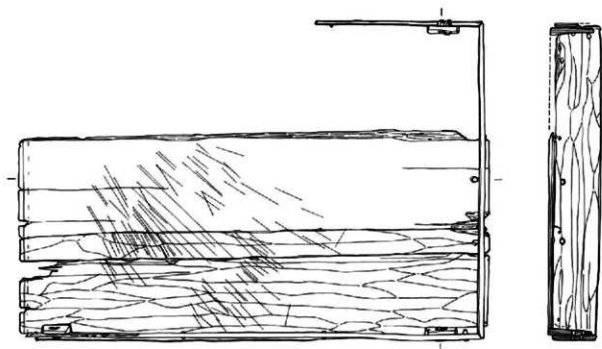
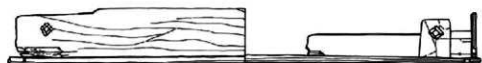

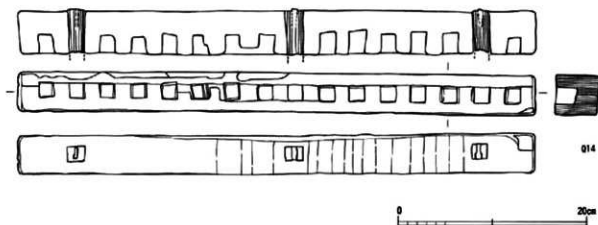
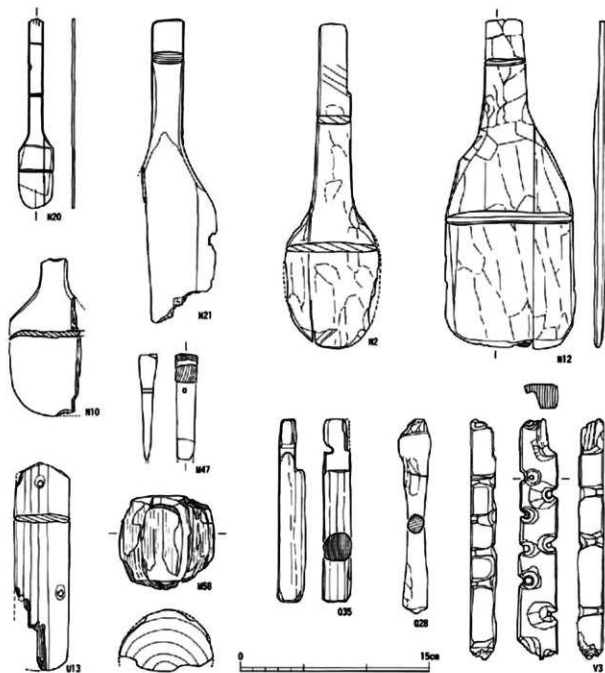



図面72 窪地西岸出土木製品14 (用途不明品)

深田遺跡

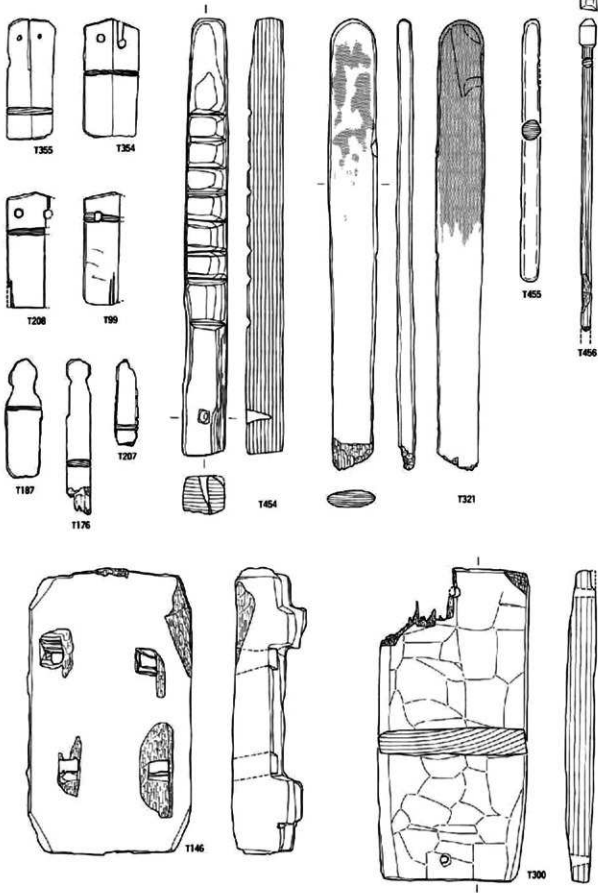

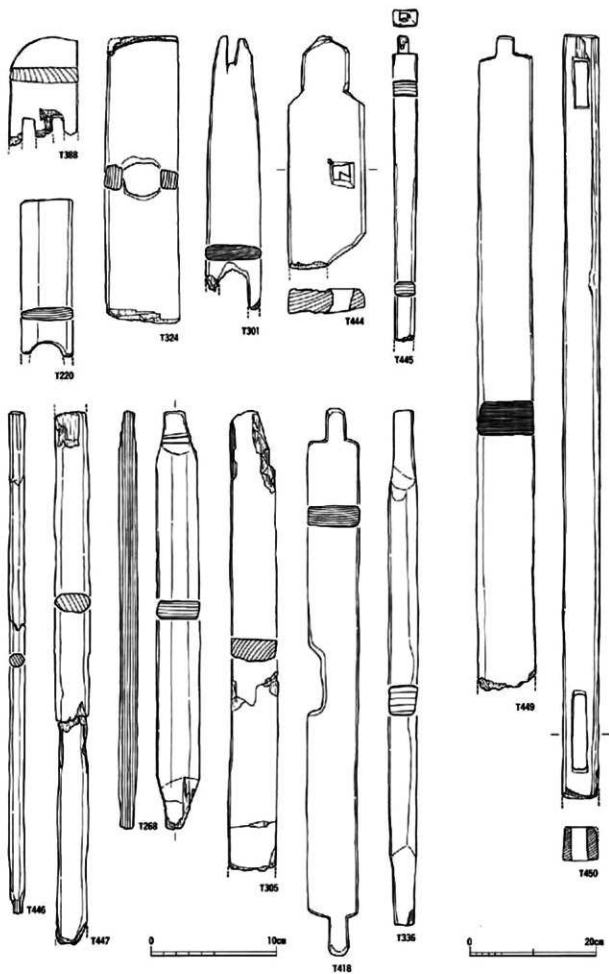

図面74 窪地東岸出土木製品1 (人形)

深田通勝

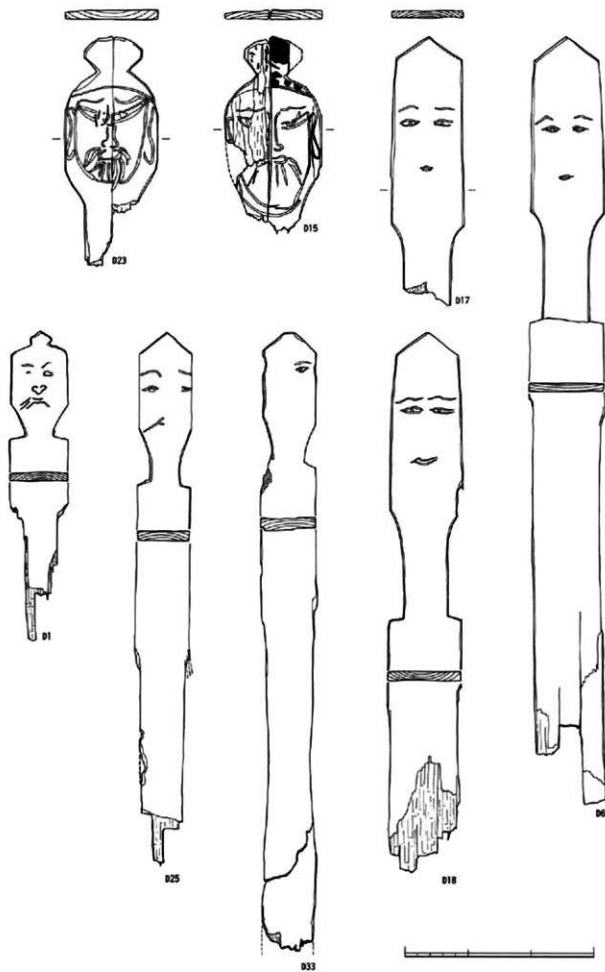

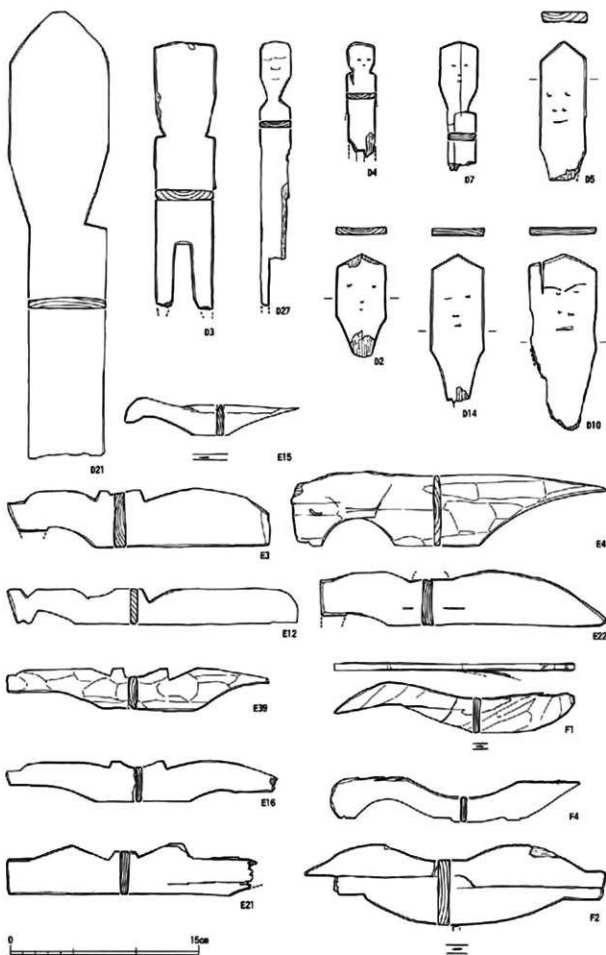

0 15cm

図面76 窪地東岸出土木製品3 (刀子形・剣形・斎串)

深田遺跡

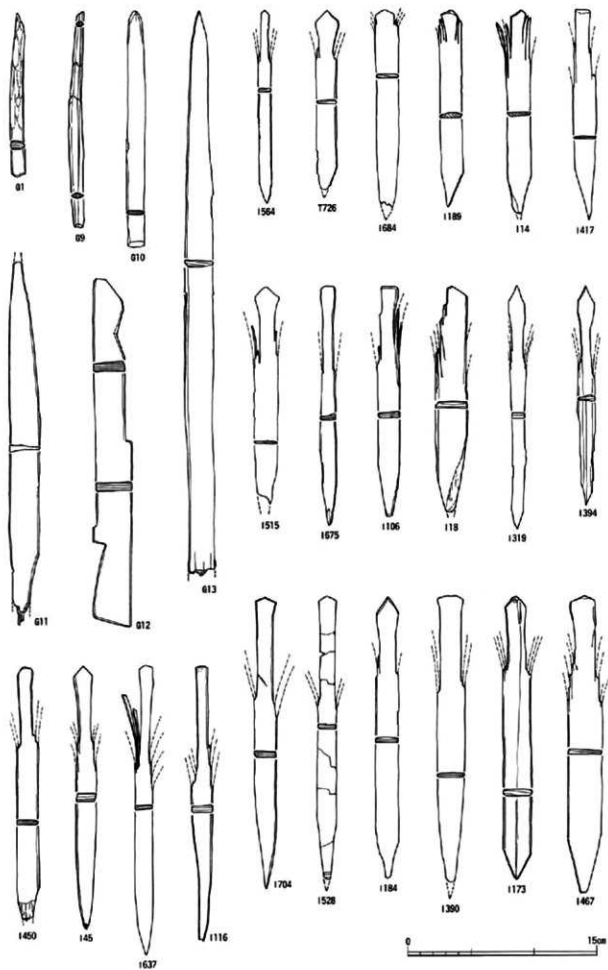

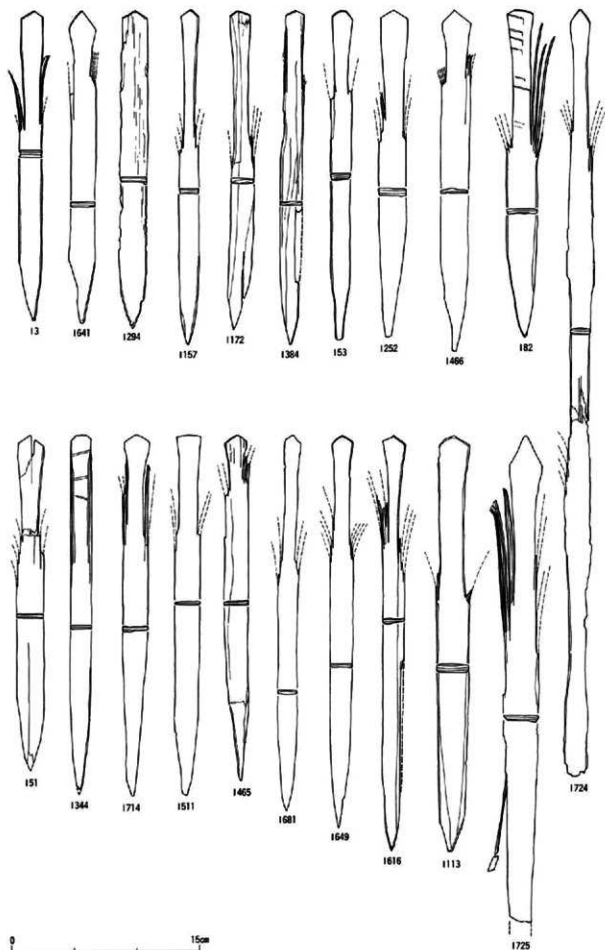

0 15cm

図面78 窪地東岸出土木製品 5 (扇子・櫛・留針・櫛・木履・下駄)

深田遺跡

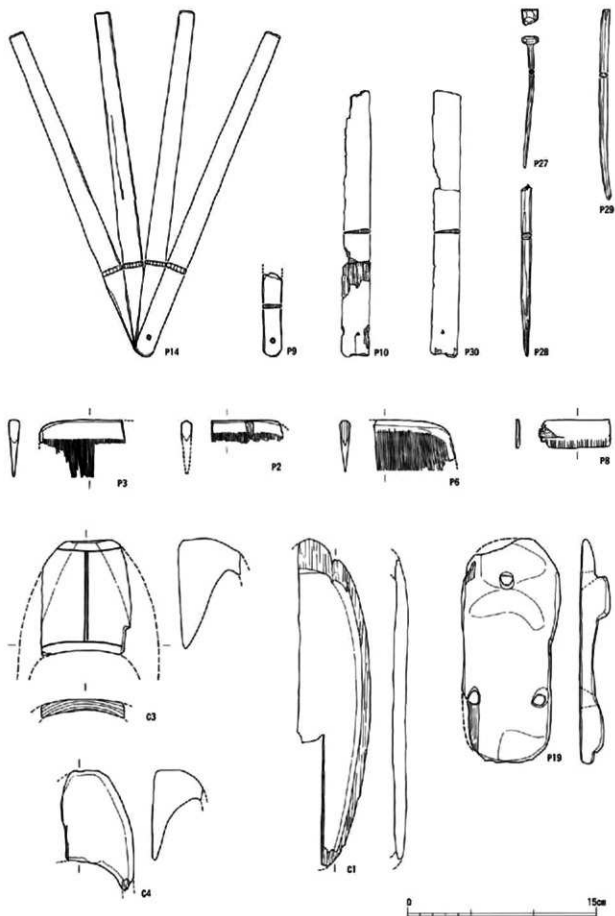

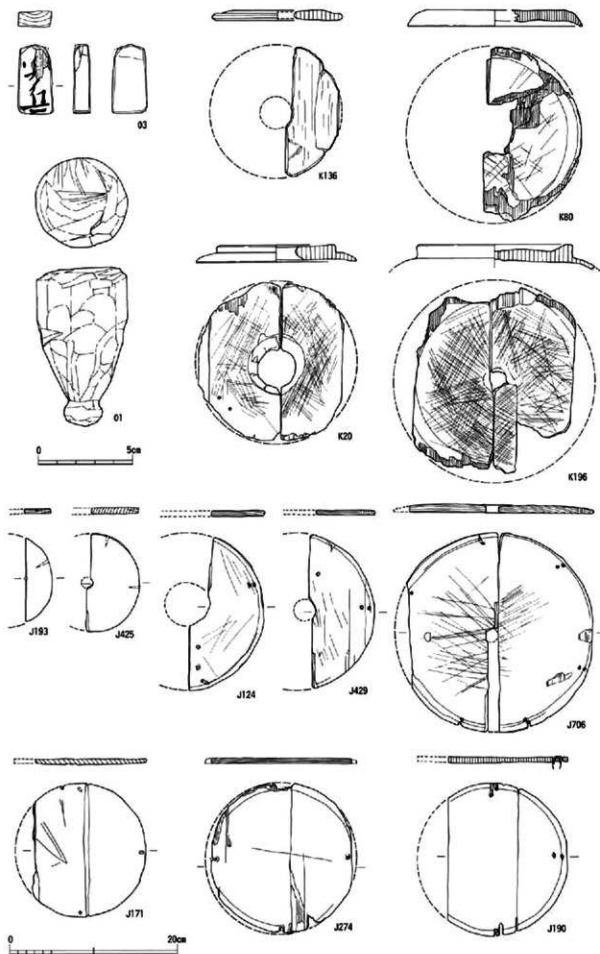



図面80 窪地東岸出土木製品7 (蓋・曲物)

深田遺跡

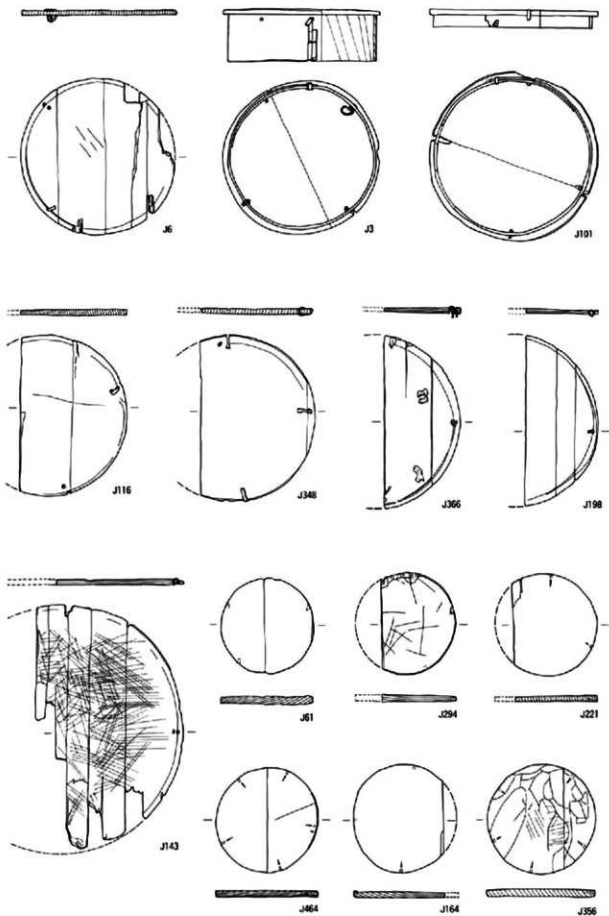

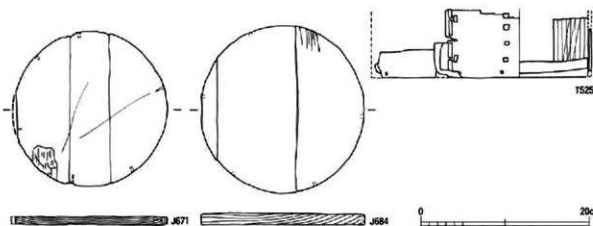
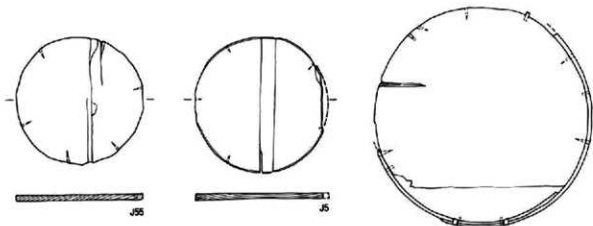
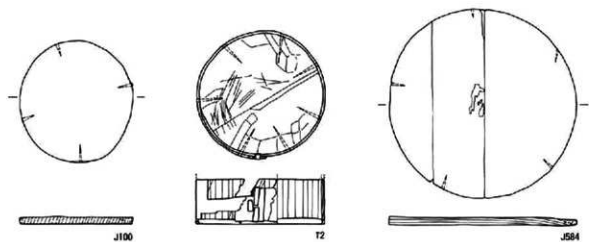
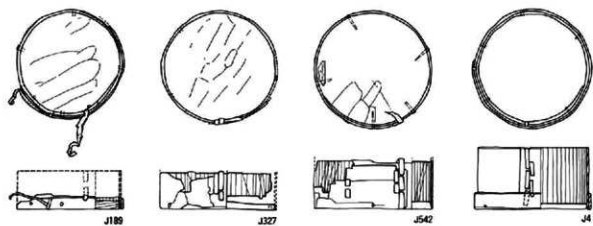

0 20cm

図面82 窪地東岸出土木製品9 (撈物A)

深田  
遺跡

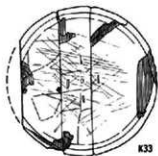
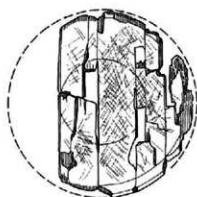
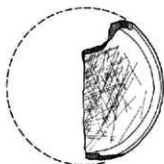

K33

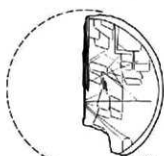

K34

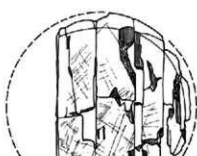

K34

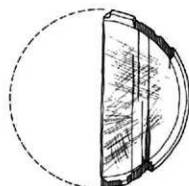
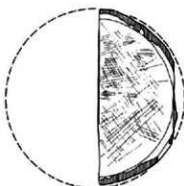

K35

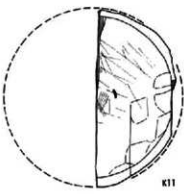

K11

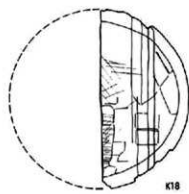

K16



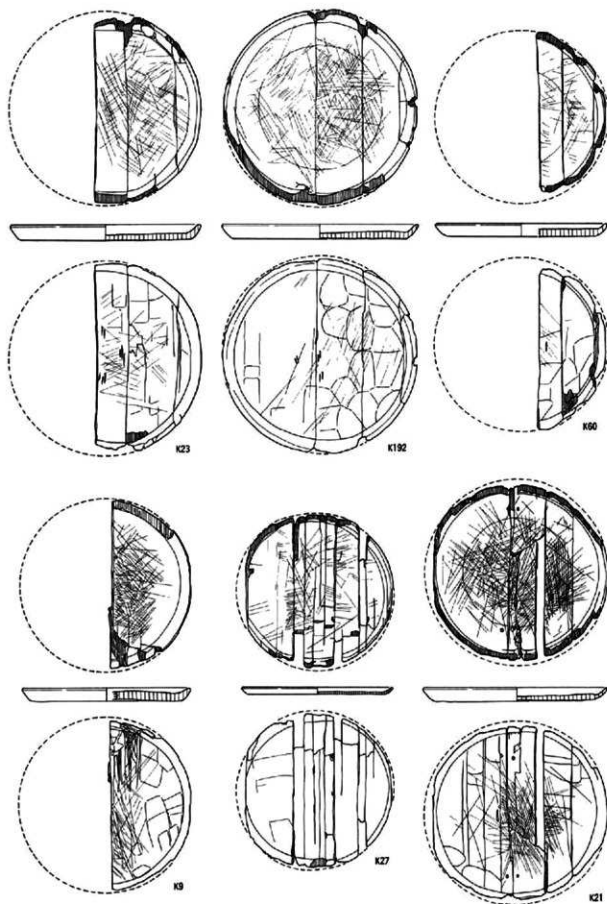

図面84 窪地東岸出土木製品11 (撈物B)

深田遺跡

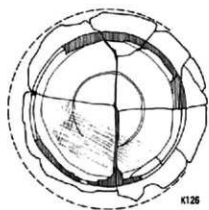
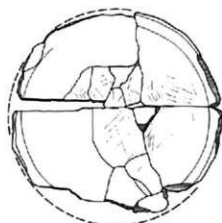
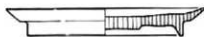
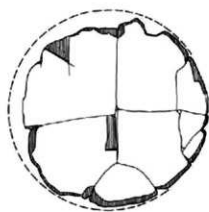

K128

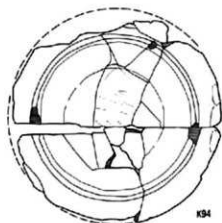

K134

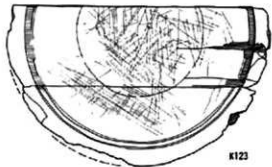
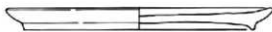

K122

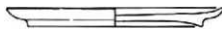
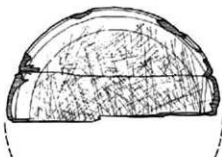

K203



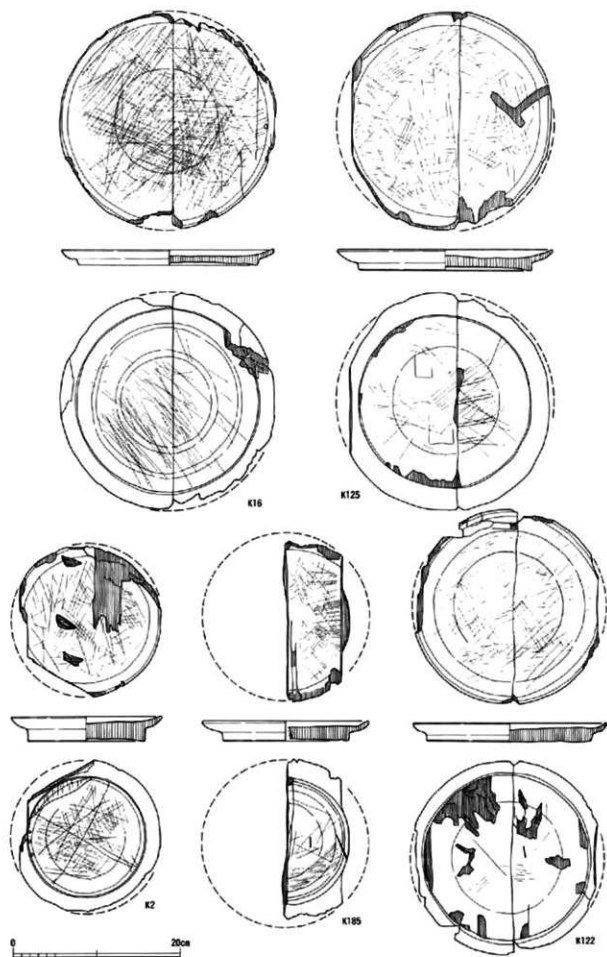

図面86 窪地東岸出土木製品13 (撿物B)

深田遺跡

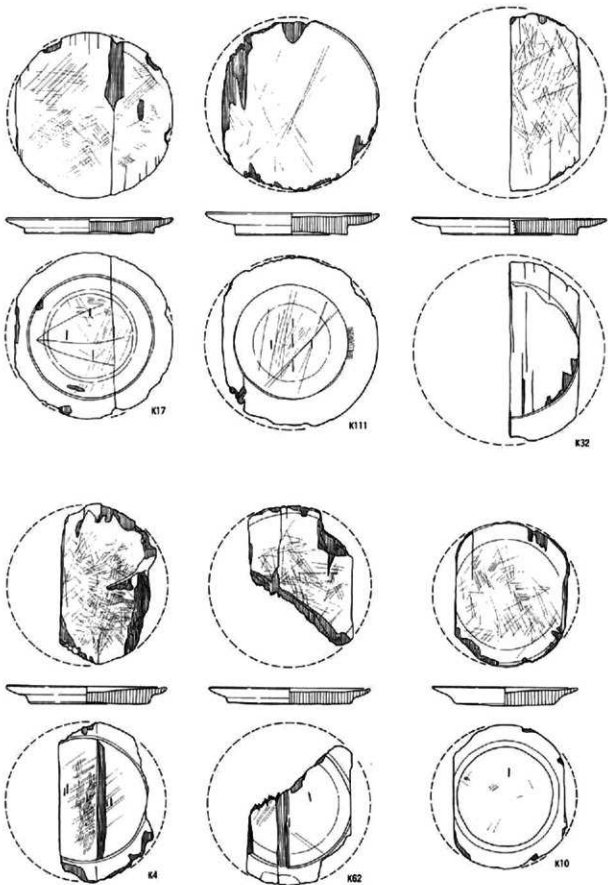

0 20cm

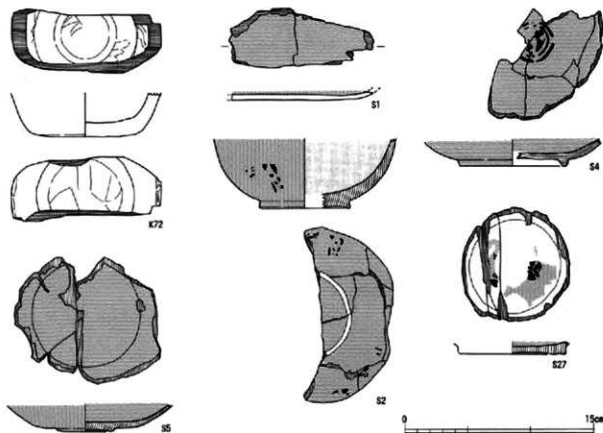
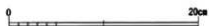
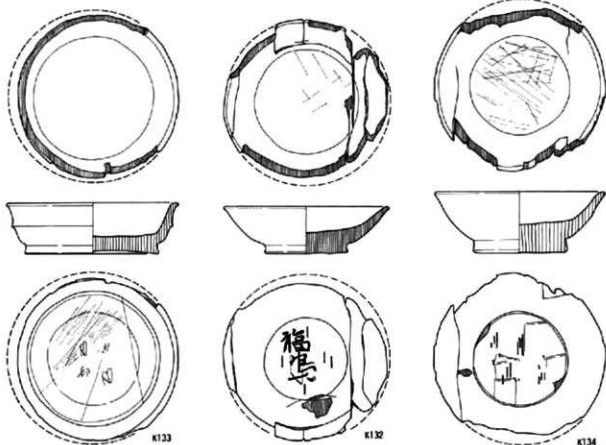



図面88 窪地東岸出土木製品15 (剃物・柄杓形木器・剃物匙)

深田遺跡

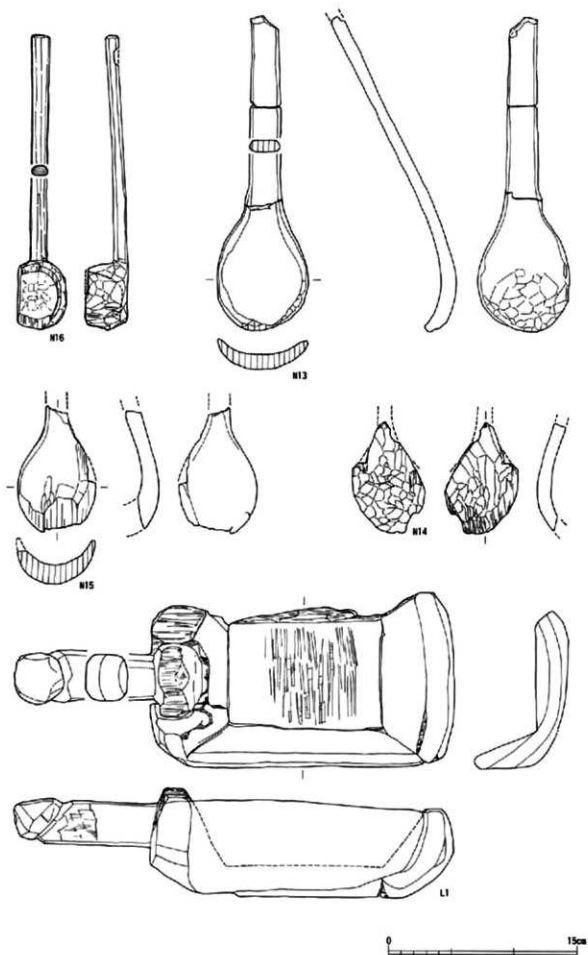



N4



I



N5



N17



N3



I



N5



N18



N7



I



N11



N19



N6



V2



図面90 窪地東岸出土木製品17 (台座)

深田 繪

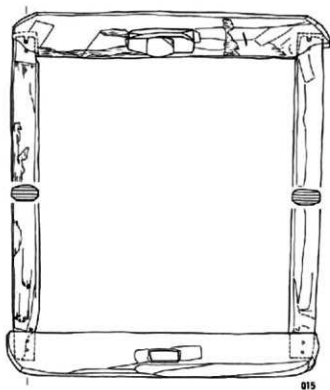
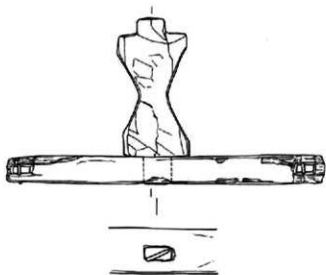

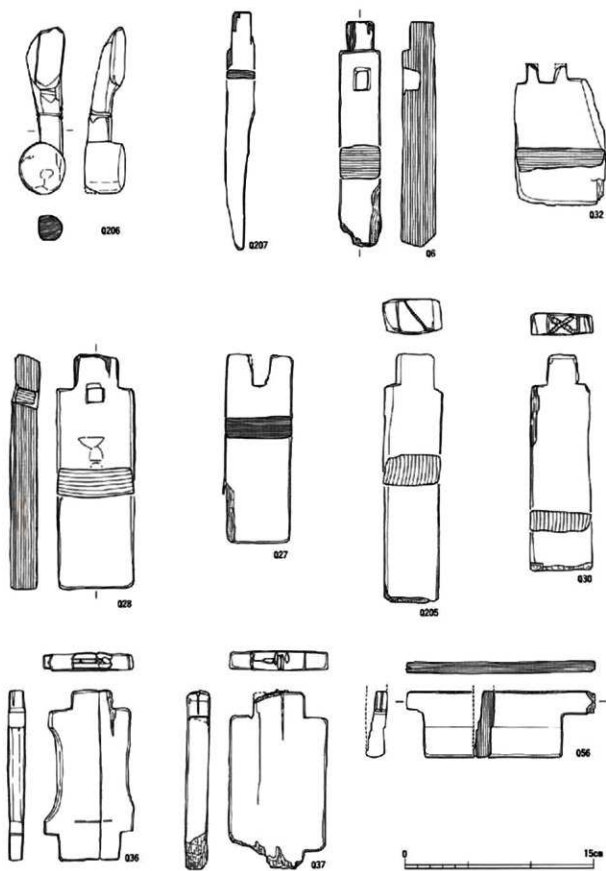

図面92 窪地東岸出土木製品19 (刷毛・柄・柄・楔)

深田遺跡

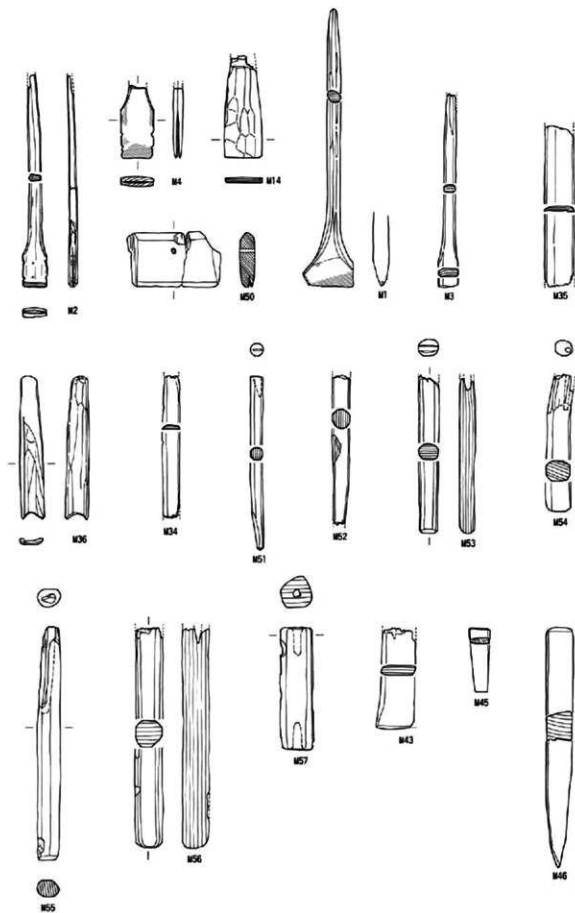

0 15cm

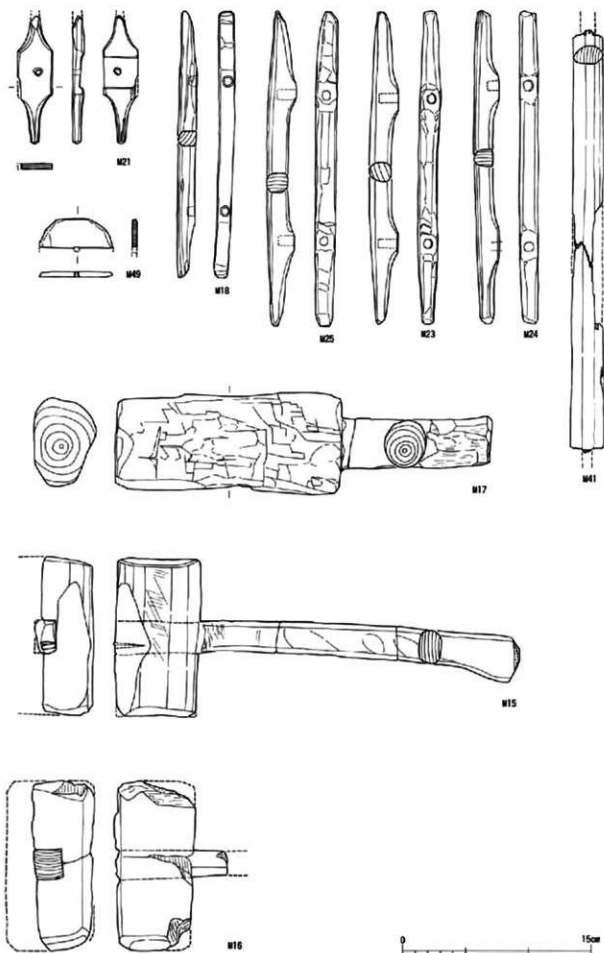

M21

M21

M49

M18

M25

M23

M24

M41

M17

M15

M16

0 15cm

図面94 窪地東岸出土木製品21 (田下駄)

深田遺跡

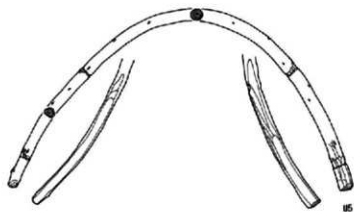
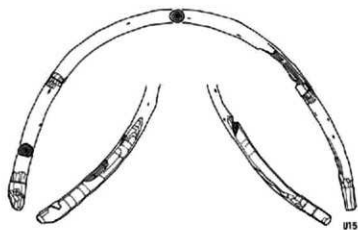
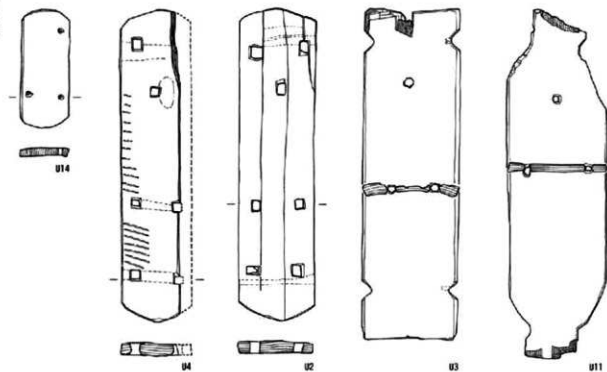

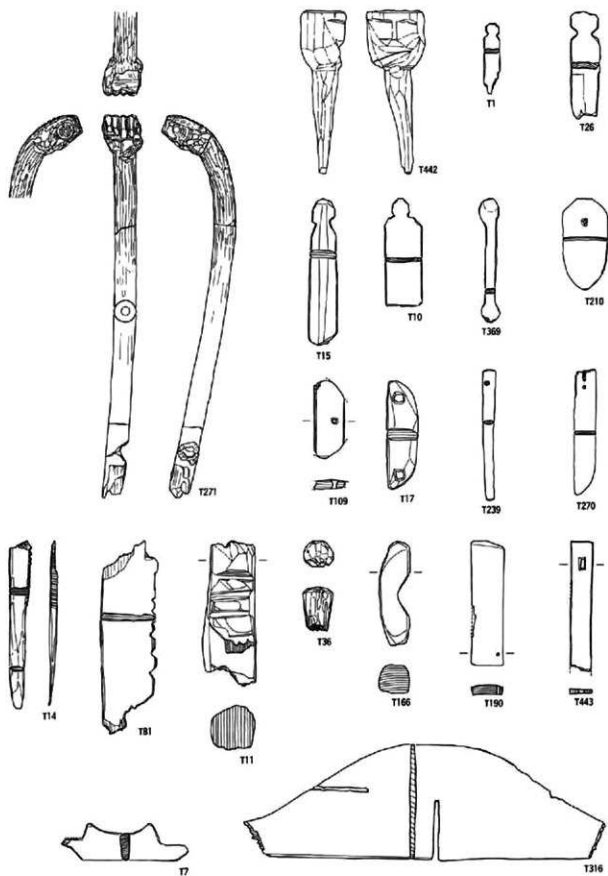



図面96 窪地東岸出土木製品23 (用途不明品部材)

深田遺跡

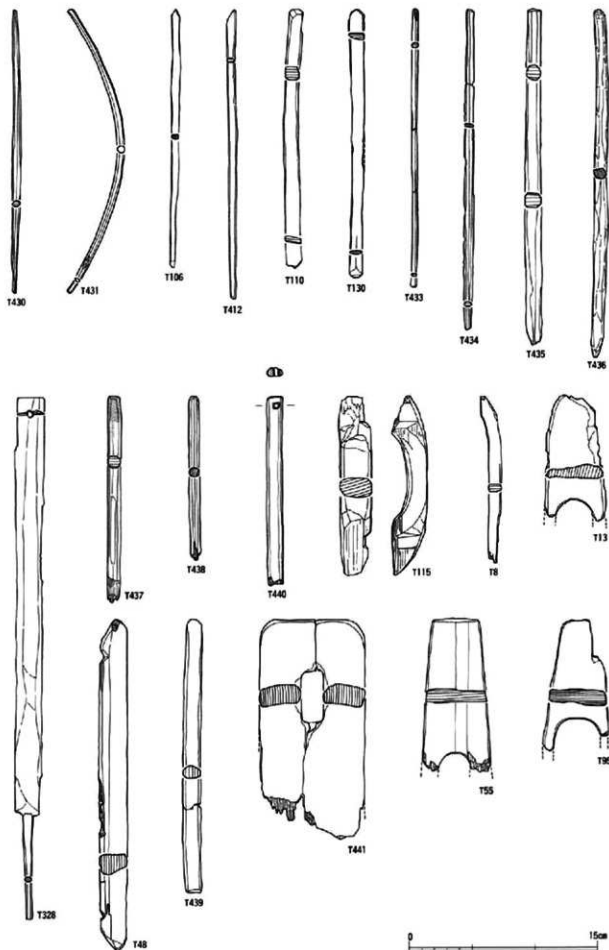

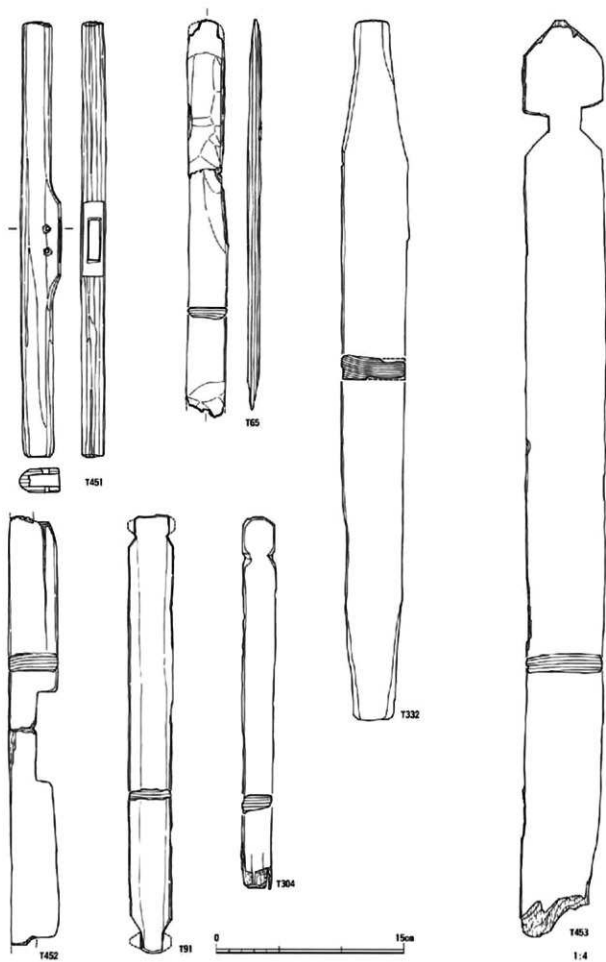

図面98 窪地東・西岸出土木製品25 (用途不明部材)

深田遺跡

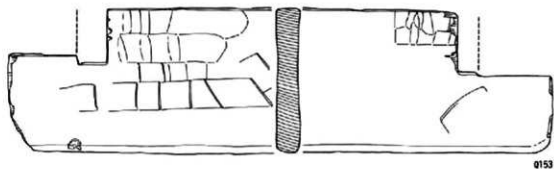
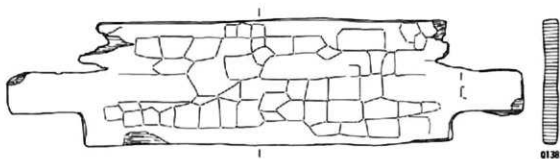

0 30cm

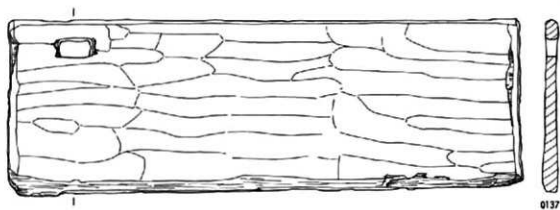
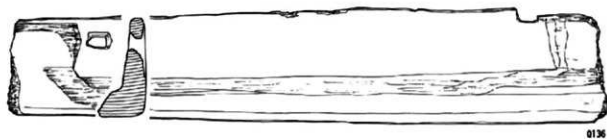
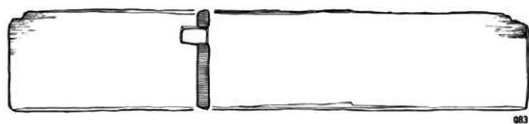

0 20cm

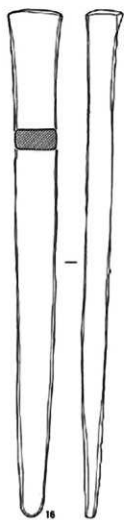
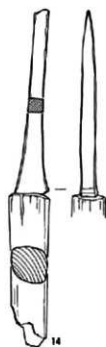
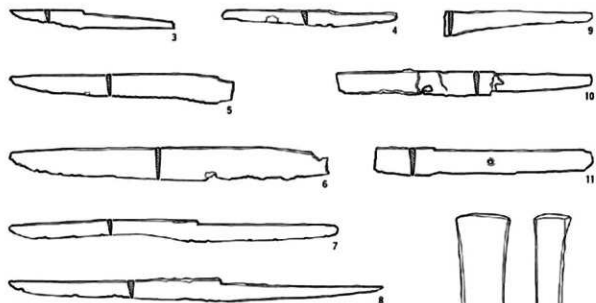
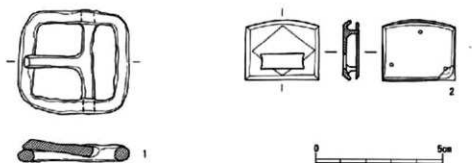

図面100 金属製品 2

深田遺跡

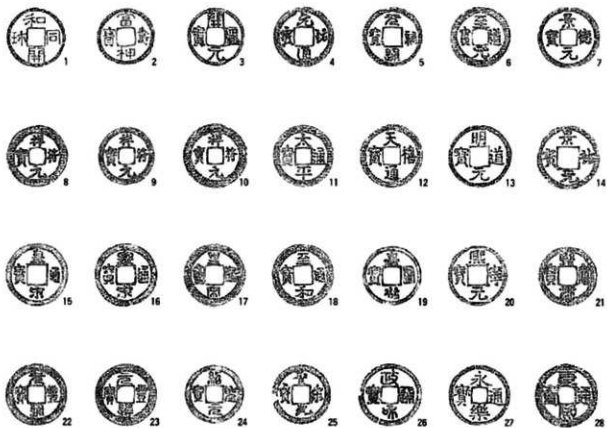
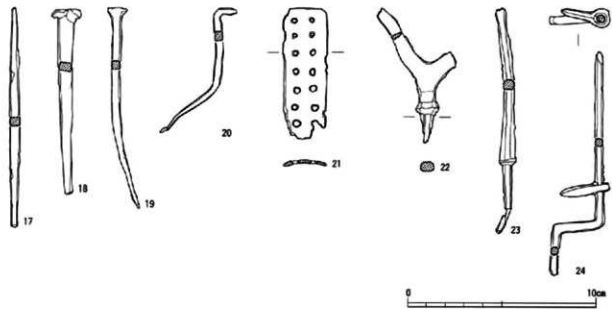

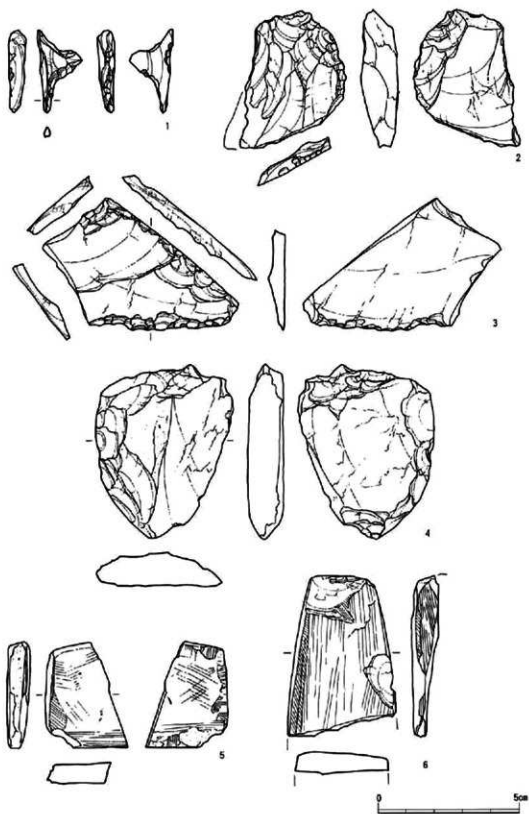

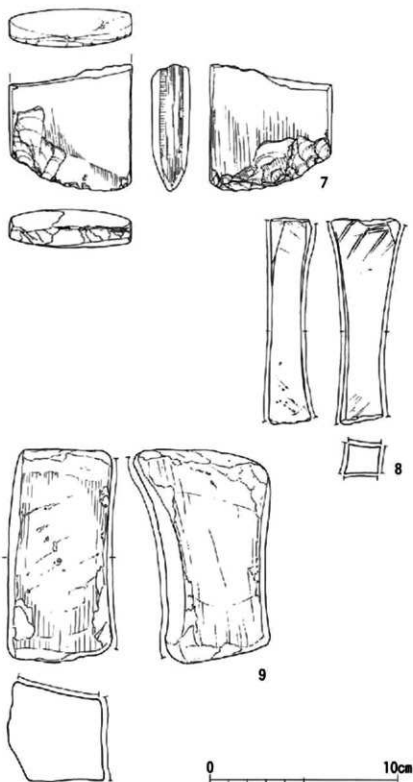

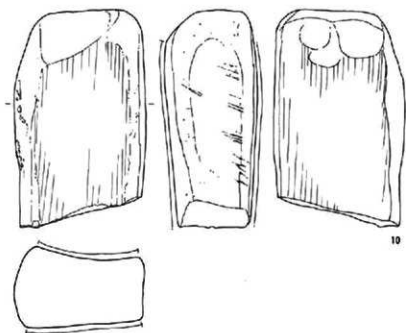

10

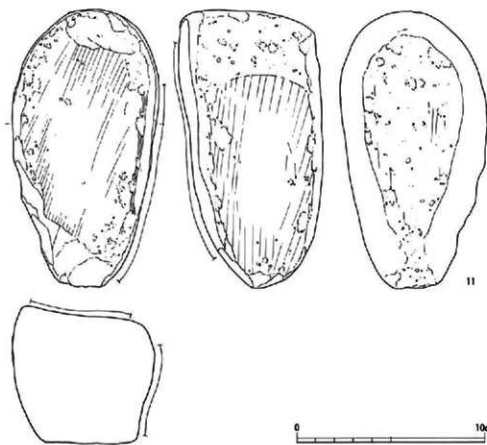

11

0 10cm



図面104 土器・土製品

カナゲ田遺跡

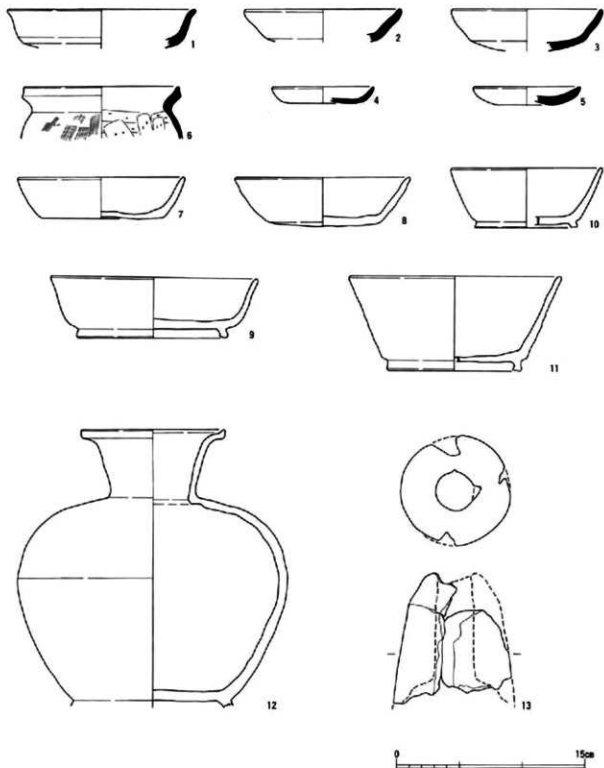

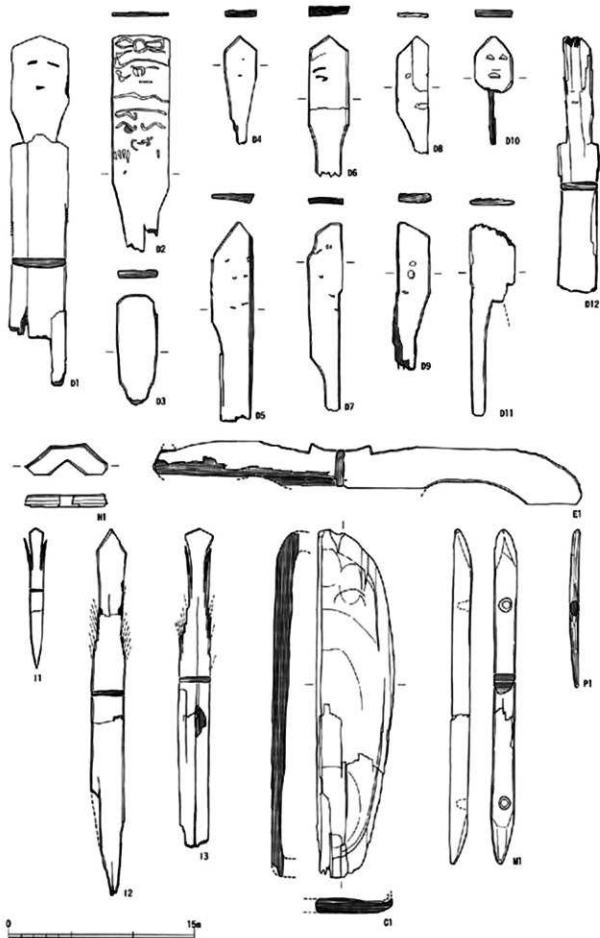

図面106 木製品 2

カナゲ田遺跡

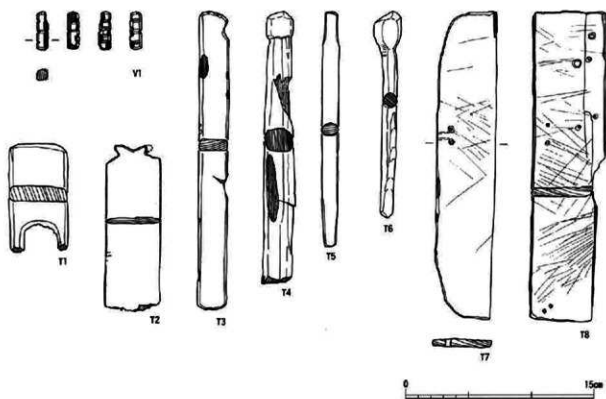
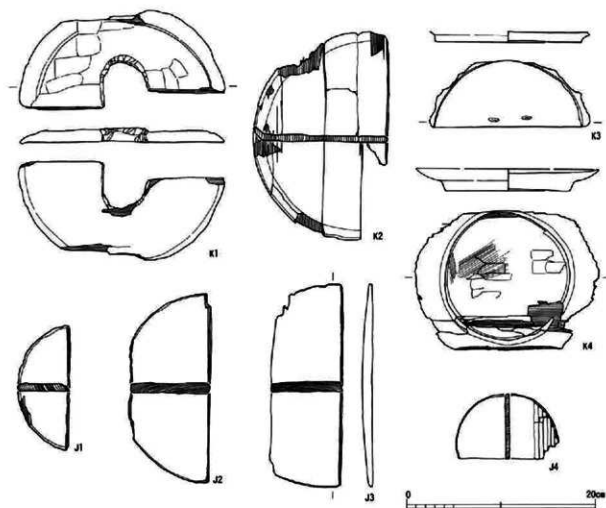

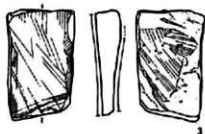
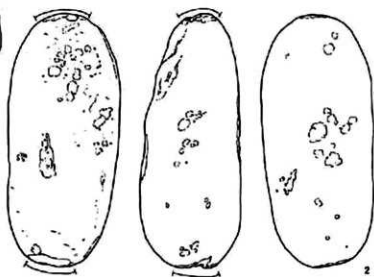
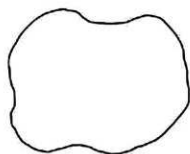
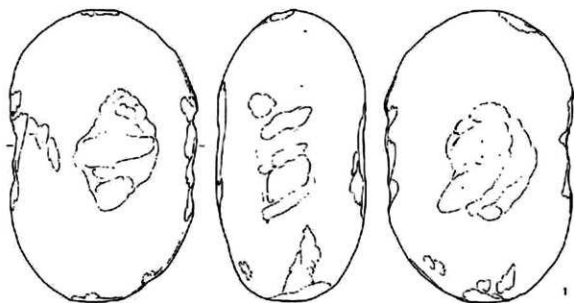

# 圖 版



1. I区航空写真(西から) 2. I区航空写真(北から)



1. 遺地全景  
2. 遺地内の状況

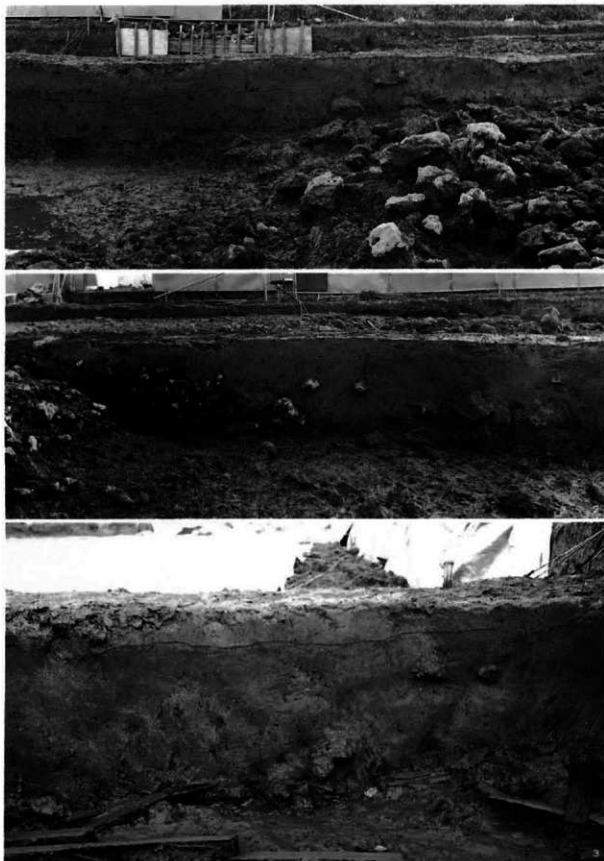

1. 窪地西岸土層（北から） 2. 窪地東岸土層（北から） 3. 窪地南端土層（西から）





1. 西隣高地 (北から)  
2. 西隣高地 (東から)



1. 西岸北半の壘地と溝2 (東から)
2. 西岸北半の壘地 (北から)
3. 西岸北半壘地 除去後

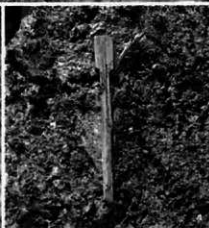

1. 西岸南半の整地  
(北から)
2. 西岸南半整地除去後の人形出土状態
3. 西岸南半整地除去後の遺物出土状態
4. 西岸南半整地除去後の木簡出土状態

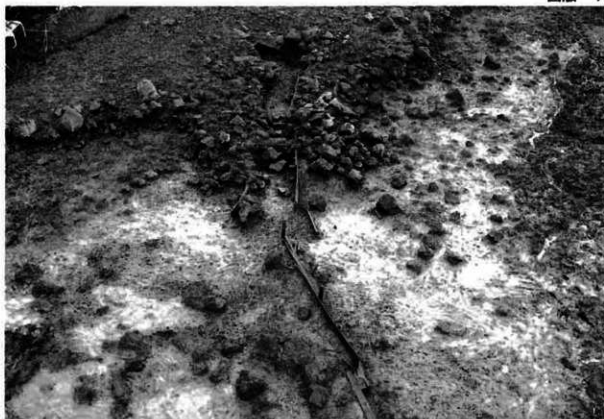

1. 井戸1と溝1 (北から)
2. 井戸1 (北から)
3. 井戸1埋土 (北から)



1. 井戸 2
2. 井戸 2 井戸枠
3. 井戸 2 井戸枠底部



1. 北東隅の墓石 2. 通路1 (東から) ↓



1. 東岸遺物出土状態
2. 東岸遺物出土状態
3. 東岸馬骨出土状態



1. 東岸遺物出土状態 2. 東岸遺物出土状態 (Q-215) 3. 東岸遺物出土状態 (T-271)





1. 全景 2. 柱穴群（東か5） 3. 柱穴2内遺物出土状態 4. 柱穴2

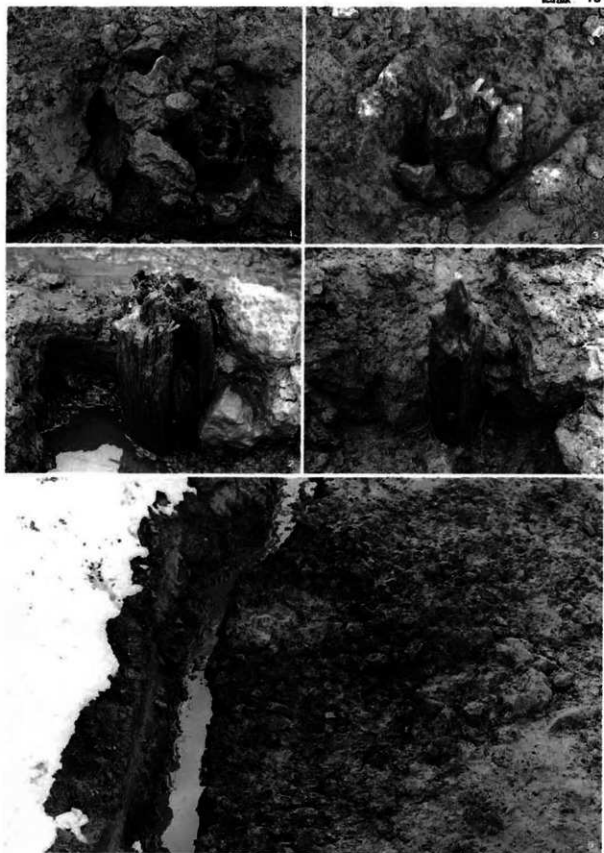

1. 柱穴1 2. 柱穴1内の柱根 3. 柱穴3 4. 柱穴3内の柱根 5. 土壌1



1. 全景 (西から)  
2. 土層 (南から)



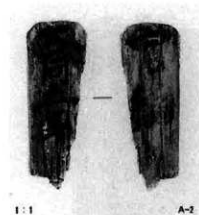

1:1

A-2

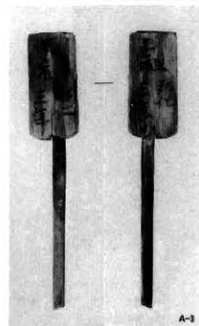

A-3

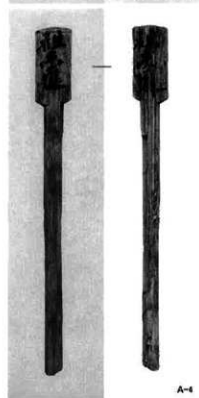

A-5



A-7

A-8

2:1



A-18



A-12



A-22



A-15



A-16



窪地西岸灰色シルト下出土

A-38  
1:1

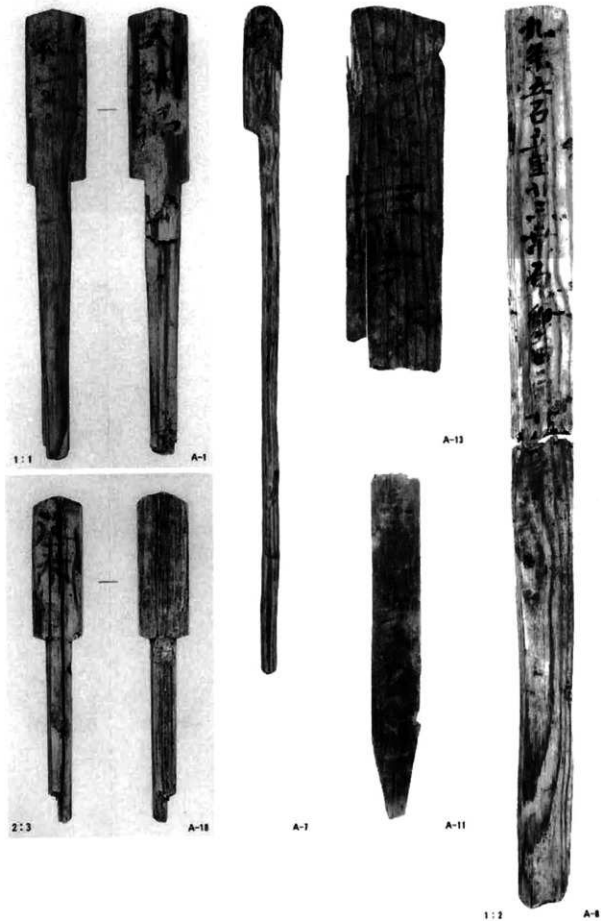



1:1



A-18



2:3



A-23



1:2



A-24

2:3



A-25



1:1



A-34



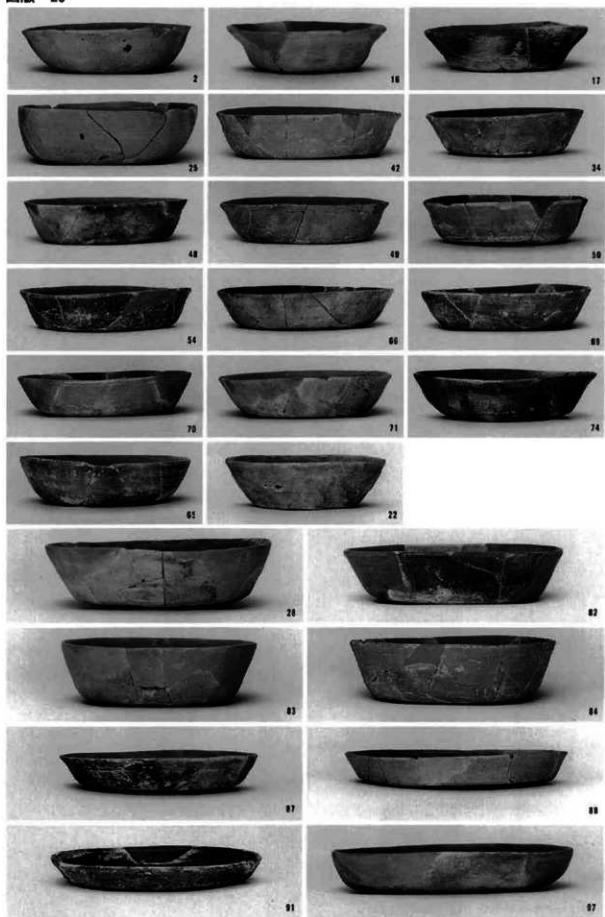



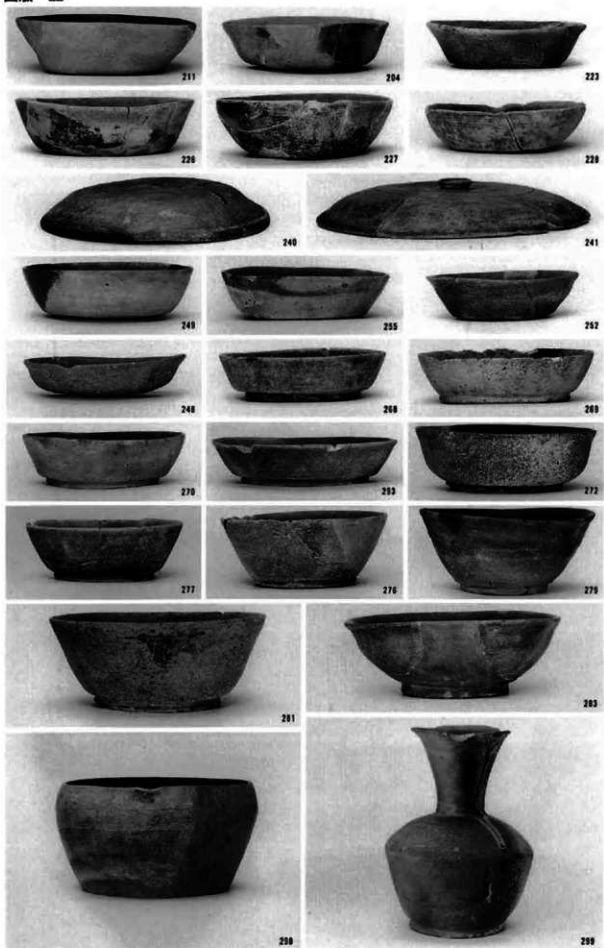



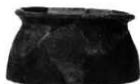

窪地西岸黒灰色シルト上・灰色シルト下



352

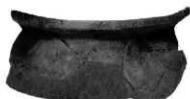

354



356



358



357



362



355



364



365



366



368



367

窪地西岸黒灰色シルト下・灰色シルト上出土

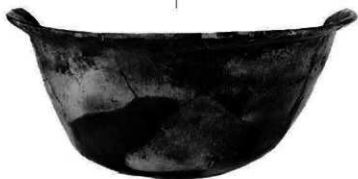

372

378

381

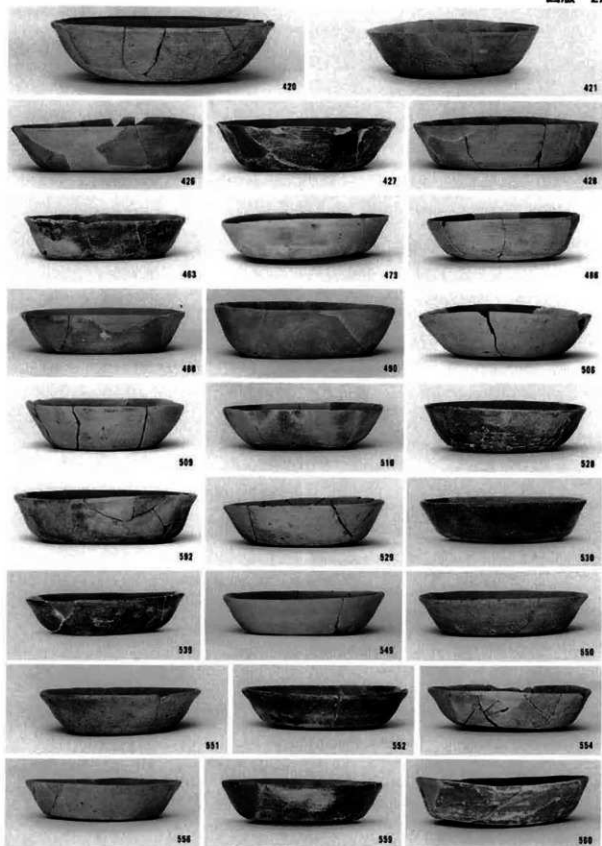

窪地東岸黒灰色シルト出土