

付図1 弥生時代中・後期～古墳時代遺構(第5次遺構面)I・II区(1/600)

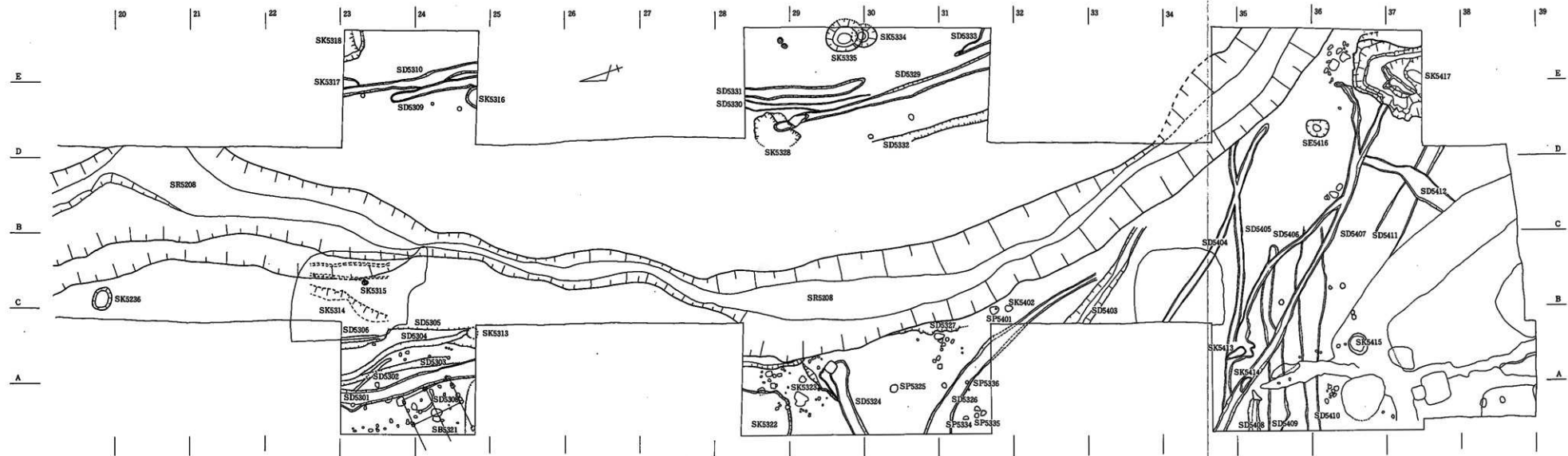

付図2 弥生時代中・後期～古墳時代遺構（第5次遺構面）Ⅲ・Ⅳ区（1/500）

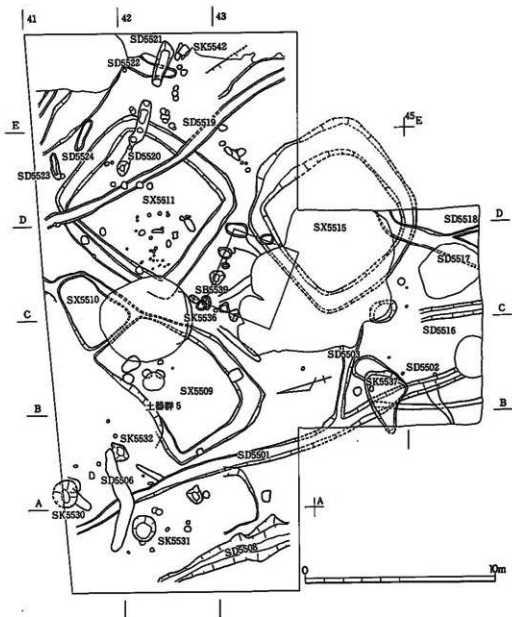

付図3 弥生時代中・後期～古墳時代遺構（第5次遺構面）V区（ $\frac{1}{200}$ ）

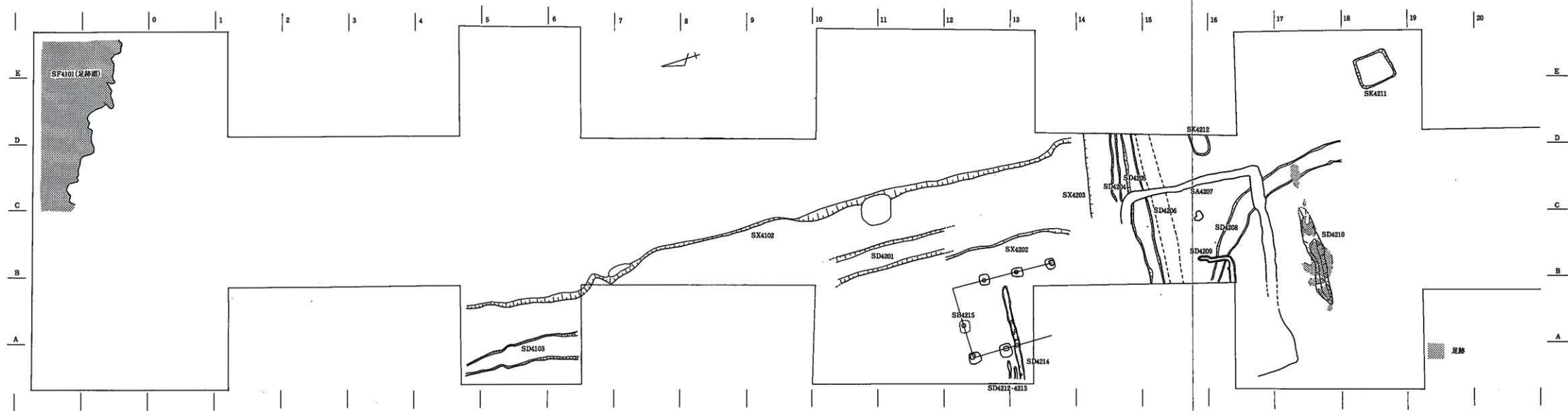

付図4 古代～中世遺構（第4次遺構面）Ⅰ・Ⅱ区（ $\frac{1}{500}$ ）

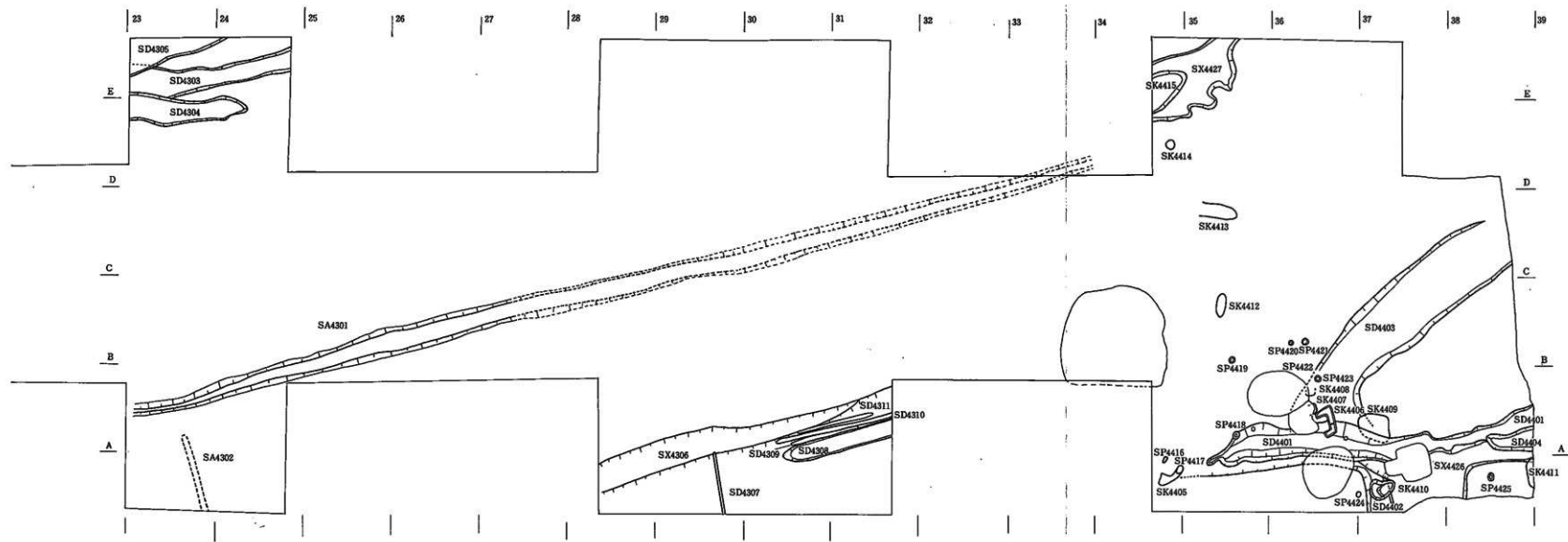

付图5 古代~中世遺構(第4次遺構面)Ⅲ・Ⅳ区(1/500)

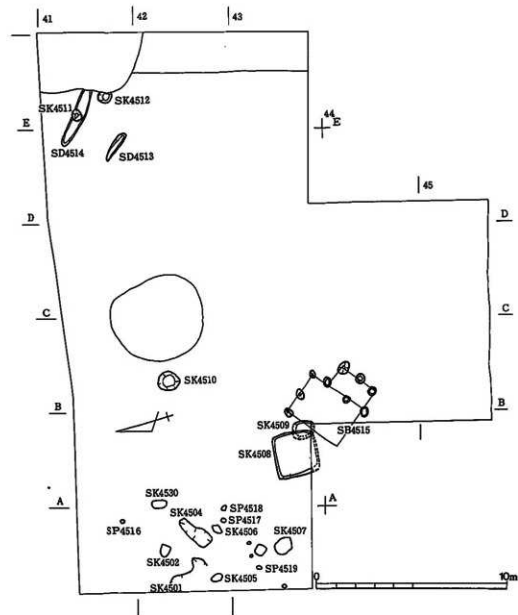

付図6 古代~中世遺構(第4次遺構面)V区(1/500)

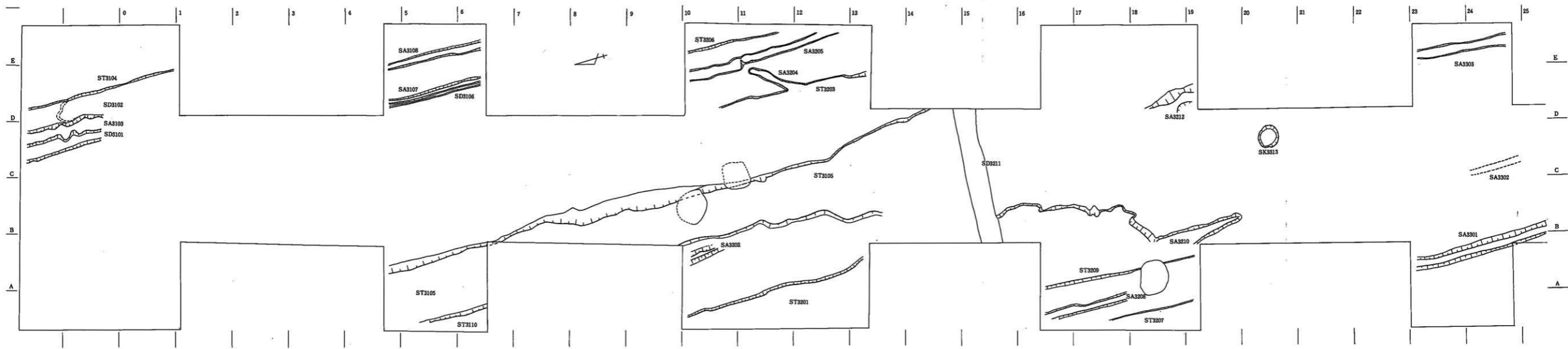

付图7 中世遺構(第3次遺構面)I·II区(1/600)

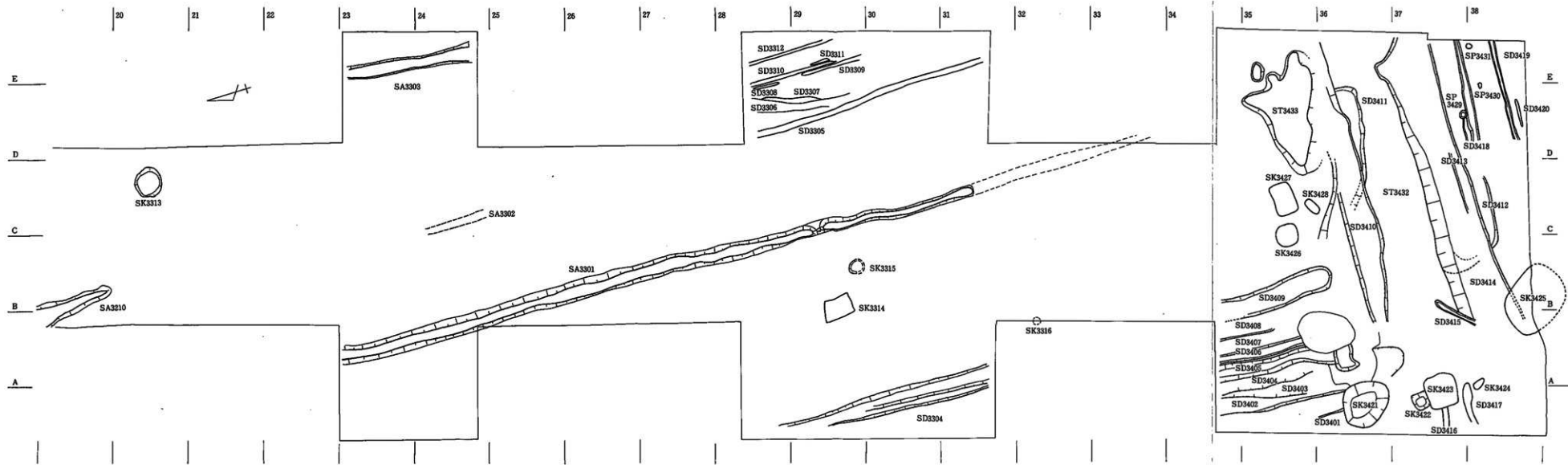

付图8 中世遺構(第3次遺構面)Ⅲ・Ⅳ区(1/200)

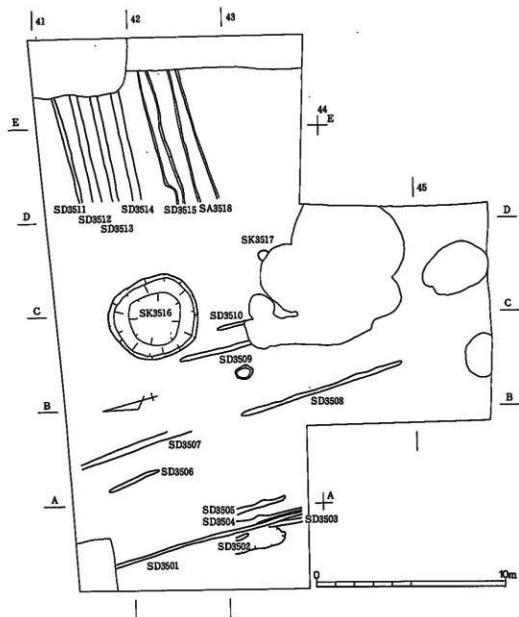

付图9 中世遺構(第3次遺構面)V区(1/500)

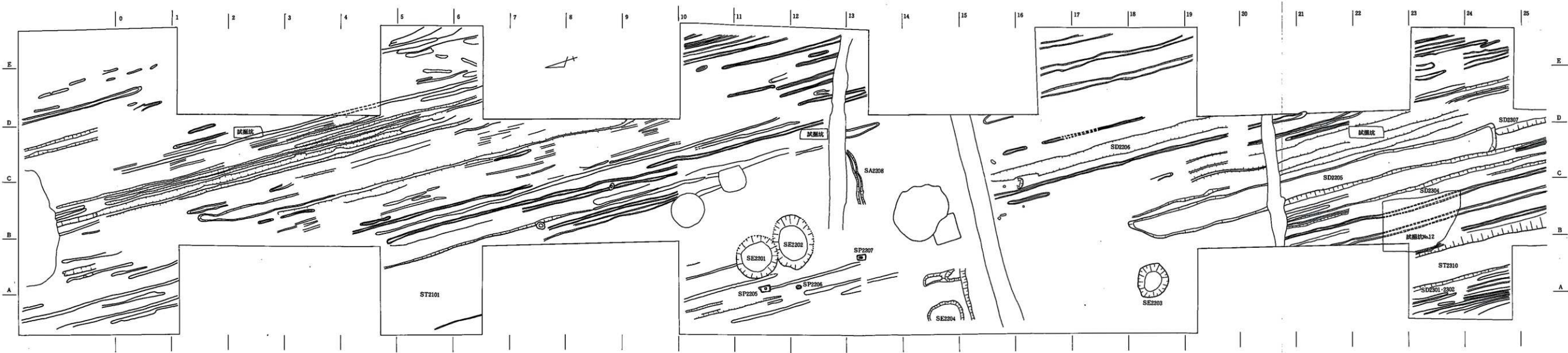

付图10 中世~近世遺構(第2次遺構面) I・II区 (1/60)

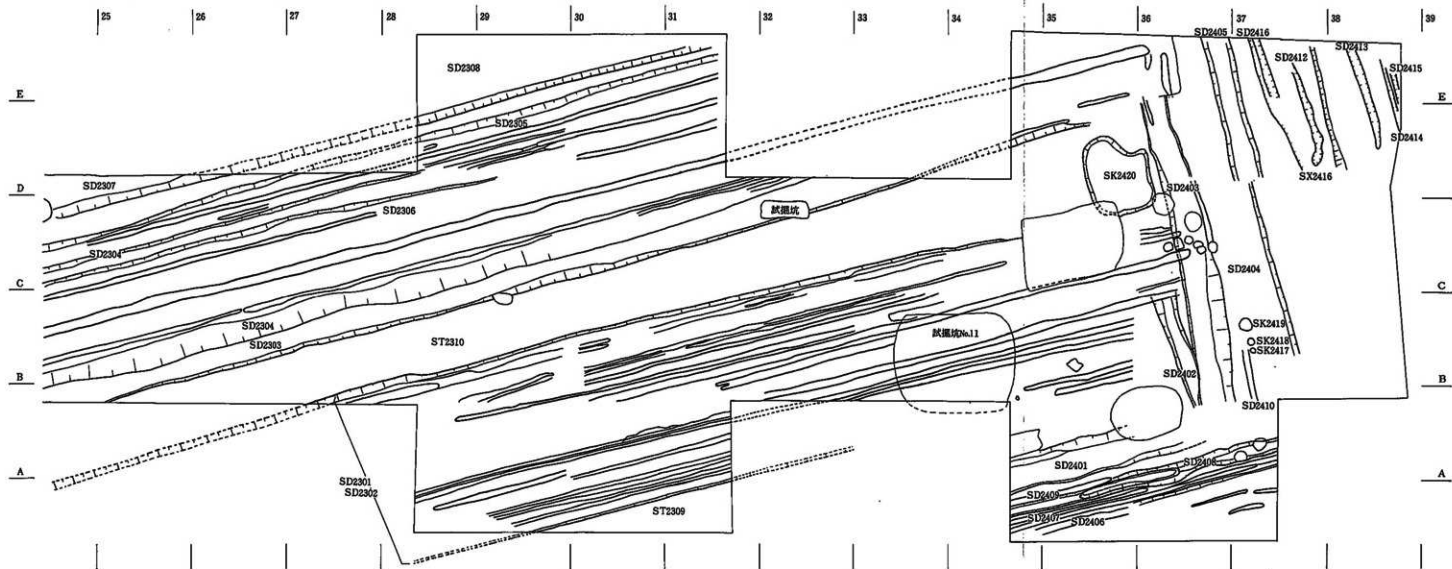

付图11 中世~近世遺構(第2次遺構面)Ⅲ・Ⅳ区(1/600)

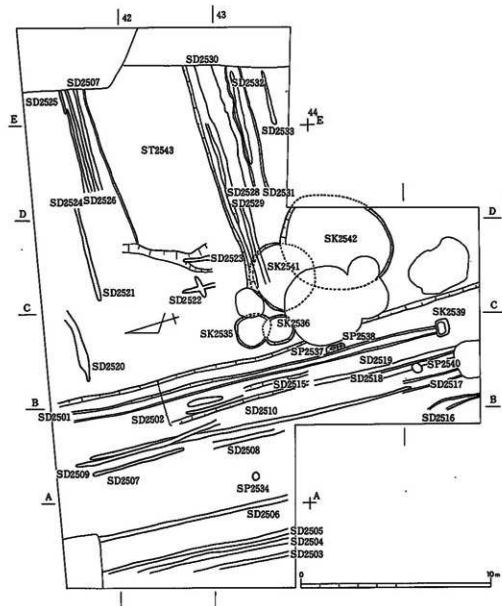

付図12 中世～近世遺構（第2次遺構面）V区（1/60）

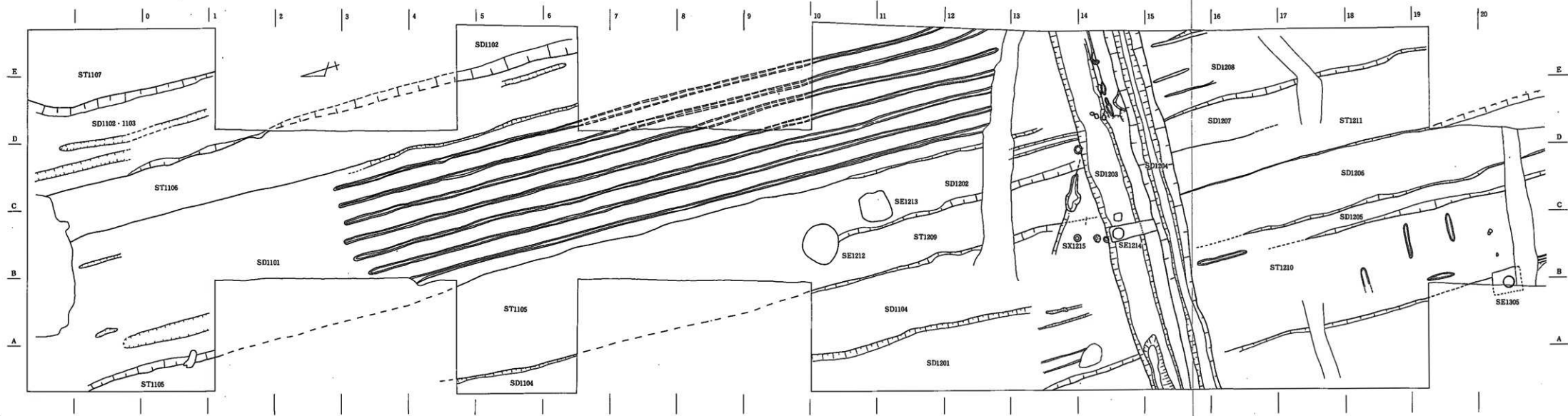

付図13 近代～現代遺構（第1次遺構面）I・II区（1/200）

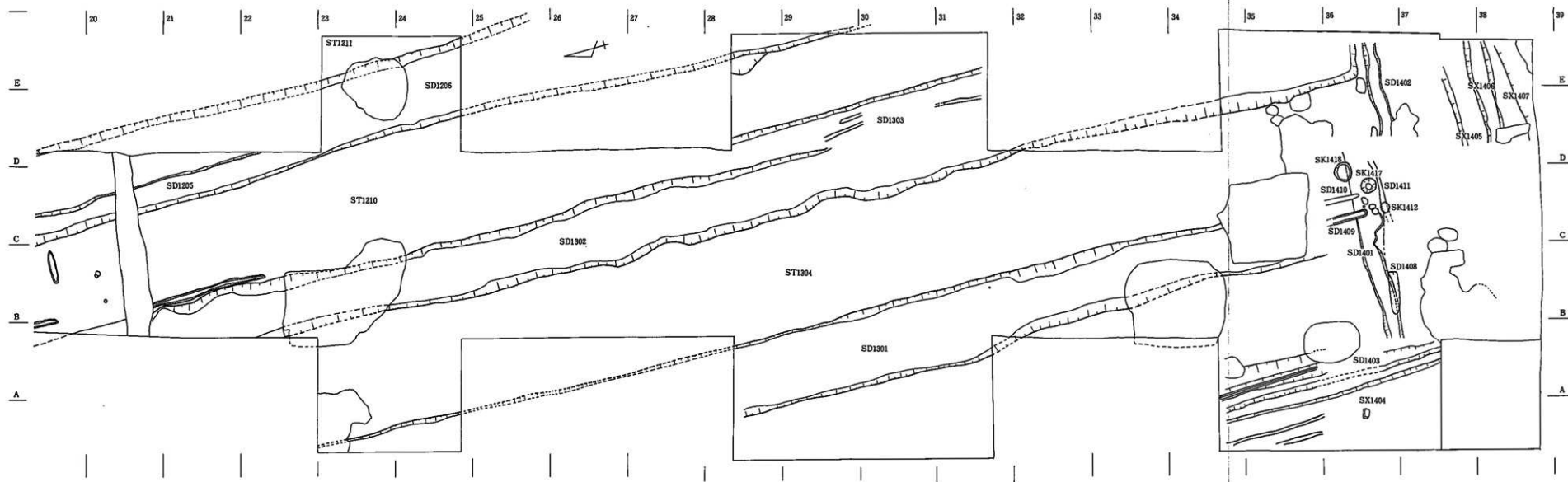

付图14 近代~現代遺構 (第1次遺構面) III・IV区 (1/50,000)

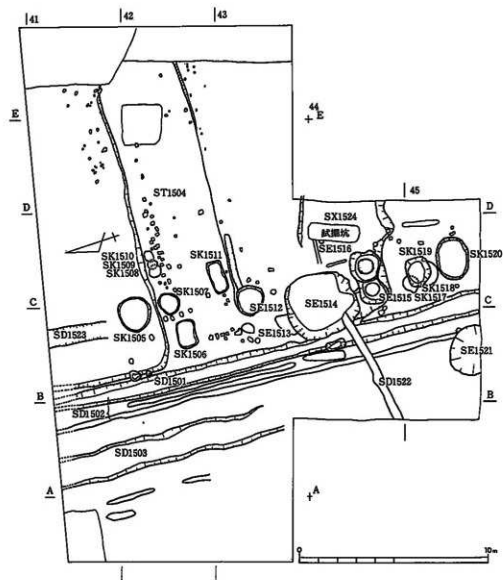

付図15 近代～現代遺構（第1次遺構面）V区（1/500）

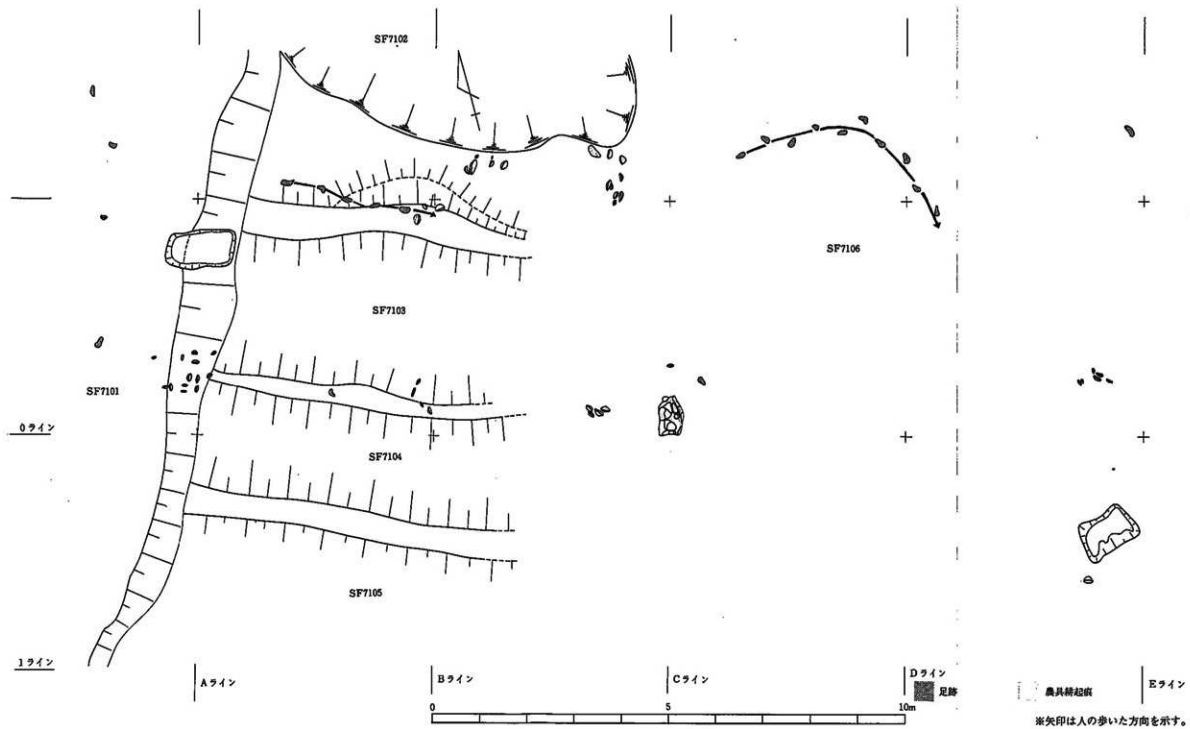

付図16 弥生時代前期水田面 畦畔・足跡・農具耕起痕 1Aトレンチ (3%)

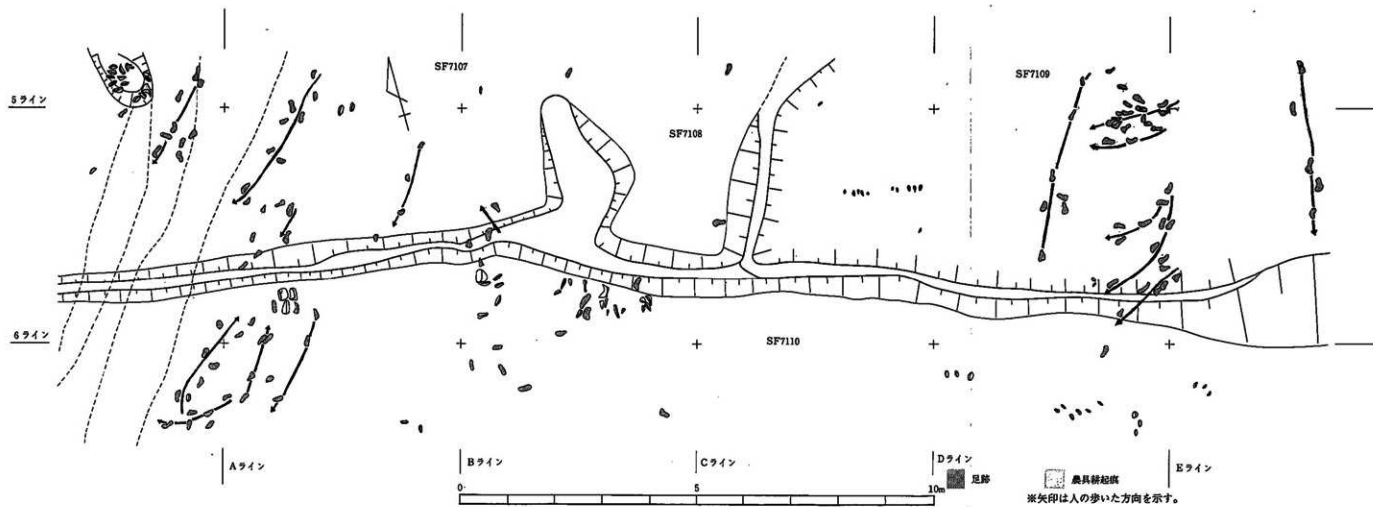

付図17 弥生時代前期水田面 畦畔・足跡・農具耕起痕 2Aトレンチ (3%)

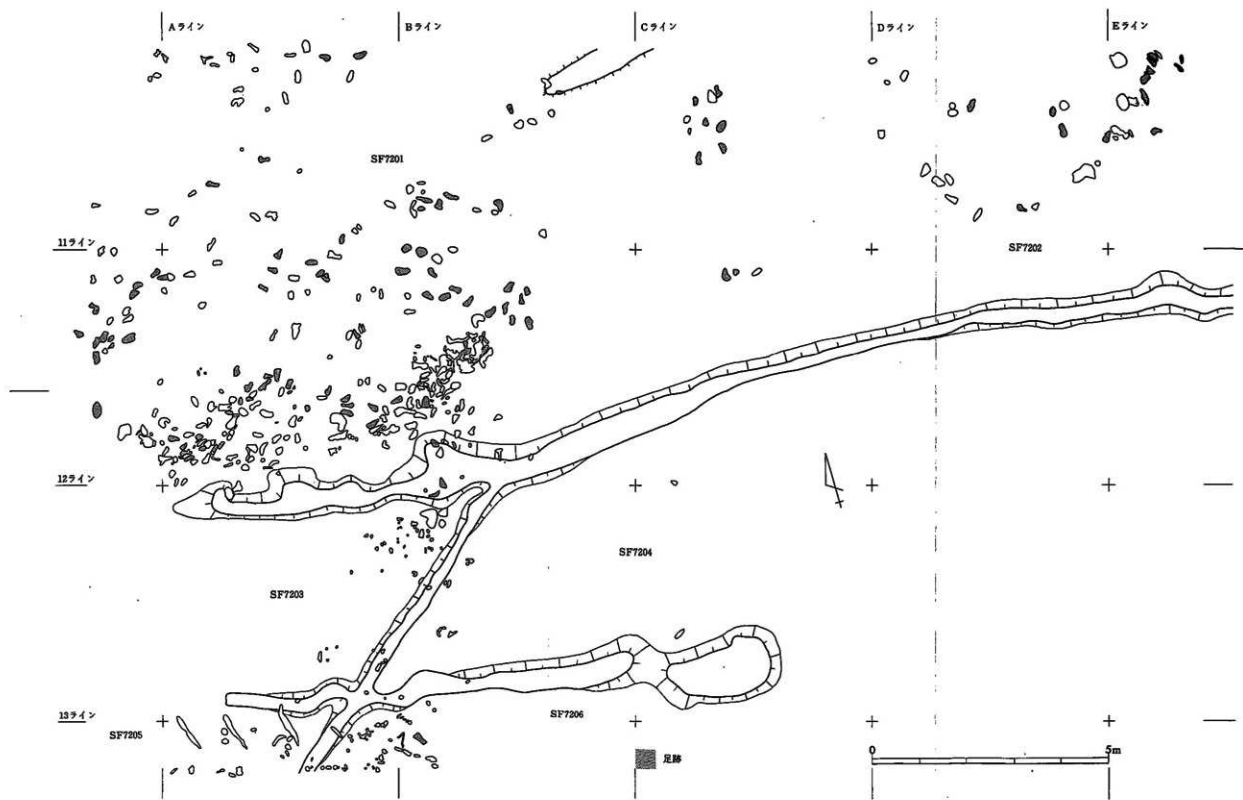

付図18 弥生時代前期水田 畦畔・足跡 3Aトレンチ (1/6)

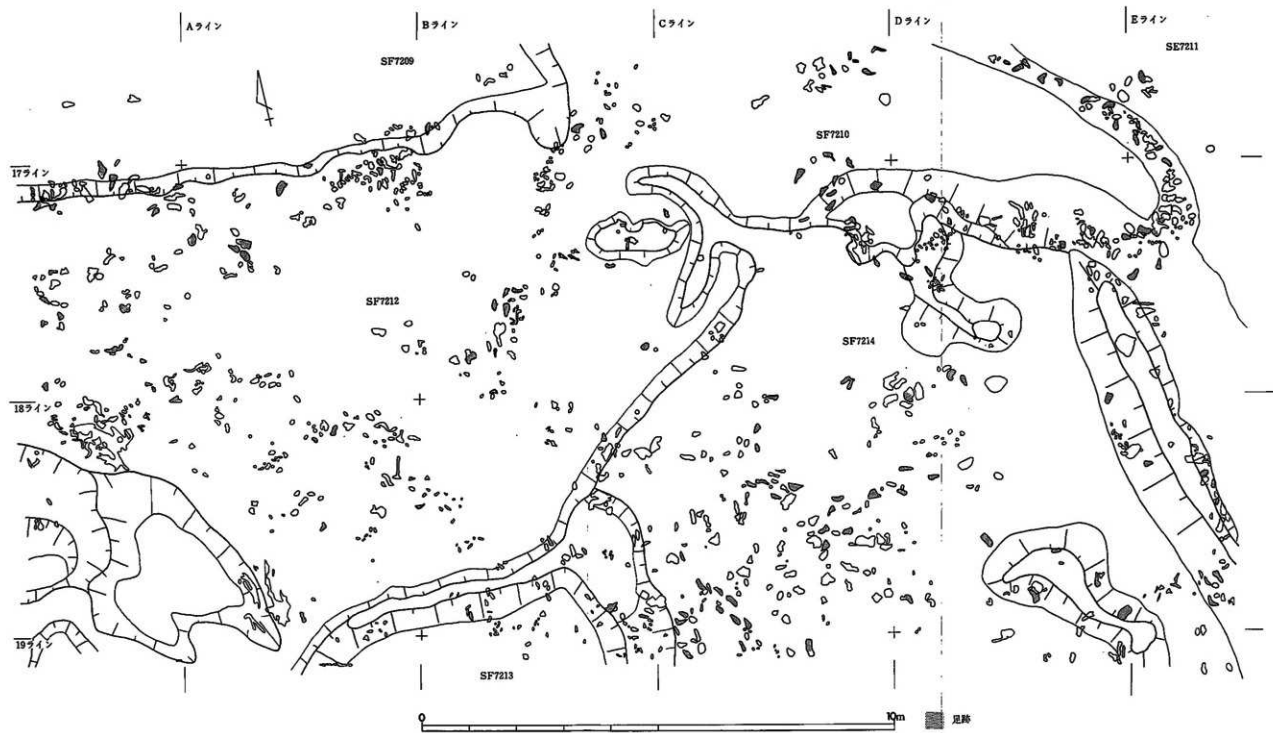

付図19 弥生時代前期水田面 畦畔・足跡 4Aトレンチ (3%)

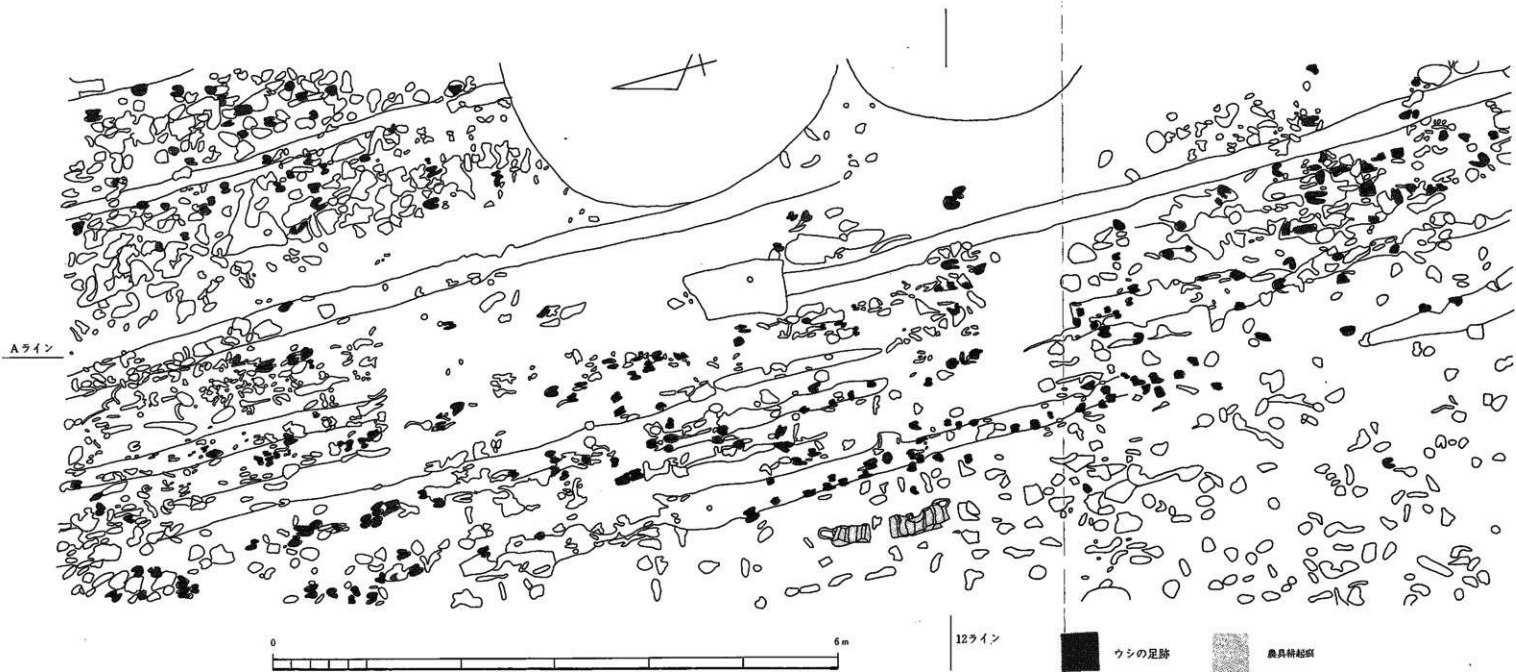

付図20 近世足跡面 足跡・農具耕起痕 3AWトレンチ (3/4)

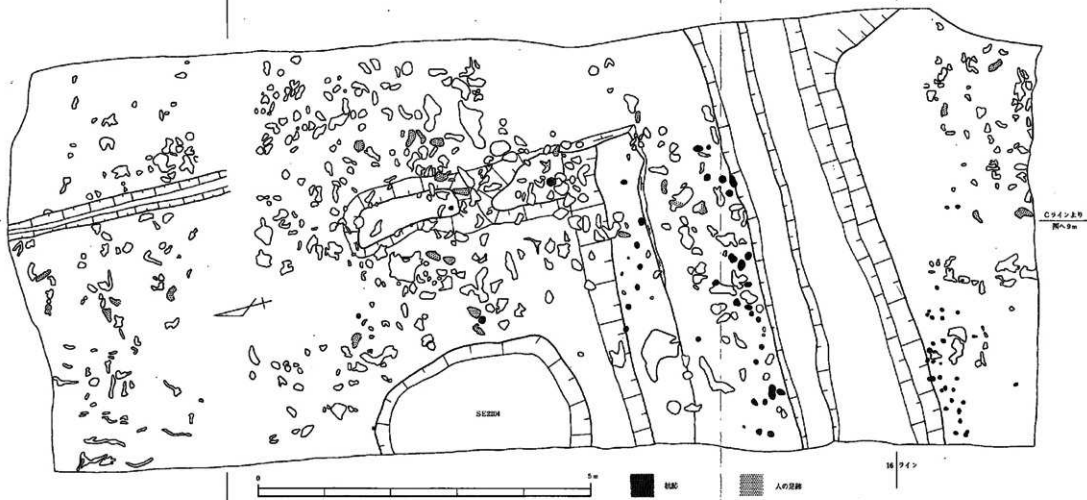

付図21 近世足跡画 3・4間Wトレンナ (36)

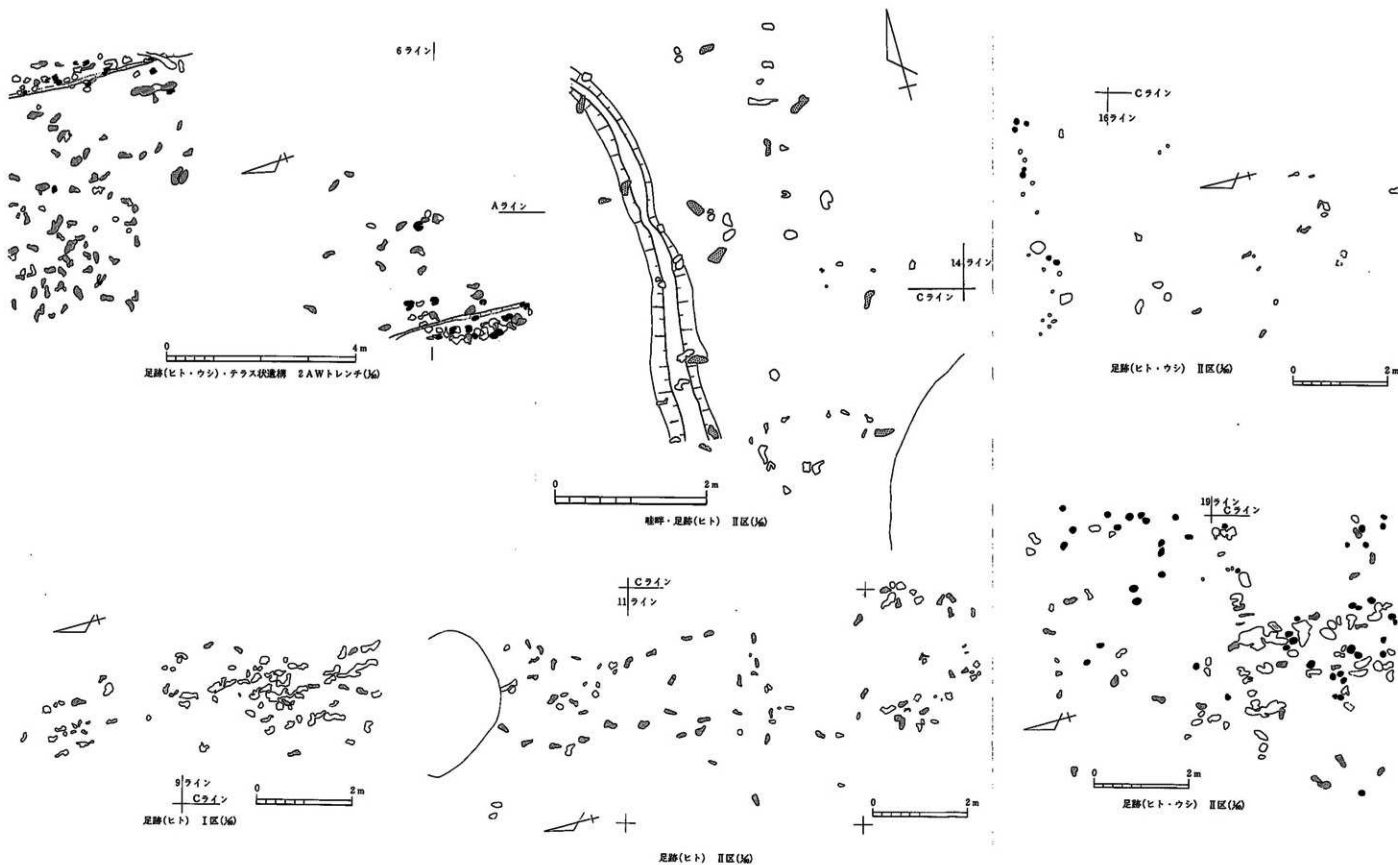

付図22 近世足跡面 I・II区

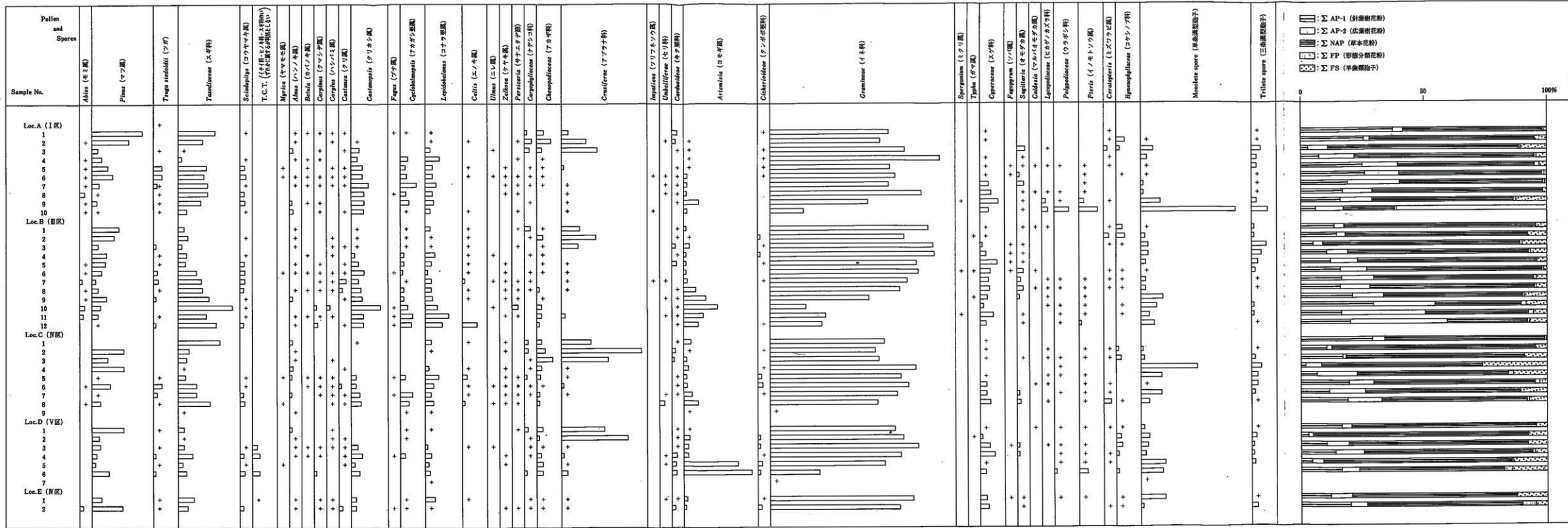

0 50 100%

- AP-1 (針葉樹花粉)
- AP-2 (広葉樹花粉)
- NAP (草本花粉)
- FP (浮遊分粒花粉)
- FS (真菌類胞子)

Trilete spores (三葉型胞子)
 Monoletic spores (単葉型胞子)

付図23 主要花粉・胞子化石ダイアグラム (Loc. A~Loc. E)

0 10 20 30 40 50(%)
+: 1%未満の検出および質微化石試料における検出を示す

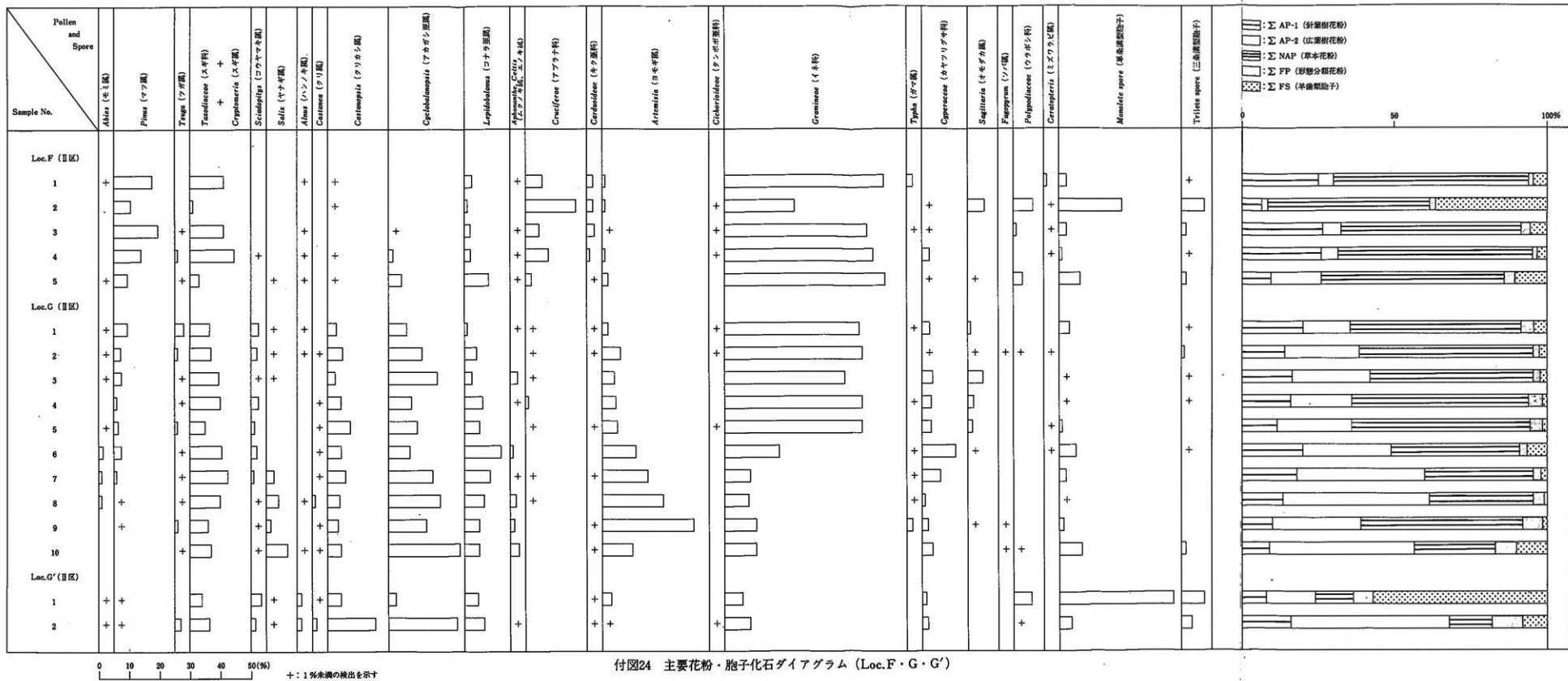

付図24 主要花粉・胞子化石ダイアグラム (Loc. F・G・G')

+: 1%未満の検出を示す

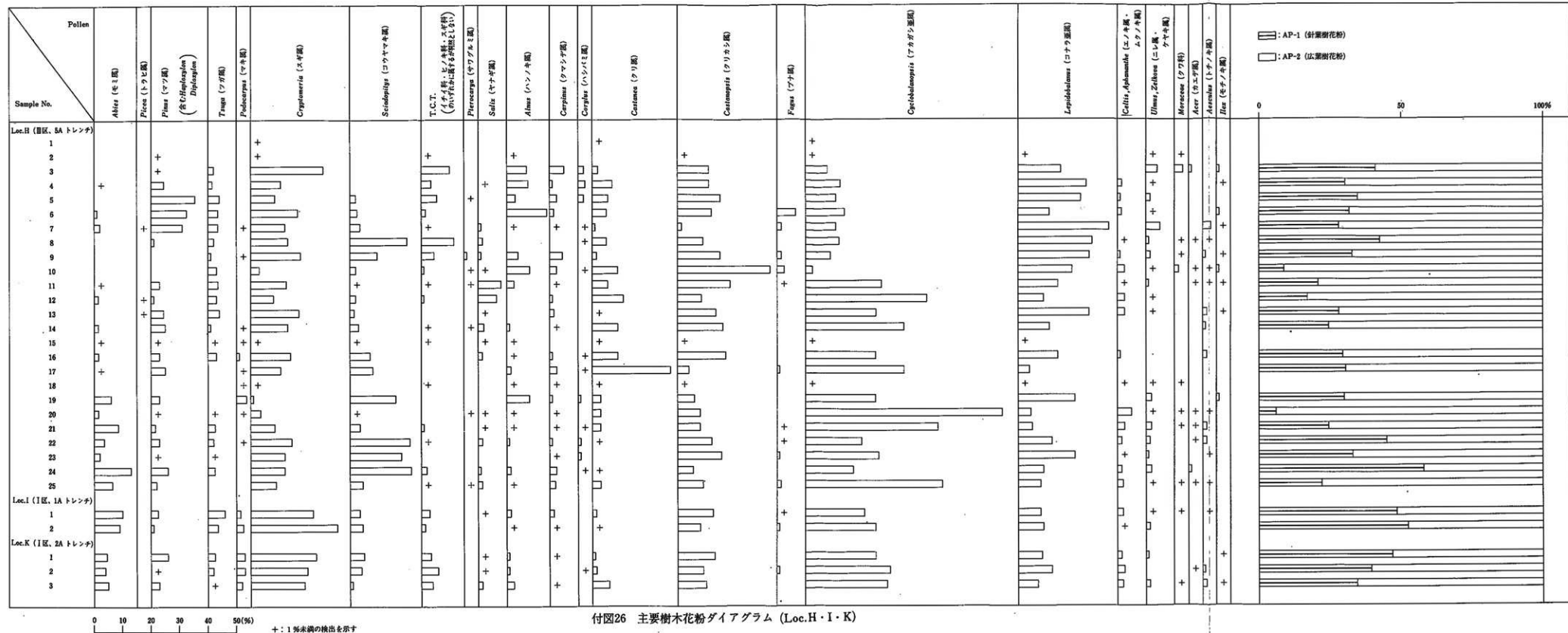

付図26 主要樹木花粉ダイアグラム (Loc.H・I・K)

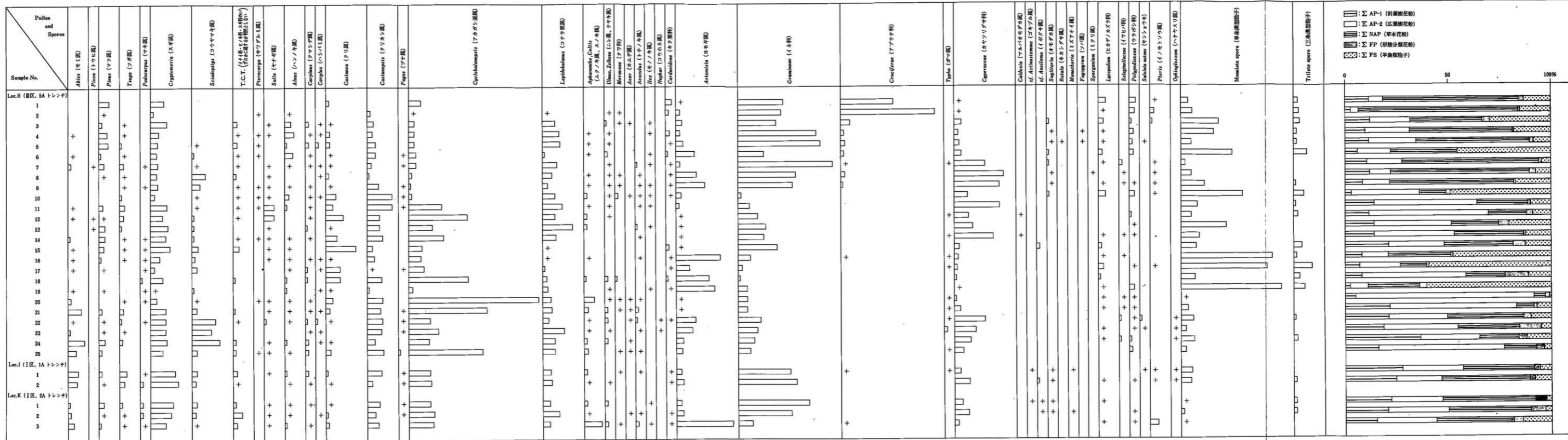

付図25 主要花粉・胞子化石ダイアグラム (Loc.H・I・K)

第1次遺構面 (近代～現代)

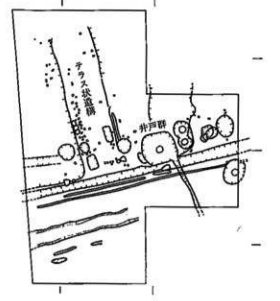
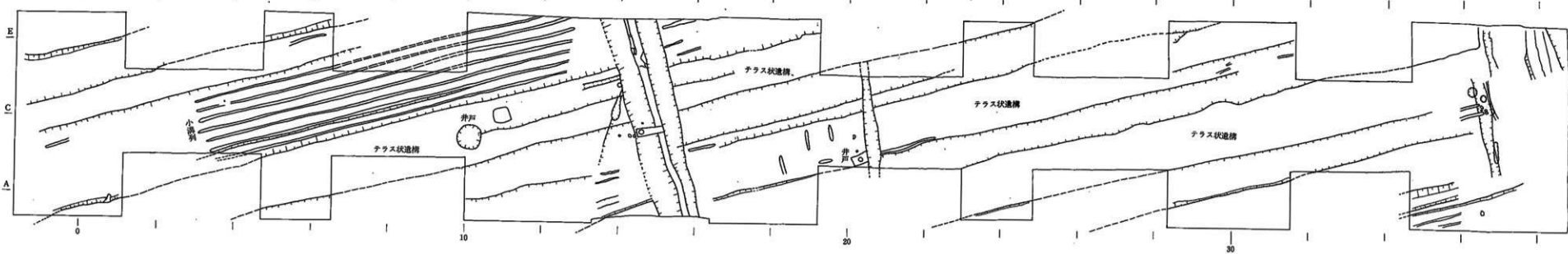

第2次遺構面 (中世～近世)

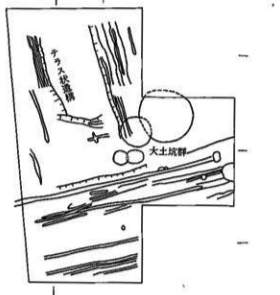
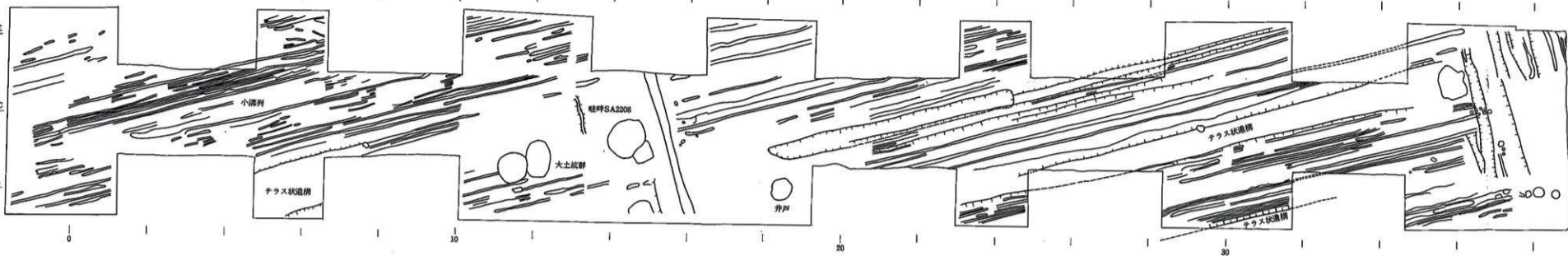

第3次遺構面 (中世)

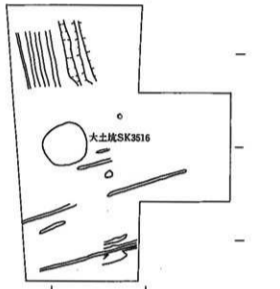
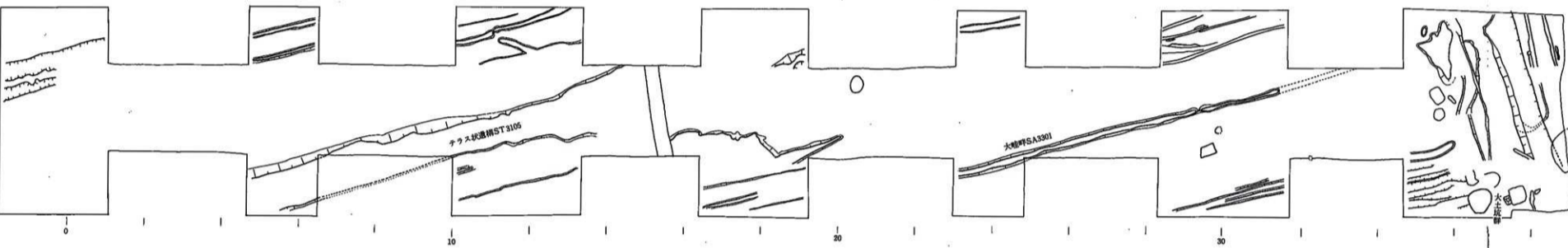

第4次遺構面 (古代～中世)

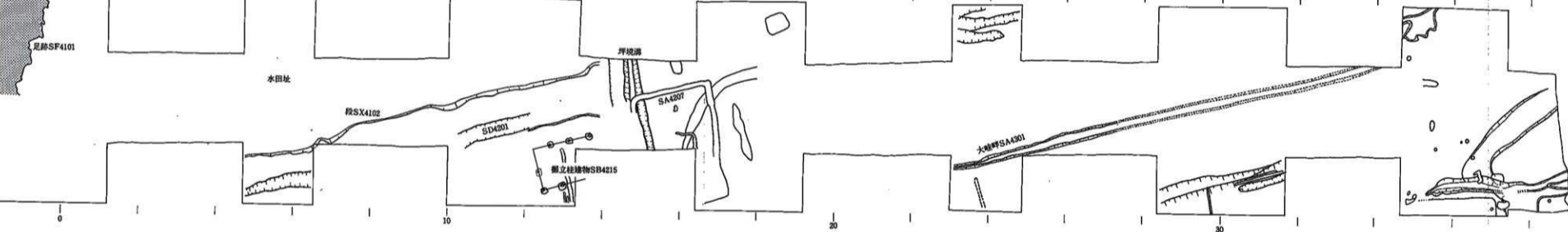

第5次遺構面 (弥生時代中・後期～古墳時代後期)

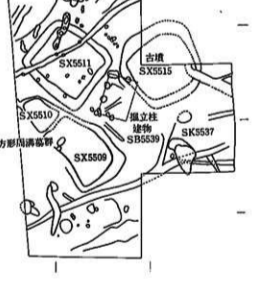
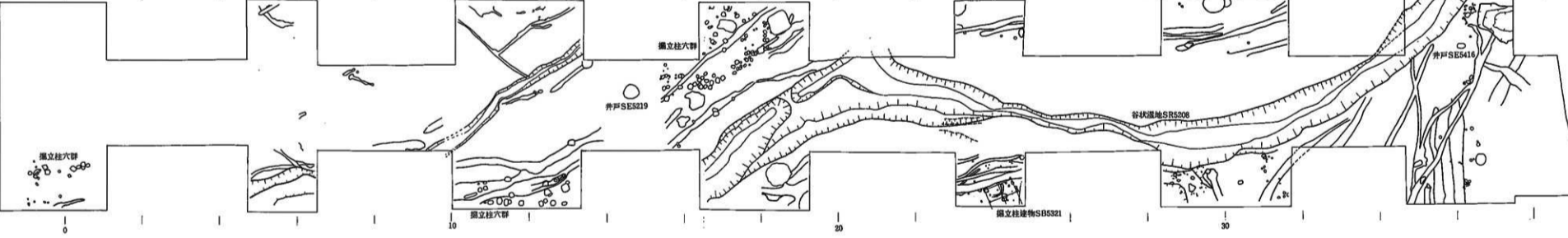

第6次遺構面 (弥生時代中期)

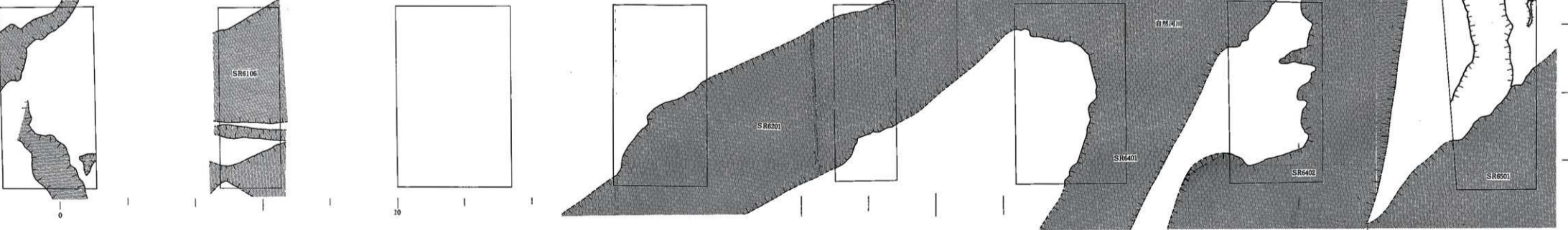

第7次遺構面 (弥生時代前期)

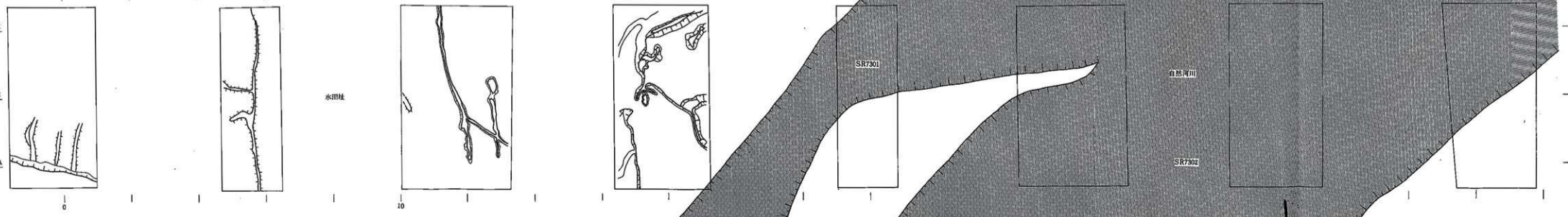

付図27 友井東遺跡遺構変遷図 (1/60)

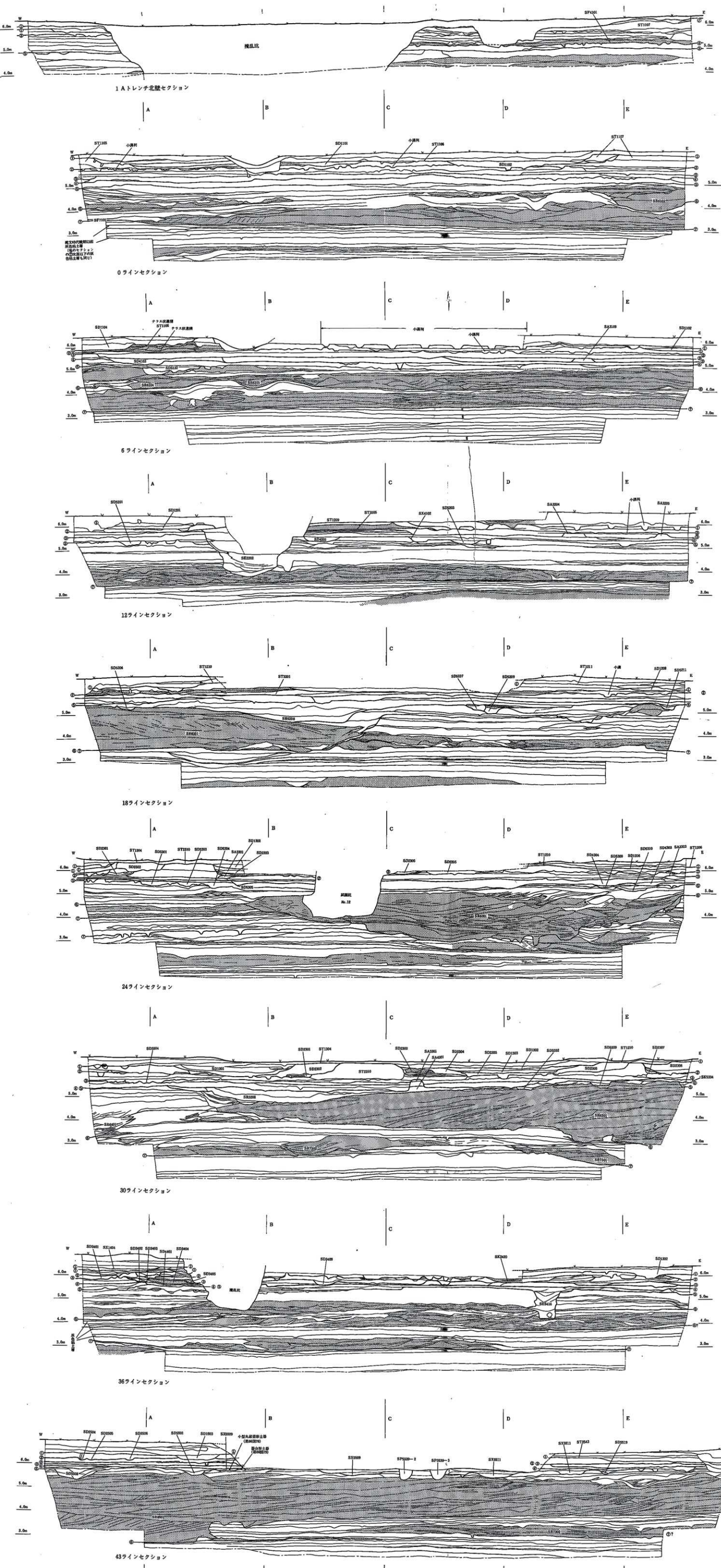

①-④は調査範囲を示す。
 ⑤-⑦は調査範囲外を示す。
 調査範囲は必ず表示する。

付図 28 友井東遺跡横断面図(%)

付表3 花粉・孢子出現率表 (第3次花粉分析)

試料名	採取地	採取日	採取時	Pollen (花粉)		Spores (孢子)		その他	備考
				種類	出現率(%)	種類	出現率(%)		
1									
2									
3									
4									
5									
6									
7									
8									
9									
10									
11									
12									
13									
14									
15									
16									
17									
18									
19									
20									
21									
22									
23									
24									
25									
26									
27									
28									
29									
30									
31									
32									
33									
34									
35									
36									
37									
38									
39									
40									
41									
42									
43									
44									
45									
46									
47									
48									
49									
50									
51									
52									
53									
54									
55									
56									
57									
58									
59									
60									
61									
62									
63									
64									
65									
66									
67									
68									
69									
70									
71									
72									
73									
74									
75									
76									
77									
78									
79									
80									
81									
82									
83									
84									
85									
86									
87									
88									
89									
90									
91									
92									
93									
94									
95									
96									
97									
98									
99									
100									

単位：%

+ : 1%未満の出現を示す

※ : 拡大花粉の百分率