

中央自動車道長野線
埋蔵文化財発掘調査報告書 8

— 松本市内 その5 —

北 栗 遺 跡

図 版 編

1990

日本道路公団名古屋建設局
長野県教育委員会
財)長野県埋蔵文化財センター

中央自動車道長野線
埋蔵文化財発掘調査報告書 8

—松本市内 その5—

北 栗 遺 跡

図 版 編

1990

日本道路公団名古屋建設局
長野県教育委員会
(財)長野県埋蔵文化財センター

凡 例

1 本書に掲載した実測図の縮尺は、特に断りのある場合を除いて下記のように統一してある。

(1) 遺構実測図

本文挿図 竪穴住居址・竪立柱建物址 1:60 住居址内施設・墓址・土坑 1:40

(2) 遺物実測図等

土器・陶磁器 1:4 文字関係資料 1:3 墨書文字 1:2 土器拓影 1:3

金属製品 1:2 石器・石製品 1:6 ~ 2:3 銭貨拓影 2:3

(3) 遺物写真

土器・陶磁器 2:5 内耳鍋・常滑系甕 1:4 中世土器・陶磁器破片 1:2

鉄製品 1:2 銅製品・銭貨 1:1 石器・石製品 1:6 ~ 2:3

2 遺物実測図の番号は、遺跡ごとに次のように付けてある。

(1) 縄文・弥生土器、石器……1から通し番号 (4) 文字関係資料……1から通し番号

(2) 古代土器……各遺構毎の通し番号 (5) 金属製品……1から通し番号

(3) 中・近世土器・陶磁器……1から通し番号 (6) 古代以降の石製品……1から通し番号

3 実測図中のスクリーン等は以下の事項を表わしている。

(1) 遺構

ア 竪穴住居址

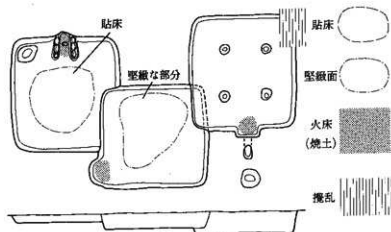

イ 竪立柱建物址

本文中の竪立柱建物址模式図は、
約1:200で以下の事項を表している。

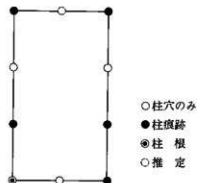

(2) 遺物

ア 古代土器

① 実測図の断面は、黒色土器、赤彩土器を含む土師器—白抜き、須恵器—施釉陶器—黒塗り、輸入陶磁器—スクリーンによって区別した。黒色処理、赤彩を施したものはその処理された器面の範囲に、漆・炭化物の付着については以下のスクリーンにより表現してある。



② 施釉陶磁器の施釉範囲は一点鎖線で示した。

イ 中・近世土器・陶磁器

① 実測図の断面は、土器—白抜き、陶器—黒塗り、輸入陶磁器—スクリーンにより区別してある。

② 国産陶磁器の釉の種類は以下のスクリーンにより区別してある。但し、灰釉は白抜きにした。



⑤ 施軸陶磁器の施軸範囲は一点鎖線で示した。

ウ 金属製品

- ① 金属製品の形状はX線等の観察にもとづいており、錆・付着物によるふくらみは線の太さをおとして表現してある。
- ② 断面図は、平面形状観察にさしさわりのない範囲で平面図に組み入れてある。
- ③ 鉄製品、銅製品の断面図と、漆、炭化物の付着および木質部をスクリーンで表現してある。



鉄製品



銅製品



漆



炭化物・木質部

エ 石器・石製品

- ① 打製石斧・磨石等の磨耗範囲は  で示し、砥石の使用面は、断面図に「← →」で示した。

オ 土製品

- ① 羽口のタール付着・ガラス状発泡範囲を  、被熱により変色した範囲を  で示した。

図 版 目 次

- | | |
|-----------------|---------------|
| 図版 1 周辺遺跡範囲図 | 図版 44 古代遺構実測図 |
| 図版 2 周辺の地形と調査範囲 | 図版 45 古代遺構実測図 |
| 図版 3 遺構分布図 古代面 | 図版 46 古代遺構実測図 |
| 図版 4 遺構分布図 中世面 | 図版 47 古代遺構実測図 |
| 図版 5 古代遺構割付図 | 図版 48 古代遺構実測図 |
| 図版 6 古代遺構実測図 | 図版 49 古代遺構実測図 |
| 図版 7 古代遺構実測図 | 図版 50 古代遺構実測図 |
| 図版 8 古代遺構実測図 | 図版 51 古代遺構実測図 |
| 図版 9 古代遺構実測図 | 図版 52 古代遺構実測図 |
| 図版 10 古代遺構実測図 | 図版 53 古代遺構実測図 |
| 図版 11 古代遺構実測図 | 図版 54 古代遺構実測図 |
| 図版 12 古代遺構実測図 | 図版 55 古代遺構実測図 |
| 図版 13 古代遺構実測図 | 図版 56 古代遺構実測図 |
| 図版 14 古代遺構実測図 | 図版 57 古代遺構実測図 |
| 図版 15 古代遺構実測図 | 図版 58 古代遺構実測図 |
| 図版 16 中世遺構割付図 | 図版 59 古代遺構実測図 |
| 図版 17 中世遺構実測図 | 図版 60 古代遺構実測図 |
| 図版 18 中世遺構実測図 | 図版 61 古代遺構実測図 |
| 図版 19 中世遺構実測図 | 図版 62 古代遺構実測図 |
| 図版 20 中世遺構実測図 | 図版 63 古代遺構実測図 |
| 図版 21 中世遺構実測図 | 図版 64 古代遺構実測図 |
| 図版 22 古代遺構割付図 | 図版 65 古代遺構実測図 |
| 図版 23 古代遺構実測図 | 図版 66 古代遺構実測図 |
| 図版 24 古代遺構実測図 | 図版 67 古代遺構実測図 |
| 図版 25 古代遺構実測図 | 図版 68 古代遺構実測図 |
| 図版 26 古代遺構実測図 | 図版 69 古代遺構実測図 |
| 図版 27 古代遺構実測図 | 図版 70 古代遺構実測図 |
| 図版 28 古代遺構実測図 | 図版 71 古代遺構実測図 |
| 図版 29 古代遺構実測図 | 図版 72 古代遺構実測図 |
| 図版 30 古代遺構実測図 | 図版 73 古代遺構実測図 |
| 図版 31 古代遺構実測図 | 図版 74 古代遺構実測図 |
| 図版 32 古代遺構実測図 | 図版 75 古代遺構実測図 |
| 図版 33 古代遺構実測図 | 図版 76 古代遺構実測図 |
| 図版 34 古代遺構実測図 | 図版 77 古代遺構実測図 |
| 図版 35 古代遺構実測図 | 図版 78 古代遺構実測図 |
| 図版 36 古代遺構実測図 | 図版 79 古代遺構実測図 |
| 図版 37 古代遺構実測図 | 図版 80 古代遺構実測図 |
| 図版 38 古代遺構実測図 | 図版 81 古代遺構実測図 |
| 図版 39 古代遺構実測図 | 図版 82 古代遺構実測図 |
| 図版 40 古代遺構実測図 | 図版 83 古代遺構実測図 |
| 図版 41 古代遺構実測図 | 図版 84 古代遺構実測図 |
| 図版 42 古代遺構実測図 | 図版 85 古代遺構実測図 |
| 図版 43 古代遺構実測図 | 図版 86 古代遺構実測図 |

- 图版 87 古代漆器实测图
- 图版 88 古代漆器实测图
- 图版 89 古代漆器实测图
- 图版 90 古代漆器实测图
- 图版 91 古代漆器实测图
- 图版 92 中世漆器实测图
- 图版 93 中世漆器实测图
- 图版 94 中世漆器实测图
- 图版 95 中世漆器实测图
- 图版 96 中世漆器实测图
- 图版 97 中世漆器实测图
- 图版 98 中世漆器实测图
- 图版 99 中世漆器实测图
- 图版 100 中世漆器实测图
- 图版 101 中世漆器实测图
- 图版 102 中世漆器实测图
- 图版 103 中世漆器实测图
- 图版 104 中世漆器实测图
- 图版 105 中世漆器实测图
- 图版 106 中世漆器实测图
- 图版 107 中世漆器实测图
- 图版 108 中世漆器实测图
- 图版 109 中世漆器实测图
- 图版 110 中世漆器实测图
- 图版 111 中世漆器实测图
- 图版 112 中世漆器实测图
- 图版 113 中世漆器实测图
- 图版 114 中世漆器实测图
- 图版 115 中世漆器实测图
- 图版 116 中世漆器实测图
- 图版 117 中世漆器实测图
- 图版 118 中世漆器实测图
- 图版 119 中世漆器实测图
- 图版 120 中世漆器实测图
- 图版 121 中世漆器实测图
- 图版 122 中世漆器实测图
- 图版 123 中世漆器实测图
- 图版 124 中世漆器实测图
- 图版 125 中世漆器实测图
- 图版 126 中世漆器实测图
- 图版 127 縄文·弥生土器实测图
- 图版 128 古代土器实测图 SB 2~5
- 图版 129 古代土器实测图 SB 6~9
- 图版 130 古代土器实测图 SB 9·11·13
- 图版 131 古代土器实测图 SB 14·15·18
- 图版 132 古代土器实测图 SB 16·19·20·24
- 图版 133 古代土器实测图 SB 22·23
- 图版 134 古代土器实测图 SB 25·27·28
- 图版 135 古代土器实测图 SB 26·29·30
- 图版 136 古代土器实测图 SB 31·32
- 图版 137 古代土器实测图 SB 33·34·36·37
- 图版 138 古代土器实测图 SB 38~42
- 图版 139 古代土器实测图 SB 43·44
- 图版 140 古代土器实测图 SB 45·46
- 图版 141 古代土器实测图 SB 47·48·50
- 图版 142 古代土器实测图 SB 49
- 图版 143 古代土器实测图 SB 52
- 图版 144 古代土器实测图 SB 51·53~56·59
- 图版 145 古代土器实测图 SB 57·58·60~62
- 图版 146 古代土器实测图 SB 62~66
- 图版 147 古代土器实测图 SB 66~68·70
- 图版 148 古代土器实测图 SB 72·75
- 图版 149 古代土器实测图 SB 75
- 图版 150 古代土器实测图 SB 73·74·76~78
- 图版 151 古代土器实测图 SB 78·79·81
- 图版 152 古代土器实测图 SB 81~84
- 图版 153 古代土器实测图 SB 83·85~87
- 图版 154 古代土器实测图 SB 88~93
- 图版 155 古代土器实测图 SB 94·96
- 图版 156 古代土器实测图 SB 95·97·98
- 图版 157 古代土器实测图 SB 98~100
- 图版 158 古代土器实测图 SB 100·102~104
- 图版 159 古代土器实测图 SB 105·106
- 图版 160 古代土器实测图 SB 107~110
- 图版 161 古代土器实测图 SB 110·111
- 图版 162 古代土器实测图 SB 111~114
- 图版 163 古代土器实测图 SB 112~113
- 图版 164 古代土器实测图 SB 113·115·117·118
- 图版 165 古代土器实测图 SB 119·120
- 图版 166 古代土器实测图 SB 121~124·126
- 图版 167 古代土器实测图 SB 125·127
- 图版 168 古代土器实测图 SB 127~129
- 图版 169 古代土器实测图 SB 129~131
- 图版 170 古代土器实测图 SB 132~134·136·137·139·140
- 图版 171 古代土器实测图 SB 141~144
- 图版 172 古代土器实测图 SB 144·148
- 图版 173 古代土器实测图 SB 145~147·149~151
- 图版 174 古代土器实测图 SB 152~154
- 图版 175 古代土器实测图 SB 154~156

図版176	古代土器実測図	SB157・159・160・162・167
図版177	古代土器実測図	SB161・163・166
図版178	古代土器実測図	SB164・168・169
図版179	古代土器実測図	SB169～171
図版180	古代土器実測図	SB172～174
図版181	古代土器実測図	SB174～176・180
図版182	古代土器実測図	SB177・178
図版183	古代土器実測図	SB178
図版184	古代土器実測図	SB179・183
図版185	古代土器実測図	SB181・182・184
図版186	古代土器実測図	SB184～186
図版187	古代土器実測図	SB186～190
図版188	古代土器実測図	SB191
図版189	古代土器実測図	SB192・194～197
図版190	古代土器実測図	SB198
図版191	古代土器実測図	SB199・200・202
図版192	古代土器実測図	SB202～207
図版193	古代土器実測図	SB207～209
図版194	古代土器実測図	SB210～214
図版195	古代土器実測図	SB215～217・219・220
図版196	古代土器実測図	SB218
図版197	古代土器実測図	SB221～224
図版198	古代土器実測図	SB224・225・228
図版199	古代土器実測図	SB226・227
図版200	古代土器実測図	SB229・230・232・234
図版201	古代土器実測図	SB233・235
図版202	古代土器実測図	SB236・ST3・11・13・18・21・ 25・26・41

図版203	古代土器実測図	ST42・54・56・57・63・67・SD 16・71・SK42・43・50・98・343
図版204	古代土器実測図	SK35・38・51・55・97・106・ 162・180・276・333・338・347・ 379・387・392・402・418・433
図版205	古代土器実測図	SK435・443・450・456・511・ 568・575
図版206	古代土器実測図	SK602・614・NR4・5 中国製輸入陶磁器（白磁）
図版207	文字関係資料実測図	
図版208	文字関係資料実測図	
図版209	文字関係資料実測図	
図版210	文字関係資料実測図	
図版211	文字関係資料実測図	
図版212	文字関係資料実測図	
図版213	文字関係資料実測図	
図版214	古代金属製品実測図	
図版215	古代金属製品・石製品実測図	
図版216	古代石製品実測図	
図版217	古代石製品実測図	
図版218	古代土製品実測図	
図版219	中世土器・陶磁器実測図	
図版220	中世土器・陶磁器実測図	
図版221	中世土器・陶磁器実測図	
図版222	中世土器・陶磁器実測図	
図版223	中世金属製品実測図	
図版224	中世金属製品・石製品実測図	
図版225	中世石製品・土製品実測図	

写真図版目次

PL 1	遺跡周辺航空写真
PL 2	遺跡遠景航空写真
PL 3	遺跡遠景航空写真
PL 4	遺跡遠景航空写真
PL 5	SB1・周溝・柱穴・竪
PL 6	SB3・カマド・カマド石組状況
PL 7	SB7・カマド、SB8・カマド
PL 8	SB20・掘り方・カマド・土器出土状況
PL 9	SB23礎石状況・カマド付近遺物出土状況 カマド、SB29付近
PL 10	SB33・炭化材出土状況・カマド
PL 11	SB42・掘り方・カマド・遺物出土状況、SB43 床下遺物

PL 12	SB46・掘り方、SB47・掘り方
PL 13	SB49・ピット内遺物・カマド、SB50掘り 方・ピット内遺物・断面
PL 14	SB51・掘り方・カマド石組状況、SB63・ カマド
PL 15	SB66、SB69、SB70
PL 16	SB75・遺物出土状況・カマド遺物出土状況
PL 17	SB76・北側カマド・北側カマド煙道先ピッ ト、SB78礎石状況
PL 18	SB92・カマド、SB95・石鍾出土状況
PL 19	SB96・カマド、SB102・カマド
PL 20	SB111、SB112・カマド・SB120・カマ ド

- P L 21 SB147、SB150・カマド
 P L 22 SB154・礫出土状況、SB174
 P L 23 SB178・礫遺物出土状況・西側カマド・北側カマド
 P L 24 SB218・カマド、SB221・カマド
 P L 25 SB226・礫出土状況、SB233・カマド
 P L 26 ST 8、ST12-13-14、ST21
 P L 27 ST22、ST23、ST24-25
 P L 28 ST26、ST34、ST39-40
 P L 29 SA1・SD3付近、SD3断面、SL1
 P L 30 SK43・遺物出土状況、SK50、SK54、SK81、SK333・遺物出土状況・断面
 P L 31 SK343遺物出土状況・断面、SK435遺物出土状況、SK450遺物出土状況、SK97遺物出土状況、SK419・礫出土状況
 P L 32 SB251、SB252・礫出土状況
 P L 33 SB253、SB254・礫出土状況
 P L 34 SB261・遺物出土状況・SB262
 P L 35 SB267・遺物出土状況・SB272
 P L 36 ST88・付属土坑、ST90
 P L 37 ST104-105-106・付属土坑
 P L 38 ST107・付属土坑・礫出土状況、ST119
 P L 39 SD30~35付近・断面、SD54
 P L 40 SD56・57、SD60付近・土橋・礫出土状況、SD64
 P L 41 SD61・66付近、SD66、SD69~71付近
 P L 42 SD73~76、SK701・礫出土状況、SK736、SK737礫出土状況、SK775、SK843礫出土状況、SK1044
 P L 43 SK933、SK935、SK969、SK1017・礫出土状況・炭化物出土状況、SK1018・礫出土状況
 P L 44 SK1203、SK1325礫出土状況、SK1393遺物出土状況・木質部出土状況、SK1533・礫出土状況、SK1534・炭化物出土状況
 P L 45 SK1539、SK1567、SK1568、SK1569、SK1591、SK1600、SL3、NR11礫出土状況
 P L 46 縄文土器、弥生土器・SB1
 P L 47 古代出土土器 SB3・4
 P L 48 古代出土土器 SB15-20
 P L 49 古代出土土器 SB29-31-42
 P L 50 古代出土土器 SB43
 P L 51 古代出土土器 SB72-75
 P L 52 古代出土土器 SB75
 P L 53 古代出土土器 SB75-81
 P L 54 古代出土土器 SB100-106
 P L 55 古代出土土器 SB106-110-111
 P L 56 古代出土土器 SB112-117
 P L 57 古代出土土器 SB125-127
 P L 58 古代出土土器 SB127-152
 P L 59 古代出土土器 SB155-169-173
 P L 60 古代出土土器 SB174-176
 P L 61 古代出土土器 SB181-196
 P L 62 古代出土土器 SB196-198
 P L 63 古代出土土器 SB198-202
 P L 64 古代出土土器 SB202-209-218
 P L 65 古代出土土器 SB218-220
 P L 66 古代出土土器 SK435-450
 P L 67 緑釉陶器、輸入陶磁器
 P L 68 文字関係資料
 P L 69 文字関係資料
 P L 70 古代金属製品
 P L 71 古代金属製品
 P L 72 古代金属製品、古代石製品
 P L 73 古代石製品・土製品
 P L 74 古代土製品
 P L 75 古代石製品
 P L 76 中世土器、陶磁器
 P L 77 中世土器、陶磁器
 P L 78 中世土器、陶磁器
 P L 79 中世土器、陶磁器
 P L 80 中世土器、陶磁器
 P L 81 中世金属製品
 P L 82 中世銅鏡、中・近世銭貨・煙管
 P L 83 中世石製品・土製品

圖 版

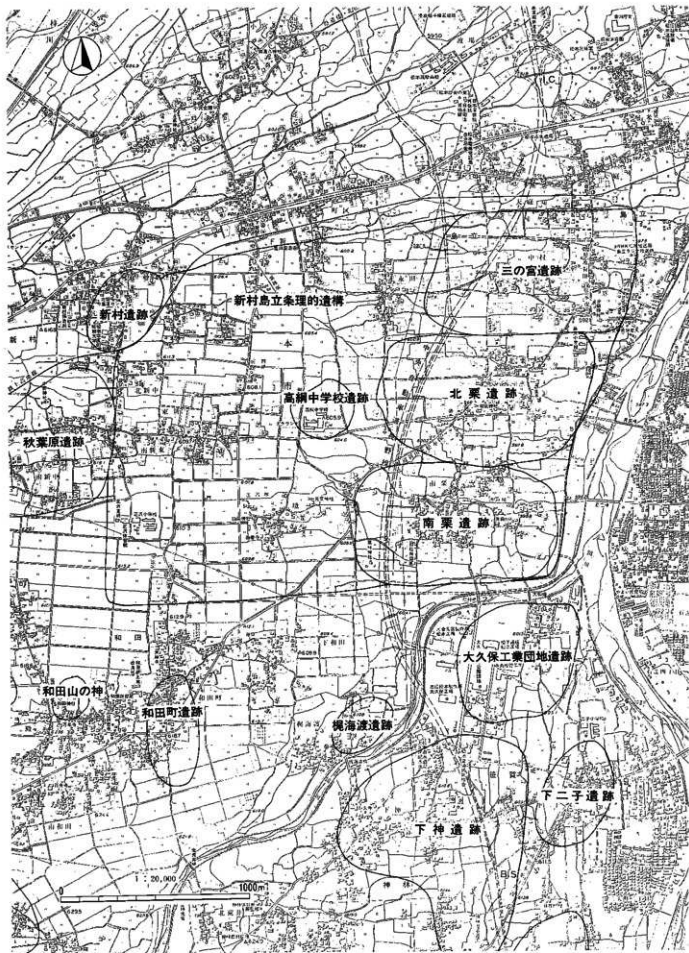

図版2 周辺の地形と調査範囲

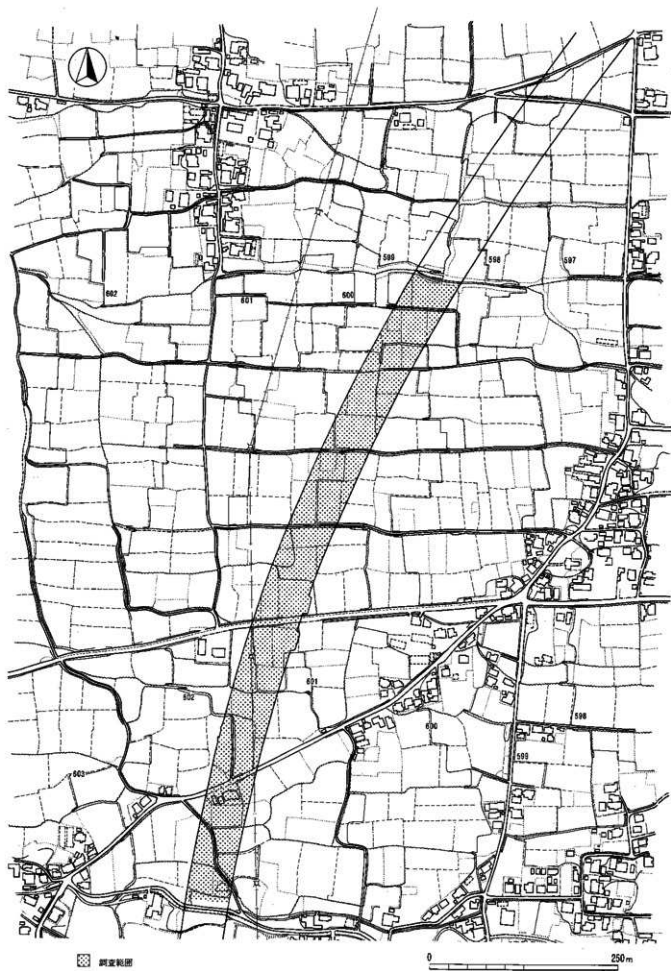



图版4 遺構分布図 中世面



0 100m
1 : 1000

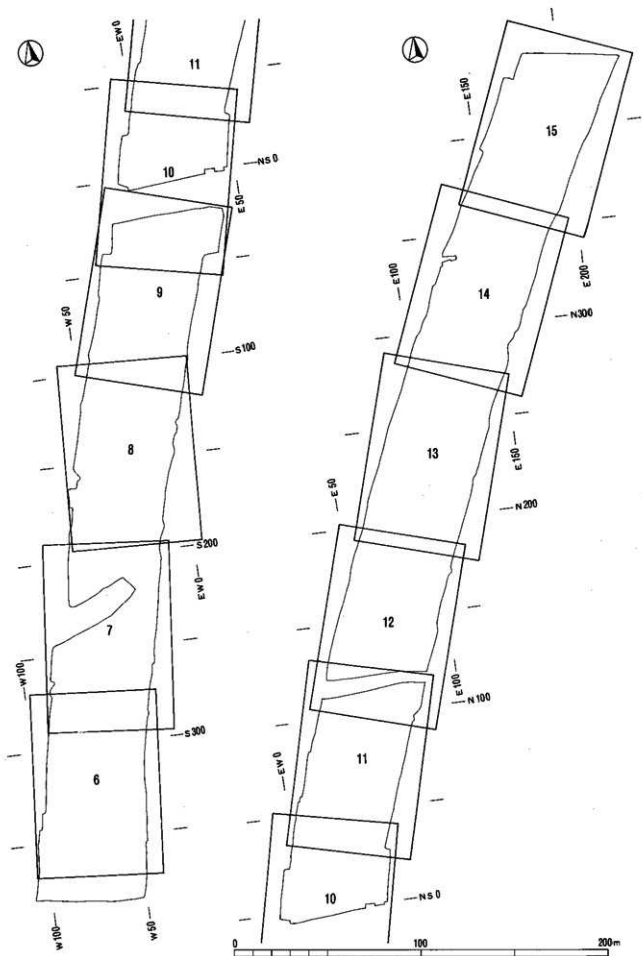

図版 6 古代遺構実測区

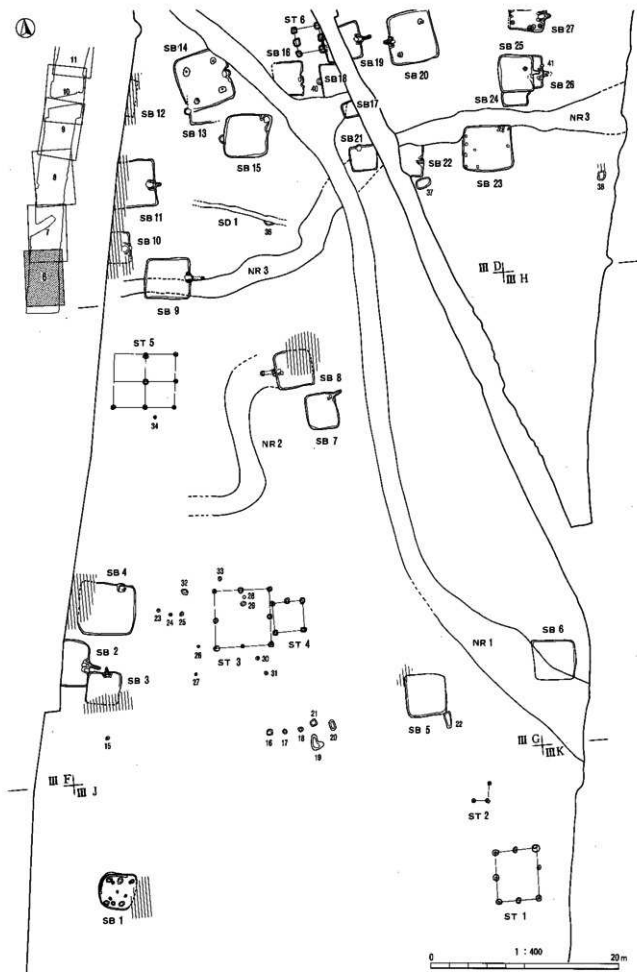

土坑は記号「SK」を略し番号のみ表記した。以下図版126まで同じ。

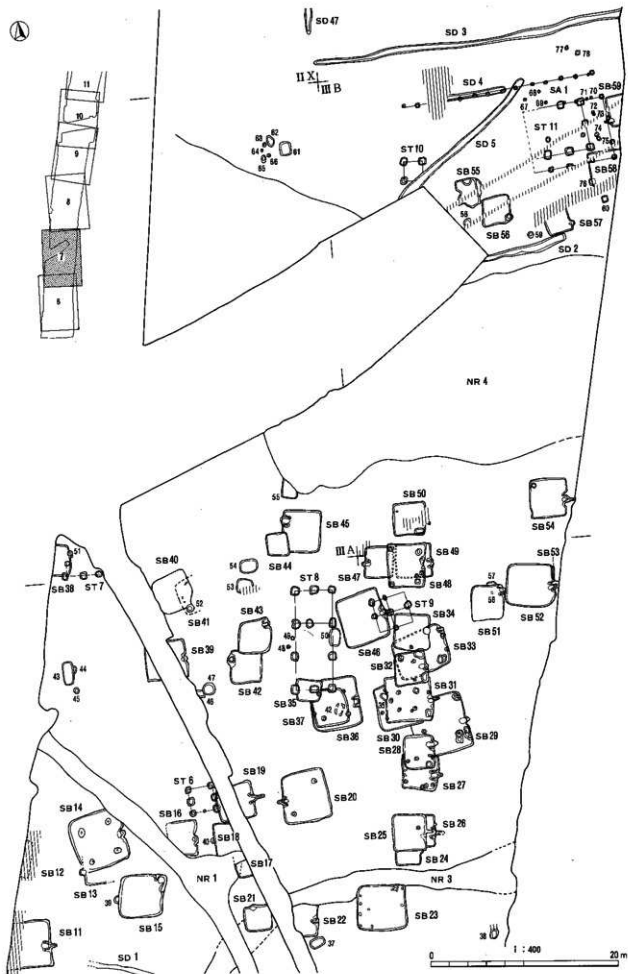

図版 8 古代遺構実測図

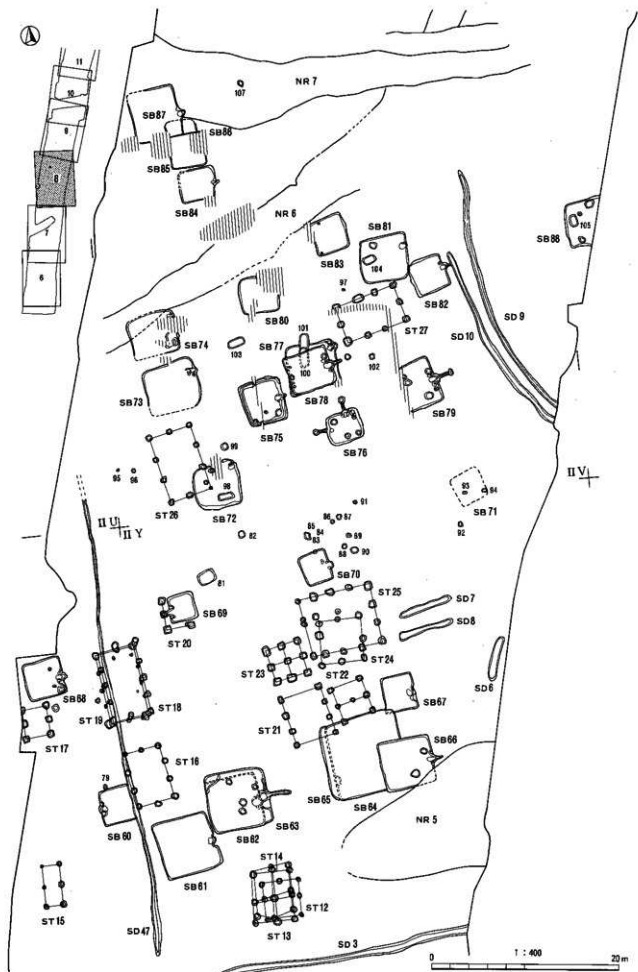



图版10 古代遺構実測図

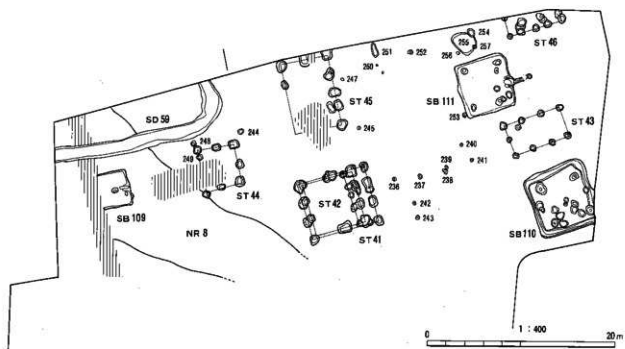
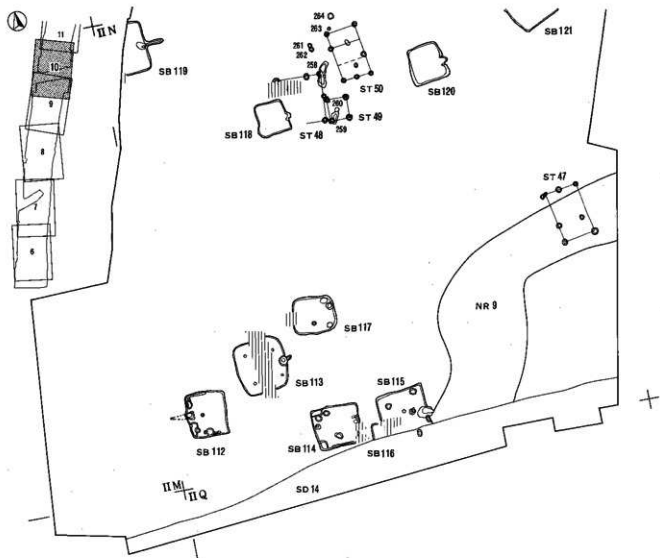

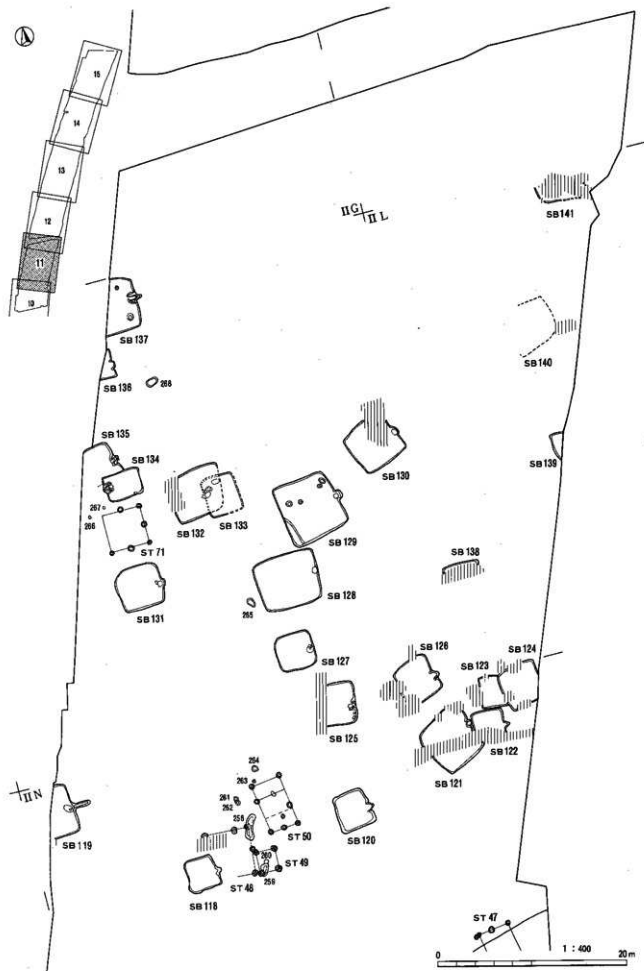

図版12 古代遺構実測図

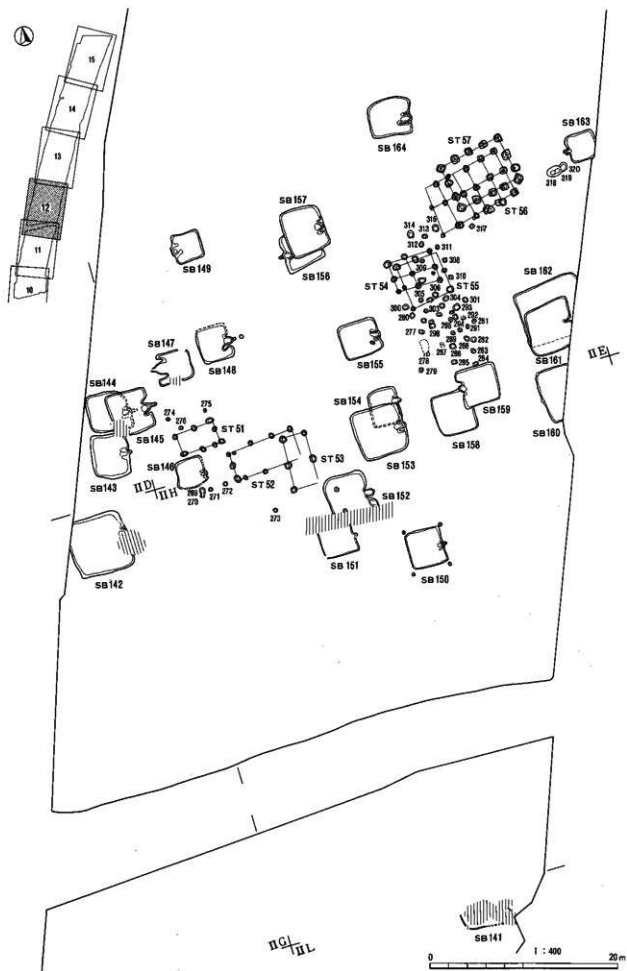

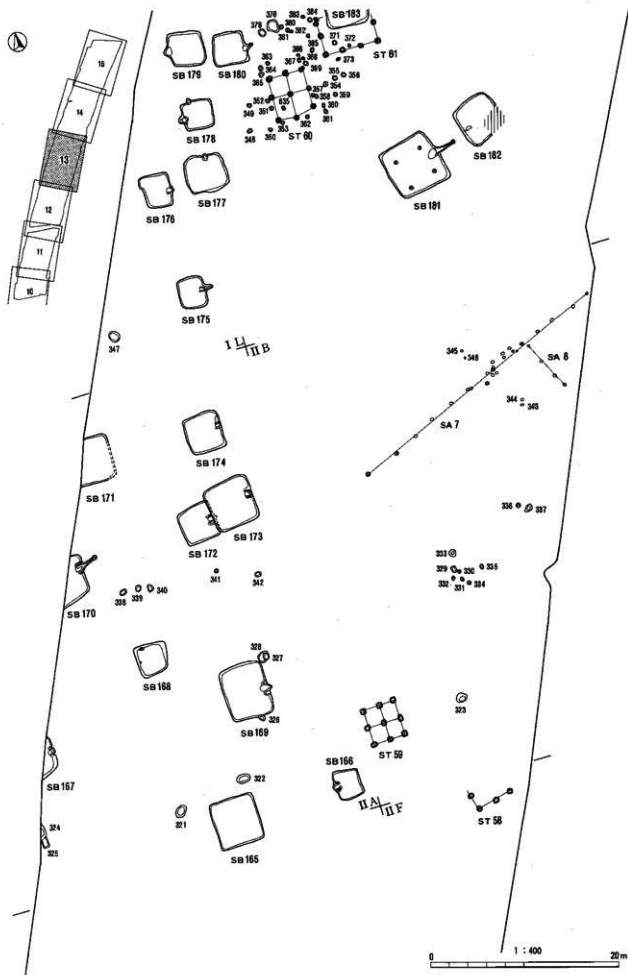

图版14 古代遺構実測図

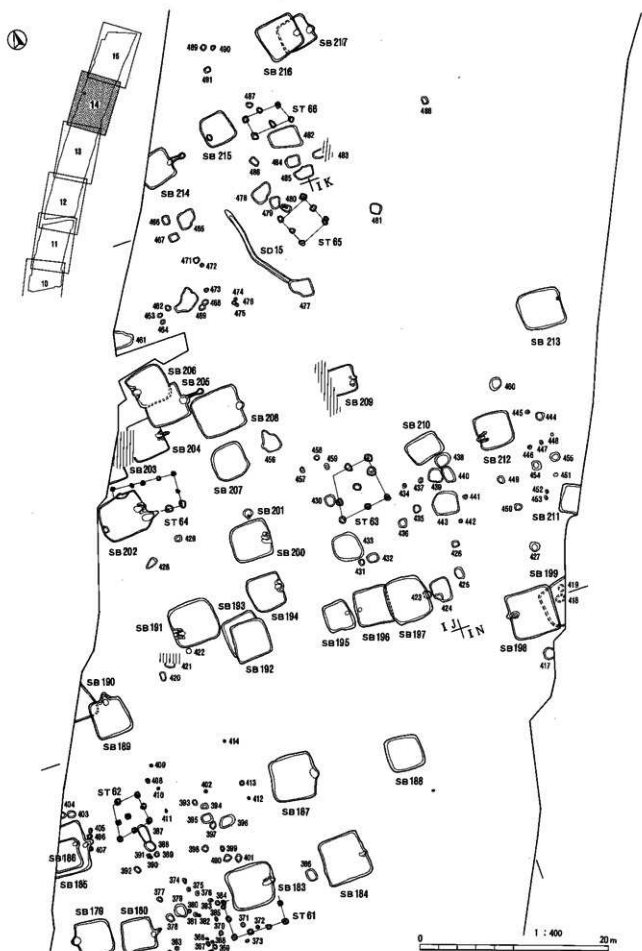

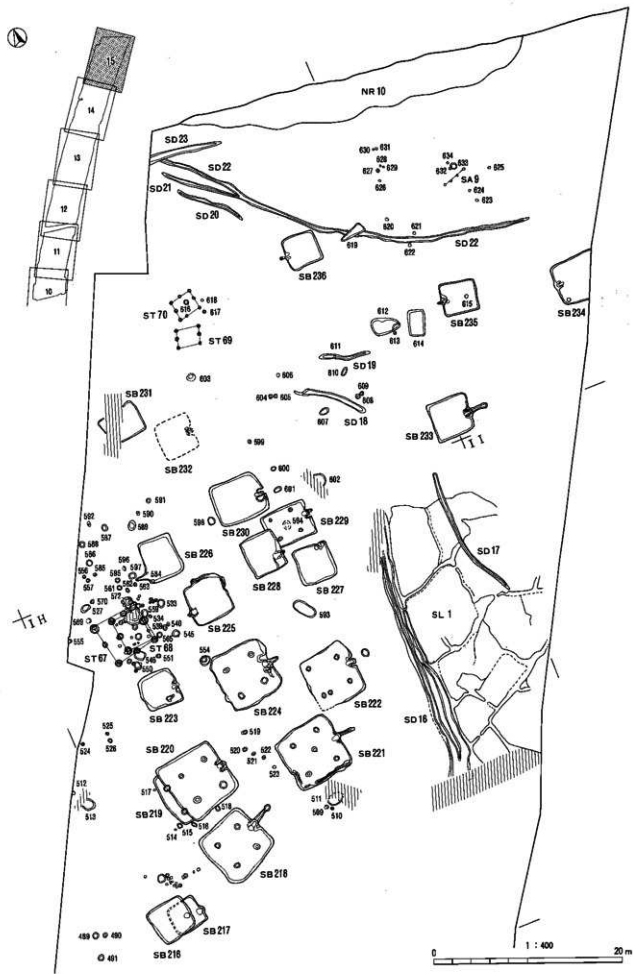

図版16 中世遺構割付図

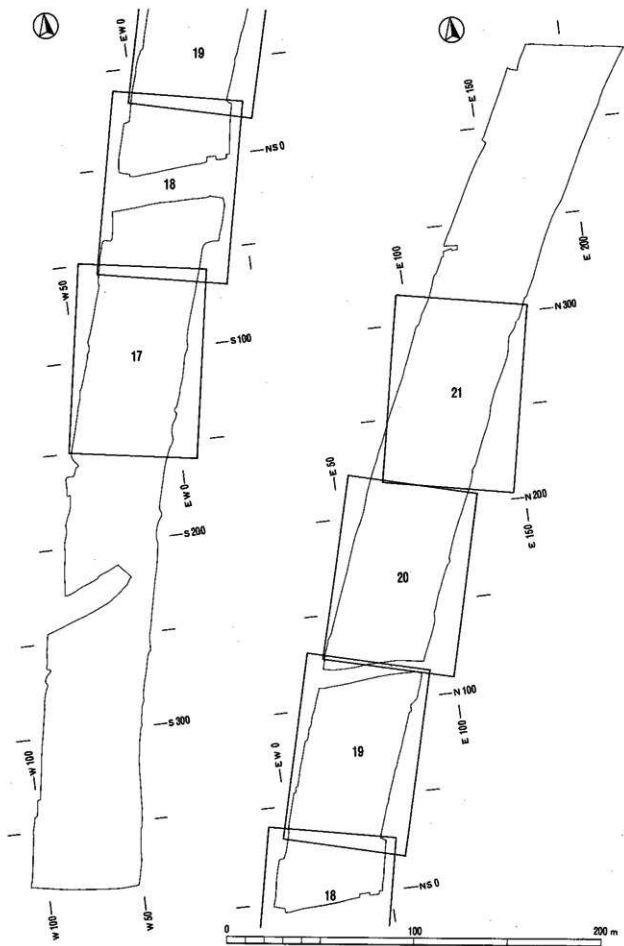

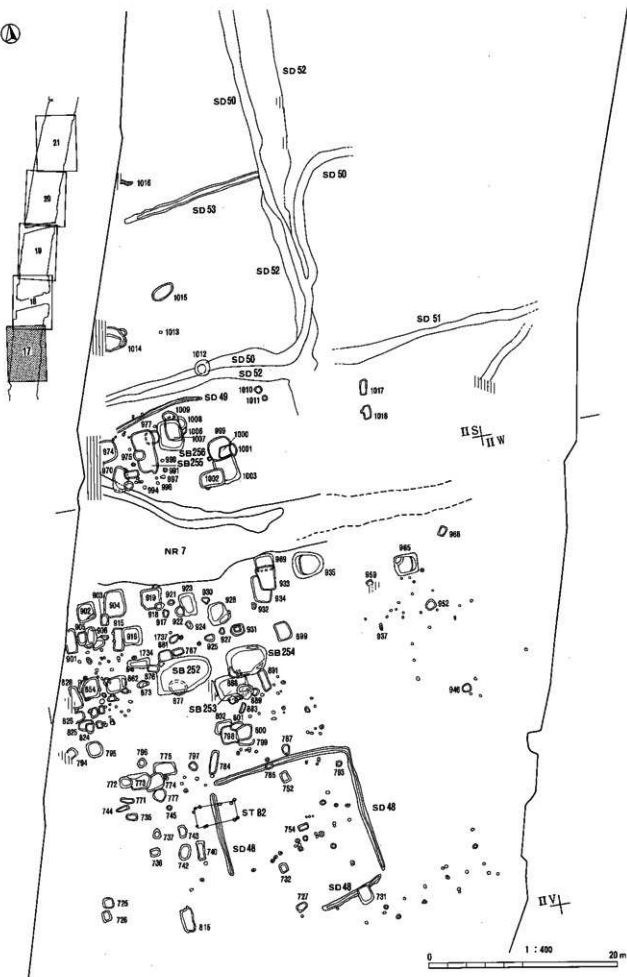

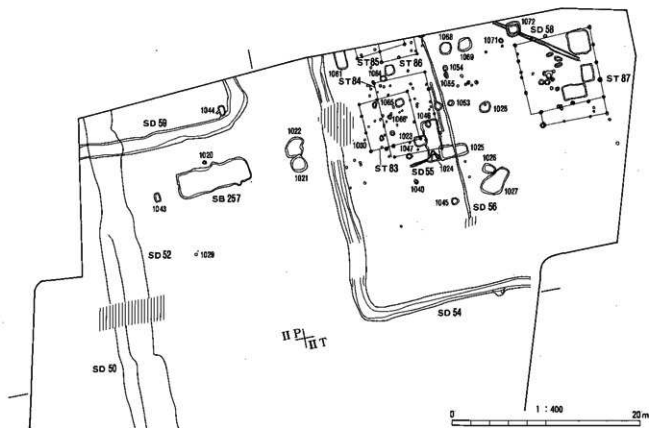
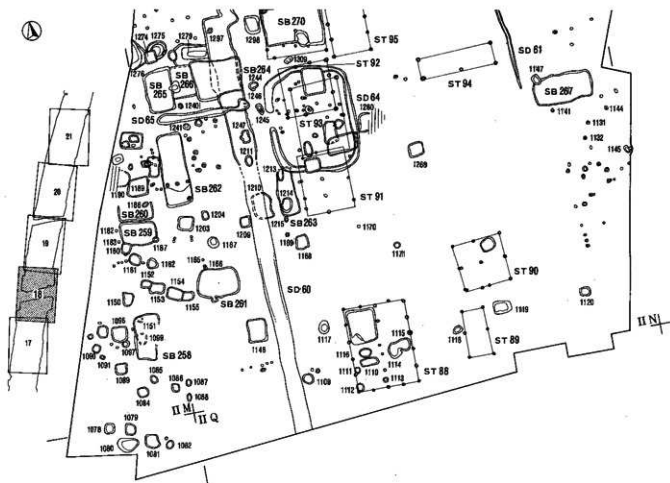



图版20 中世遺構実測区

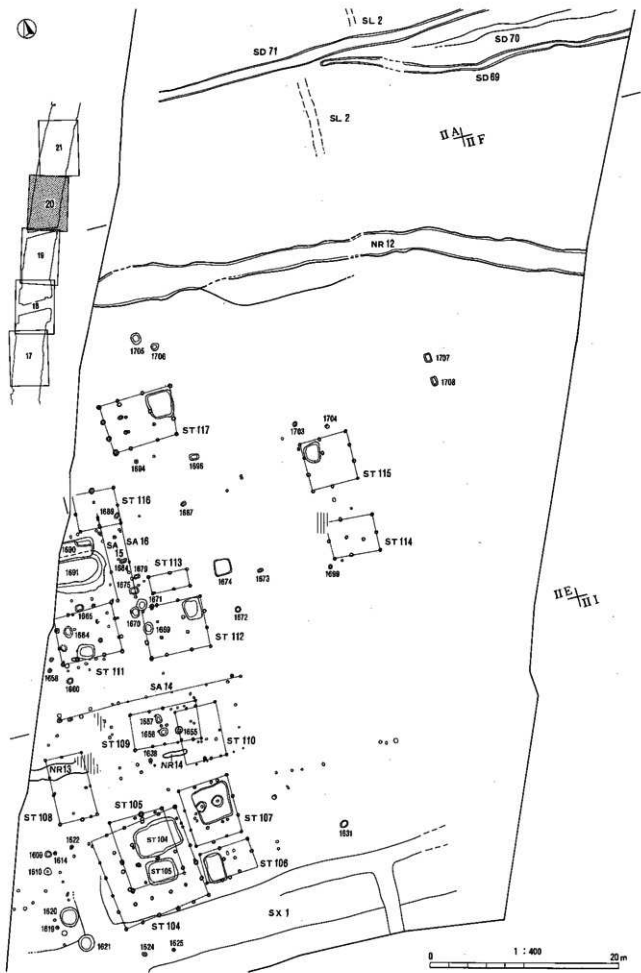

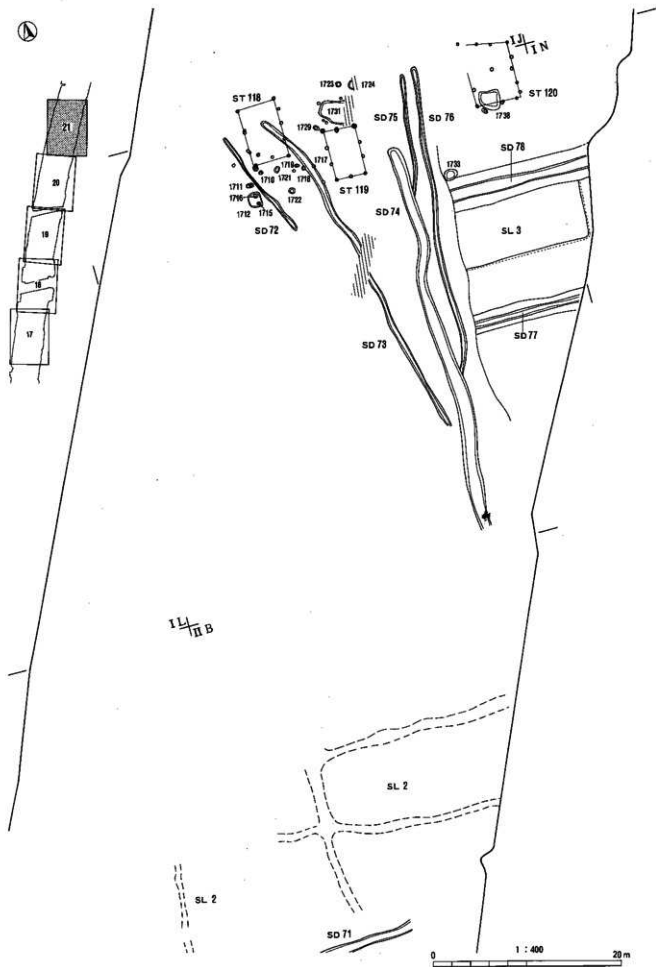

図版22 古代遺構割付図

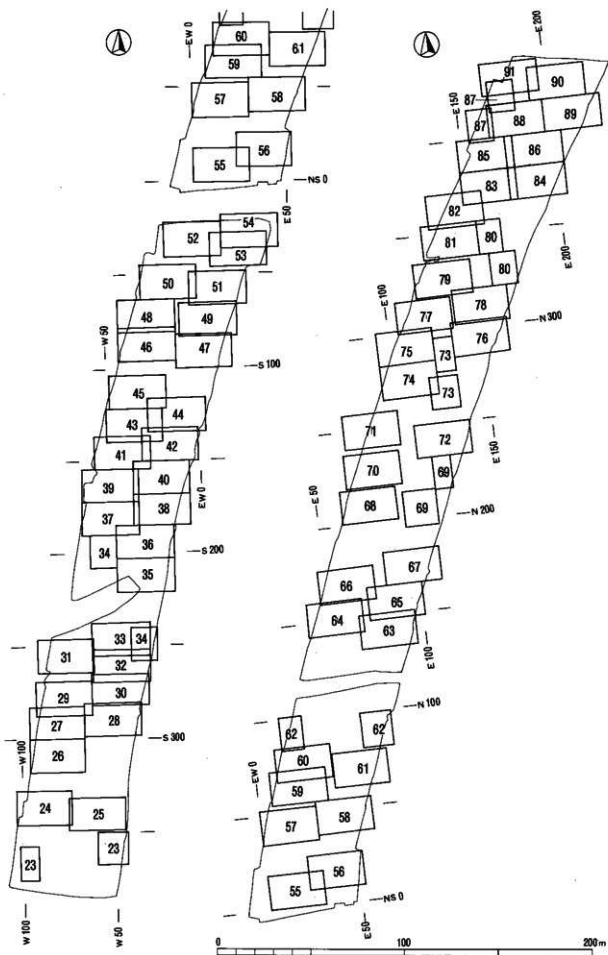

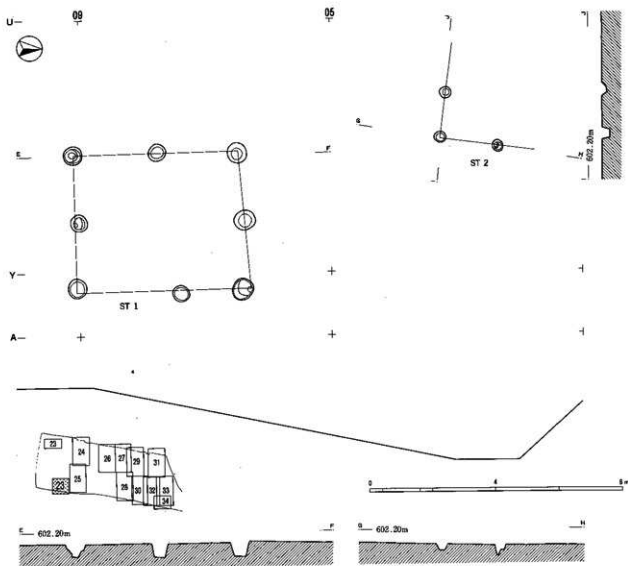
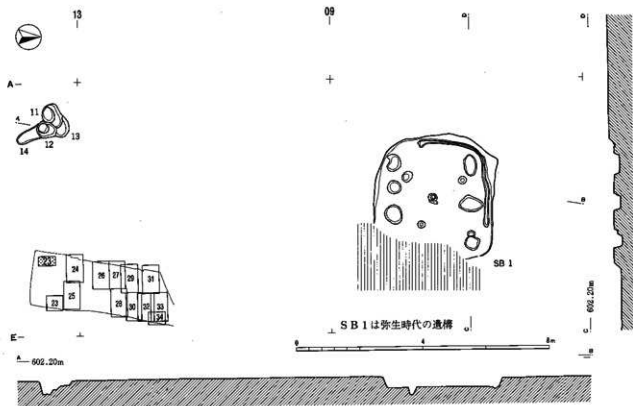

图版24 古代遺構実測図

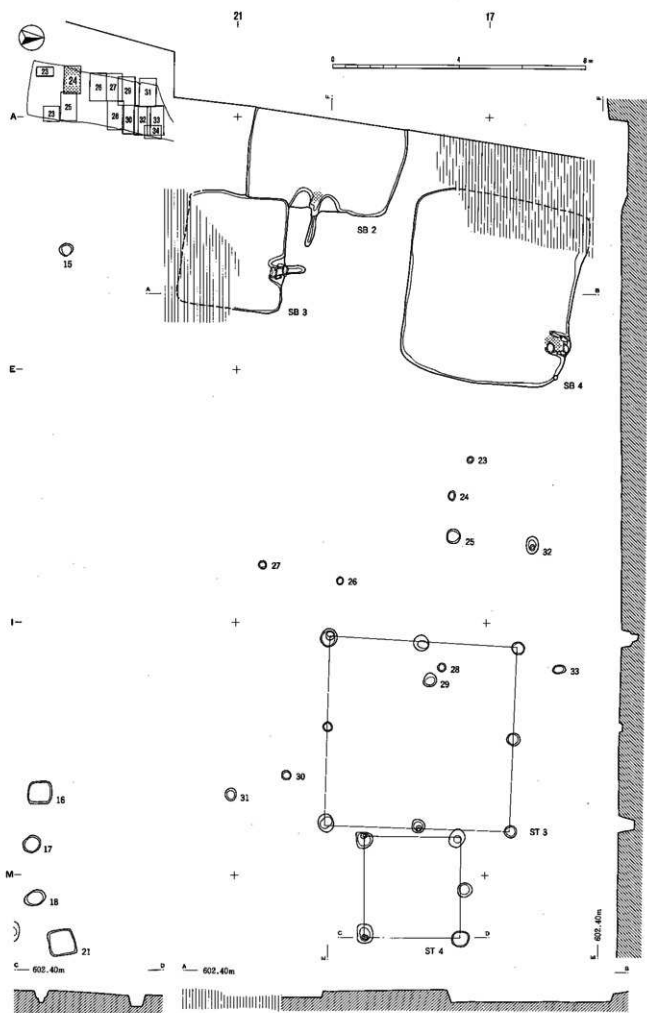

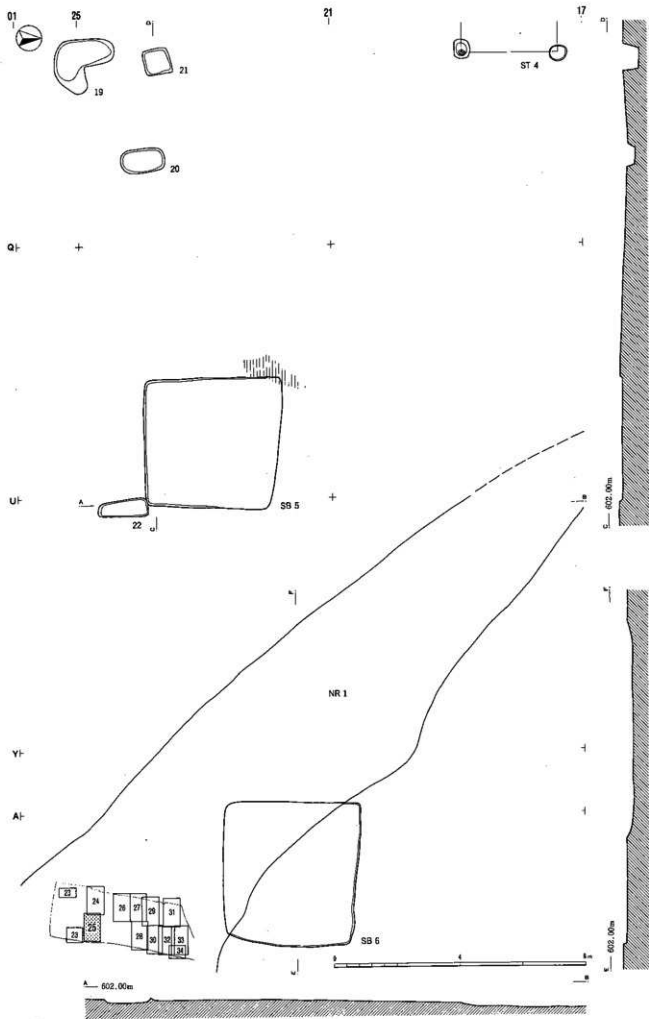

図版26 古代遺構実測図

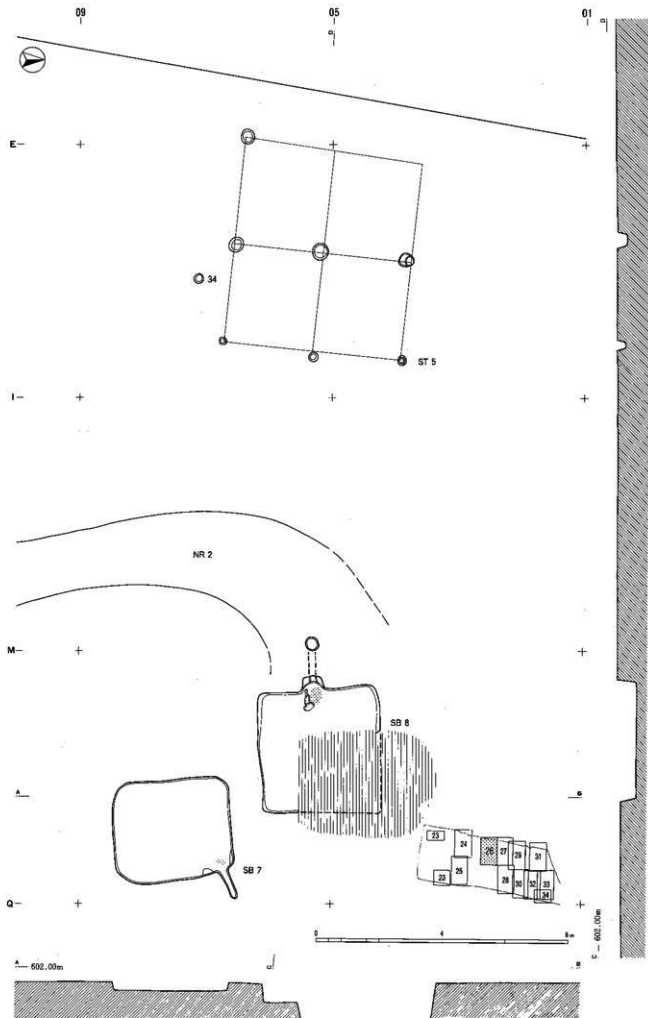

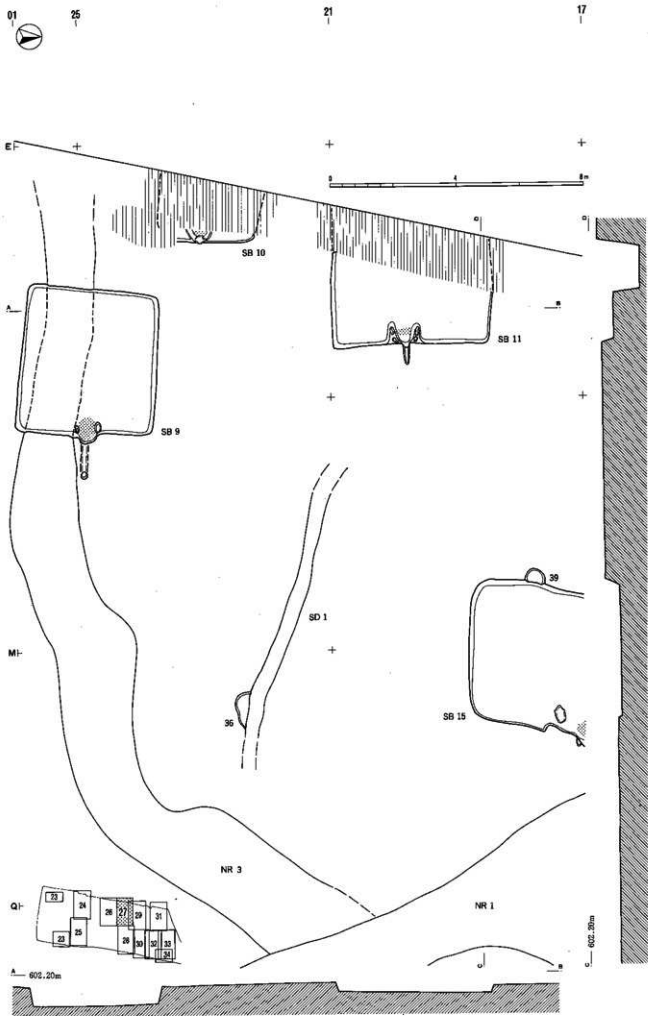

図版28 古代遺構実測図

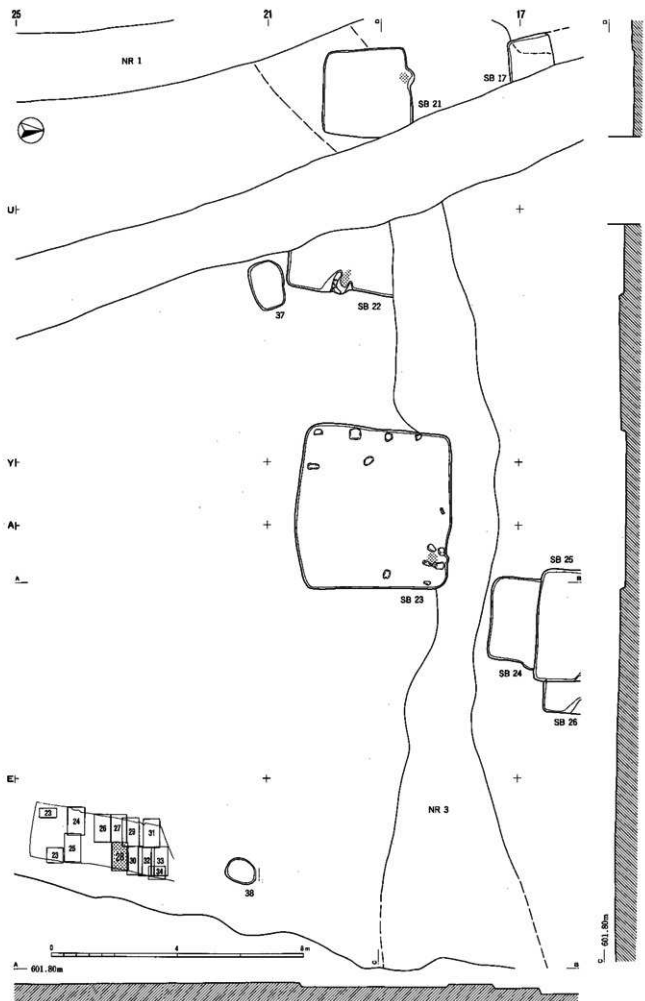

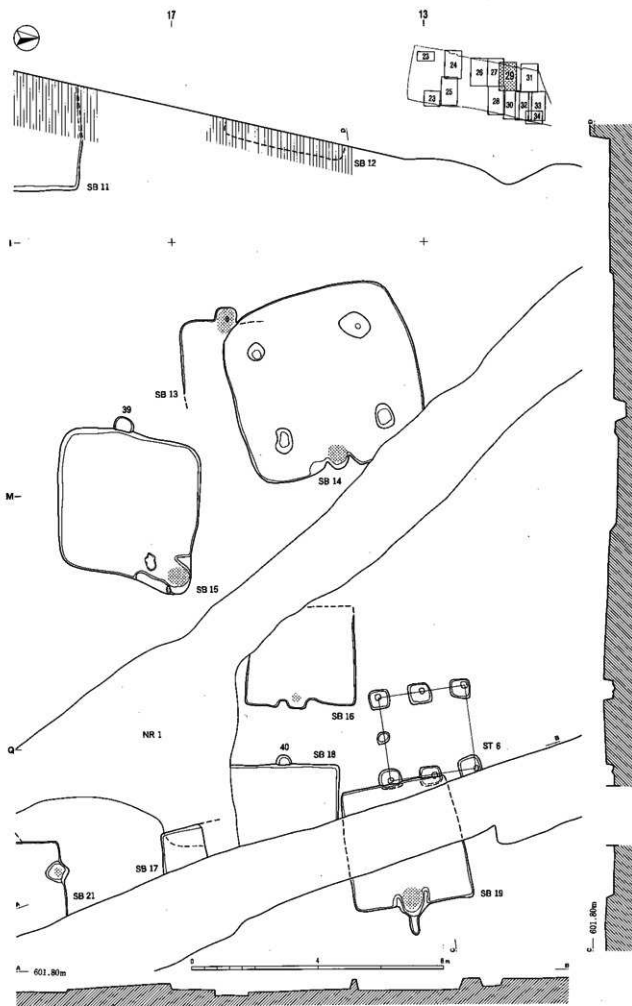

图版30 古代遺構実測図

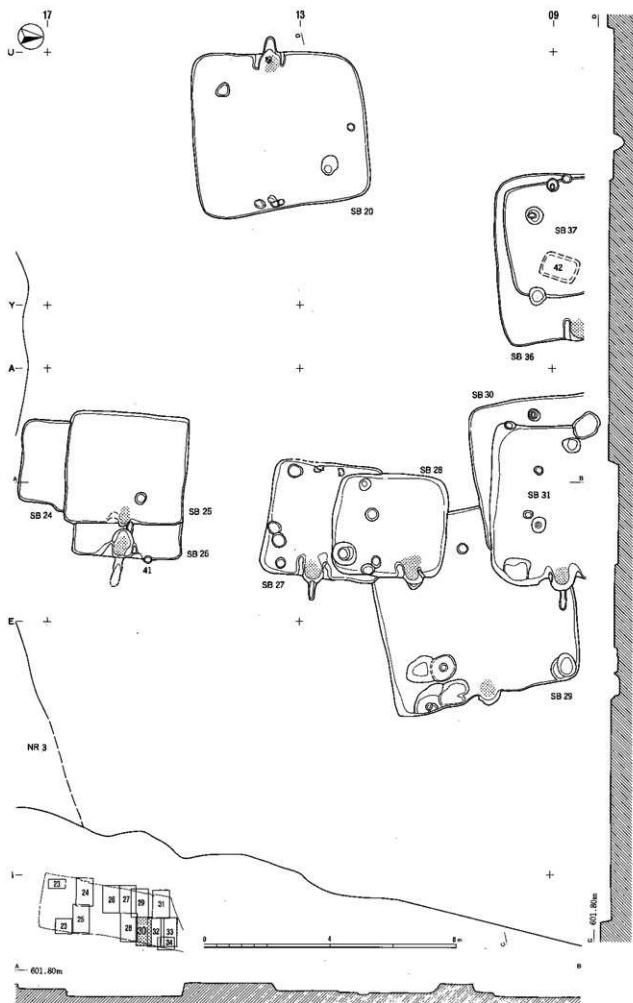

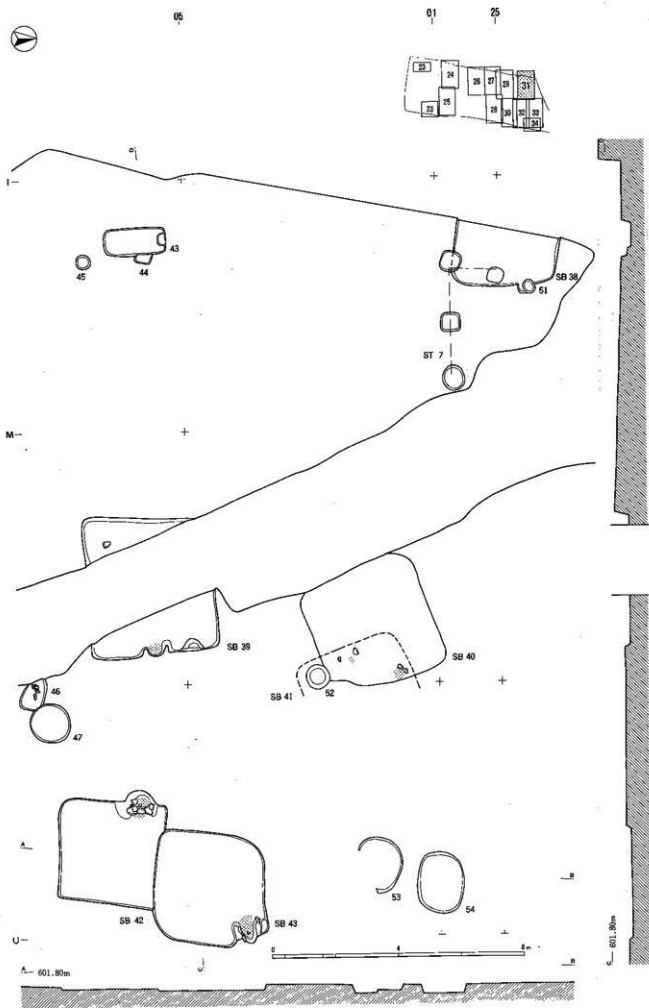

圖版32 古代遺構實測圖

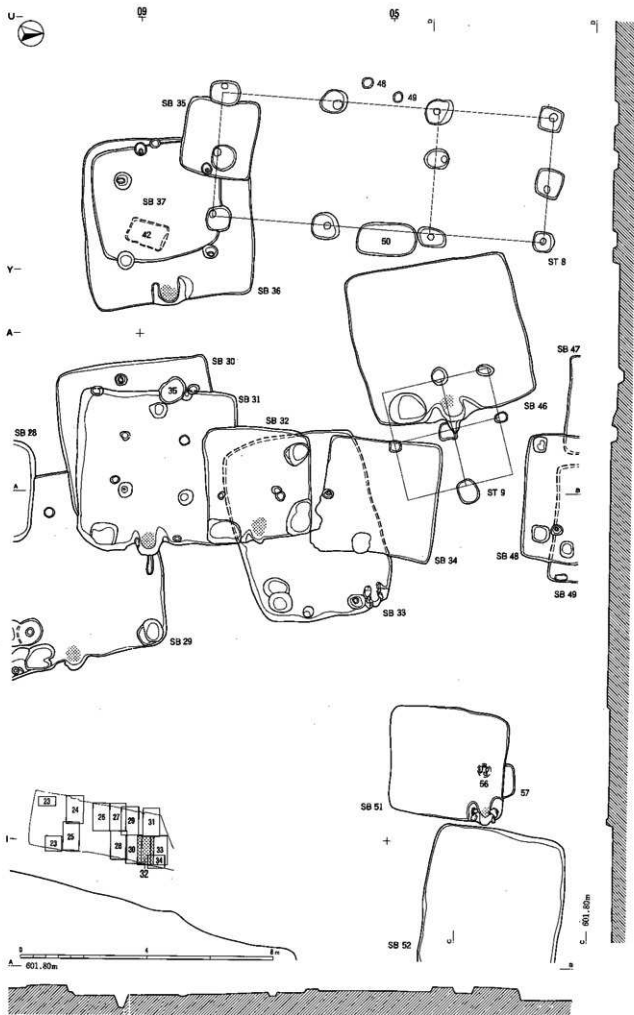

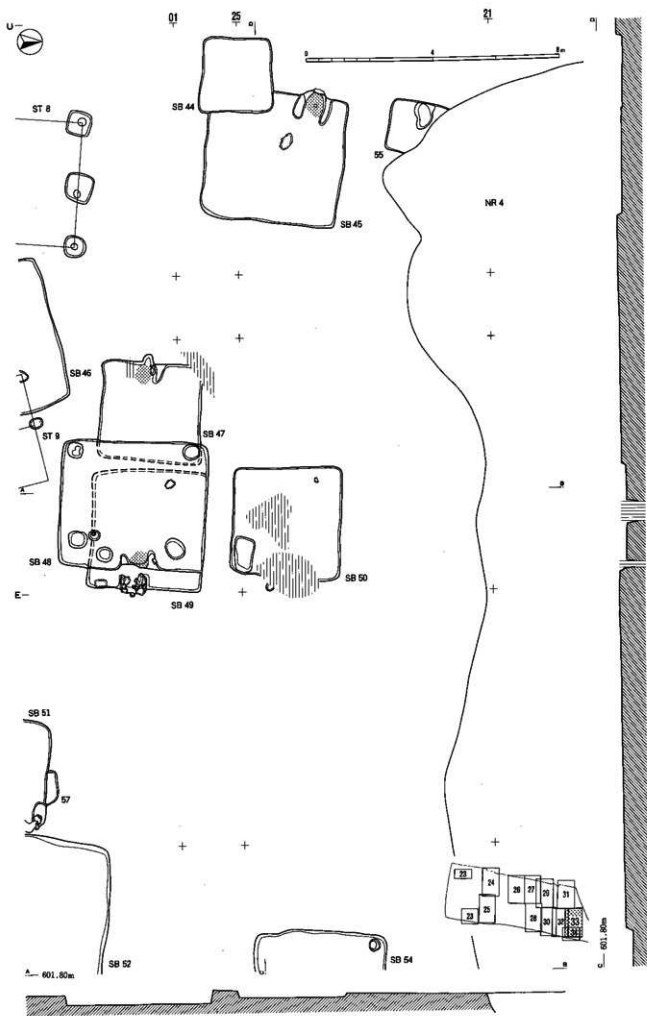

图版34 古代遺構実測図

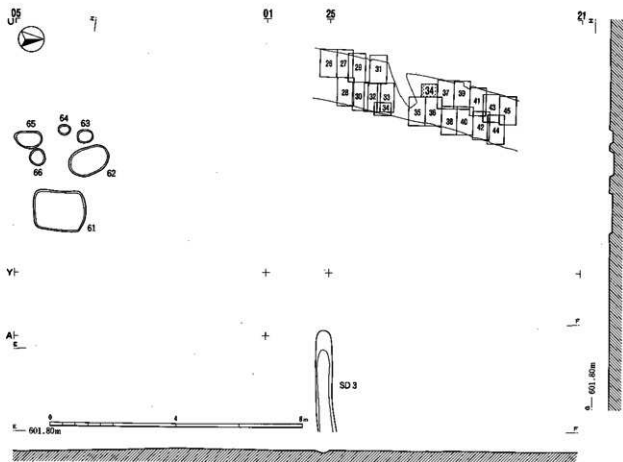
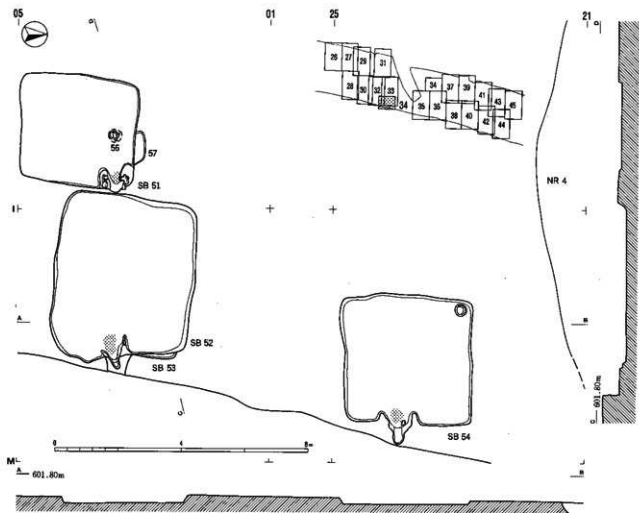

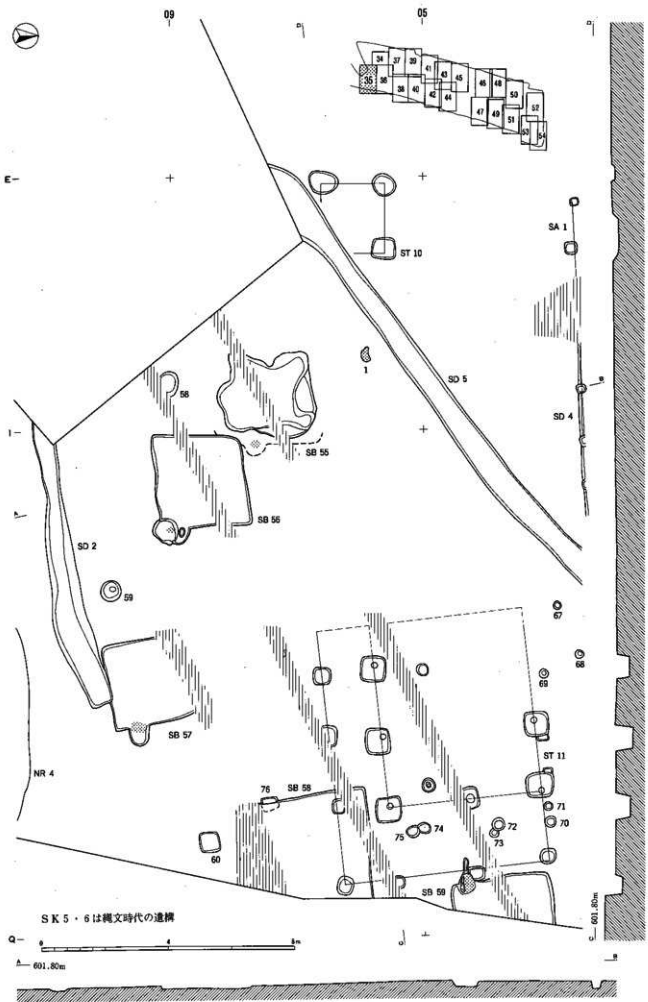

SK 5・6は縄文時代の遺構

601.80m

601.80m

図版36 古代遺構実測図

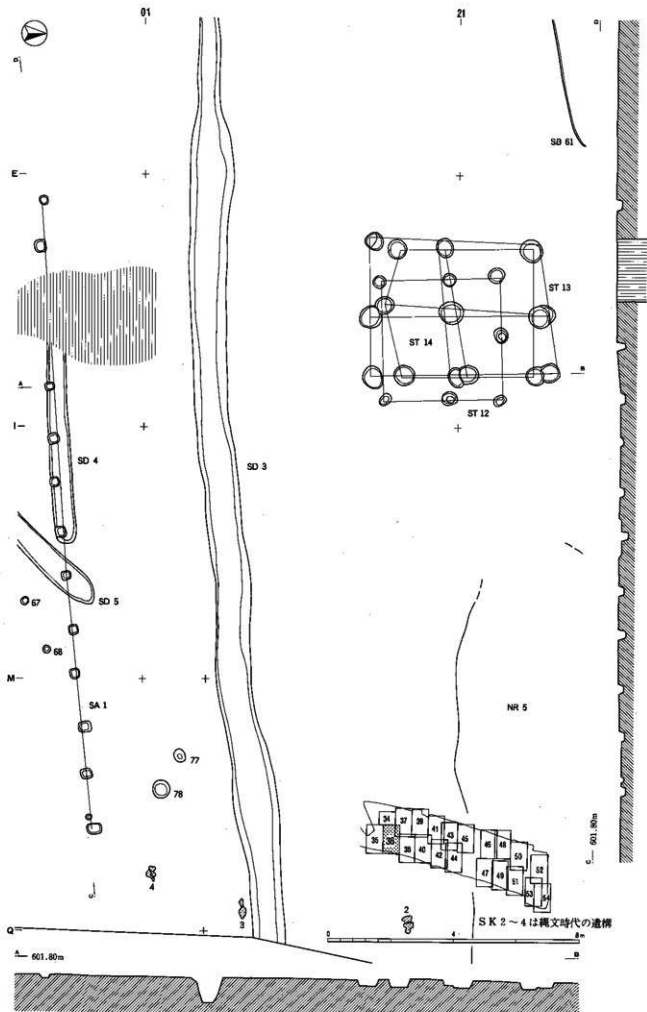

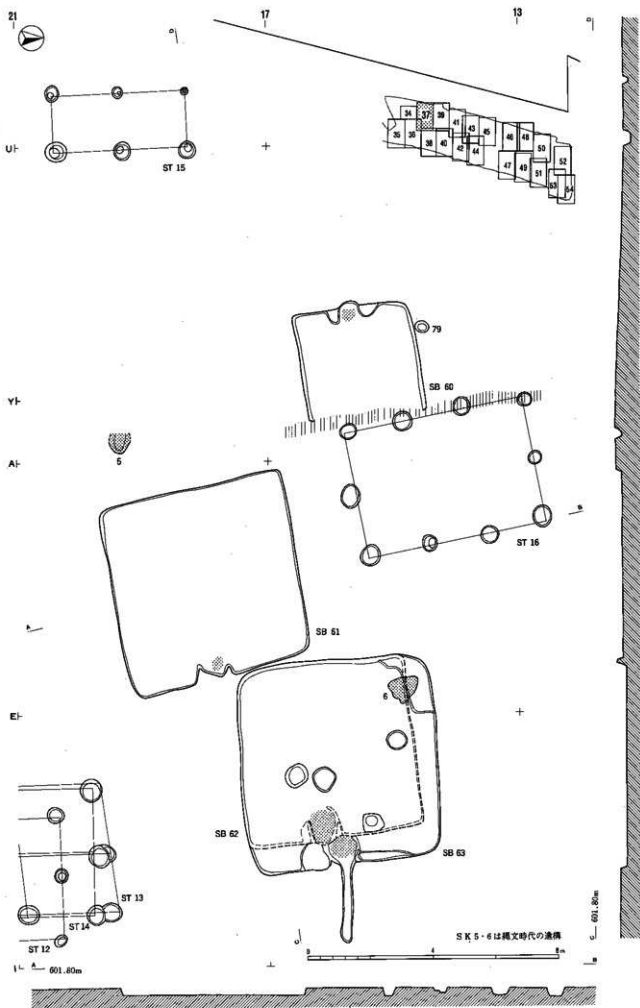

图版38 古代遺構実測図

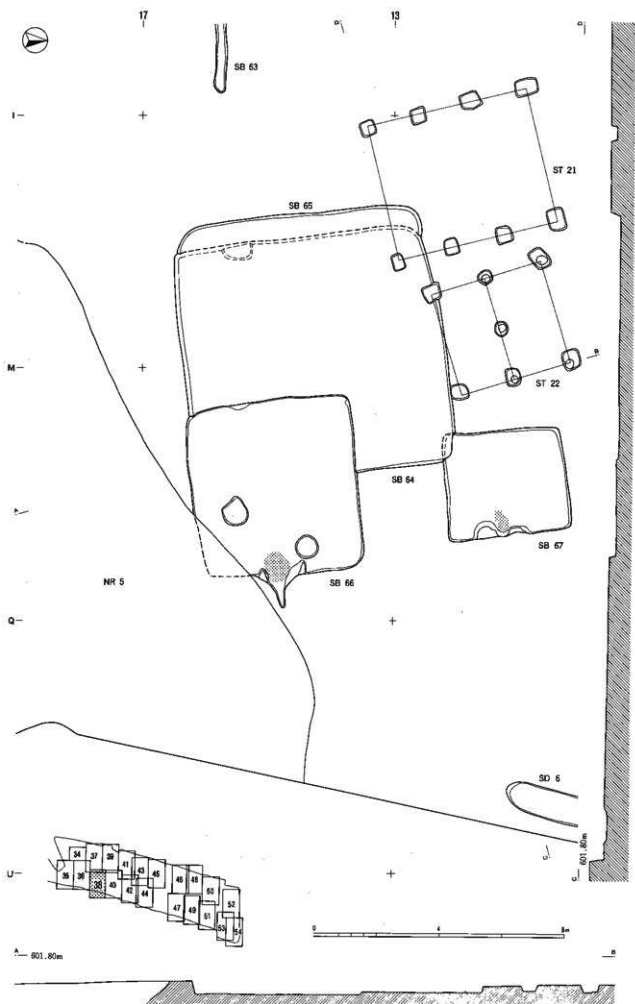

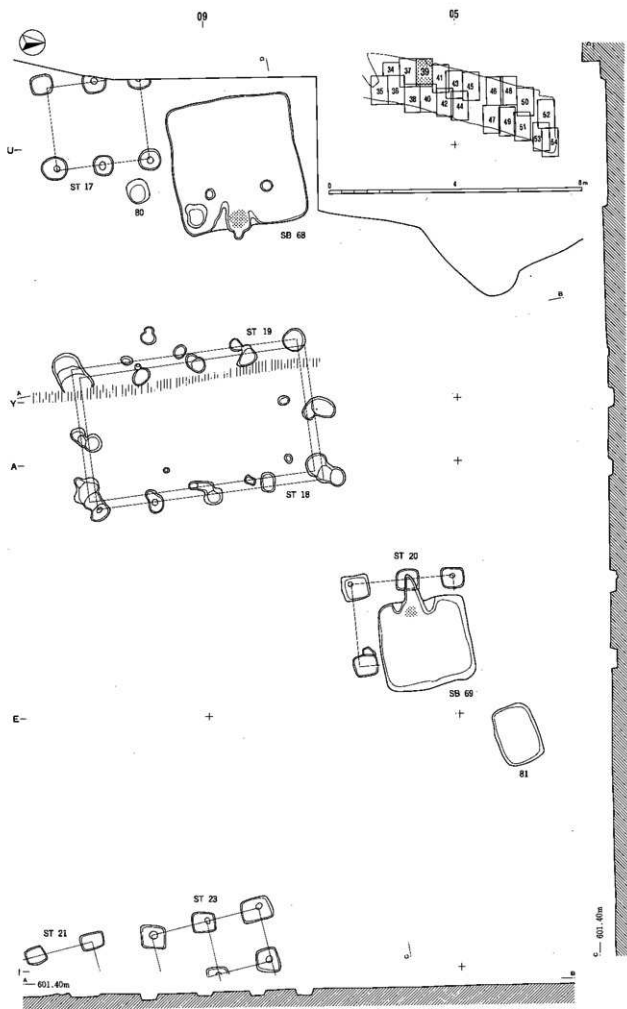

图版40 古代遺構実測図

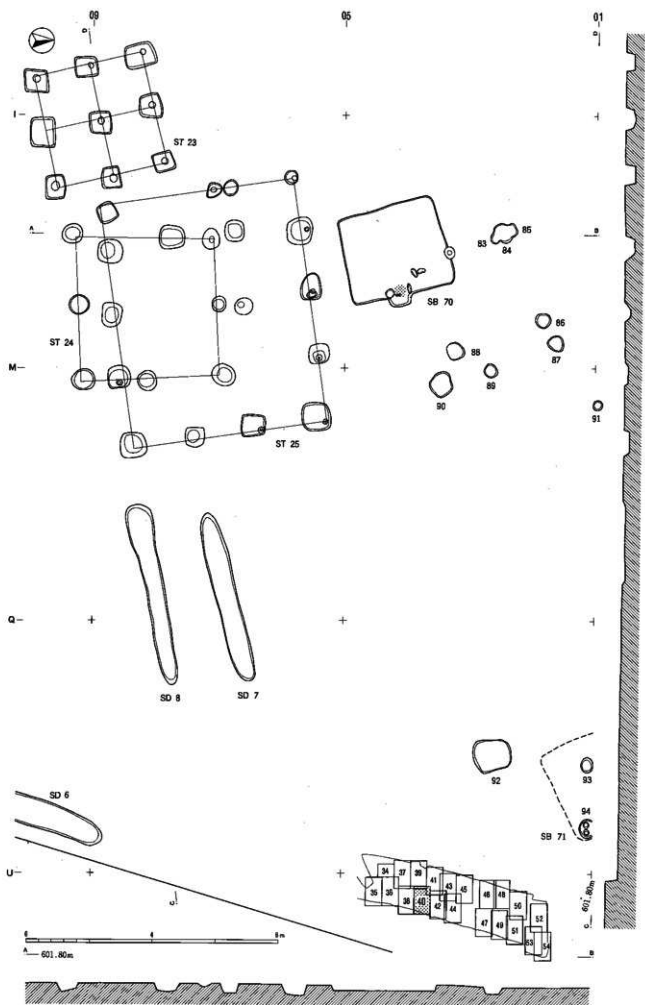

图版42 古代遺構実測図

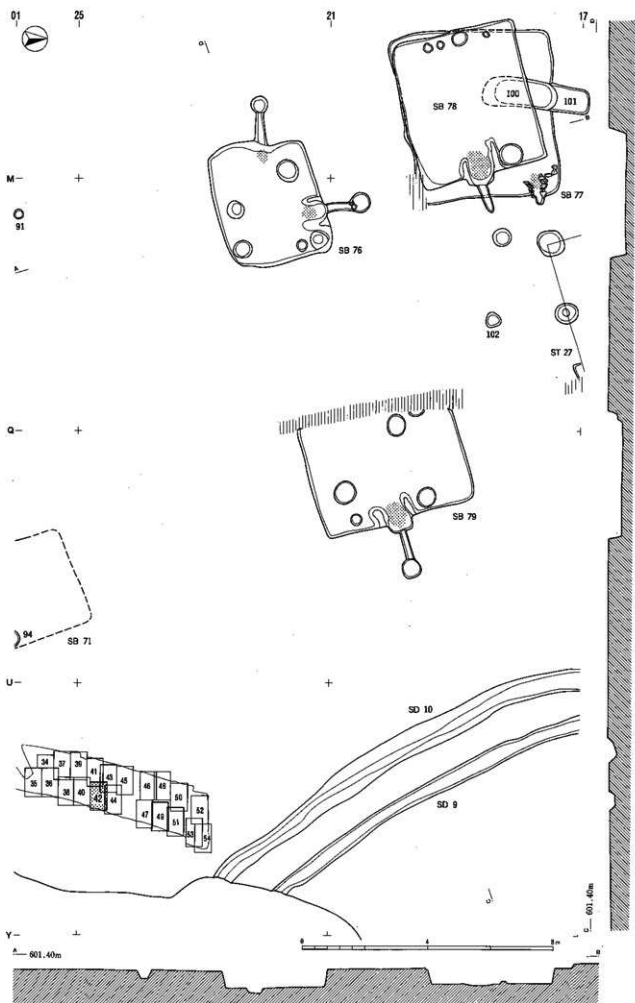

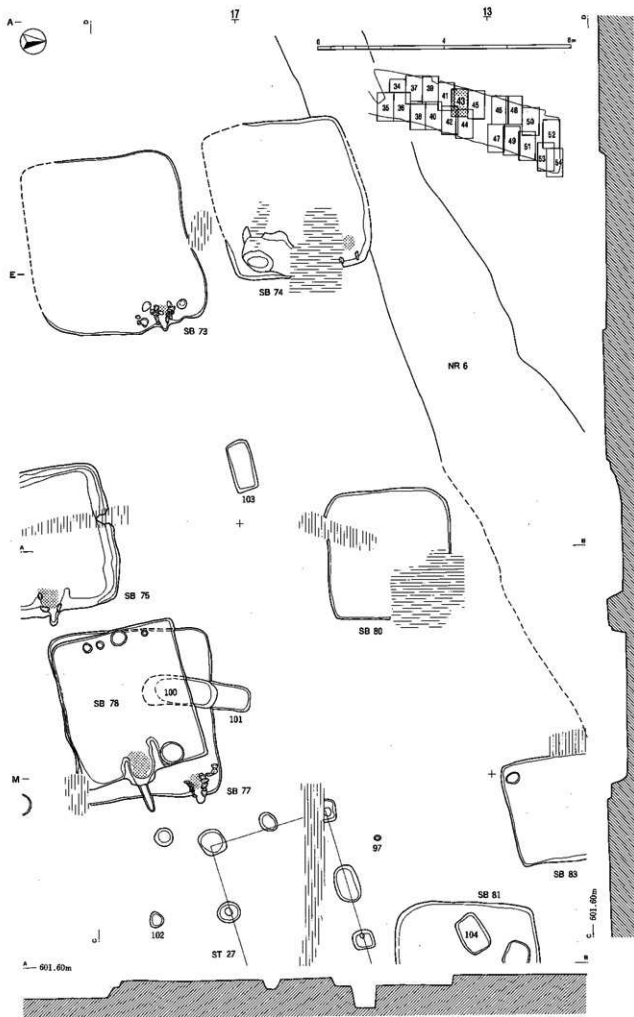

图版44 古代遺構実測図

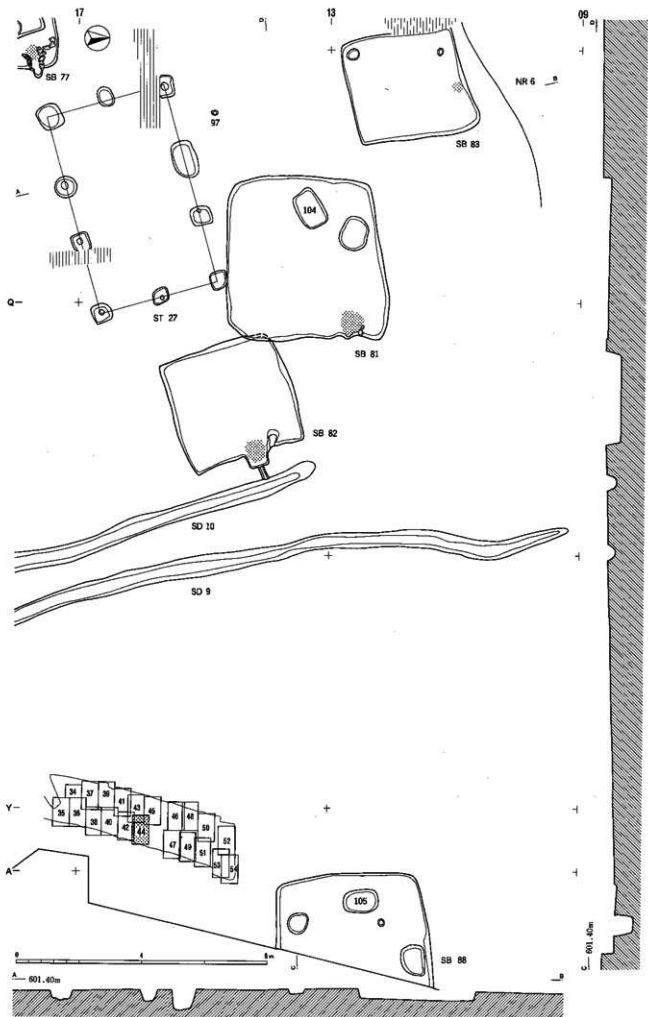

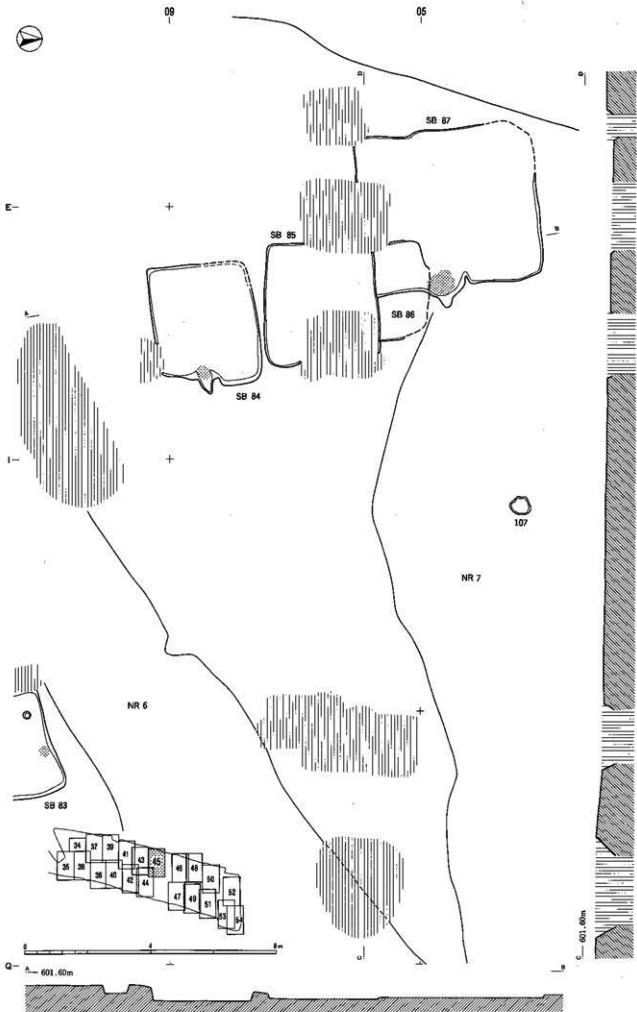



21

17

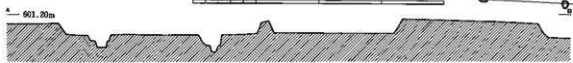
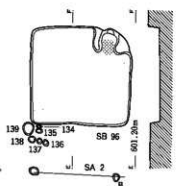
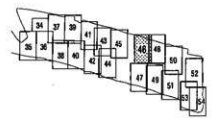
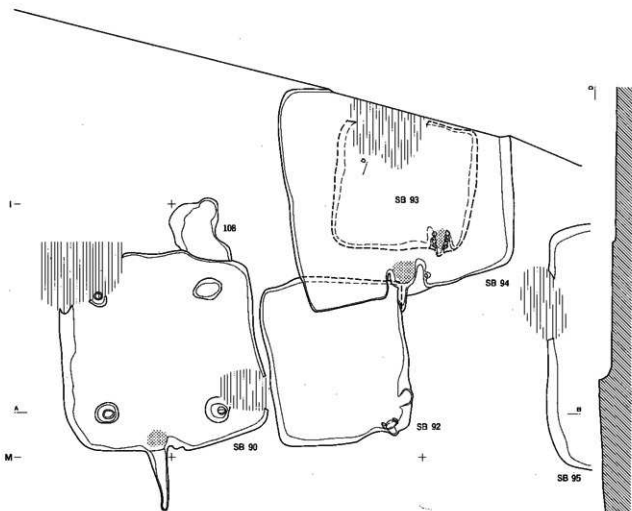

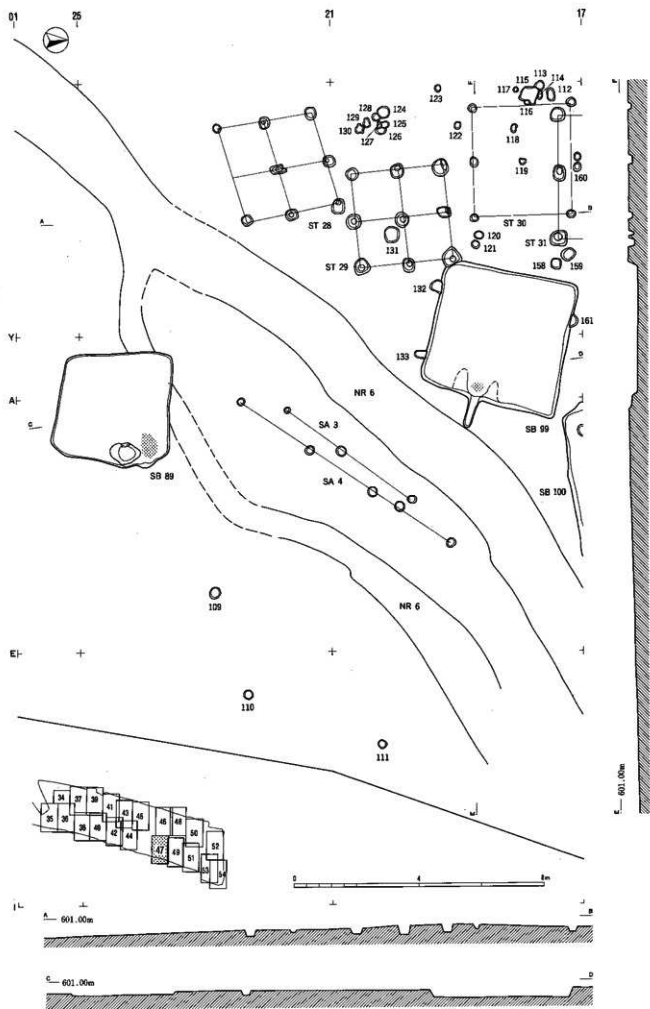

图版48 古代遺構実測図

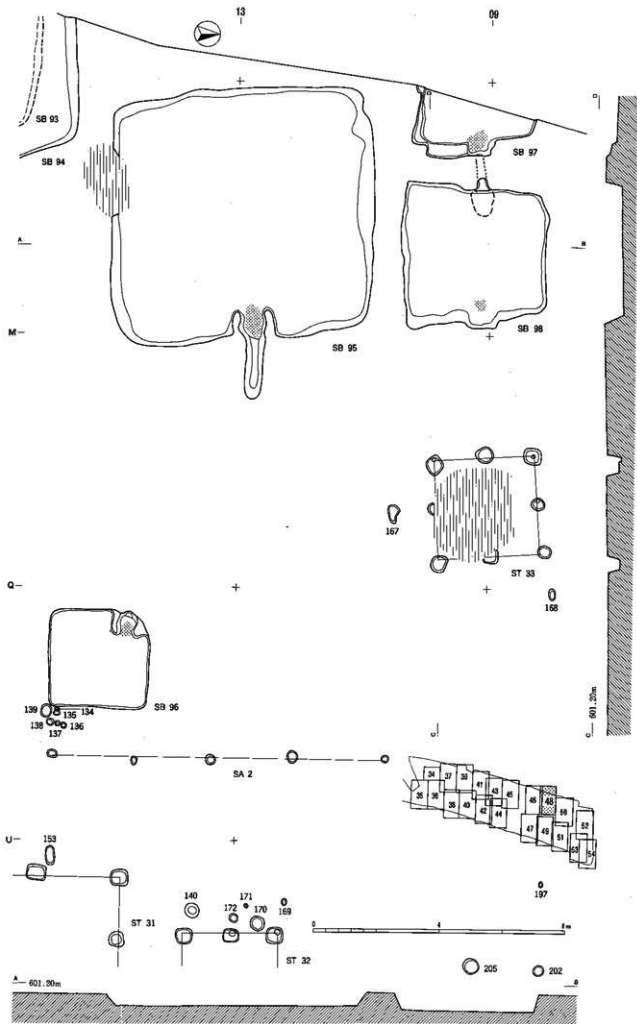

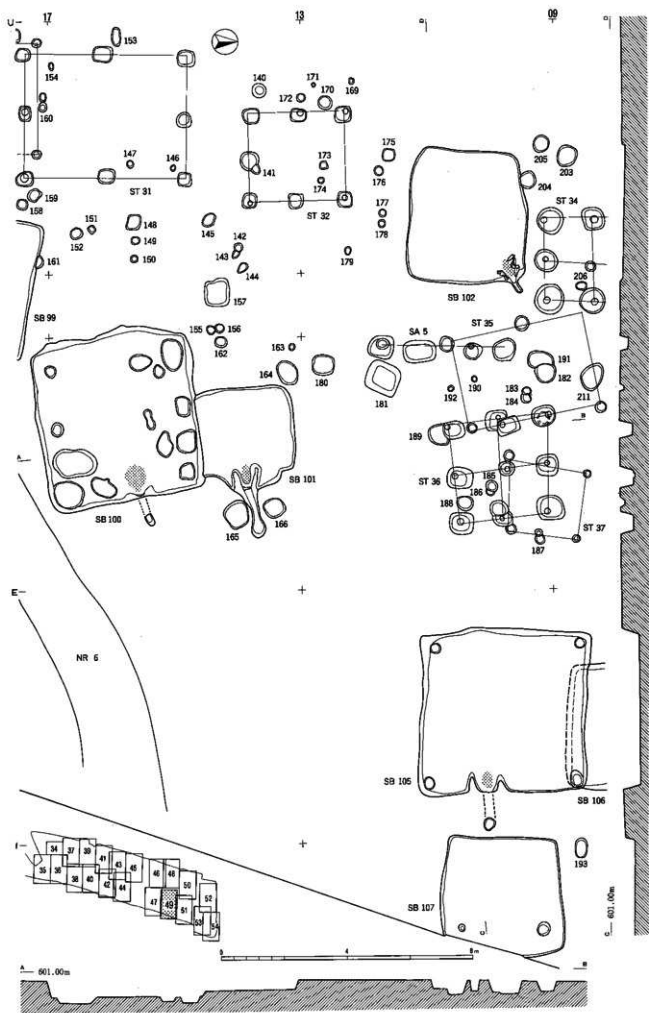

图版50 古代遺構実測図

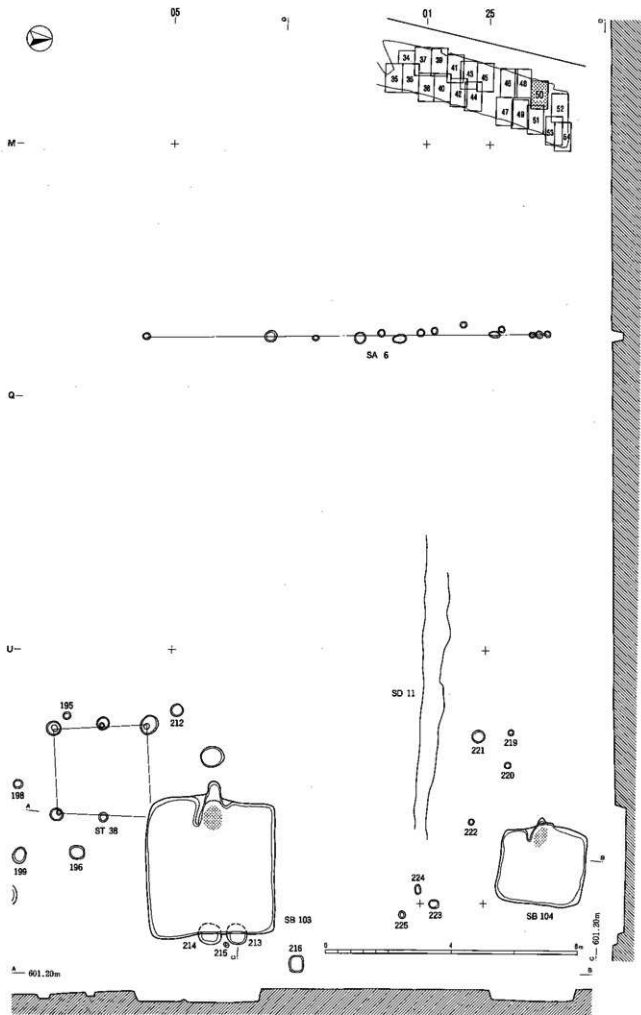

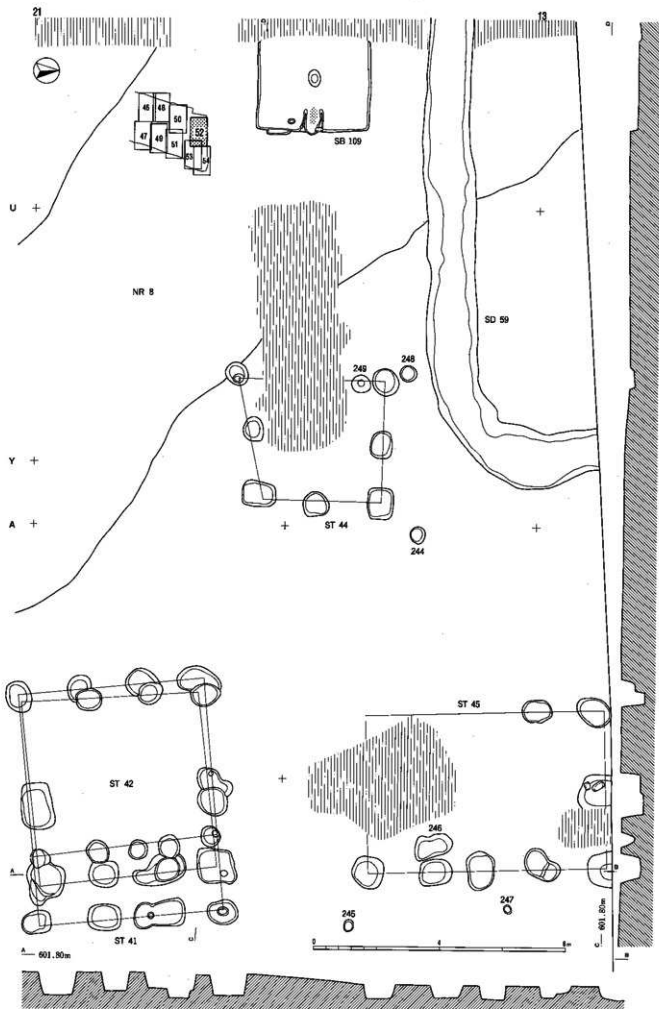

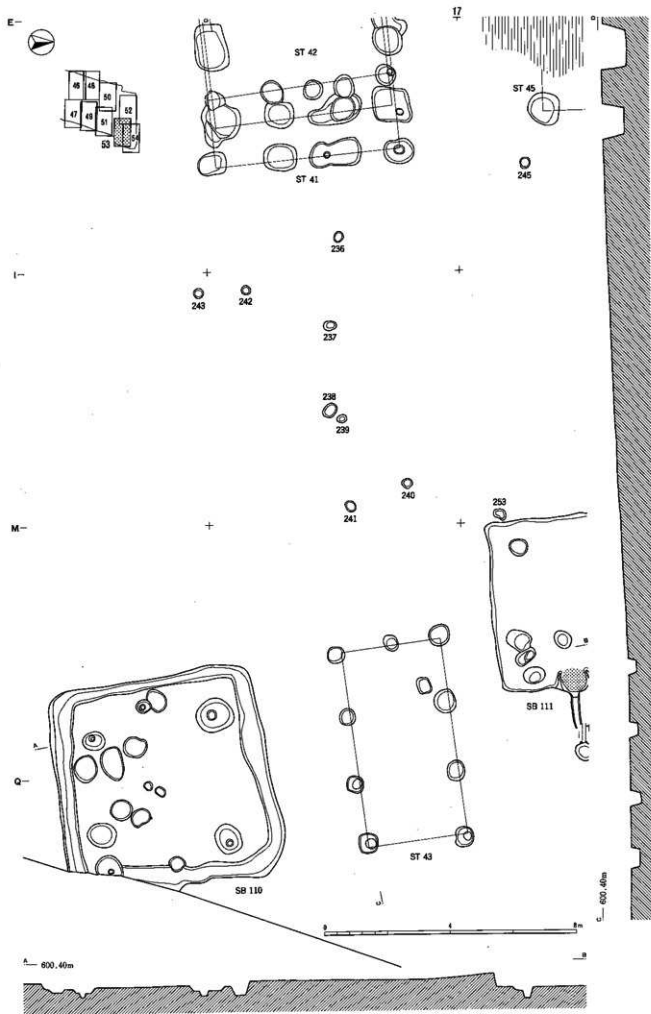

図版54 古代遺構実測図

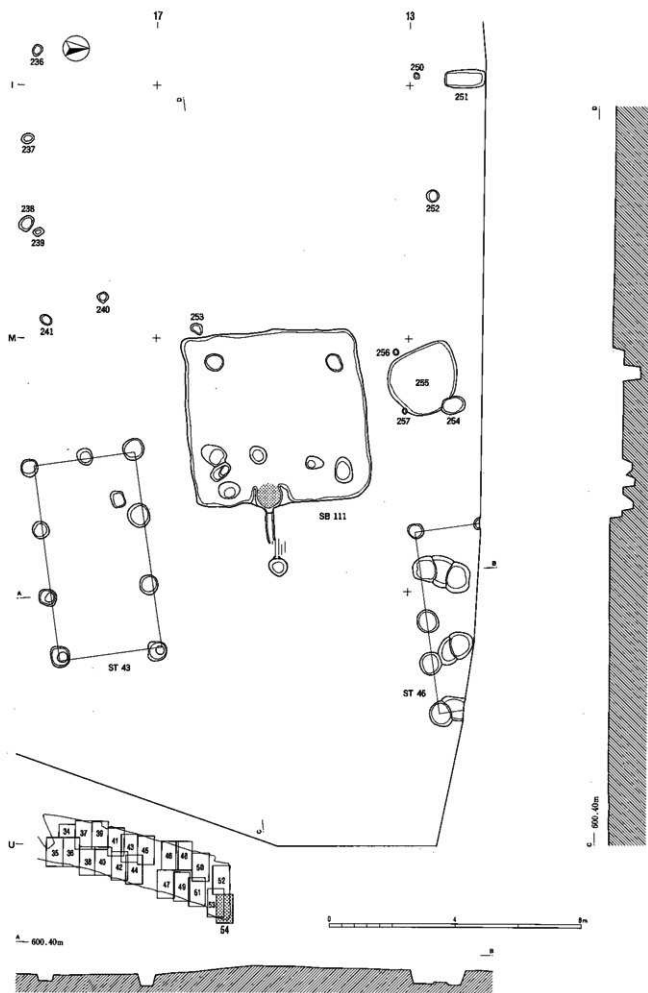

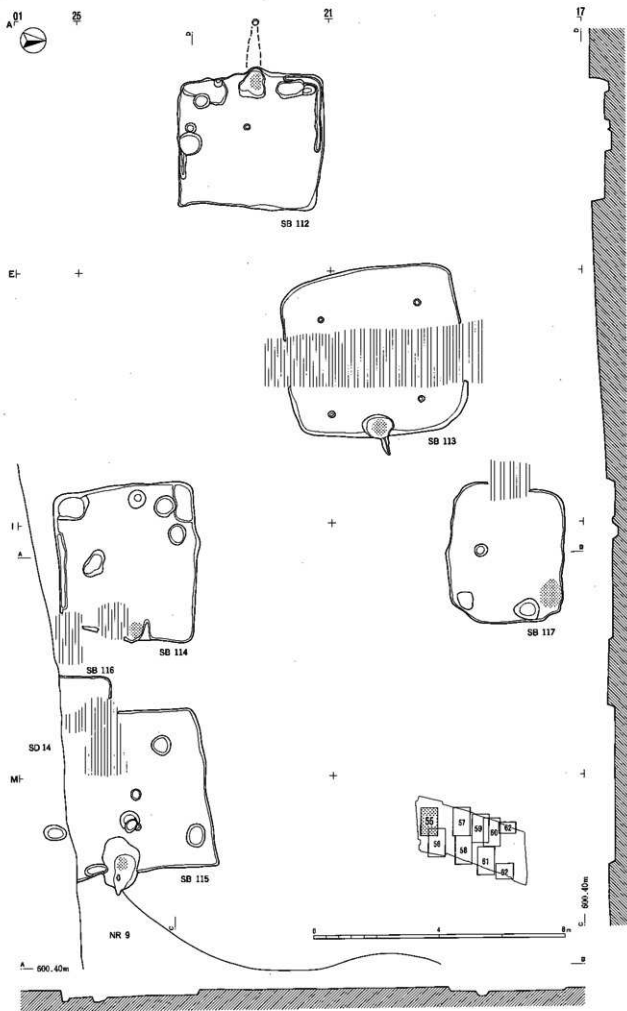

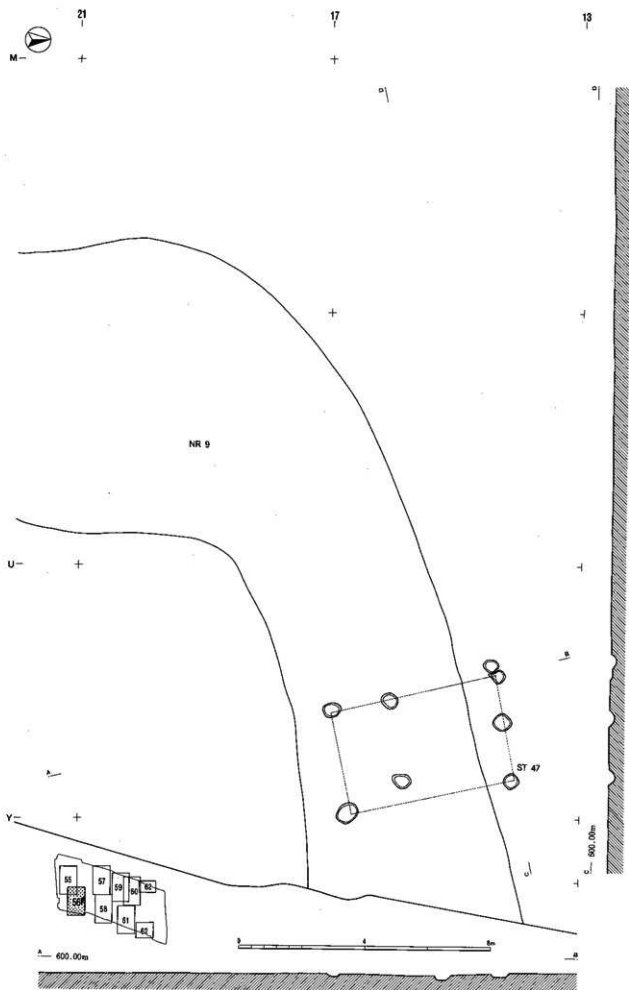

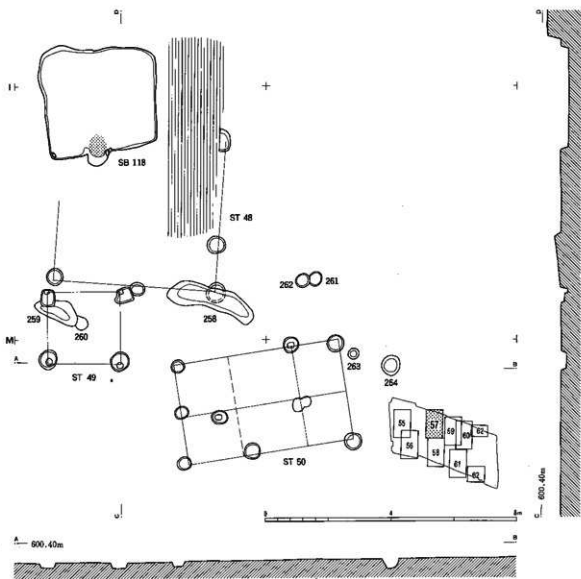
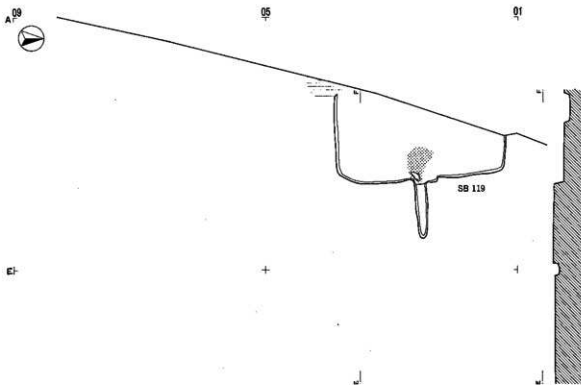

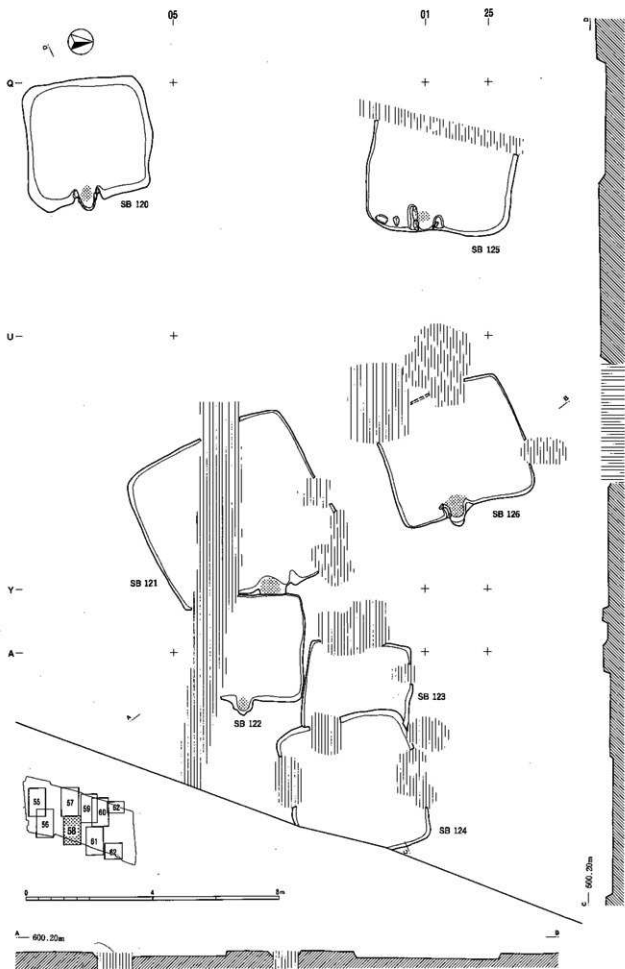

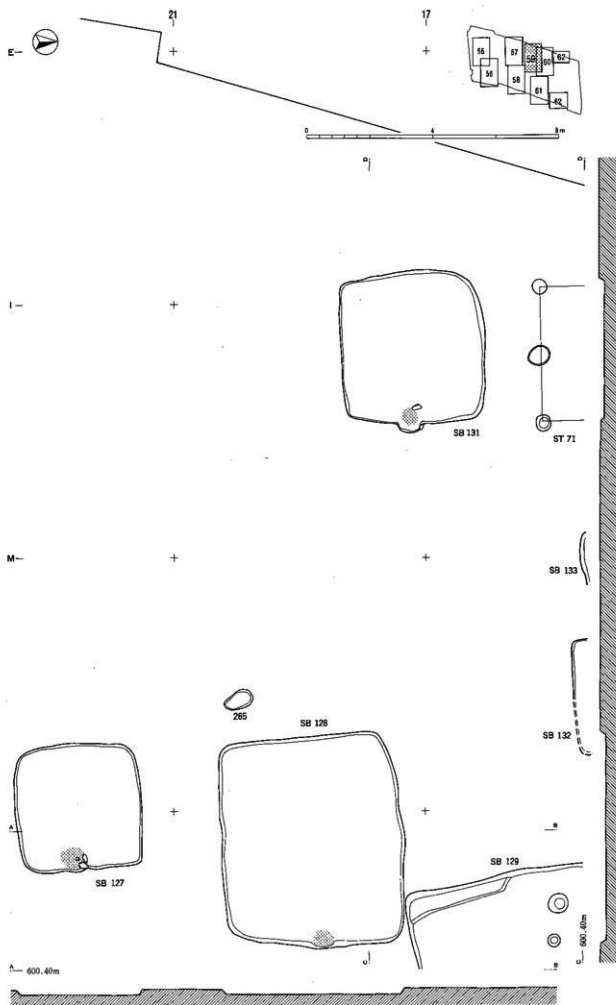

图版60 古代遺構実測図

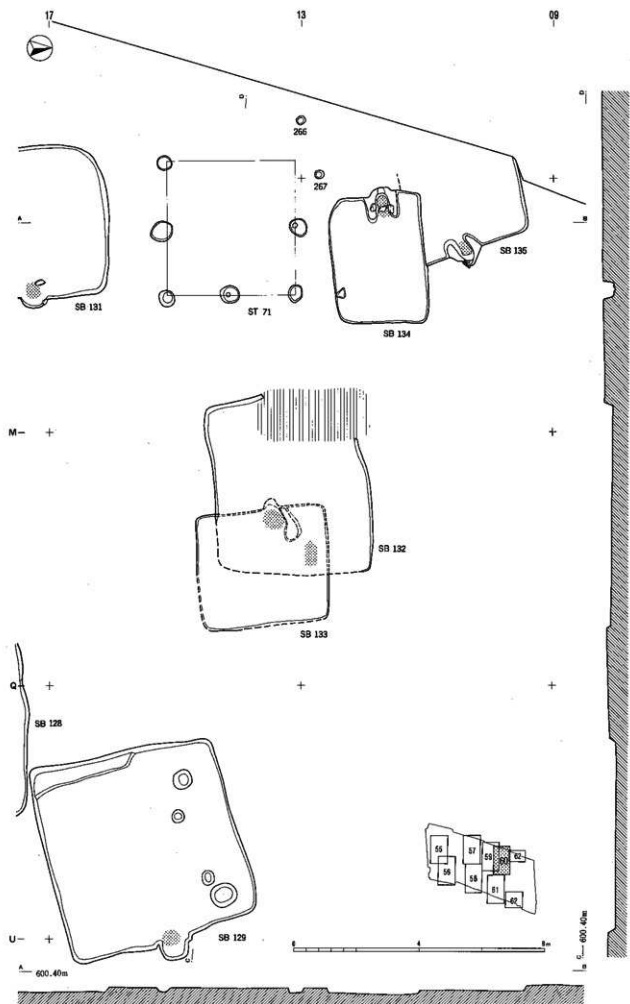

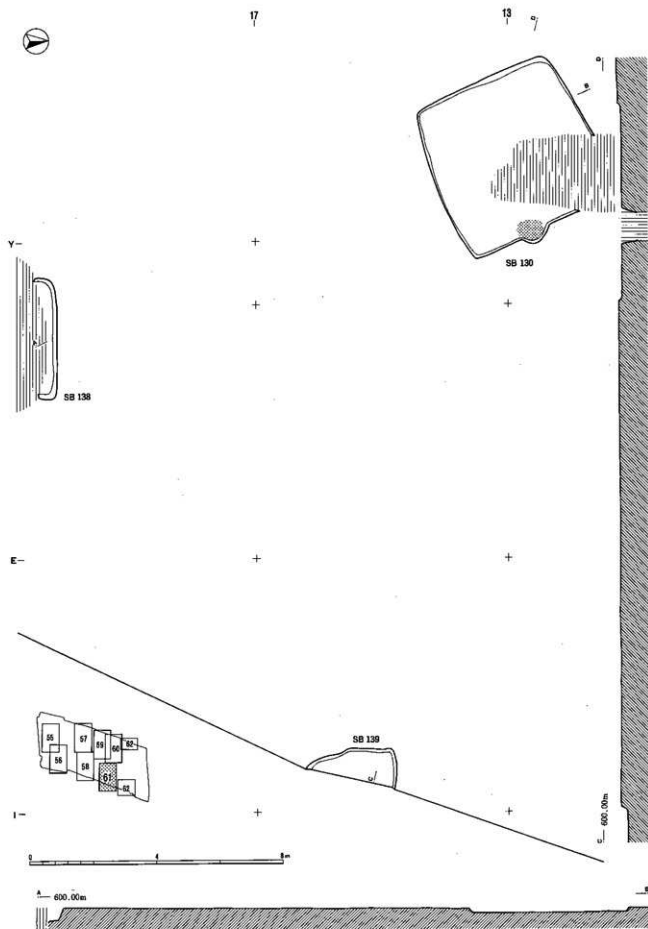

图版62 古代遺構実測図

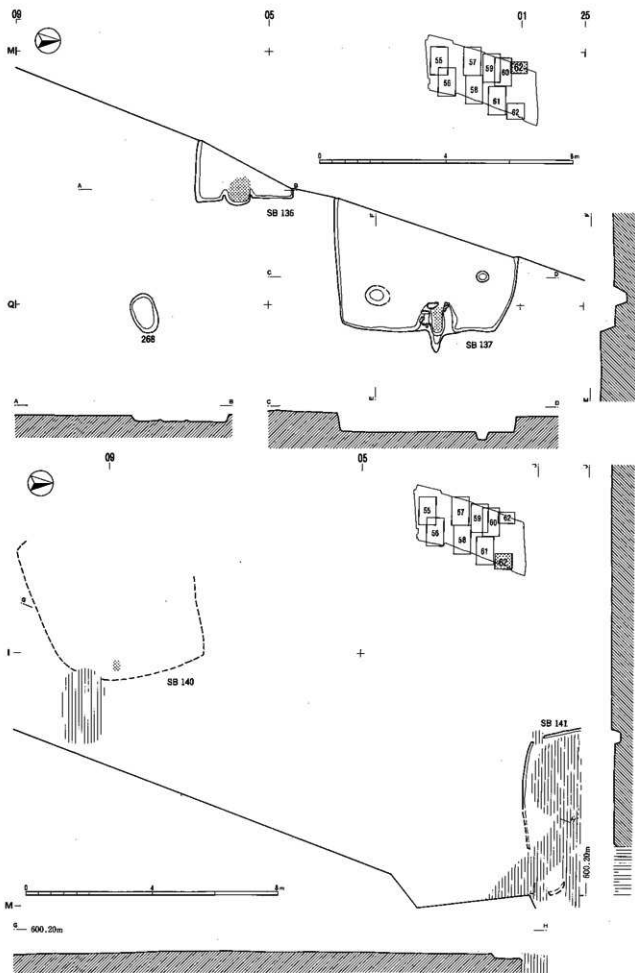

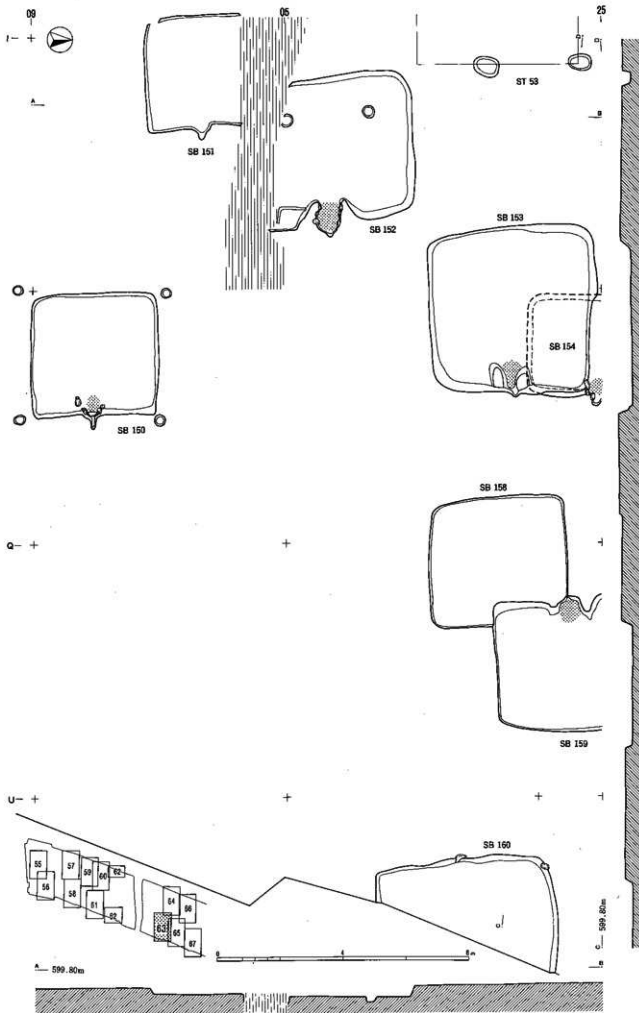

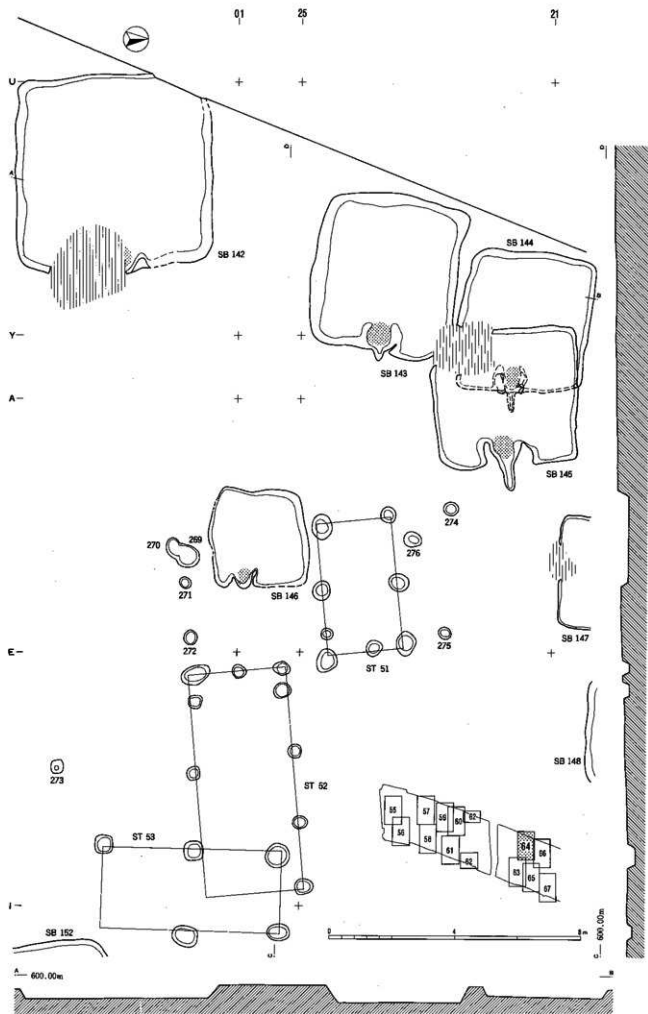

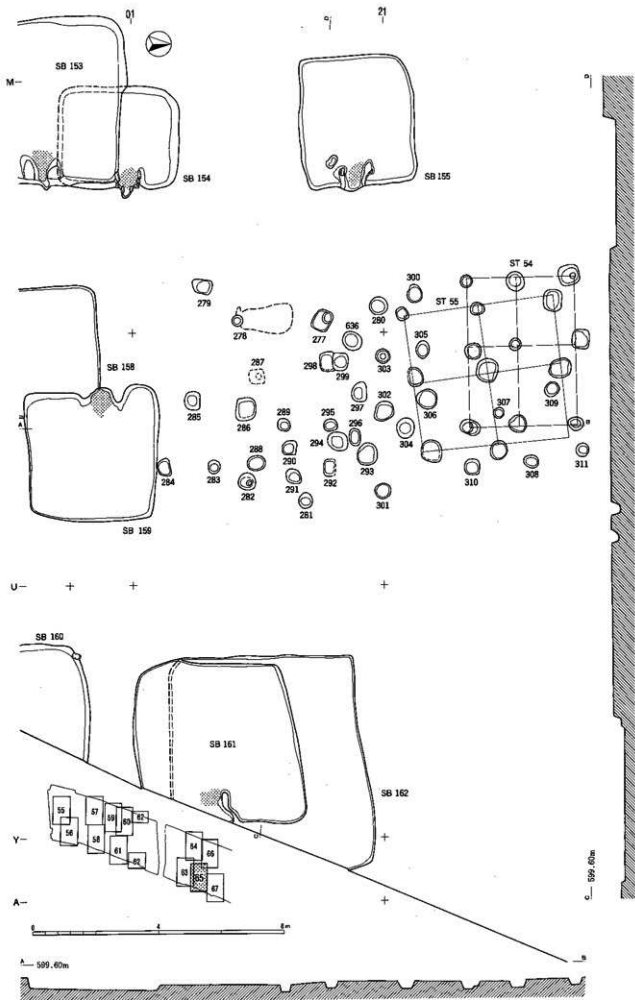

図版66 古代遺構実測図

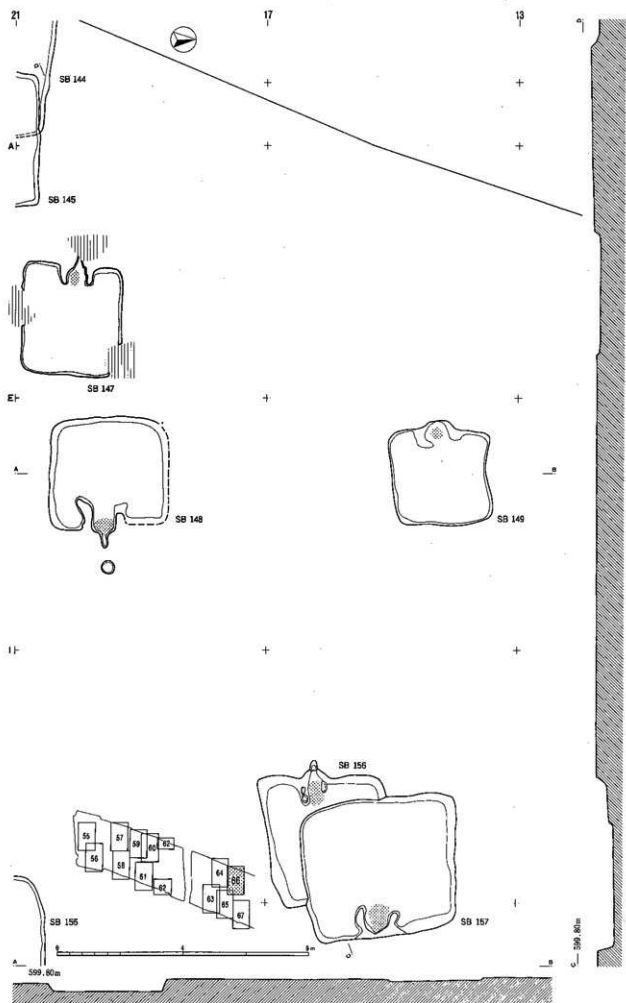

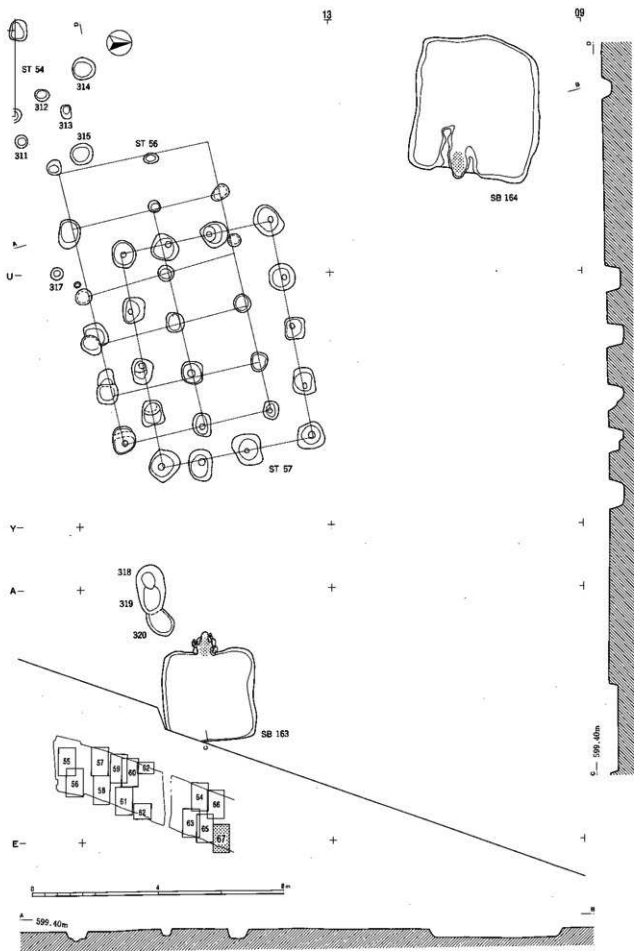

図版68 古代遺構実測図

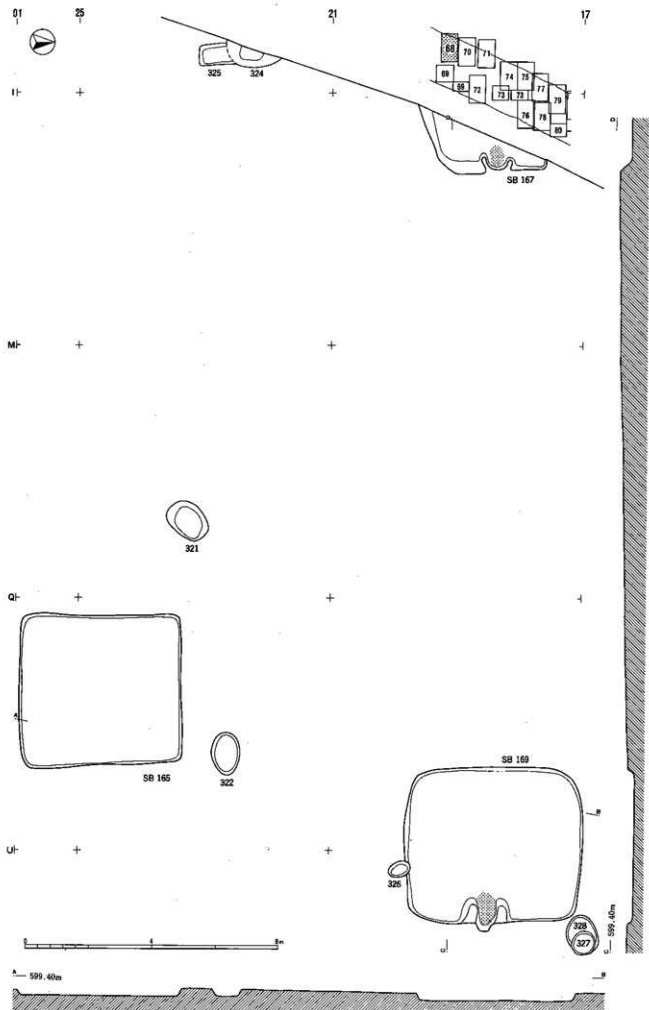

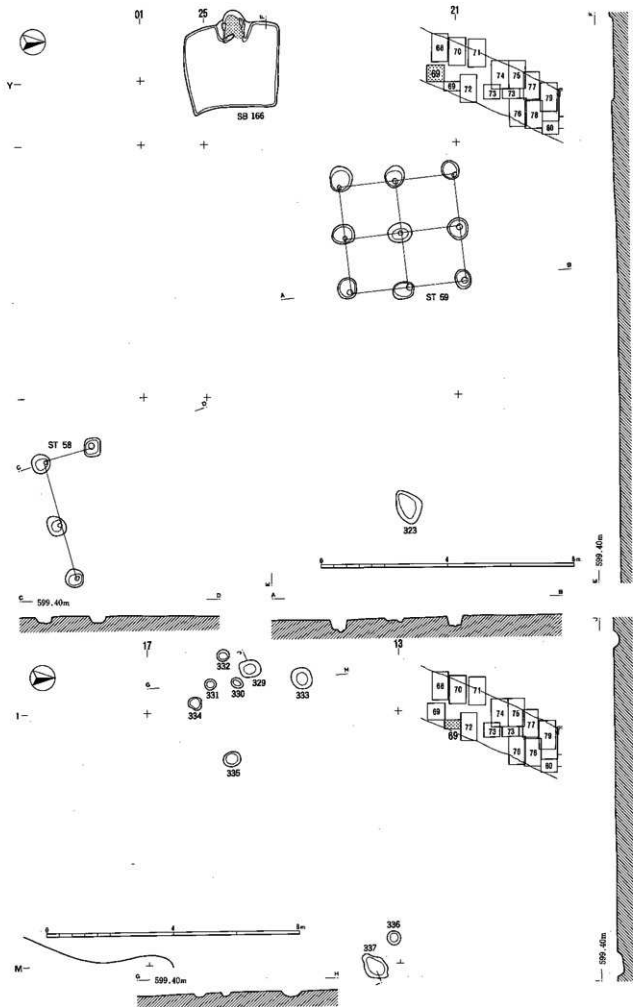

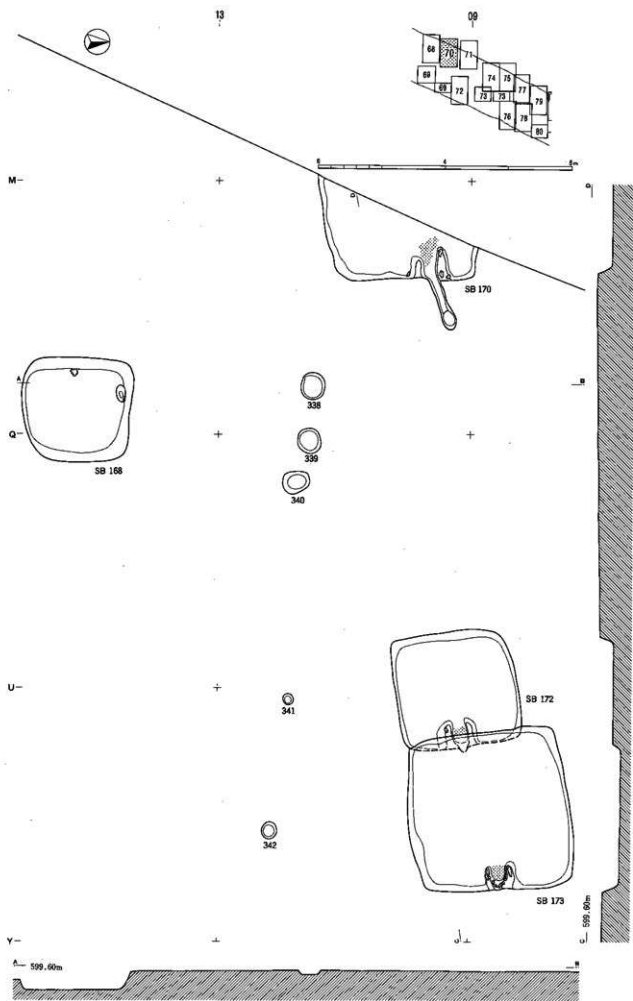

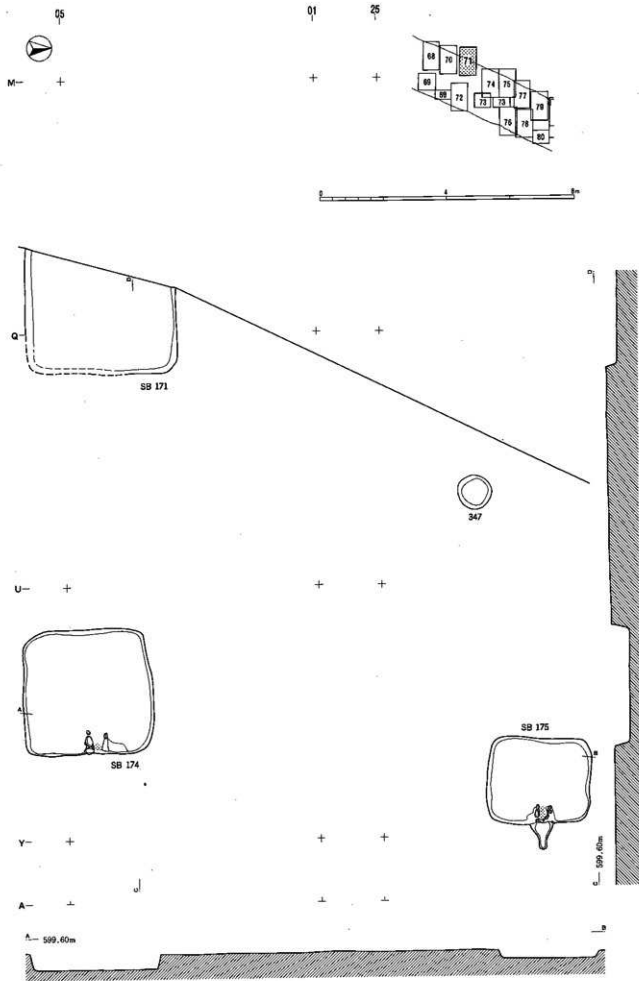

图版72 古代遺構実測図

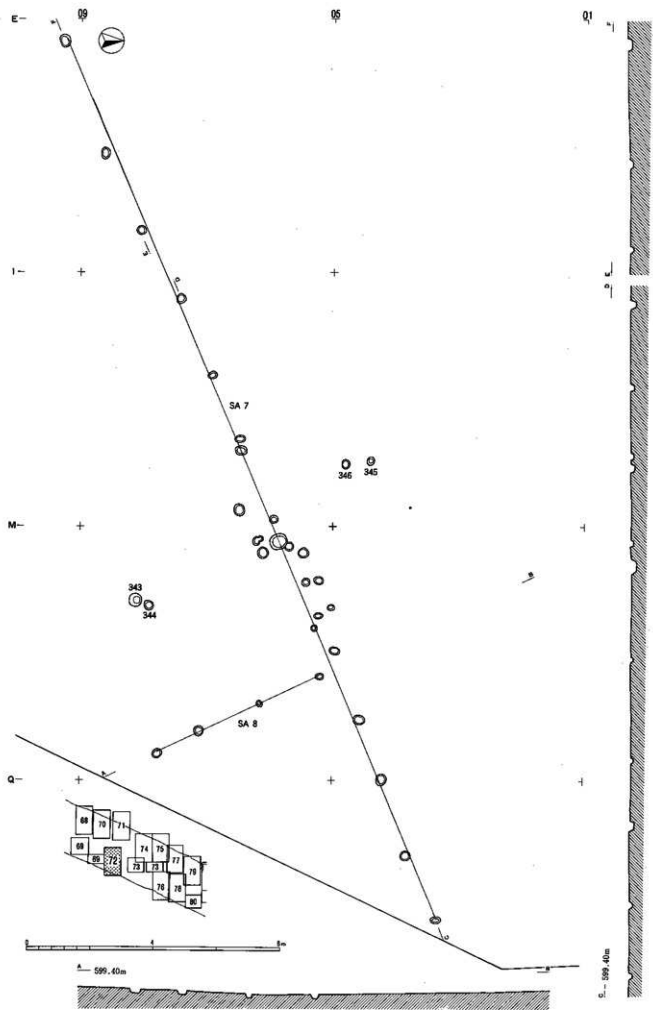

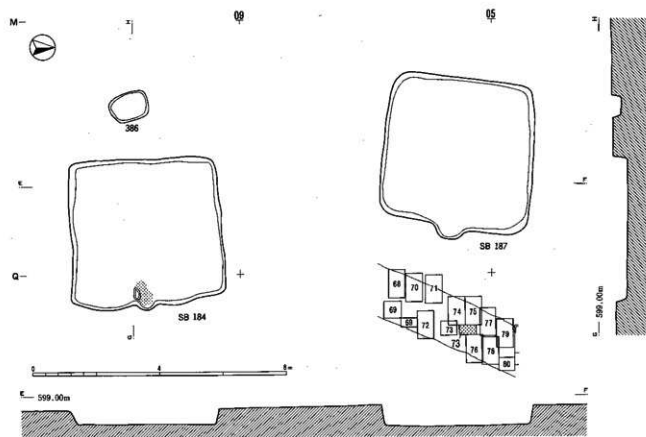
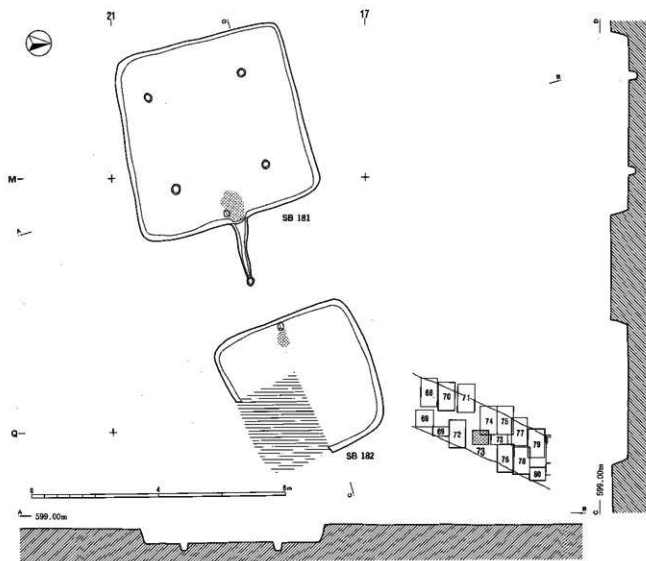

图版74 古代遺構実測図

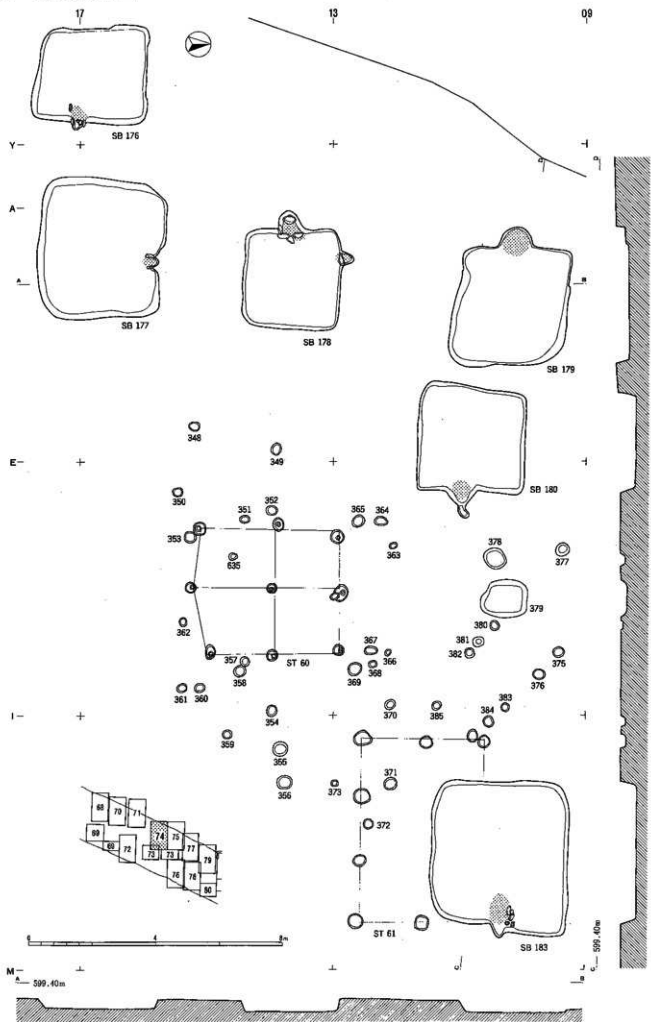

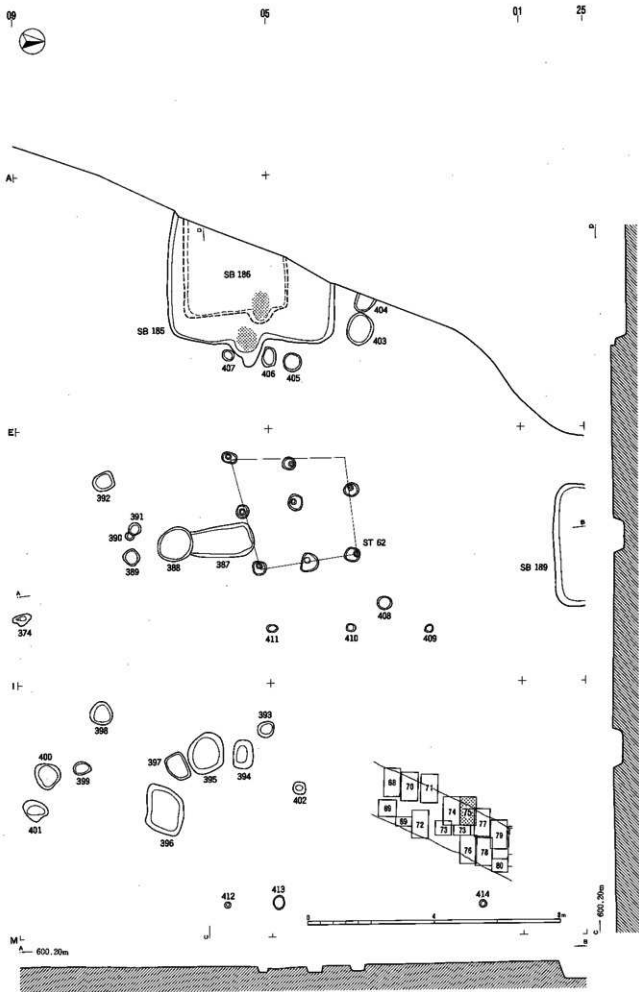

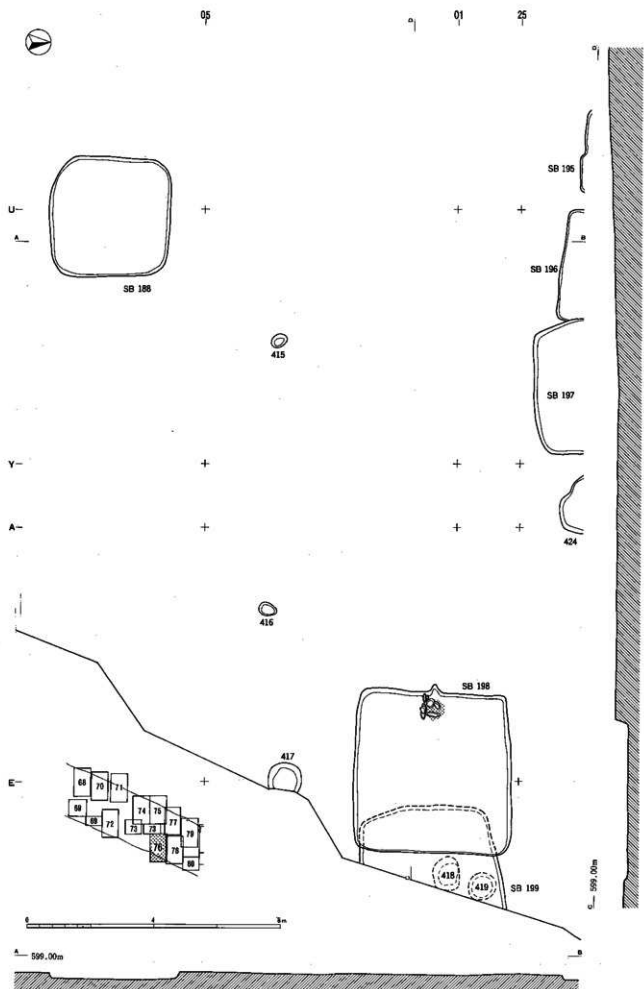

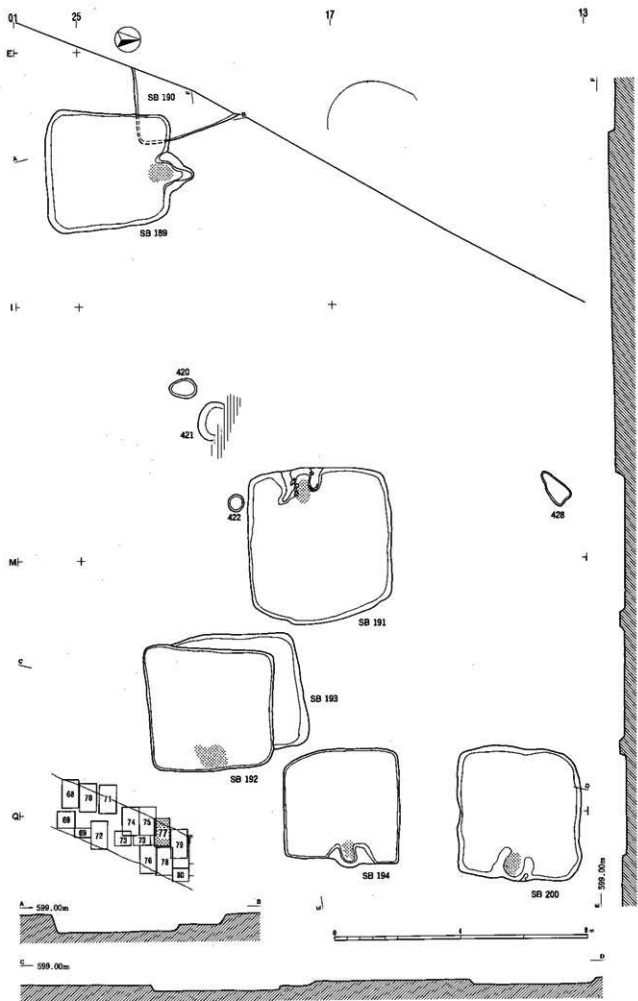

図版78 古代遺構実測図

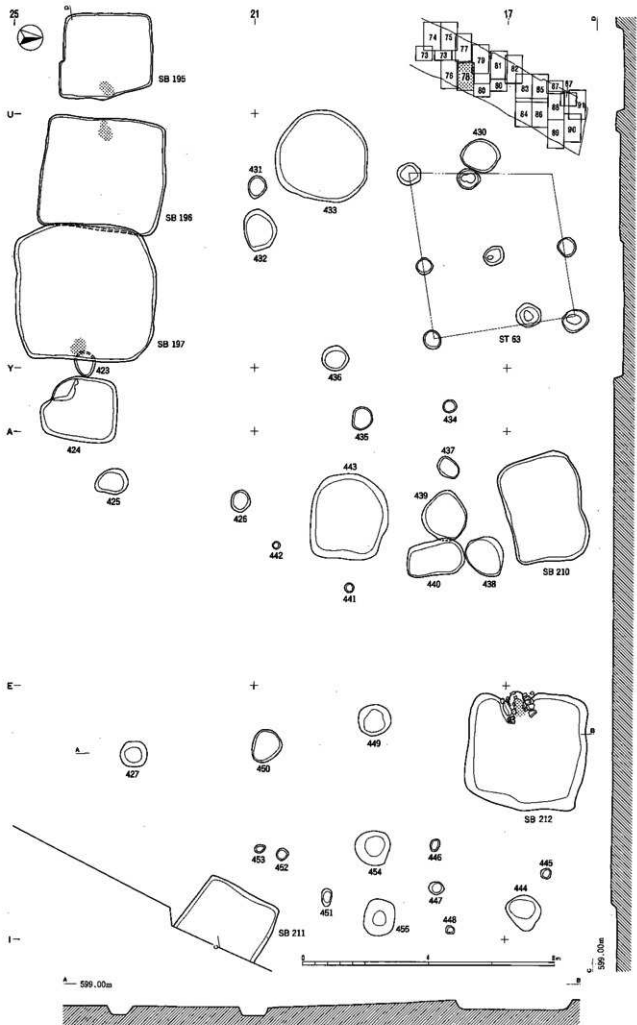

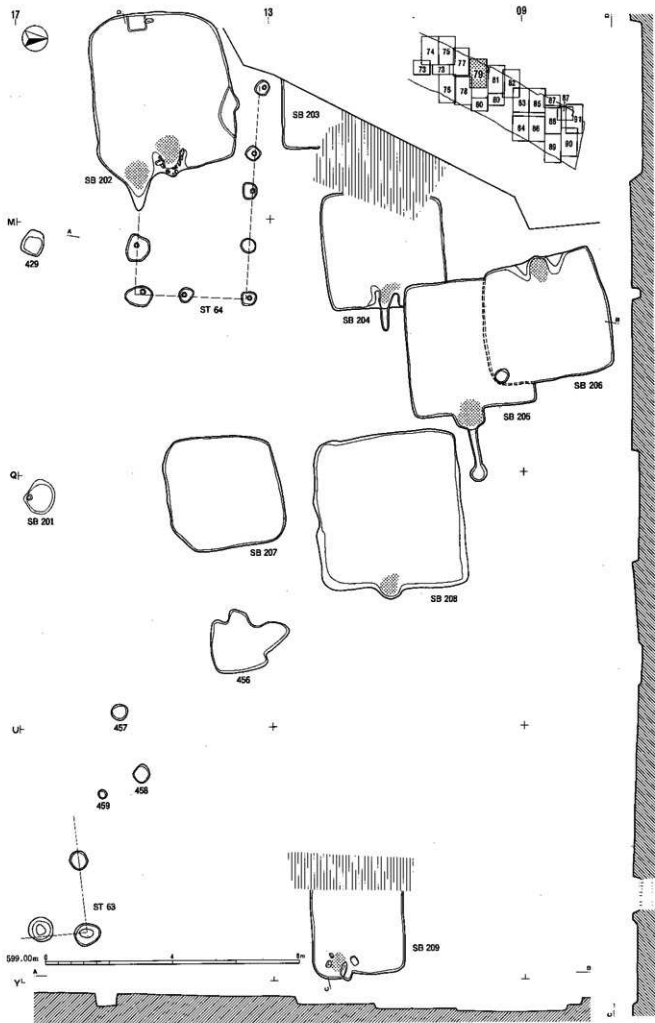

图版80 古代遺構実測図

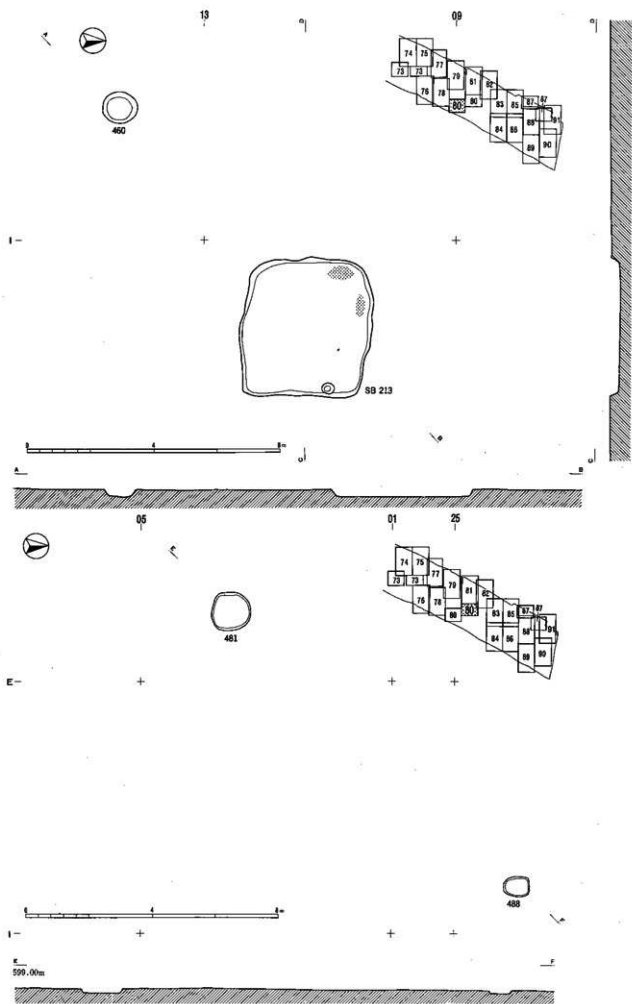

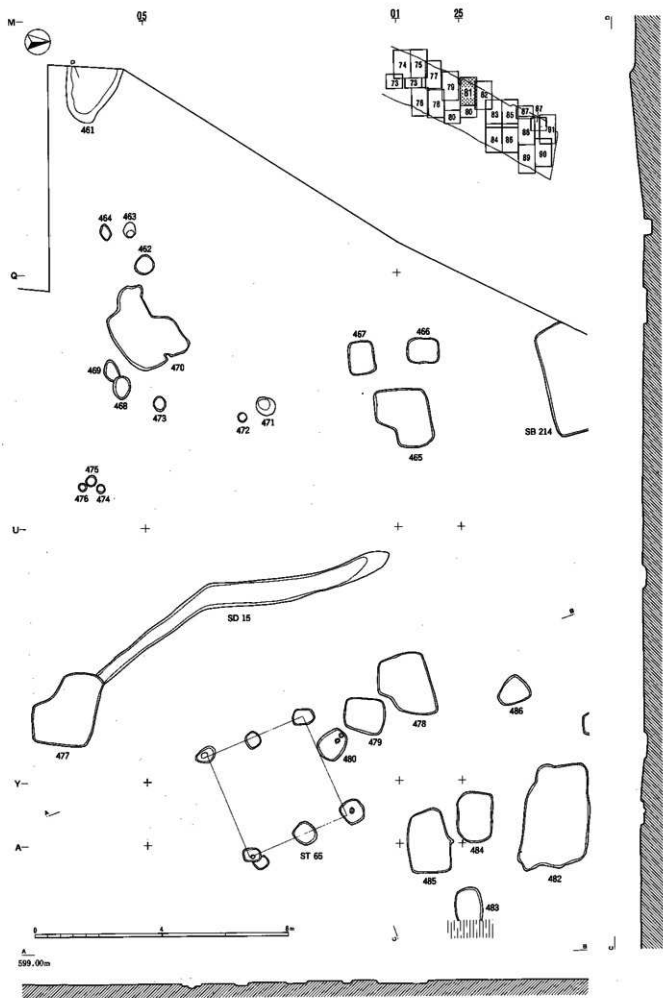

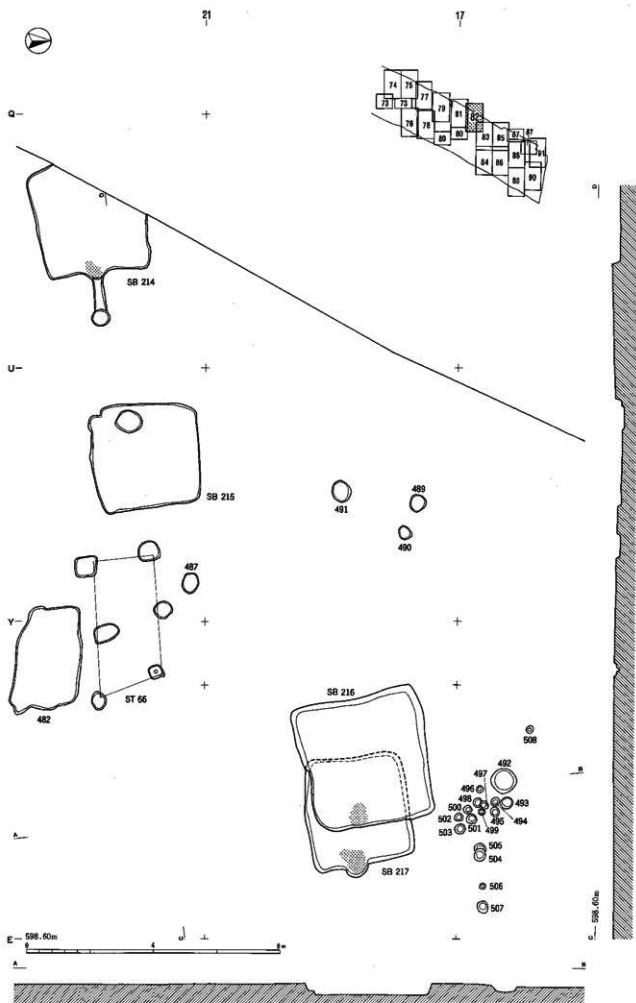

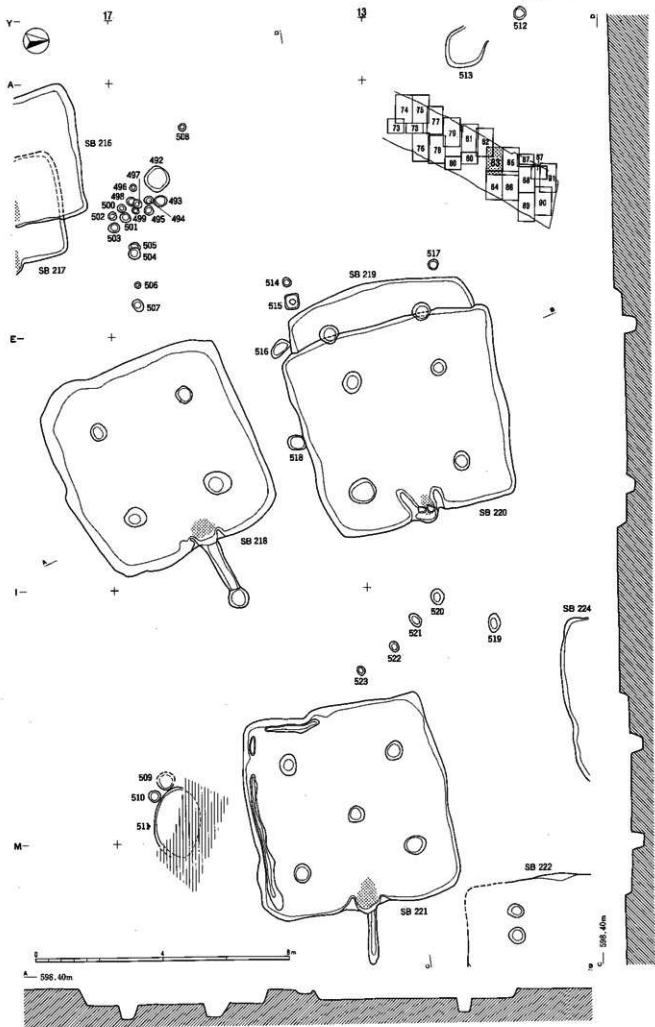

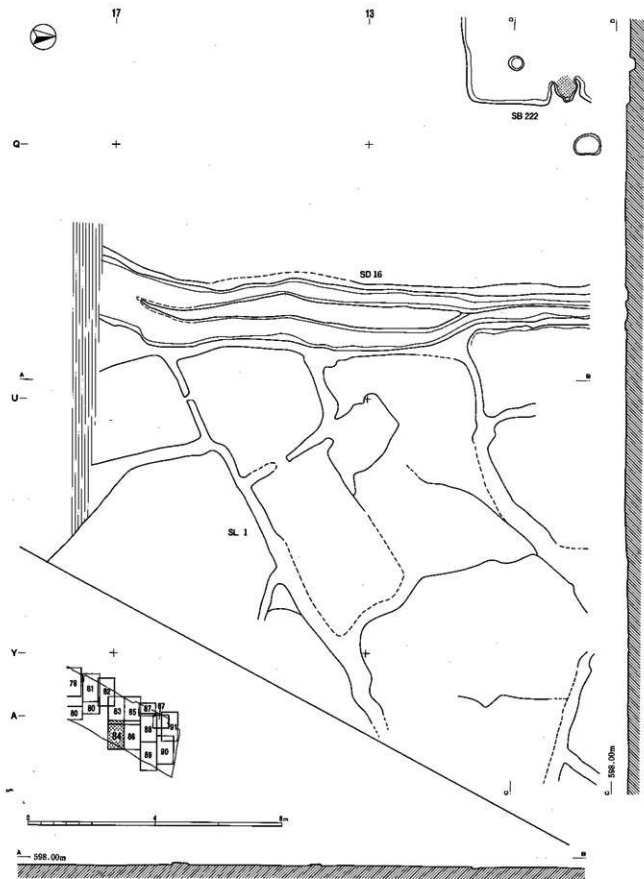

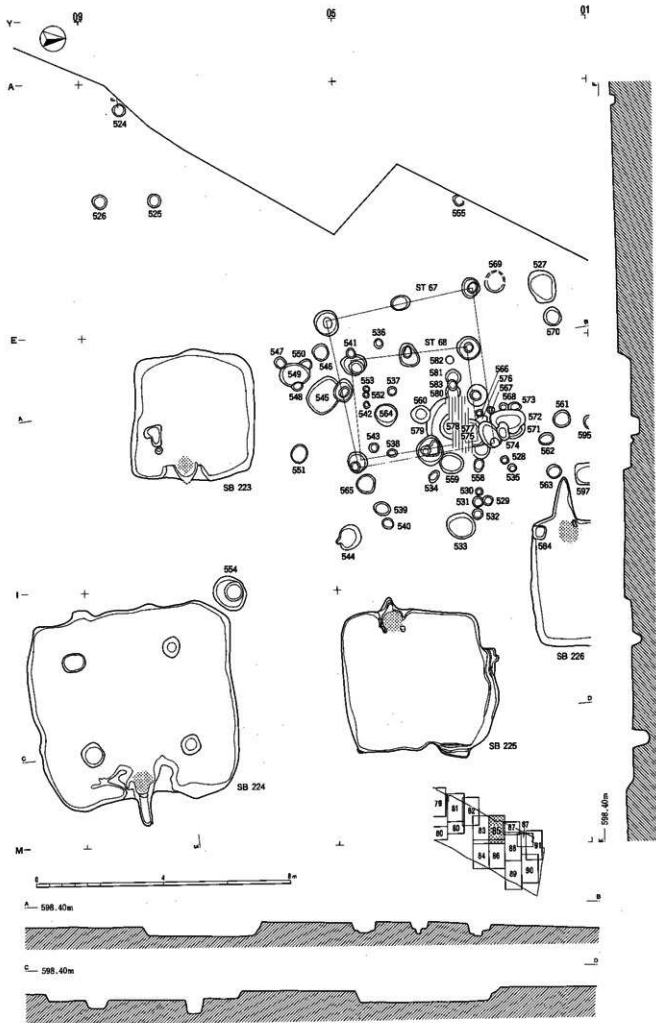

图版86 古代遺構実測図

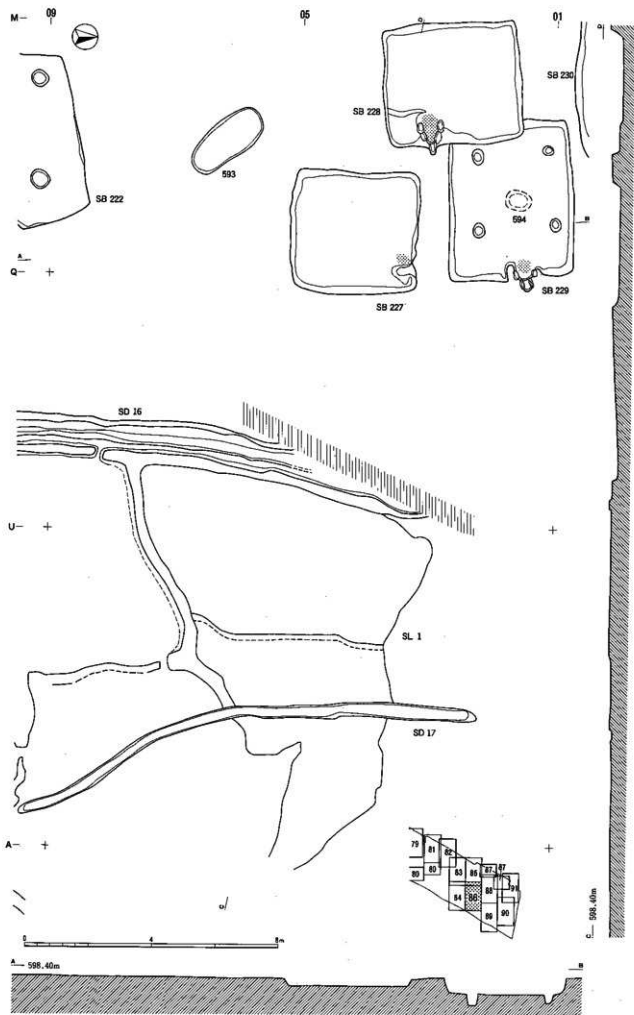

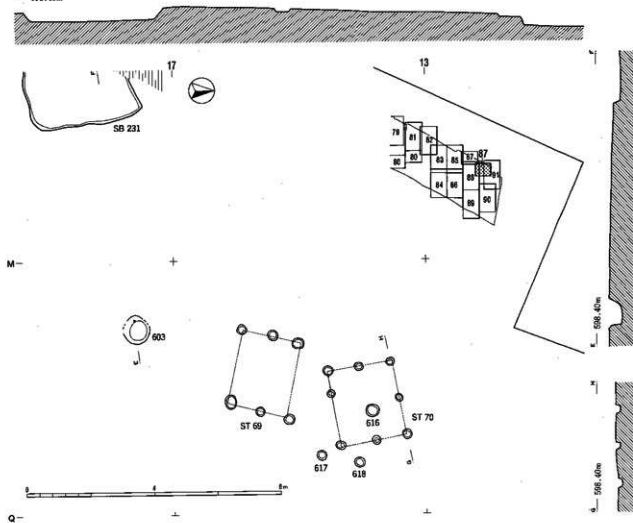
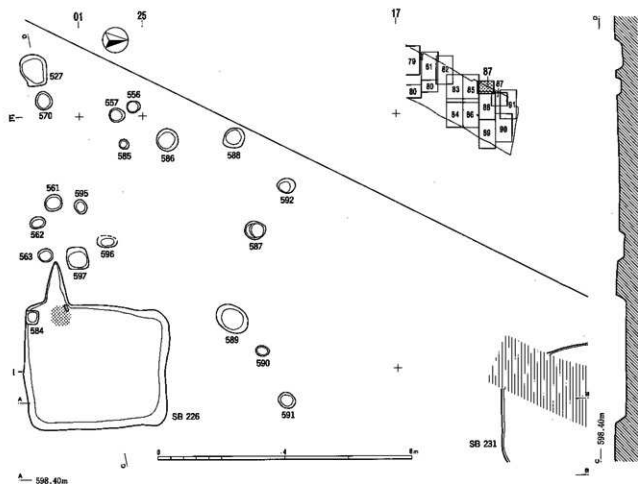

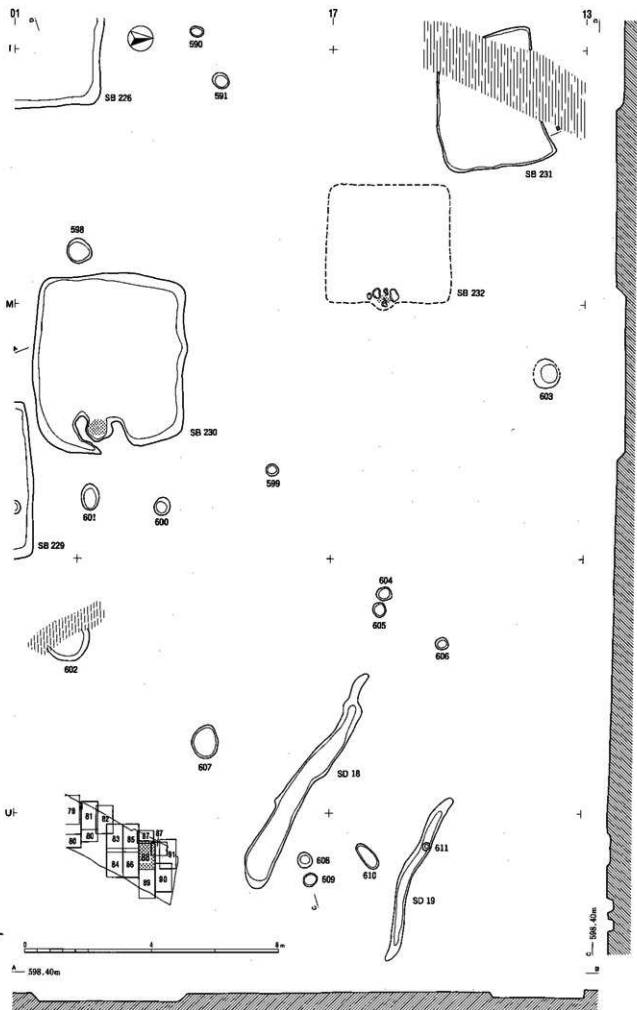

图版90 古代遺構実測図

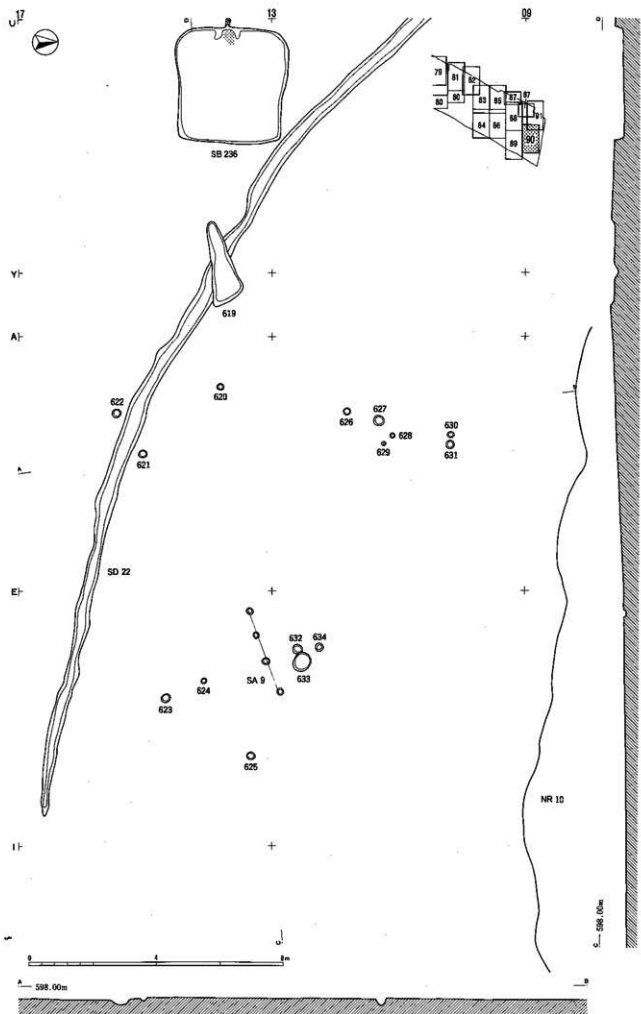

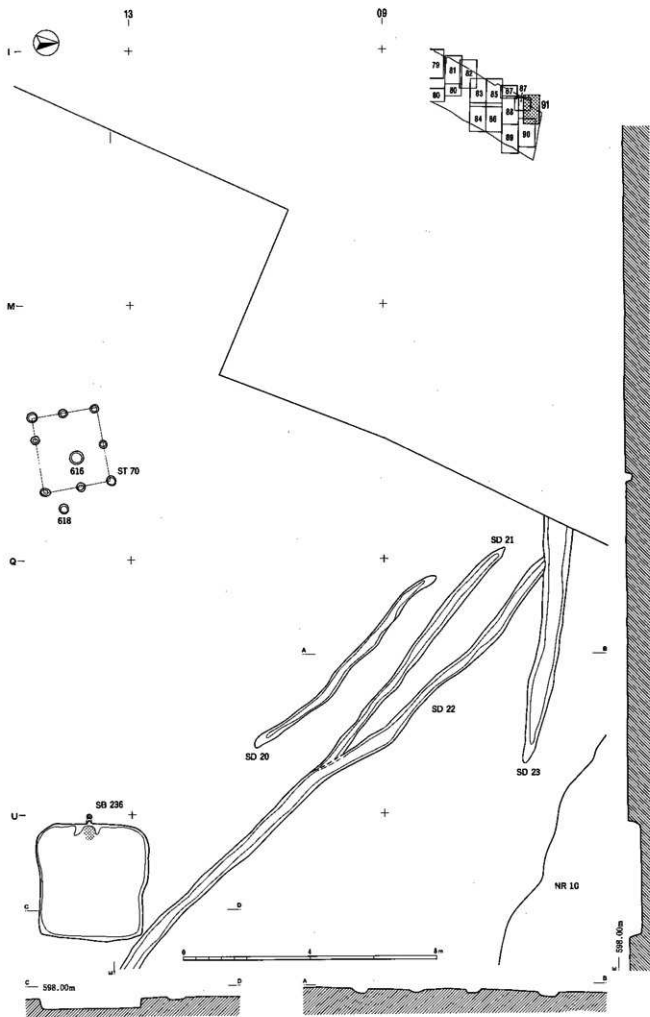

図版92 中世遺構割付図

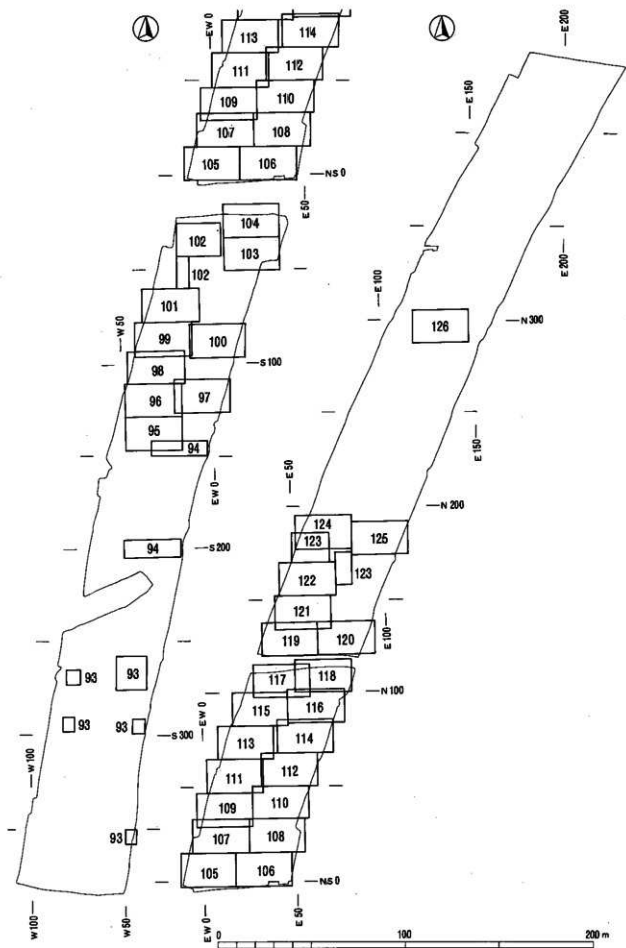

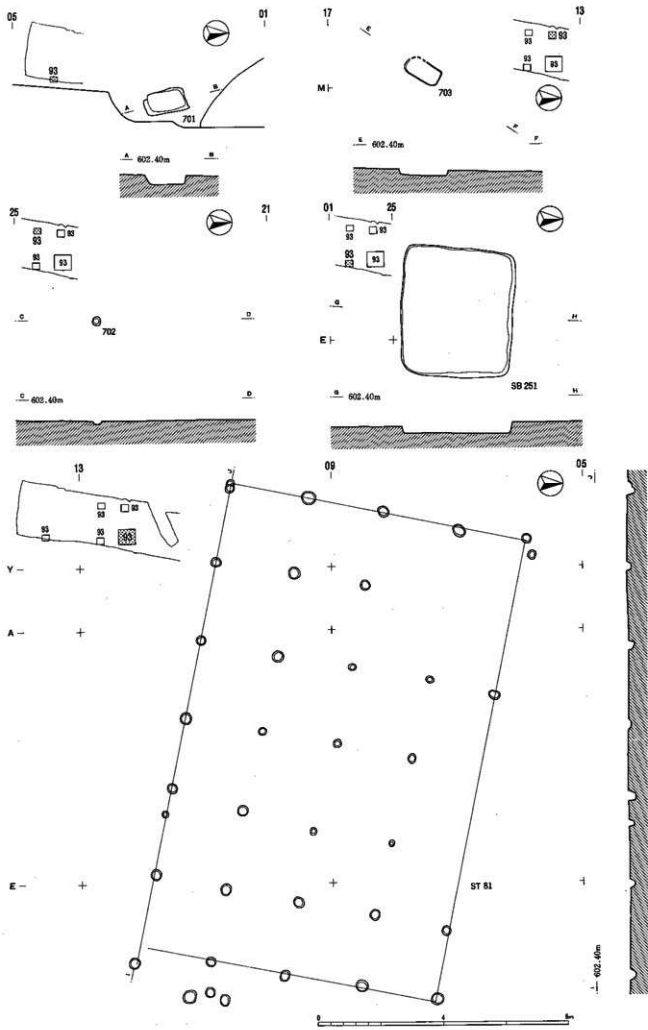

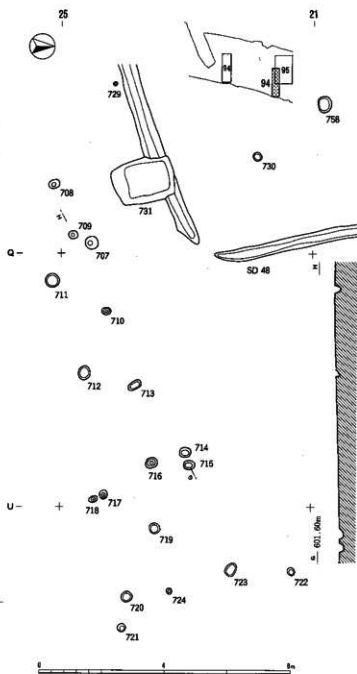
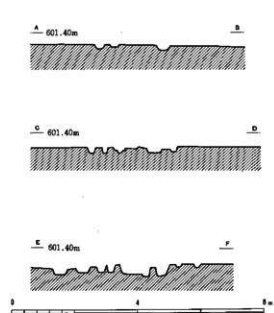
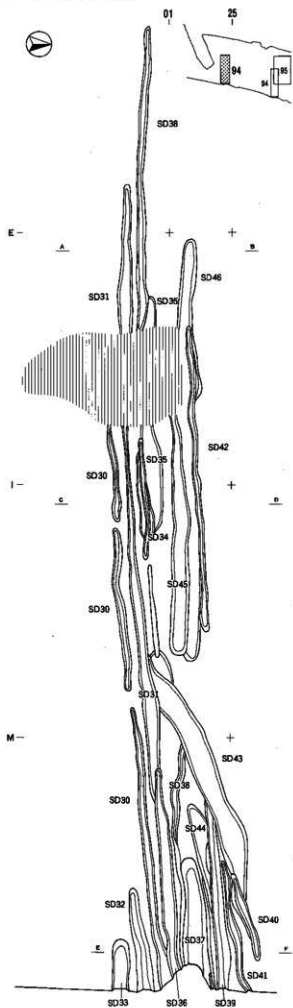

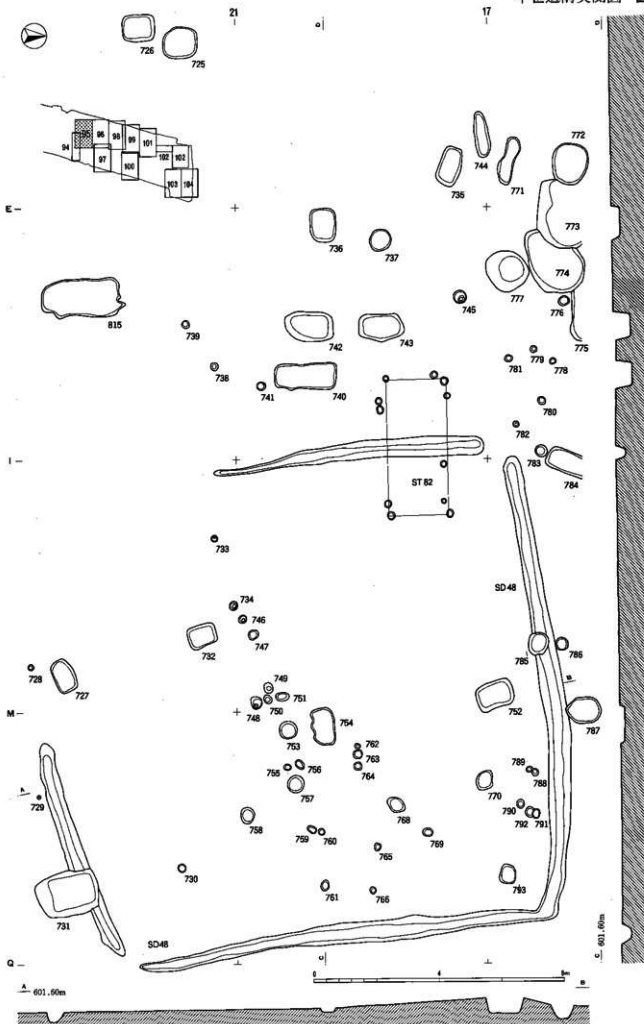

图版96 中世遺構実測図

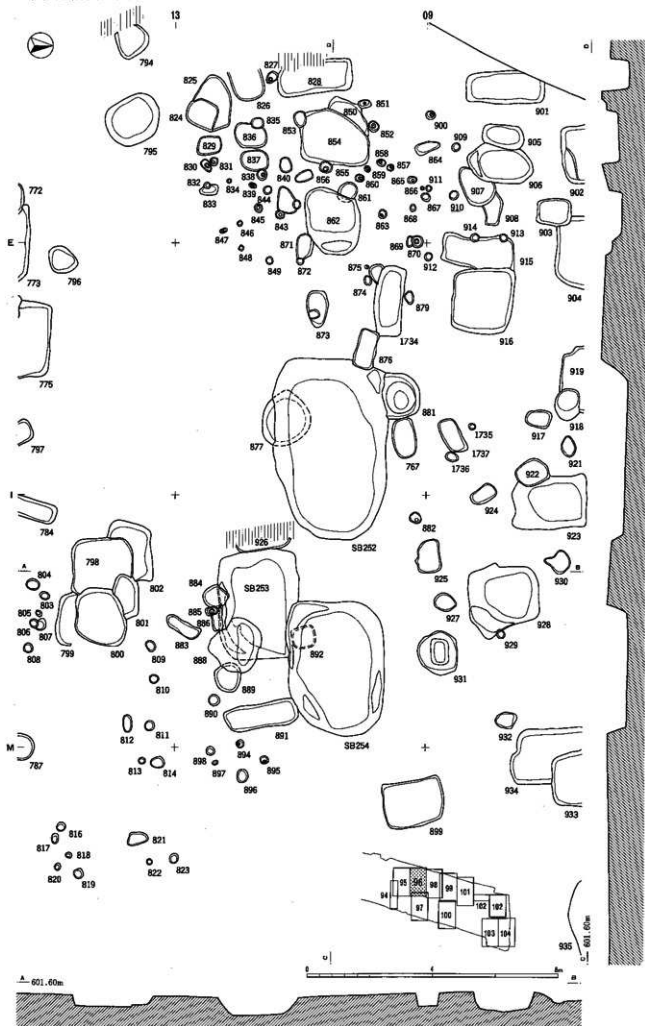

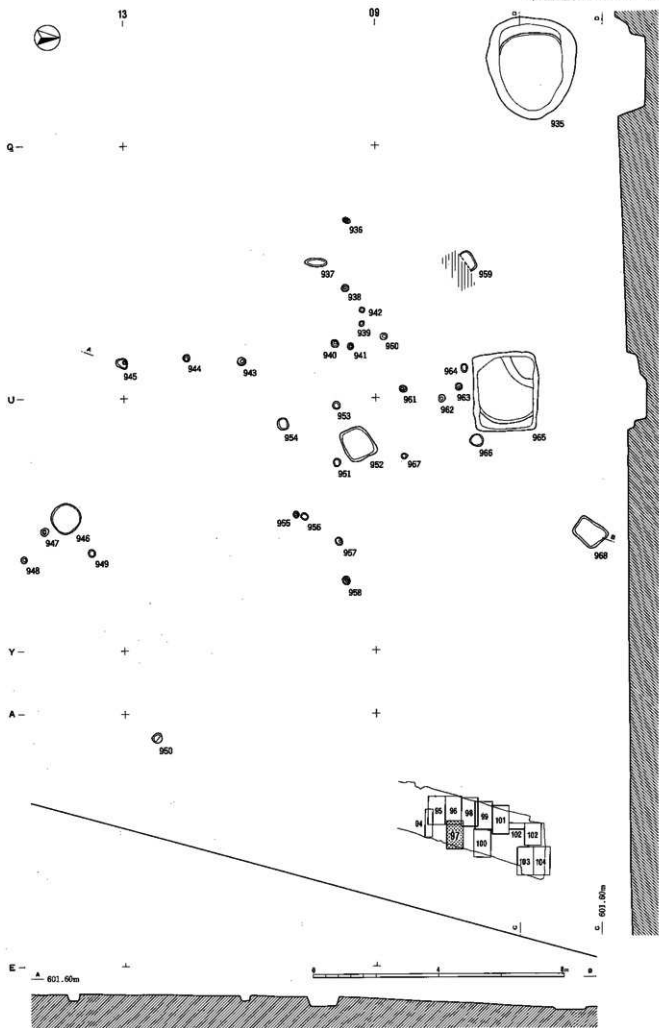

図版98 中世遺構実測図

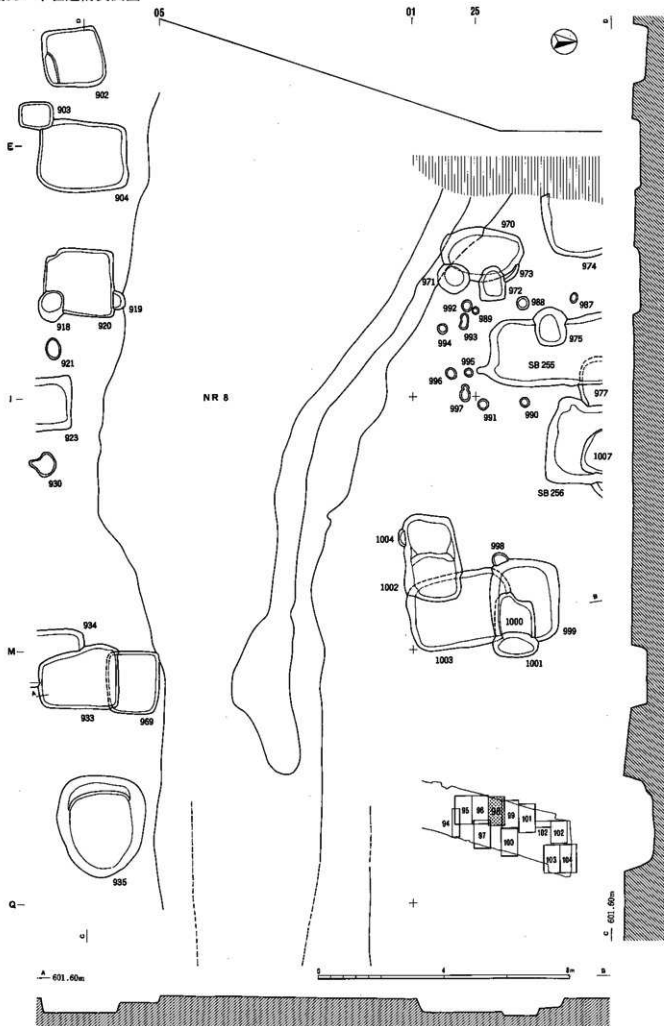

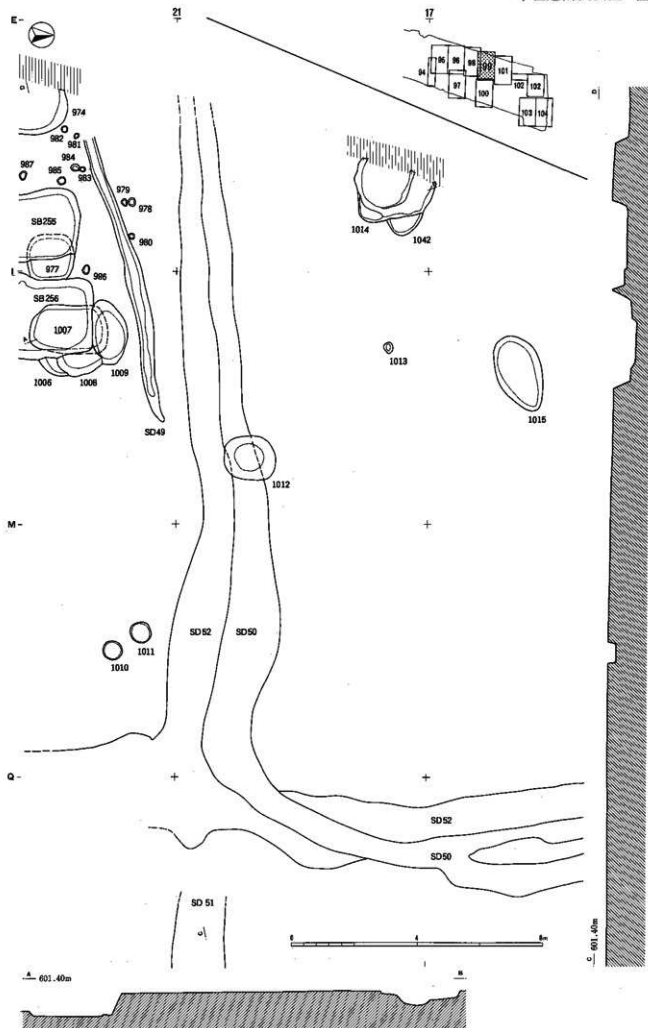

圖版100 中世遺構実測図

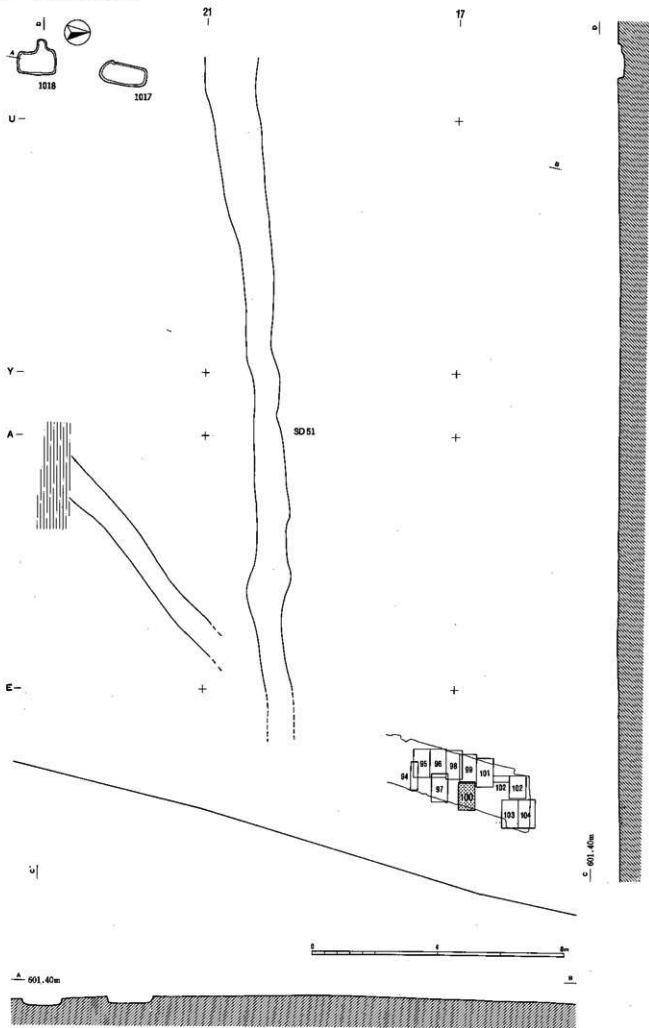

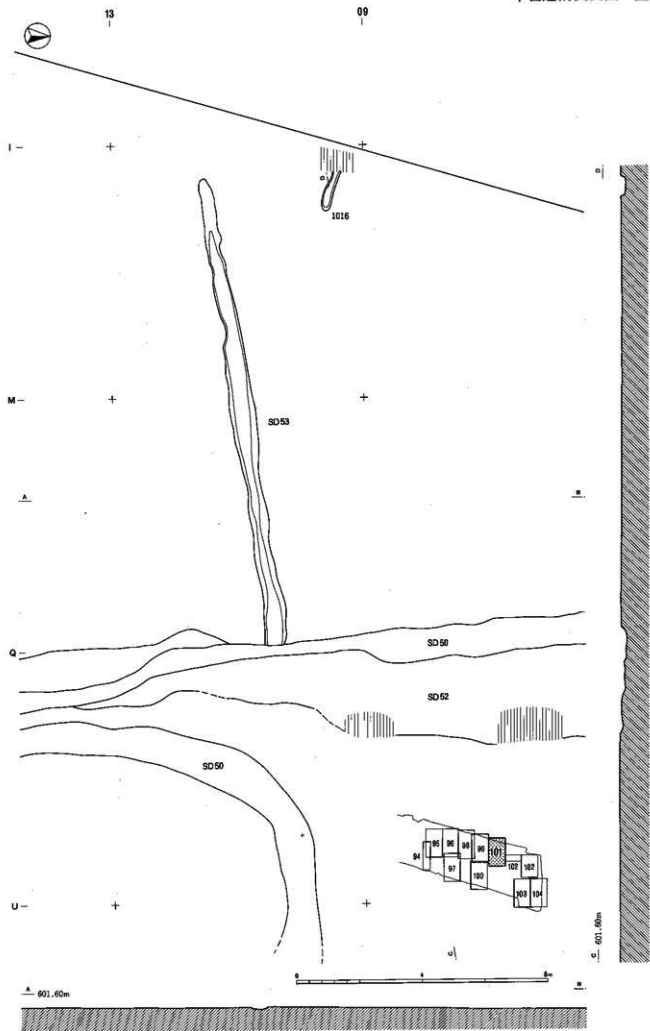

図版102 中世遺構実測図

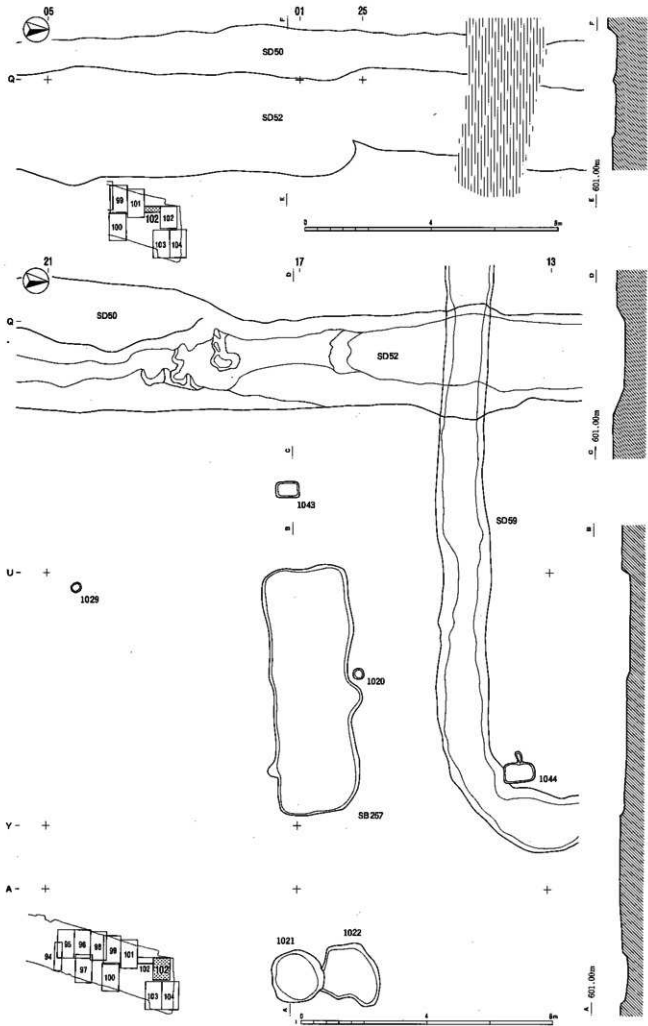

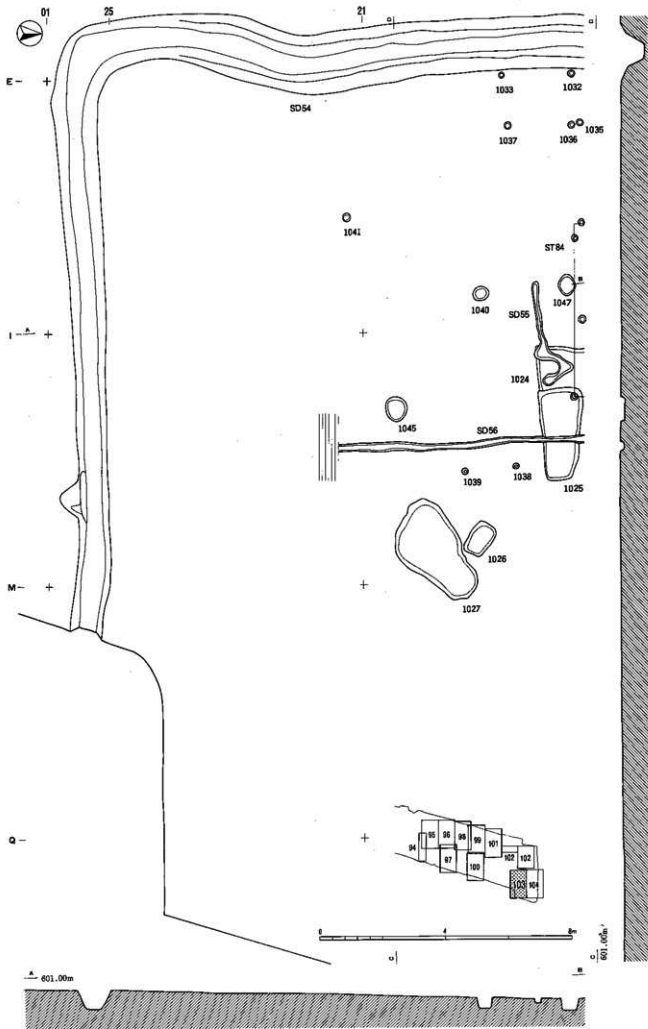

図版104 中世遺構実測図

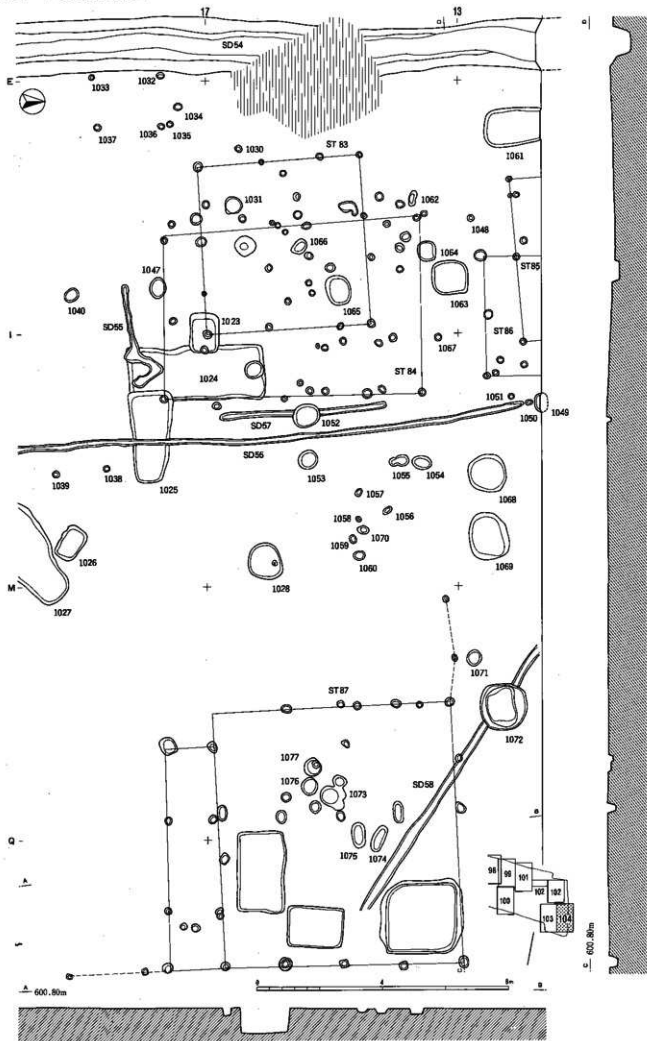

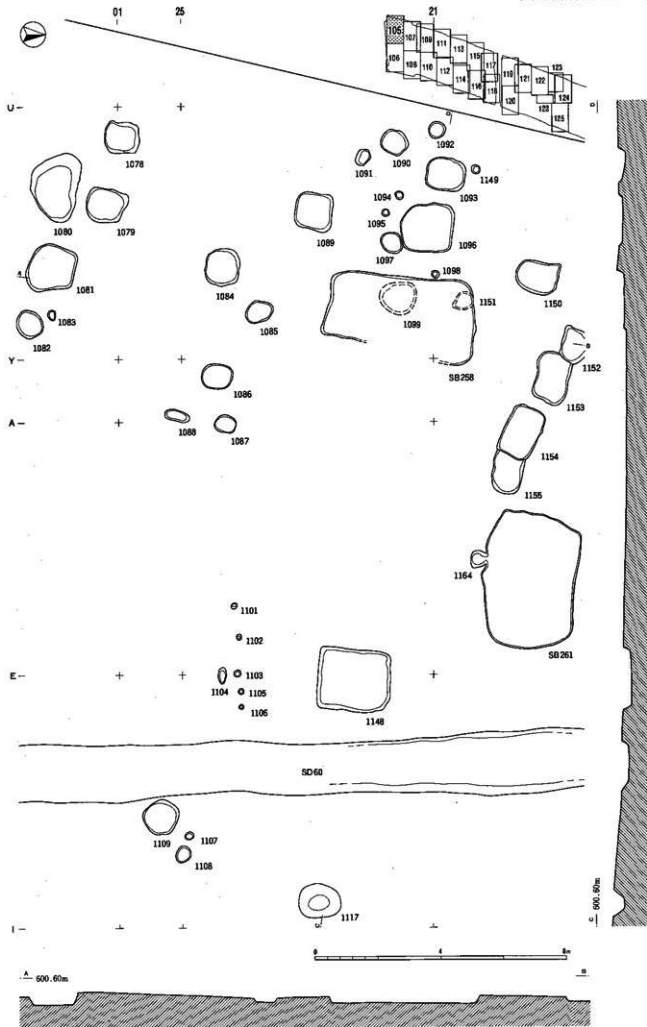

图版106 中世遺構実測図

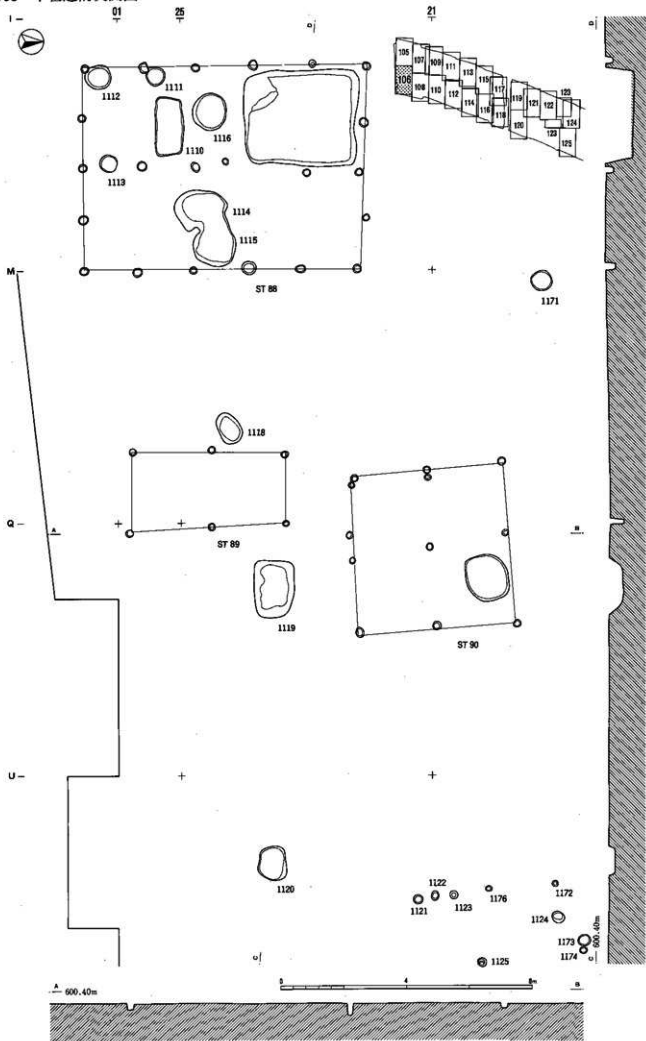

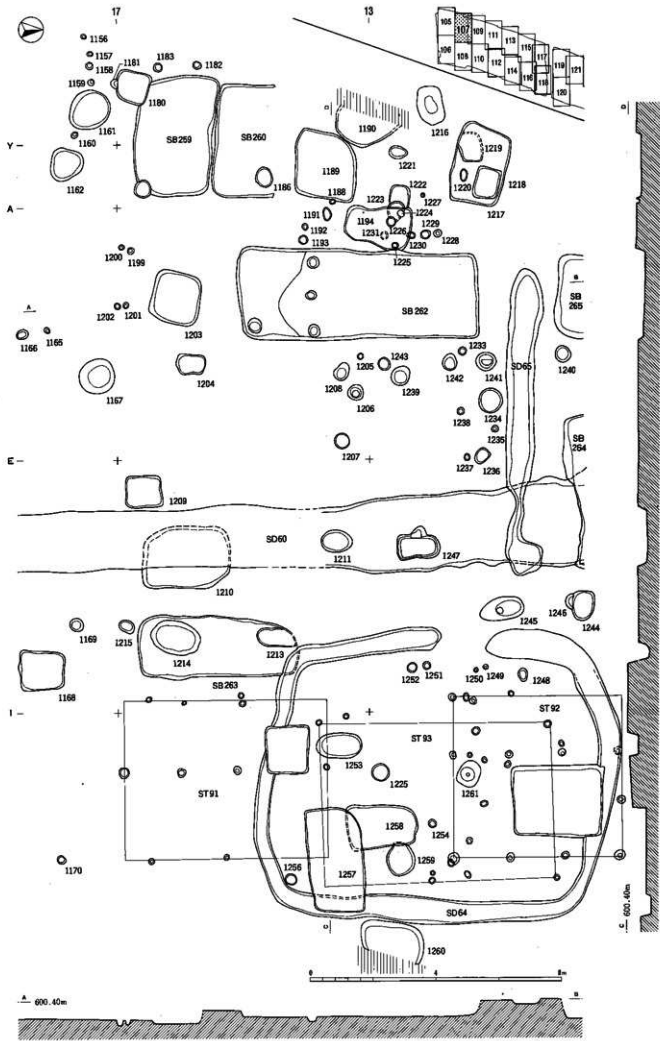

図版108 中世遺構実測図

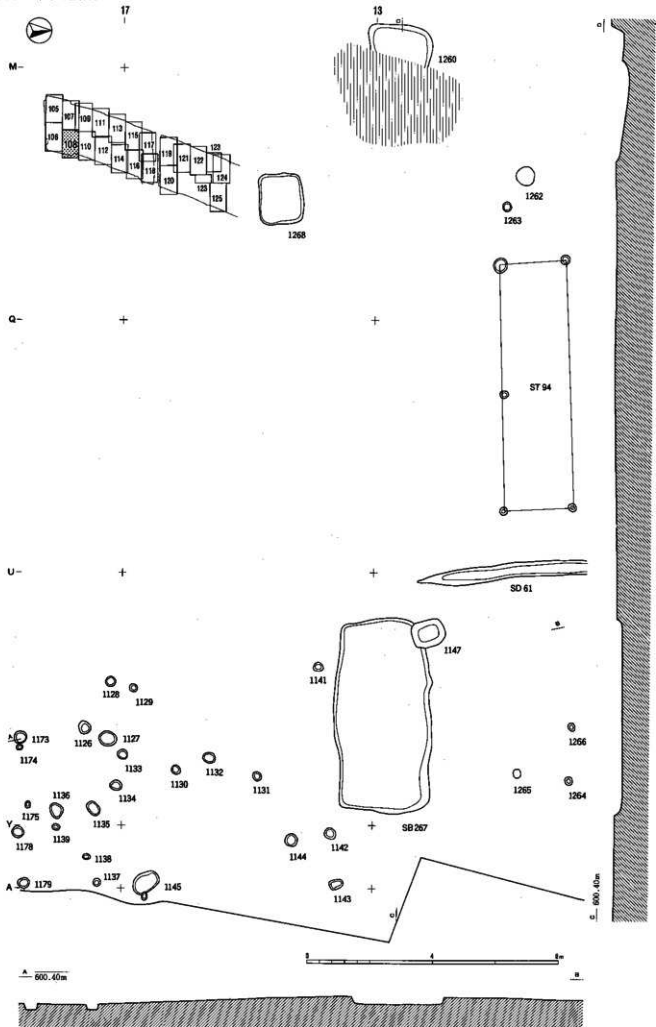

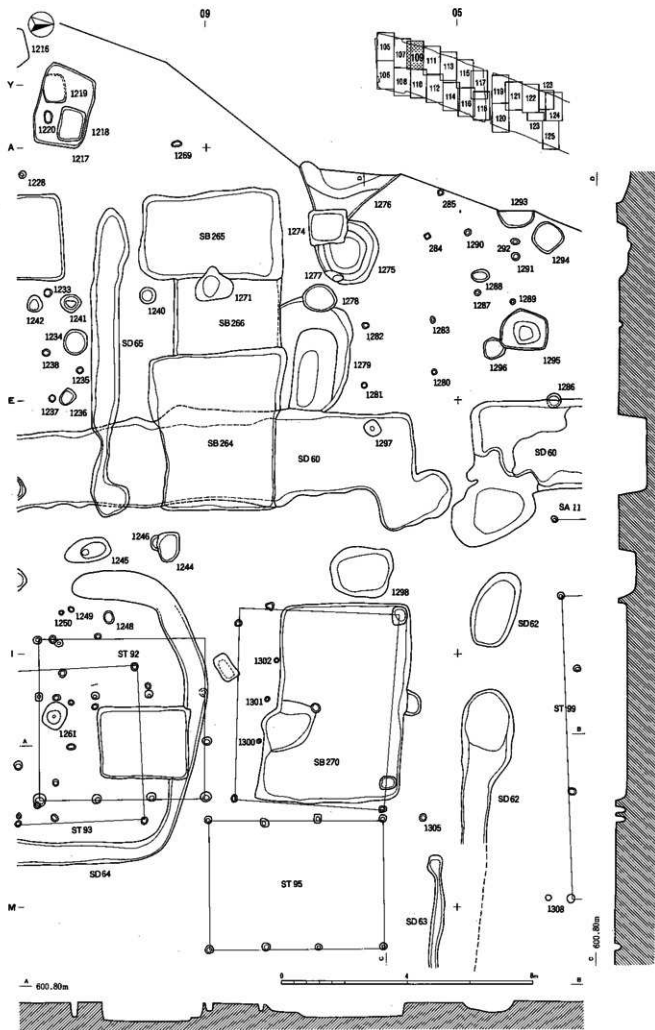

図版110 中世遺構実測図

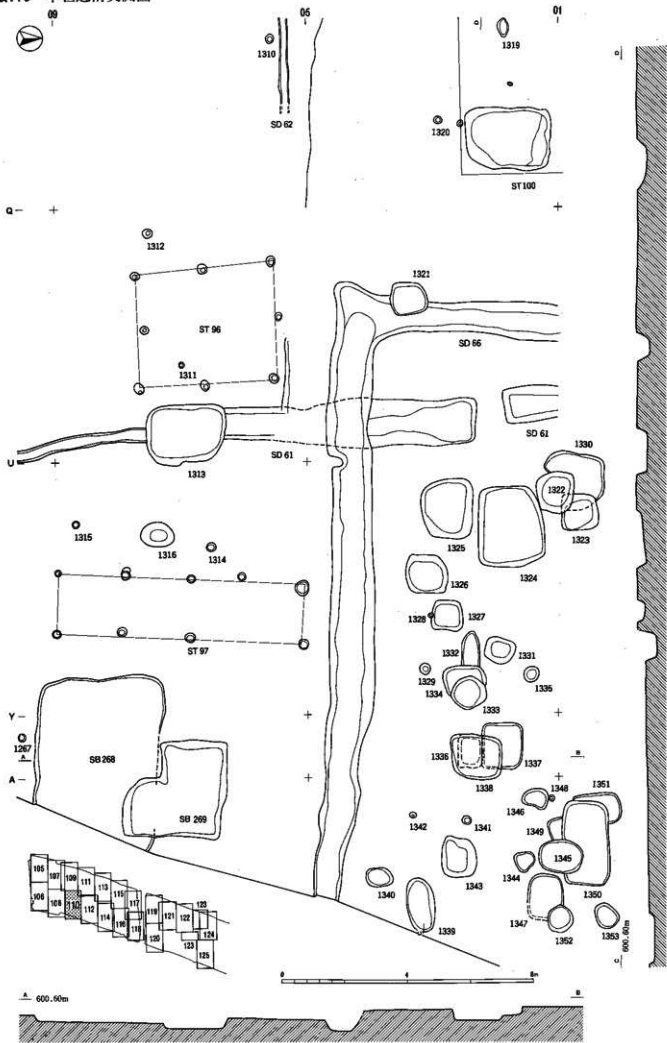

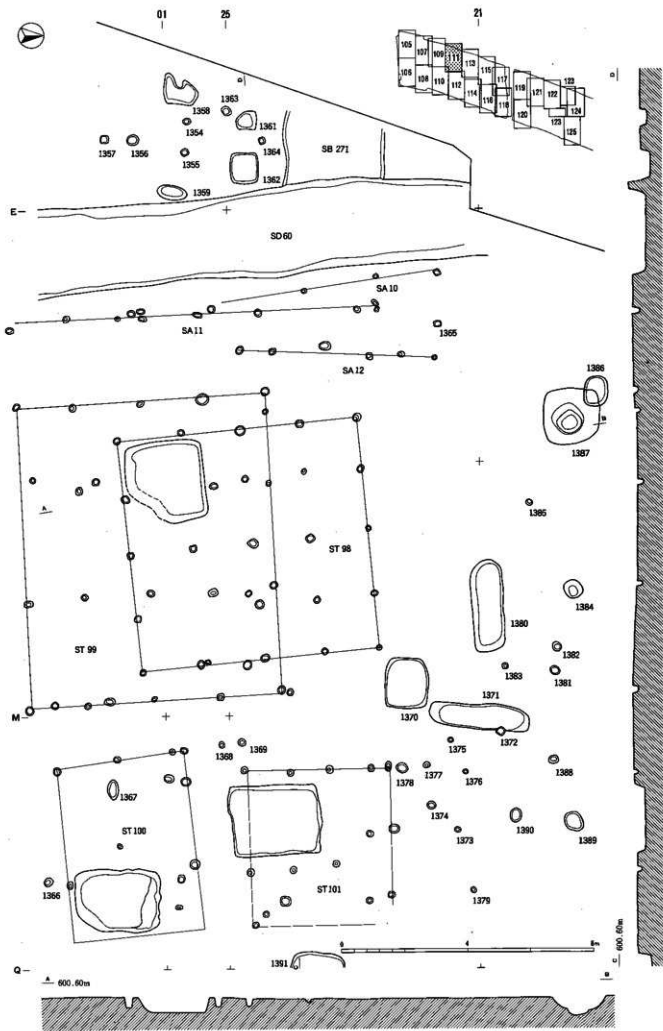

図版112 中世遺構実測図

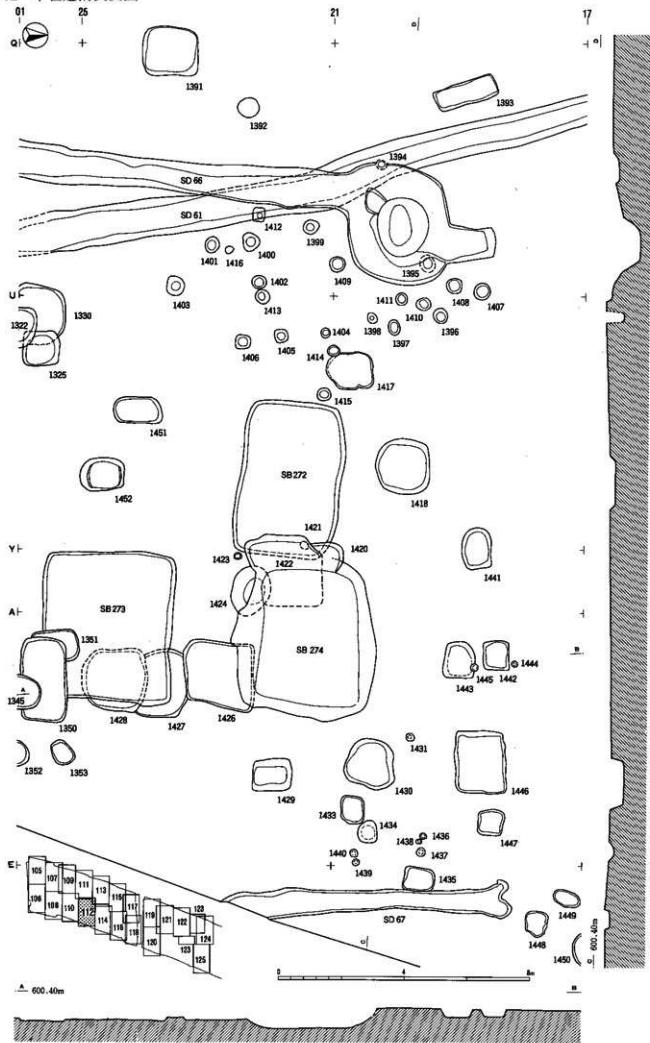

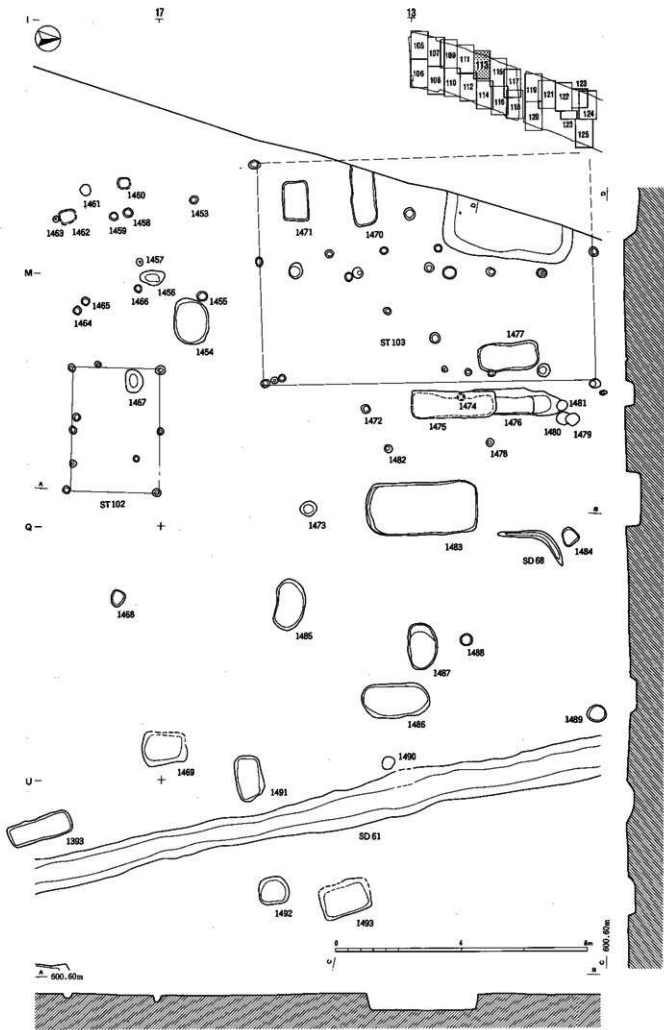

图版114 中世遺構実測図

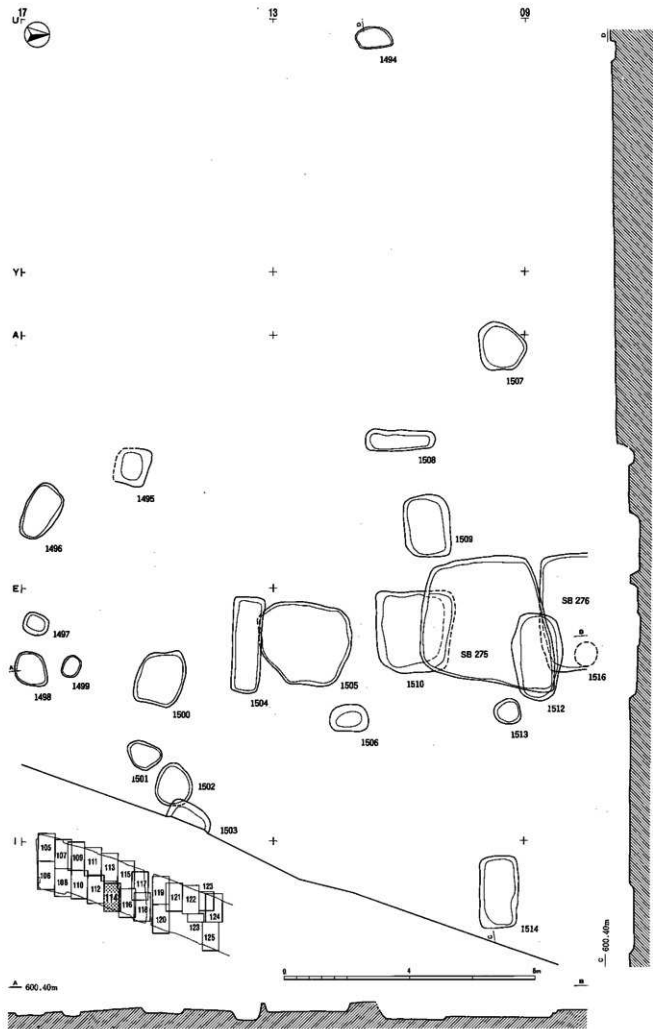

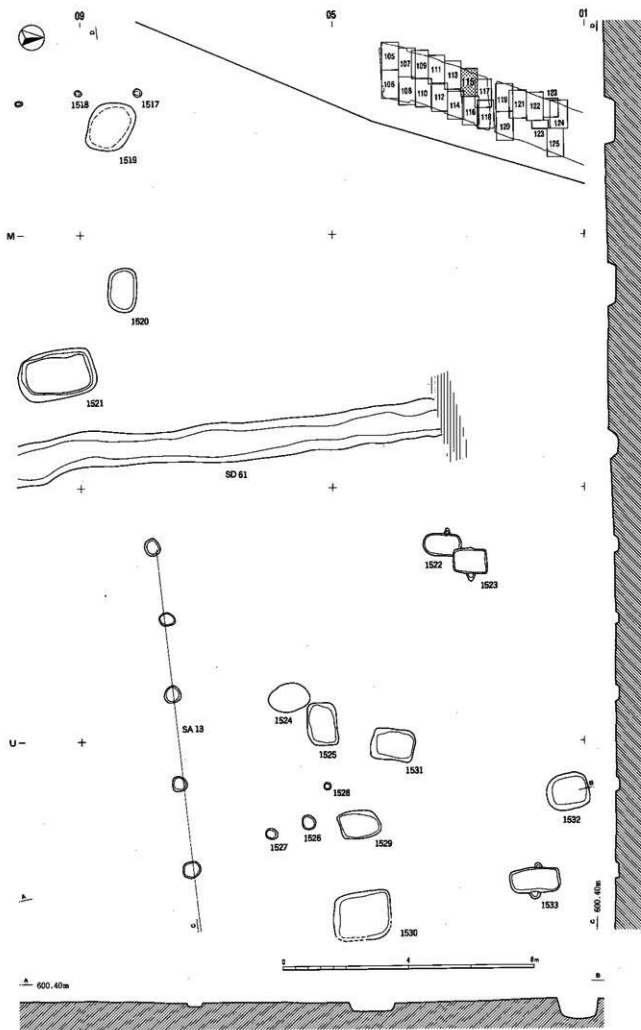

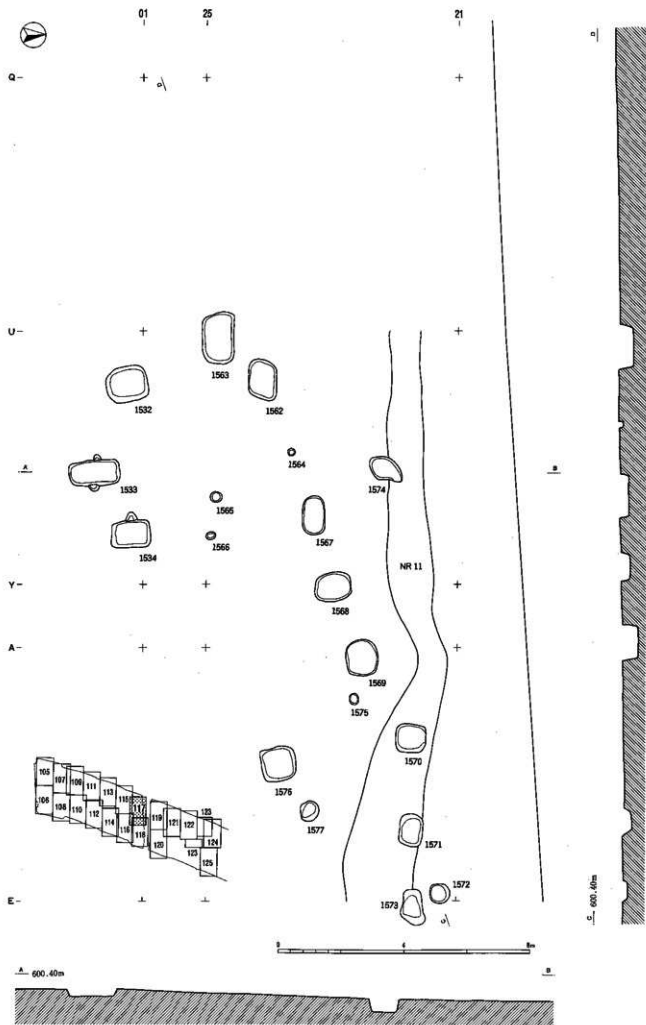

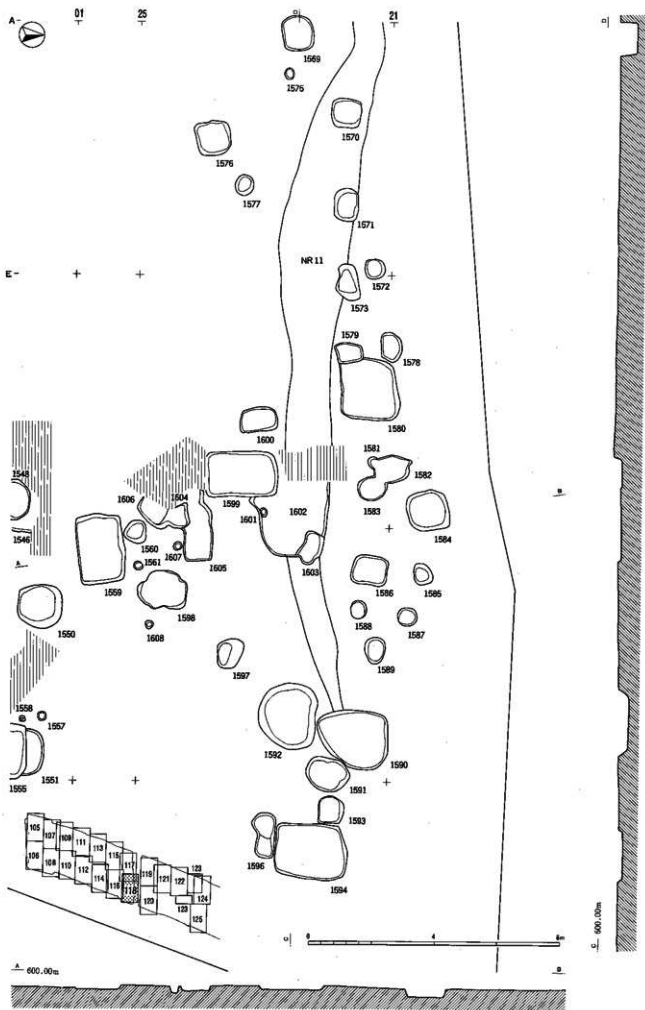

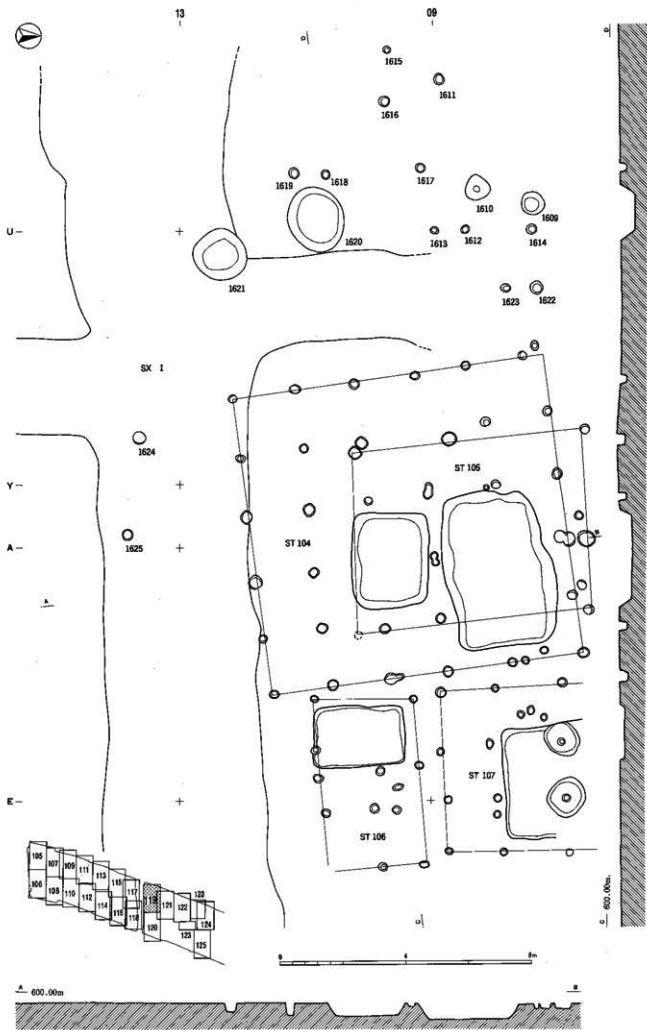

图版120 中世遺構実測図

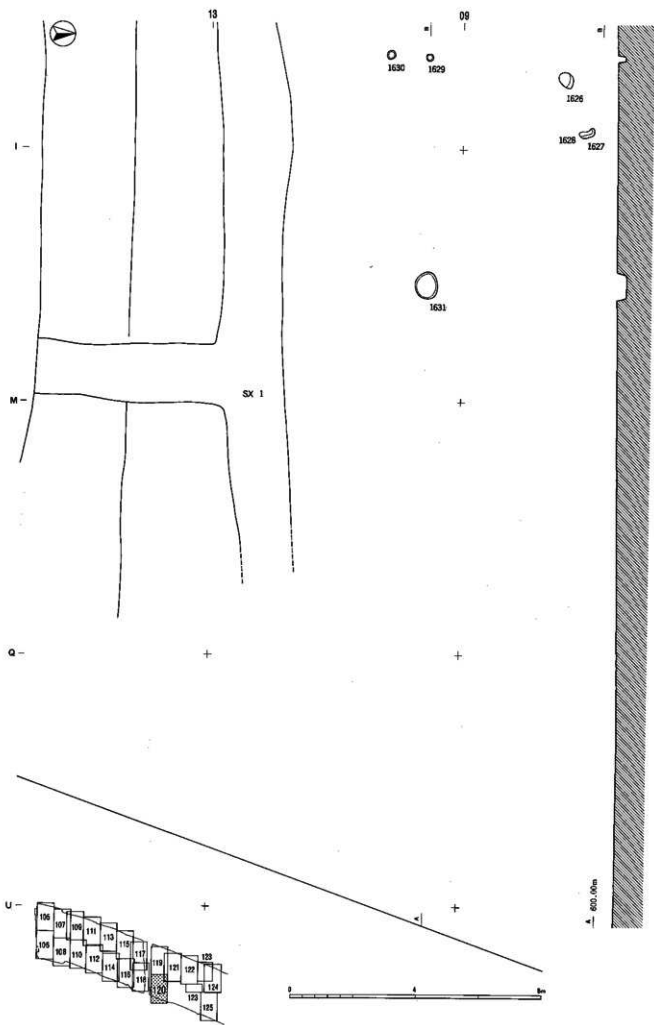

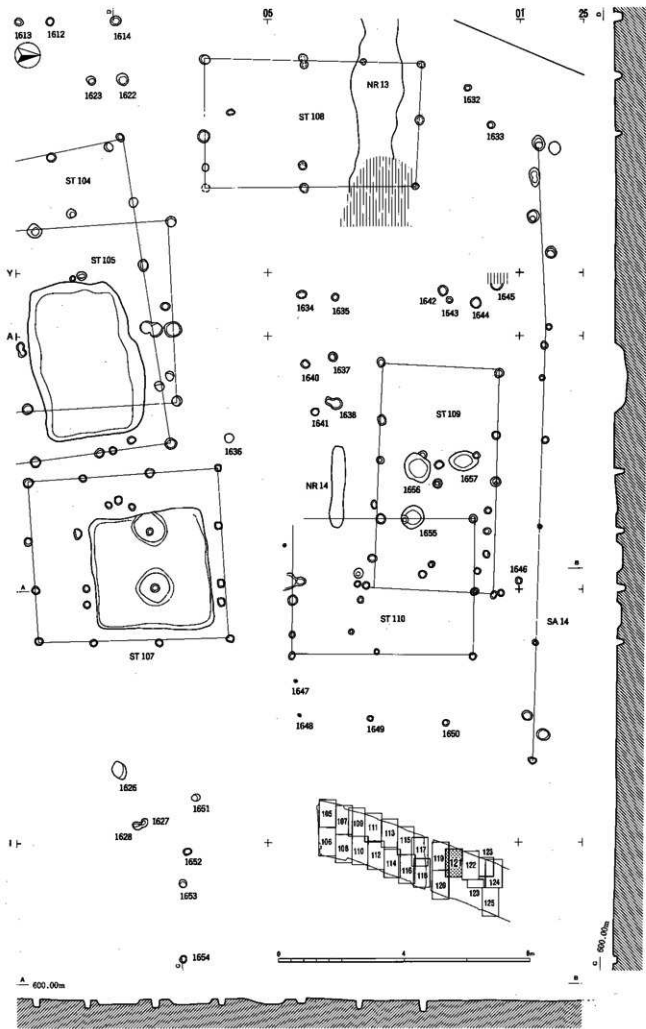

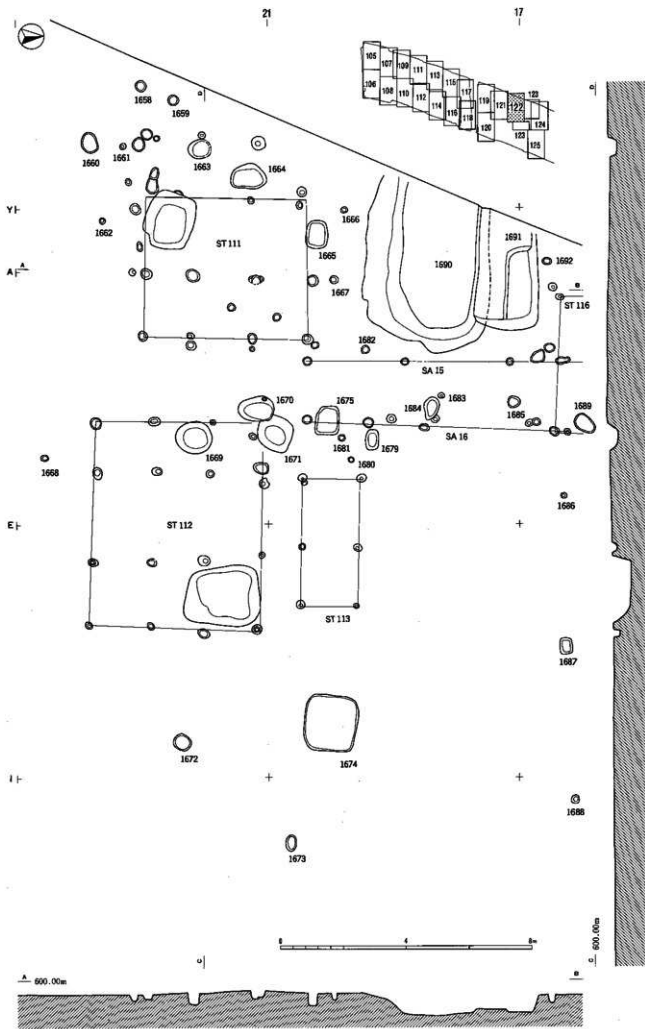

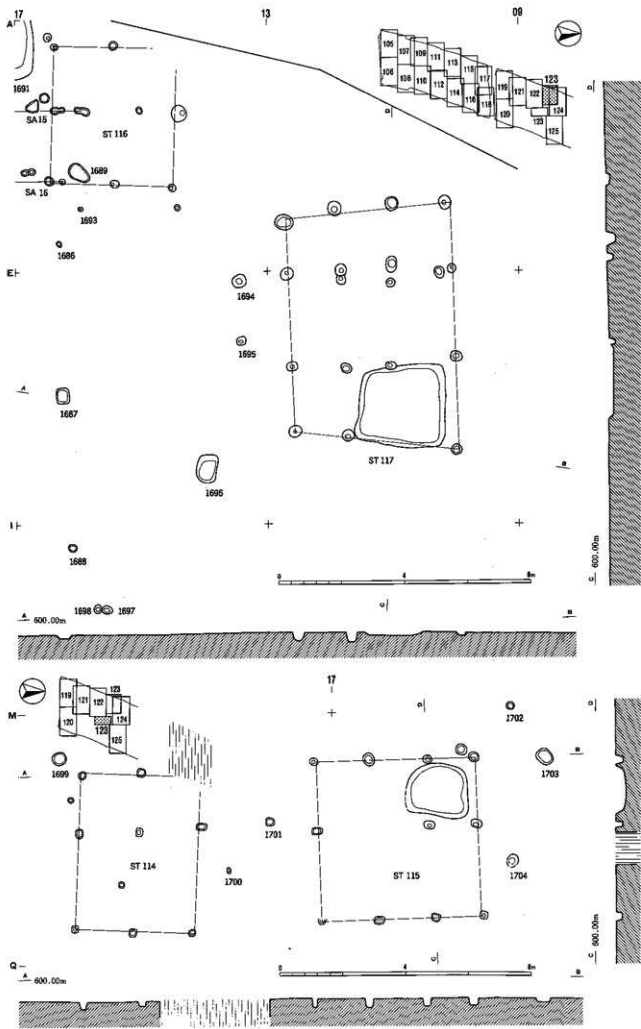

图版124 中世遺構実測図

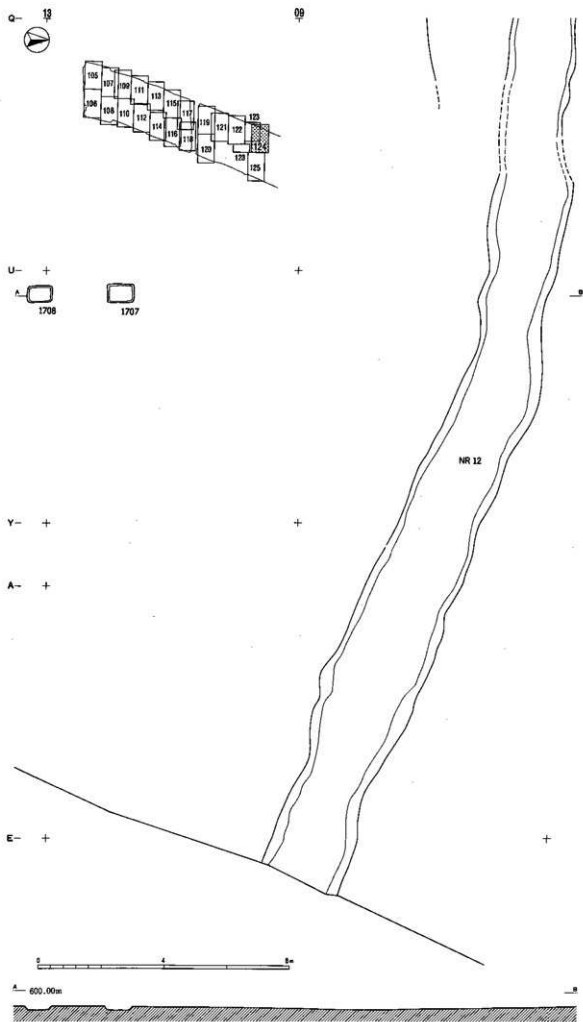

圖版126 中世遺構実測図

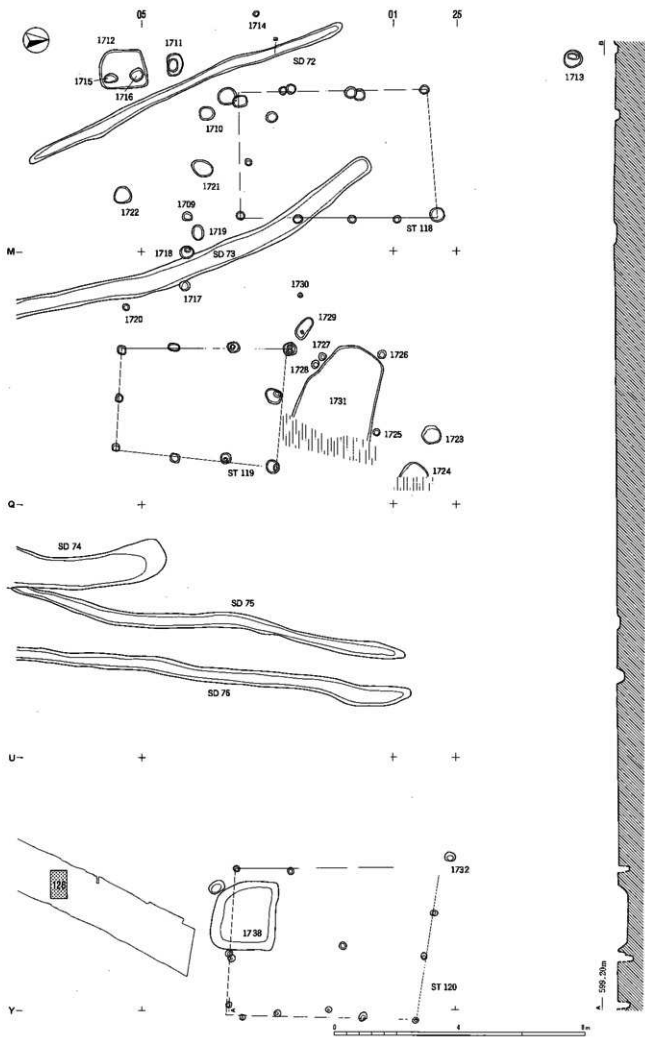

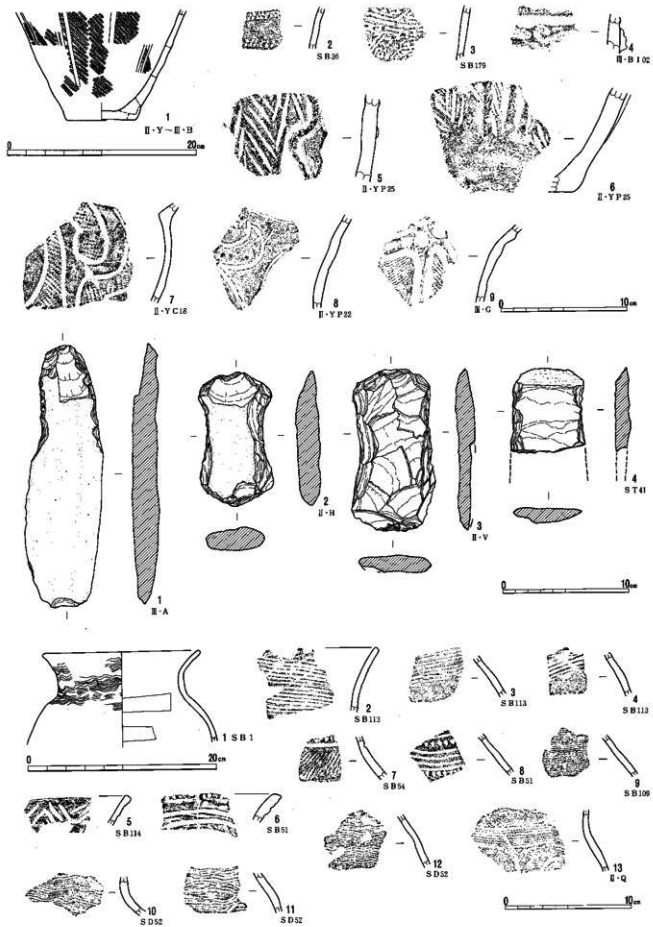

SB 2



SB 5

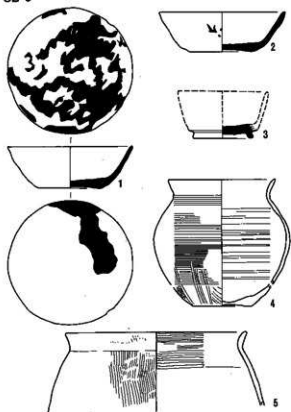

SB 3

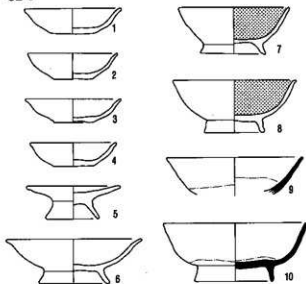

SB 4

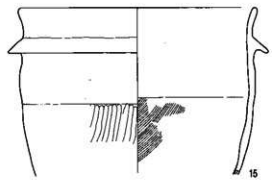
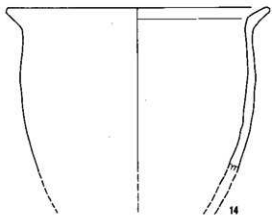
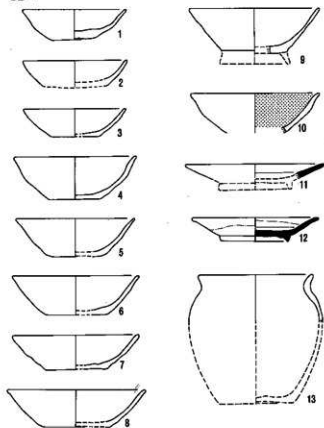

SB 6

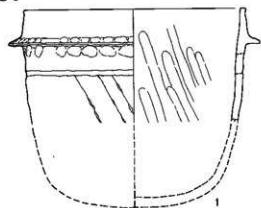

SB 7

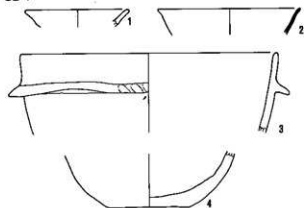

SB 8

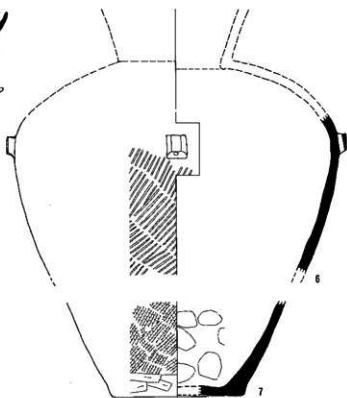
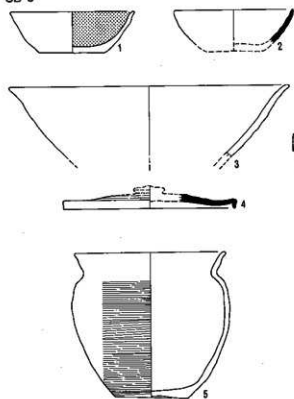

SB 9

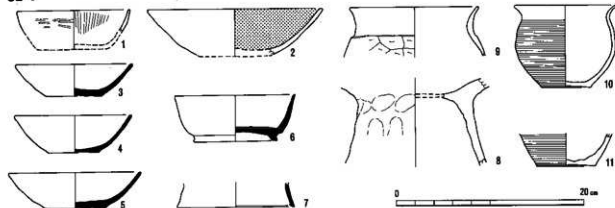

SB 9

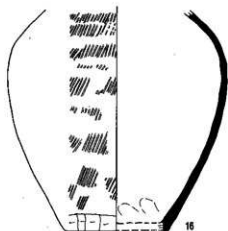
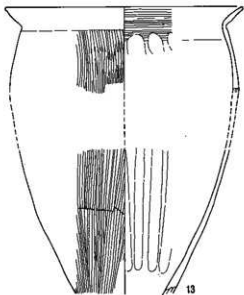
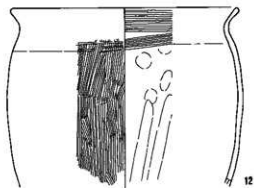

SB 11

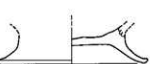
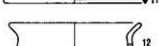
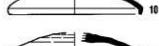
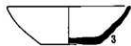
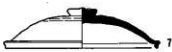

SB 13

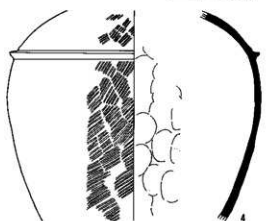
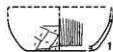

SB 14

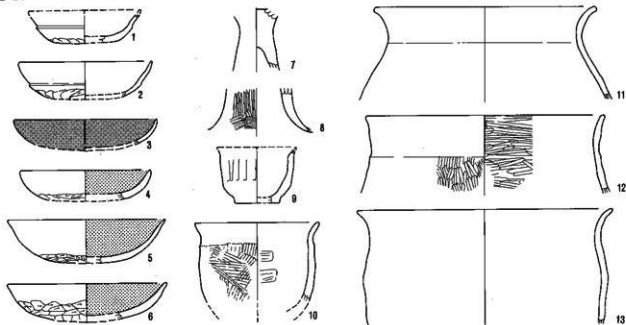

SB 15

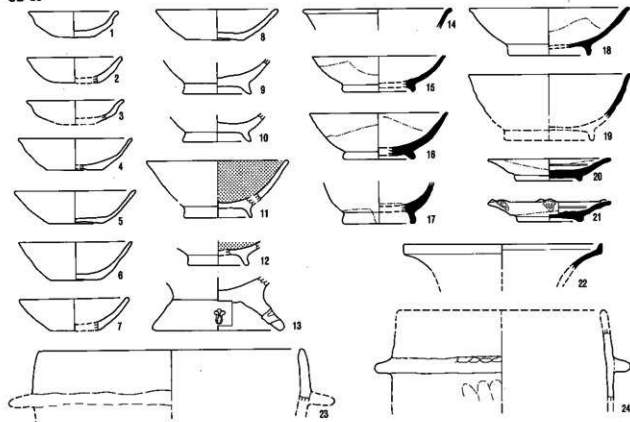

SB 18



SB 16

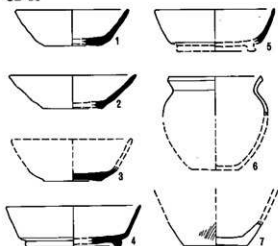

SB 19

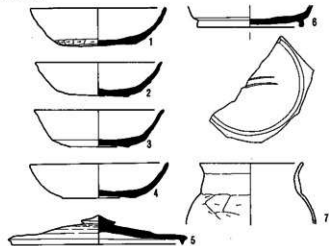

SB 20

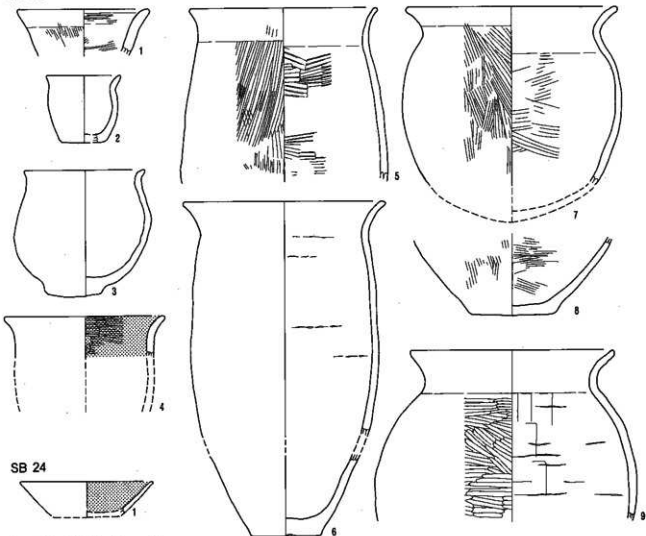

SB 24

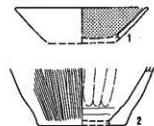

SB 22

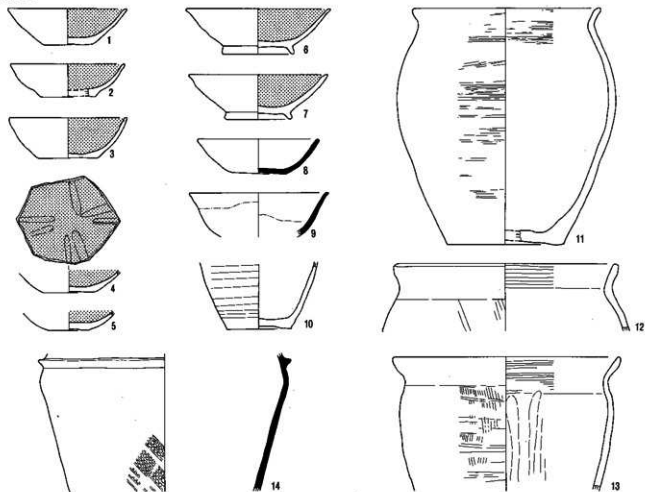

SB 23

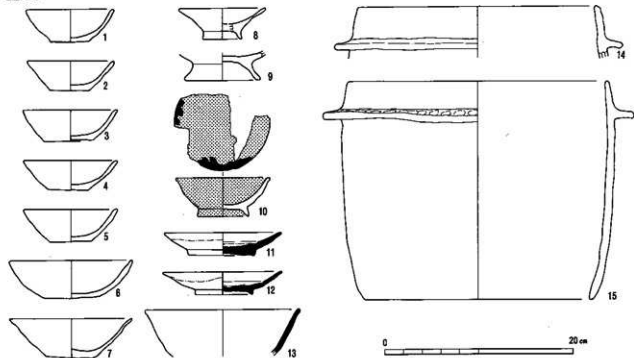

SB 25

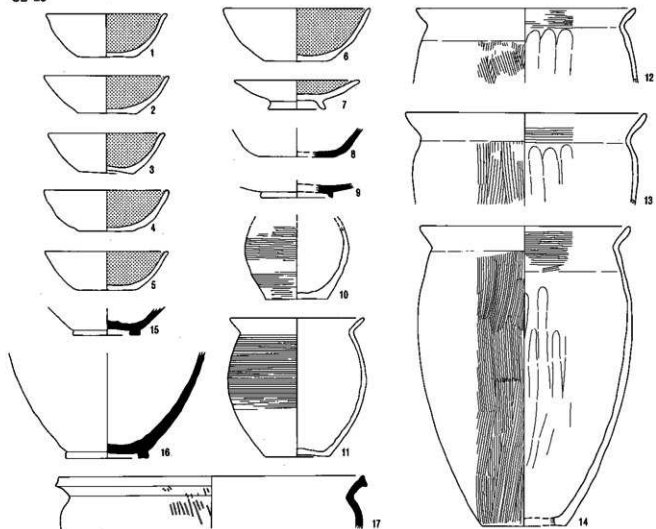

SB 27

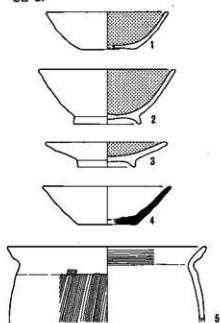

SB 28

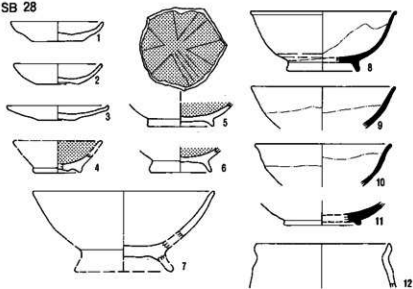

0 20 cm

SB 26

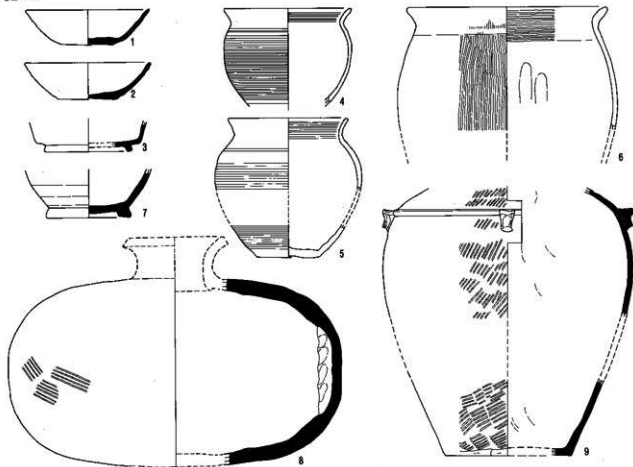

SB 29

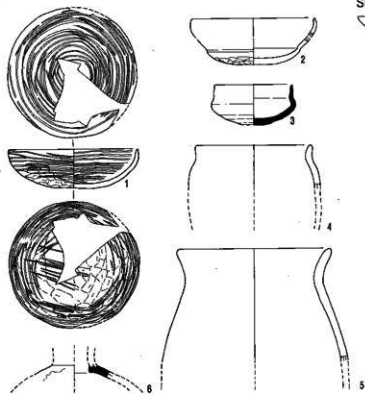

SB 30

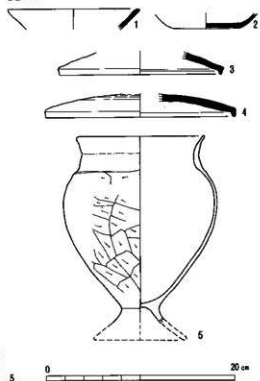

SB 31

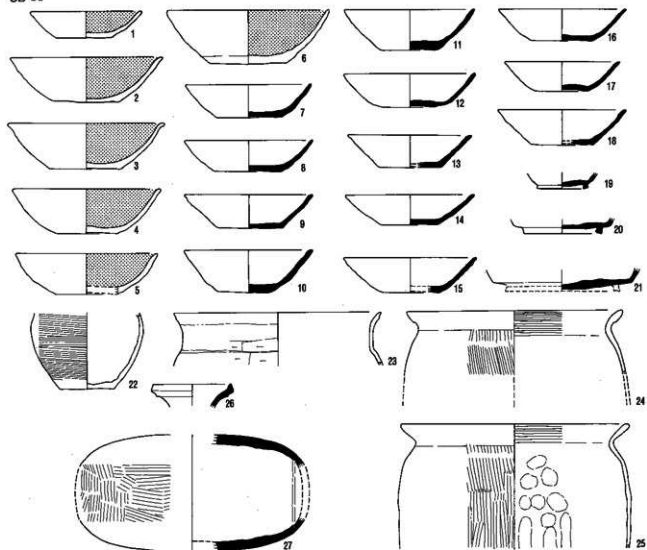

SB 32

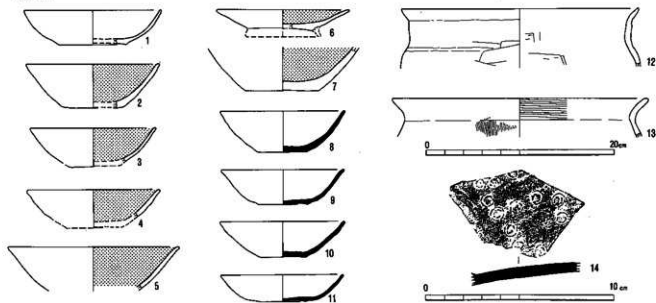

SB 33

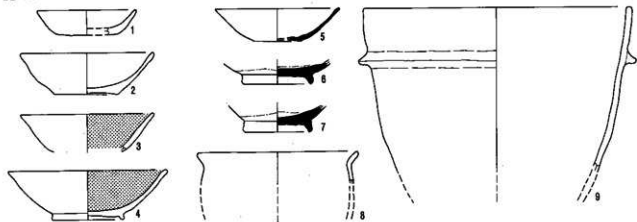

SB 34

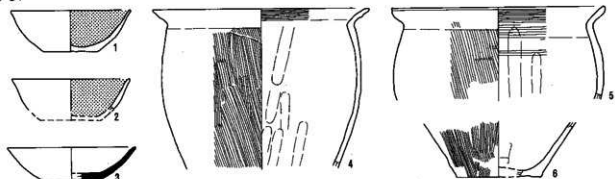

SB 36

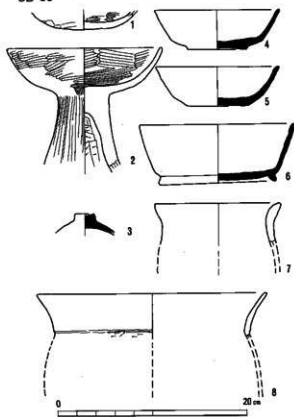

SB 37

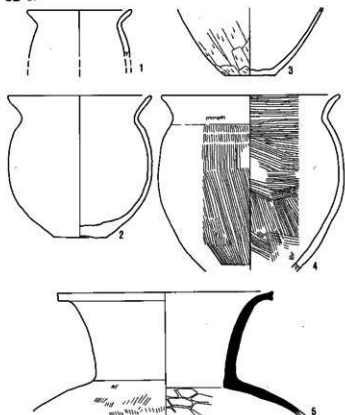

SB 39

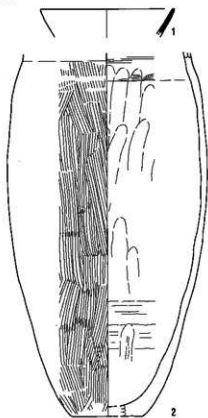

SB 42

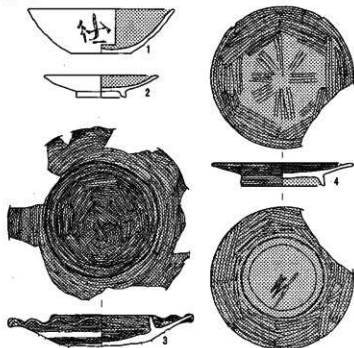

SB 38

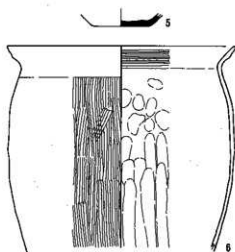
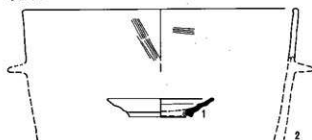

SB 40

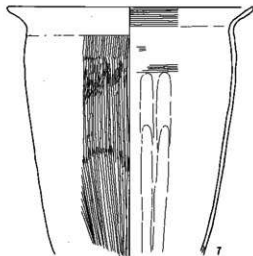

SB 41



SB 43

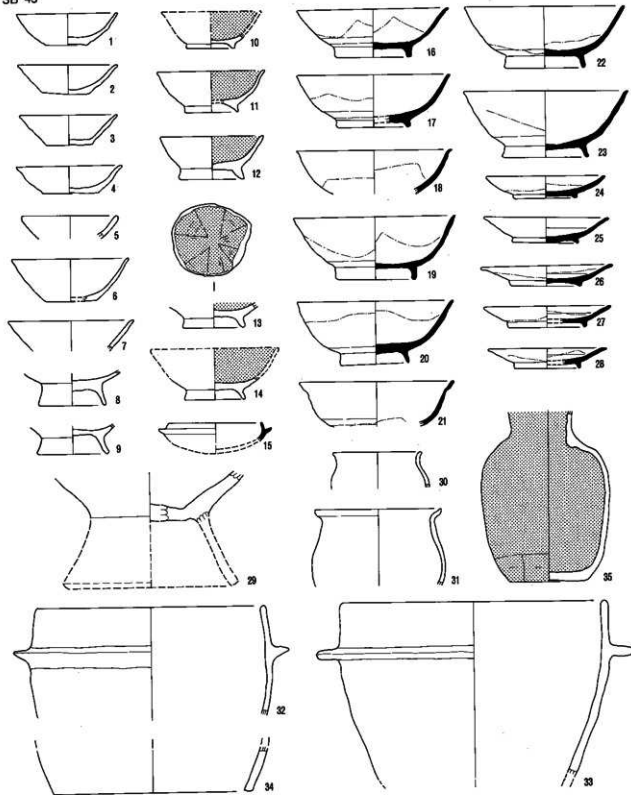

SB 44



SB 45

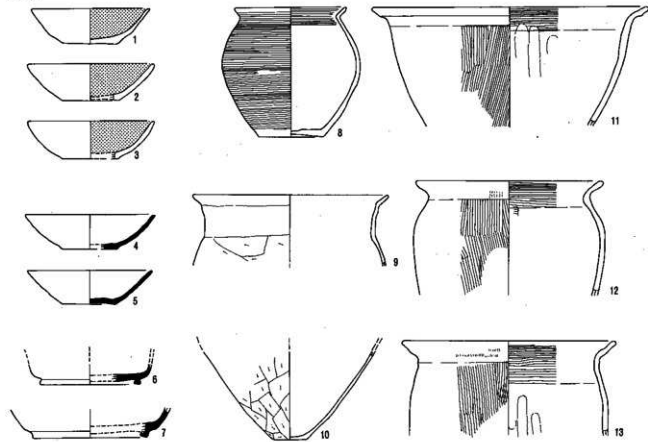

SB 46

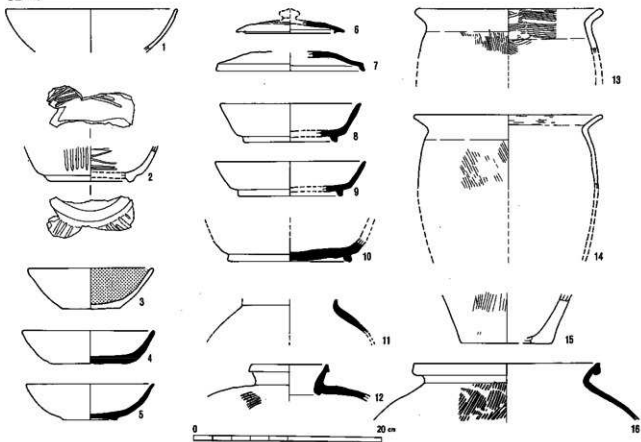

SB 47

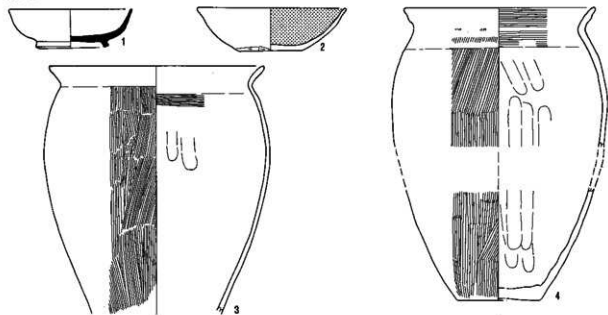

SB 48

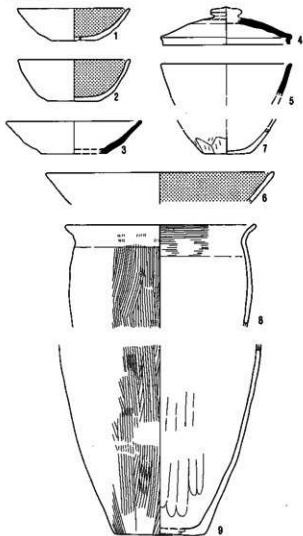

SB 50

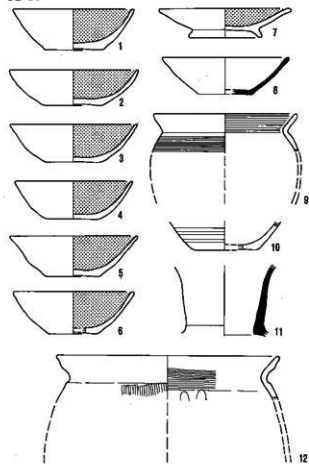

0 20 cm

SB 49

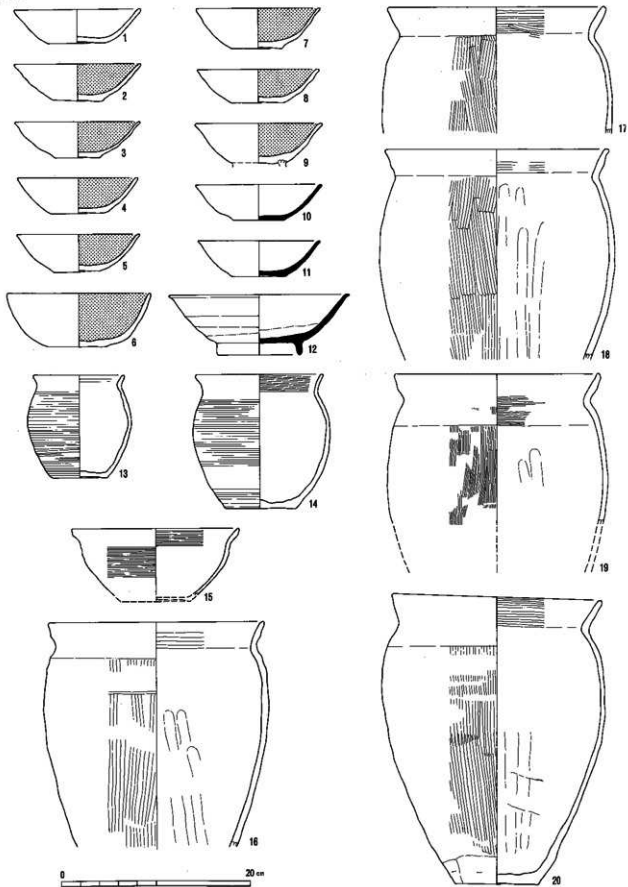

SB 52

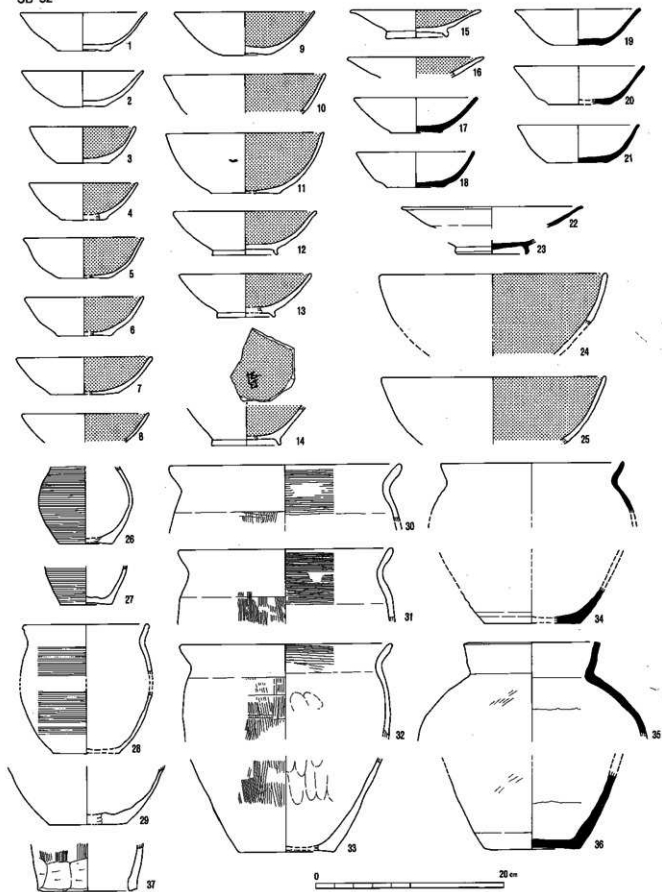

SB 52

SB 51

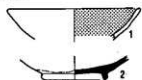

SB 53

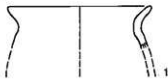

SB 54

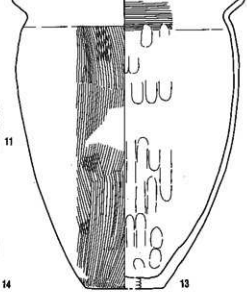
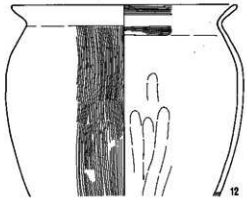
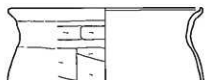
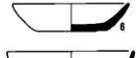
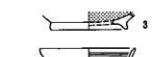
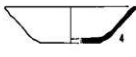

SB 56

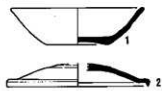

SB 55



SB 59

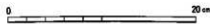
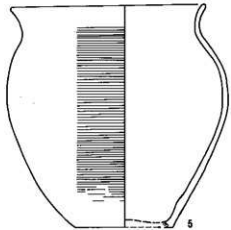
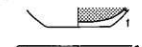

SB 57

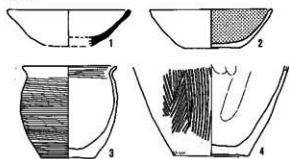

SB 61

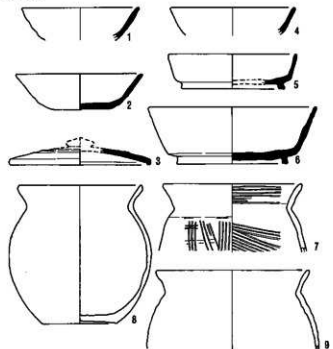

SB 58

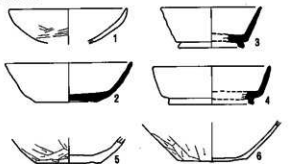

SB 60

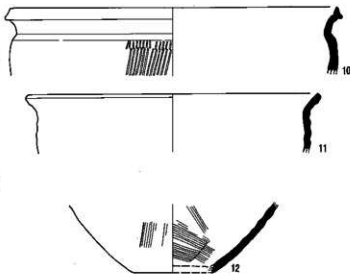
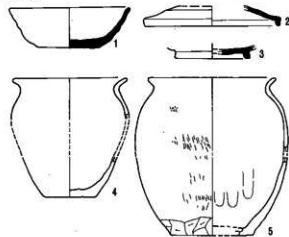

SB 62

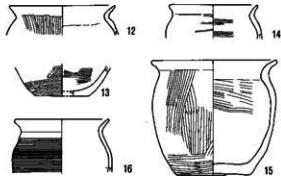
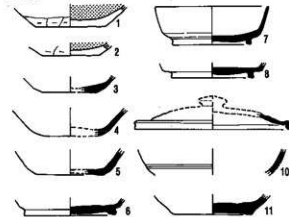

SB 62

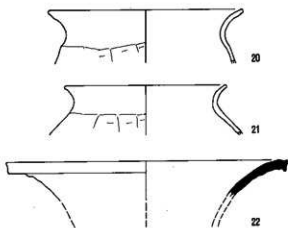
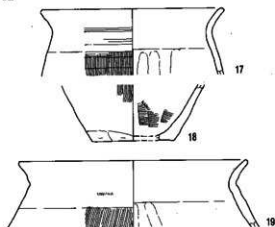

SB 63

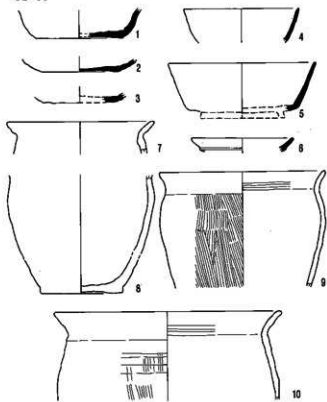

SB 64

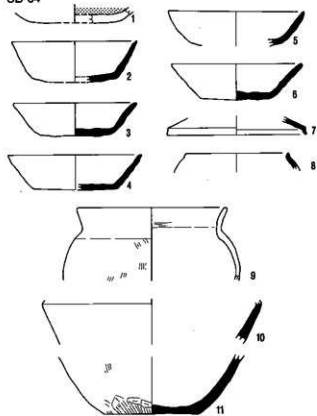

SB 65

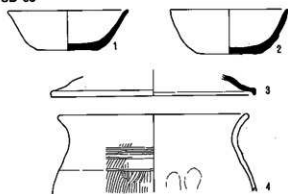

SB 66

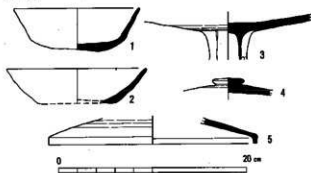

SB 66

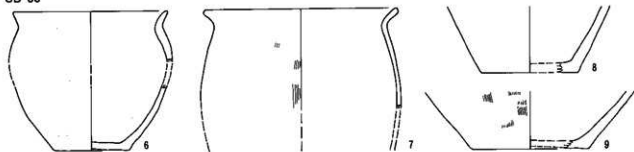

SB 67

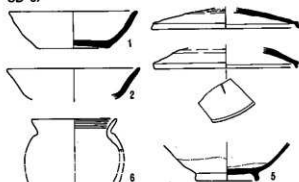

SB 70

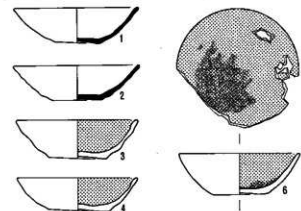

SB 68

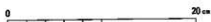
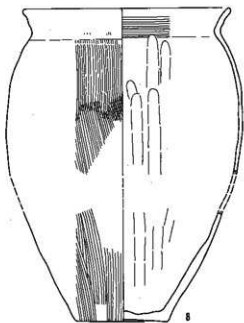
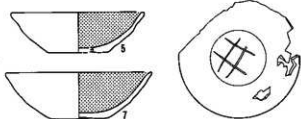
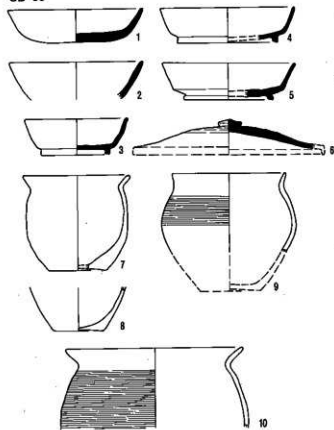

SB 72

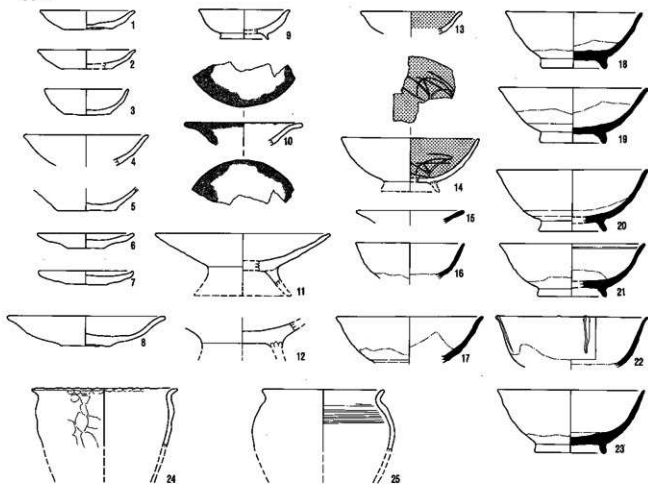

SB 75

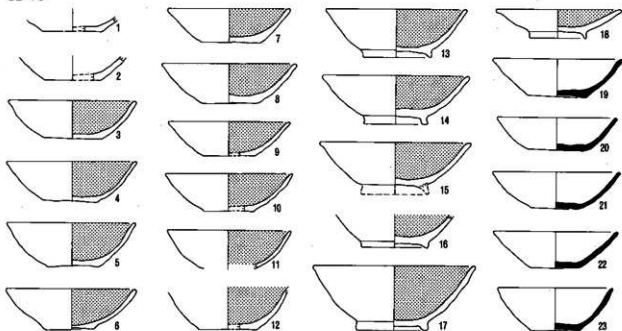

0 20 cm

SB 75

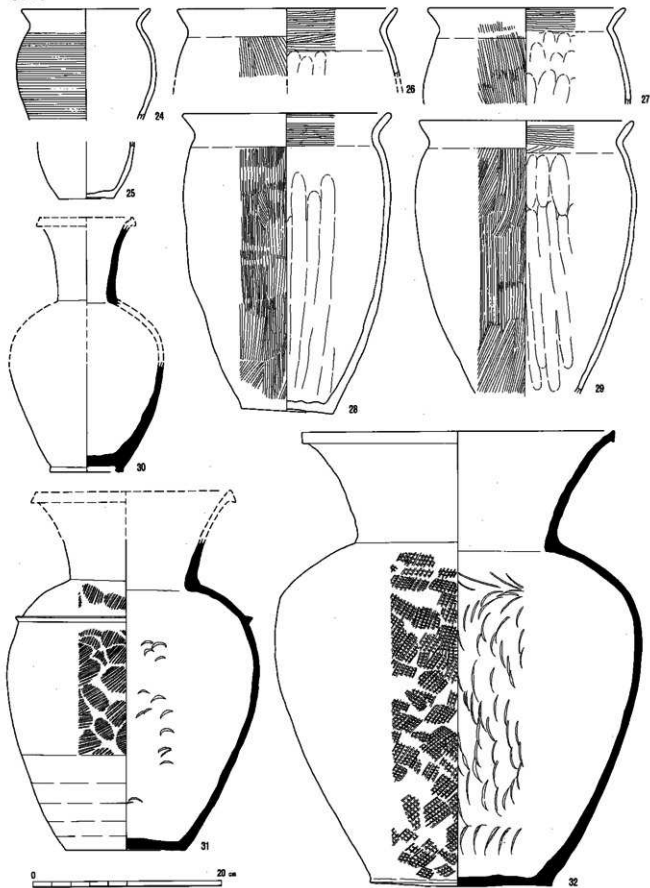

SB 75

SB 73

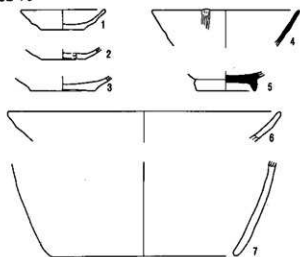

SB 76

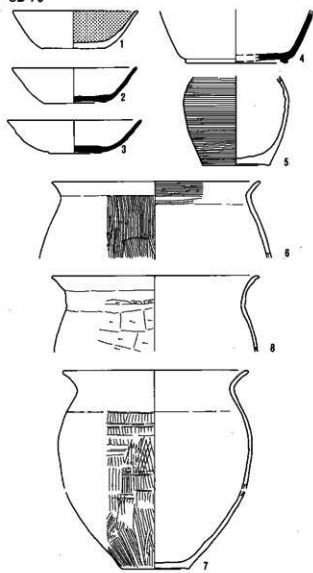

SB 74

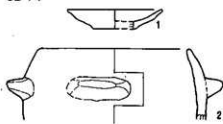

SB 77

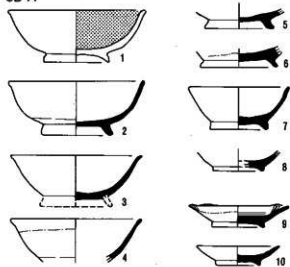

SB 78

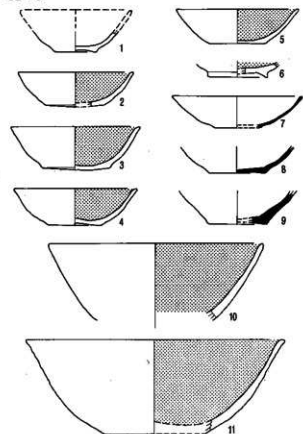

SB 78

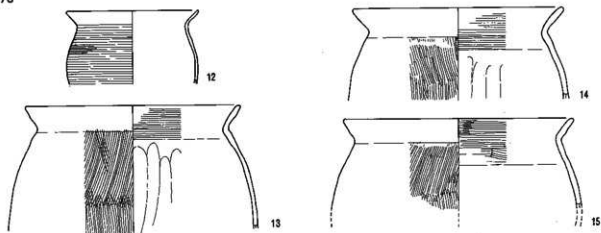

SB 79

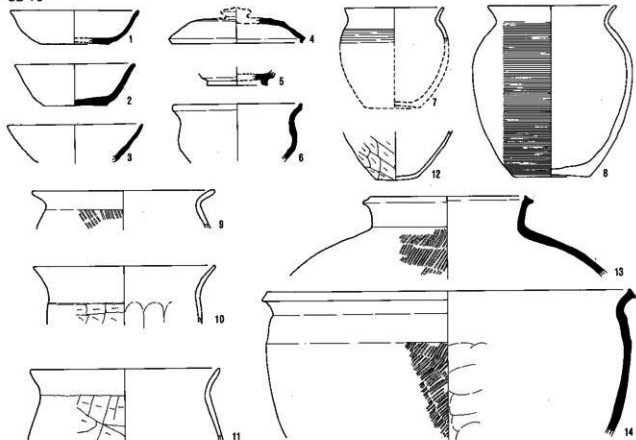

SB 81

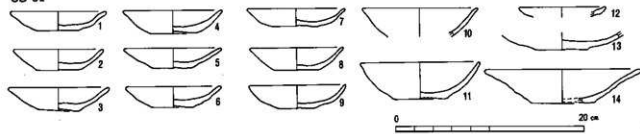

SB 81

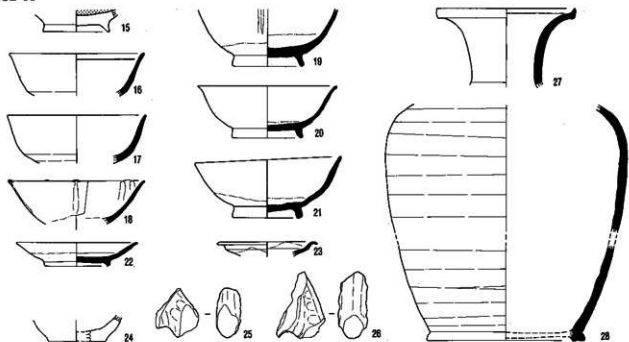

SB 82

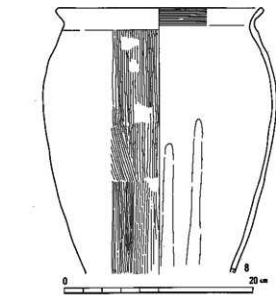
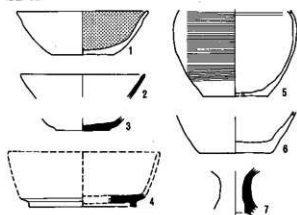

SB 84

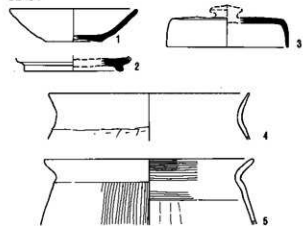

SB 83

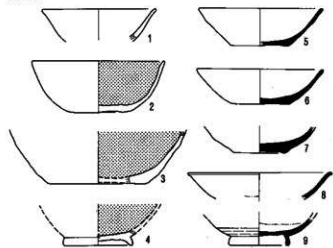

SB 83

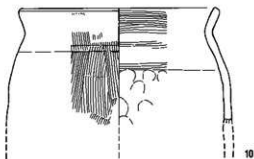
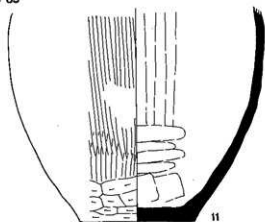

SB 85

SB 87

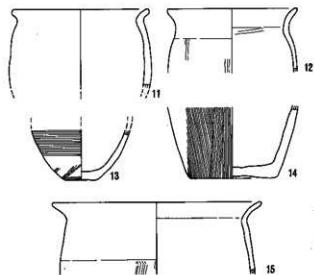
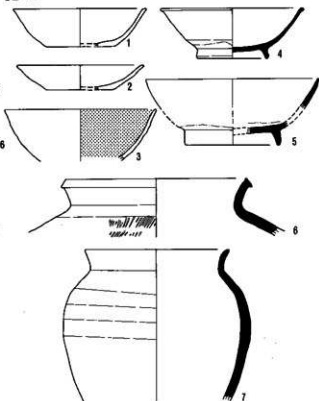
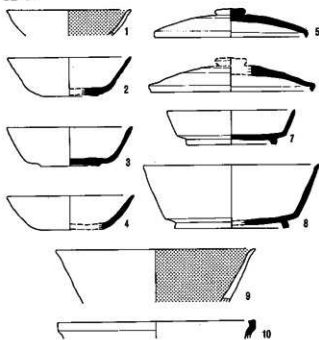

SB 86

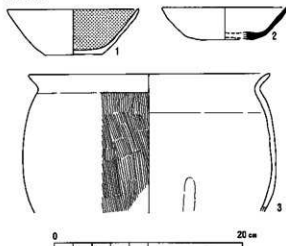

SB 88

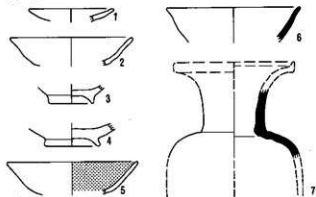

SB 89

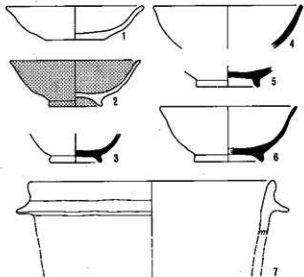

SB 90

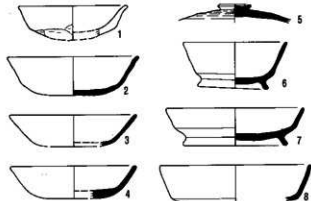

SB 91

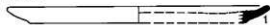

SB 92

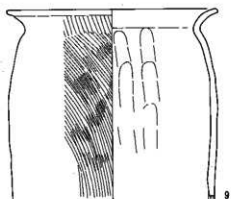
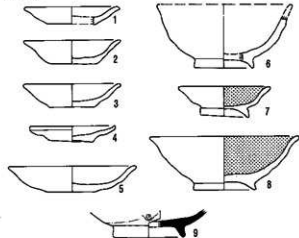

SB 93

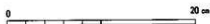
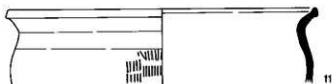
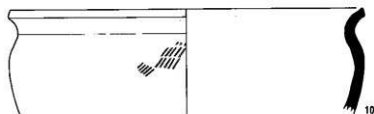
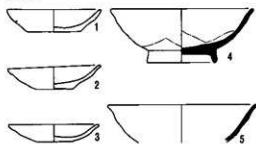

SB 94

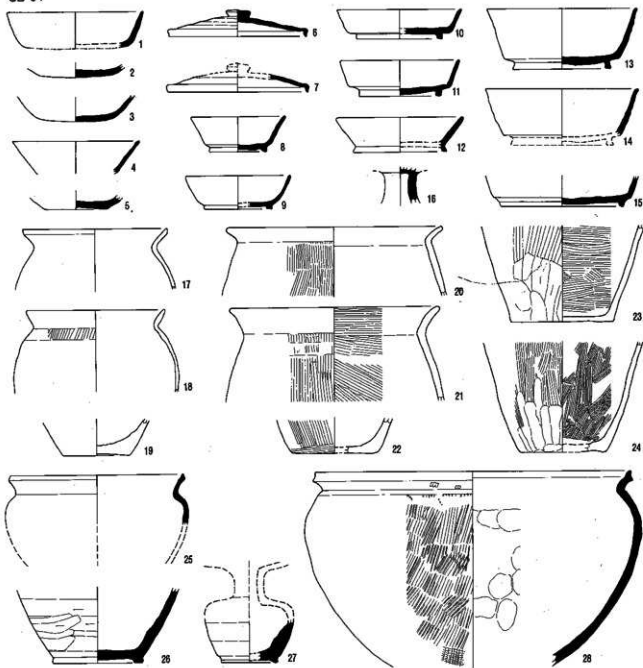

SB 96

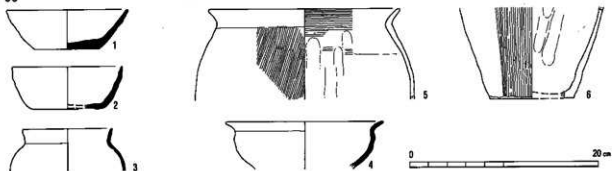

SB 95.

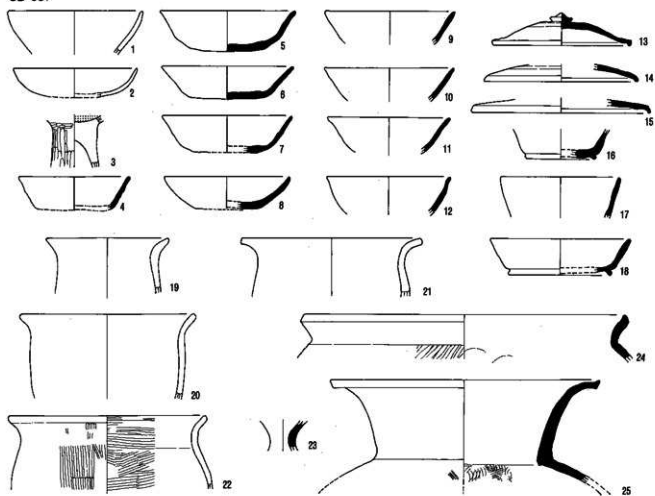

SB 97

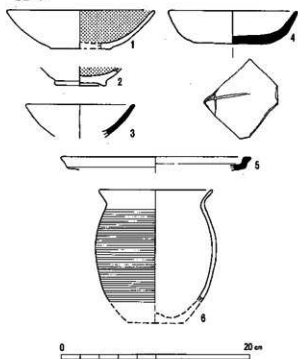

SB 98

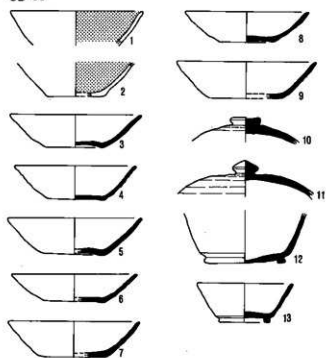

SB 98

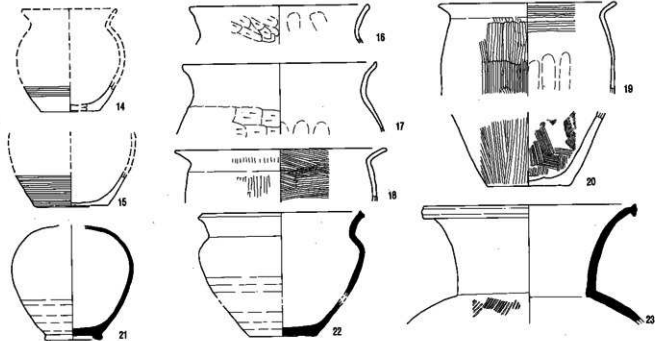

SB 99

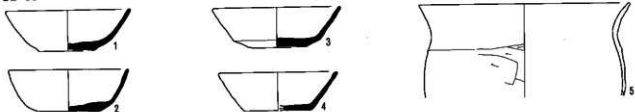

SB 100

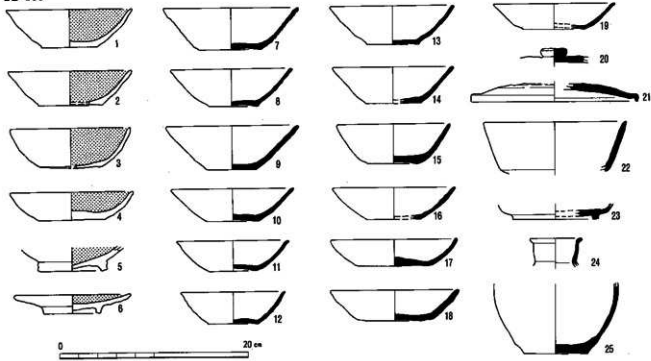

SB 100

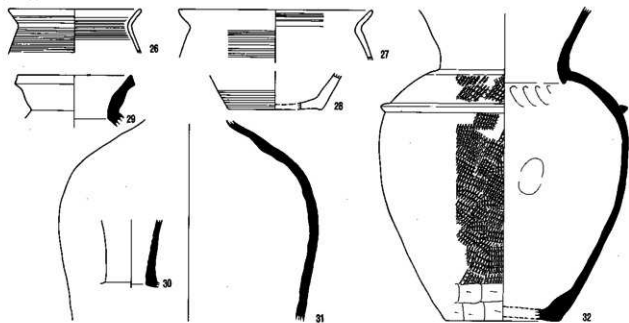

SB 102

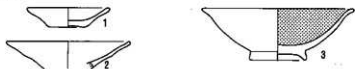

SB 103

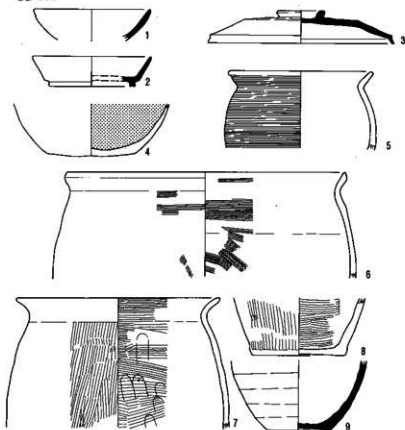

SB 104

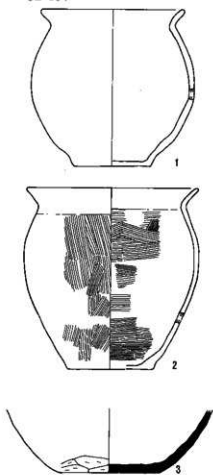

SB 105

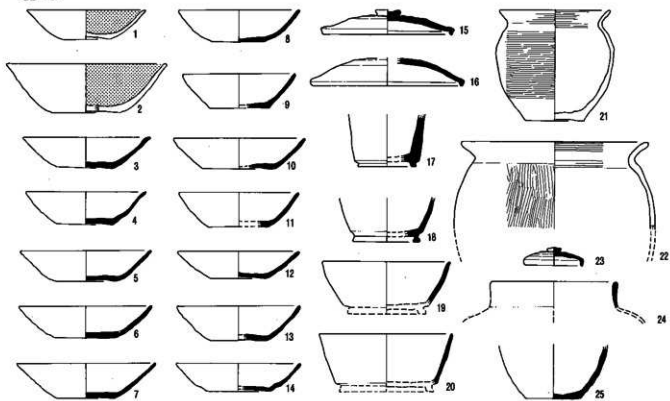

SB 106

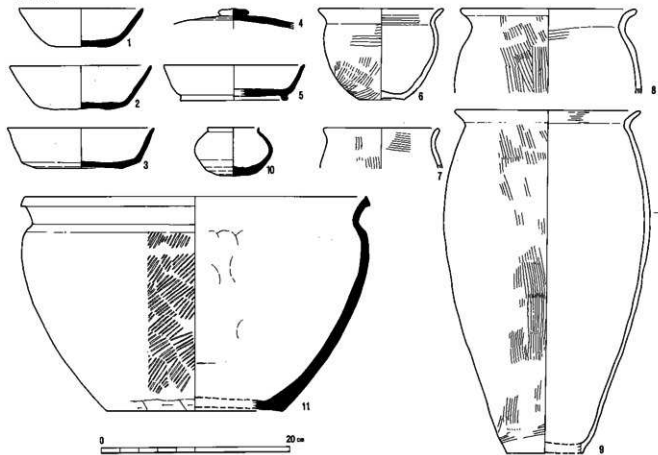

SB 107

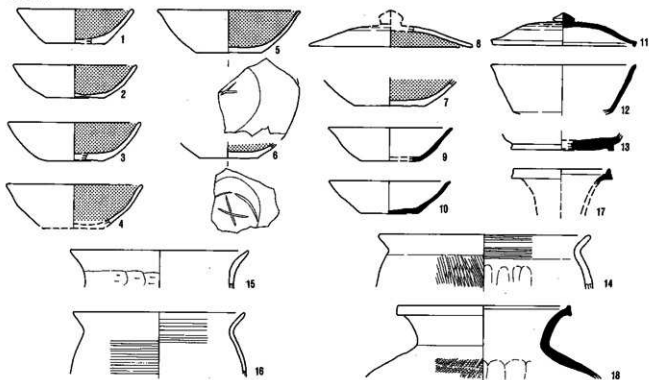

SB 109

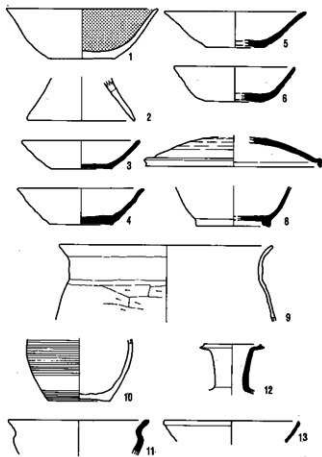

SB 108

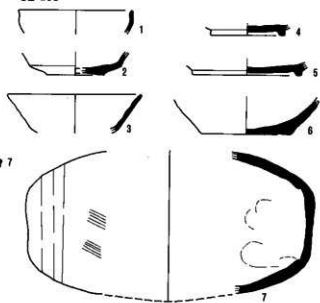

SB 110

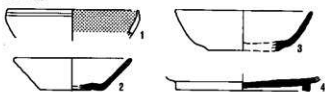

SB 110

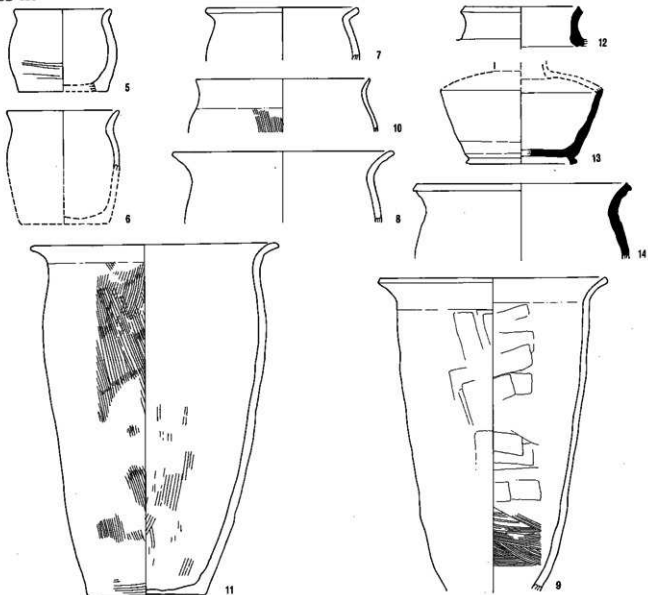

SB 111

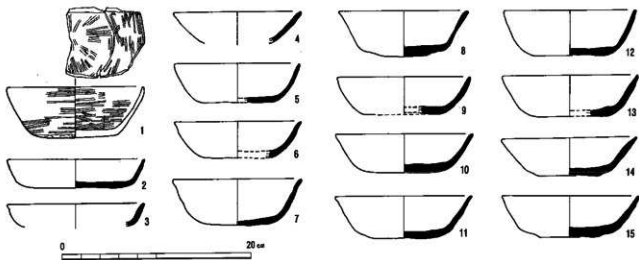

SB 111

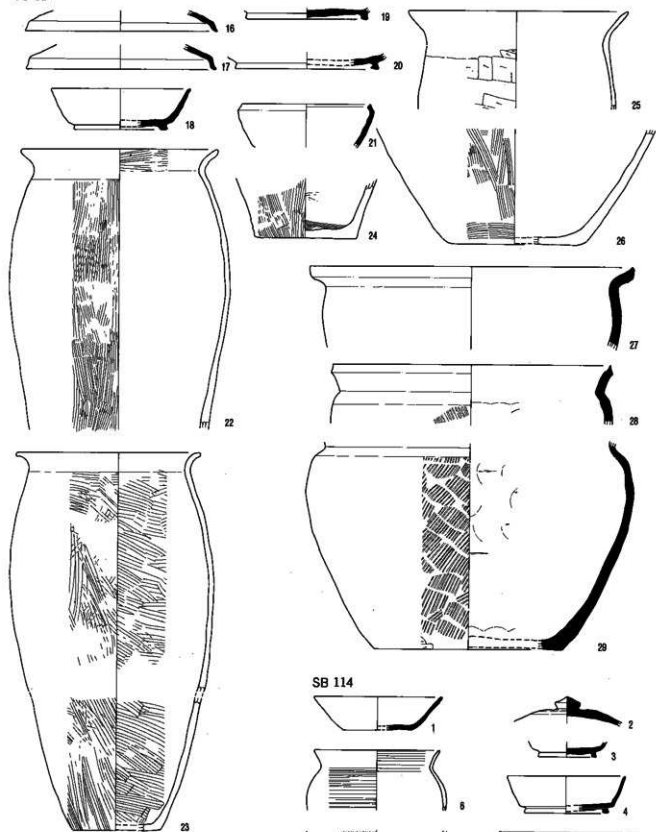

SB 114

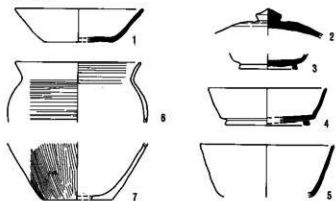

SB 112

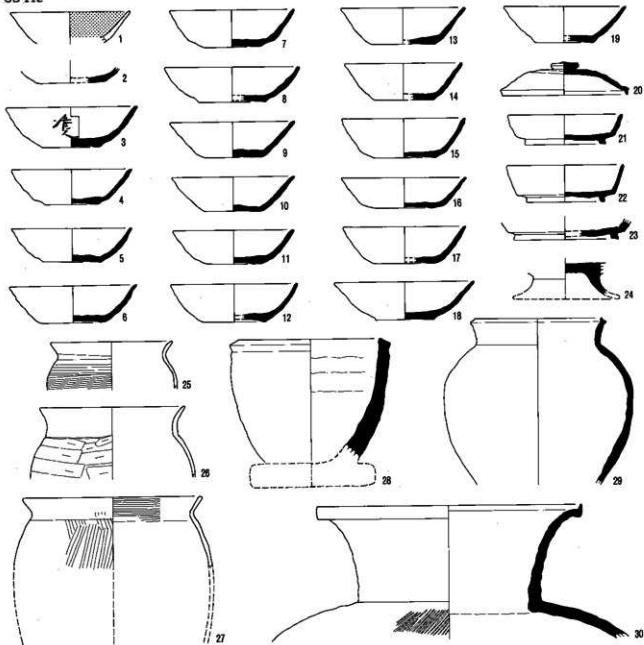

SB 113

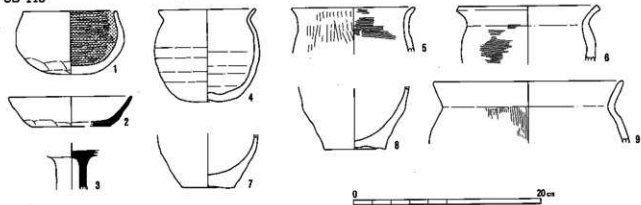

SB 113

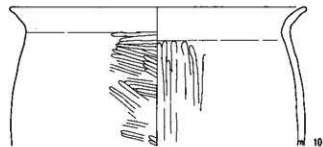

SB 118

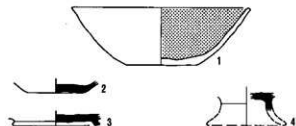

SB 115

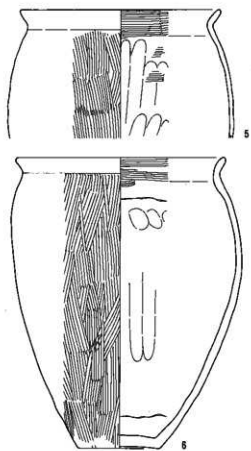
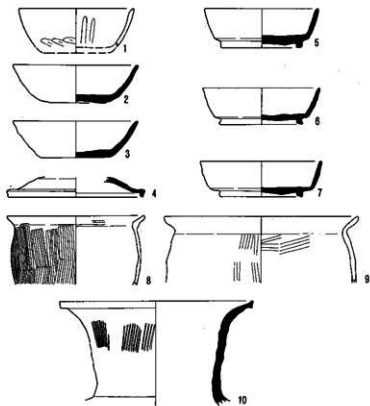

SB 117

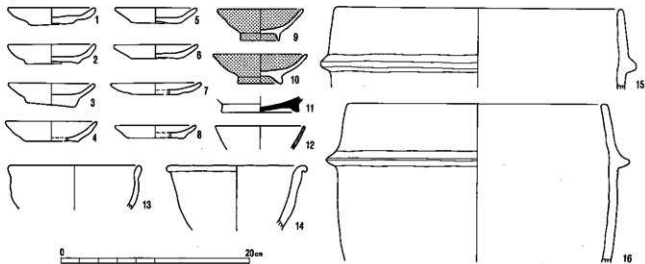

SB 120

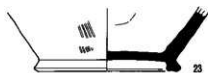
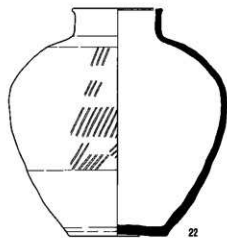
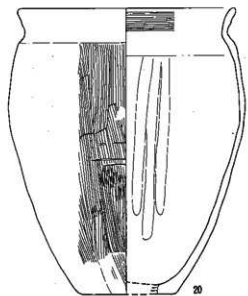
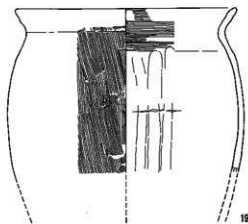
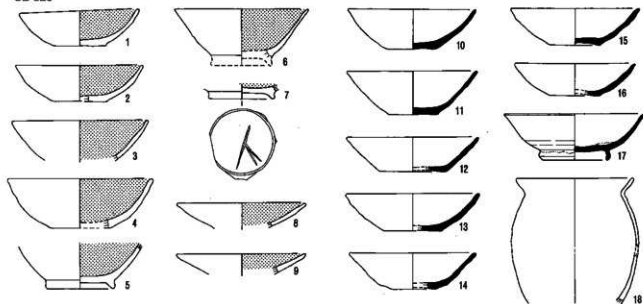

SB 119



SB 121

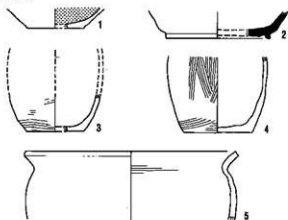

SB 124

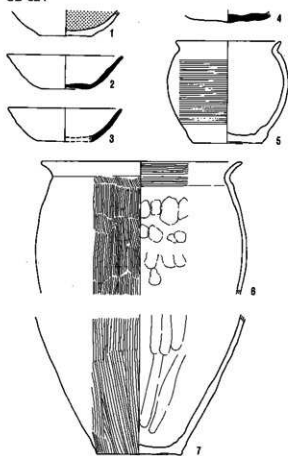

SB 122

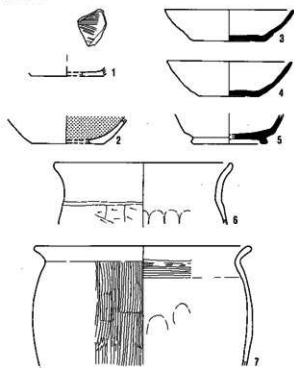

SB 126

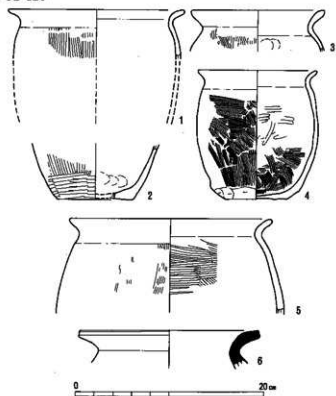

SB 123

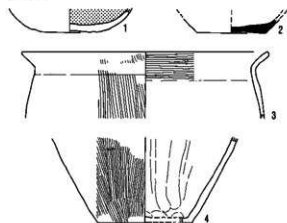

SB 125

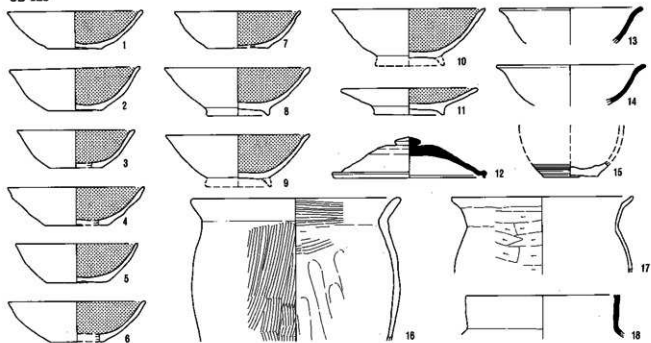

SB 127

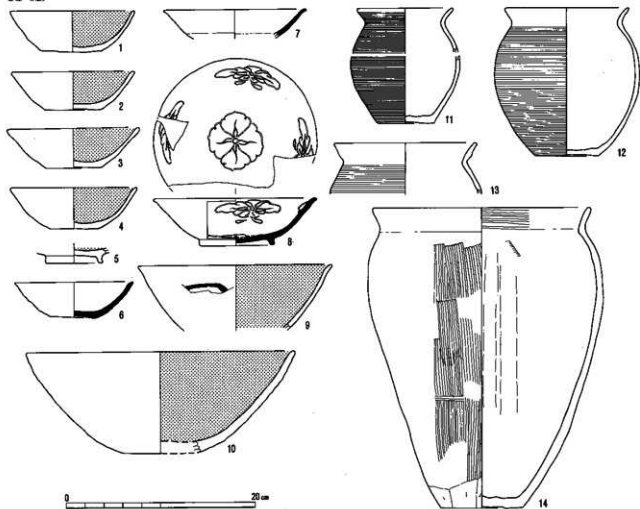

SB 127

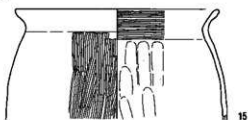

15

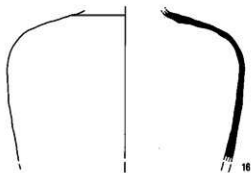

16

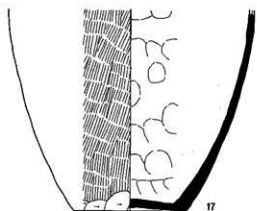

17

SB 129



1



2



3



4

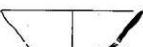

5



6

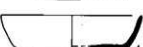

7



8



9



10

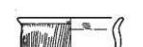

11



12



13

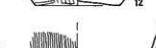

14

SB 128



1



2

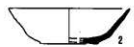

3

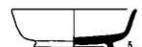

4

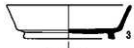

5



6

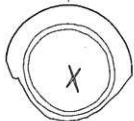

7



8

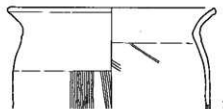

9

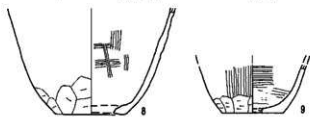

10



20cm

SB 129

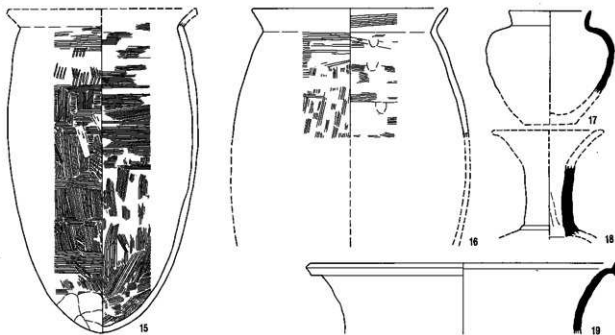

SB 130

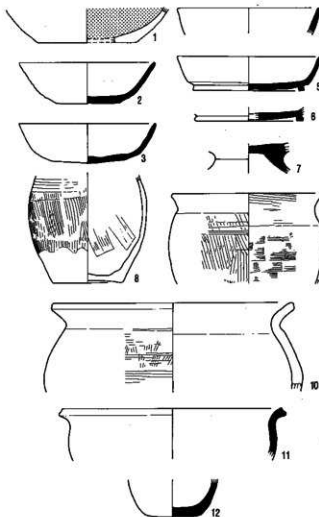

SB 131

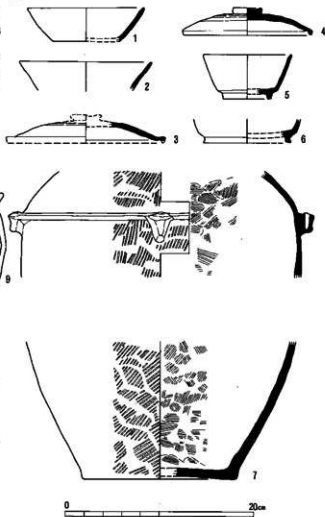

SB 132



SB 136

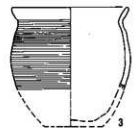

SB 133

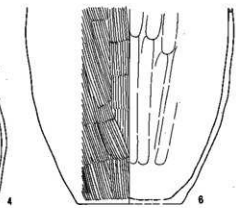
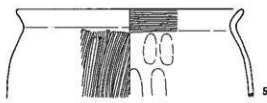
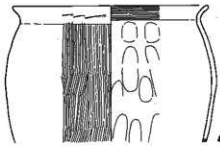
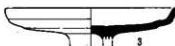
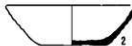
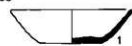

SB 137

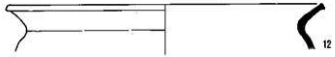
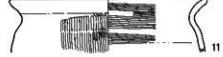
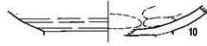
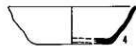
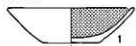

SB 134



SB 139

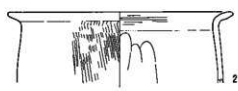

SB 140

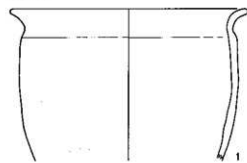

SB 141

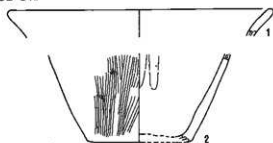

SB 142

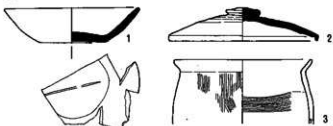

SB 143

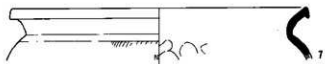
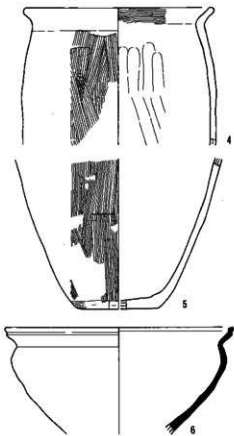
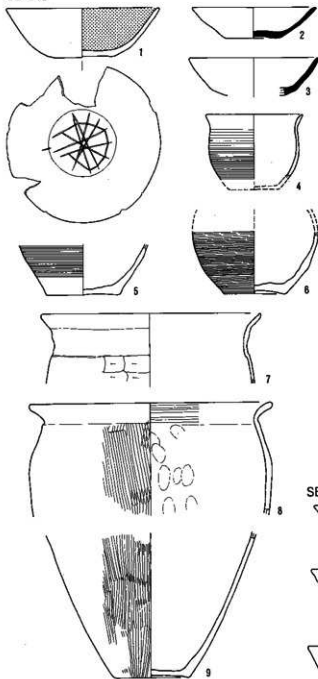

SB 144

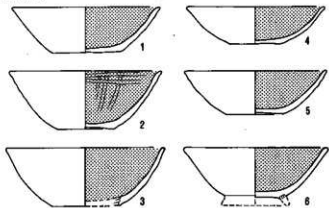

SB 144

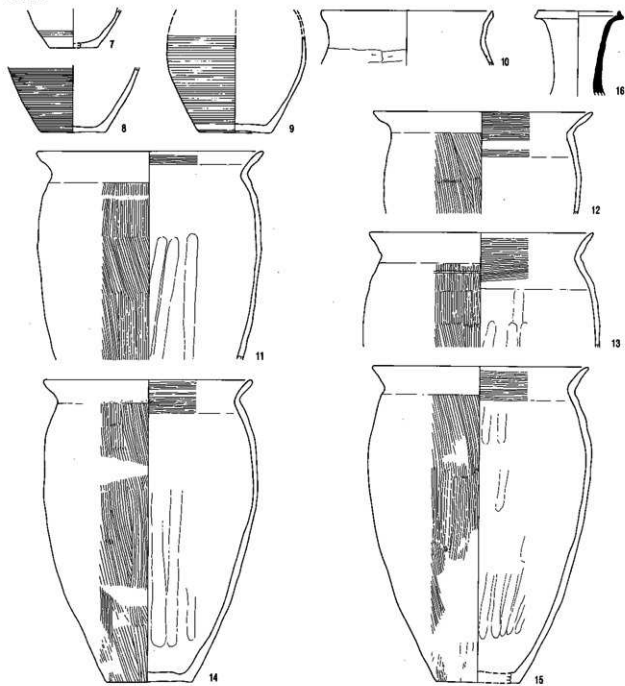

SB 148

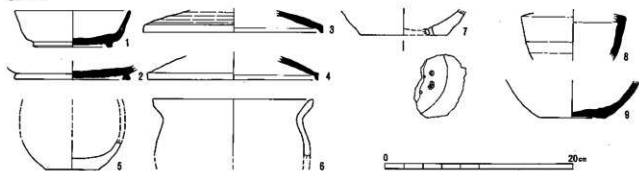

SB 145

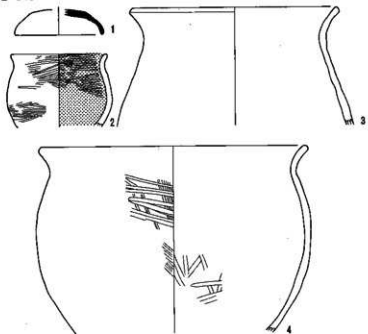

SB 146

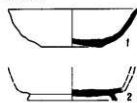

SB 149

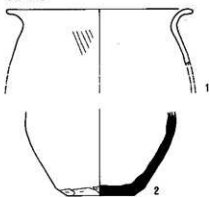

SB 147

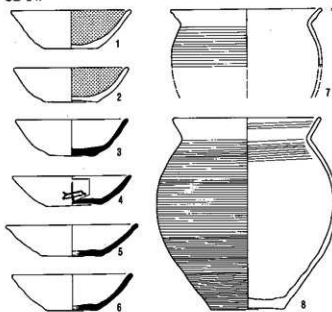

SB 150

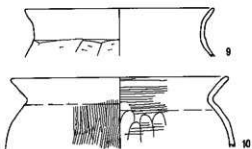
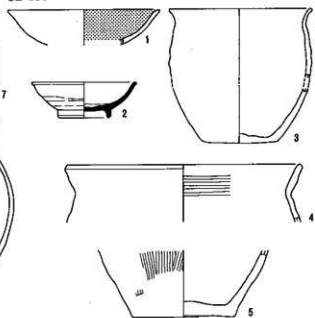

SB 151

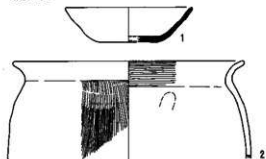

SB 152

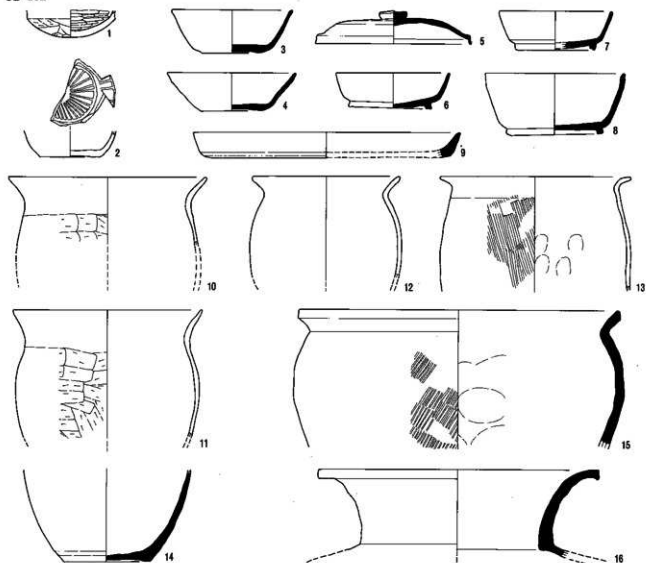

SB 153

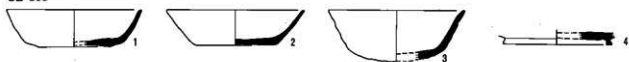

SB 154

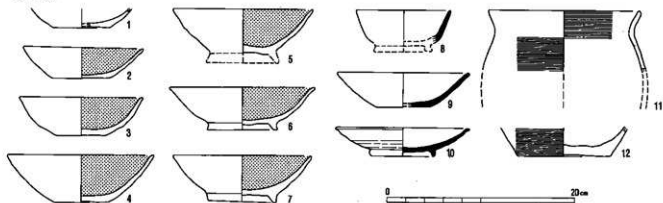

SB 154

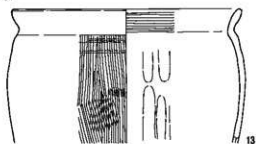

13



14

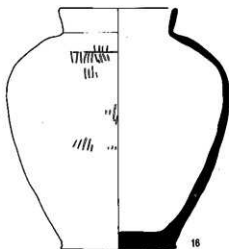

16



15

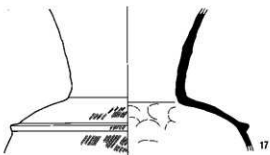

17

SB 155



1



3

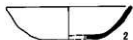

2



4

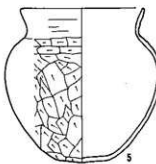

5



6

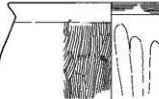

7

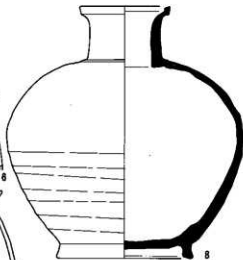

8

SB 156



1



3



5



6



2

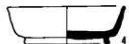

4



SB 157

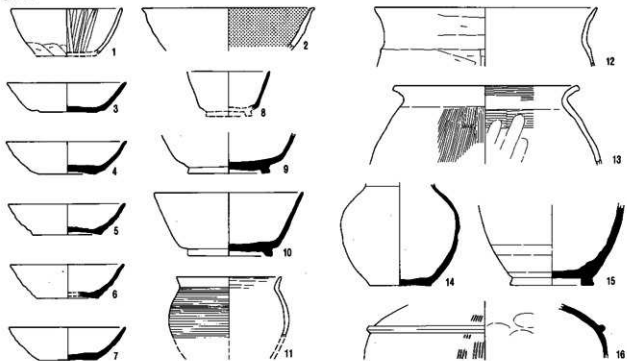

SB 159

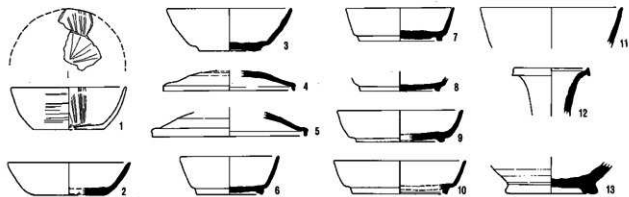

SB 160

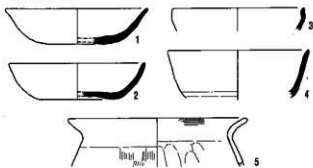

SB 162

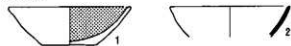

SB 167

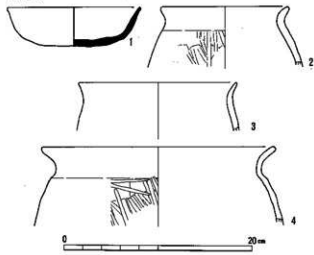

SB 161

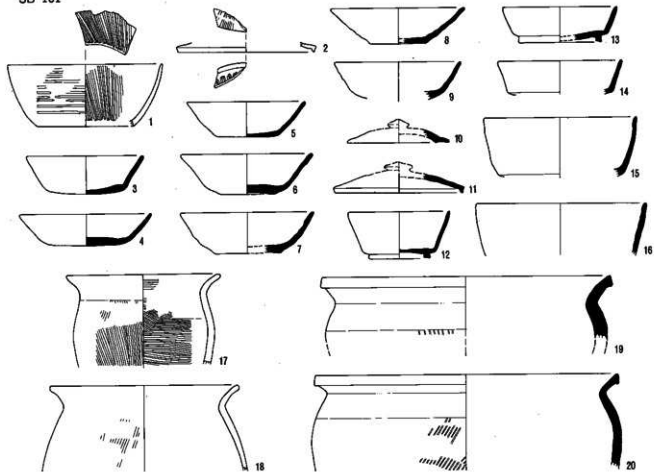

SB 163

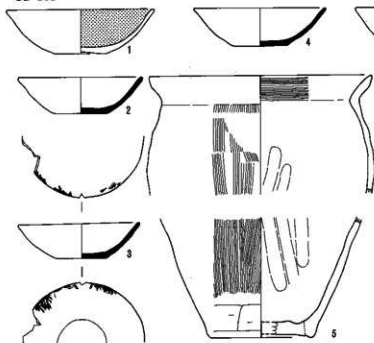

SB 166

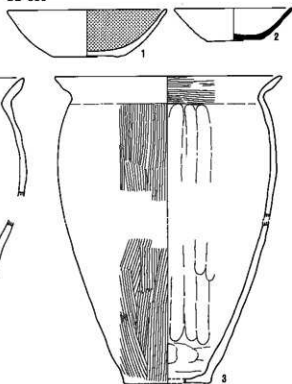

SB 164

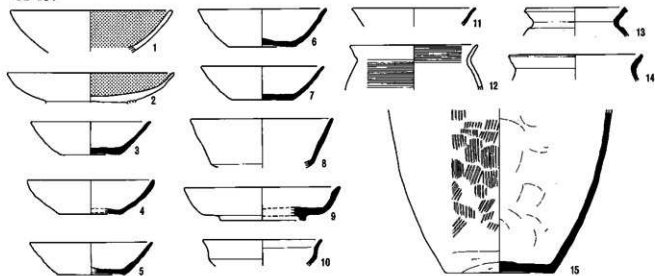

SB 168

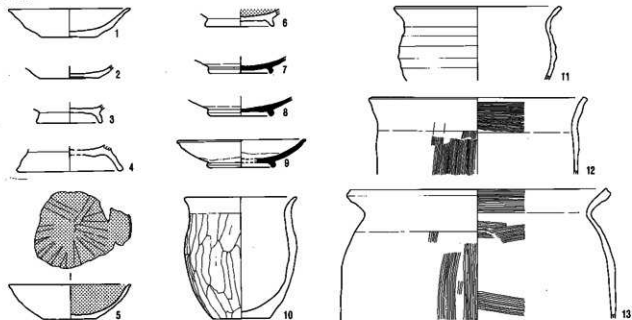

SB 169

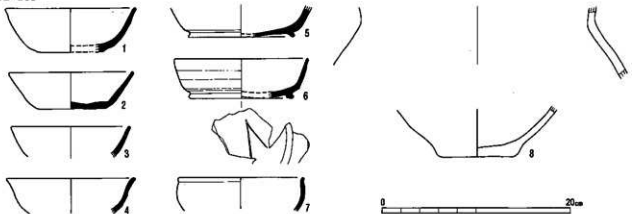

SB 169

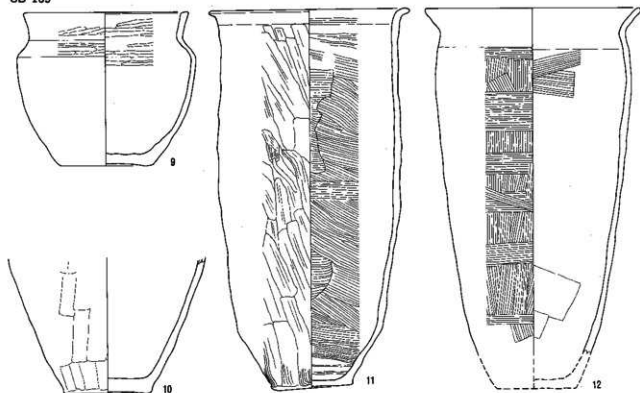

SB 170

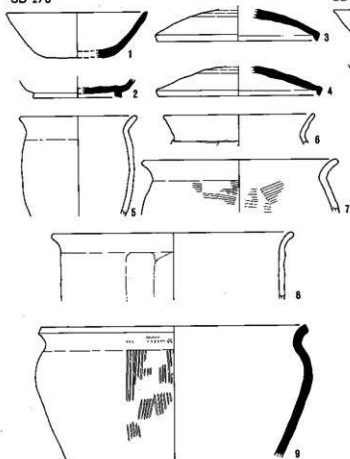

SB 171

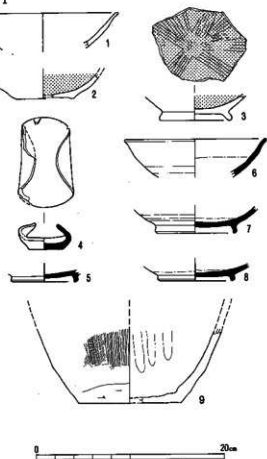

SB 172

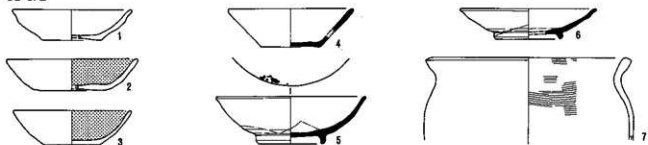

SB 173

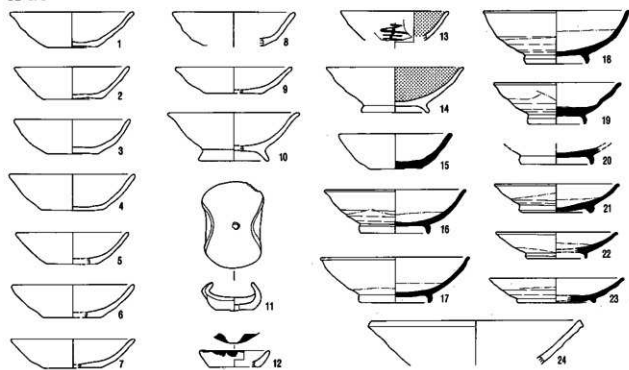

SB 174

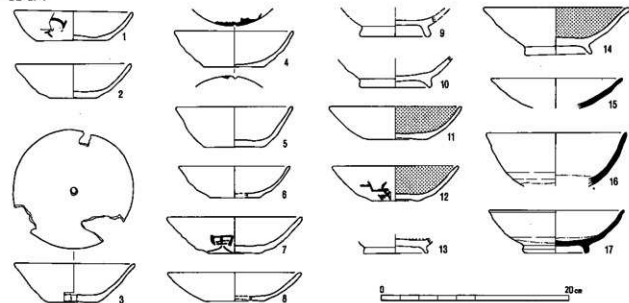

SB 174

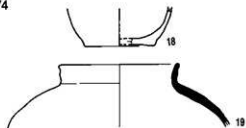

SB 175

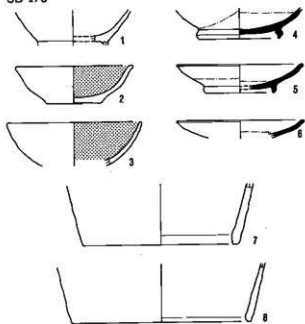

SB 180

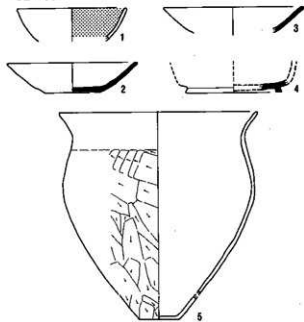

SB 176

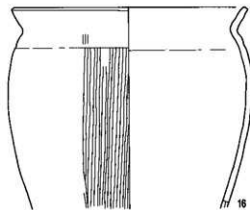
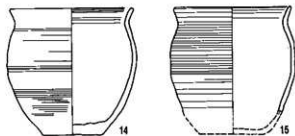
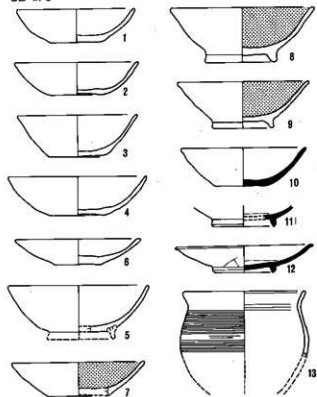

SB 177

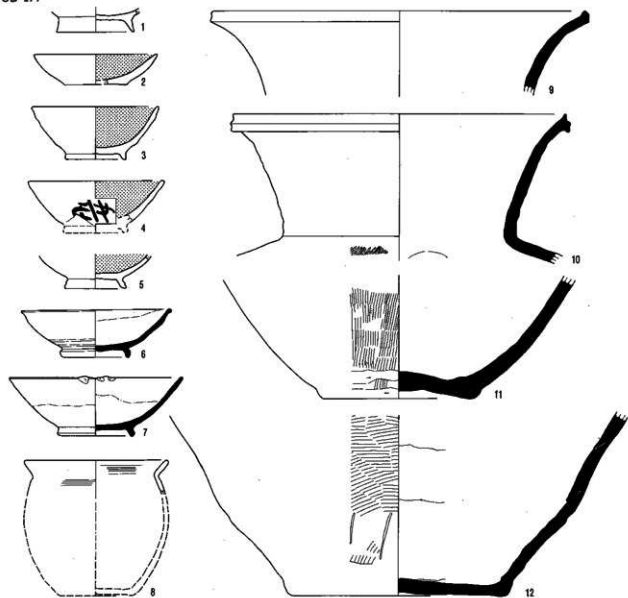

SB 178

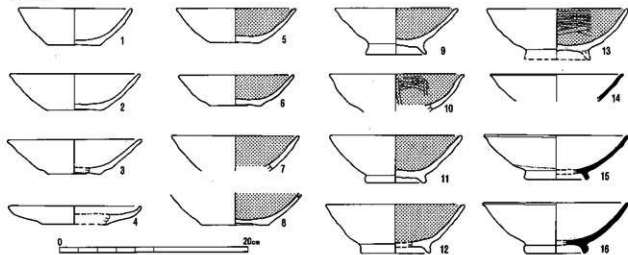

SB 178

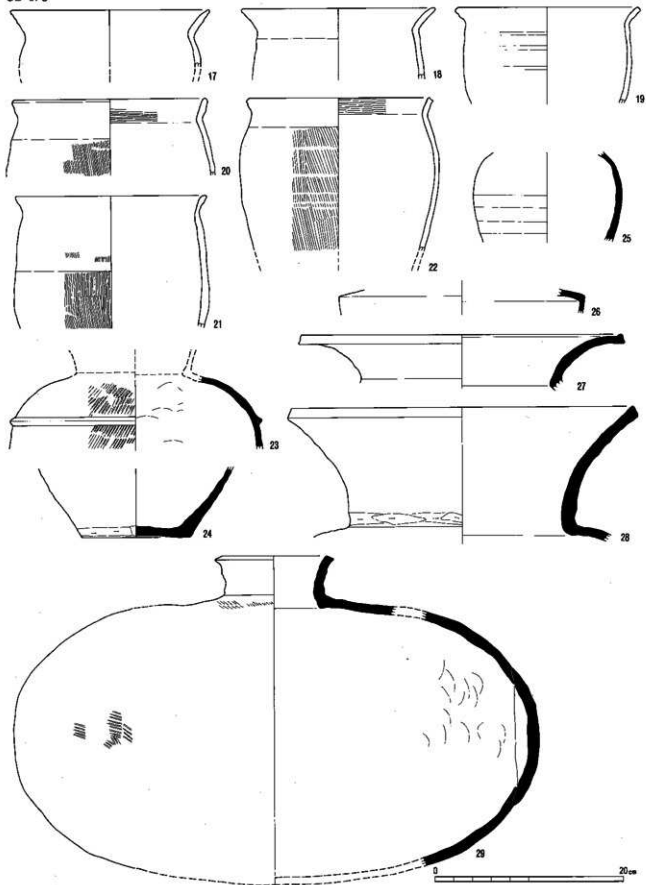

SB178

SB 179

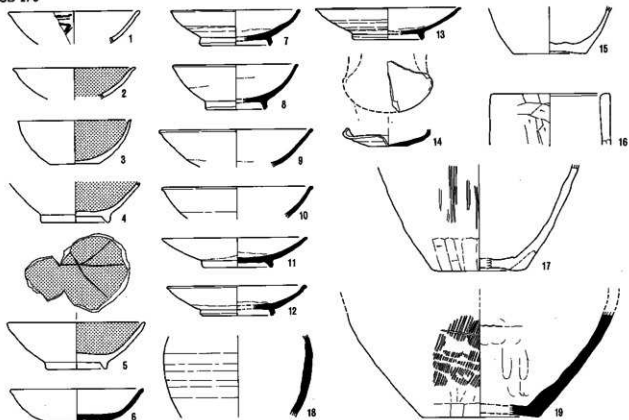

SB 183

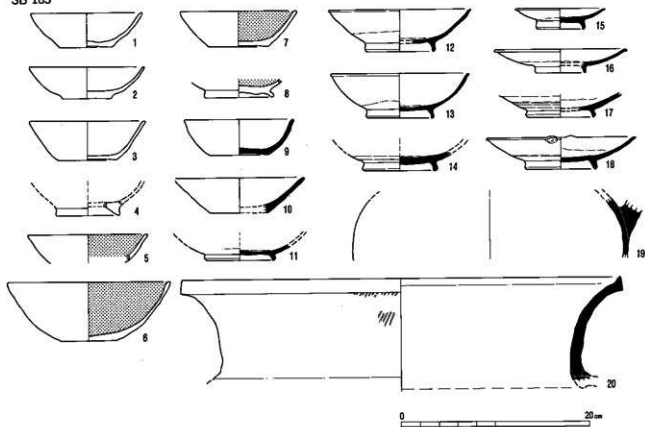

SB 181

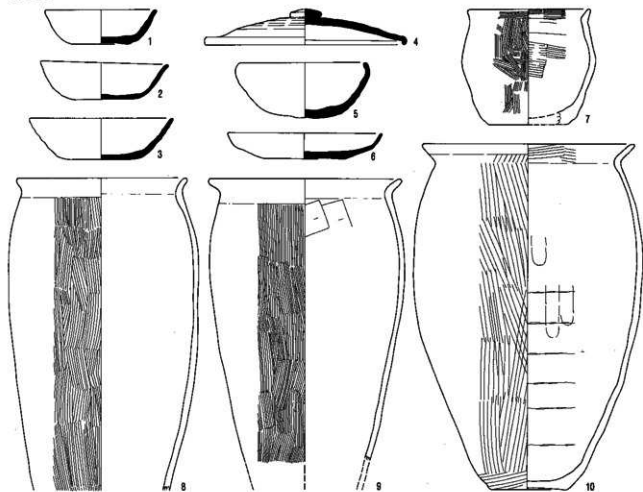

SB 182



SB 184

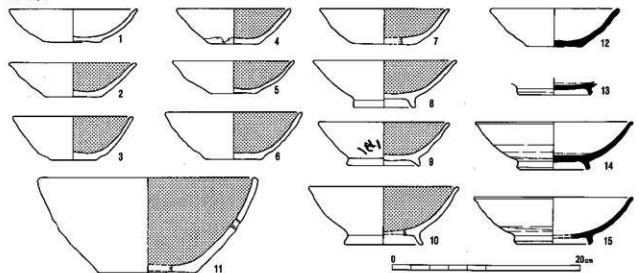

SB 184

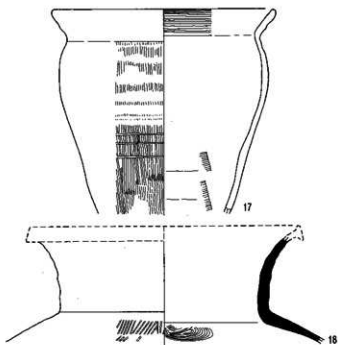
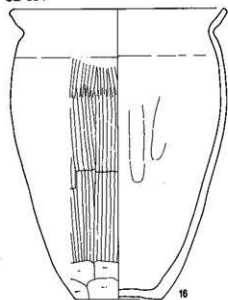

SB 185

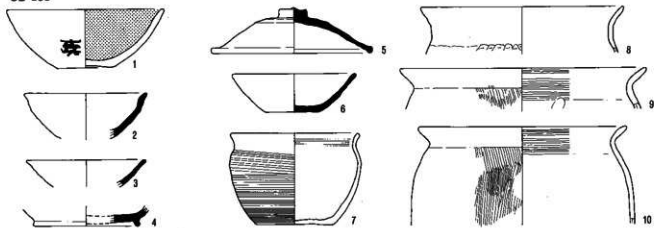

SB 186

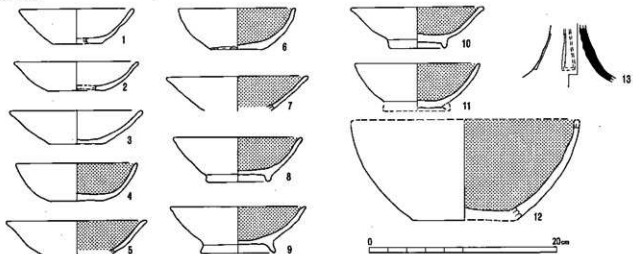

SB 186

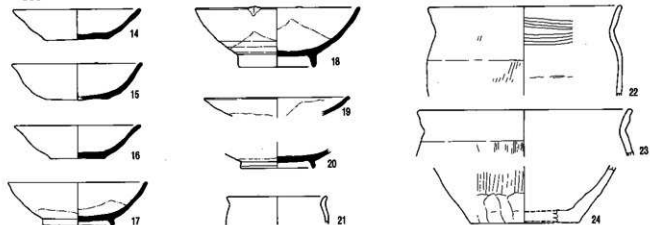

SB 187

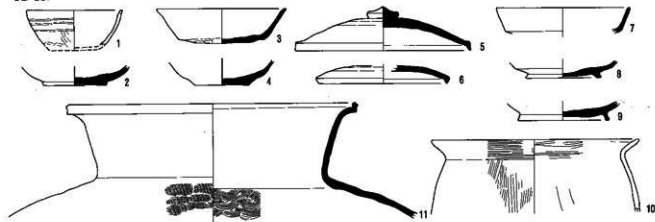

SB 188

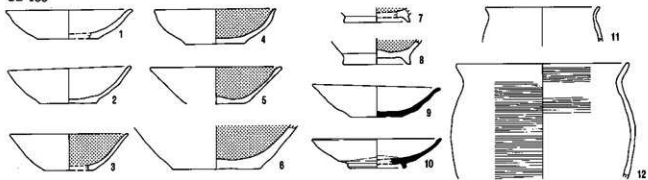

SB 189

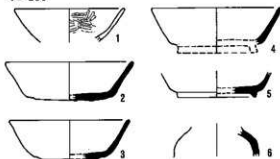

SB 190



SB 191

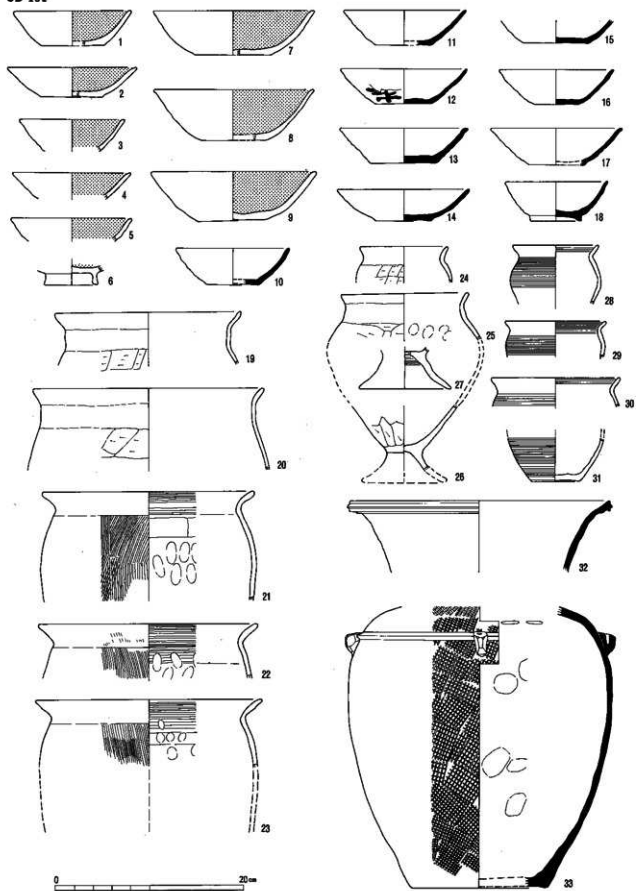

SB 192

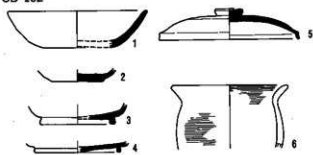

SB 194

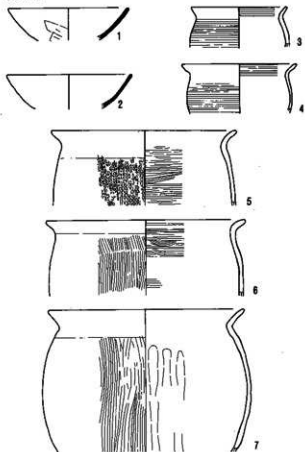

SB 195

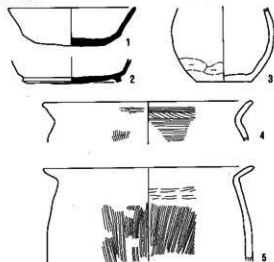

SB 196

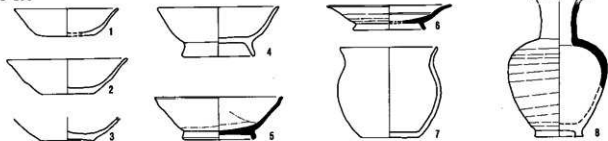

SB 197

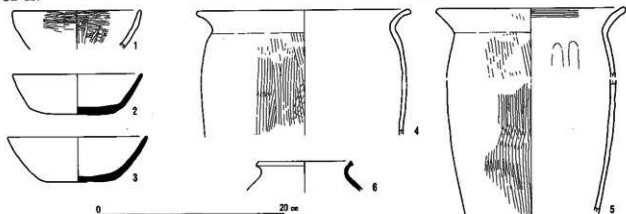

SB 198

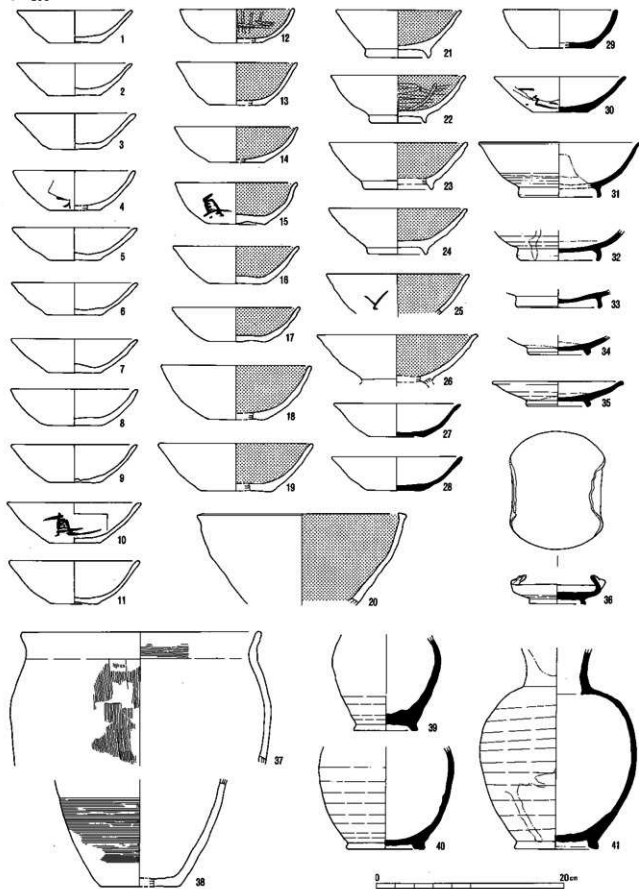

SB 199

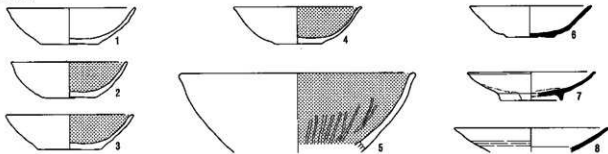

SB 200

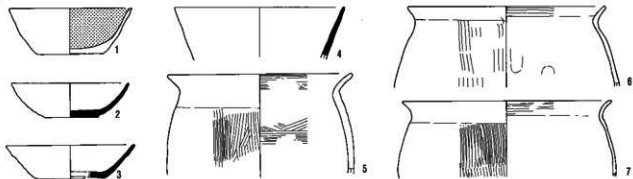

SB 202

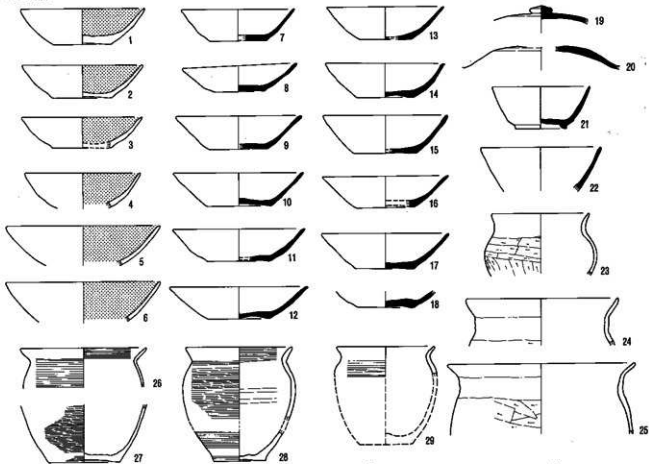

SB 202

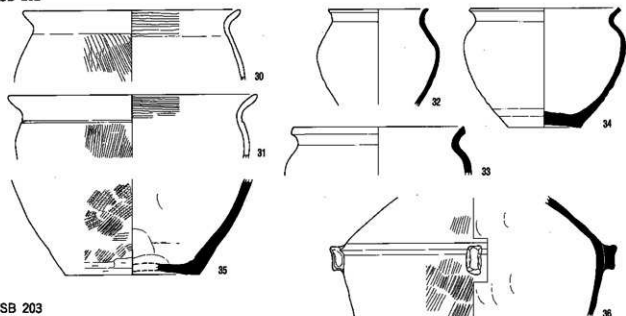

SB 203

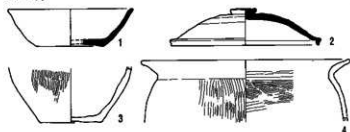

SB 204

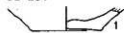

SB 206

SB 205

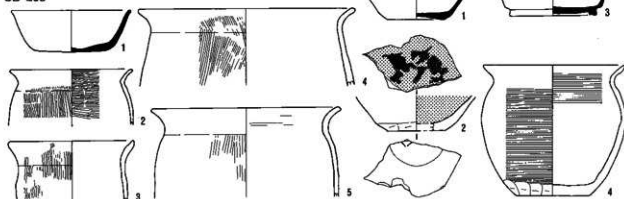

SB 207

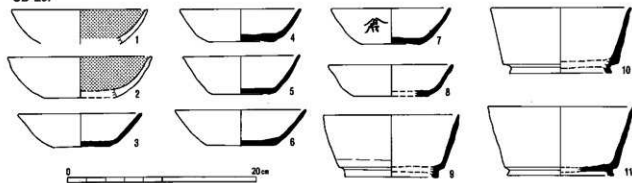

SB 207

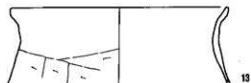

SB 208

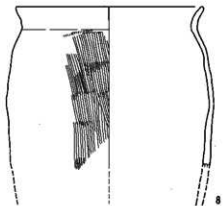
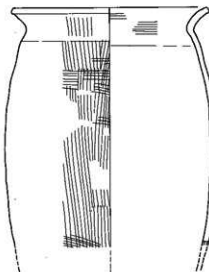
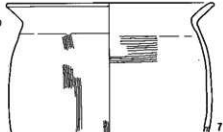
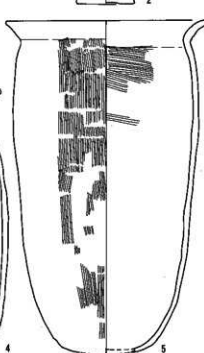

SB 209

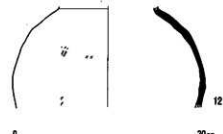
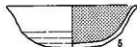
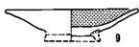
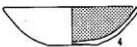
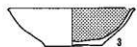

SB 210

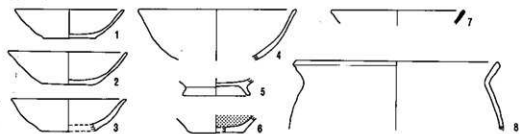

SB 211

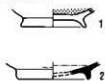

SB 212

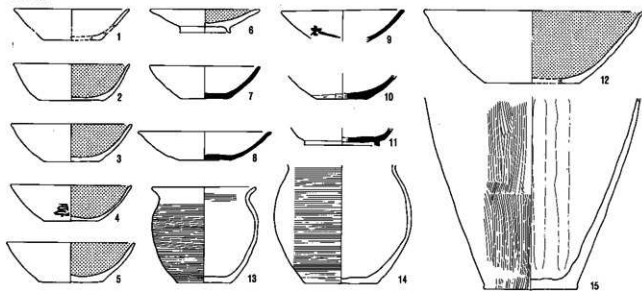

SB 213

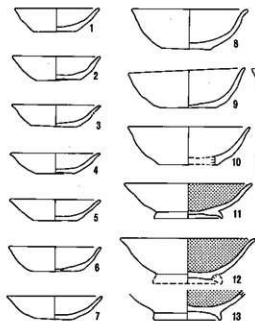

SB 214

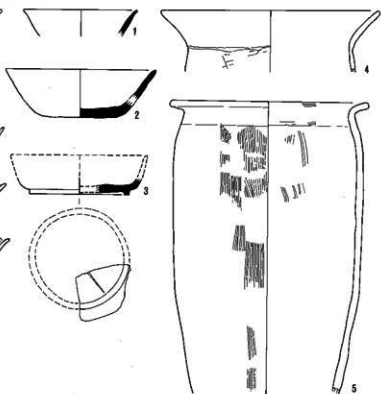

SB 215

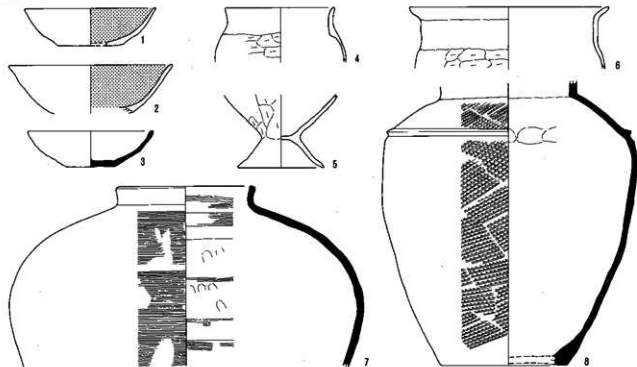

SB 216

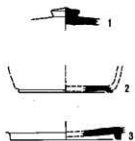

SB 217

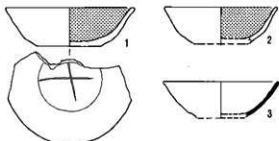

SB 219

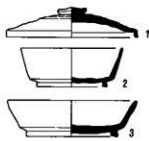

SB 220

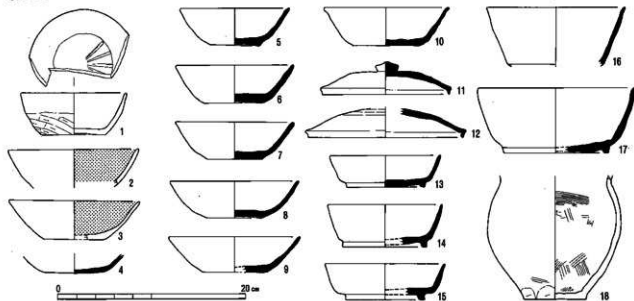

SB 218

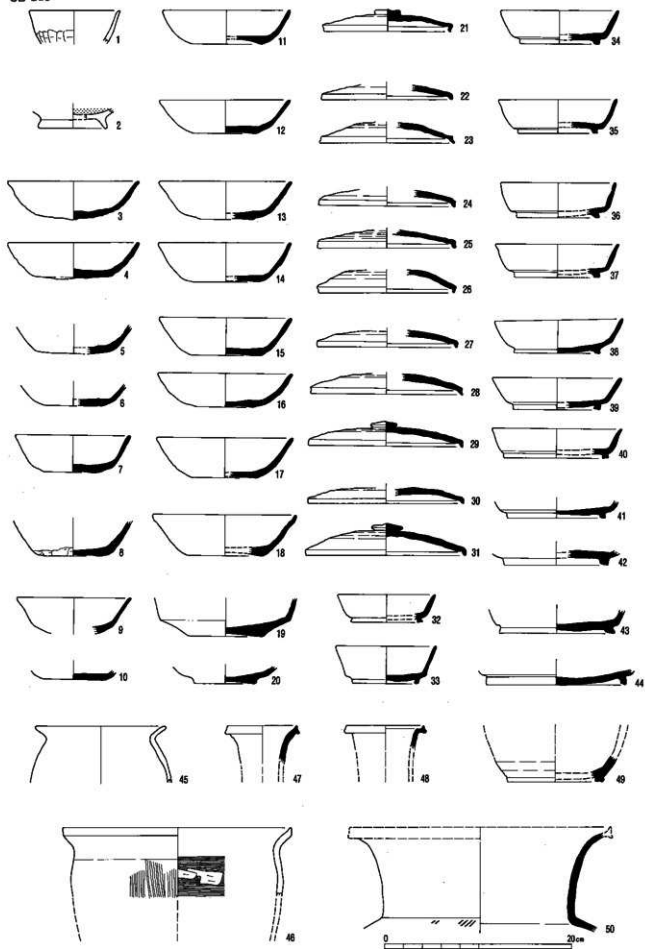

SB 221

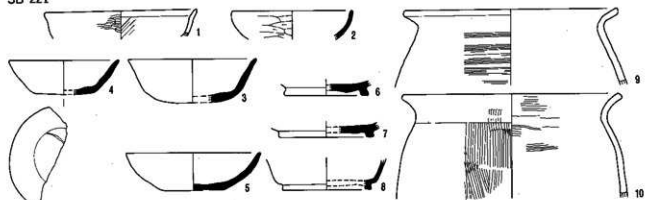

SB 222



SB 223

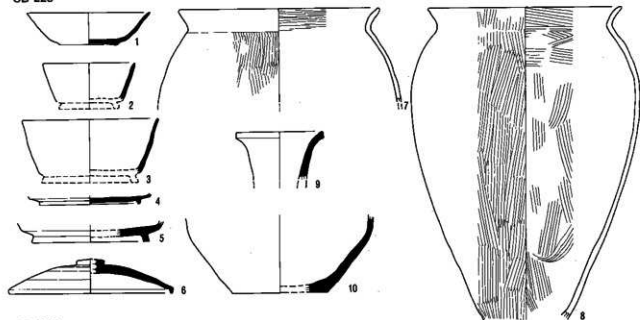

SB 224

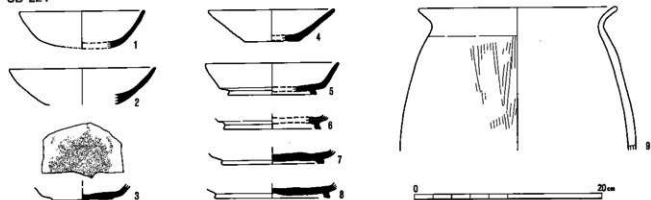

SB 224

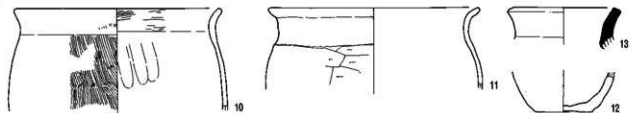

SB 225

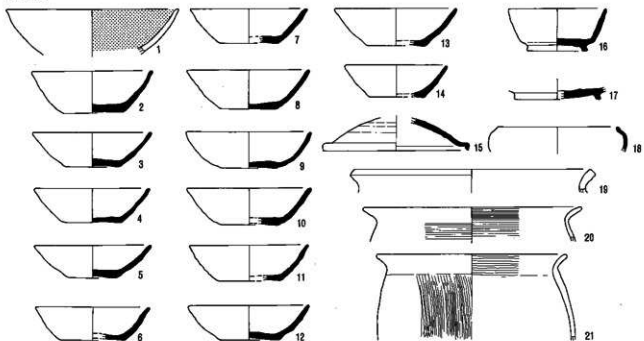

SB 228

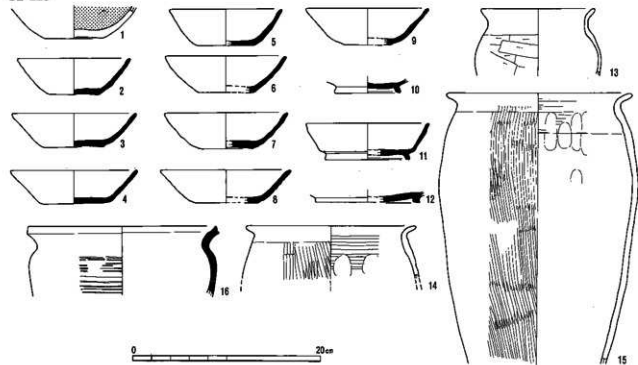

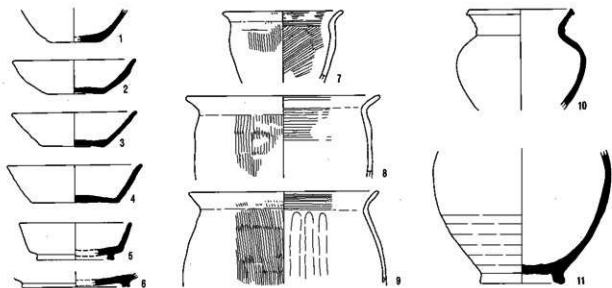

SB 226

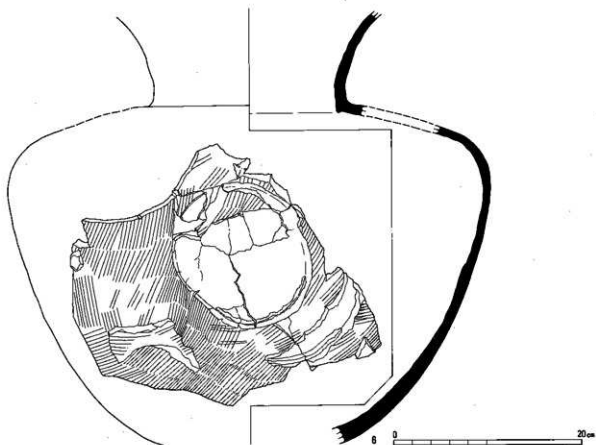
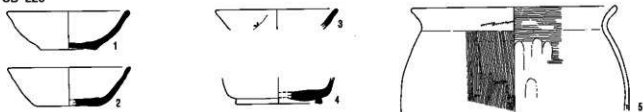

SB 229

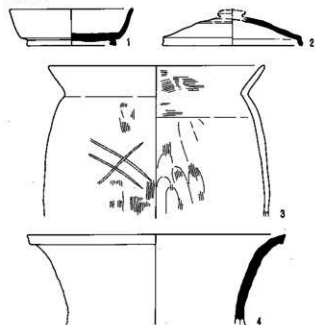

SB 232

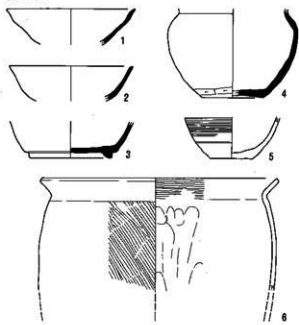

SB 230



SB 234

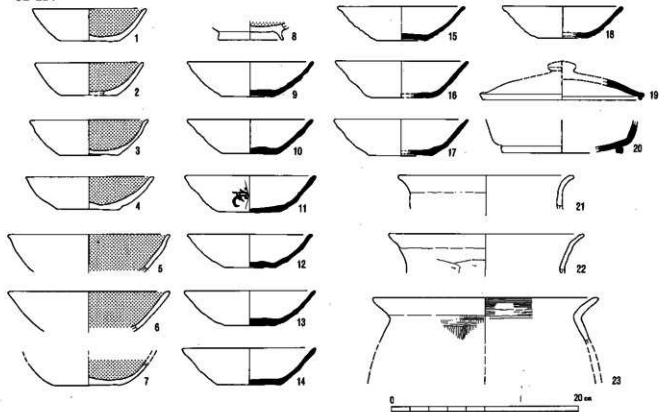

SB 233

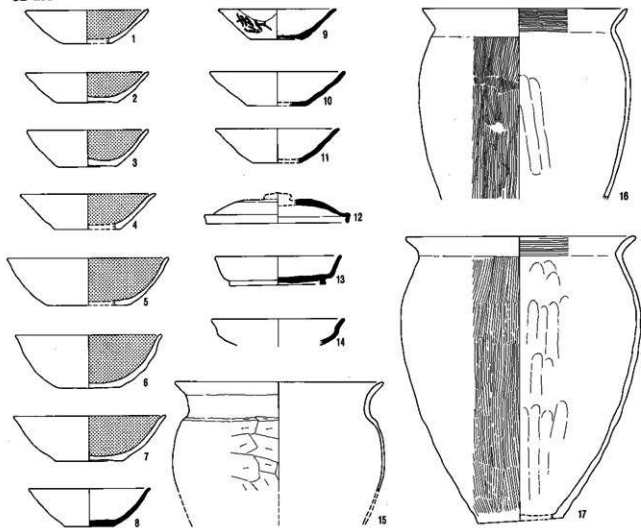

SB 235

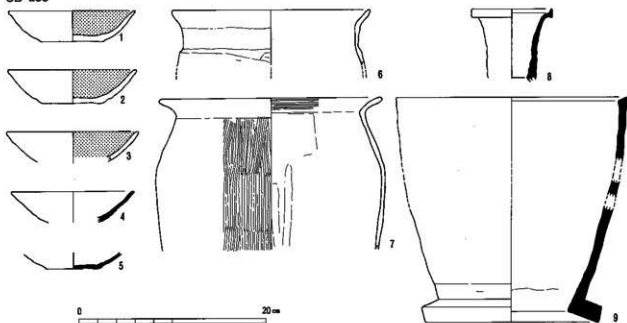

SB 236

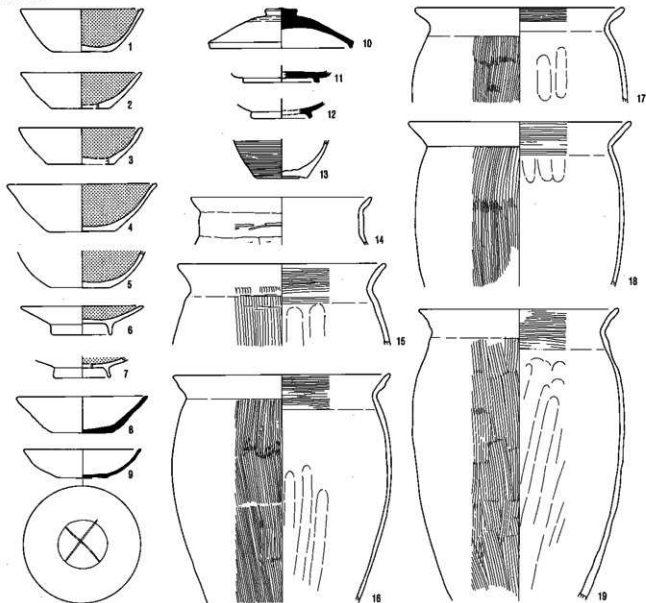

ST 3

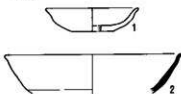

ST 11

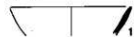

ST 13



ST 21



ST 18

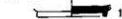

ST 41

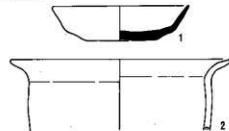

ST 25



ST 26



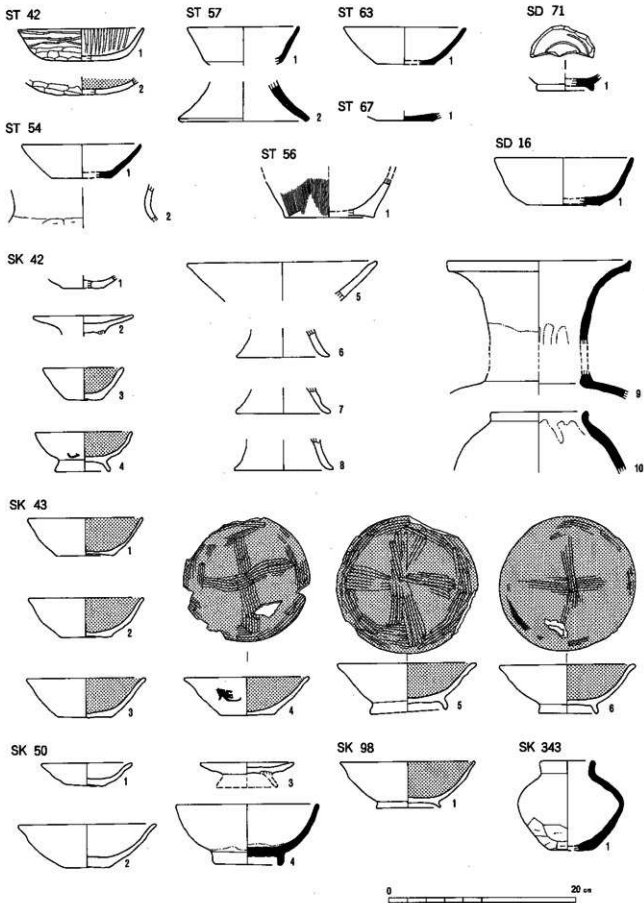

SK 333

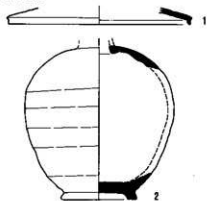

SK 35



SK 55

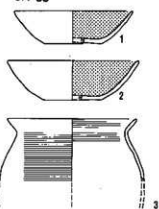

SK 38

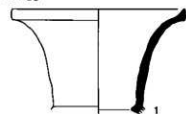

SK 51



SK 97

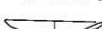
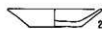

SK 106

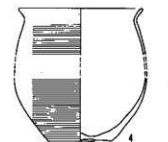

SK 162



SK 180

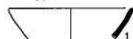

SK 276

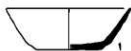

SK 338



SK 379

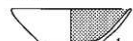

SK 347



SK 402



SK 392



SK 433

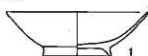

SK 387

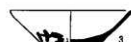
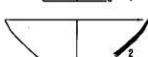

SK 418



SK 435

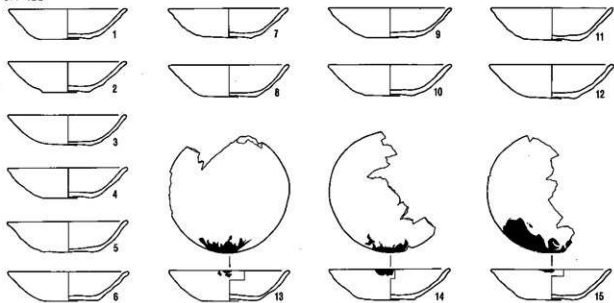

SK 450

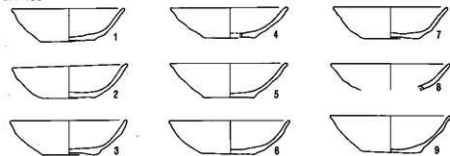

SK 575

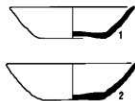

SK 456

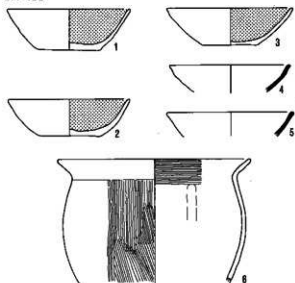

SK 511



SK 568



SK 443

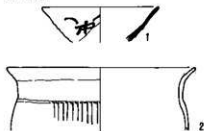

SK 602

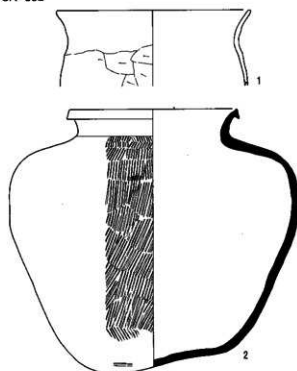

NR 4



SK 614

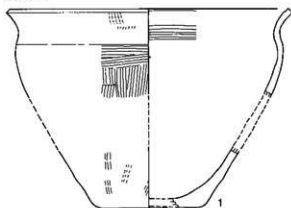

NR 5

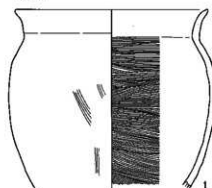

中国製輸入陶磁器 (白磁)

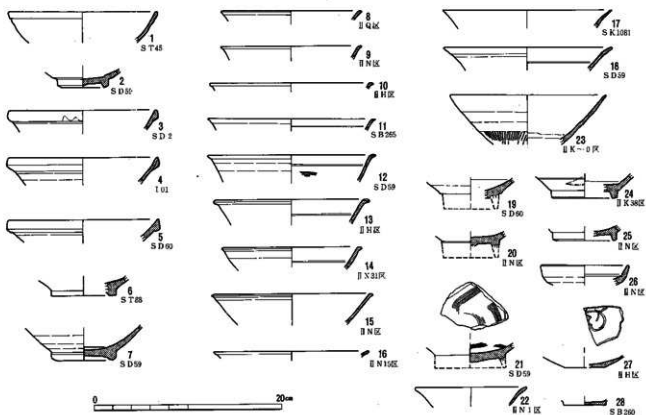

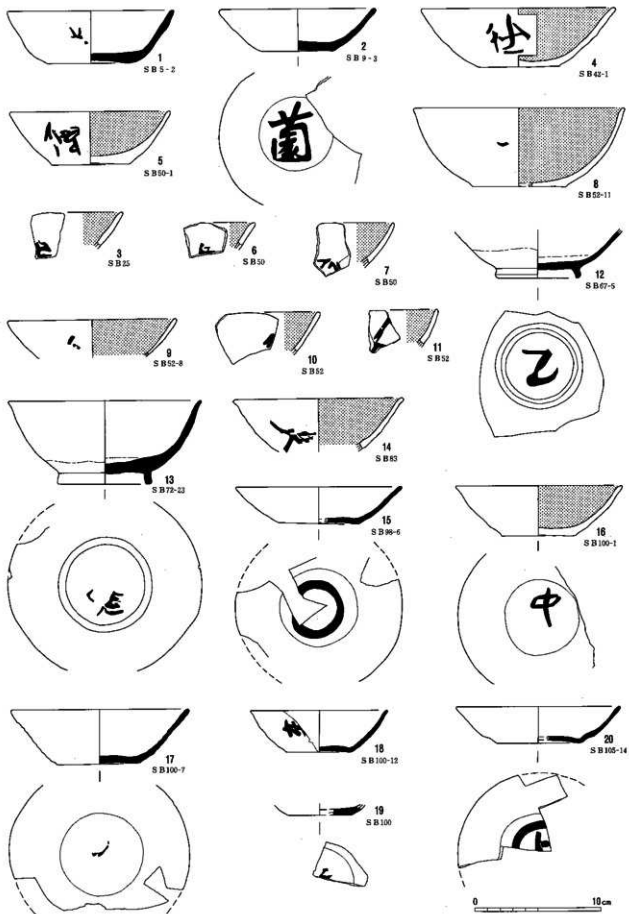

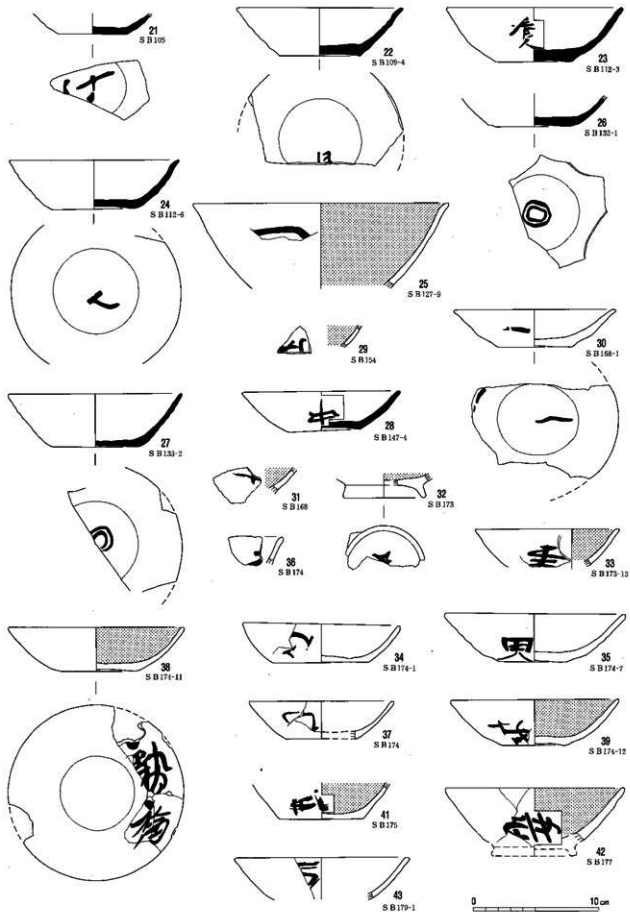

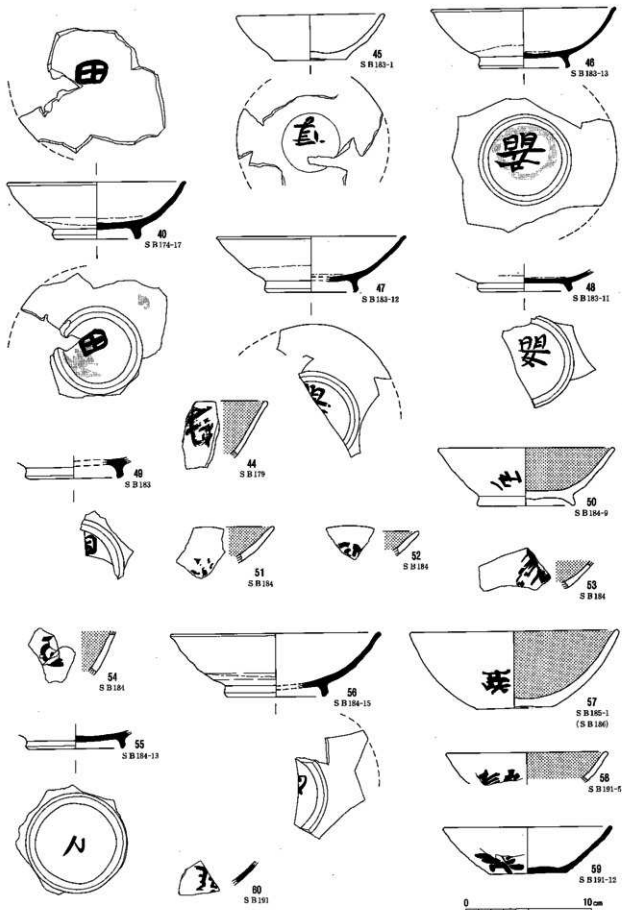

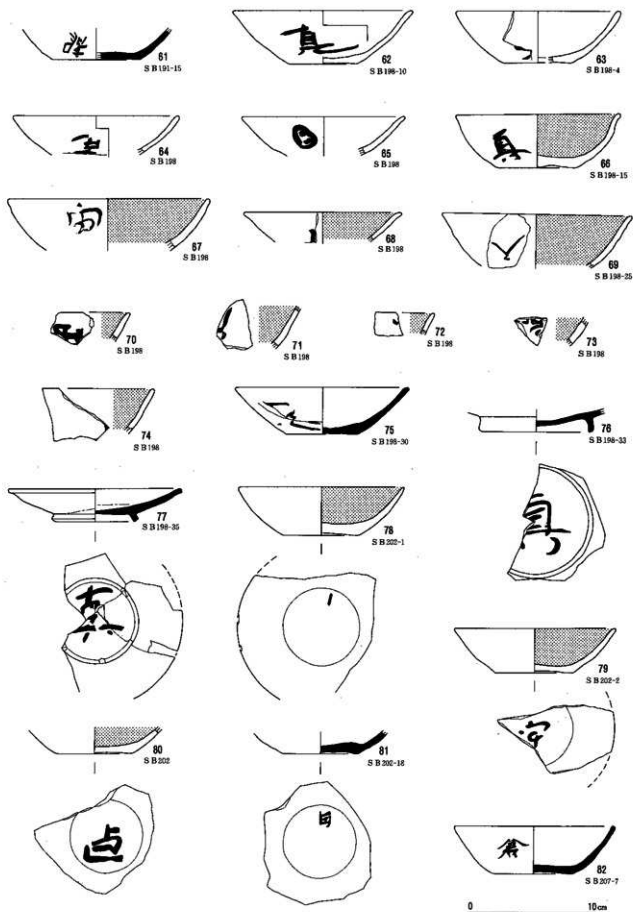

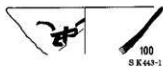
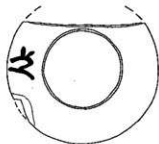
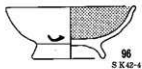
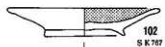
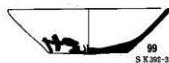
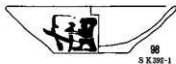
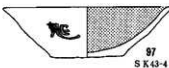
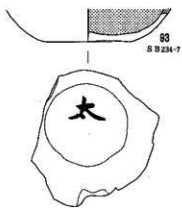
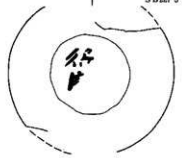
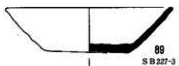
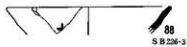
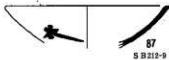
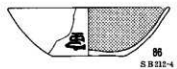
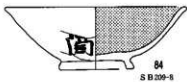
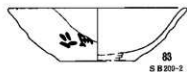

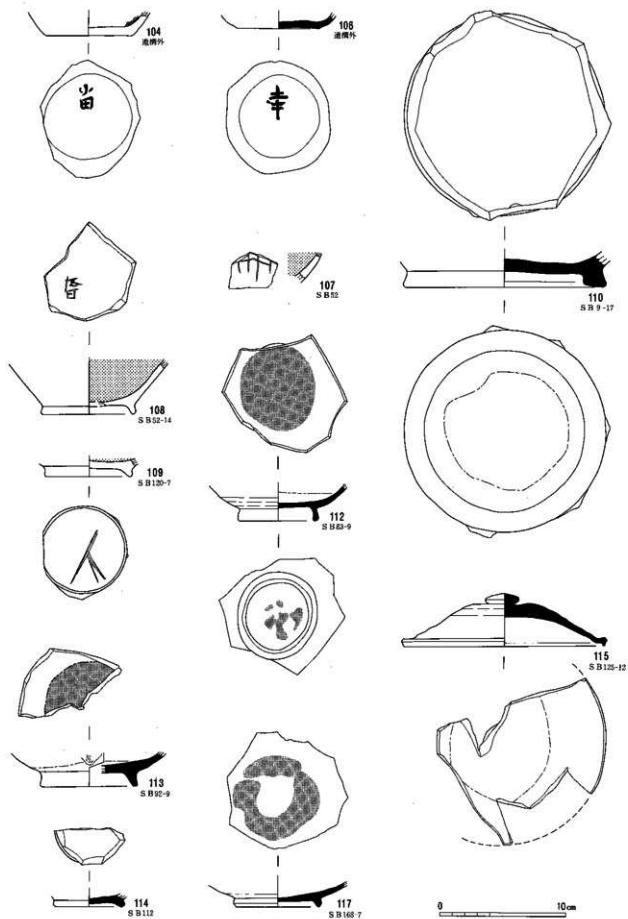

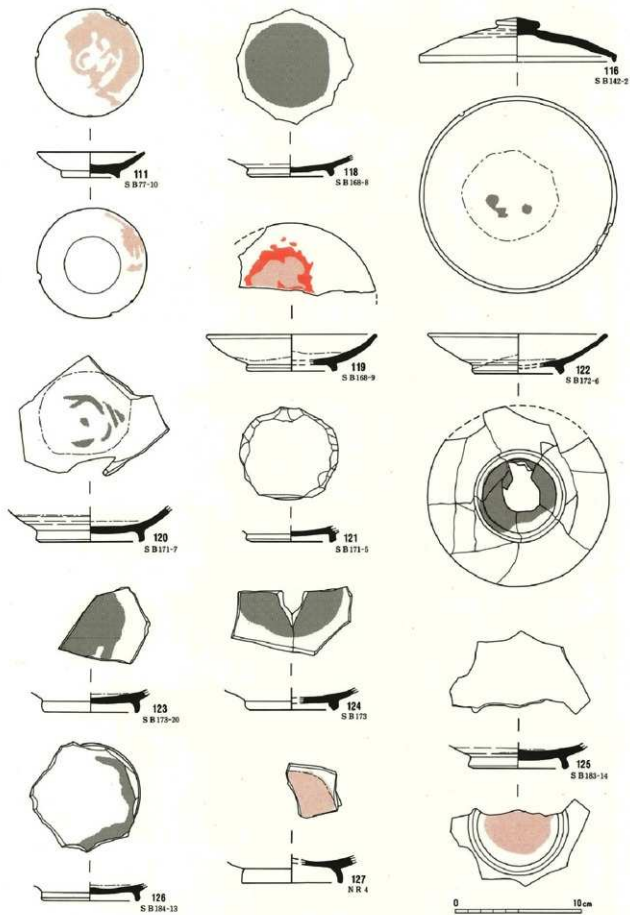

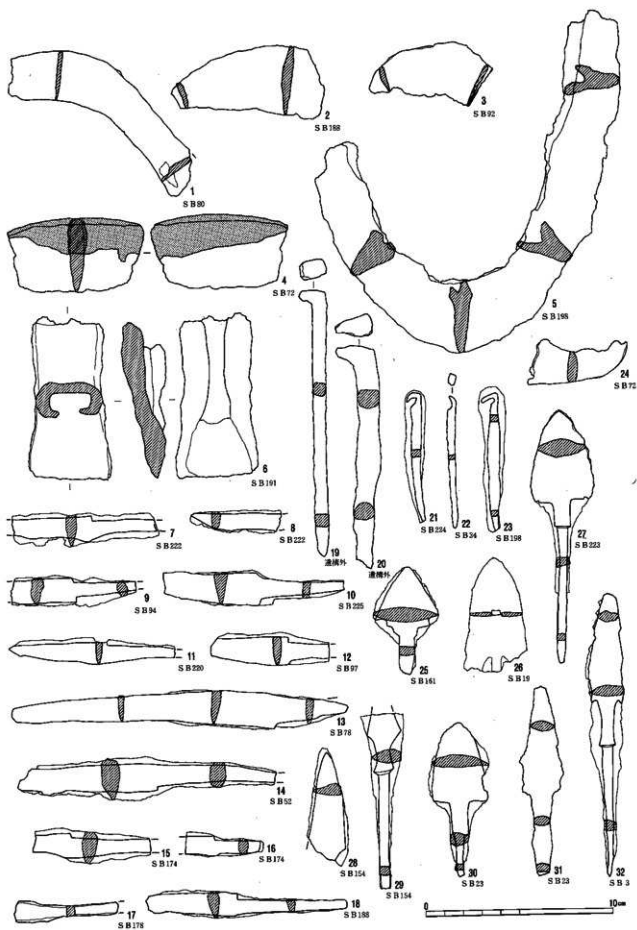

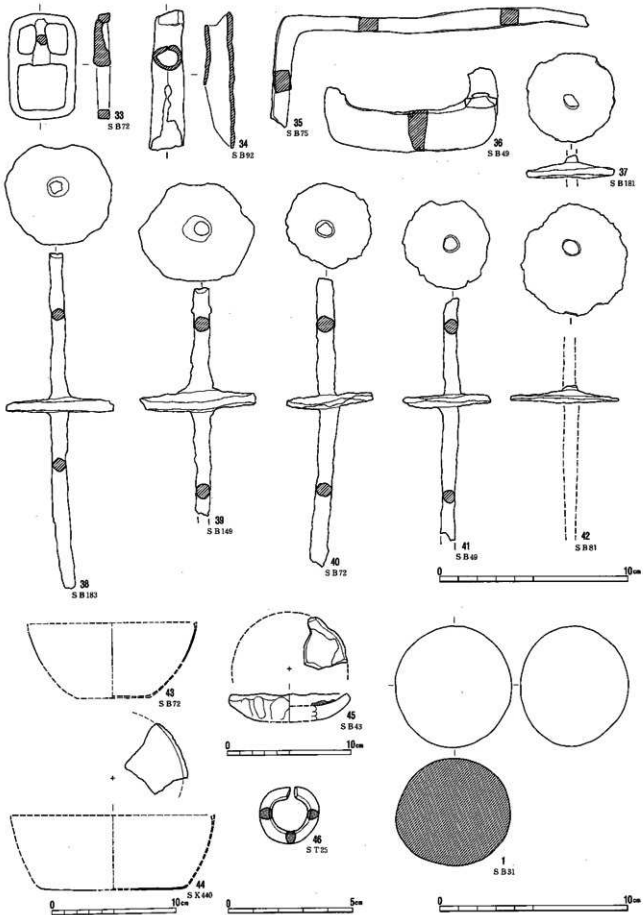



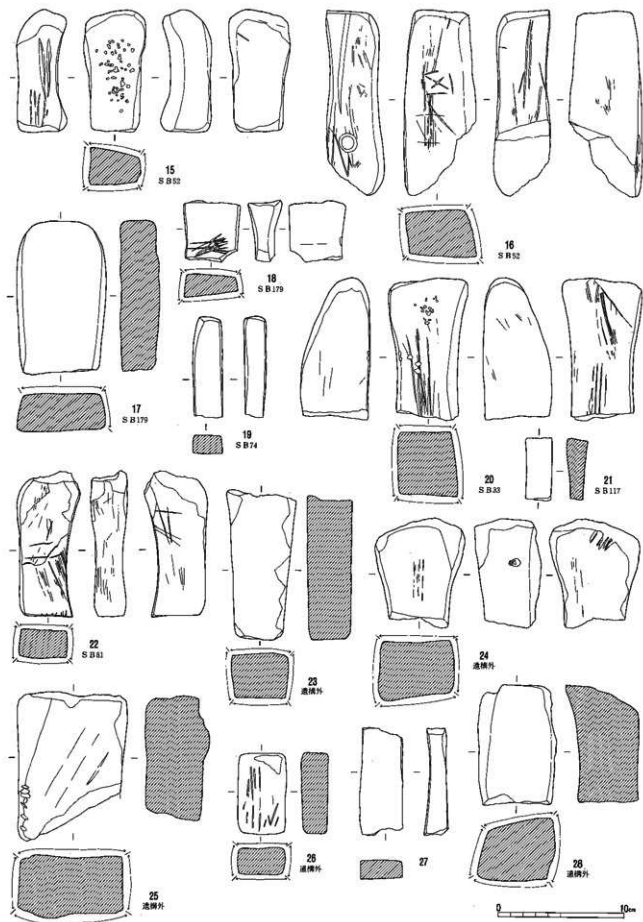

土製品

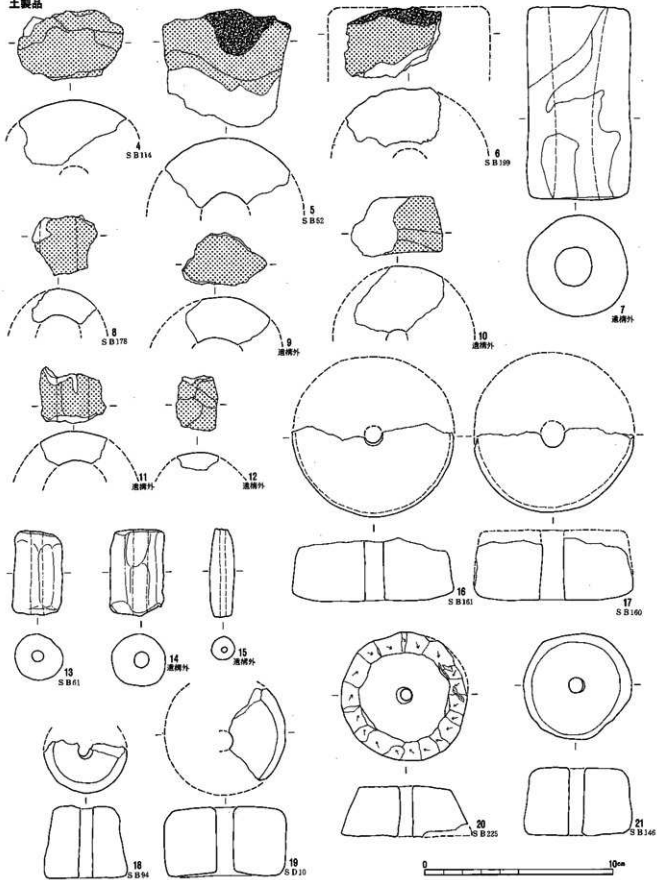

SB 252

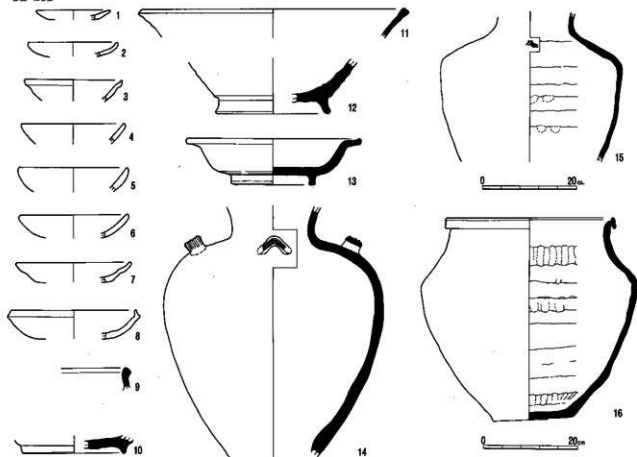

SB 254

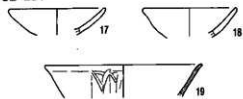

SB 259

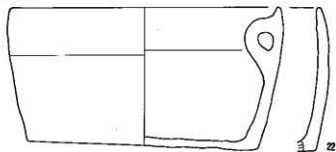

SB 256

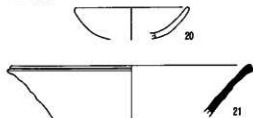

SB 262

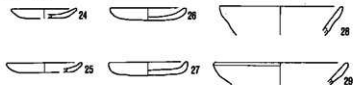

SB 260

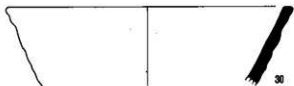

SB 264

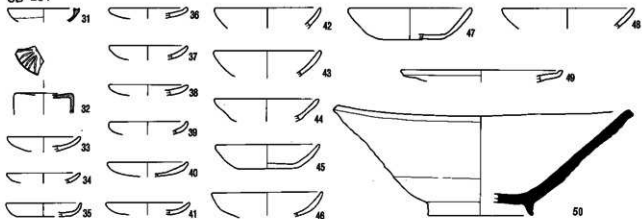

SB 265

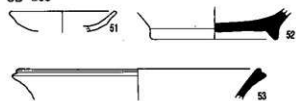

SB 267

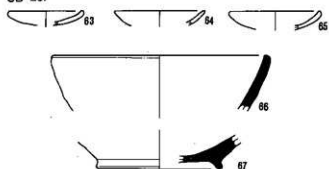

SB 266

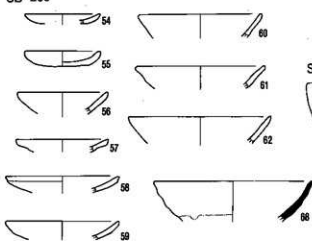

SB 272



SB 251



ST 88

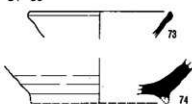

ST 117



ST 82



ST 87

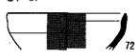

ST 112

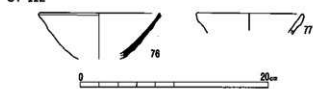

SD 59

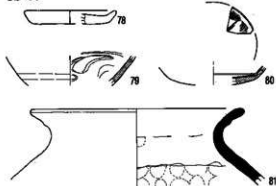

SD 64

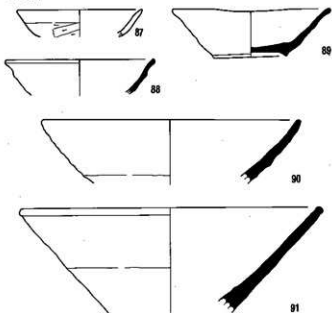

SD 60

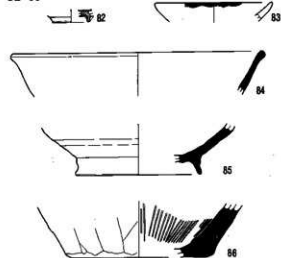

SD 66

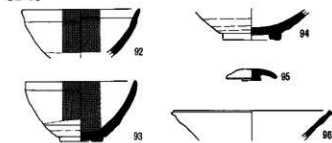

その他 (土坑・包含層の出土遺物)

土師器皿

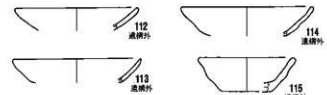
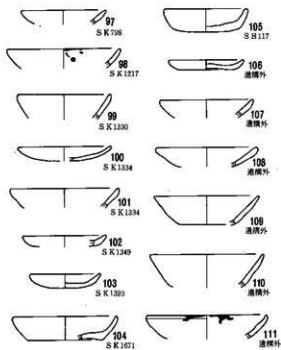

内耳鍋

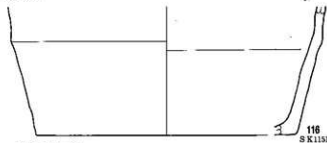

土師質片口鉢



古瀬系陶磁

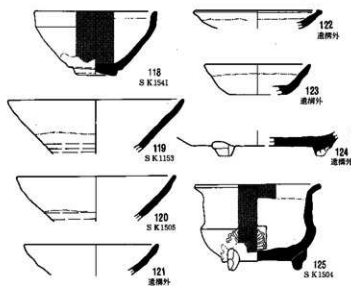

山茶碗

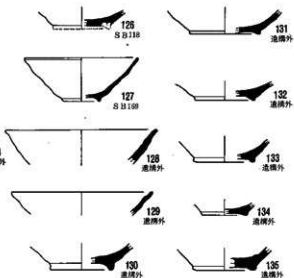

捏鉢

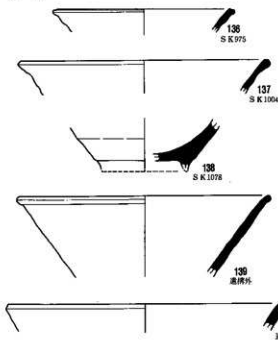

常滑系甕

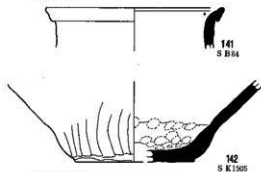

須恵質措鉢

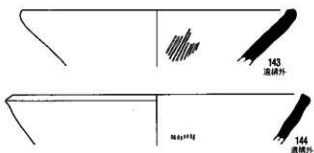

輸入陶磁器

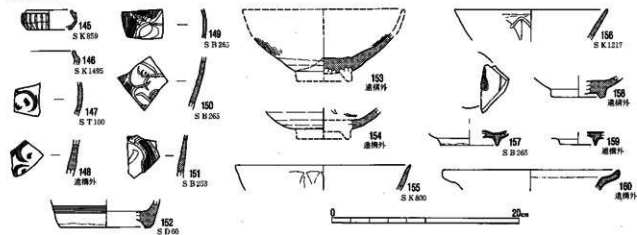

金属製品

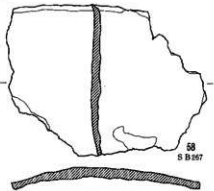
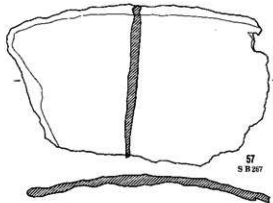
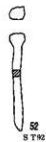
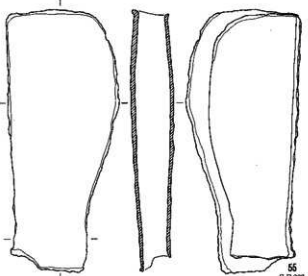
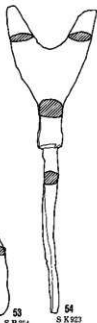
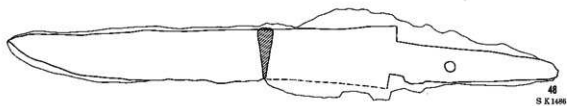

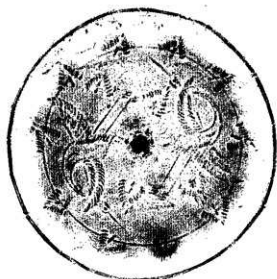

59
S B 291

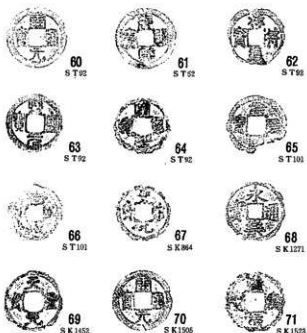

60
S T 92

61
S T 92

62
S T 93

63
S T 92

64
S T 92

65
S T 101

66
S T 101

67
S K 964

68
S K 1273

69
S K 1452

70
S K 1506

71
S K 1523



72
透鏡外

73
透鏡外

74
透鏡外

75
透鏡外

76
透鏡外



77
S K 1009

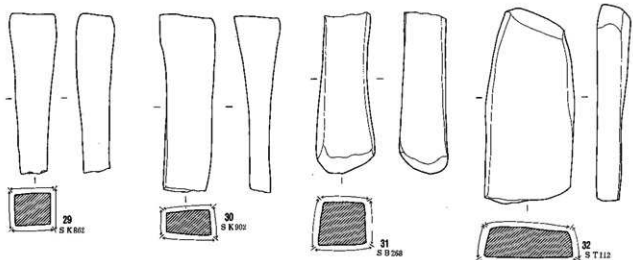

29
S K 801

30
S K 902

31
S B 258

32
S T 112

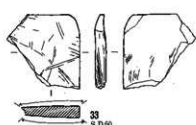

33
S D 60

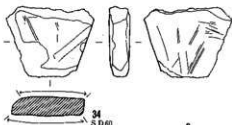

34
S D 60

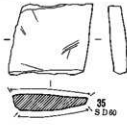

35
S D 60

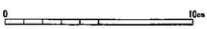

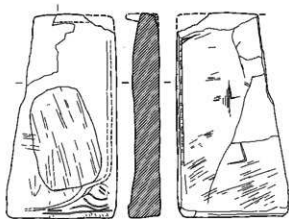

35
S K 740

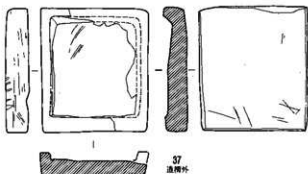

37
透輝石

土製品

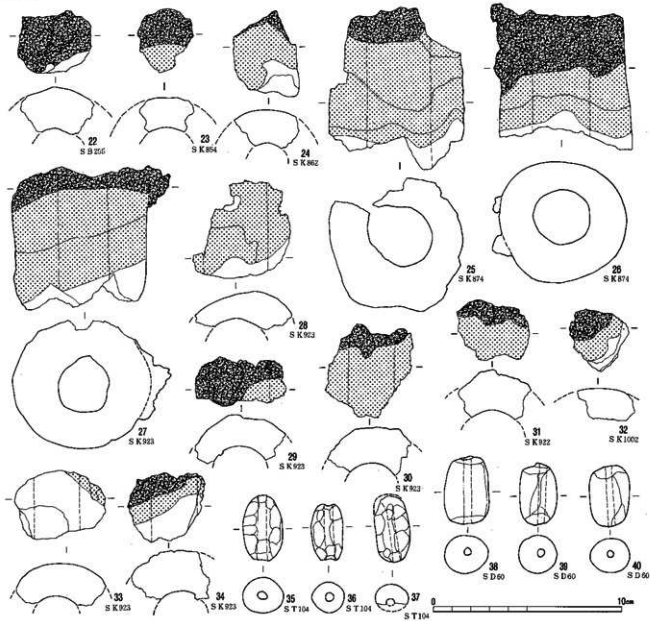

22
S B 256

23
S K 604

24
S K 602

25
S K 674

26
S K 674

28
S K 923

27
S K 923

29
S K 923

31
S K 922

32
S K 1002

30
S K 923

33
S K 923

34
S K 923

35
S T 104

36
S T 104

37
S T 104

38
S D 60

39
S D 60

40
S D 60

0 10cm

写 真 图 版

(P L)



- 1：南栗遺跡
- 2：北栗遺跡
- 3：三の宮遺跡
- 4：下神遺跡
- 5：中二子遺跡
- 6：下二子遺跡
- 7：くまのかわ遺跡
- 8：南沢井遺跡
- 9：大久保工業団地遺跡
- 10：既海渡遺跡
- 11：和田町遺跡
- 12：和田山の神遺跡
- 13：太子堂遺跡
- 14：川西遺跡
- 15：秋葉原遺跡
- 16：高瀬中学校遺跡
- 17：新村遺跡
- 18：高松遺跡
- 19：南中遺跡



南部南地区東半
全景



南部北地区
全景



中部南地区
全景

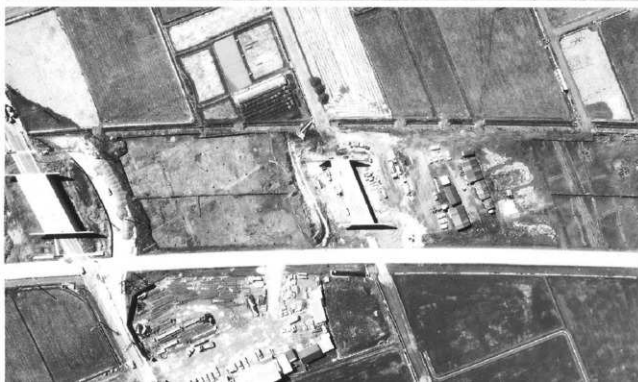

PL4



南部北地区
全景

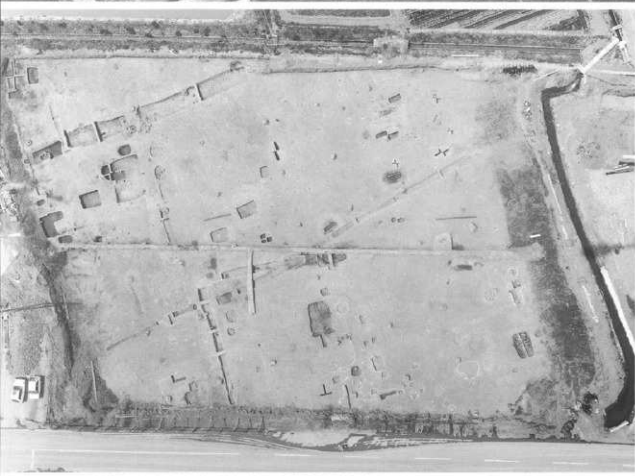

中部北地区
中世面全景



北部地区
中·近世面全景



SB1全景
西より

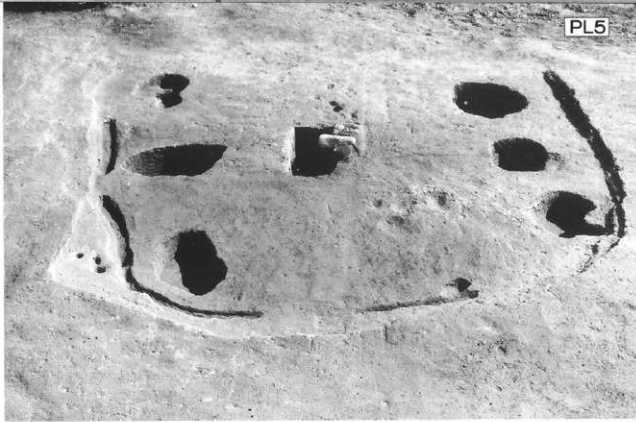

SB1周溝・柱穴



左SB1炉



右SB1炉断面



SB3 全景
南より

左SB3カマド完掘



右SB3カマド石組状況



左SB3カマド石組状況



右SB3カマド石組状況

SB7 全景
西より

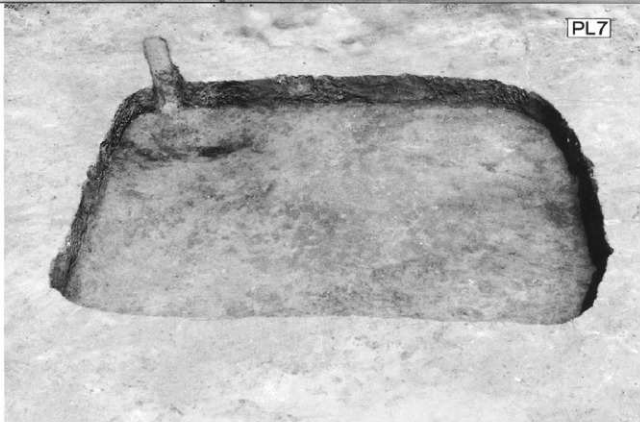

SB8 全景
東より



左SB7 カマド
西より



右SB8 カマド
東より



PL8



古代遺構

SB20全景

東より

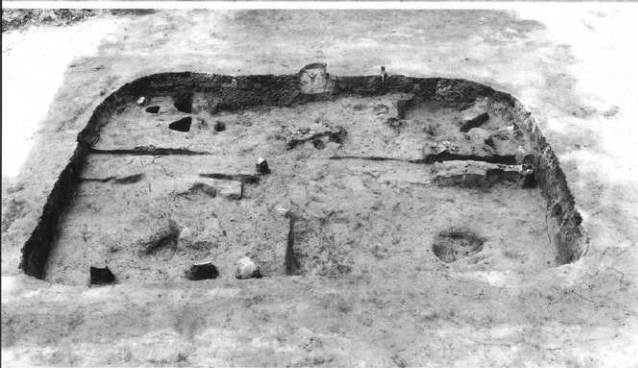

SB20掘り方

東より



左SB20カマド

東より

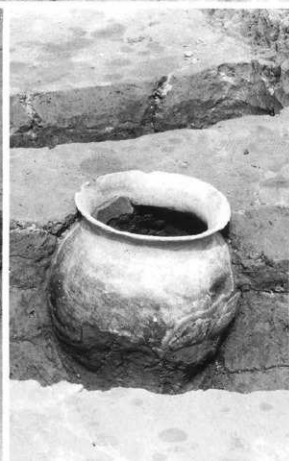

右SB20

土器出土状況

古代遺構

SB23礎石状況
南より



左SB23カマド付近
遺物出土状況
南より



右SB23カマド
南より



SB29付近全景
西より



PL10



古代遺構

S B33全景

西より



S B33炭化材出土状況

西より



左S B33

炭化材出土状況

北より



右S B33カマド

西より

古代遺構

PL11

SB42全景
東より

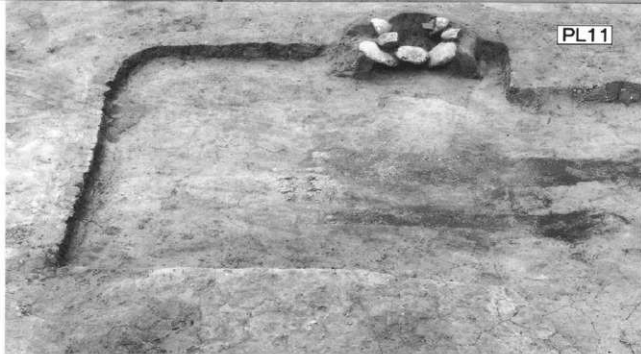

SB42掘り方
東より



左SB42カマド遺存
状況
東より



右SB42カマド遺物
状況
東より



右SB42カマド
東より



左SB43床下遺物
南より

