

図面56 窪地西岸出土墨書土器 2

深田遺跡

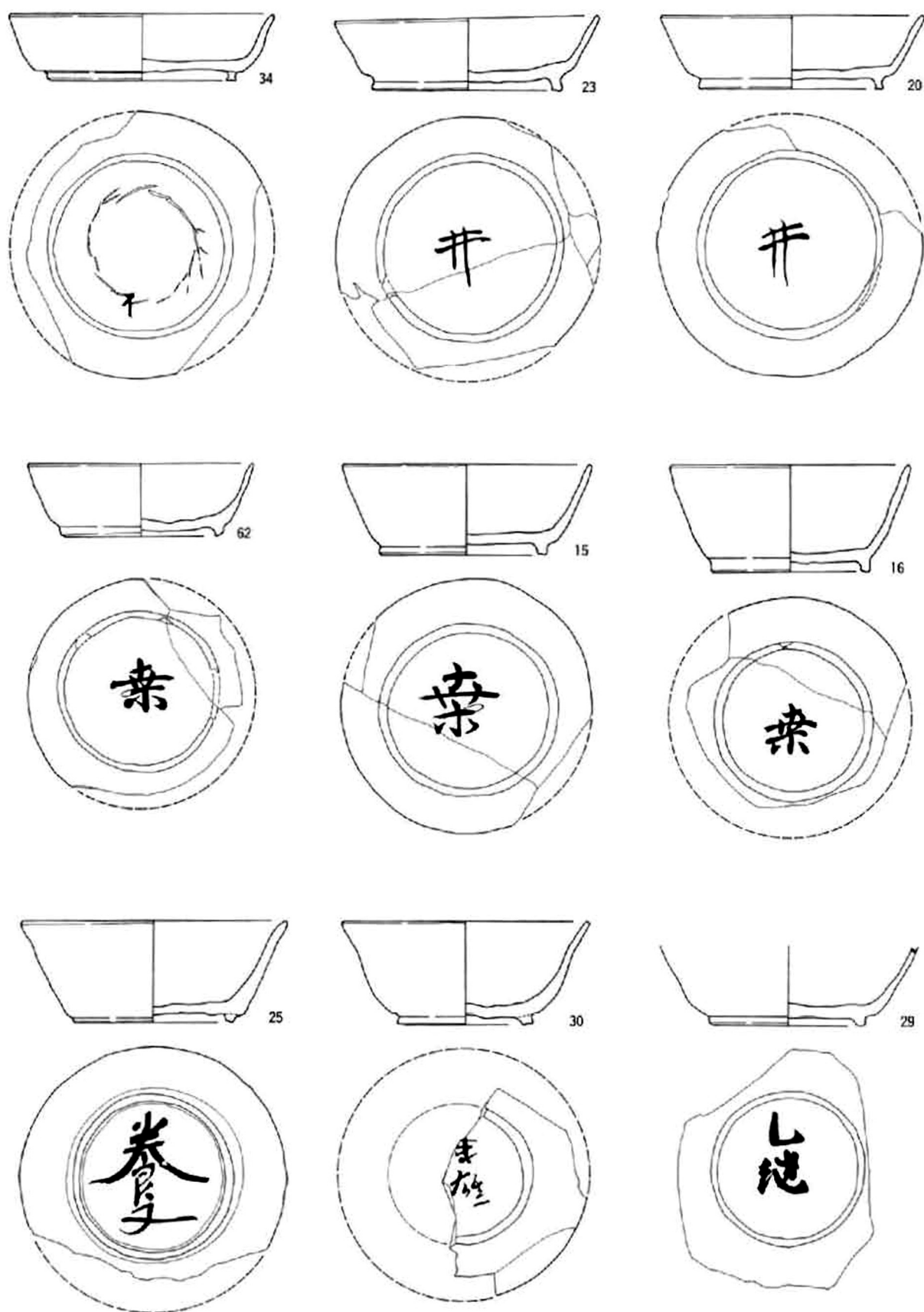

0 15cm

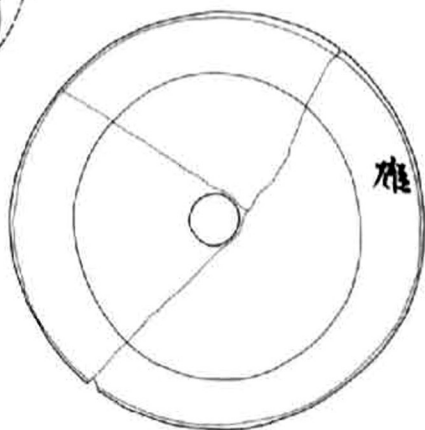
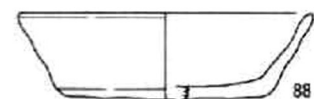
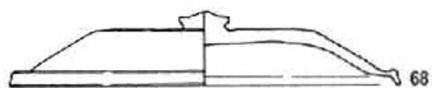
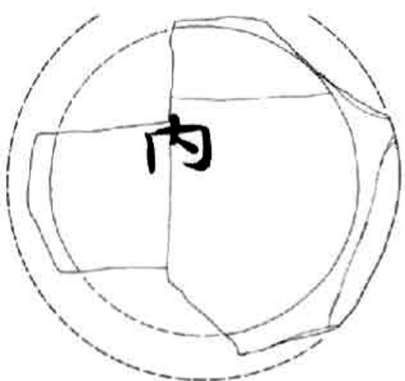
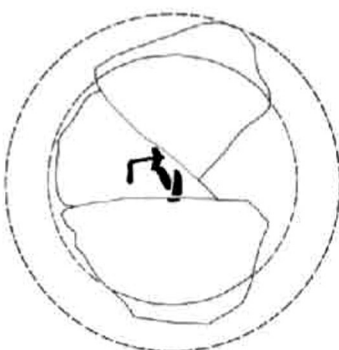
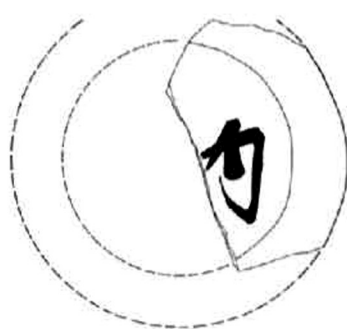
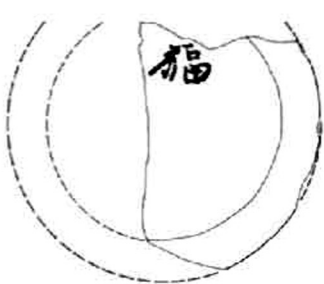
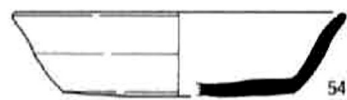

図面58 窪地東岸出土墨書土器 2

深田遺跡

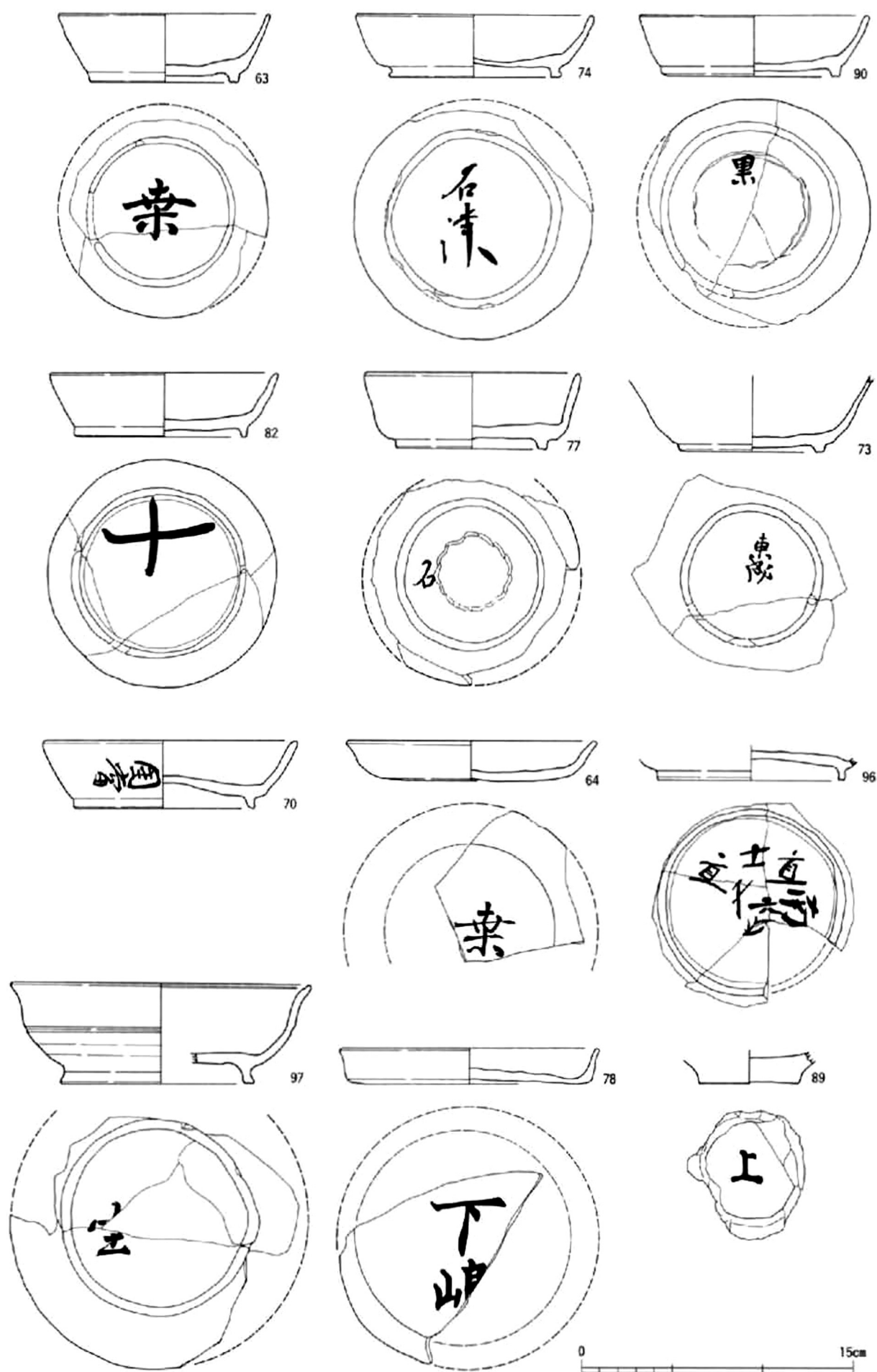

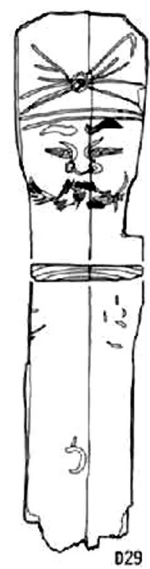
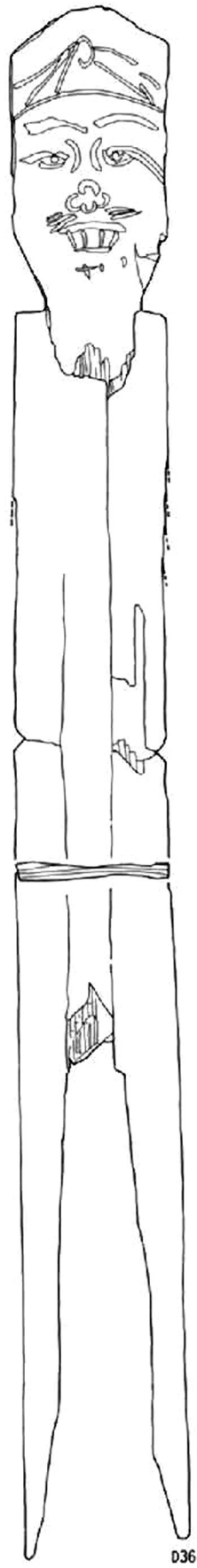

図面60 窪地西岸出土木製品2 (人形・馬形)

深田遺跡

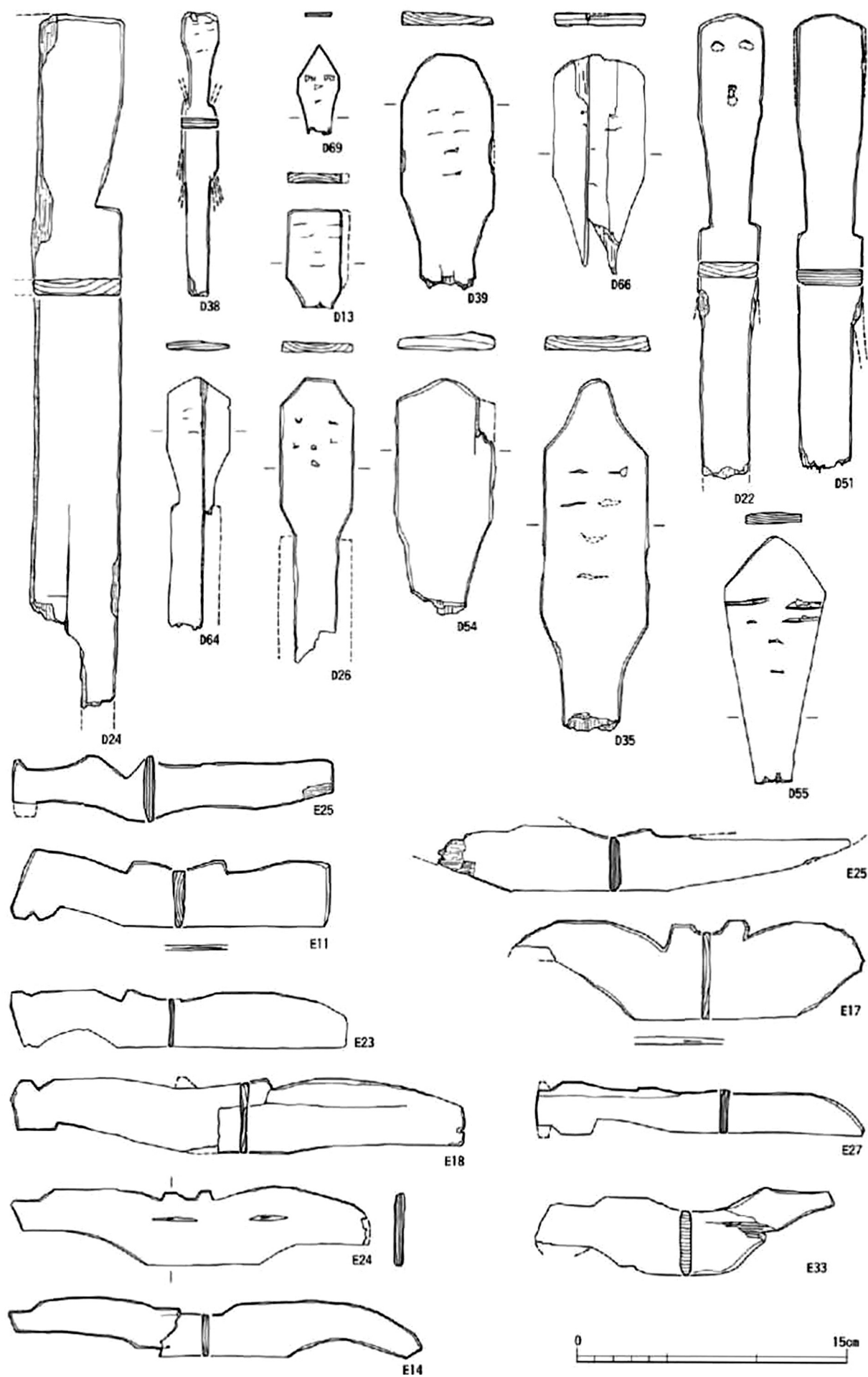

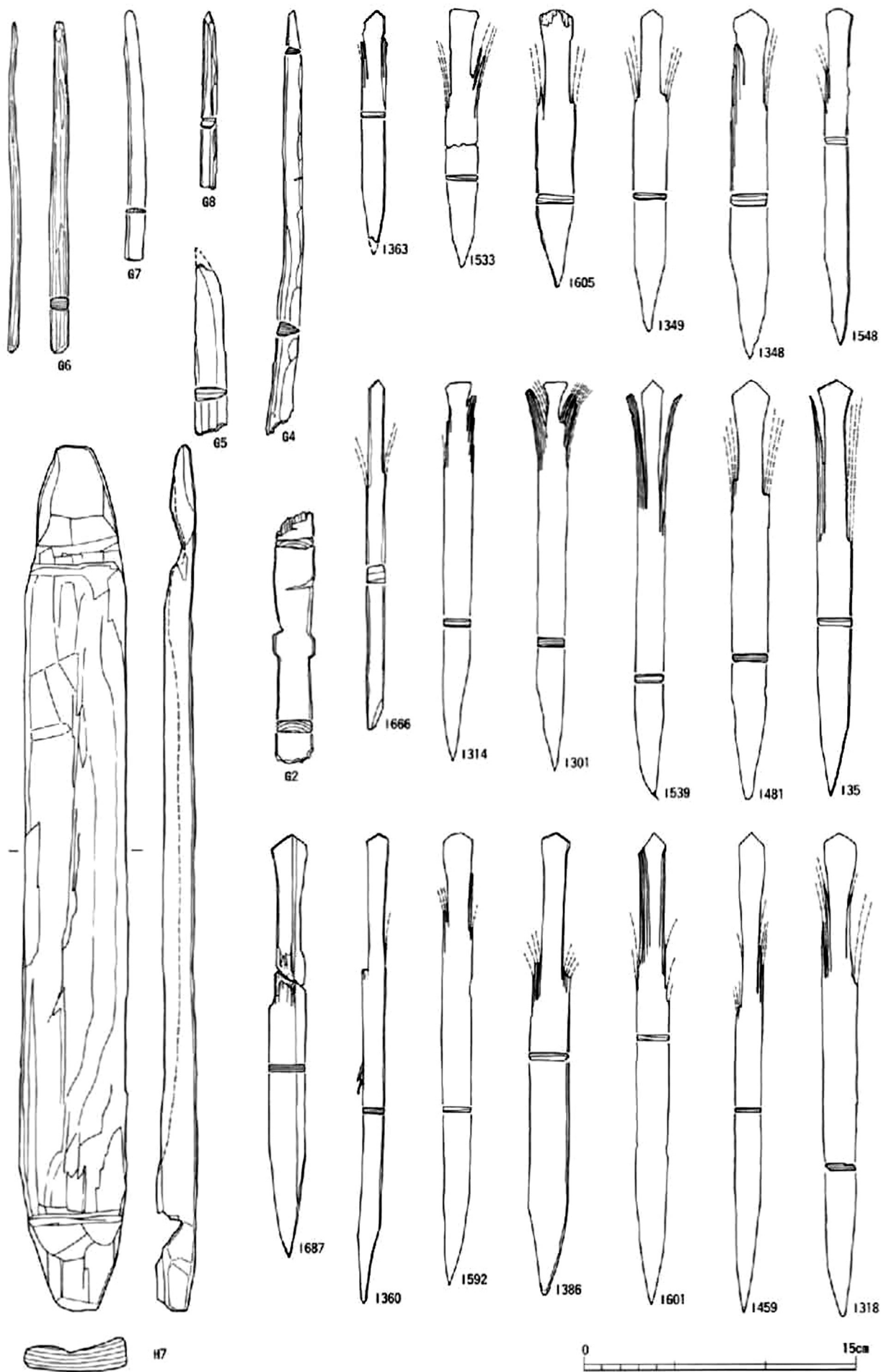

図面62 窪地西岸出土木製品 4 (斎串)

深田遺跡

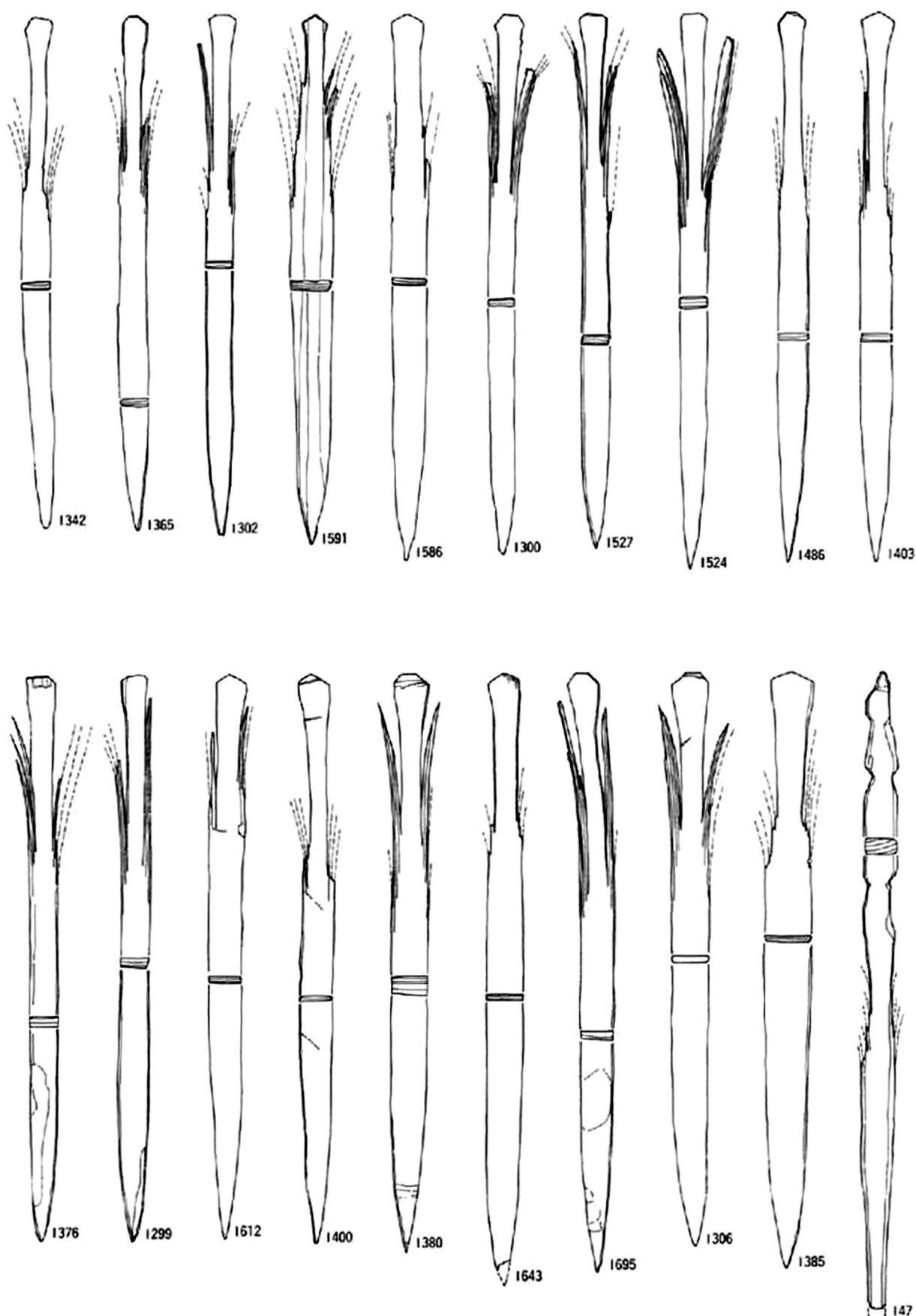

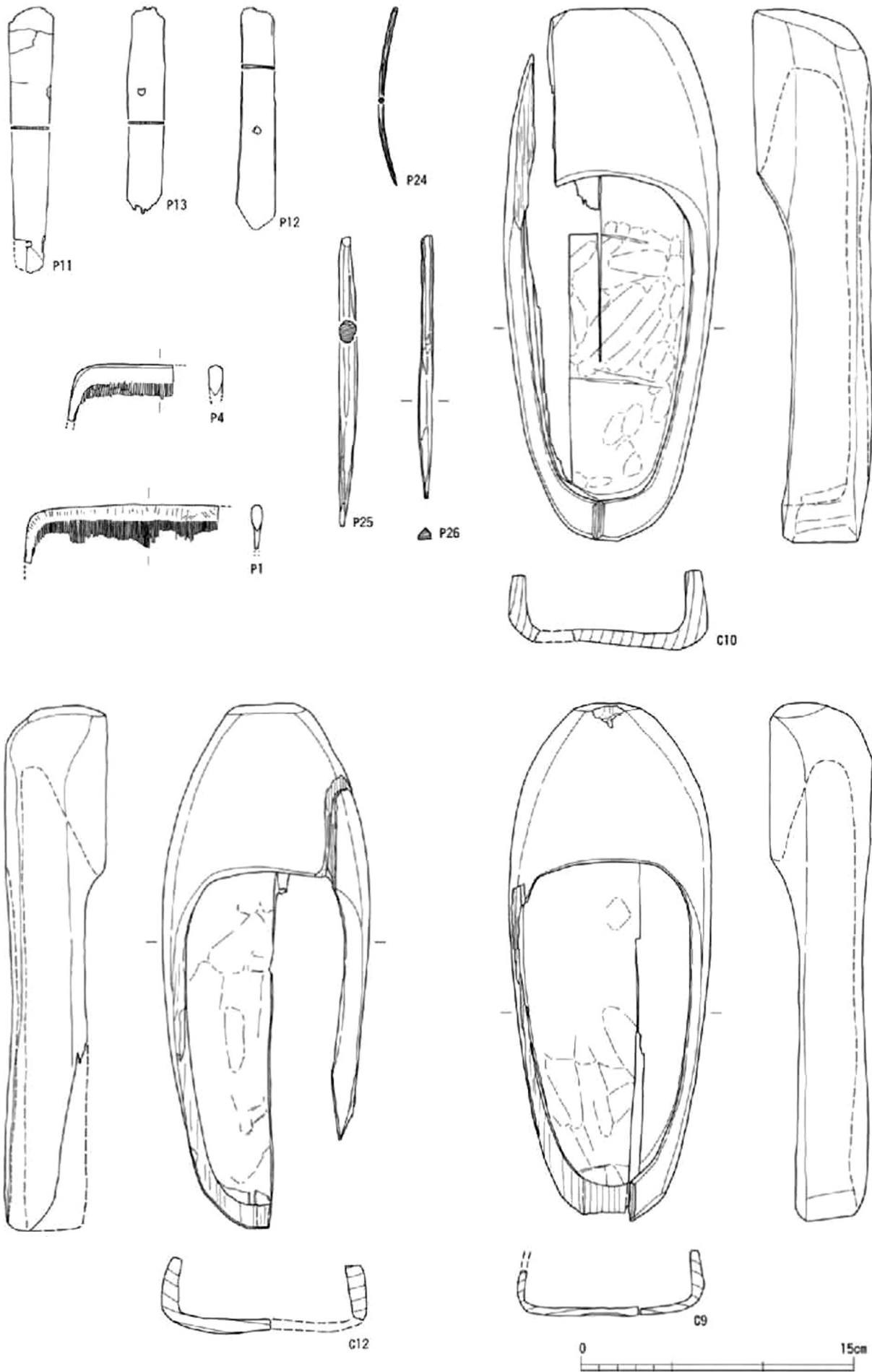

図面64 窪地西岸出土木製品6 (木履・下駄)

深田遺跡

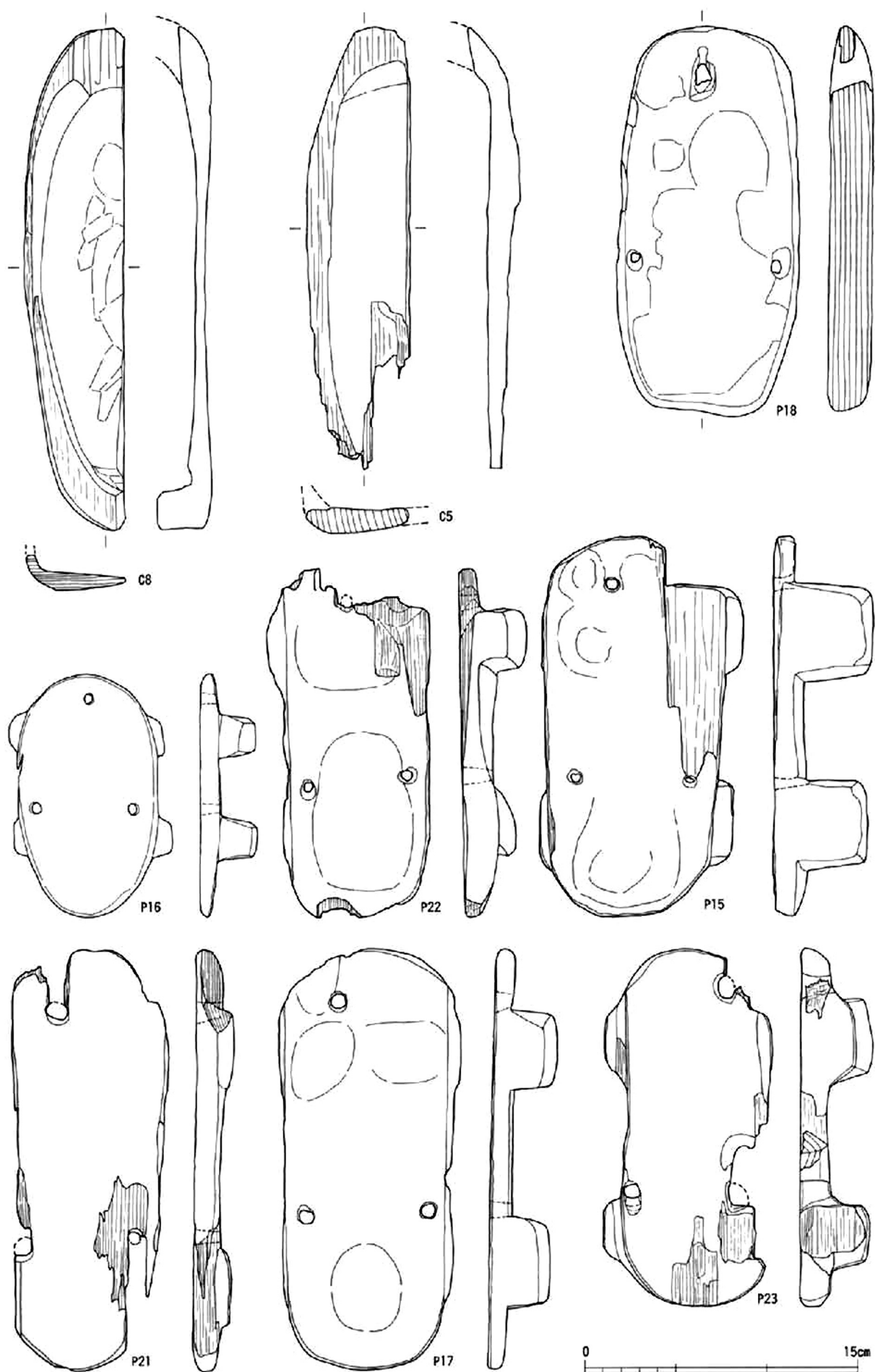

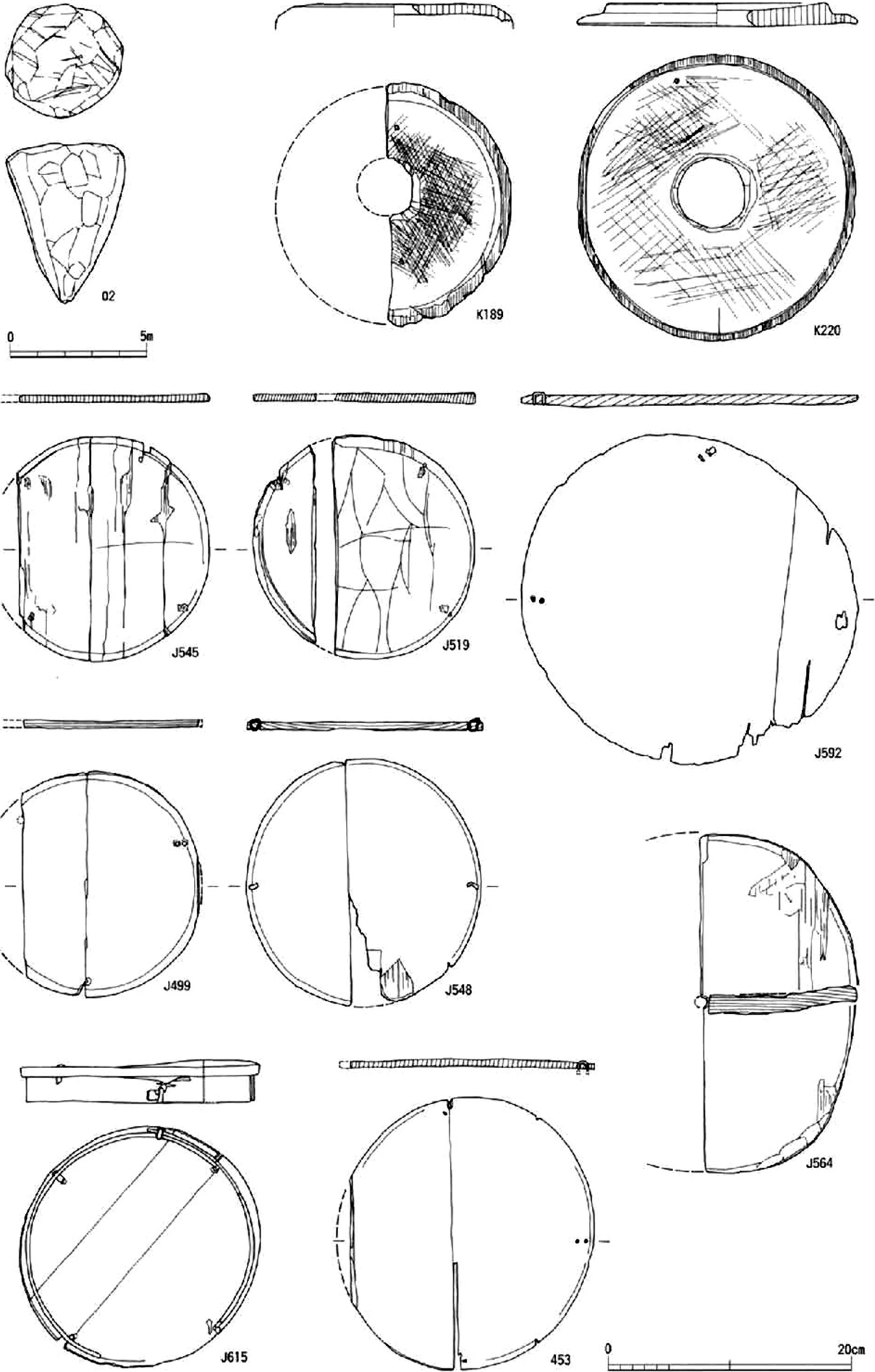

図面66 窪地西岸出土木製品 8 (挽物A)

深田遺跡

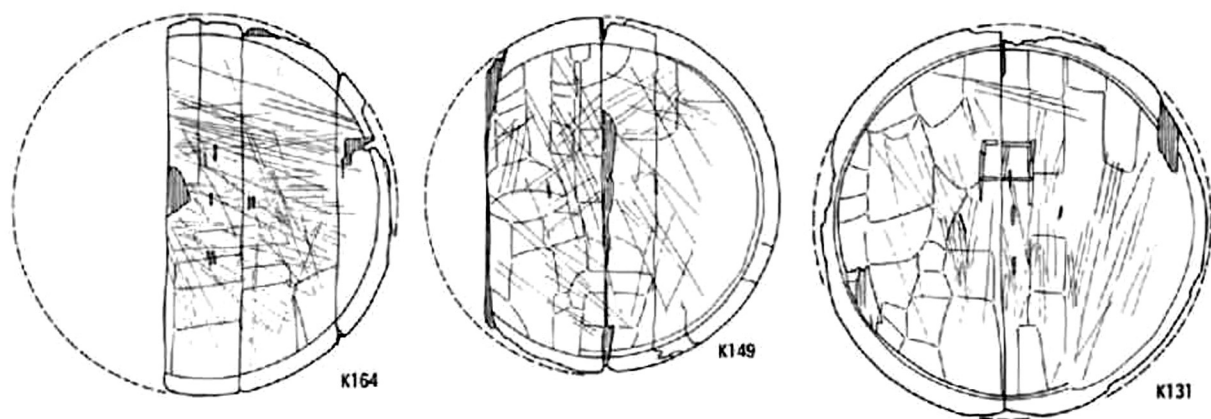
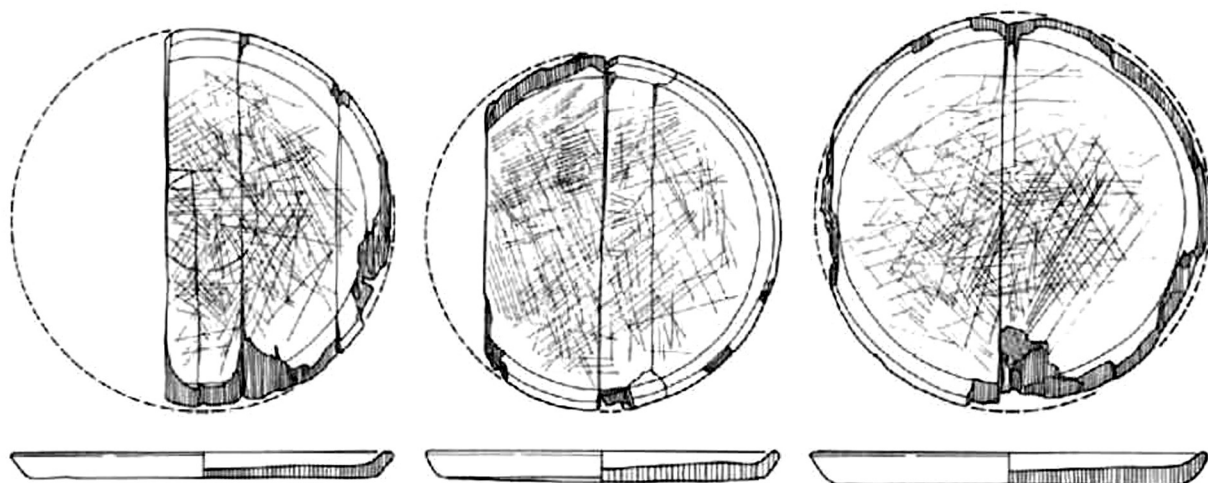
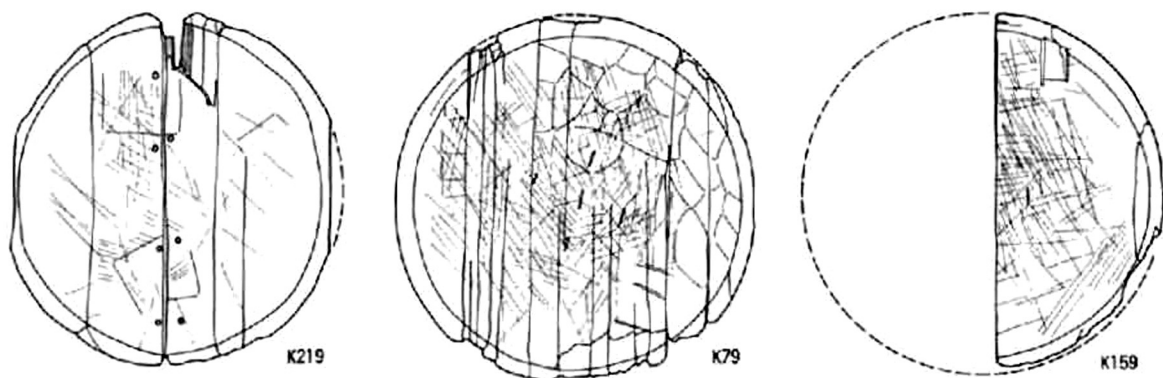
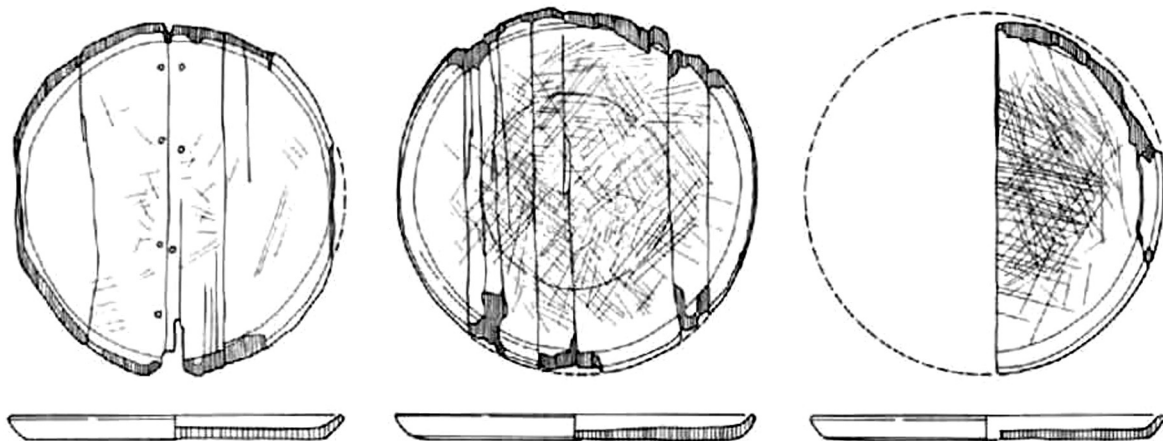

0 20cm

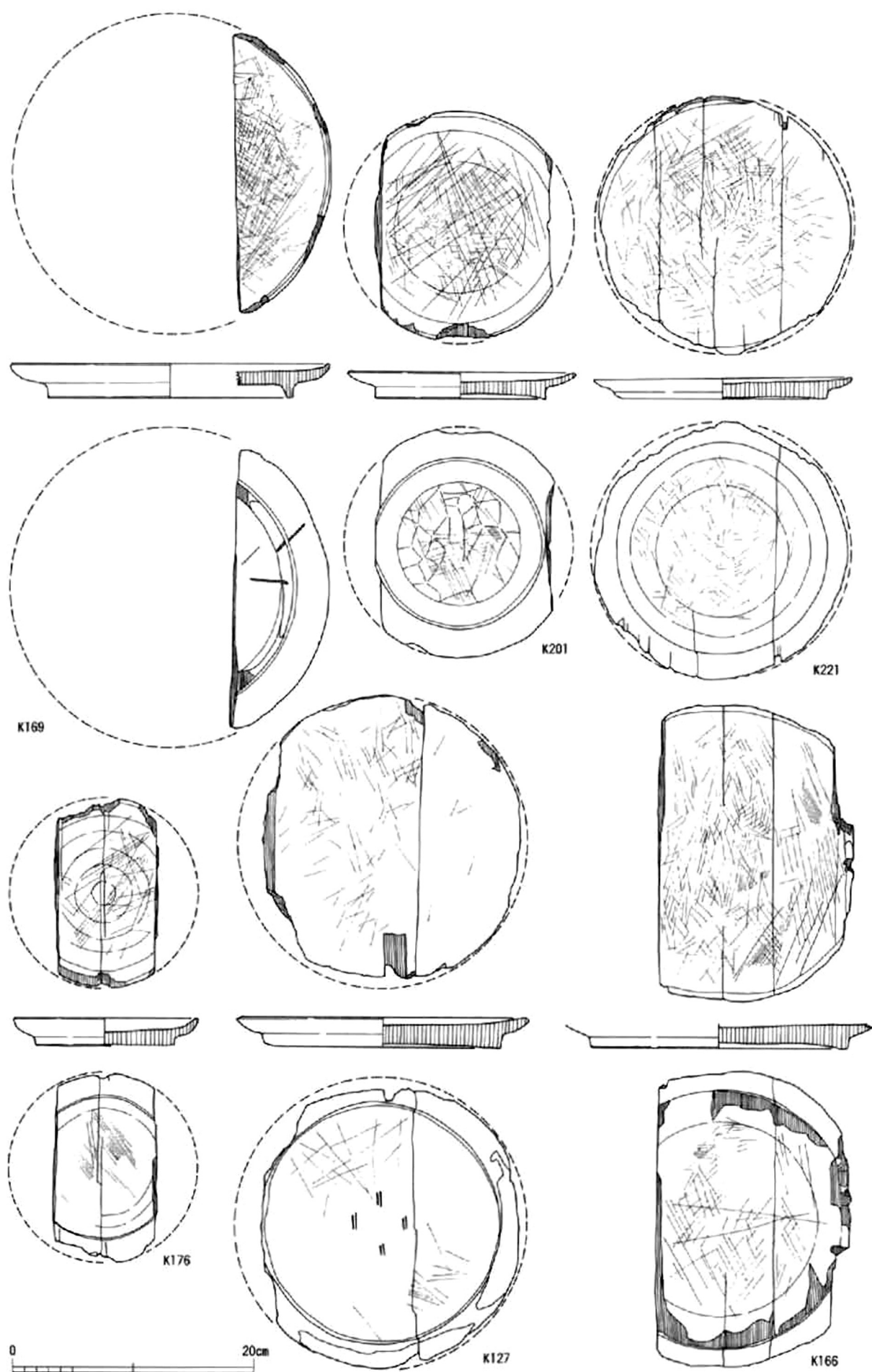

図面68 窪地西岸出土木製品10 (挽物B)

深田遺跡

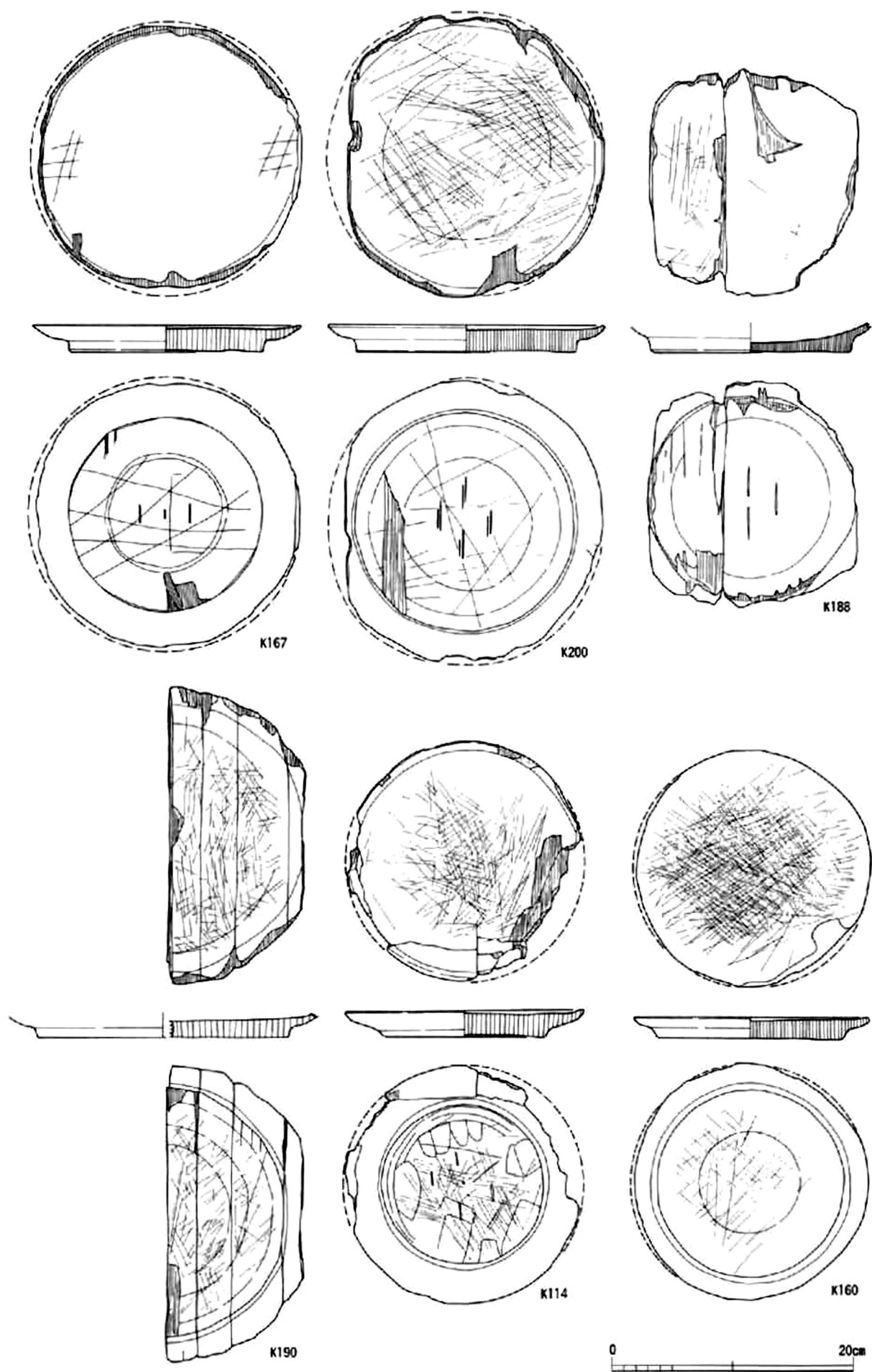

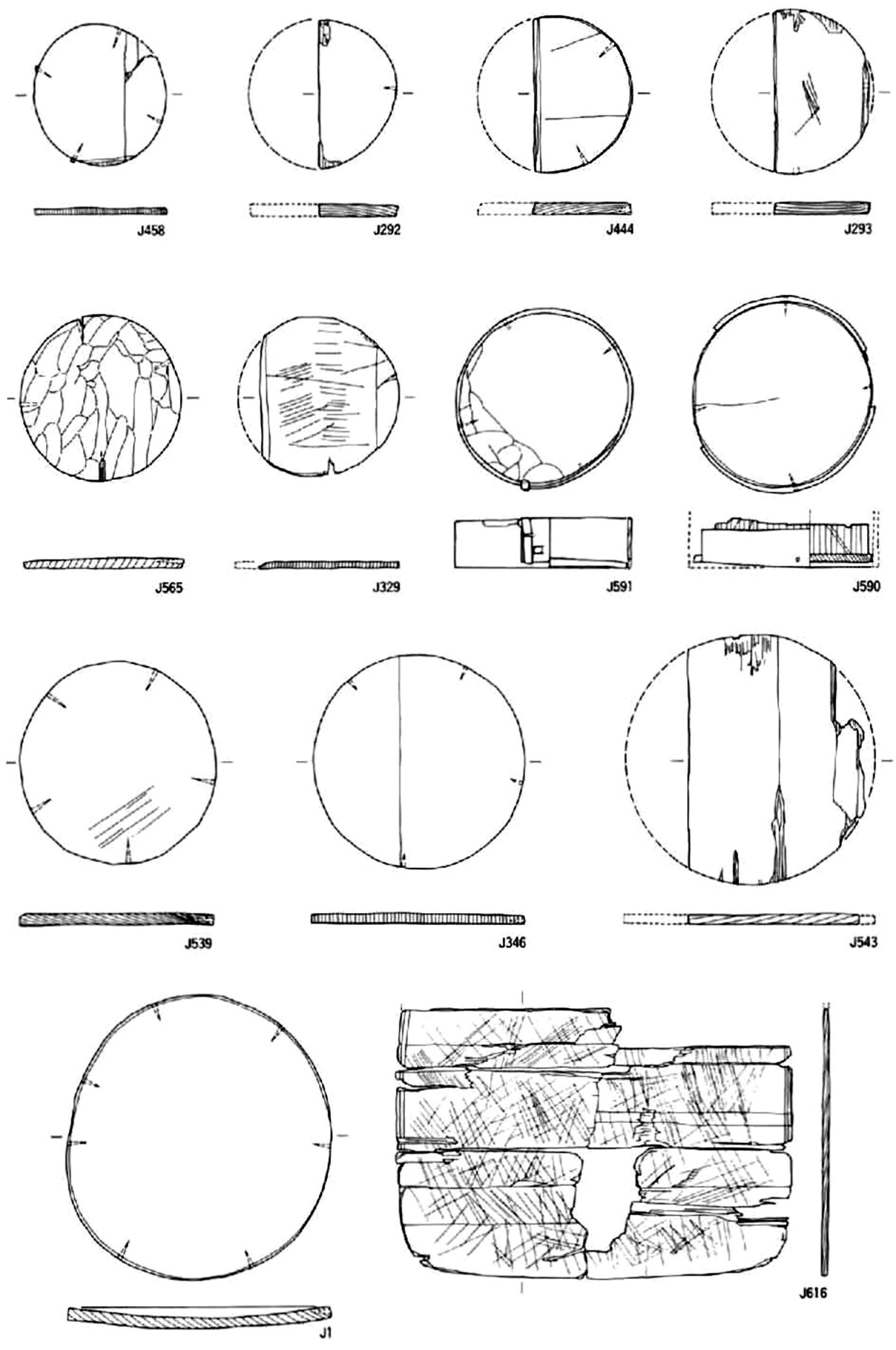

0 20cm

図面70 窪地西岸出土木製品12 (箱・割物・柄・栓)

深田遺跡

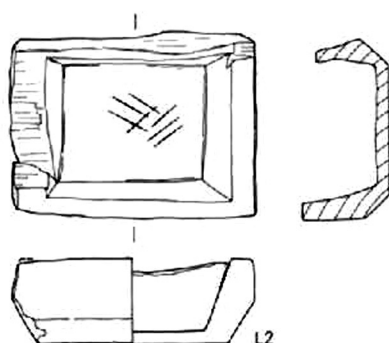
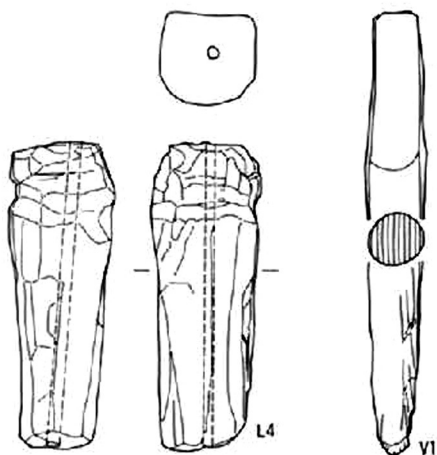
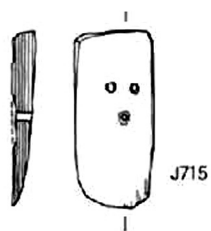
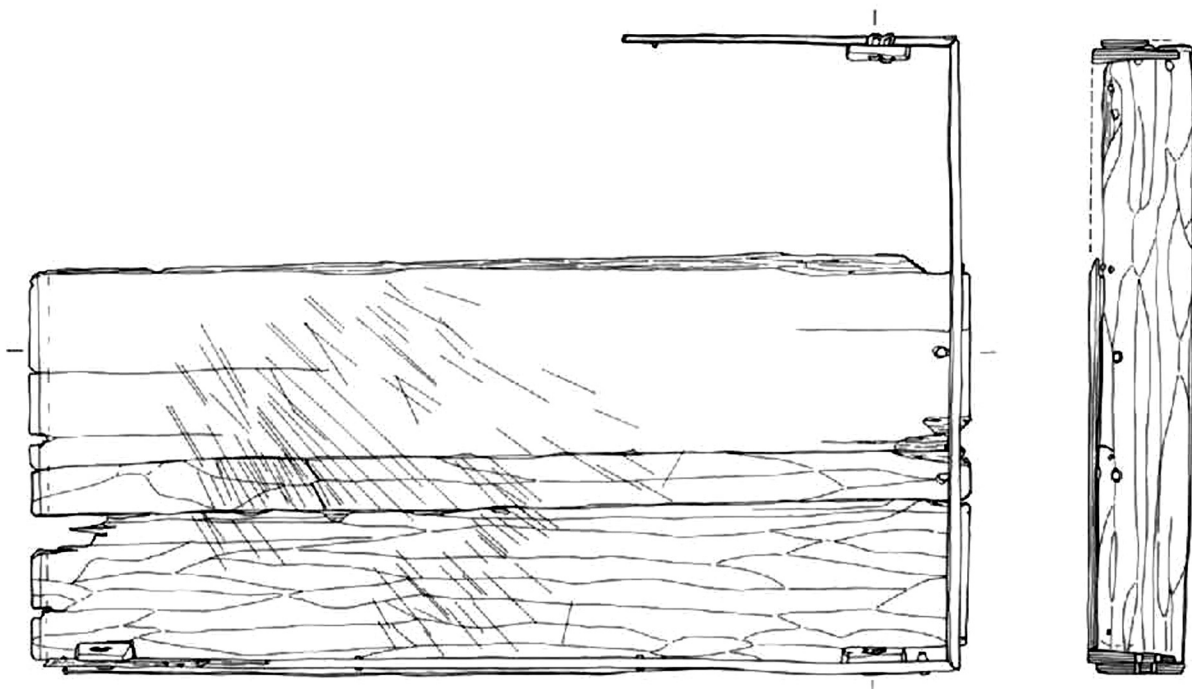
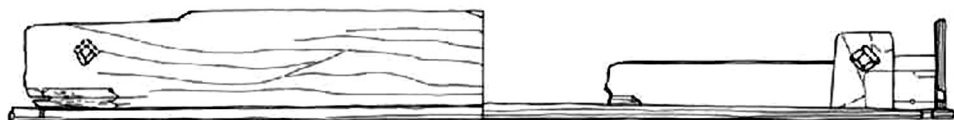

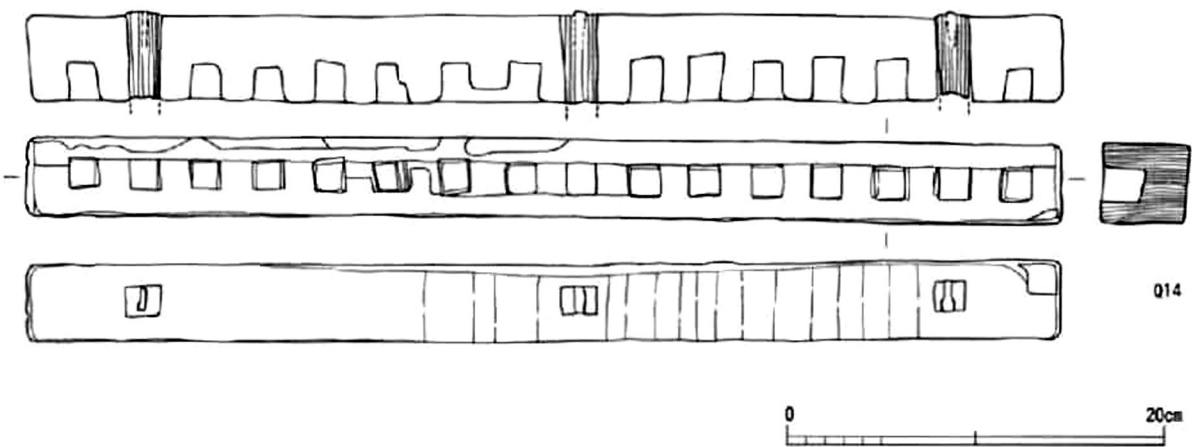
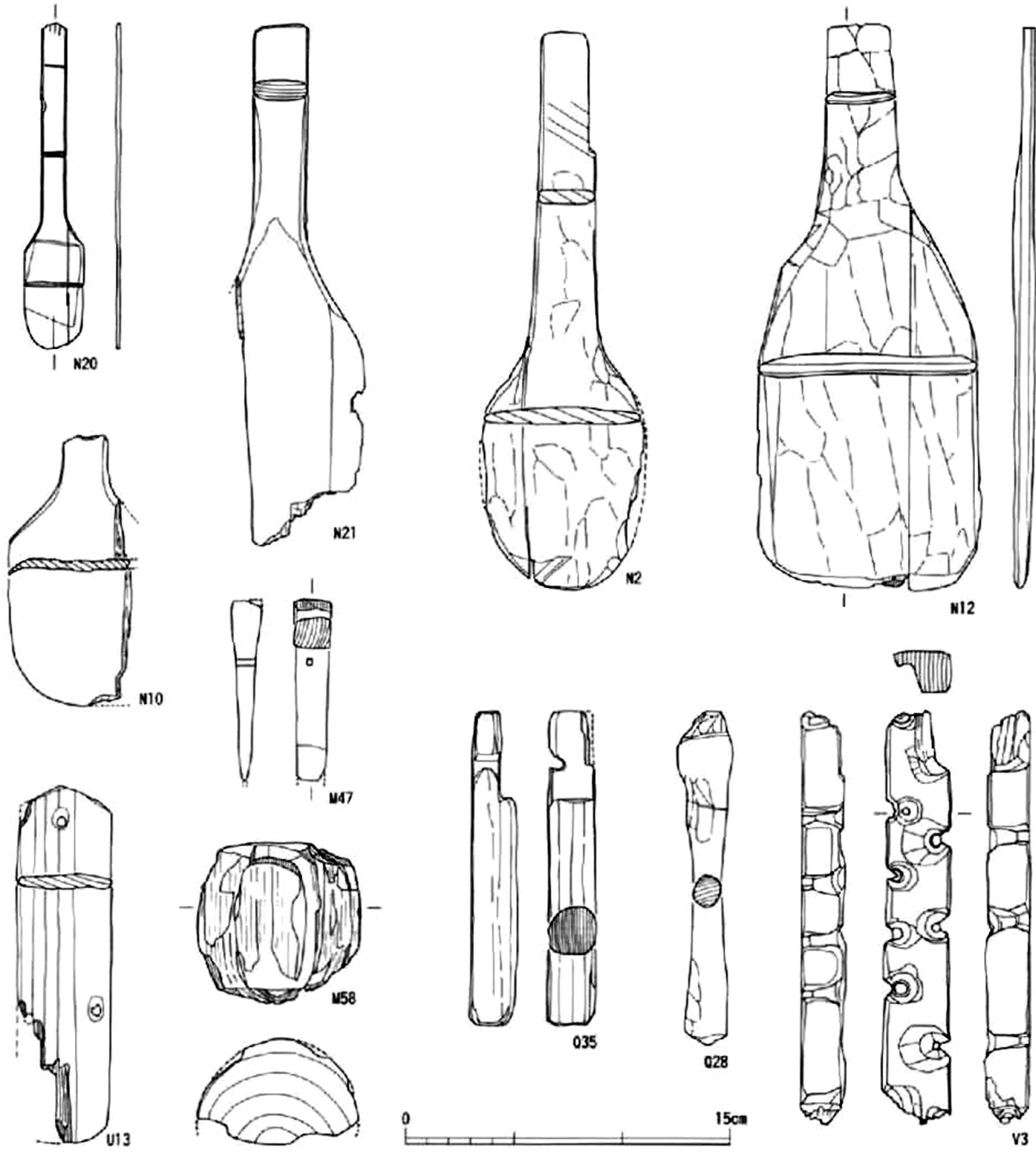

図面72 窪地西岸出土木製品14 (用途不明品)

深田遺跡

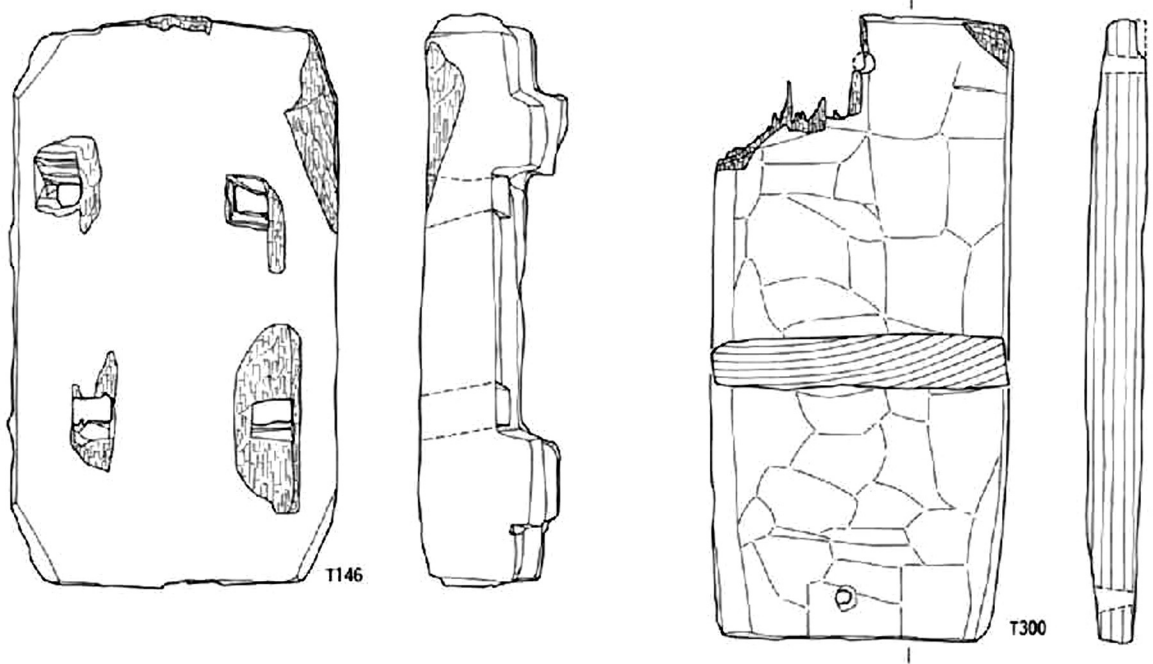
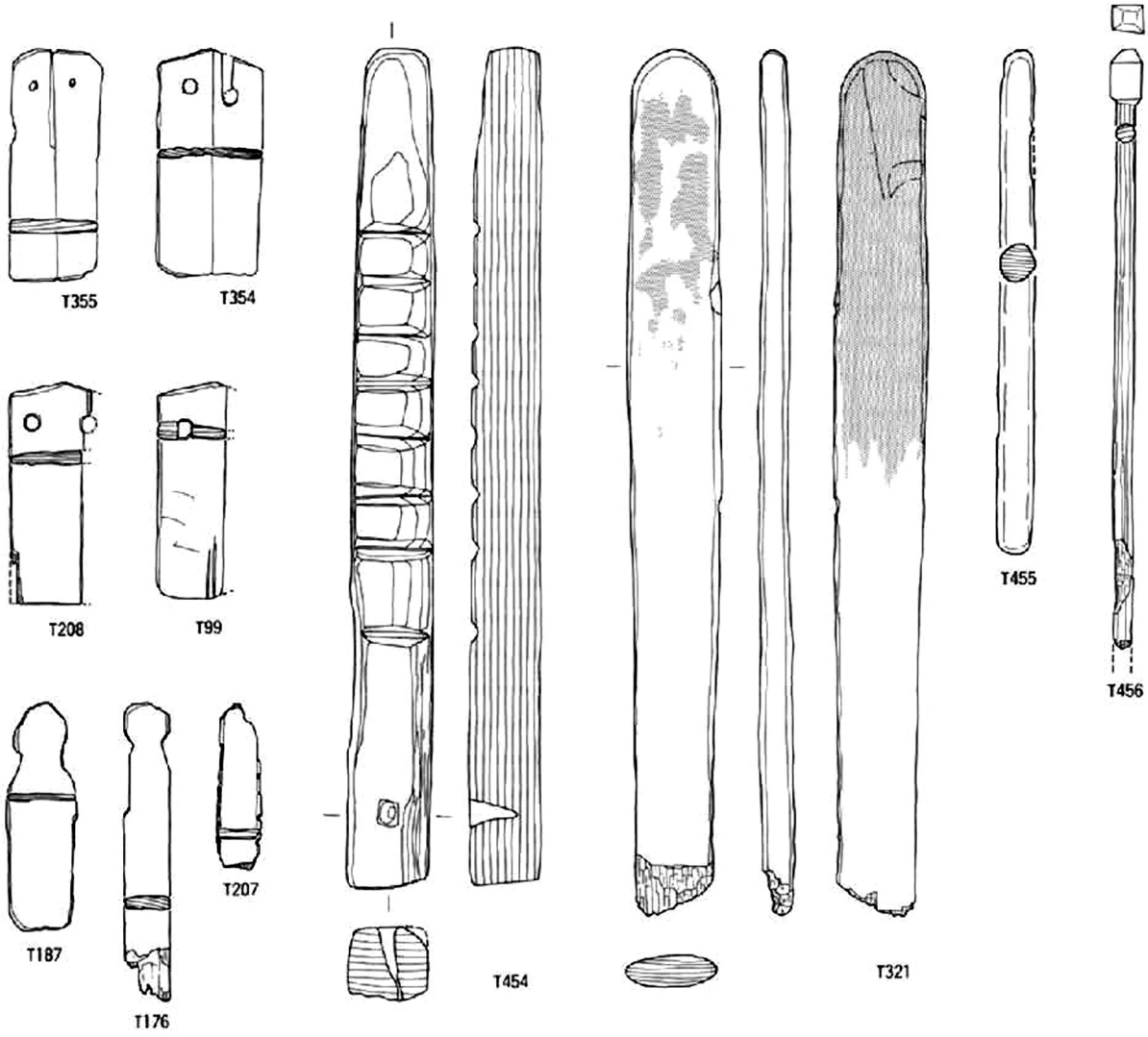

0 15cm

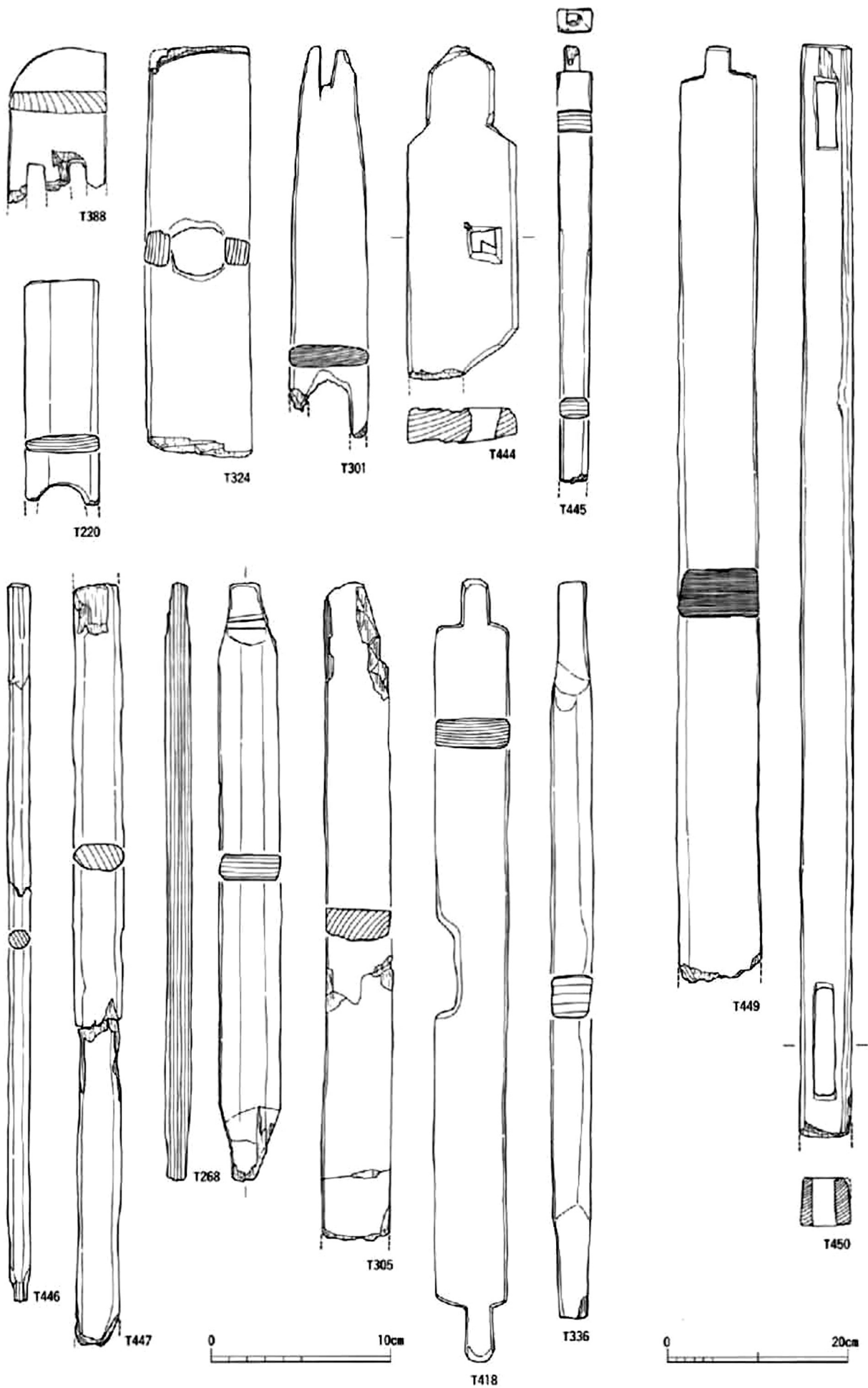

図面74 窪地東岸出土木製品 1 (人形)

深田遺跡

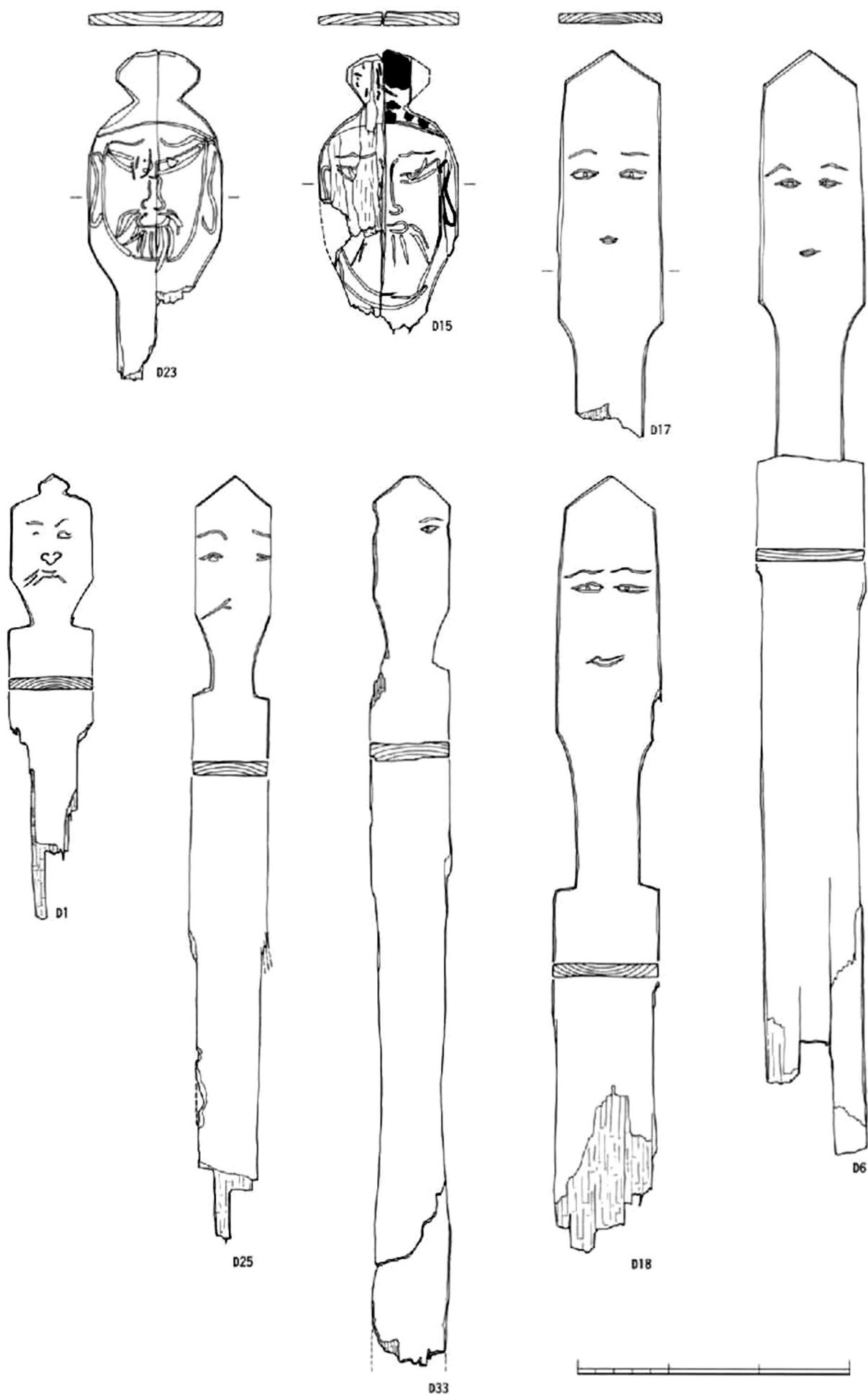

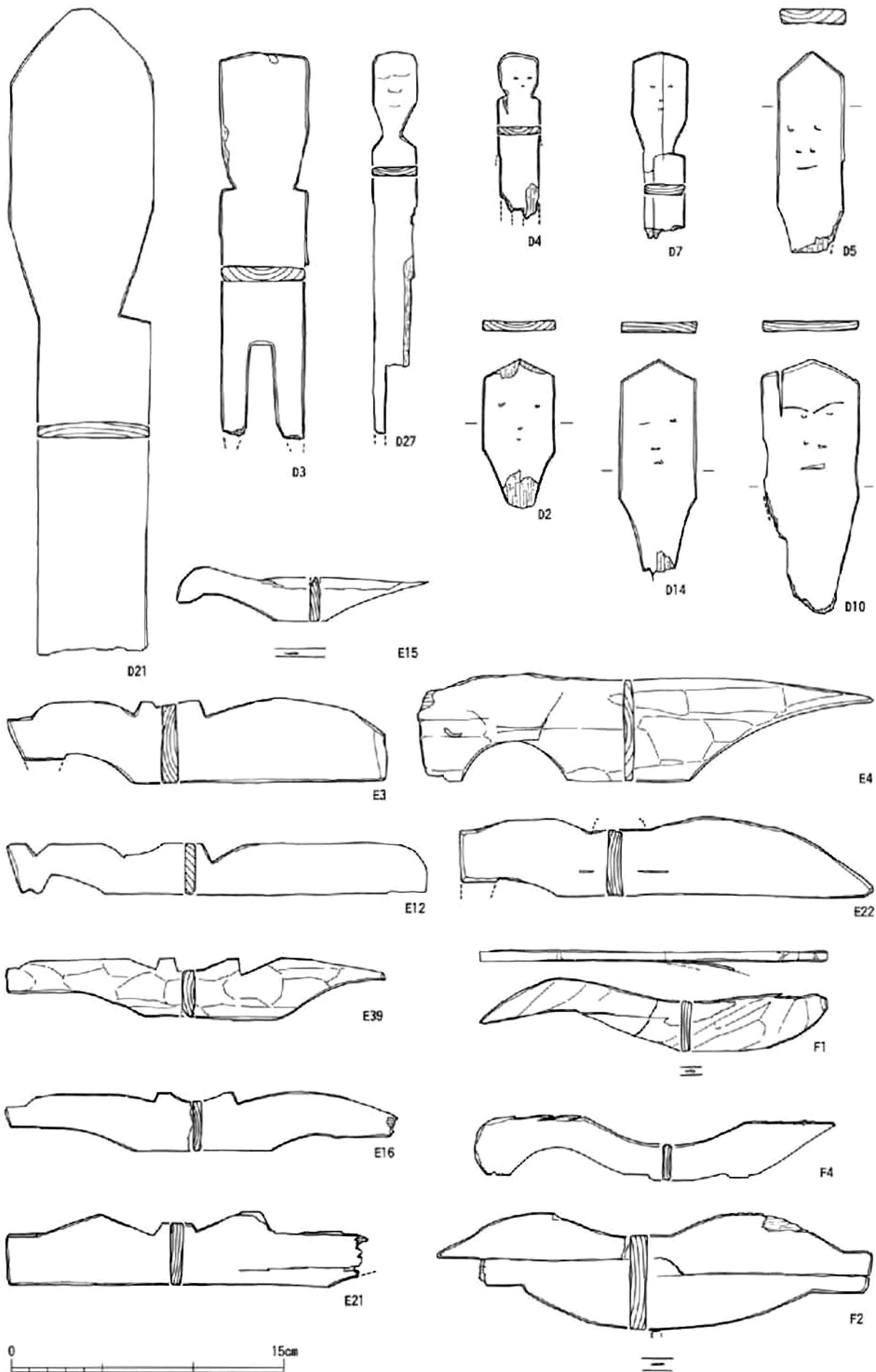

図面76 窪地東岸出土木製品 3 (刀子形・剣形・斎串)

深田遺跡

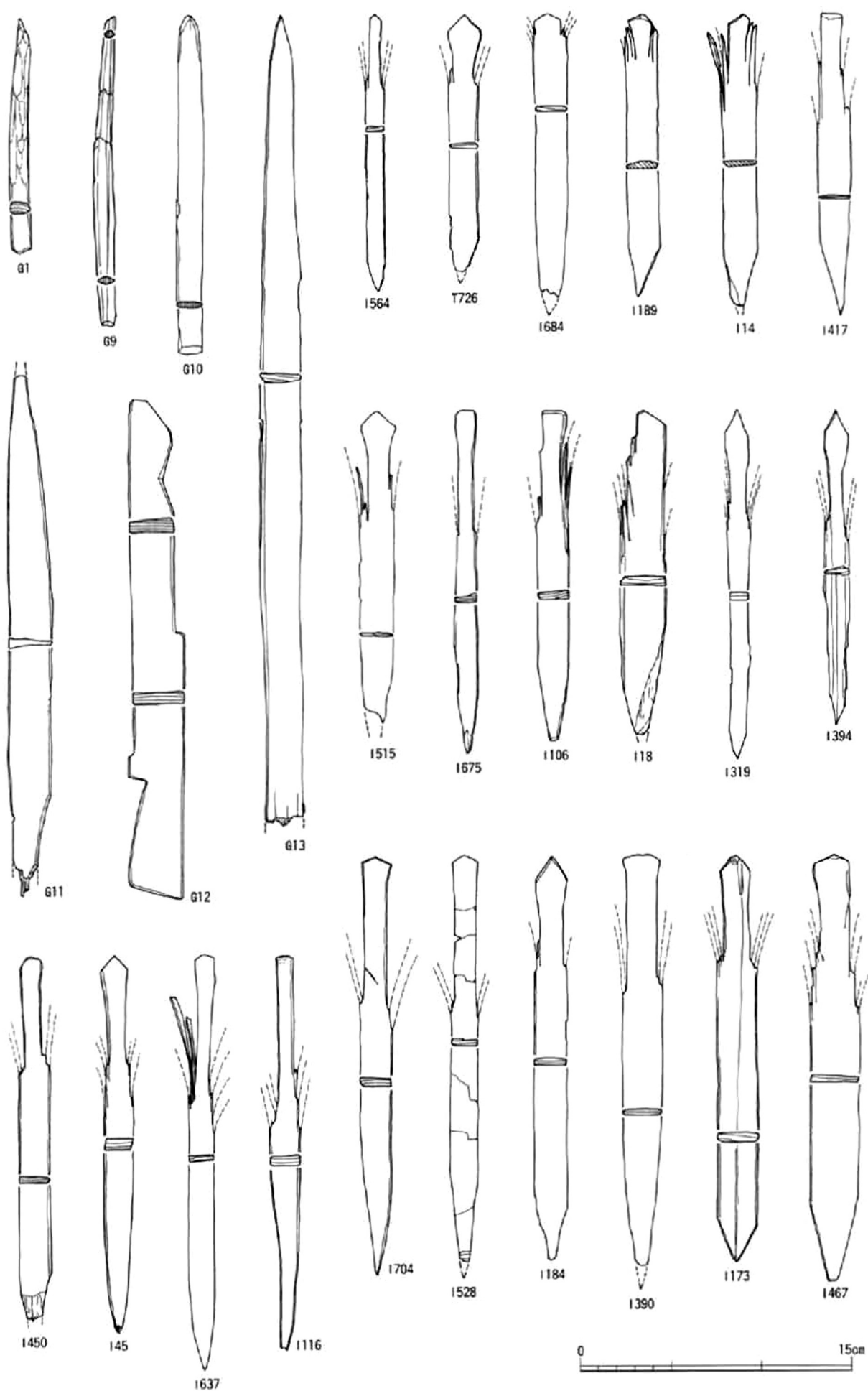

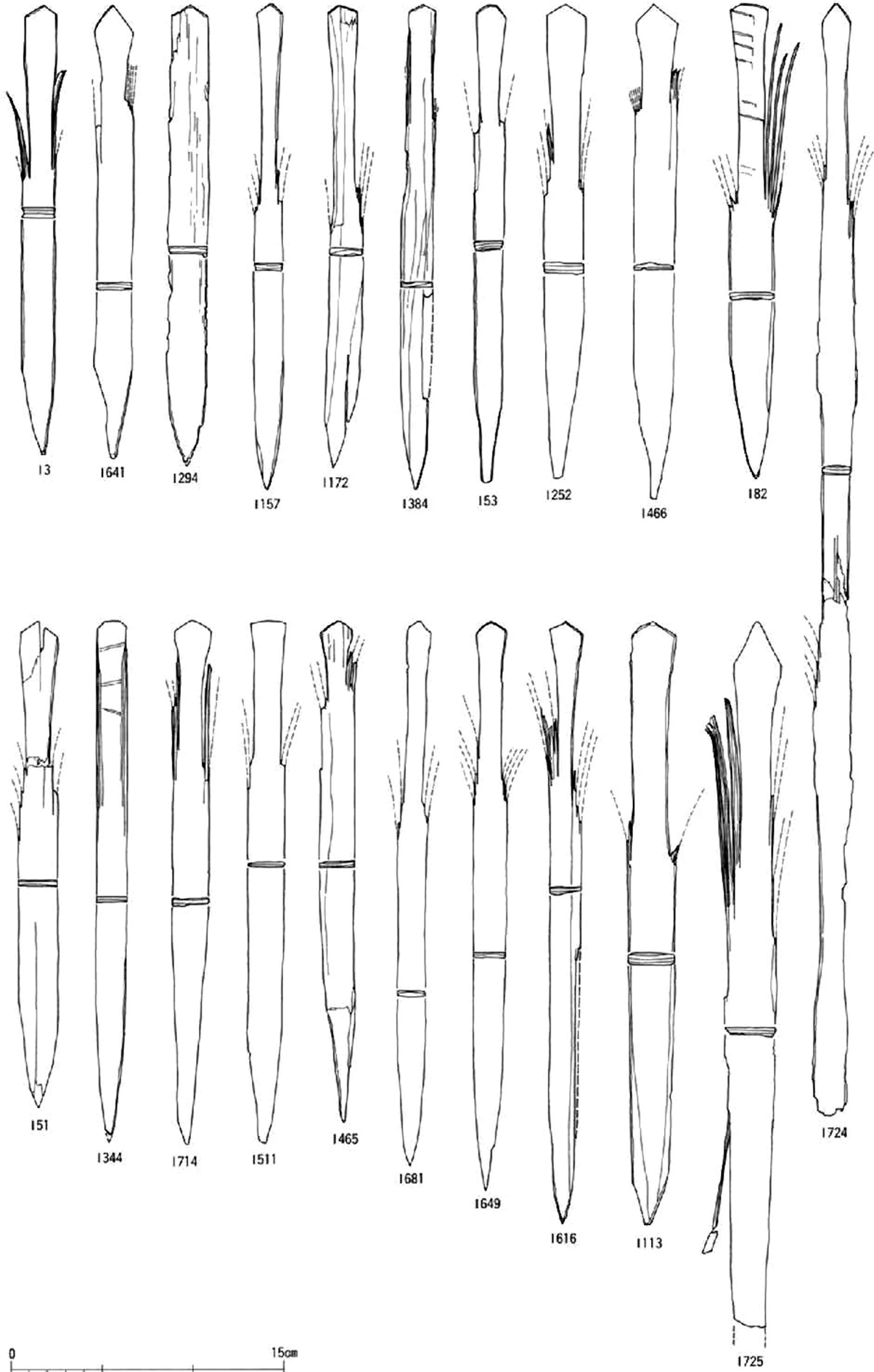

0 15cm

図面78 窪地東岸出土木製品5 (扇子・檜扇・留針・櫛・木履・下駄)

深田遺跡

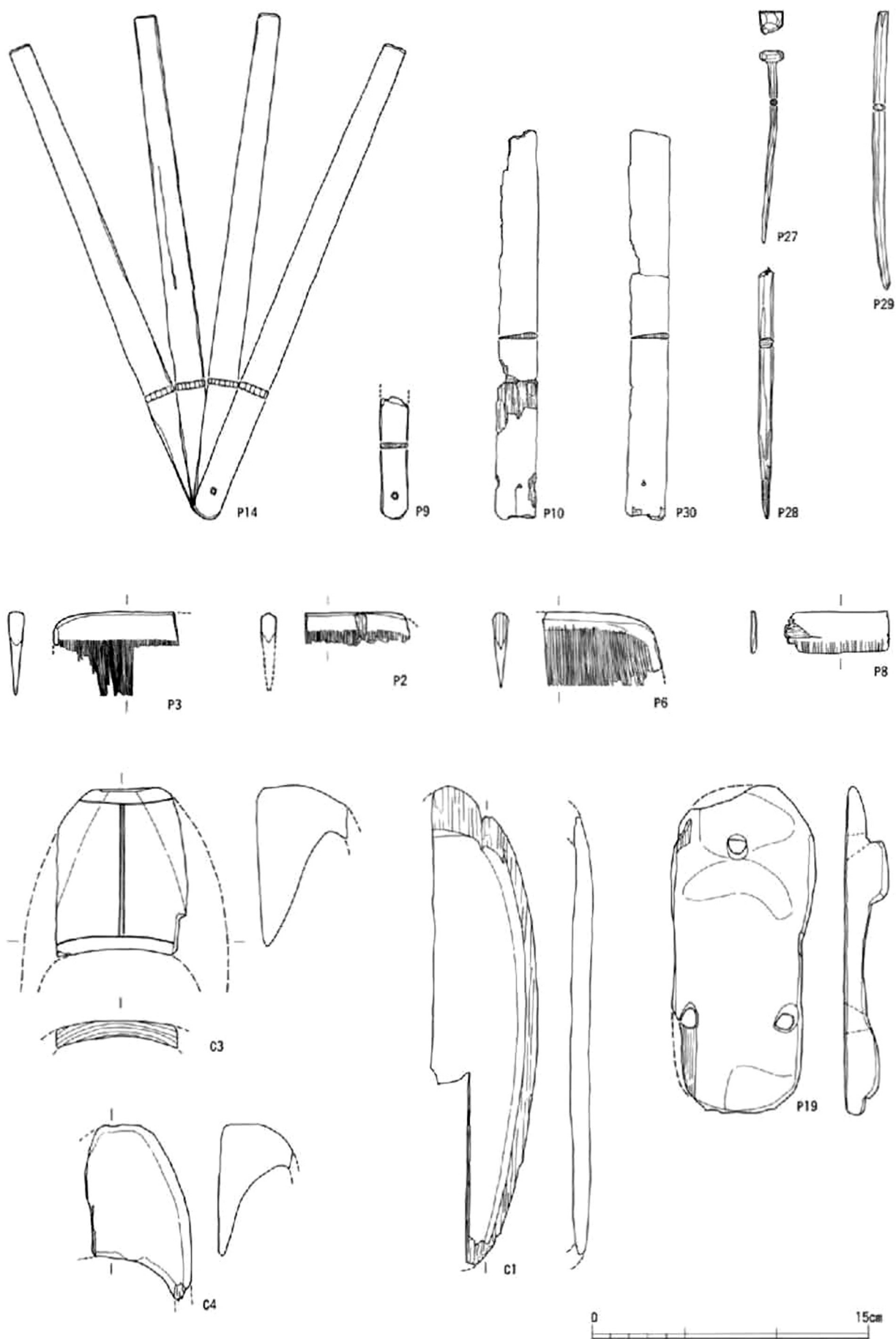

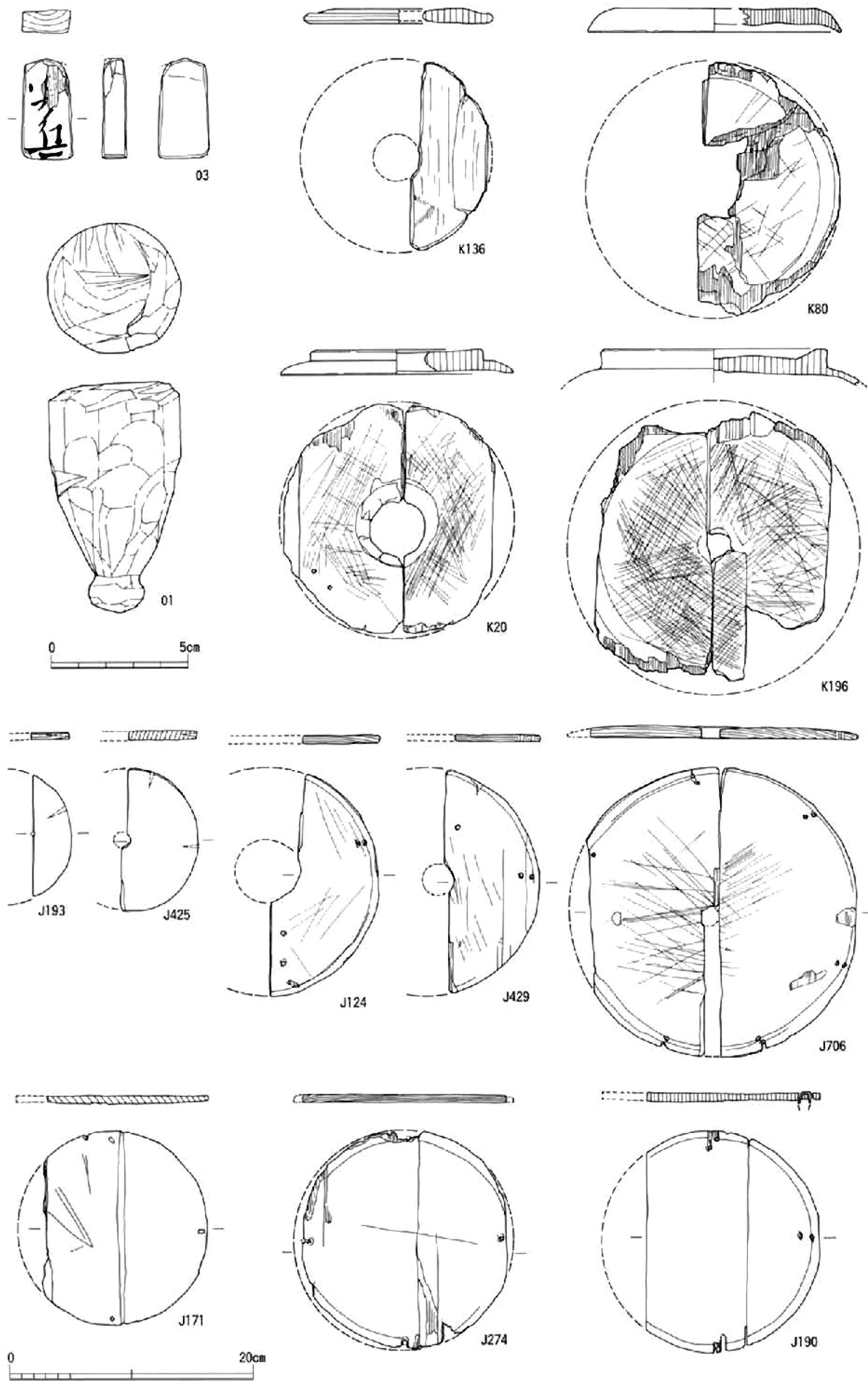

図面80 窪地東岸出土木製品7 (蓋・曲物)

深田遺跡

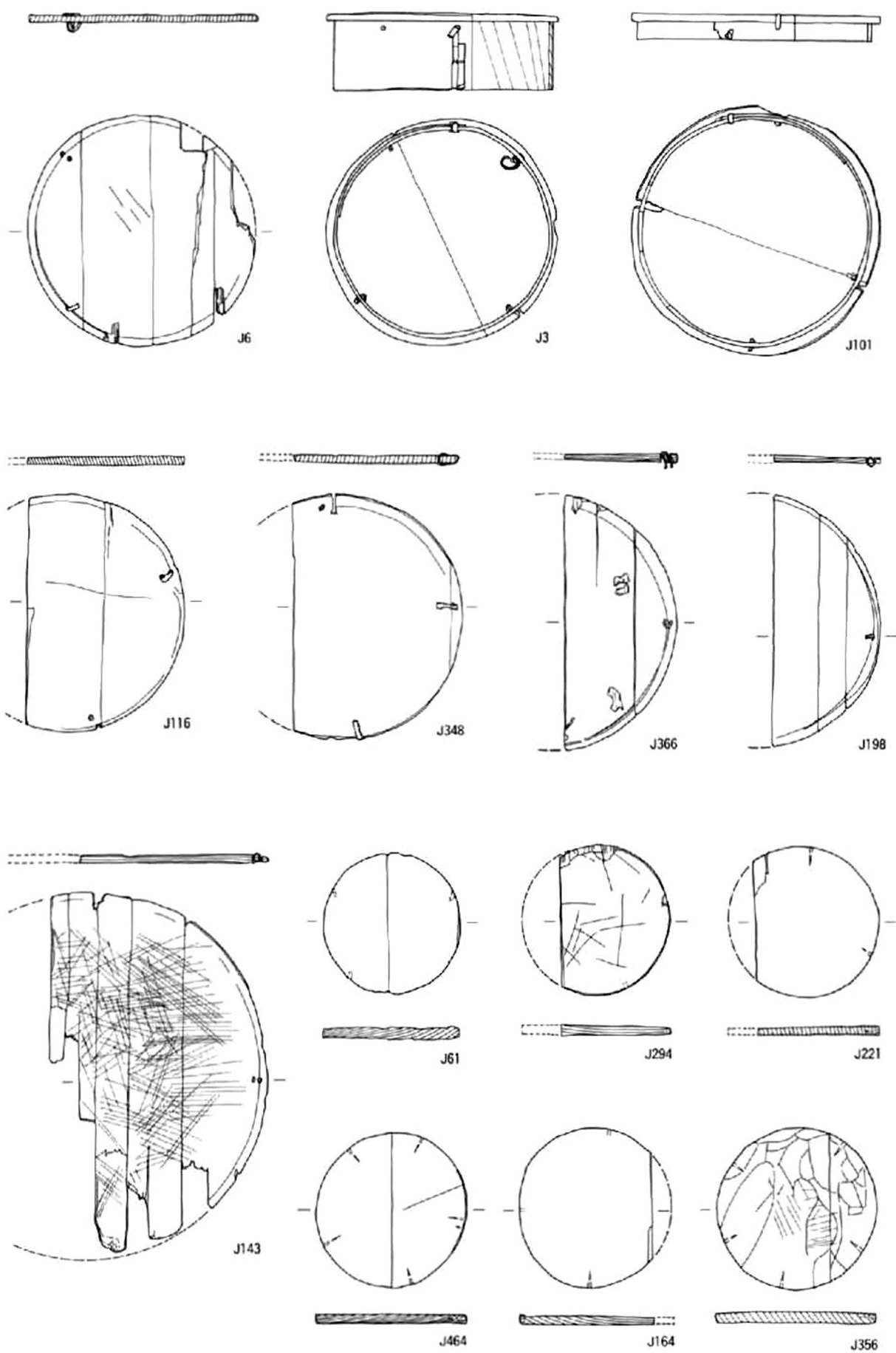

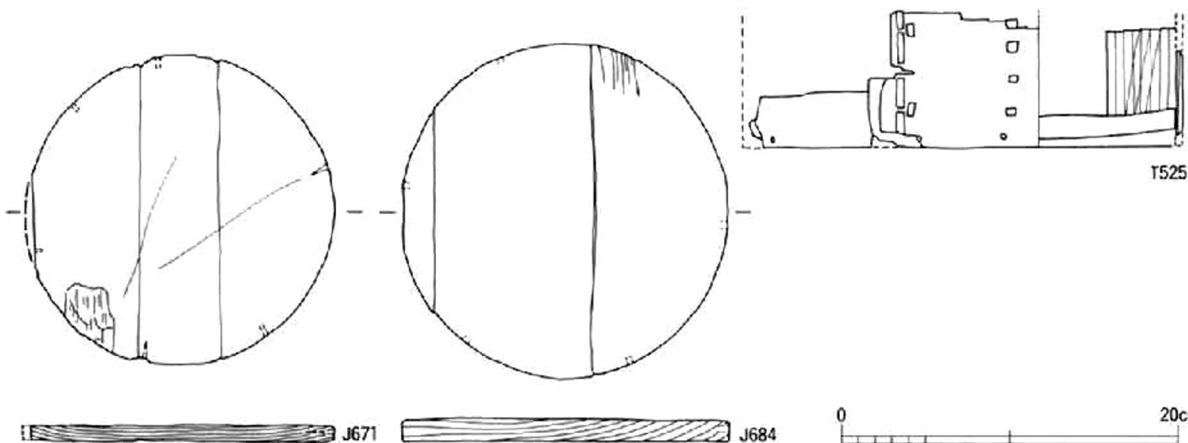
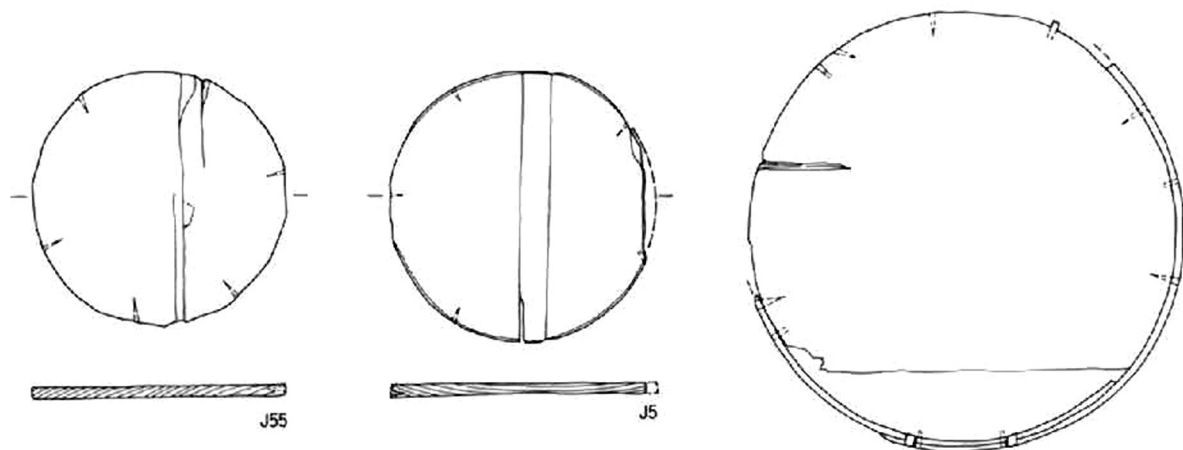
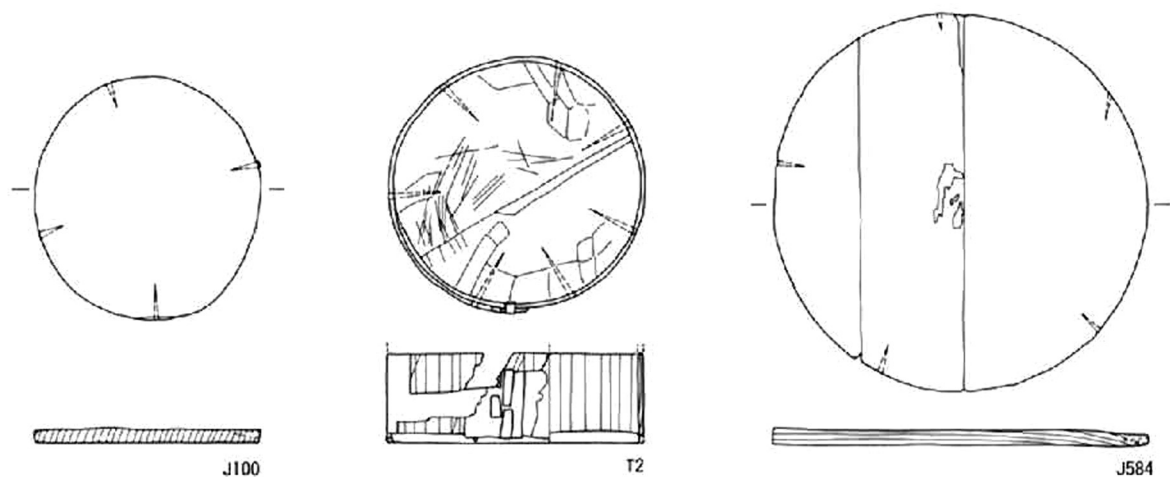
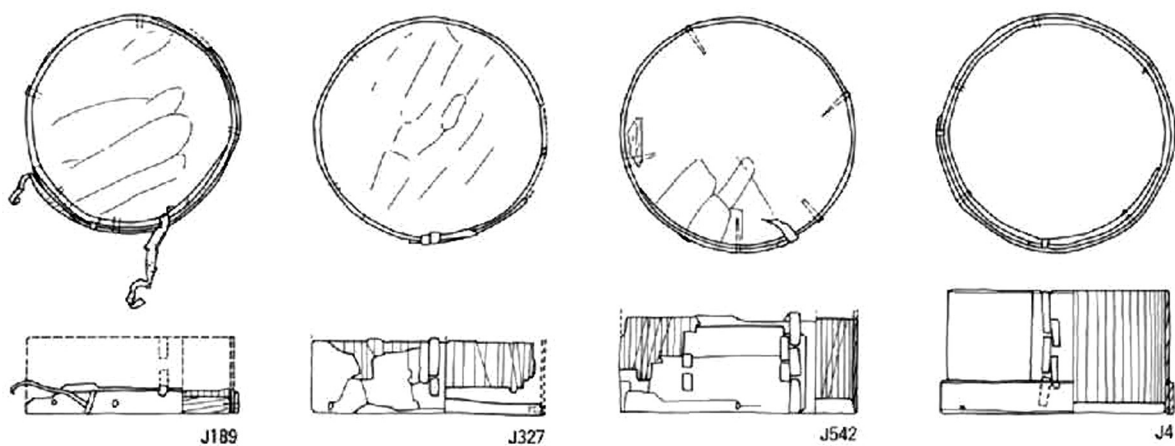

図面82 窪地東岸出土木製品9 (挽物A)

深田遺跡

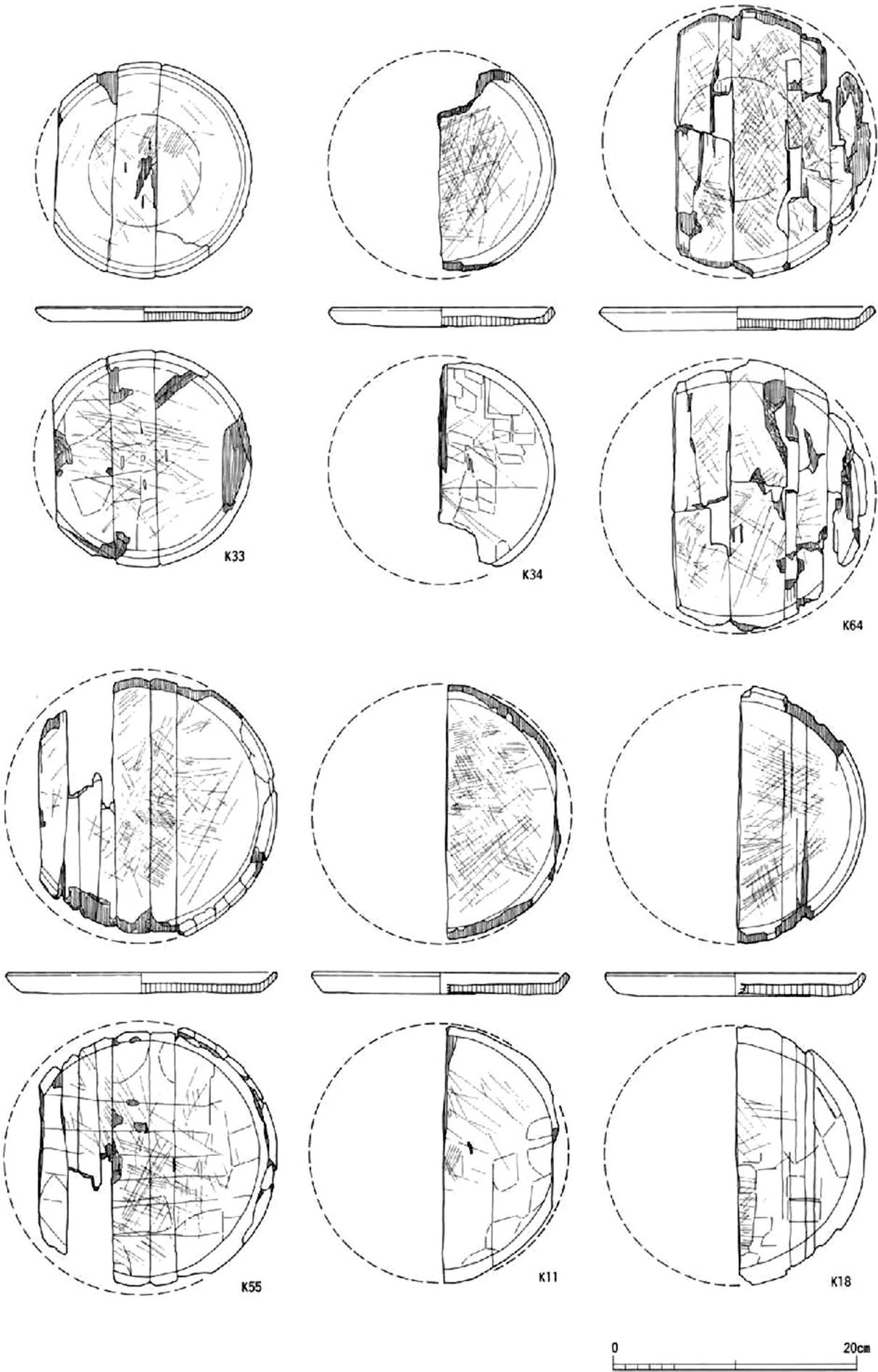

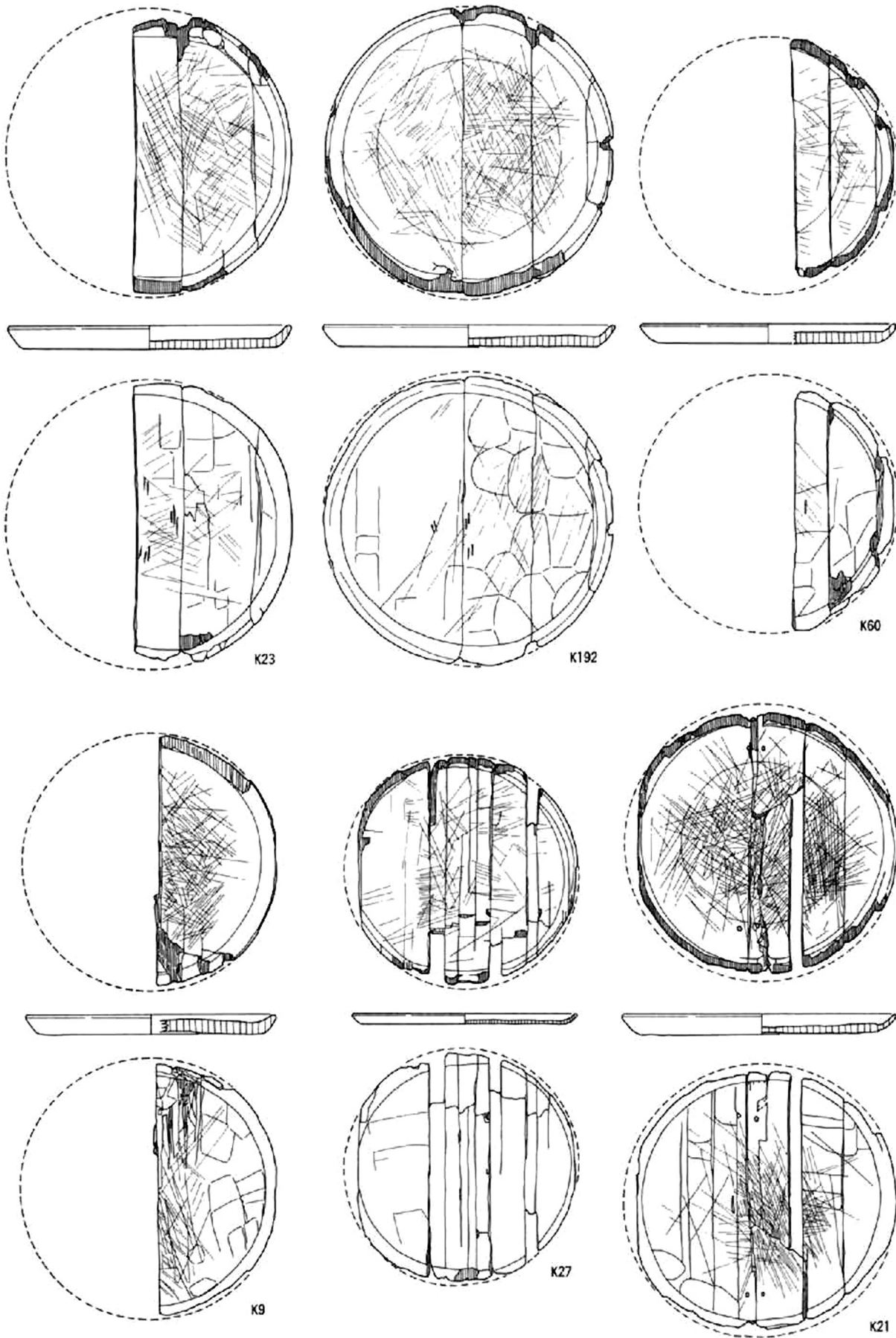

0 20cm

図面84 窪地東岸出土木製品11 (挽物B)

深田遺跡

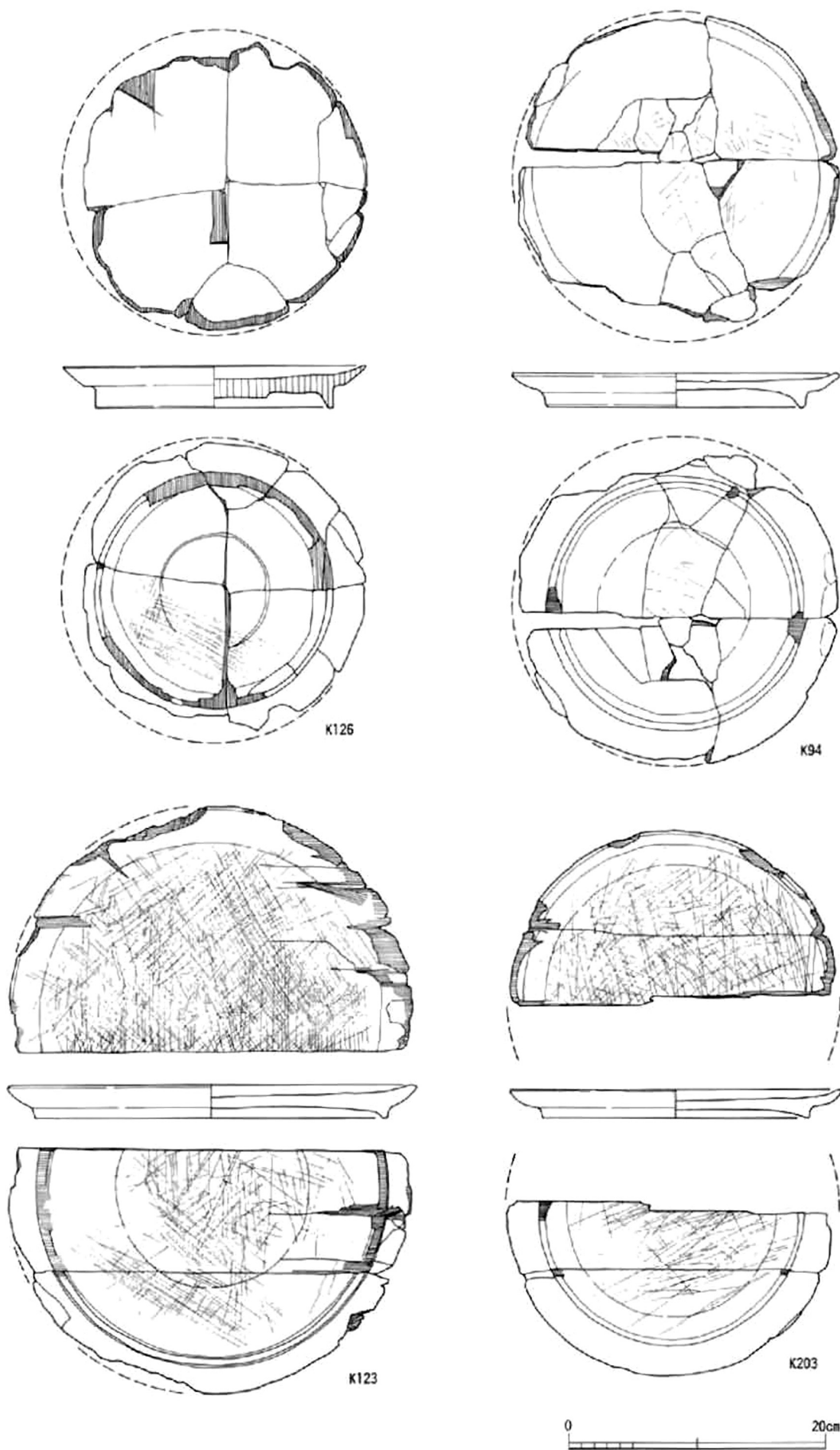

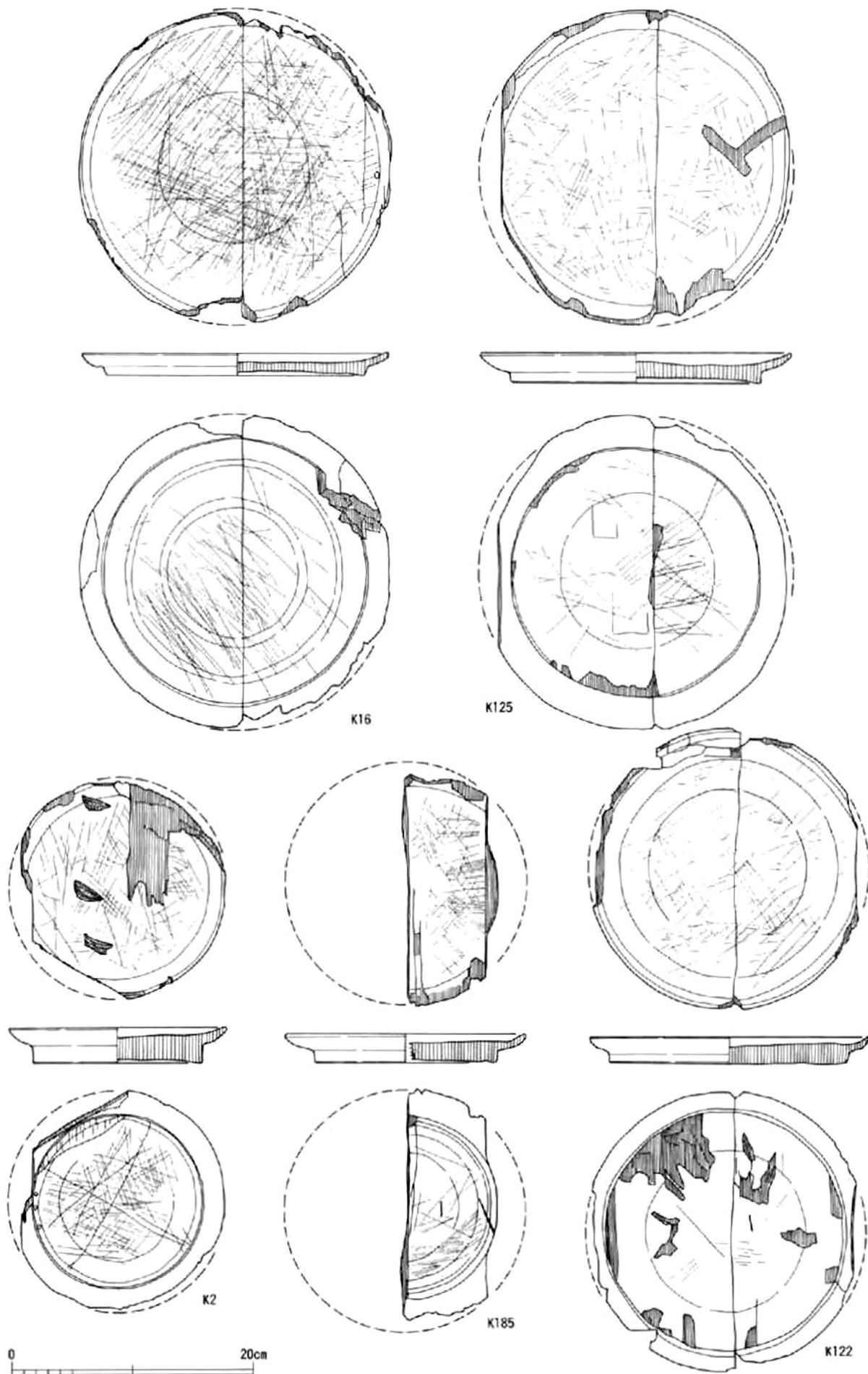

図面86 窪地東岸出土木製品13 (挽物B)

深田遺跡

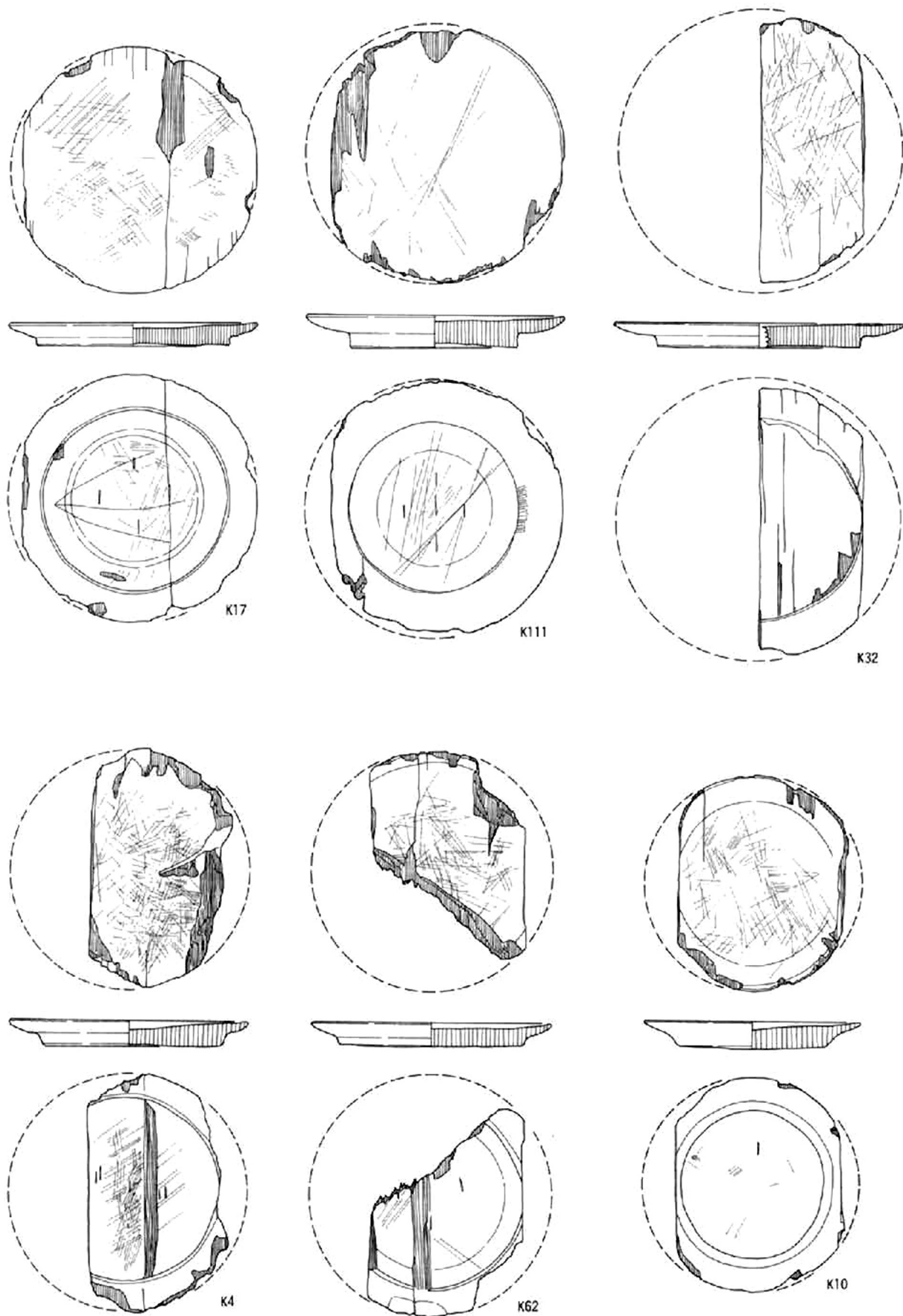

0 20cm

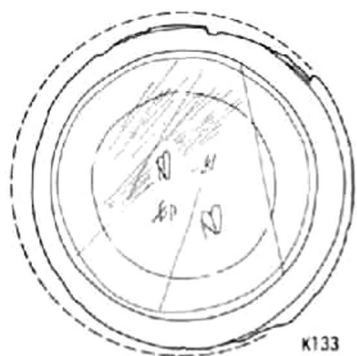
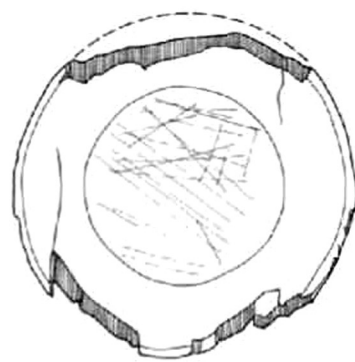
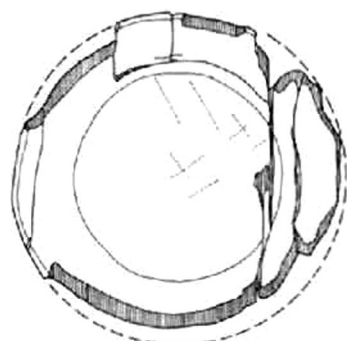
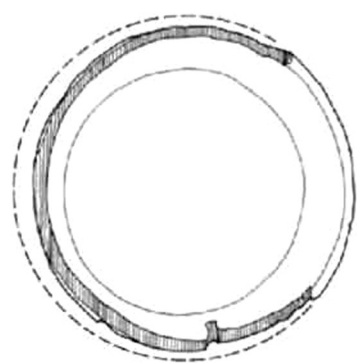

K133

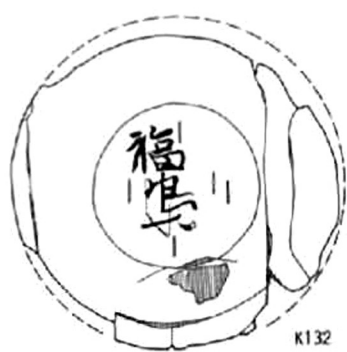

K132

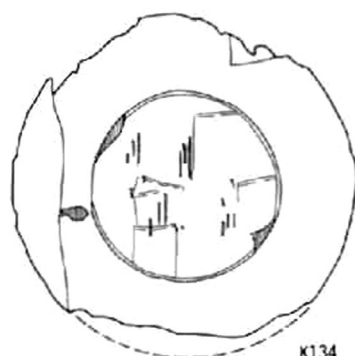

K134

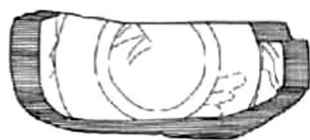
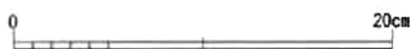

K72



S1

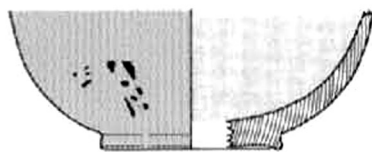

S2



S4

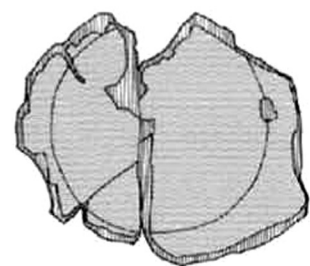

S5

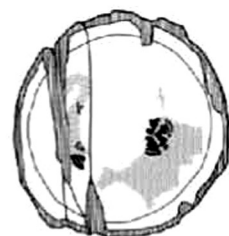
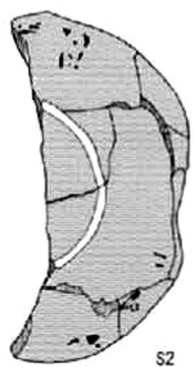

S27



図面88 窪地東岸出土木製品15 (刮物・柄杓形木器・刮物匙)

深田遺跡

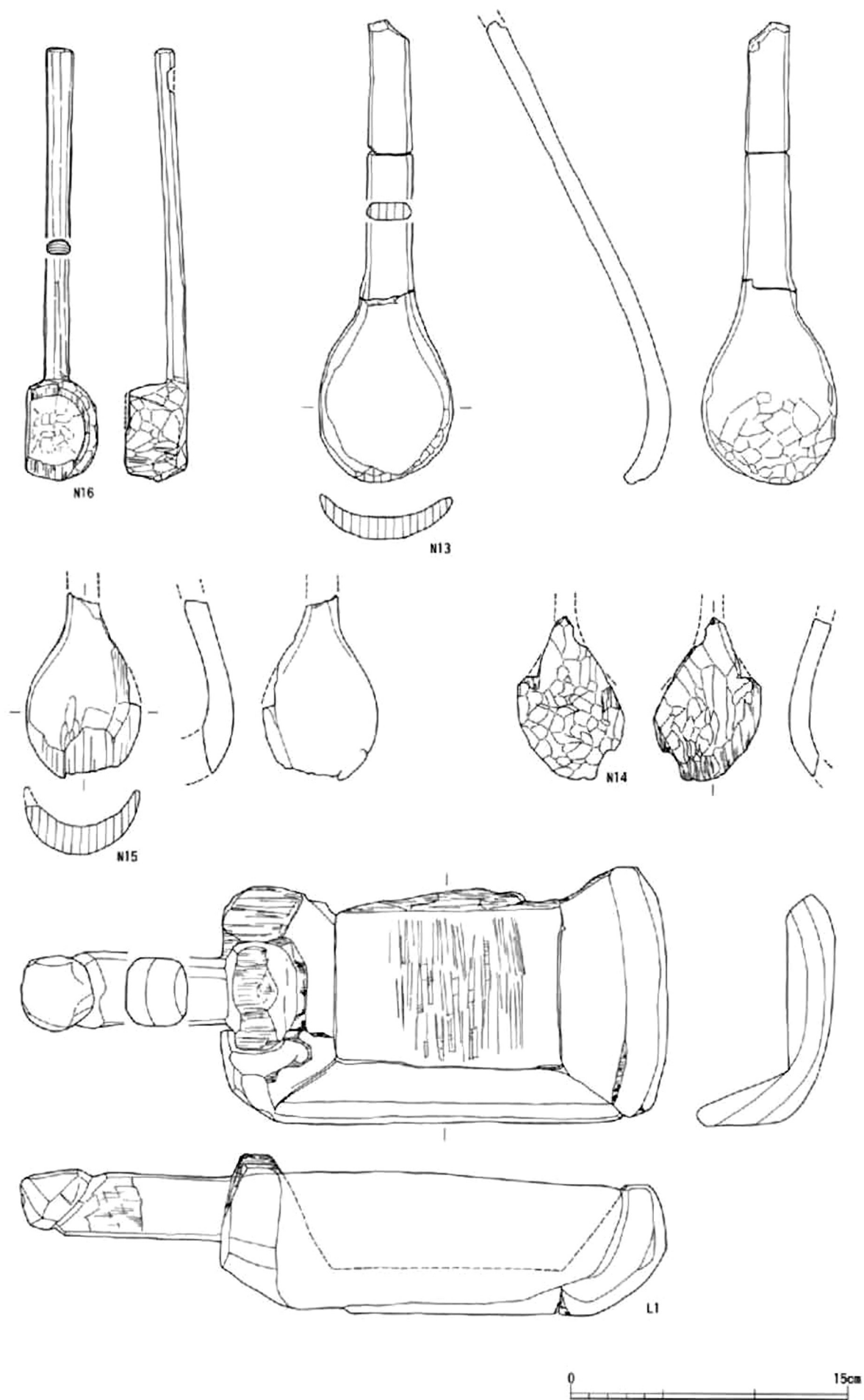

深田遺跡

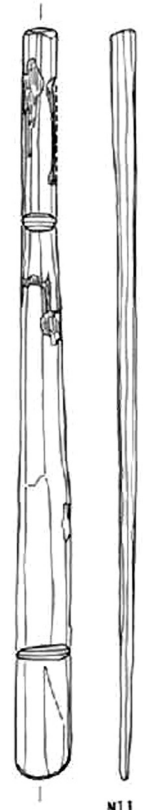
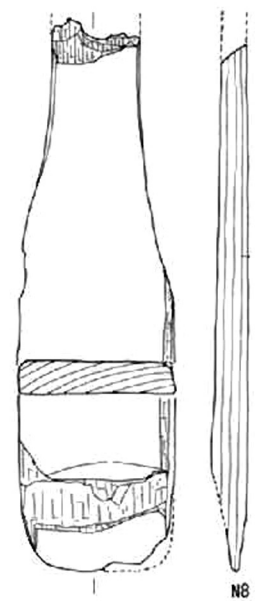

図面90 窪地東岸出土木製品17 (台座)

深田遺跡

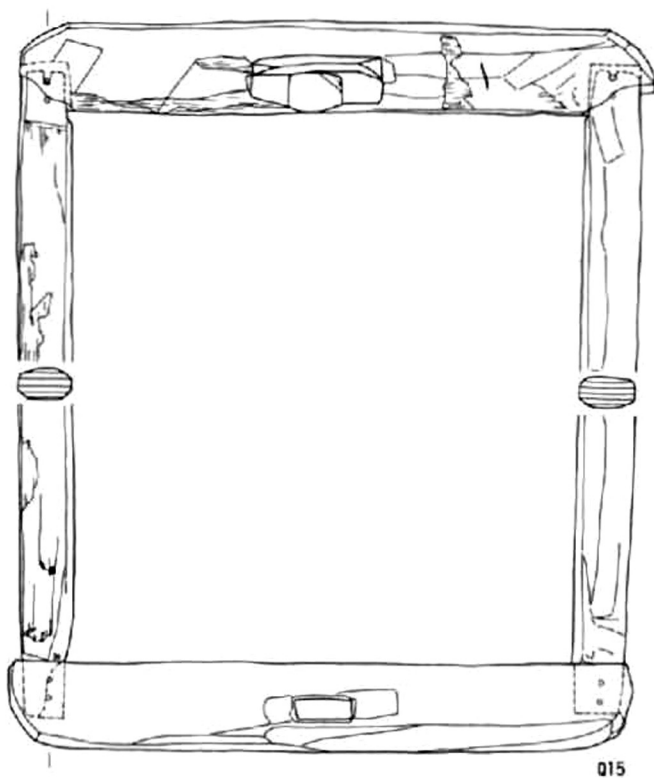
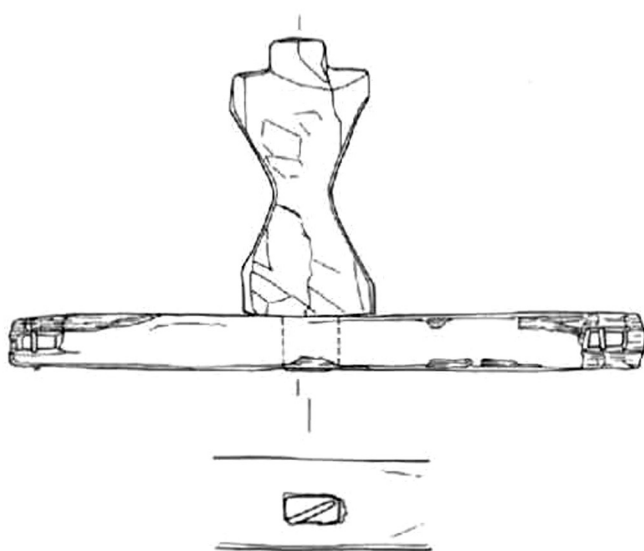

015



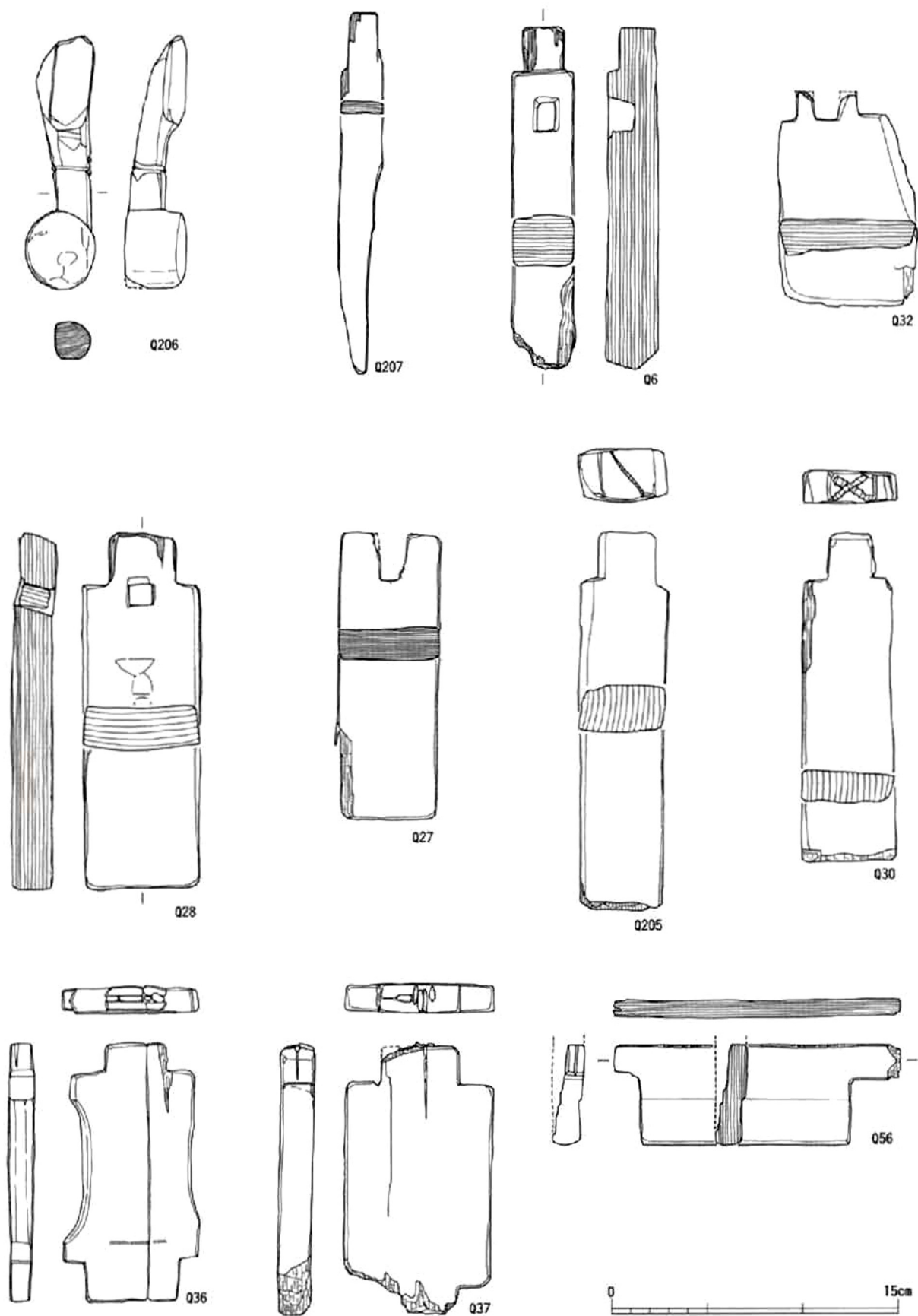

図面92 窪地東岸出土木製品19 (刷毛・鞘・柄・楔)

深田遺跡

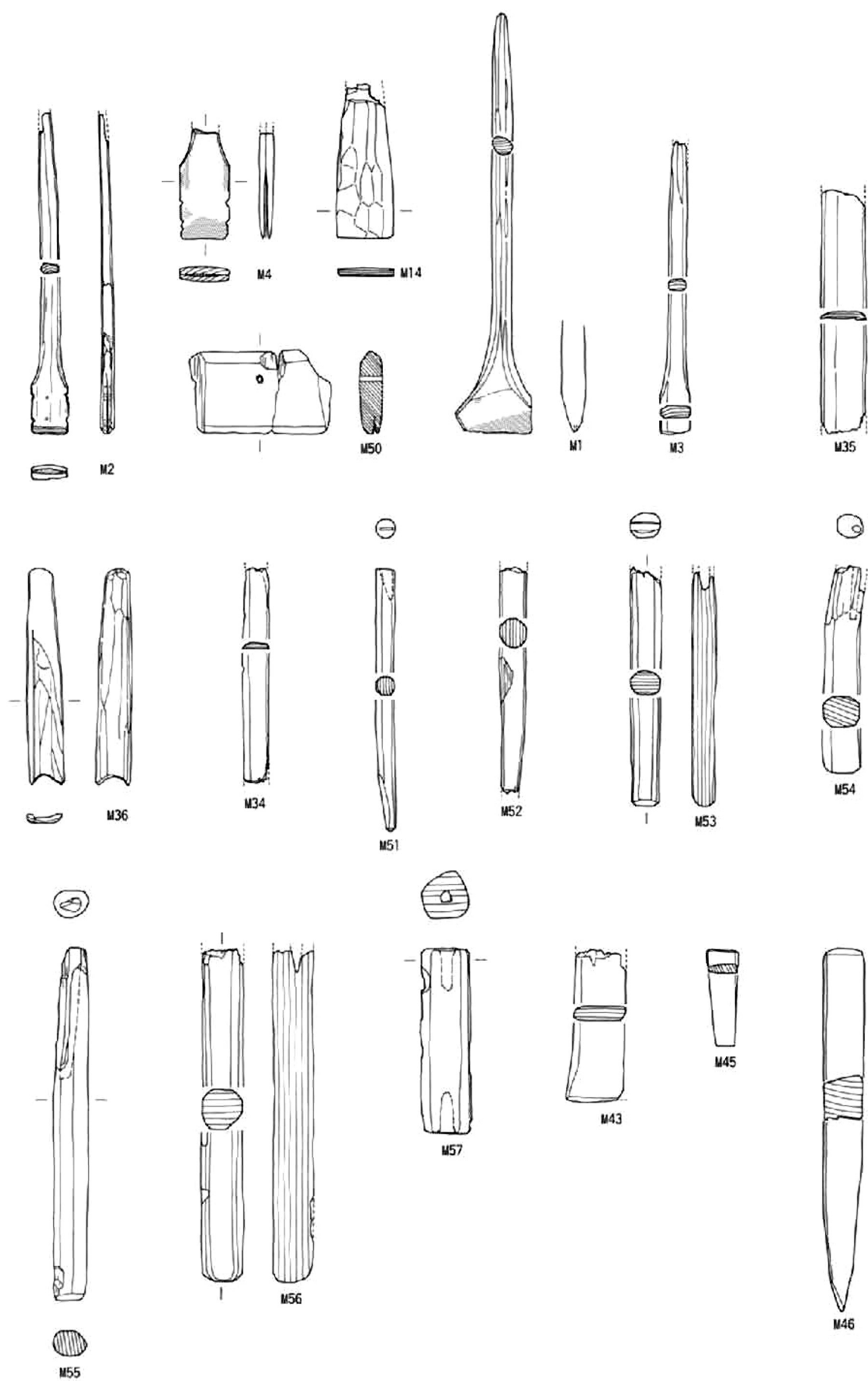

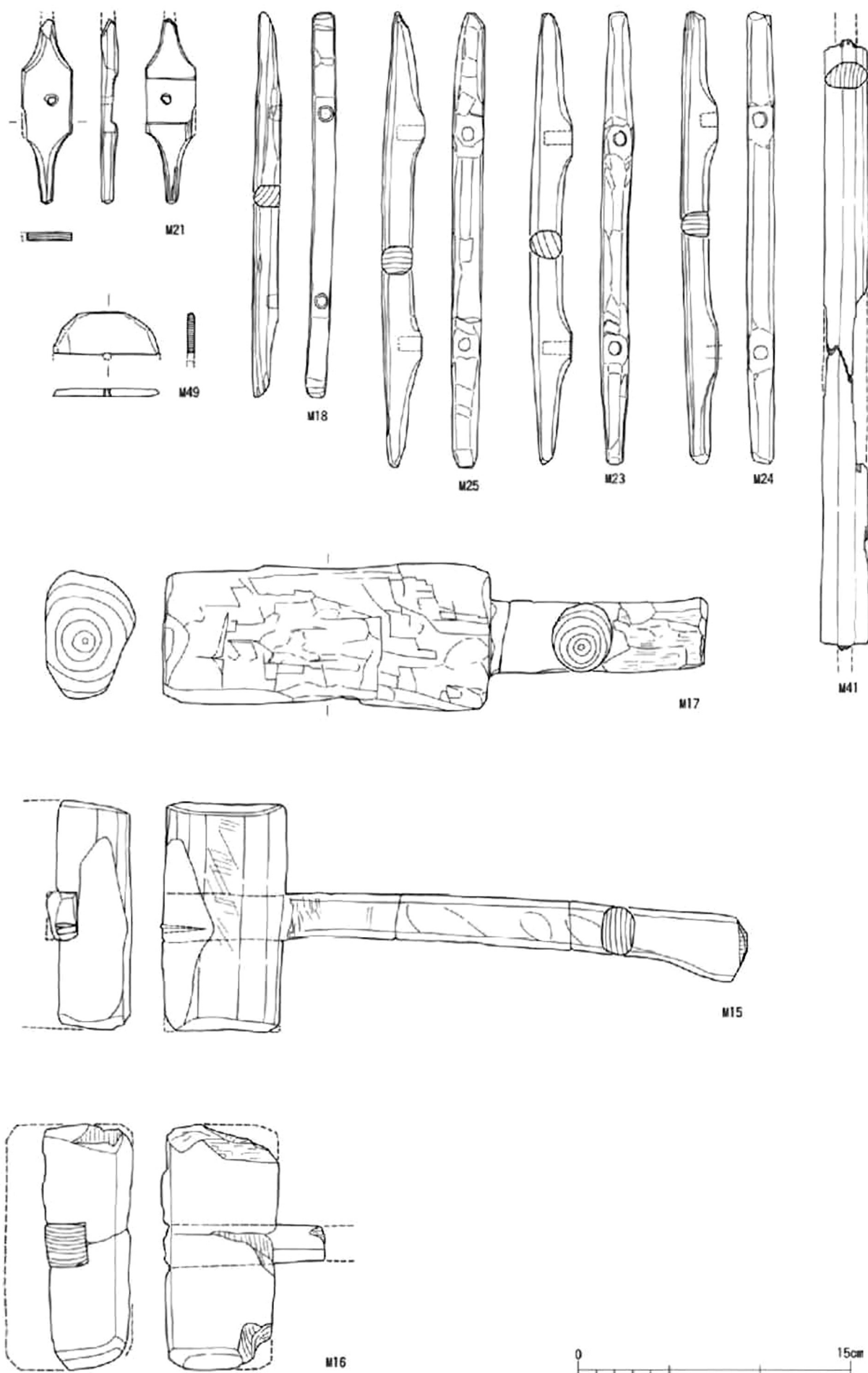

図面94 窪地東岸出土木製品21 (田下駄)

深田遺跡

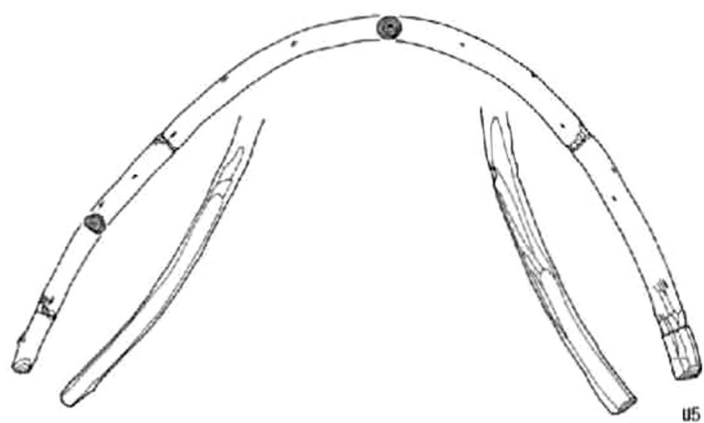
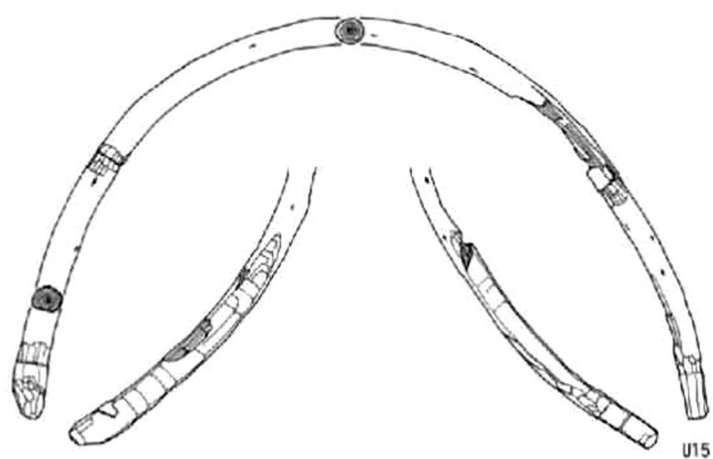
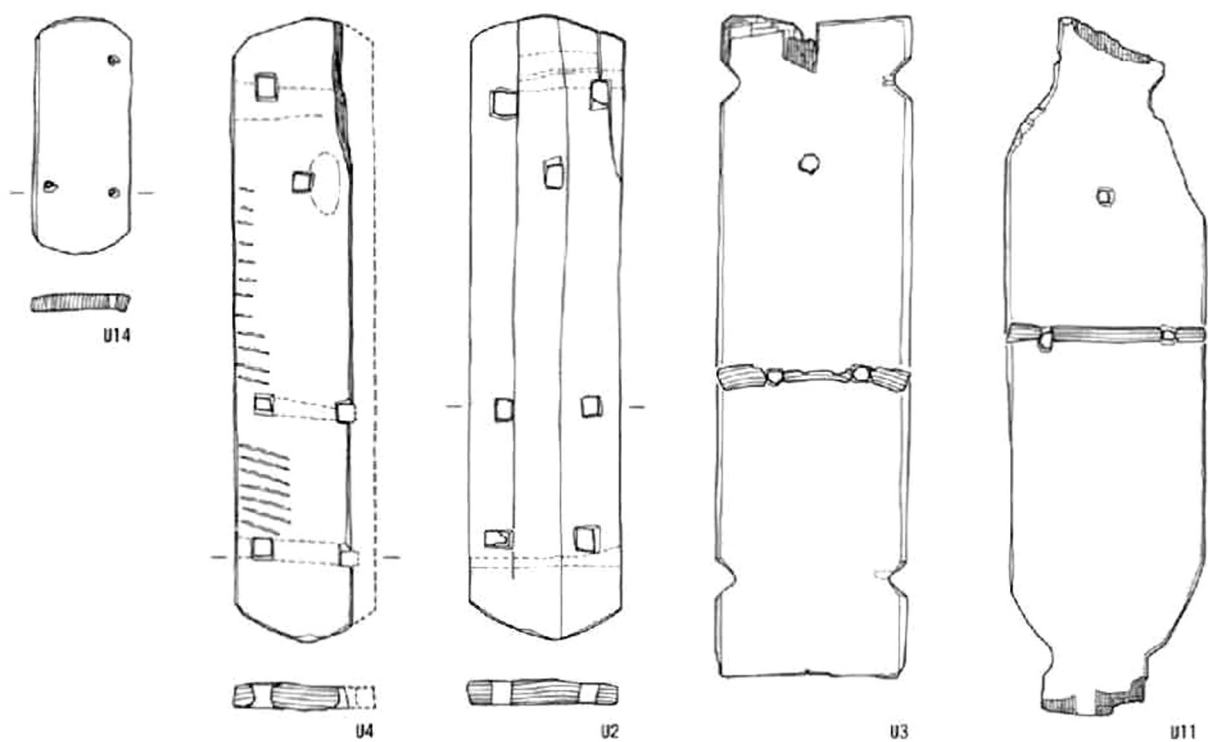

0 30cm

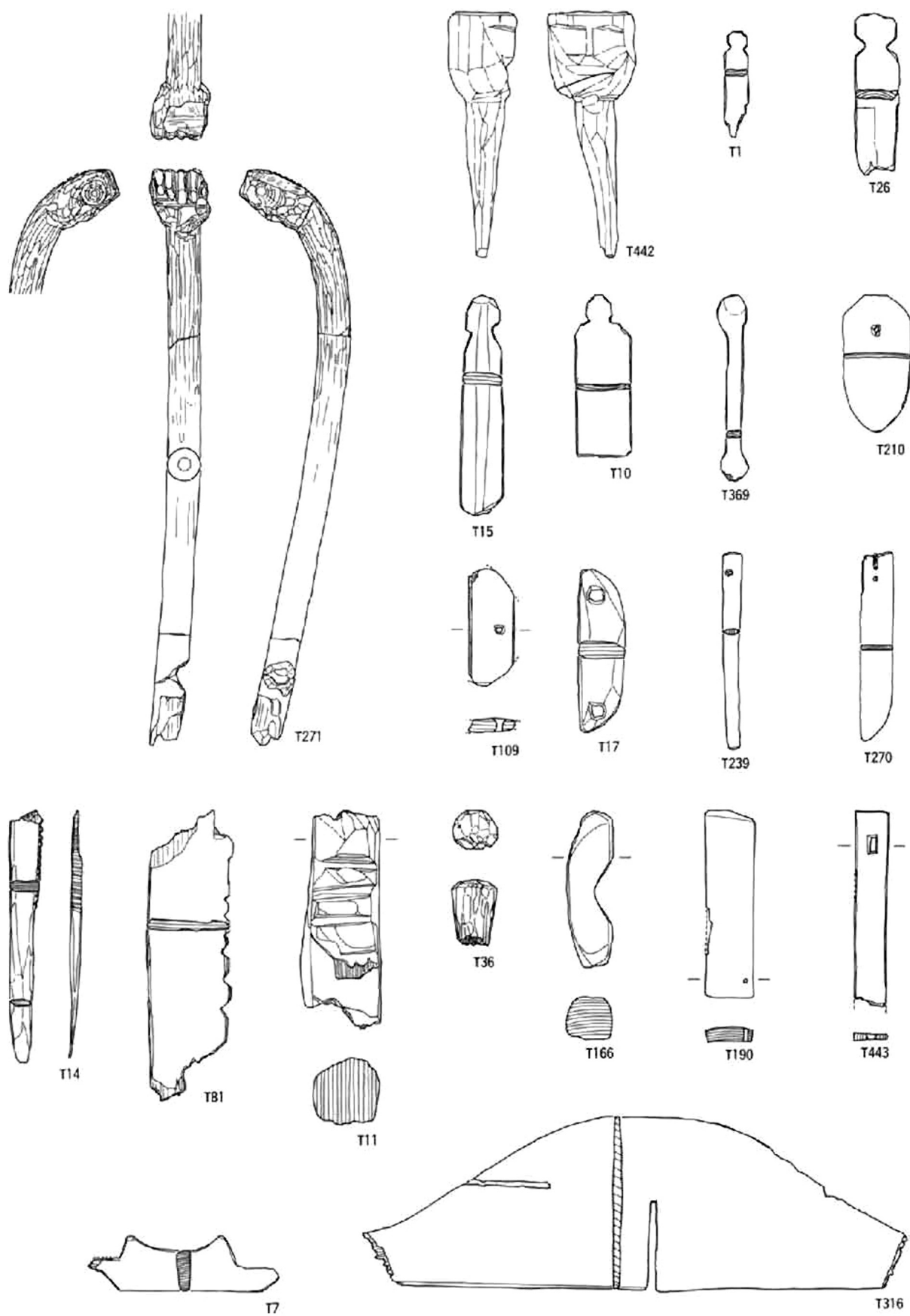

0 15cm

図面96 窪地東岸出土木製品23 (用途不明品部材)

深田遺跡

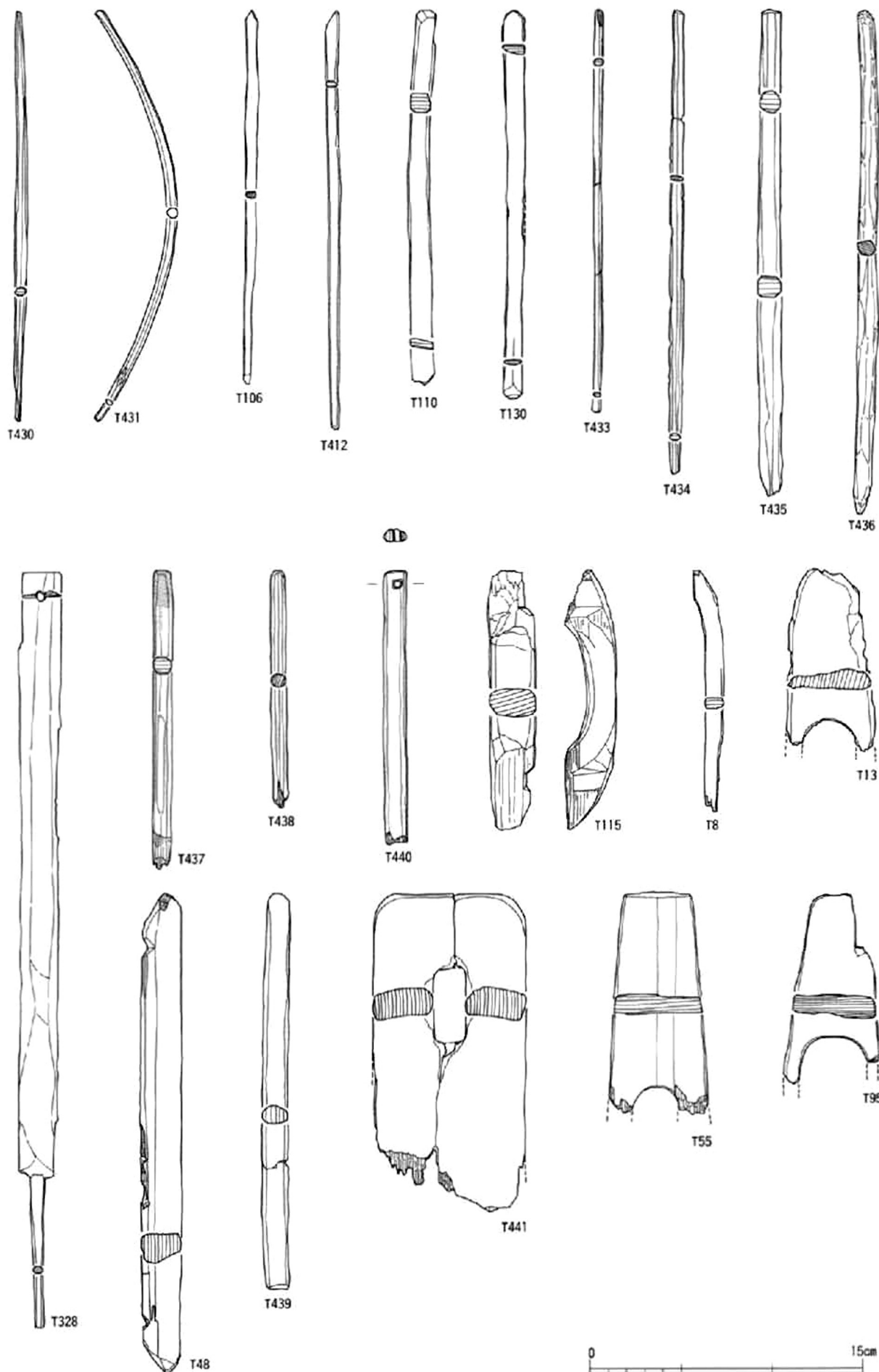

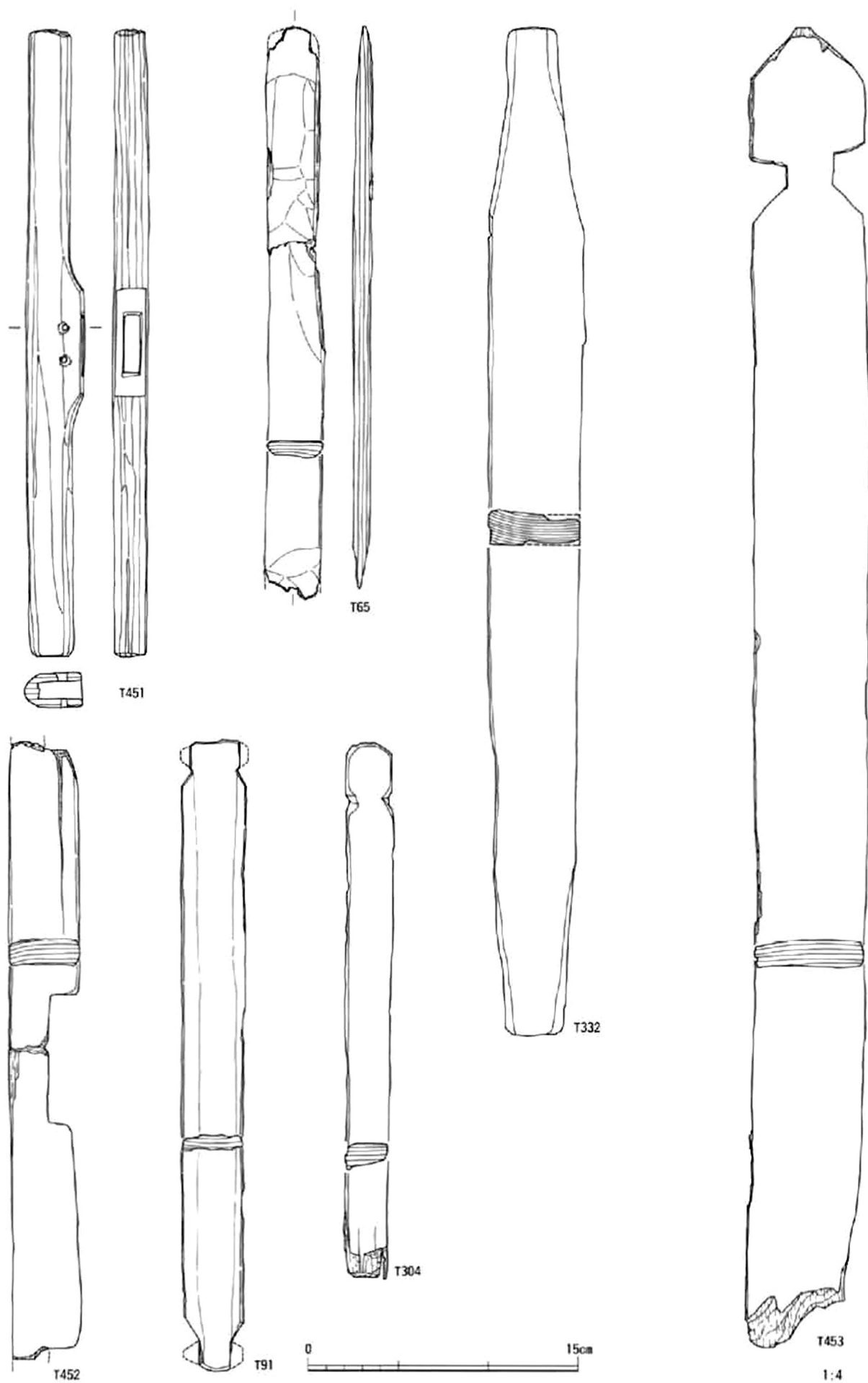

T452

T91

0 15cm

T453

1:4

T451

T65

T332

T304

図面98 窪地東・西岸出土木製品25 (用途不明部材)

深田遺跡

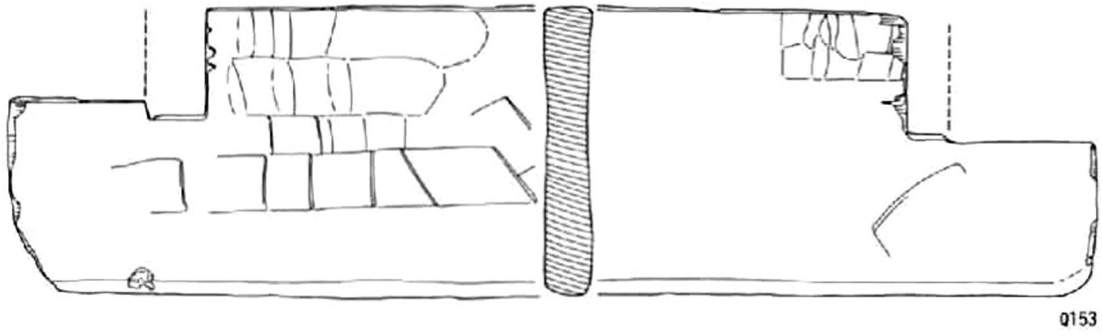
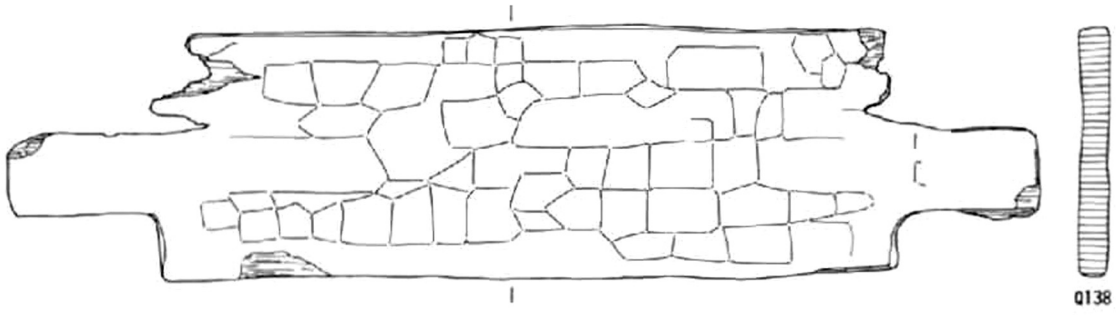

0 30cm

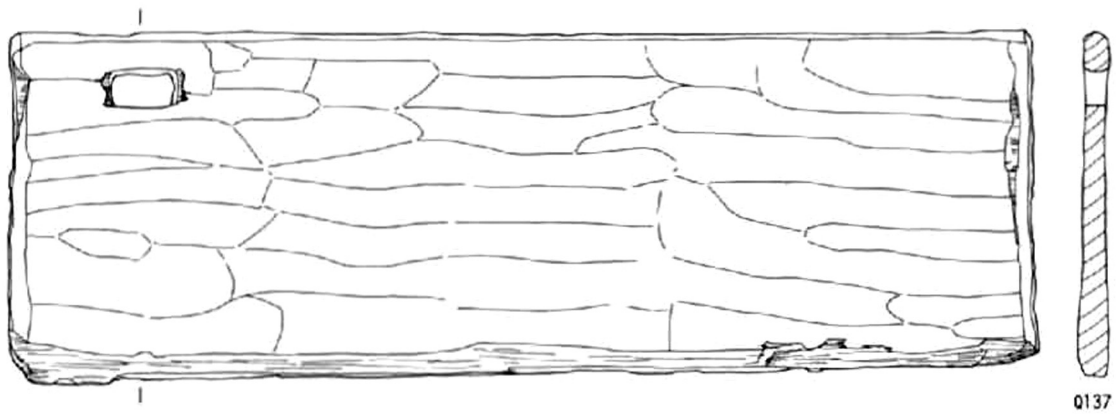
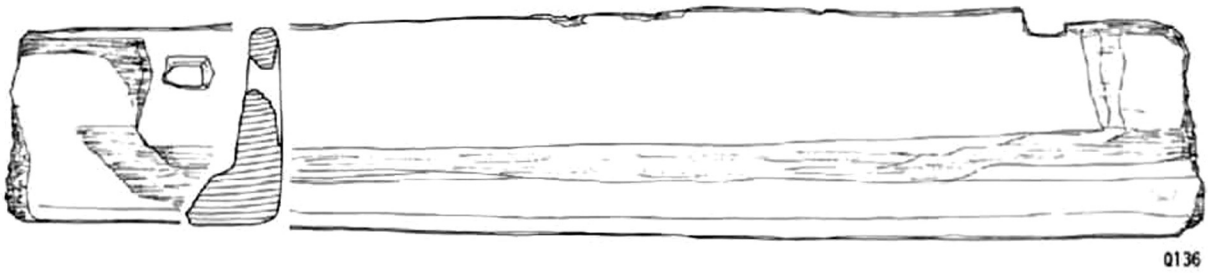
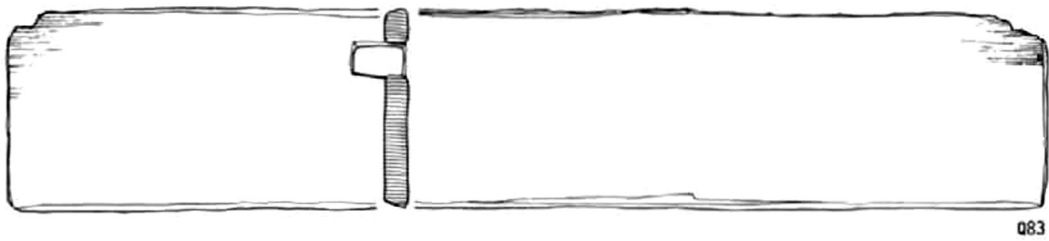

0 20cm

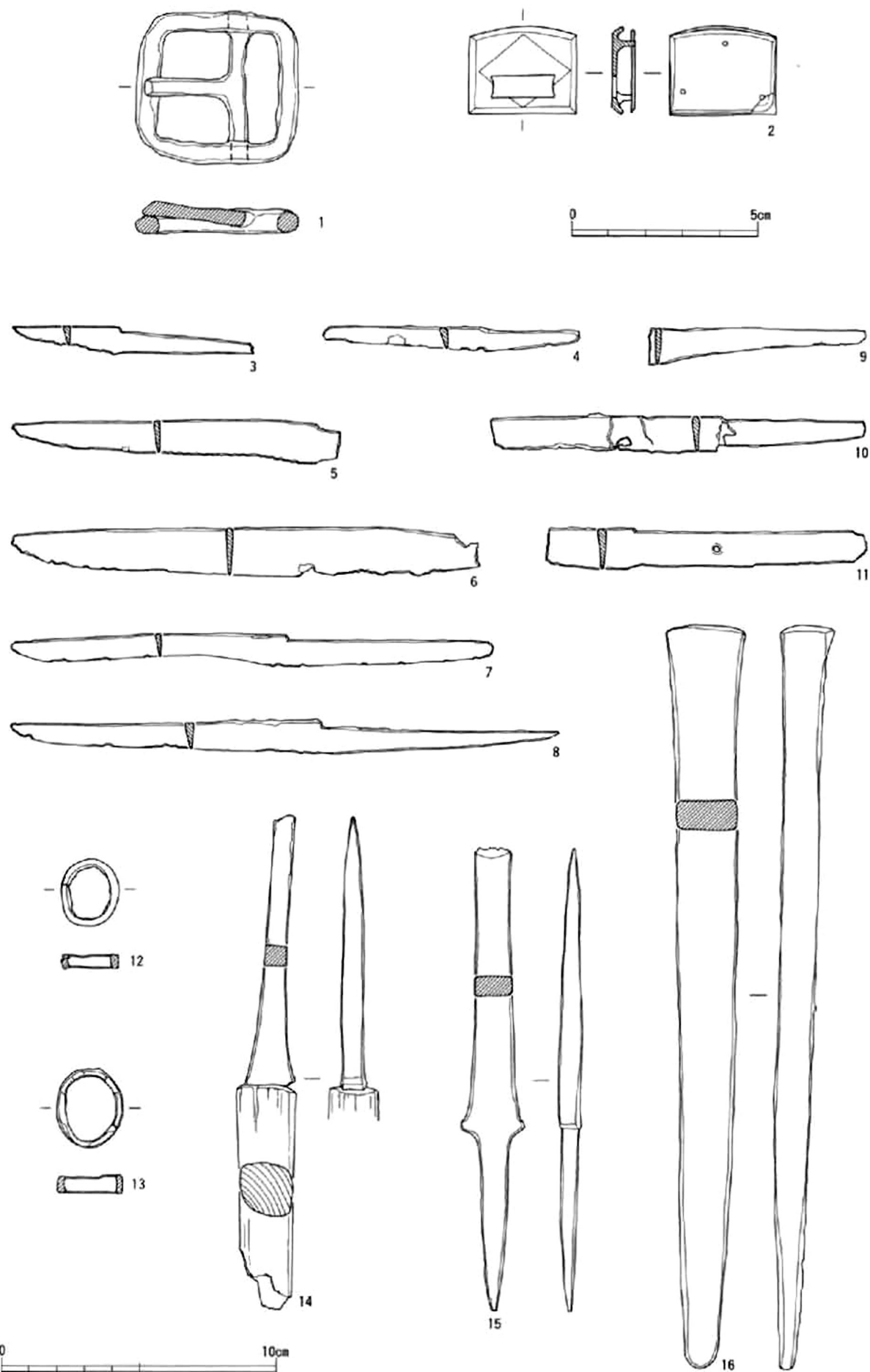

図面100 金属製品2

深田遺跡

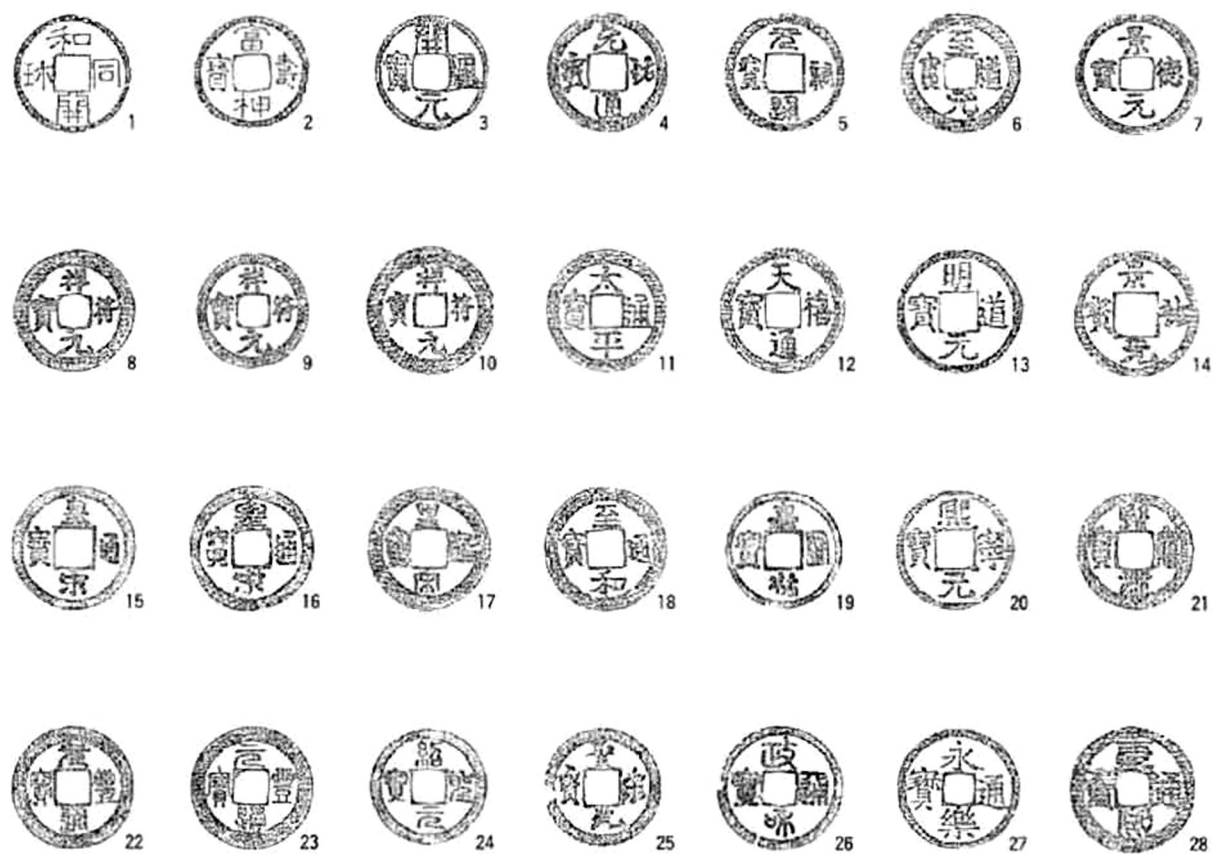
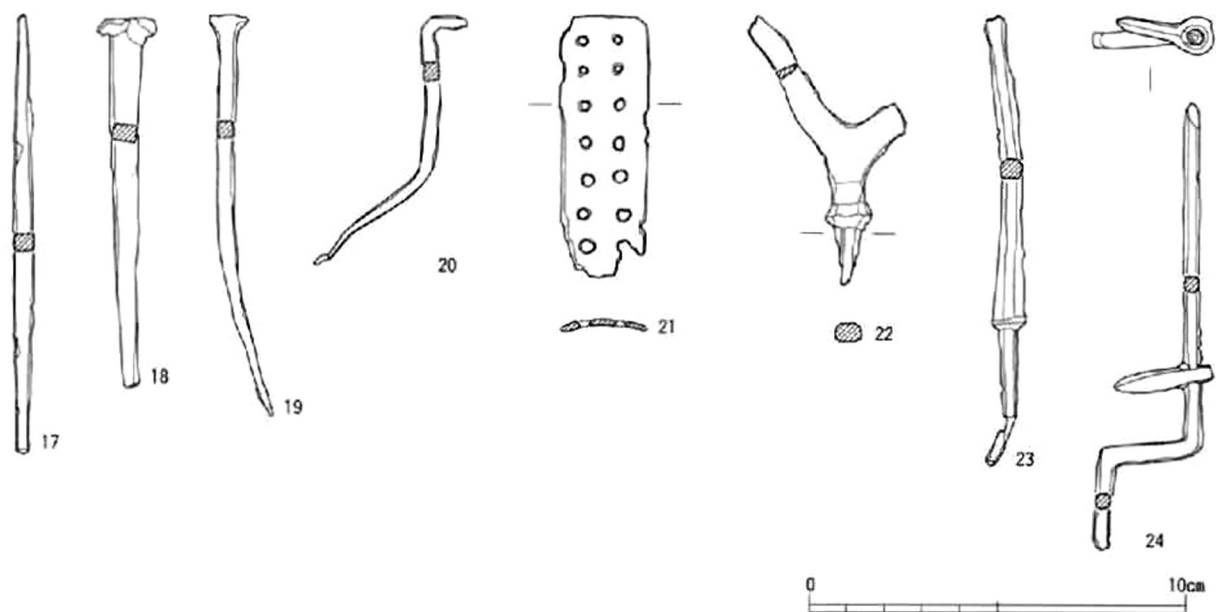

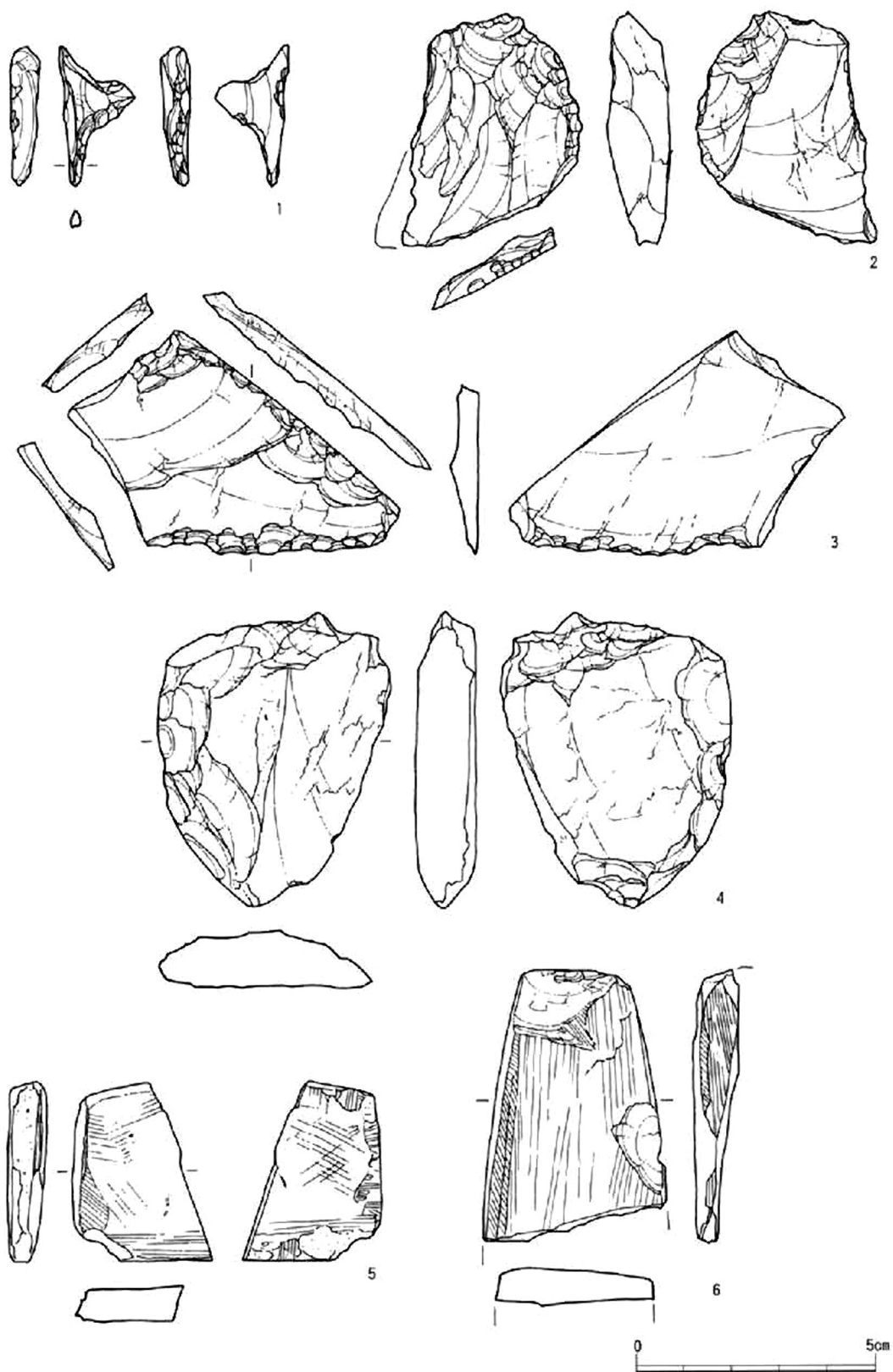

図面102 石器 2

深田遺跡

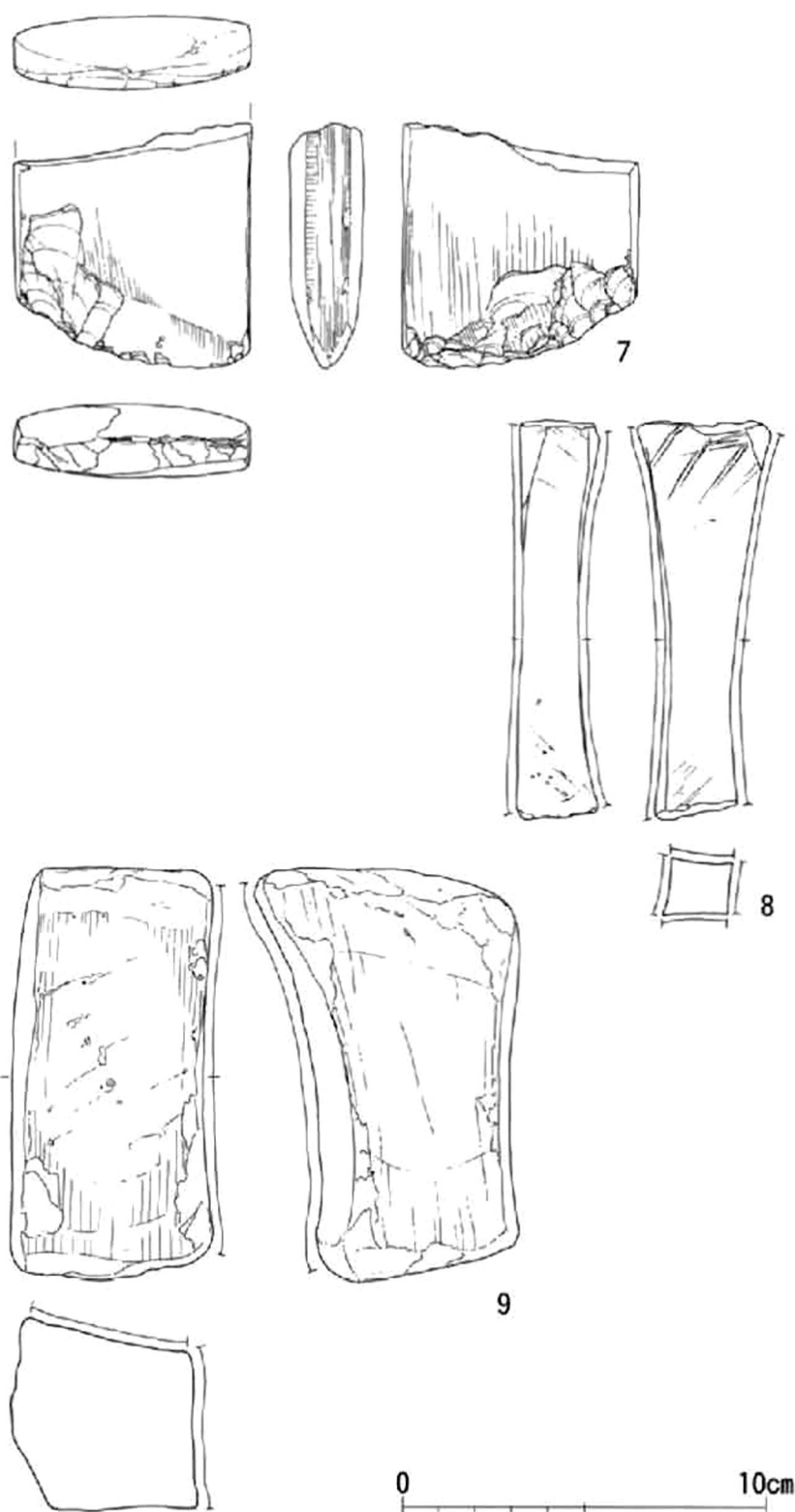

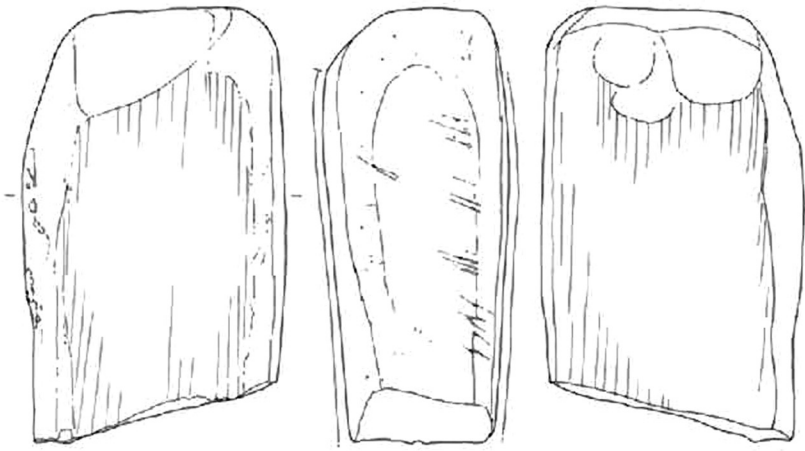

10

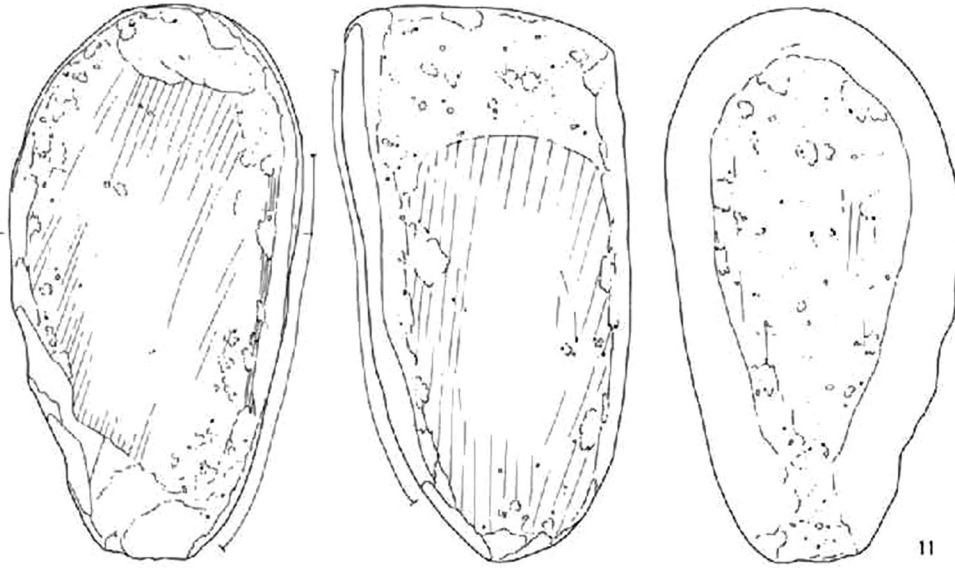

11



図面104 土器・土製品

カナゲ田遺跡

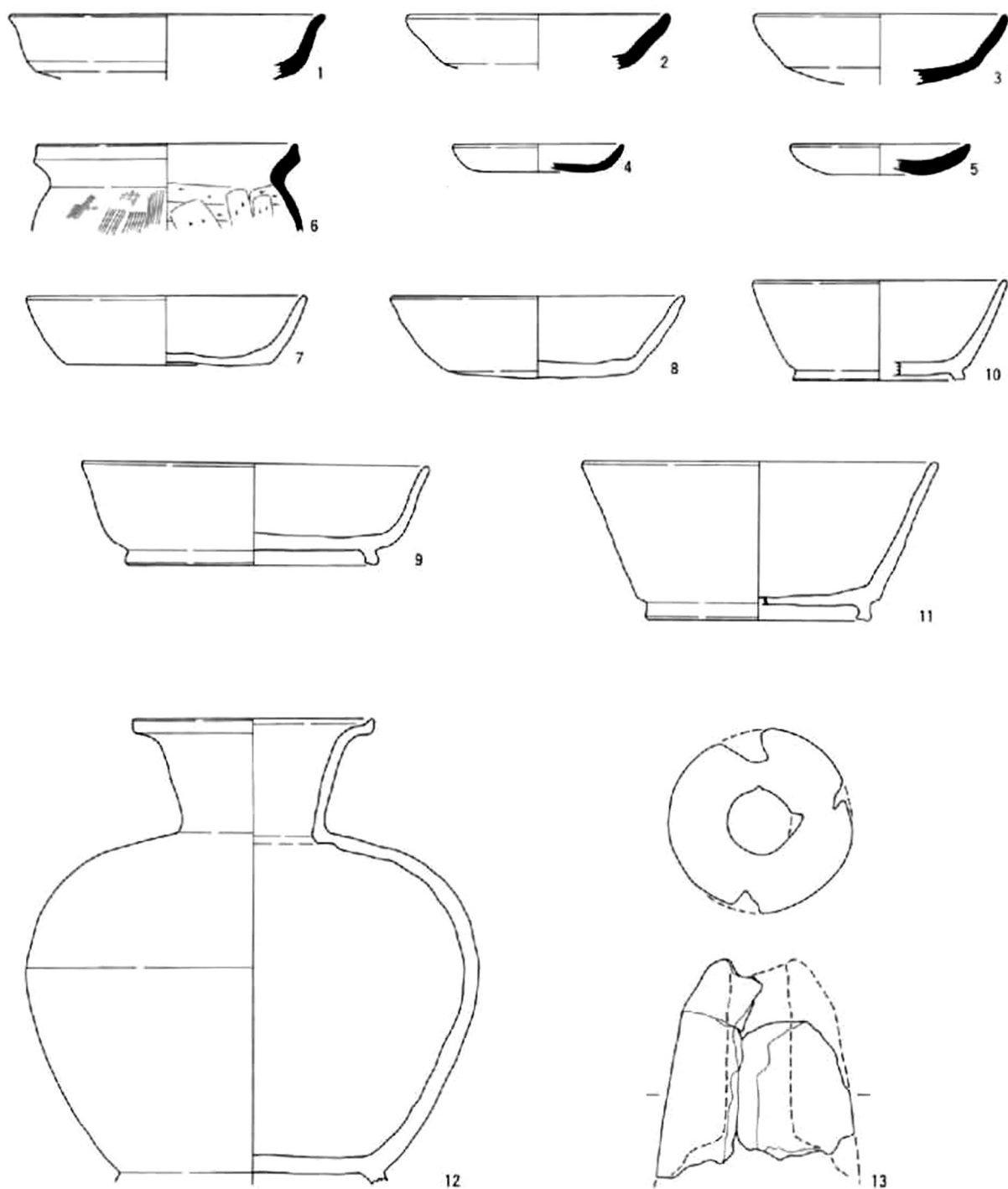

0 15cm

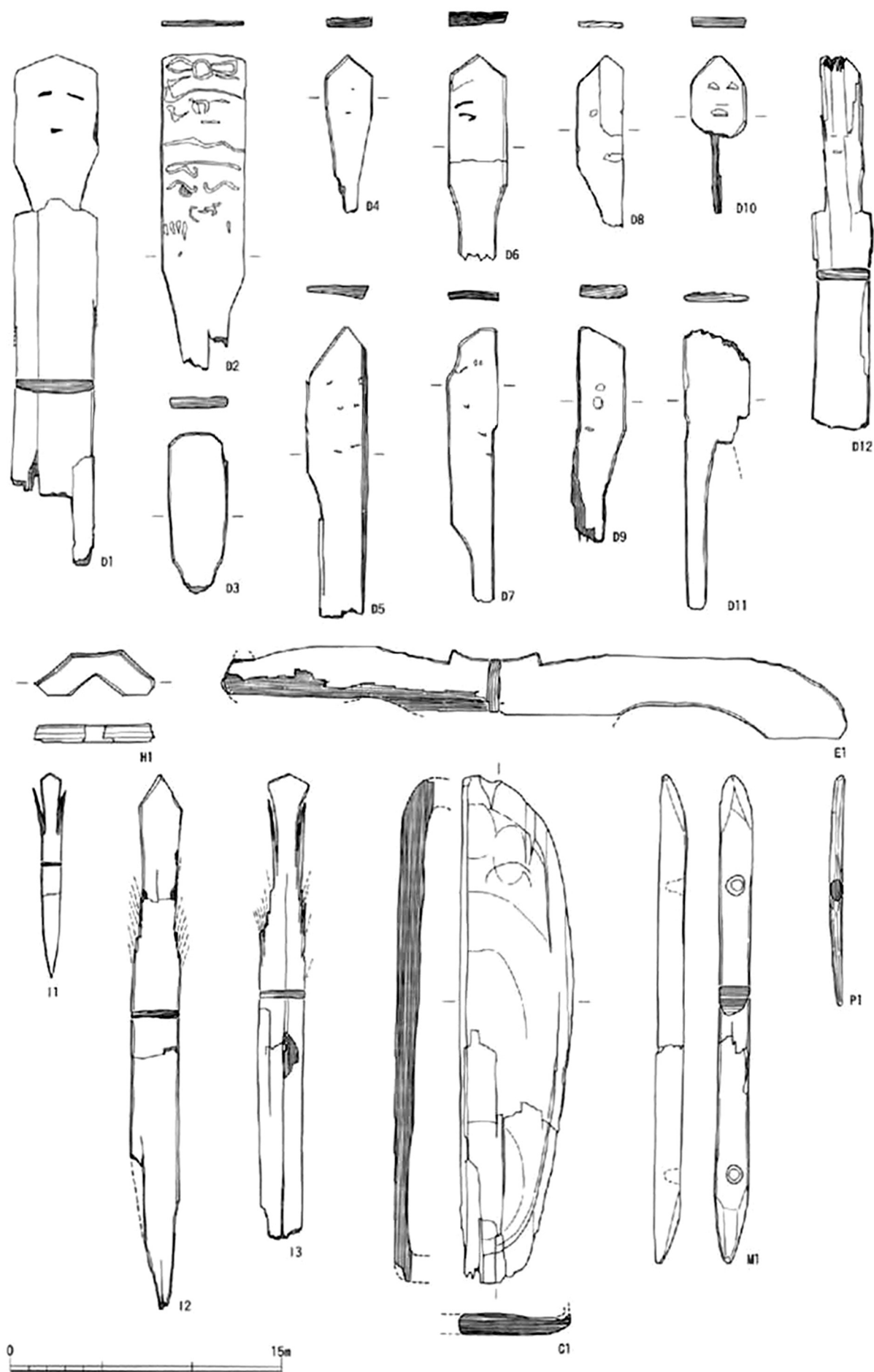

図面106 木製品 2

カナゲ田遺跡

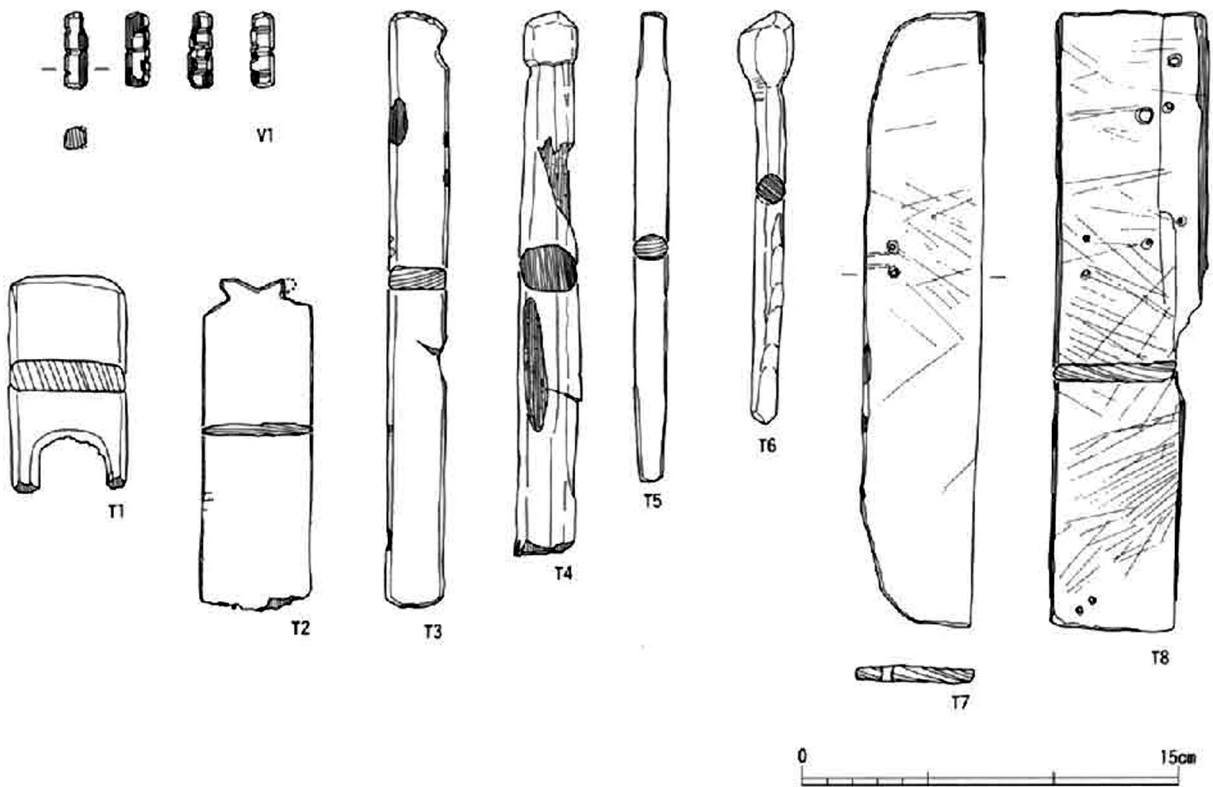
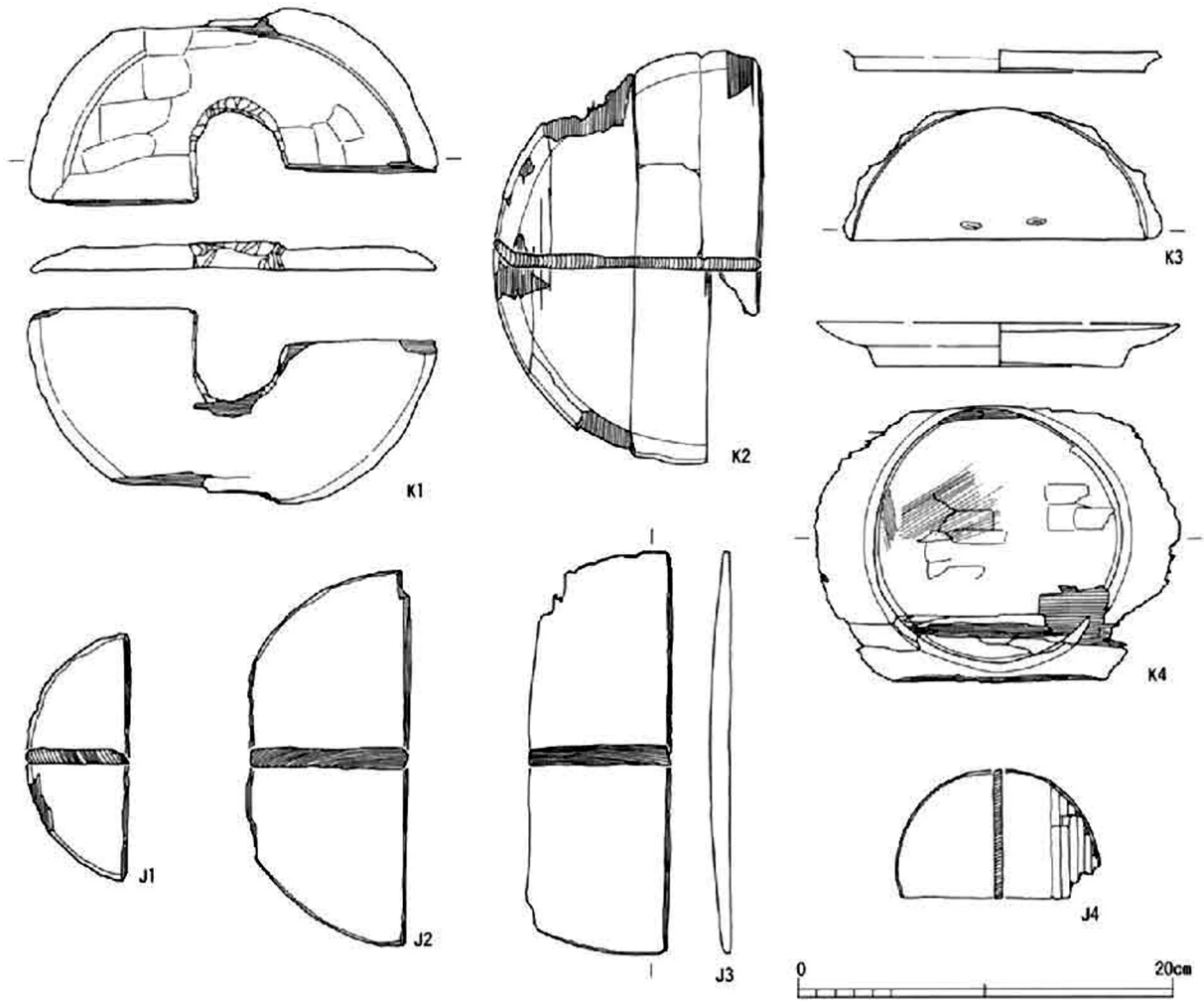



図 版



1. I区航空写真（西から） 2. I区航空写真（北から）

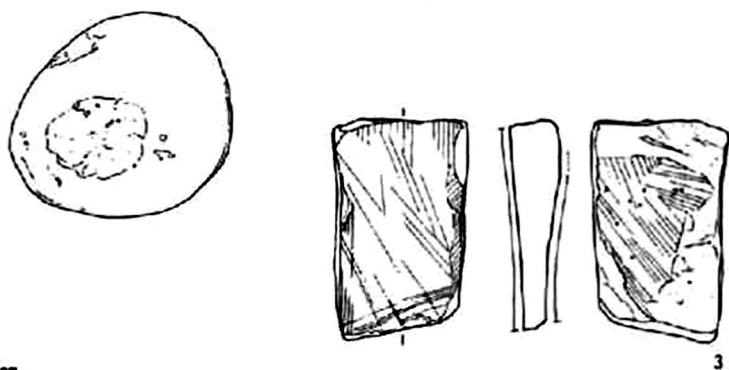
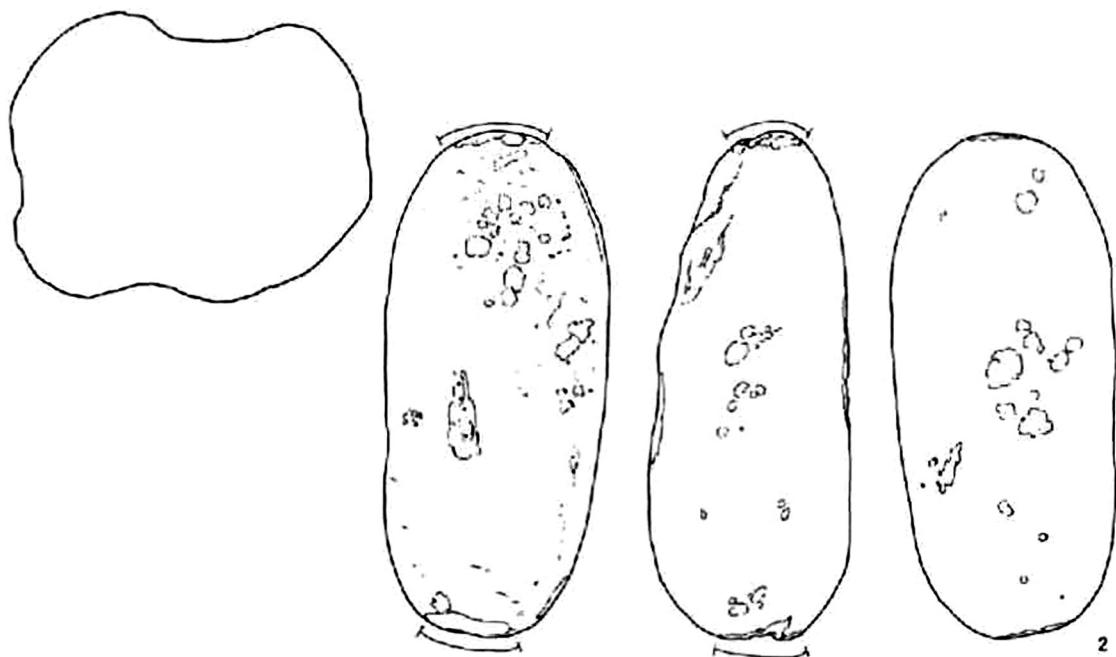
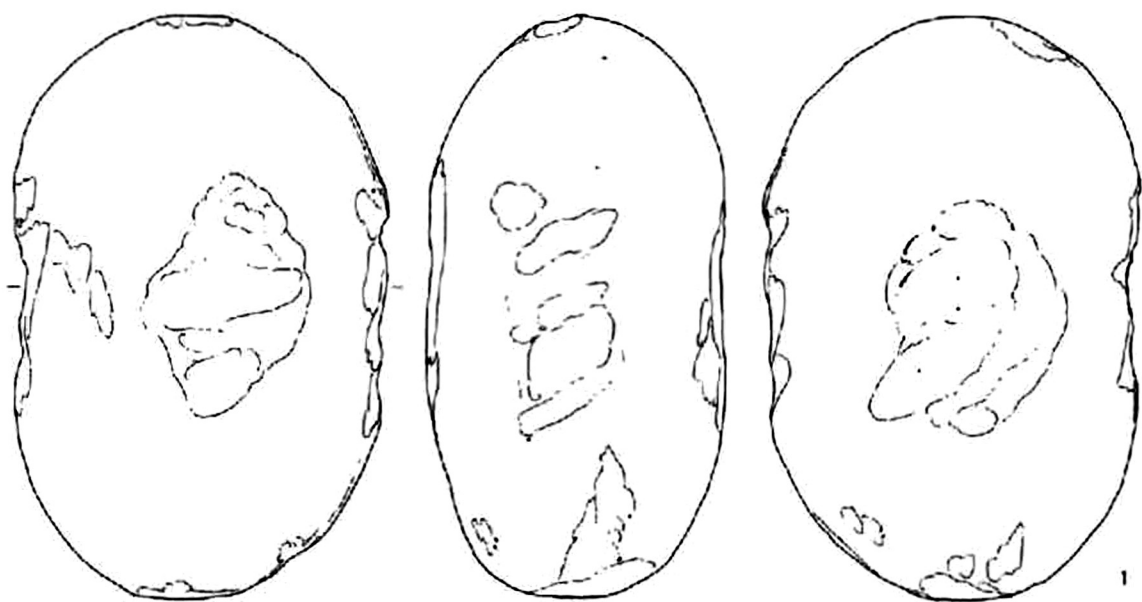
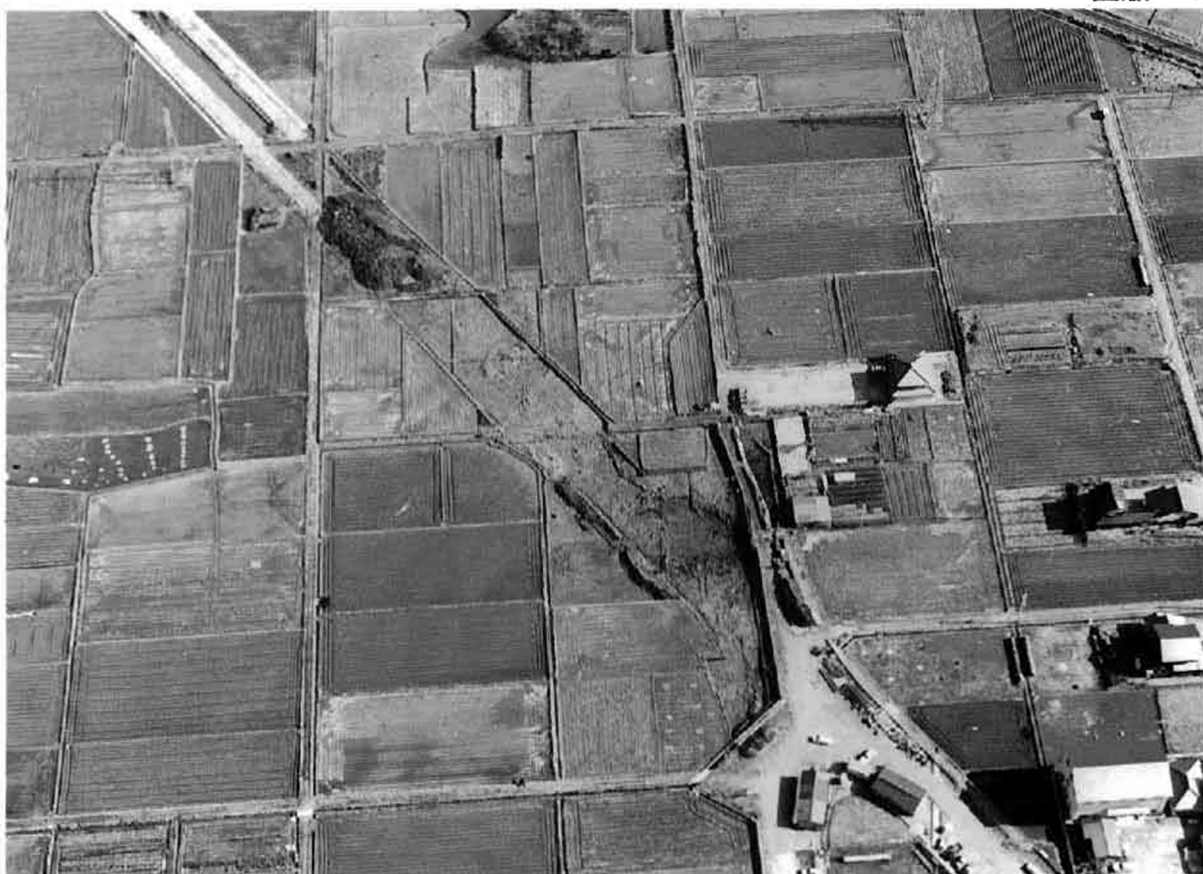

1. 窪地全景
2. 窪地内の状況



1. 窪地西岸土層（北から） 2. 窪地東岸土層（北から） 3. 窪地南端土層（西から）



1. 西微高地（北から）
2. 西微高地（東から）



1. 西岸北半の整地と溝2 (東から)
2. 西岸北半の整地 (北から)
3. 西岸北半整地 除去後



1. 西岸南半の整地
(北から)
2. 西岸南半整地除去後の
人形出土状態
3. 西岸南半整地除去後の
遺物出土状態
4. 西岸南半整地除去後の
木簡出土状態

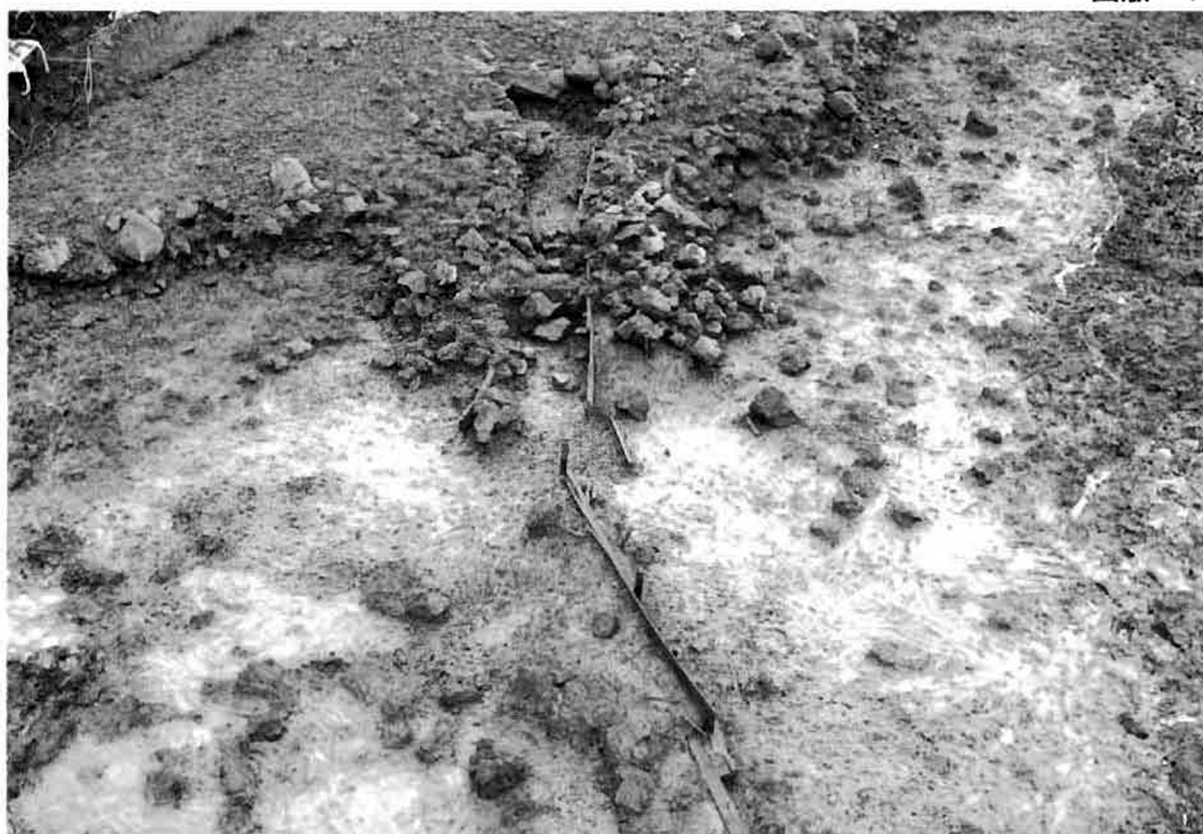

1. 井戸1と溝1 (北から)
2. 井戸1 (北から)
3. 井戸1埋土 (北から)



1. 井戸 2
2. 井戸 2 井戸枠
3. 井戸 2 井戸枠底部



1. 北東隅の集石 2. 通路1 (東から) ↓



1. 東岸遺物出土状態
2. 東岸遺物出土状態
3. 東岸馬骨出土状態



1. 東岸遺物出土状態 2. 東岸遺物出土状態 (Q-215) 3. 東岸遺物出土状態 (T-271)

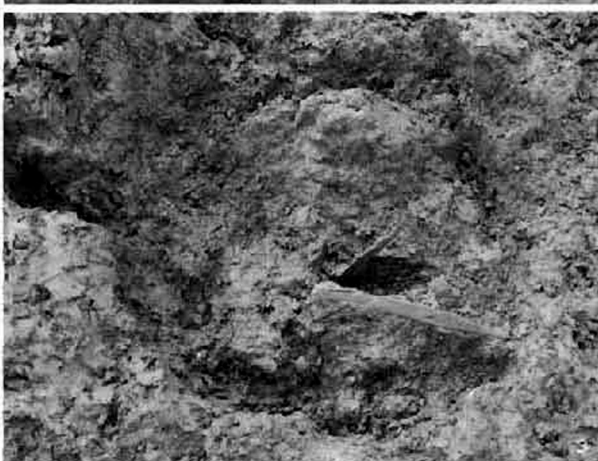

1. 全景 2. 柱穴群（東から） 3. 柱穴2内遺物出土状態 4. 柱穴2

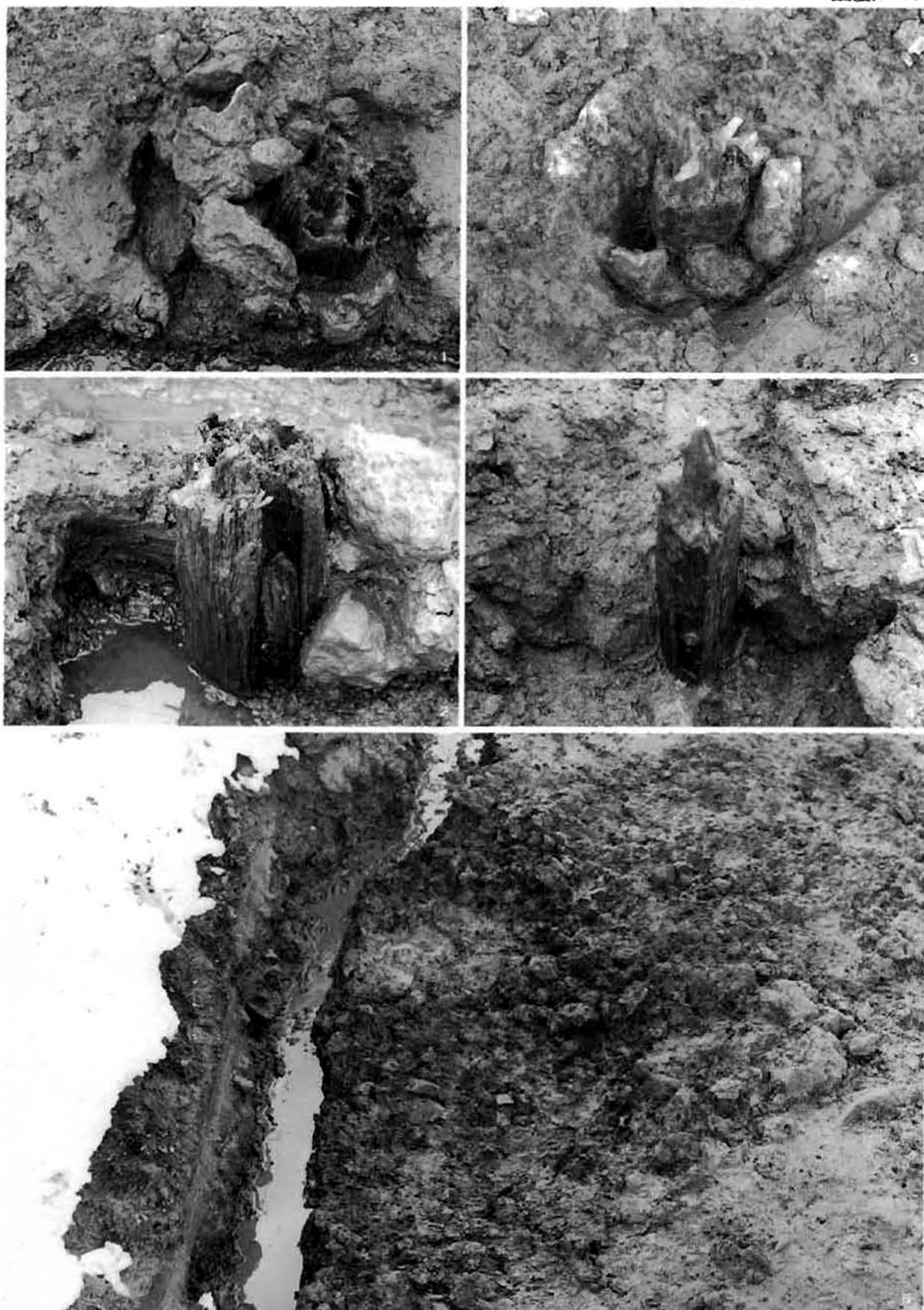

1. 柱穴1 2. 柱穴1内の柱根 3. 柱穴3 4. 柱穴3内の柱根 5. 土壌1



1. 全景 (西から)
2. 土壌 (南から)



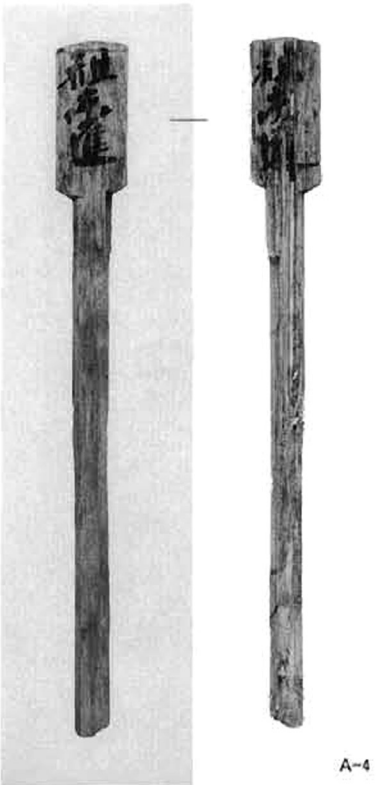
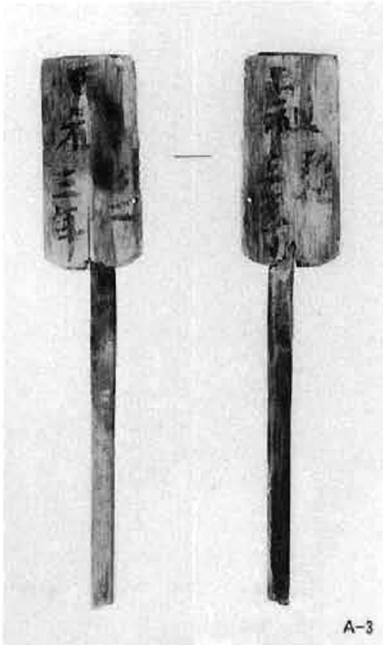
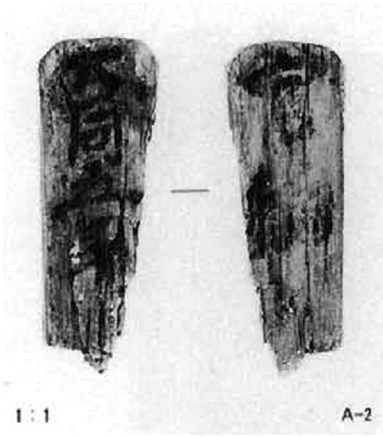



A-10



A-12



A-22



A-15

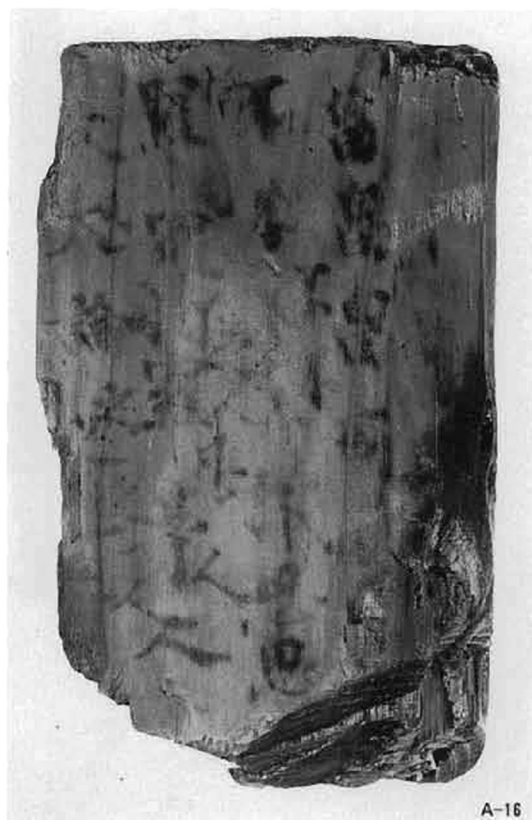

A-16

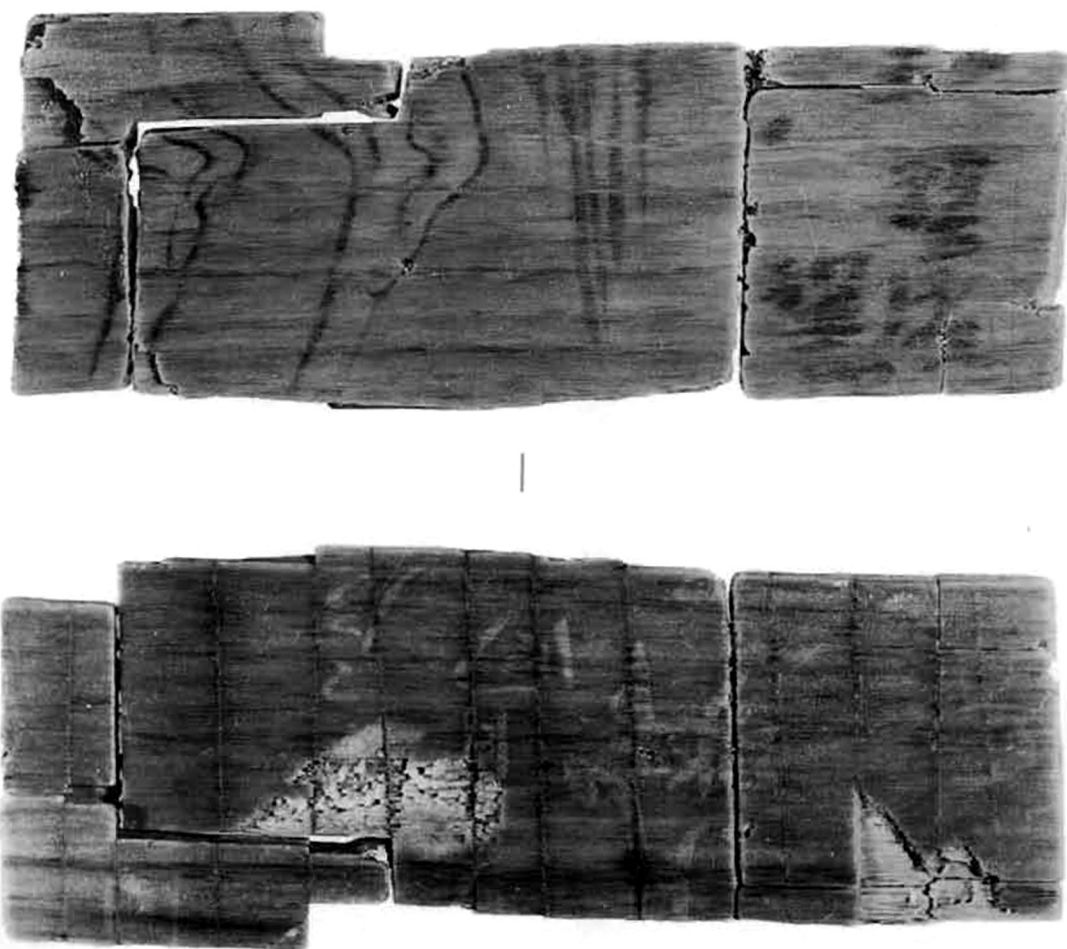

窪地西岸灰色シルト下出土

A-30

1:1

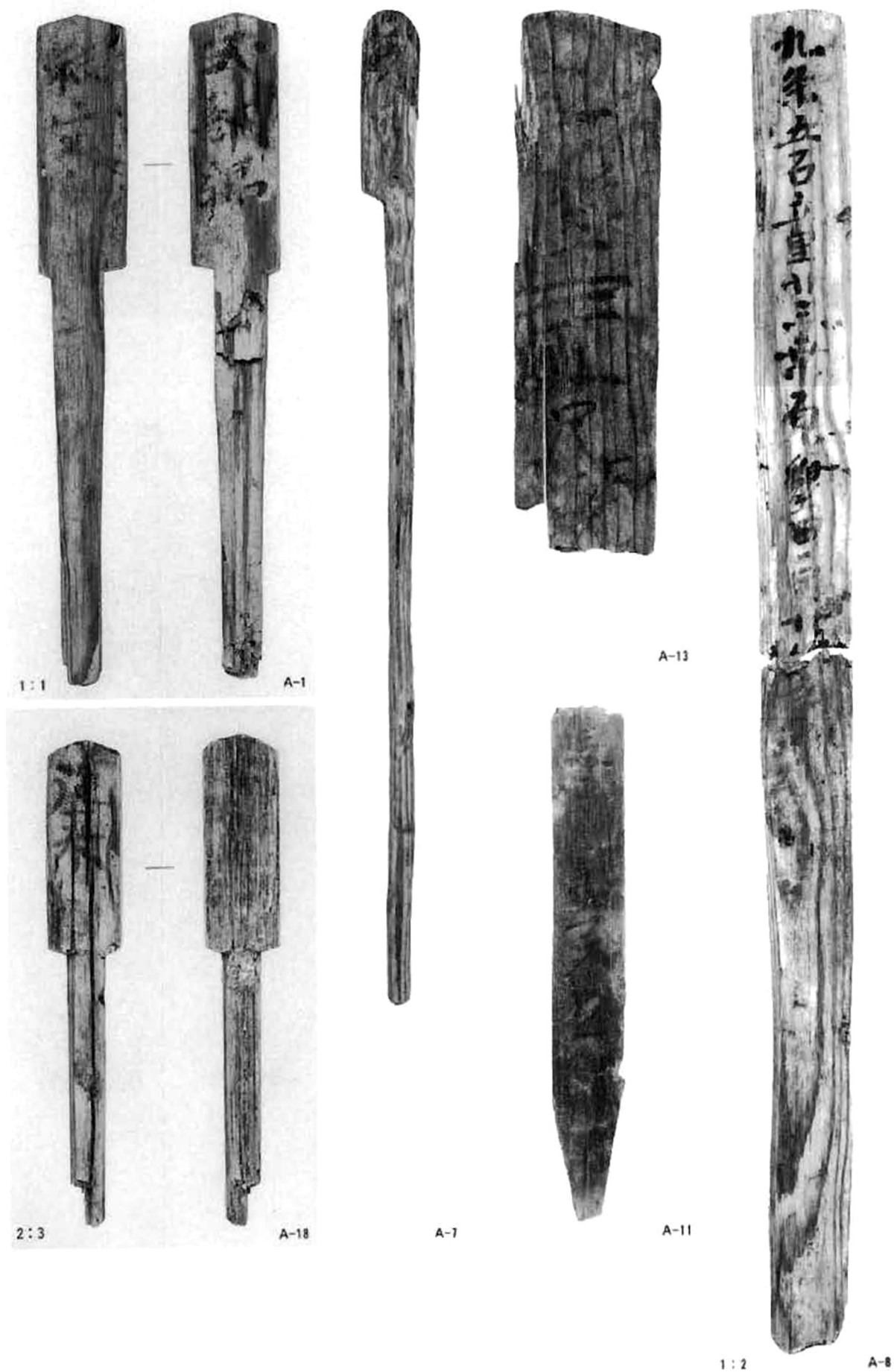

窪地東岸黒灰色シルト出土



1:1



A-19



2:3

A-9



2:3

A-23



1:2

A-28



2:3

A-24



2:3

A-20



1:1



A-34

窪地東岸黒灰色シルト上、灰色シルト下、灰色シルト出土

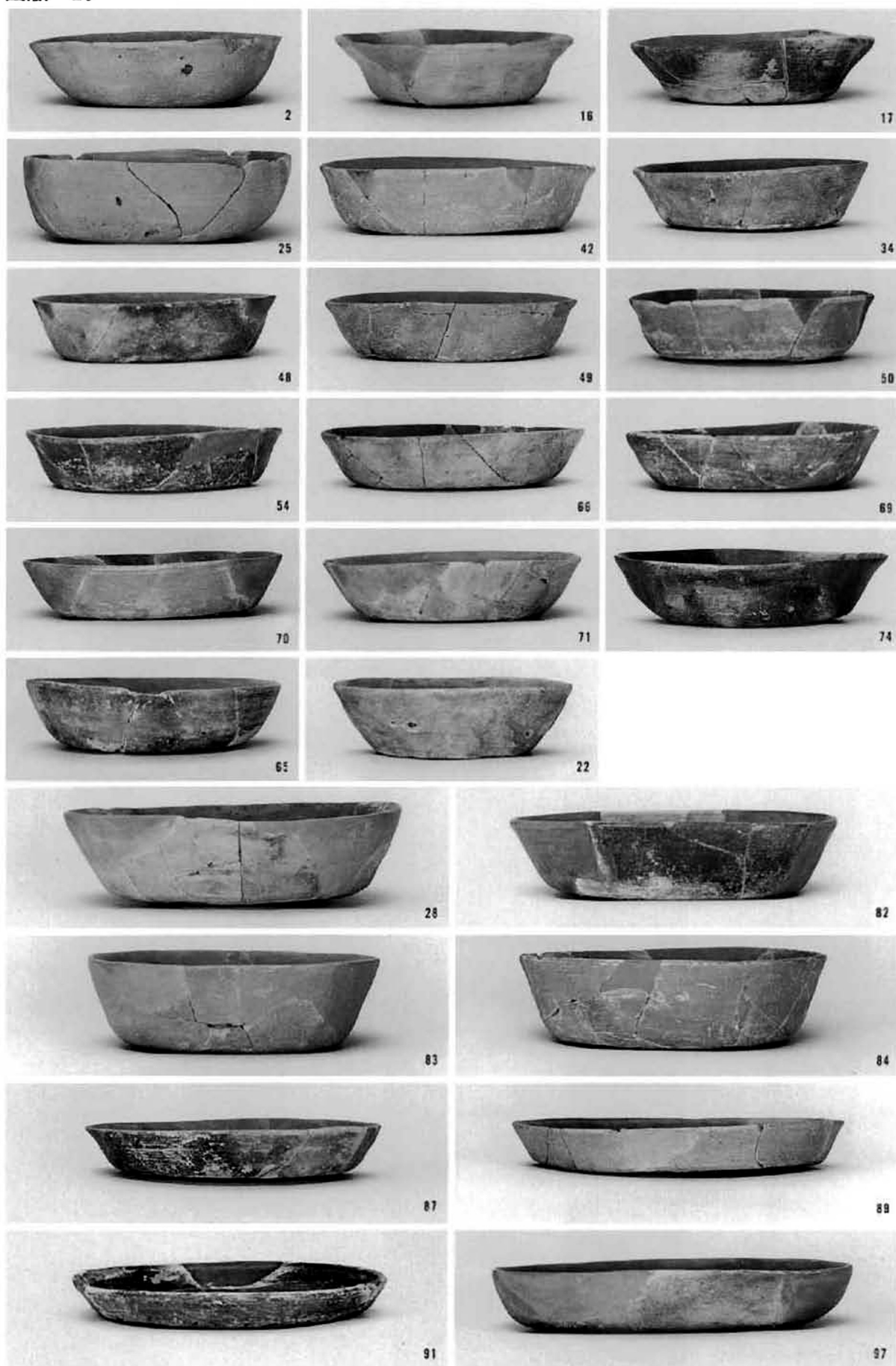



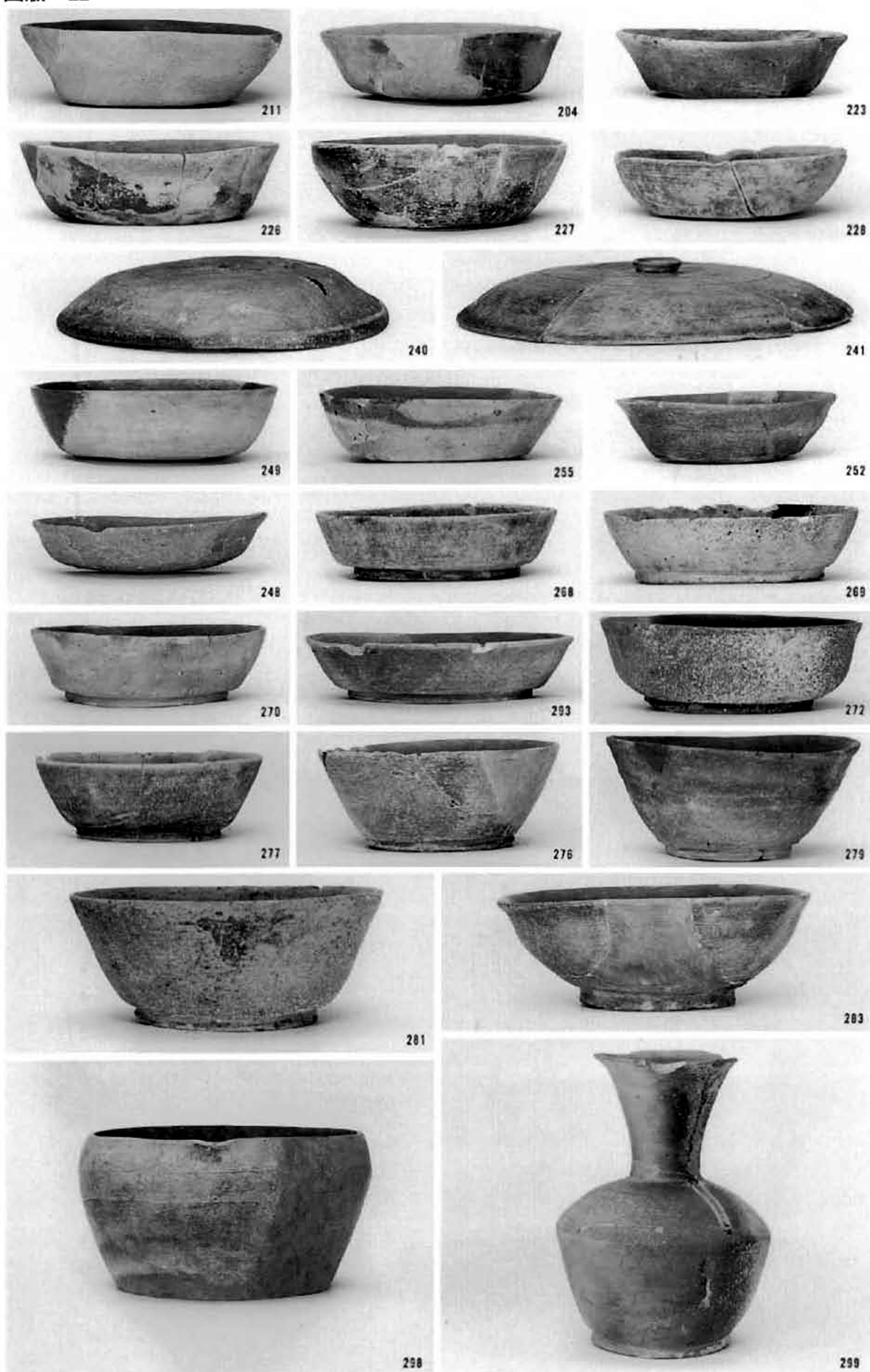



311



313



316



317



318



323



324



333



334



335



窪地西岸黒灰色シルト上・灰色シルト下

371



352



354



356



358



357



362



355



364



365



366



360



367

窪地西岸黒灰色シルト下・灰色シルト上出土



372



379



381

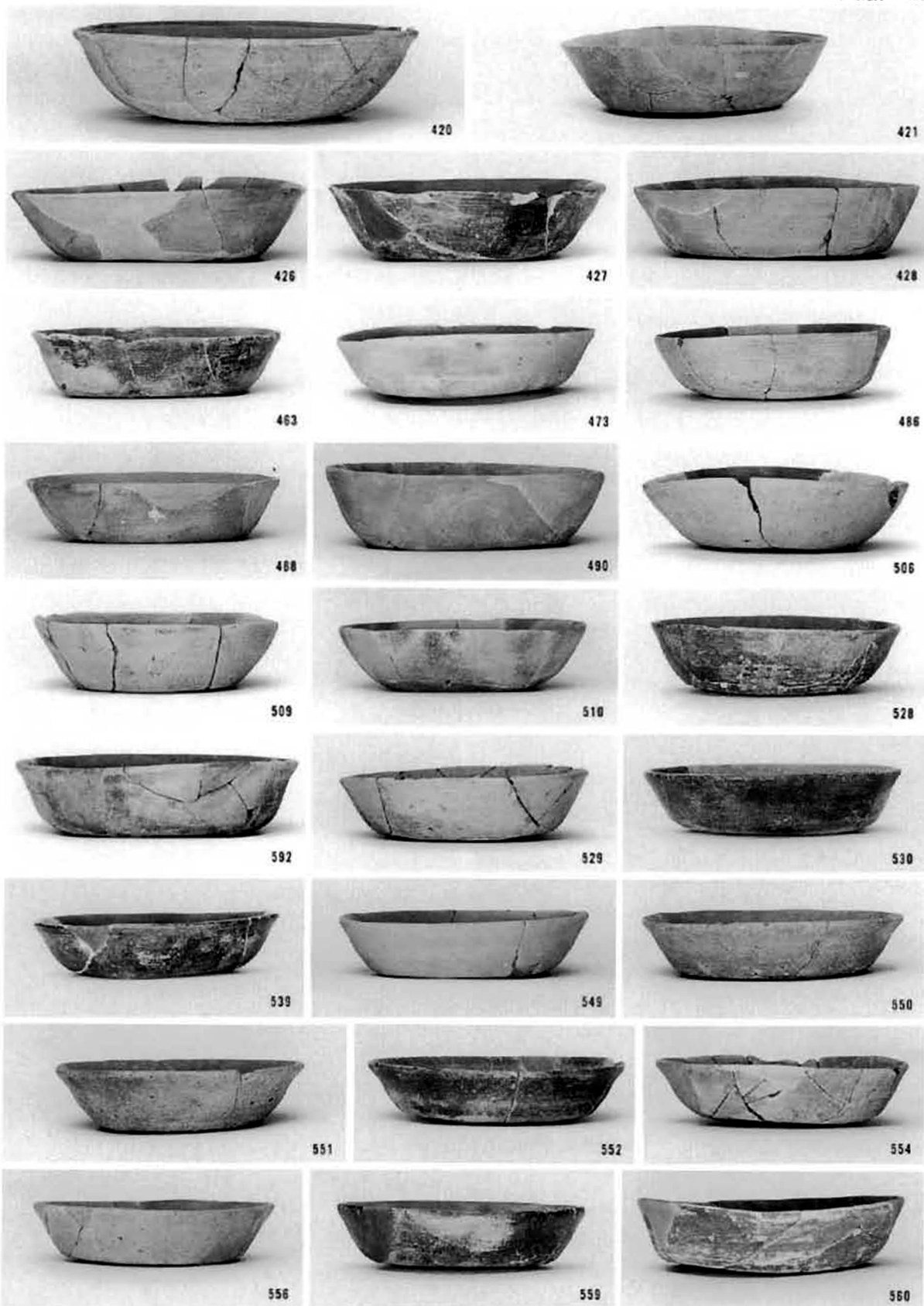

窪地東岸黒灰色シルト出土