

図版十七 遺跡B地区 信太山1・2号(新) 窯地形測量図

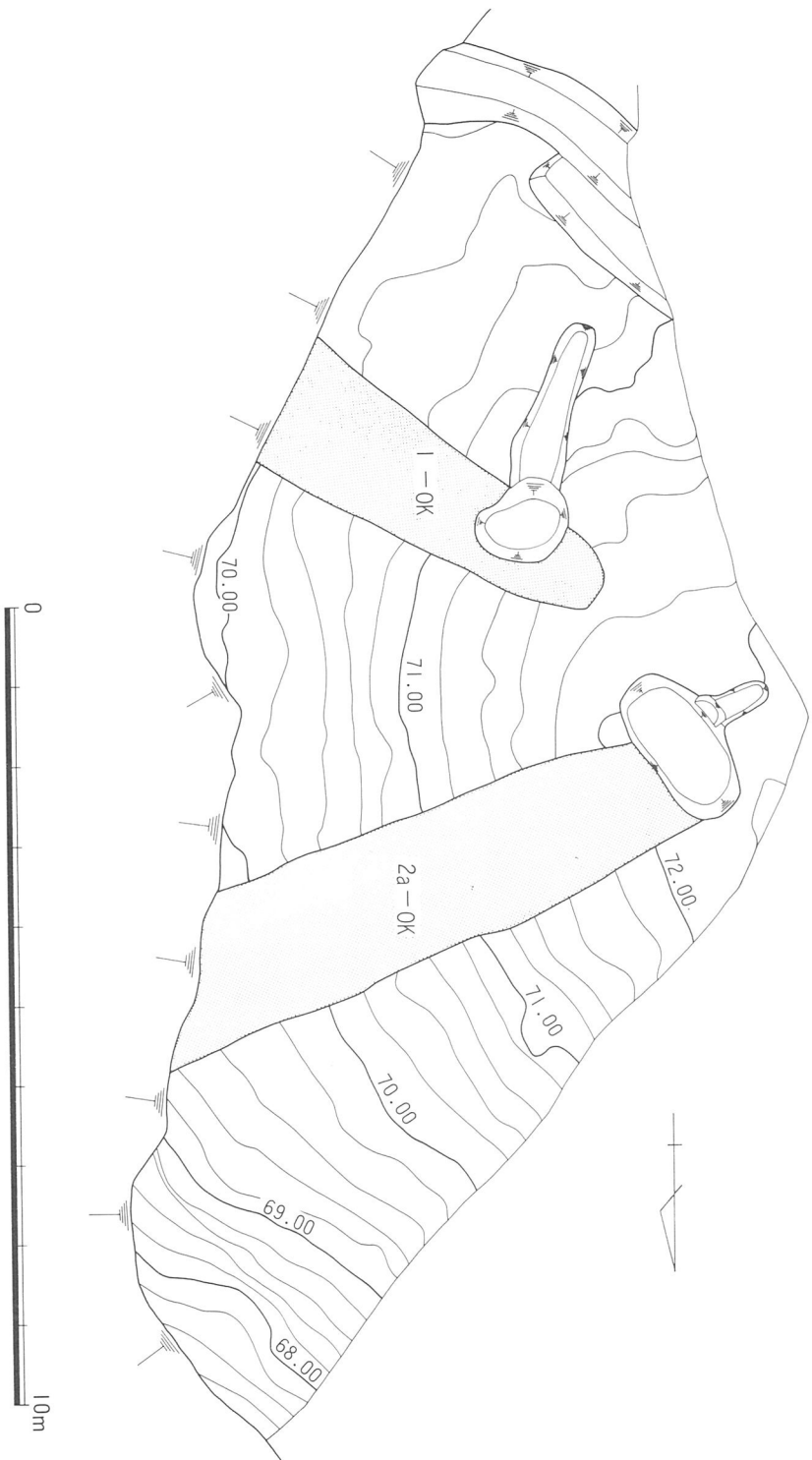

- 貼り壁
- 基底
- - - 掘り方
- 赤色酸化層
- 窯体壁・天井
- //// 大阪層群地山

- 第1層 焼土混り土10YR6/6・10YR7/6
- 第2層 窯体片・焼土混り土10YR6/4
- 第3層 焼土2.5YR5/8
- 第4層 炭化物を多量に含む土10YR3/2
- 第5層 わずかに有機質を含む土10YR6/6

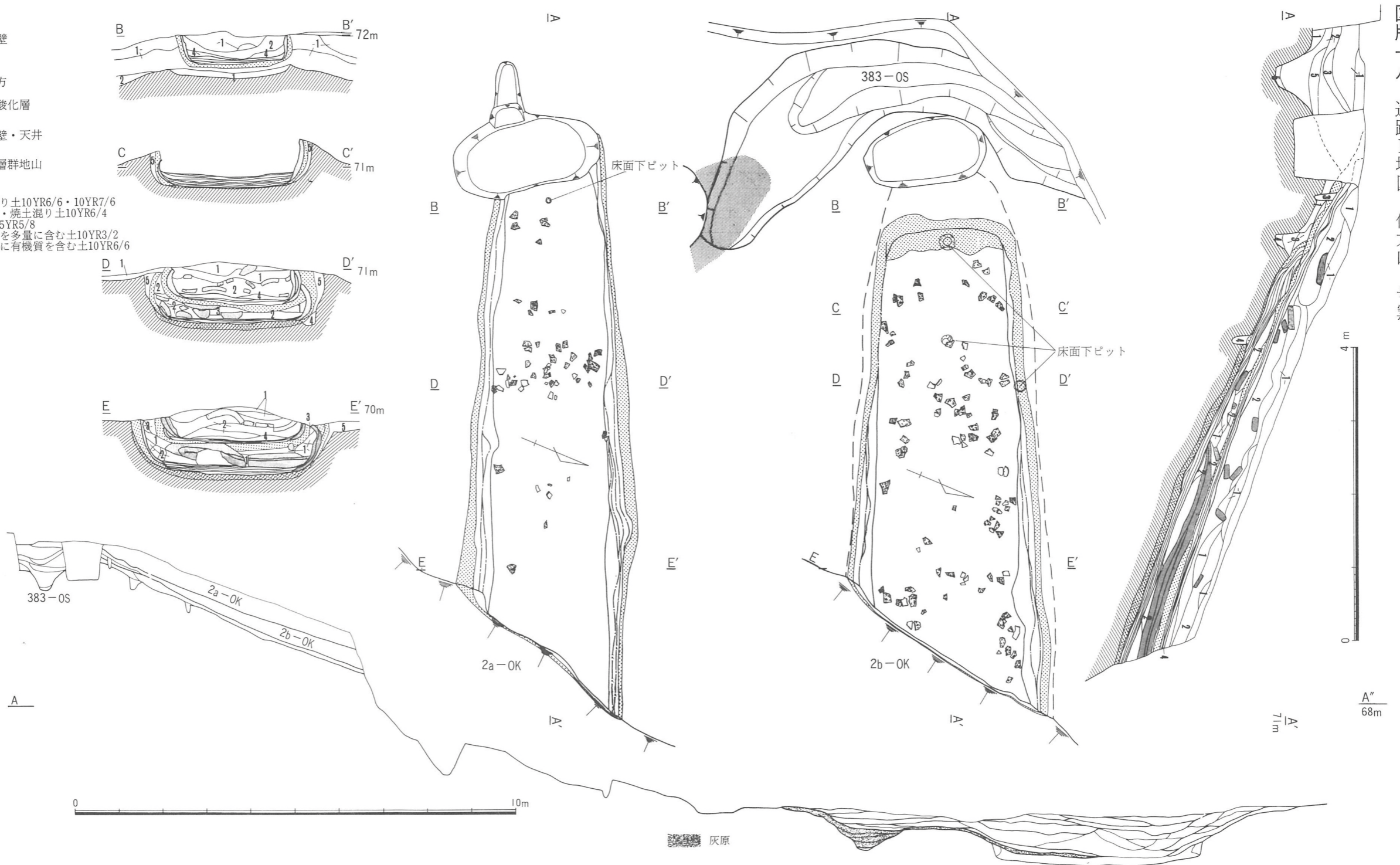

図版十九 遺跡B地区 信太山3号窯地形測量図

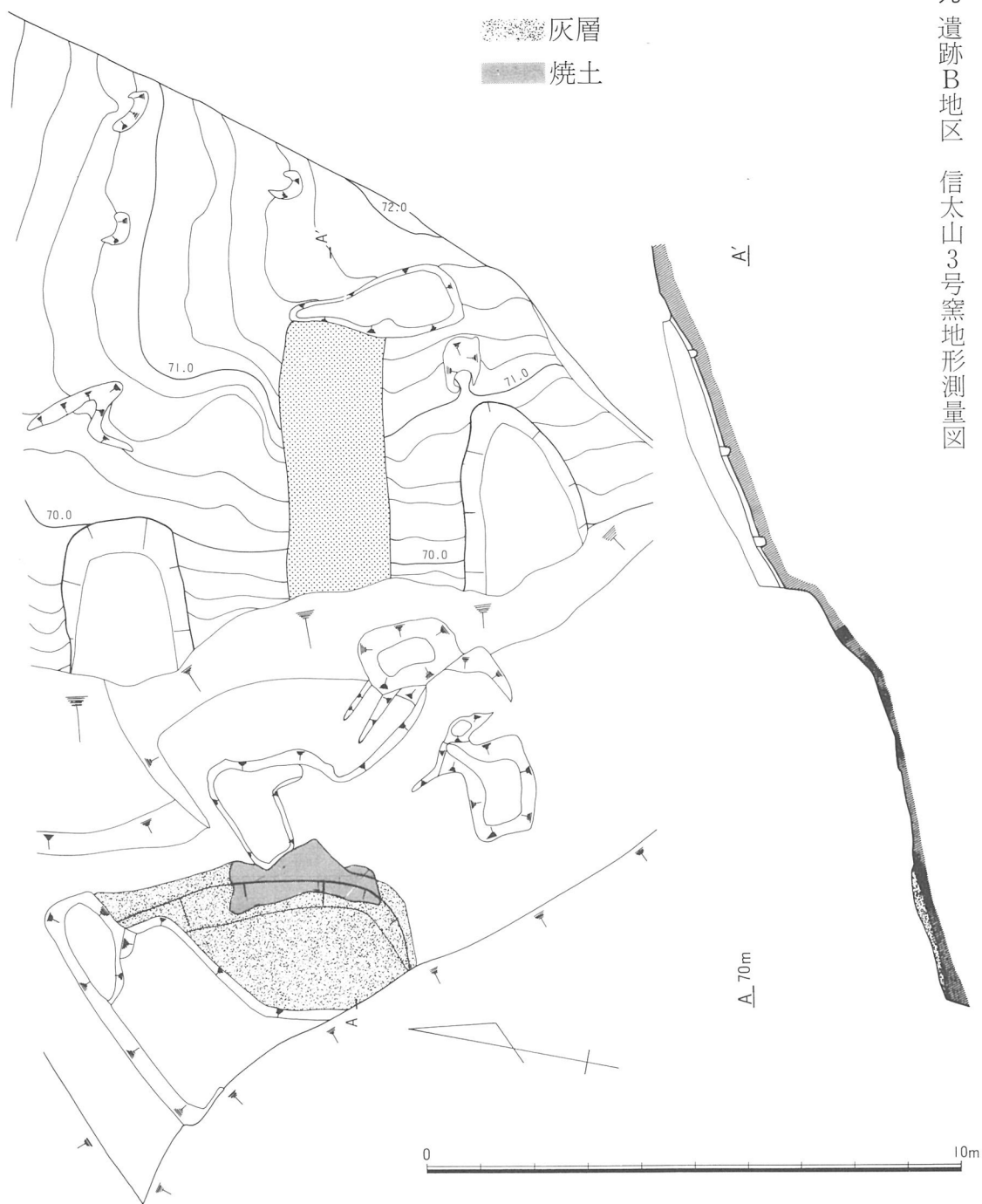

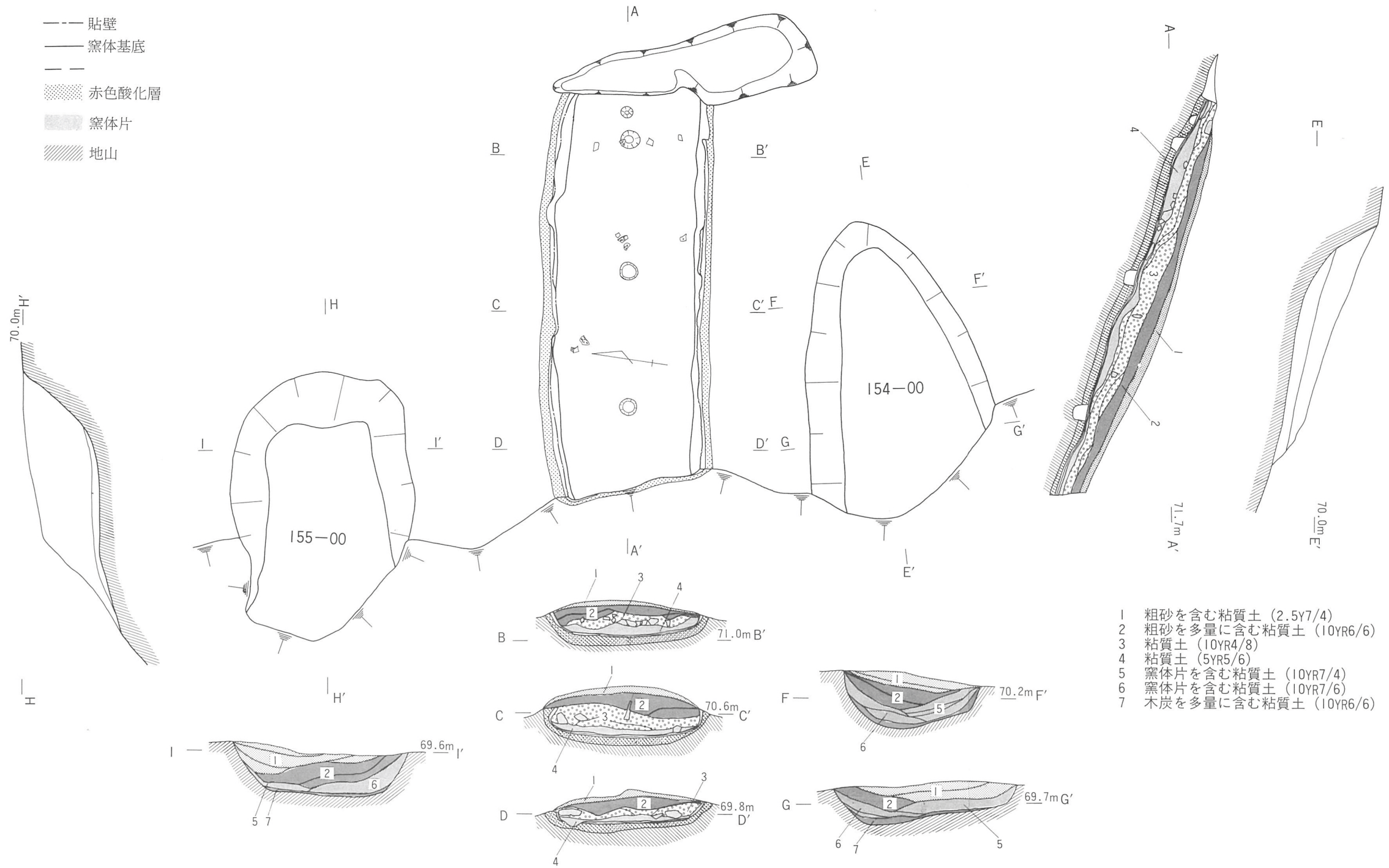

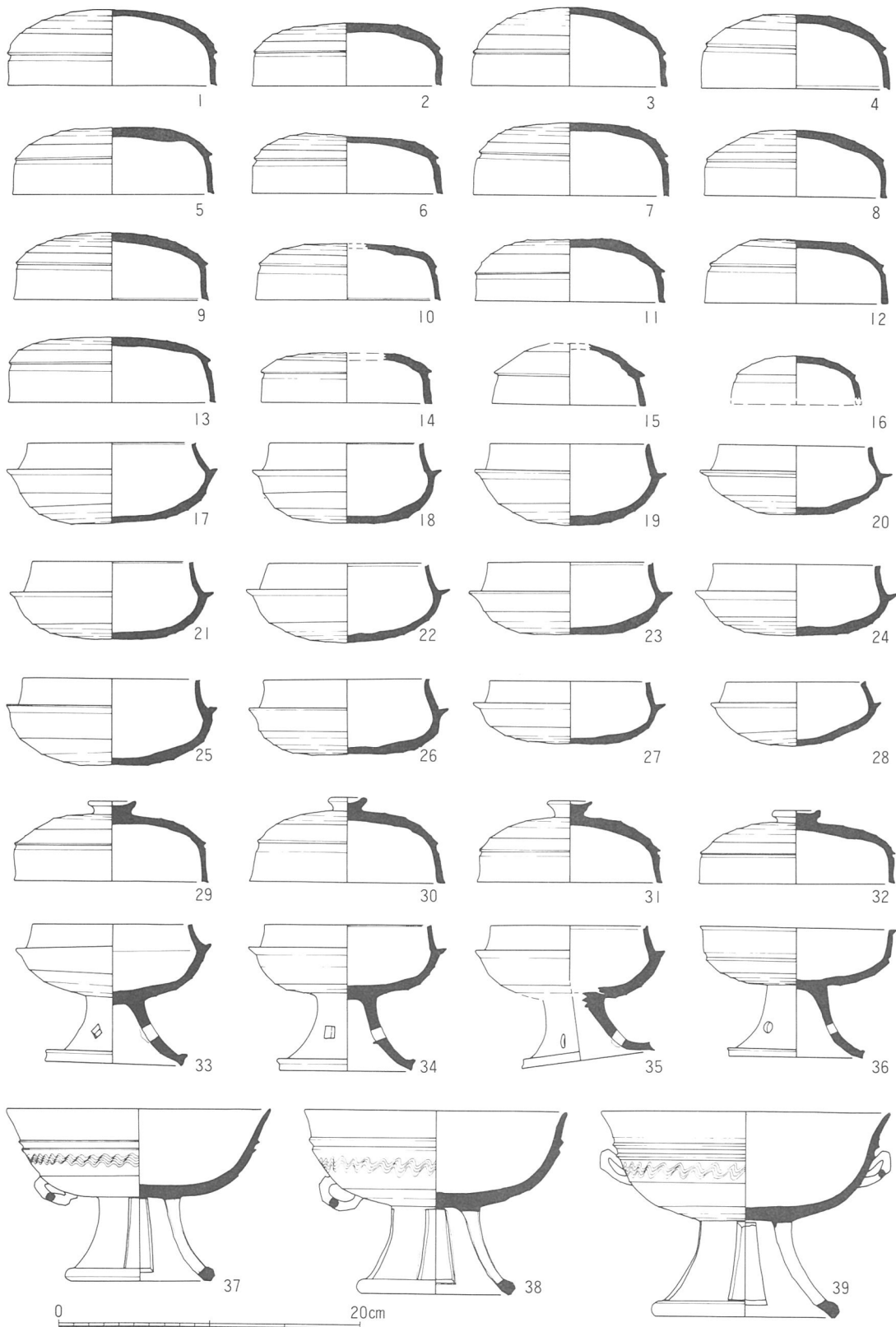

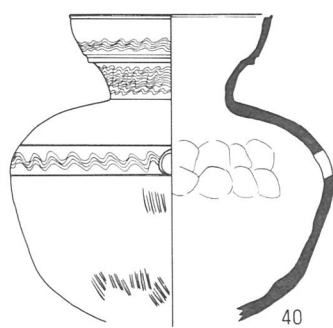

40

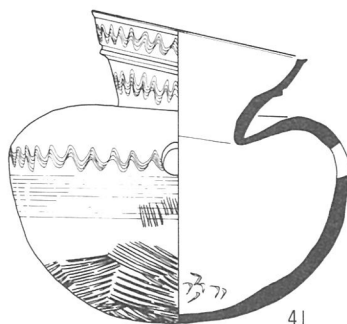

41

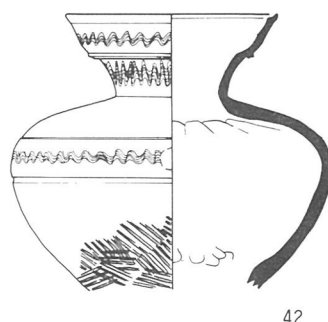

42

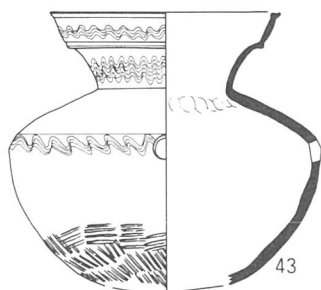

43

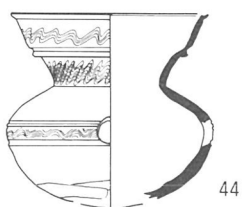

44

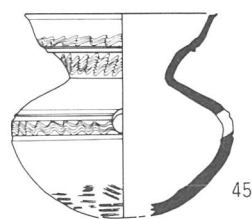

45

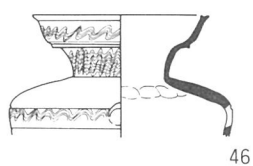

46

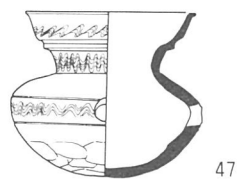

47

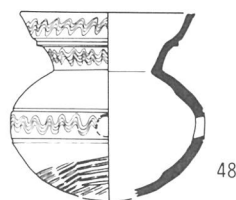

48

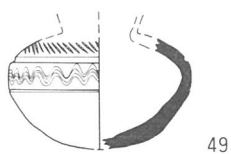

49

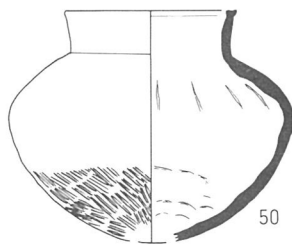

50

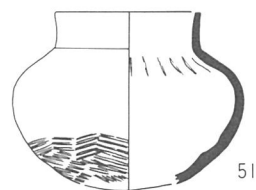

51

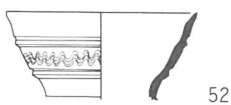

52

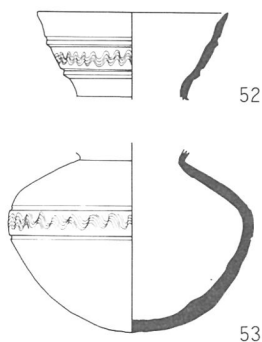

53

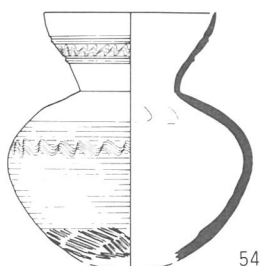

54

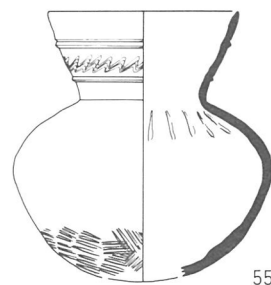

55



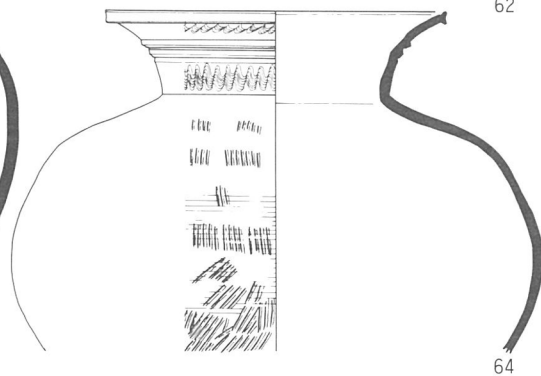
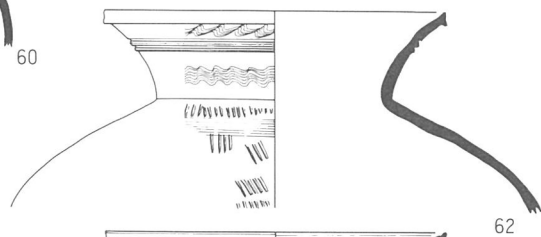
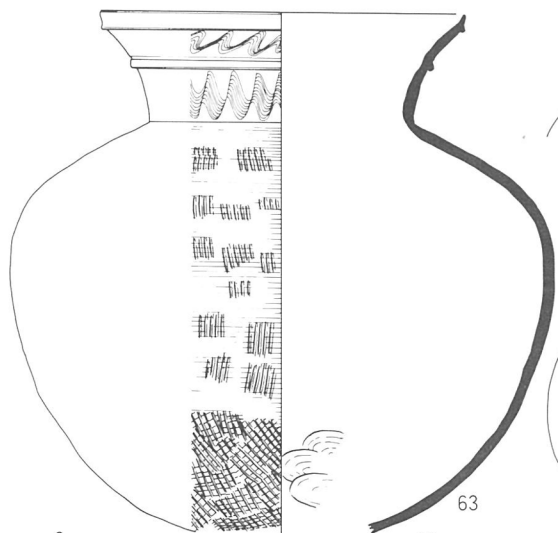
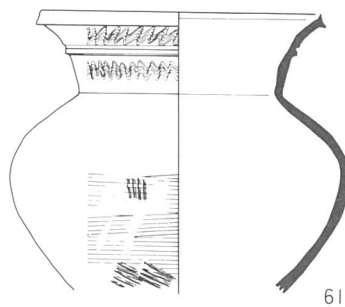
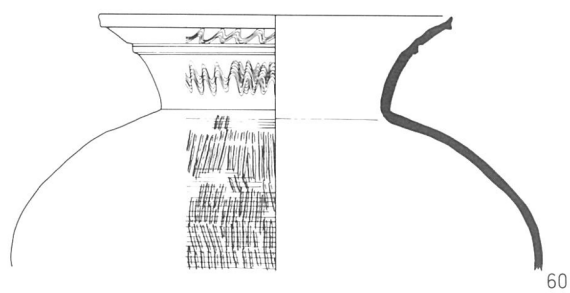
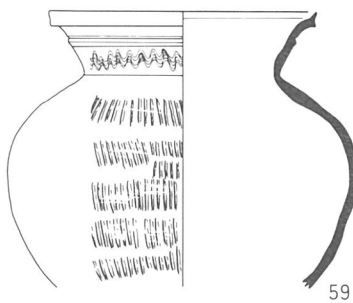
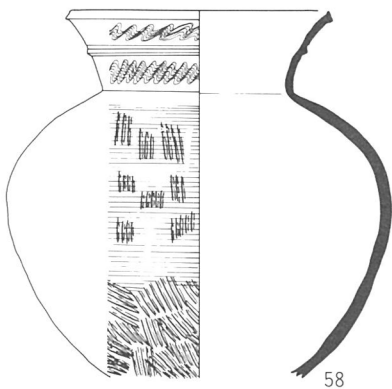
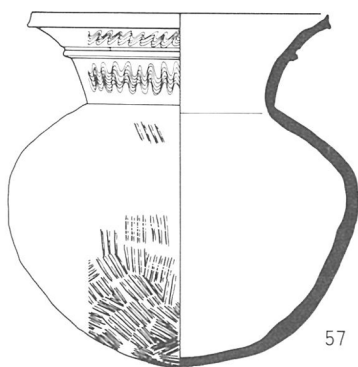
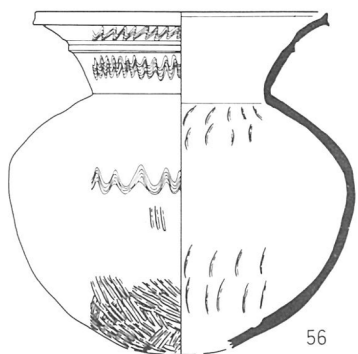

0 20cm

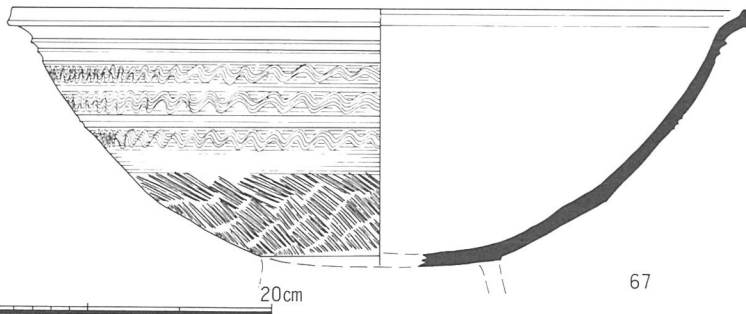
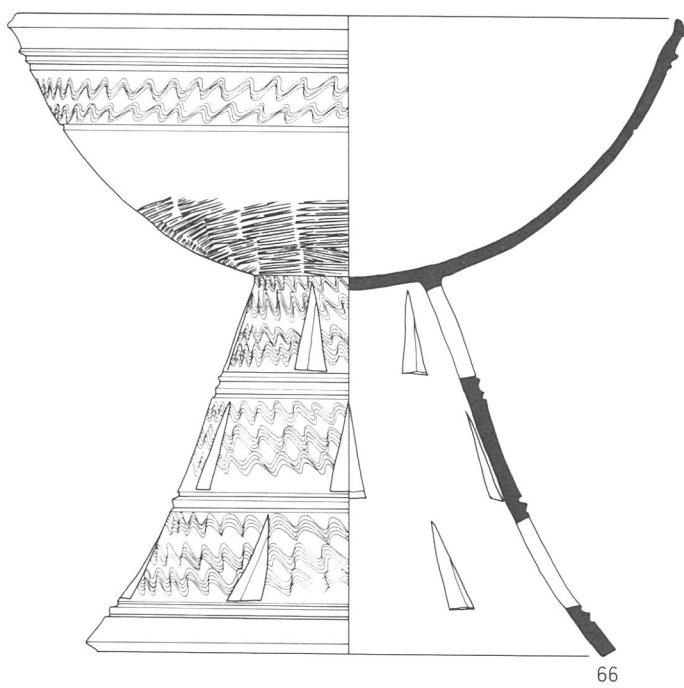
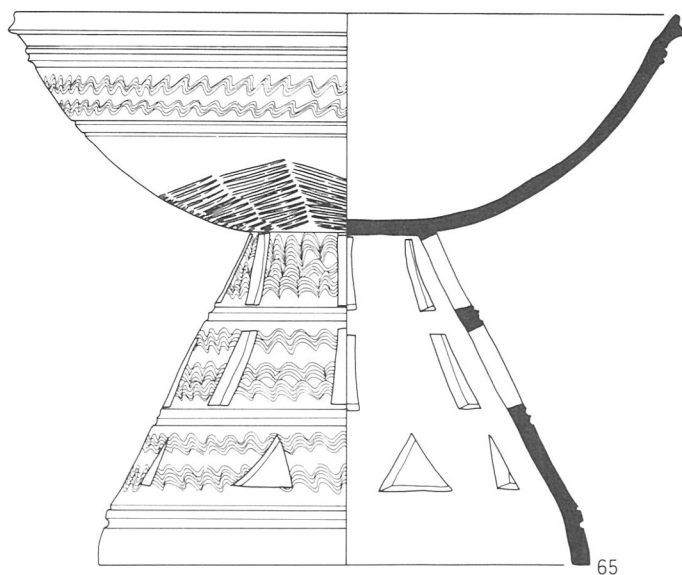



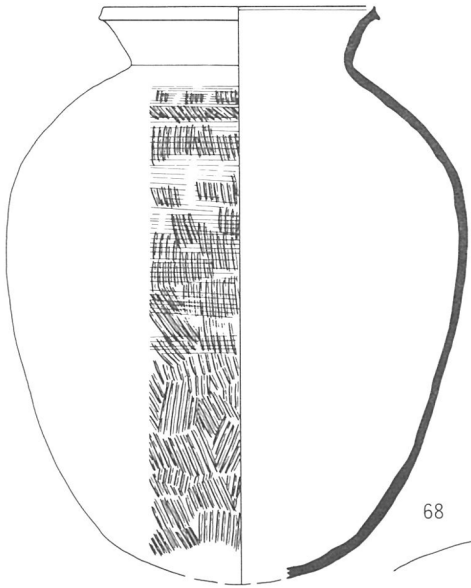

68

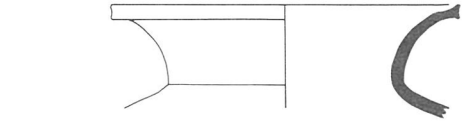

69

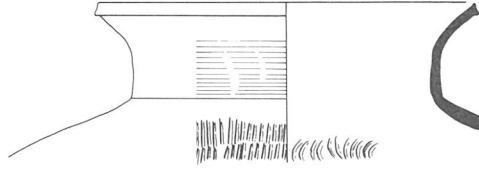

70

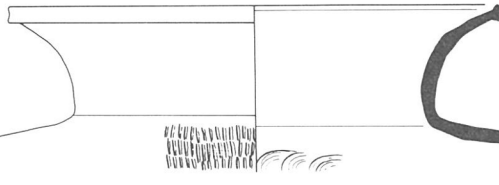

71

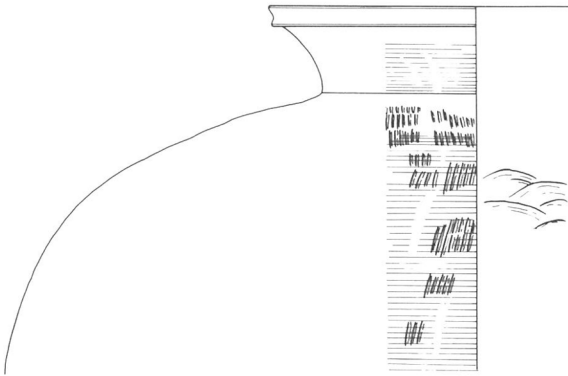

72

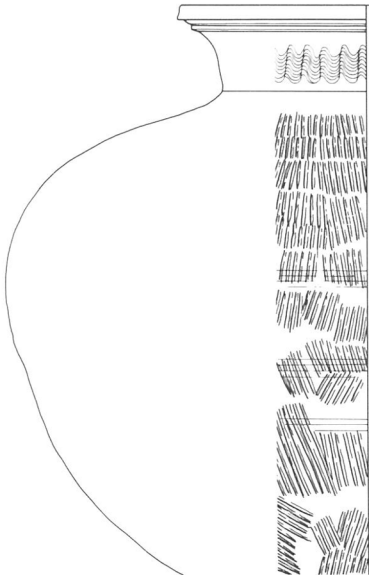

73



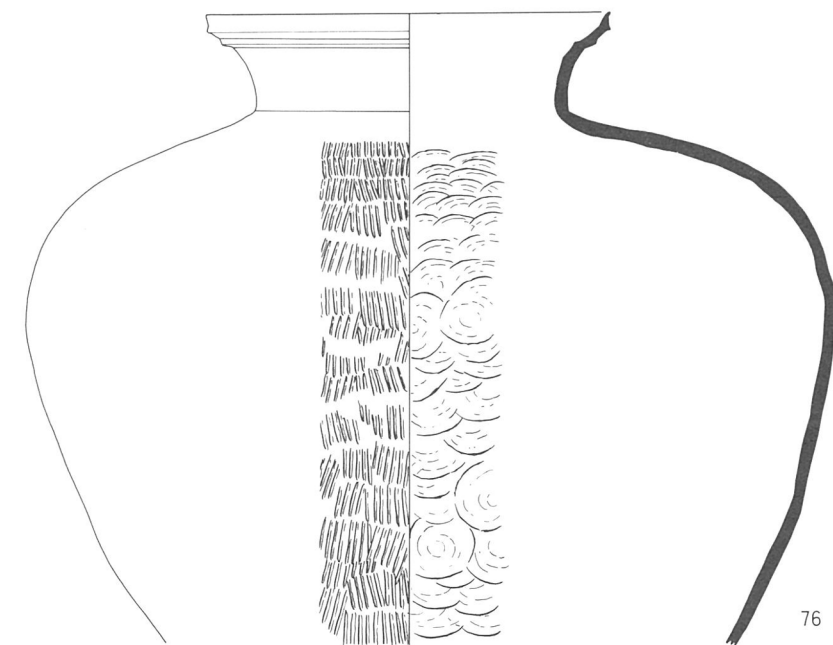
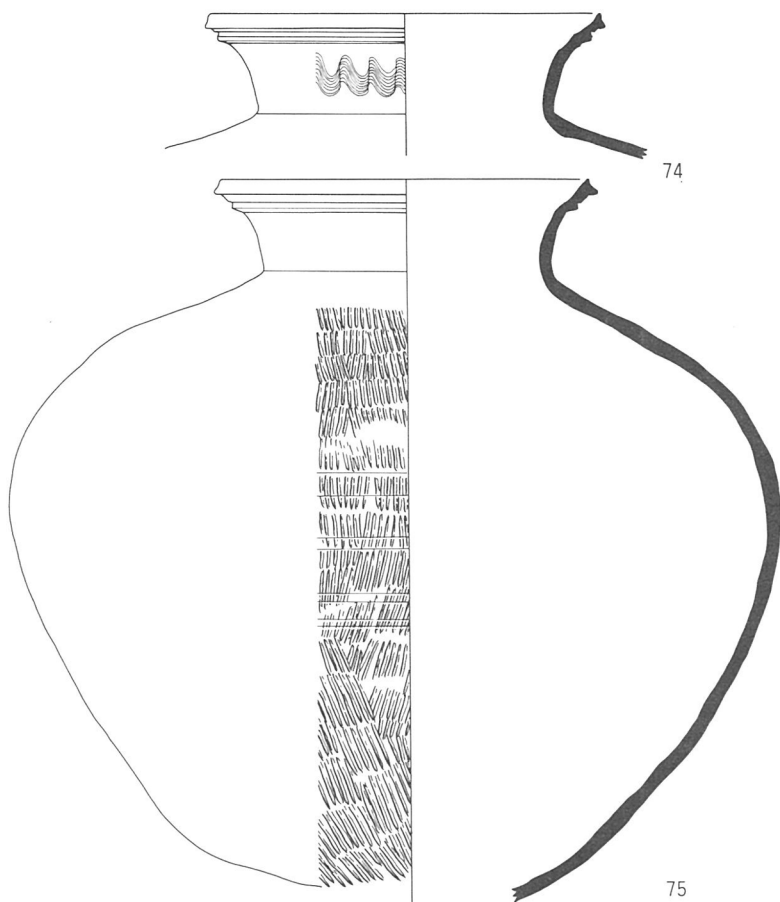

0 20cm

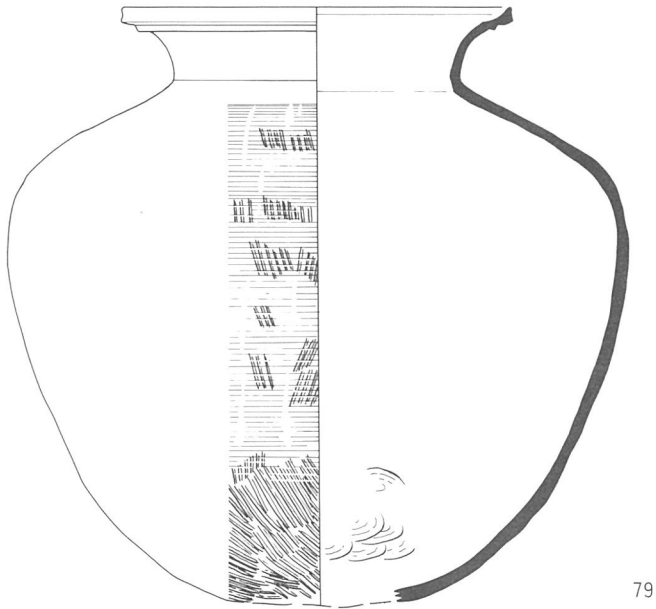
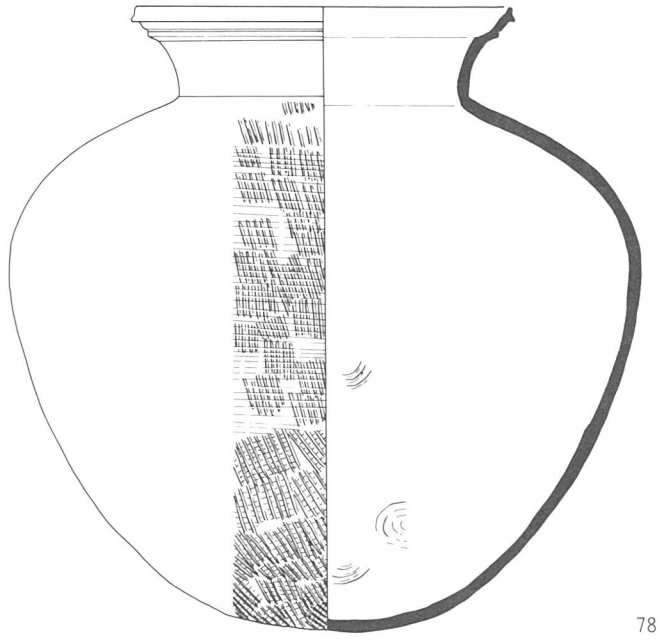
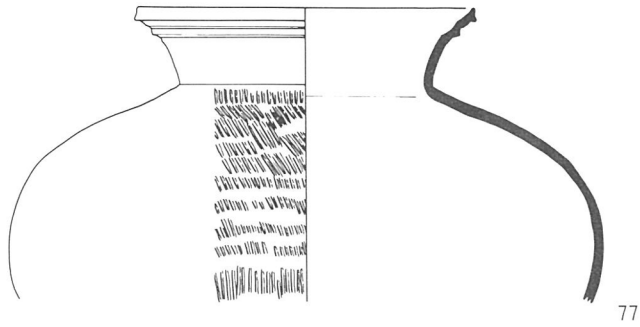

0 20cm

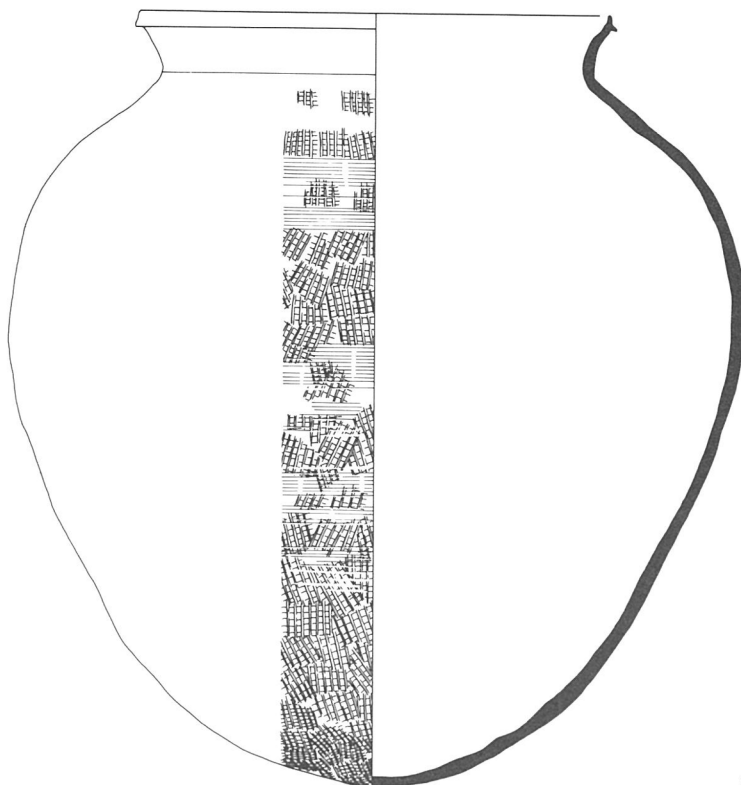

80

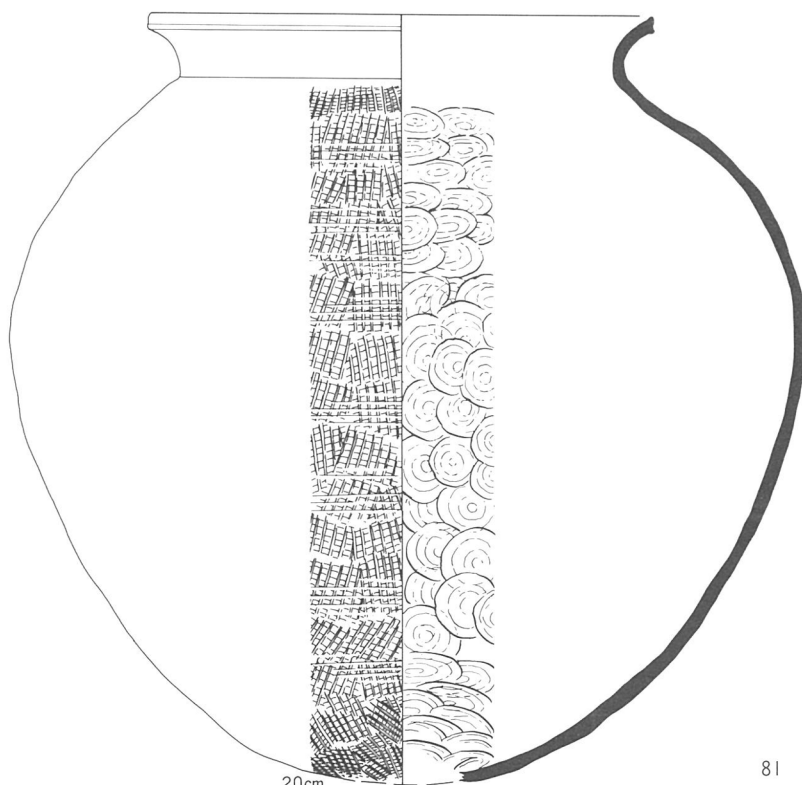

0 20cm

81

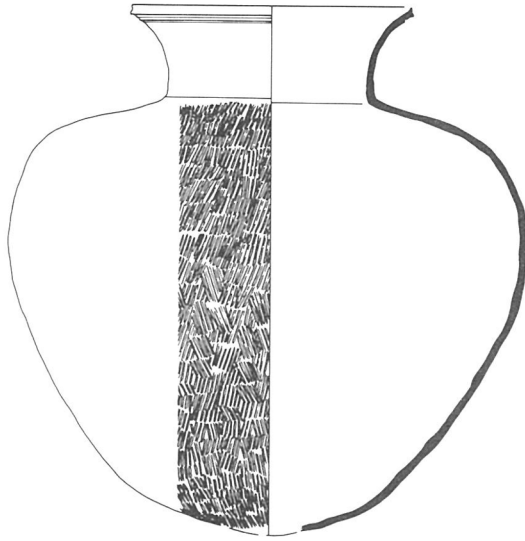

82

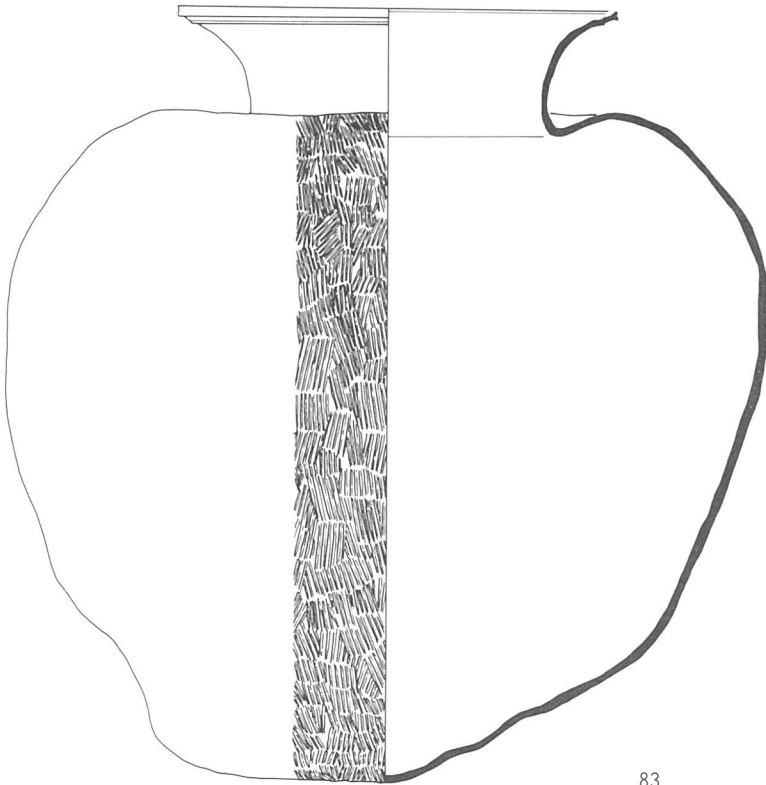

83

0 40cm

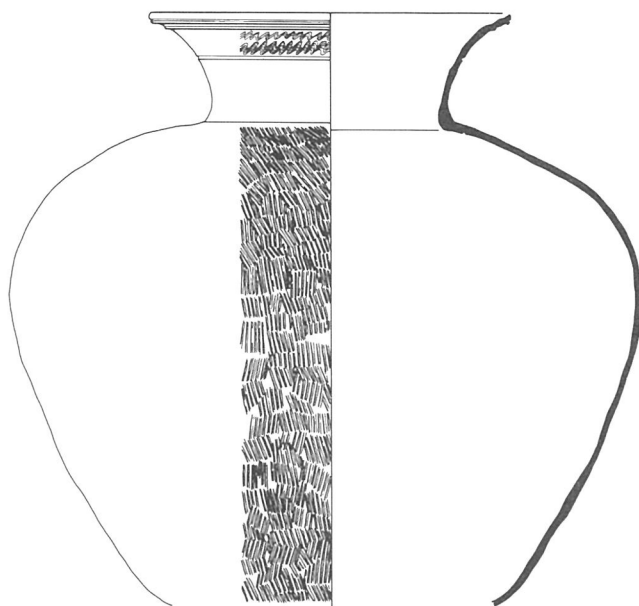

84

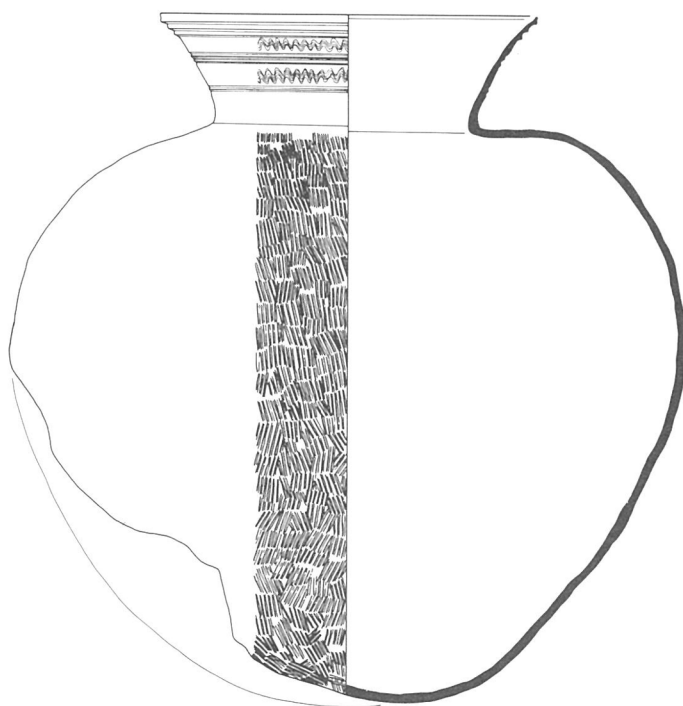

85

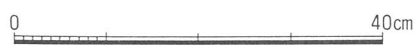

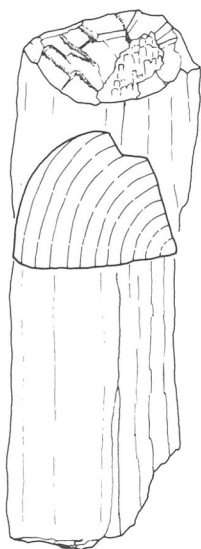
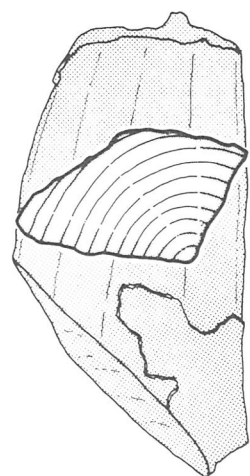
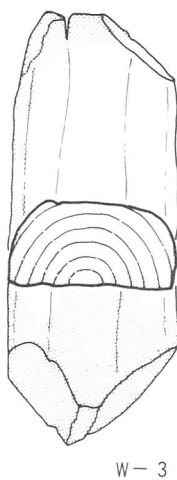
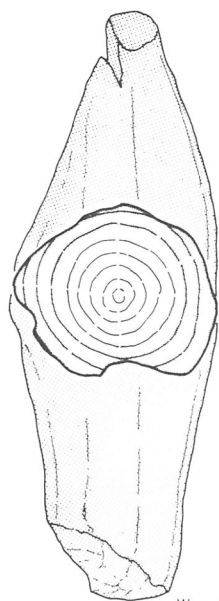
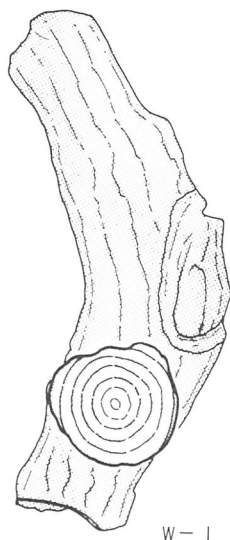

W-7

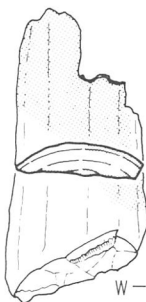

W-10

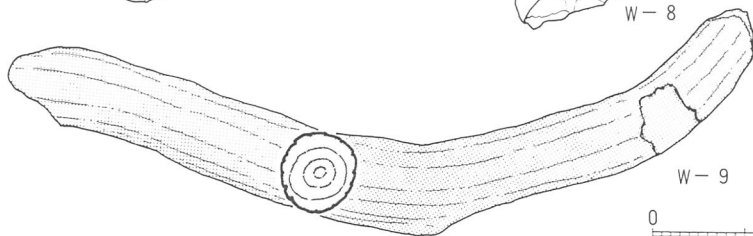

0 40cm

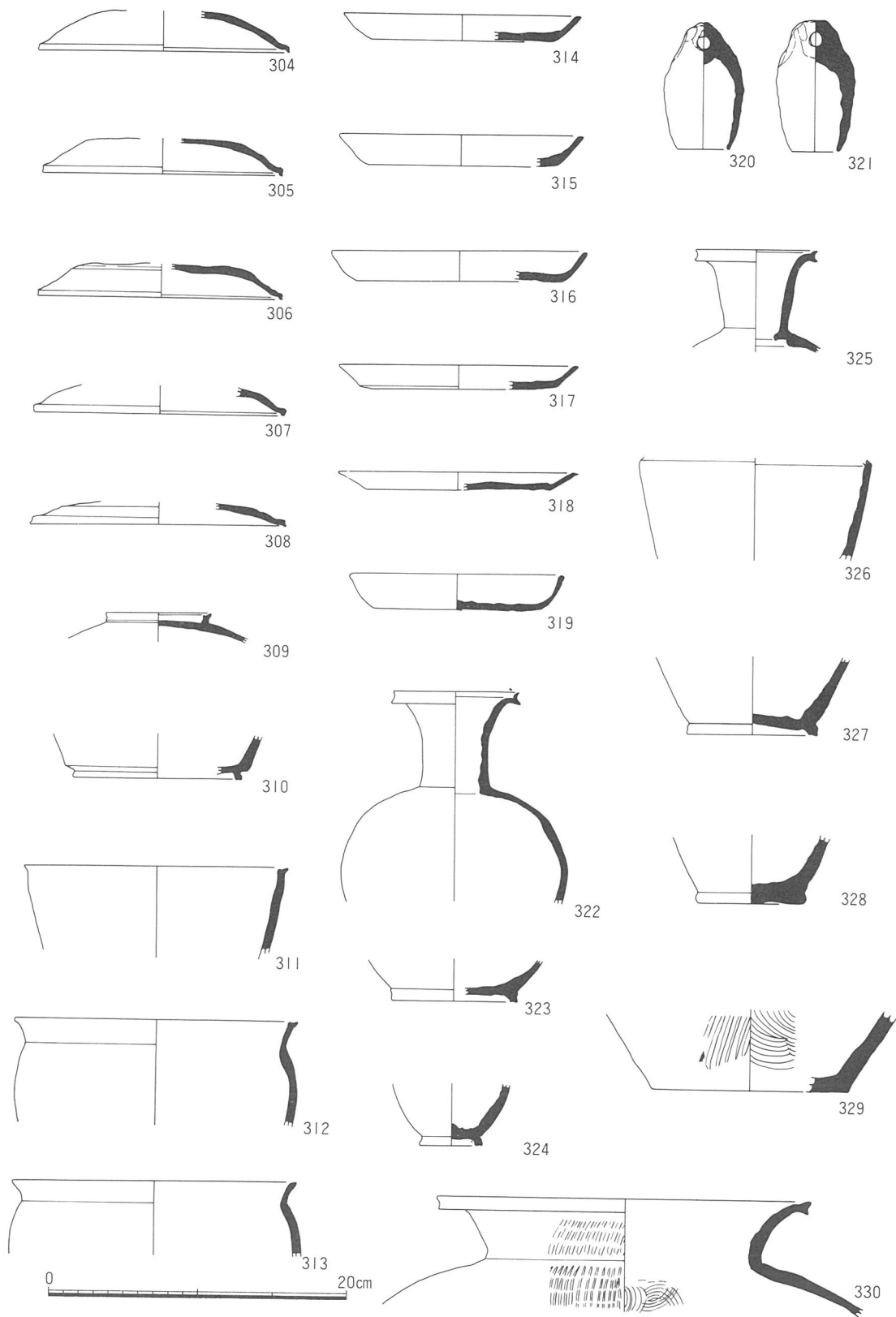



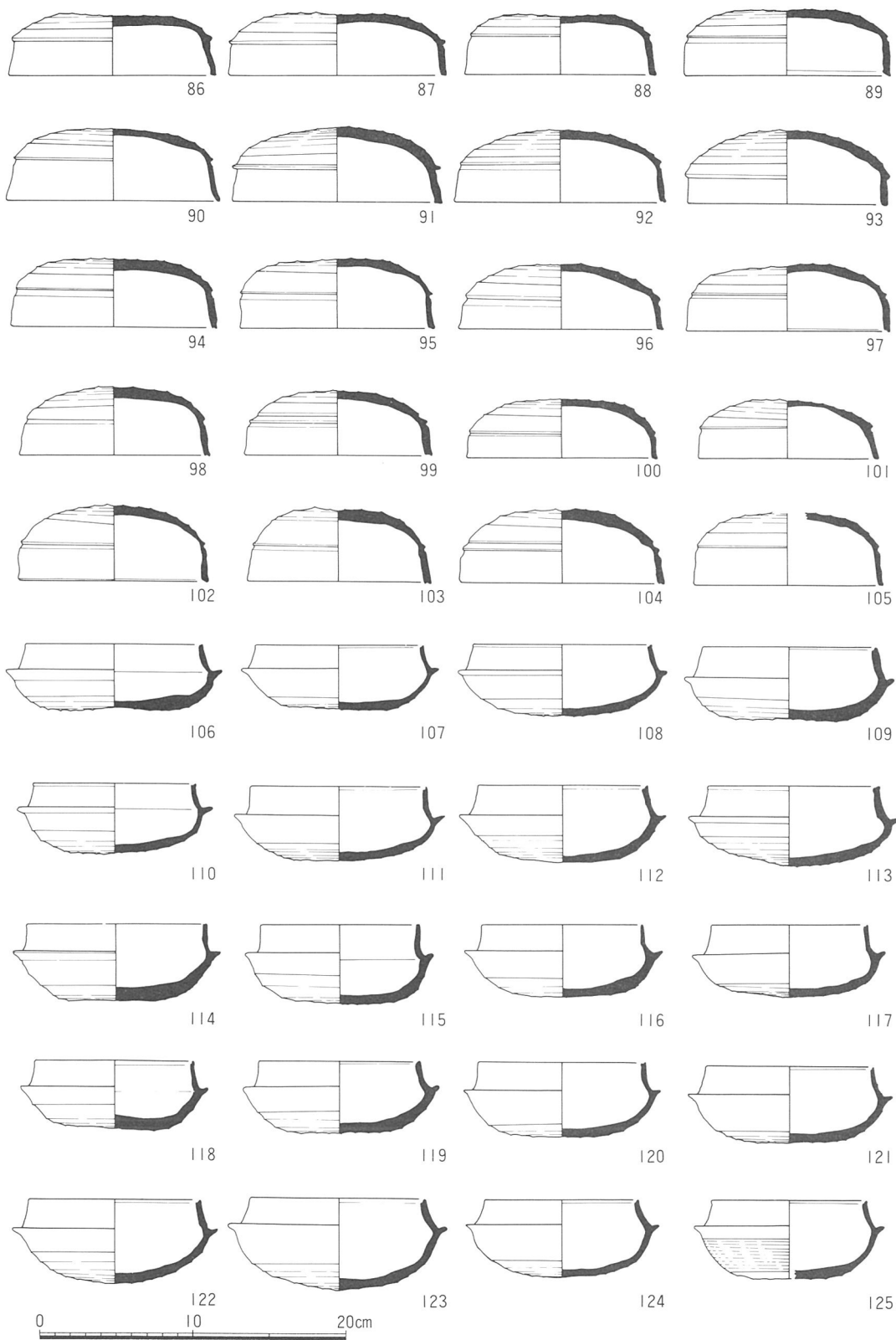

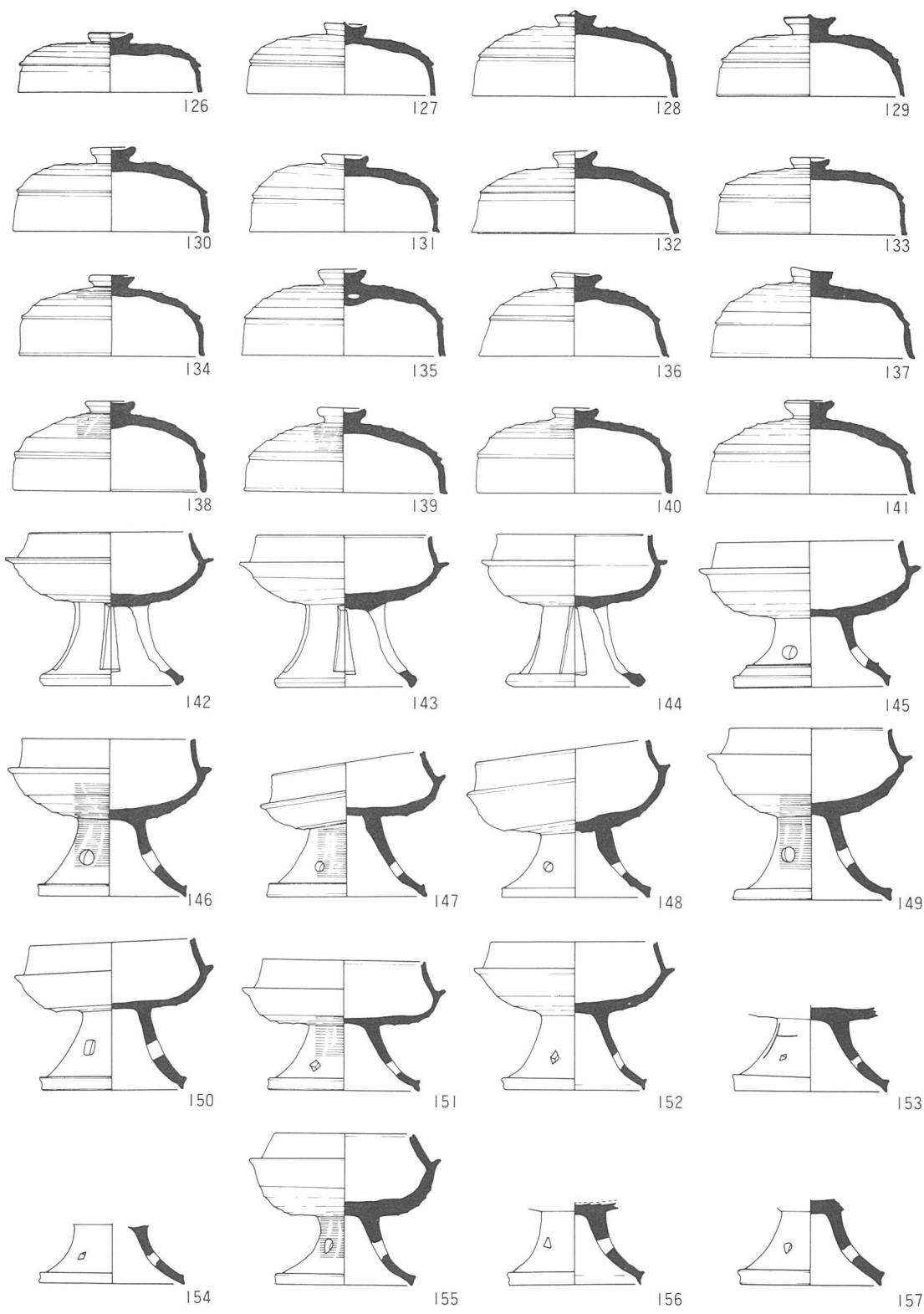

0 20cm

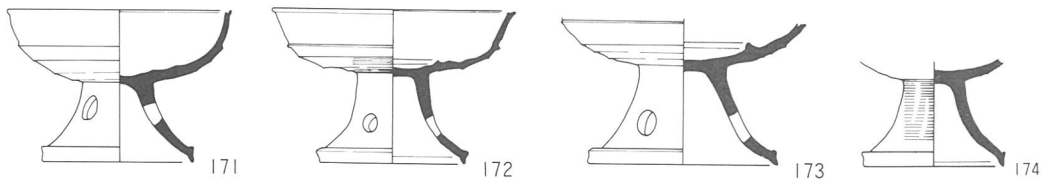
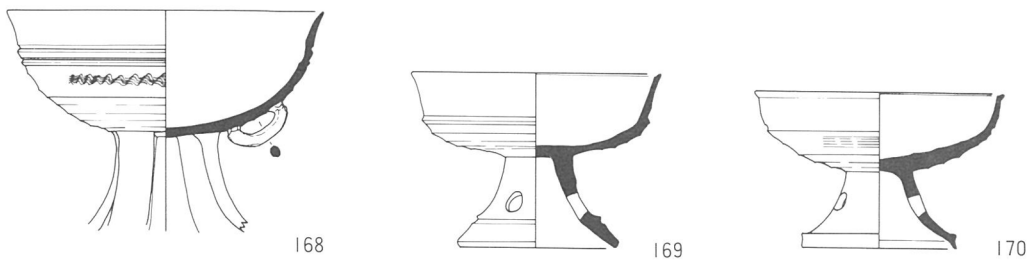
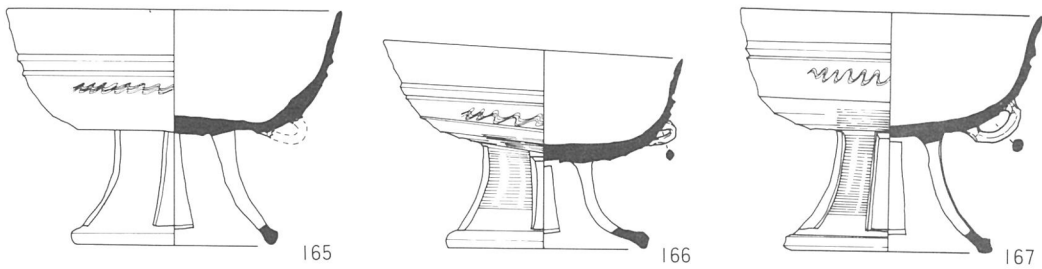
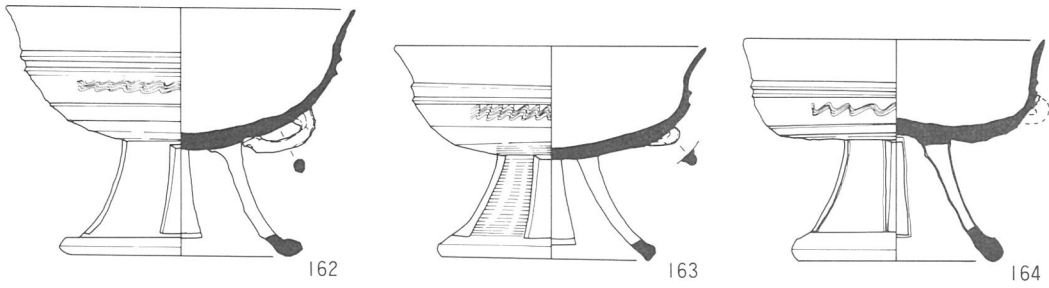
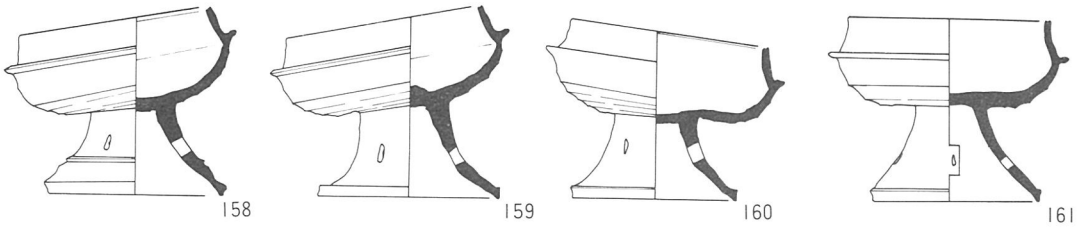

0 20cm

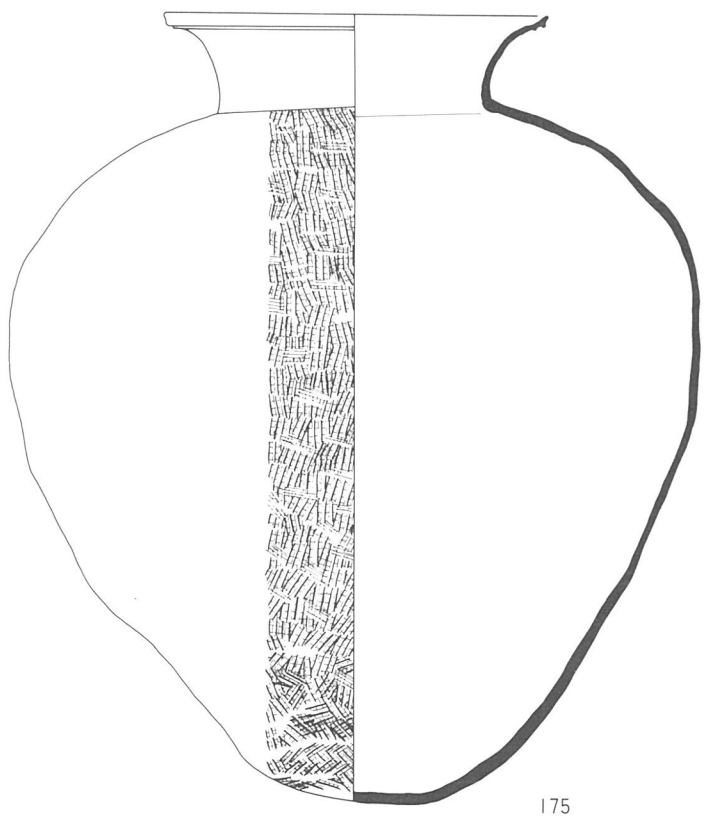
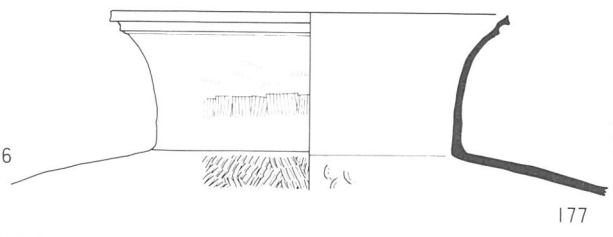
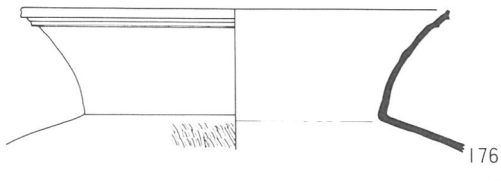
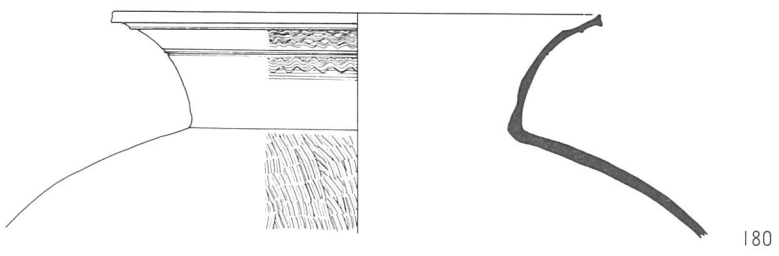
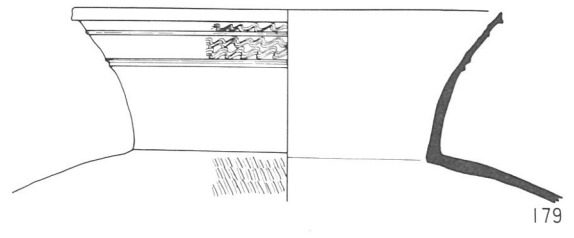
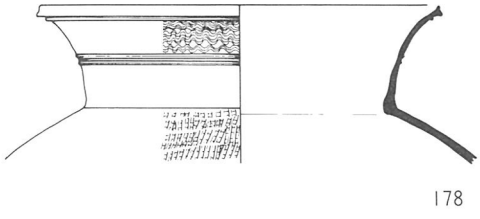

0 40cm

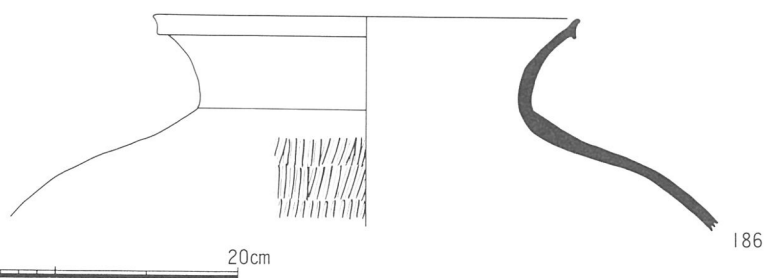
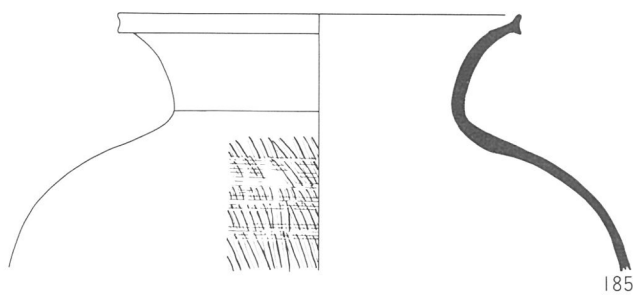
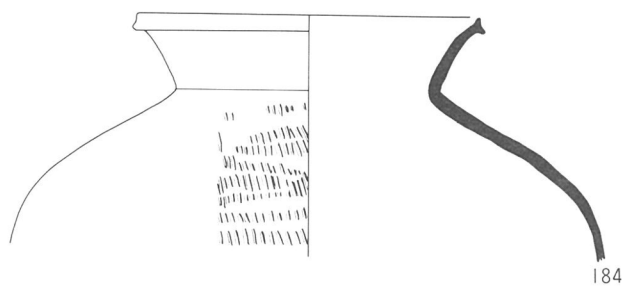
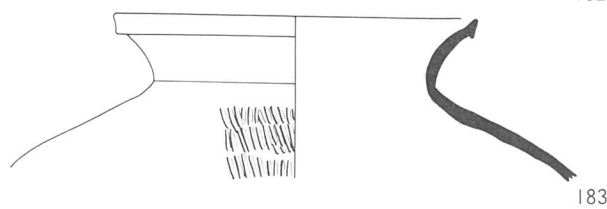
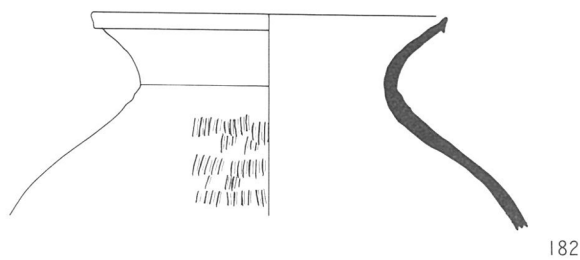
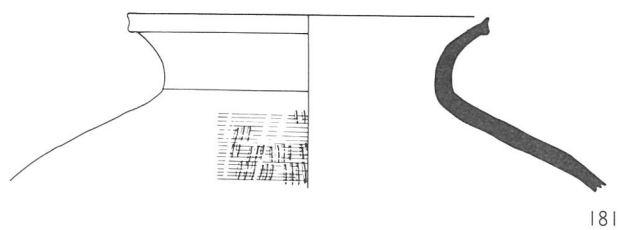

0 20cm

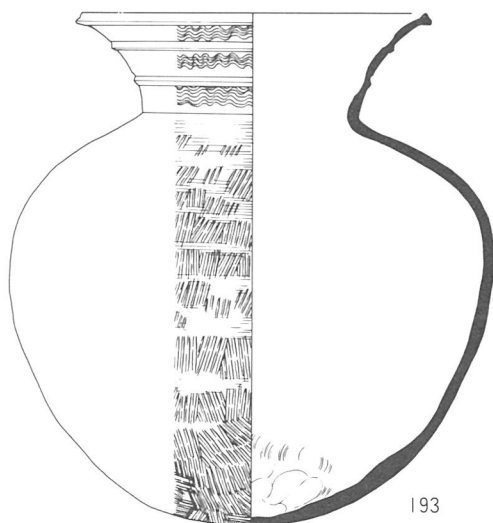
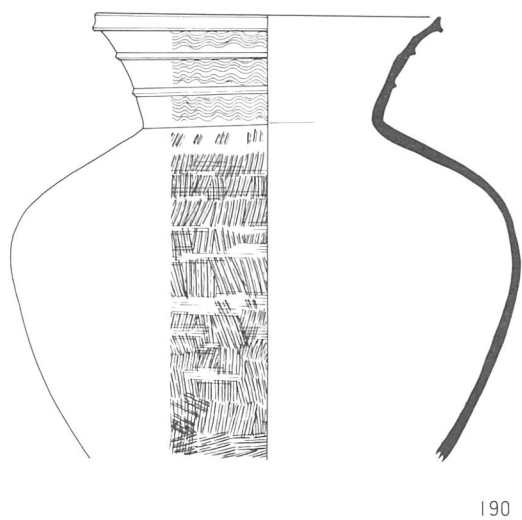
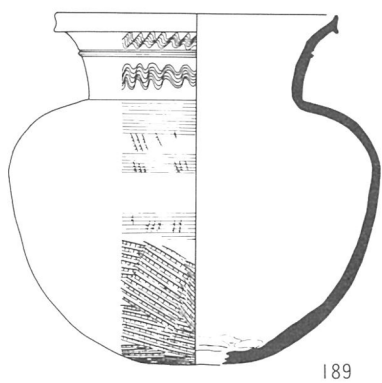
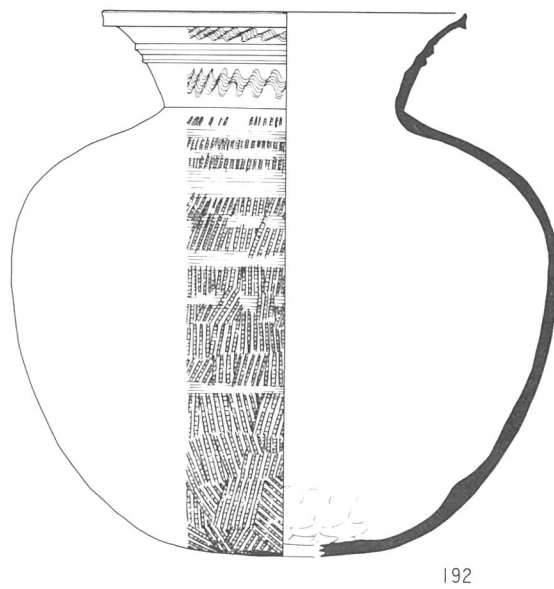
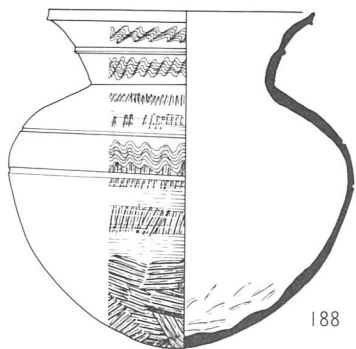
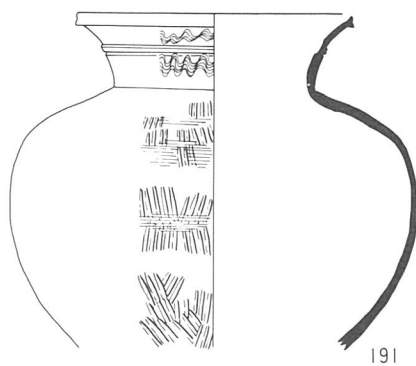
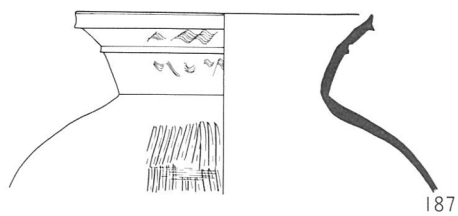

0 20cm

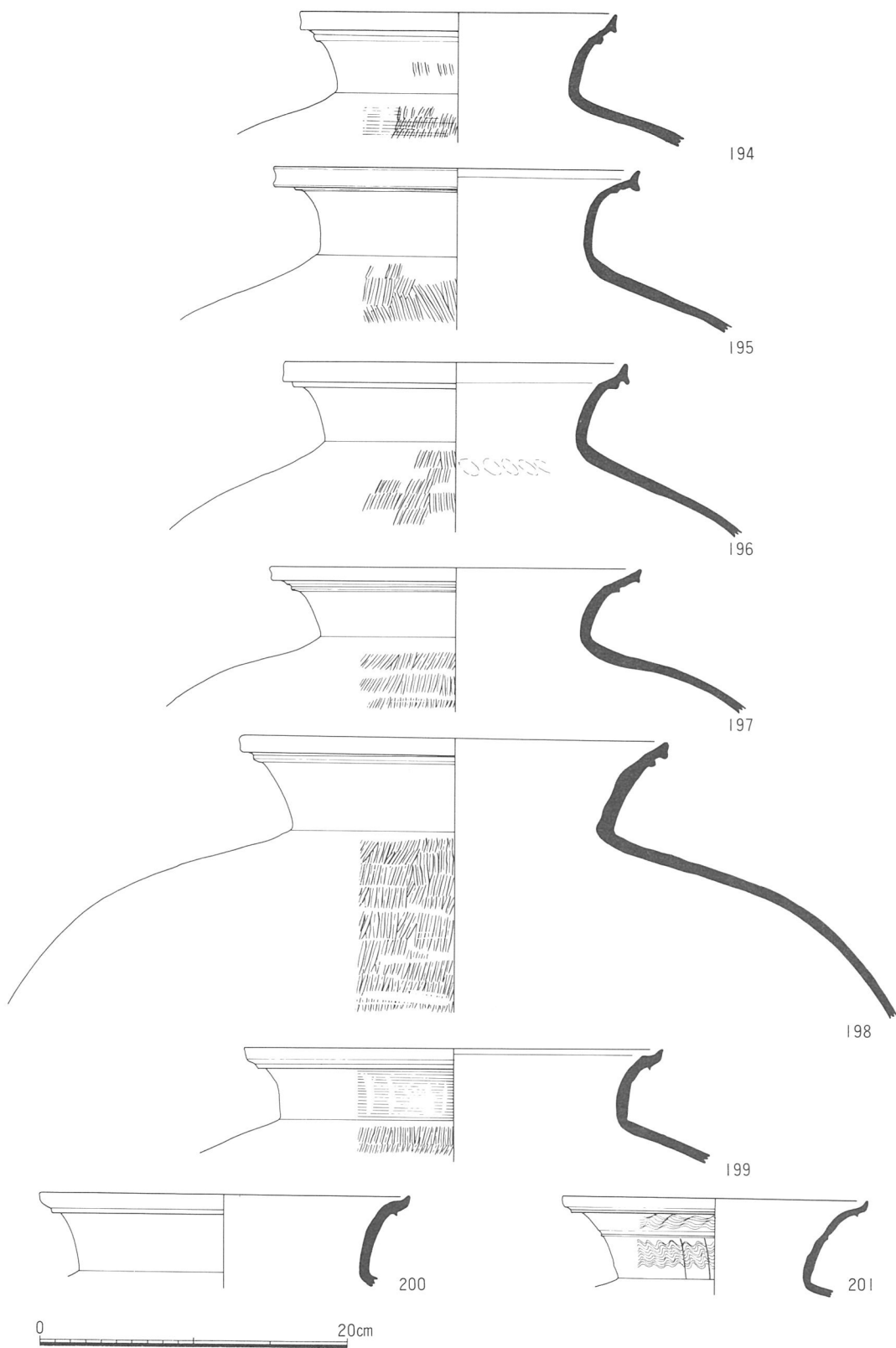

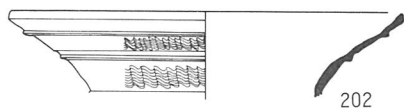

202

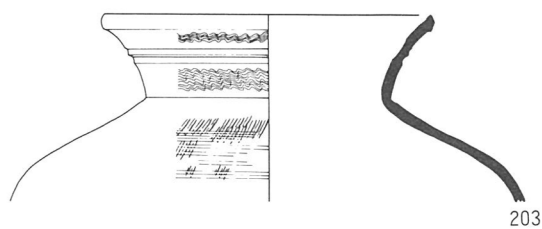

203

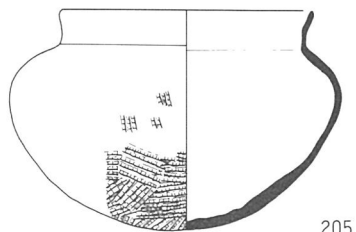

205

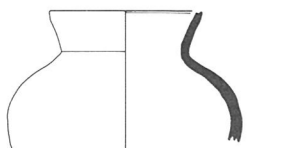

206

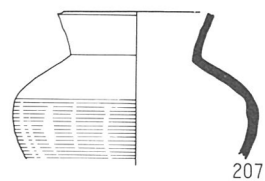

207

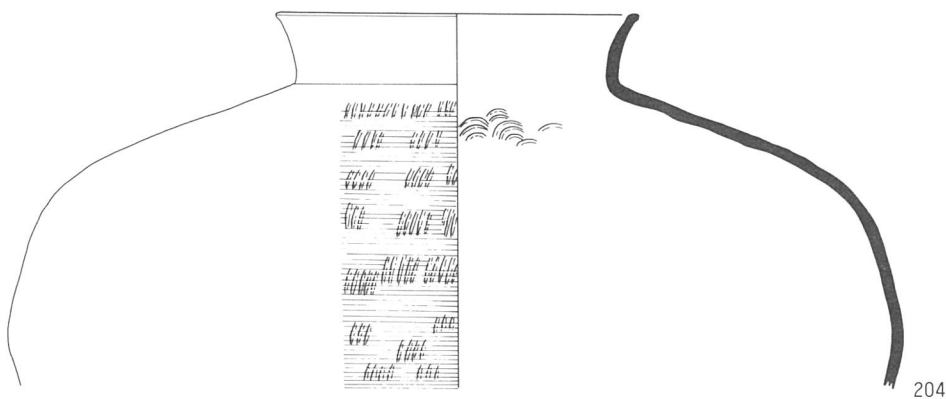

204



208

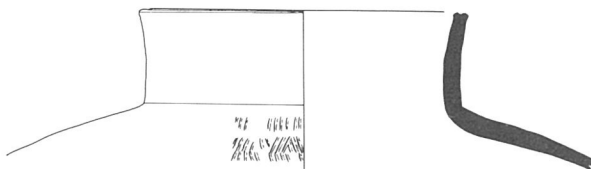

209

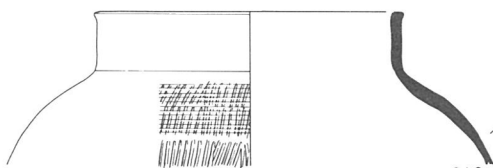

210

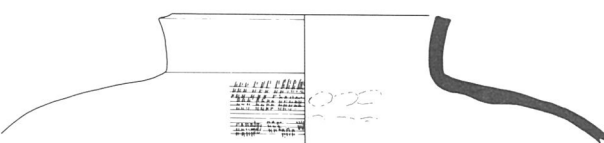

211

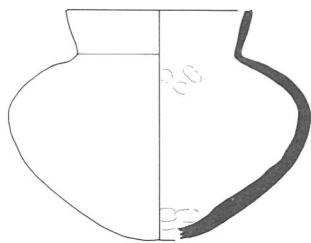

212

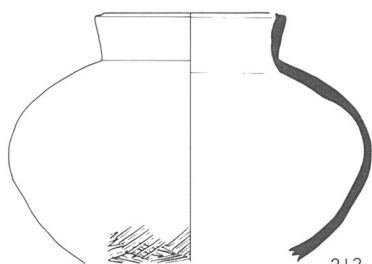

213

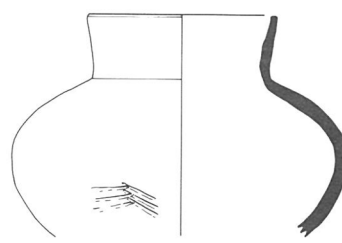

214





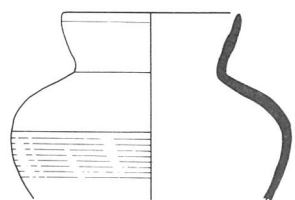

215

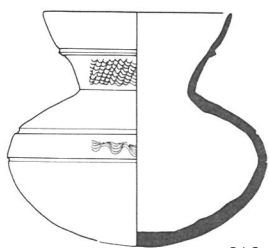

216

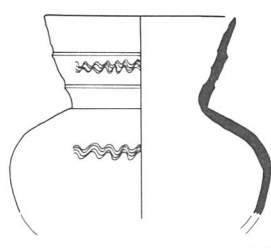

217

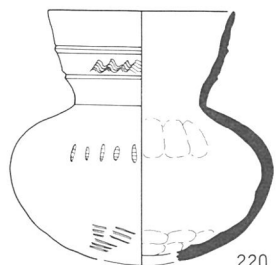

220

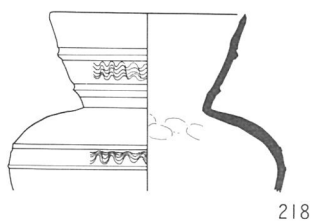

218

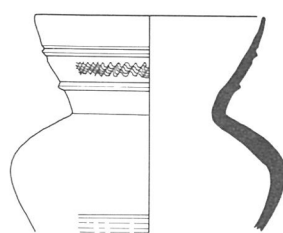

219

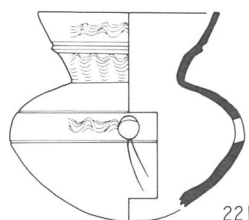

221

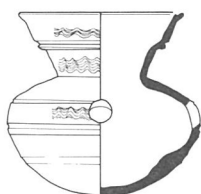

222

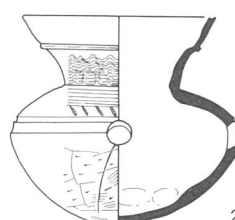

223

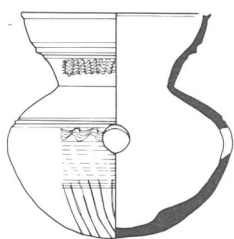

224

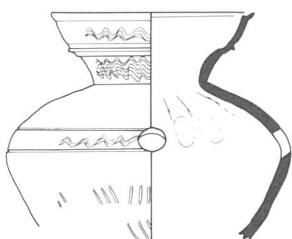

225

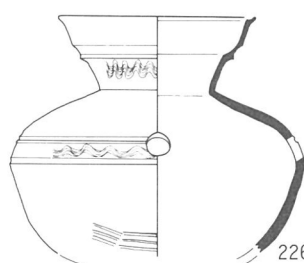

226

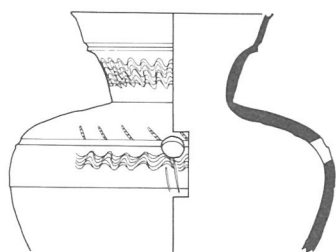

227

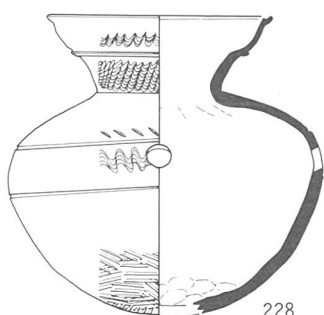

228

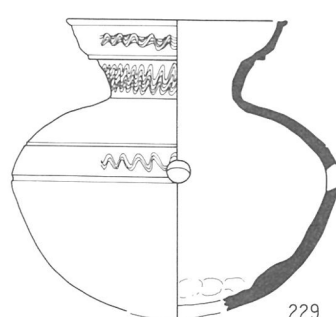

229

0 20cm



230

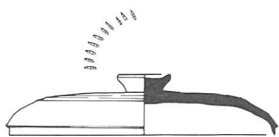

232

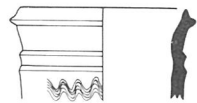

240

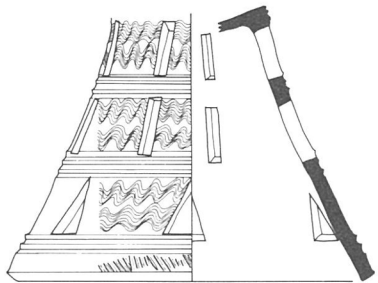

236

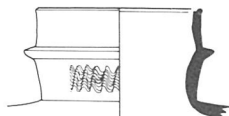

234

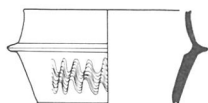

235

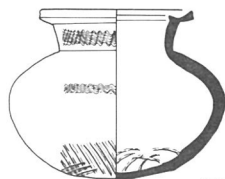

239

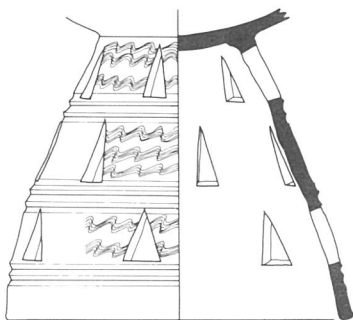

237



231

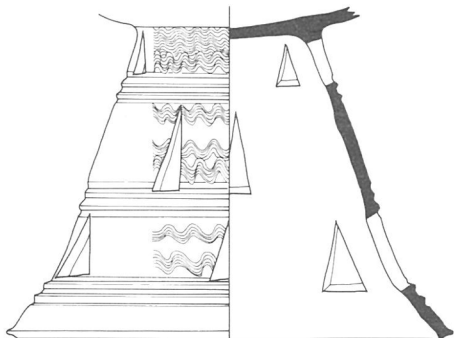

238

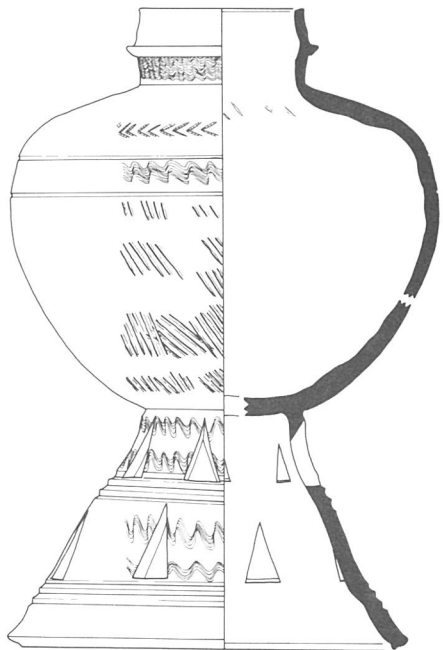

233



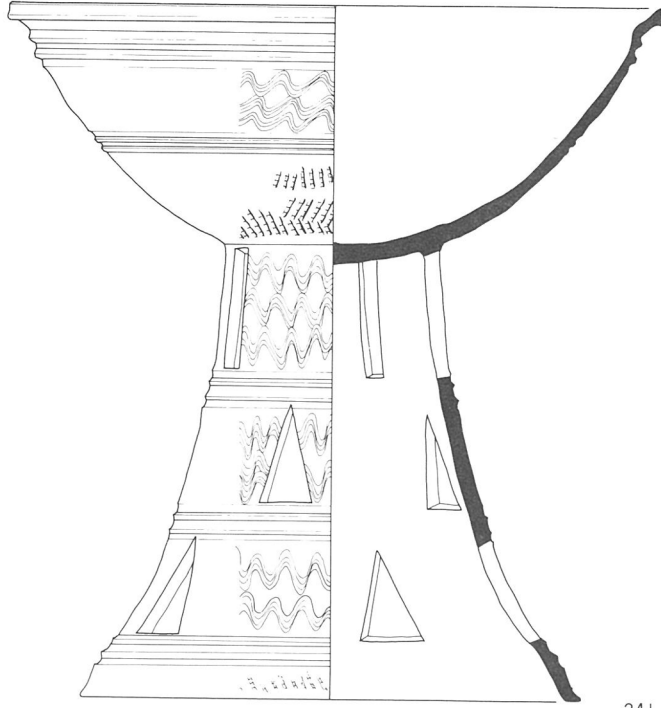

241

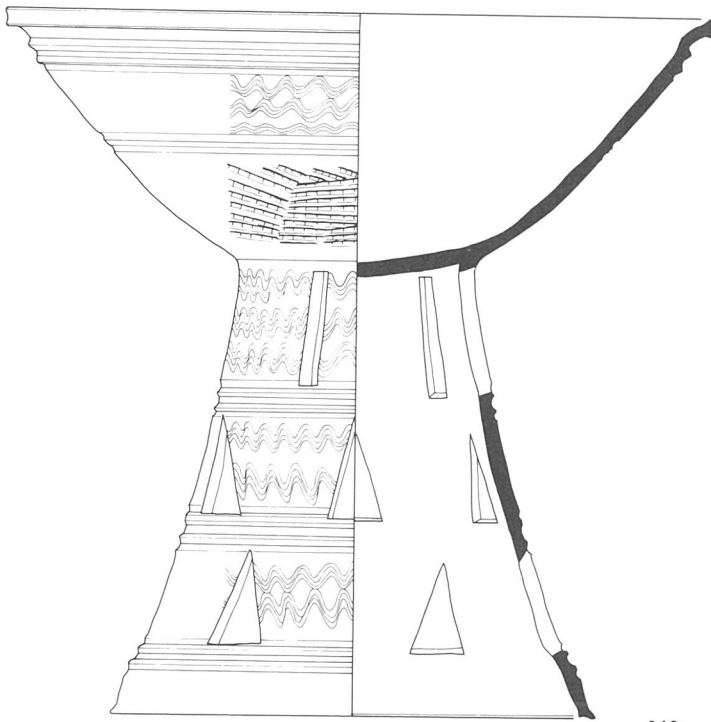

242

0 20cm

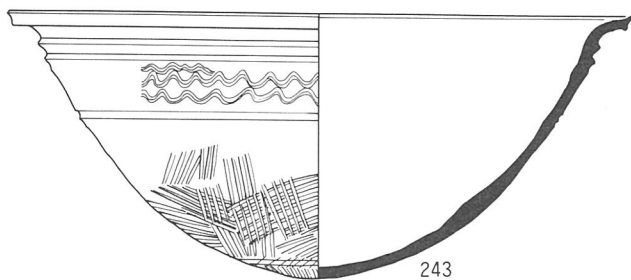

243

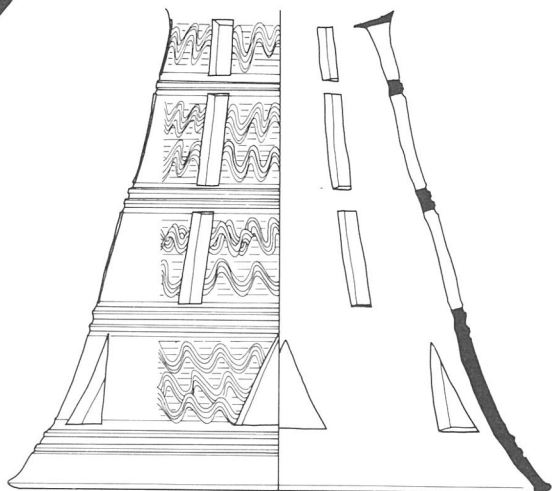

245

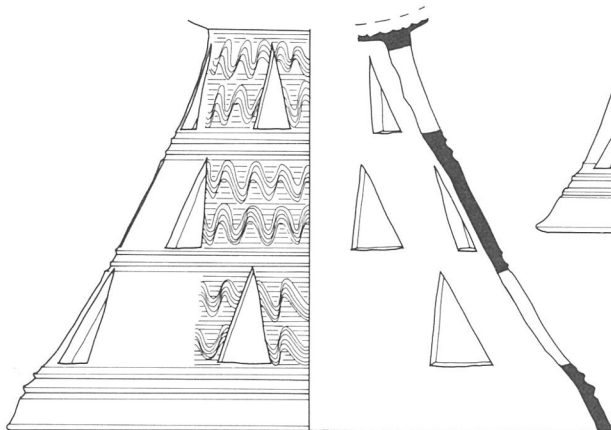

244

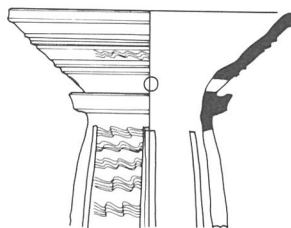

247

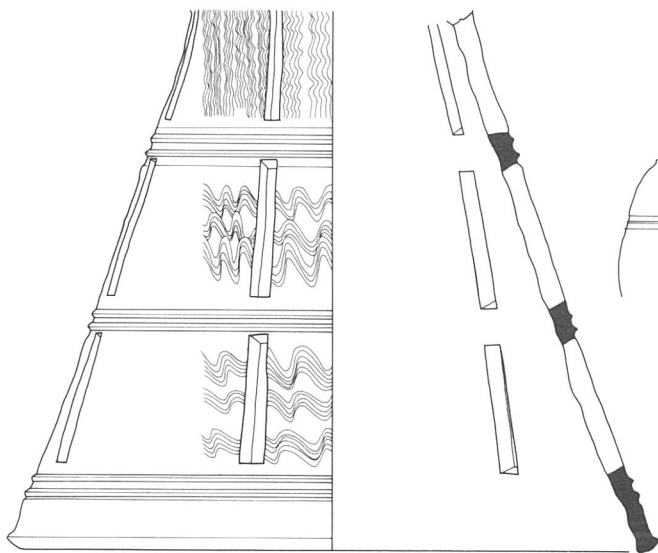

246

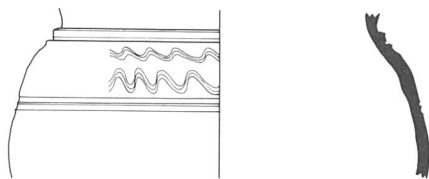

248

0 20cm

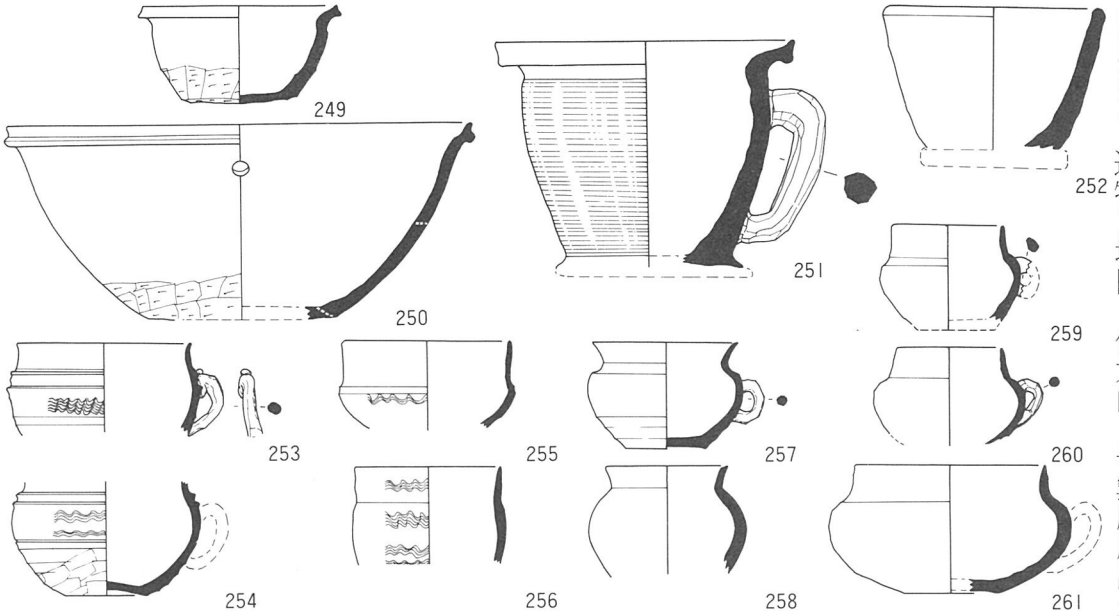

0 20cm

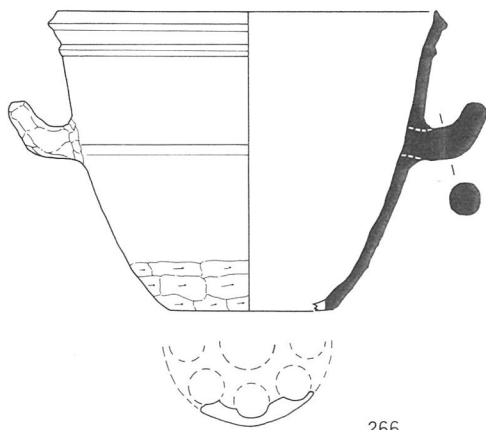

266

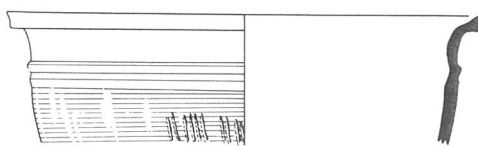

267

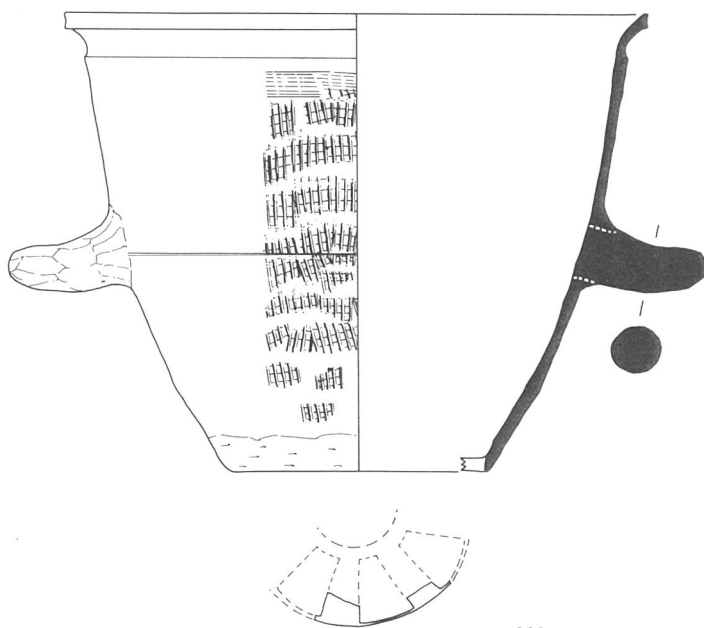

268

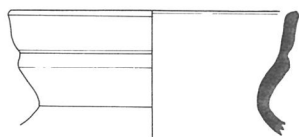

269

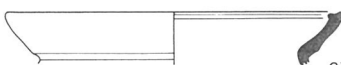

270



271

0 20cm

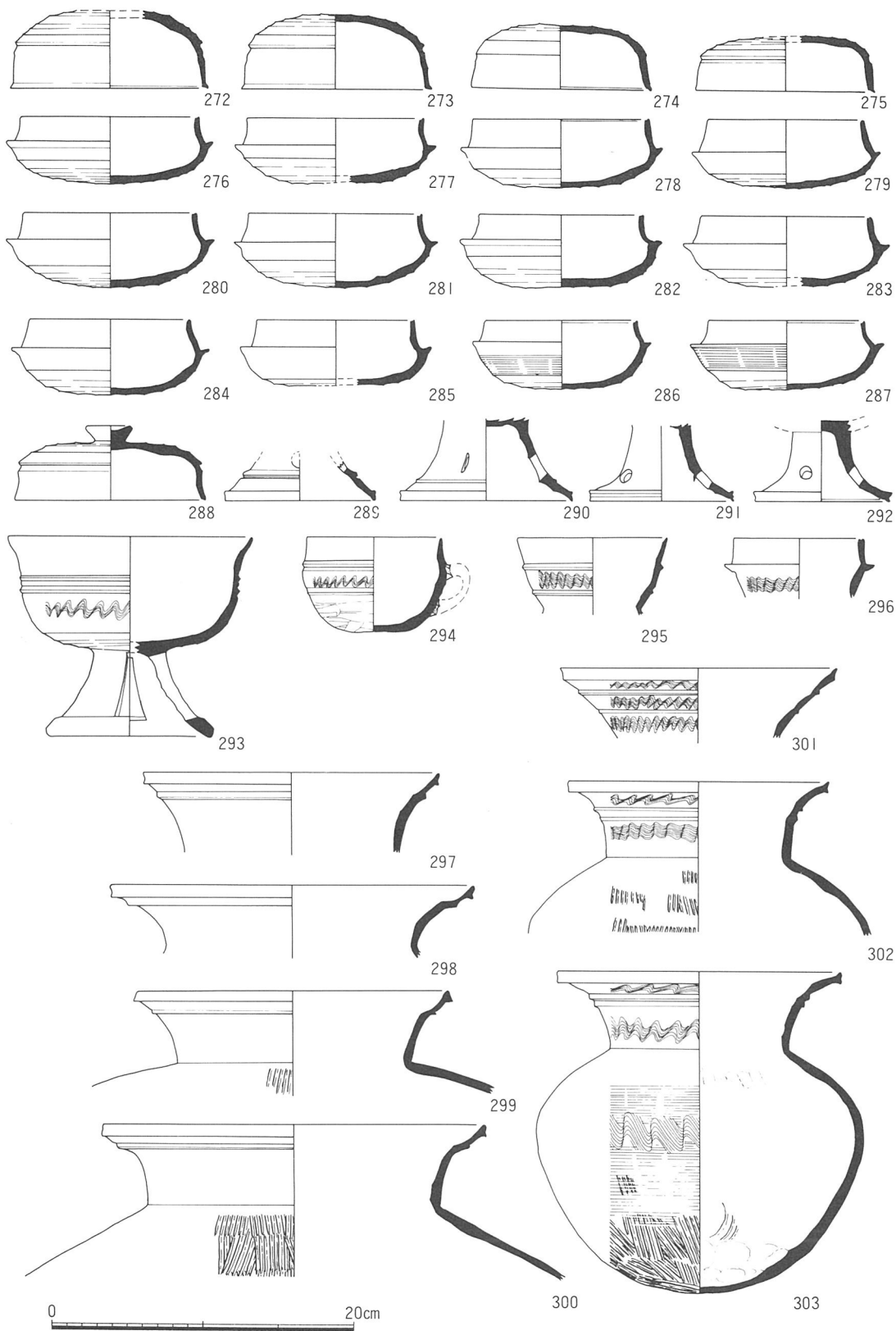

# 版 圖





A地区 C22区全景（南から）



1 C07区調査前の状況（北から）



2 C22区調査前の状況（南から）



1 C05区全景（北から）



2 C05区全景（南から）



1 C07、C12区全景（北から）



2 C07、C12区全景（南から）

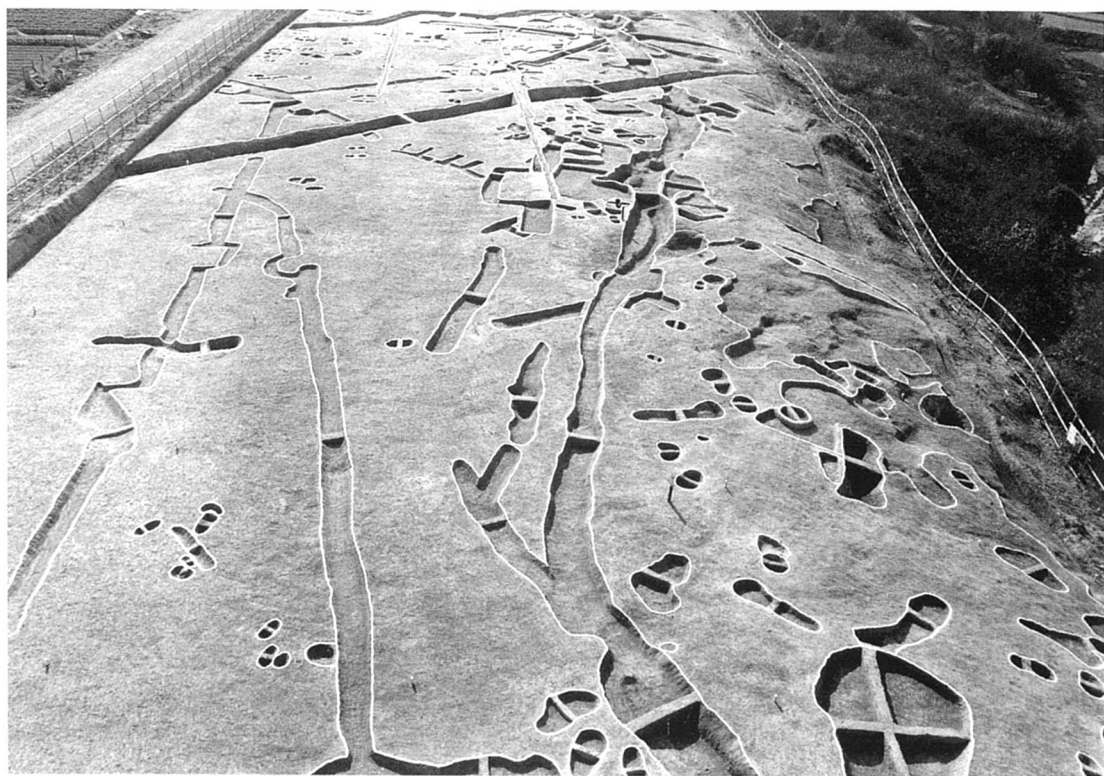

1 C17区全景（北から）



2 C17区全景（南から）



1 C22区全景（北から）



2 C22区全景（南から）



1 C07区土層断面（南東から）



2 C12区土層断面（東から）

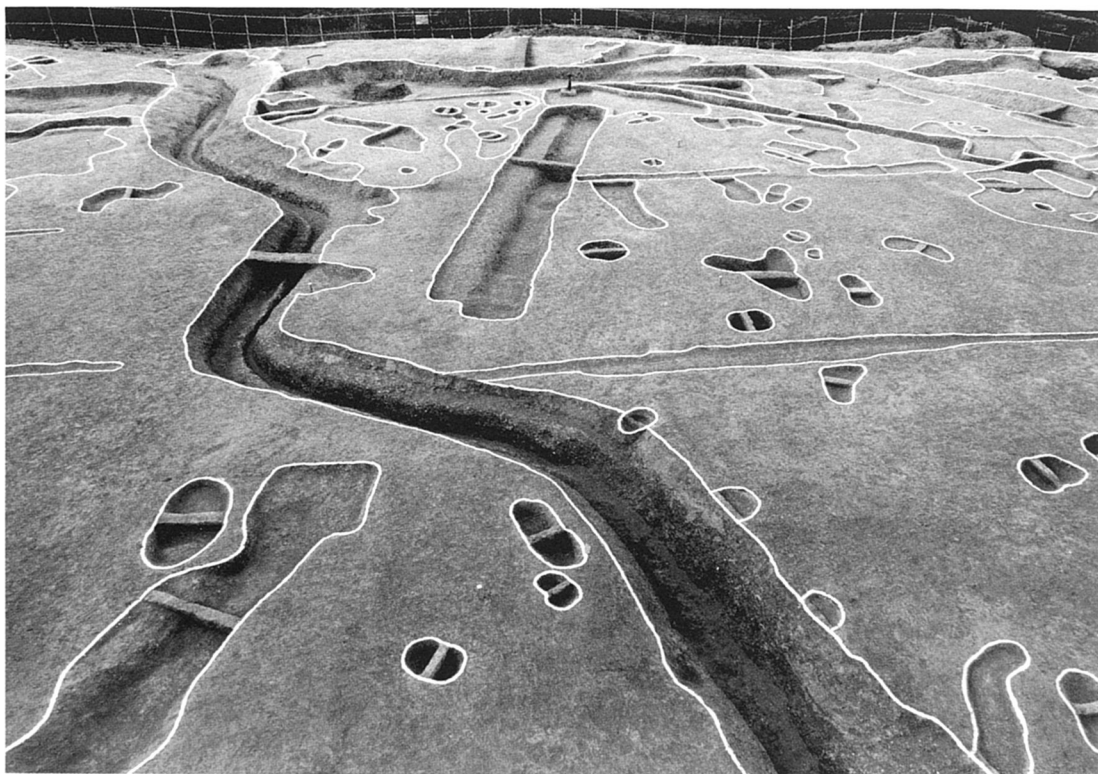

1 C12区塹壕（東から）1365-OX



2 C05区塹壕（西から）228-OX





1 C12区塹壕（東から）1301-0X



2 C22区塹壕（南から）1541-0X

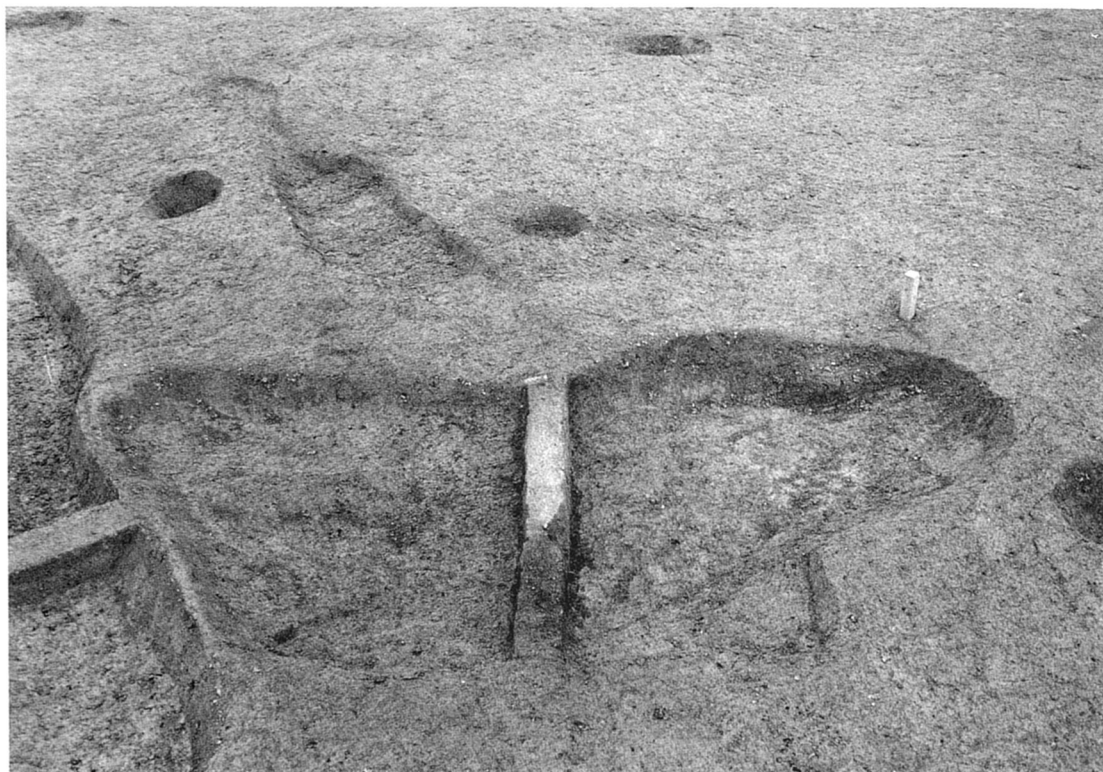

1 240-00 (南から)

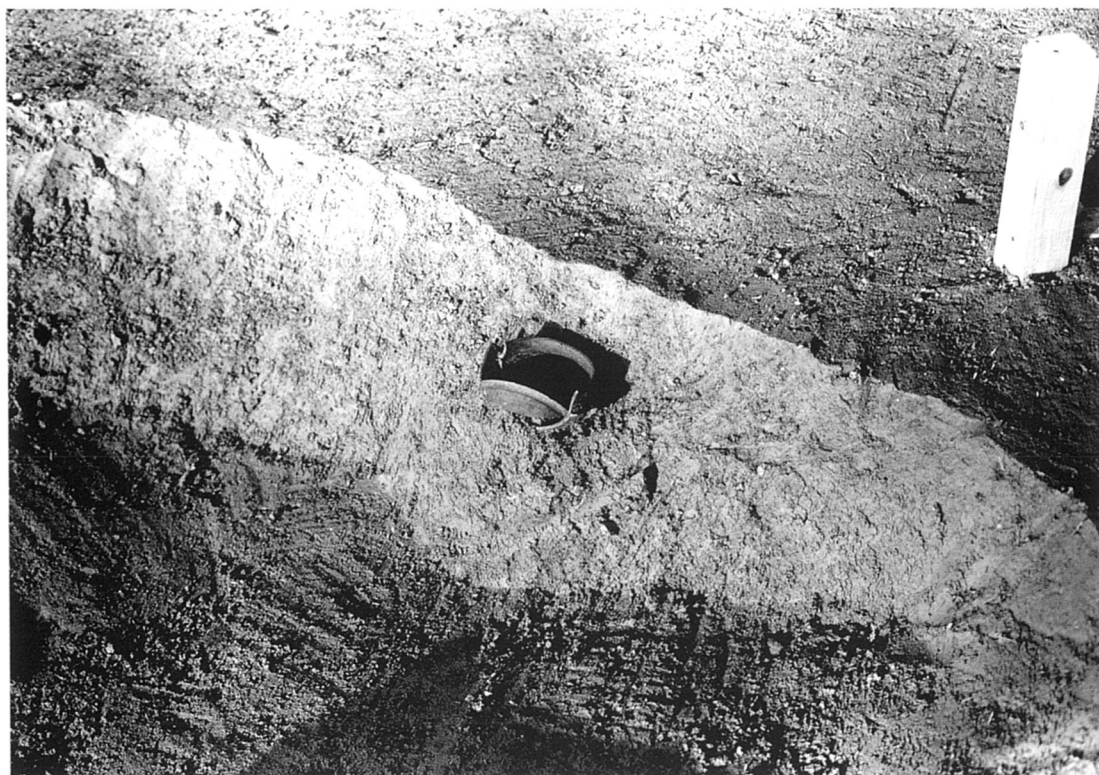

2 240-00 遺物出土状況

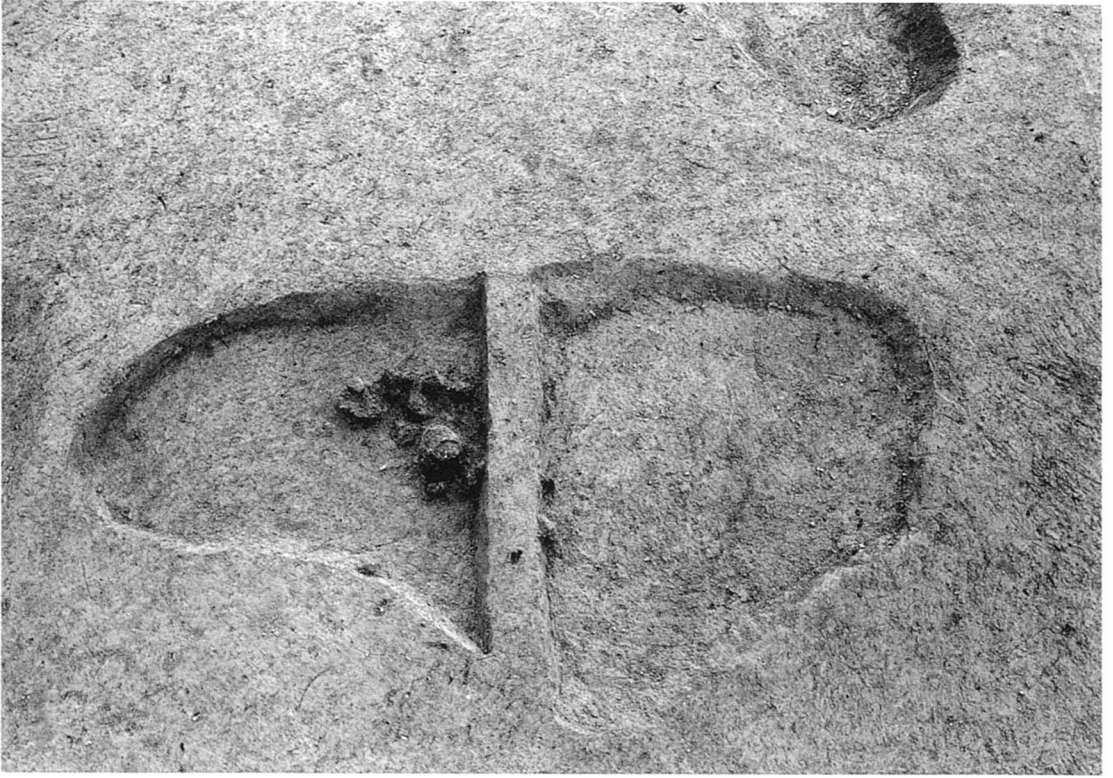

1 162-00 (北から)

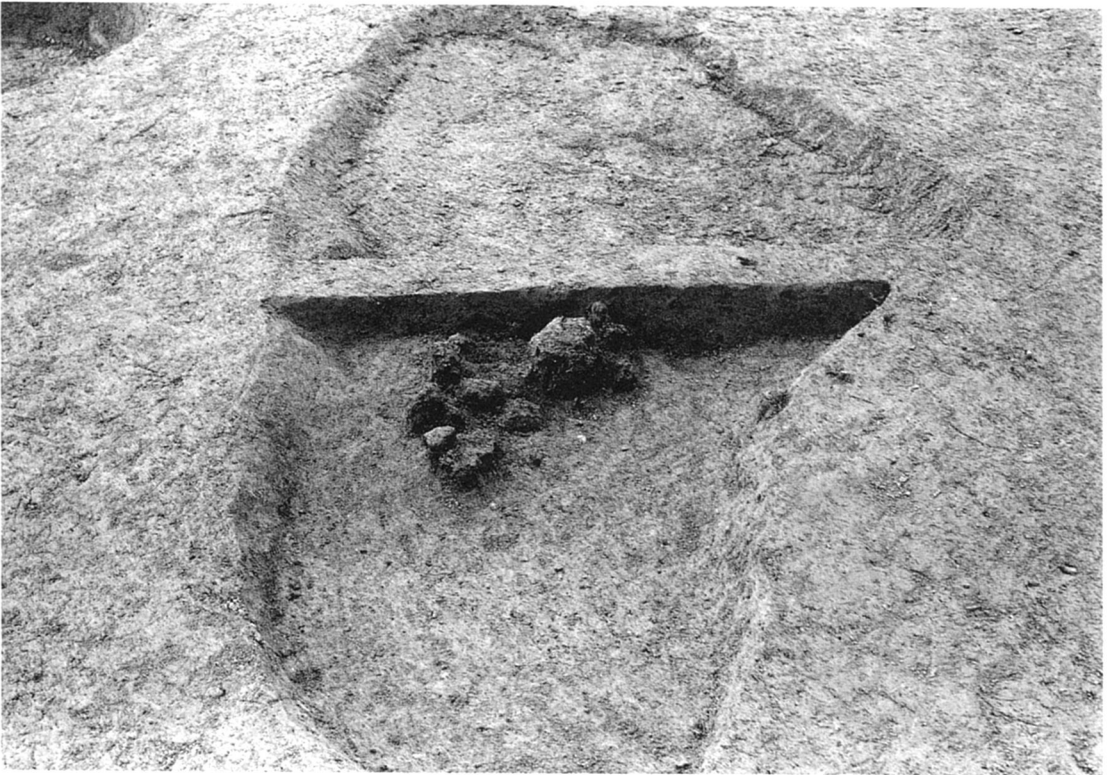

2 162-00 (東から)



1 1480-00 (南から)

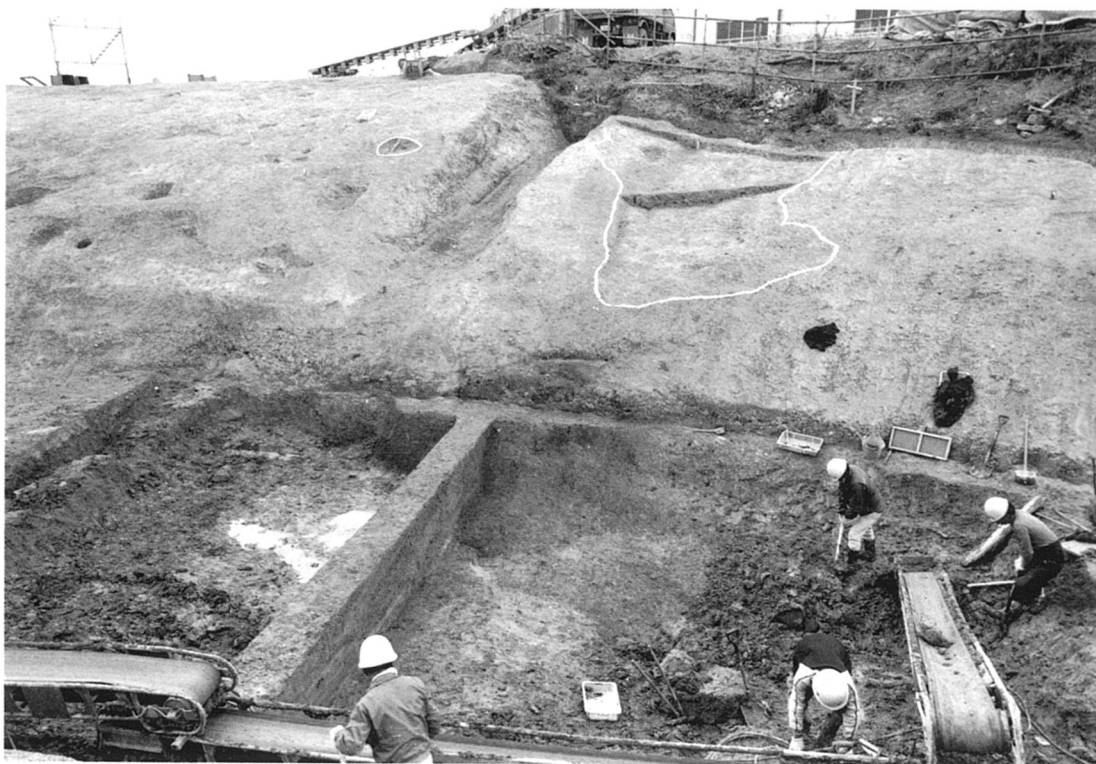

2 C22区掘削風景 (南から)



1 4号窯 (1481-OK) 検出状況 (南から)

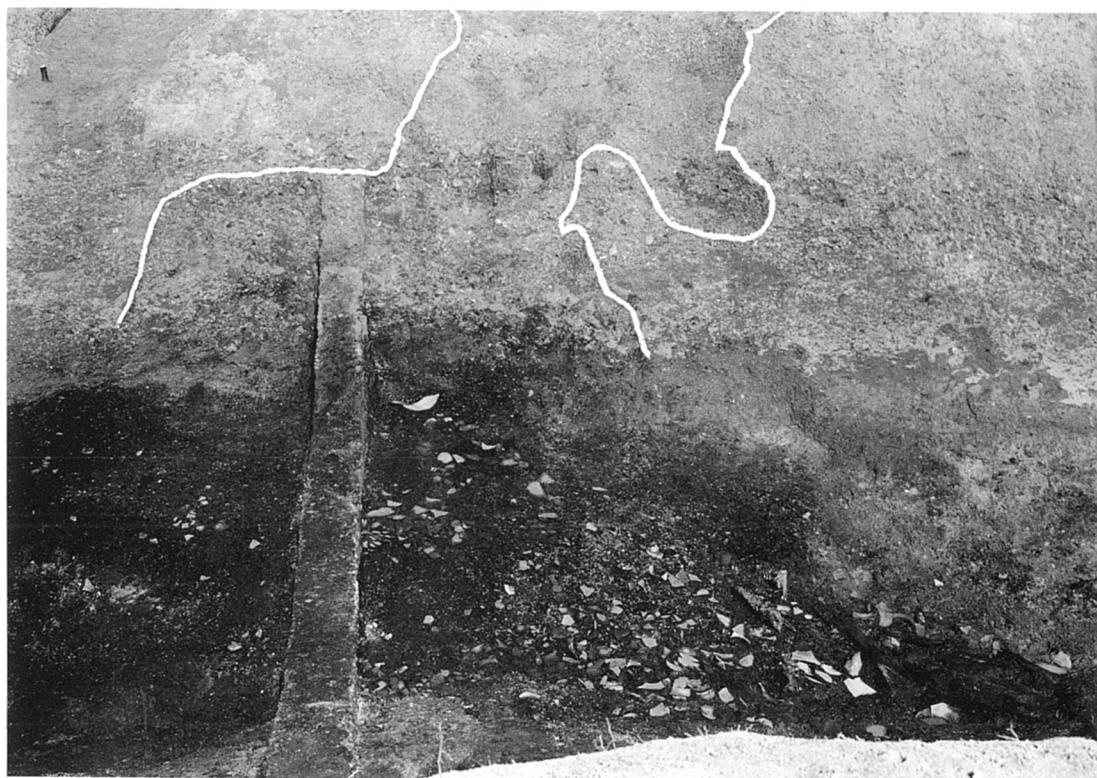

2 4号窯 (1481-OK) 灰層検出状況 (南から)



1 4号窯(1481-OK)灰原検出状況(東から)



2 4号窯(1481-OK)灰原検出状況(北西から)



1 4号窯(1481-OK)第4層上面遺物検出状況(東から)



2 4号窯(1481-OK)灰原南北断面(東から)



1 4号窯 (1481-OK) 灰原断面第1・2層 (東から)



2 4号窯 (1481-OK) 灰原断面第3～第10層 (東から)