

S X 10 (2層中の貝出土状況)

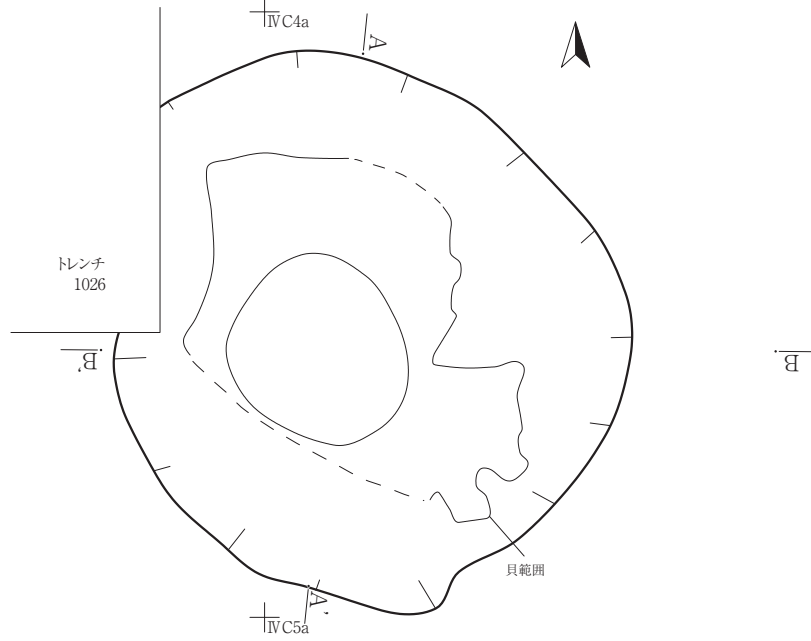

S X 10 (5層中の貝出土状況)

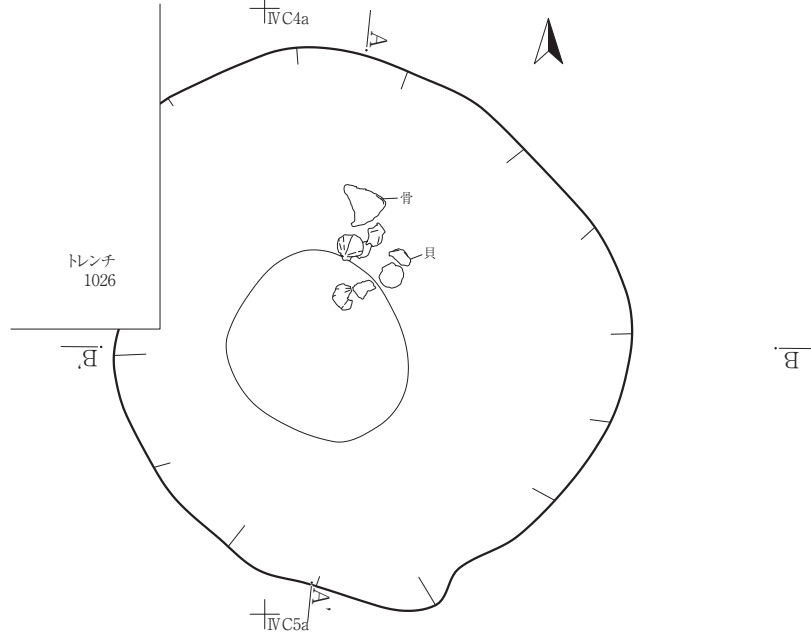

S X 10 A-A'

A. L=14.000m

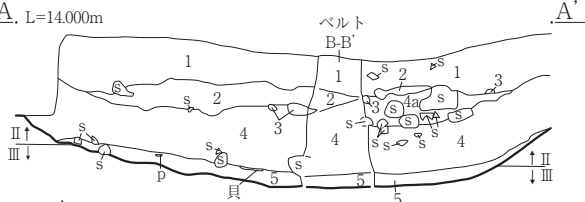

S X 10 B-B'

B. L=13.900m

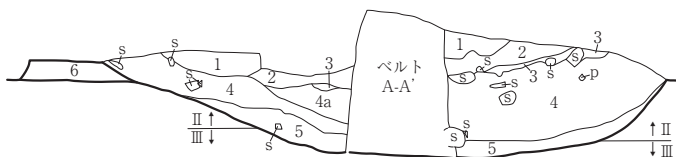

S X 10 A-A'・B-B'

- |    |           |     |  |
|----|-----------|-----|--|
| 1  | 10YR2/3   | 黒褐色 | 砂質シルト 締まり中 花崗岩粒10%含む   |
| 2  | 10YR2/2   | 黒褐色 | シルト 締まり中 貝30% 混貝土層   |
| 3  | 10YR5/6   | 黄褐色 | 砂礫 締まり密  |
| 4  | 10YR2/1   | 黒色  | シルト 締まり中 貝5% 混貝土層<br>3層下位~4a層にかけて径10~20cm大の垂角礫含む<br>40% 黄色土3%含む 花崗岩粒1%含む |
| 4a | 10YR2/1   | 黒色  | シルト 締まり中 4層と同質の層で礫が含まれる層   |
| 5  | 10YR1.7/1 | 黒色  | シルト 締まり中 粘性強 貝・小礫1%含む<br>黄色土1%含む ブロック状に砂礫層が入る                            |
| 6  | 10YR3/3   | 暗褐色 | 砂質シルト 締まり密 黄色土10%含む<br>花崗岩粒3%含む (古代住居跡の貼床)                               |

B'

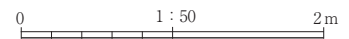

第241図 S X 10貝層

SX11 ⅣC5c

ⅣC5d

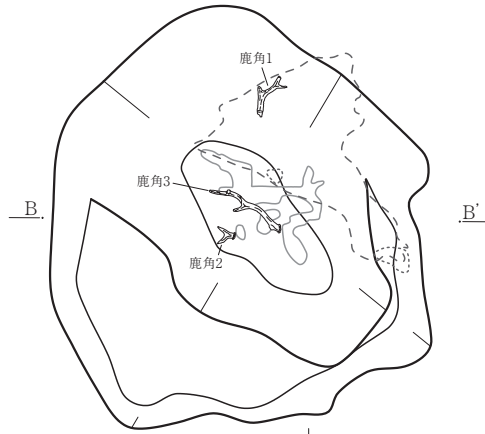

ⅣC6d

SX11 A-A'  
A. L=13.500m

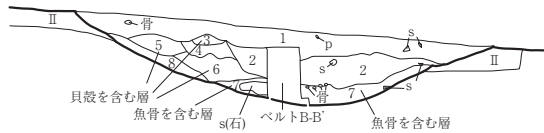

SX11 B-B'  
B. L=13.300m



SX11 A-A'・B-B'	
1	10YR3/1 黒褐色 シルト～極細砂 粘性弱 締まり中 粗砂～細礫を3%含む
2	10YR2/1 黒色 シルト～極細砂 粘性弱 締まり中 粗砂～細礫を3%含む
3	10YR3/1 黒褐色 シルト～極細砂 粘性弱 締まり疎 粗砂～細礫を3% 1～2cm大の貝を40%含む
4	10YR2/1 黒色 シルト～極細砂 粘性弱 締まり疎 粗砂～細礫を2%含む
5	10YR2/1 黒色 シルト～極細砂 粘性弱 締まり疎 粗砂～細礫を2% 1～2cm大の貝を10%含む
6	1～5cm大の貝層 10YR3/1 黒褐色 粘性弱 締まり疎 シルトブロック土を15%含む
7	10YR2/1 黒色 シルト 粘性中 締まり中 1cm大の魚骨を1%含む
8	10YR3/1 黒褐色 シルト～極細砂 粘性弱 締まり中 粗砂～細礫を5%含む
9	10YR4/1 褐灰色 シルト～極細砂 粘性弱 締まり中 5～20mm大の10YR6/3にぶい黄橙色シルトブロック土を5%含む
II	10YR4/1 褐灰色 シルト～極細砂 粘性弱 締まりやや密 粗砂～細礫を3%含む

SX11 (3・5・6層中の貝殻出土状況)

SX11 (7層中の魚骨・獣骨出土状況)

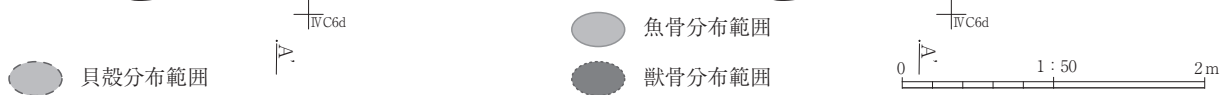
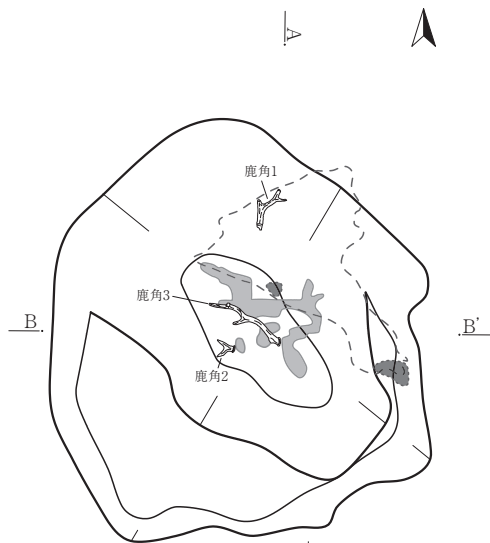
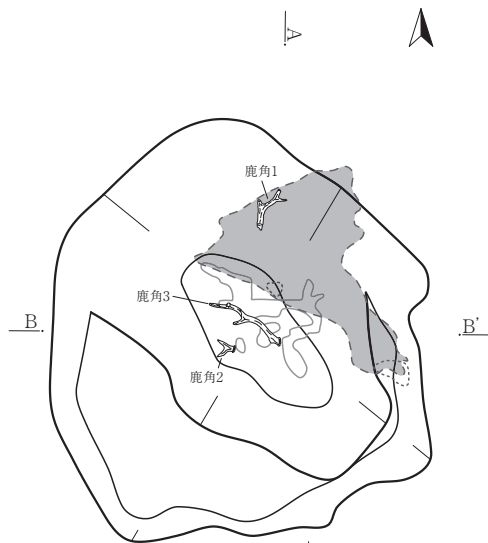

第242図 SX11貝層

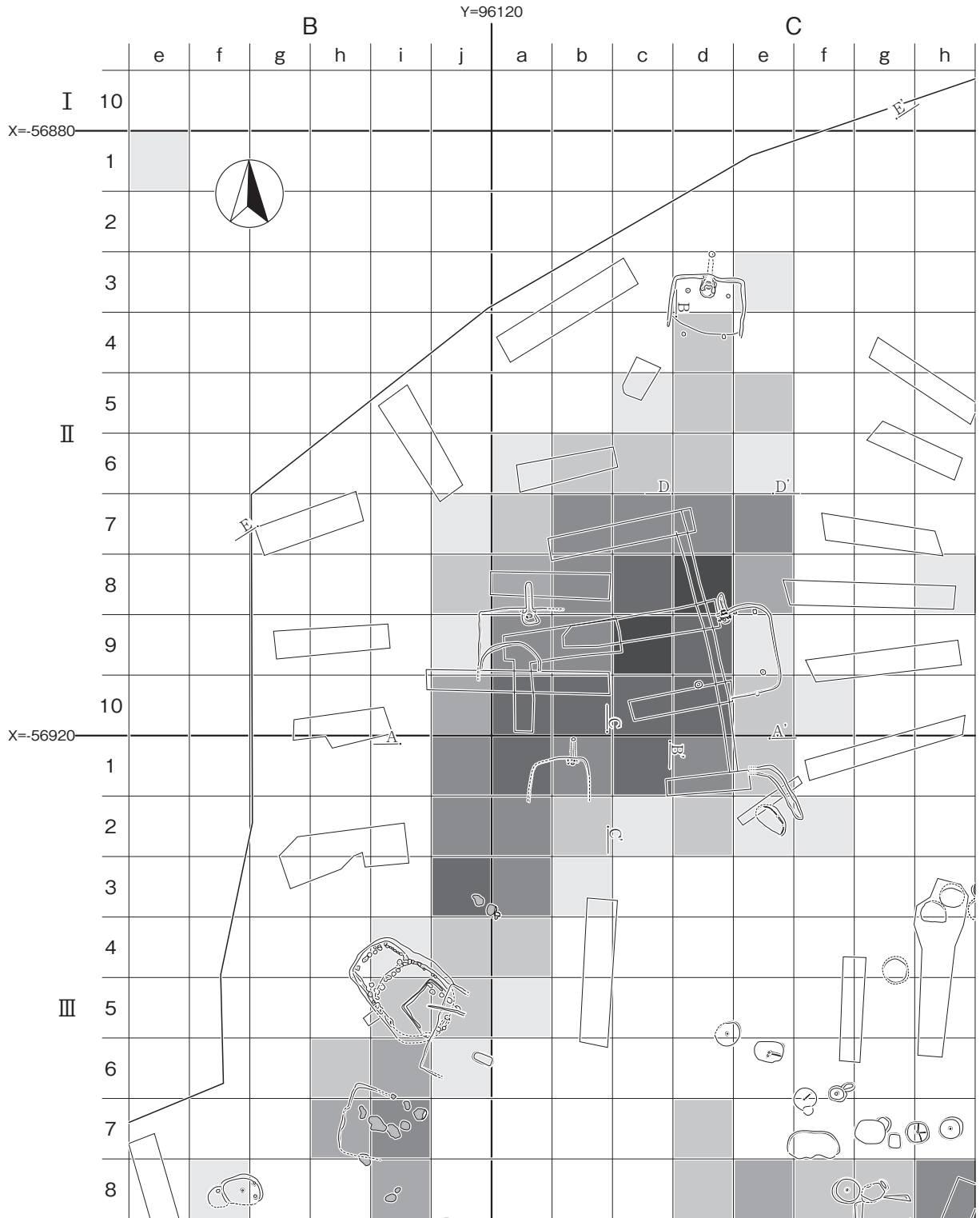

グリッド別遺物重量分布図：縄文土器

土器重量 (kg)

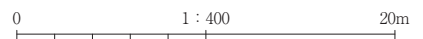
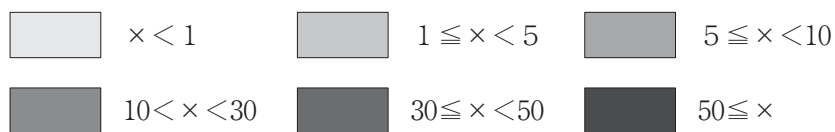

第243図 B区遺物包含層(1)

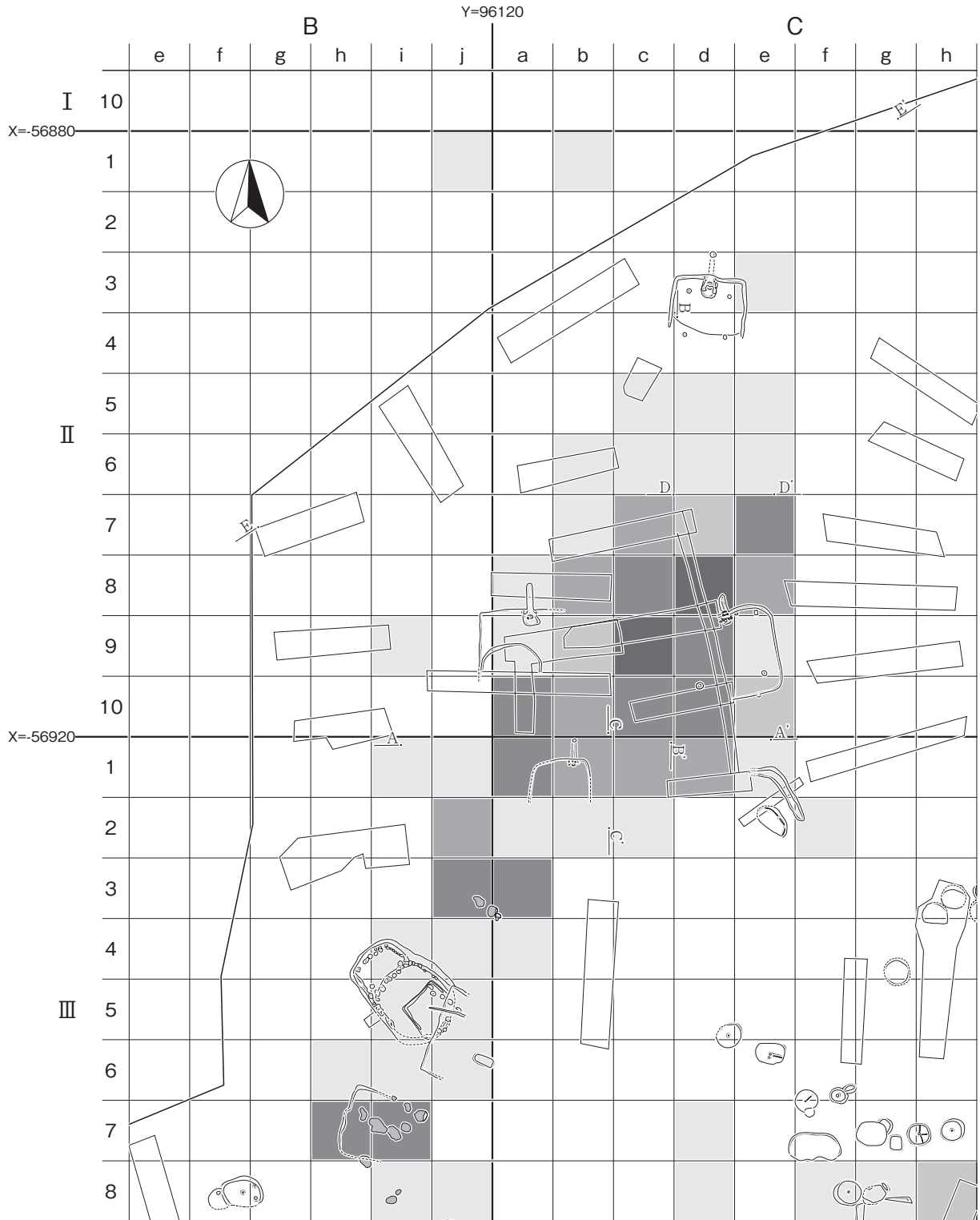

グリッド別遺物重量分布図：石器（剥片）

石器（剥片）重量（g）

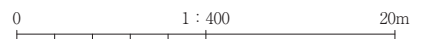
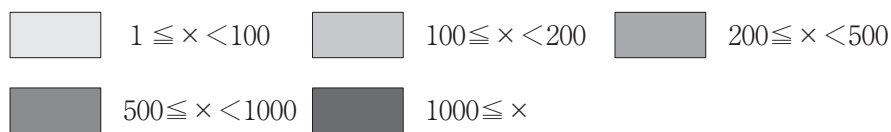

第244図 B区遺物包含層（2）



B区 B-B'

B区 B-B'

B. L=23,200m

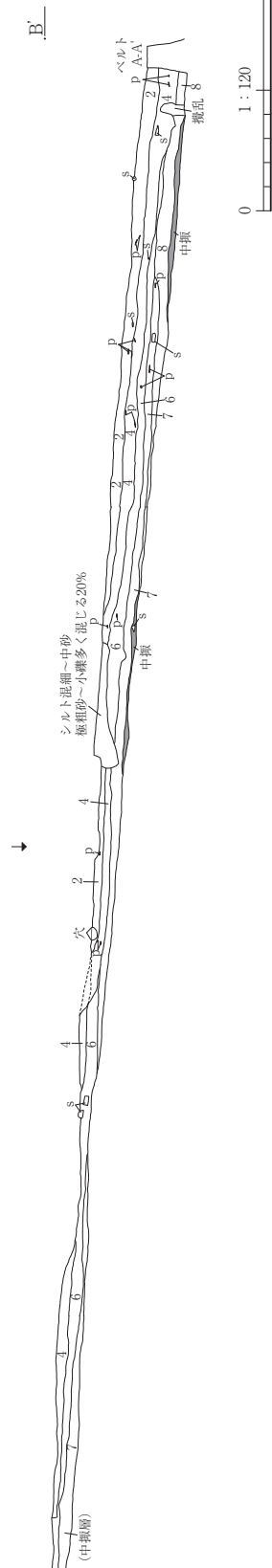

拡大図

B. L=23,200m B'

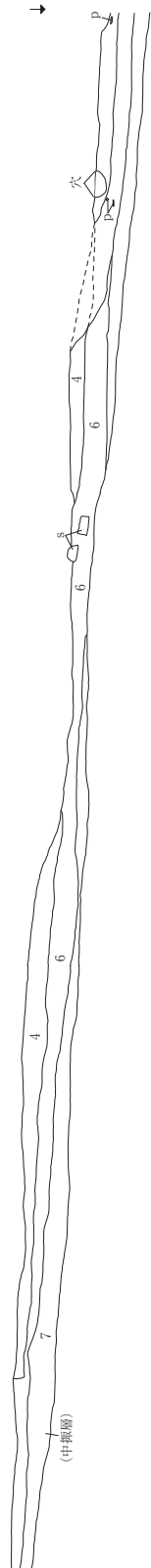

L=23,200m B'

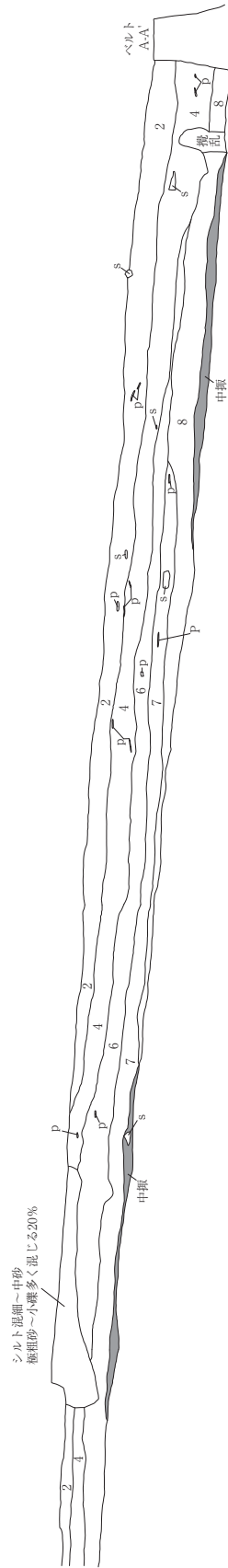

B区 南東包含層 B-B'

- |   |          |            |     |       |                  |       |             |                      |
|---|----------|------------|-----|-------|------------------|-------|-------------|----------------------|
| 1 | 10YR4/4  | 褐色～10YR3/4 | 暗褐色 | 砂質シルト | 砂質シルト            | 締まり良  | 中～小礫混20～25% | 遺物多い (包含層上1)         |
| 2 | 10YR2/3  | 黒褐色        |     | 砂質シルト | 砂質シルト            | 締まり良  | 中～極粗砂混5%    | 遺物多い炭 (包含層上)         |
| 3 | 7.5YR2/1 | 黒色         |     | 砂質シルト | 砂質シルト            | 締まり良  | 細～中砂混25%～   | 遺物多い炭 (包含層中1)        |
| 4 | 10YR3/5  | にぶい黄褐色     |     | 細砂～中砂 | シルト質でやや土壌化した部分多い | 締まり良  | 細砂非常に多い     | 遺物多い炭 (包含層中2)        |
| 5 | 7.5YR3/2 | 黒褐色        |     | 砂質シルト | 砂質シルト            | 締まり良  | 細～中砂極粗砂混15% | 遺物やや少ないか? (包含層下1)    |
| 6 | 10YR2/3  | 黒褐色        |     | 砂質シルト | 砂質シルト            | 締まり良  | 細砂混20～30%   | 中継10YR8/8黄橙混 (包含層下2) |
| 7 | 5YR1/1   | 黒色         |     | 粘質シルト | 粘質シルト            | 粘質シルト |             |                      |
| 8 | 10YR2/3  | 黒色         |     | 粘質シルト | 粘質シルト            | 粘質シルト | 細砂～中砂混20%   | (包含層下3)              |

第246図 B区遺物包含層 (4)

B区 C-C'

B区 C-C'  
C. L=21.300m

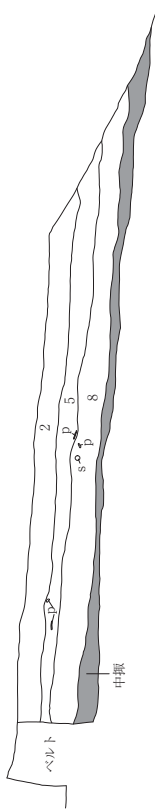

B区 南東包含層 C-C'

- |   |          |            |     |       |      |               |                               |
|---|----------|------------|-----|-------|------|---------------|-------------------------------|
| 1 | 10YR4/4  | 褐色～10YR3/4 | 暗褐色 | 砂質シルト | 締まり良 | 中～小礫混20～25%   | 遺物多い (包含層上1)                  |
| 2 | 10YR2/3  | 黒褐色        |     | 砂質シルト | 締まり良 | 中～極粗砂混5%      | 遺物多い炭 (包含層上)                  |
| 3 | 7.5YR2/1 | 黒色         |     | 細砂～中砂 | シルト質 | 細～中砂混25%      | 遺物多い炭 (包含層中1)                 |
| 4 | 10YR3/5  | にぶい黄褐色     |     | 砂質シルト | 締まり良 | 細砂非常に多い       | 遺物多い炭 (包含層中2)                 |
| 5 | 7.5YR3/2 | 黒褐色        |     | 砂質シルト | 締まり良 | 細～中砂極粗砂混じる15% | 遺物やや少ないか? (包含層下1)             |
| 6 | 10YR2/3  | 黒褐色        |     | 粘質シルト | 良    | 細砂混20～30%     | 中粒10YR8/8黄橙混 (プロック状に) (包含層下2) |
| 7 | 5YR1/1   | 黒色         |     |       |      |               |                               |
| 8 | 10YR2/3  | 黒色         |     |       |      |               |                               |

B区 D-D'

B区 D-D'  
D. L=23.900m

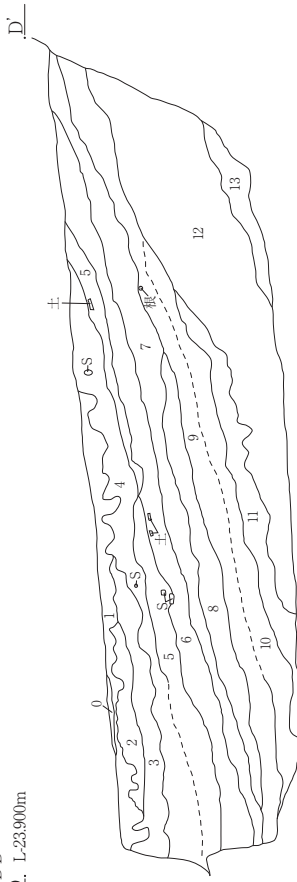

B区 D-D'

- |    |          |             |       |        |                                |              |   |
|----|----------|-------------|-------|--------|--------------------------------|--------------|---|
| 0  | 2.5Y4/2  | 暗灰黄色        |       | シルト質細砂 | 極粗砂～小レキ混じる10%                  | 土師層          | この層の下面で土師の住居 (S I 04-06?) を確認している                             |
| 1  | 10YR2/1  | 黒色          |       | 砂質シルト  | 極粗砂～小レキ混じる5%                   | 細文土器混じる      |   |
| 2  | 5YR3/2   | 暗赤褐色        |       | 砂質シルト  | 極粗砂～小レキ混じる5%                   | 細文土器混じる      |   |
| 3  | 10YR2/2  | 黒褐色         |       | 砂質シルト  | 極粗砂10%                         | 細文土器混じる      |   |
| 4  | 10YR4/2  | 灰黄褐色        |       | 砂質シルト  | 極粗砂～小レキ15～20%                  | 上位           | 全体的には、部分的な粗砂～小レキ主体の層などがあるため、部分により土質が相違するが、この3層を上・中・下に分けて掘削した。 |
| 5  | 10YR4/3  | にぶい黄褐色      |       | 砂質シルト  | 極粗砂～小レキ10%                     | 中位           |   |
| 6  | 7.5YR4/3 | 褐色          |       | 砂質シルト  | 極粗砂～小レキ10%                     | 下位           |   |
| 7  | 7.5YR3/1 | 黒褐色         |       | シルト質細砂 | 右底部分に部分的にこうした砂の堆積がみられる。細文土器混じる |              |   |
| 8  | 10YR4/1  | 褐灰色～10YR4/2 | 灰黄褐   | シルト質細砂 | 中～粗砂わずかに混じる5%                  | 中セリプロック状に混じる |   |
| 9  | 7.5YR2/1 | 黒色          |       | シルト質細砂 | 粗～極細                           | 20%          |   |
| 10 | 7.5YR3/1 | 黒褐色         |       | シルト質細砂 | 粗～極細                           | 10%          |   |
| 11 | 10YR3/2  | 黒褐色         |       | シルト質細砂 | 粗～小レキ混じる                       | 20%          |   |
| 12 | 10YR3/2  | 暗褐色         |       | シルト質細砂 | 粗～小レキ混じる                       | 20%          |   |
| 13 | 10YR4/4  | 暗褐色         | にぶい黄褐 | 砂質シルト  | 中～粗砂混じる                        | 5%           | III層系の土壌化の進行したものの。  |



第247図 B区遺物包含層 (5)

B区 E-E'

B区 E-E' L=28800m

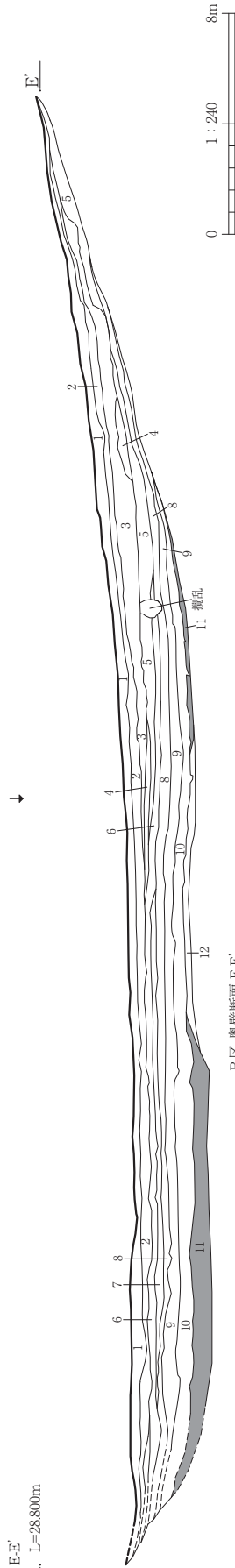

- B区 奥壁断面 E-E'
- 1 7.5YR2/2 黒褐色
  - 2 5YR2/1 黒褐色
  - 3 7.5YR2/1 黒色
  - 4 10YR5/2 灰黄褐色
  - 5 10YR5/2 灰黄褐色
  - 6 10YR5/2 灰黄褐色
  - 7 7.5YR4/2 黒色
  - 8 7.5YR1/7 灰黄褐色～10YR2/2 黒褐色
  - 9 10YR4/2 灰褐色～7.5YR2/2 黒褐色
  - 10 7.5YR4/2 黒褐色
  - 11 10YR5/3～10YR4/3 に近い黄褐色
  - 12 10YR7/8 黄褐色

拡大図

L=28800m

- シルト～細砂 締まり疎 基本層序 I 層相当
- シルト 締まりやや疎
- 細砂 締まり中
- シルト～極細砂 シルト混じる 6層よりやや明るいか？分層できるが...
- シルト 締まり疎 細砂20%混じる
- シルト～細砂 締まり疎 細砂20%混じる
- シルト 締まりやや疎 細～中砂20%混じる
- シルト～極細砂 粘性ややあり 締まり中 粗砂～小礫10%混じる 下面で土師住居跡検出
- シルト～細砂 締まり中 粗砂～小礫15%混じる 縄文前期包含層（包含層断面の（上）に対応）
- シルト 締まり中 粗砂～小礫10～15%混じる 縄文前期包含層（包含層断面の（中）；（下）に対応）
- シルト 締まり中 細砂～粗砂20%混じる 遺物は混じらないようである 上面で火山灰をブロック状に検出
- 粘土～シルト 粘性あり 締まり良 基盤層 基本層序 III 層相当

第248図 B区遺物包含層（6）

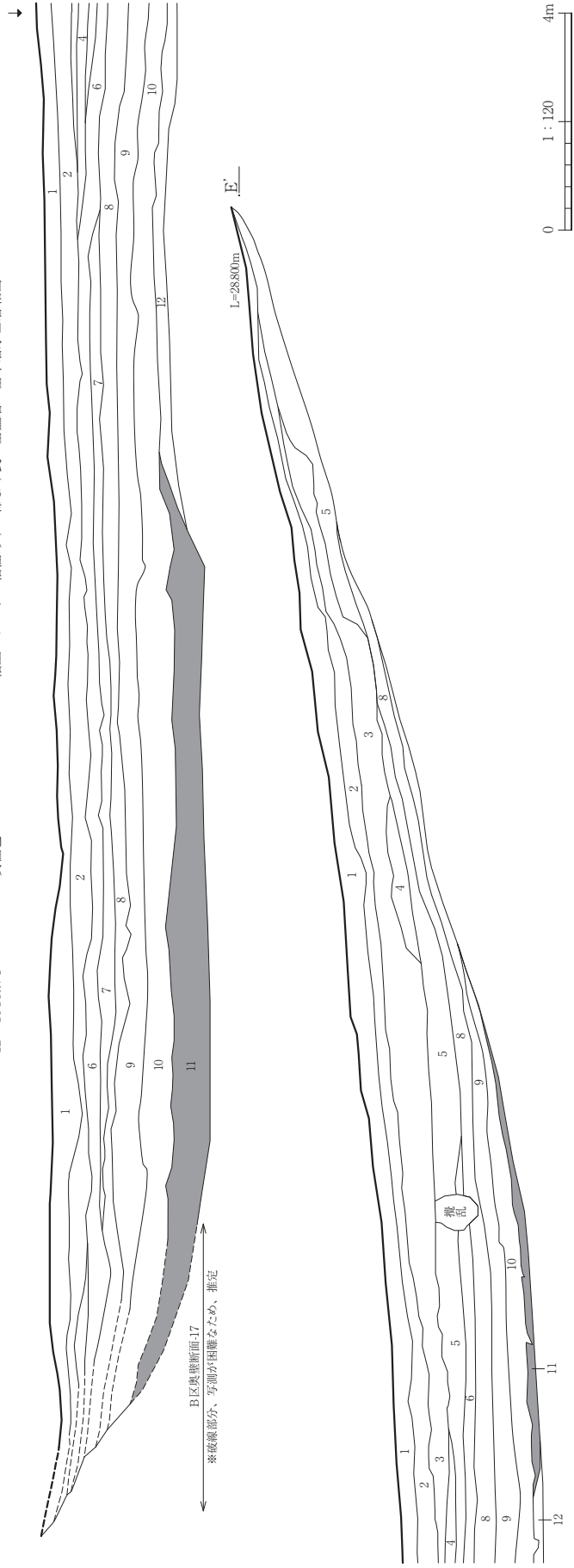



S 101



1



2

S 103 (1)

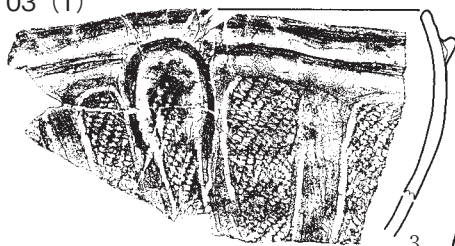

3

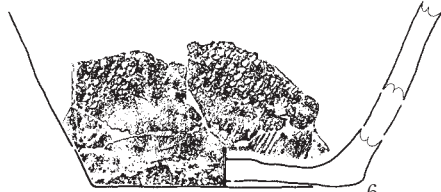

6

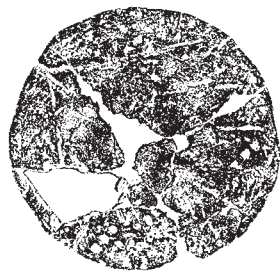

4

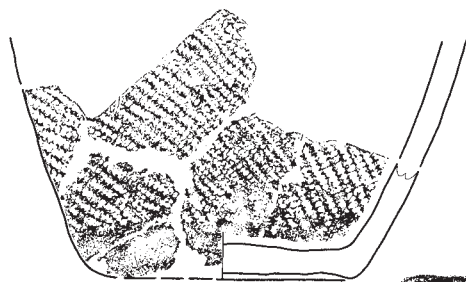

7

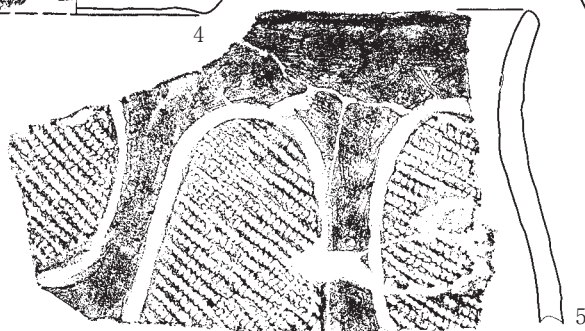

5

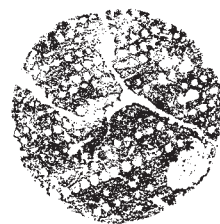

0 1:3 10cm

第249図 縄文土器 (1)

S 103 (2)

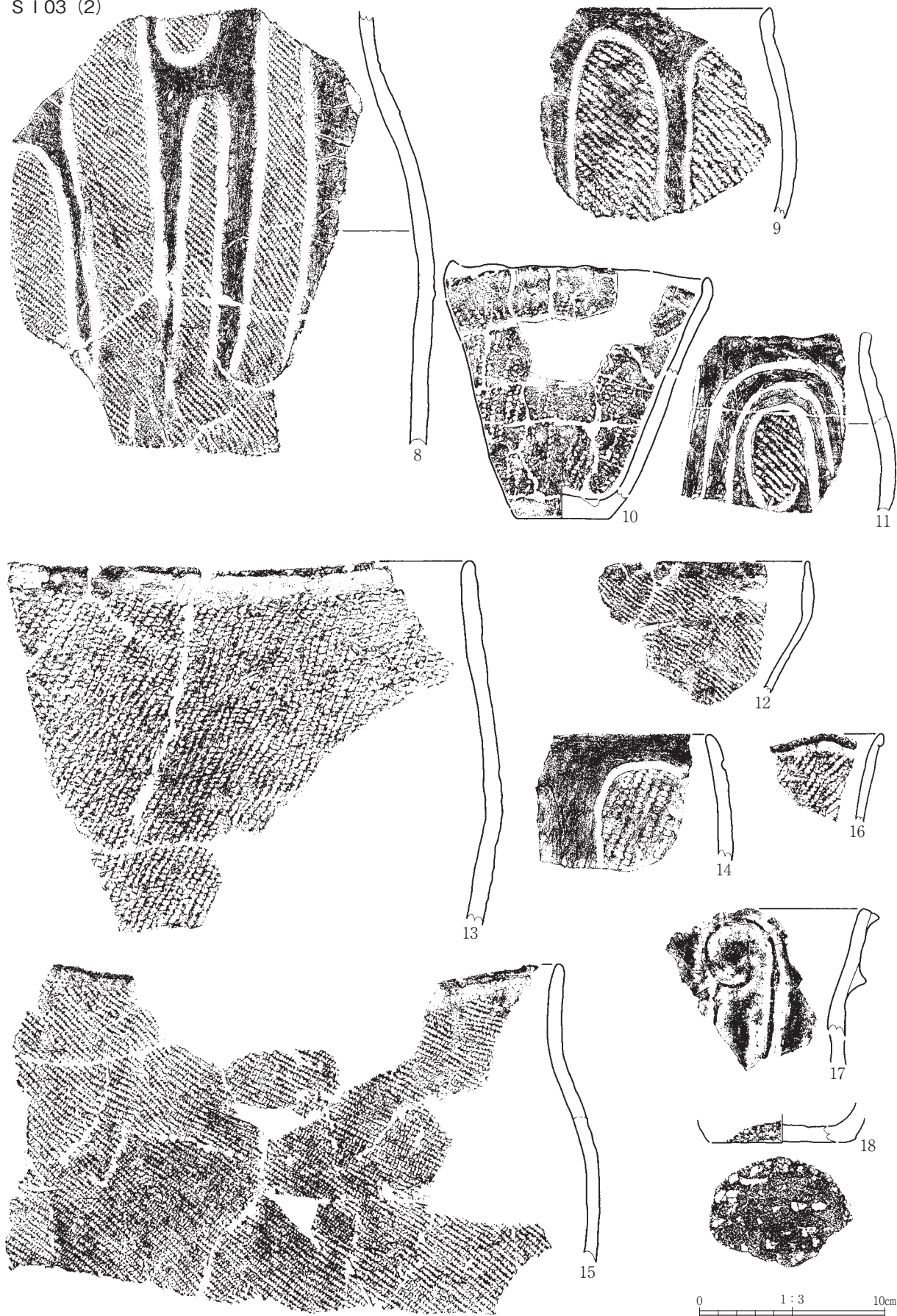

第250図 縄文土器 (2)

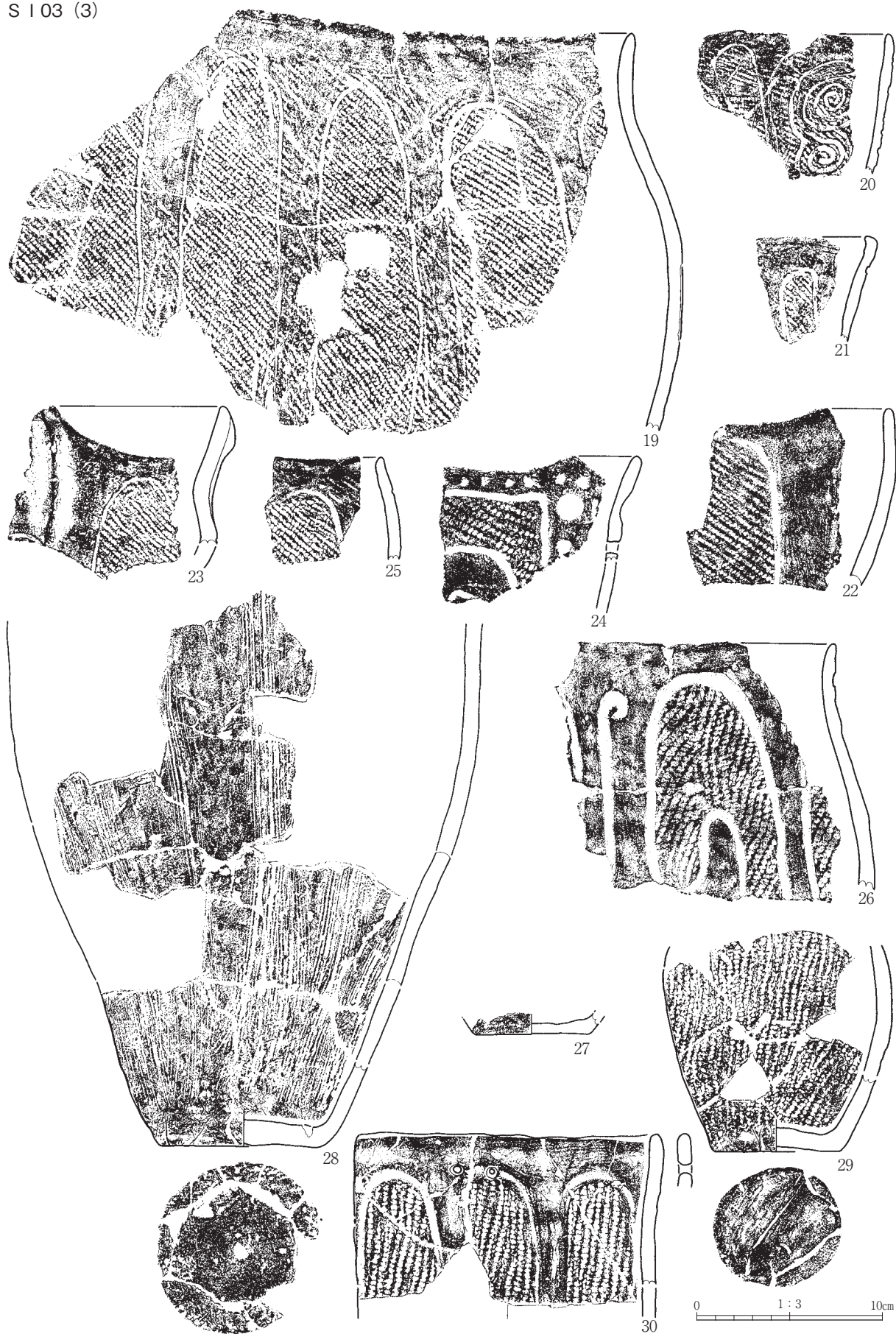

第251図 縄文土器 (3)

S 112 (1)

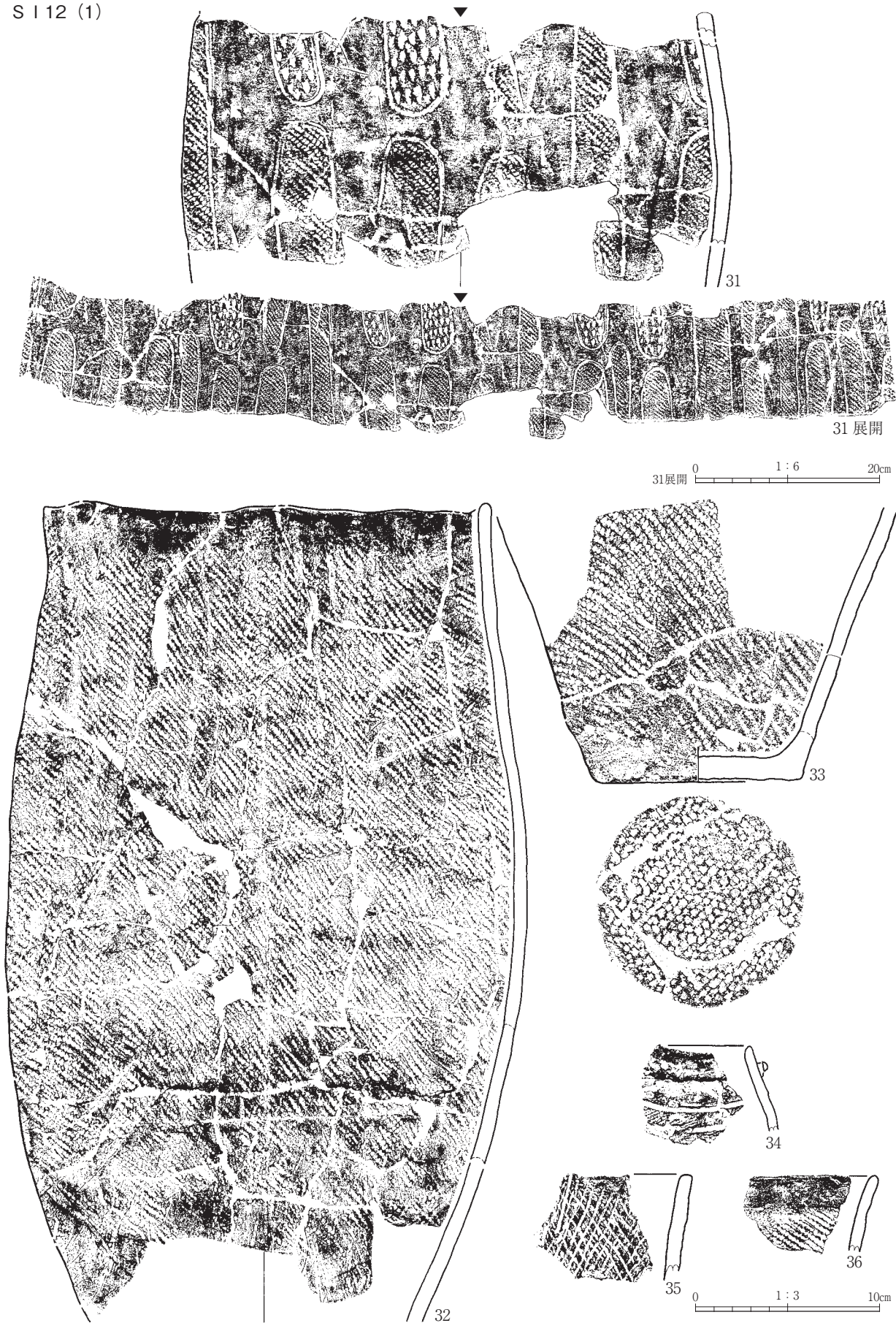

第252図 縄文土器 (4)

S I 12 (2)

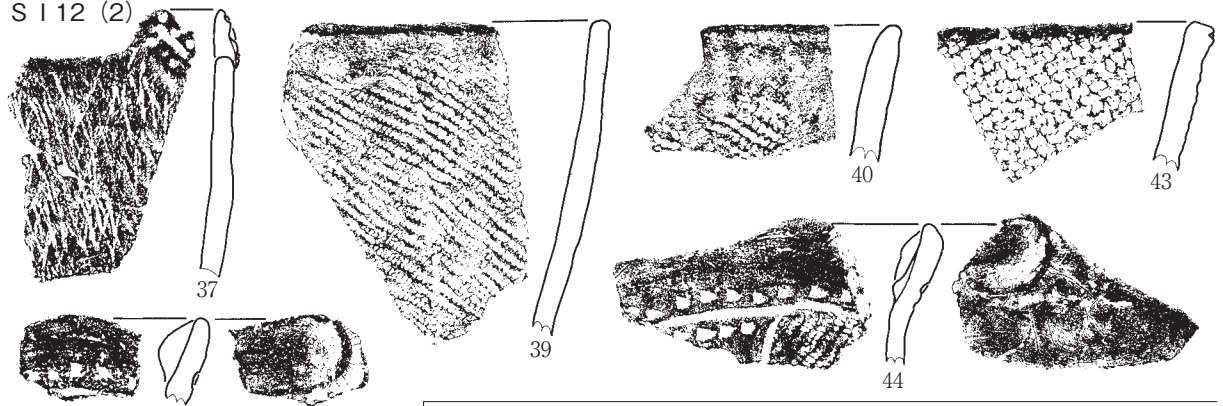

S I 13 (1)

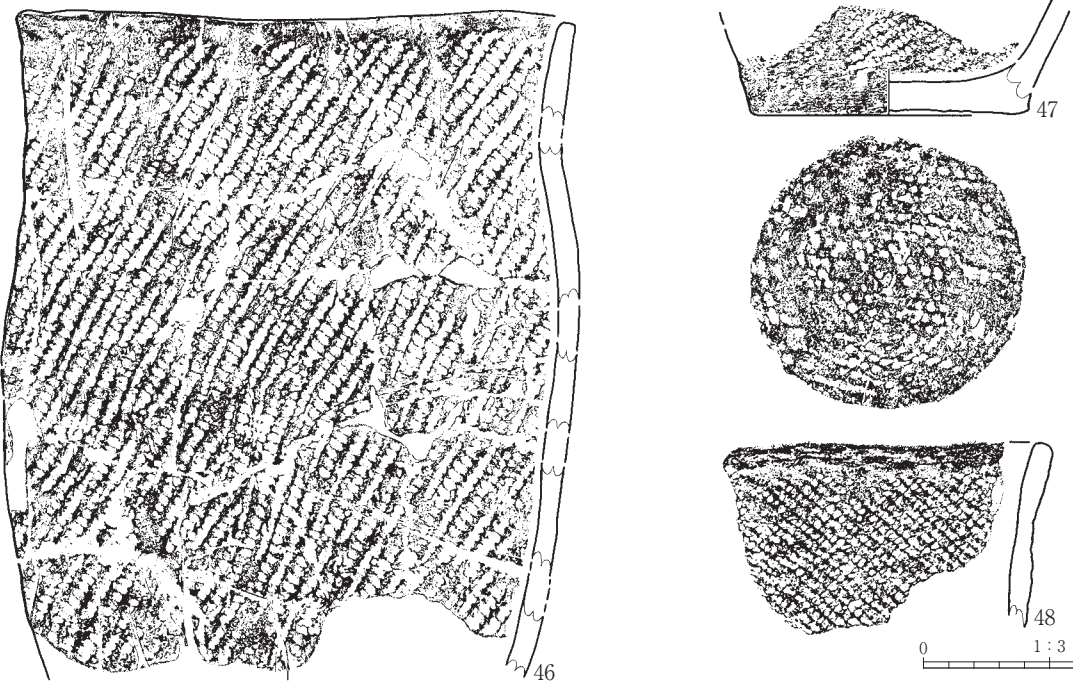
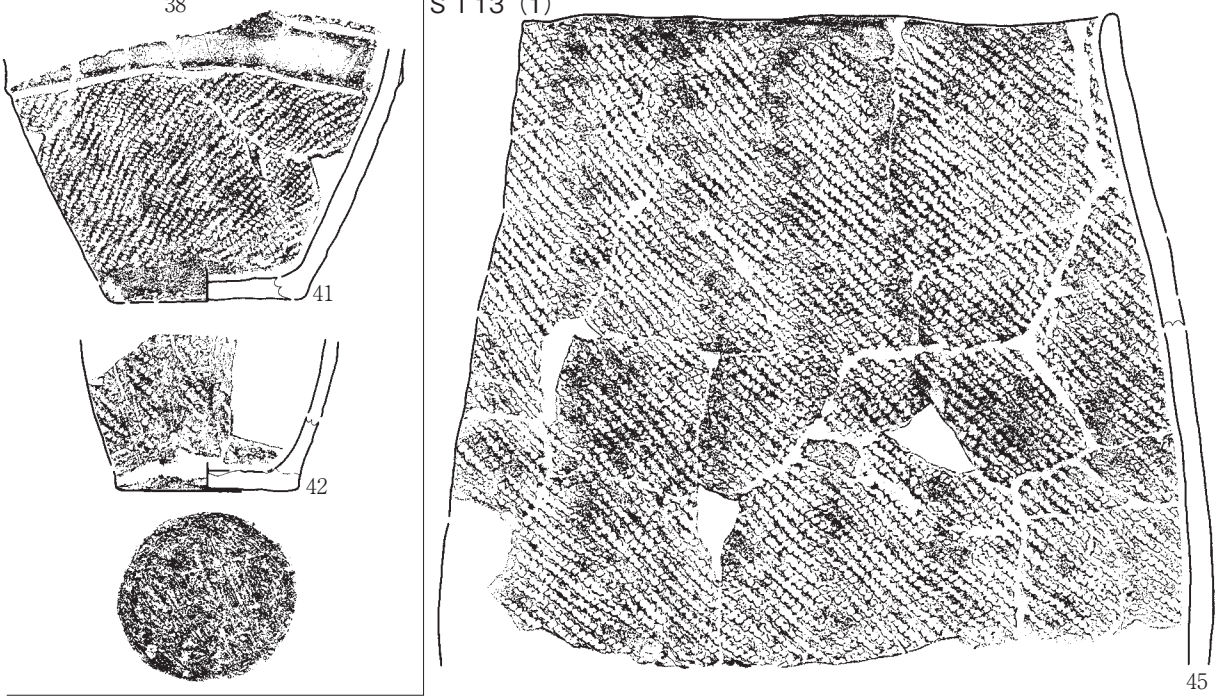

0 1:3 10cm

第253図 縄文土器 (5)

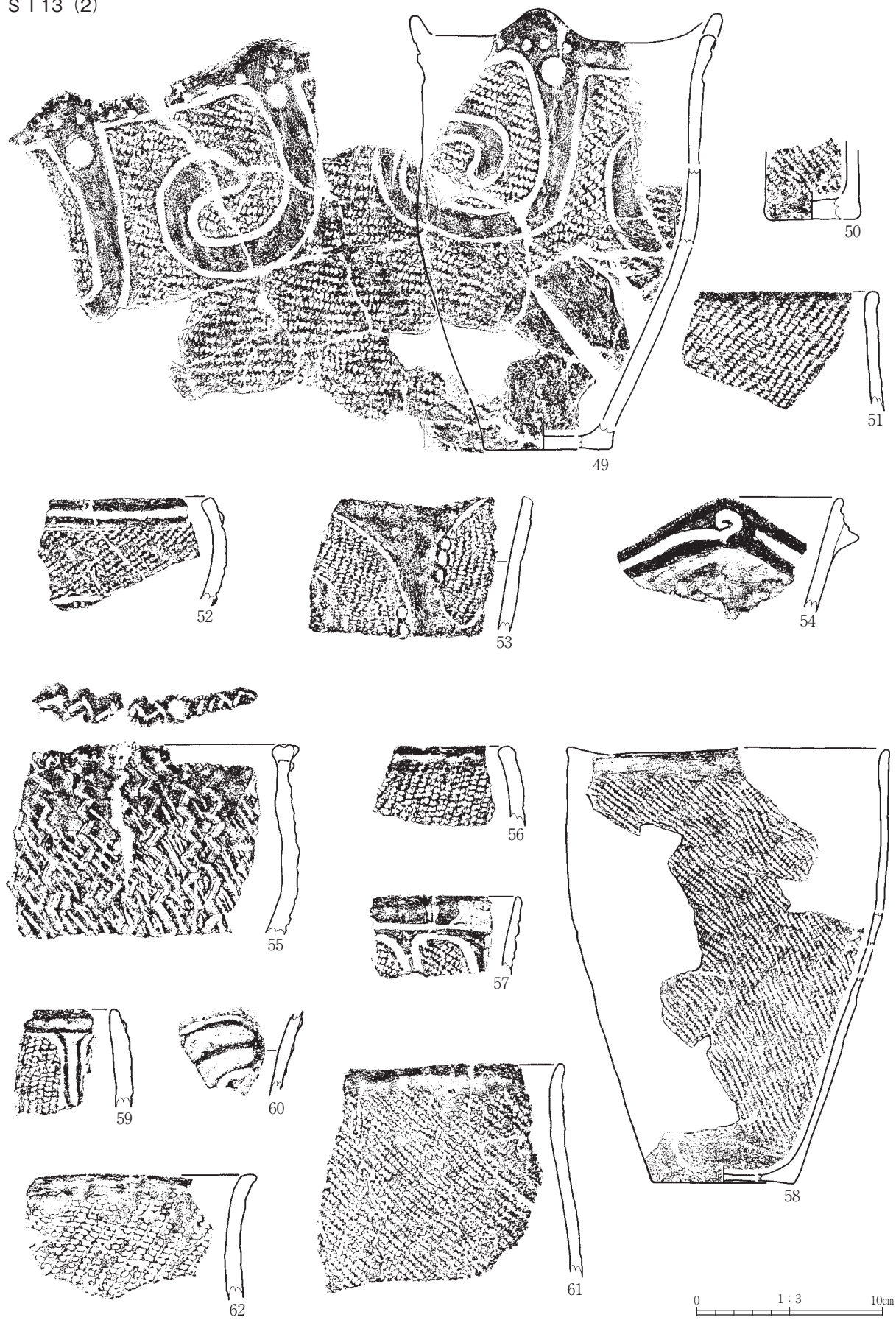

第254図 縄文土器 (6)

S I 13 (3)

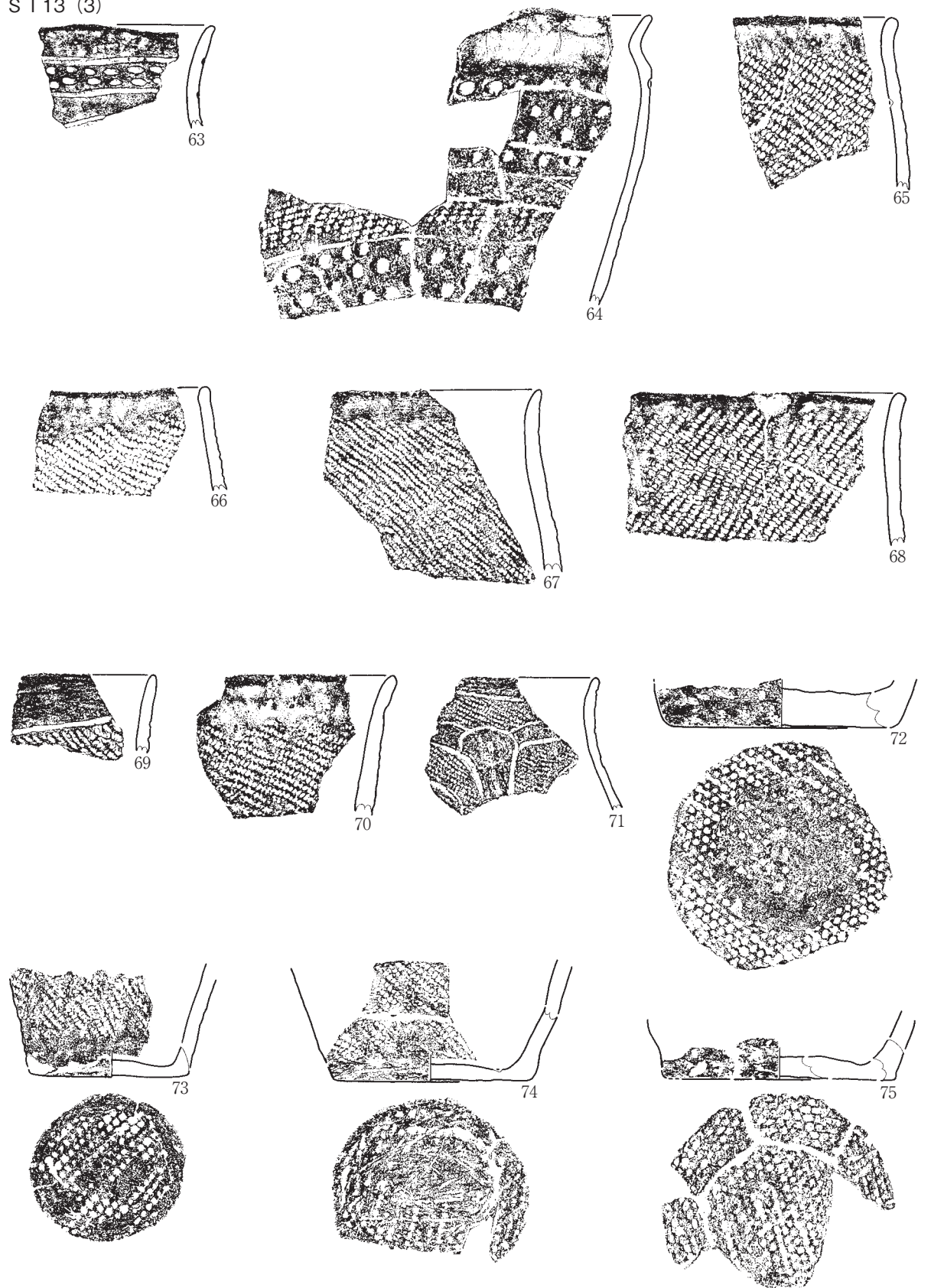

第255図 縄文土器 (7)

S I 13 (4)

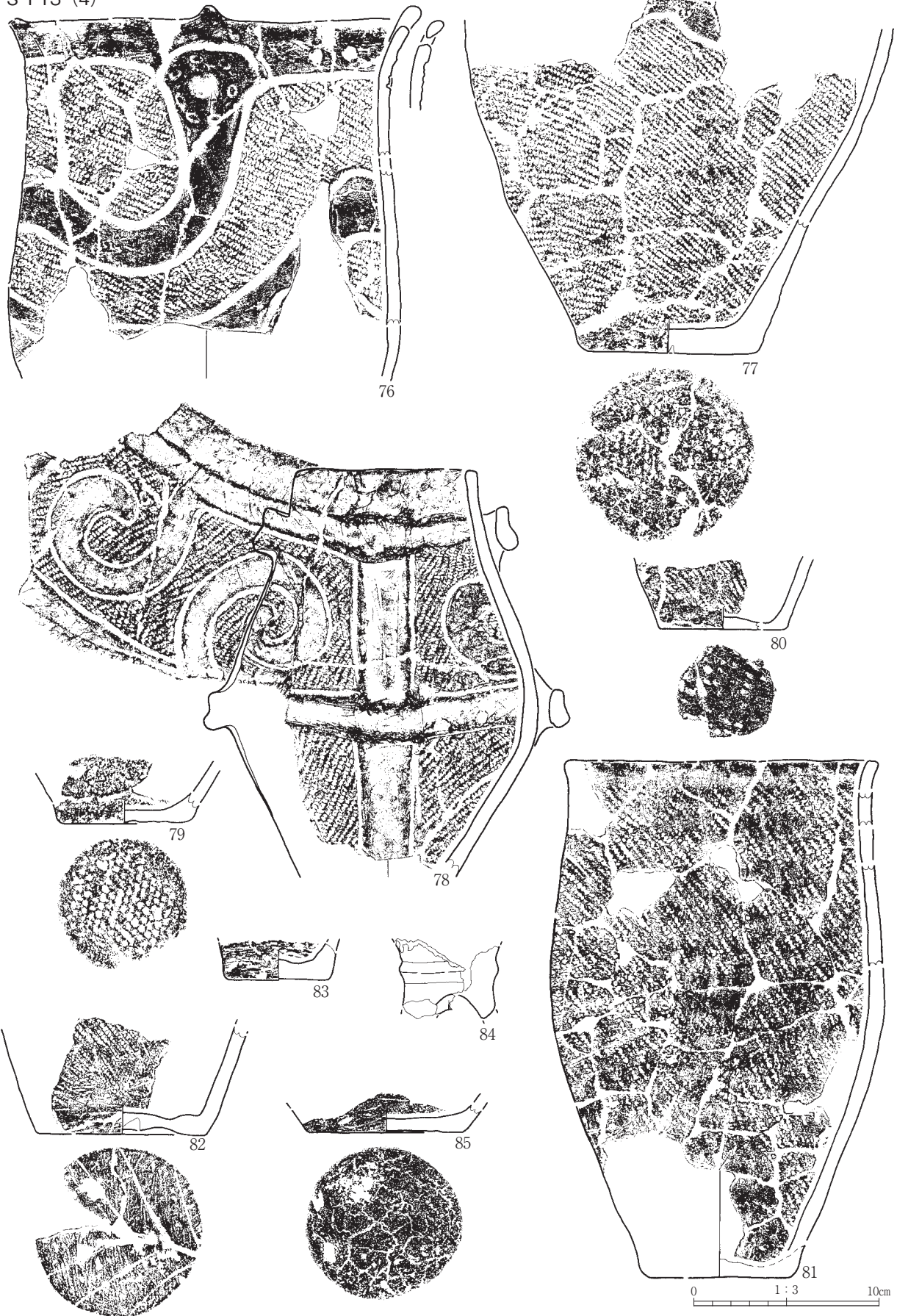

第256図 縄文土器 (8)



S 114

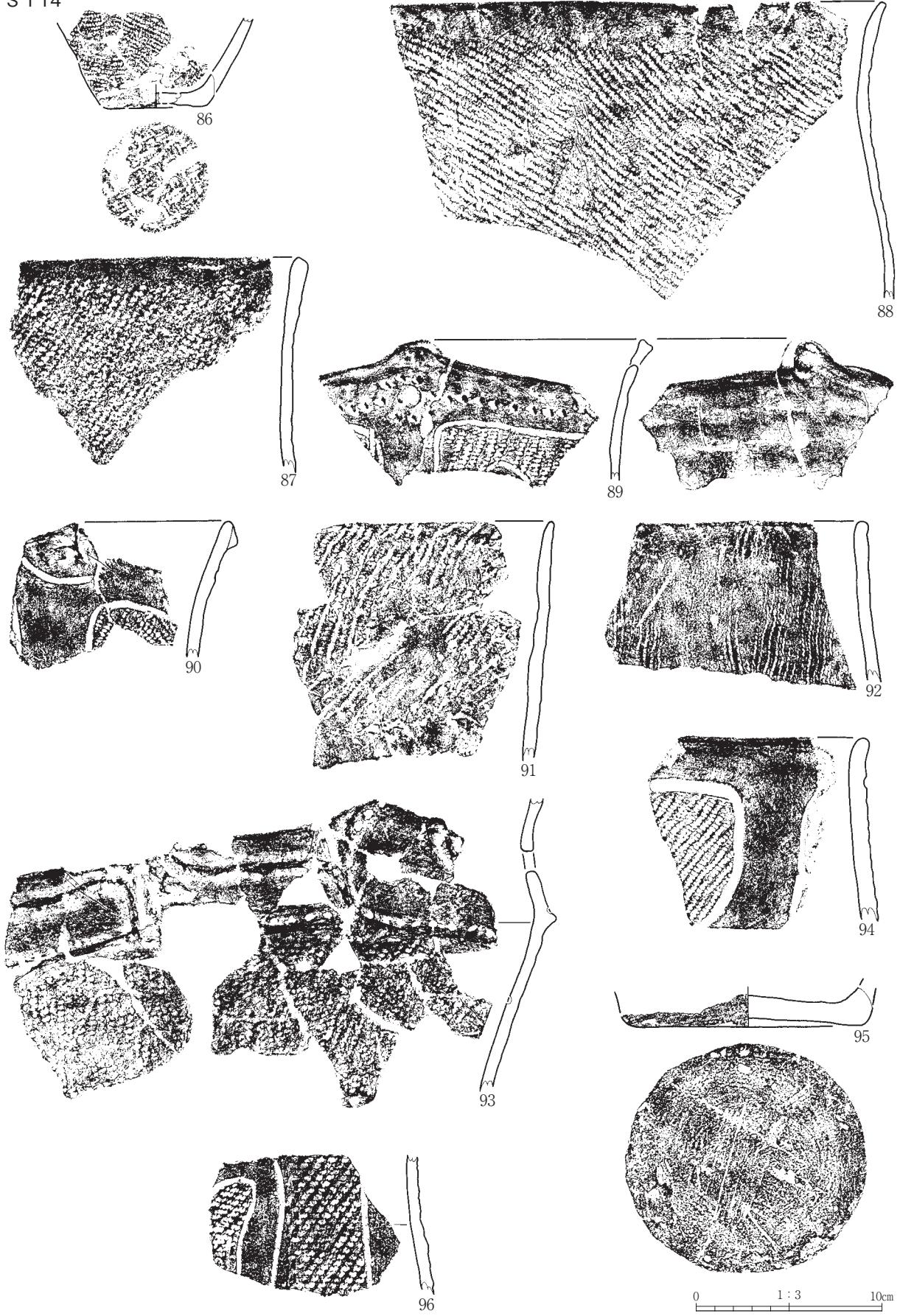

第257図 縄文土器 (9)

S I 14・15



97

S I 15 (1)

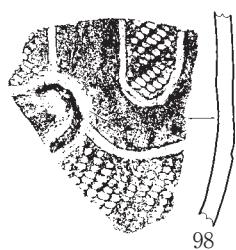

98



99

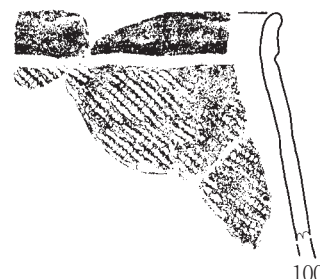

100



101



102

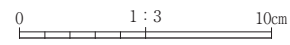
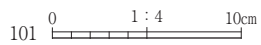

第258図 縄文土器 (10)

S 115 (2)

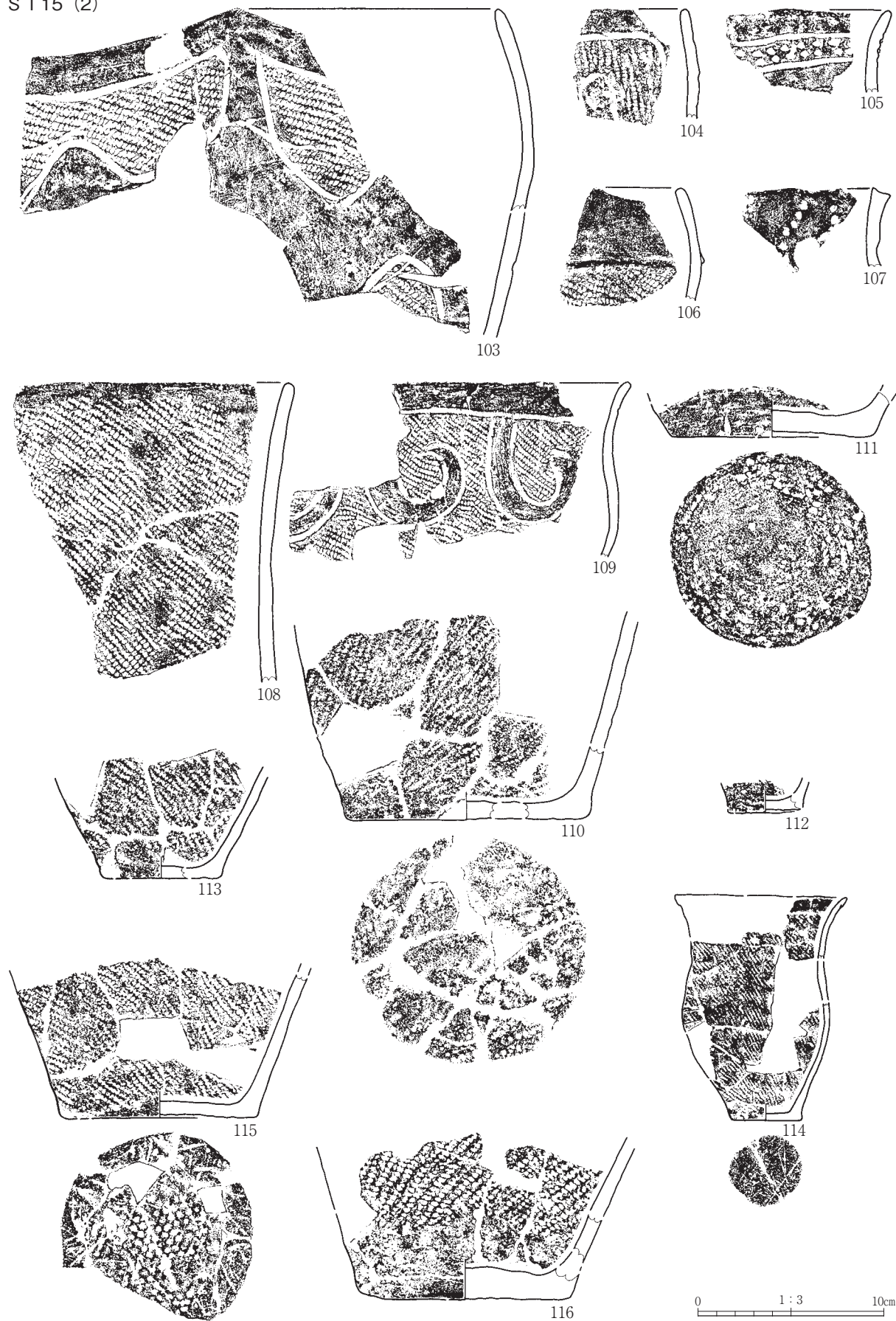

第259図 縄文土器 (11)

S 118 (1)

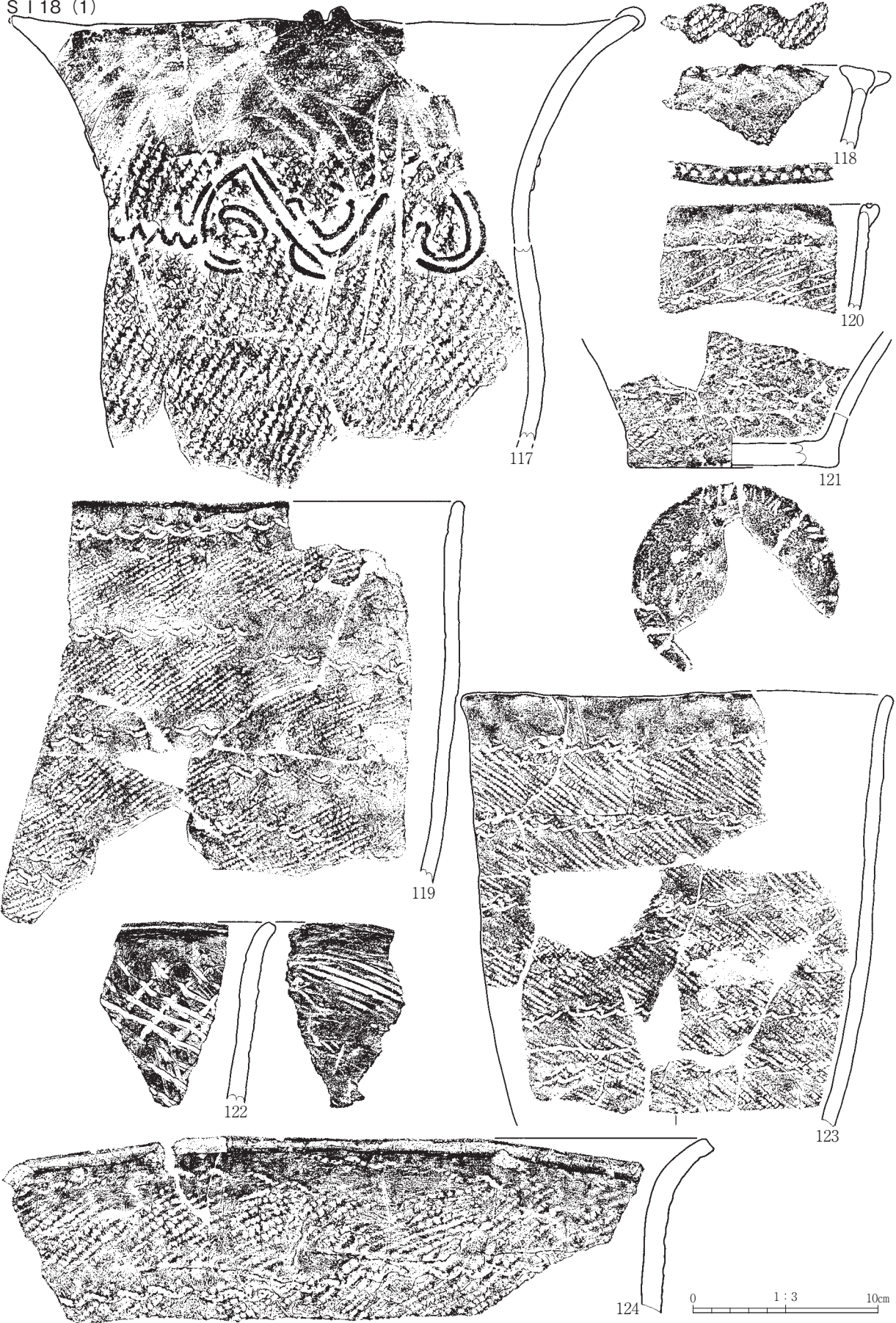

第260図 縄文土器 (12)

S 118 (2)

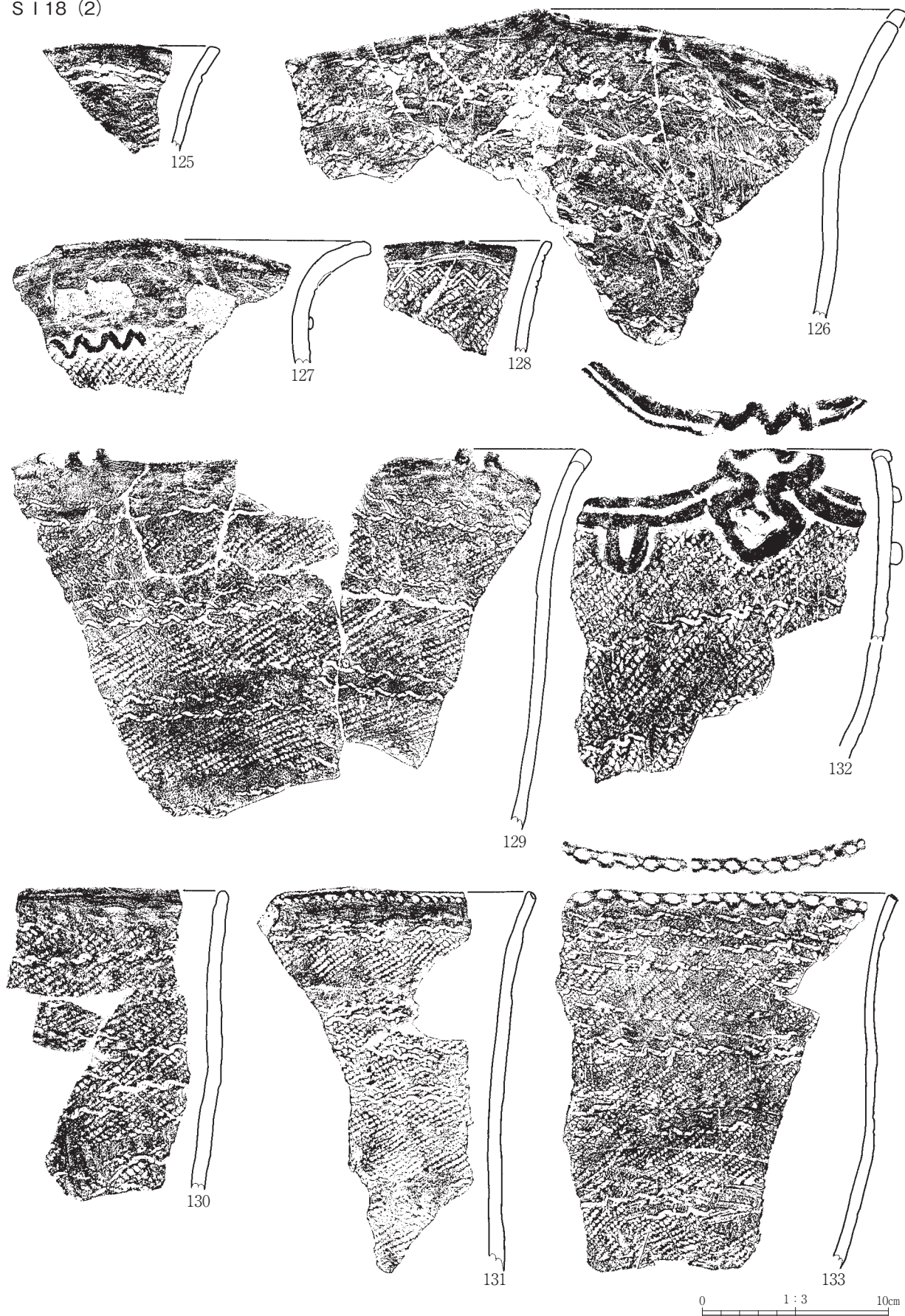

第261図 縄文土器 (13)

S I 18 (3)



第262図 縄文土器 (14)

S 118 (4)



第263図 繩文土器 (15)

S 118 (5)

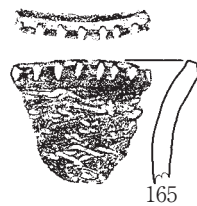
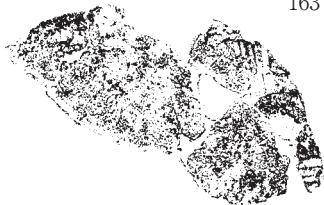
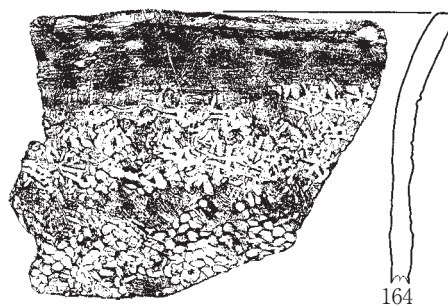
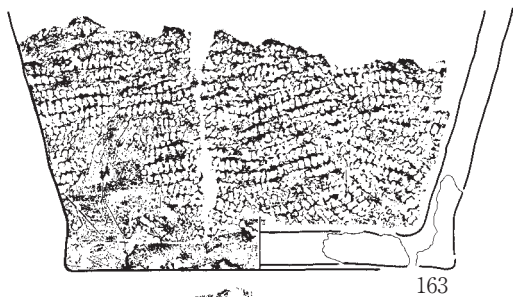
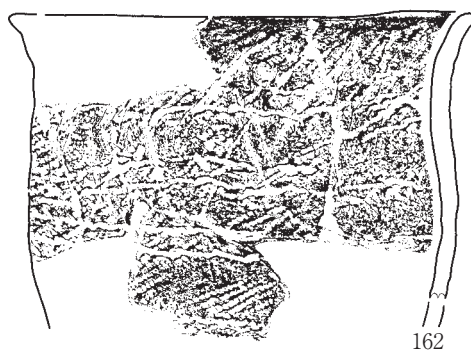
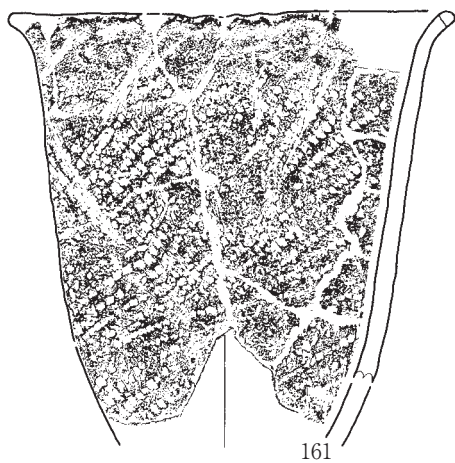
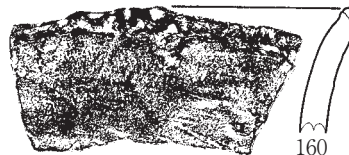
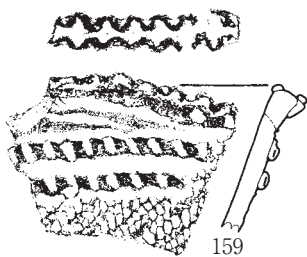
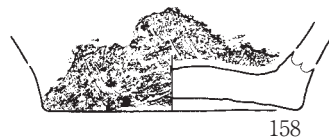
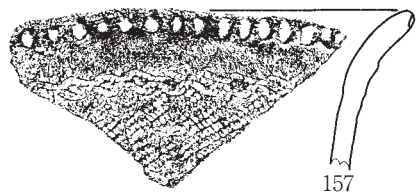

0 1:3 10cm

第264図 縄文土器 (16)



S 119 (1)

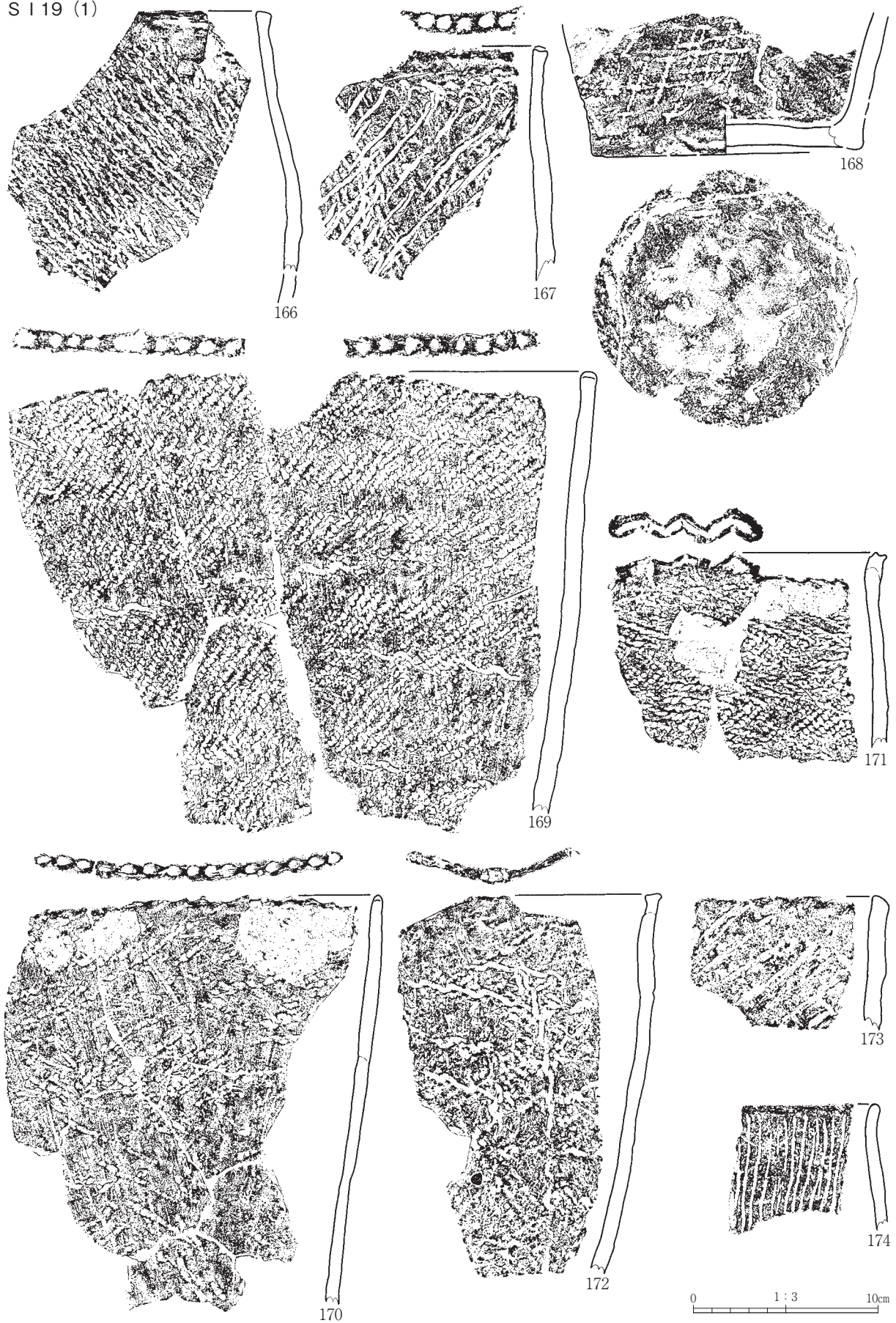

第265図 縄文土器 (17)

S 119 (2)

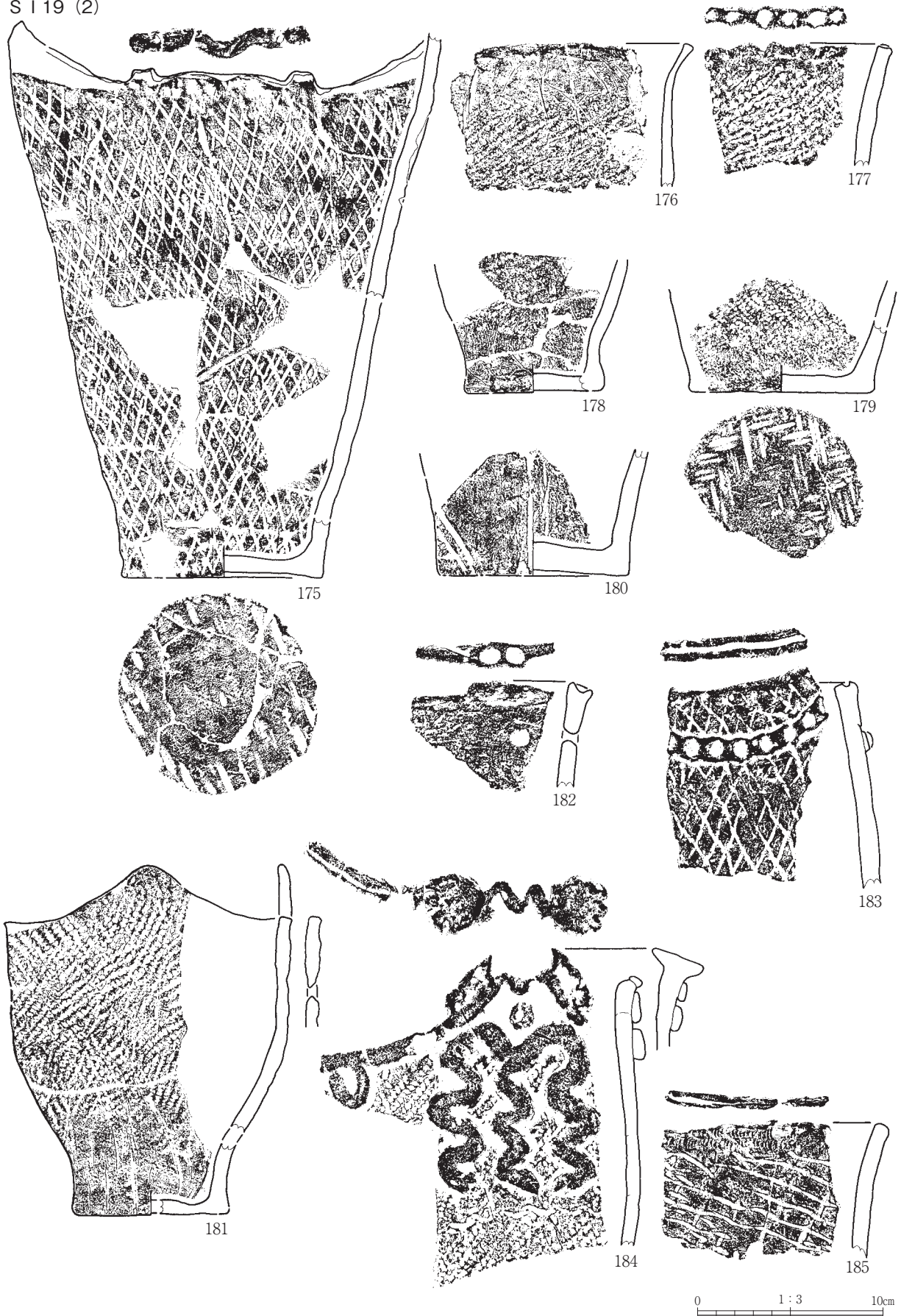

第266図 繩文土器 (18)

S | 20

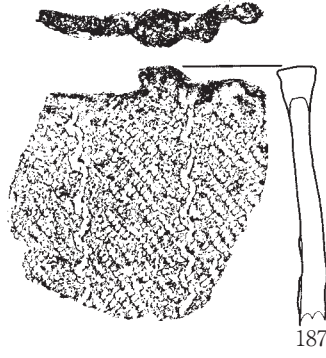

S | 23

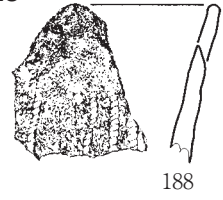

S | 24 (1)

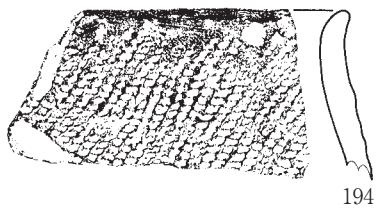
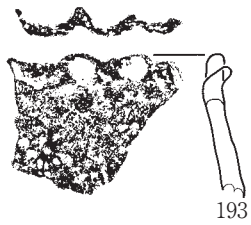
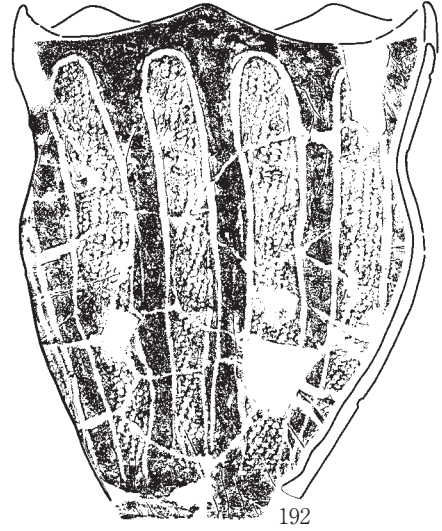
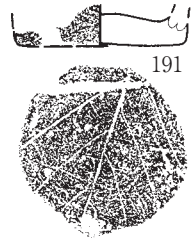
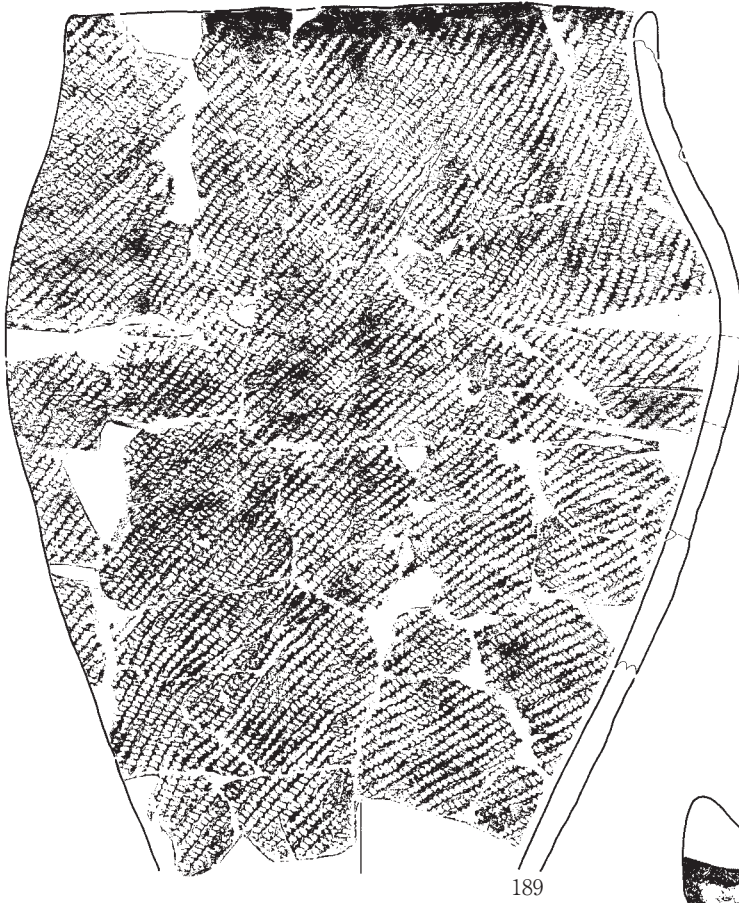

0 1:3 10cm

第267図 縄文土器 (19)

S 124 (2)

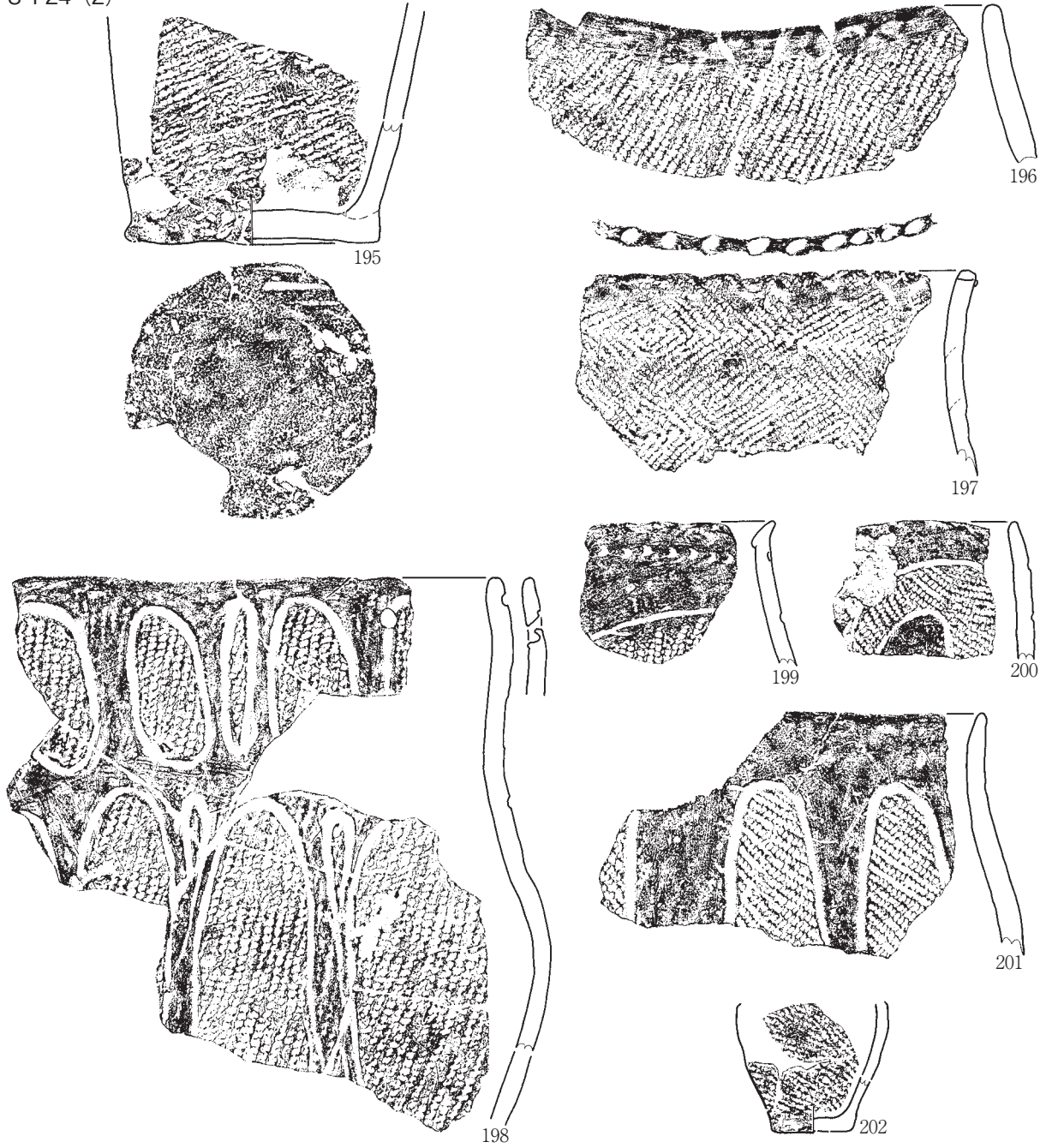

S 125

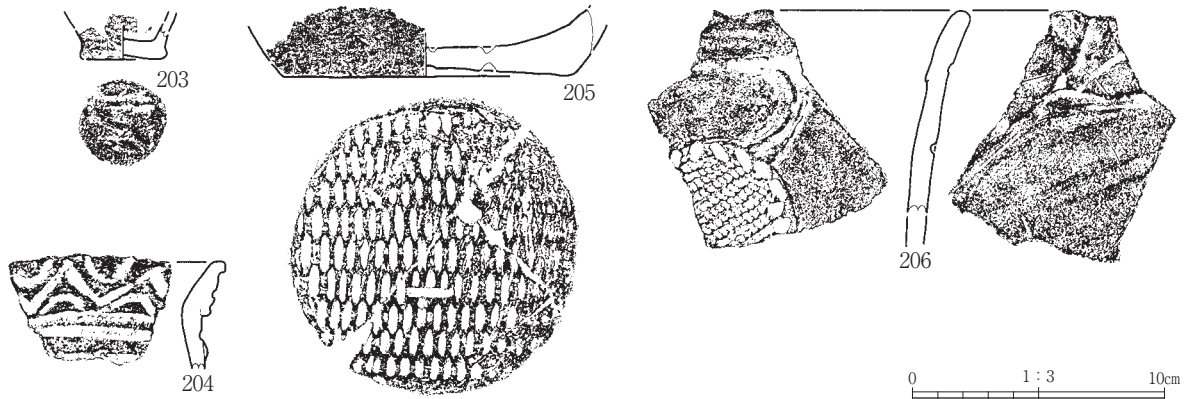

第268図 縄文土器 (20)

S I 29

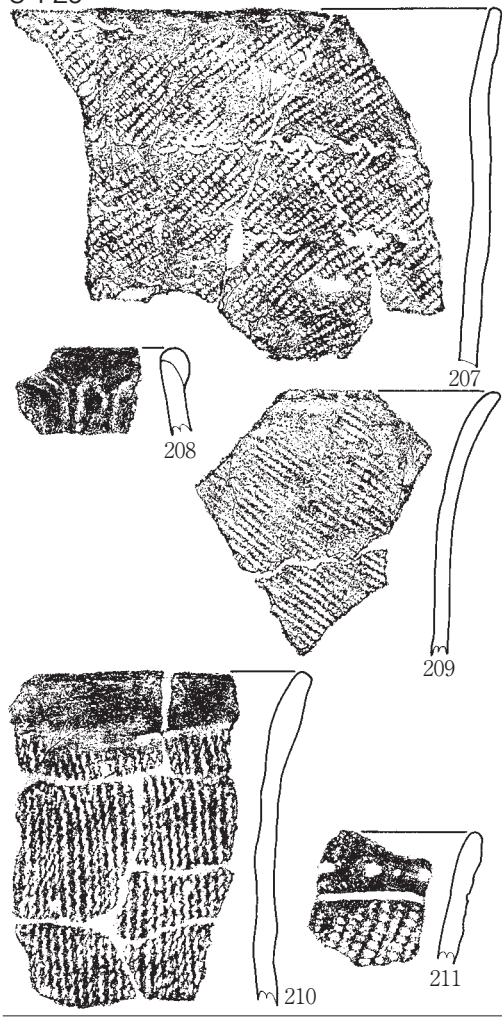

S I 30(1)

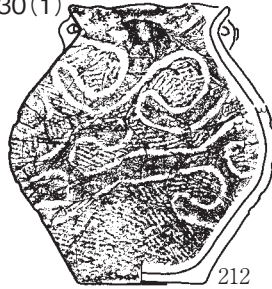

212 赤彩範圍

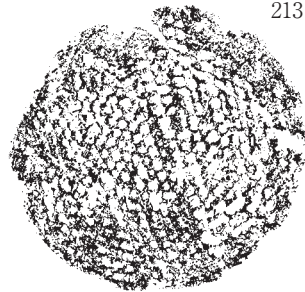
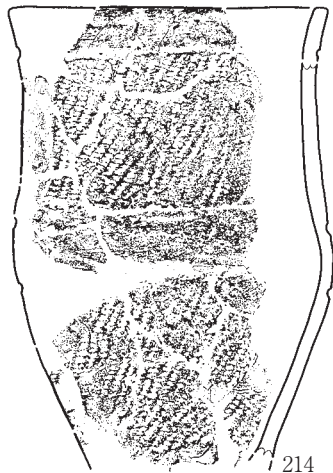

0 1:3 10cm

第269図 縄文土器 (21)

S I 30 (2)

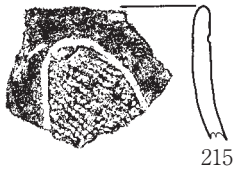

215



216



S I 30~32

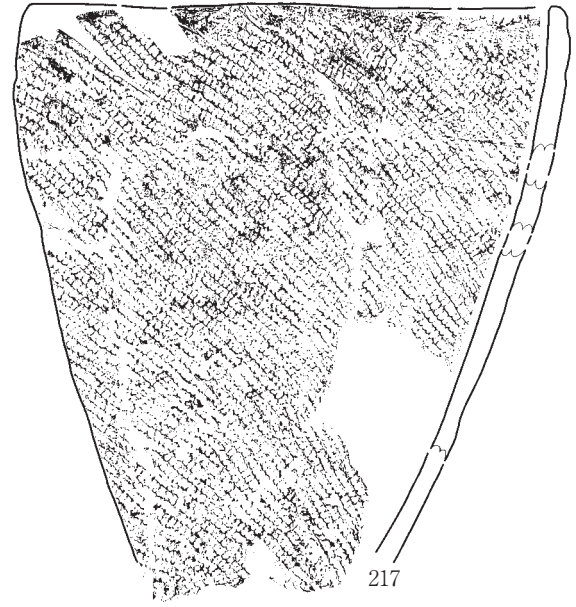

217

S I 31 (1)

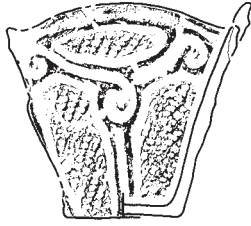

218



219

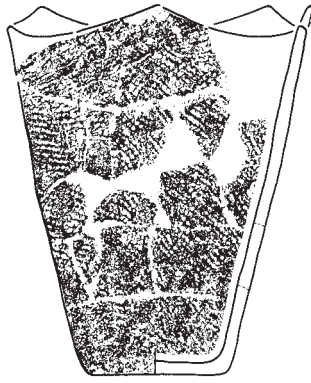

220



221

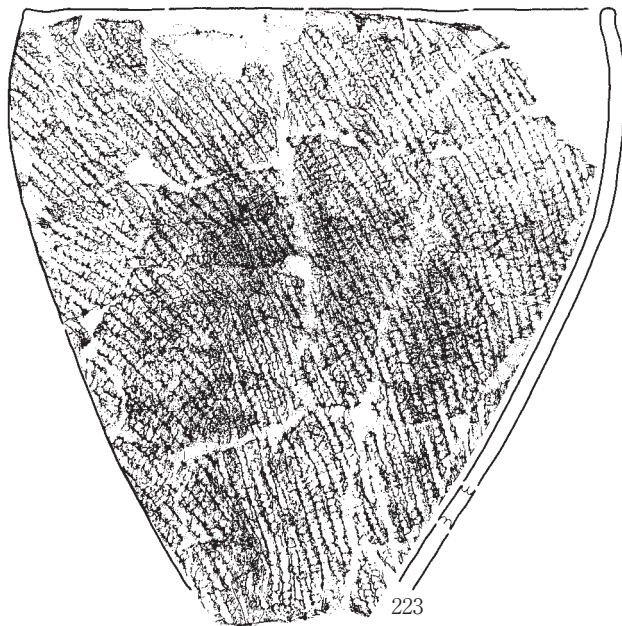

223

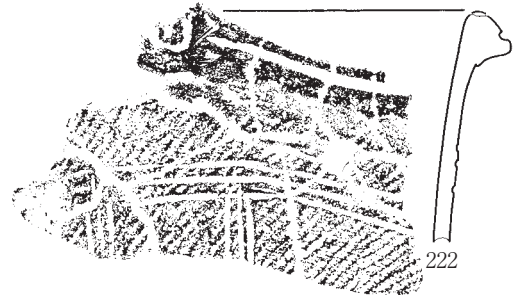

222

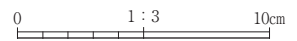

第270図 縄文土器 (22)

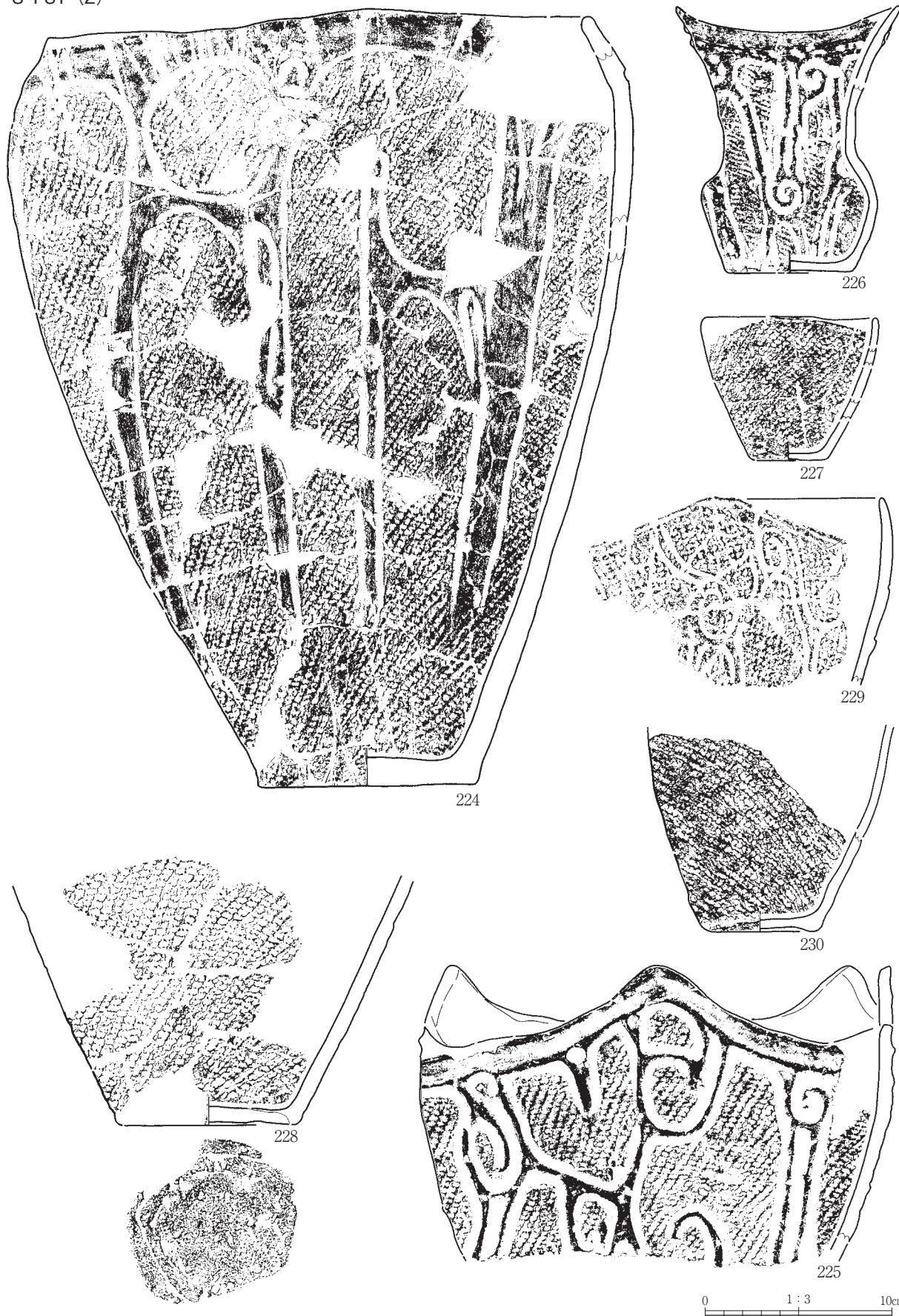

第271図 縄文土器 (23)

S 131 (3)



第272図 縄文土器 (24)



S I 31 (4)

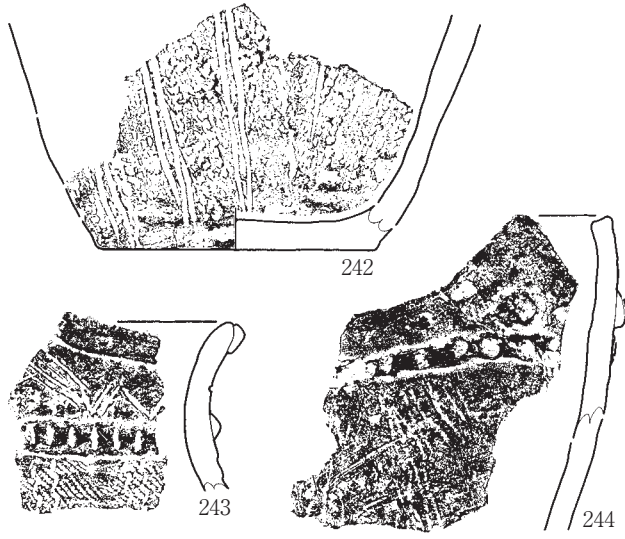

S I 32

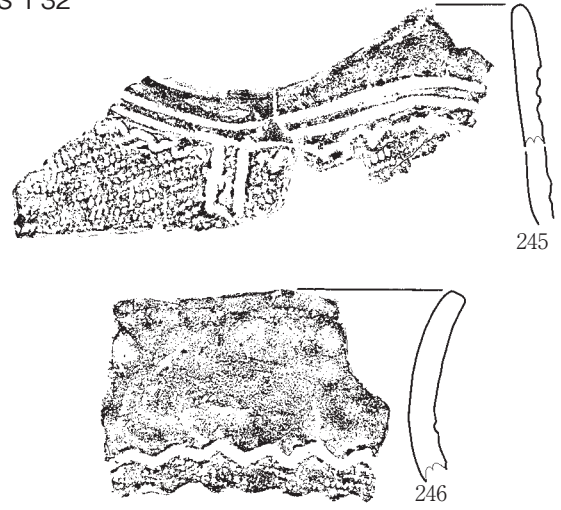

S I 33

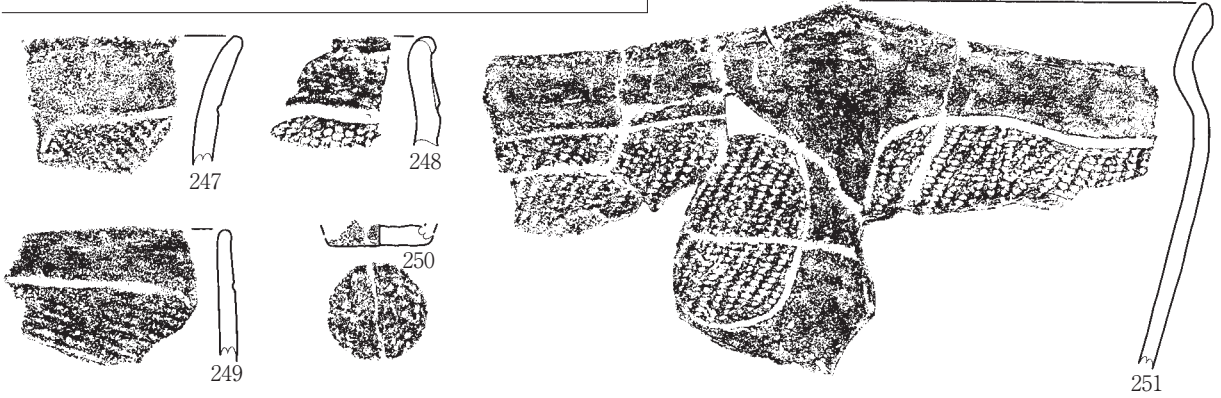

S I 34 (1)

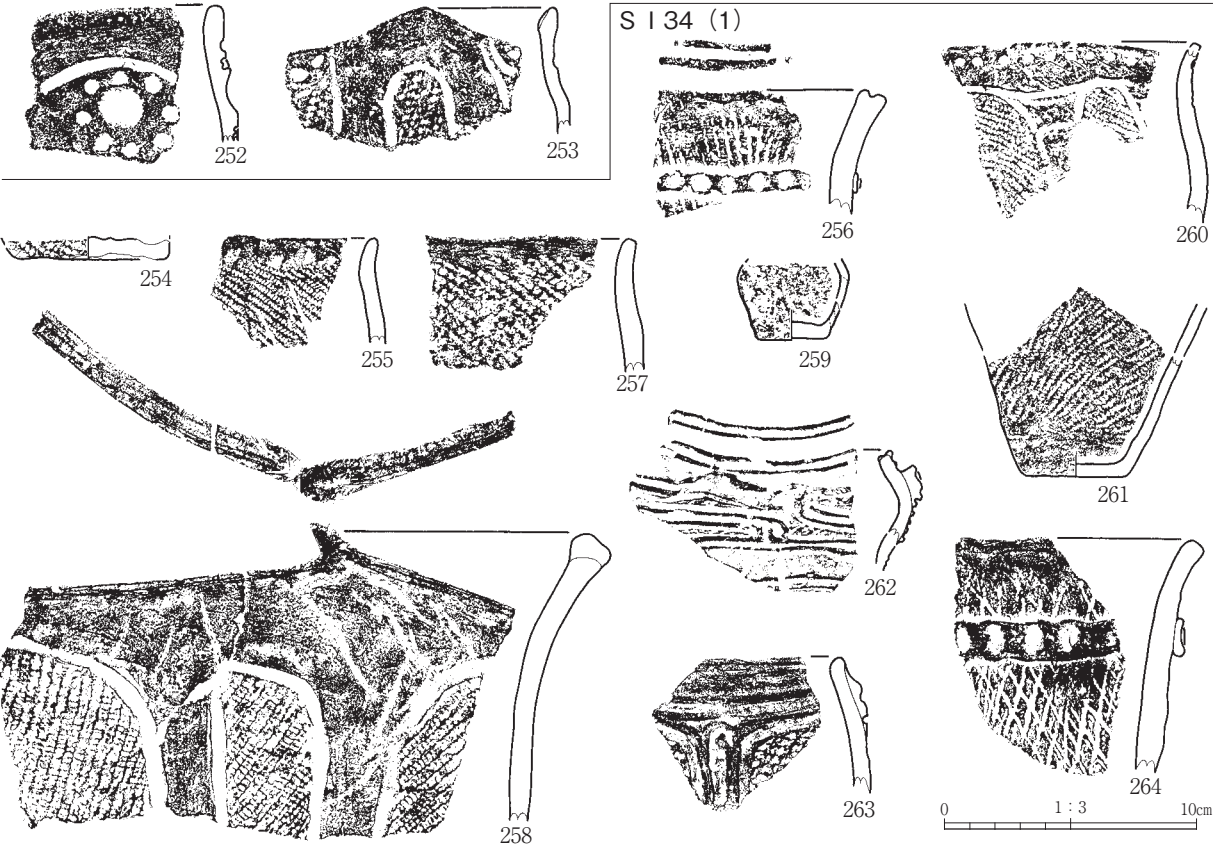

0 1:3 10cm

第273図 縄文土器 (25)

S I 34 (2)

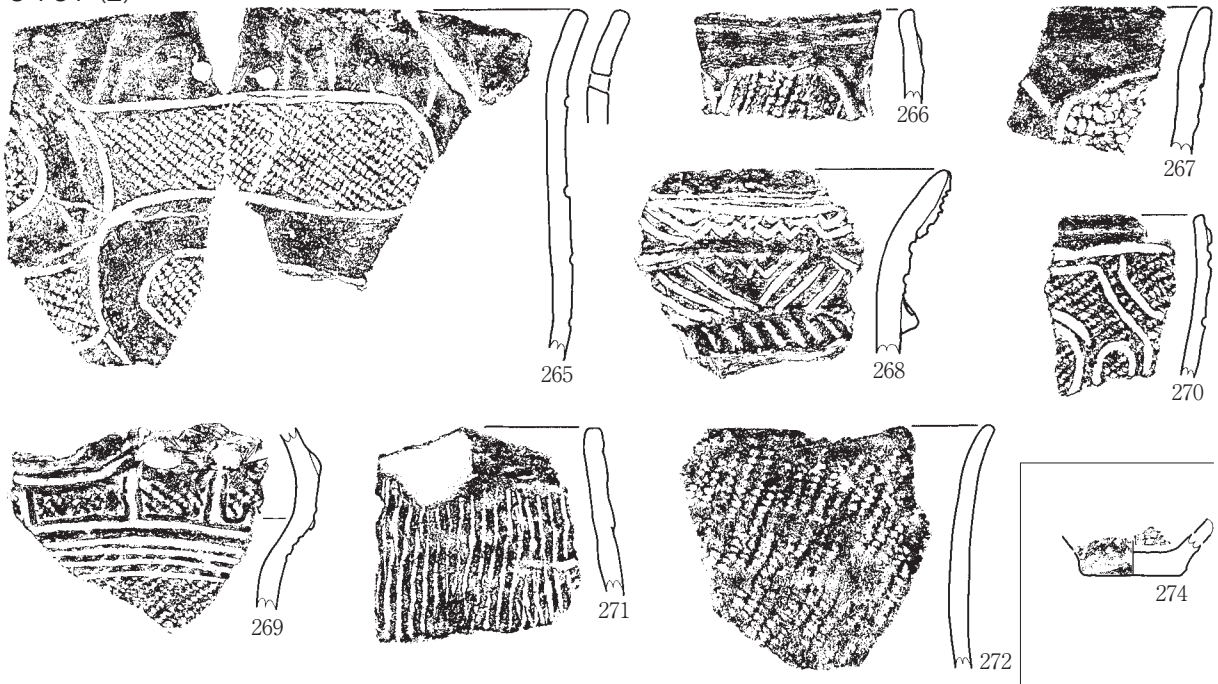

S I 35 (1)

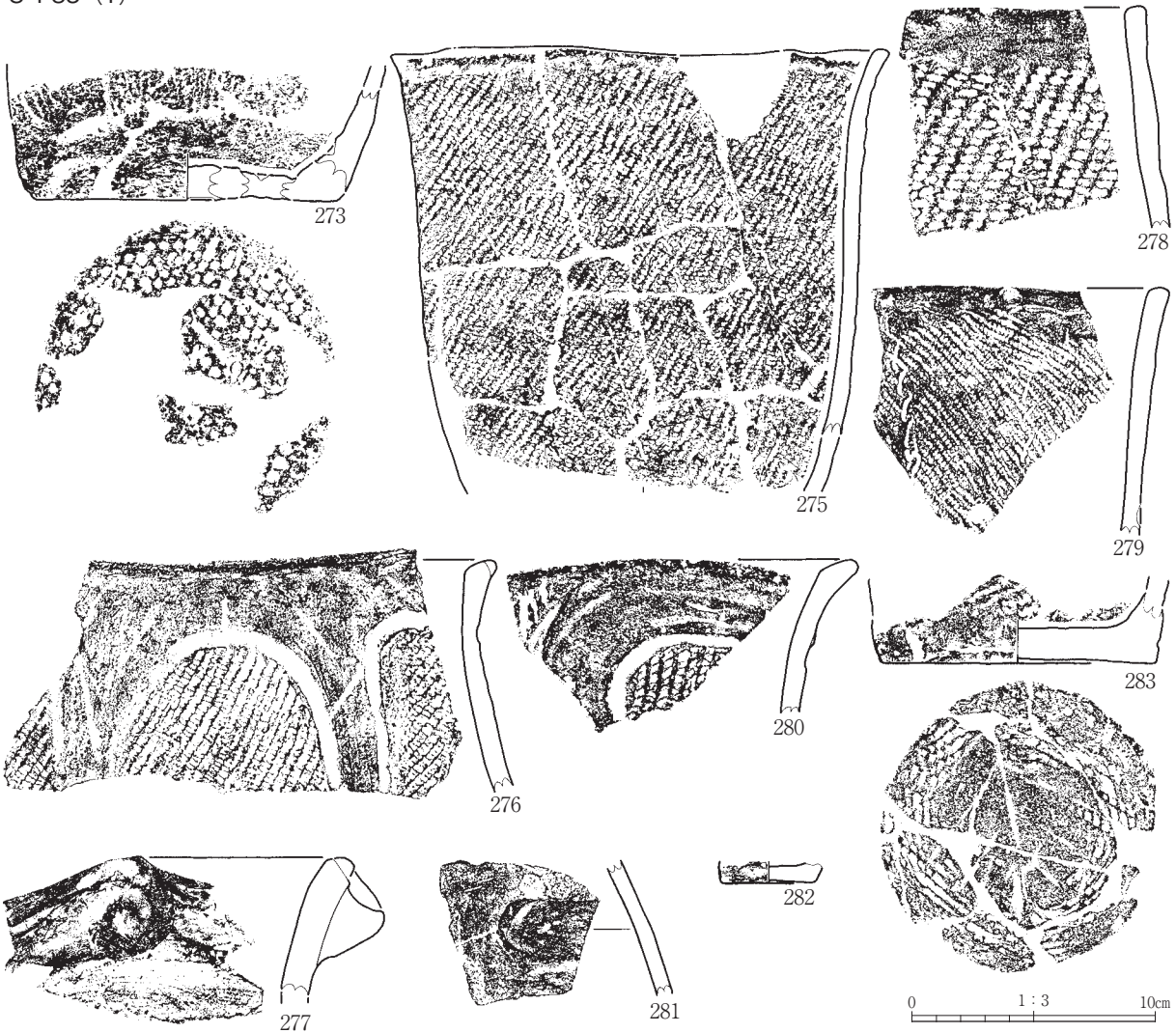

第274図 縄文土器 (26)

S I 35 (2)

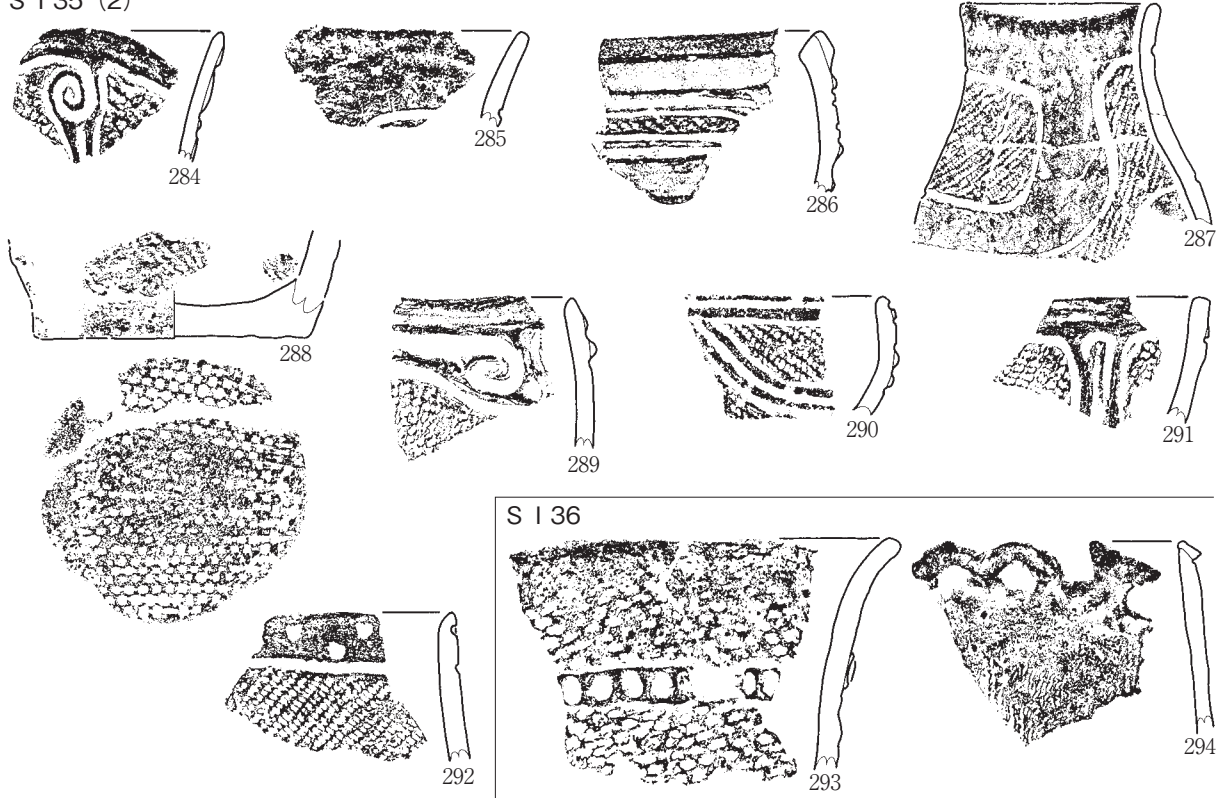

S I 36

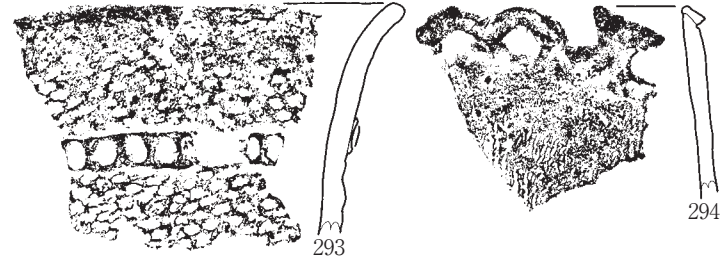

S I 37 (1)

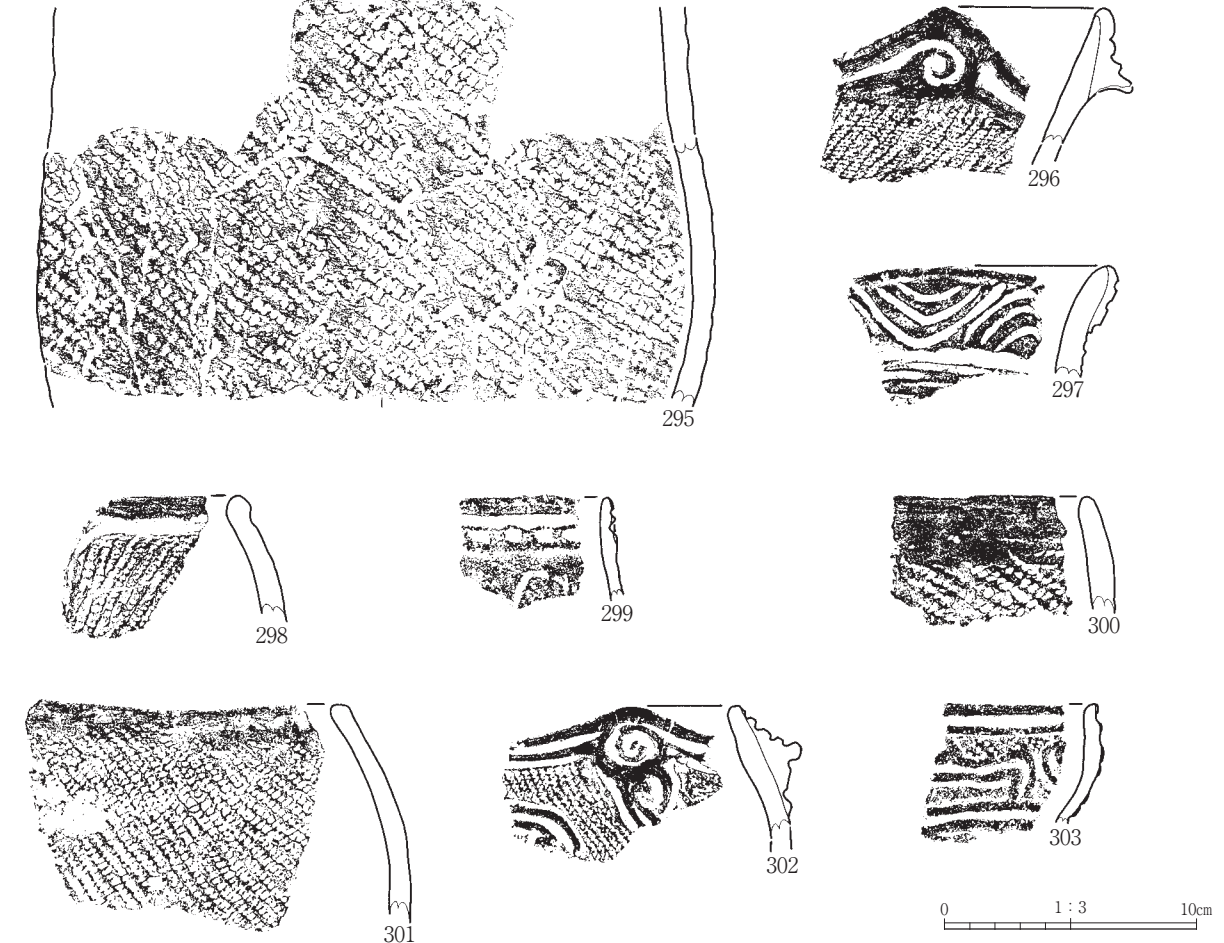

第275図 縄文土器 (27)

S 137 (2)

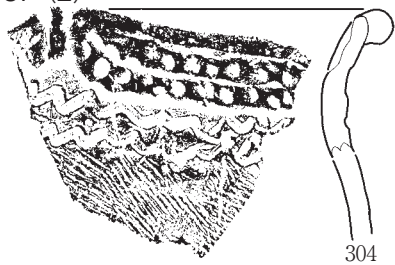

304

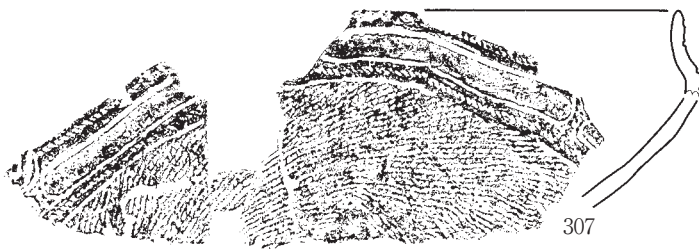

307



305



308

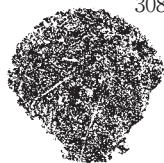

306

S 138



309

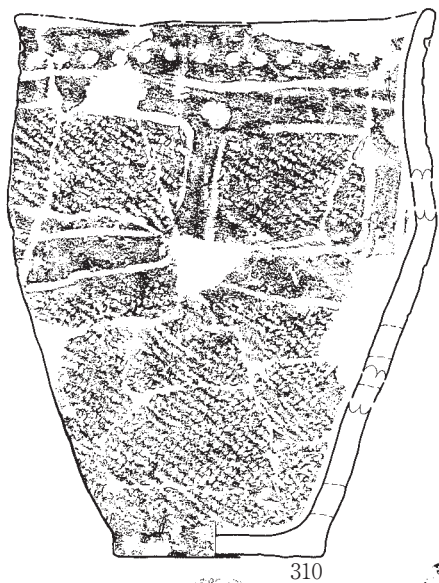

310

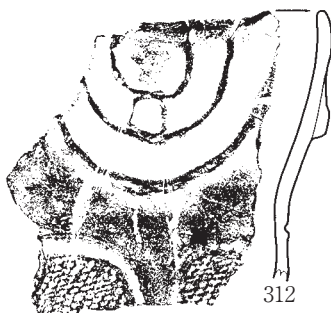
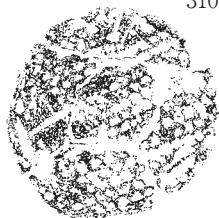

312



311



313

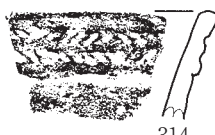

314

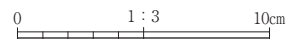

第276図 縄文土器 (28)

S 139

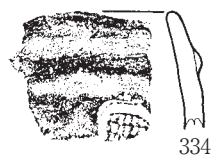
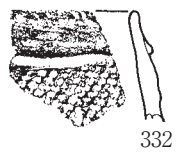
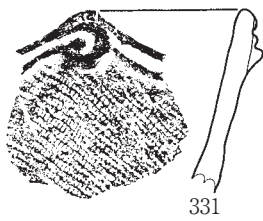
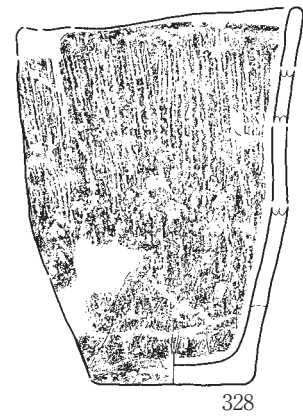
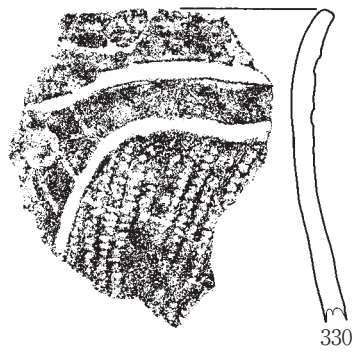
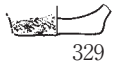
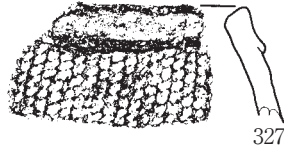
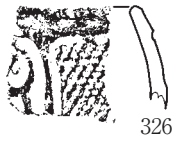
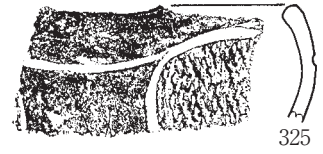
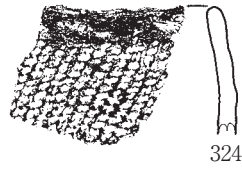
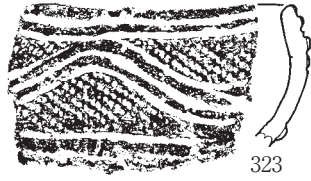
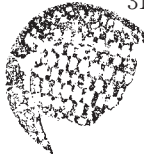
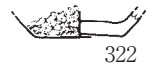
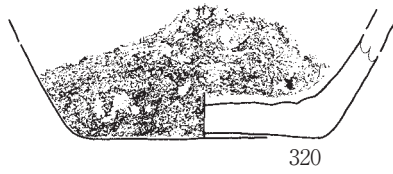
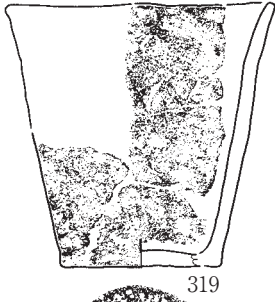
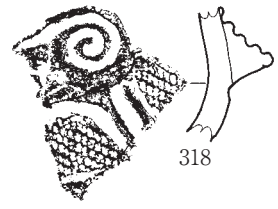
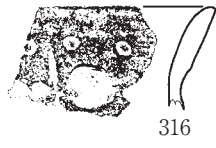

0 1:3 10cm

第277図 縄文土器 (29)

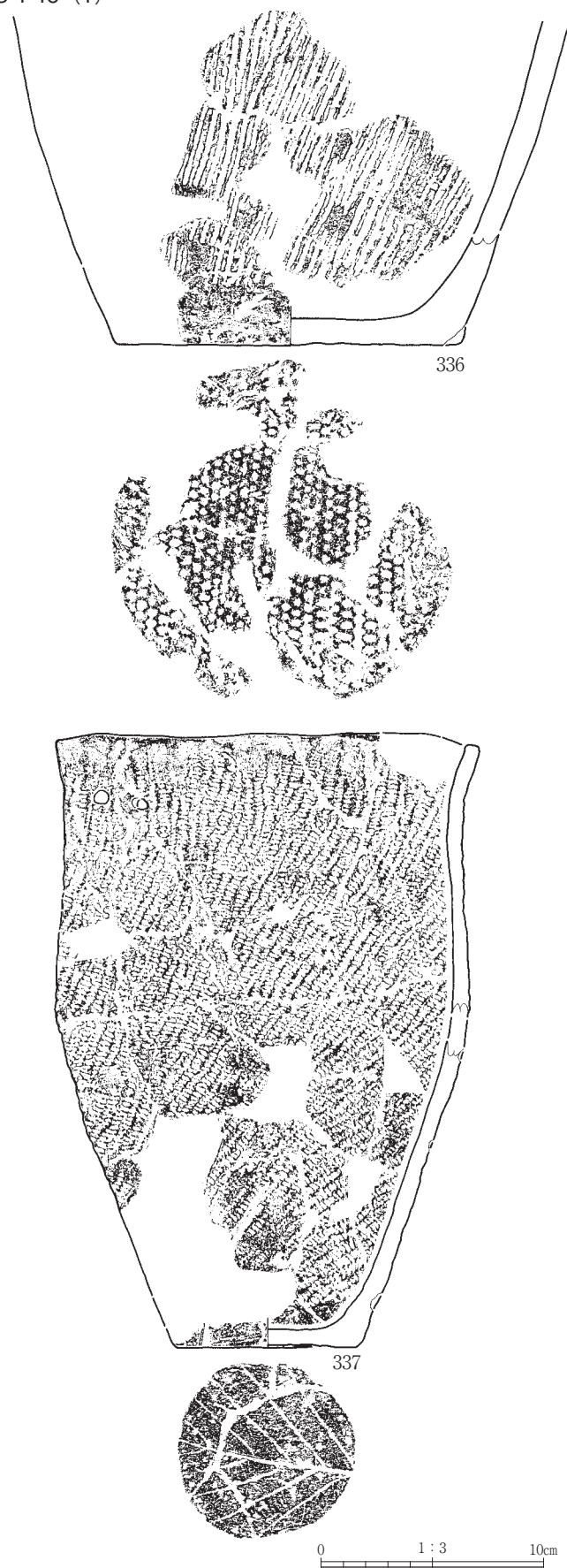
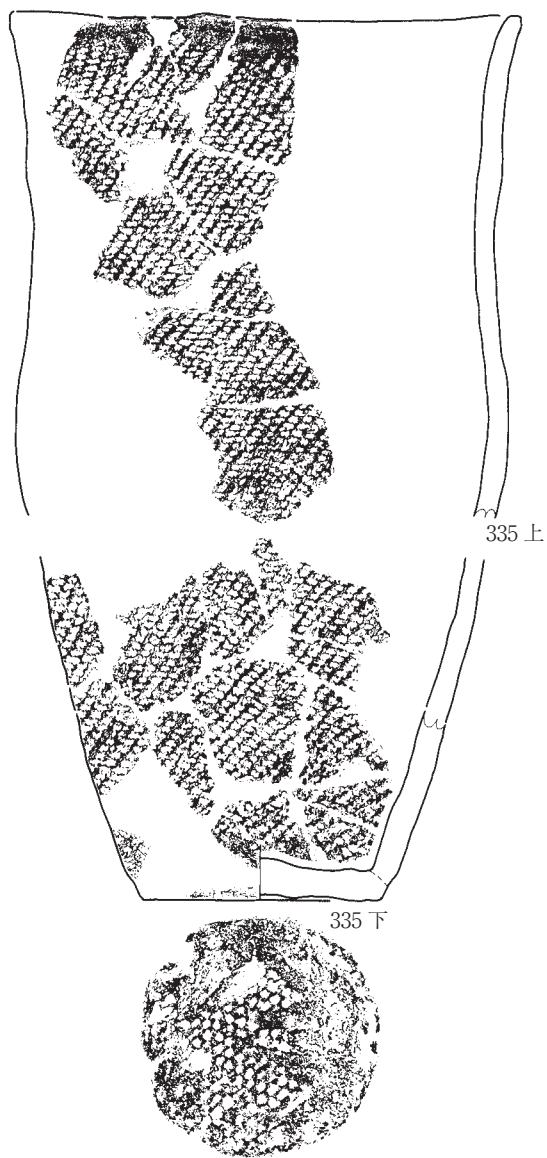

第278図 縄文土器 (30)

S I 40 (2)

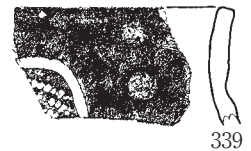
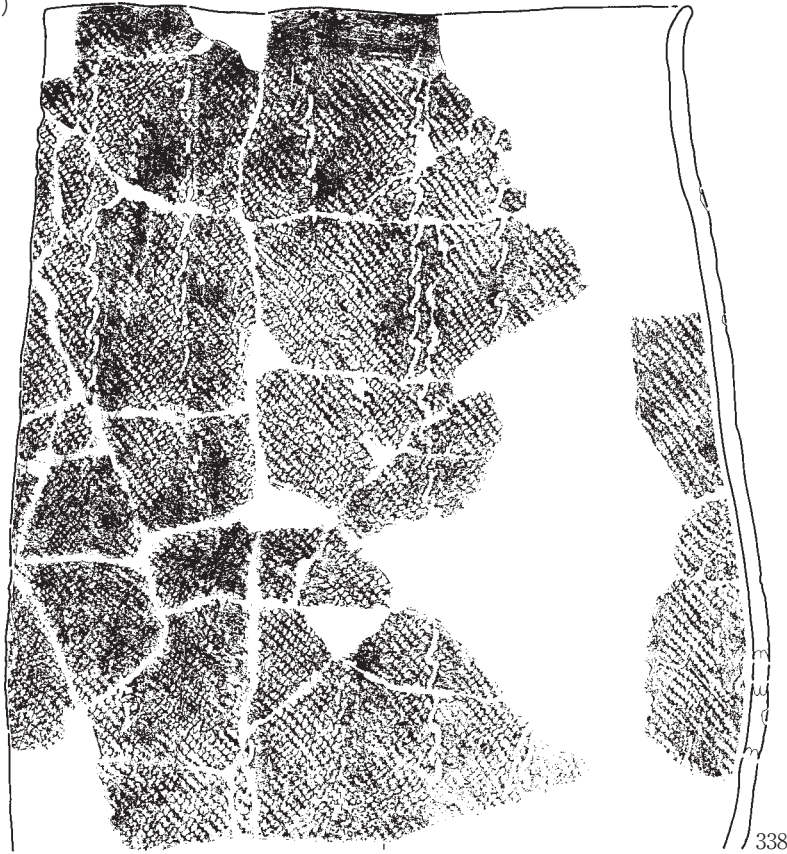

S I 41

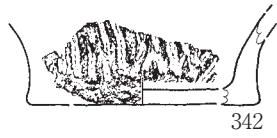
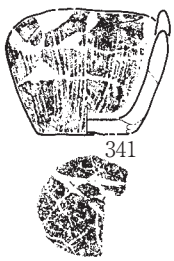

S I 42 (1)

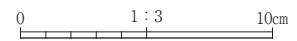
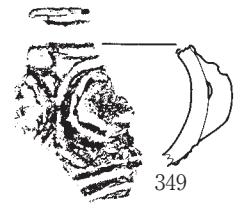
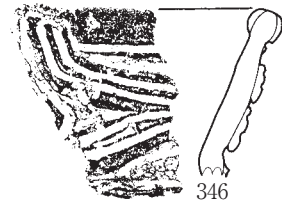

第279図 縄文土器 (31)

S I 42 (2)

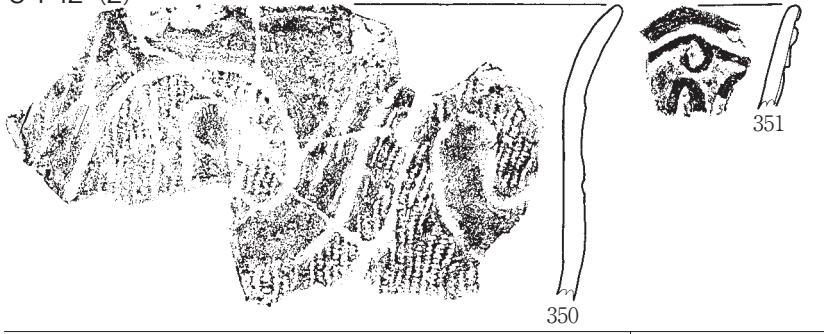

S I 43

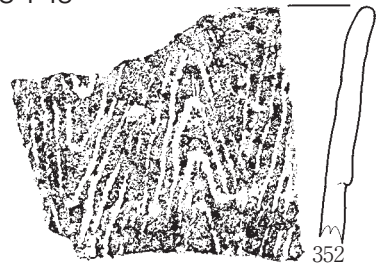

S I 44

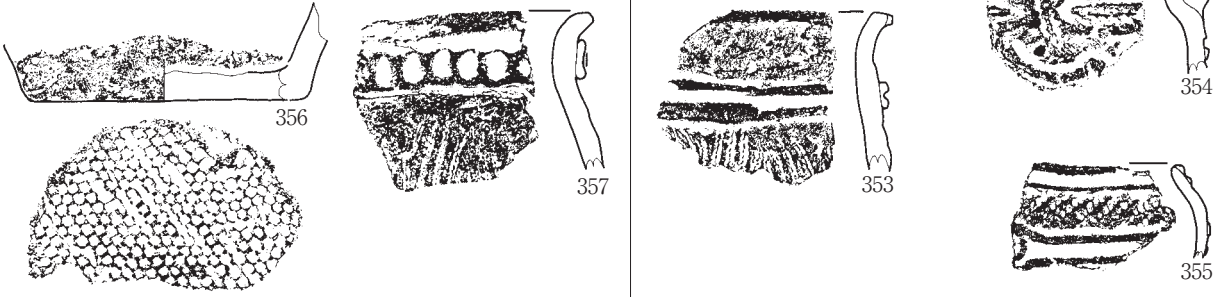

S I 45

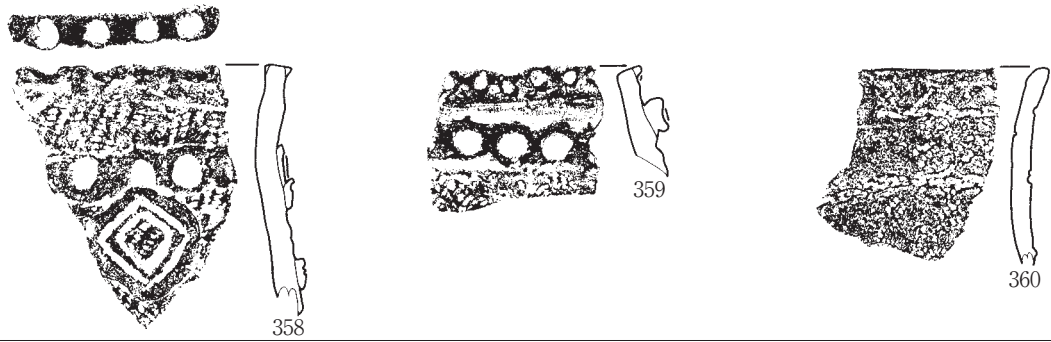

S I 46

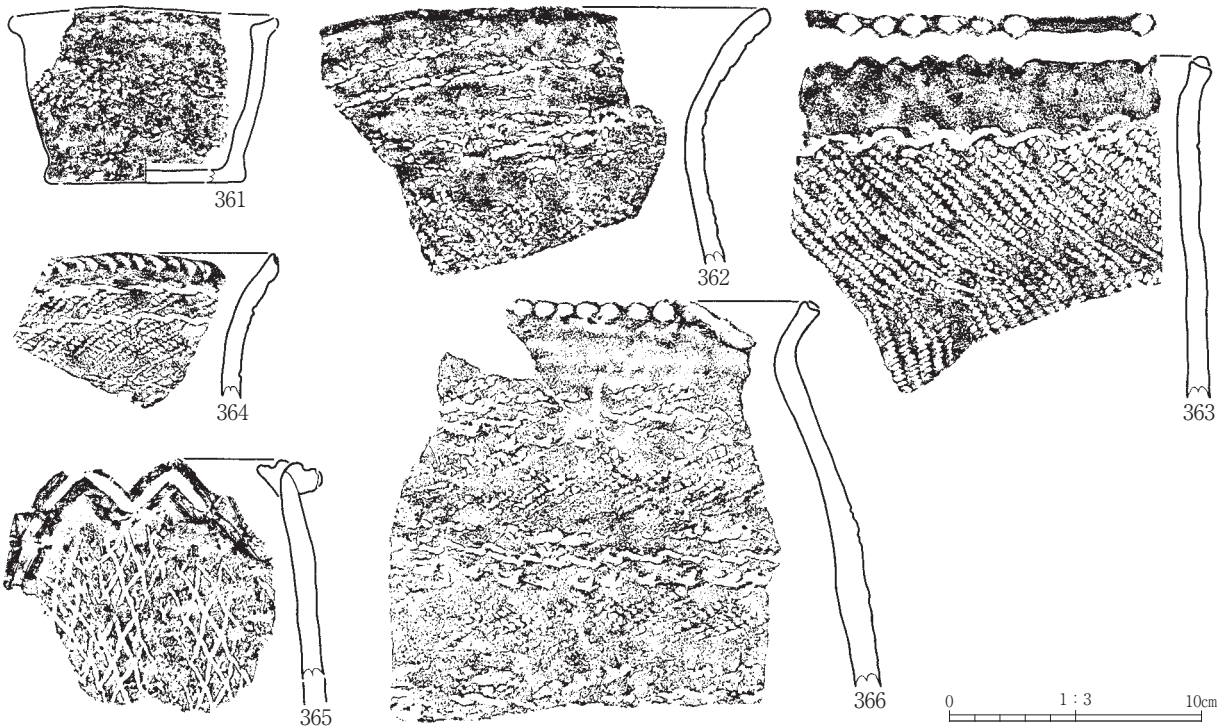

第280図 縄文土器 (32)



S I 46 · 54



367

S I 47

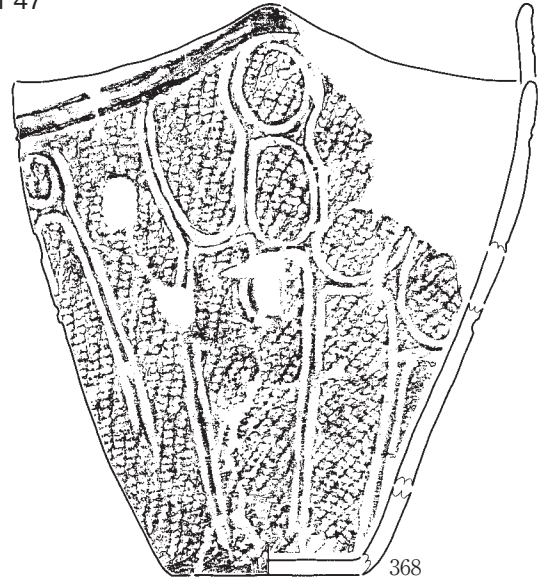

368



369



S I 48



372

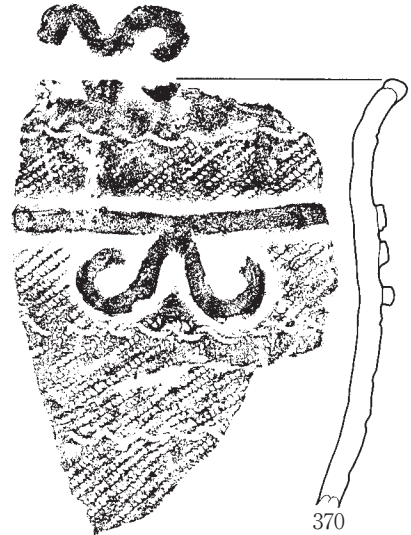

370

S I 49

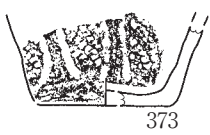

373



374

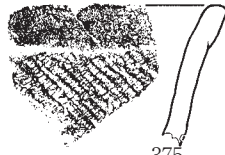

375

S I 50

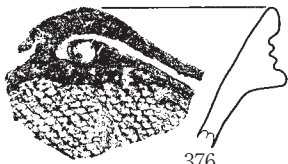

376



377

S I 51



378

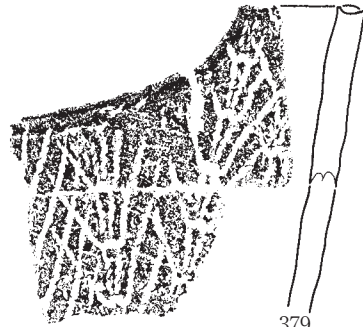

379

S I 52



380



381



382

0 1:3 10cm

第281図 縄文土器 (33)



第282図 縄文土器 (34)

S I 53 (2)

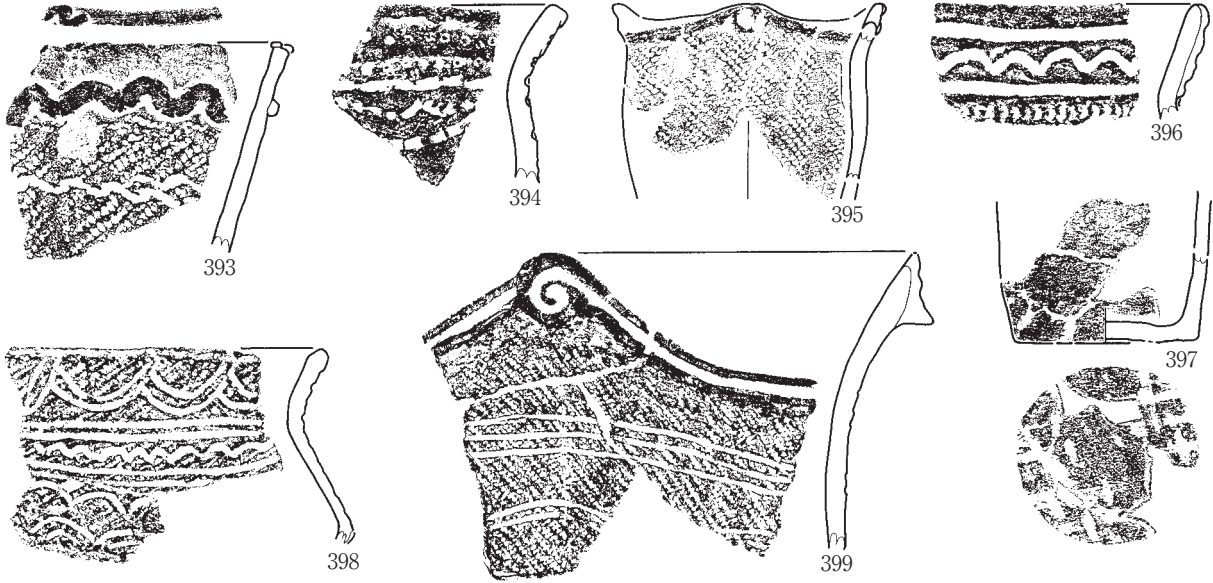

S I 54 (1)

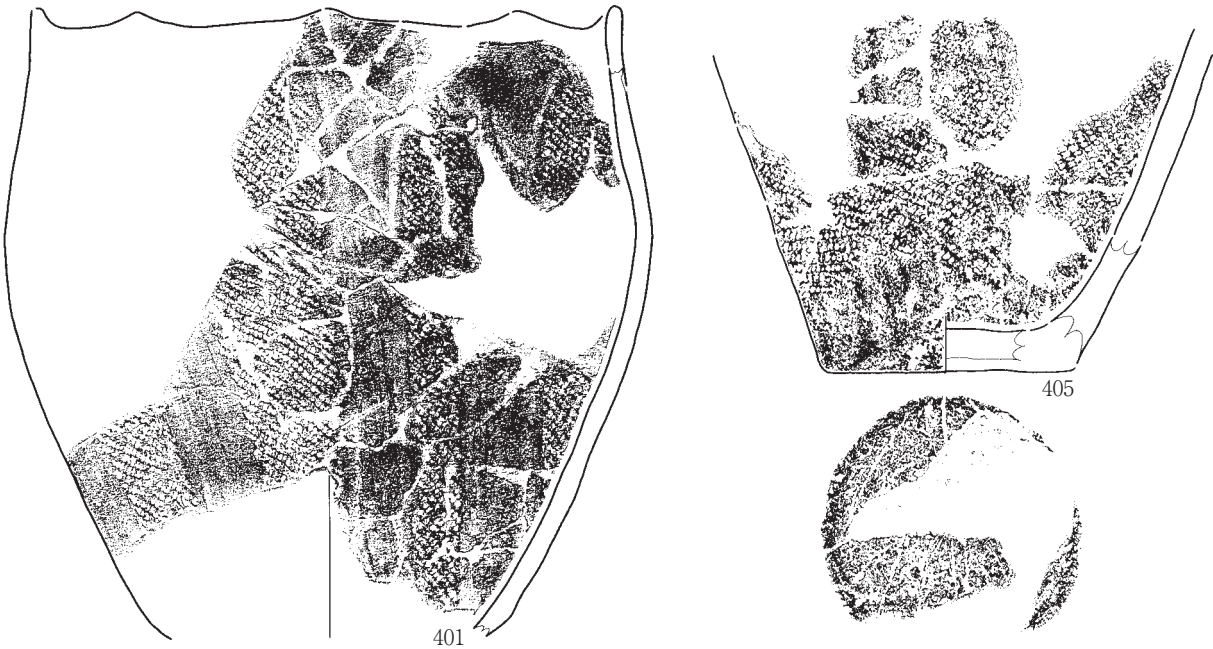
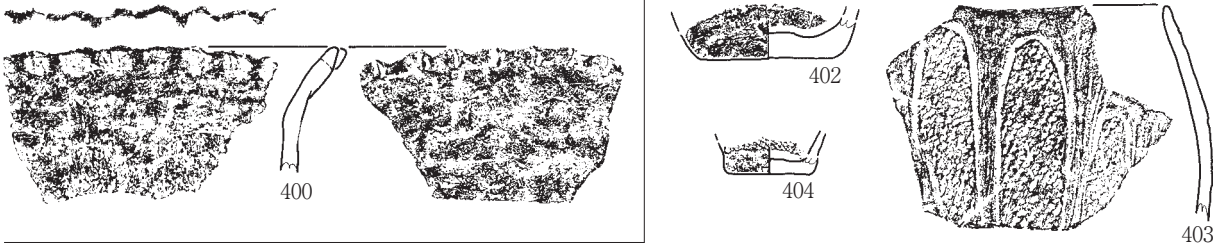

0 1:3 10cm

第283図 縄文土器 (35)

S I 54 (2)

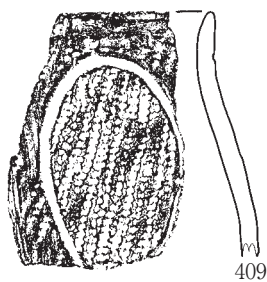

S I 54 · 55

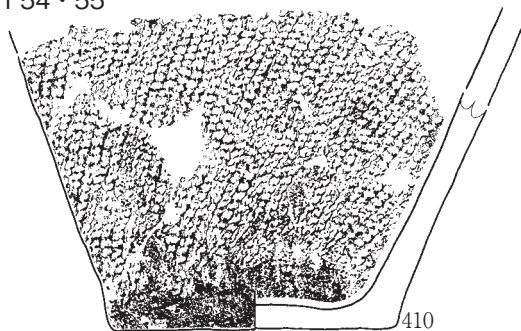

S I 55

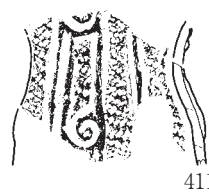

S I 55 · 65 · 73

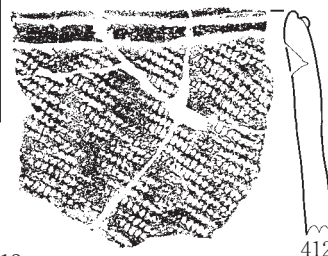
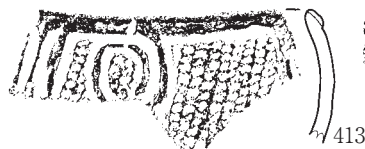

S I 56 · 73



S I 56

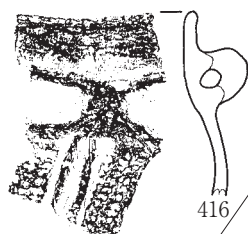
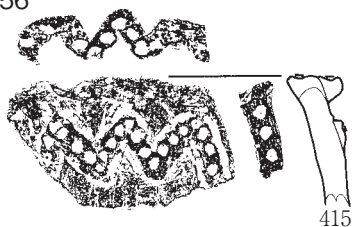

S I 57 (1)

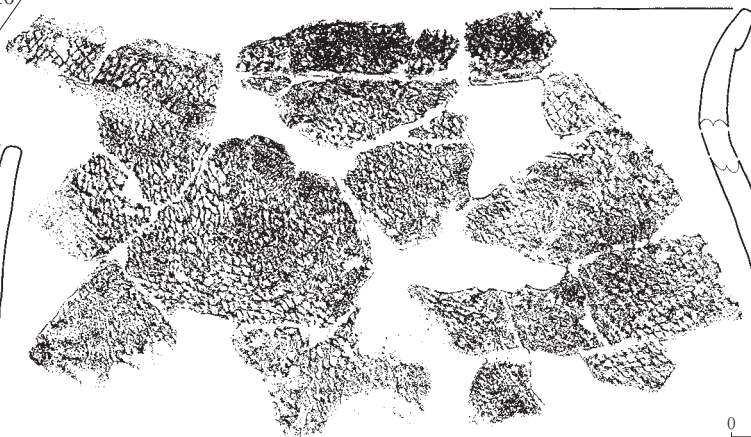
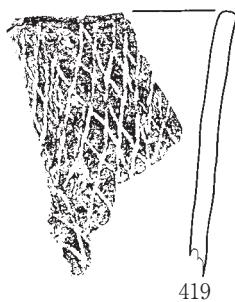

0 1:3 10cm

第284図 縄文土器 (36)

S 157 (2)

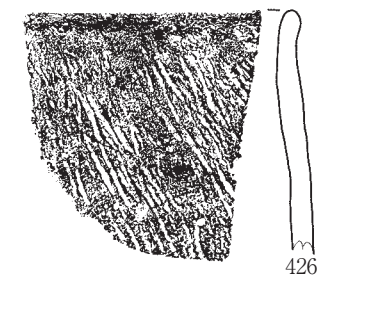
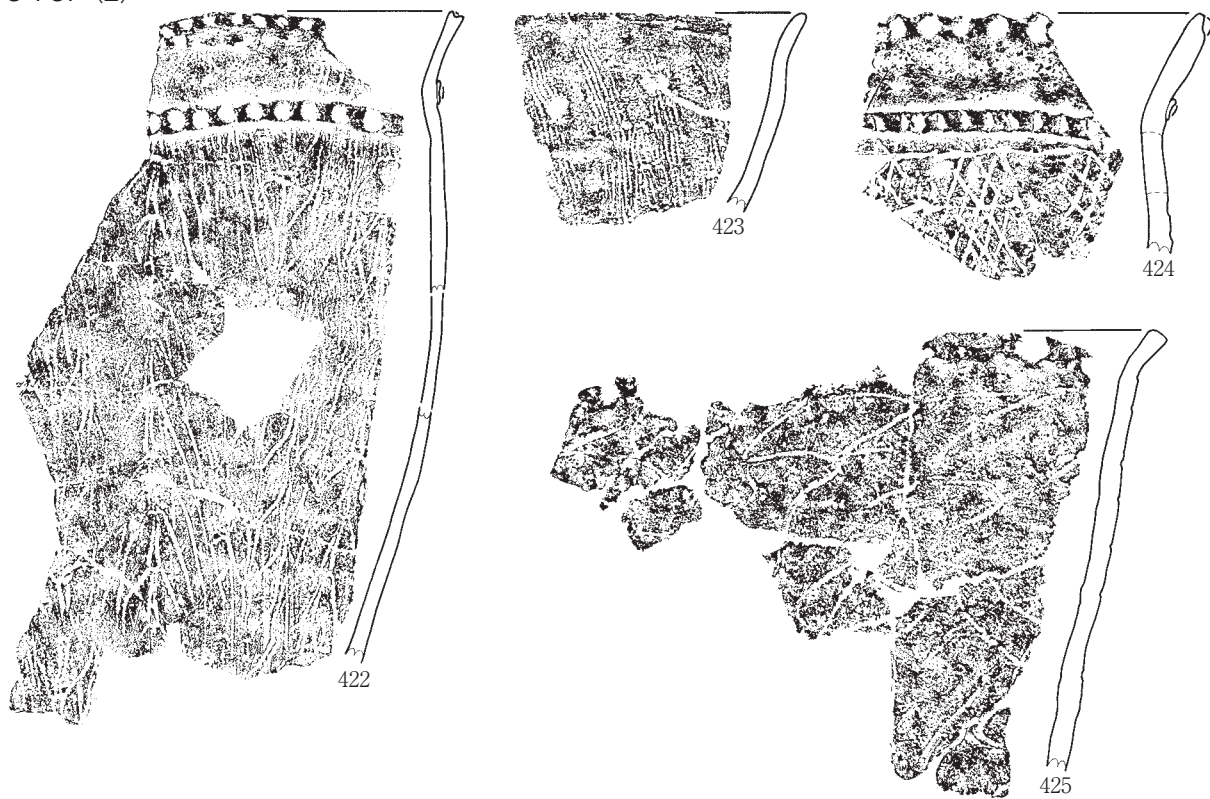

S 158 (1)

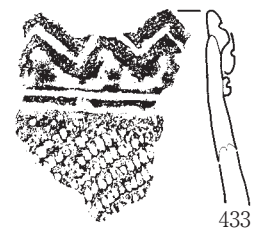
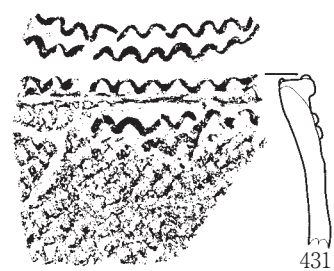
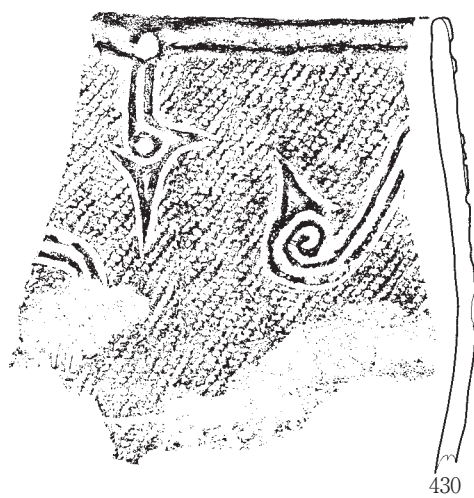
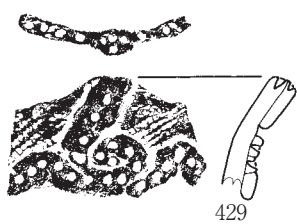
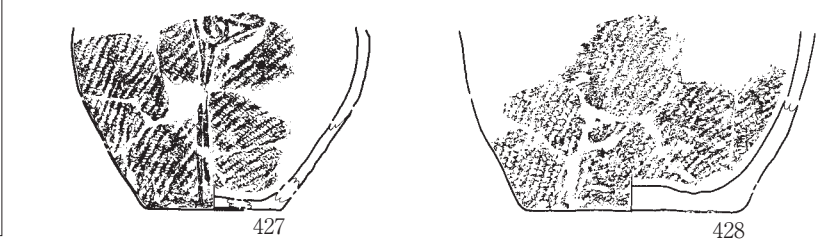

0 1:3 10cm

第285図 縄文土器 (37)

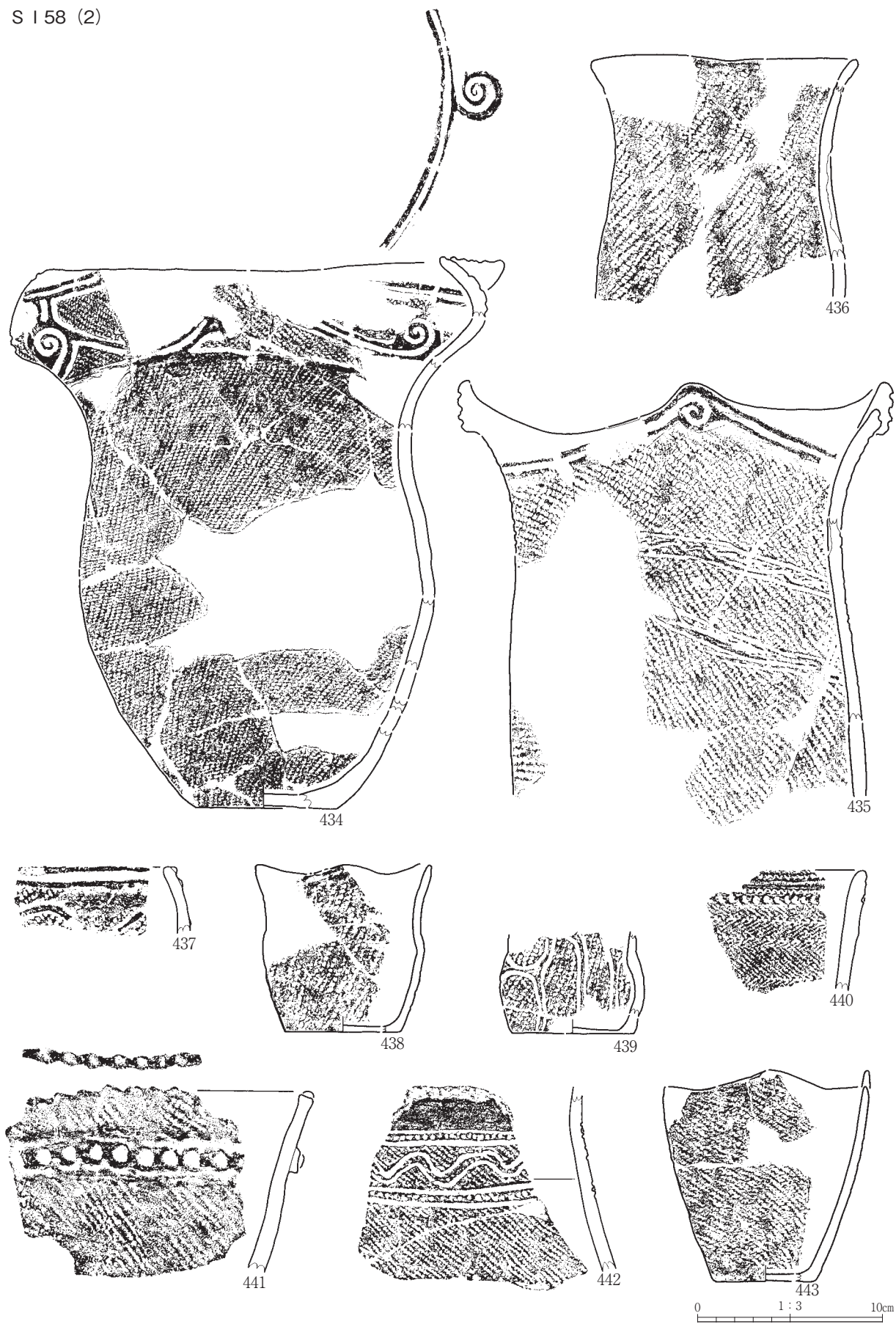

第286図 縄文土器 (38)

S 158 (3)

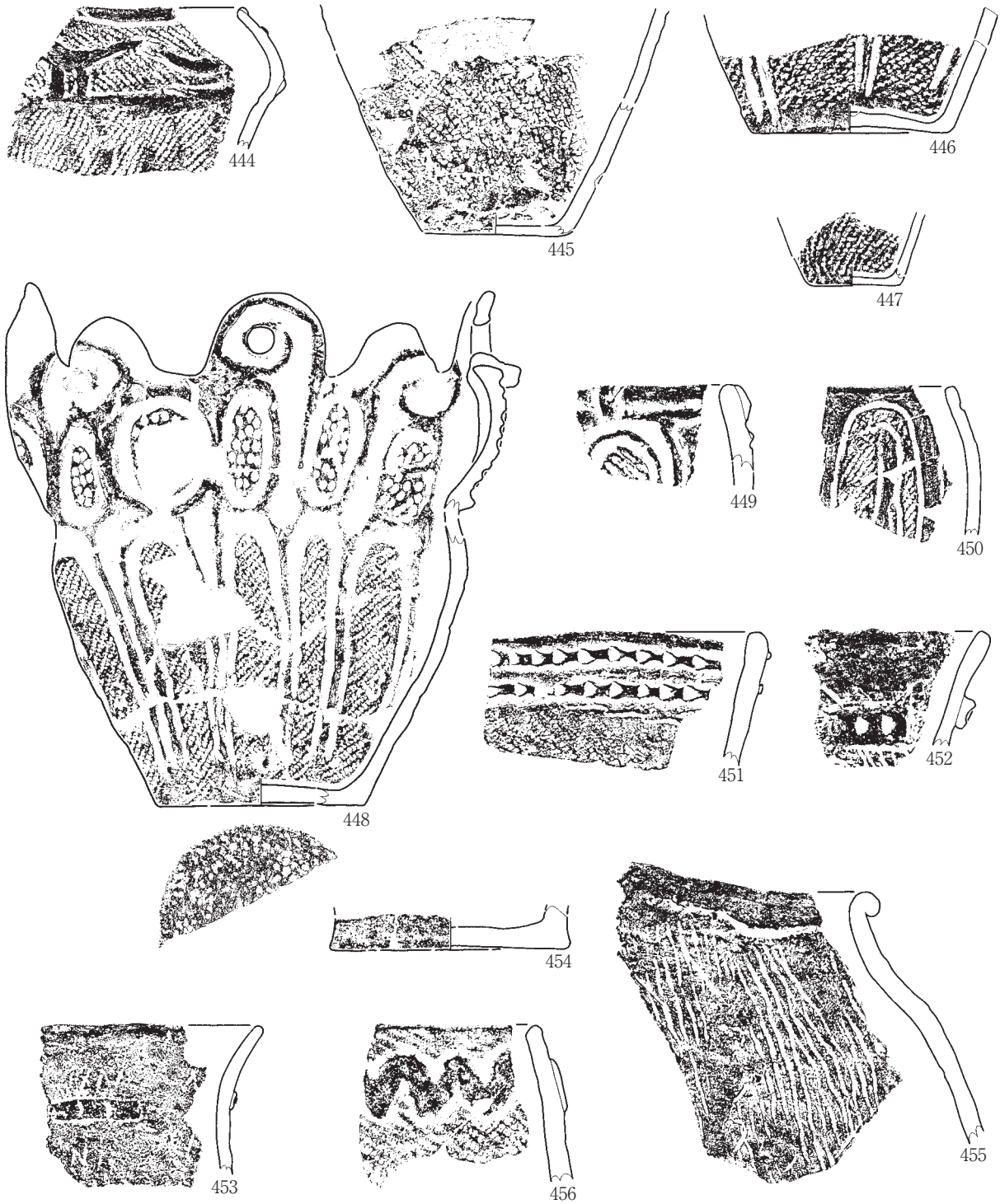

S 159

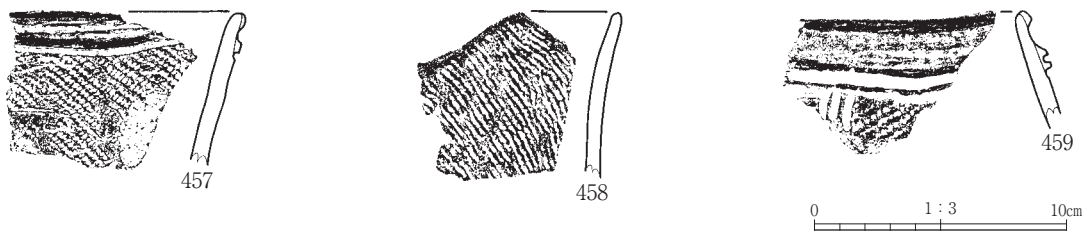

第287図 縄文土器 (39)

S I 59・60

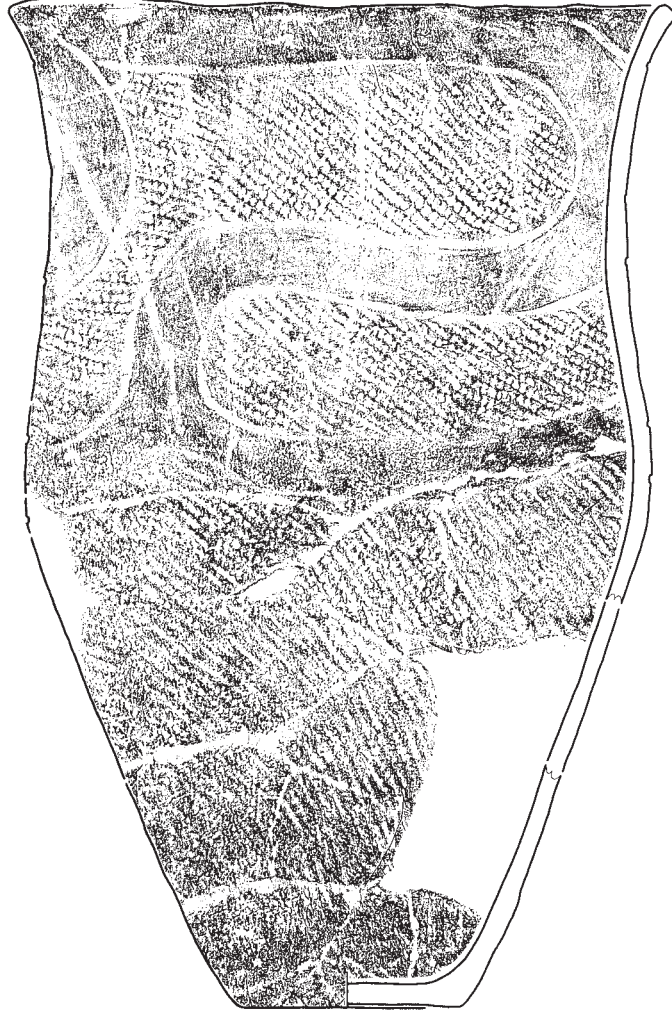

460

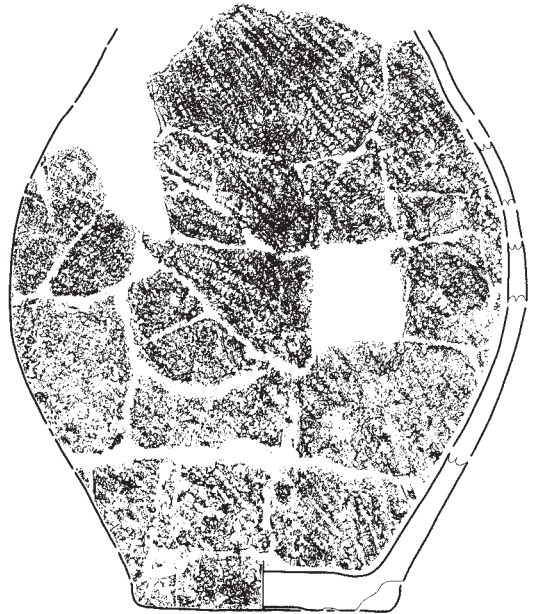

461

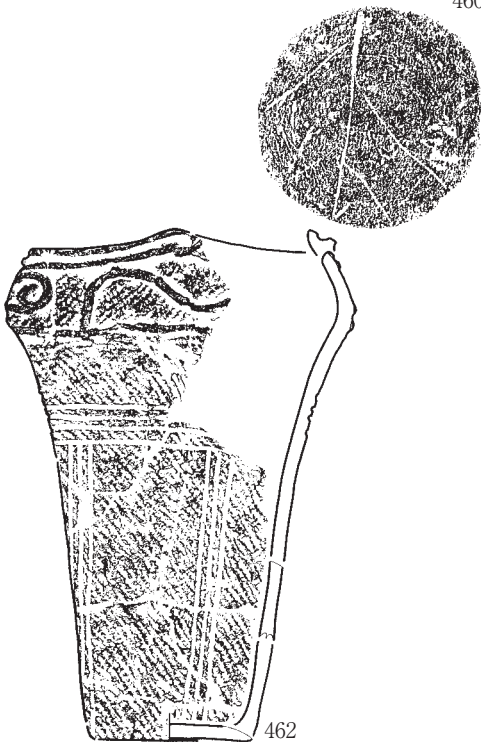

462

S I 60 (1)

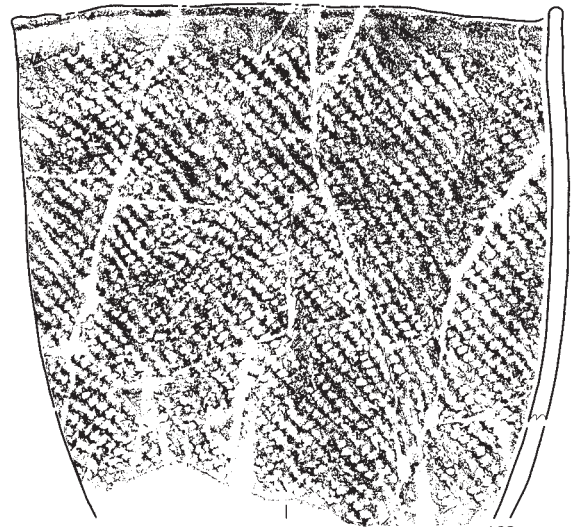

463

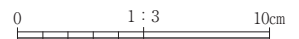

第288図 縄文土器 (40)



S I 60 (2)

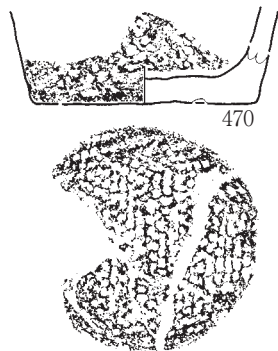
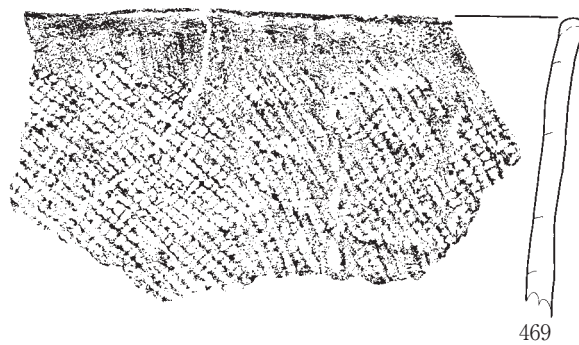
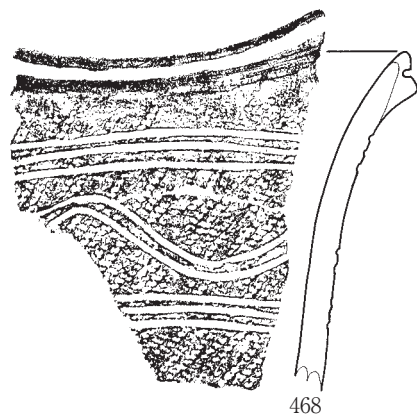
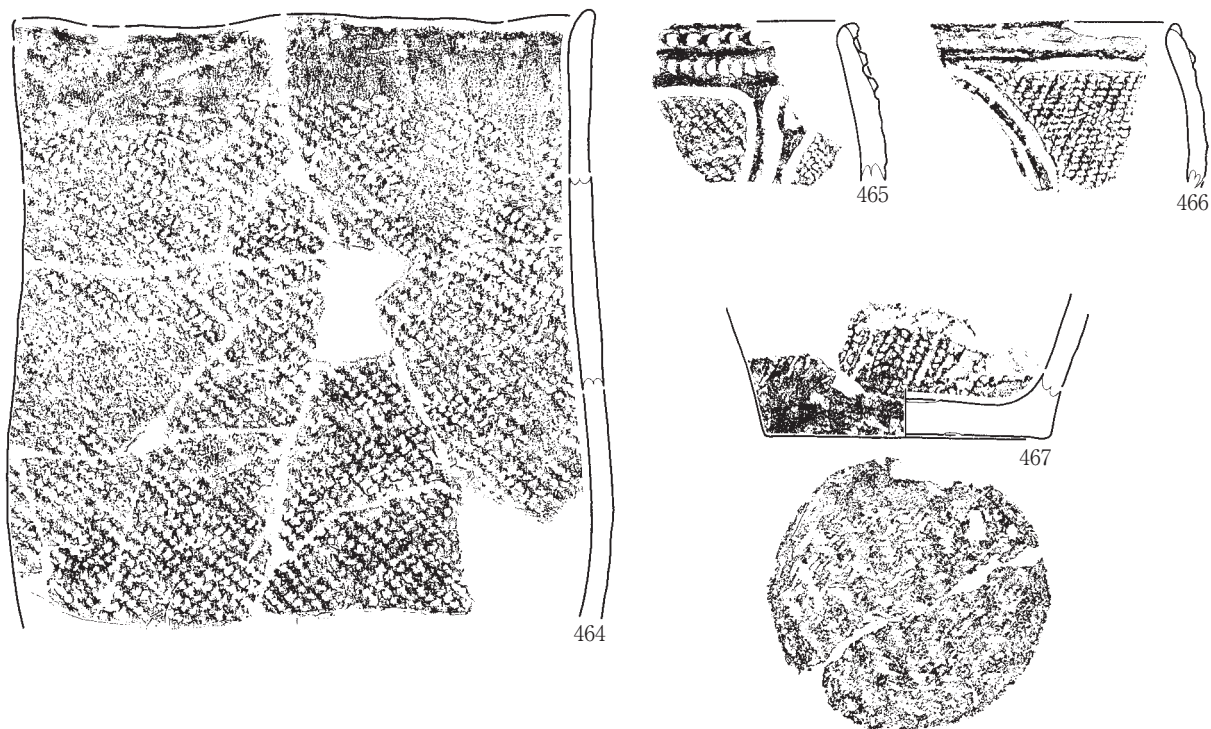

S I 60 · 69

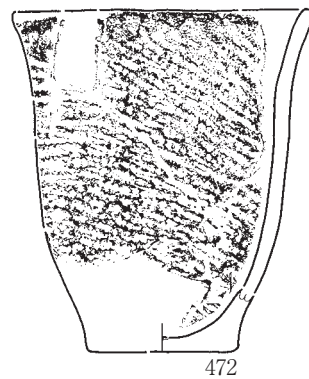

0 1:3 10cm

第289図 縄文土器 (41)

S 161 (1)



第290図 縄文土器 (42)

S 161 (2)



第291図 縄文土器 (43)

S I 62

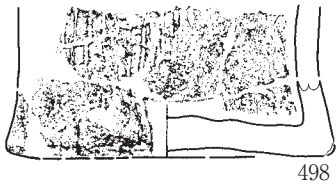
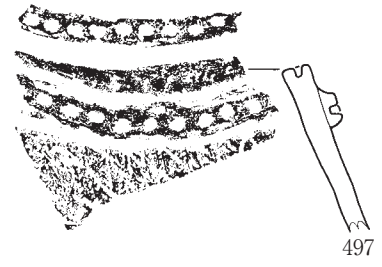
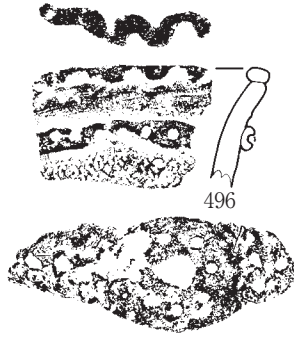
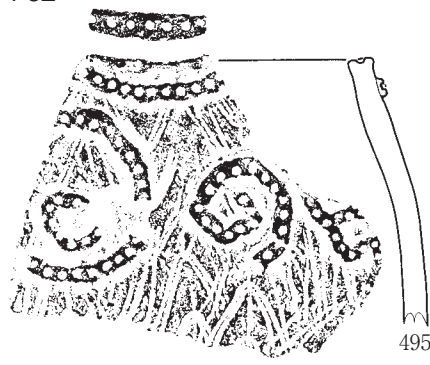

S I 63

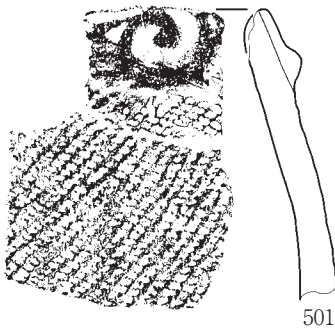

S I 64 (1)

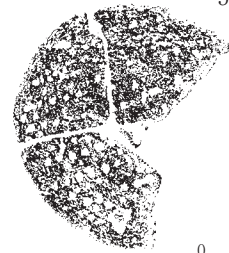
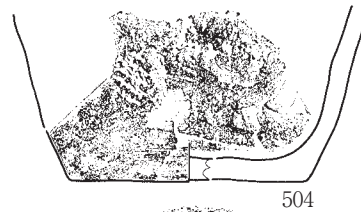
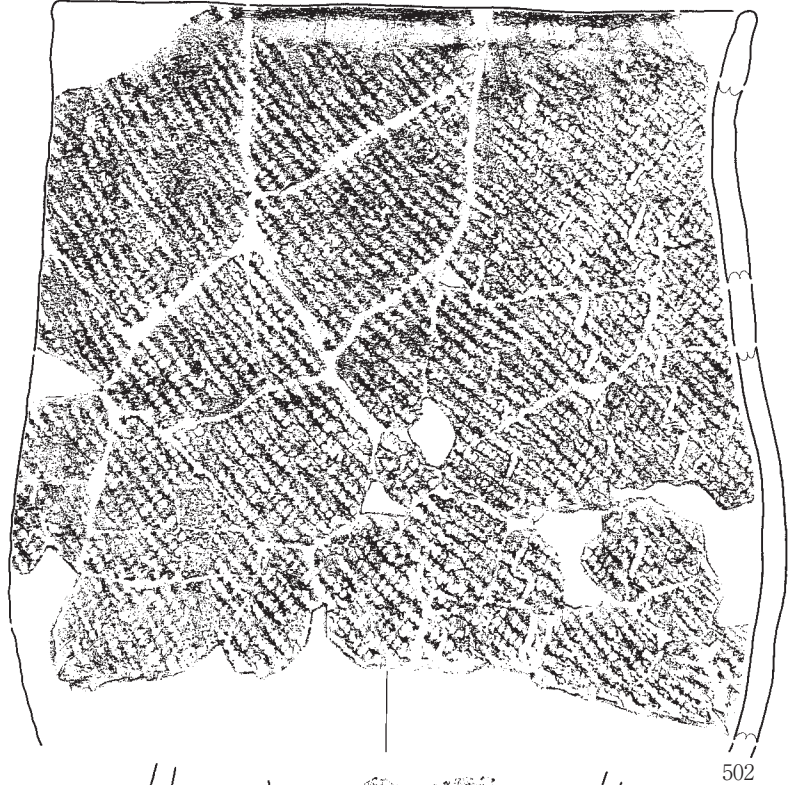

0 1:3 10cm

第292図 縄文土器 (44)

S I 64 (2)

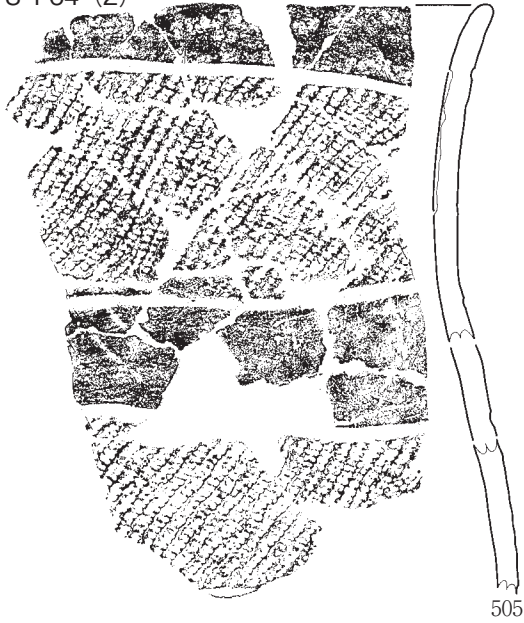

505



508

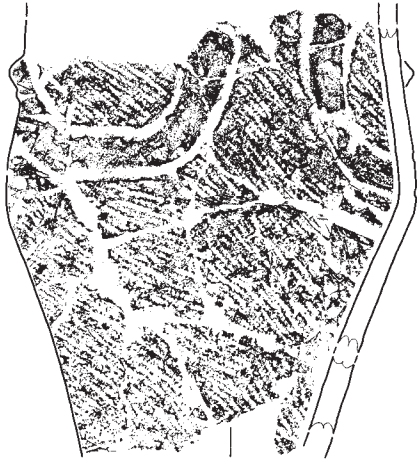

506



509

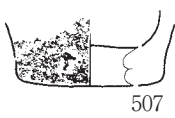

507



510

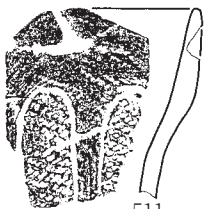
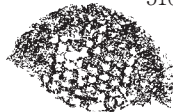

511

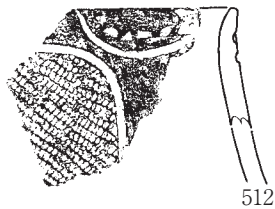

512

S I 64 · 65

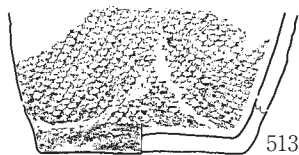

513

S I 65 (1)



514

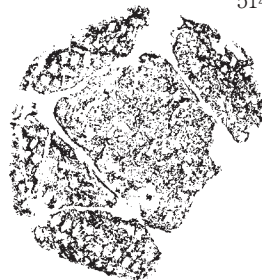

515

0 1:3 10cm

第293図 縄文土器 (45)



第294図 縄文土器 (46)

S 165 (3)

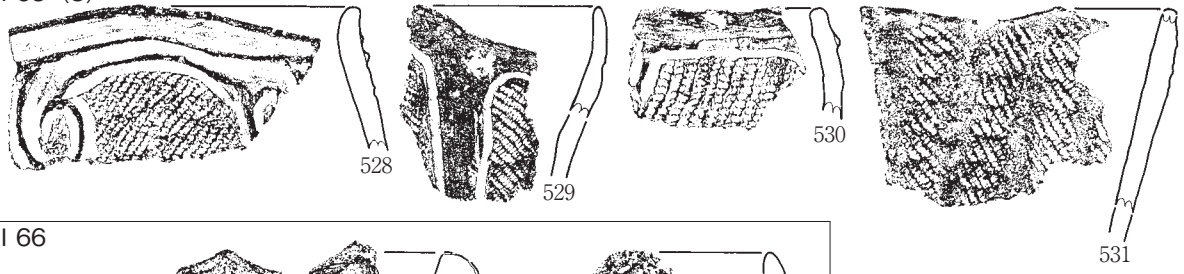

S 166

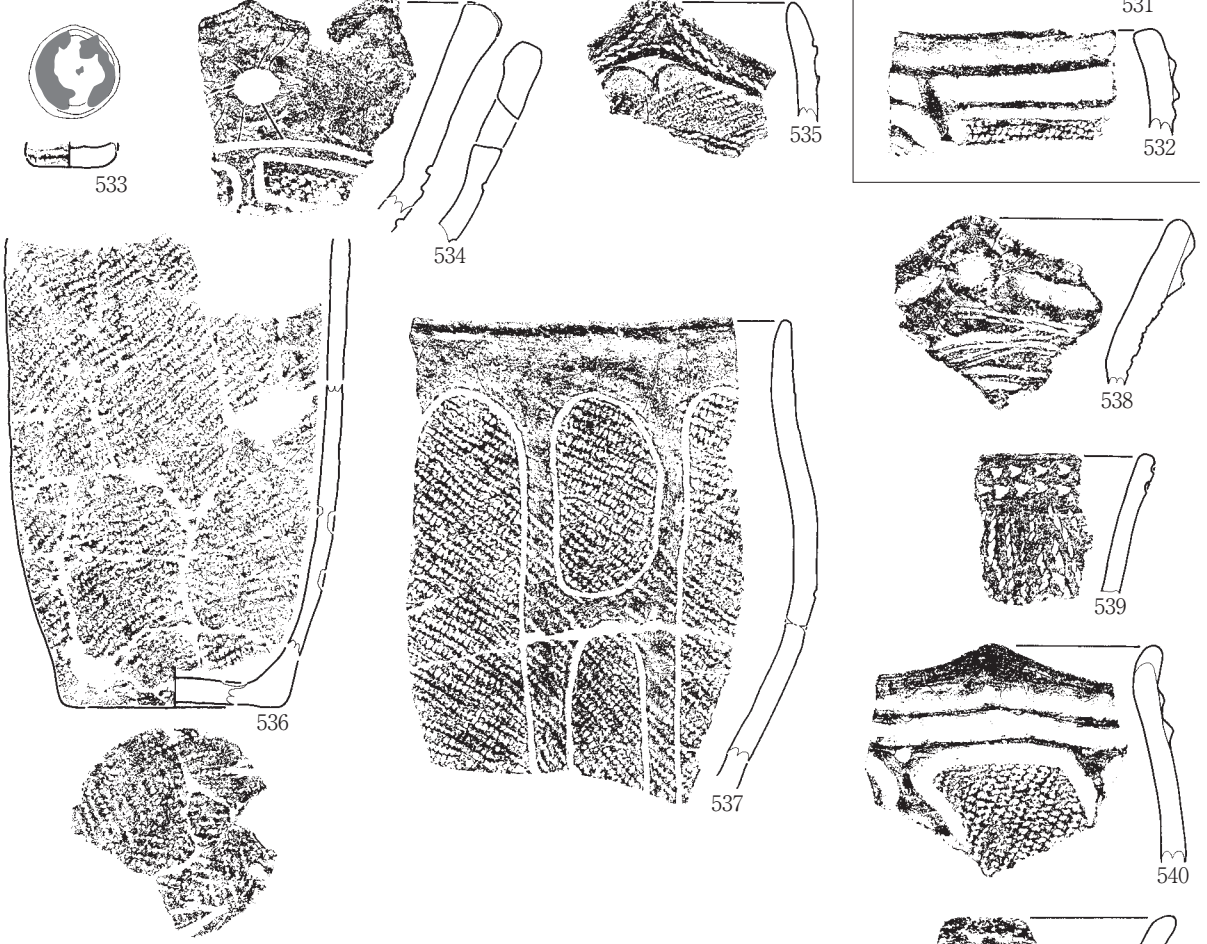

S 166 · 67

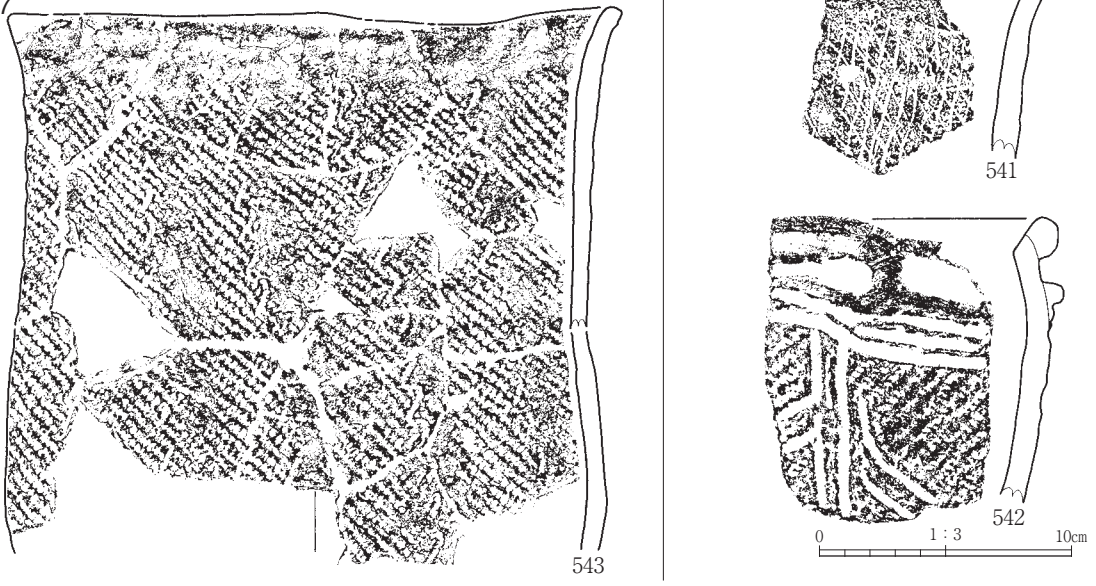

第295図 縄文土器 (47)

S 167

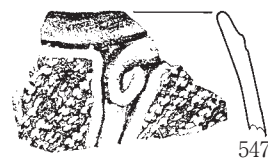
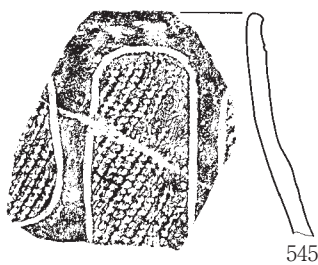
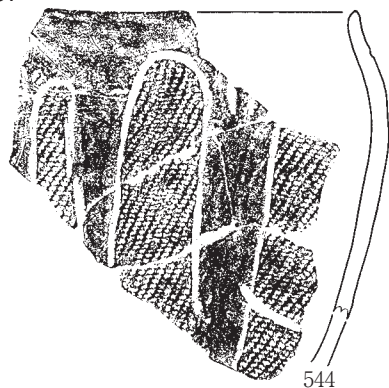

S 168 (1)

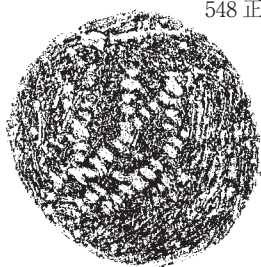

0 1:3 10cm

第296図 縄文土器 (48)



S 168 (2)

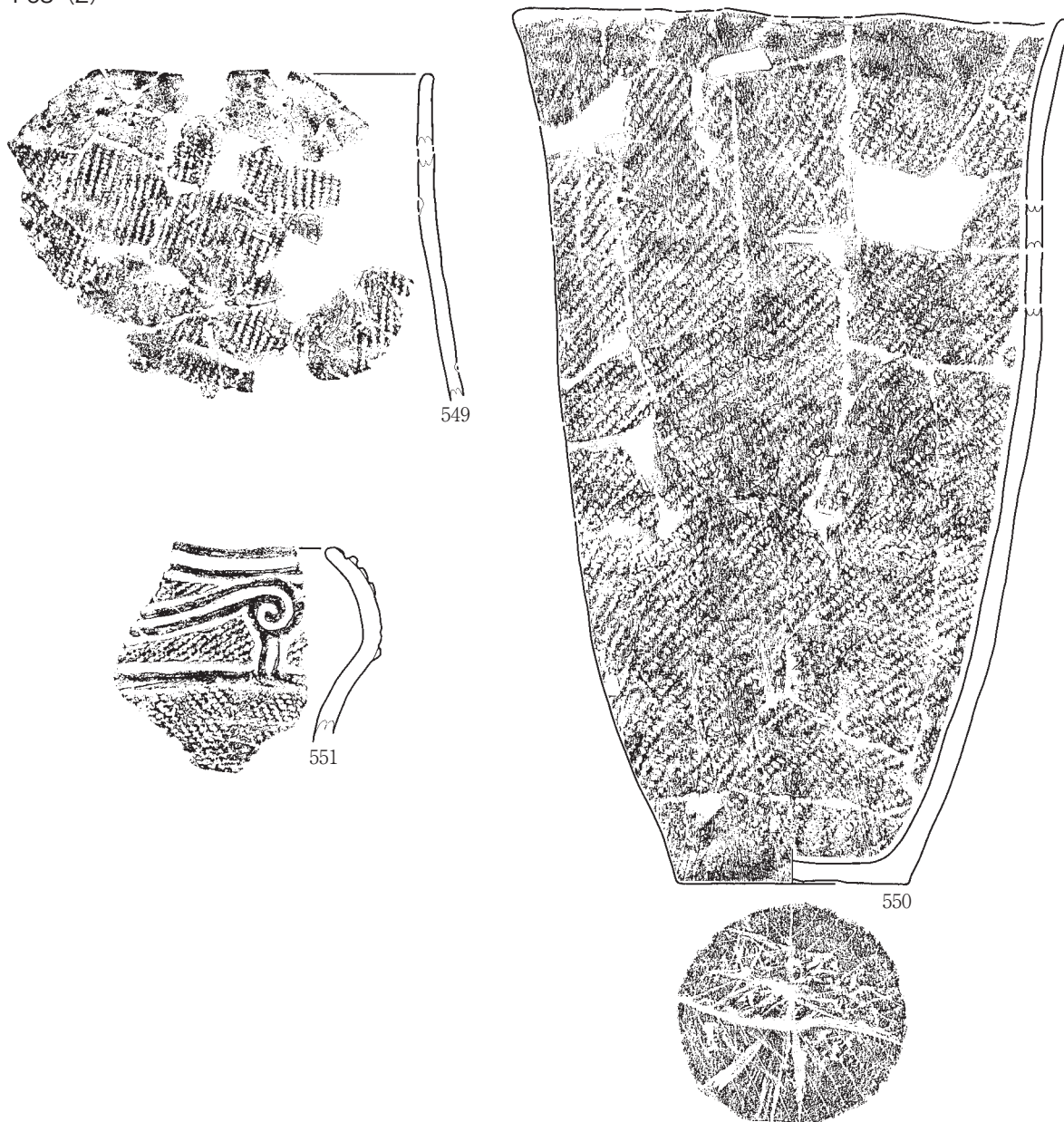

S 169

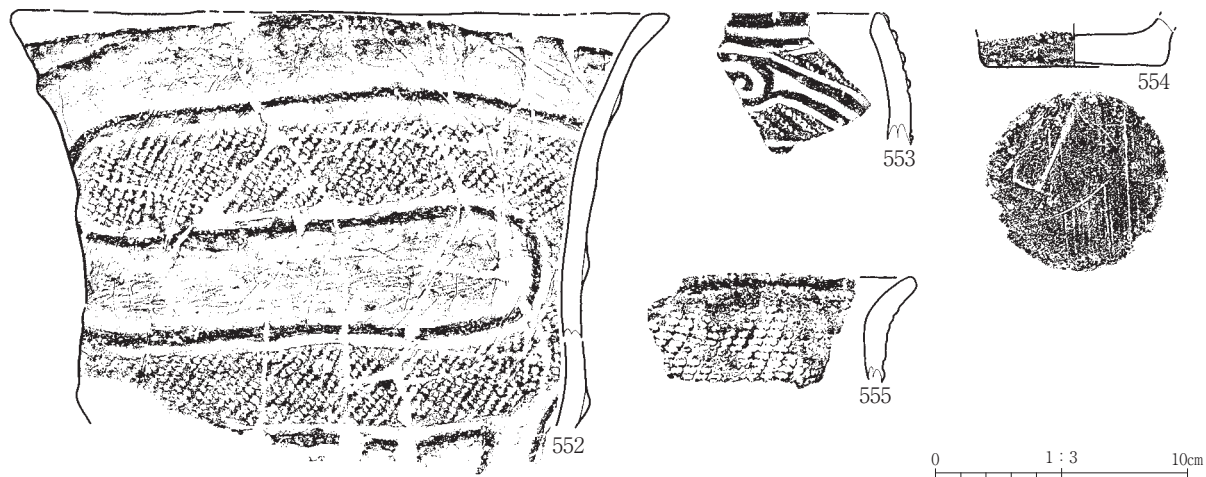

第297図 縄文土器 (49)

S 171 (1)

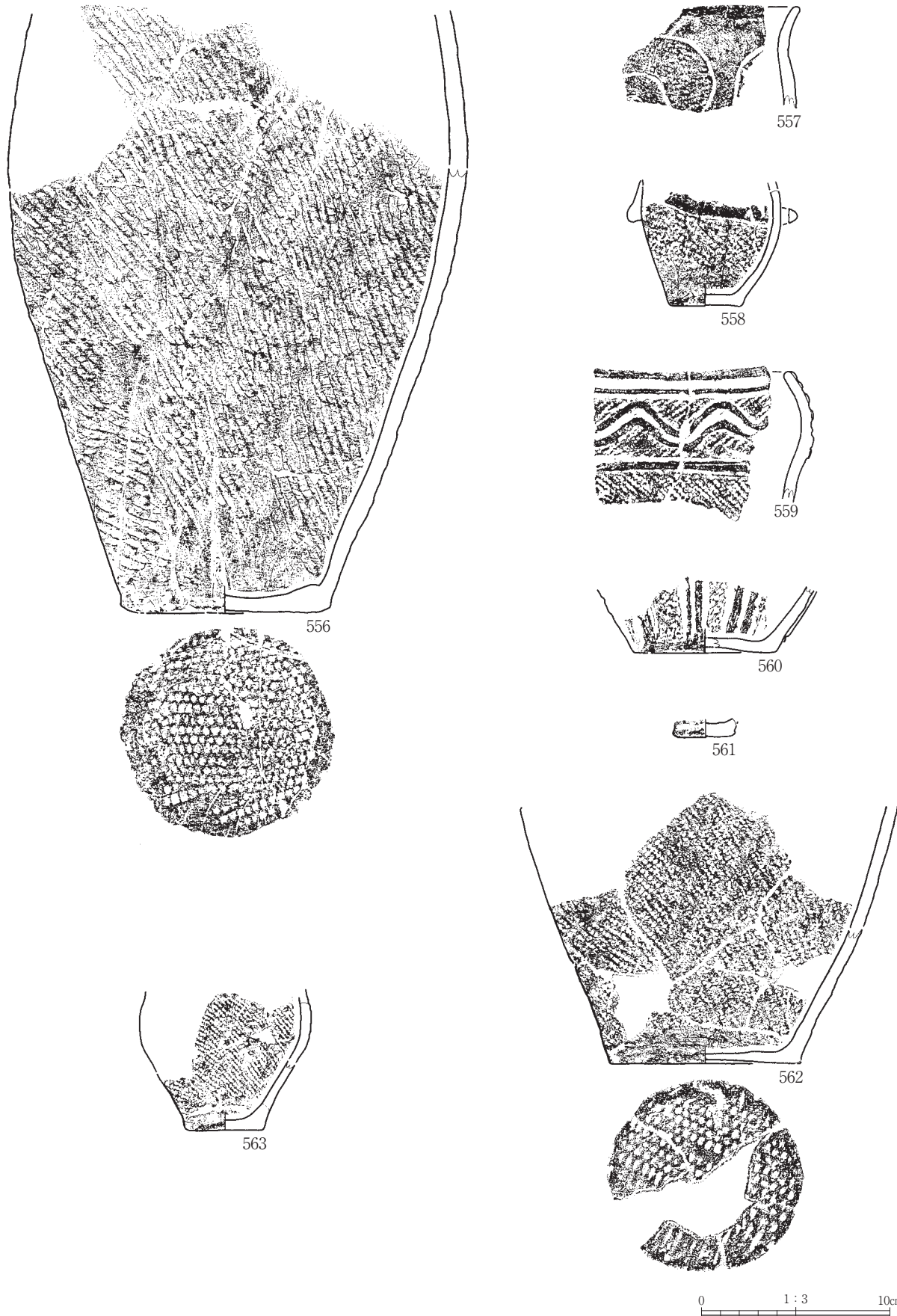

第298図 縄文土器 (50)

S 171 (2)



S 172 (1)

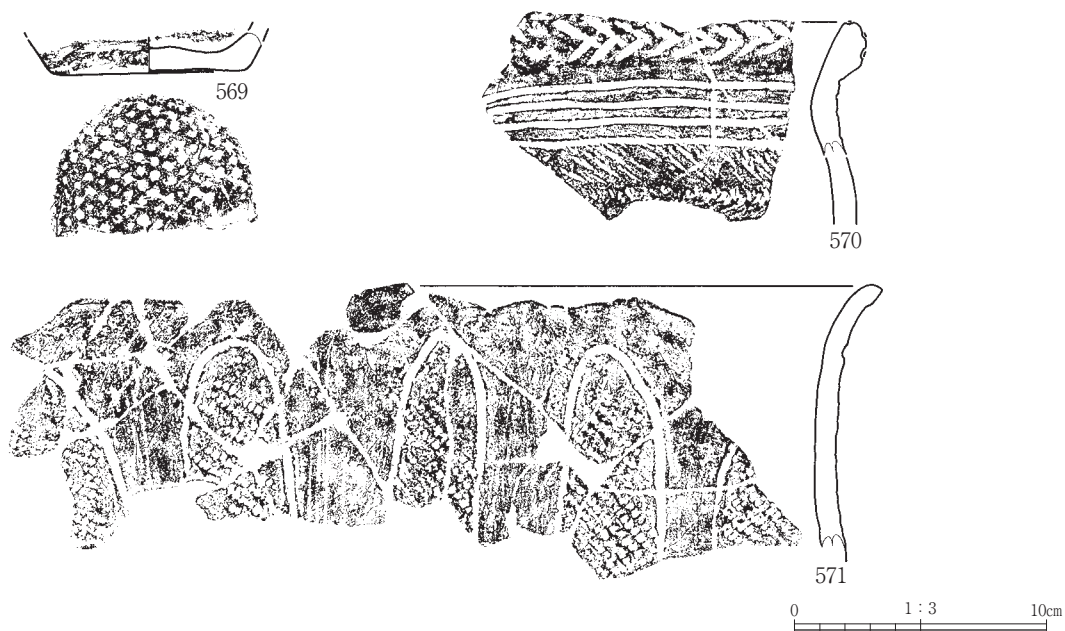

第299図 縄文土器 (51)

S 172 (2)

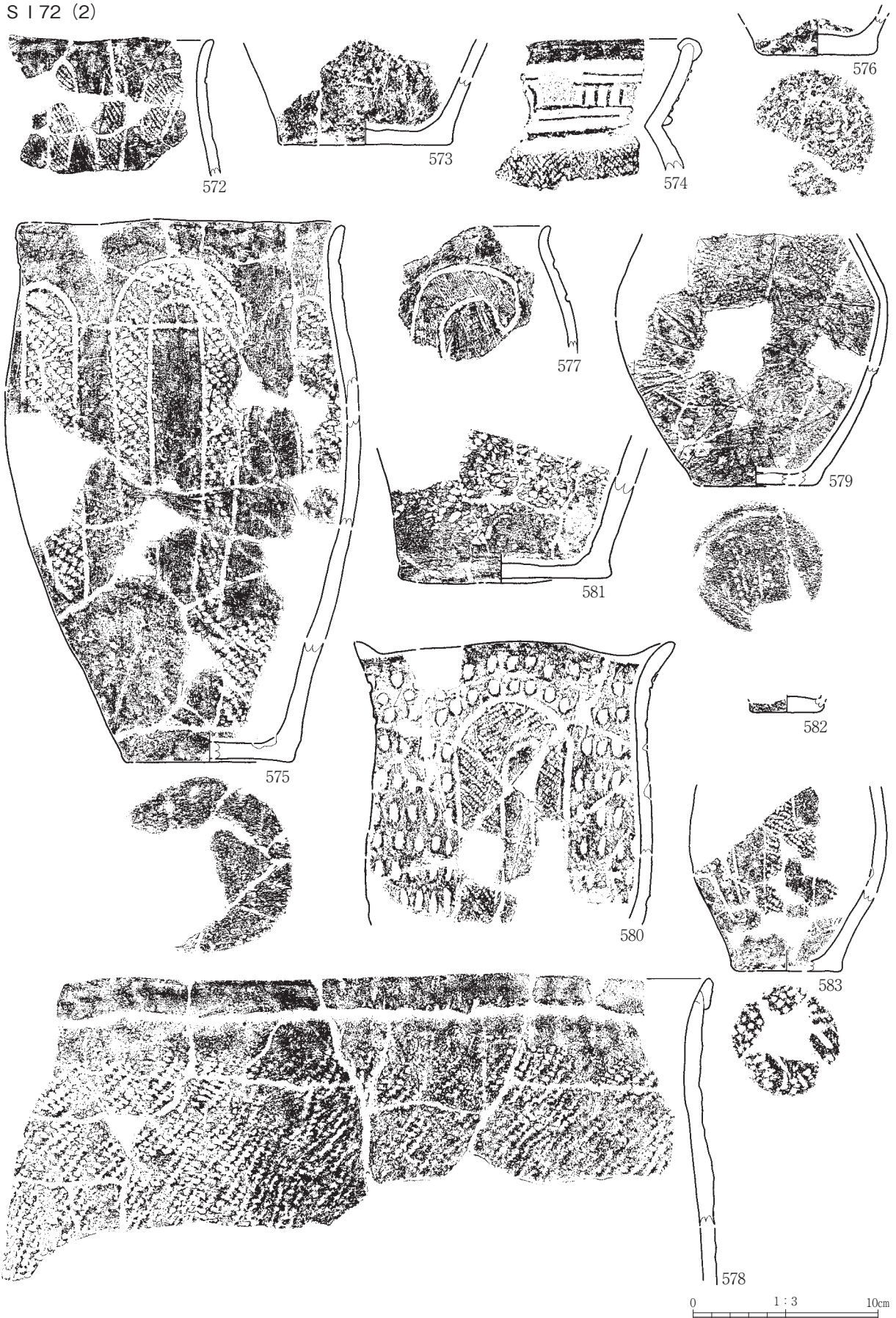

第300図 縄文土器 (52)

S 172 (3)



第301図 縄文土器 (53)

S 173



S 175 (1)

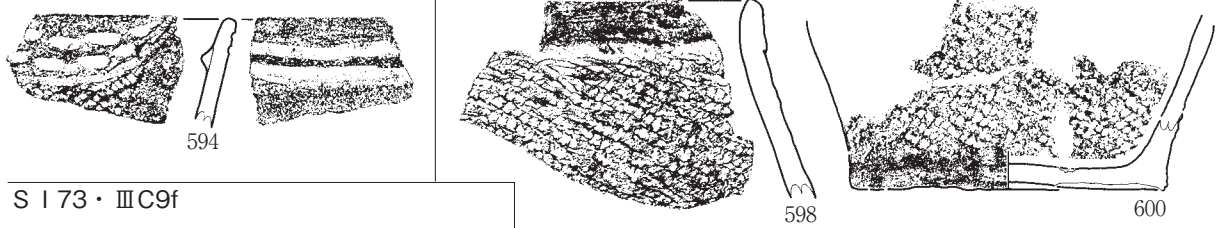

S 173 · III C9f

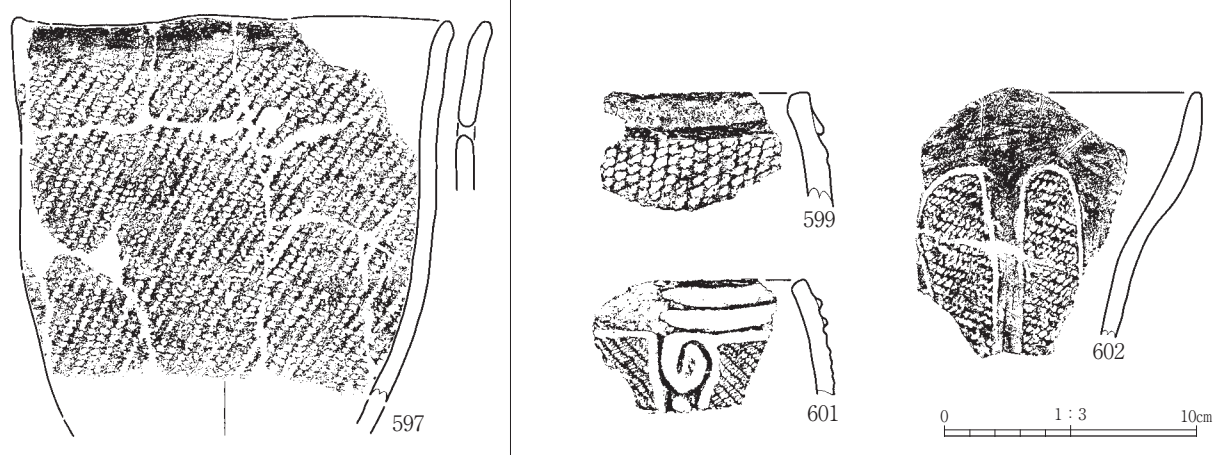

第302図 縄文土器 (54)

S 175 (2)



603

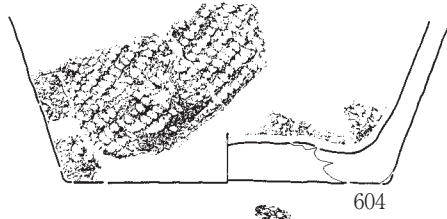

604



605



606

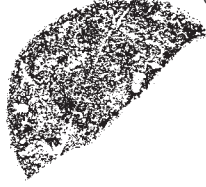

607



608

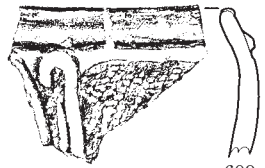

609

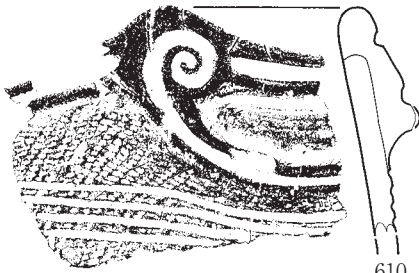

610

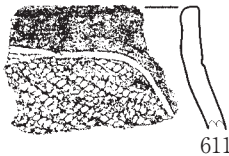

611

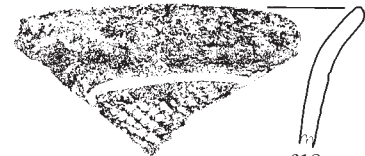

612

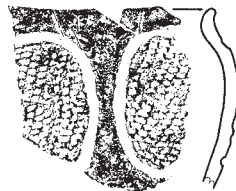

613

S 177 (1)

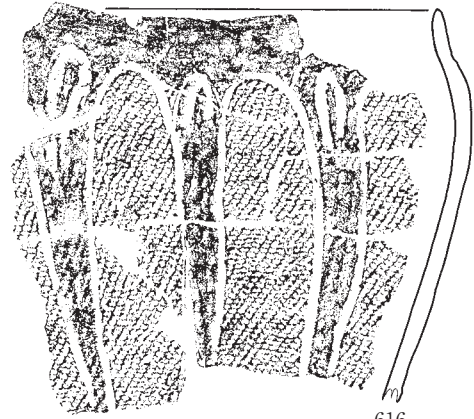

616



617



618

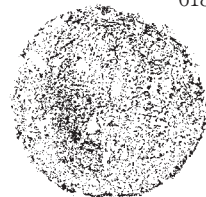

619

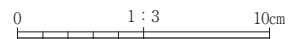

S 176

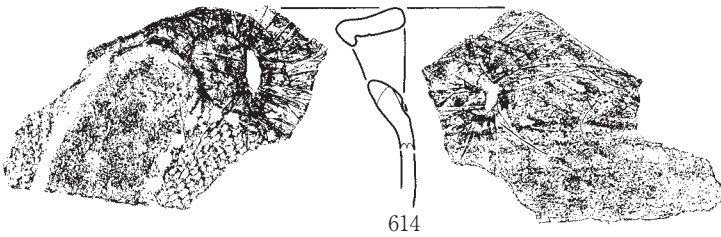

614

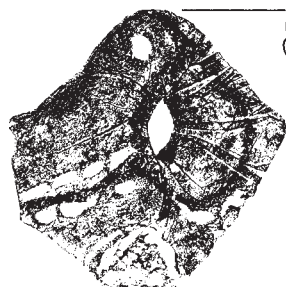

615

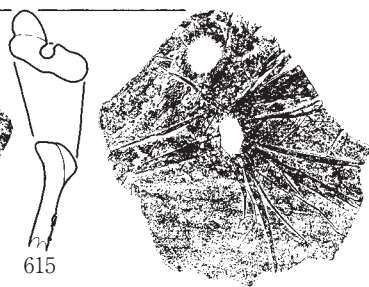

第303図 縄文土器 (55)

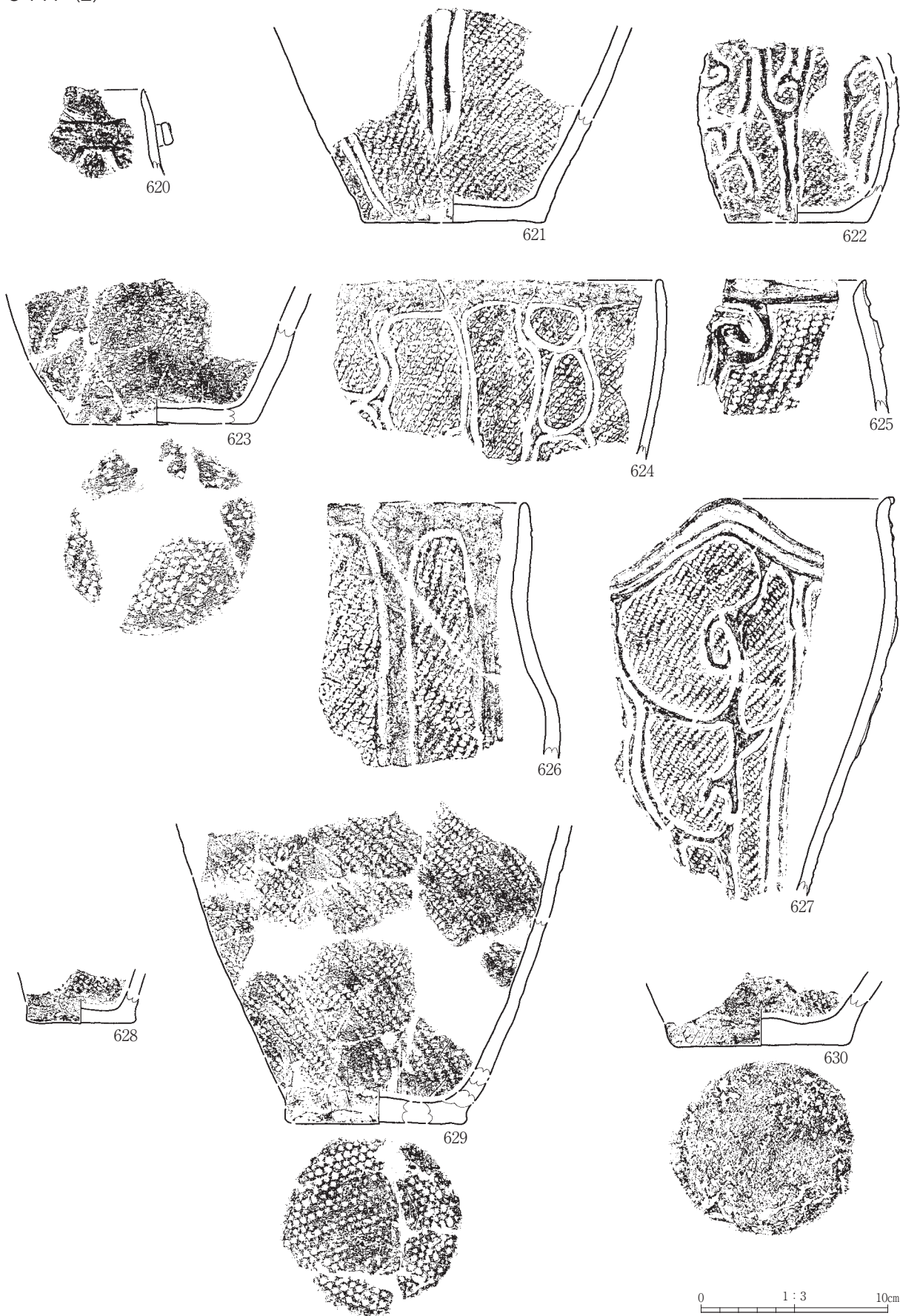

第304図 縄文土器 (56)



S 177・IVC1d



631

S 178 (1)

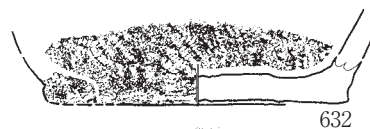

632

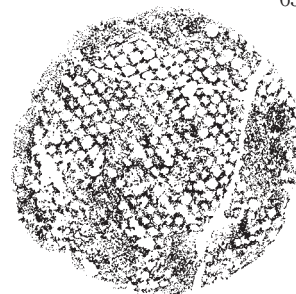

635

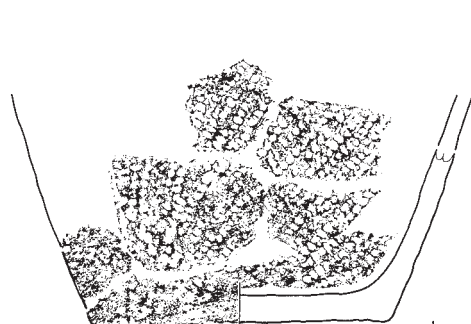
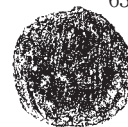

633



634

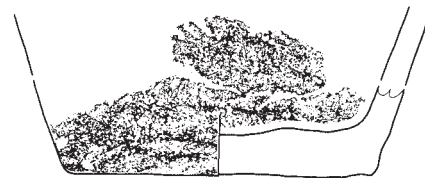

636

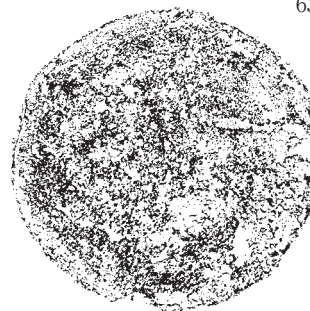

637

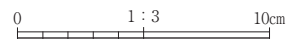

第305図 縄文土器 (57)

S 178 (2)

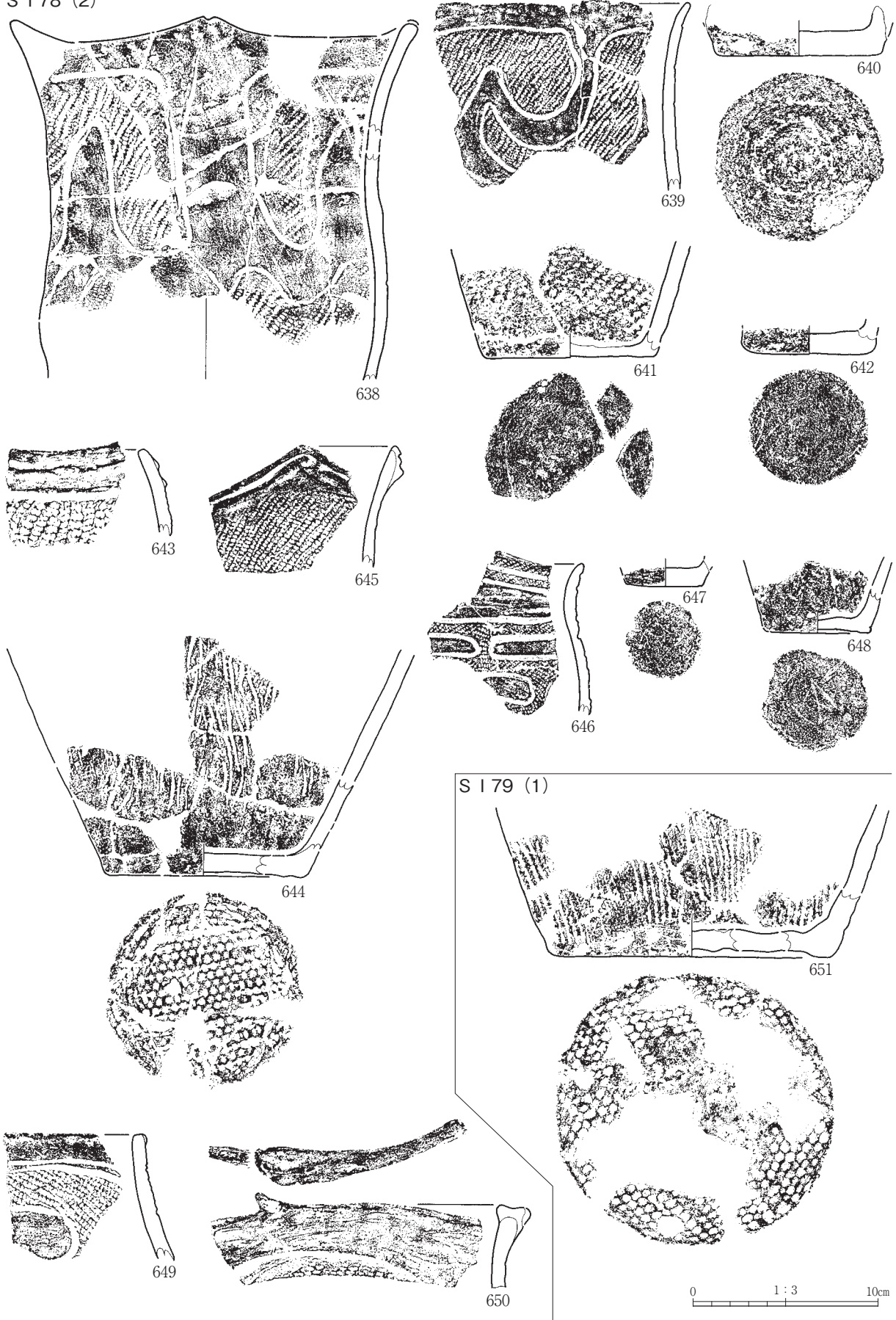

第306図 縄文土器 (58)

S 179 (2)

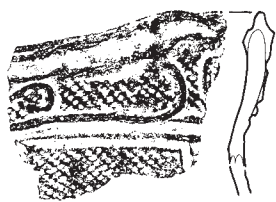

652



653

S 180 (1)



655



656



654

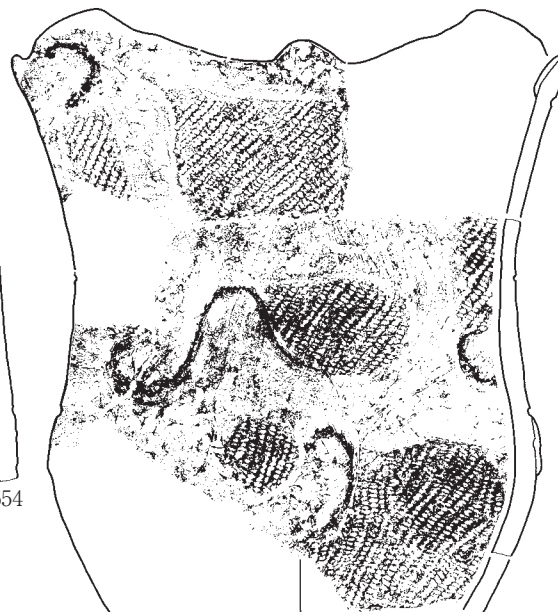

657



658



659



0 1:3 10cm

第307図 縄文土器 (59)

S 180 (2)



0 1:3 10cm

第308図 縄文土器 (60)

S 180 (3)

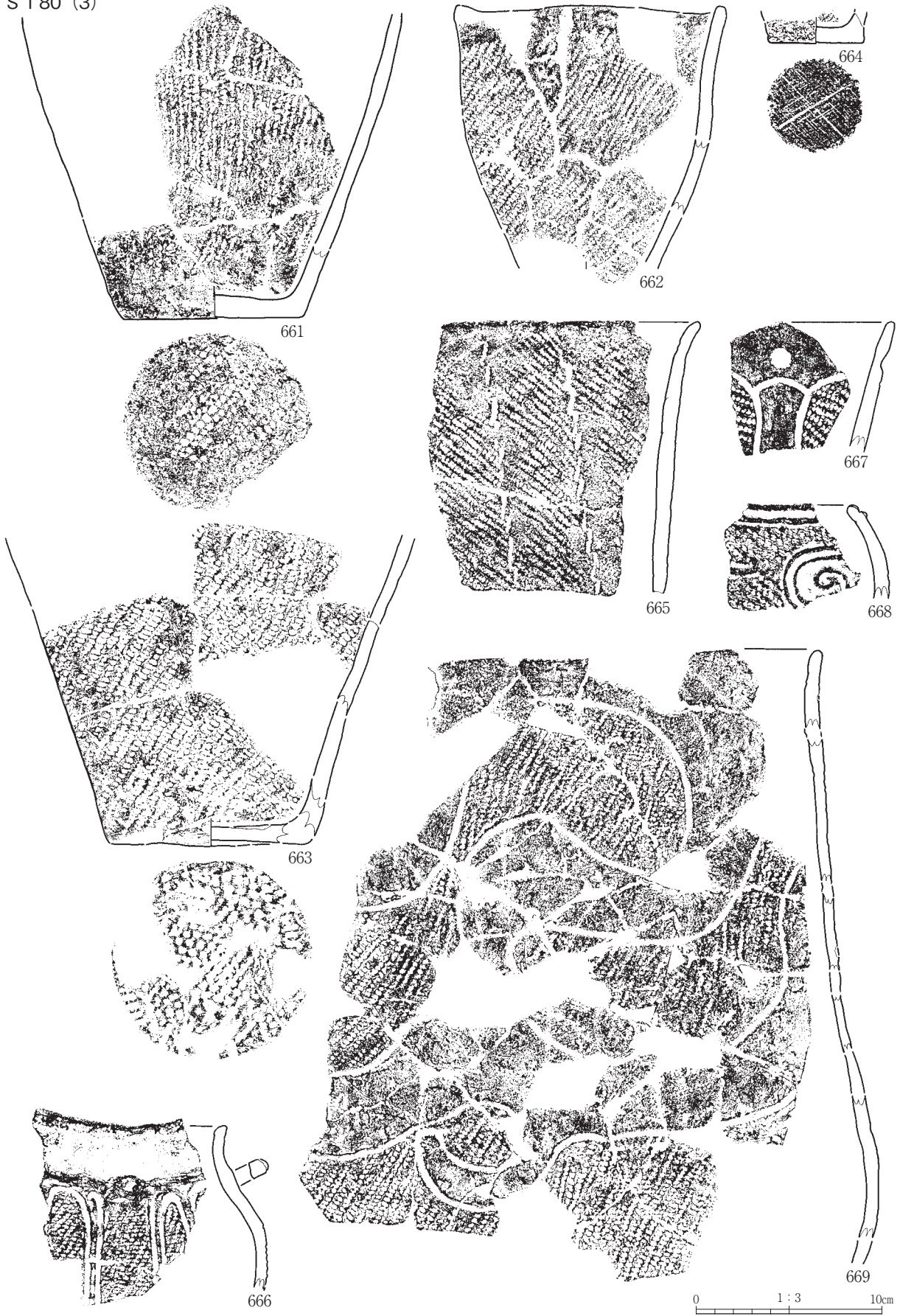

第309図 縄文土器 (61)

S 180 (4)

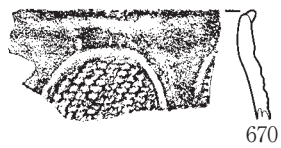

S 181

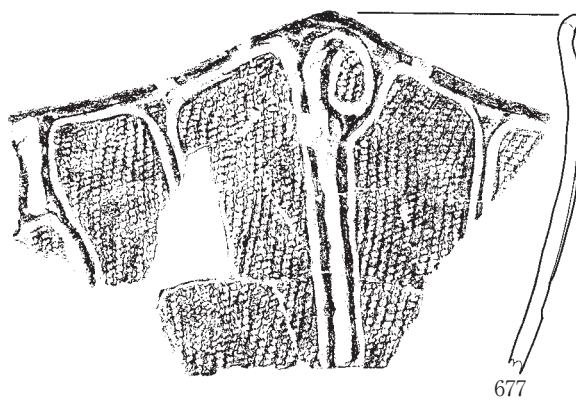
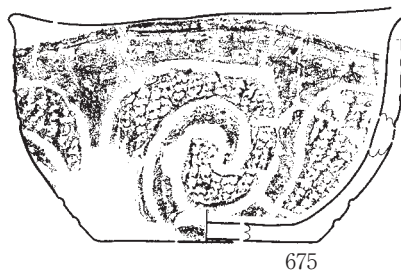
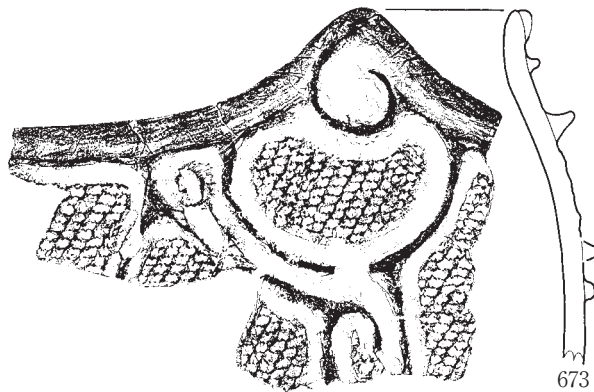
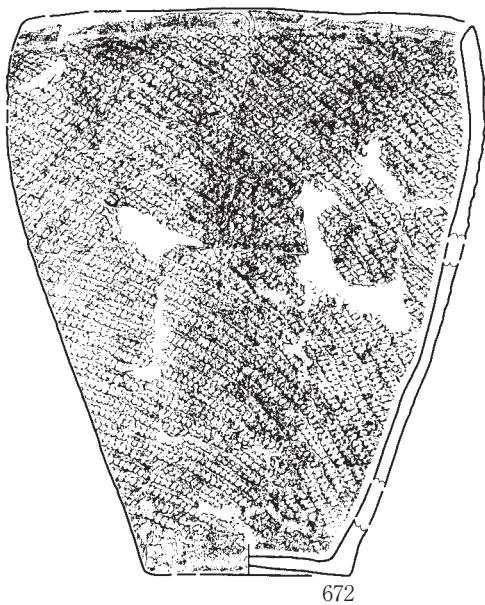

0 1:3 10cm

第310図 縄文土器 (62)

S 182 (1)

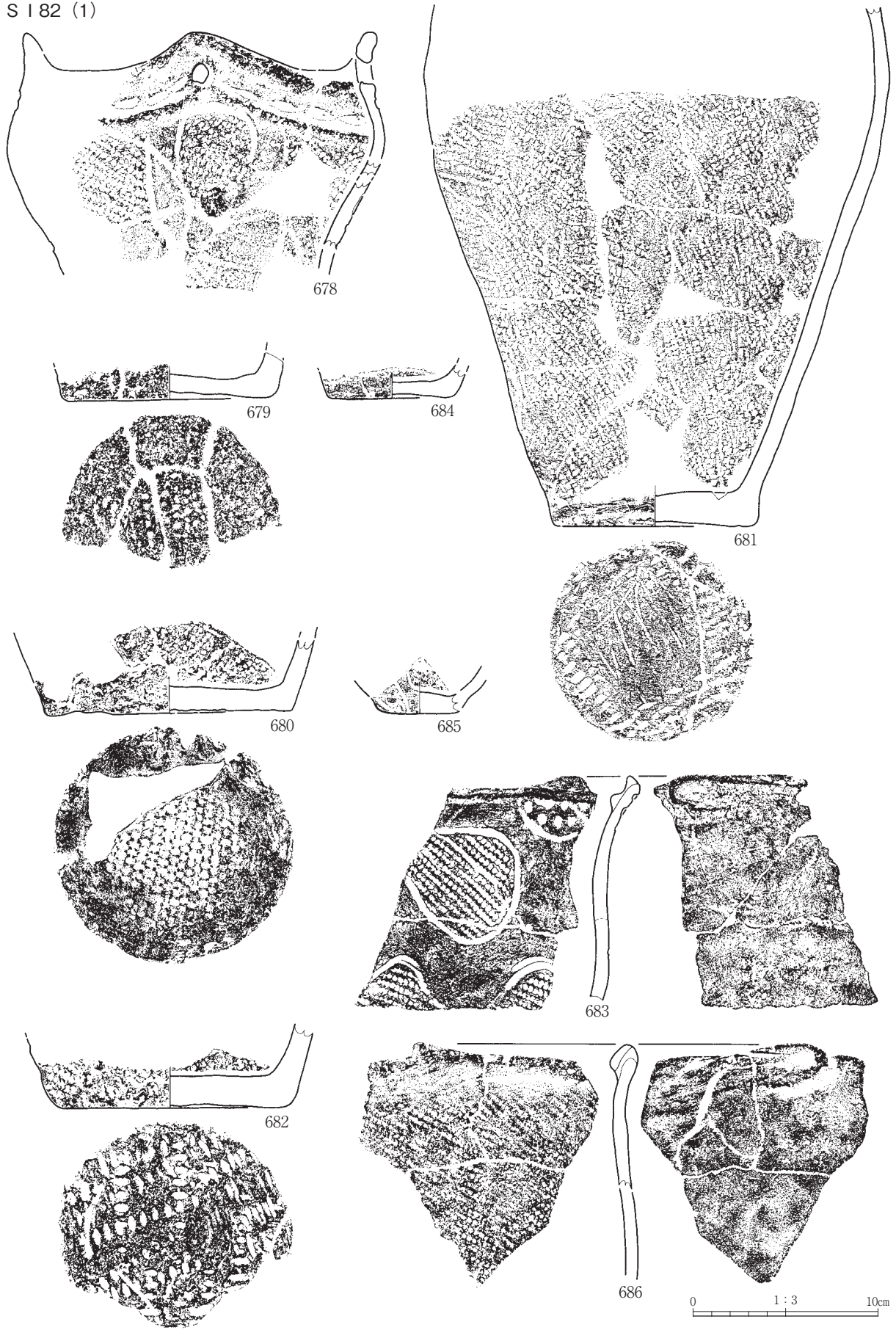

第311図 縄文土器 (63)

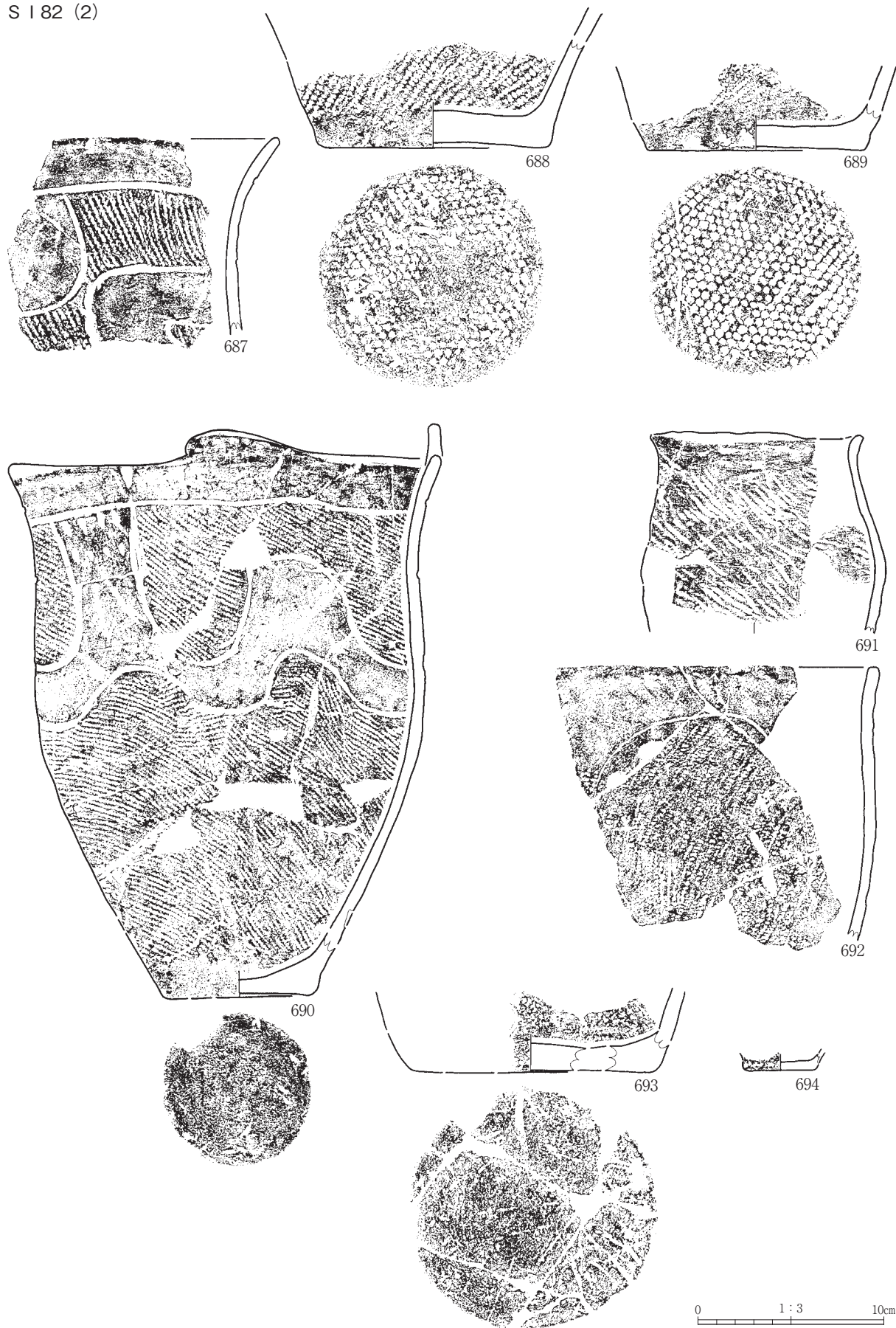

第312図 縄文土器 (64)



S 183

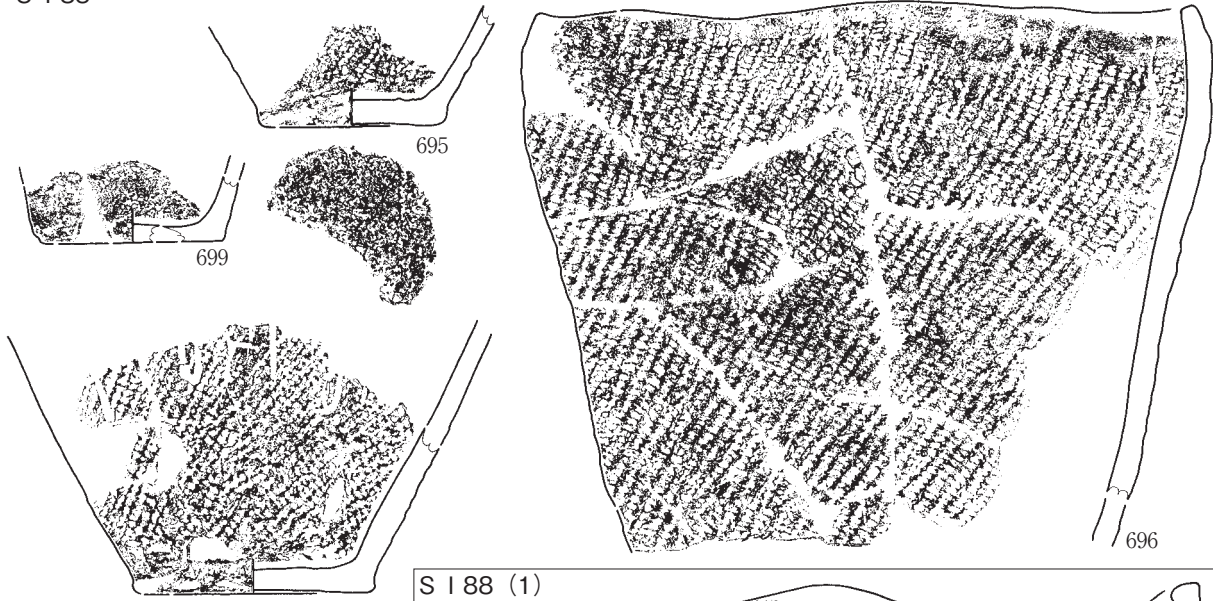

S 188 (1)

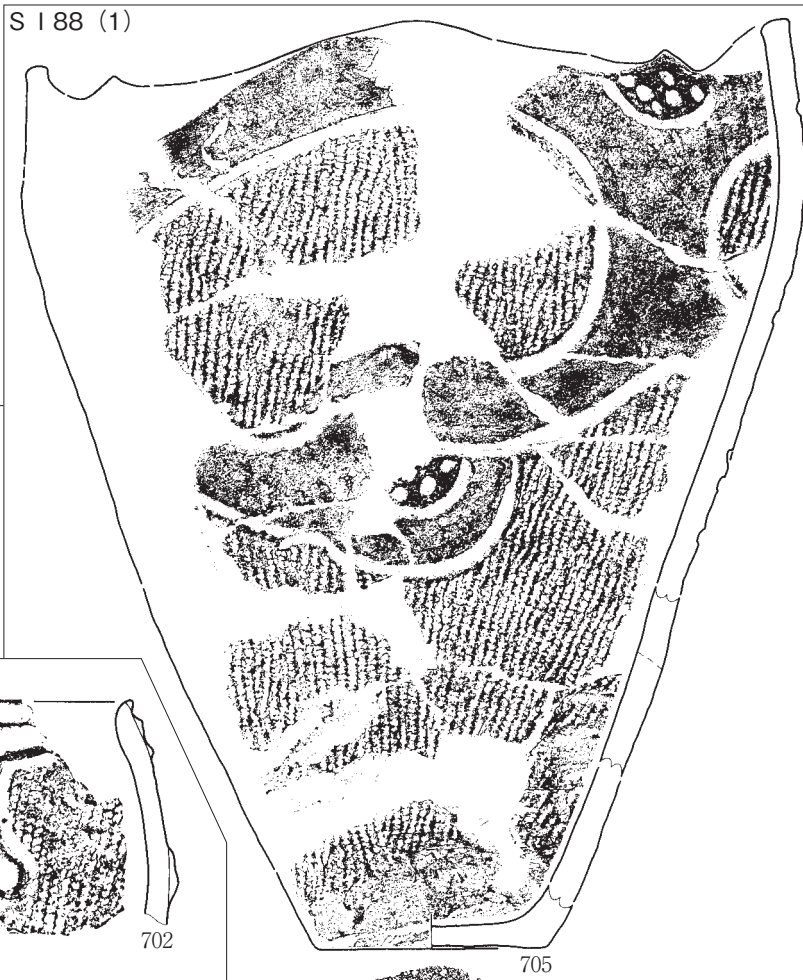

S 184

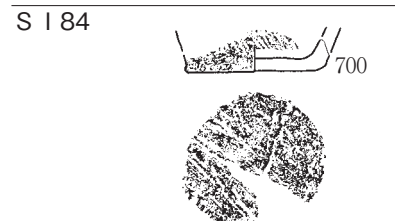

S 186

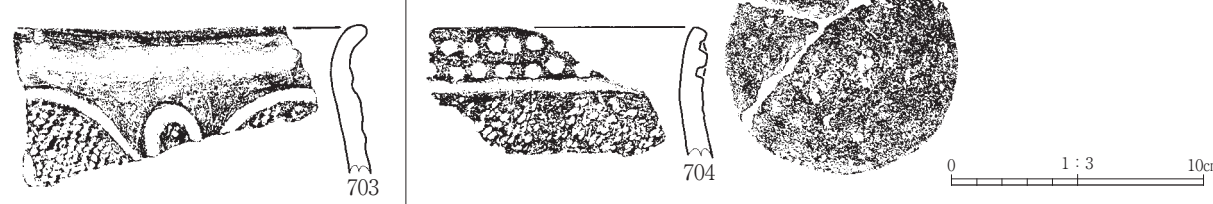
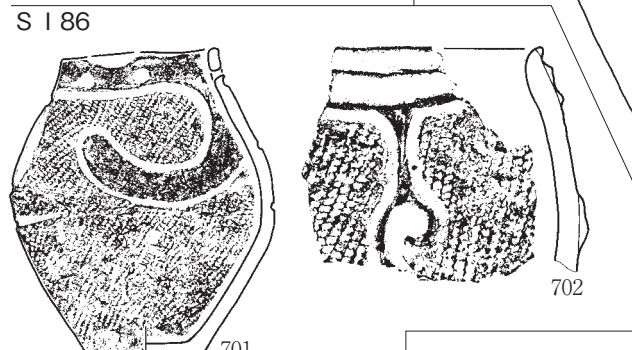

第313図 縄文土器 (65)

S 188 (2)



706

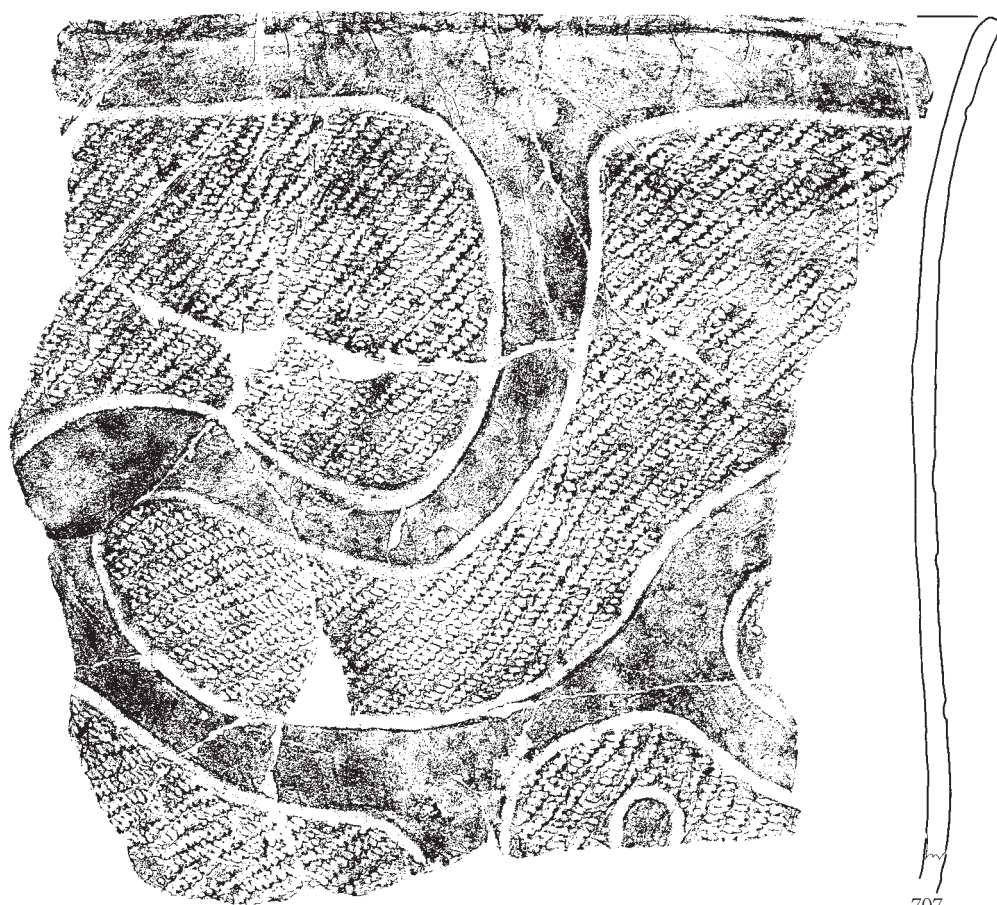

707

0 1:3 10cm

第314図 縄文土器 (66)

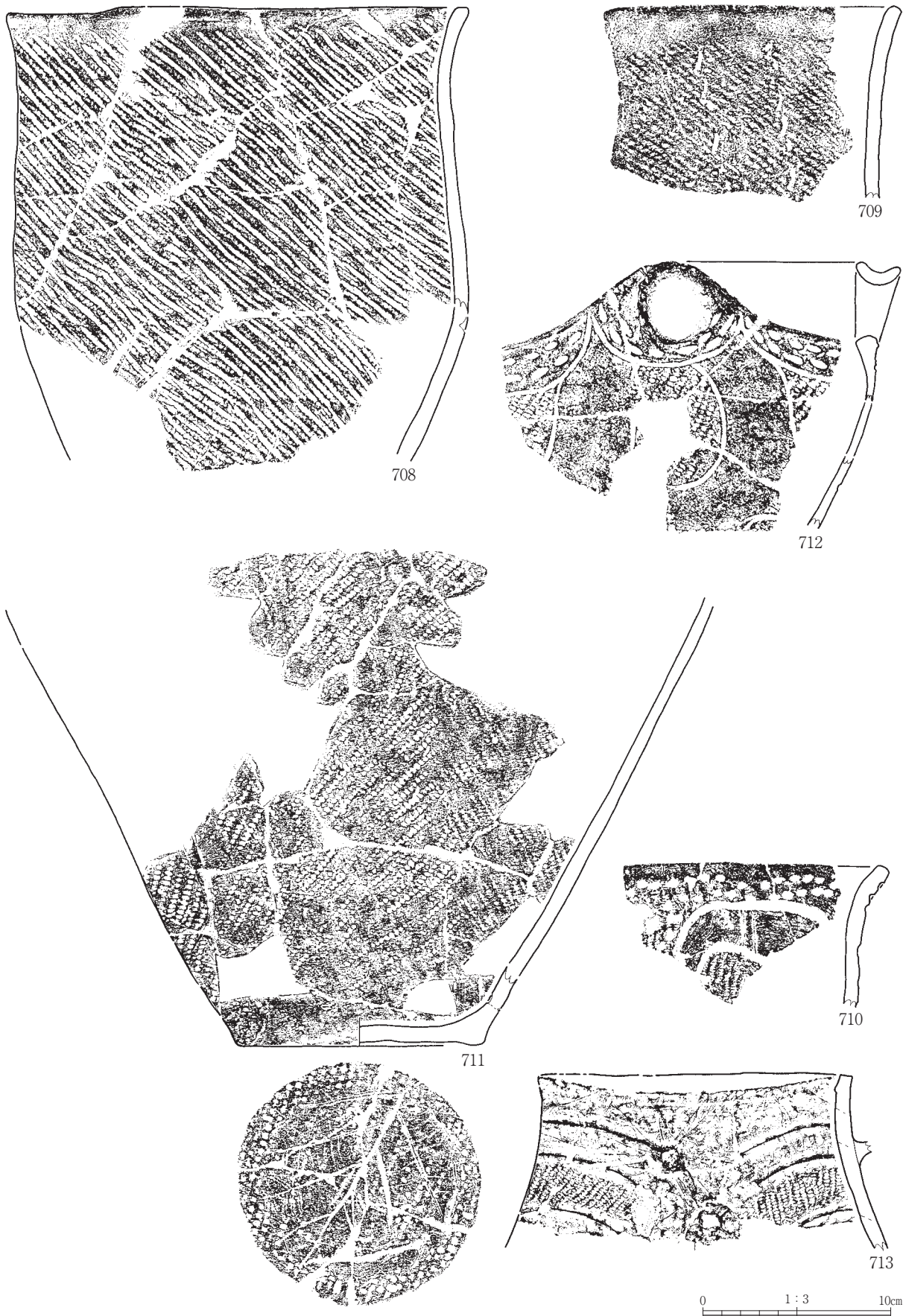

第315図 縄文土器 (67)

S 188 (4)

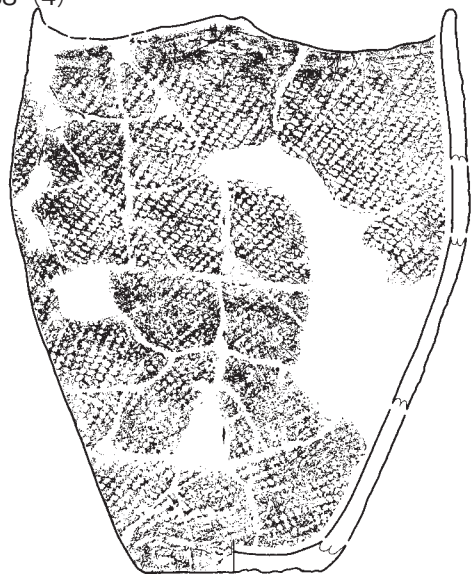

714

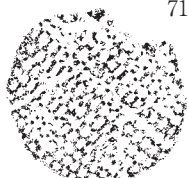

716

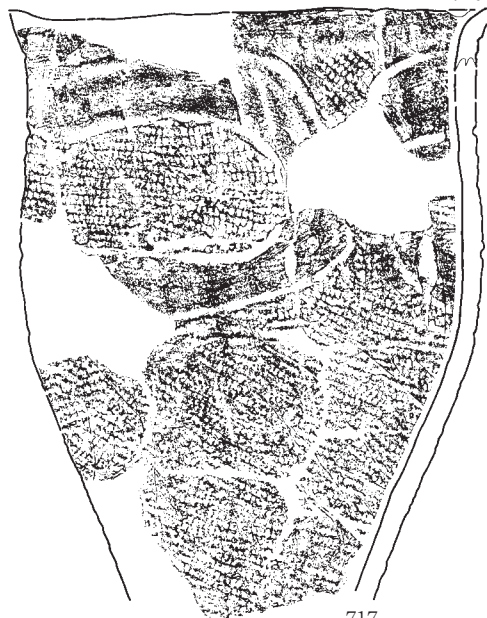

717

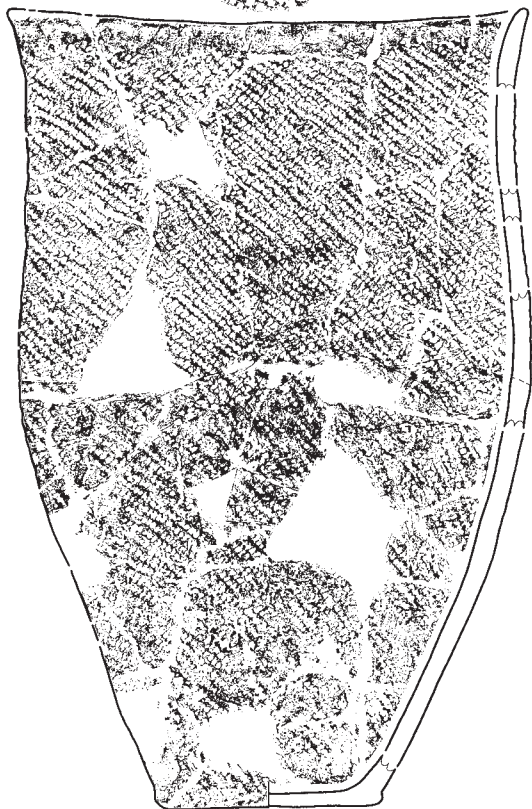

715

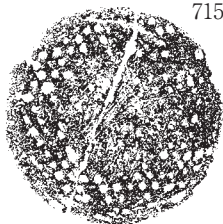

718



0 1:3 10cm

第316図 縄文土器 (68)

S 188 (5)

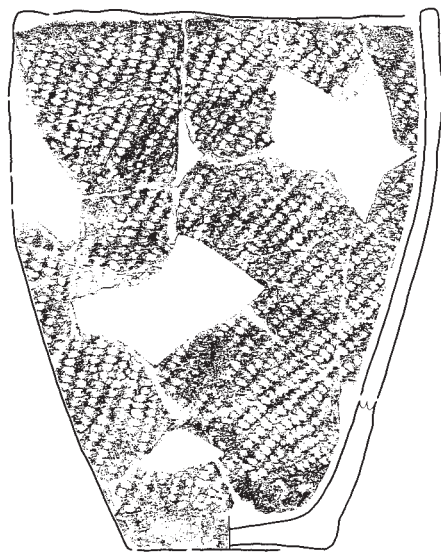

719

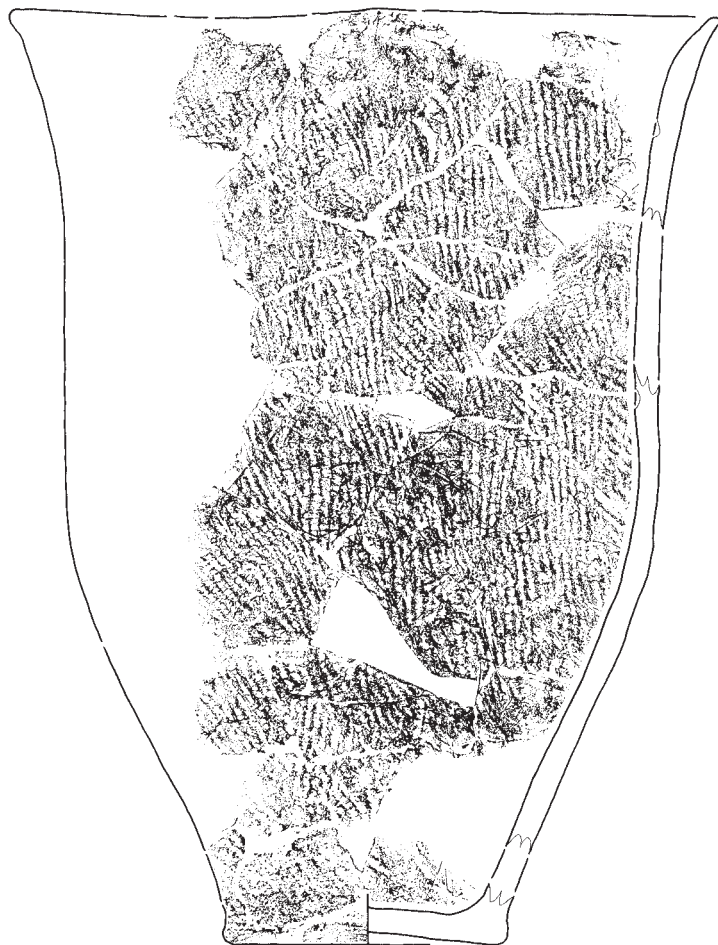

720

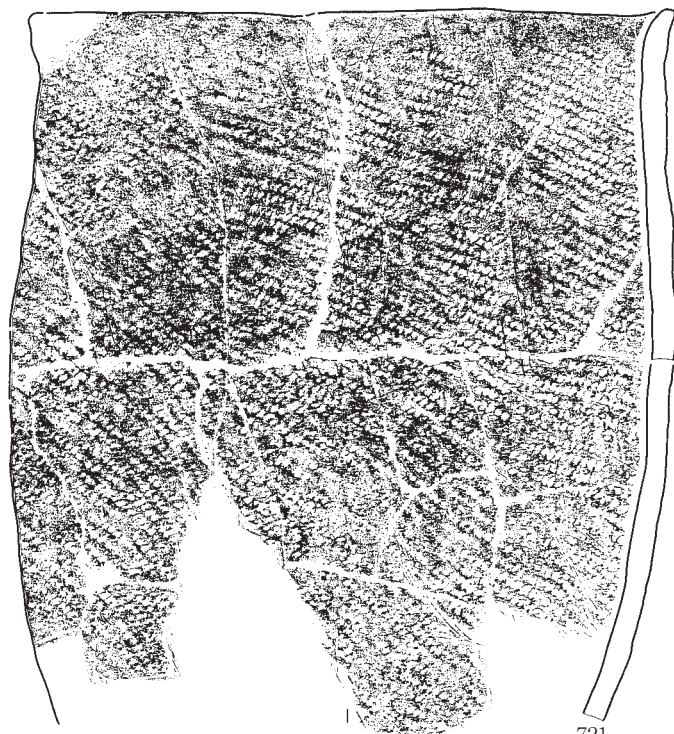

721



0 1:3 10cm

第317図 縄文土器 (69)

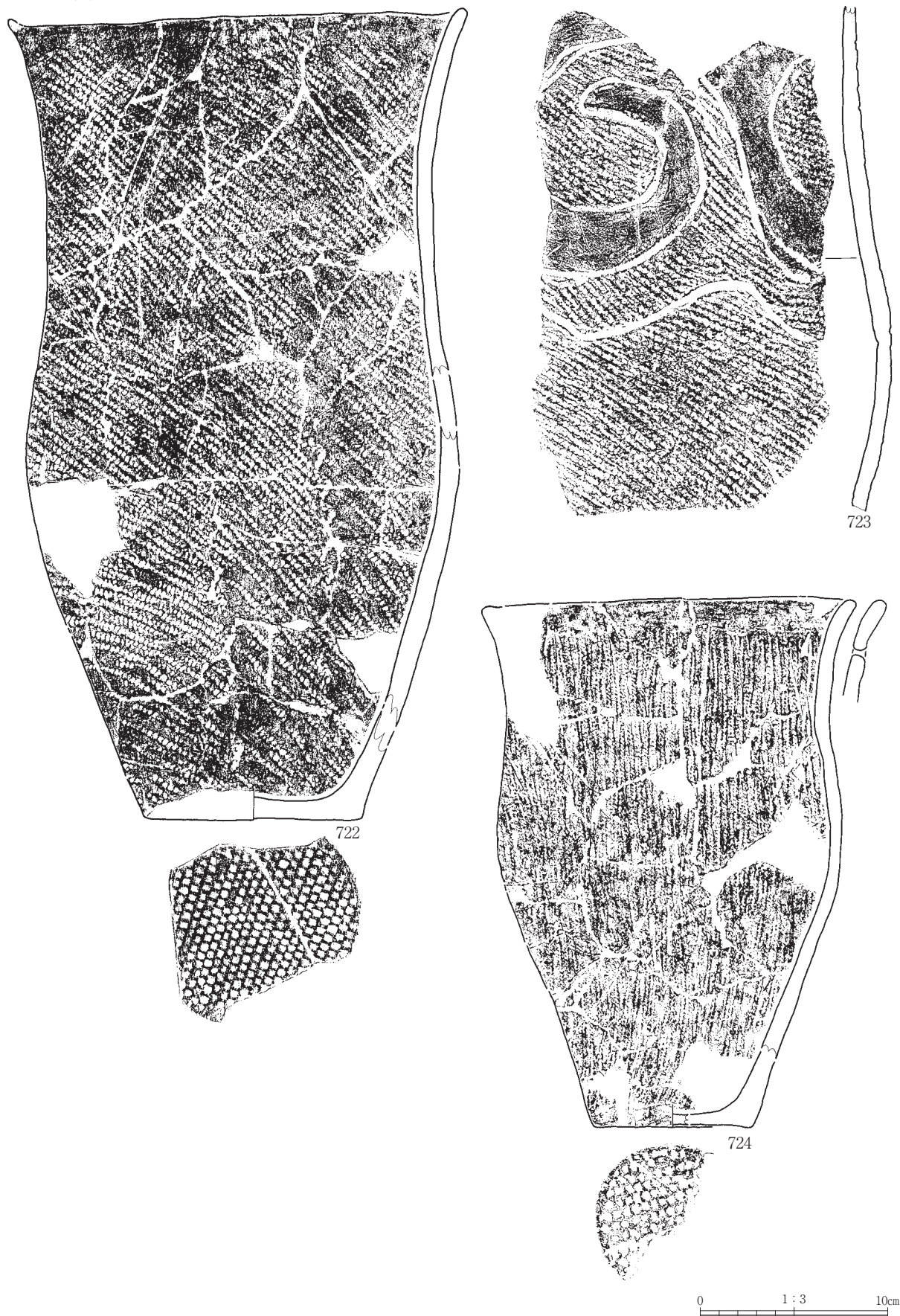

第318図 縄文土器 (70)

S 188 (7)

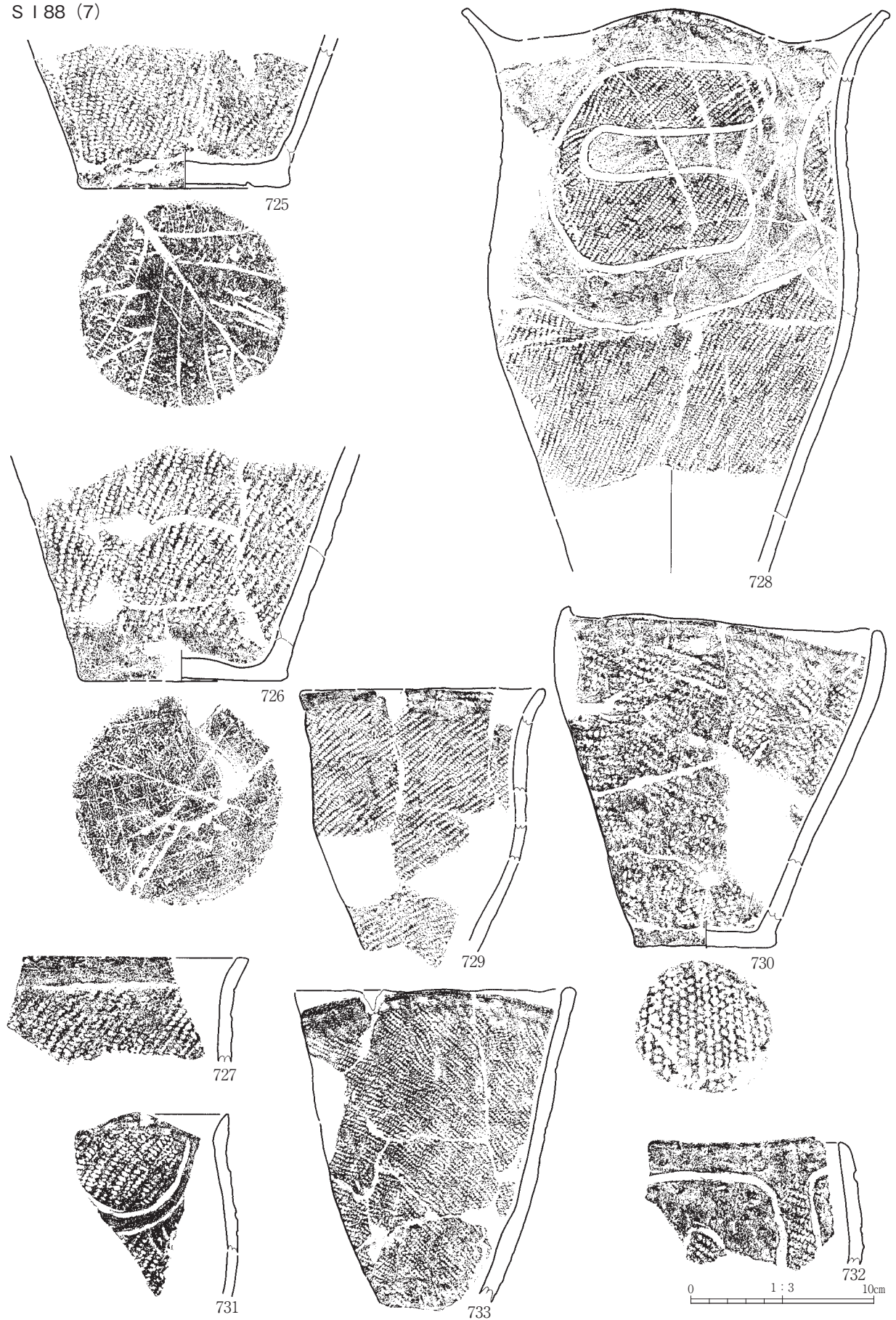

第319図 繩文土器 (71)

S 188 (8)

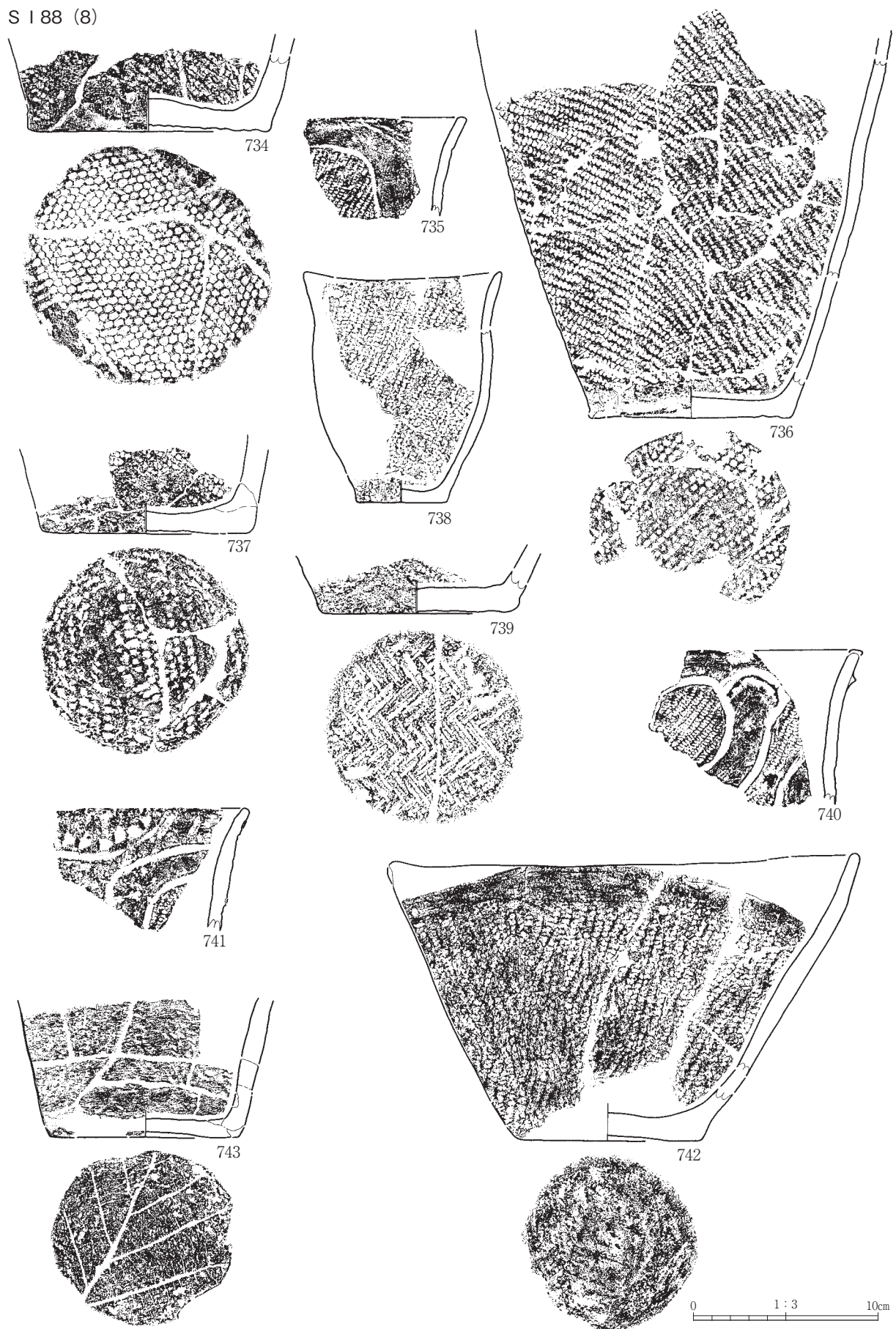

第320図 縄文土器 (72)



S 188 (9)

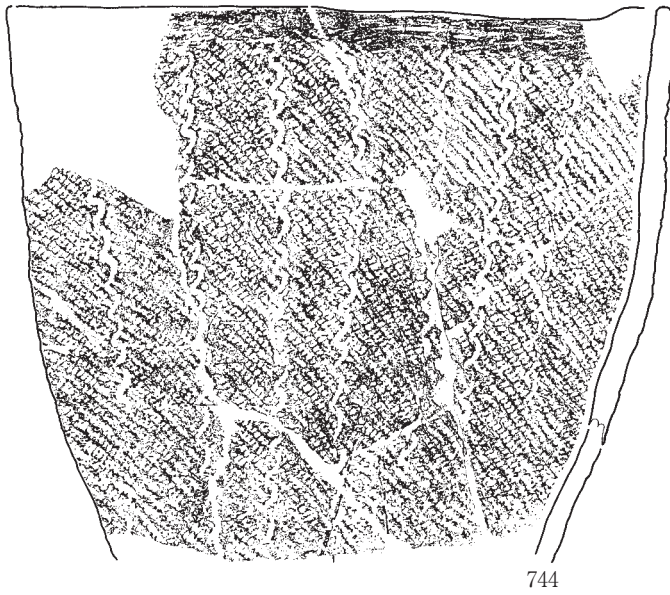

744

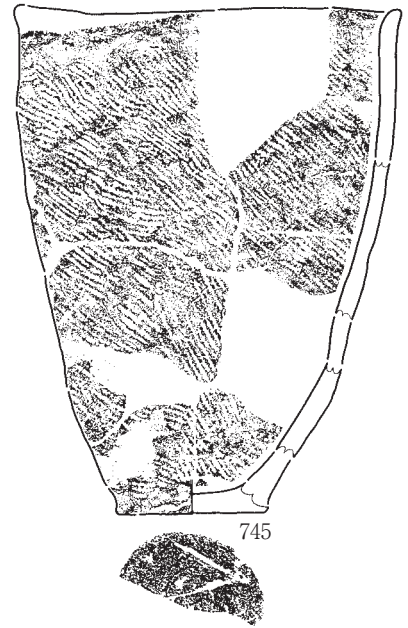

745

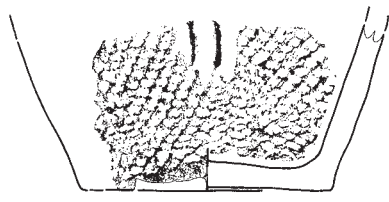

746

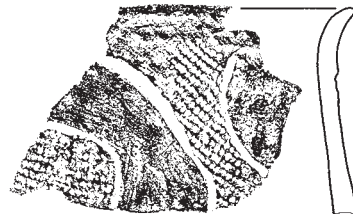

748

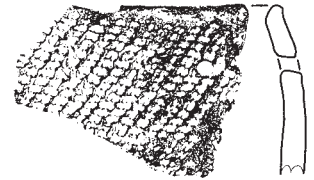

749

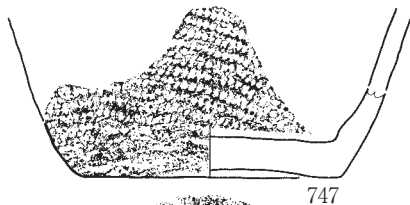

747

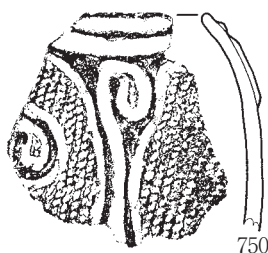
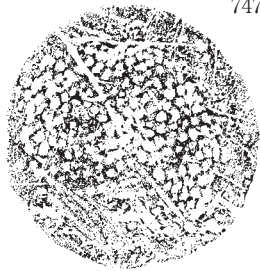

750

S 188 · 104



751



752

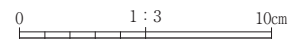

第321図 縄文土器 (73)

S I 89

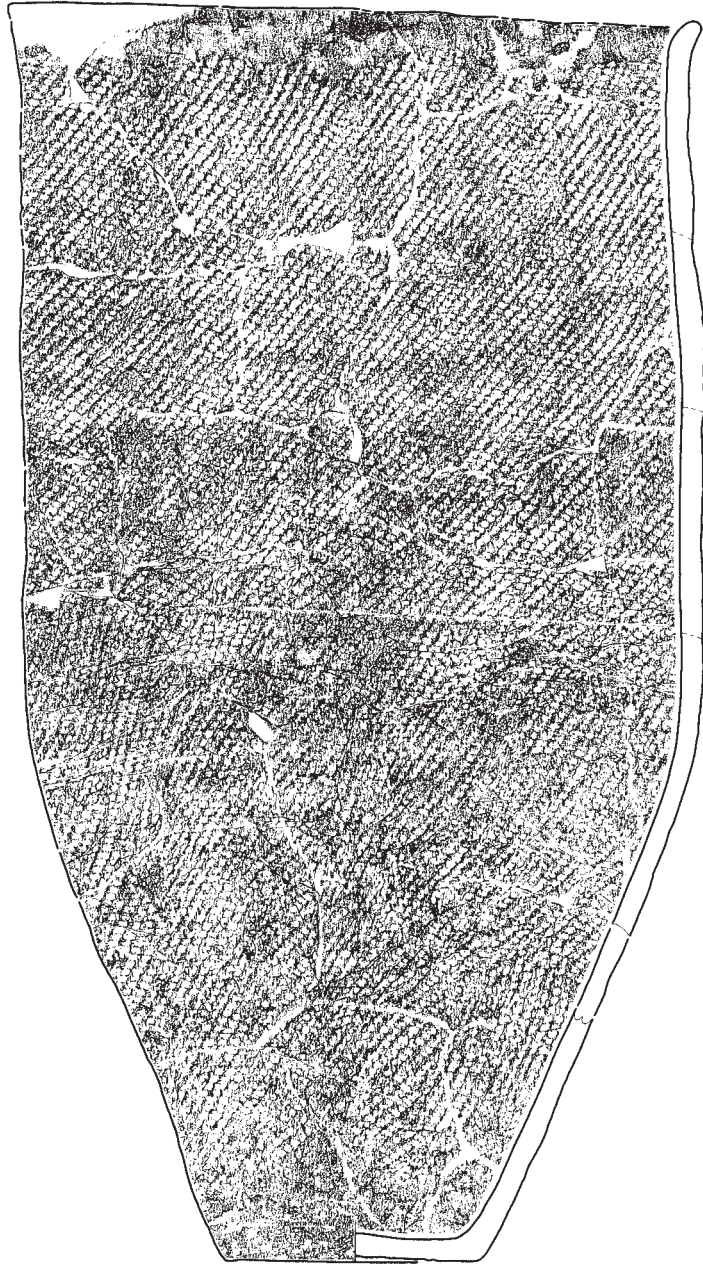

753

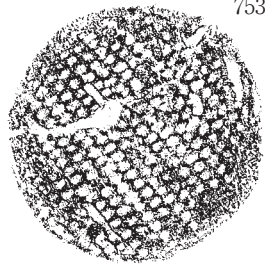

754



755

S I 89 · 93

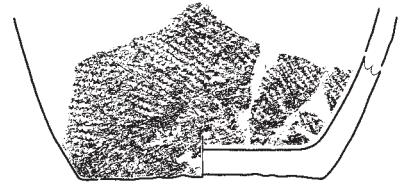

756

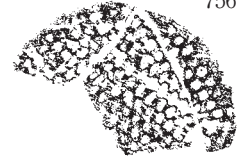

S I 90

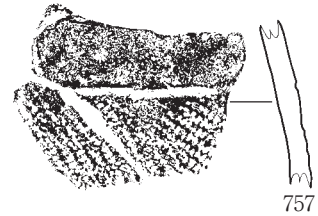

757

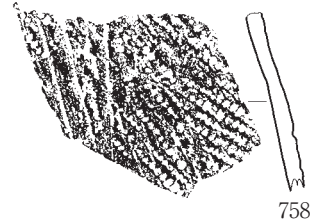

758

S I 91 (1)



759

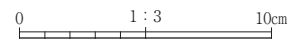

第322図 縄文土器 (74)

S 191 (2)

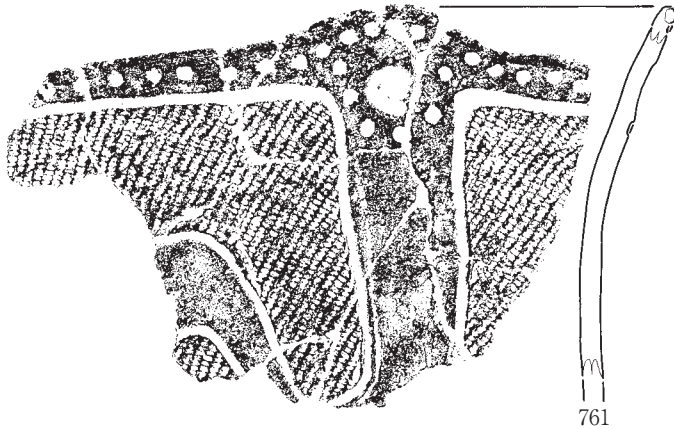
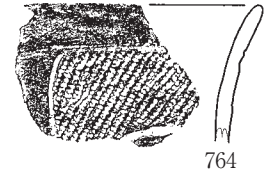
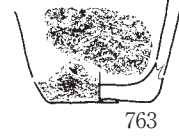
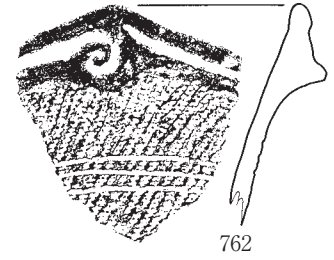
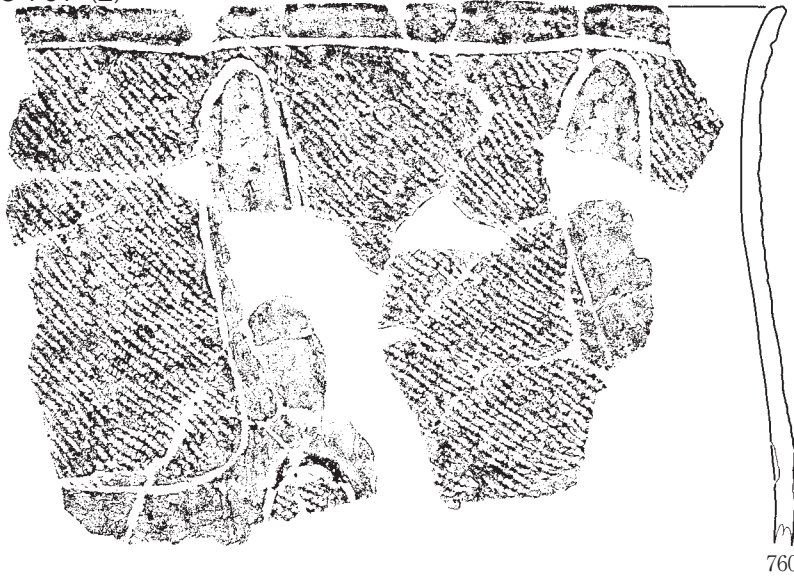

S 192 (1)

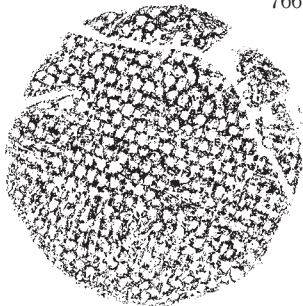
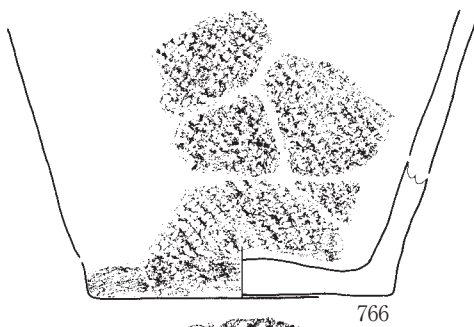
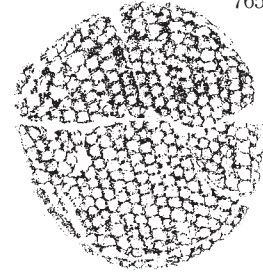

0 1:3 10cm

第323図 縄文土器 (75)

S 192 (2)



768

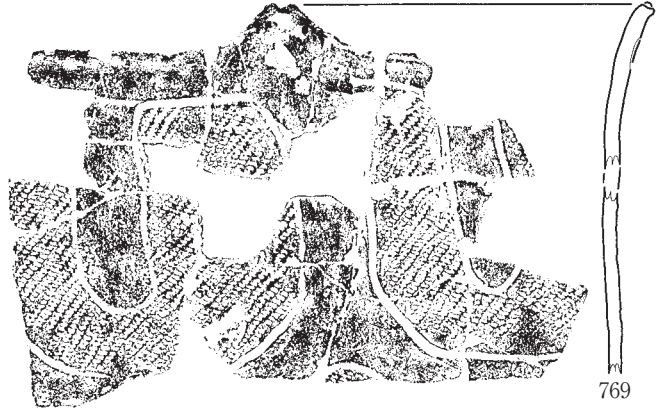

769

S 193

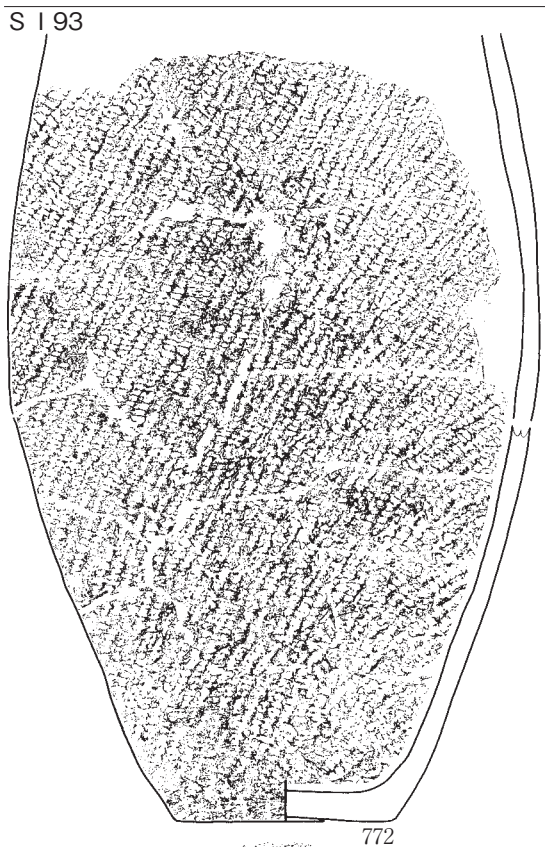

772

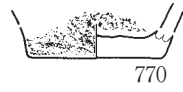

770



771

S 195 (1)

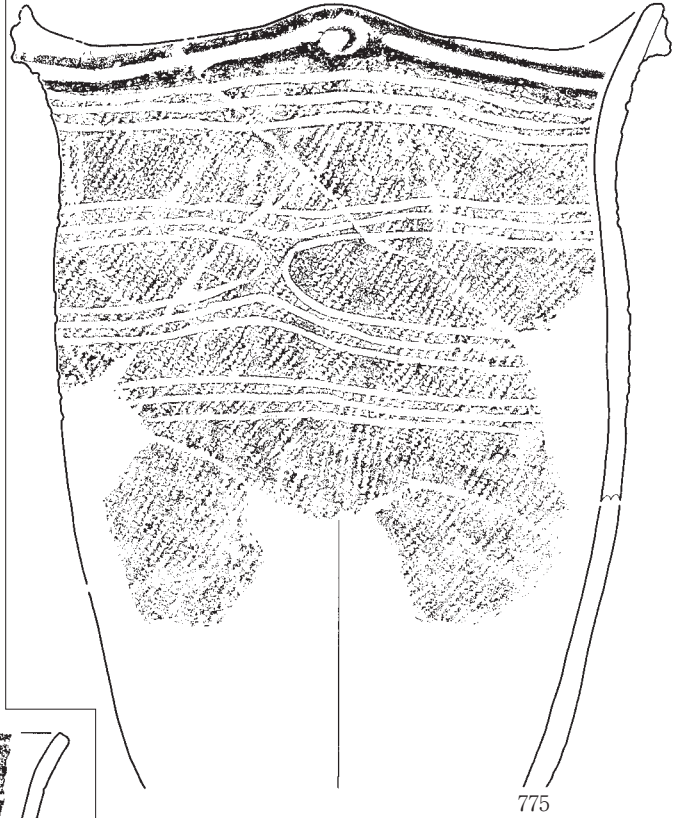

775

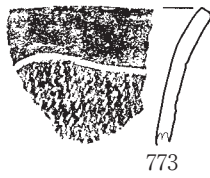
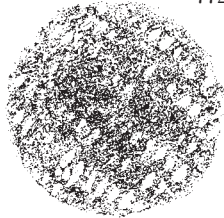

773

S 194

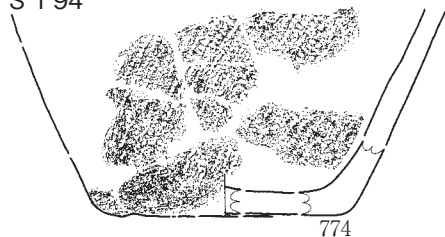

774



776

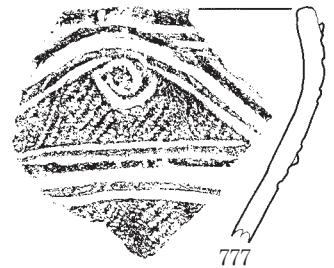

777

0 1:3 10cm

第324図 縄文土器 (76)

S 195 (2)

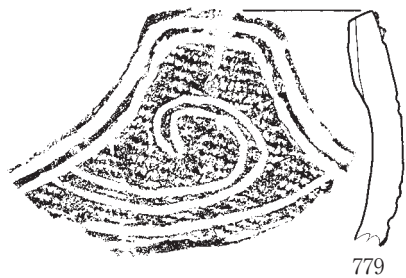
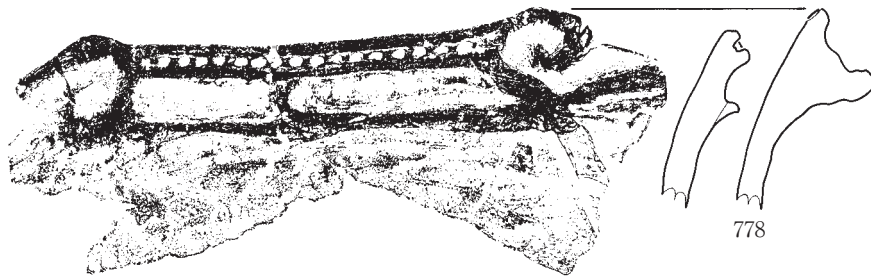

S 196

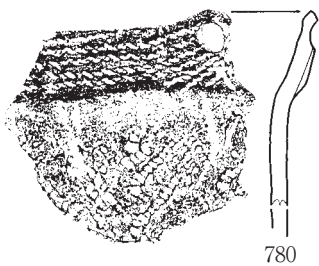

S 197

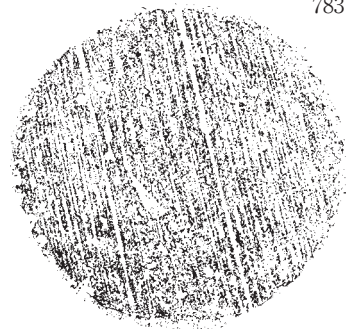
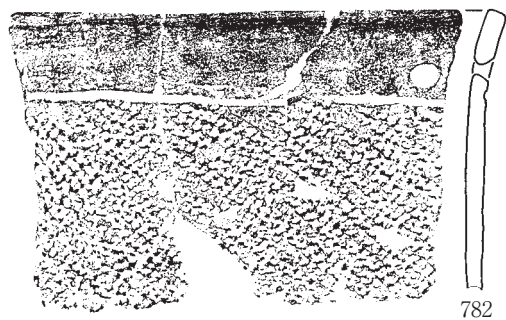
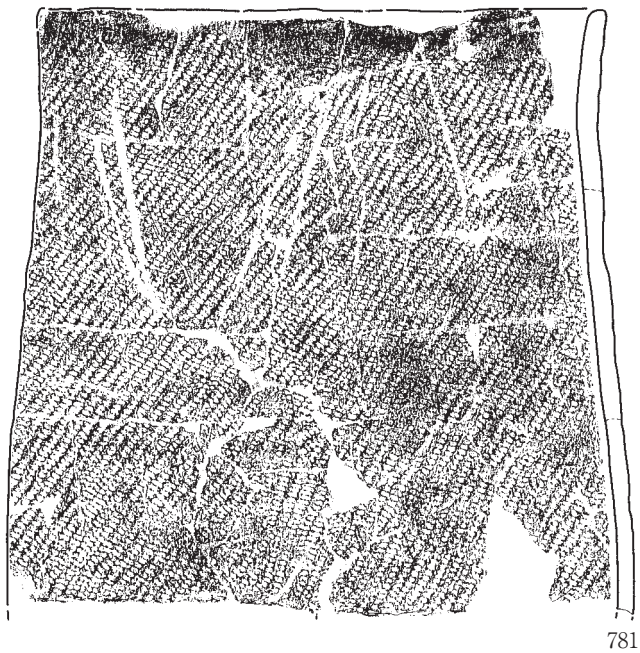

S 198

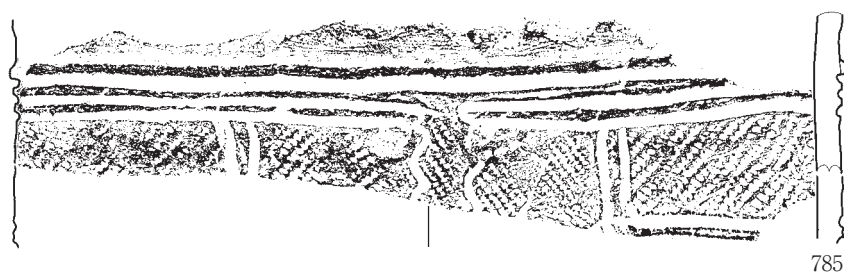

0 1:3 10cm

第325図 縄文土器 (77)

S I 99

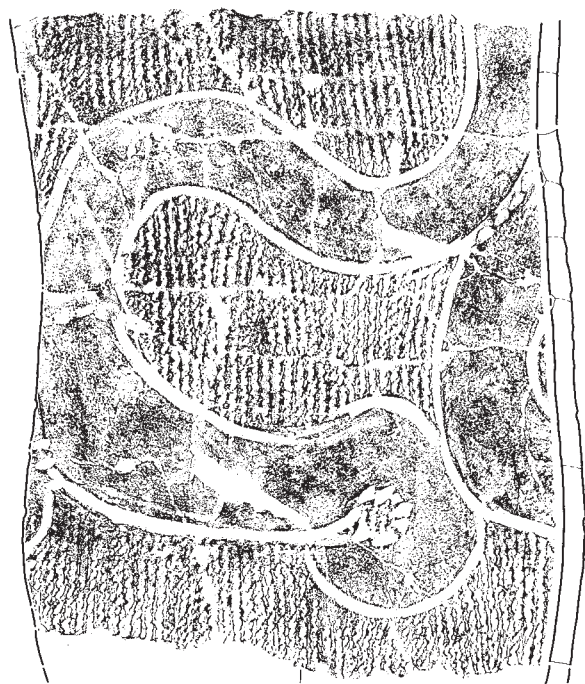

786

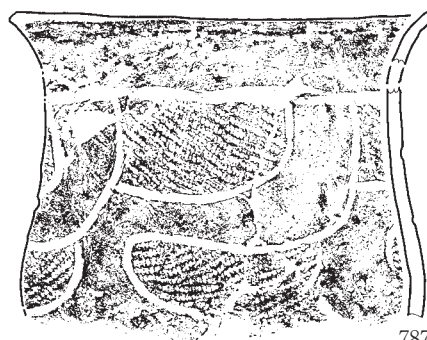

787

S I 99 · 101

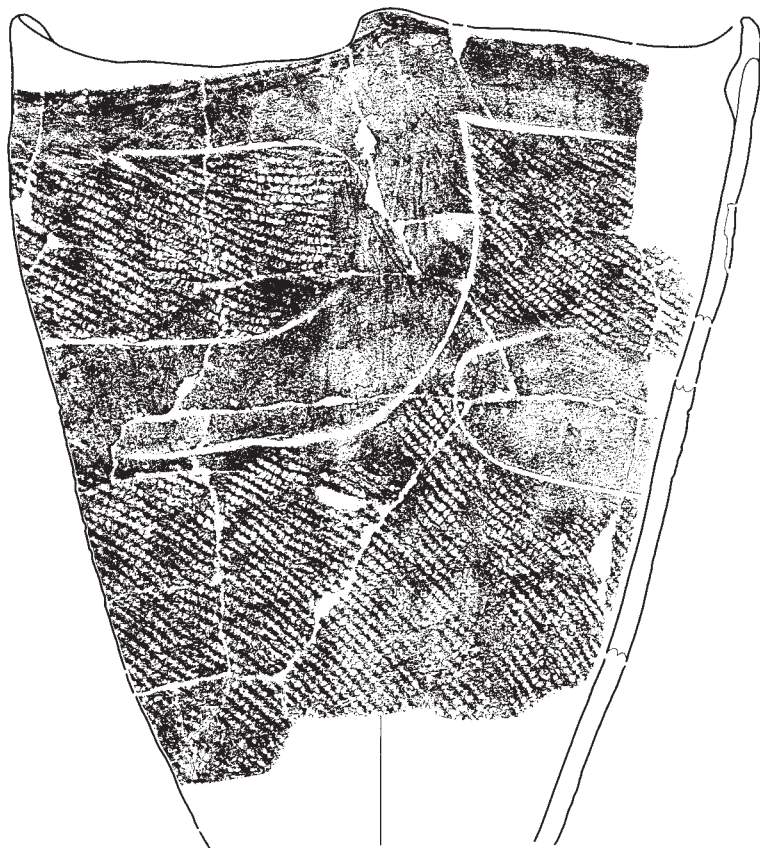

788

S I 100



789

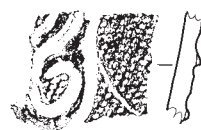

790

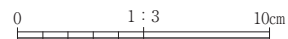

第326図 縄文土器 (78)

S I 101 (1)

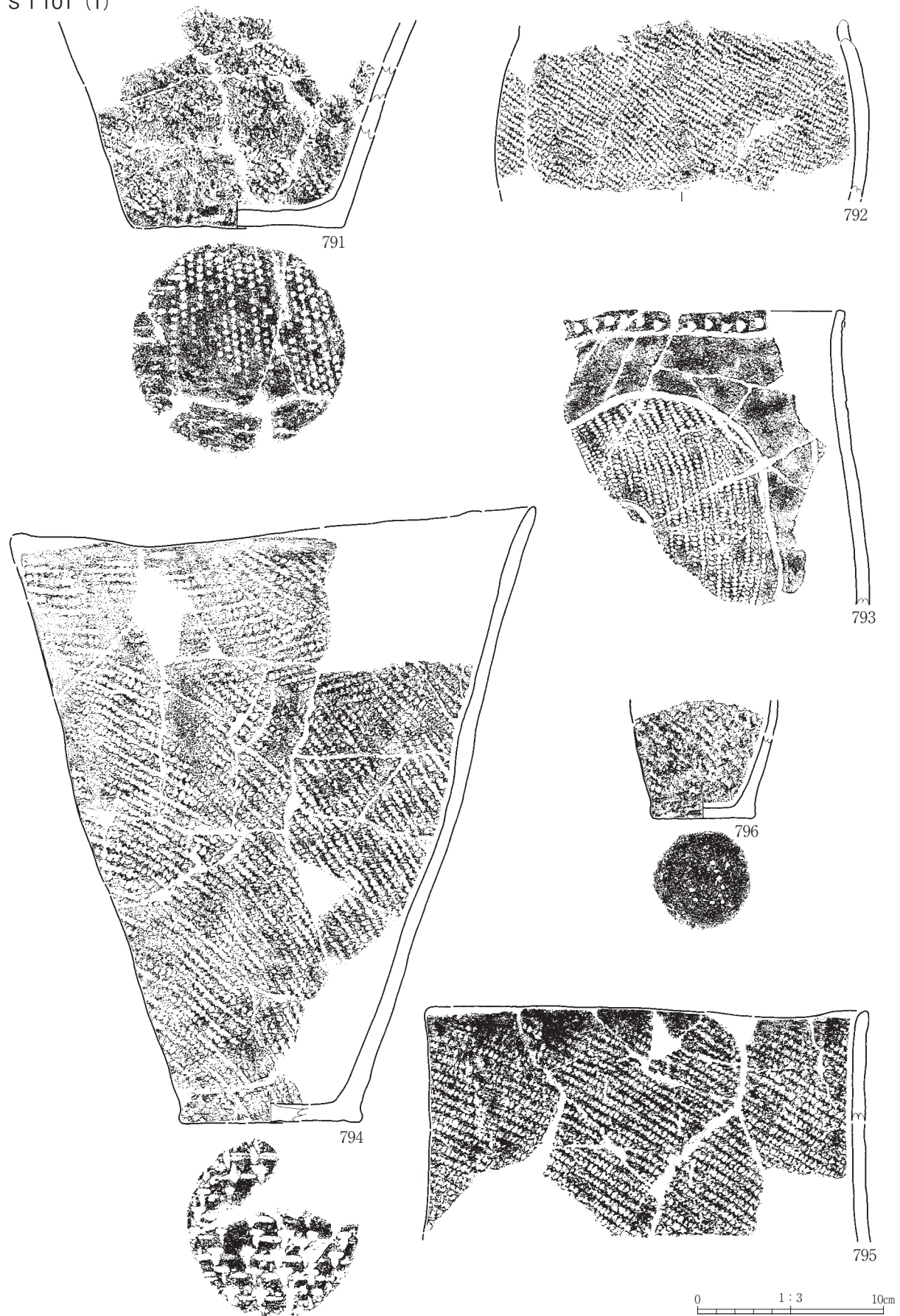

第327図 縄文土器 (79)

S I 101 (2)

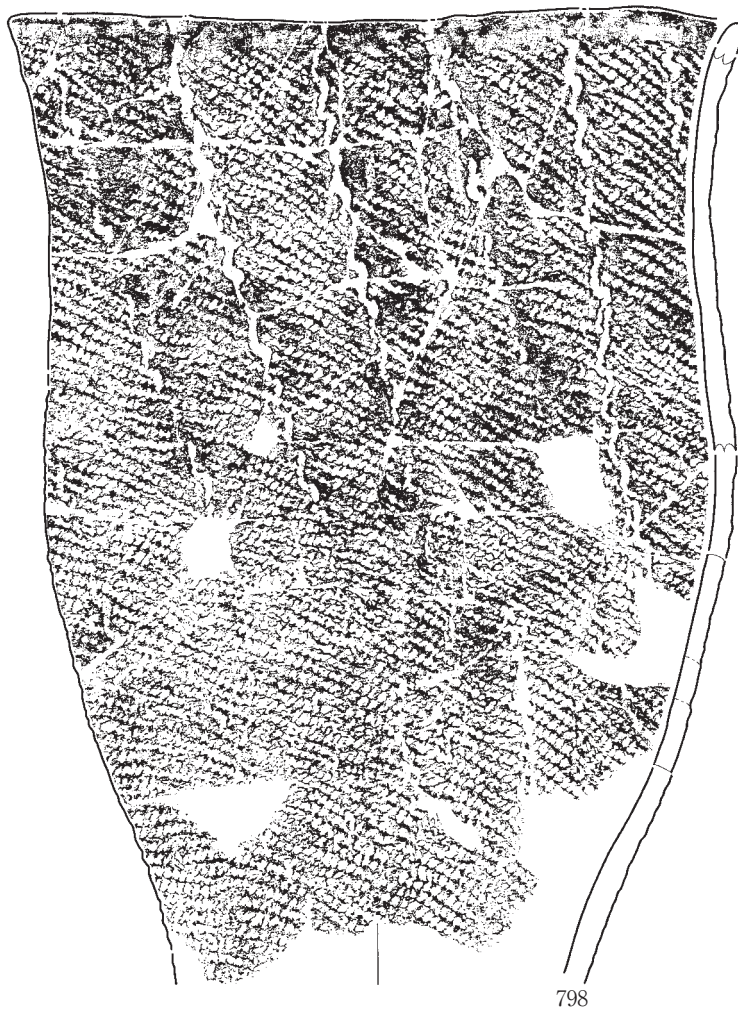

0 1:3 10cm

第328図 縄文土器 (80)



S I 101 (3)

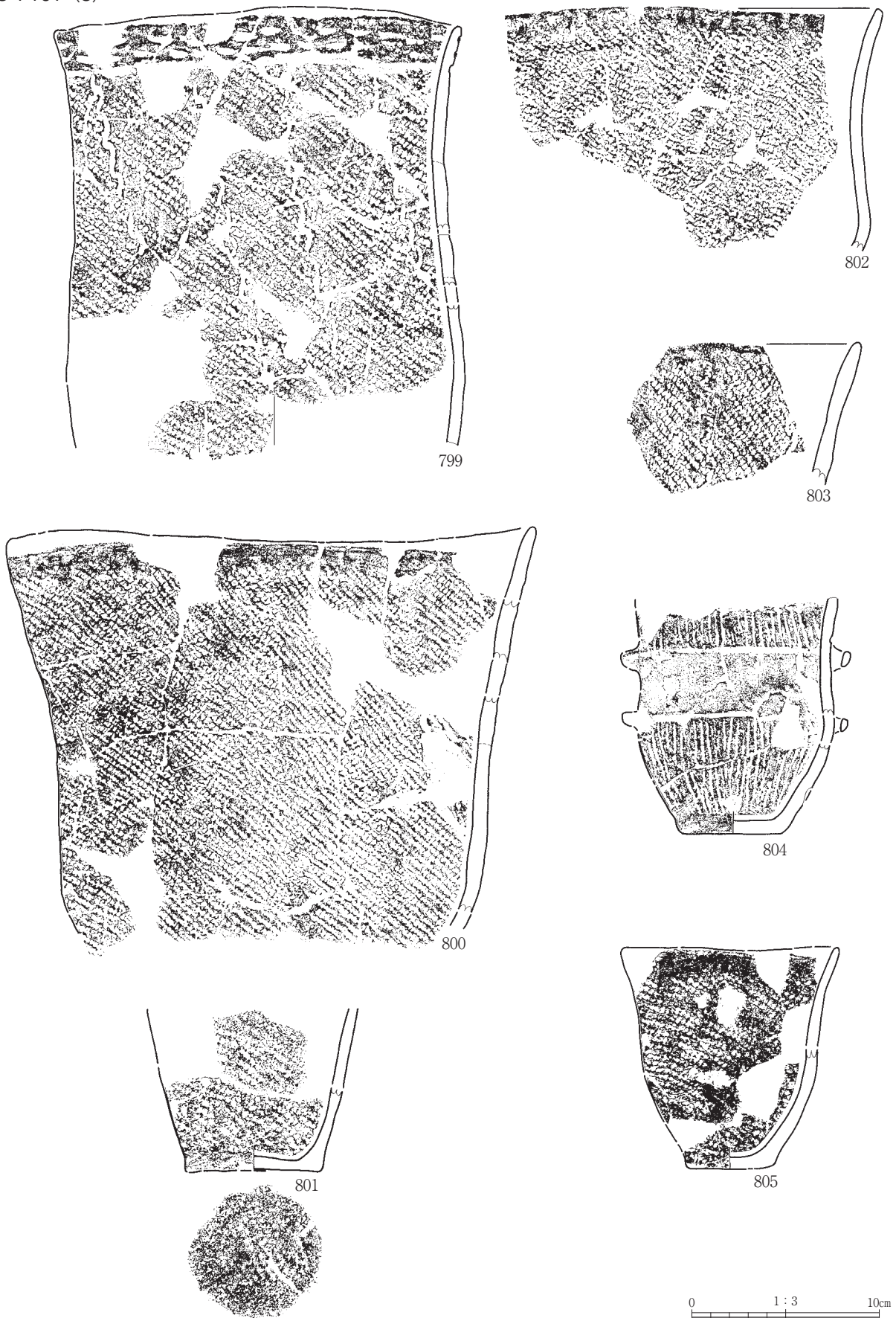

第329図 縄文土器 (81)

S I 102 (1)

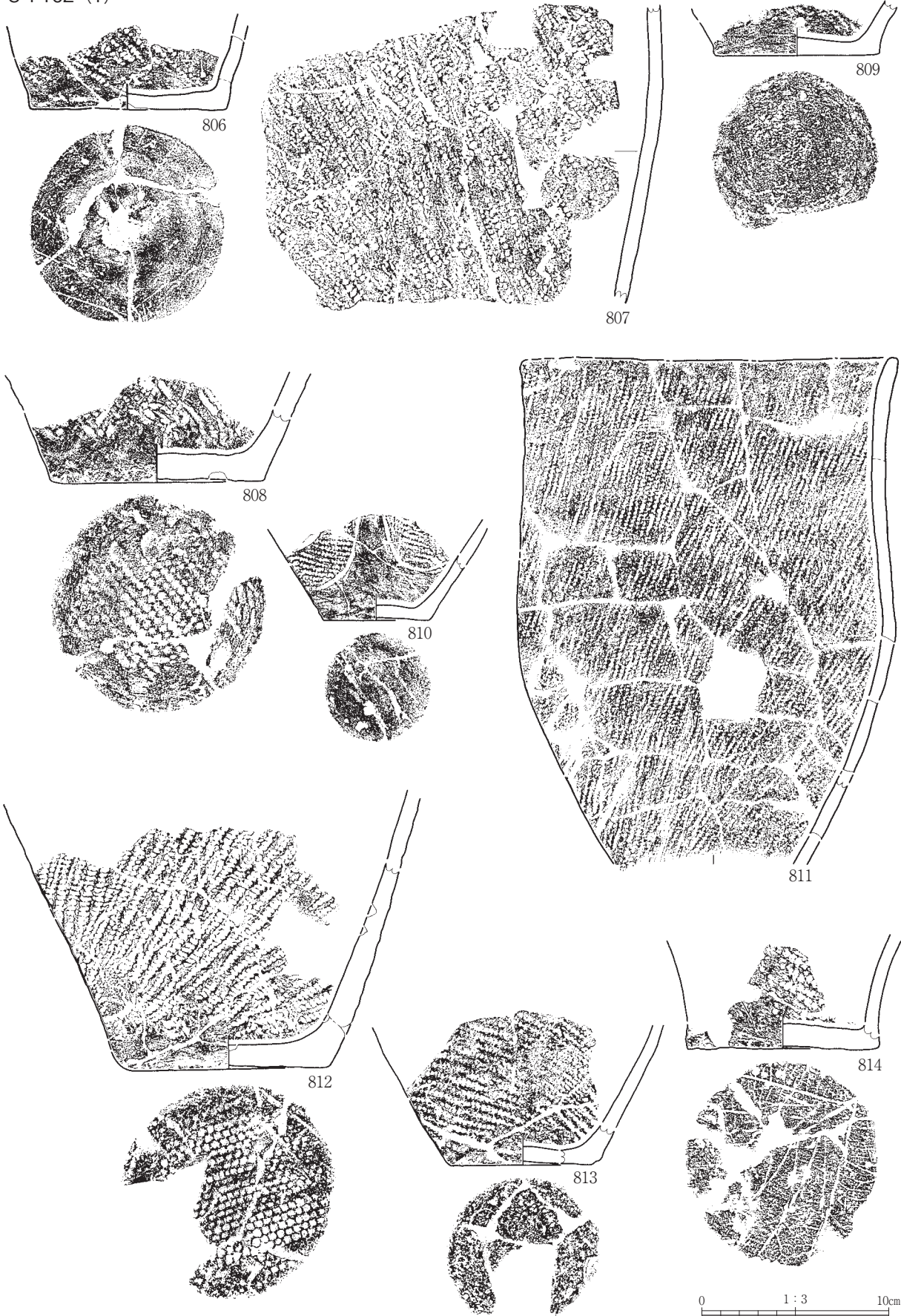

第330図 繩文土器 (82)

S I 102 (2)

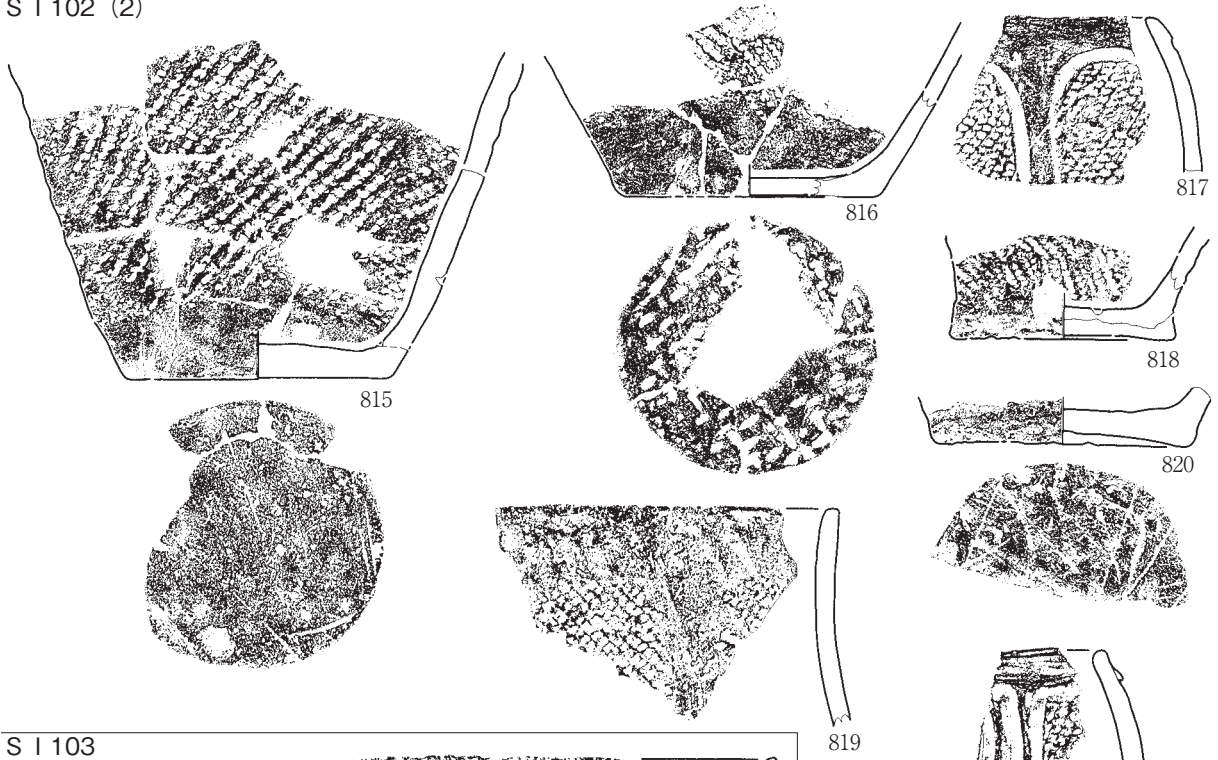

S I 103

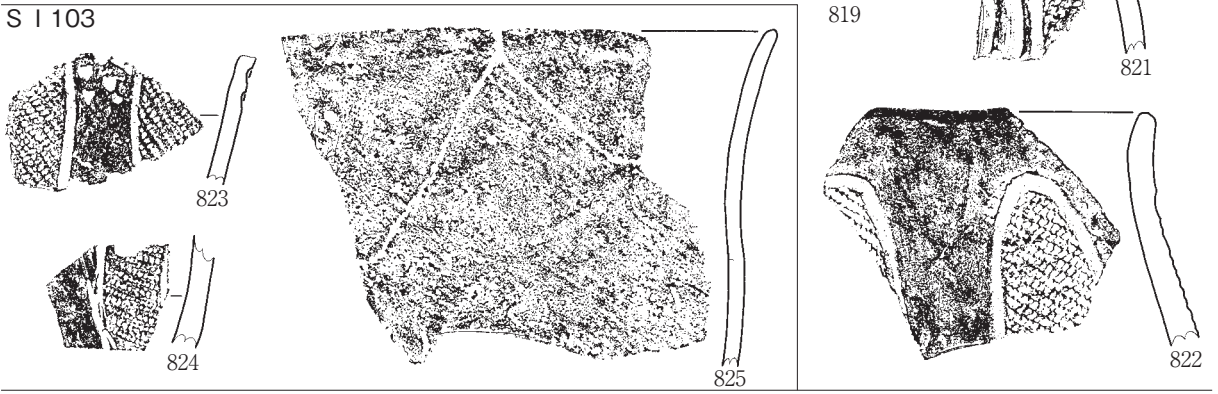

S I 104



0 1:3 10cm

第331図 縄文土器 (83)

S I 105

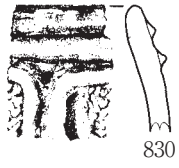

S I 105・IVC3j

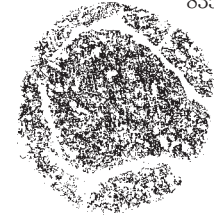
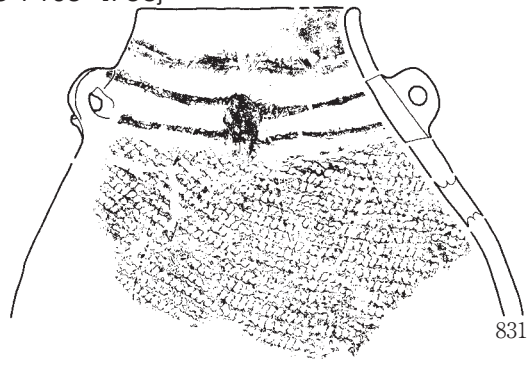

S I 106

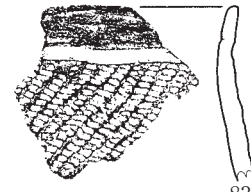
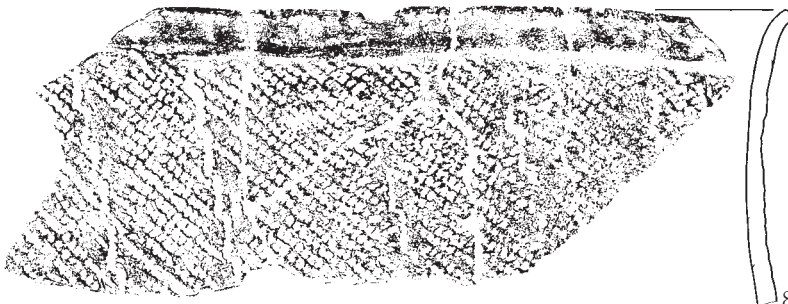
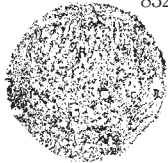
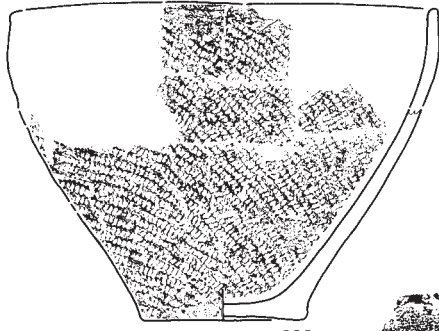

S I 107

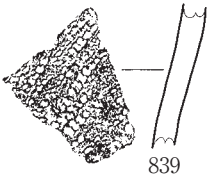

S I 108



S I 109

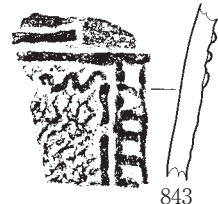
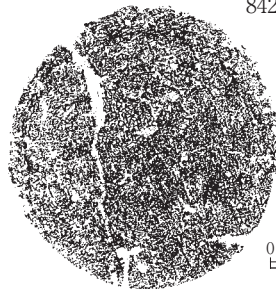
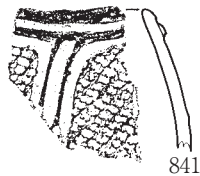

0 1:3 10cm

第332図 縄文土器 (84)

S I 110

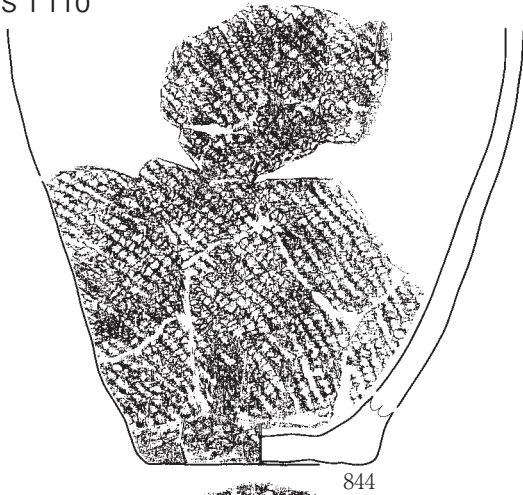

844

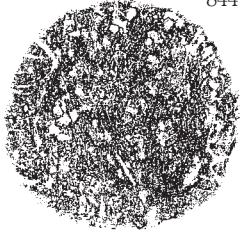

S I 111

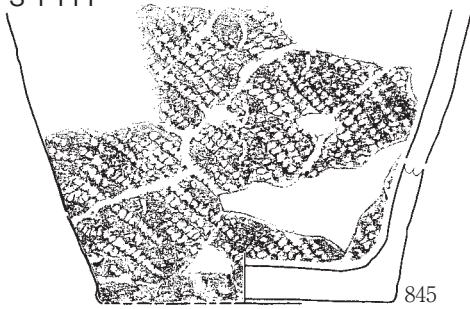

845

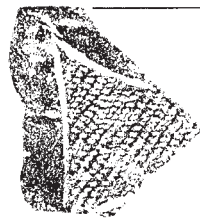

846

S I 112 (1)



847



848



849



0 1:3 10cm

第333図 縄文土器 (85)

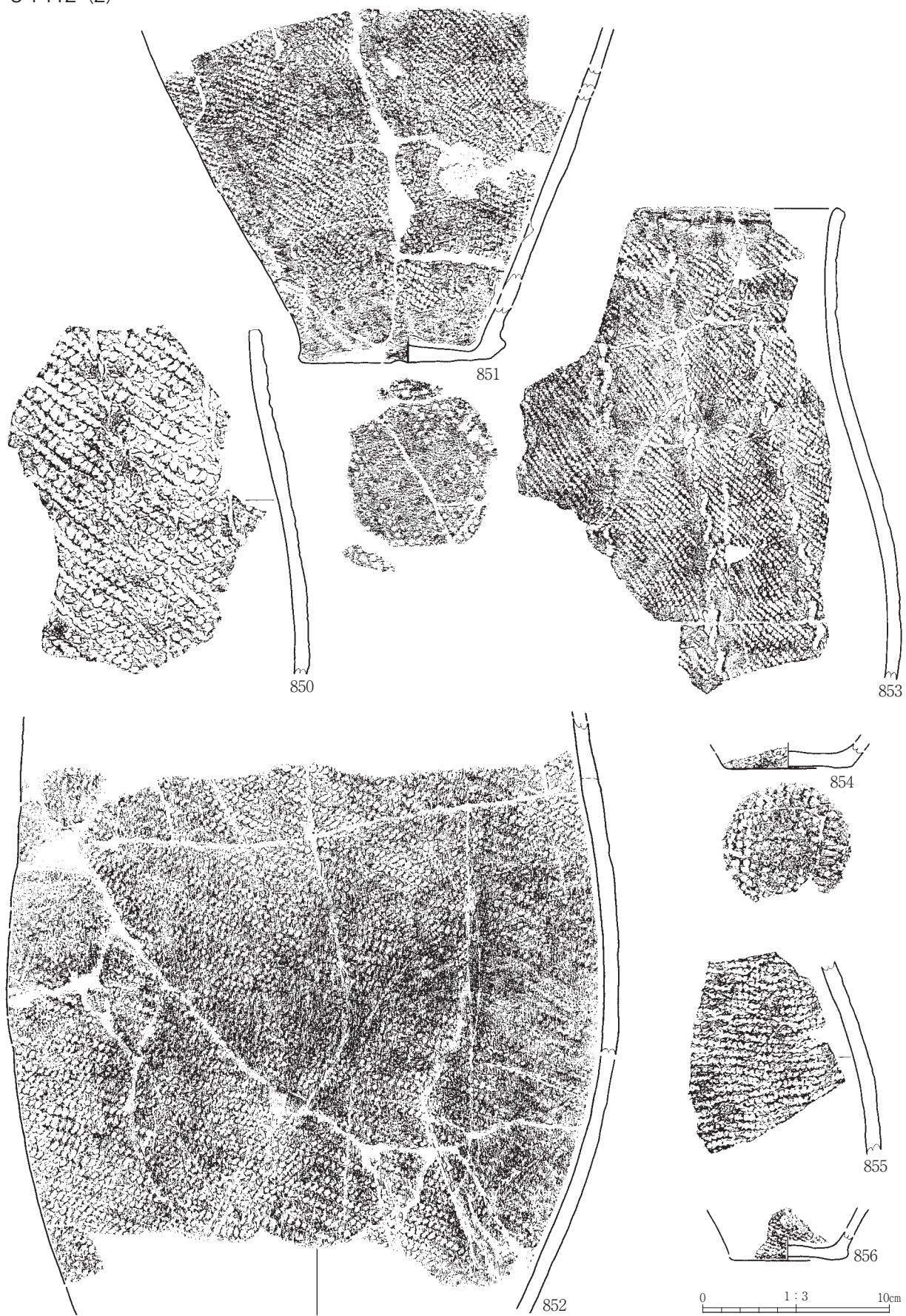

第334図 縄文土器 (86)

S I 112 (3)

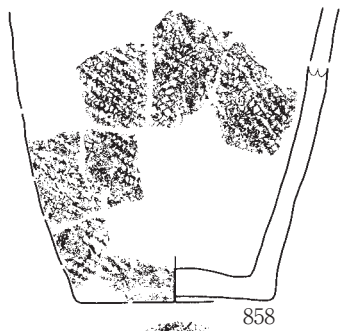
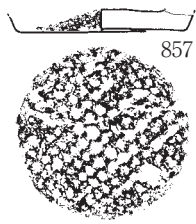

S I 114

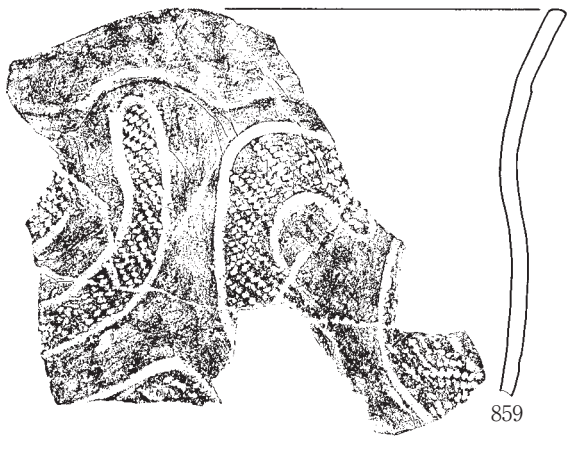
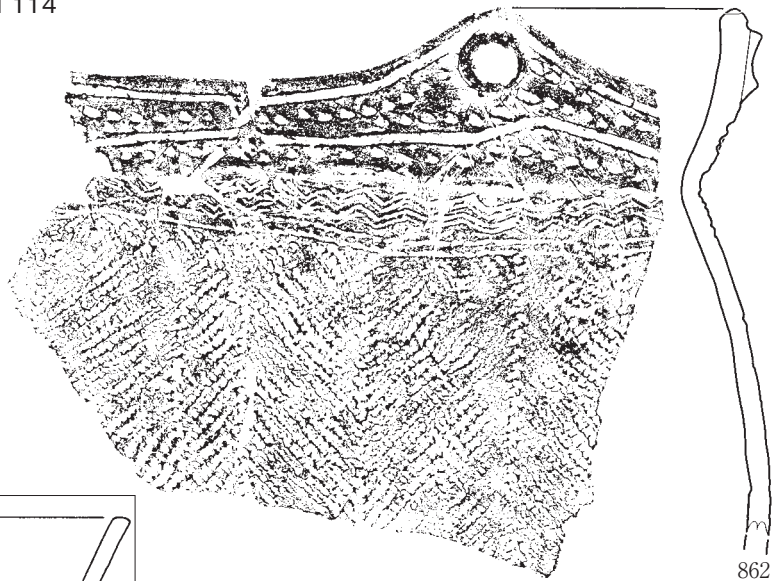

S I 113

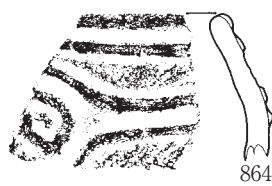
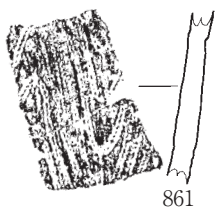

0 1:3 10cm

第335図 縄文土器 (87)

S I 115 (1)

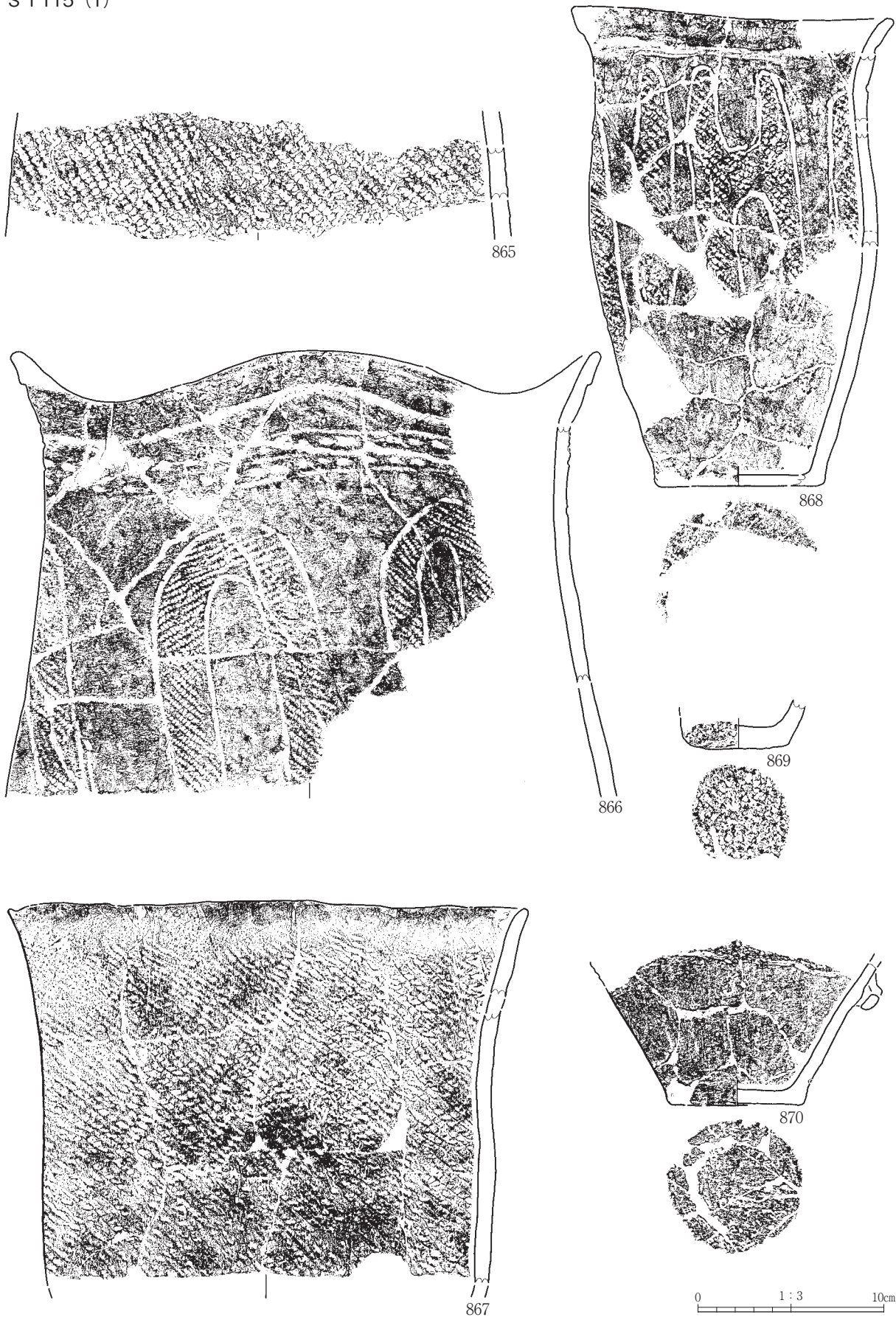

第336図 繩文土器 (88)



S I 115 (2)



第337図 縄文土器 (89)

S I 115 (3)

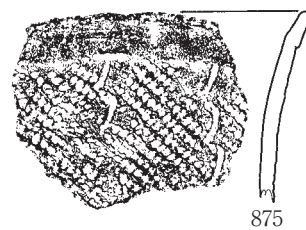

S I 116

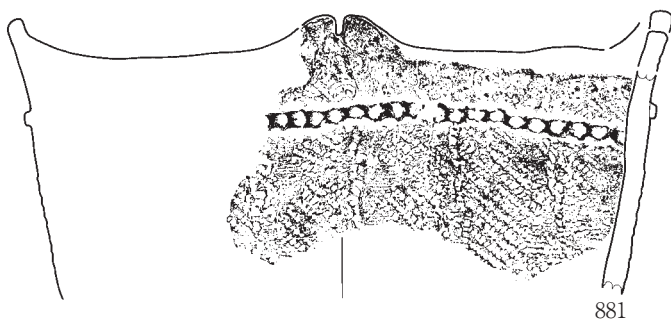
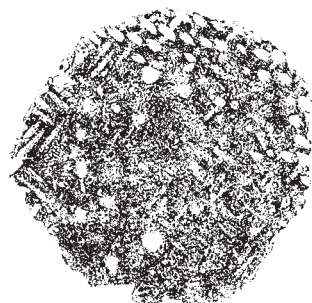
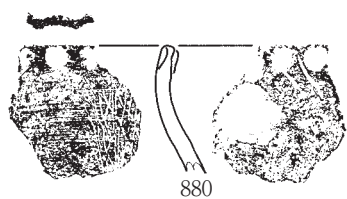
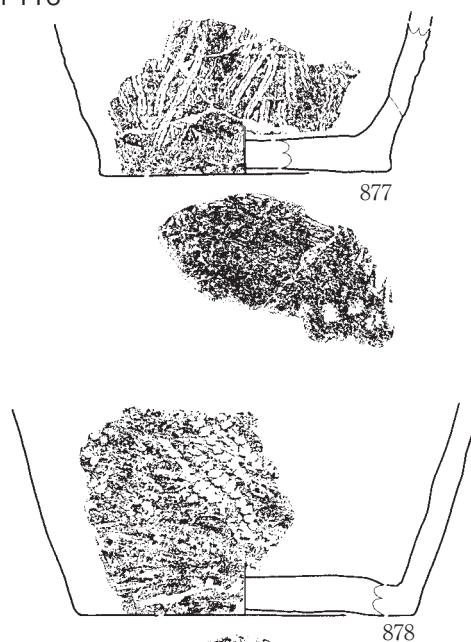

0 1:3 10cm

第338図 縄文土器 (90)

S I 117

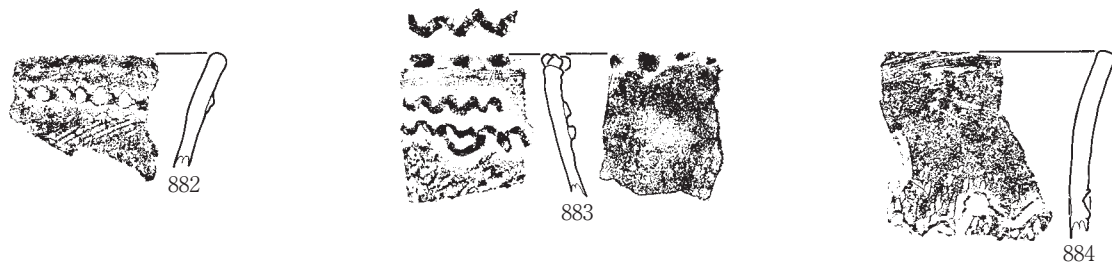

S I 118

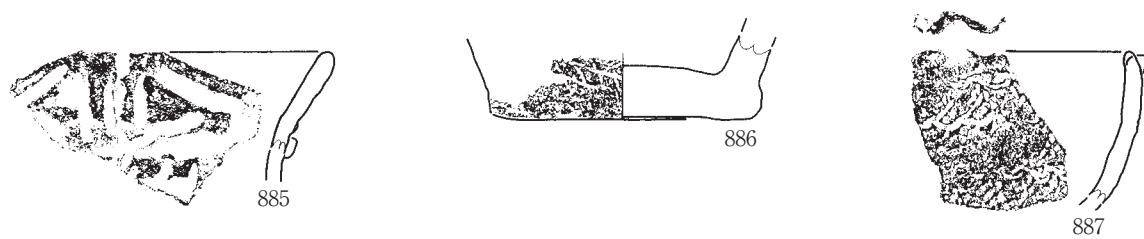

S I 118 · IVC3j



S I 120

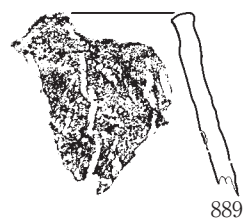

S I 123

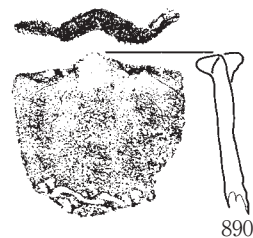

0 1:3 10cm

第339図 縄文土器 (91)

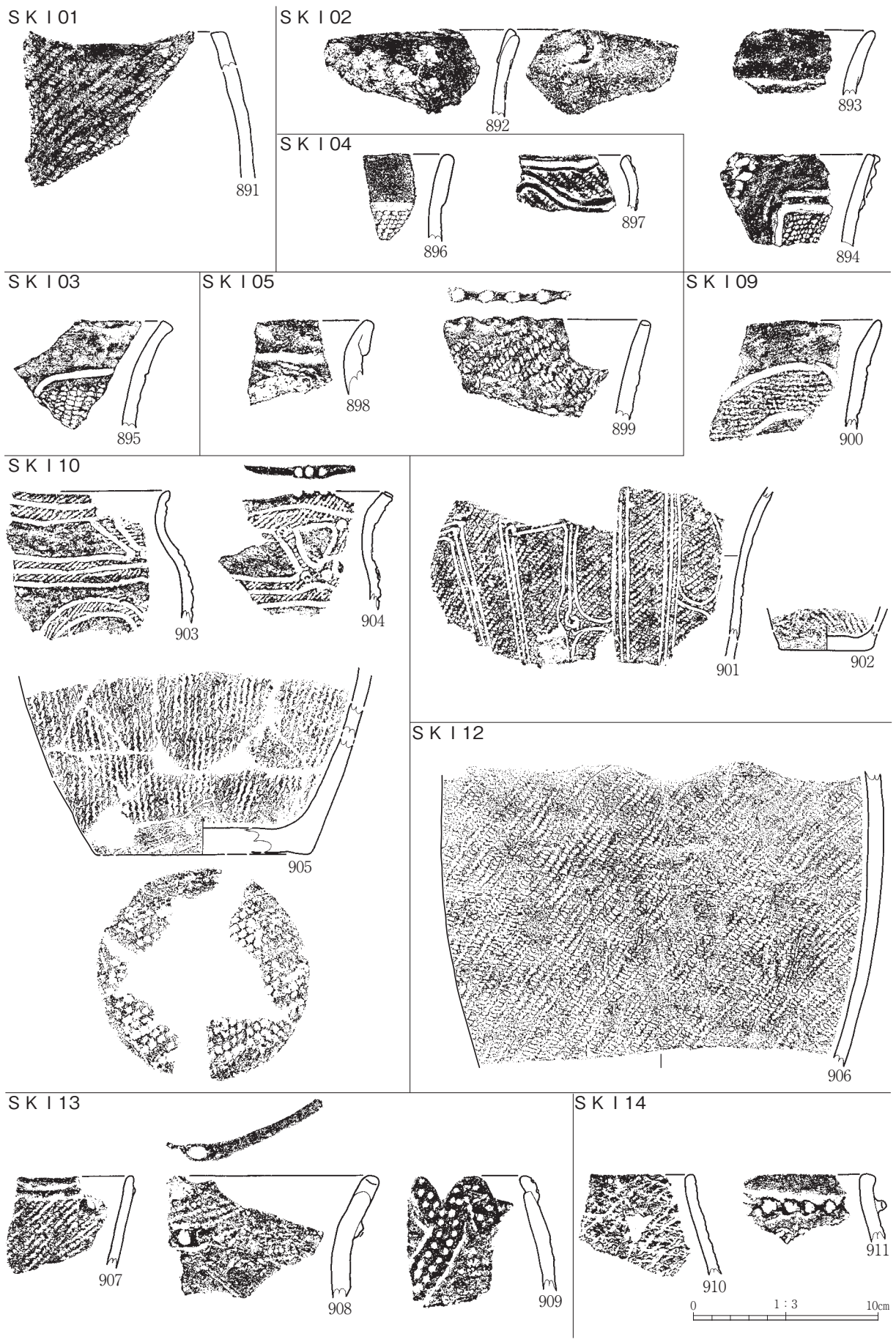

第340図 縄文土器 (92)

S K 02

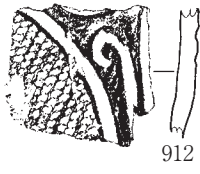

S K 03

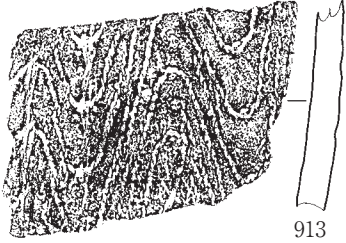

S K 05 (1)

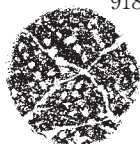
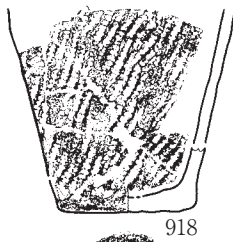
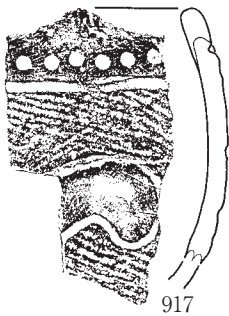
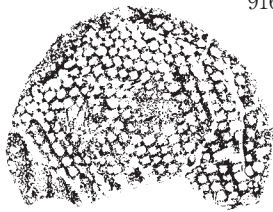
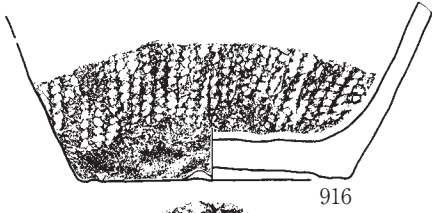
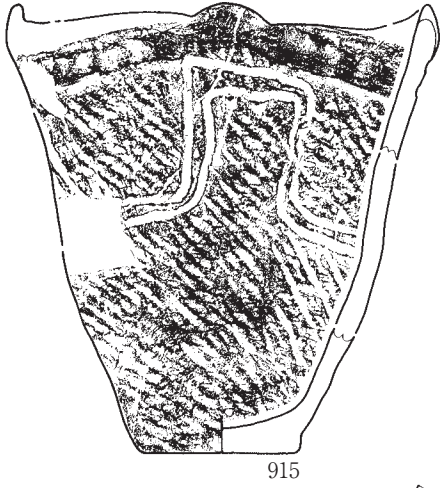
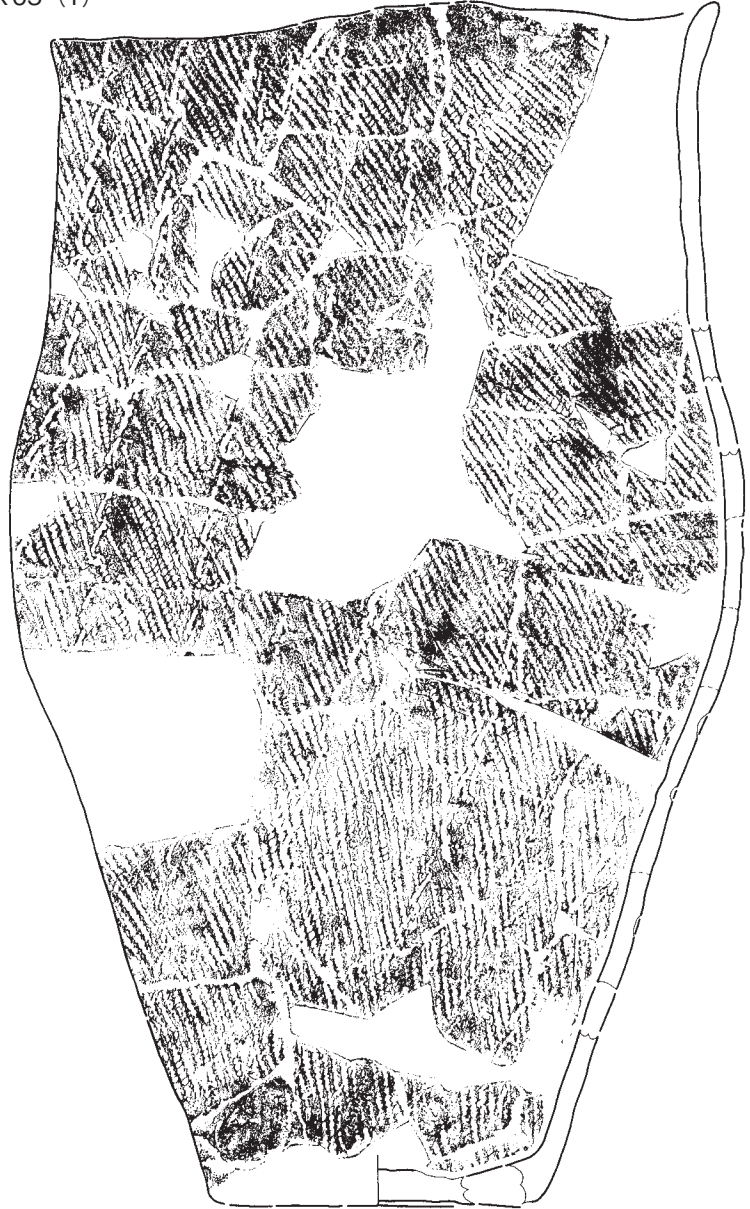

0 1:3 10cm

第341図 縄文土器 (93)

S K05 (2)

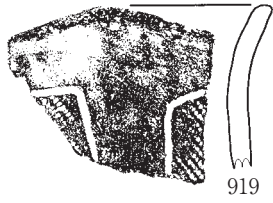

919



920

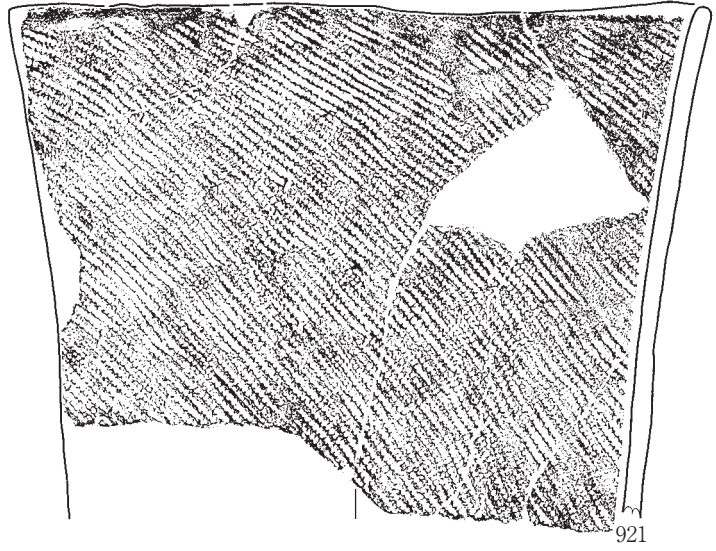

921

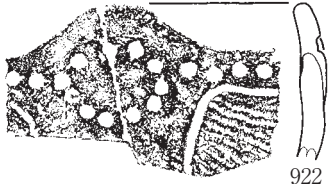

922

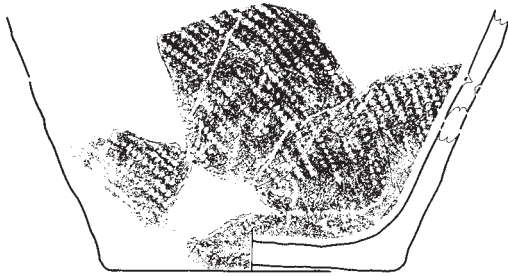

923

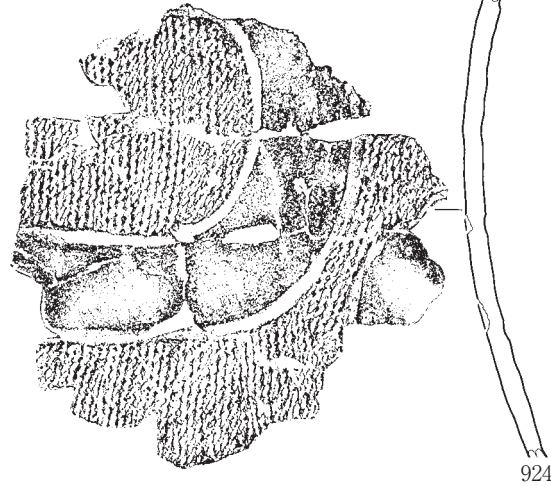

924

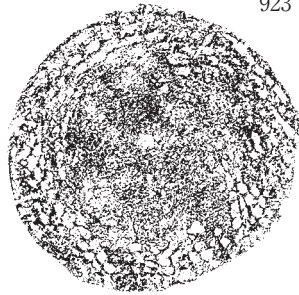

S K07

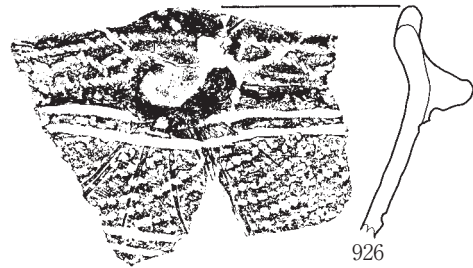

926



927

S K06

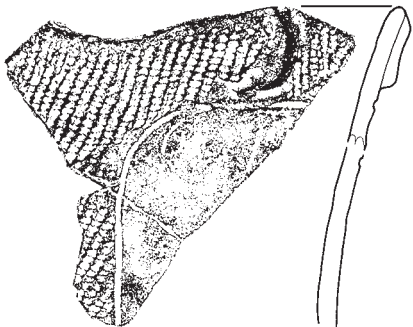

925

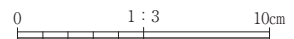

第342図 縄文土器 (94)

S K 09

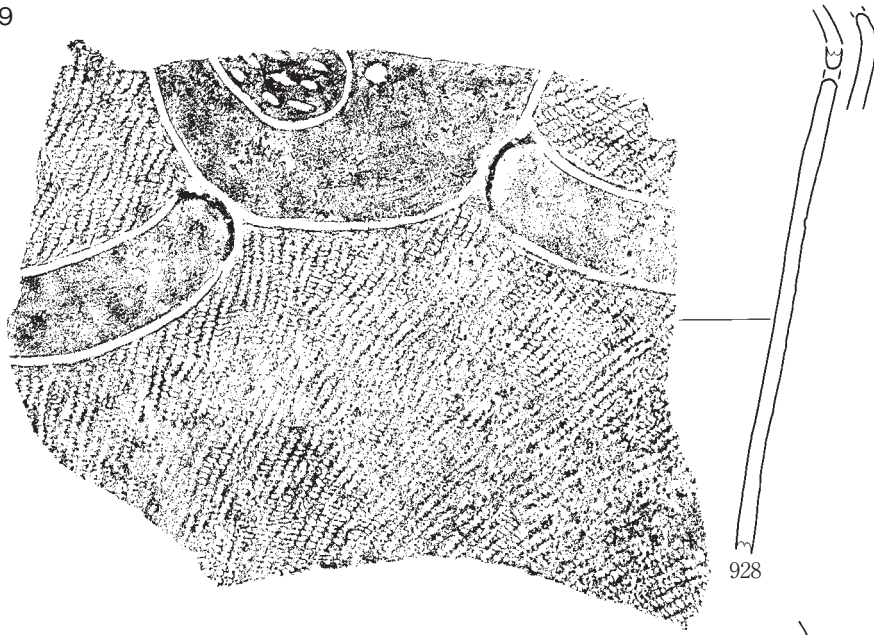

928

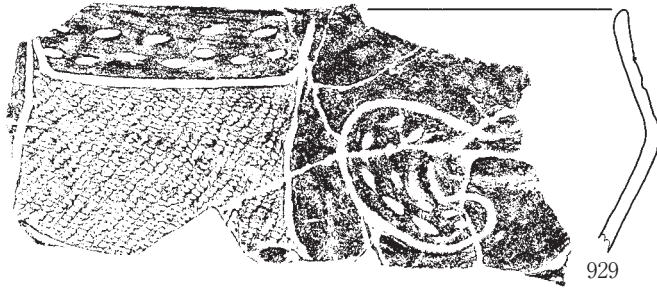

929



930

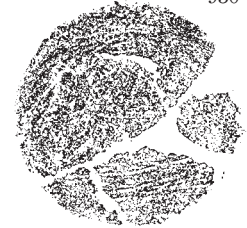

S K 10

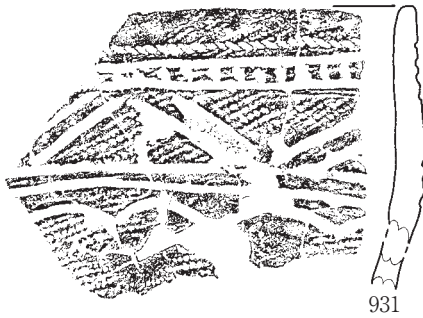

931



932

S K 12

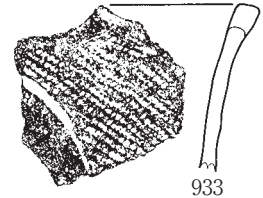

933

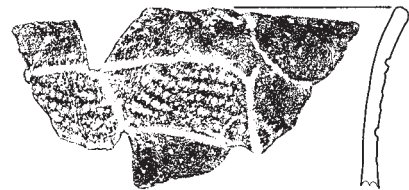

935

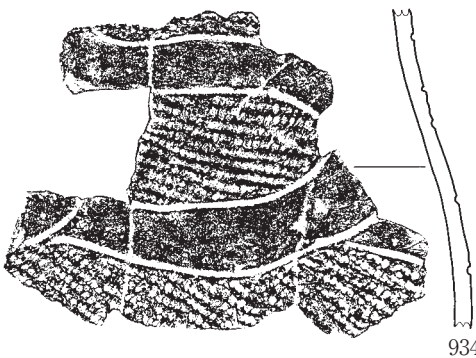

934

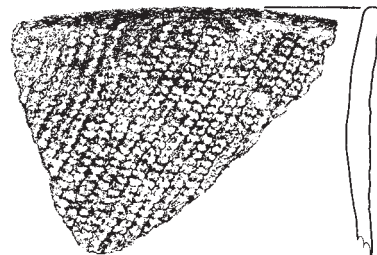

936



937

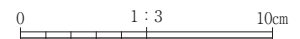

第343図 縄文土器 (95)

S K 13

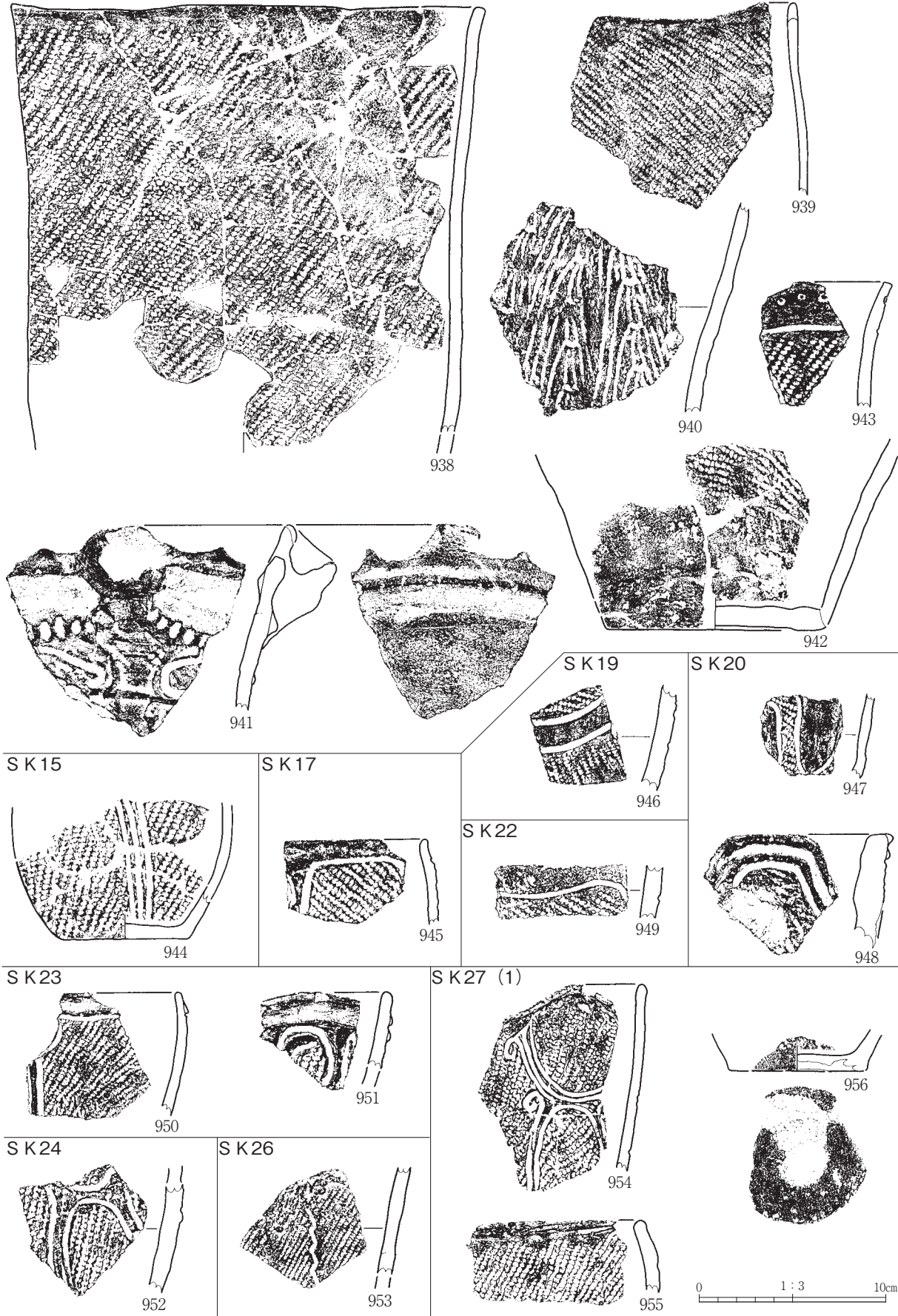

第344図 縄文土器 (96)



S K27 (2)

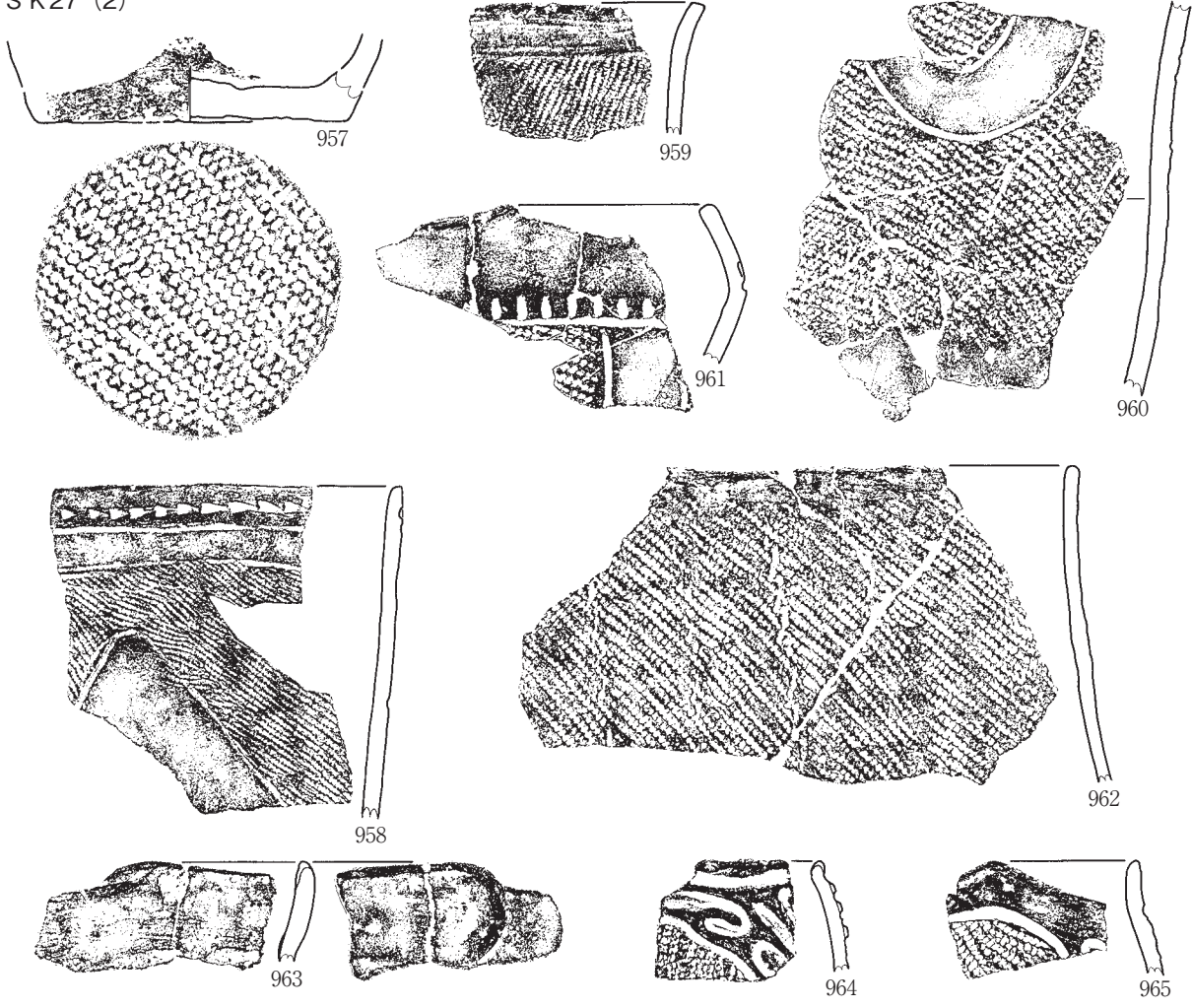

S K29 (1)

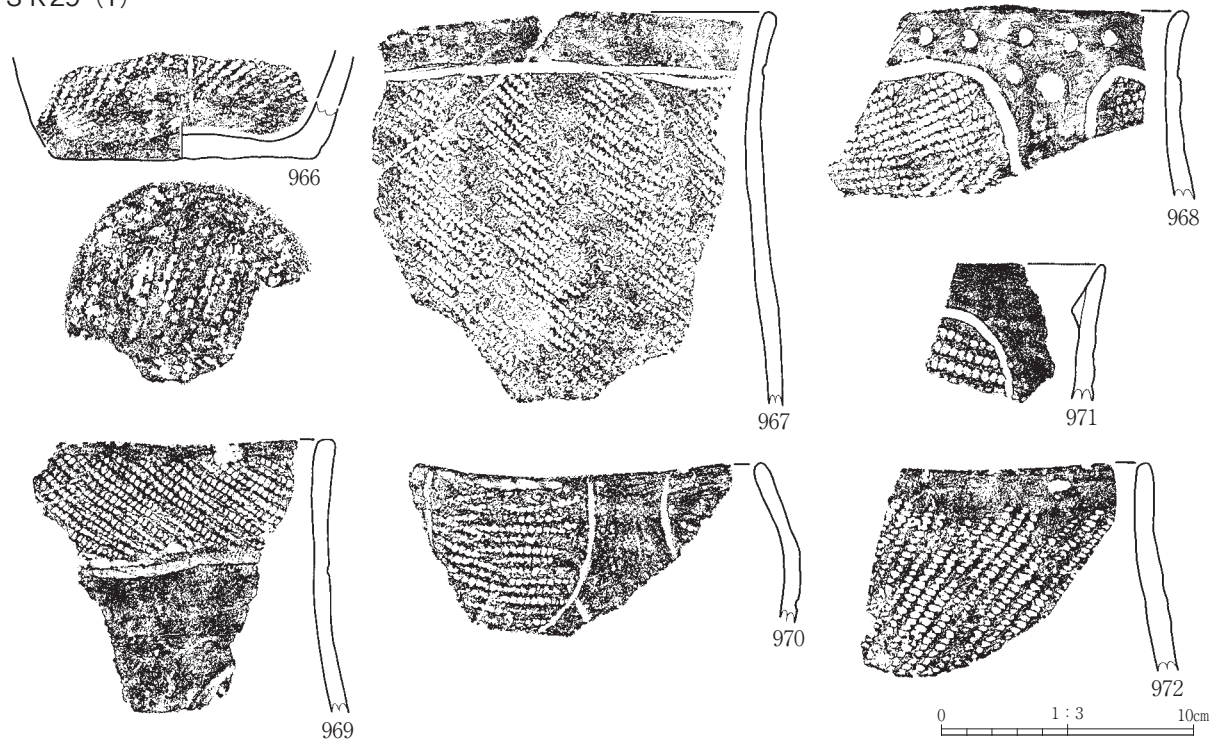

第345図 縄文土器 (97)

SK29 (2)

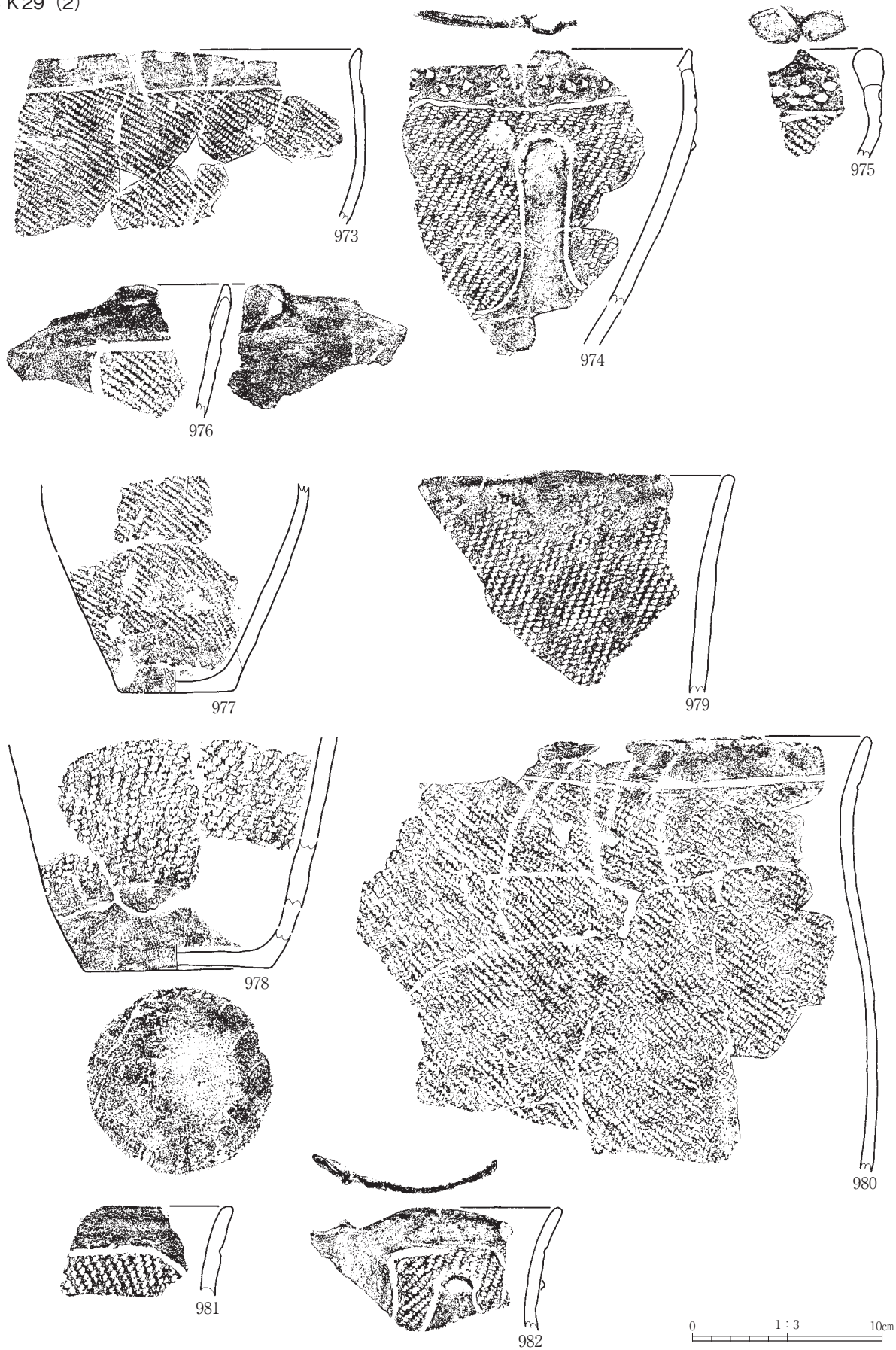

第346図 縄文土器 (98)

S K 32

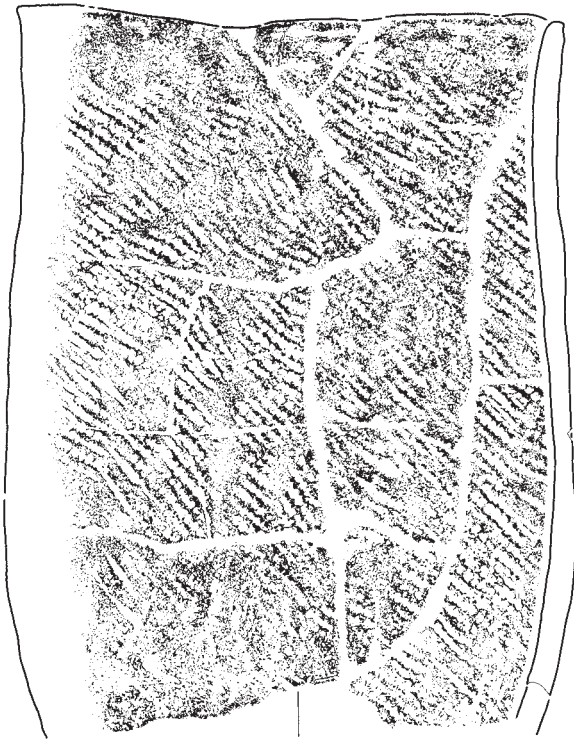

983

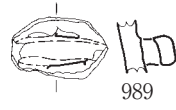

989

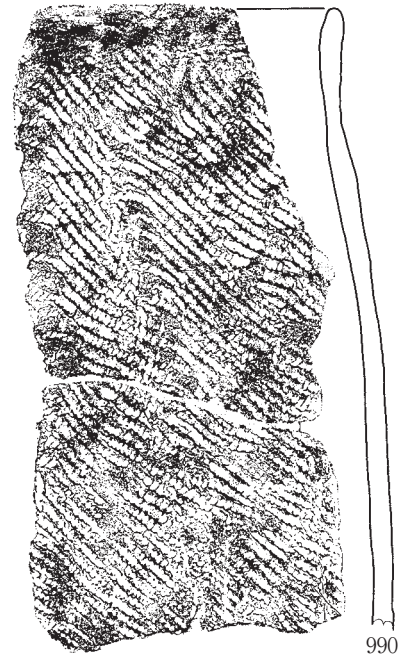

990

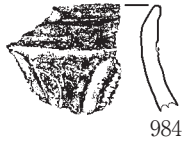

984



986



985

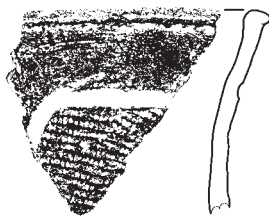

987



988

S K 34



991

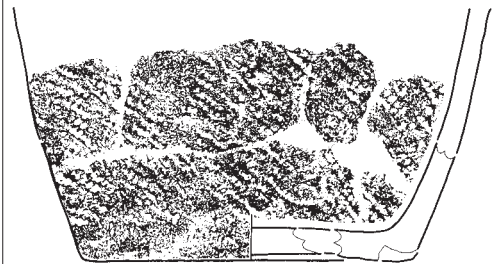

992

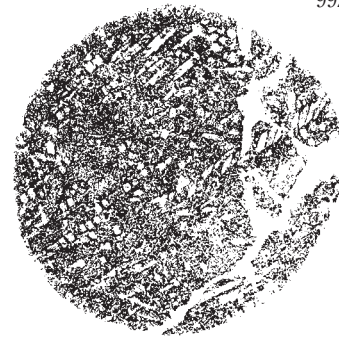

0 1:3 10cm

第347図 縄文土器 (99)

S K 35



S K 38



S K 40

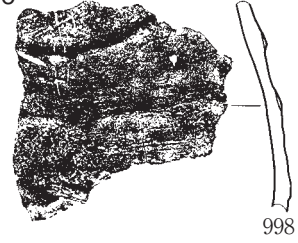

S K 42

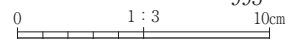
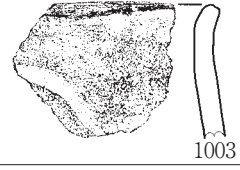
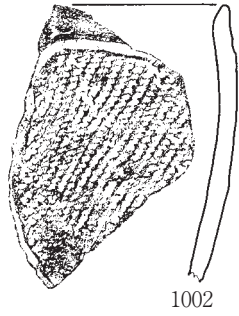
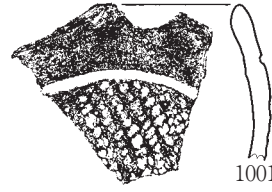
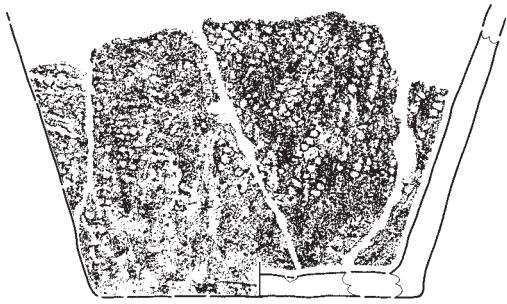
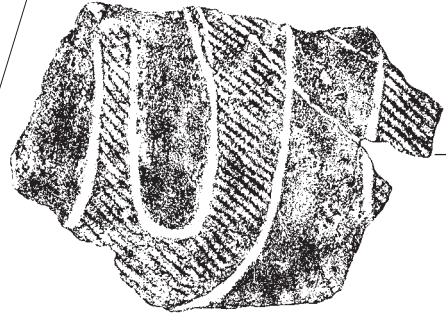
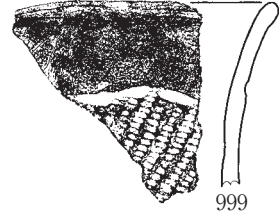

第348図 縄文土器 (100)

S K 43

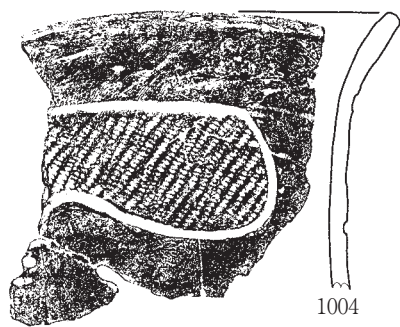

S K 46

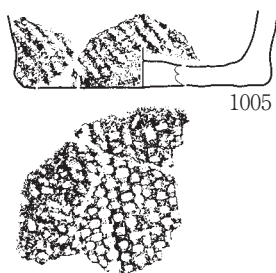

S K 47



S K 51

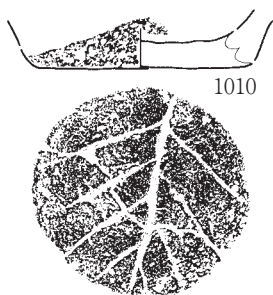
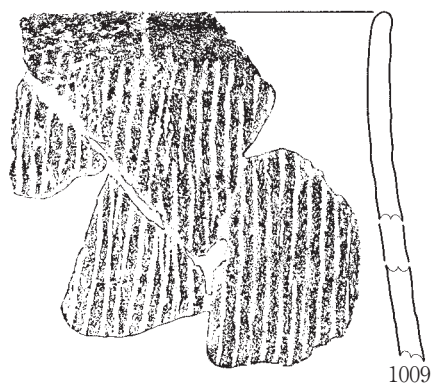
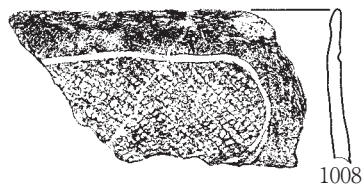
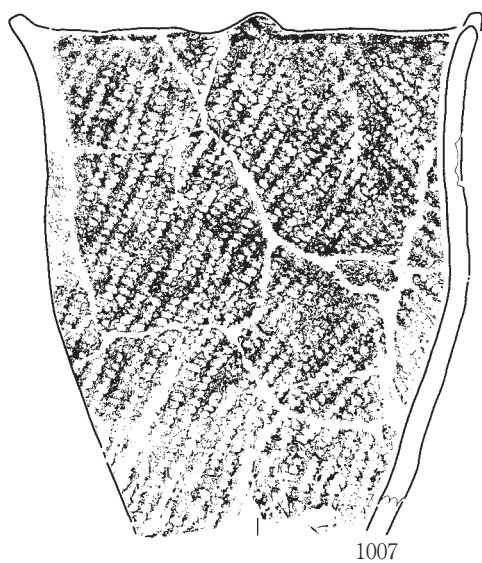

0 1:3 10cm

第349図 縄文土器 (101)

S K 52

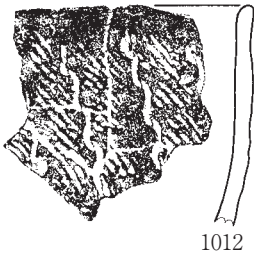

1012

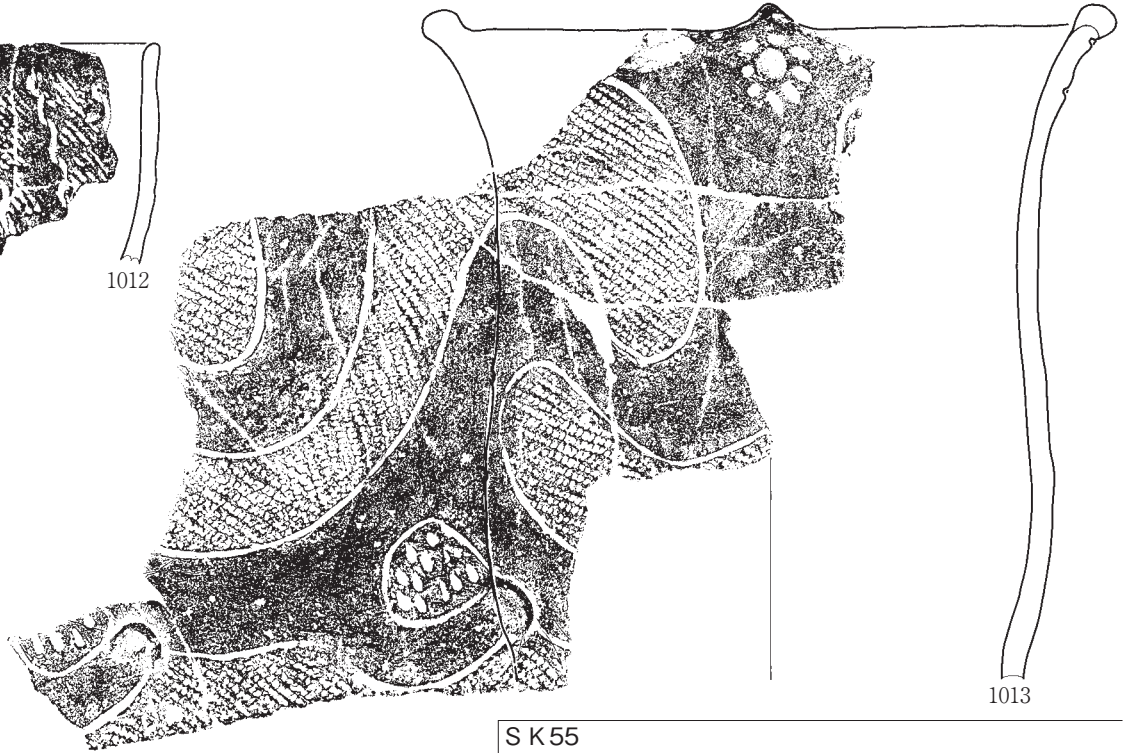

1013

S K 55

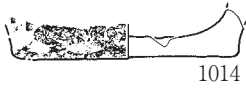

1014



1015



1016

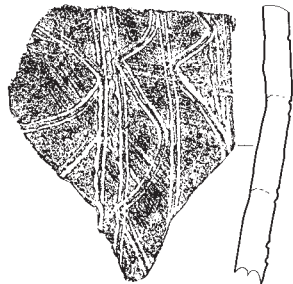

1016

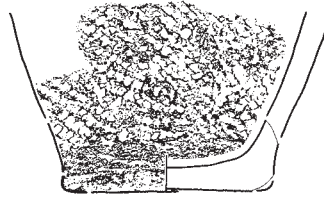

1017

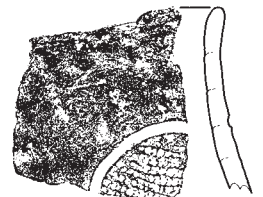

1019



1020

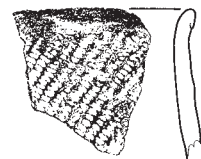

1021

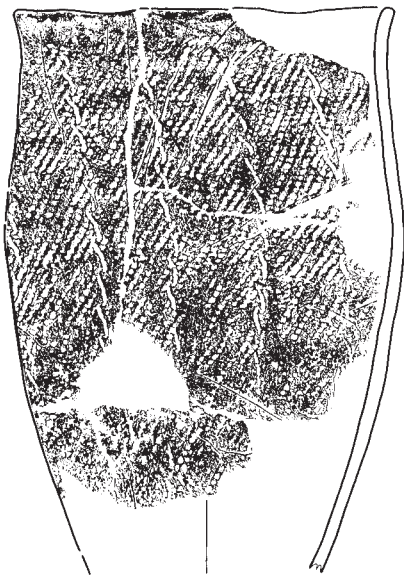

1018

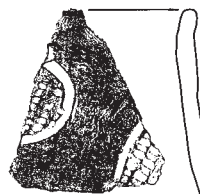
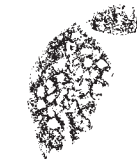

1022

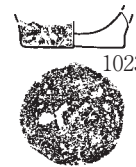

1023

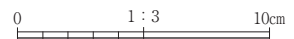

第350図 縄文土器 (102)

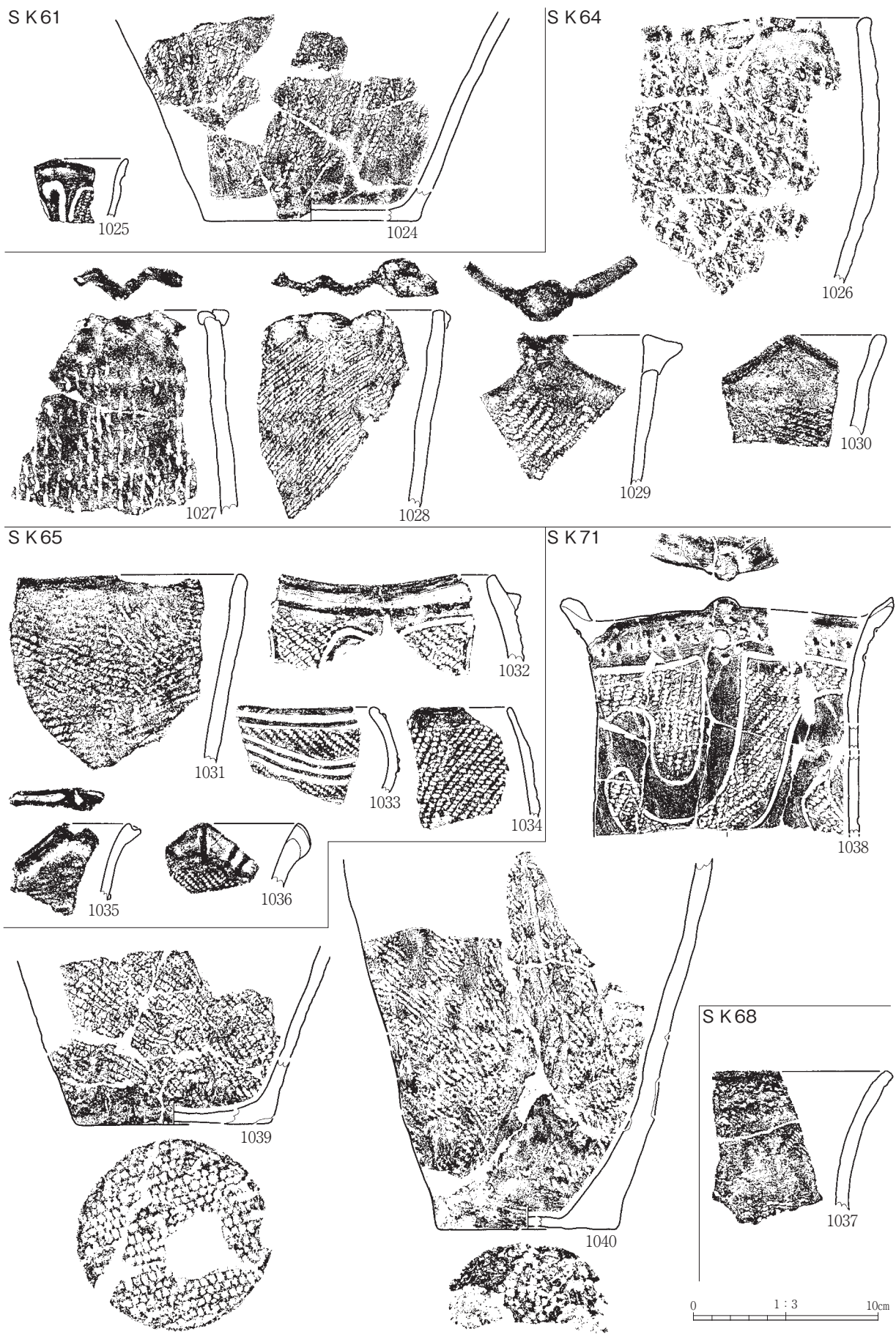

第351図 縄文土器 (103)

S K 78

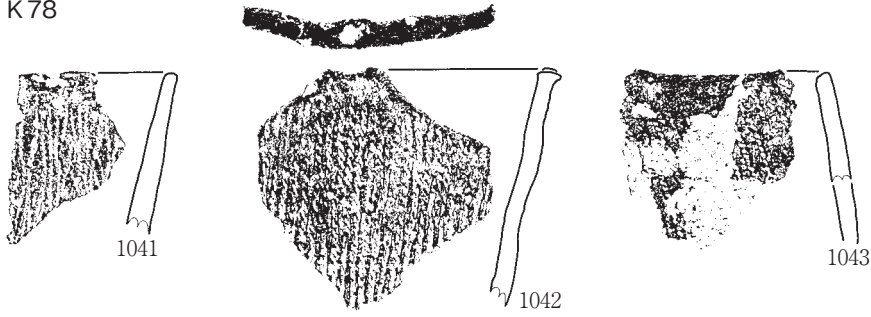

S K 79

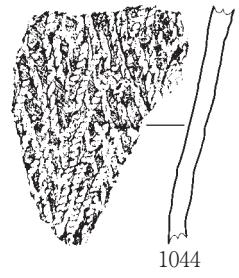

S K 83



S K 91



S K 86

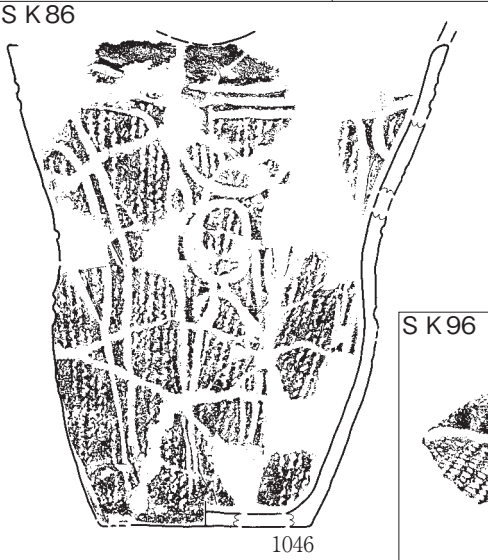

S K 93

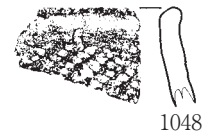

S K 96

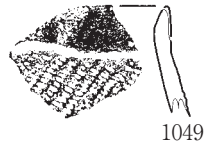

S K 99

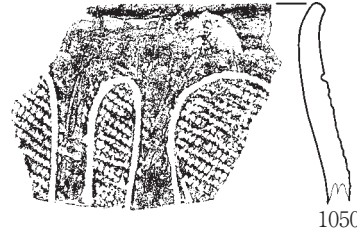

S K 102

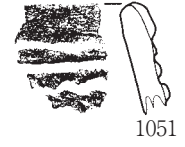

S K 103

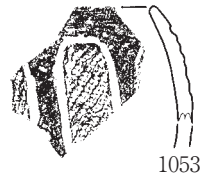

S K 104

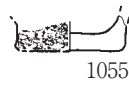

0 1:3 10cm

第352図 縄文土器 (104)



S K 108

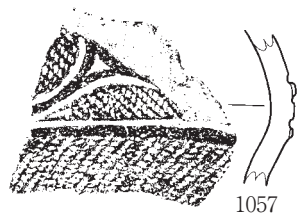

1057

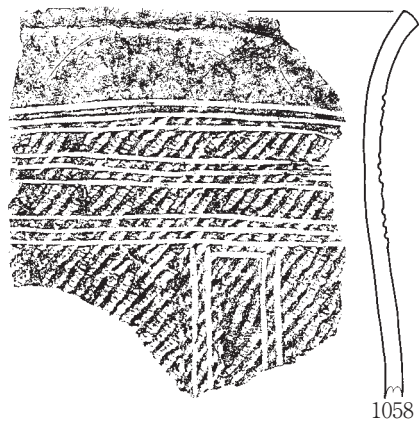

1058

S K 109



1059

S K 109 · 114

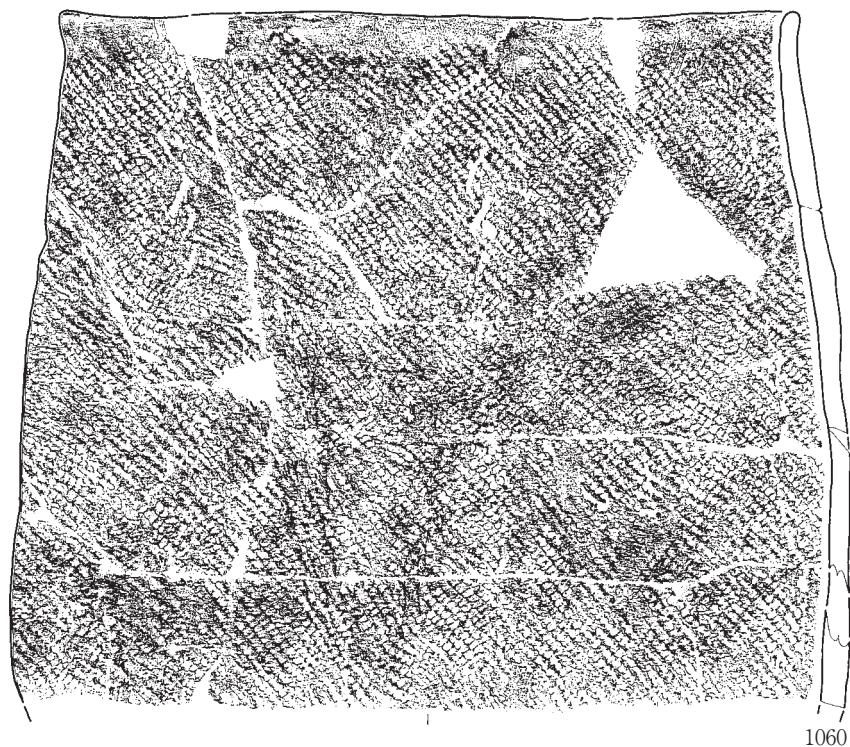

1060

S K 112

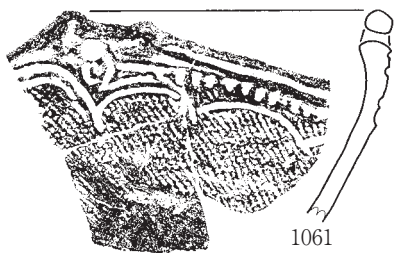

1061

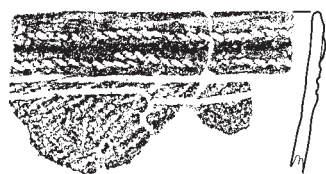

1062



1063

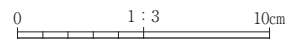

第353図 縄文土器 (105)

SK114

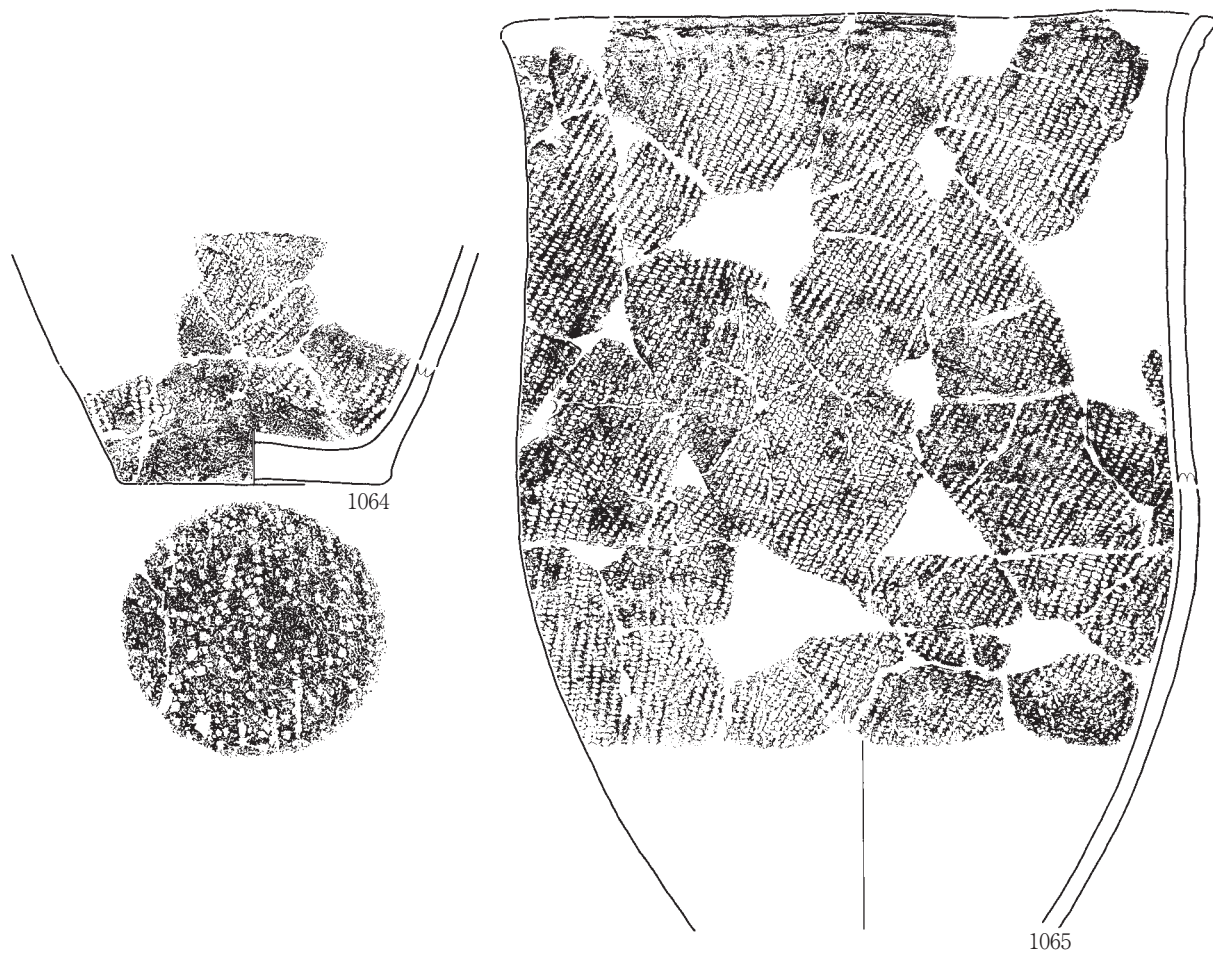

SK116

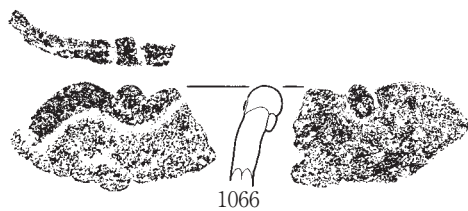

SK128

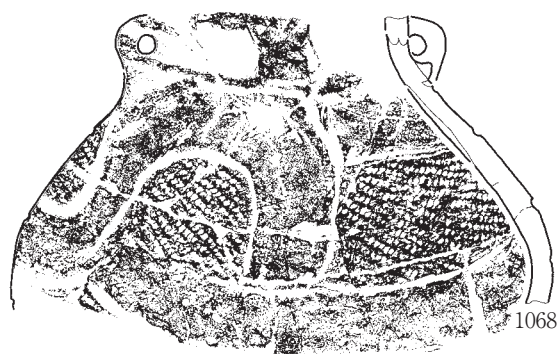

SK124

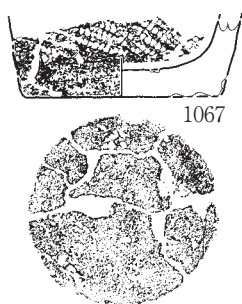

0 1:3 10cm

第354図 縄文土器 (106)

S K 131

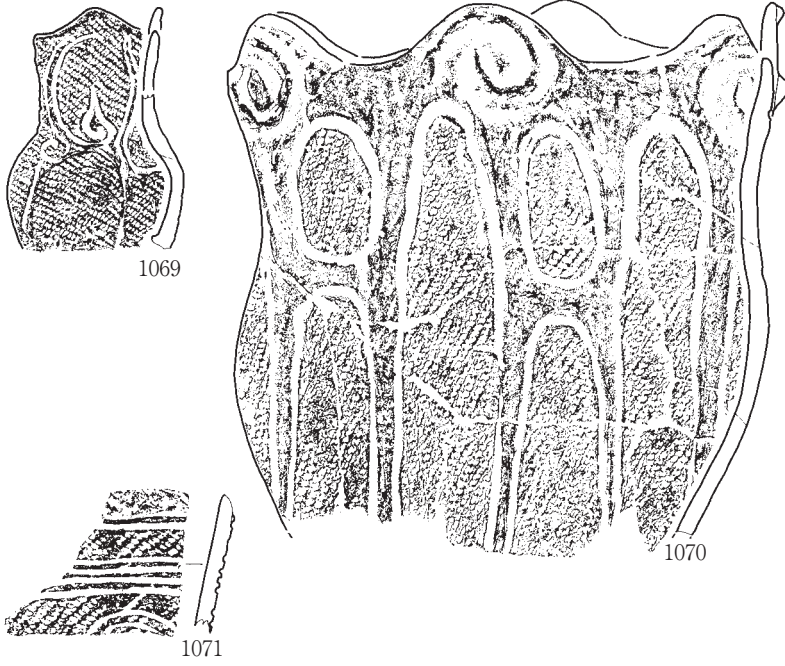

S K 134

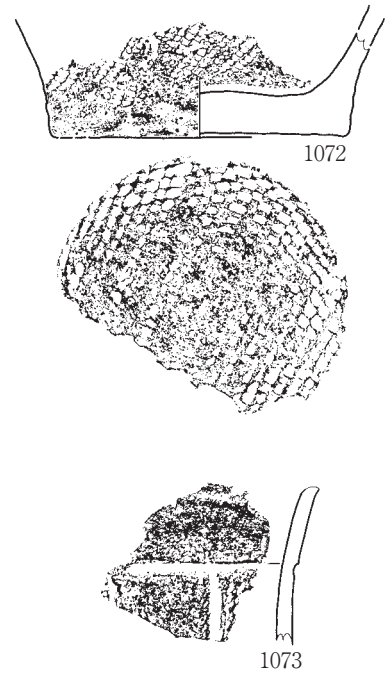

S K 136

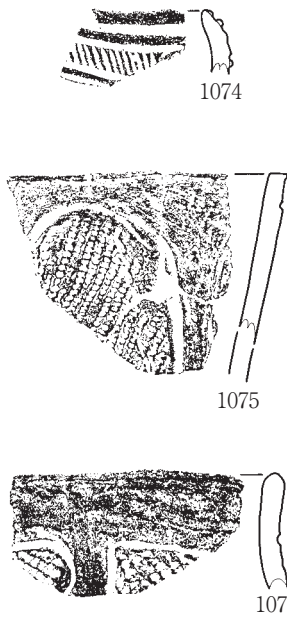

S K 138 · 144

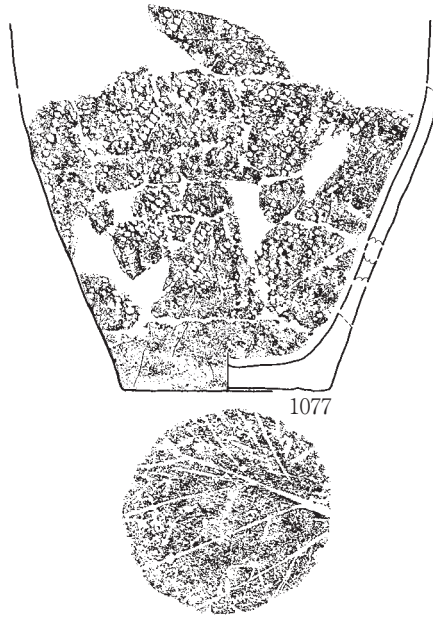

S K 144

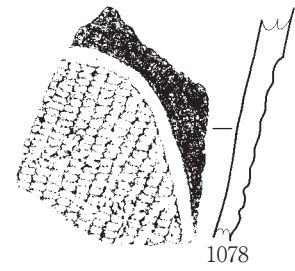

S K 146



S K 147

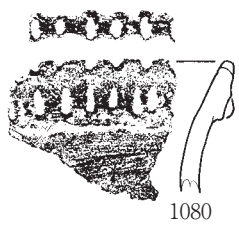

S D 01

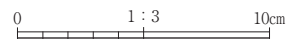
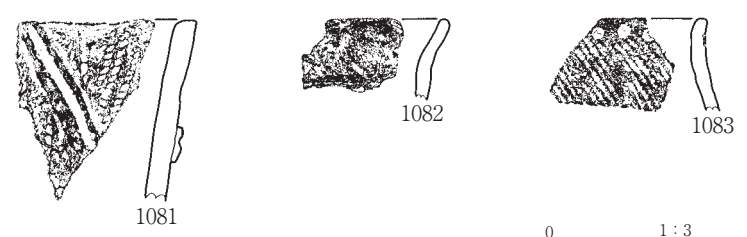

第355図 縄文土器 (107)

S N01



1084

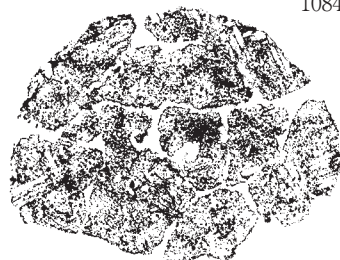

1085

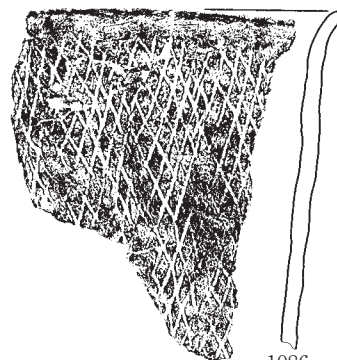

1086

S N18

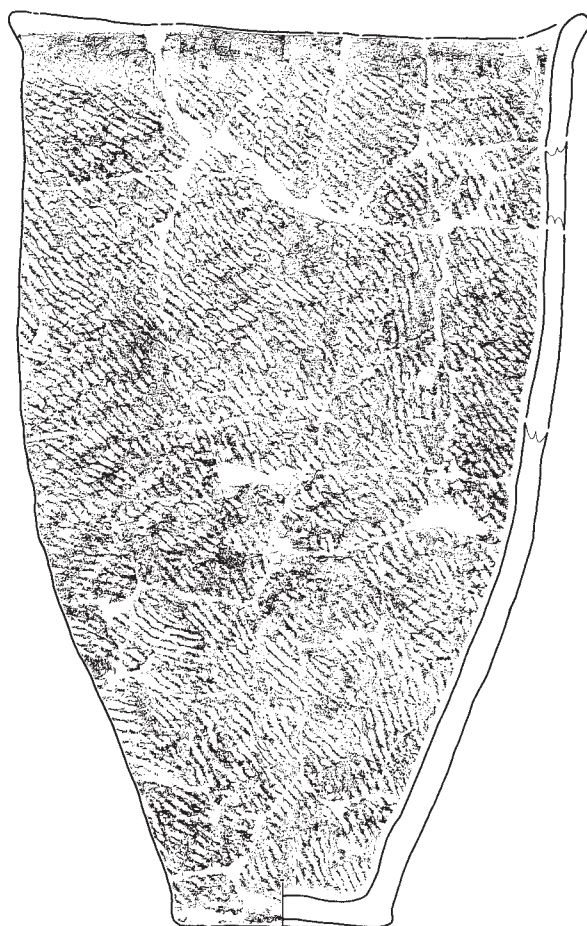

1087

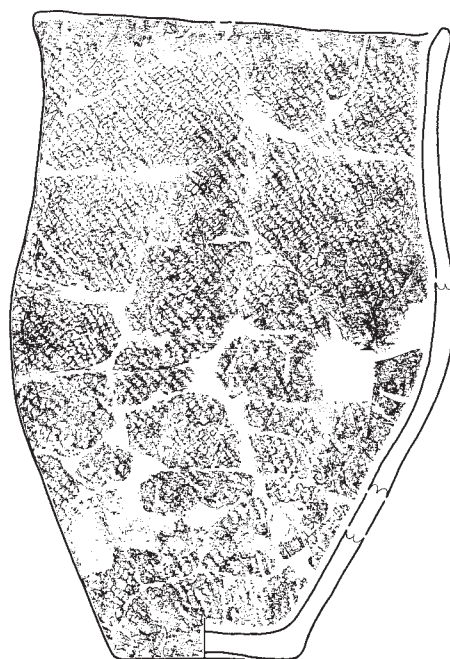
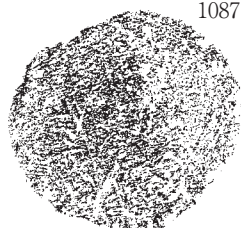

1088

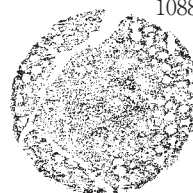

0 1:3 10cm

第356図 縄文土器 (108)

S N25

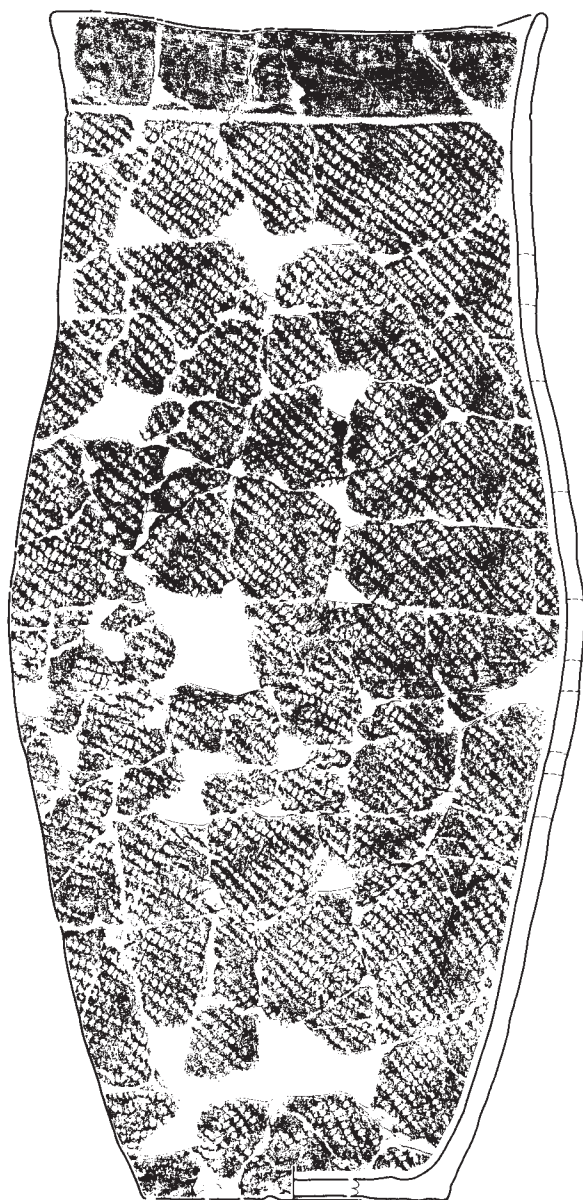

1089

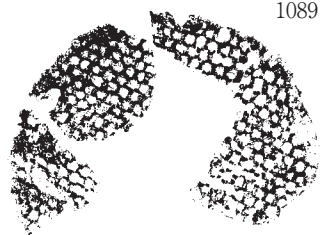

S N26



1090

S N34

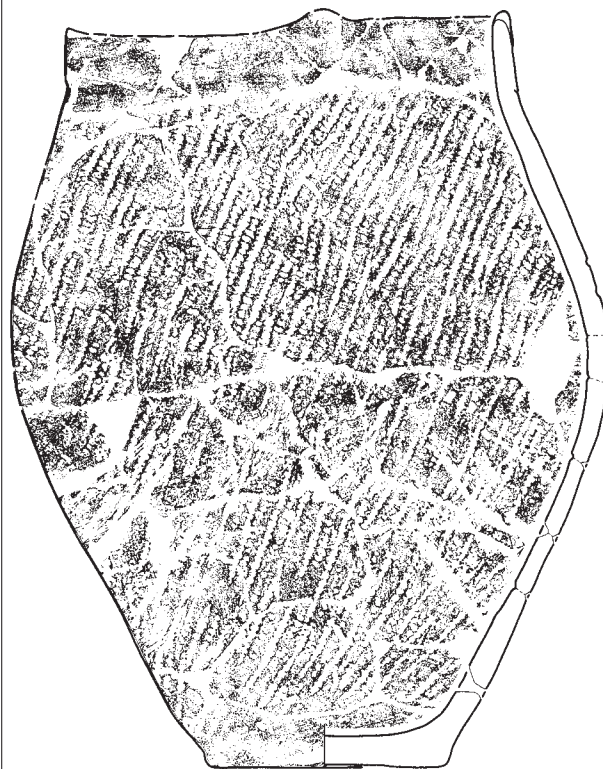

1091

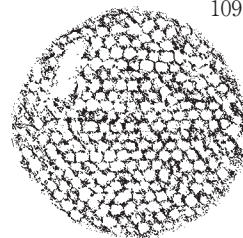

0 1:3 10cm

第357図 縄文土器 (109)

S N36



1092



1093

S X W15



1094

SW12



1095

S X 06



1097

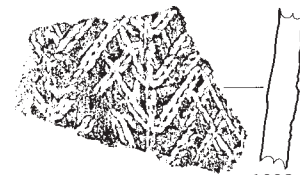

1098



1096

S X 07



1099

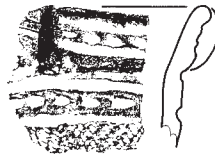

1100

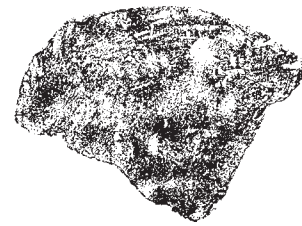

S X 10

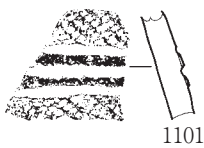

1101

P P 1

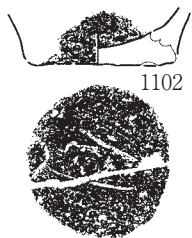

1102

P P 16



1103

P P 17



1104

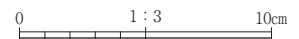

第358図 縄文土器 (110)

II B 8j

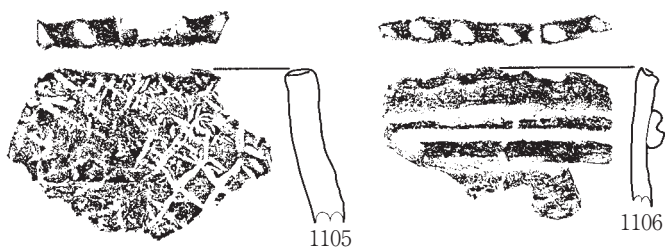

II B 9j

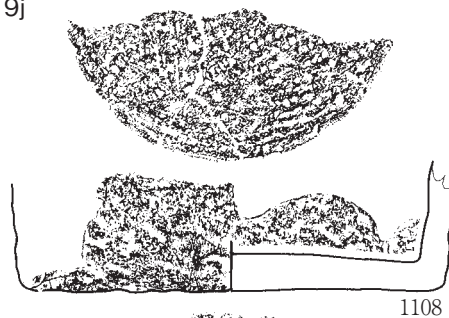

II B 8 · 9j

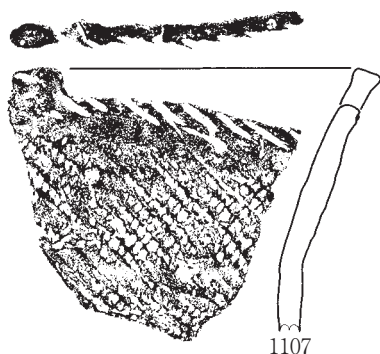

II B 9 · 10j

II B 10j

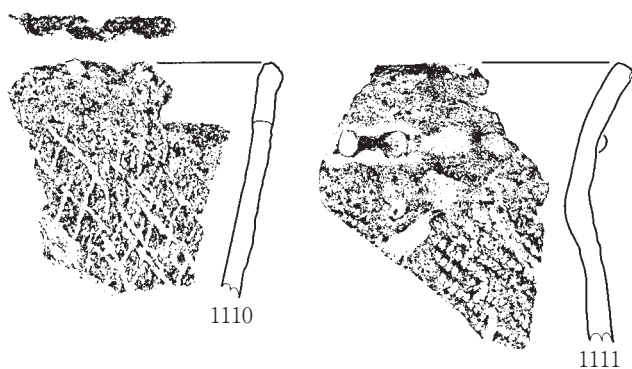

II C 3~5cd

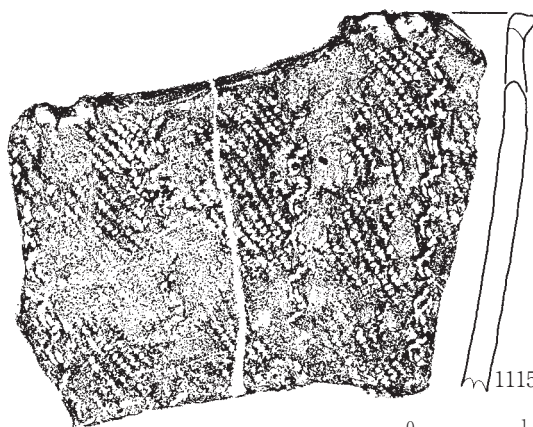
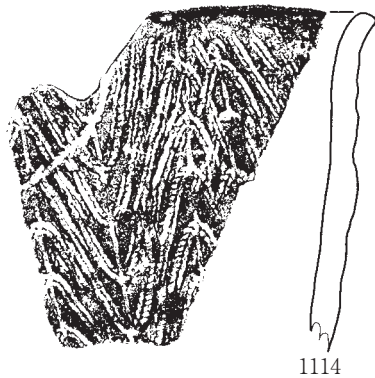

0 1:3 10cm

第359図 縄文土器 (111)

II C 4d

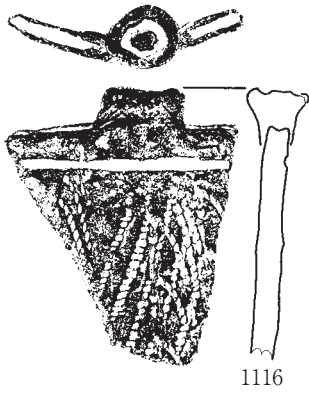

II C 5d

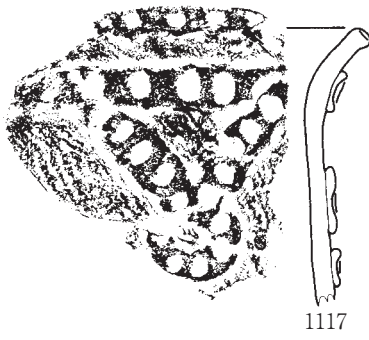

II C 5de · II C 5e

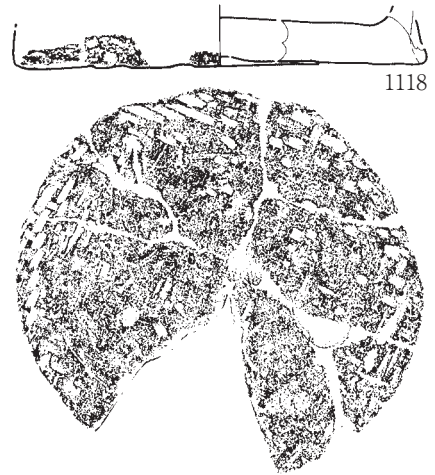

II C 5de

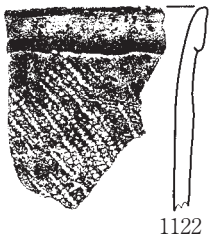
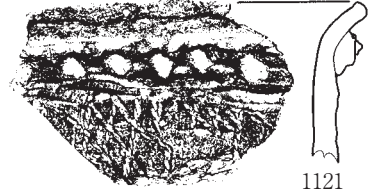
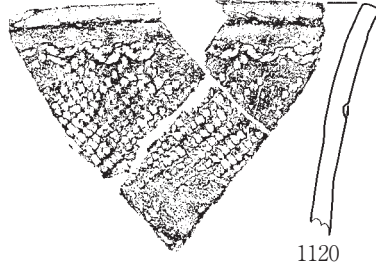
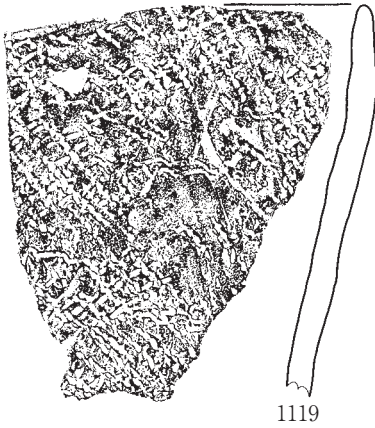

II C 5 · 6b

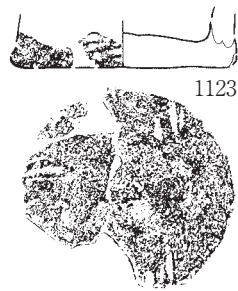

II C 6b

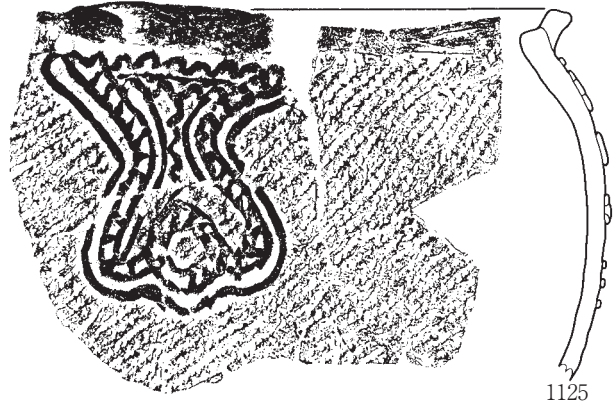
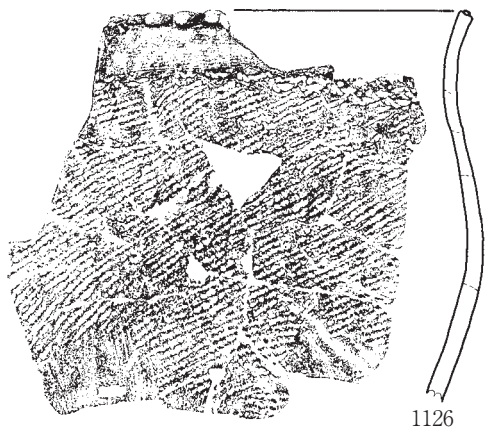
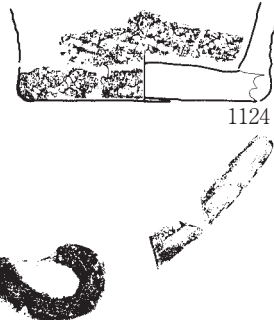

0 1:3 10cm

第360図 縄文土器 (112)



II C 6bc

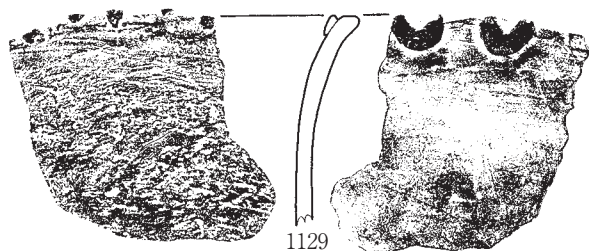
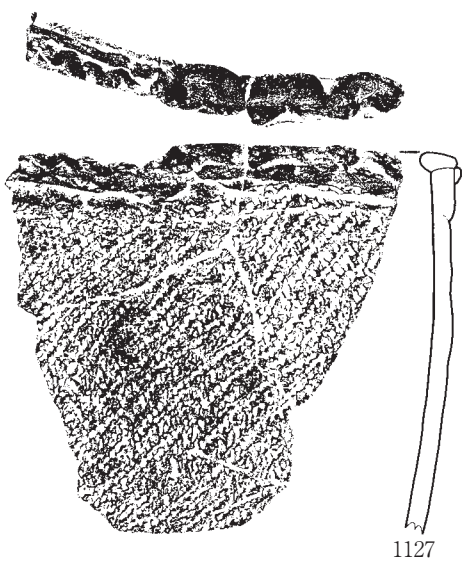

II C 6c · II C 6b



II C 6c

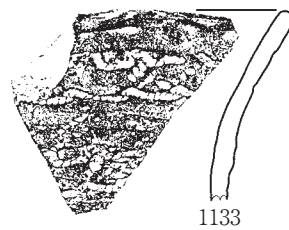
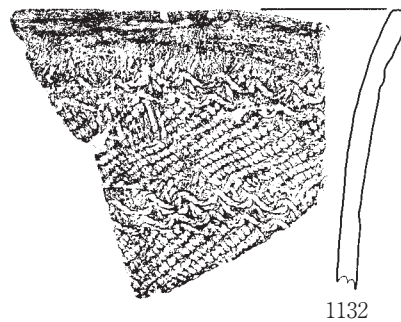
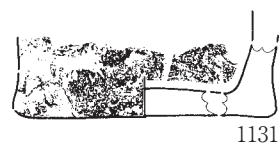

II C 6cd

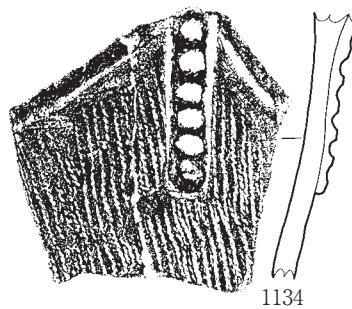

0 1:3 10cm

第361図 縄文土器 (113)

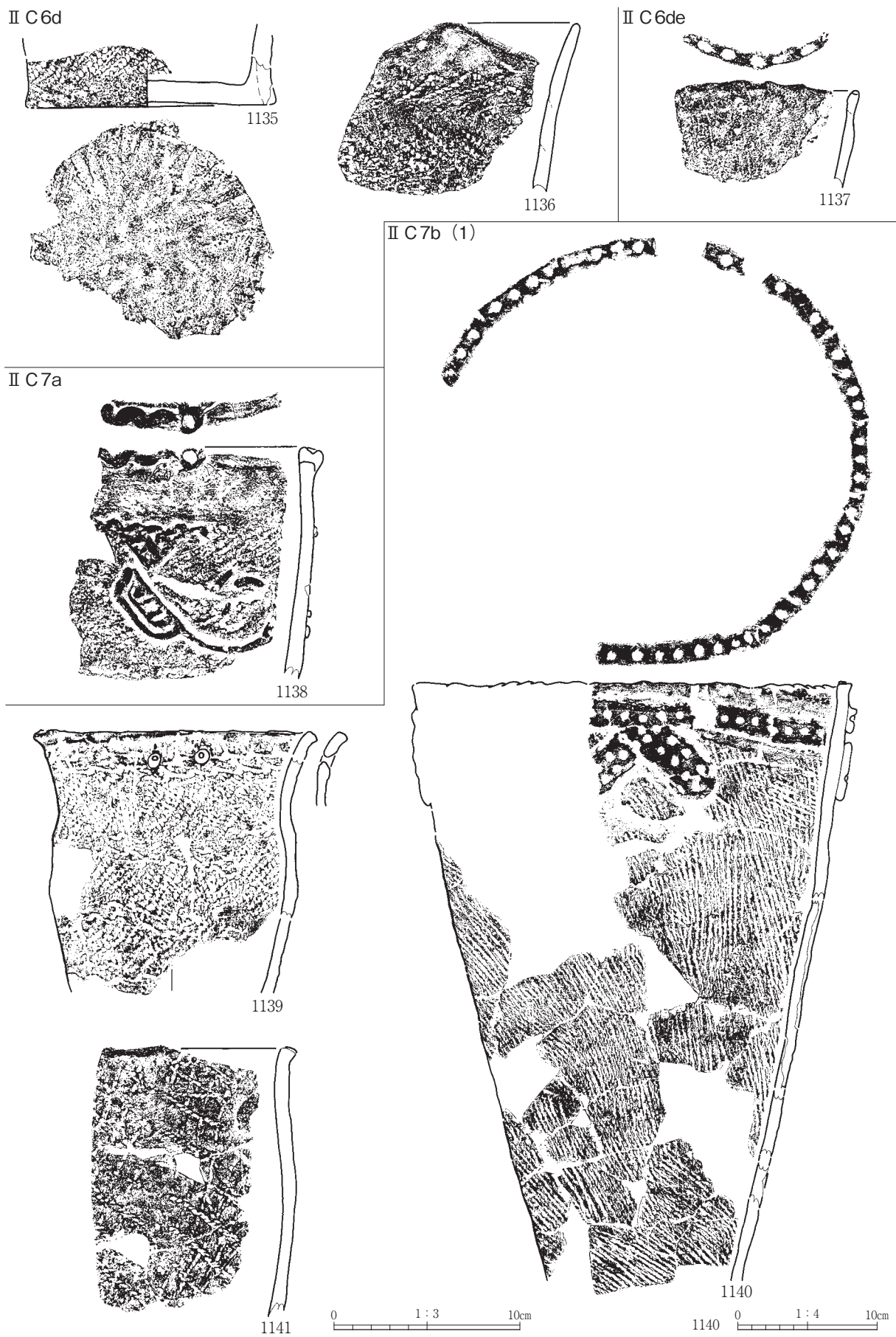

第362図 縄文土器 (114)

II C7b (2)

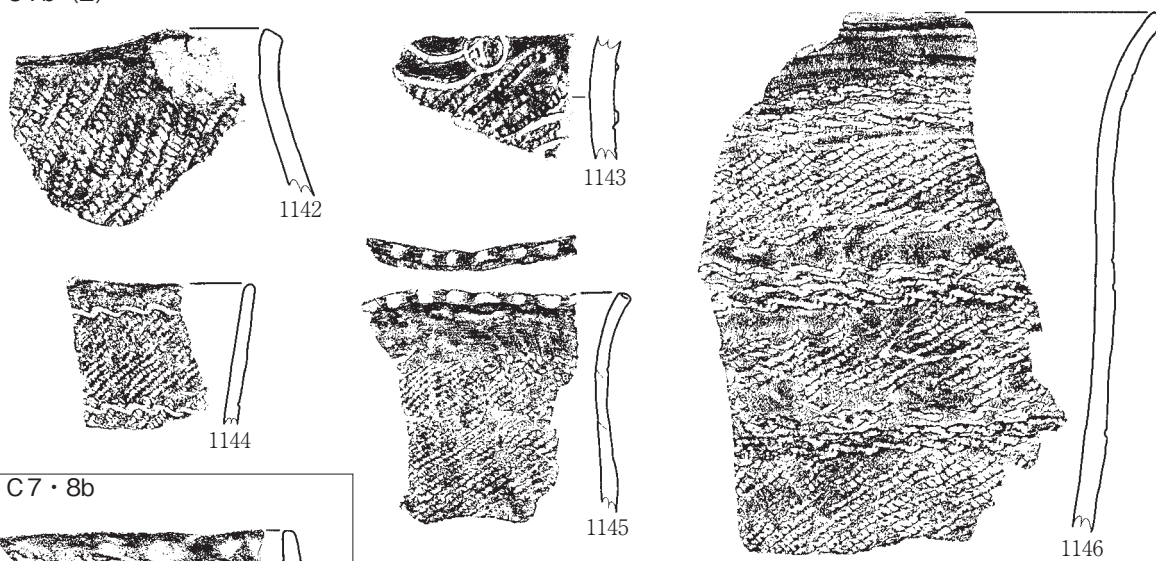

II C7・8b

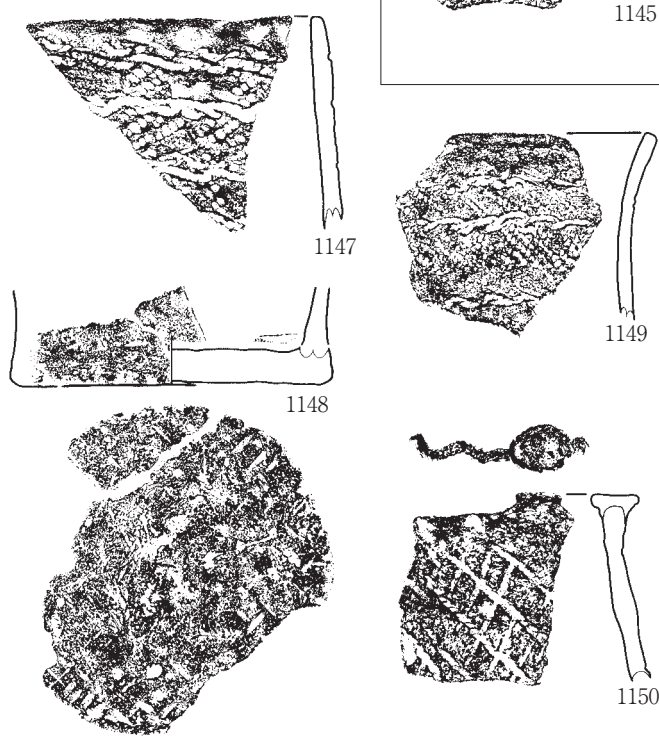

II C7bc

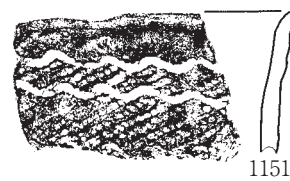

II C7c (1)

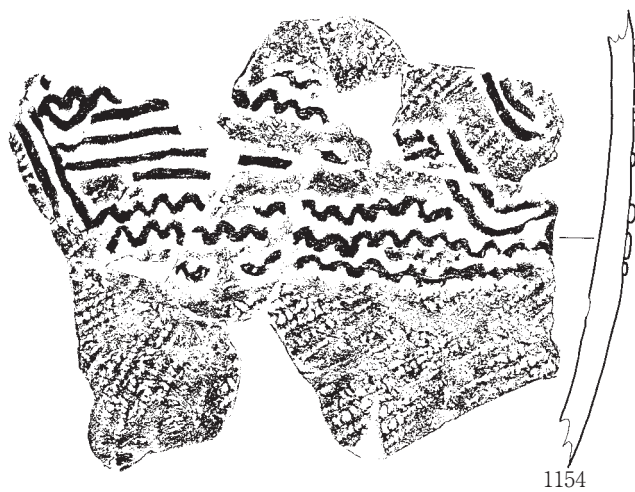
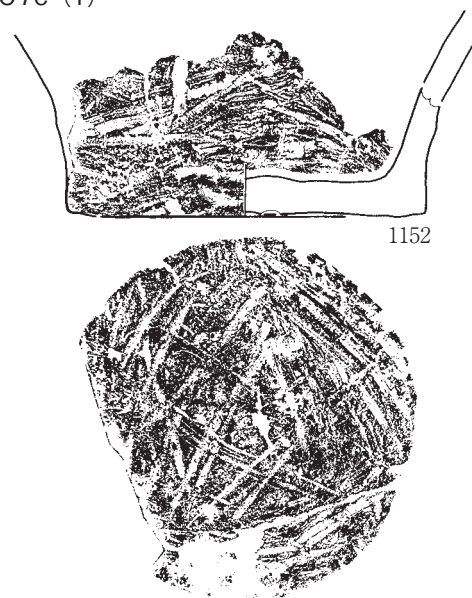

0 1:3 10cm

第363図 縄文土器 (115)

II C7c (2)

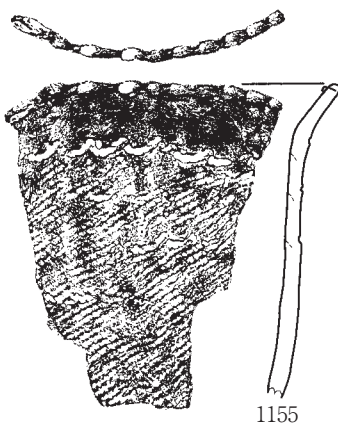

1155

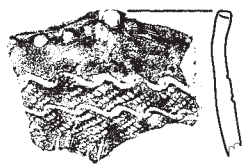

1156

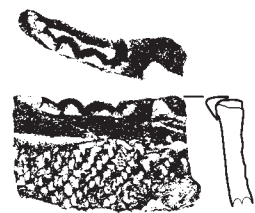

1157



1158

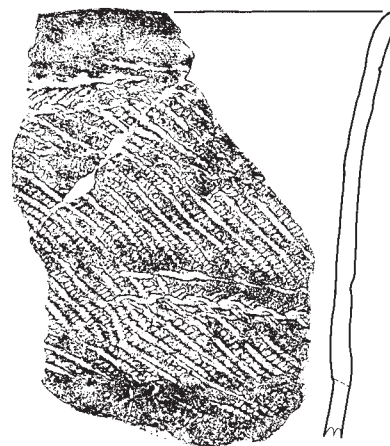

1159

II C7c · II C7 · 8c

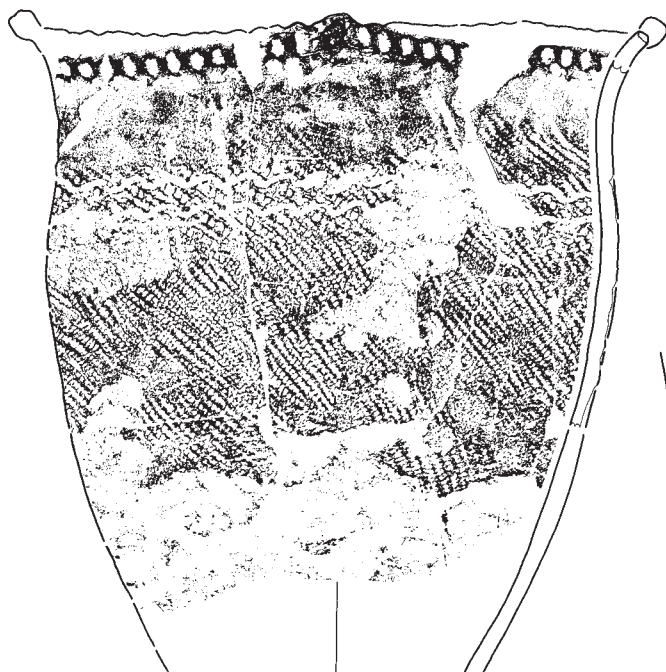

1160



1161

II C7 · 8c

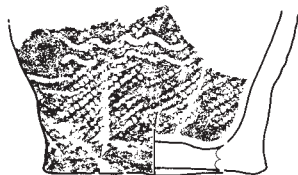

1162

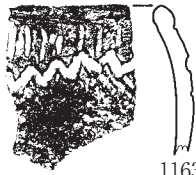

1163

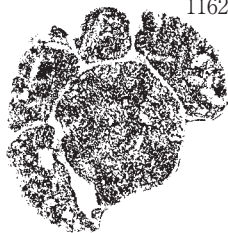

1164

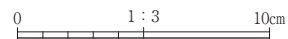
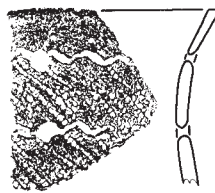

第364図 縄文土器 (116)

Ⅱ C7・8c, Ⅲ C1c



1165

0 1:3 10cm

第365図 縄文土器 (117)

II C7・8c, II C7d



II C7・8d

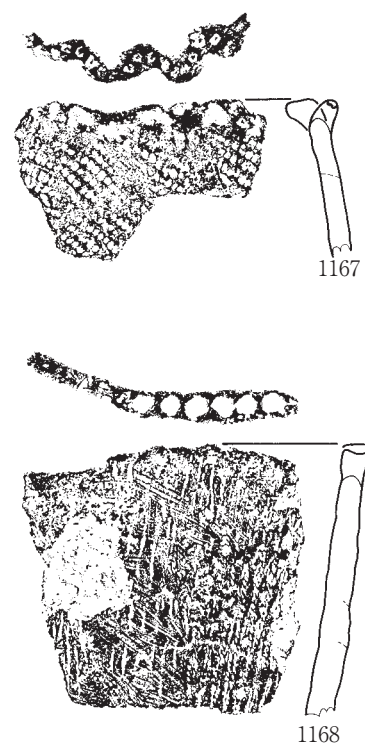

II C7d (1)

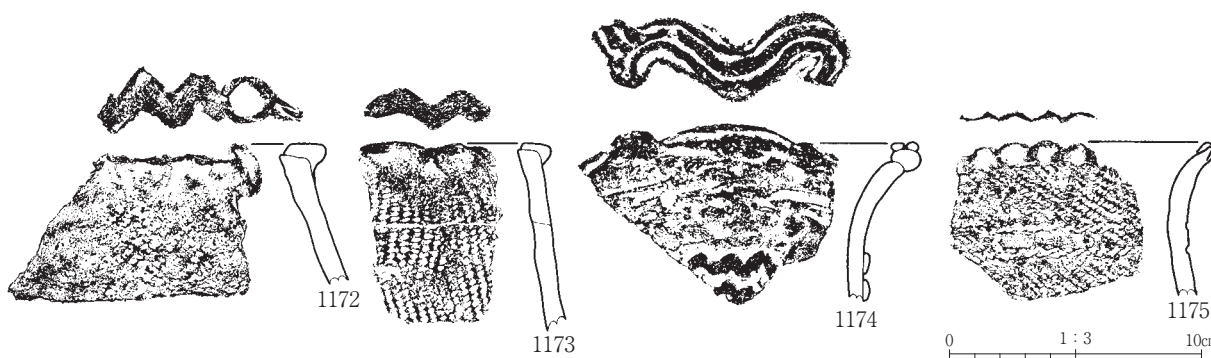

第366図 縄文土器 (118)

II C7d (2)

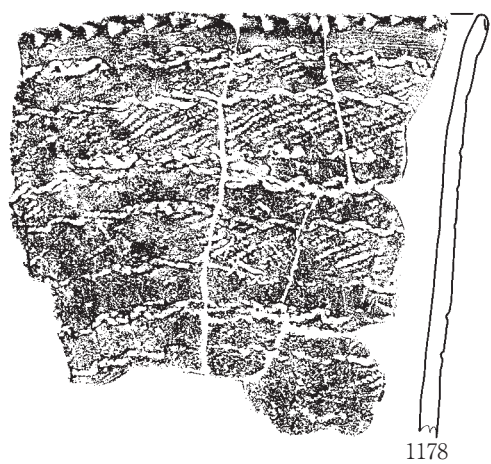
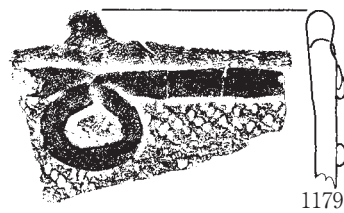
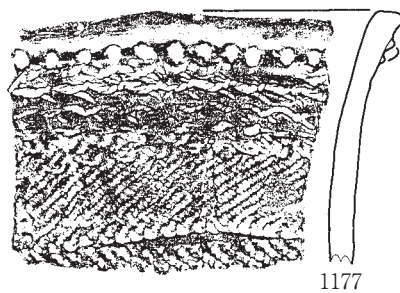
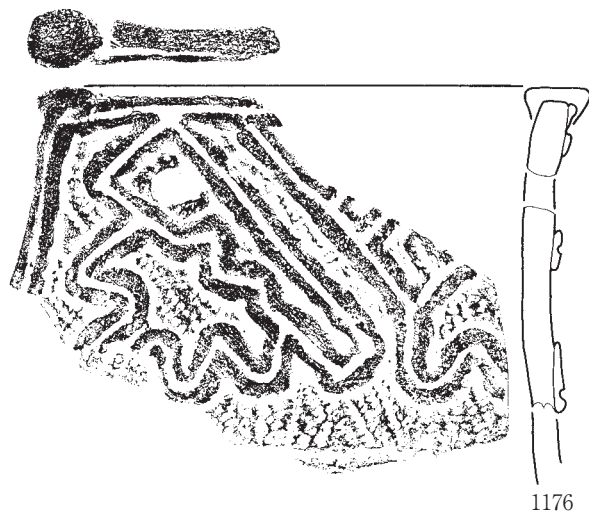

II C7d, II C1a

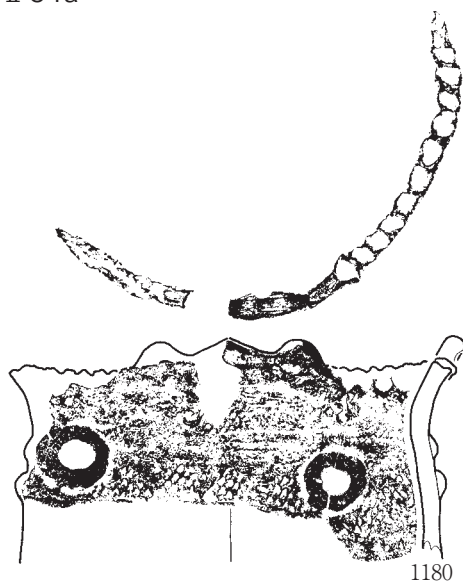

II C7d · 8d

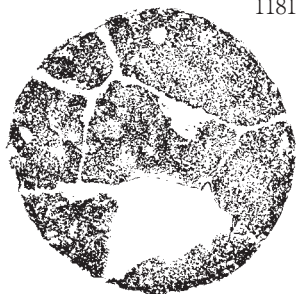

II C7c · 7d, II C8d

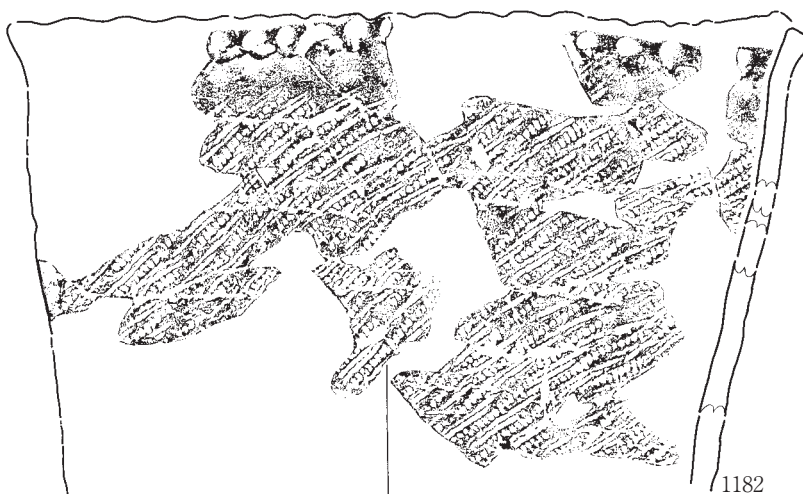

0 1:3 10cm

第367図 縄文土器 (119)

II C7・8d

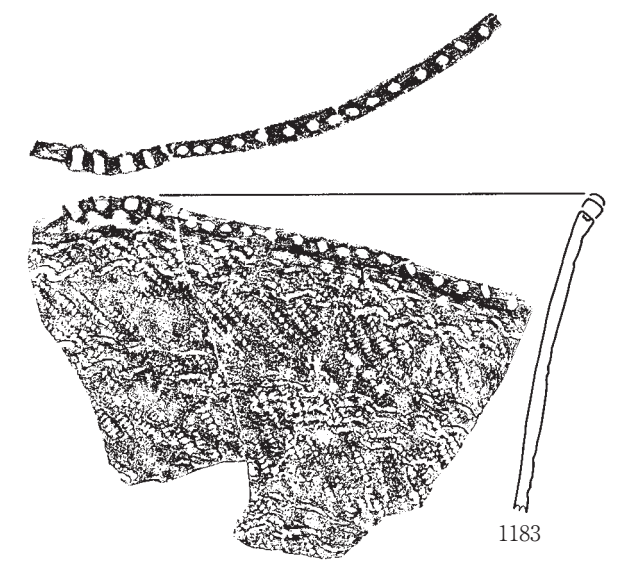

II C7e (1)

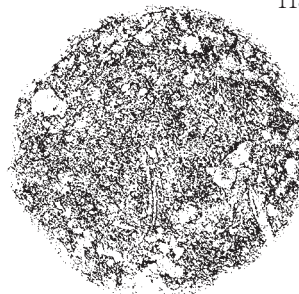
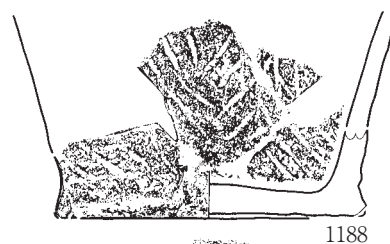
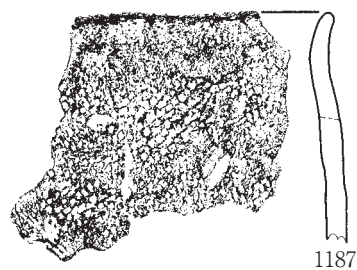
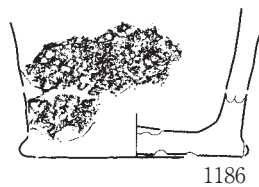
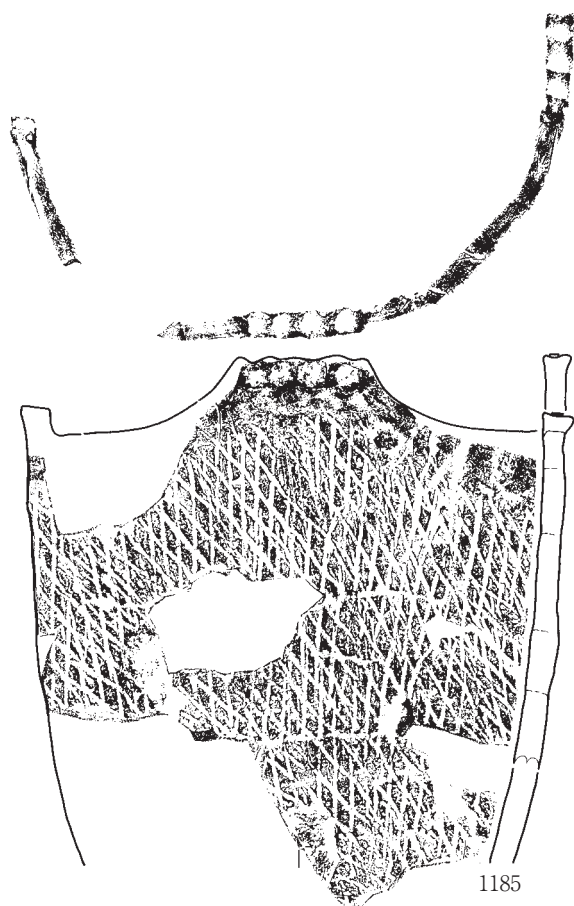

0 1:3 10cm

第368図 縄文土器 (120)



II C7e (2)

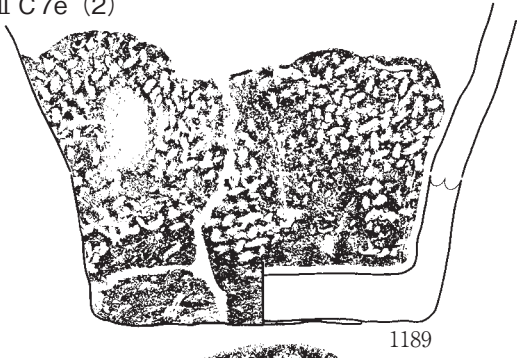

1189

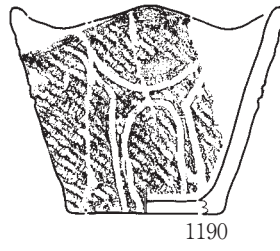

1190

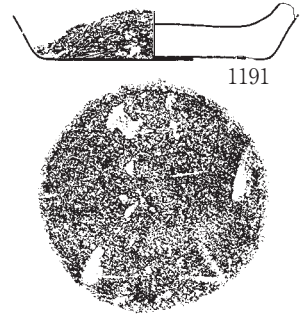

1191

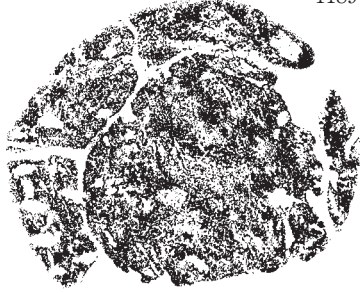

1192



1193

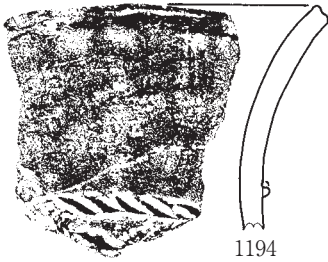

1194

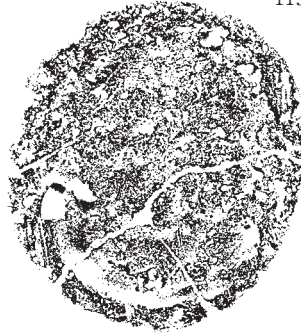

1195

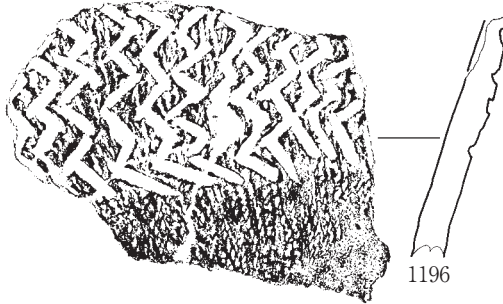

1196

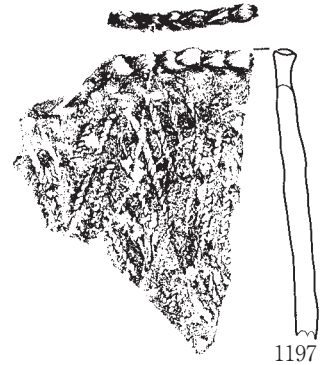

1197

II C7e, II C9c

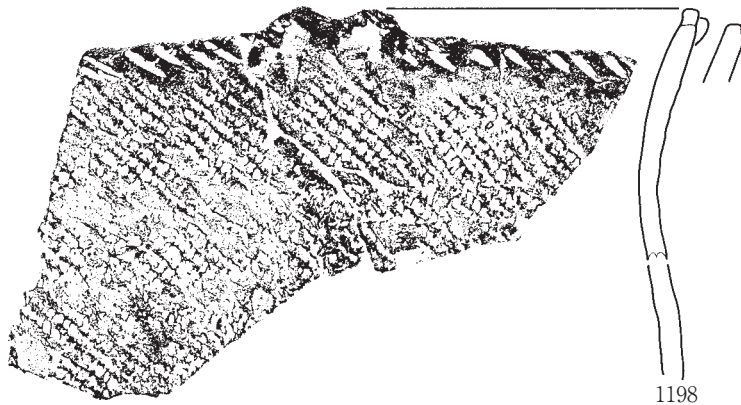

1198

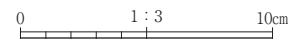

第369図 縄文土器 (121)

II C7・8e

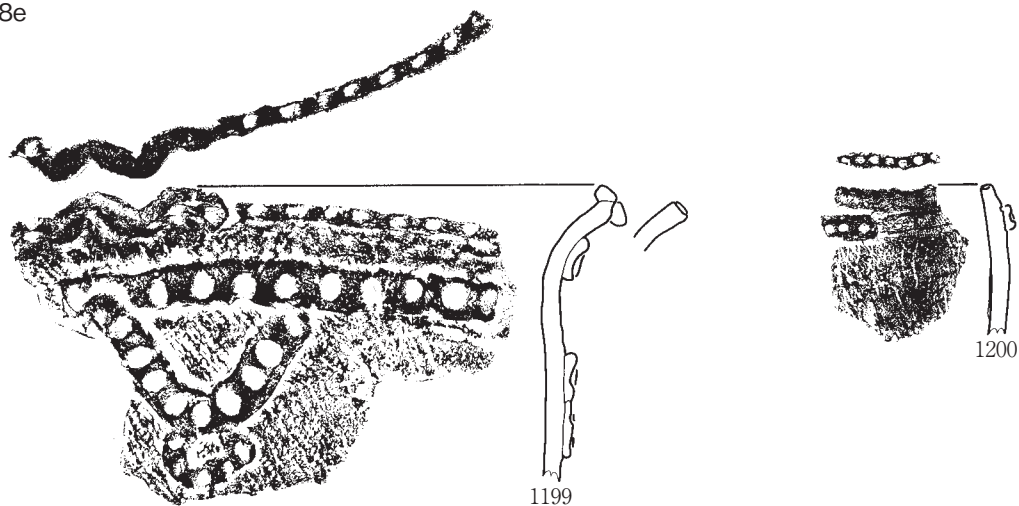

II C8a

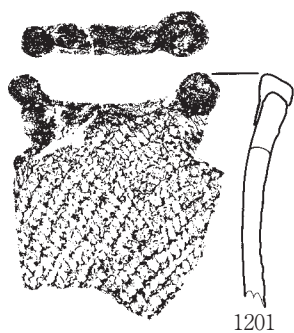

II C8・9a

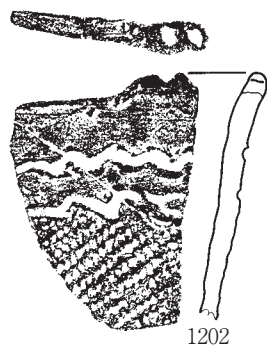

II C8b (1)

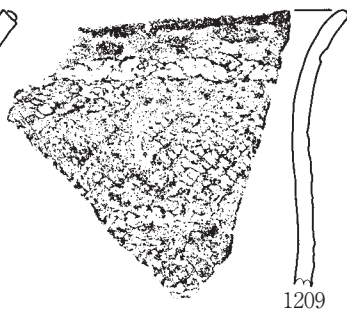
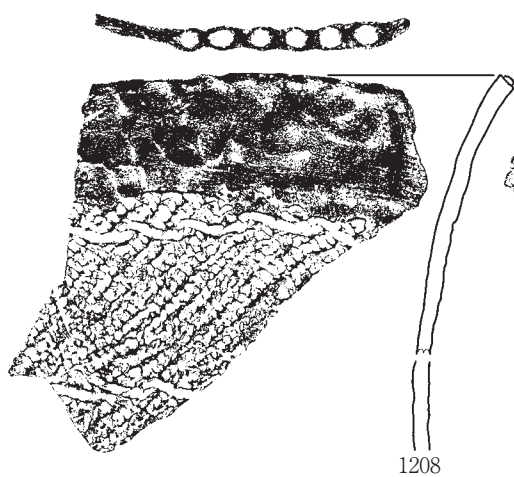
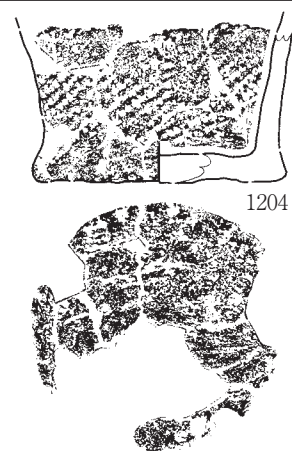
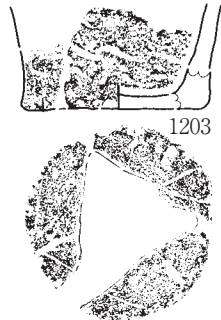

0 1:3 10cm

第370図 縄文土器 (122)

II C8b (2)

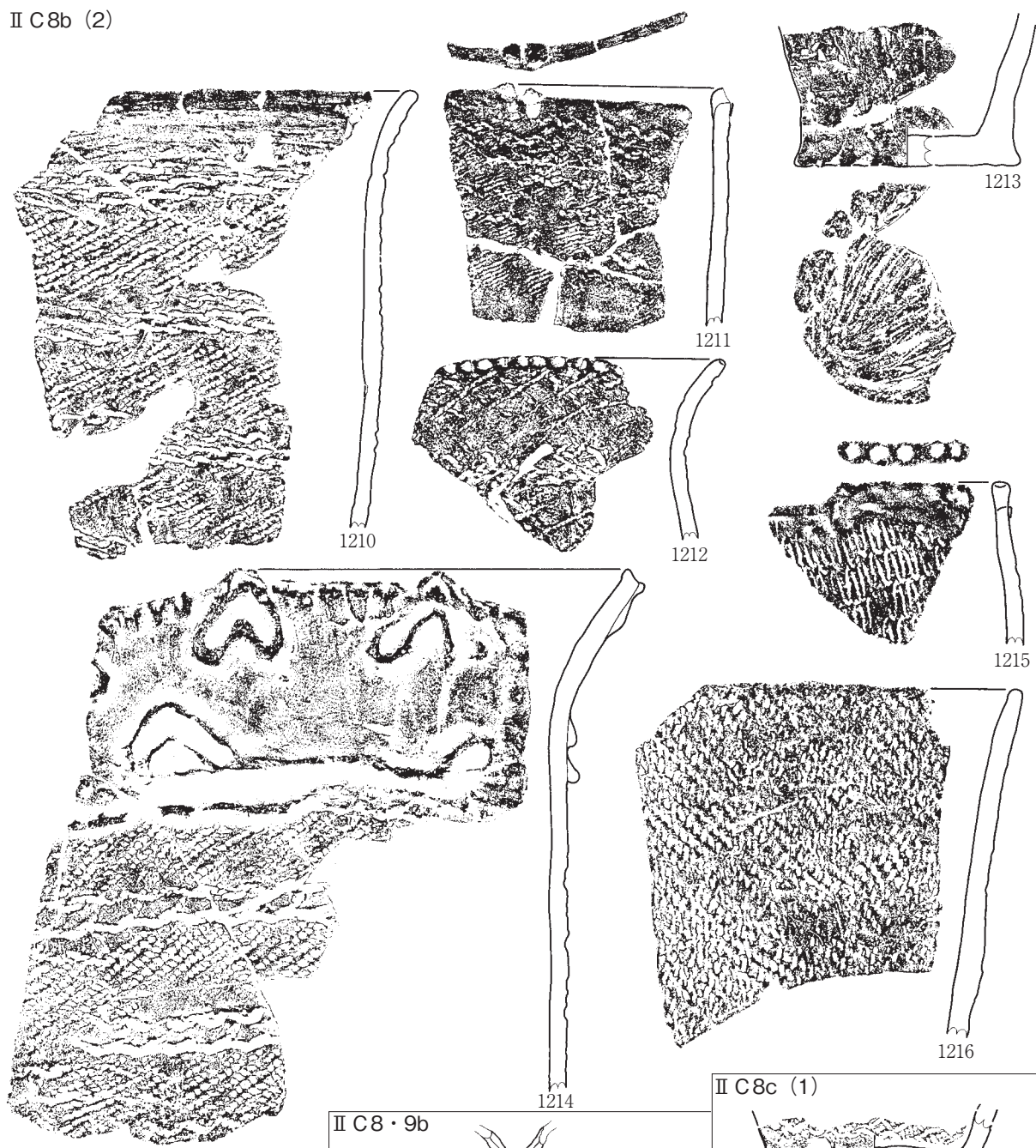

II C8b, II C9a

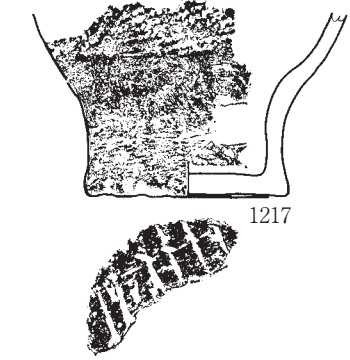

II C8 · 9b



II C8bc, II C9b

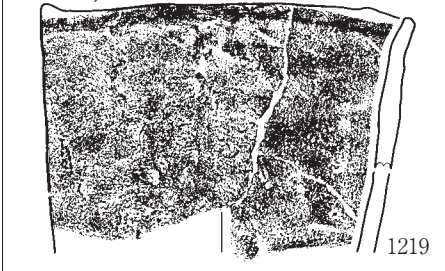

II C8c (1)

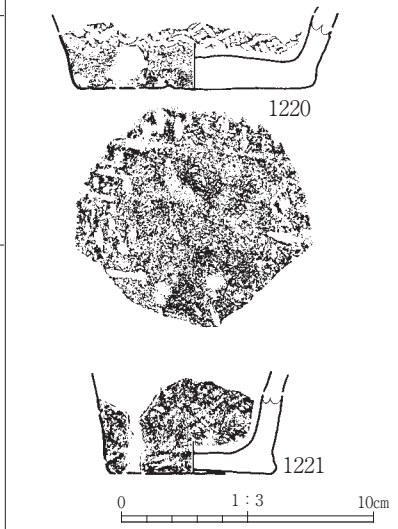

第371図 縄文土器 (123)

II C8c (2)

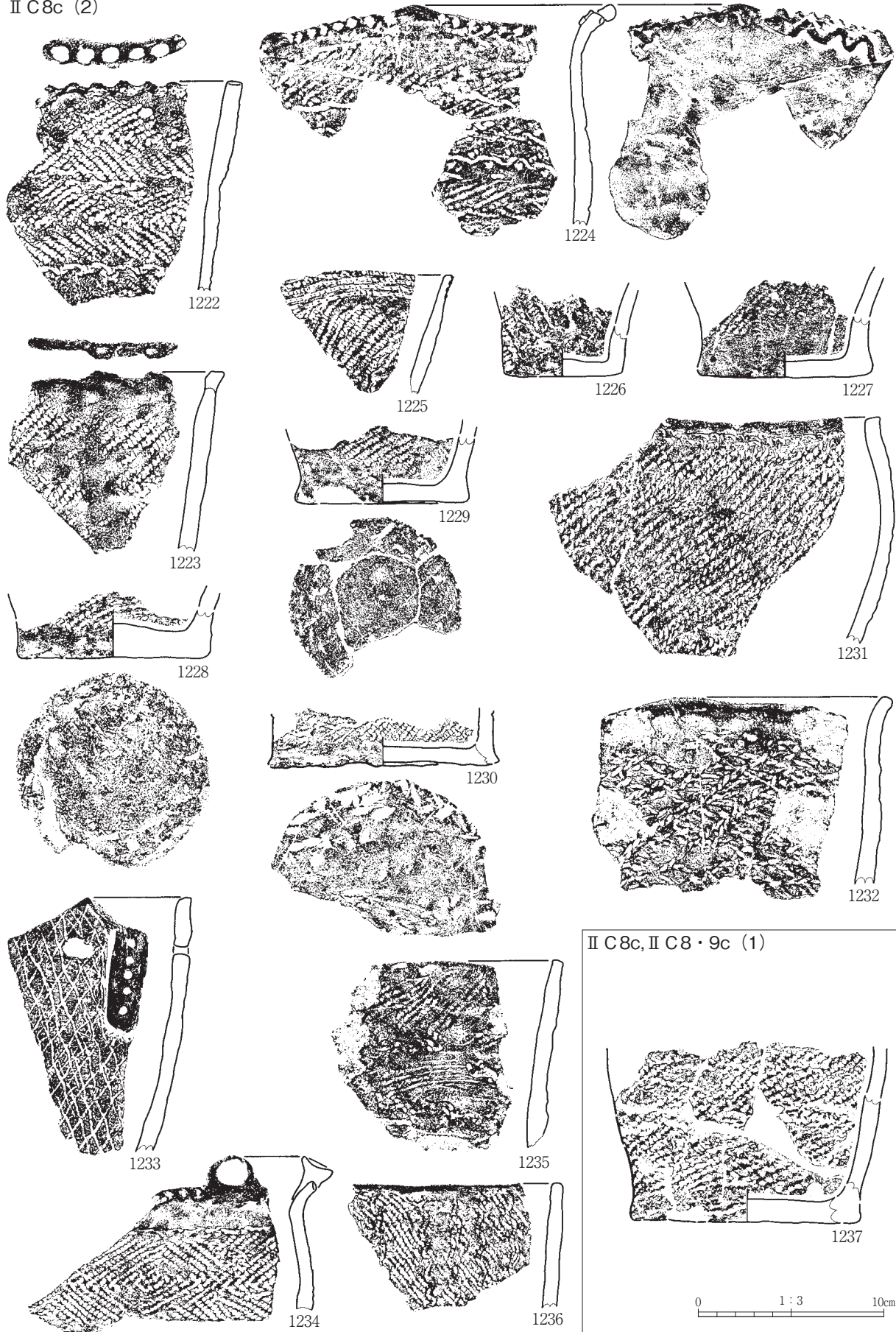

II C8c, II C8·9c (1)

第372図 縄文土器 (124)

II C8c, II C8・9c (2)

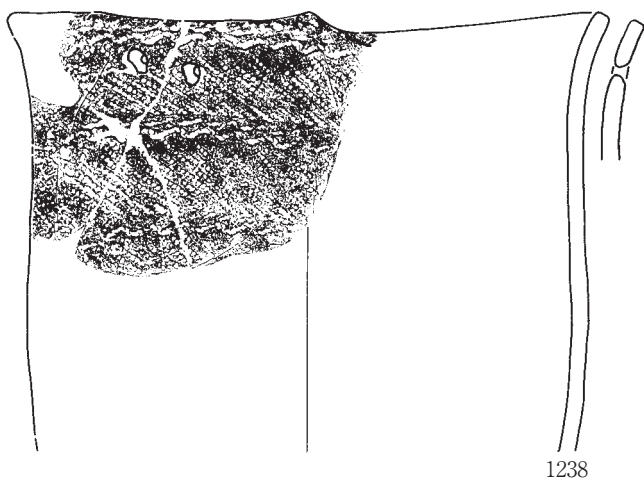

1238

II C8・9b, II C9c

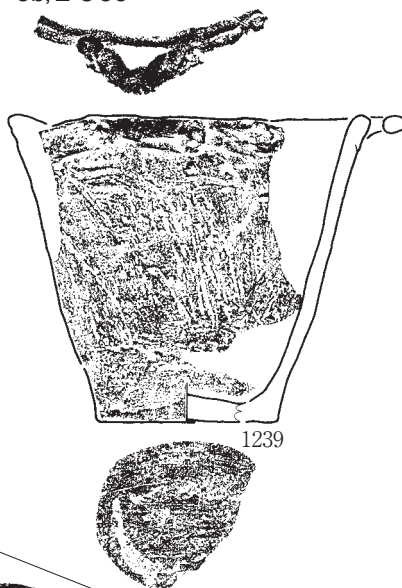

1239

II C8・9c



1240

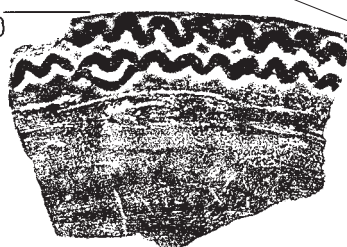

1242



1241

II C8c, II C9d

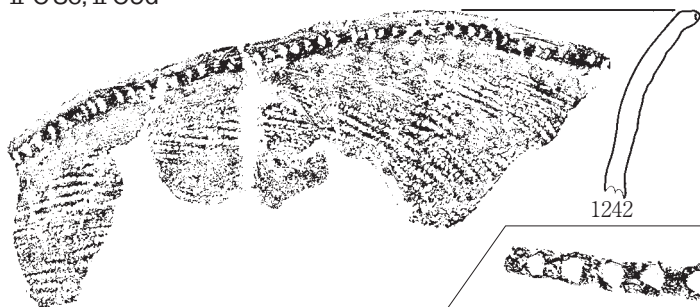

II C8d (1)

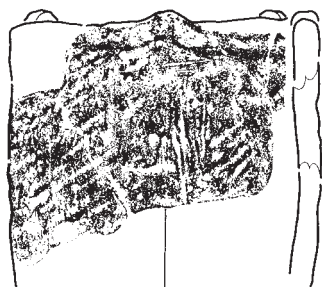

1243

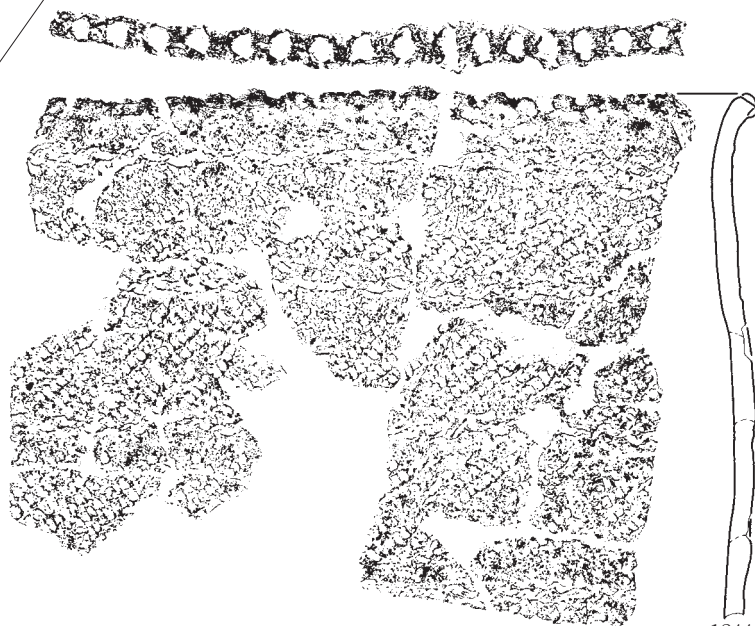

1244

0 1:3 10cm

II C8d (2)



第374図 縄文土器 (126)

II C8d (3)

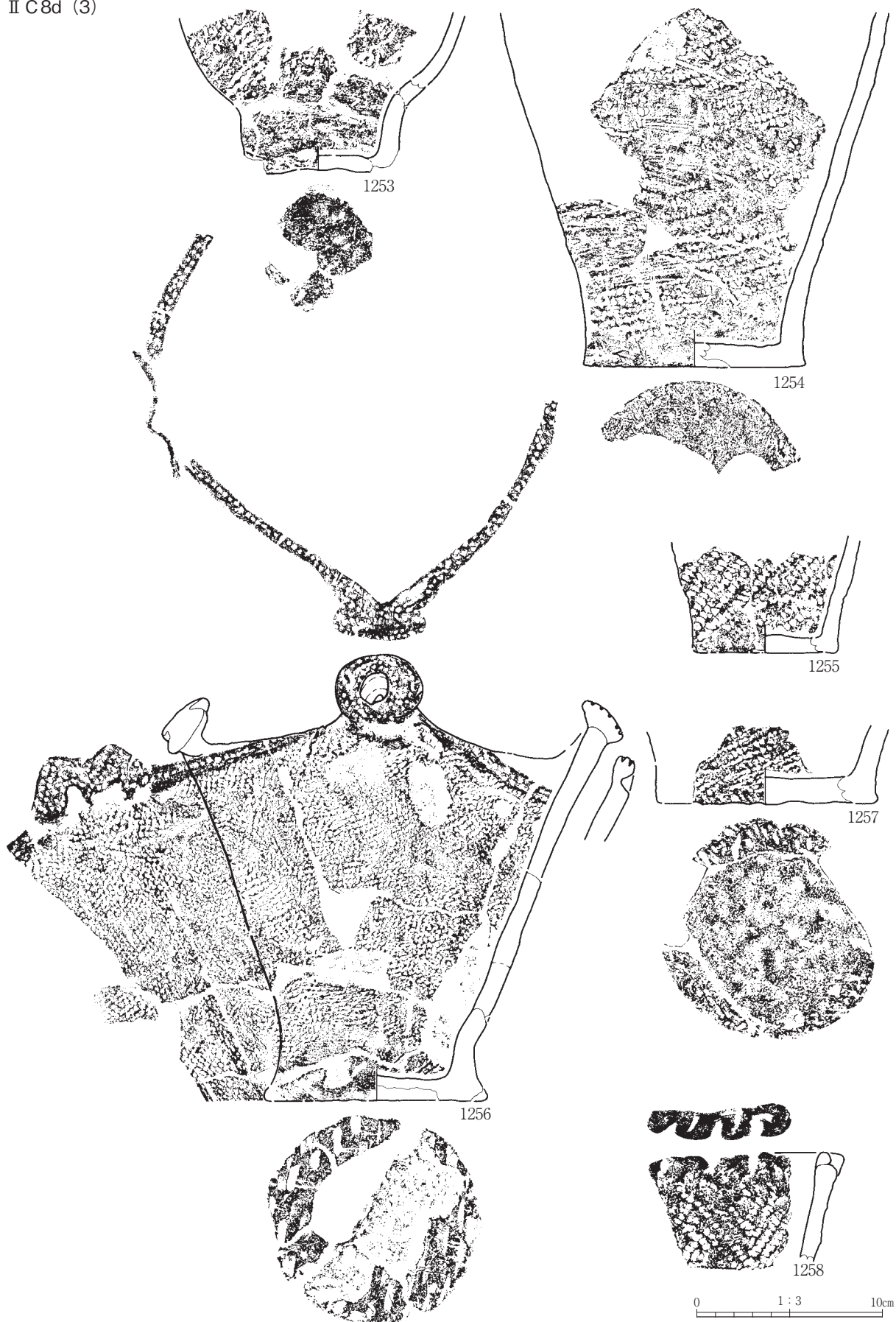

第375図 縄文土器 (127)

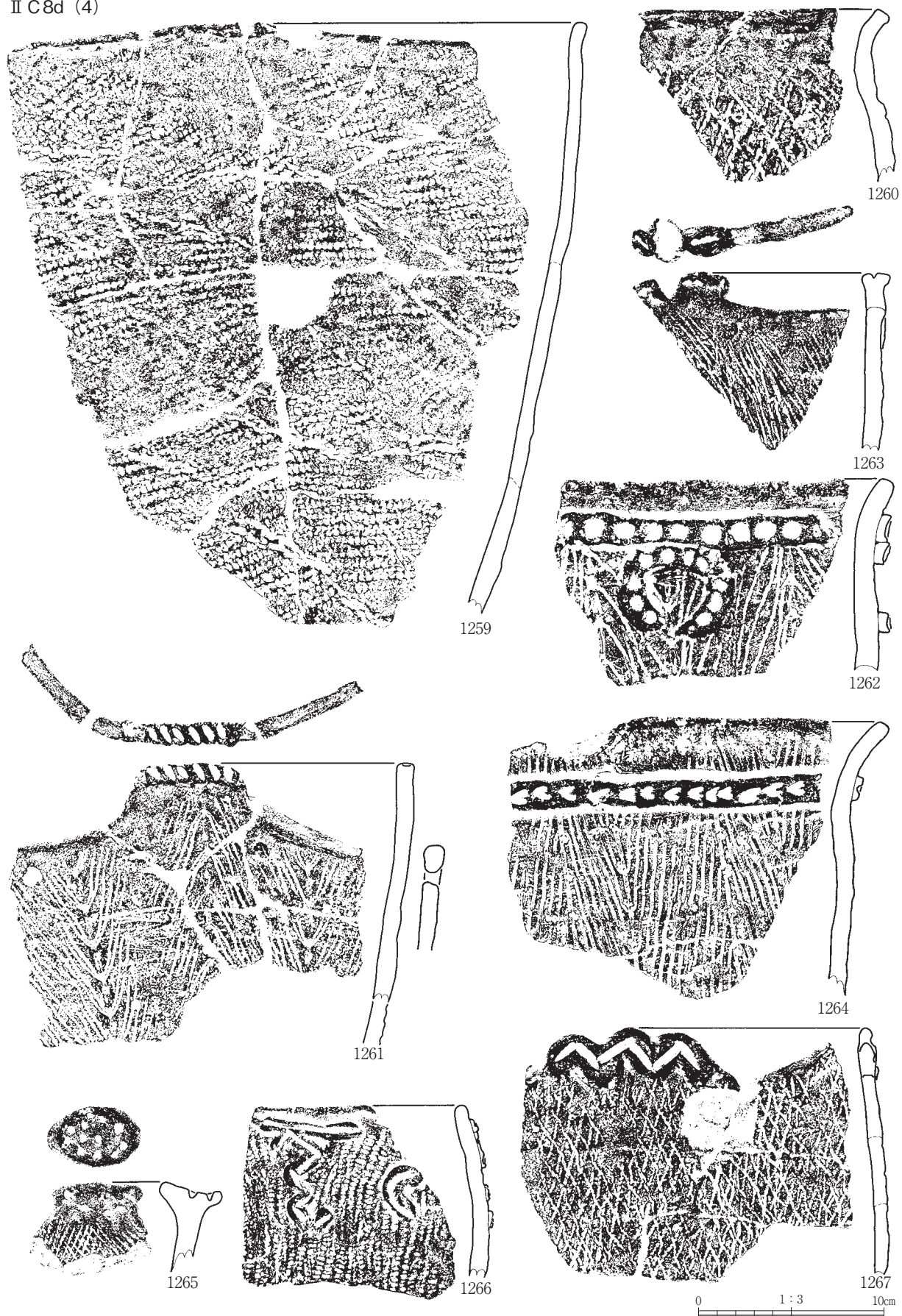

第376図 縄文土器 (128)



II C8d (5)

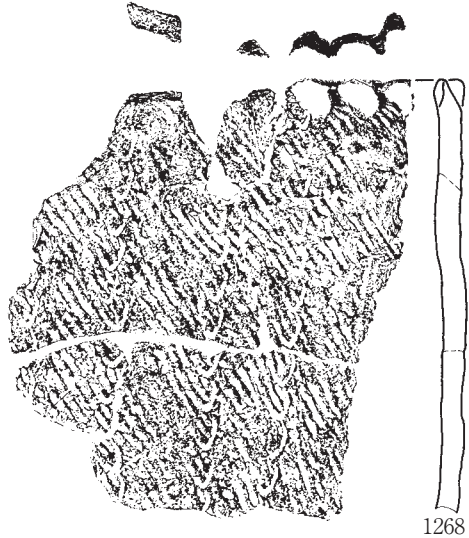

1268

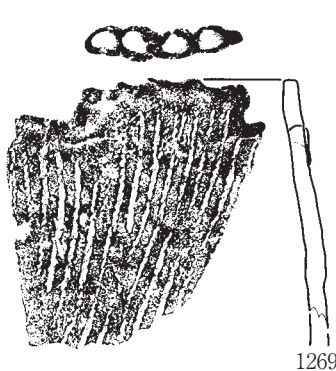

1269

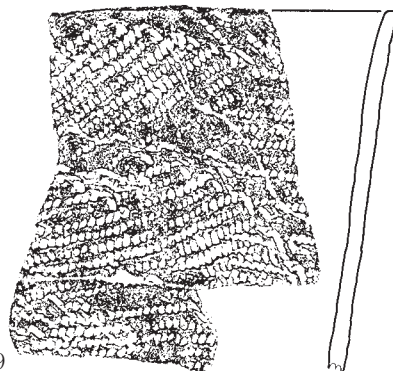

1270



1272

II C8・9d

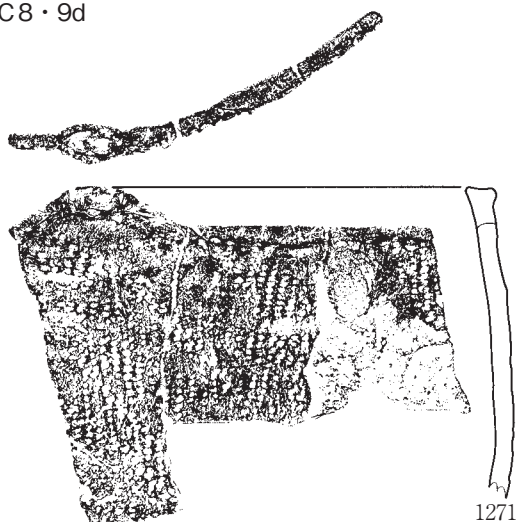

1271

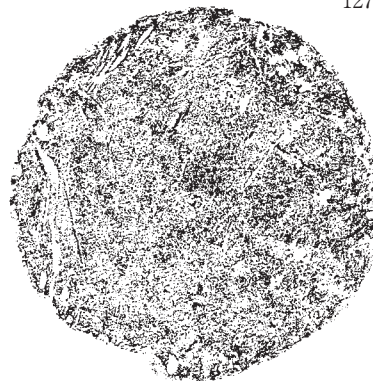

1274

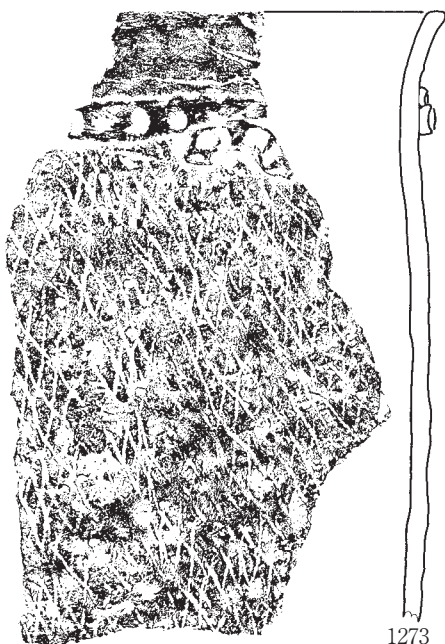

1273

II C8d, II C8・9d



1275

0 1:3 10cm

第377図 縄文土器 (129)

II C 8d, II C 8e



II C 8d, II C 9 · 10b

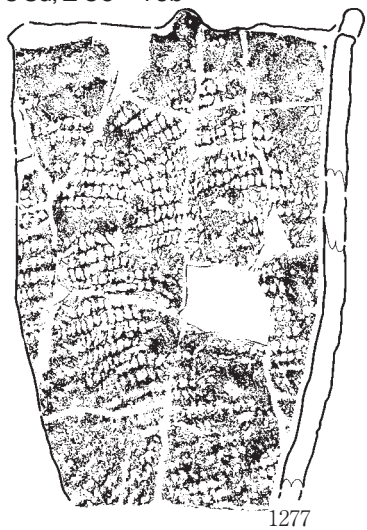

II C 8de



II C 8e

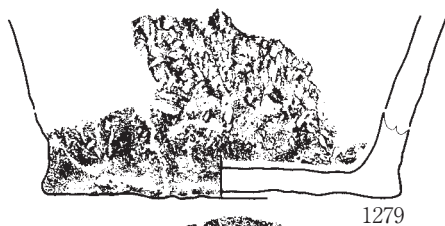

II C 9a (1)

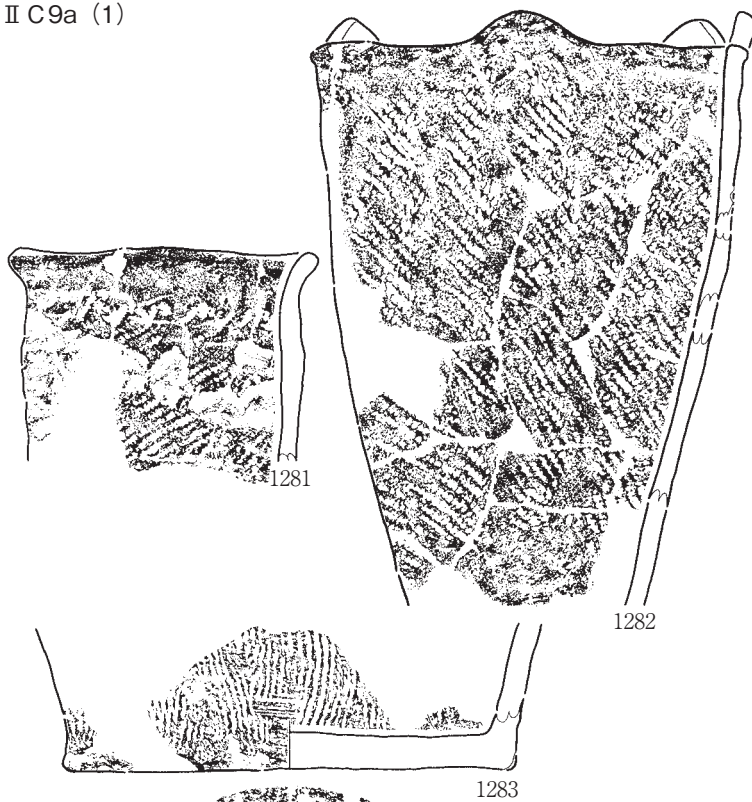

II C 8e, II C 10e

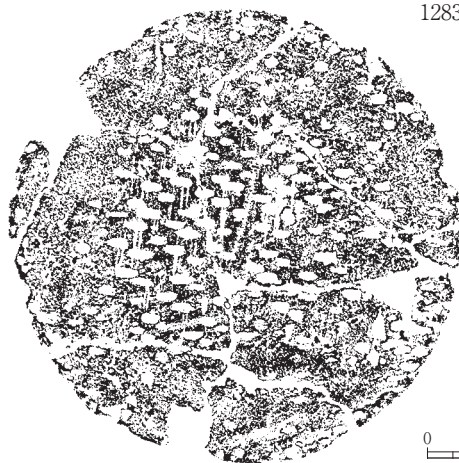
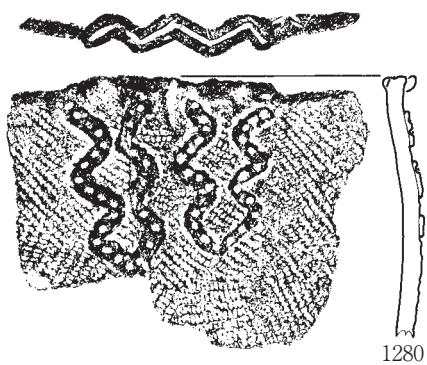

0 1:3 10cm

第378図 縄文土器 (130)

II C9a (2)



第379図 縄文土器 (131)

II C9a (3)

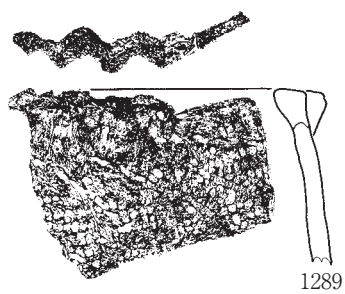

II C9a, II C9ab

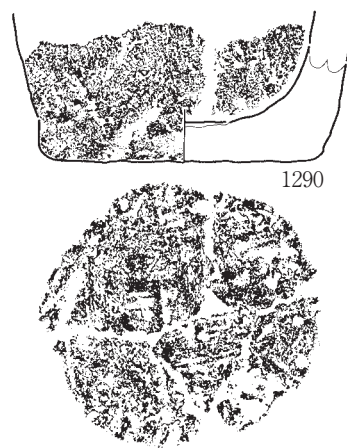

II C9・10a

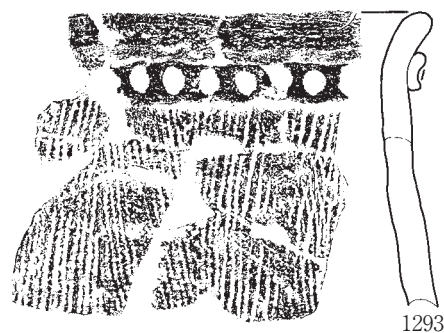
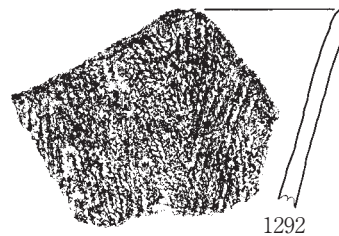
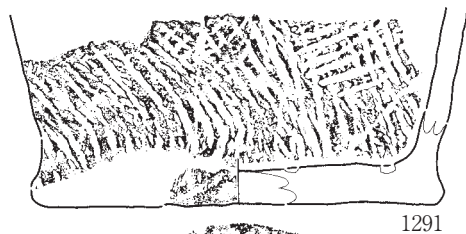

II C9b (1)

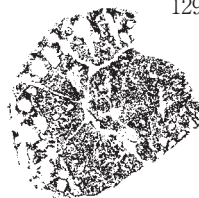
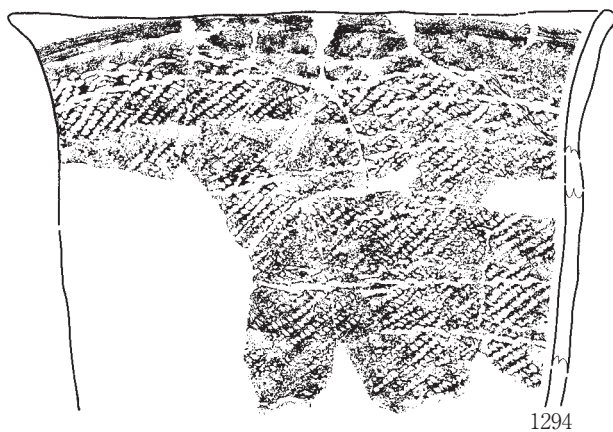

0 1:3 10cm

第380図 縄文土器 (132)

II C9b (2)

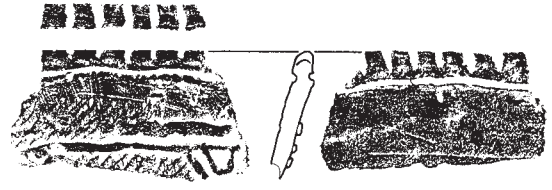

1298

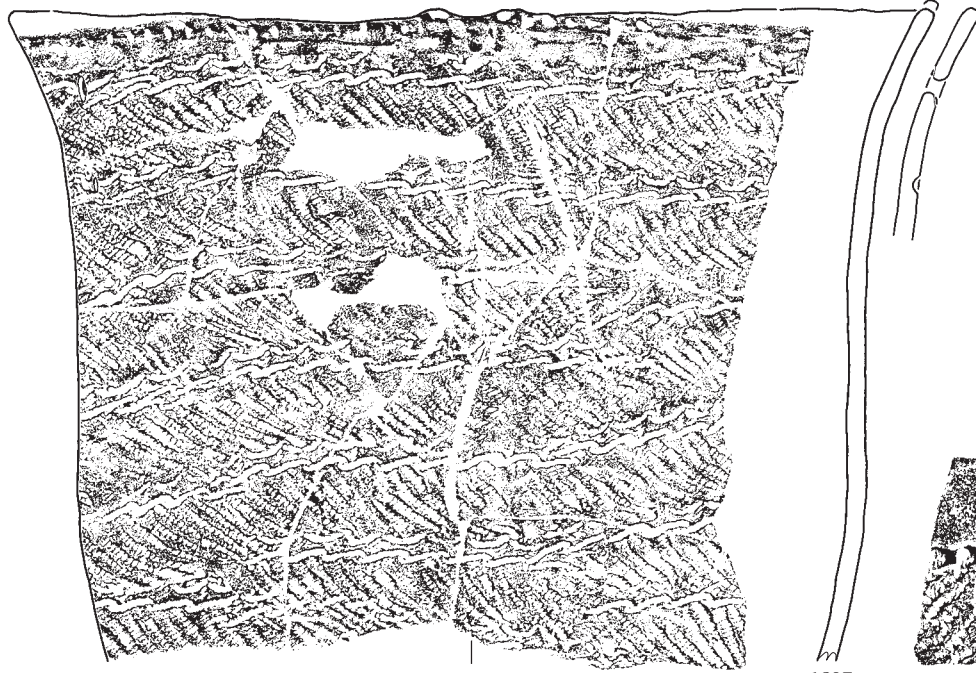

1297

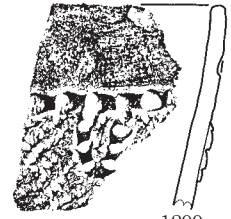

1299

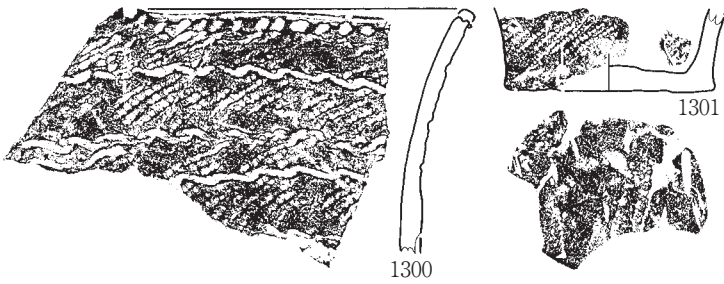

1300

1301

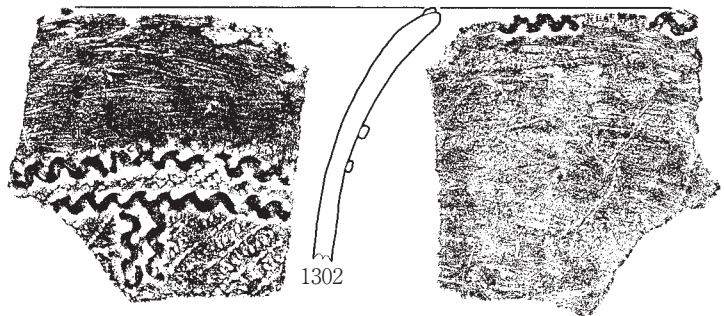

1302

II C9b, II C9bc

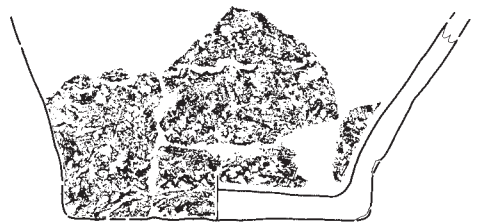

1303

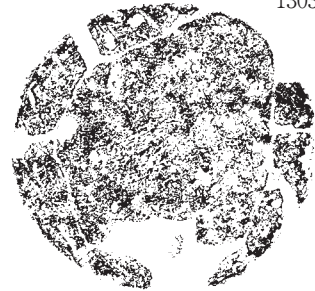

0 1:3 10cm

第381図 縄文土器 (133)

II C9c (1)

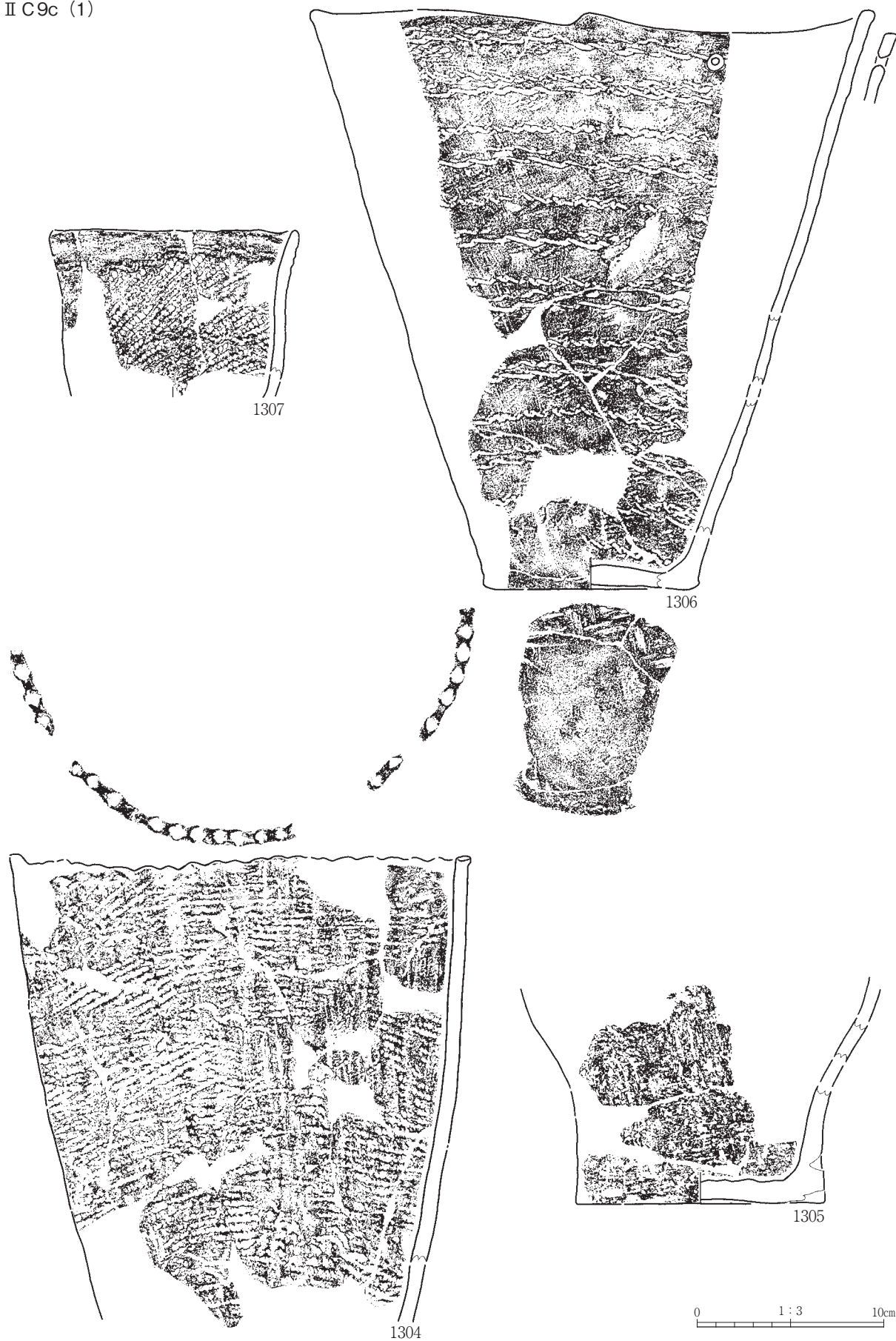

第382図 縄文土器 (134)

II C9c (2)

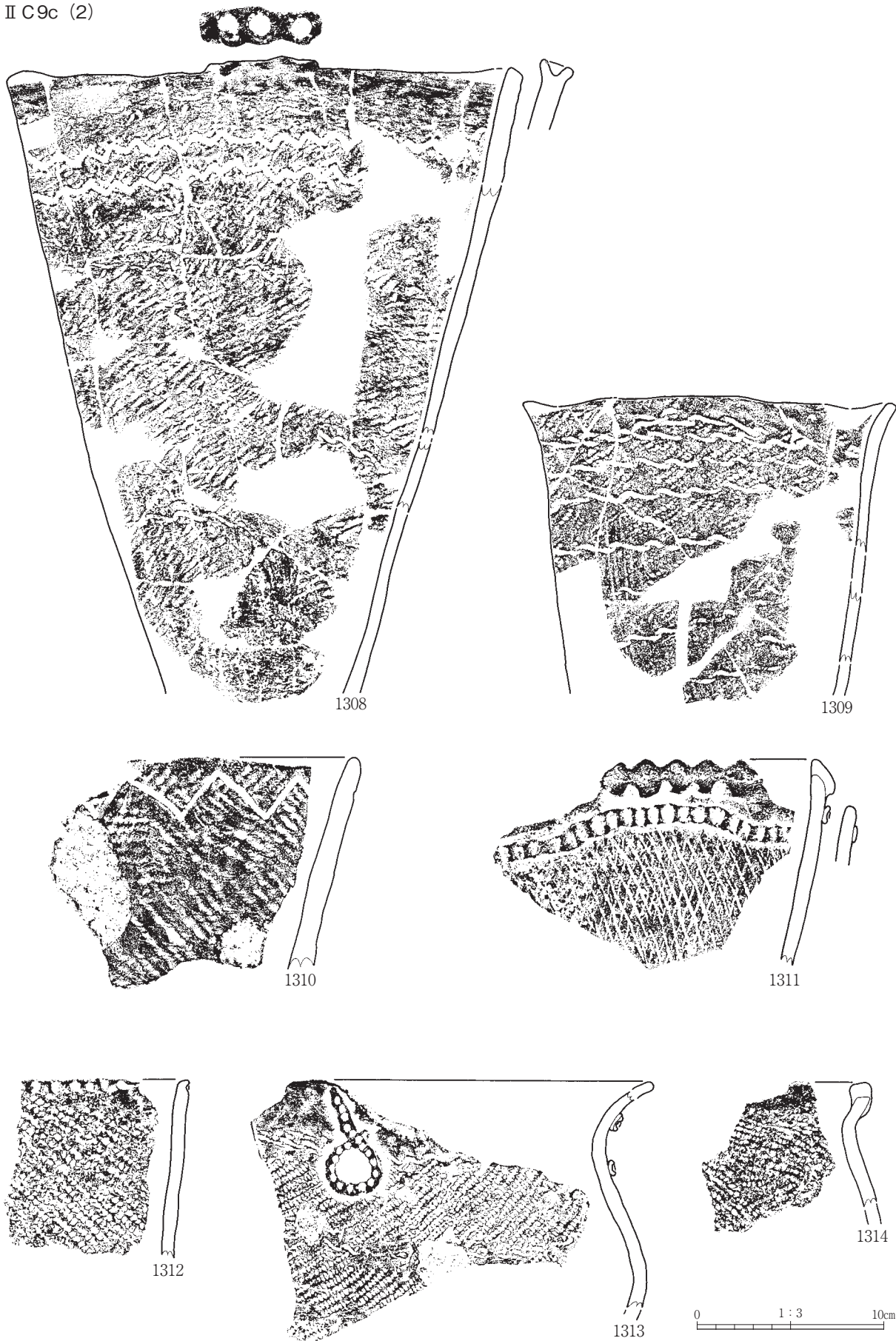

第383図 縄文土器 (135)

II C9c (3)

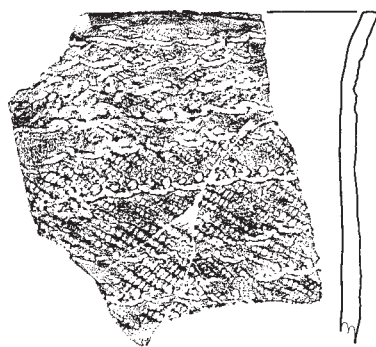

1317

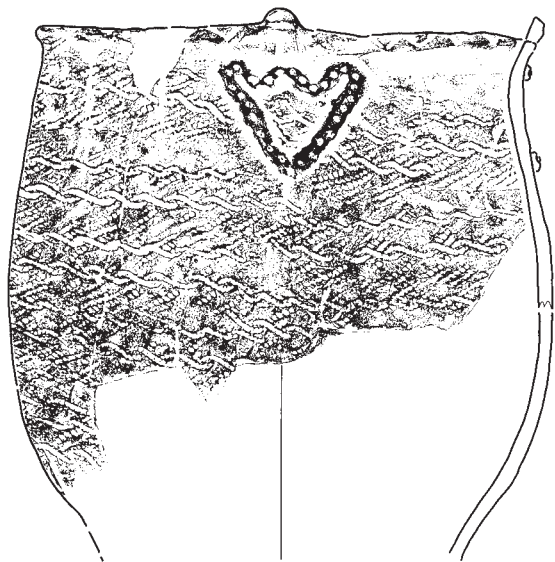

1315 正面

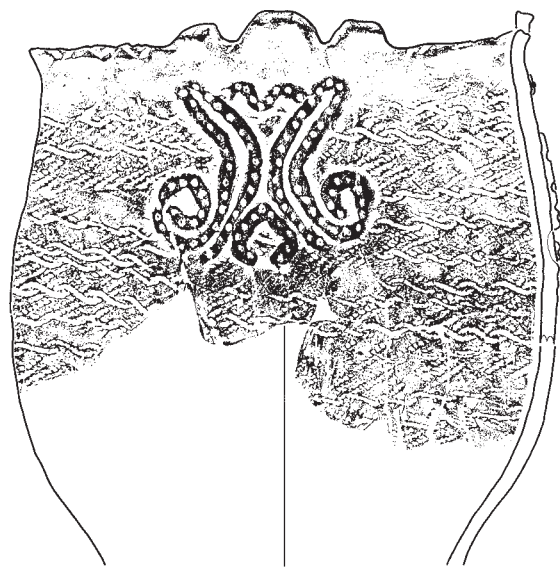

1315 裏面



1316

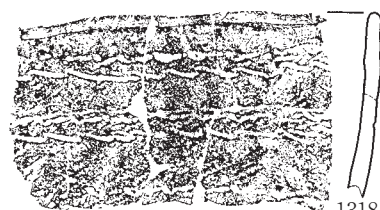

1318

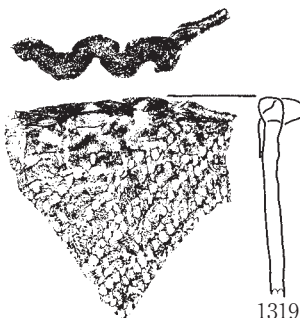

1319

1315 0 1:4 10cm

0 1:3 10cm

第384図 縄文土器 (136)



II C9c (4)



第385図 縄文土器 (137)

II C9c (5)

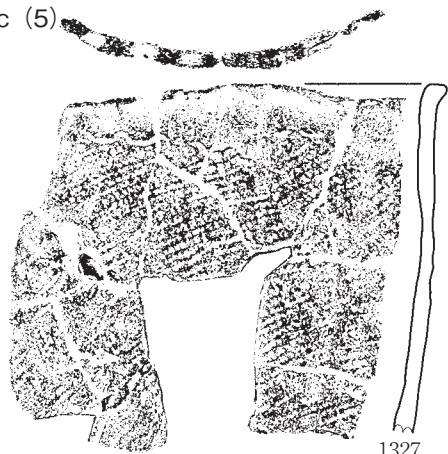

1327

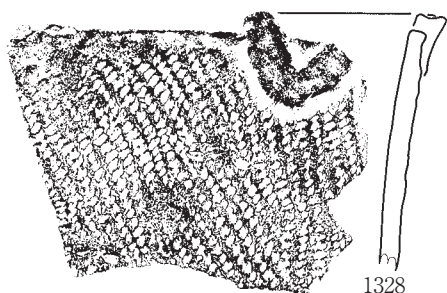

1328

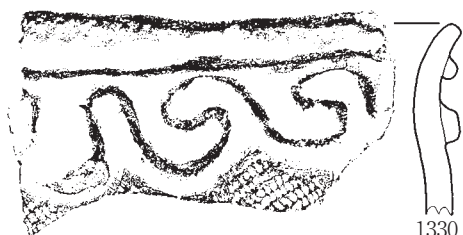

1330



1331

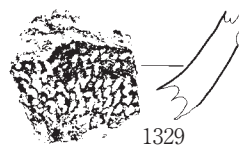
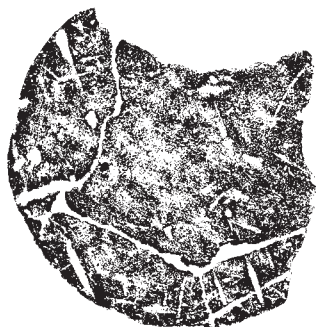

1329

II C9c, II C9d



1332

0 1:3 10cm

第386図 縄文土器 (138)

II C9c, II C10a, II C10b, III B1j

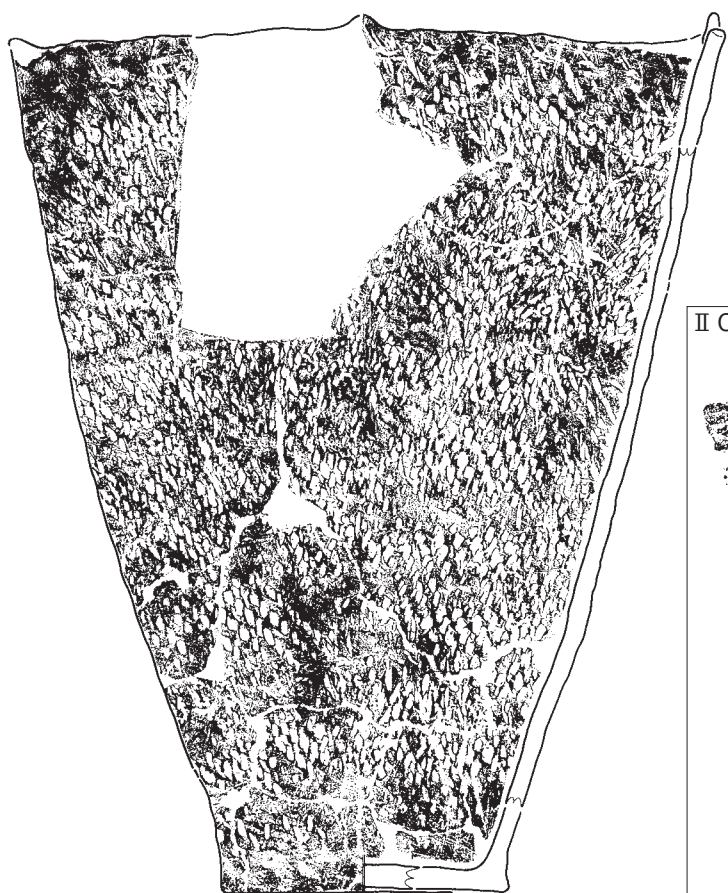

1333

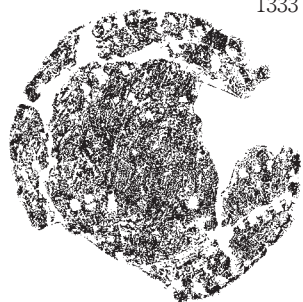

1333 0 1 : 4 10cm

II C9c, II C10a



1334

II C9 · 10c



1335

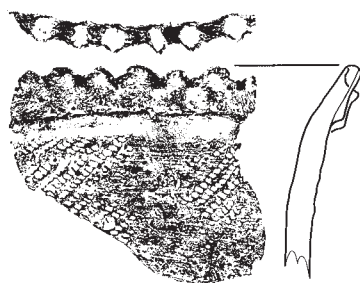

1336

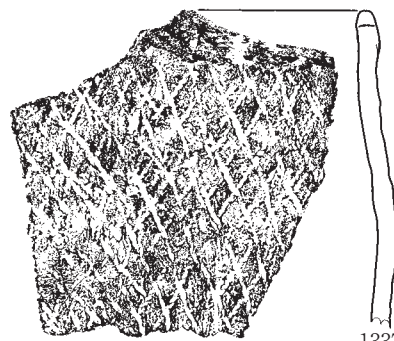

1337

0 1 : 3 10cm

第387図 縄文土器 (139)

II C9d (1)

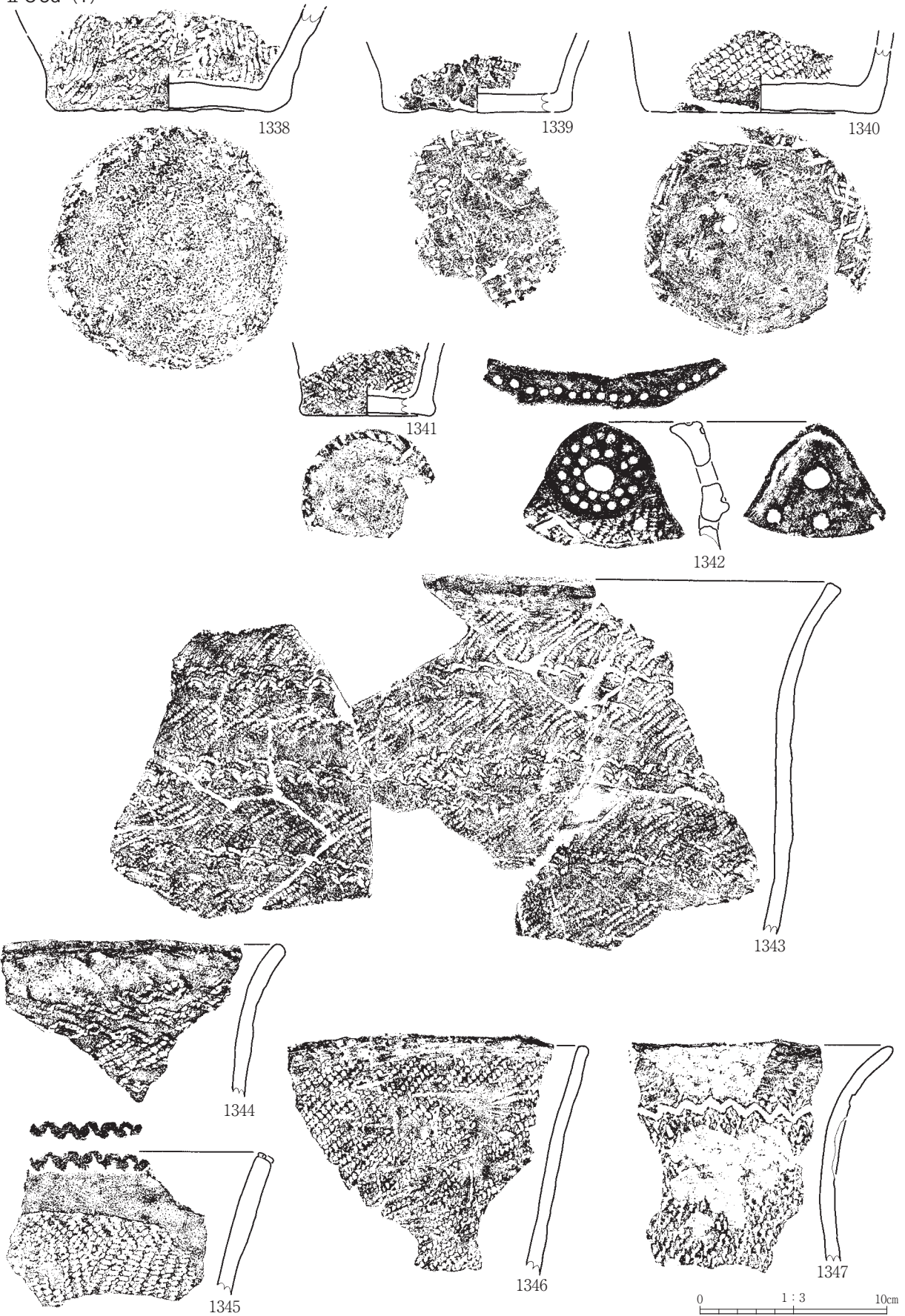

第388図 縄文土器 (140)

II C9d (2)

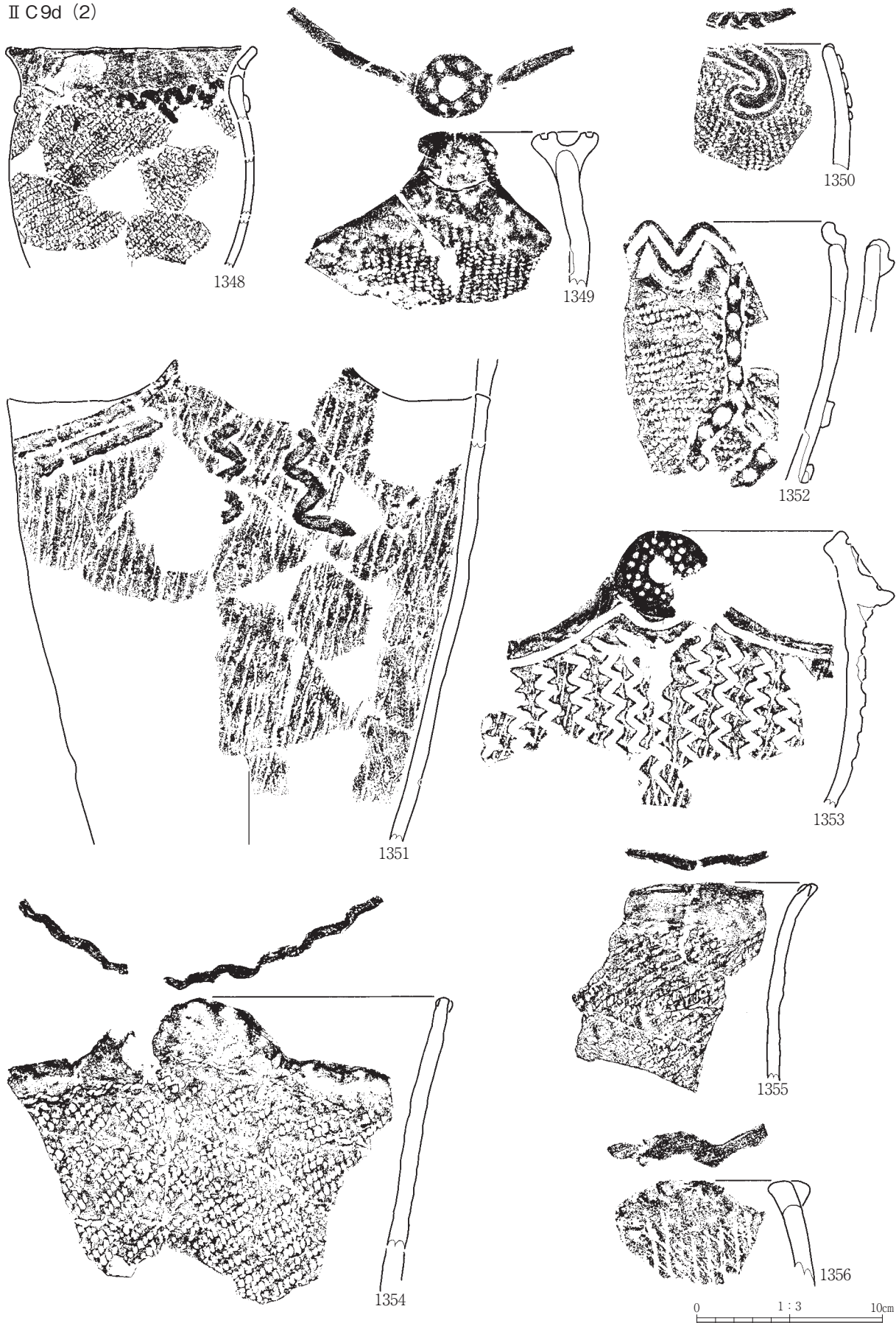

第389図 縄文土器 (141)

II C9d (3)

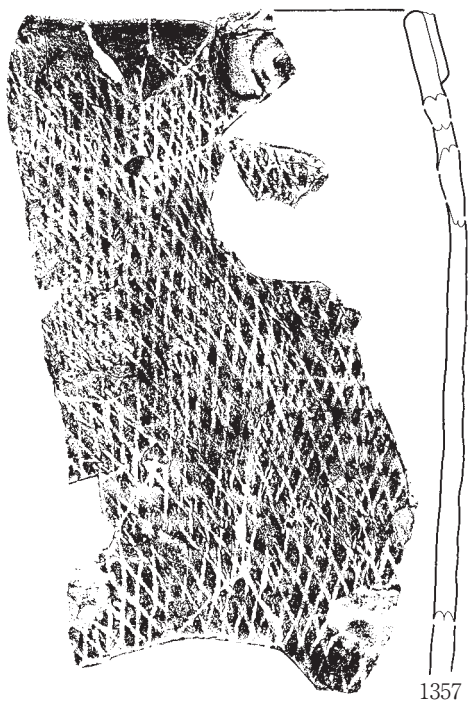

1357

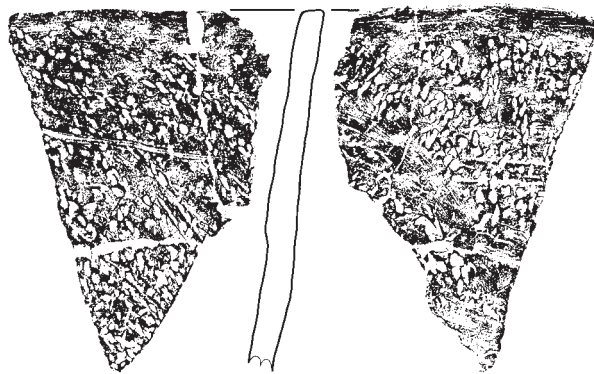

1358



1359

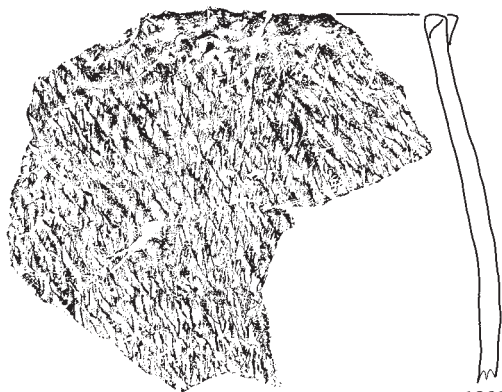

1361



1360

II C9 · 10d



1362



II C10a (1)



1363

0 1:3 10cm

第390図 縄文土器 (142)

II C 10a (2)



第391図 縄文土器 (143)

II C10a (3)



第392図 縄文土器 (144)



II C 10a (4)



1381

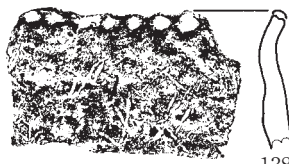

1382



1383

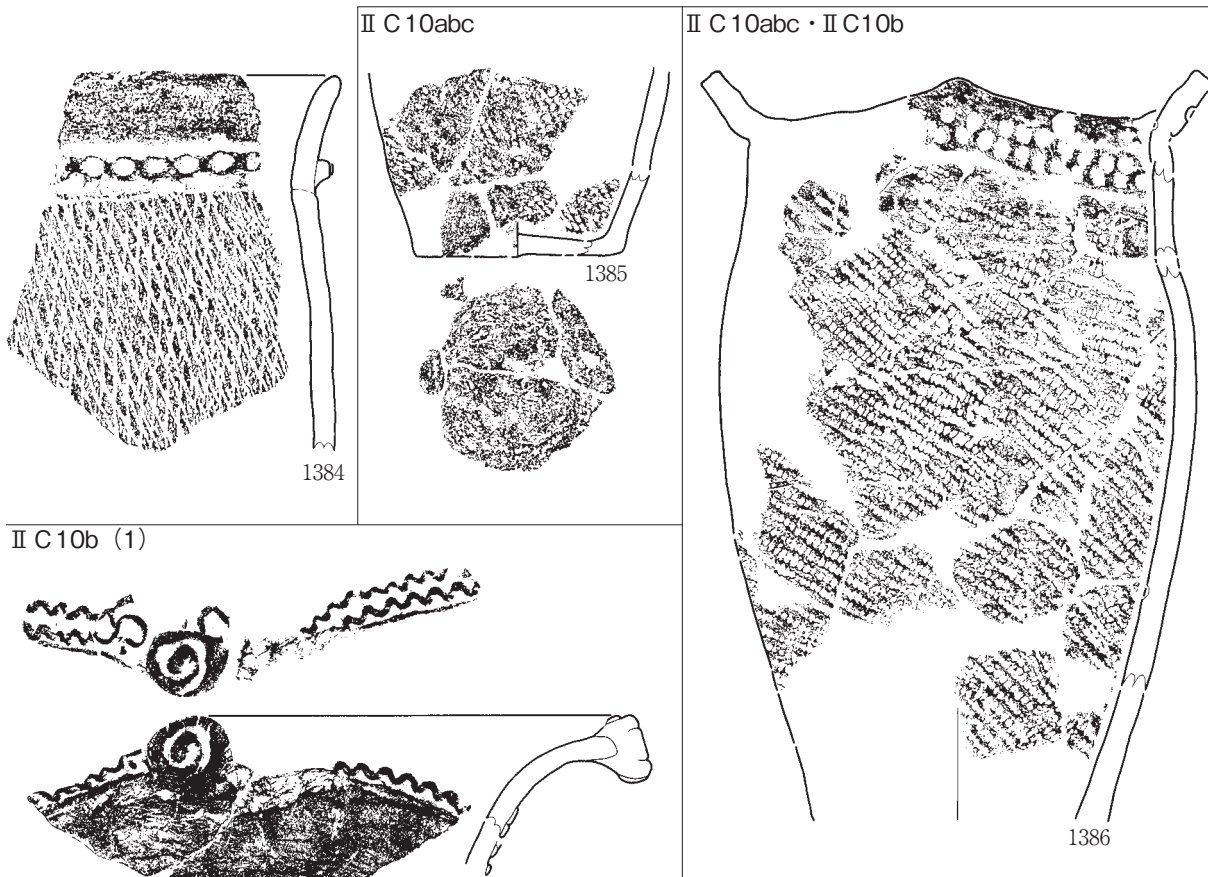

II C 10b (1)

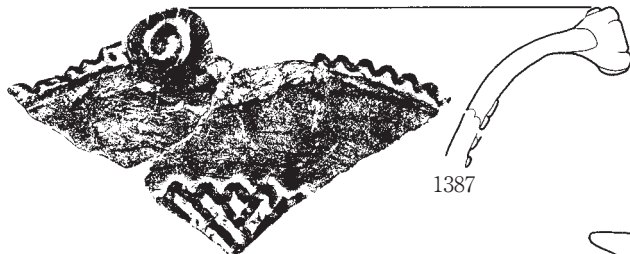

1387

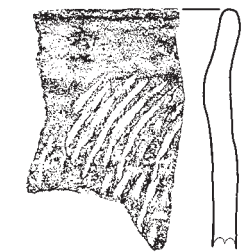

1388



1389



1390



1391

0 1:3 10cm

第393図 縄文土器 (145)

II C 10b (2)

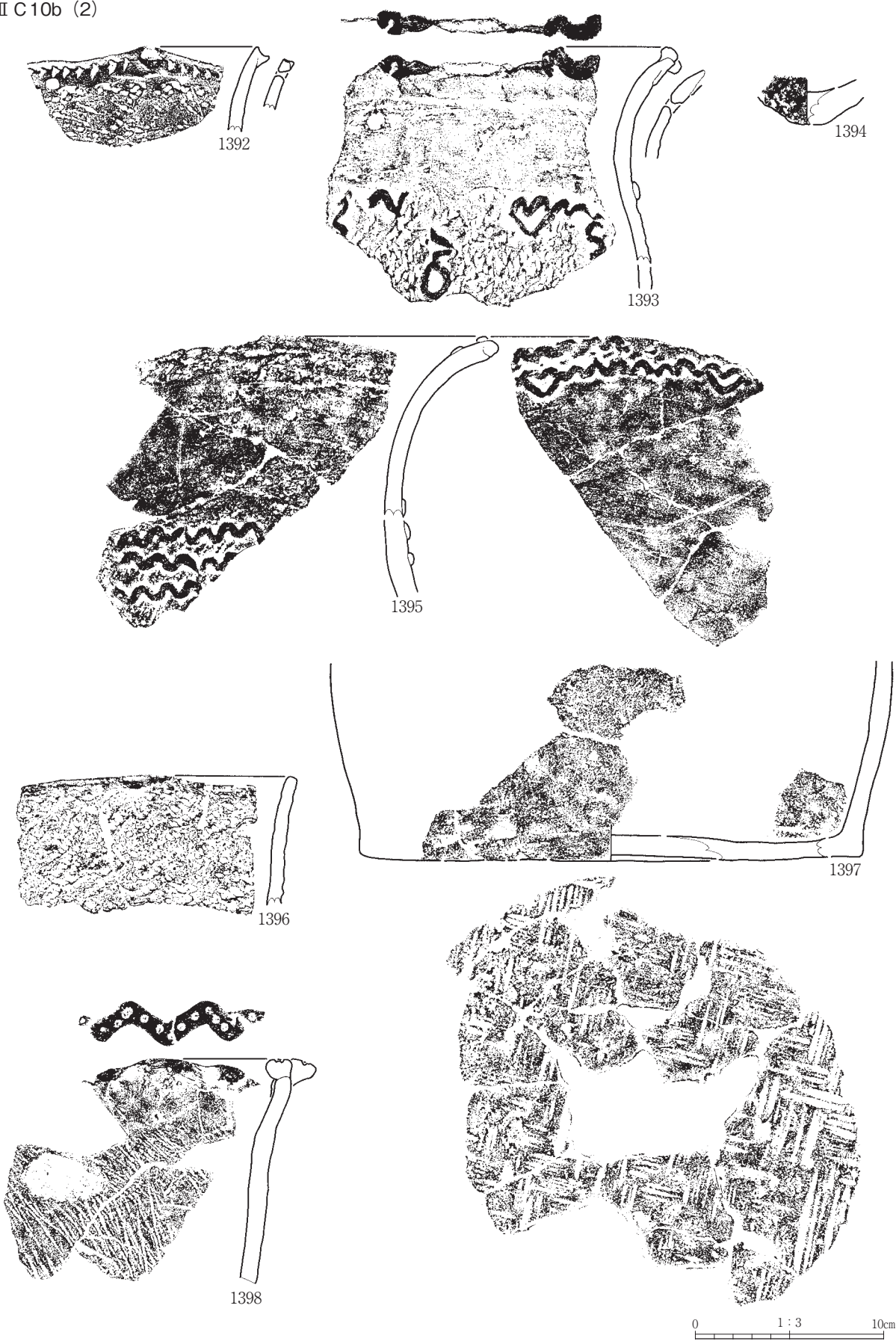

第394図 縄文土器 (146)

II C 10b (3)

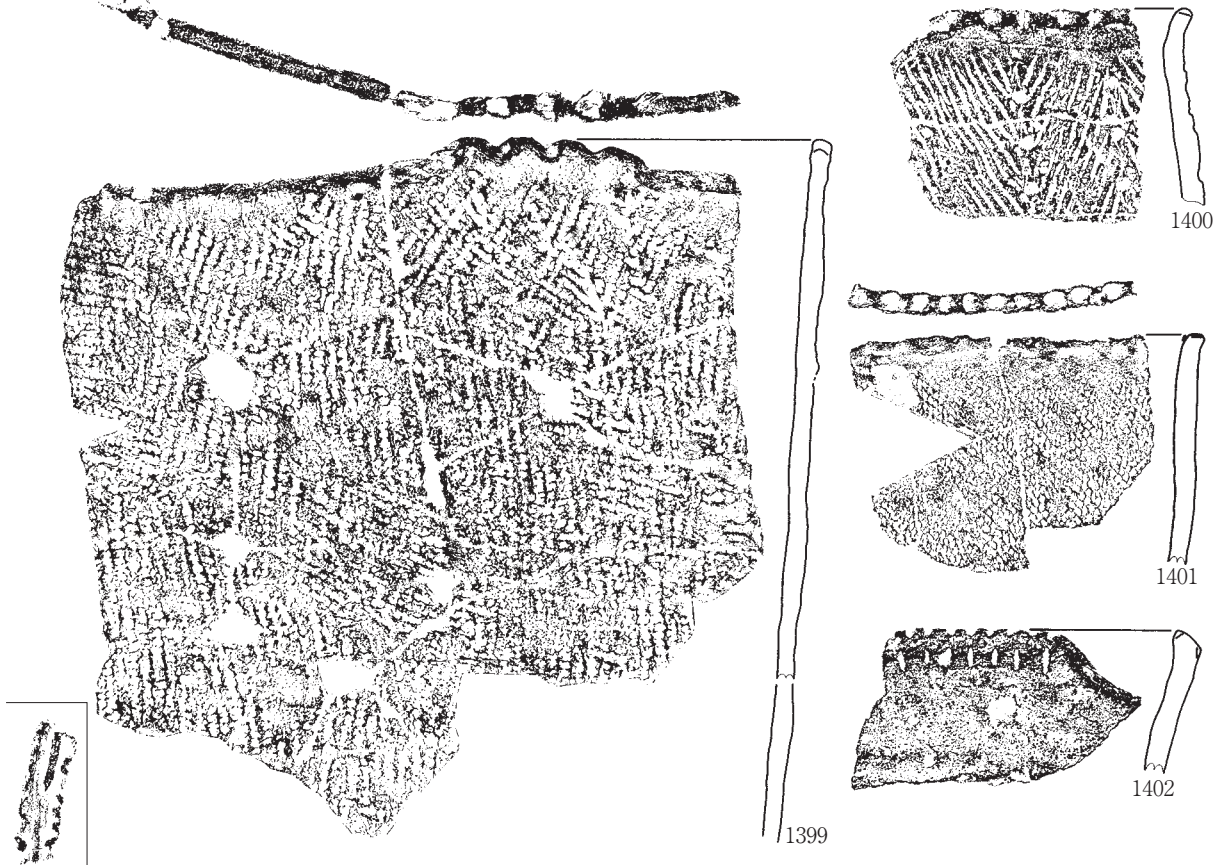

II C 10b, III C 1a



II C 10bc

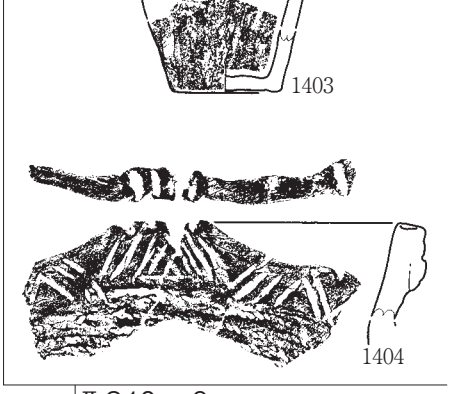

II C 10c · 9

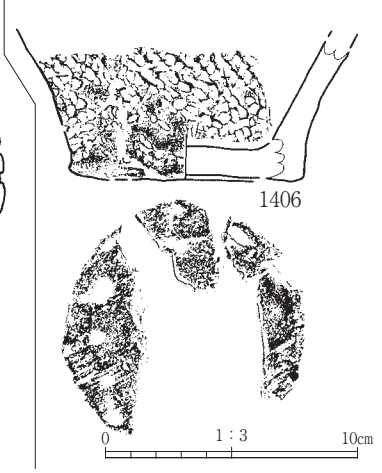

第395図 縄文土器 (147)

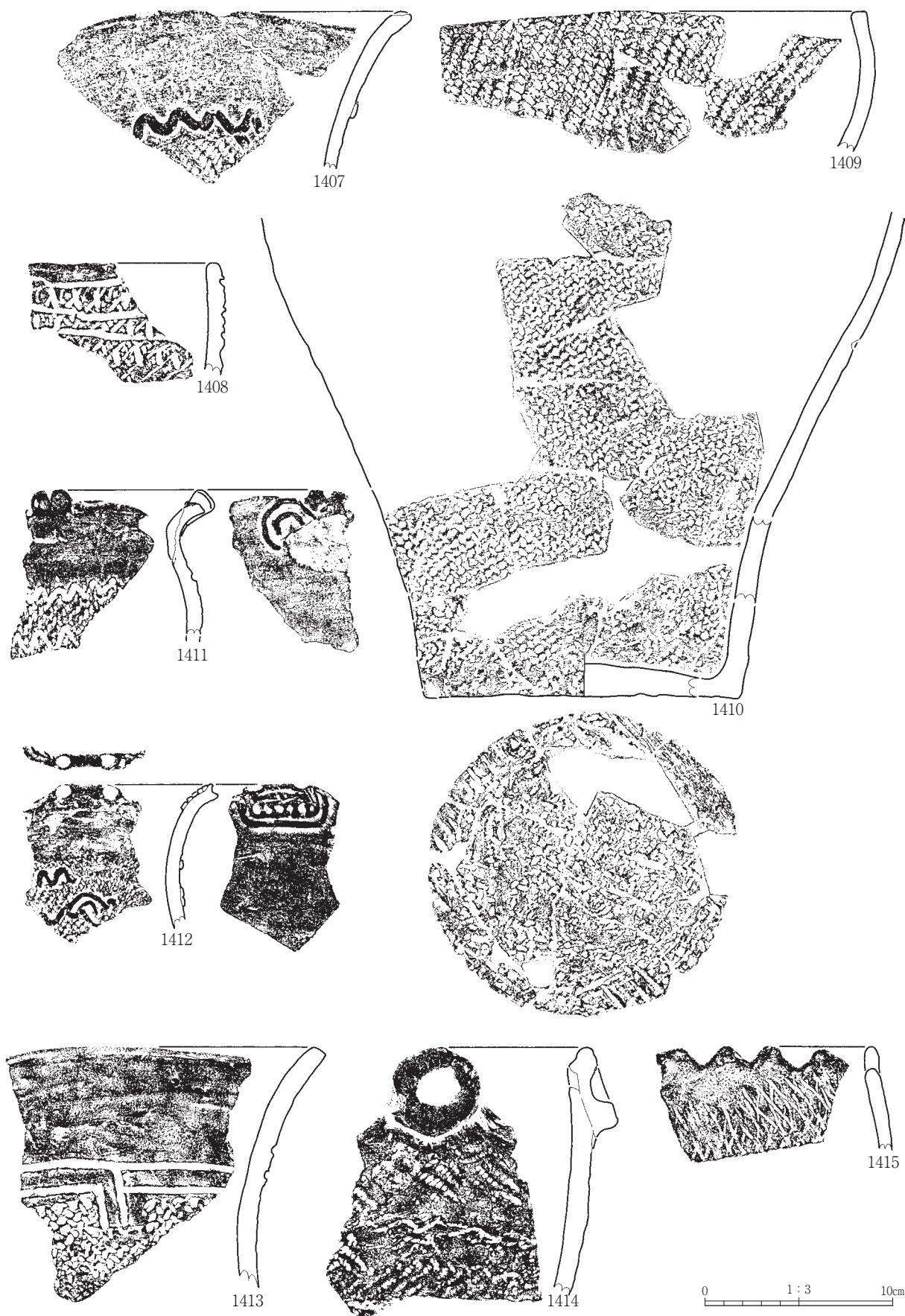

第396図 縄文土器 (148)

II C 10c (2)

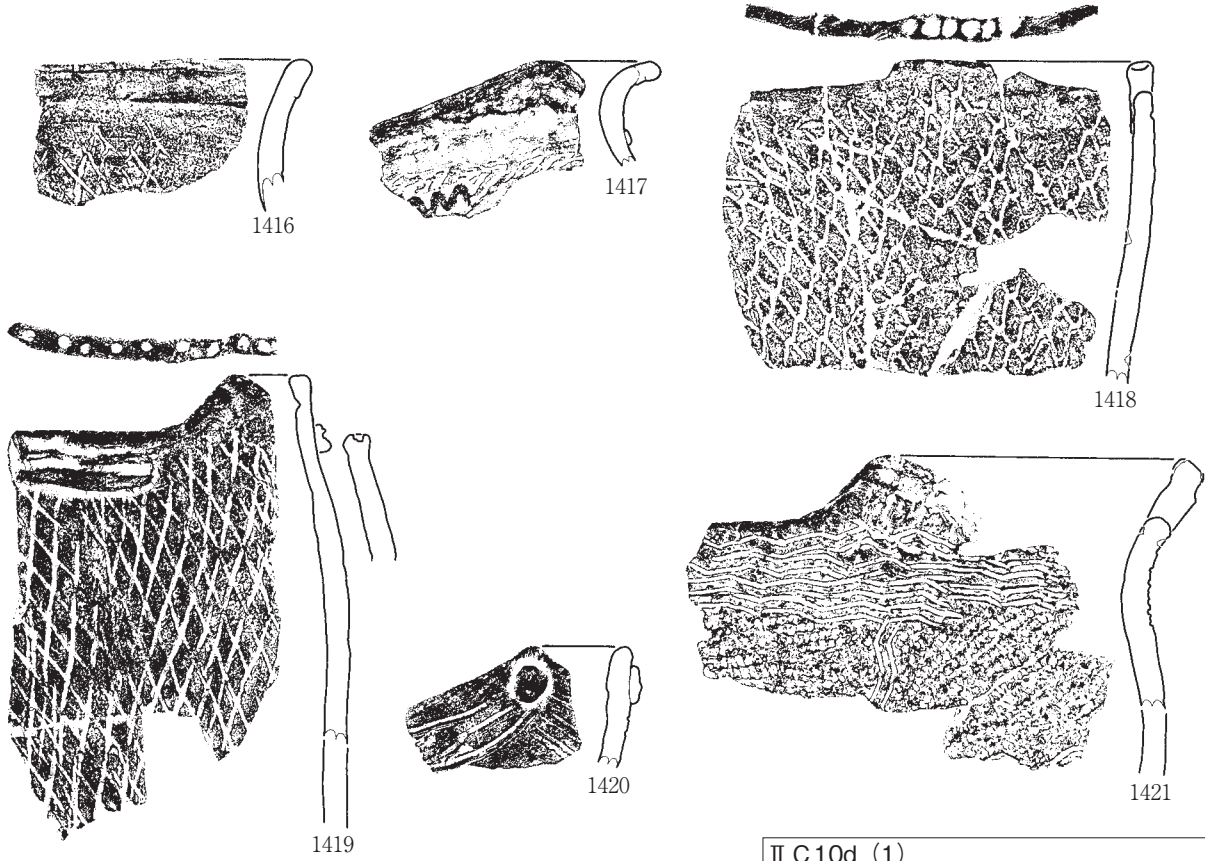

II C 10c, B 区

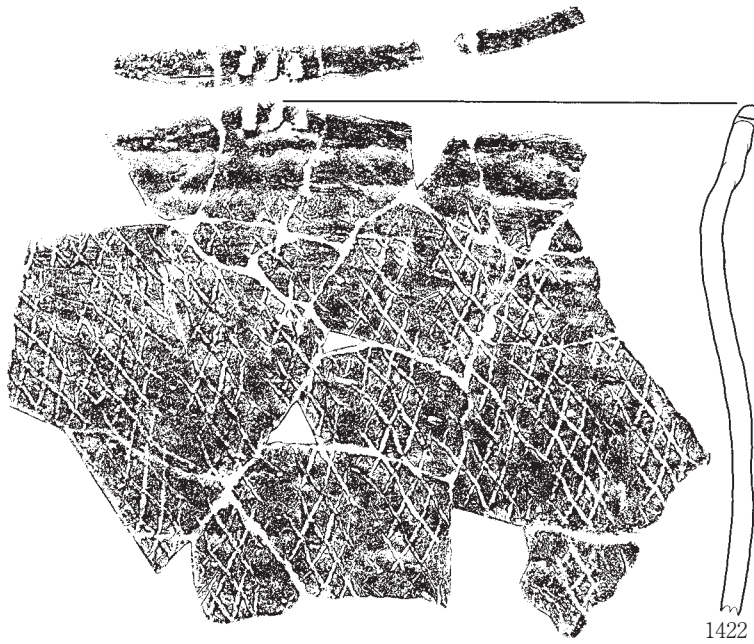

II C 10d (1)

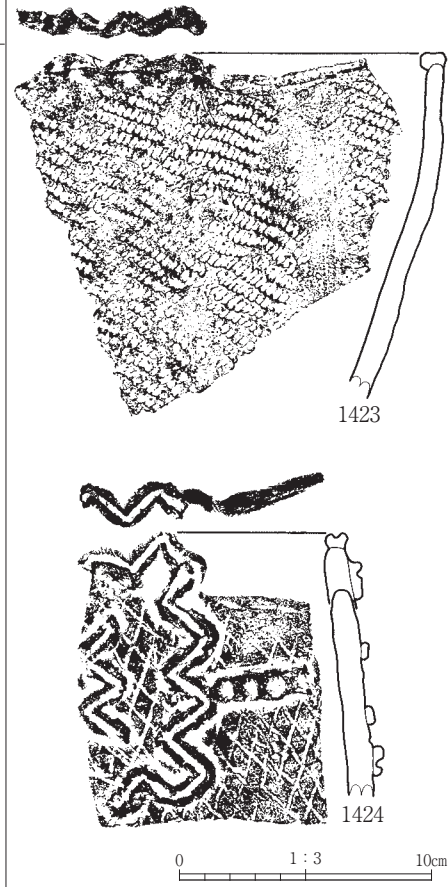

第397図 縄文土器 (149)

Ⅱ C 10d (2)

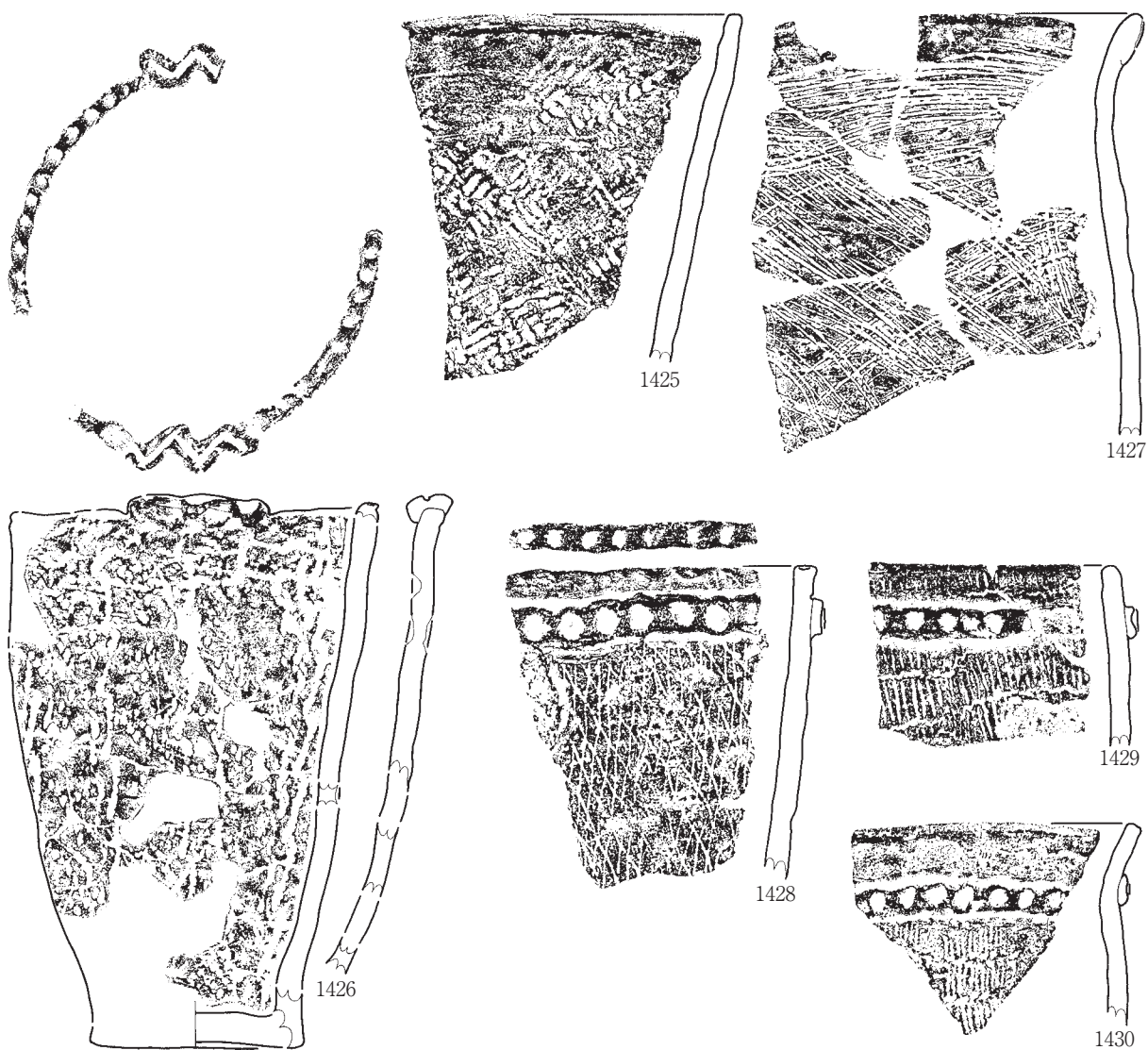

Ⅱ C 10d,ⅢC1b (1)

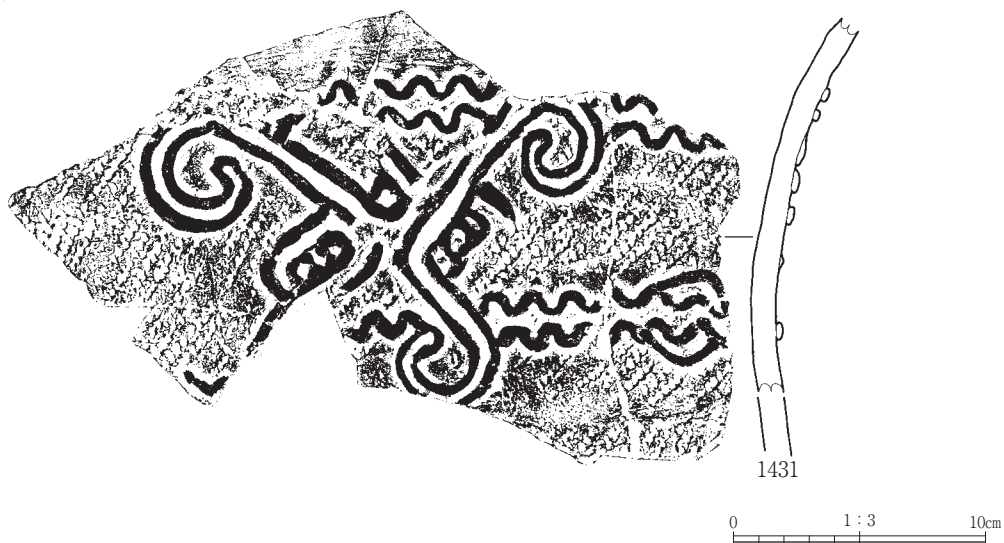

第398図 縄文土器 (150)

II C 10d, III C 1d (2)

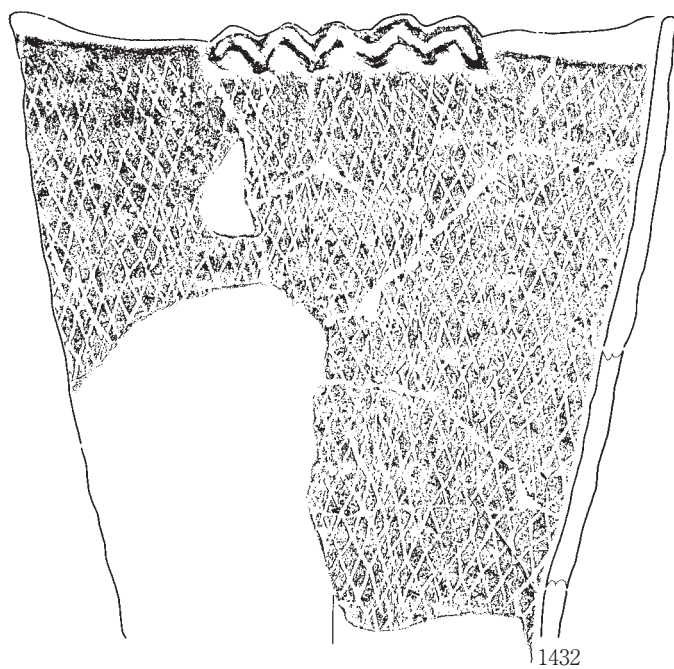

II C 10de

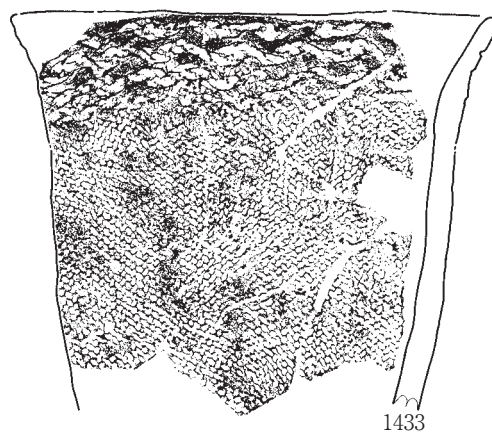

II C 10e

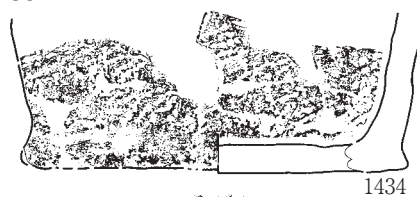

III B 1j

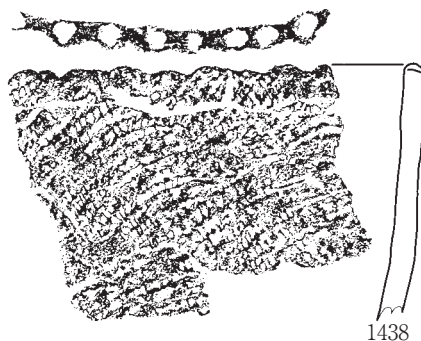
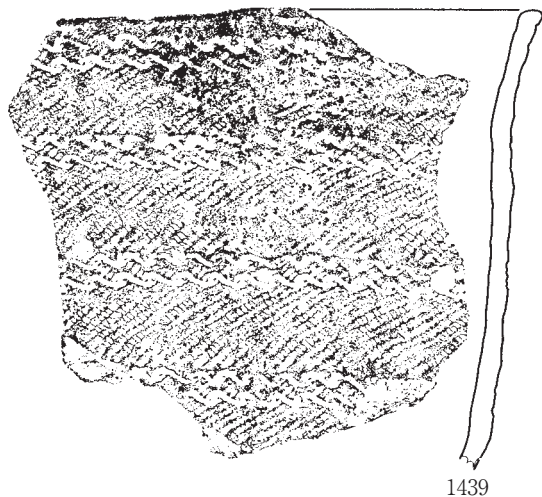
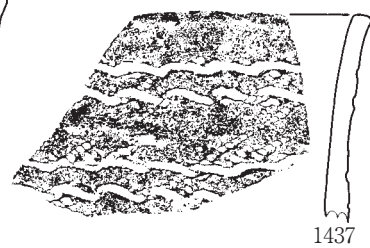
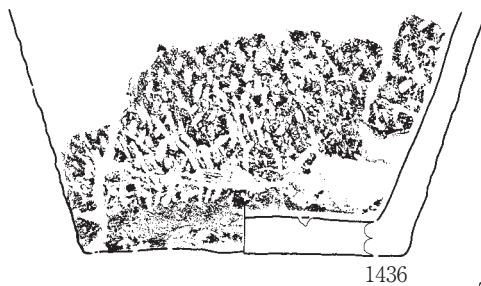

0 1:3 10cm

第399図 縄文土器 (151)

Ⅲ B 2j

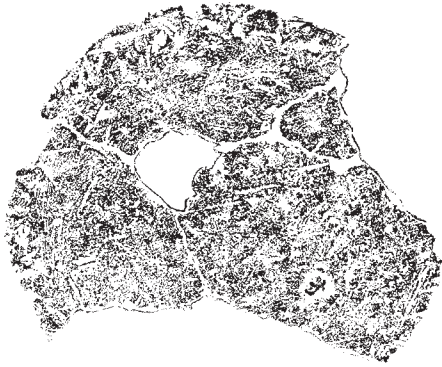
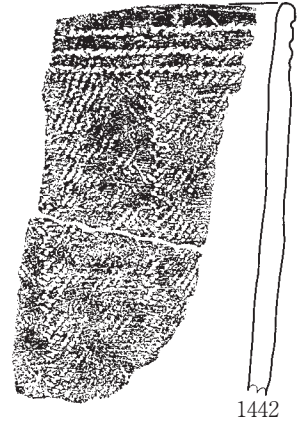
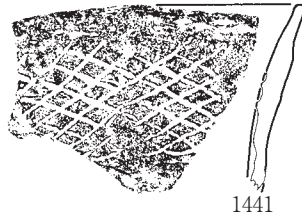

Ⅲ B 2・3j, Ⅲ B 3j



Ⅲ B 3j (1)

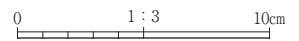
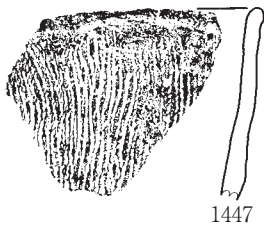
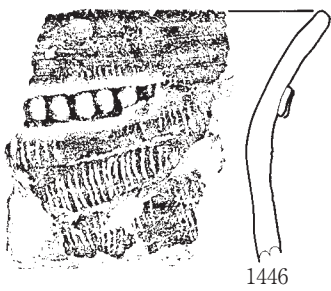
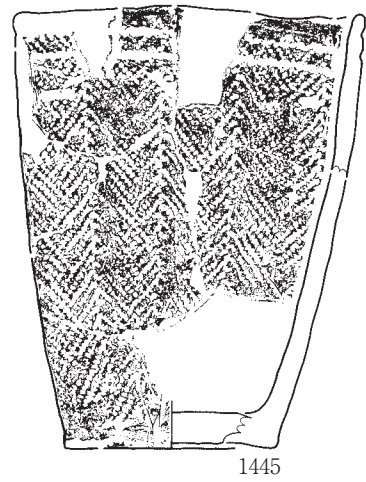

第400図 縄文土器 (152)



Ⅲ B3j (2)

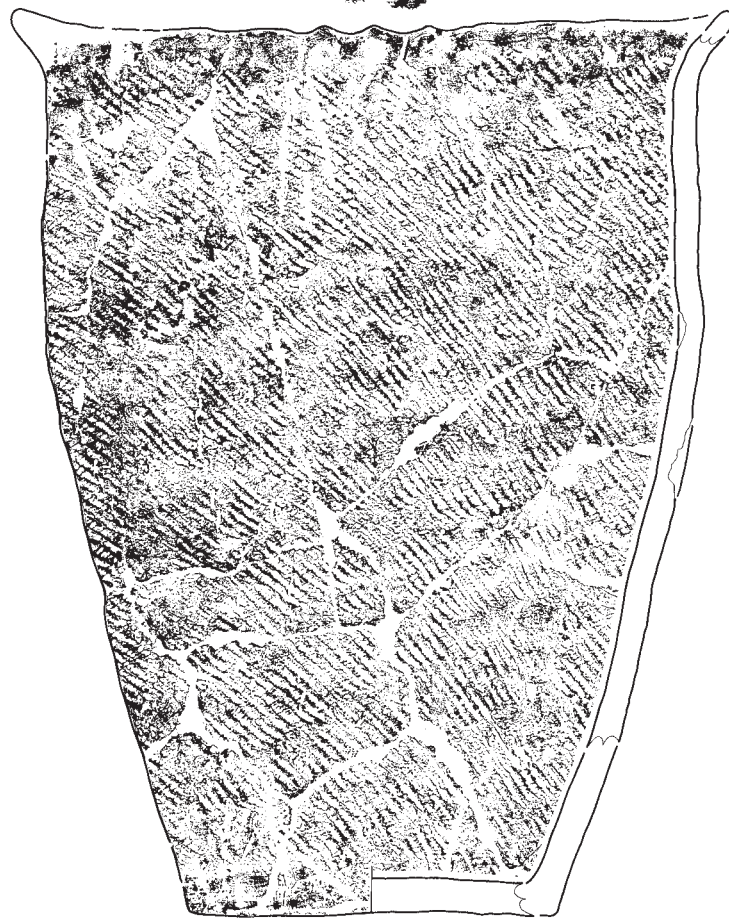

1449

0 1:3 10cm

第401図 縄文土器 (153)



1450

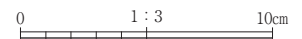

第402図 縄文土器 (154)

Ⅲ B3j (4)

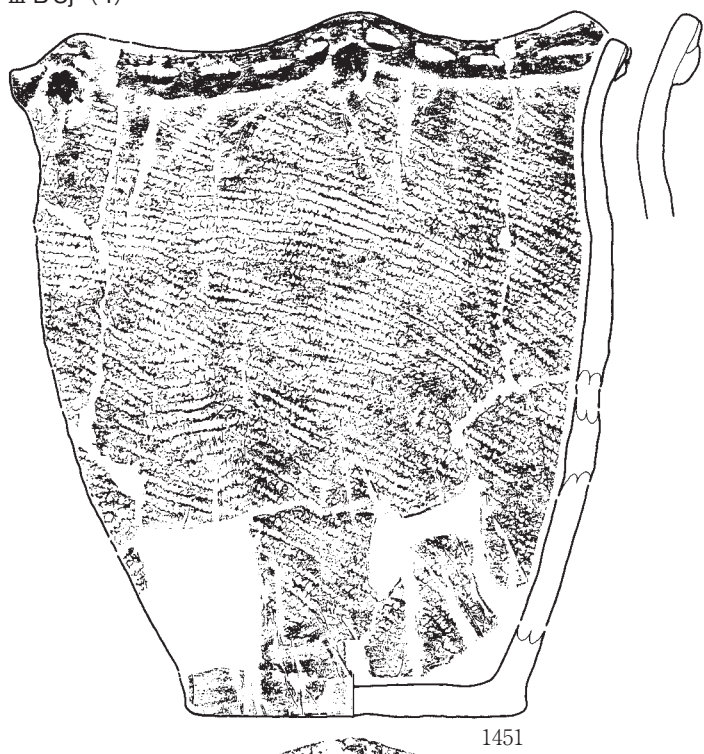

1451

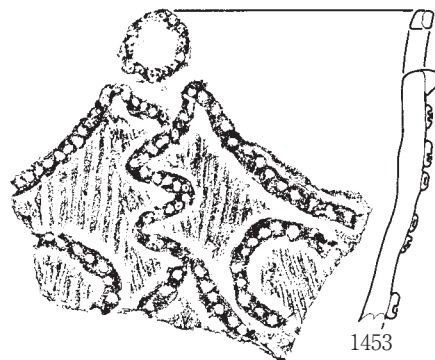

1453



1454

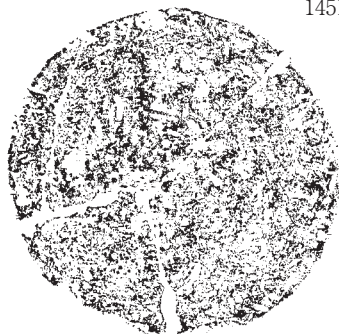

1452

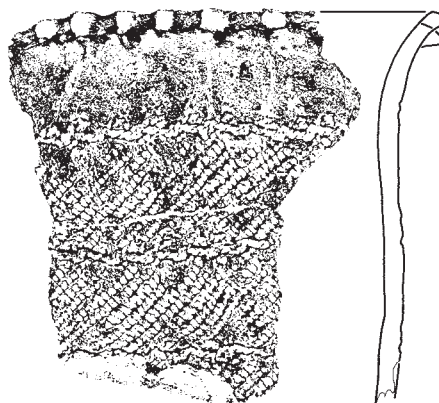

1455

Ⅲ B4j

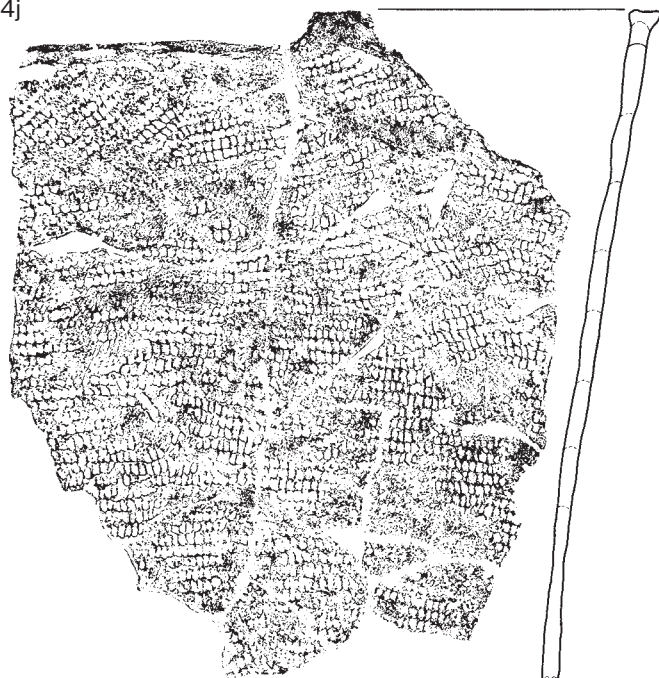

1457



1456

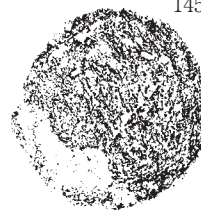

1458



0 1:3 10cm

第403図 縄文土器 (155)

Ⅲ B 4j, Ⅲ B 4 · 5ij, Ⅲ B 5j, Ⅲ C 1a



第404図 縄文土器 (156)

Ⅲ B 6i

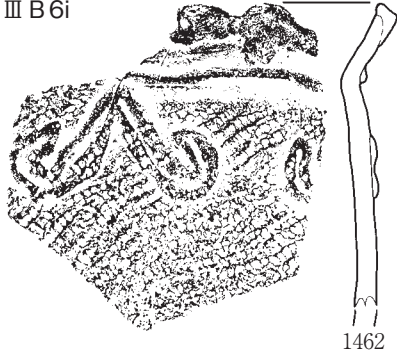

1462

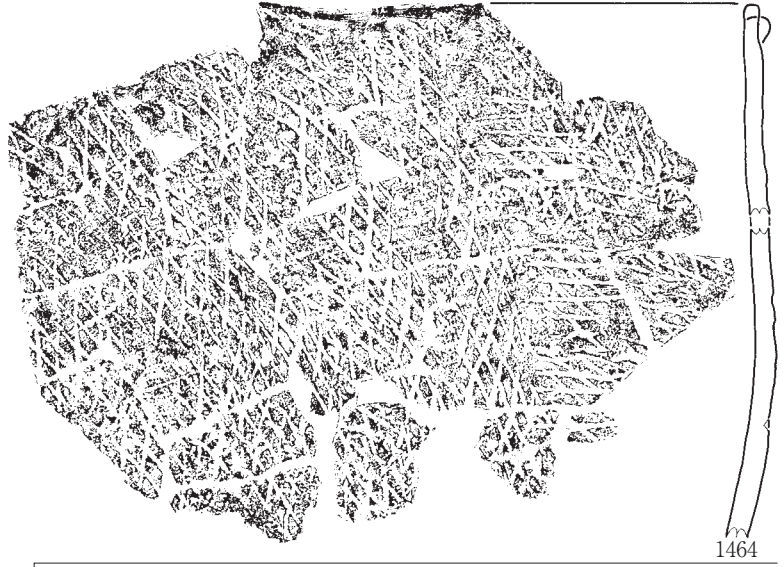

1464

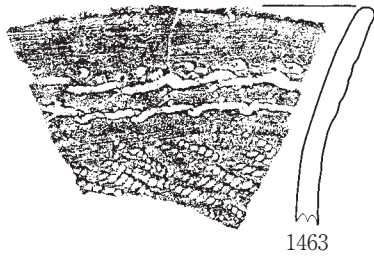

1463

Ⅲ B 7h



1465

Ⅲ B 7i (1)

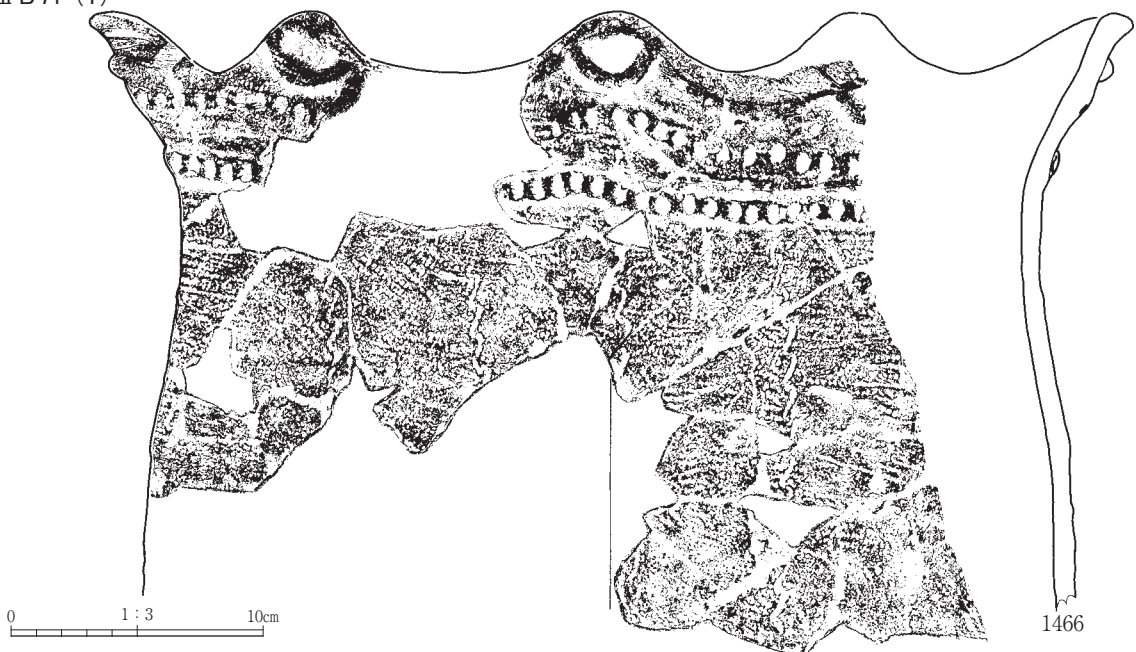

1466

第405図 縄文土器 (157)

Ⅲ B 7i (2)

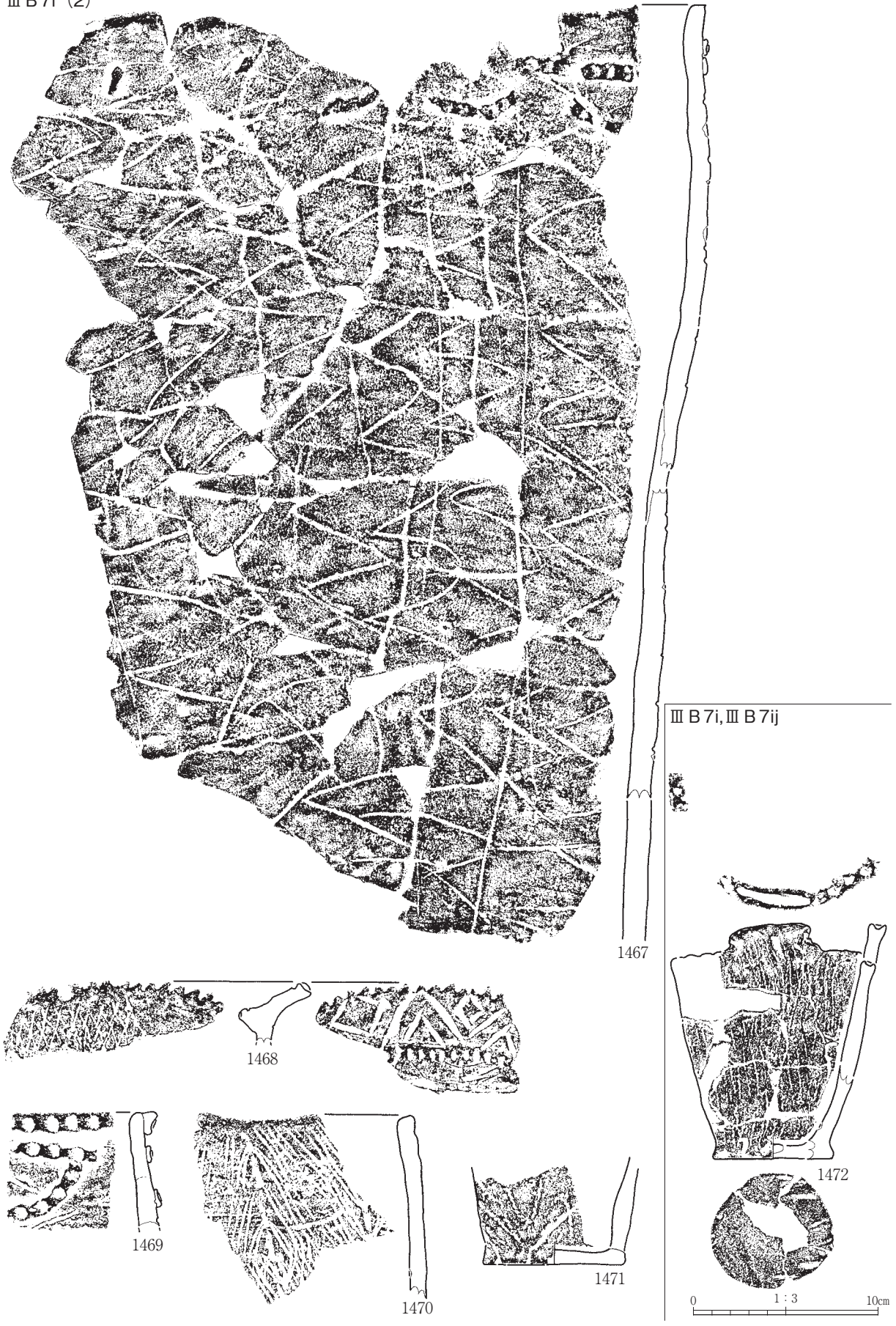

第406図 縄文土器 (158)

Ⅲ B 7・8i

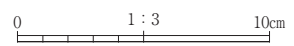
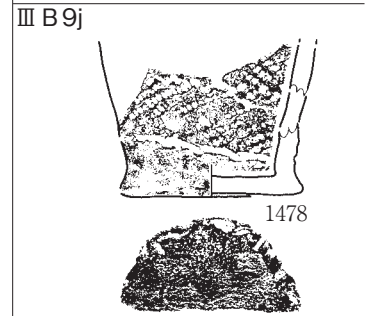
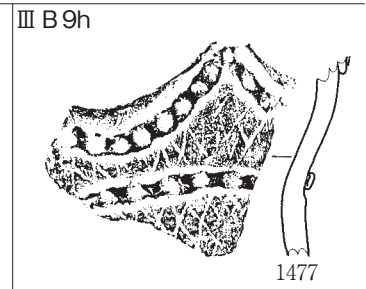
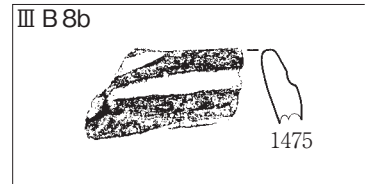
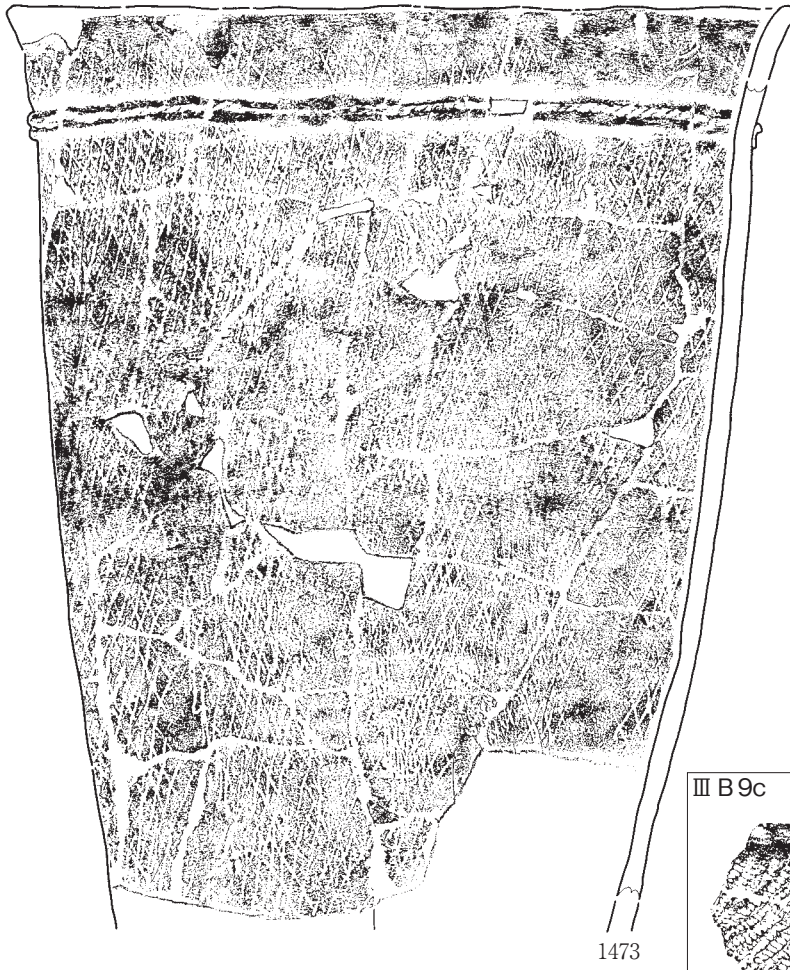

第407図 縄文土器 (159)

Ⅲ B 10j

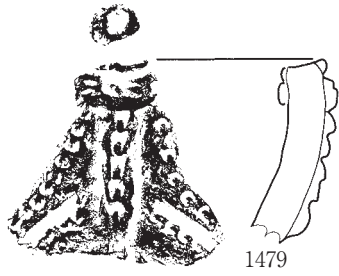

1479

Ⅲ B 10j, IV B 1i, IV B 1j

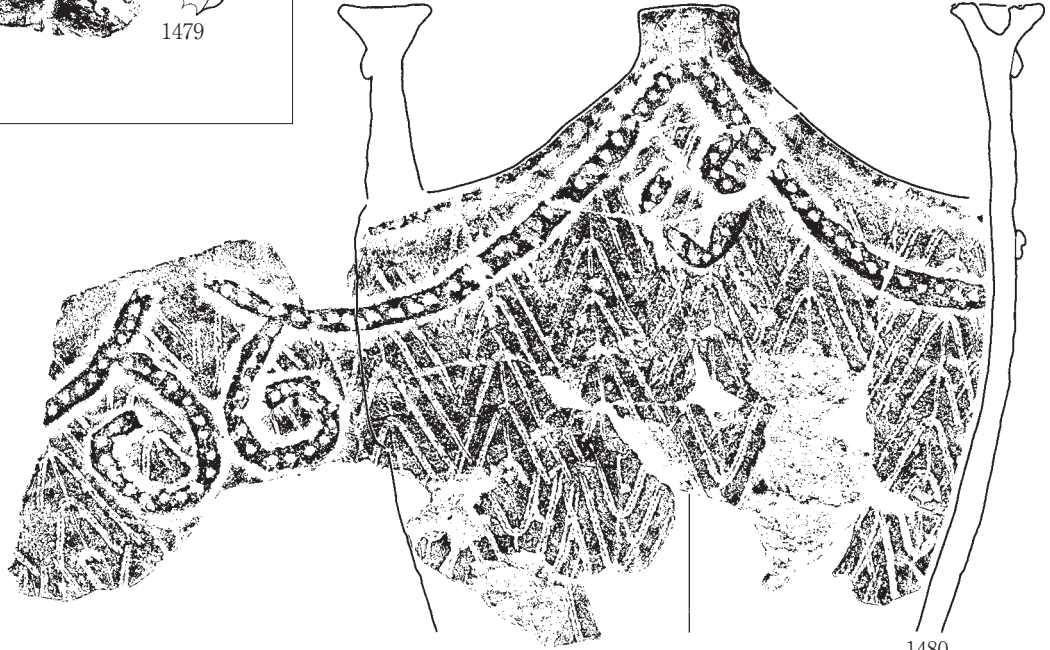

1480

Ⅲ C 1a (1)

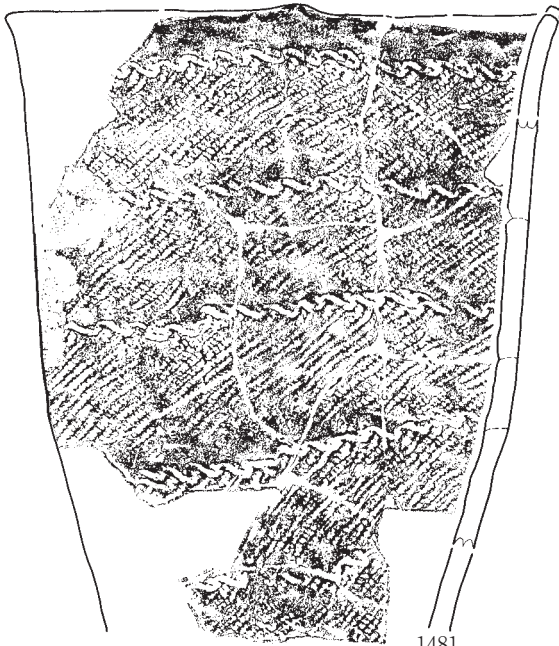

1481

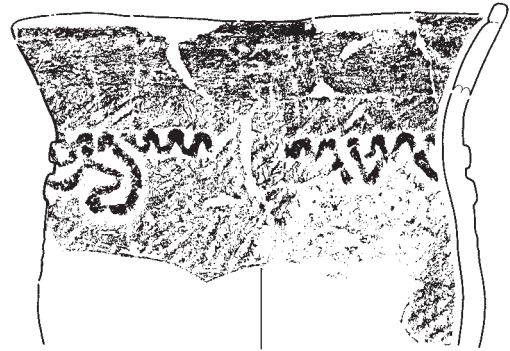

1482

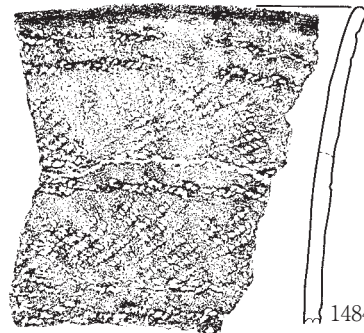

1484



1483

0 1:3 10cm

第408図 縄文土器 (160)



Ⅲ C1a (2)



1485



1486

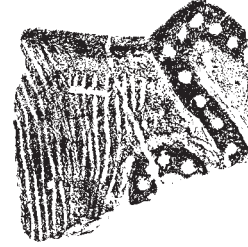

1487



1488

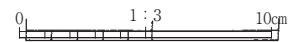

第409図 縄文土器 (161)

Ⅲ C1a (3)

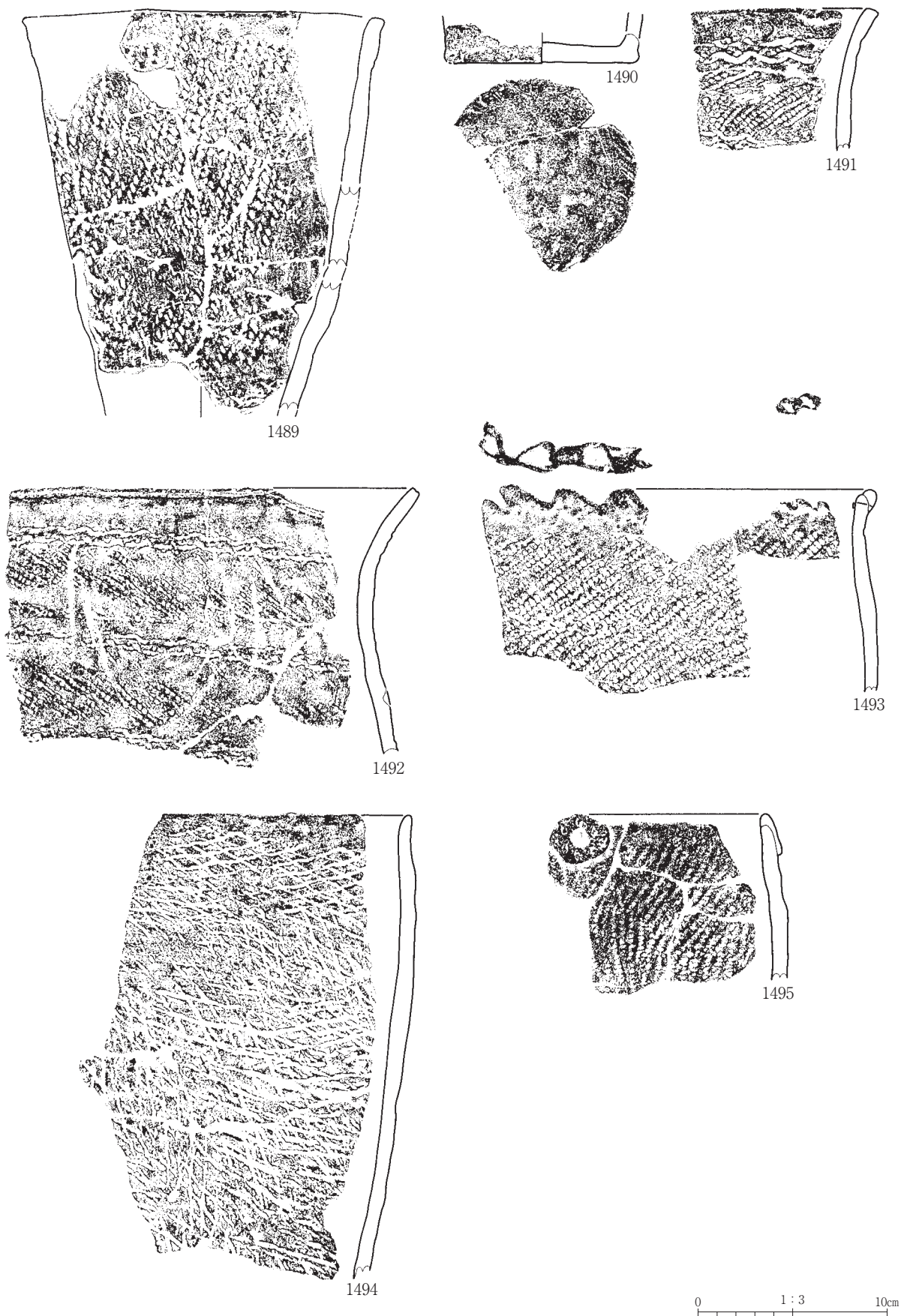

第410図 縄文土器 (162)

Ⅲ C 1b

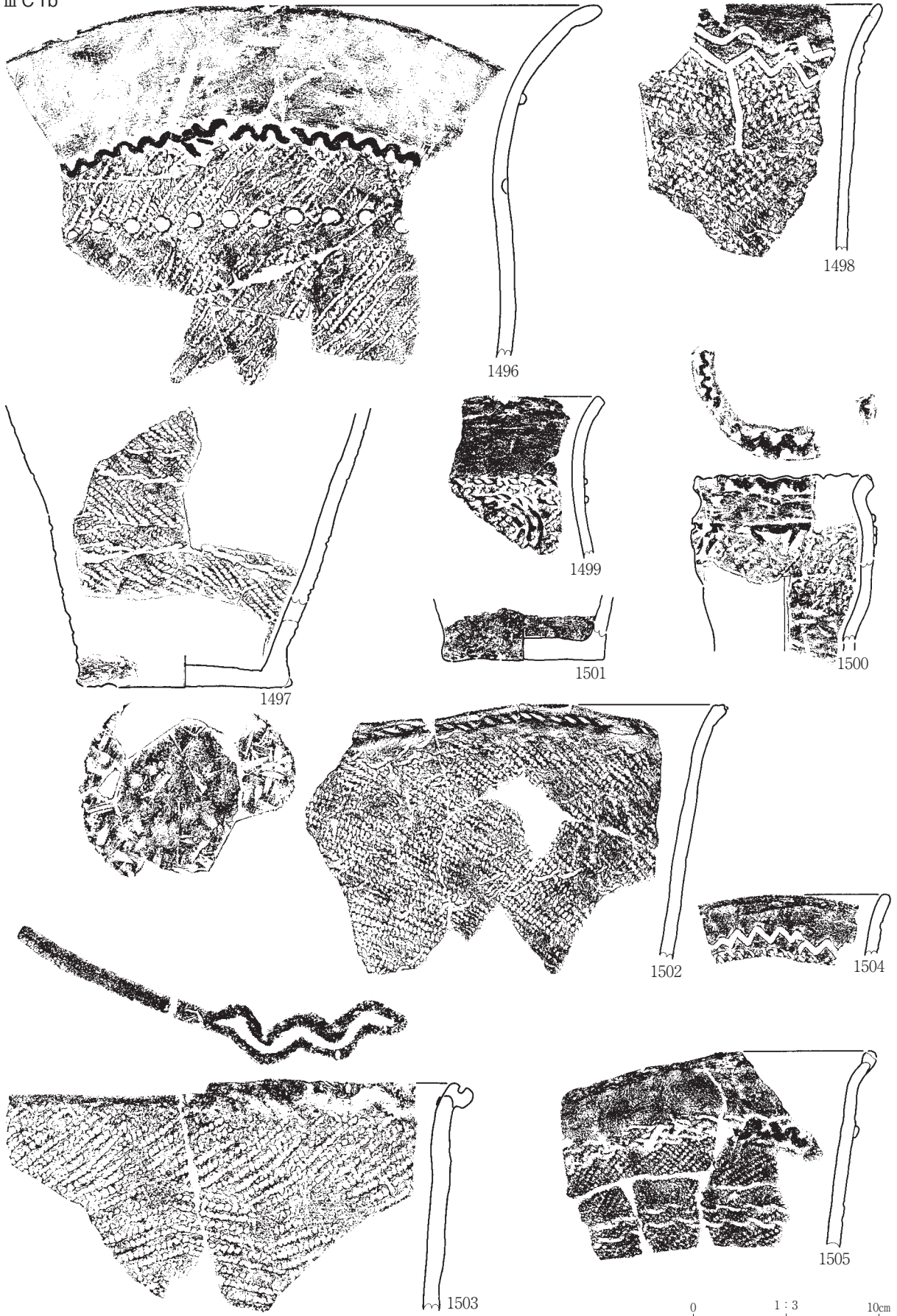

第411図 縄文土器 (163)

Ⅲ C 1b, Ⅲ C 1 · 2b

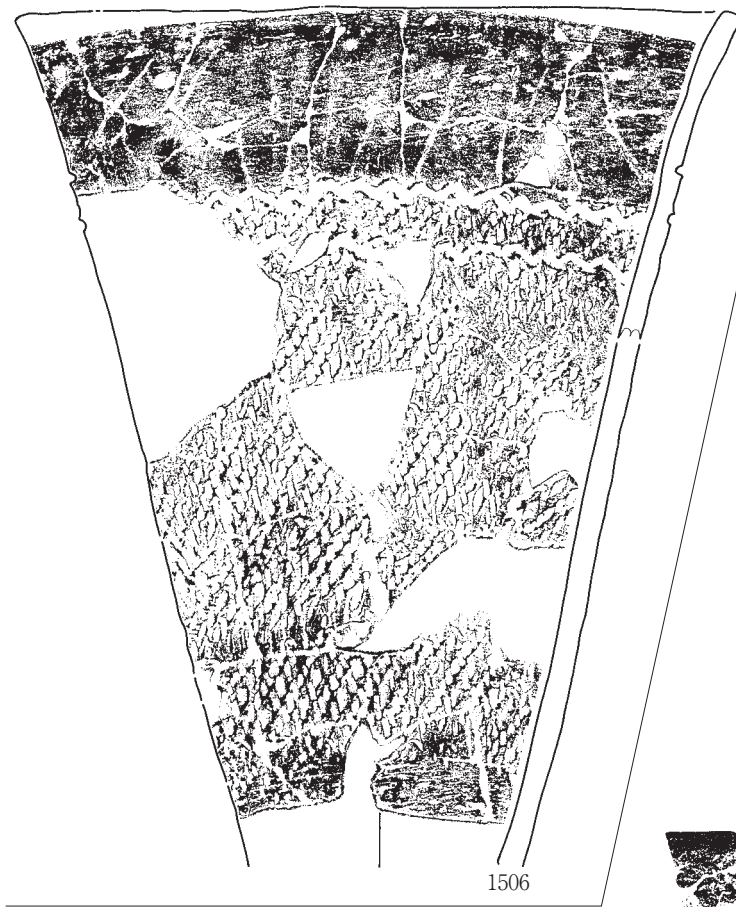

Ⅲ C 1 · 2b



Ⅲ C 1c (1)

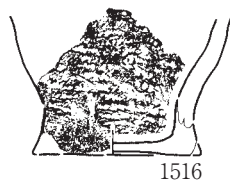
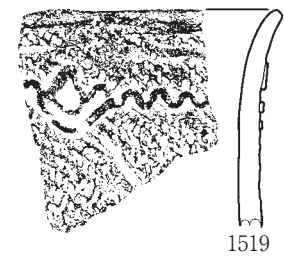
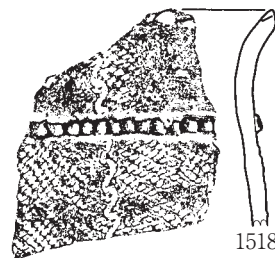
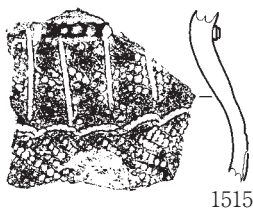
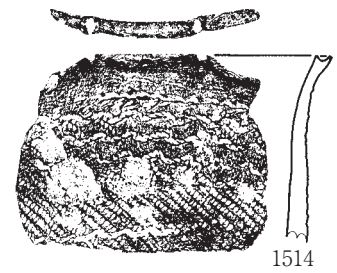
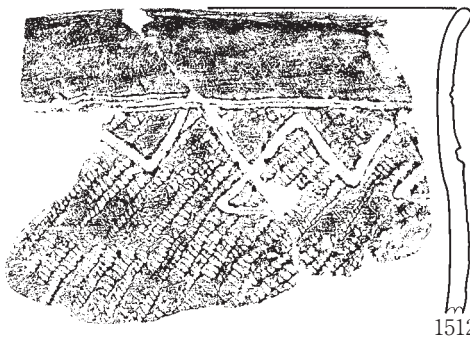
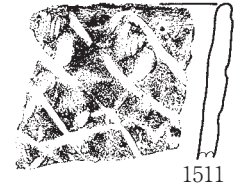
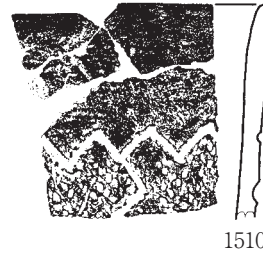
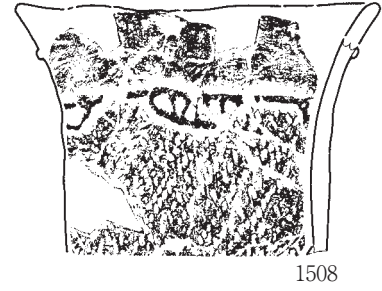

0 1:3 10cm

第412図 縄文土器 (164)

Ⅲ C1c (2)

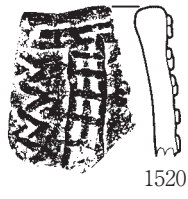

1520

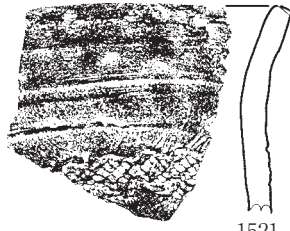

1521

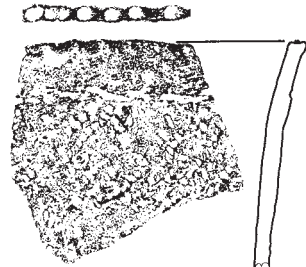

1522

Ⅲ C1・2c

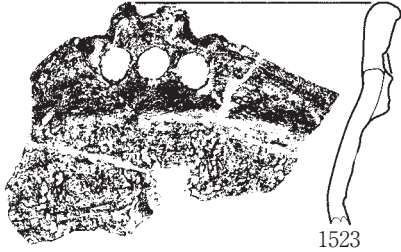

1523

Ⅲ C1d (1)

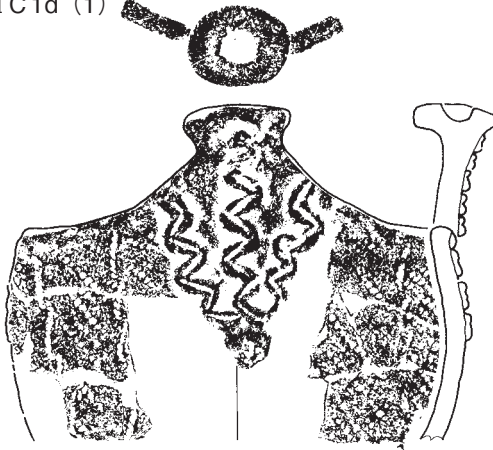

1524



1525

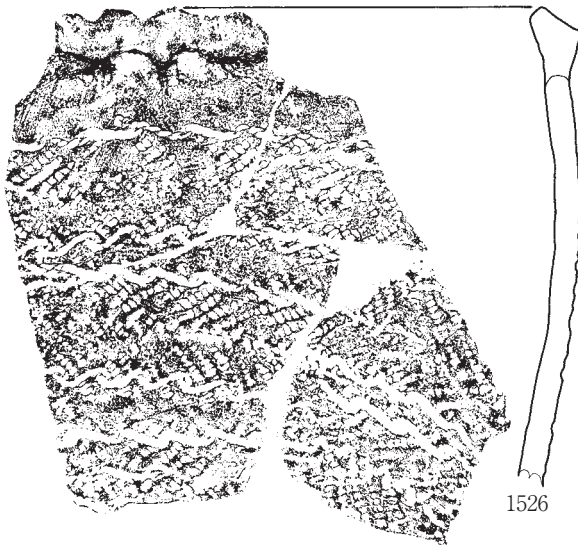

1526

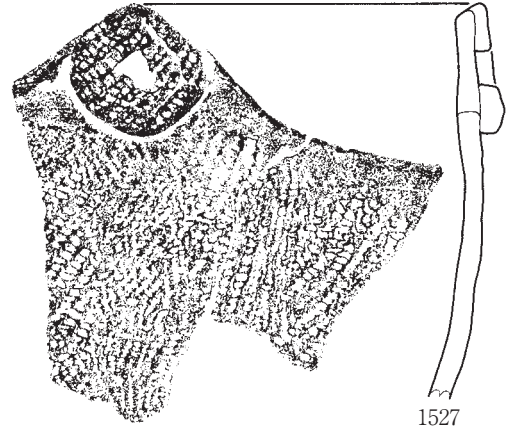

1527

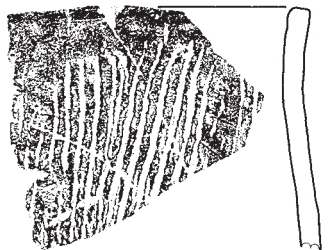

1528

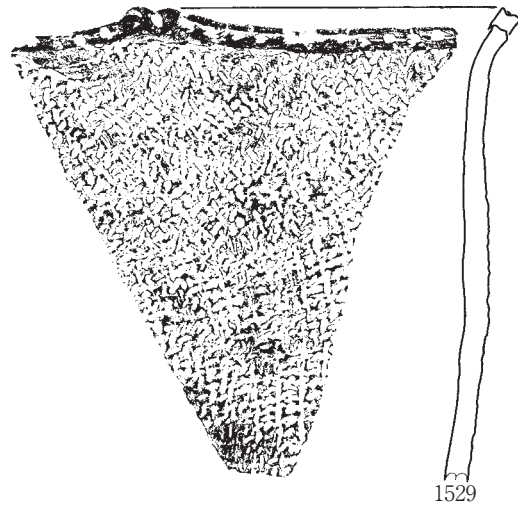

1529

0 1:3 10cm

第413図 縄文土器 (165)

III C1d (2)

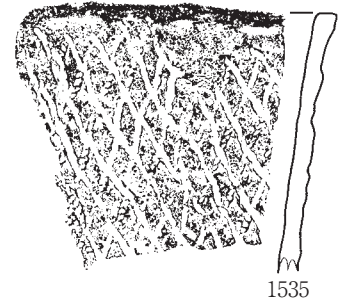
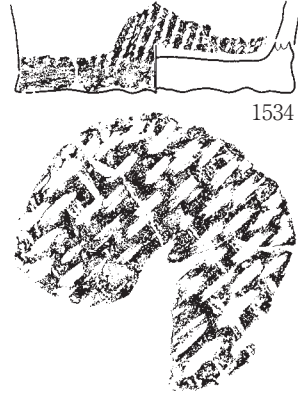
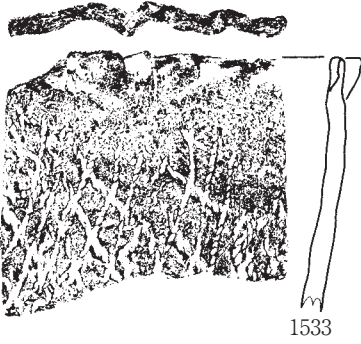
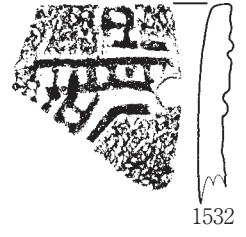
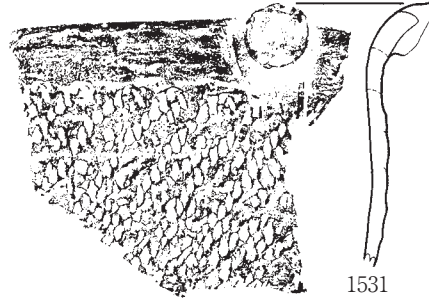
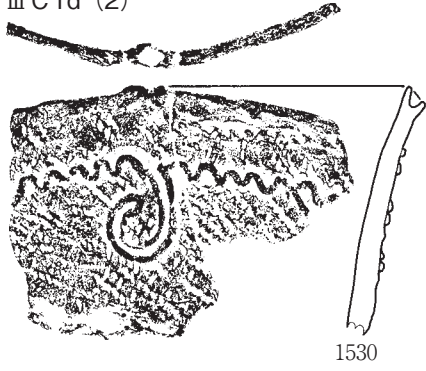

III C1 · 2d

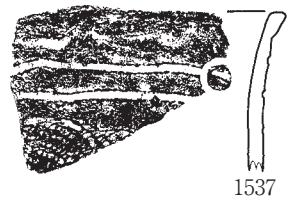
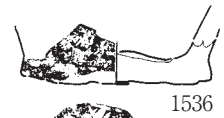
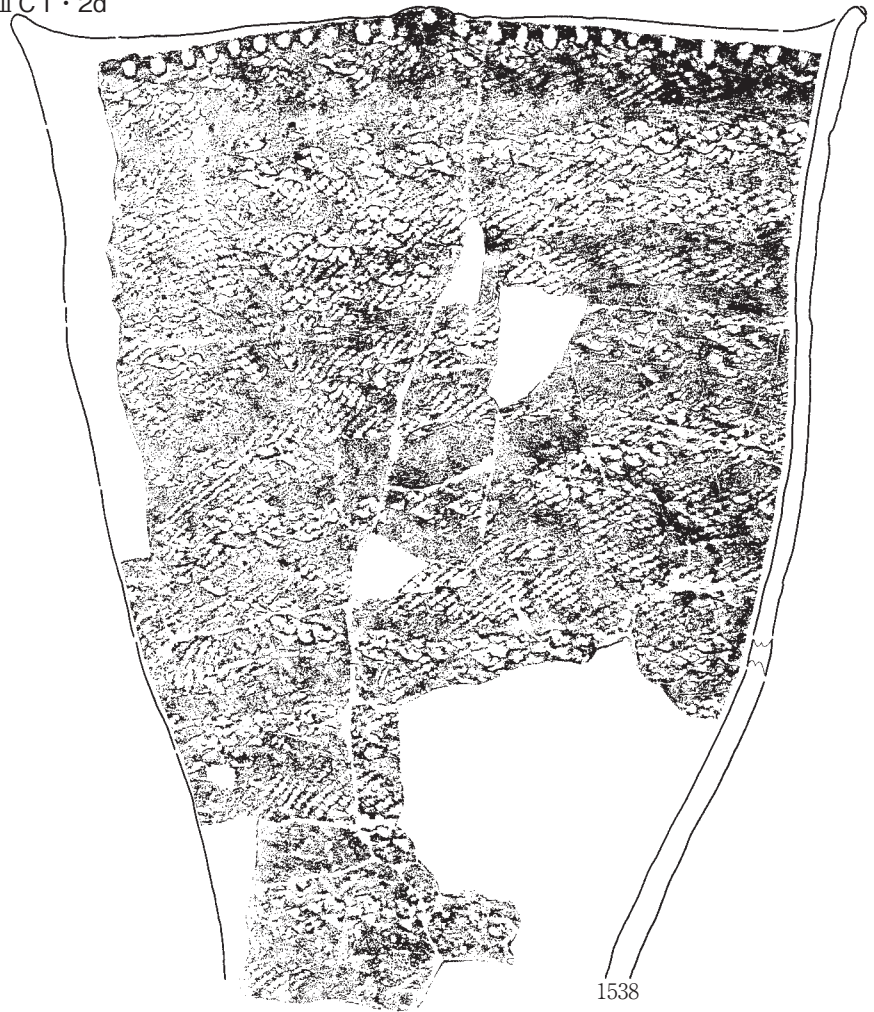

III C1de

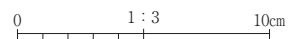
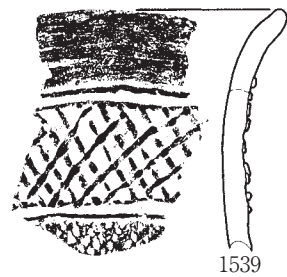

第414図 縄文土器 (166)

Ⅲ C1e

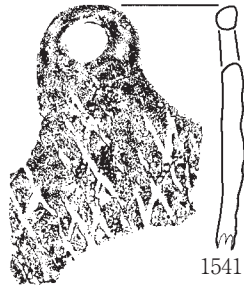
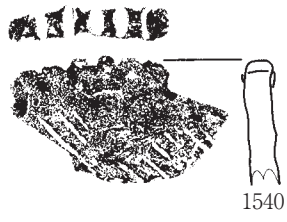

Ⅲ C2a (1)

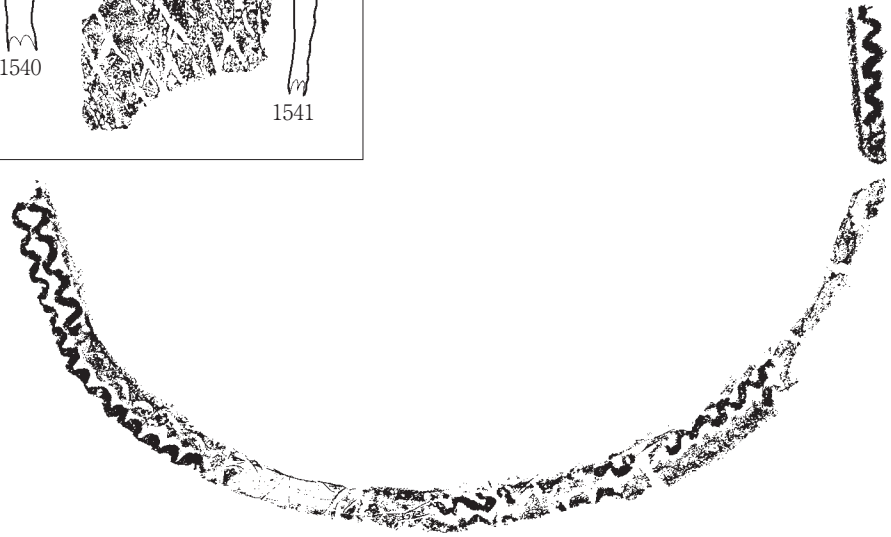

0 1:3 10cm

第415図 縄文土器 (167)

III C2a (2)

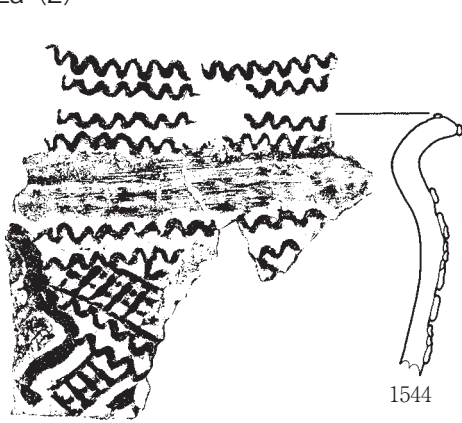

1544

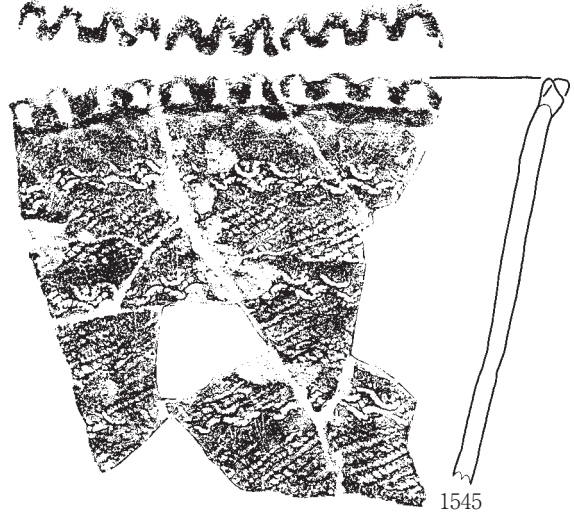

1545

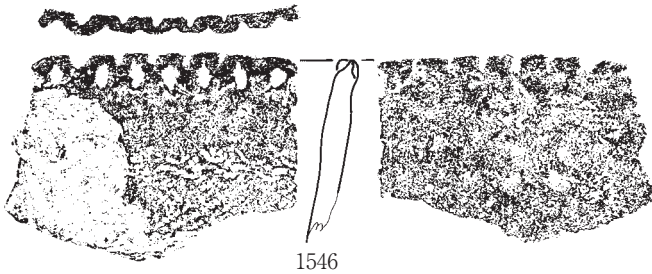

1546

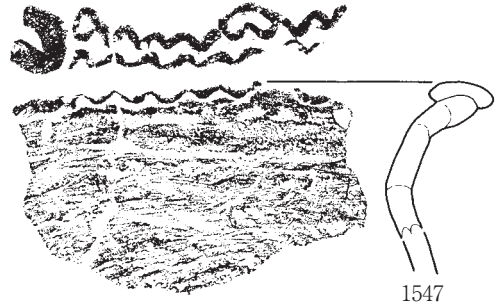

1547

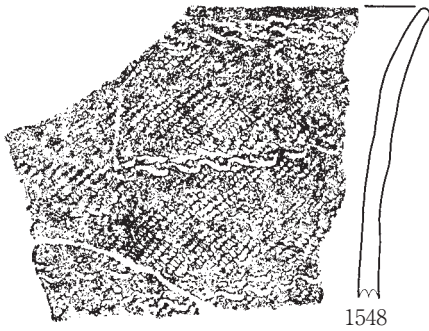

1548

III C2d



1549

III C3a (1)

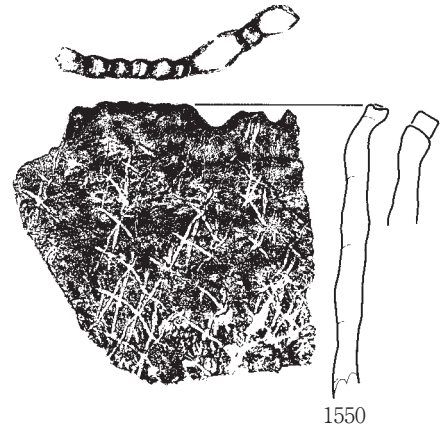

1550

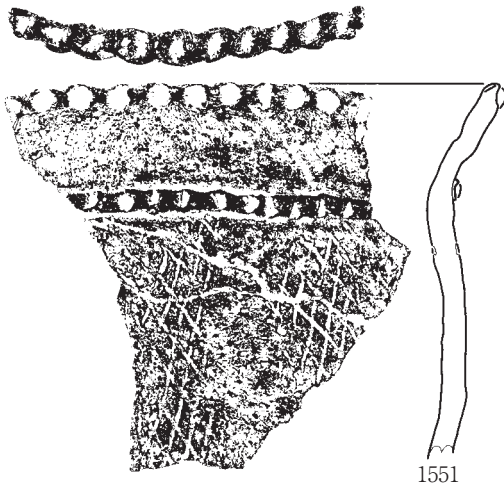

1551



1552

0 1:3 10cm

第416図 縄文土器 (168)



III C 3a (2)

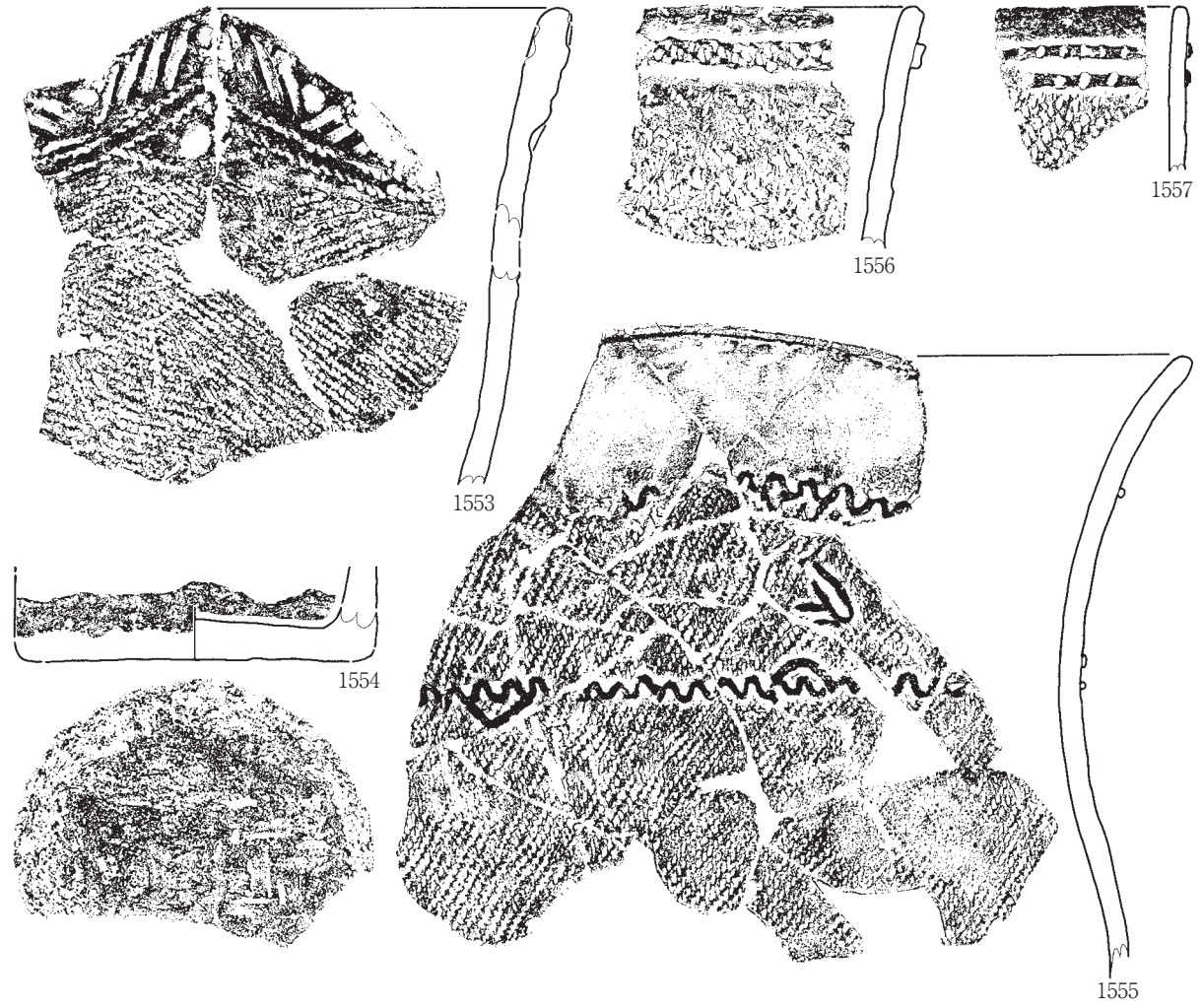

III C 4a

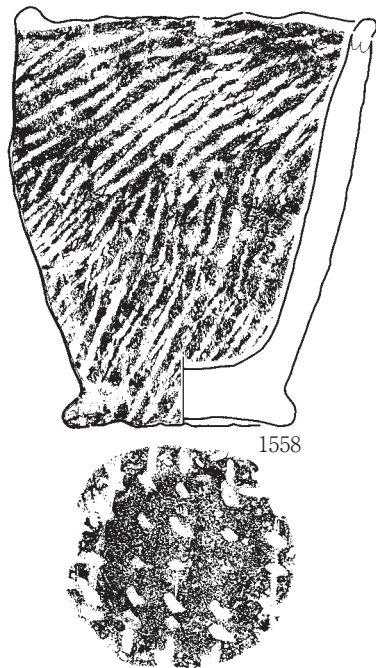

III C 4a · III C 4j

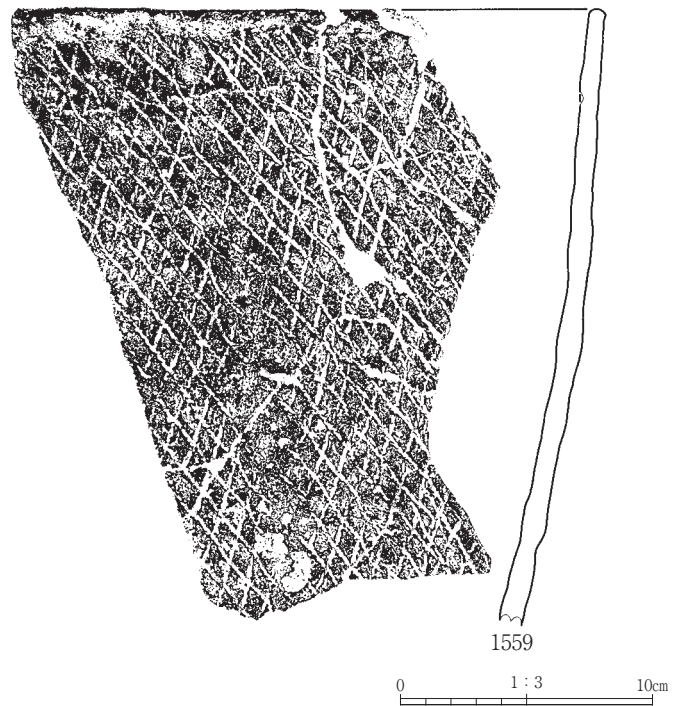

第417図 縄文土器 (169)

III C 5a

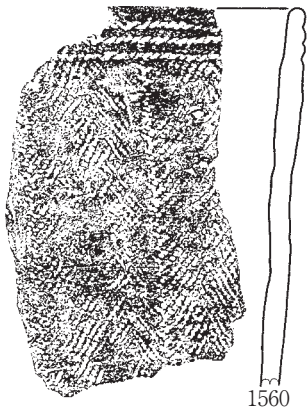

1560

III C 8d

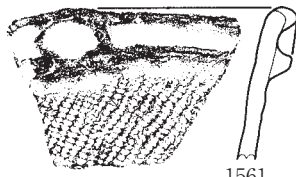

1561

III C 8d, III C 9d

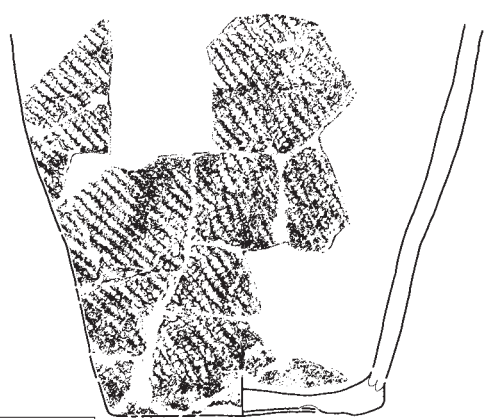

1562

III C 8e

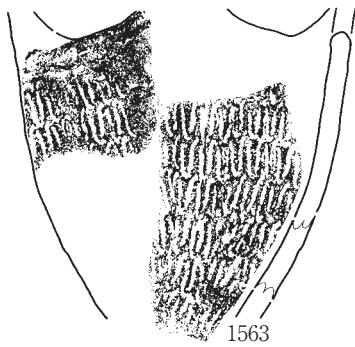

1563

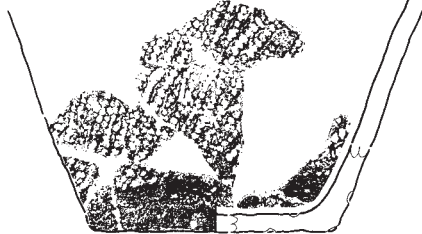

1564



III C 8f

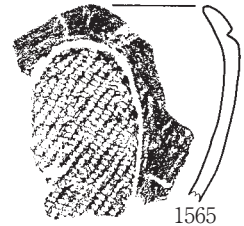

1565

III C 8h

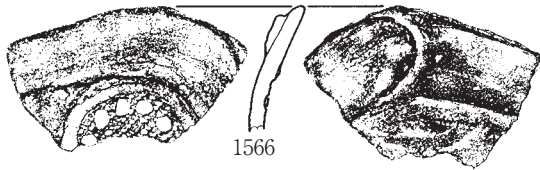

1566

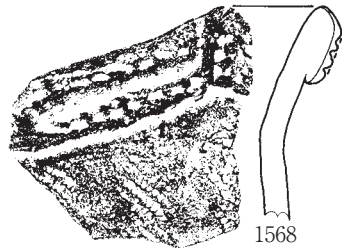

1568

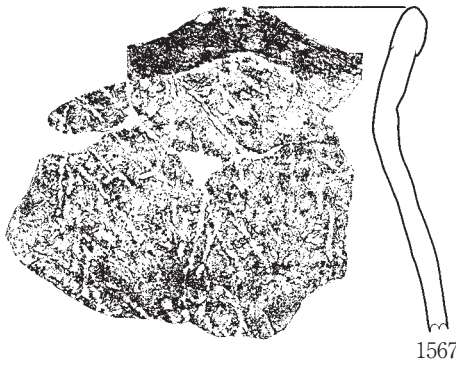

1567

III C 8h, III C 10h

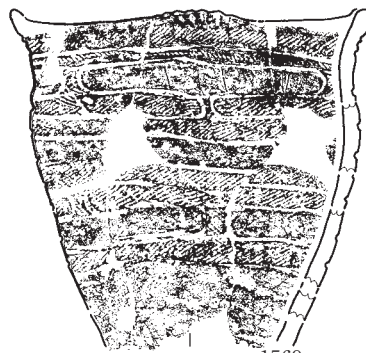

1569

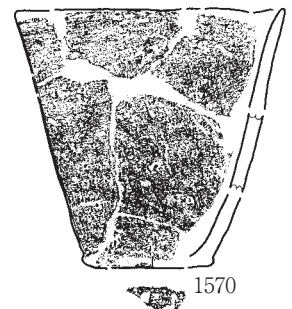

1570

0 1 : 3 10cm

第418図 縄文土器 (170)

III C8j

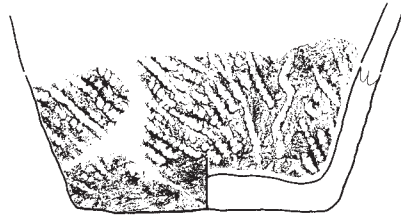

1571

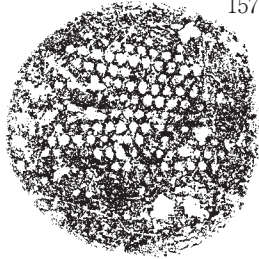

1572

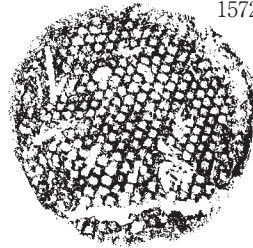

1573

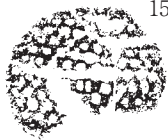

1574

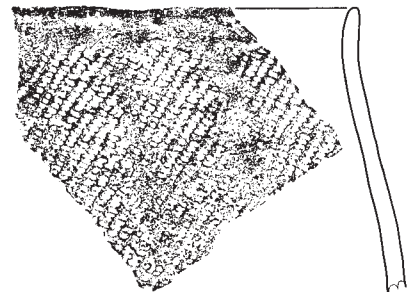
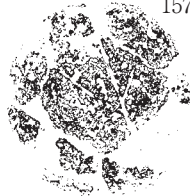

1575

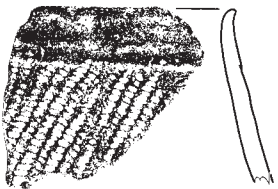

1576

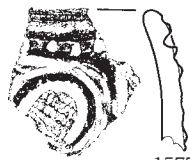

1577

III C9f (1)

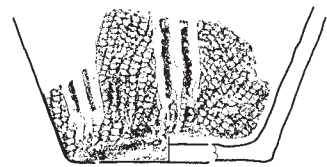

1583

III C9b



1578

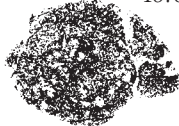

1579

III C9d



1580

III C9e



1581

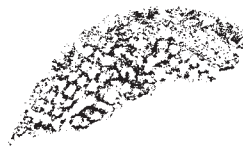

1582



1584

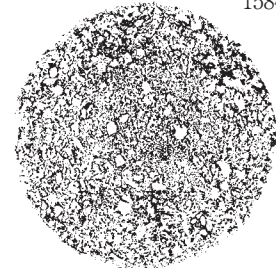

0 1:3 10cm

第419図 縄文土器 (171)

III C9f (2)

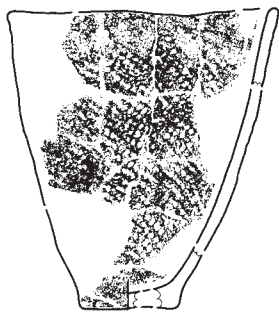

1585

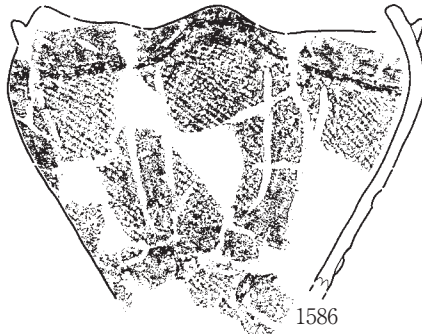

1586

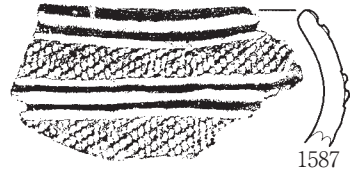

1587



1588

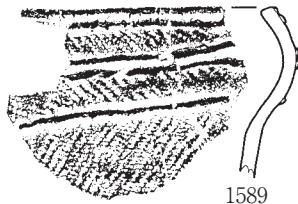

1589



1590

III C9g



1593

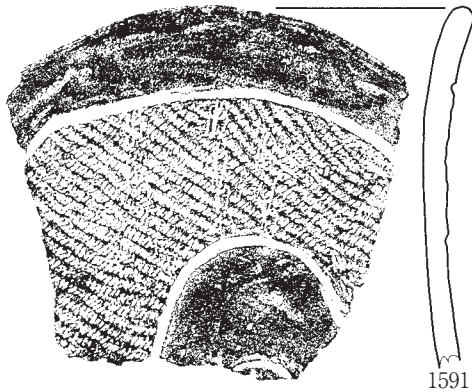

1591



1592



1595

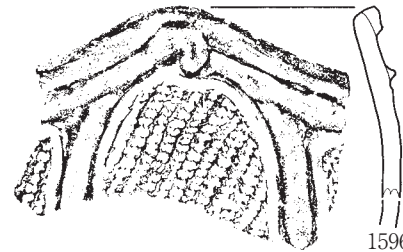

1596



1594

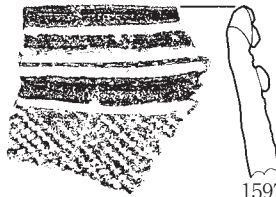

1597

III C9j



1600

III C9h



1598

III C9i

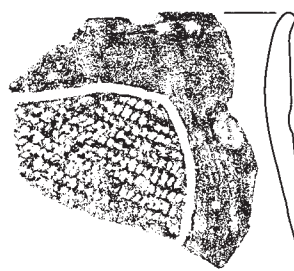

1599

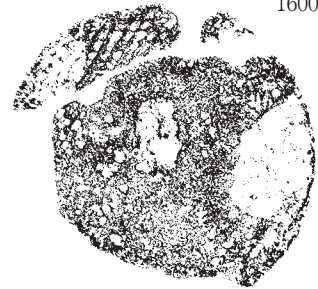

0 1:3 10cm

第420図 縄文土器 (172)

III C 10b

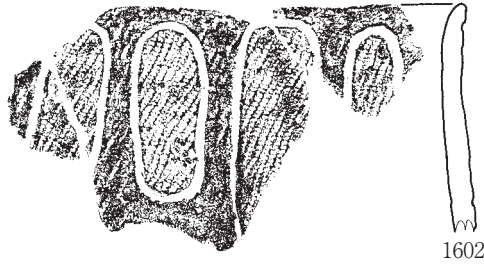
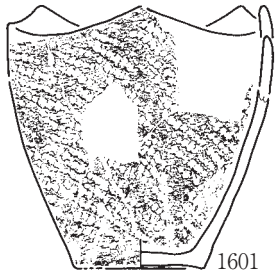

III C 10d

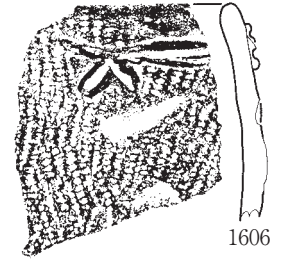

III C 10c

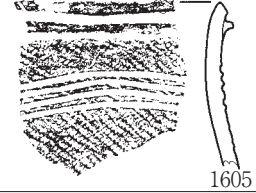
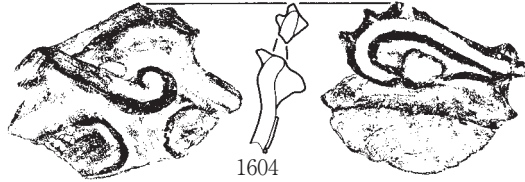
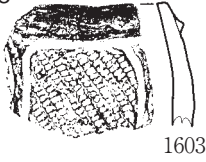

III C 10f

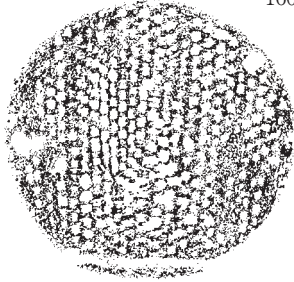
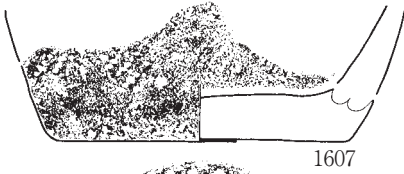

III C 10g

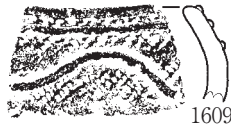
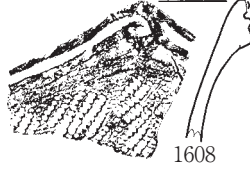

III C 10h

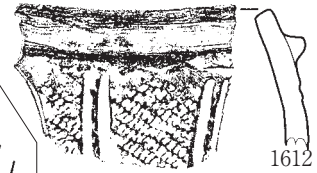
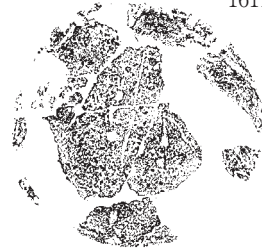
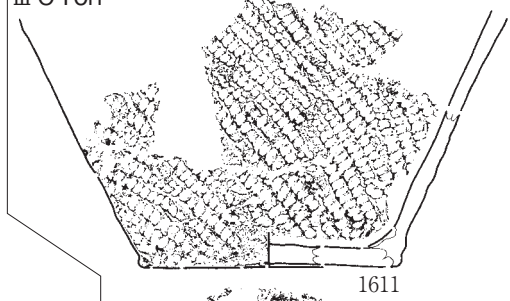

III C 10i

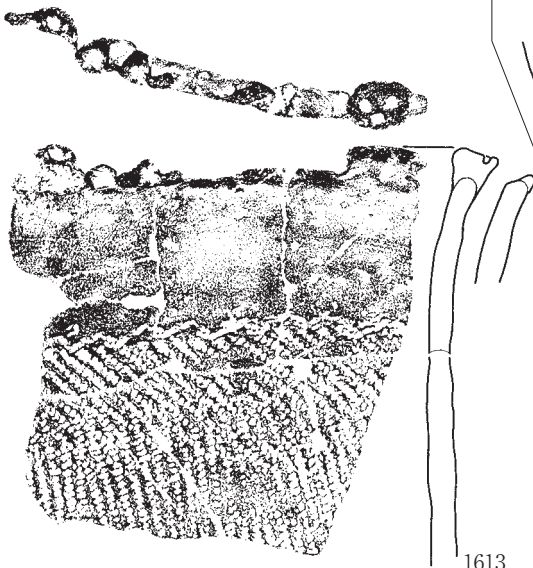

III D 7b

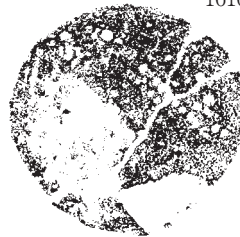
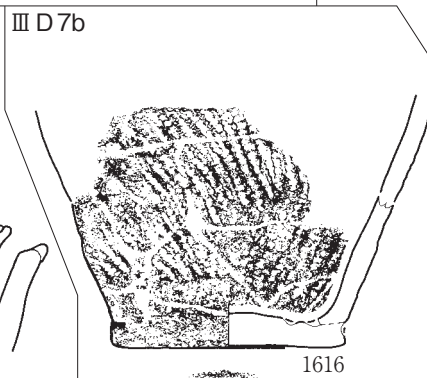

III C 10j

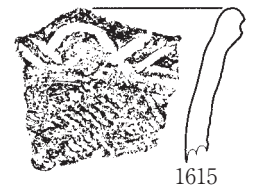
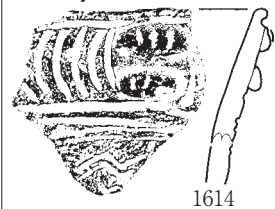

0 1:3 10cm

第421図 縄文土器 (173)

Ⅲ D7c

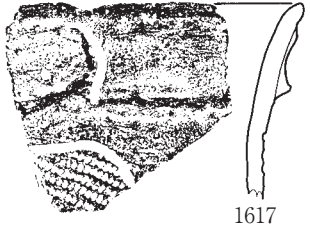

1617

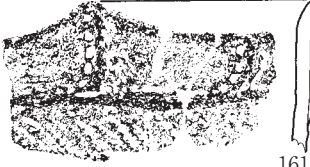

1618

Ⅲ D7c, Ⅲ D8b



1619

Ⅲ D8b

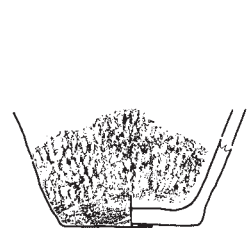

1620

Ⅲ D8c

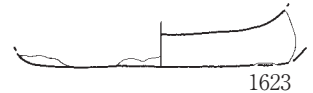

1623

Ⅲ D8b, Ⅲ D8c

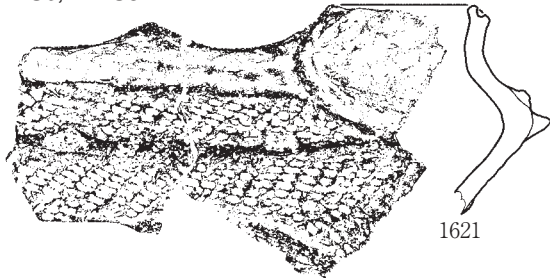

1621



1622

Ⅲ D8d

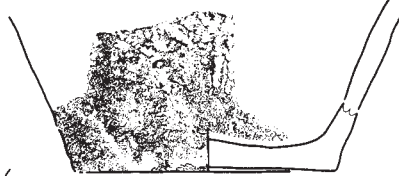

1625

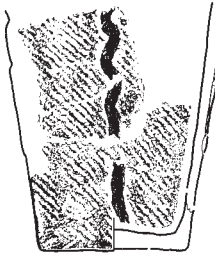

1624

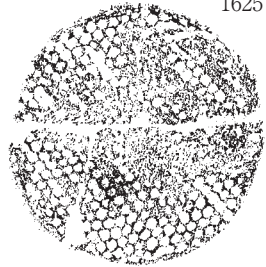

Ⅲ D9c



1627

Ⅲ D10a

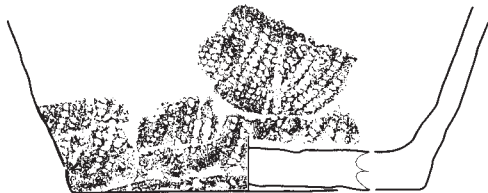

1628

Ⅲ D10b

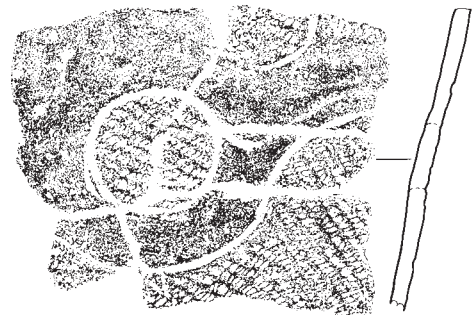

1629

Ⅲ D9a



1626

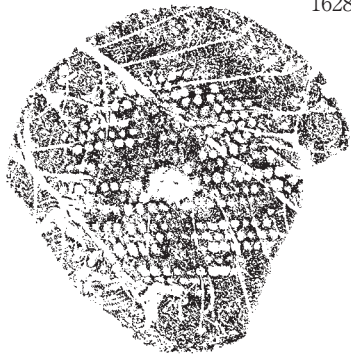

0 1 : 3 10cm

第422図 縄文土器 (174)

III D 10c

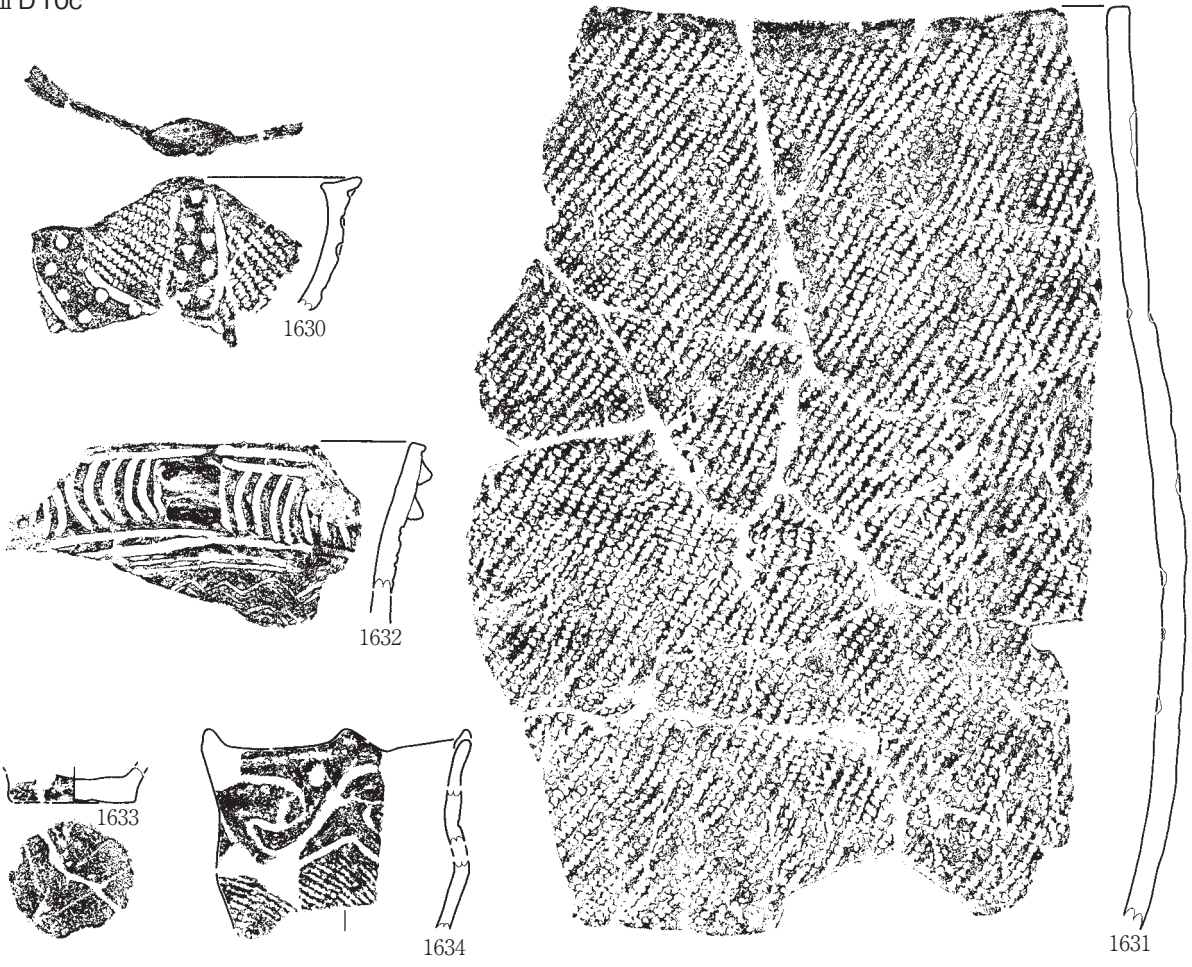

III D 10d

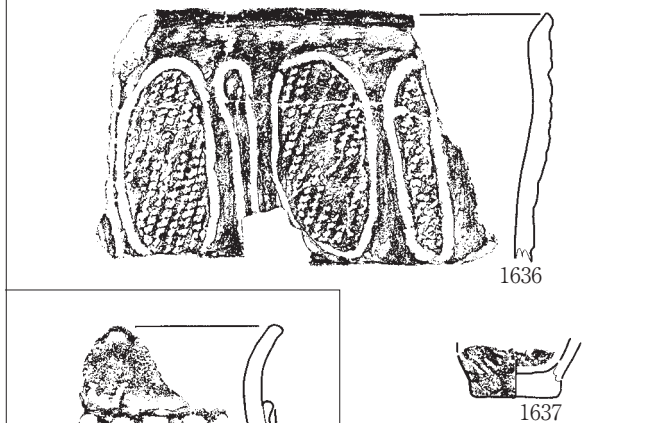

IV B 1g



第423図 縄文土器 (175)

IV B 1h

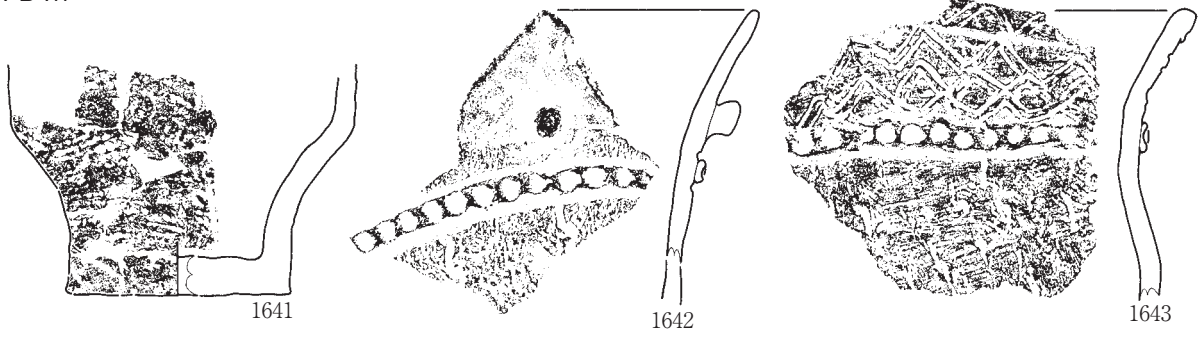

IV B 2j

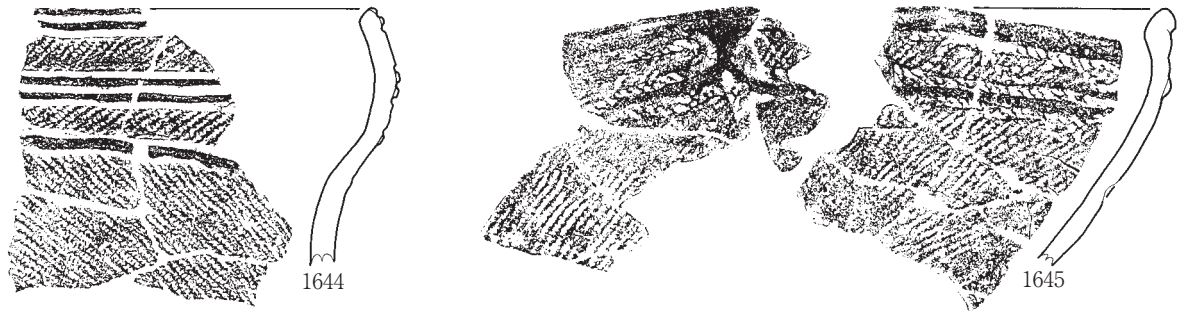

IV B 3c

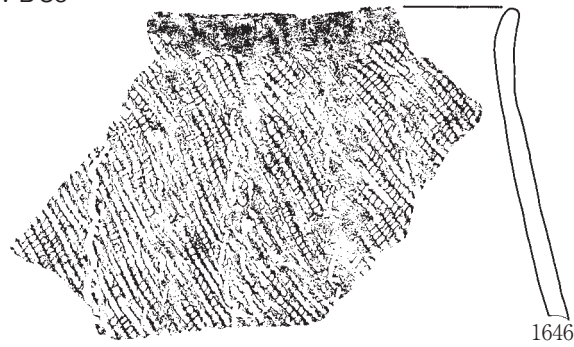

IV B 3j

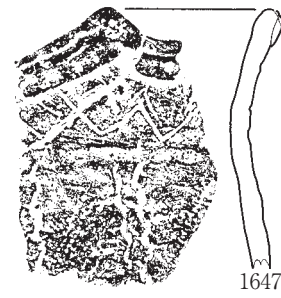

IV B 5i

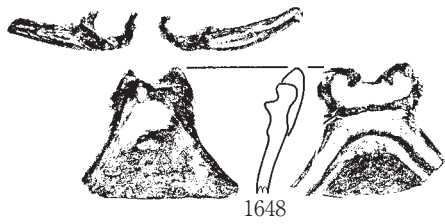

IV C 1d

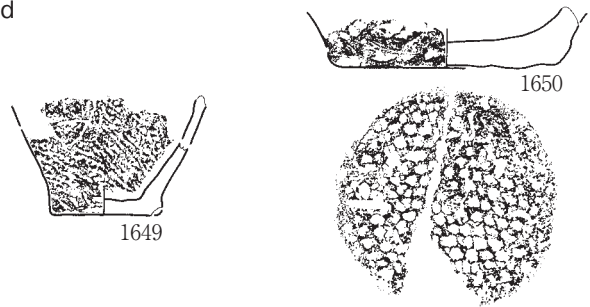

IV C 1e



IV C 1h



第424図 縄文土器 (176)



IVC2a

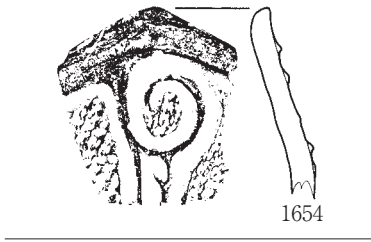

IVC2b

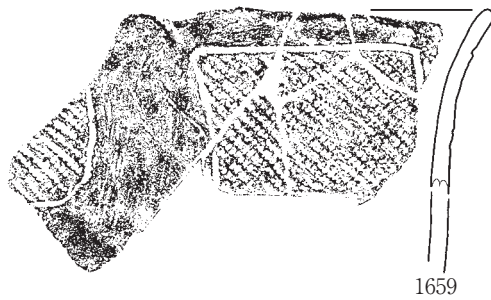
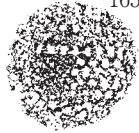
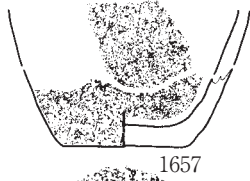
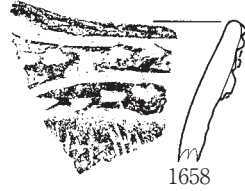
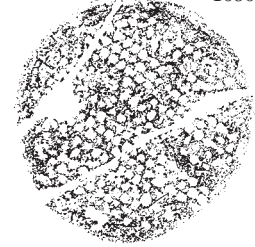
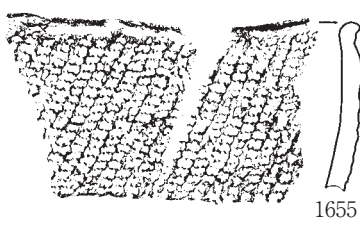

IVC2c

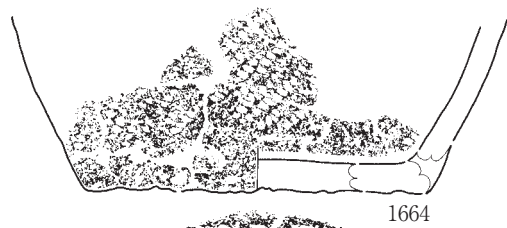
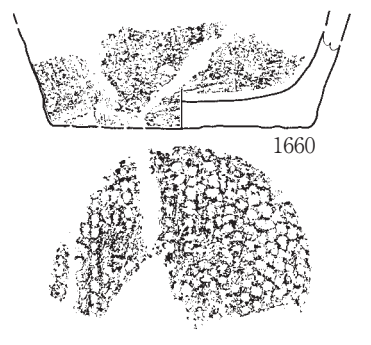

IVC2d (1)

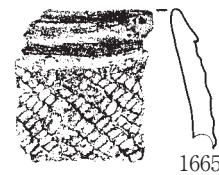
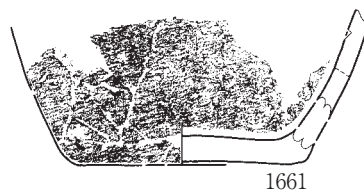
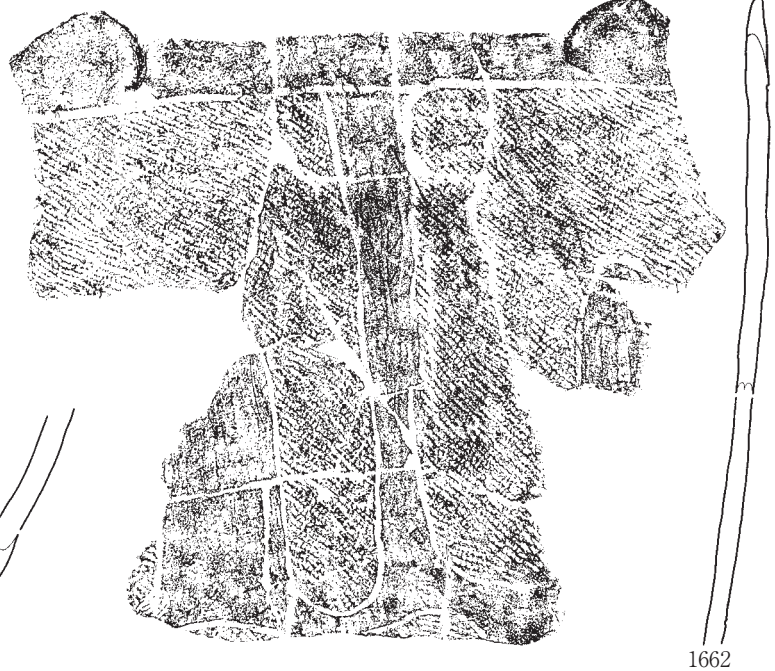

0 1:3 10cm

第425図 縄文土器 (177)

IV C2d (2)

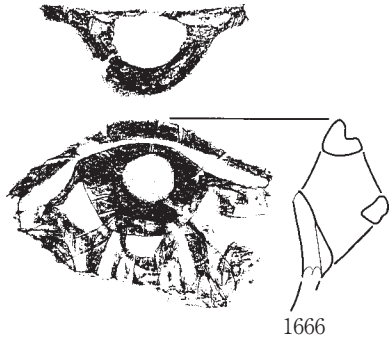

1666

IV C2f

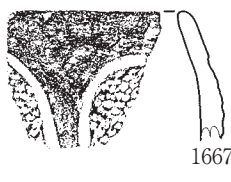

1667

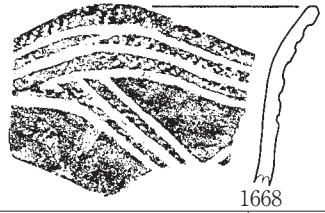

1668

IV C2g



1669



1674

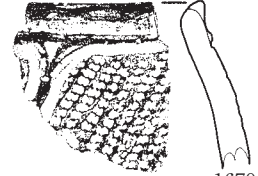

1670

IV C3a



1671

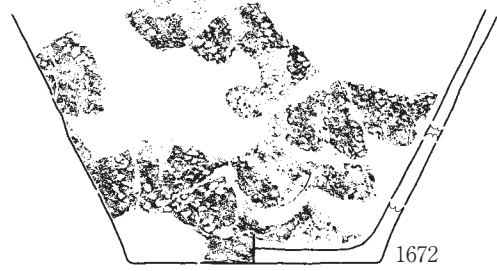

1672

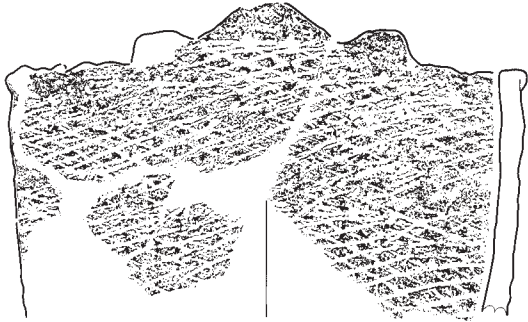

1673

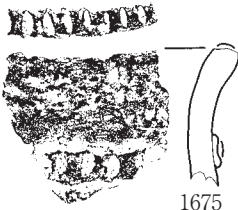
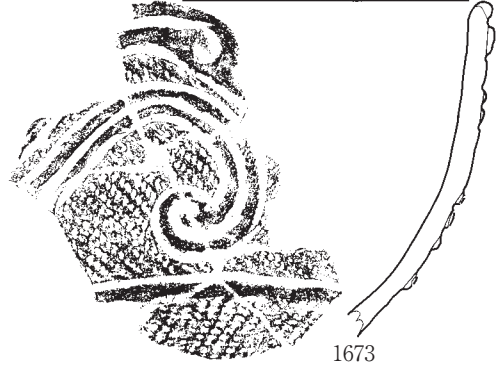

1675

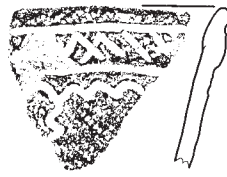

1676

IV C3b (1)



1677



1678

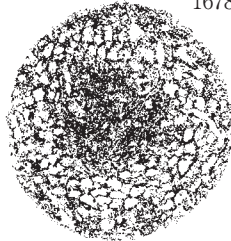

1679

0 1:3 10cm

第426図 縄文土器 (178)

IVC3b (2)



IVC3c (1)

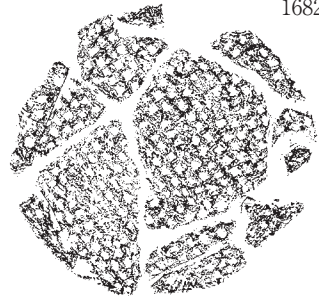
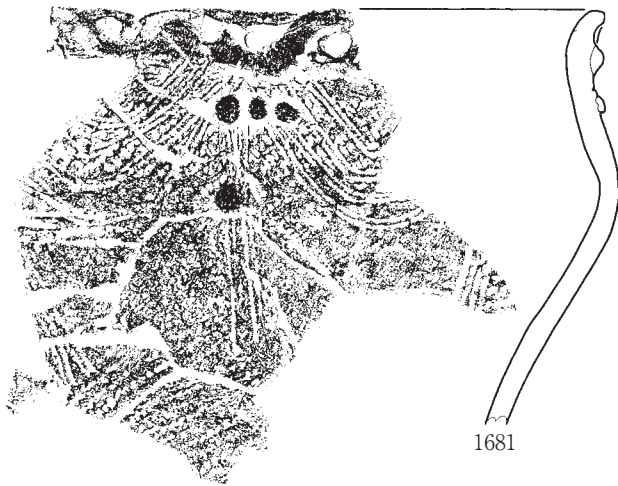
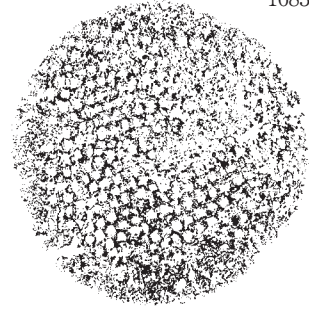
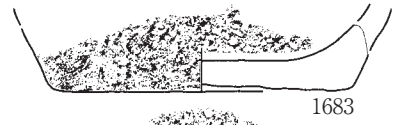

0 1:3 10cm

第427図 縄文土器 (179)

IVC3c (2)

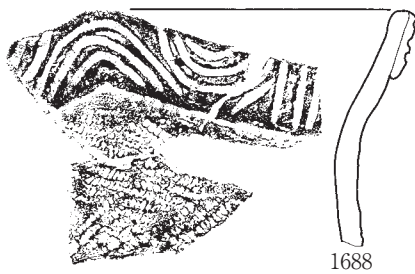
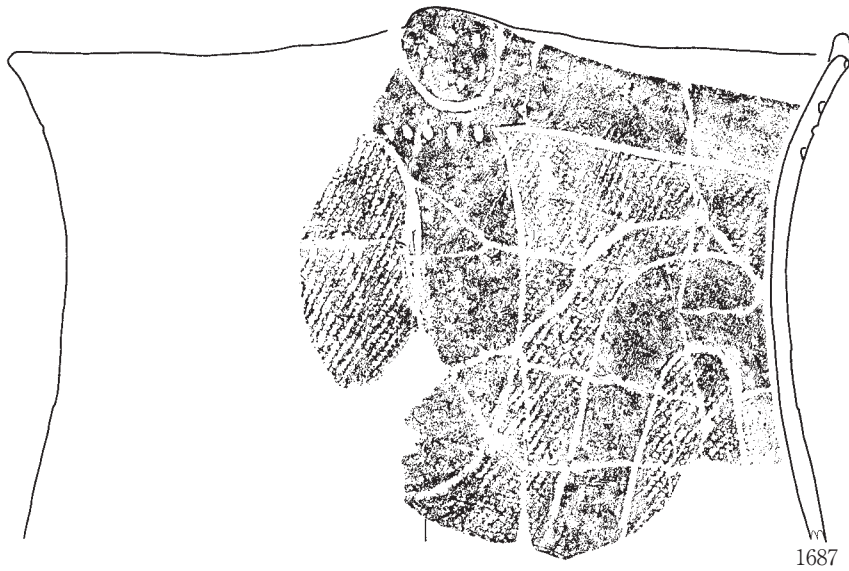
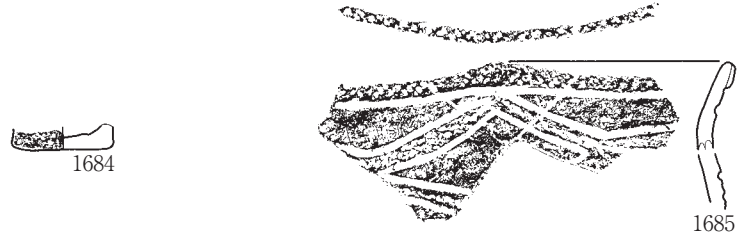

IVC3f

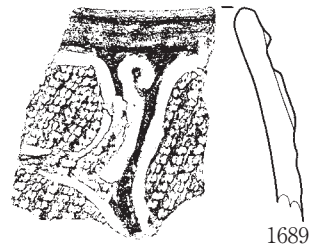

IVC3h

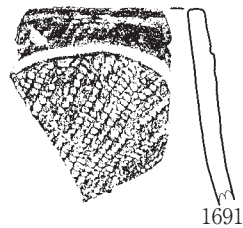
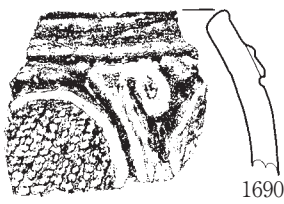

IVC3i

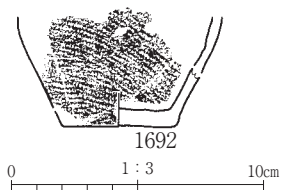

第428図 縄文土器 (180)

IV C 3i, IV C 3j



1693

0 1:3 10cm

IV C 3j



1694

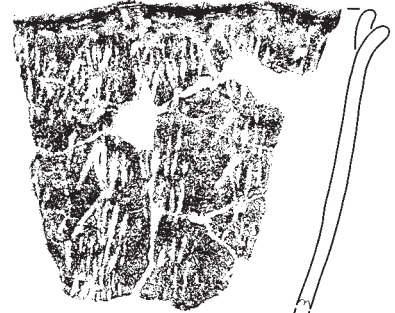
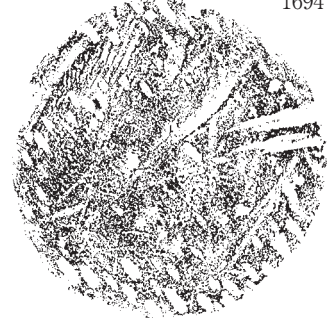

1695

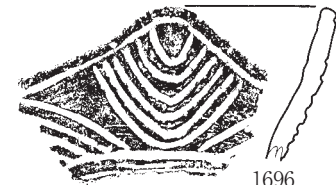

1696

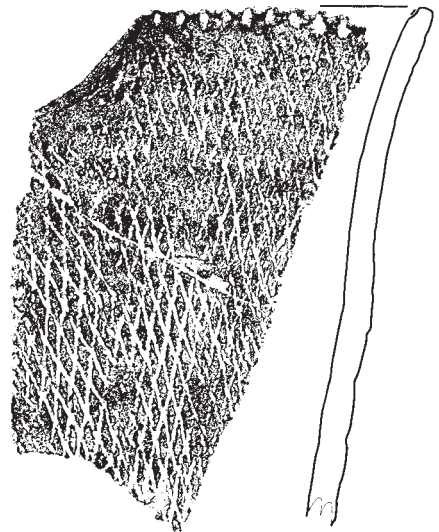

1697

第429図 縄文土器 (181)

IVC3j・IVC4i

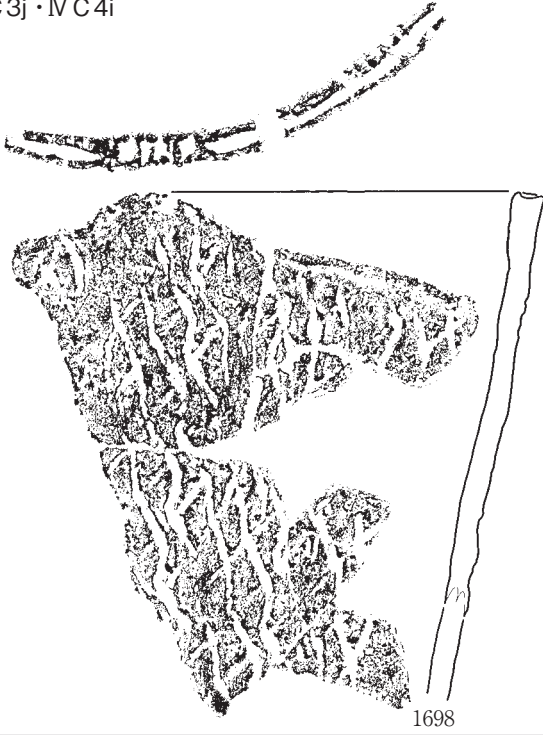

IVC3j・IVC4j

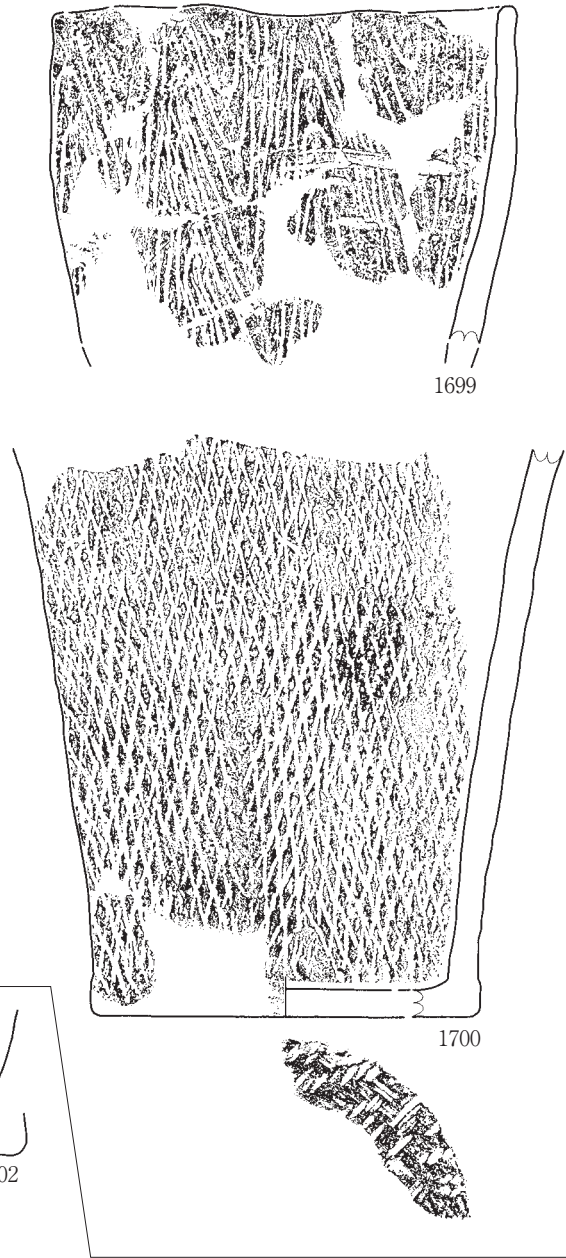

IVC4f

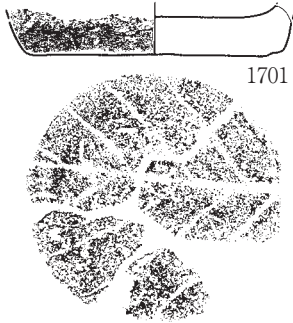

IVC4i (1)



0 1:3 10cm

第430図 縄文土器 (182)

IVC4i (2)



1704

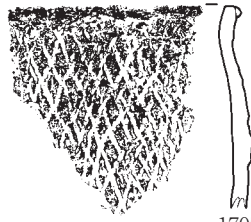

1705

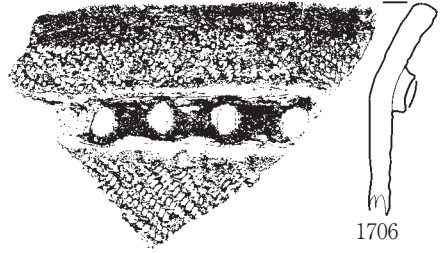

1706



1708

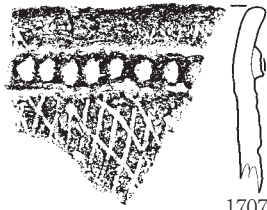

1707

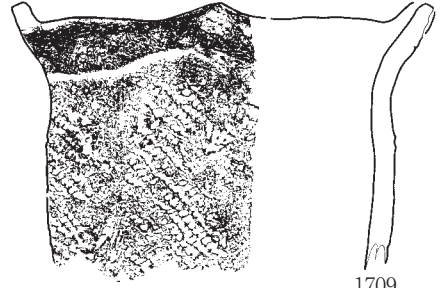
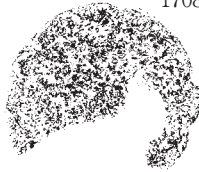

1709

IVC4j (1)



1710

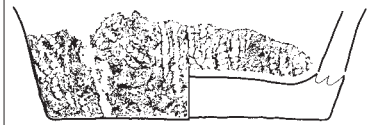

1711

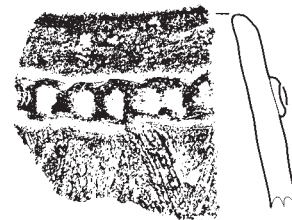
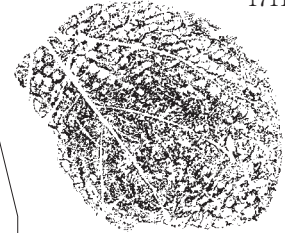

1714



1712



1713



1715

0 1:3 10cm

第431図 縄文土器 (183)

IVC4j (2)

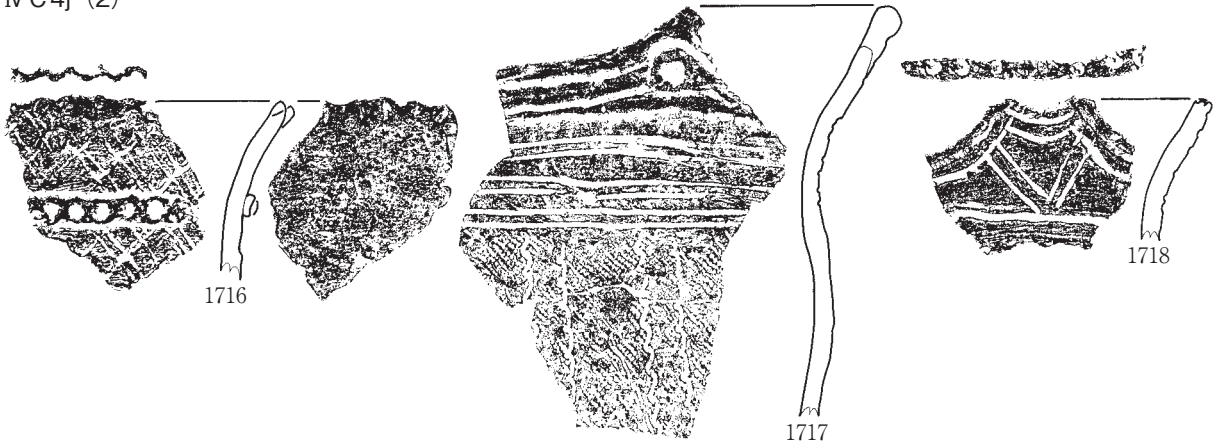

IVC5c

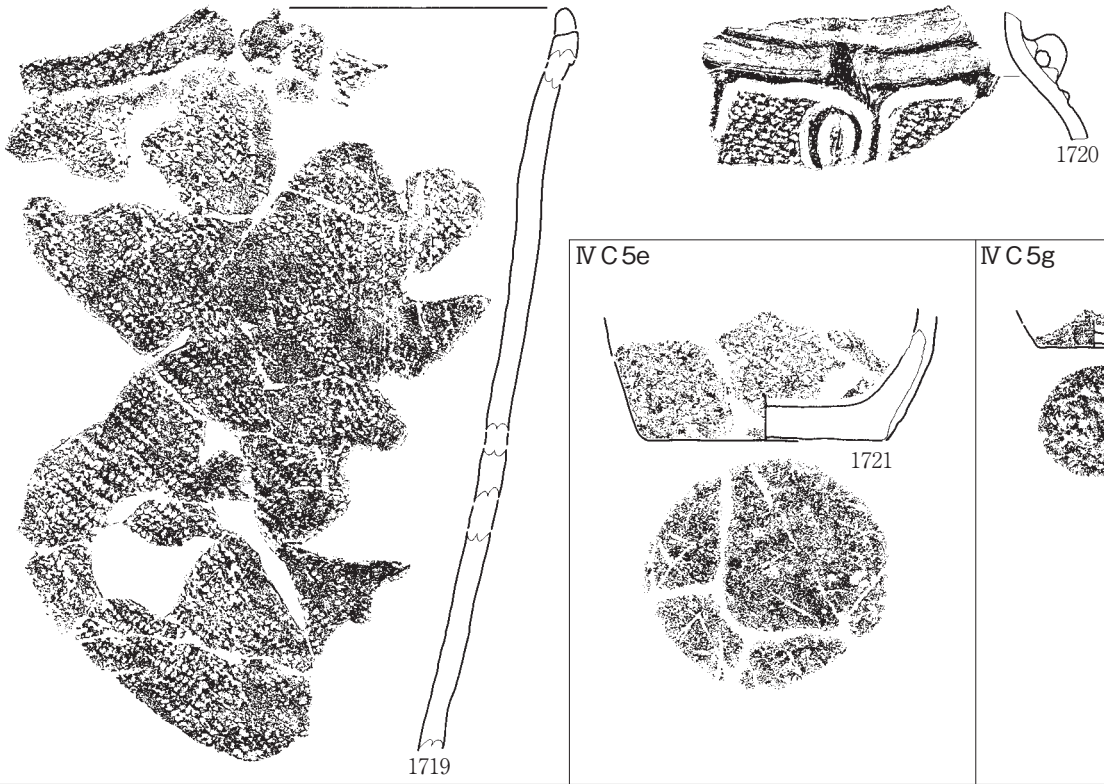

IVC5e

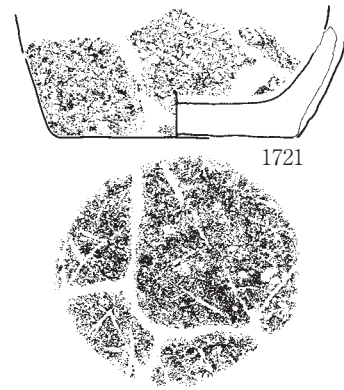

IVC5g

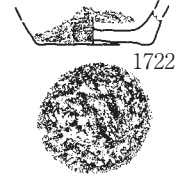

IVC5i (1)

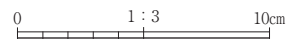
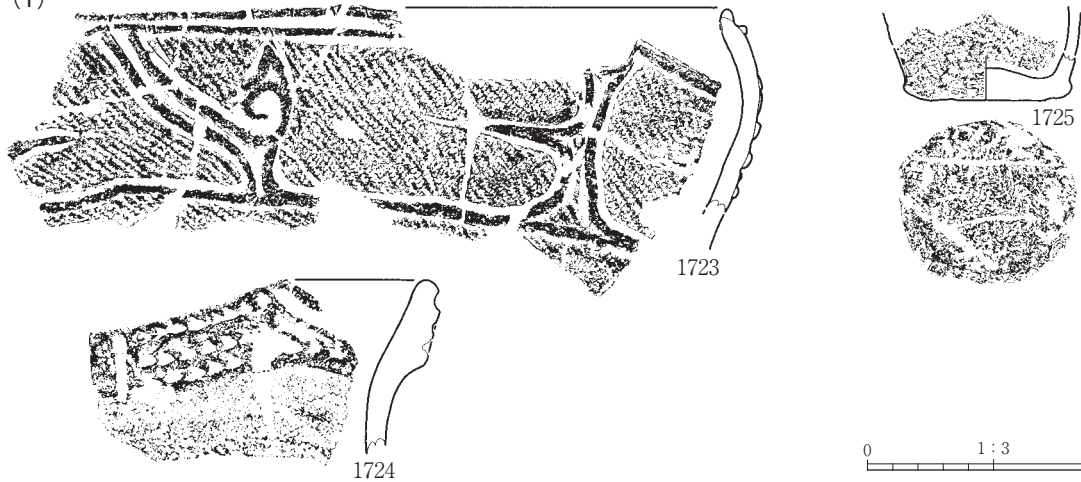

第432図 縄文土器 (184)



IV C5i (2)

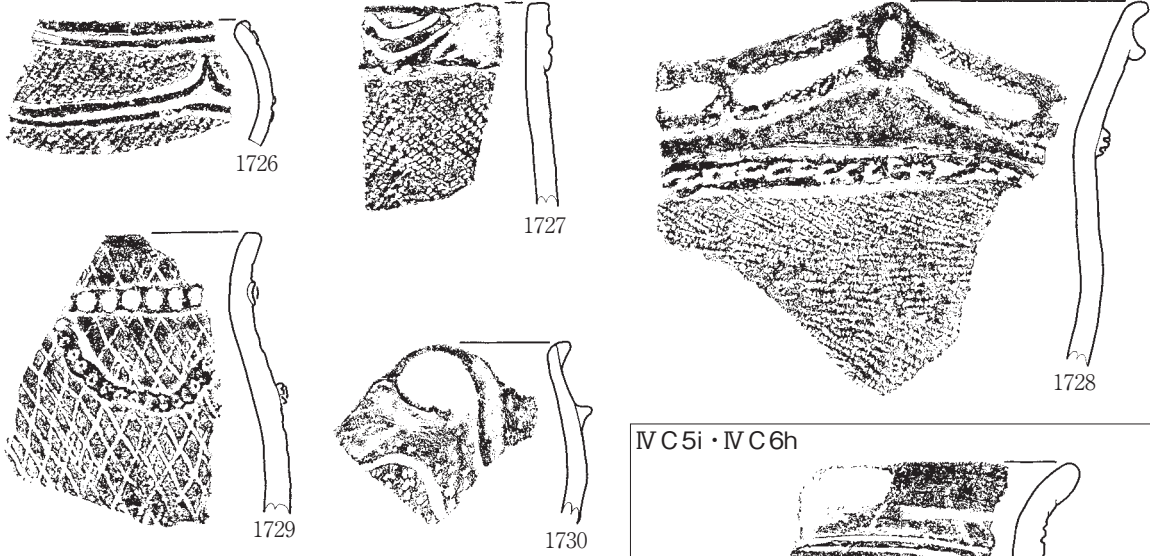

IV C5j

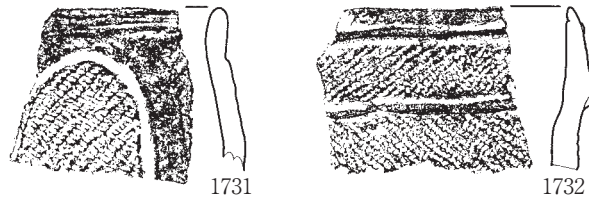

IV C6b

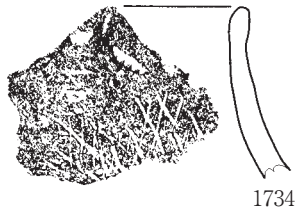

IV C6c

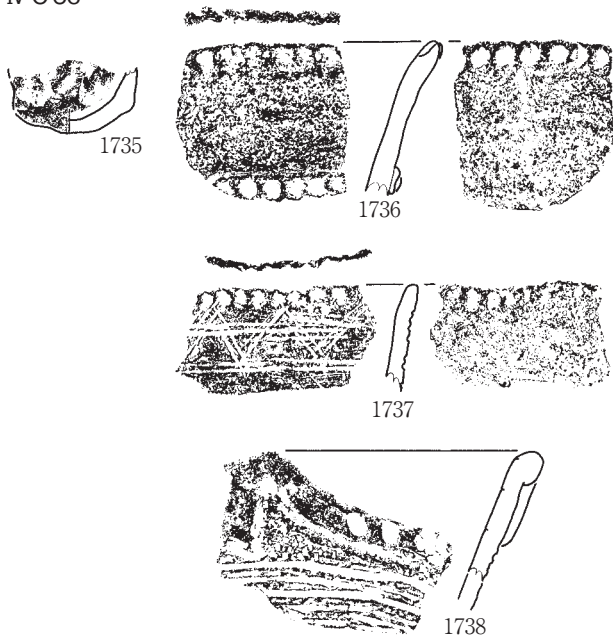

IV C5i · IV C6h

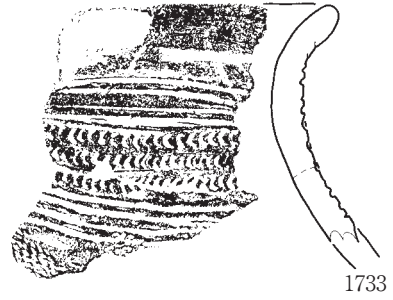

IV C6e (1)

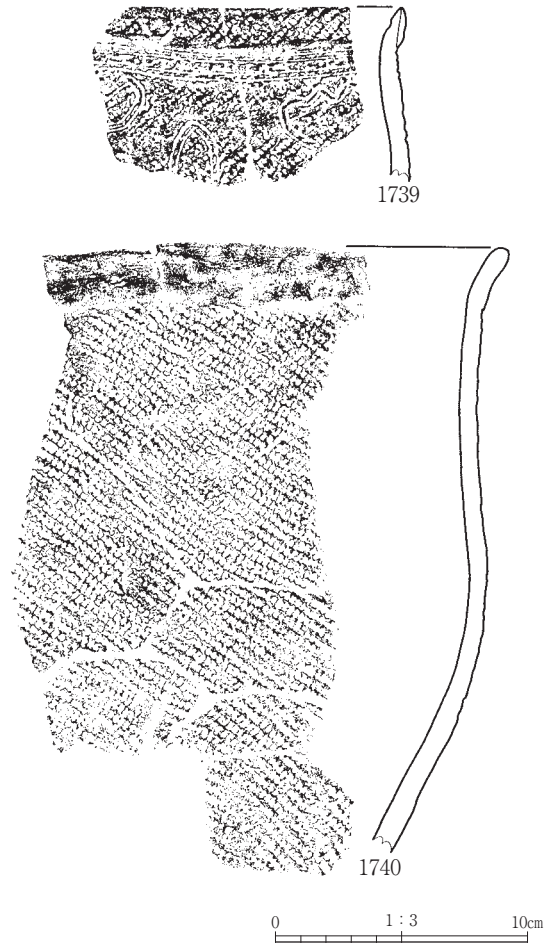

第433図 縄文土器 (185)

IVC6e (2)

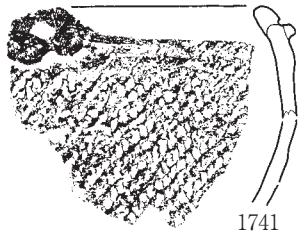

1741

IVC6g

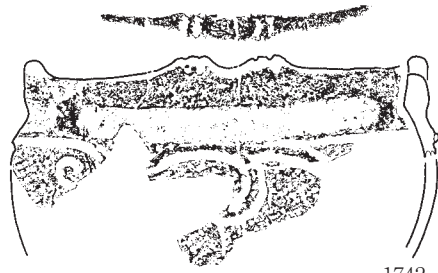

1742

IVC6h



1746

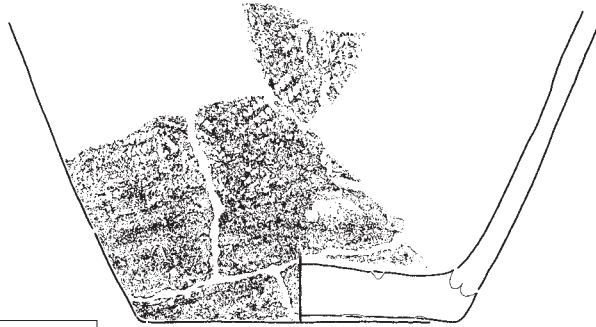

1743

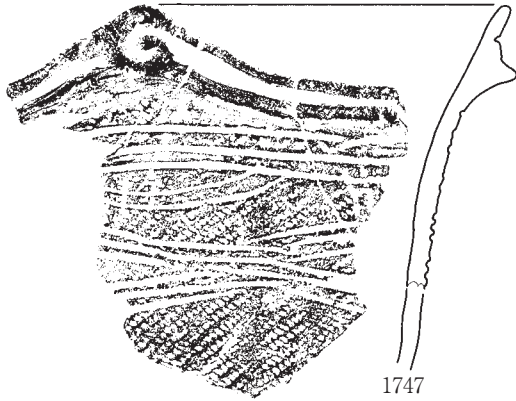

1747

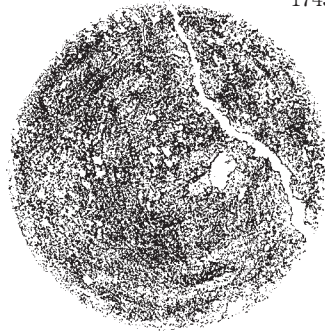

1744



1745

IVC7d

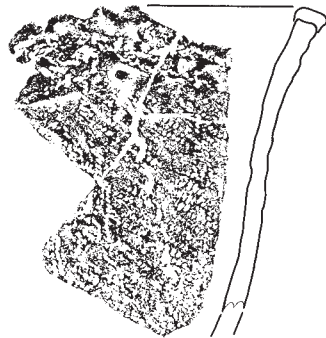

1748

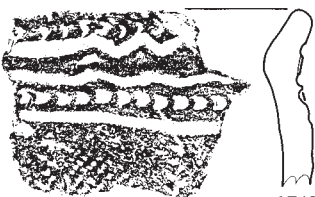

1749

IVD1a



0 1:3 1750 10cm

第434図 縄文土器 (186)

IVD2a

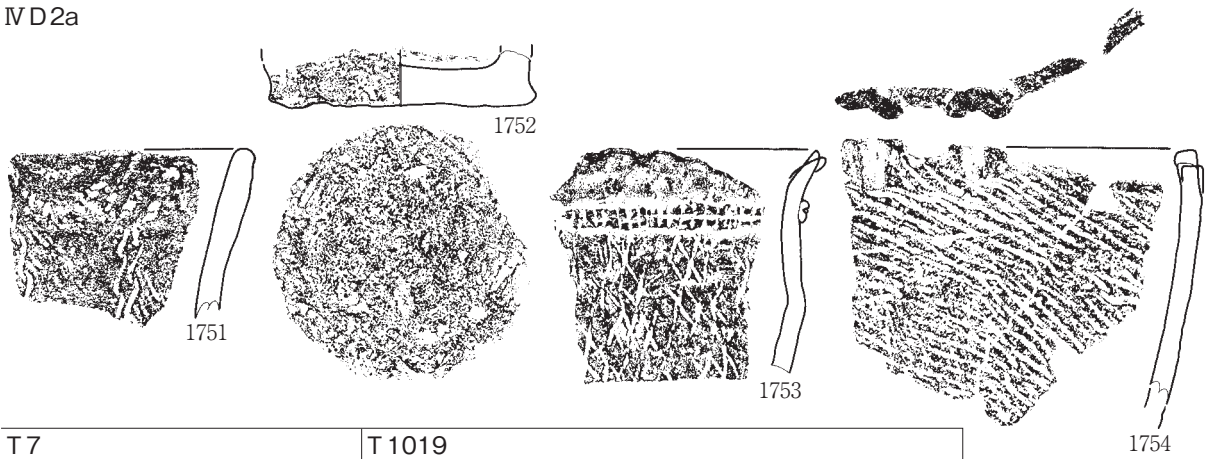

T 7



T 1019

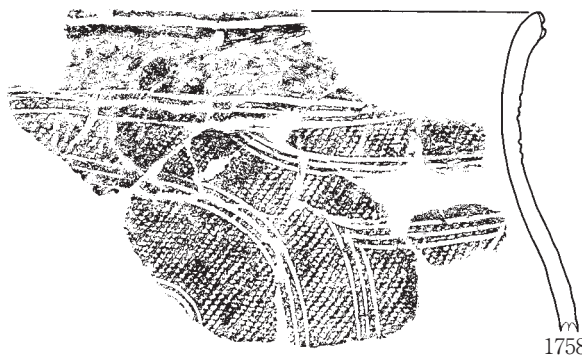

T 10

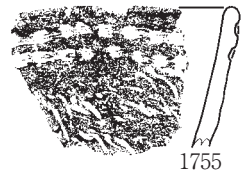
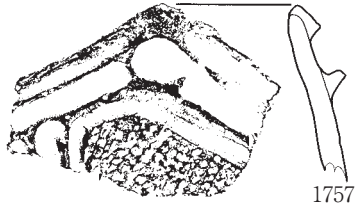

B 区

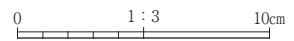
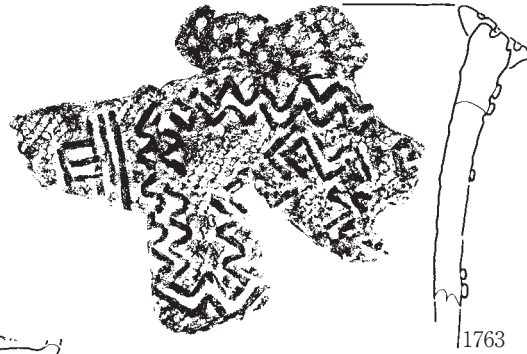
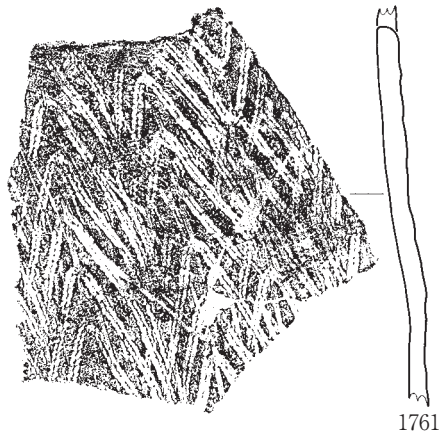
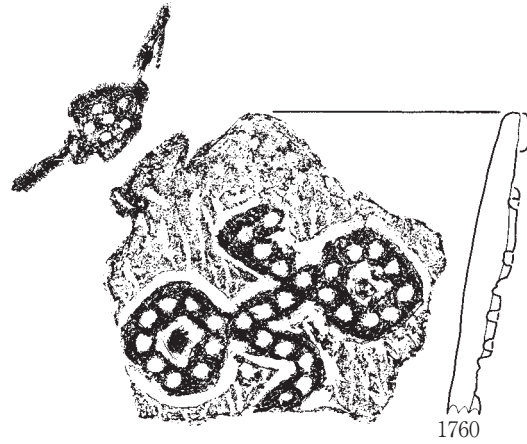
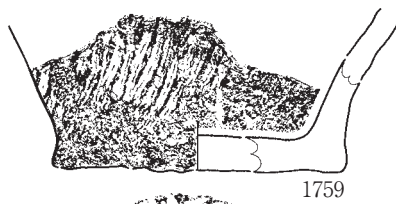

第435図 縄文土器 (187)

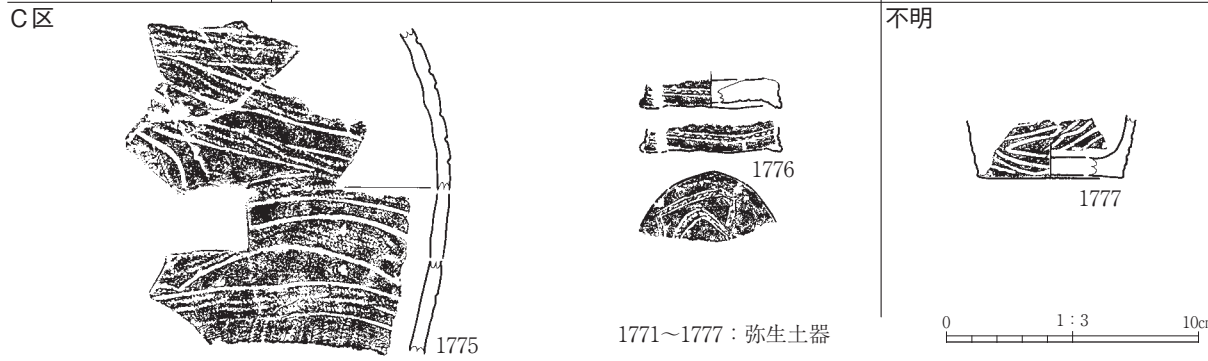
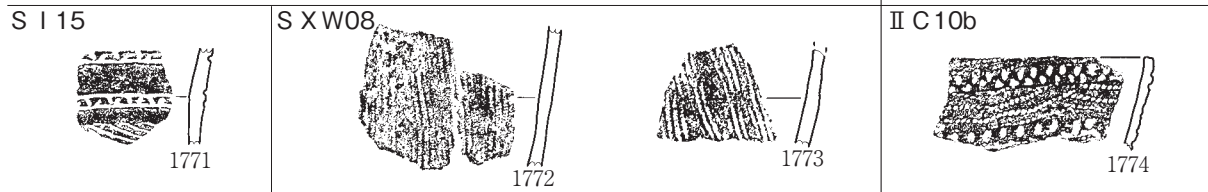
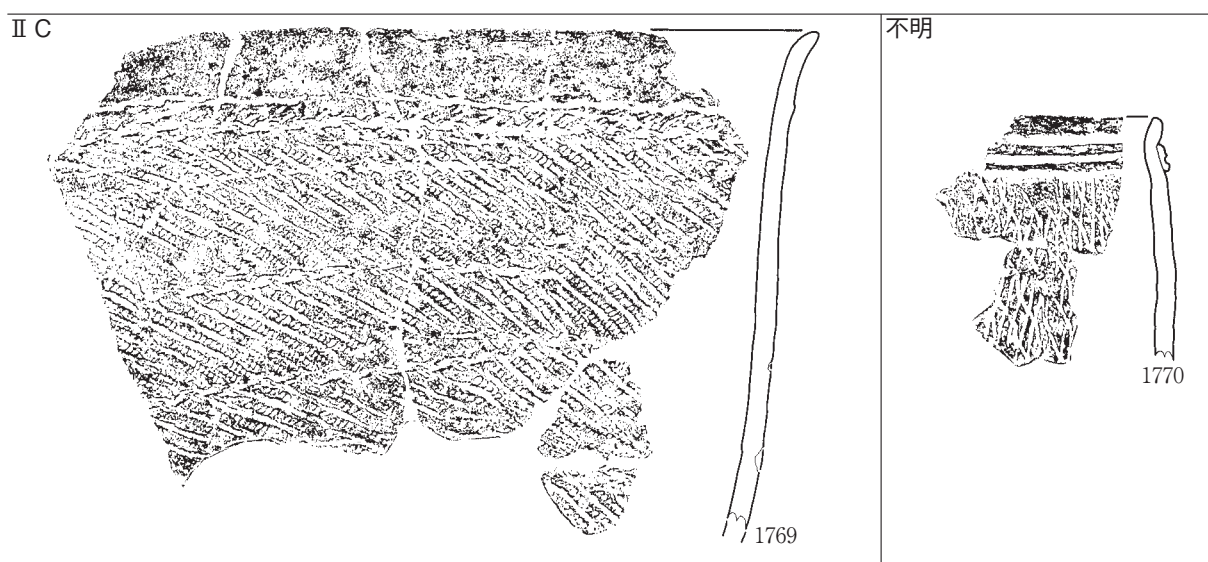
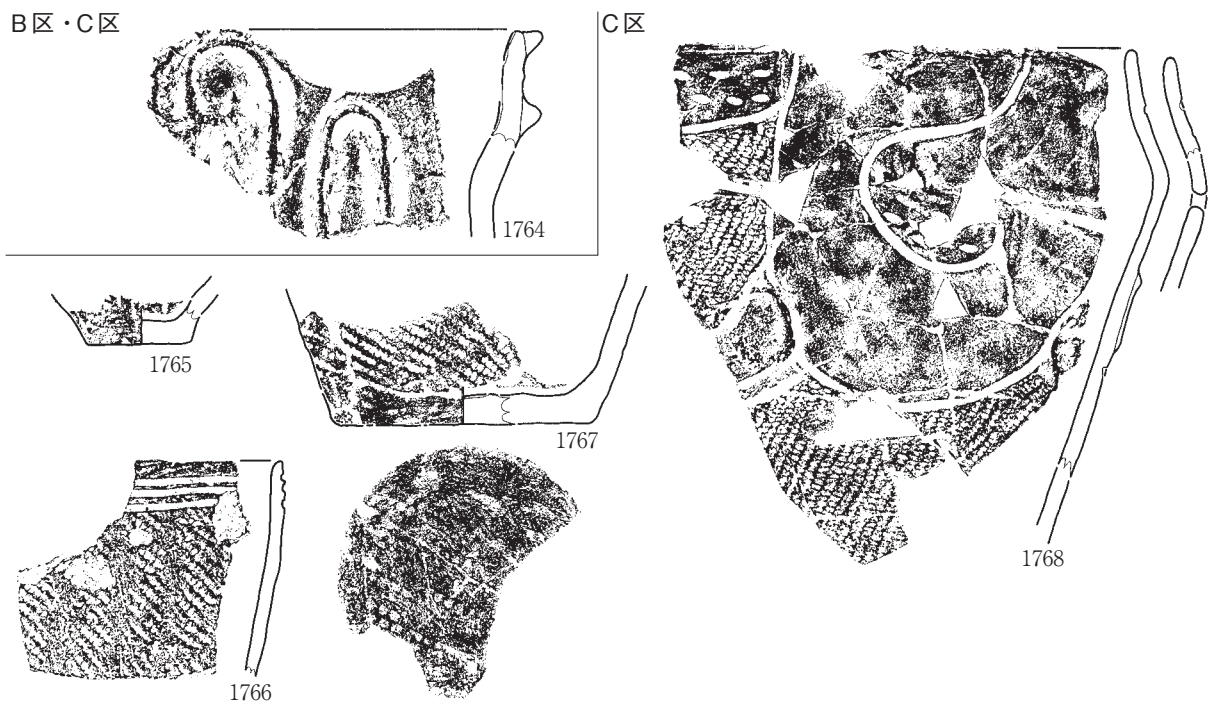

第436图 縄文土器 (188) 弥生土器

S 102

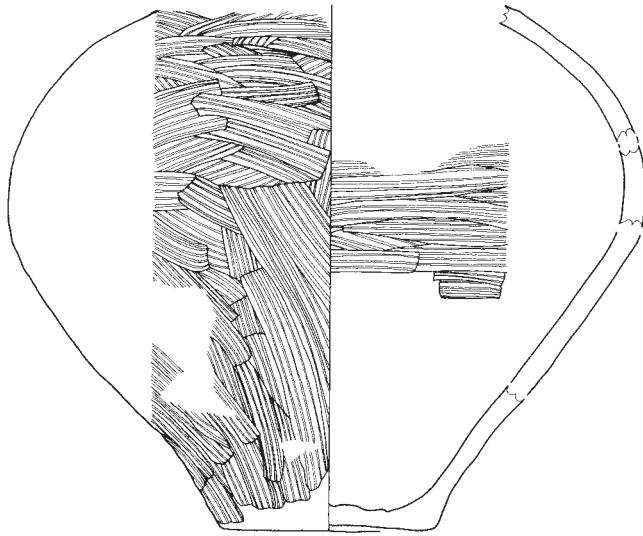

1801

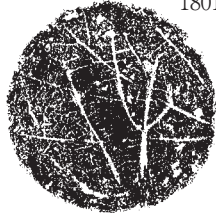

S 104 (1)

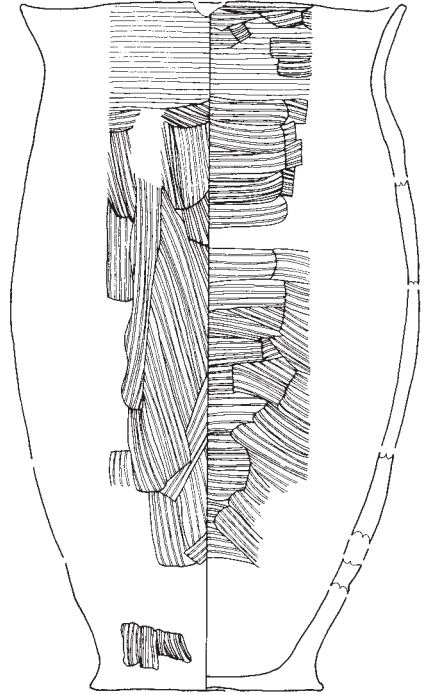

1802

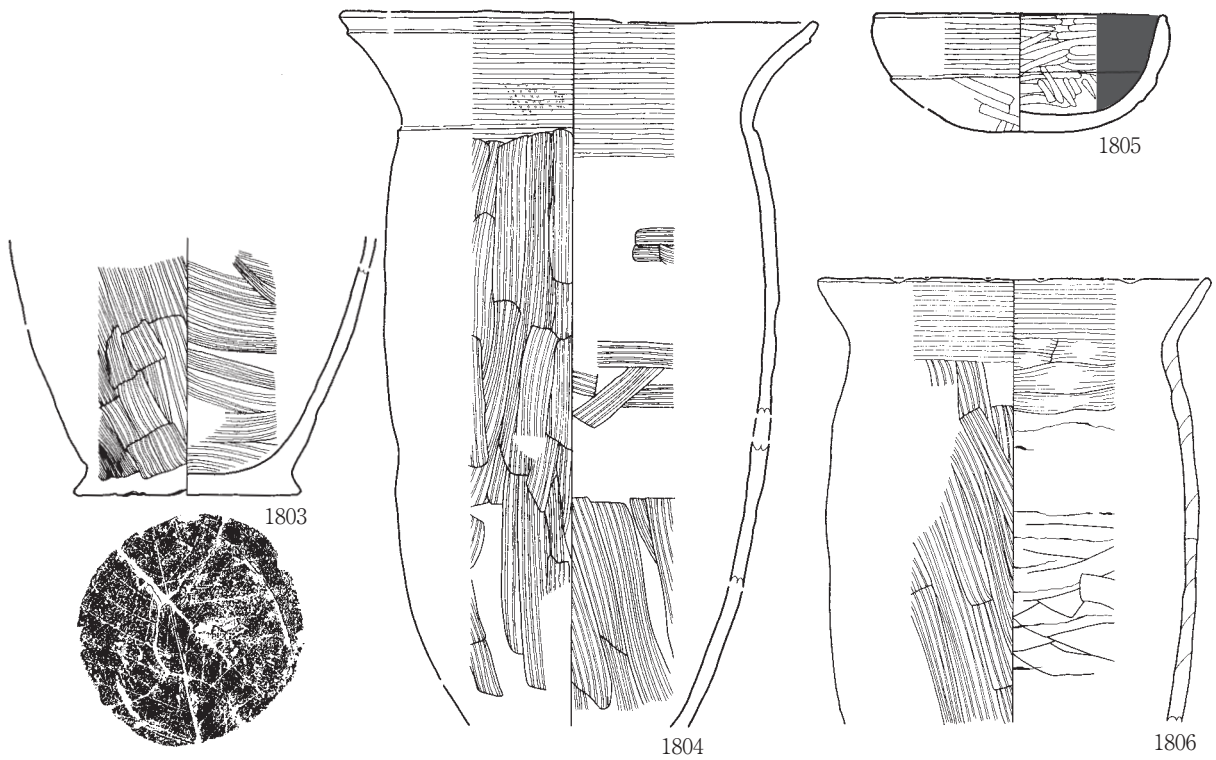

1803

1804

1805

1806

0 1:3 10cm

第437図 土師器 (1)

S 104 (2)

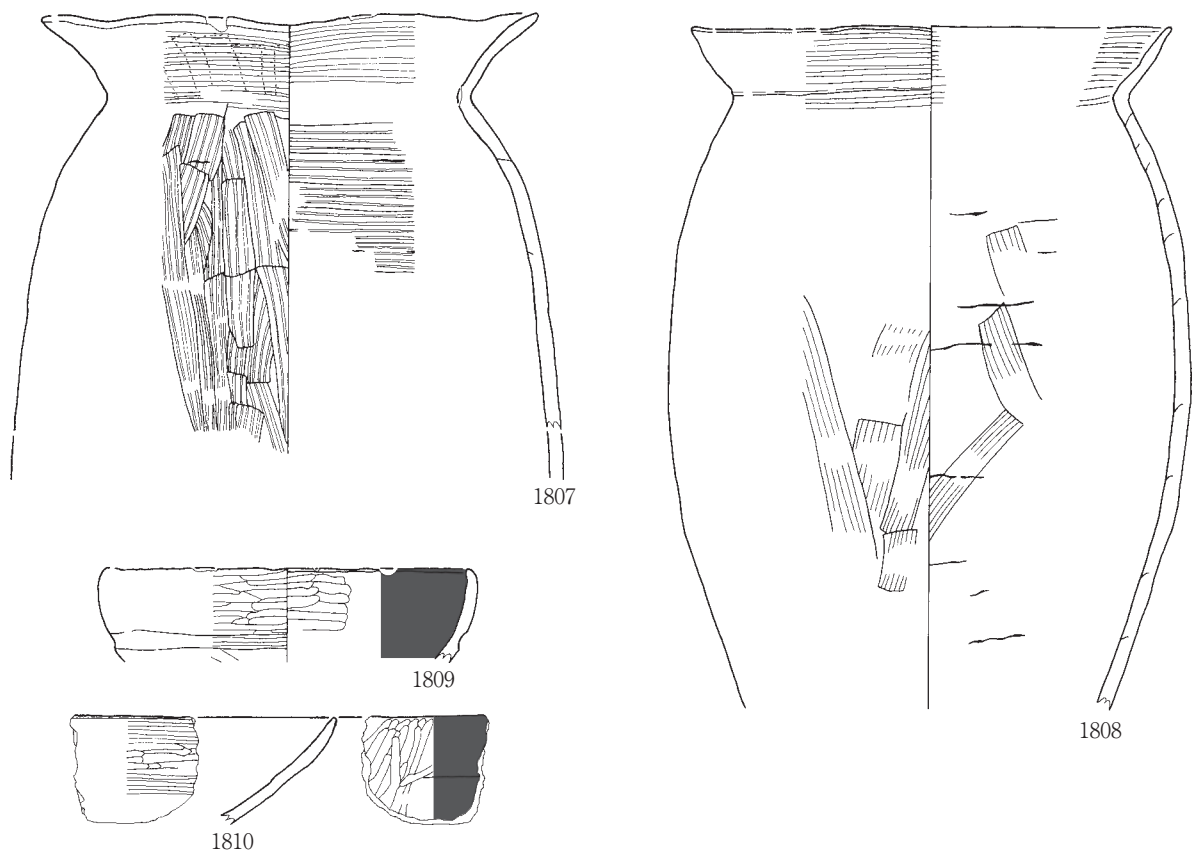

S 105

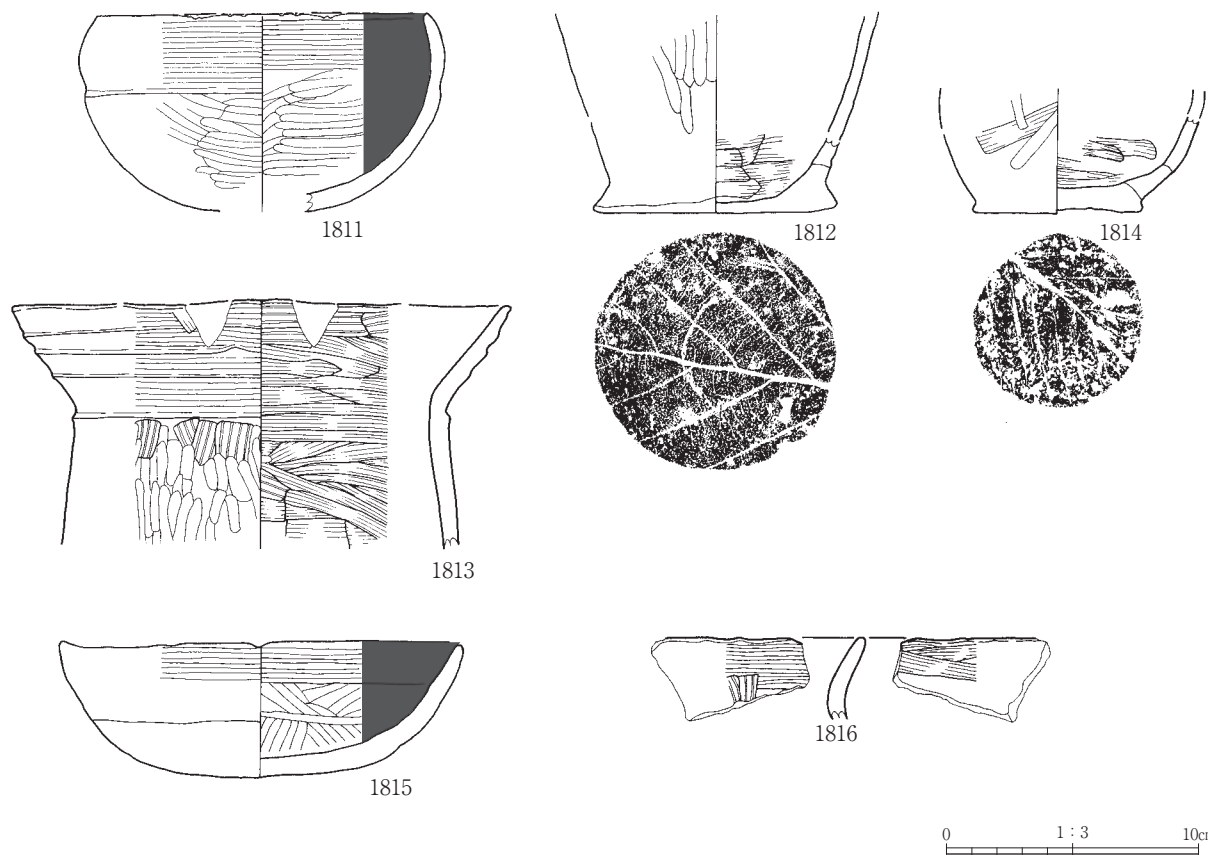

第438図 土師器 (2)

S 106

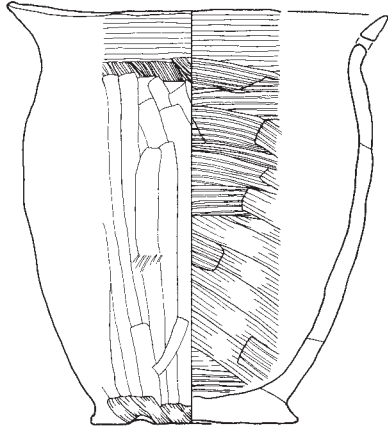

1817

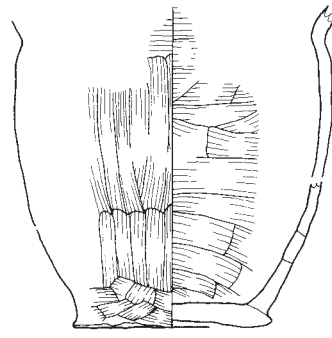
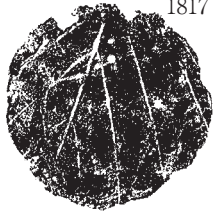

1819

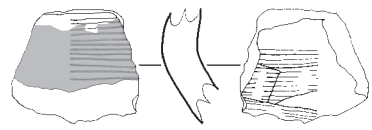

1821

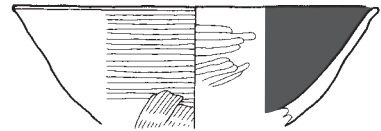

1822

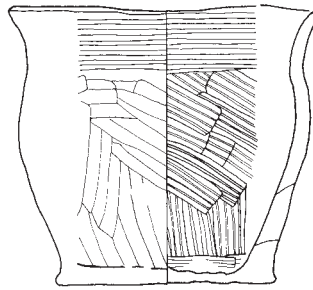

1820



1823

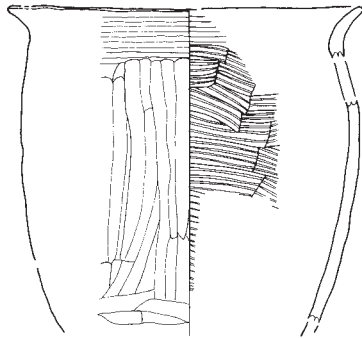

1818

S 109

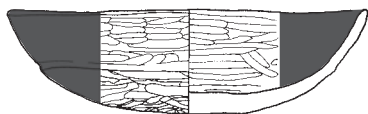

1824

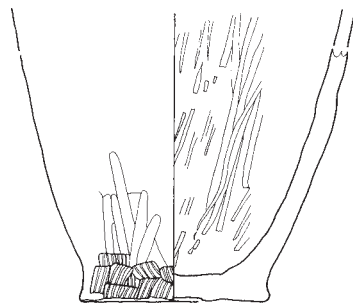
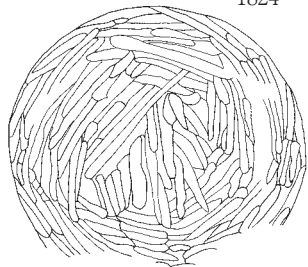

1825

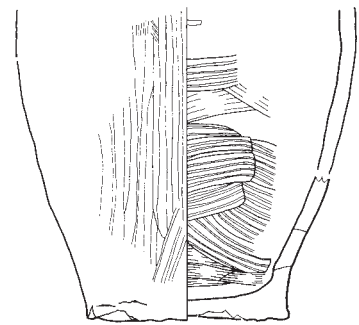
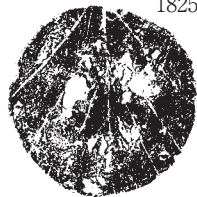

1826

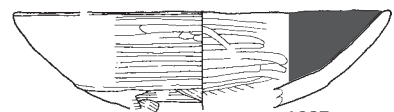

1827

0 1:3 10cm

第439図 土師器 (3)

S I 10

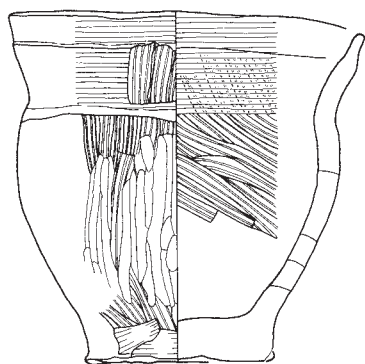

1828



S I 11

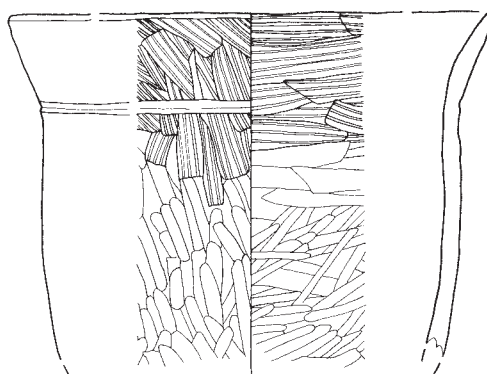

1829

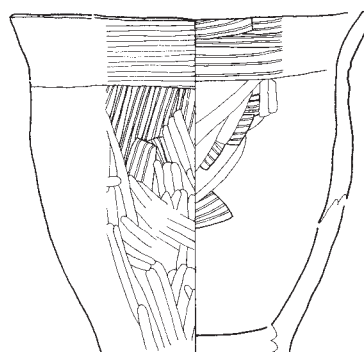

1830

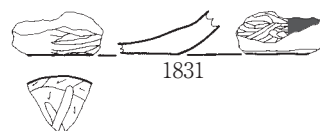

1831

S I 16

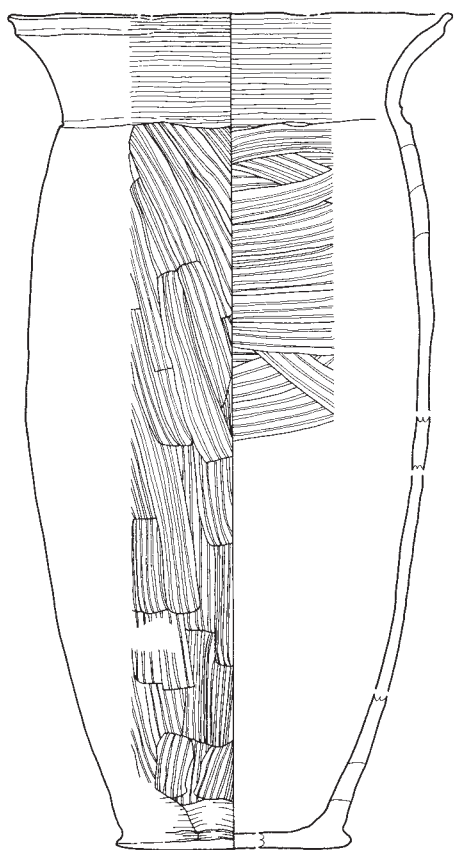

1832



S I 17

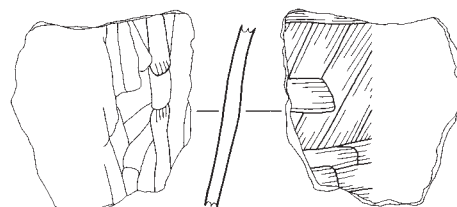

1833

0 1:3 10cm

第440図 土師器 (4)



S | 21

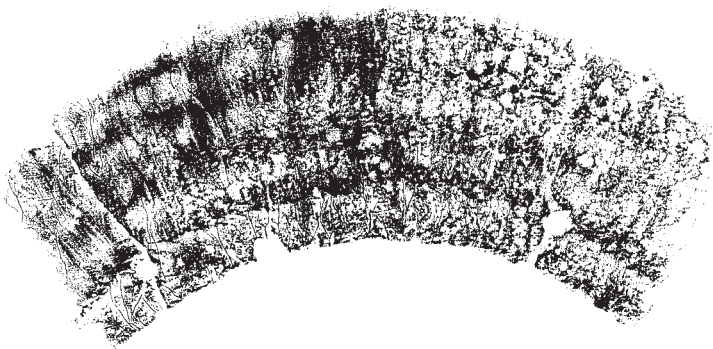
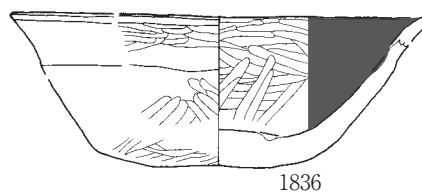
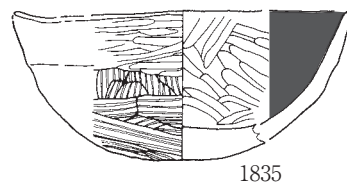
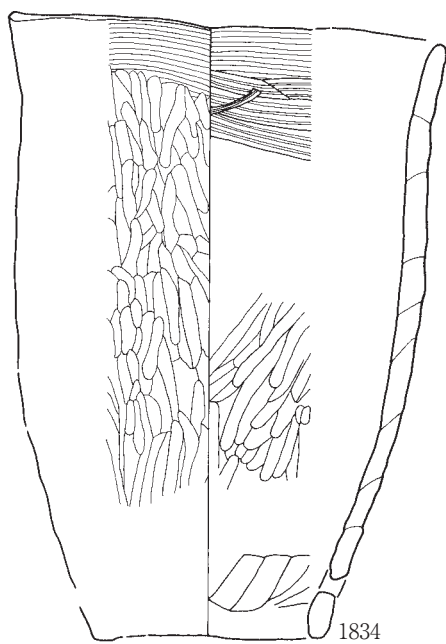

S | 22

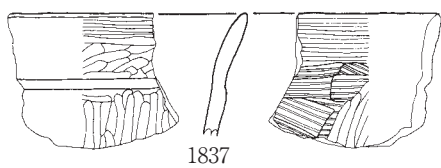

S | 25

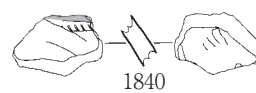
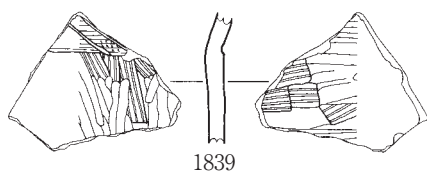
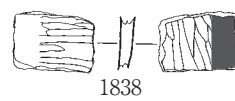

0 1:3 10cm

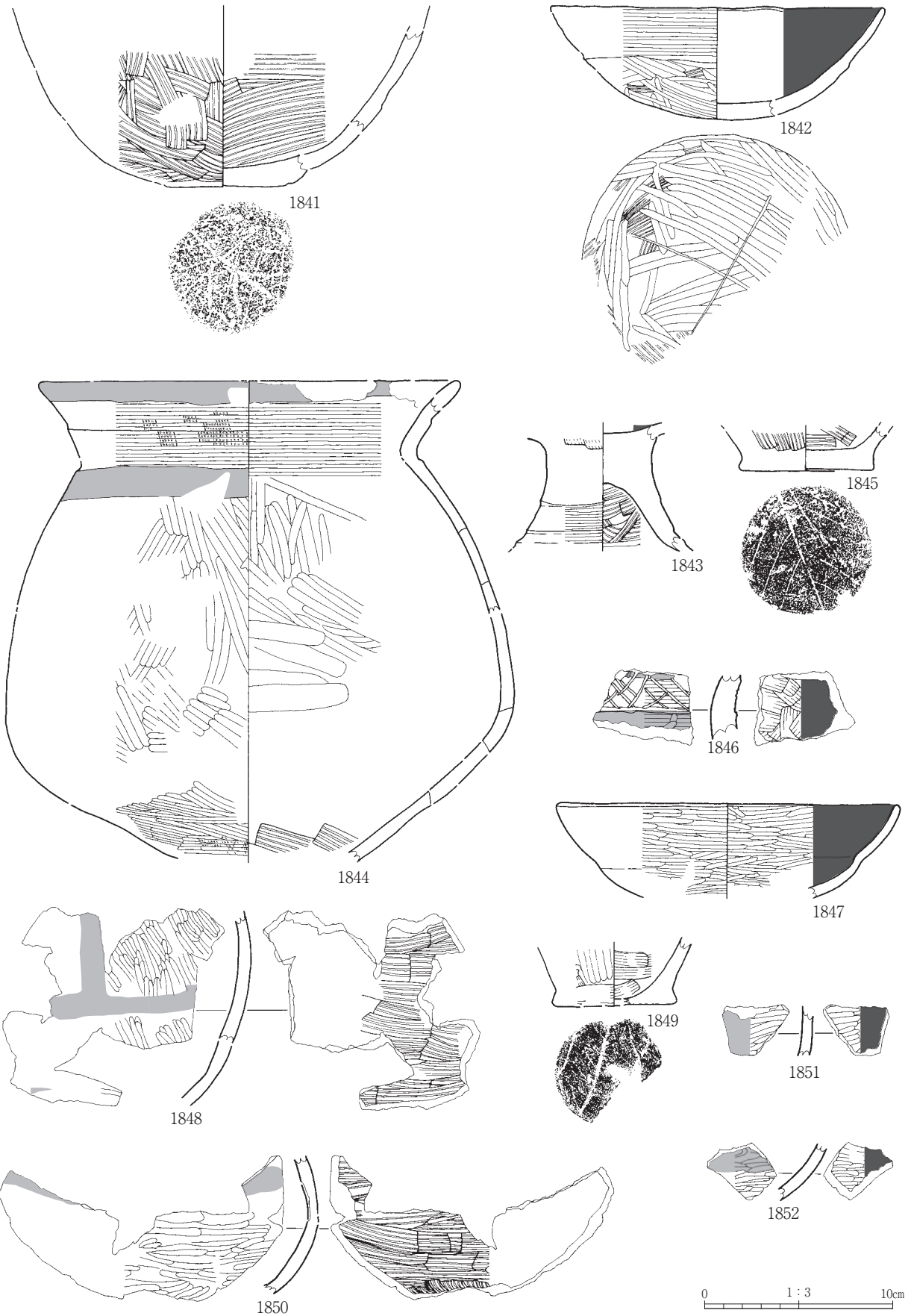

第442図 土師器 (6)

S I 33

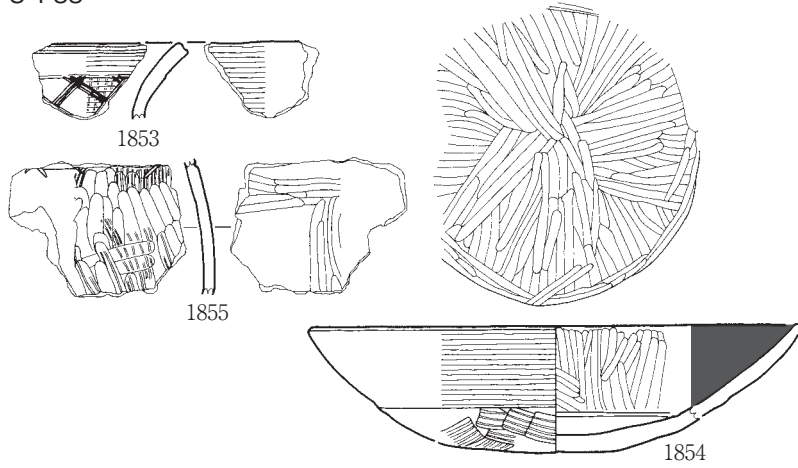

S I 36

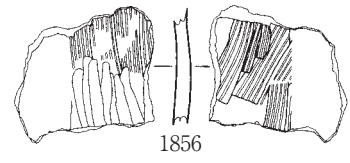

S I 39



S I 42

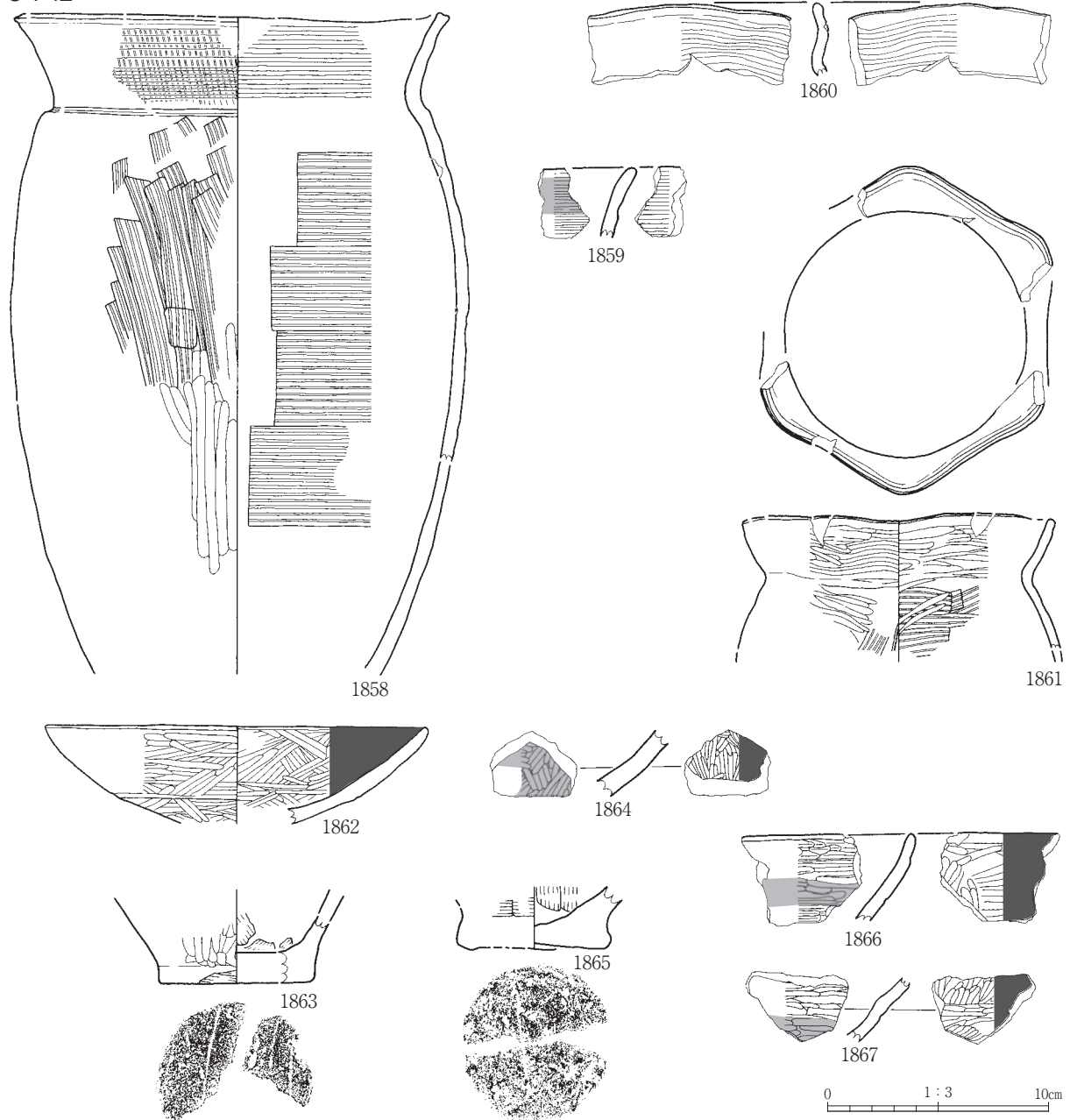

第443図 土師器 (7)

S I 44

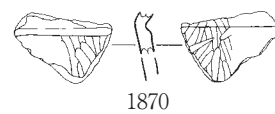
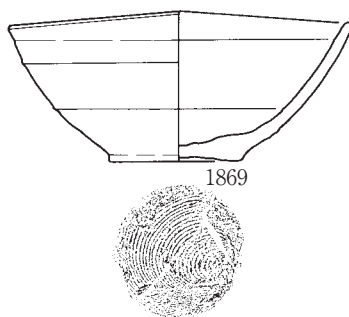
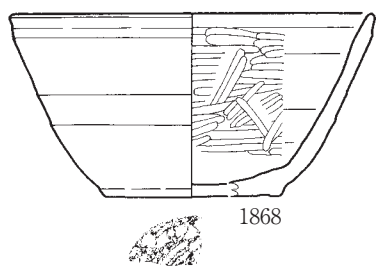

S I 48

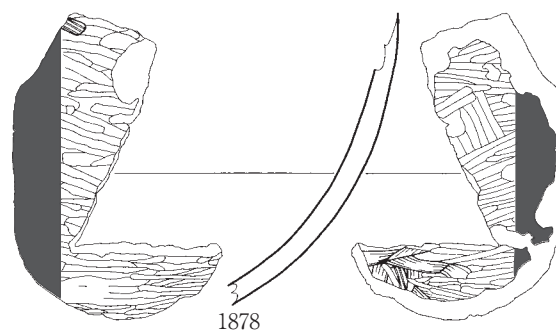
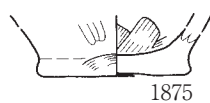
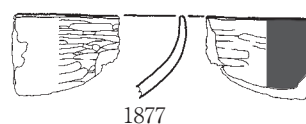
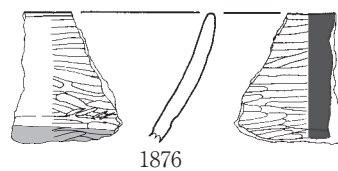
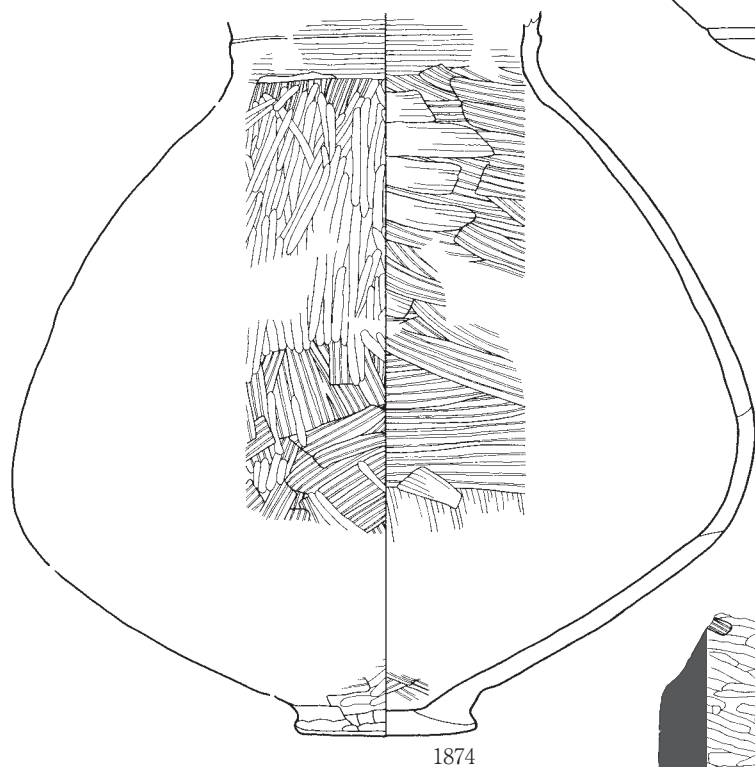
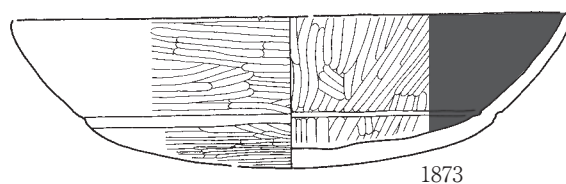
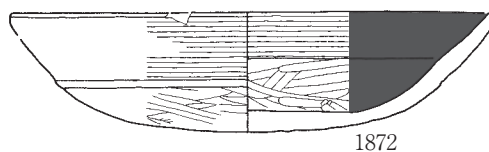
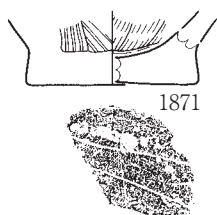

0 1:3 10cm

第444図 土師器 (8)

S 150

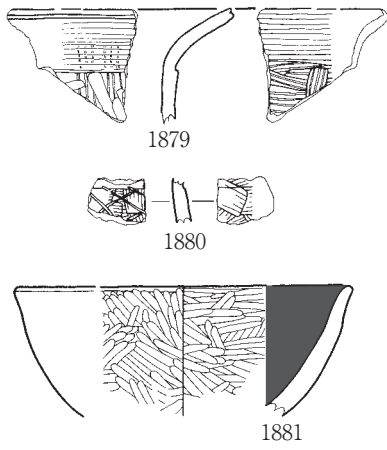

S 152

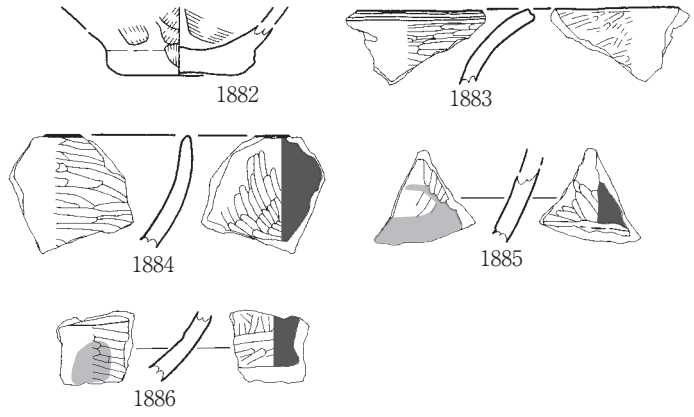

S 163

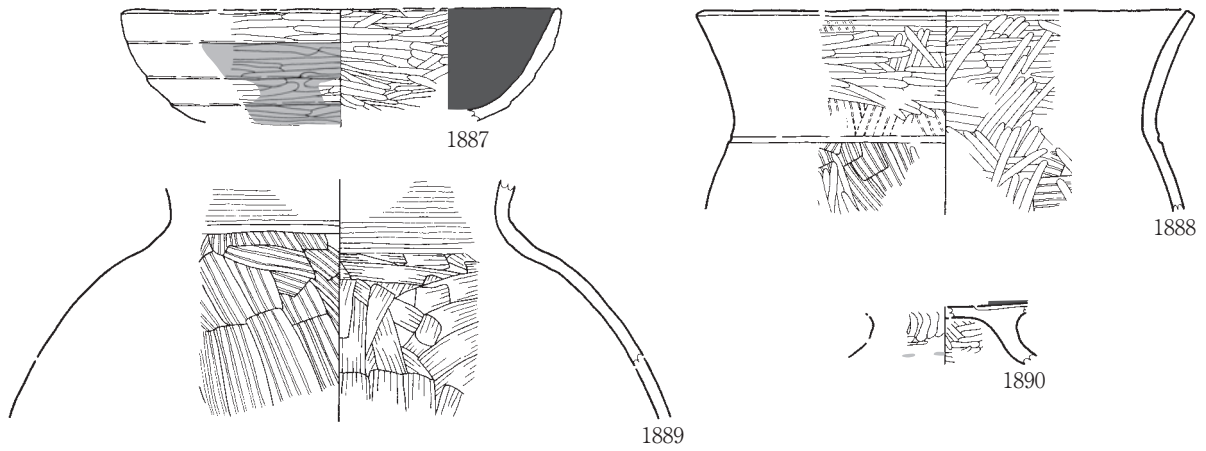

S 174 (1)

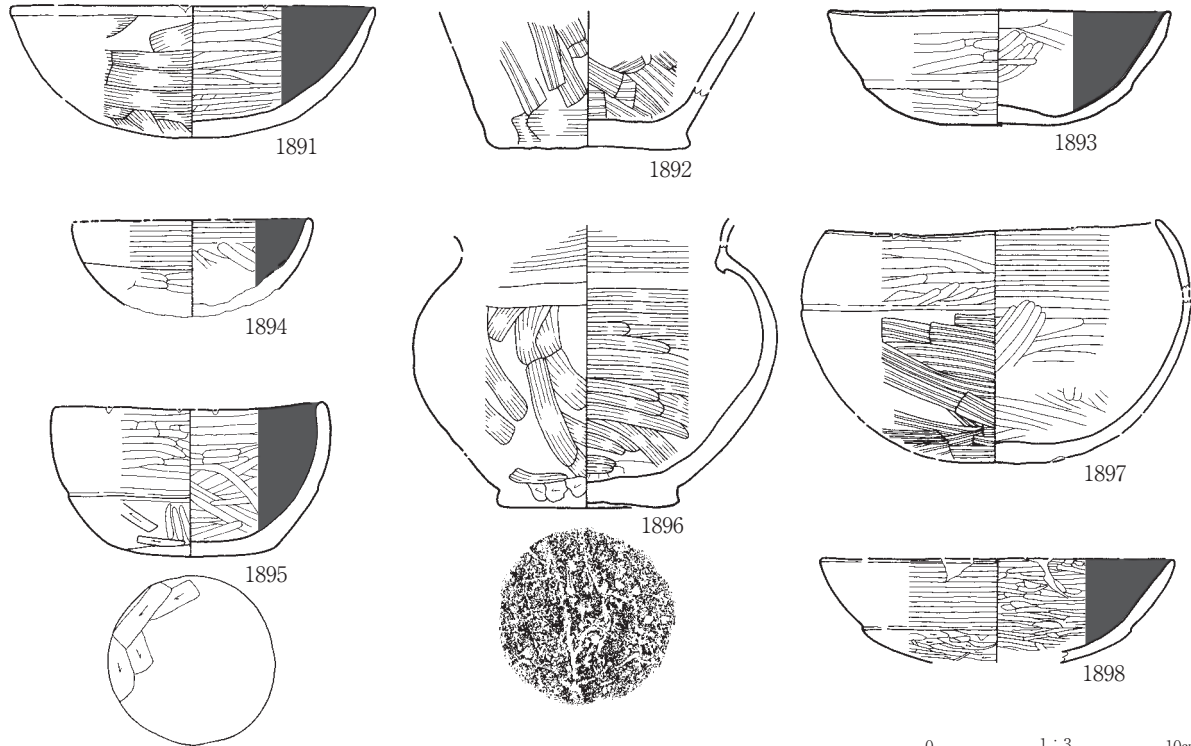

0 1:3 10cm

第445図 土師器 (9)

S 174 (2)

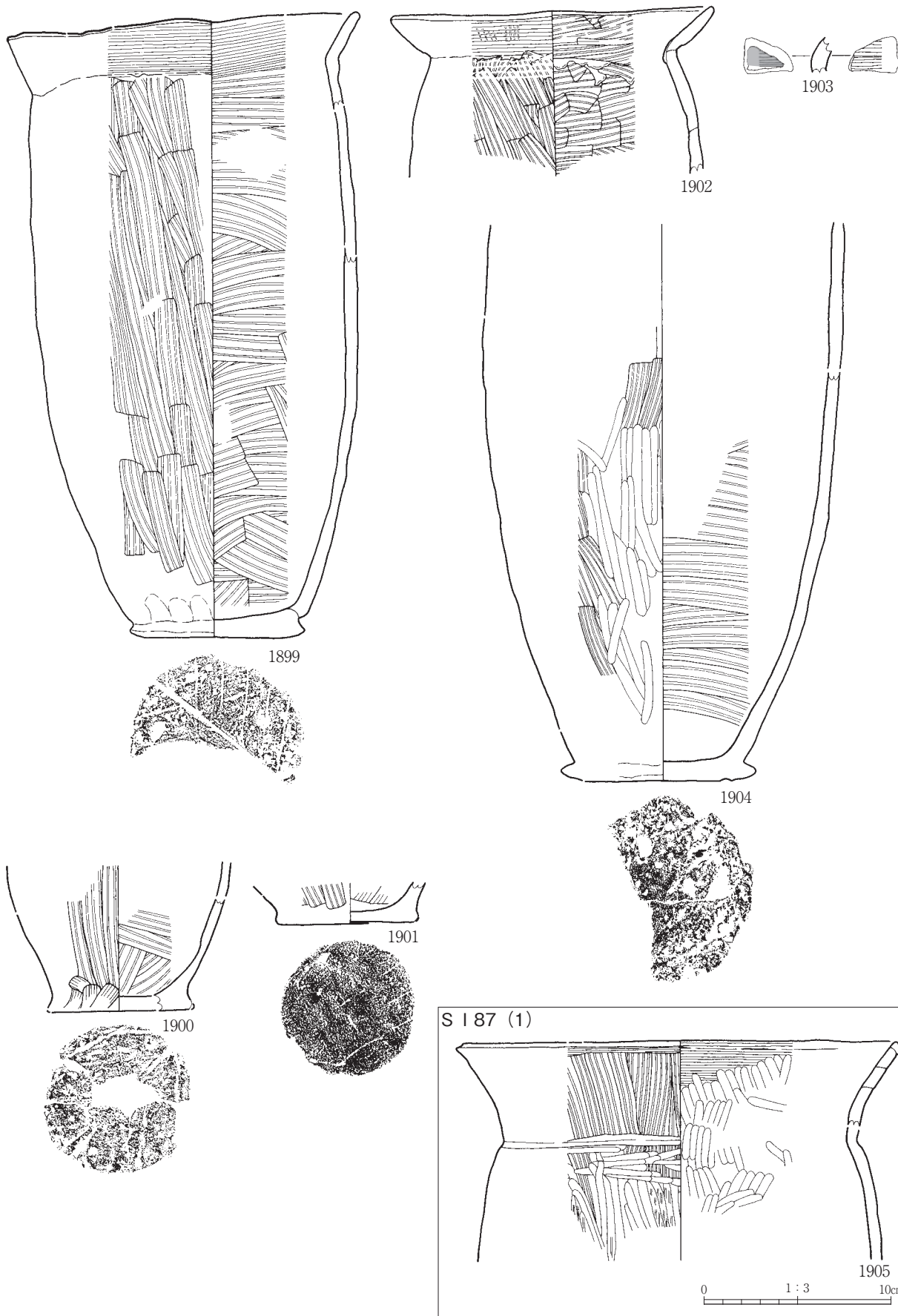

第446図 土師器 (10)

S 187 (2)

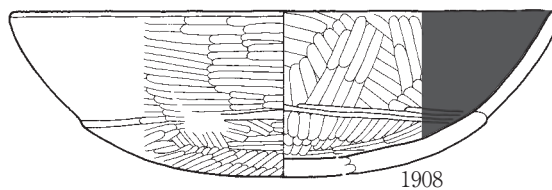
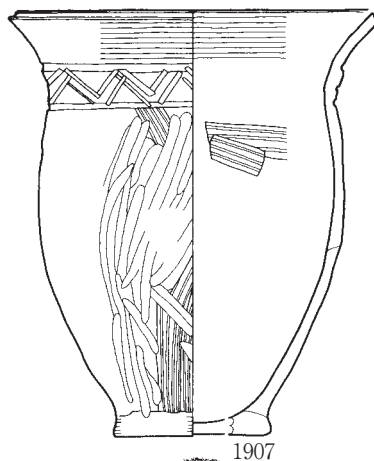
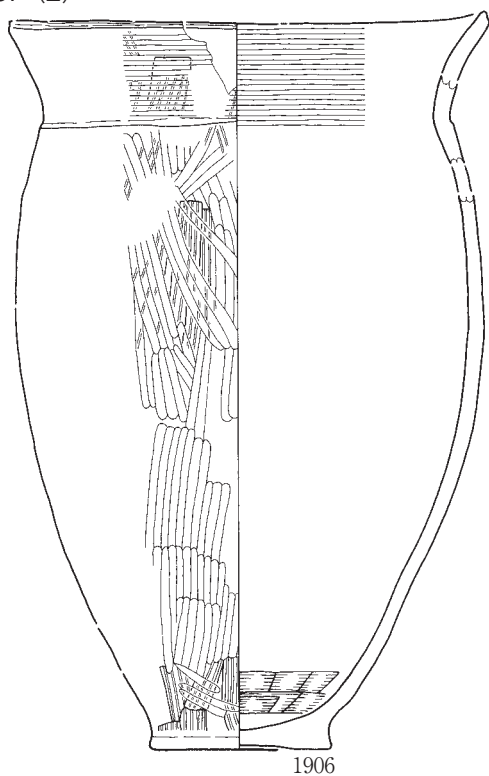

S 1105 (1)

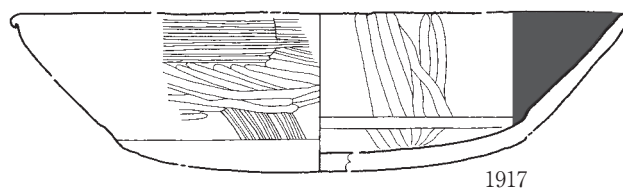
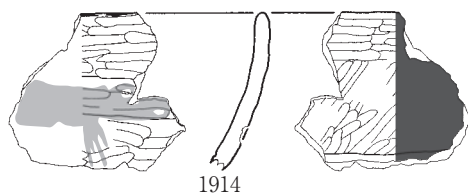
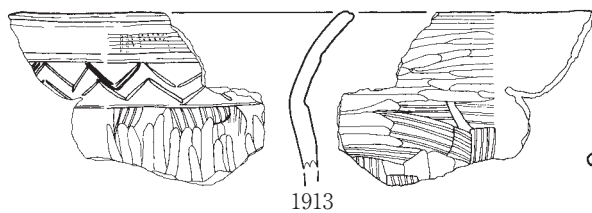
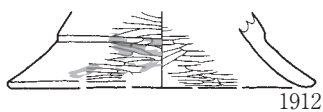
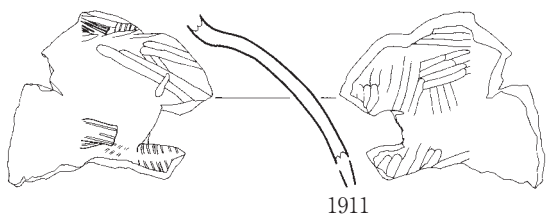
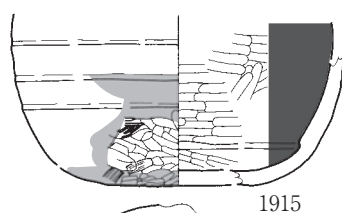
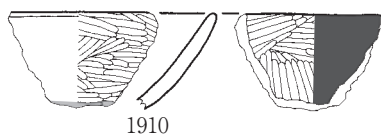
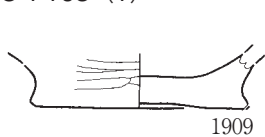

0 1:3 10cm

第447図 土師器 (11)

S I 105 (2)

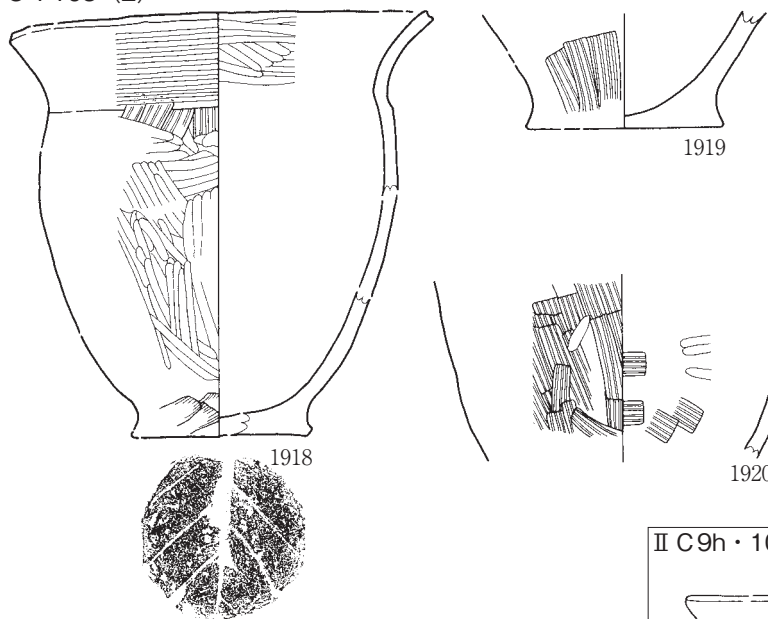

S K I 04

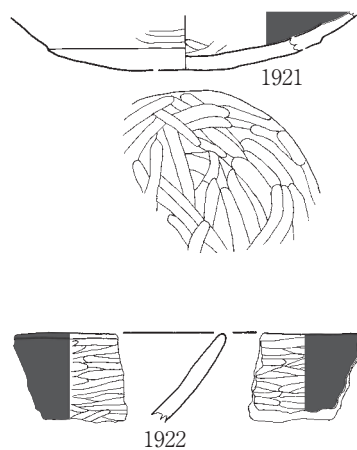

S K 26 · 27

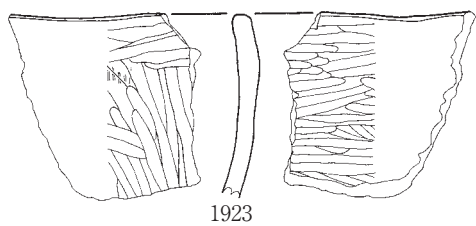

II C 10e

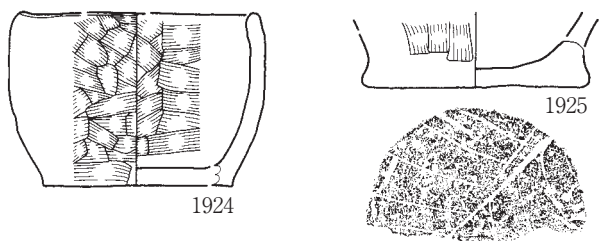

II C 9h · 10h

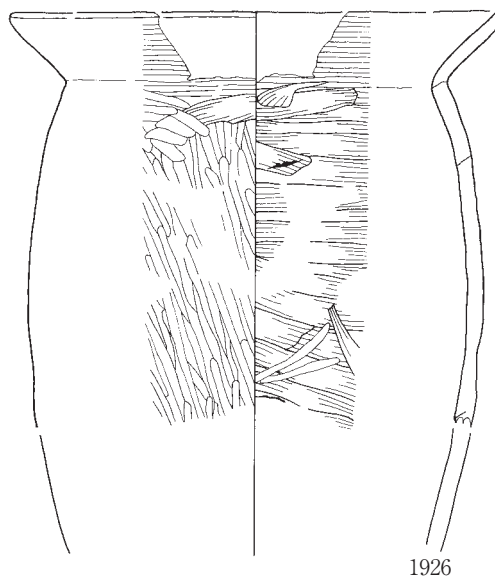

III C 1c

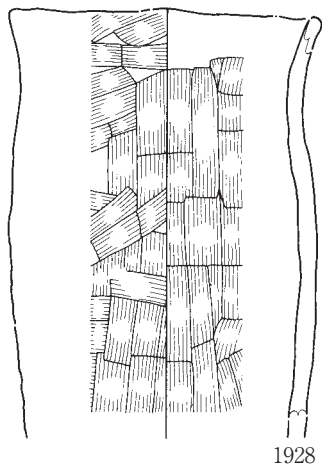

II D 2e

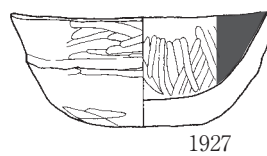

III C 8h

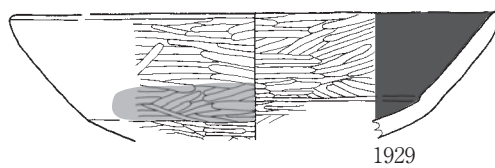

0 1 : 3 10cm

第448図 土師器 (12)



Ⅲ C 8i

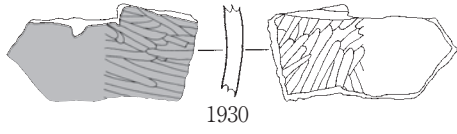

Ⅲ C 10b

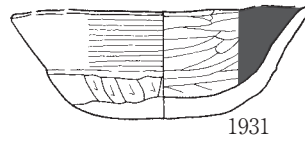

Ⅳ A 1h

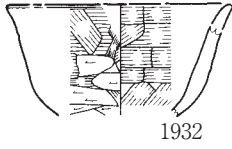

Ⅳ B 5i



Ⅳ B 10j

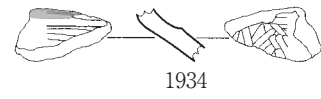

Ⅳ C 1d

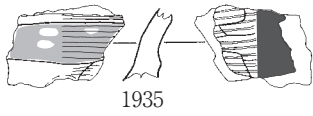

Ⅳ C 1h



Ⅳ C 2f

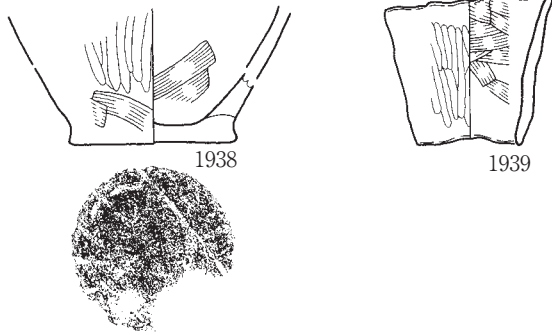

Ⅳ C 6b

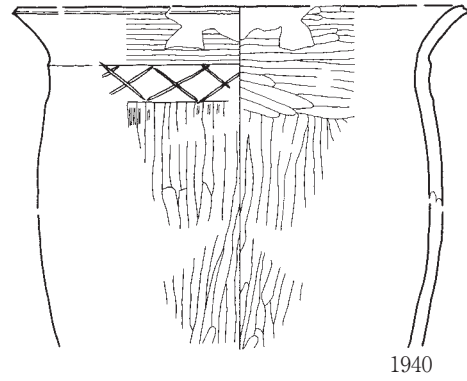

東奥谷部分試掘トレンチ付近

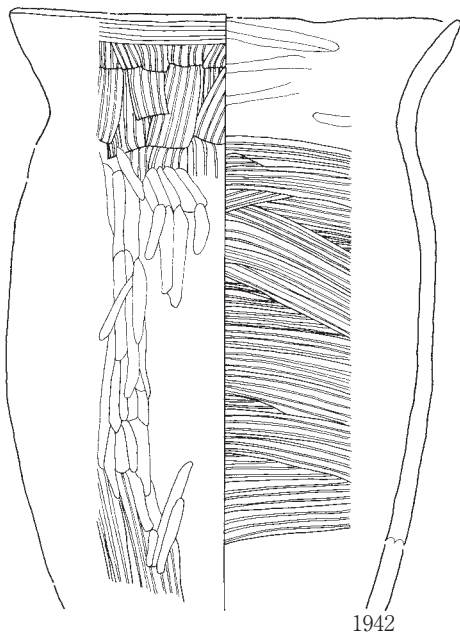

Ⅳ D 3b

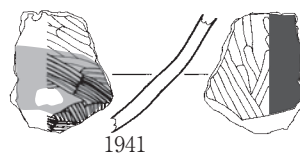

トレンチ 7

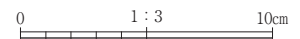
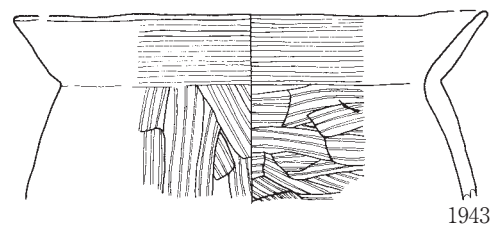

第449図 土師器 (13)

S I 04



S I 06

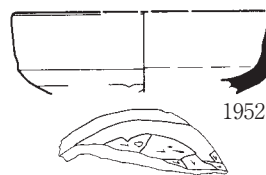

S I 52

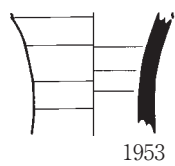

S I 74

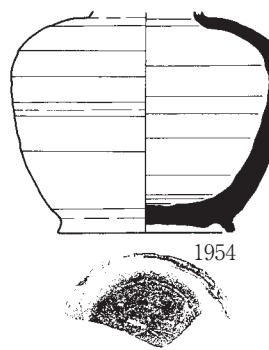

SK I 10

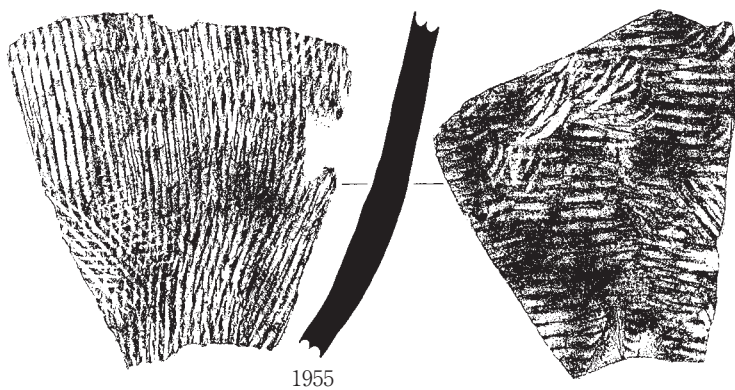

S X 07

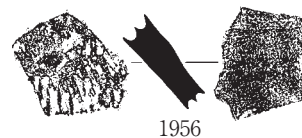

S X 10

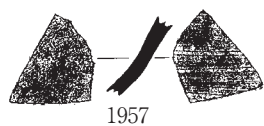

III C 1a · 1b

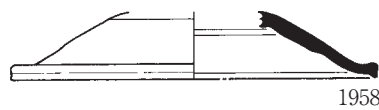

IV C 16



IV C 6c

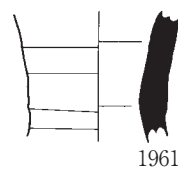

IV C 3a

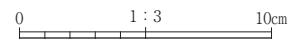

第450図 須恵器

S I 50

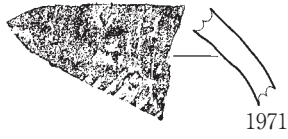

1971

S K I 05

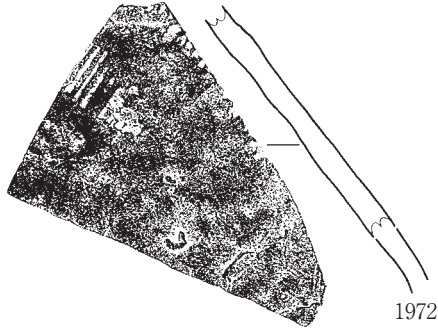

1972

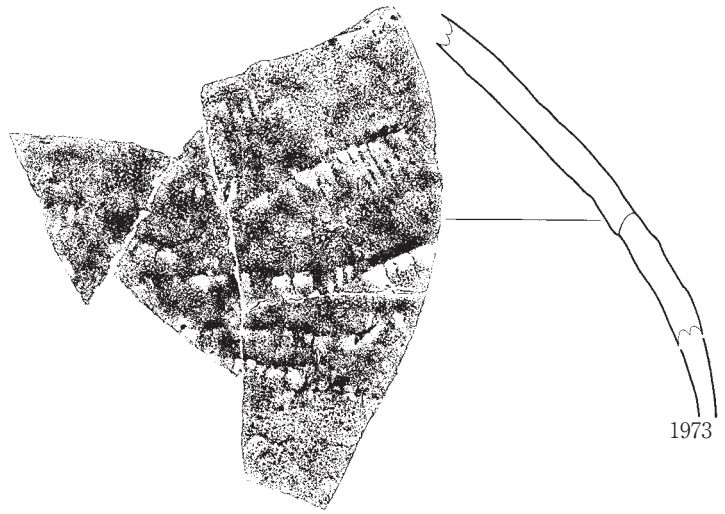

1973

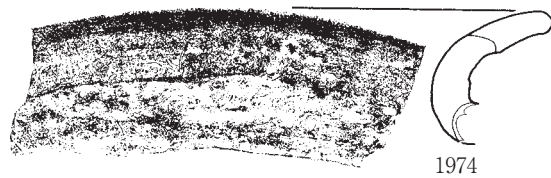

1974

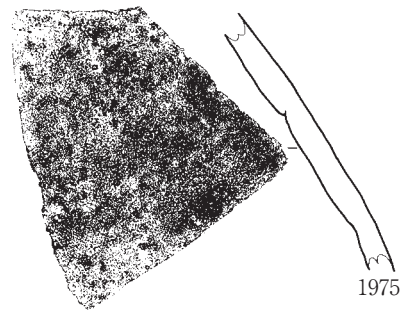

1975

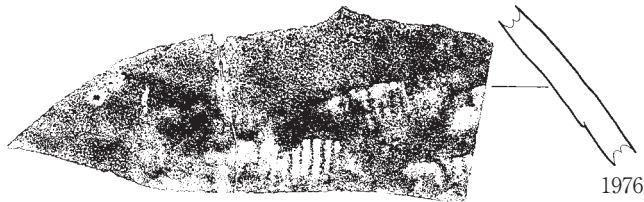

1976

S X 07

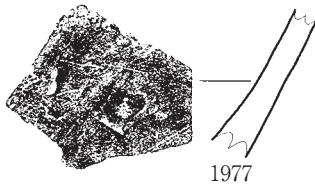

1977

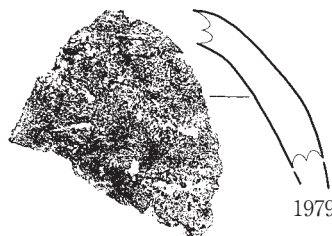

1979

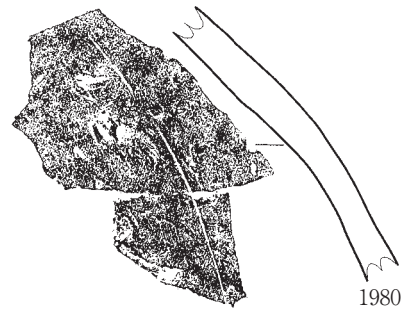

1980

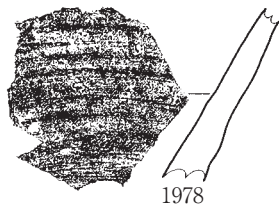

1978

1971~1980 : 中世陶器

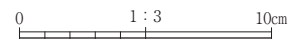

第451図 陶磁器 (1)

Ⅲ B7e

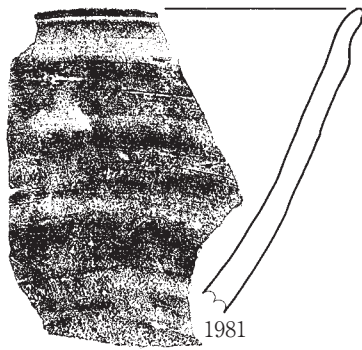

Ⅳ C4d

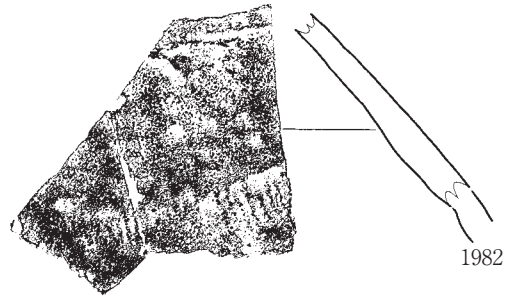

Ⅳ C6c

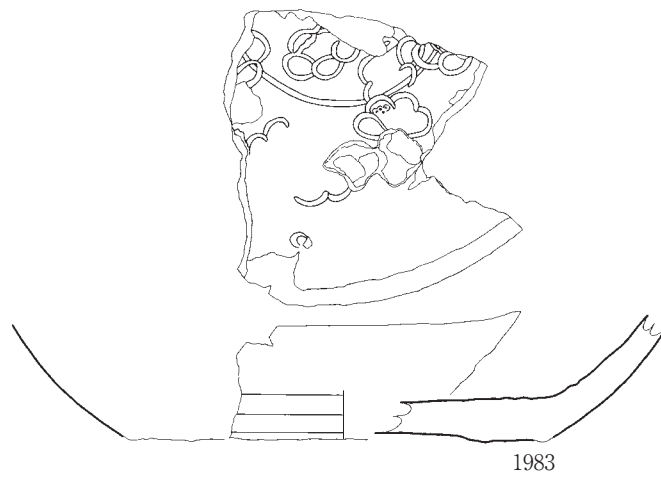

S X07

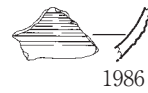
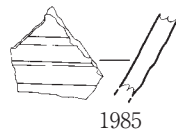

1981~1983 : 中世陶器  
 1984~1986 : 近世陶器

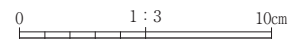

第452図 陶磁器 (2)

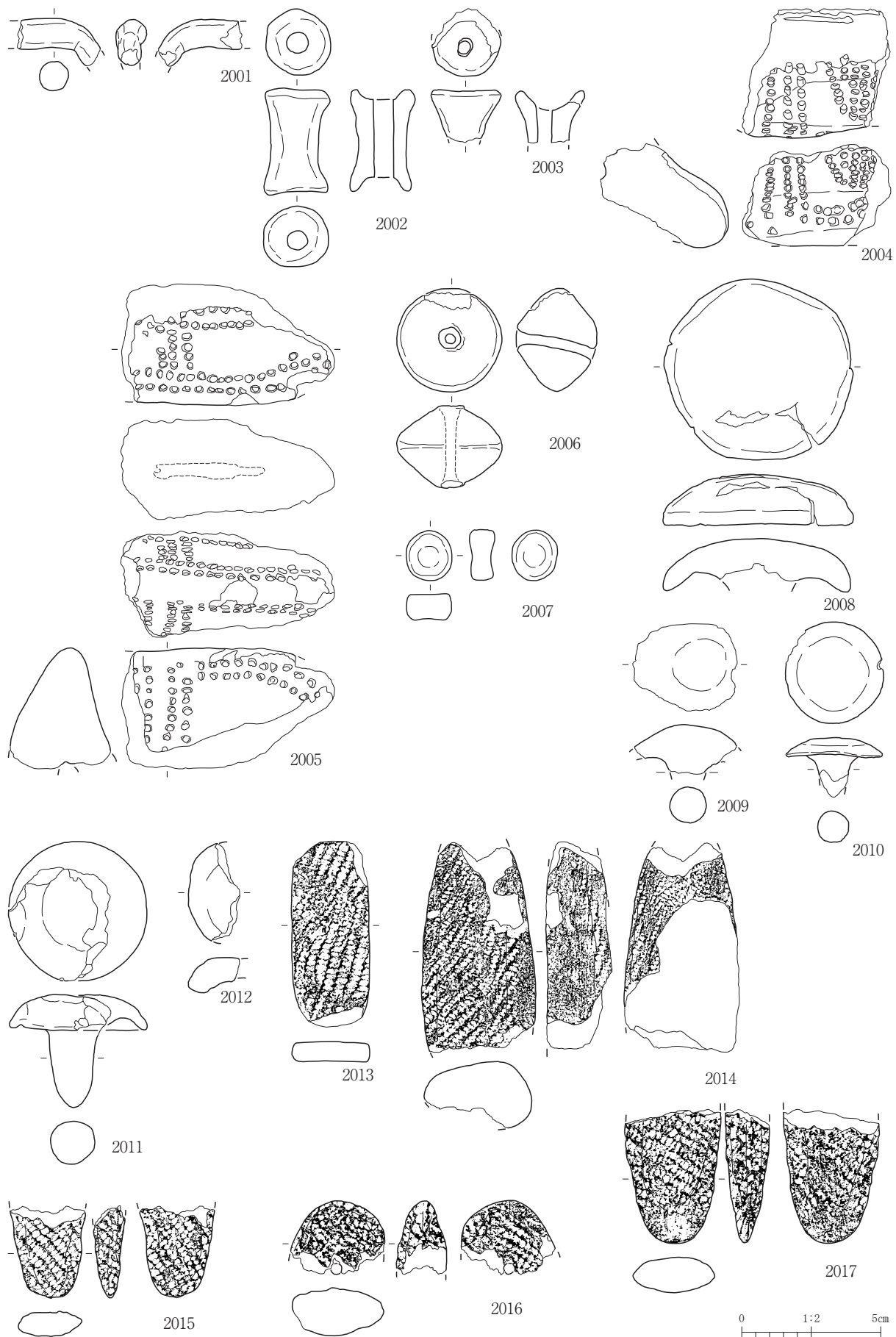

第453図 土製品 (1)

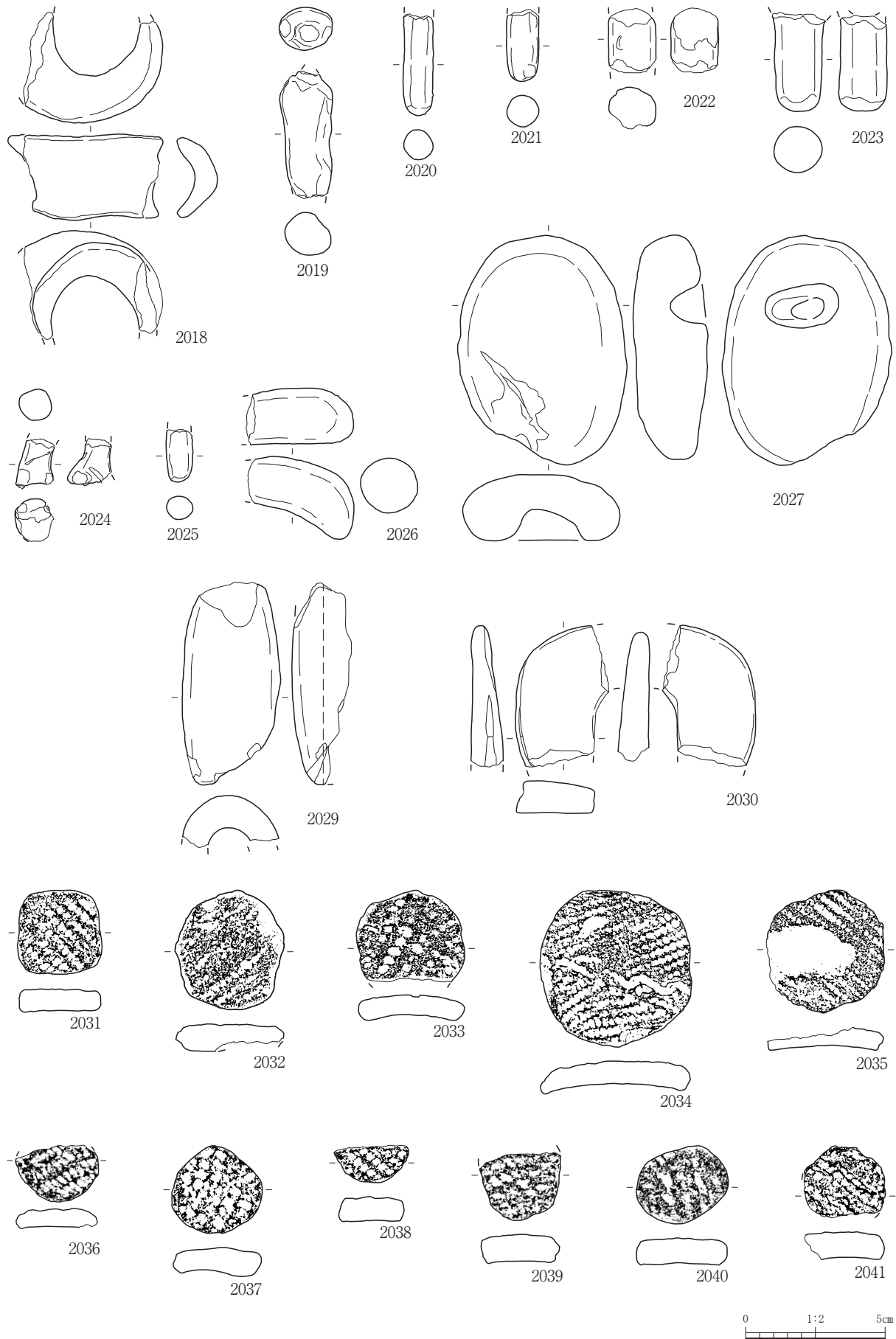

第454図 土製品 (2)

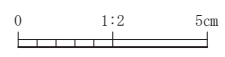
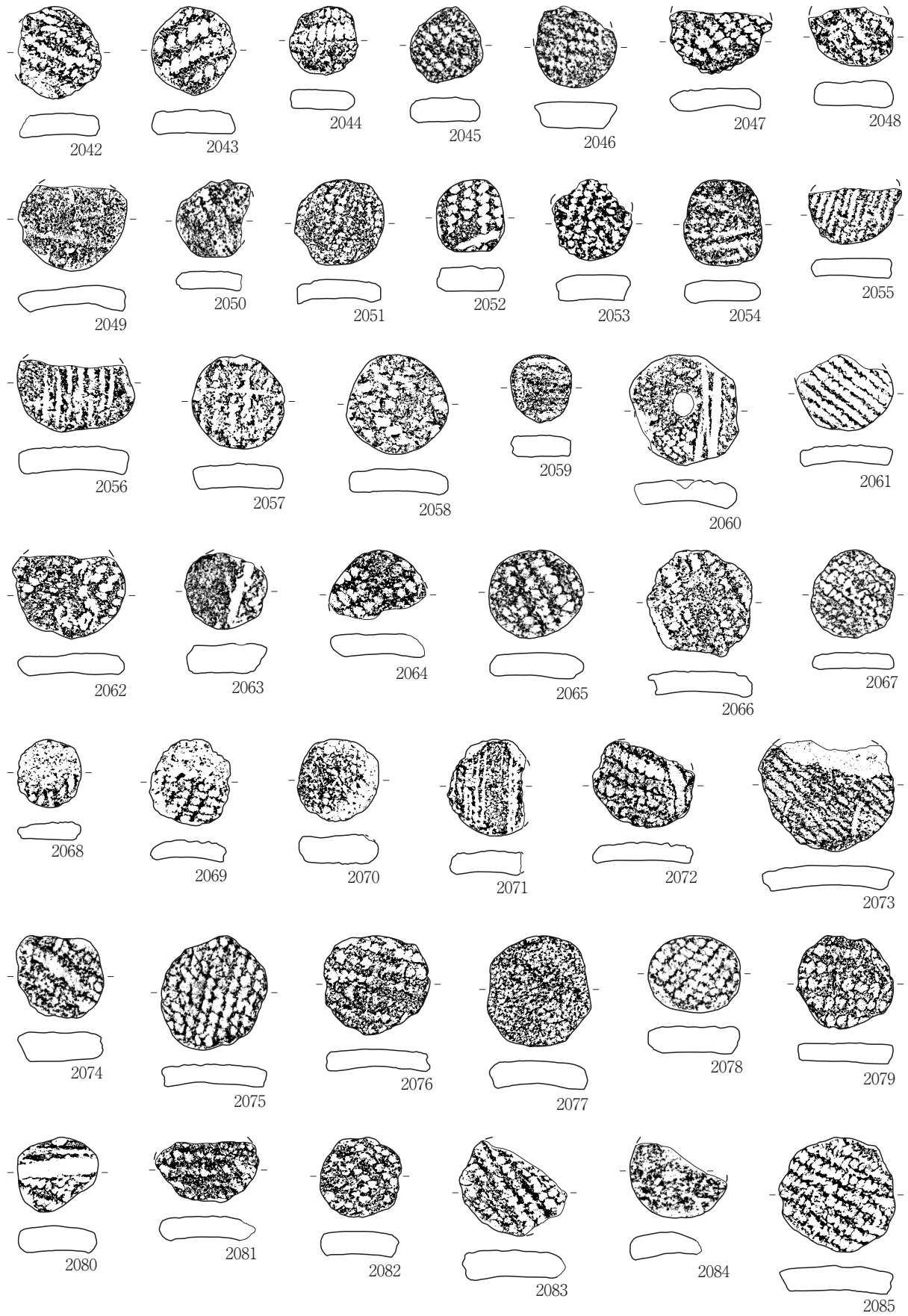

第455図 土製品 (3)

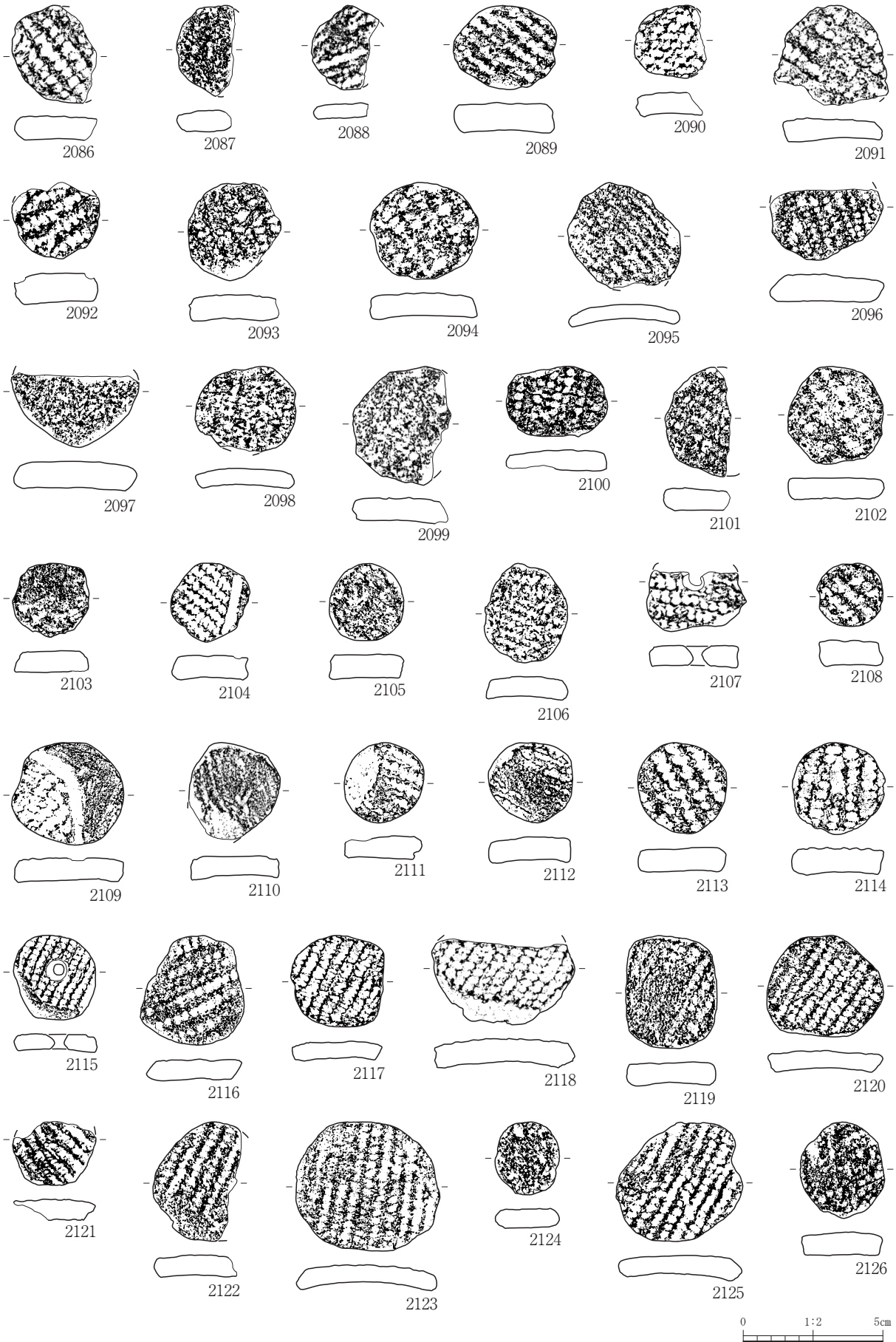

第456図 土製品 (4)



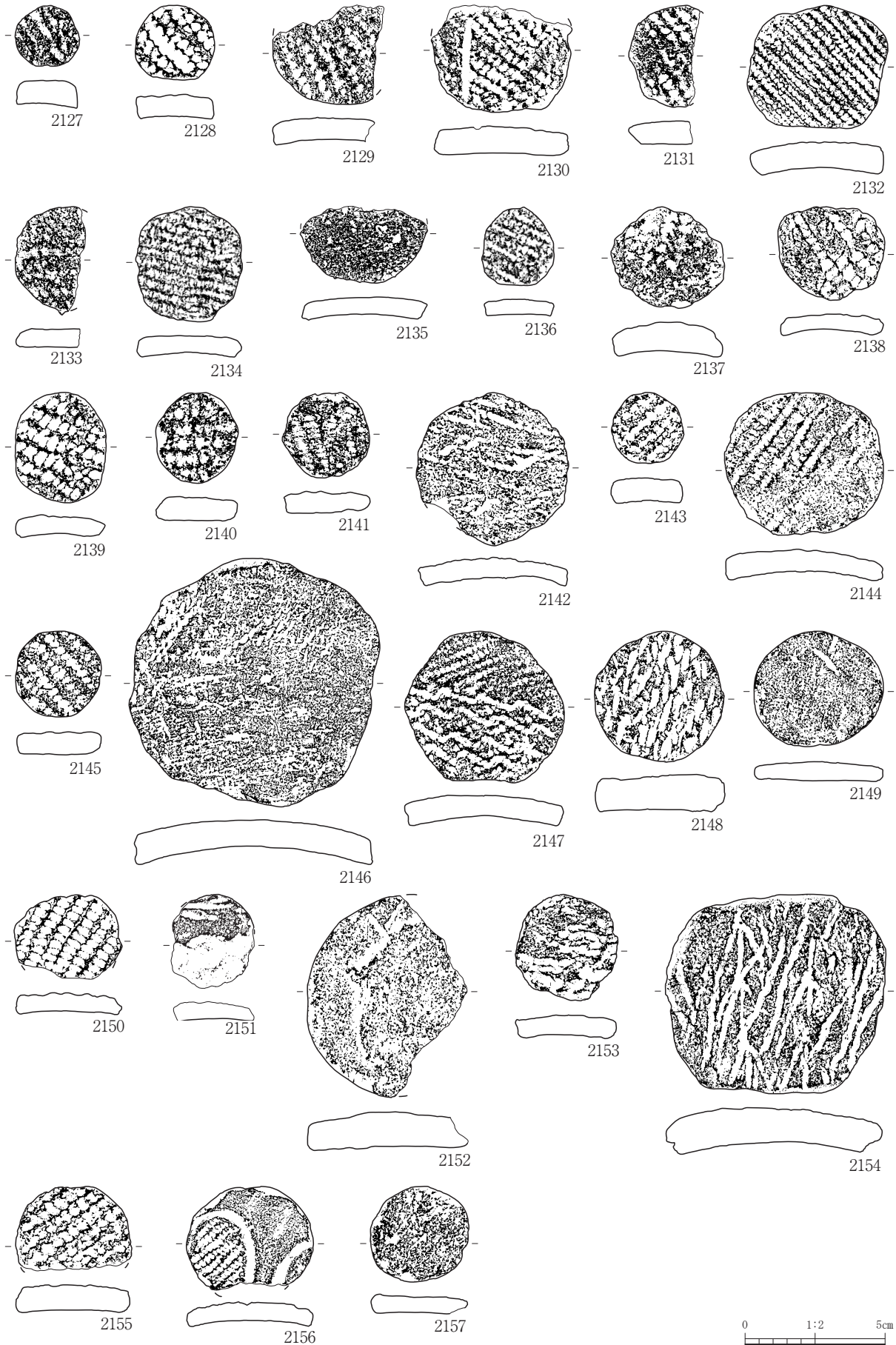

第457図 土製品 (5)

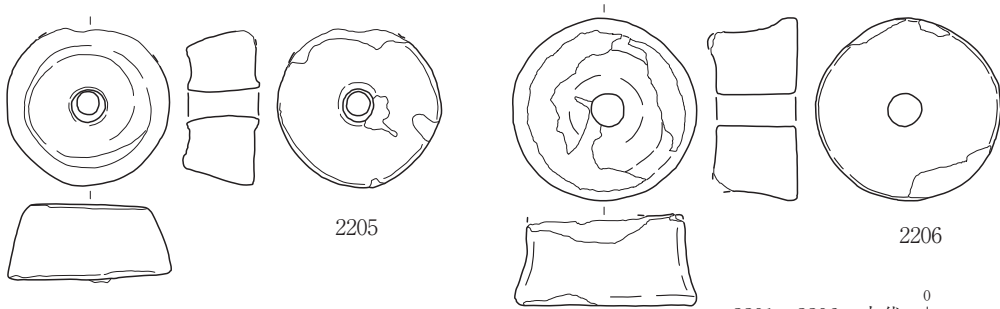
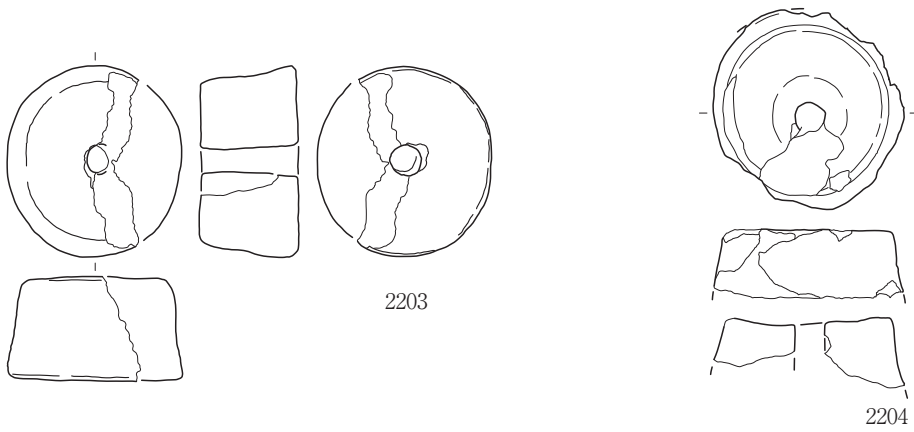
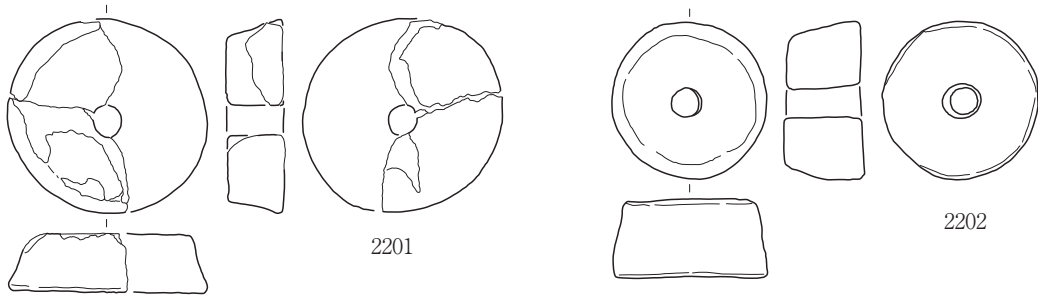
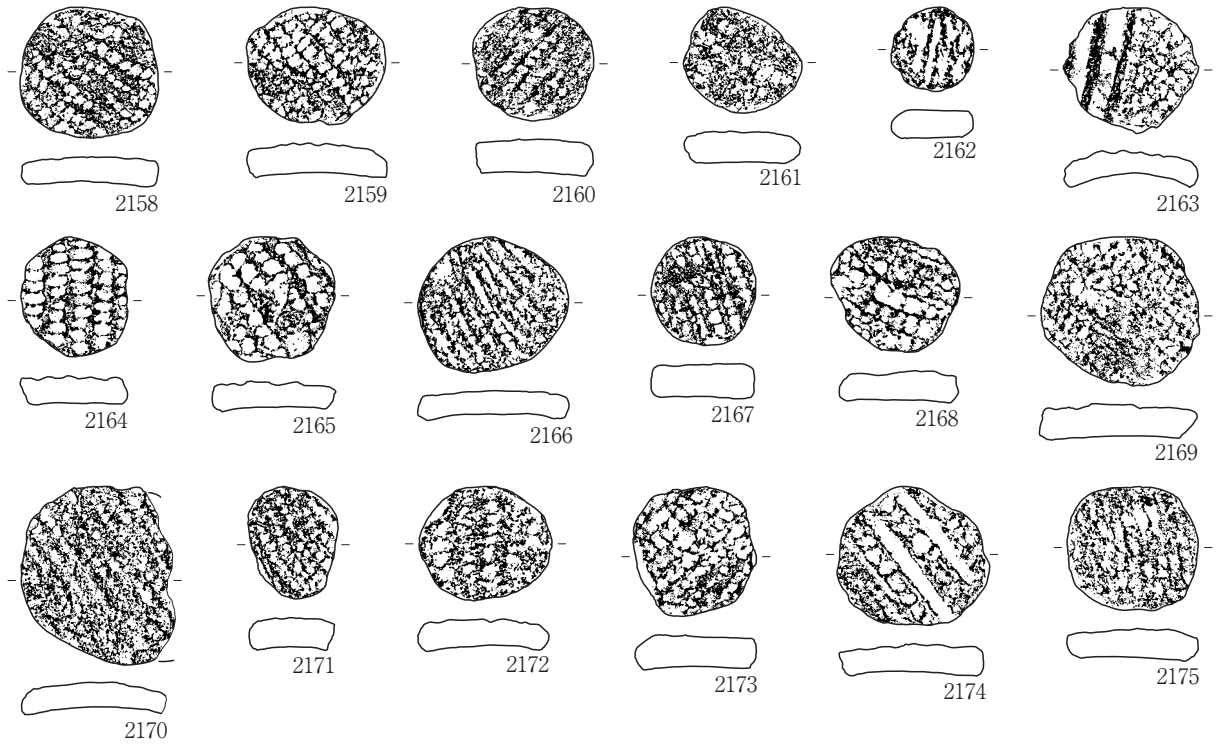

2201~2206 : 古代 0 1:2 5cm

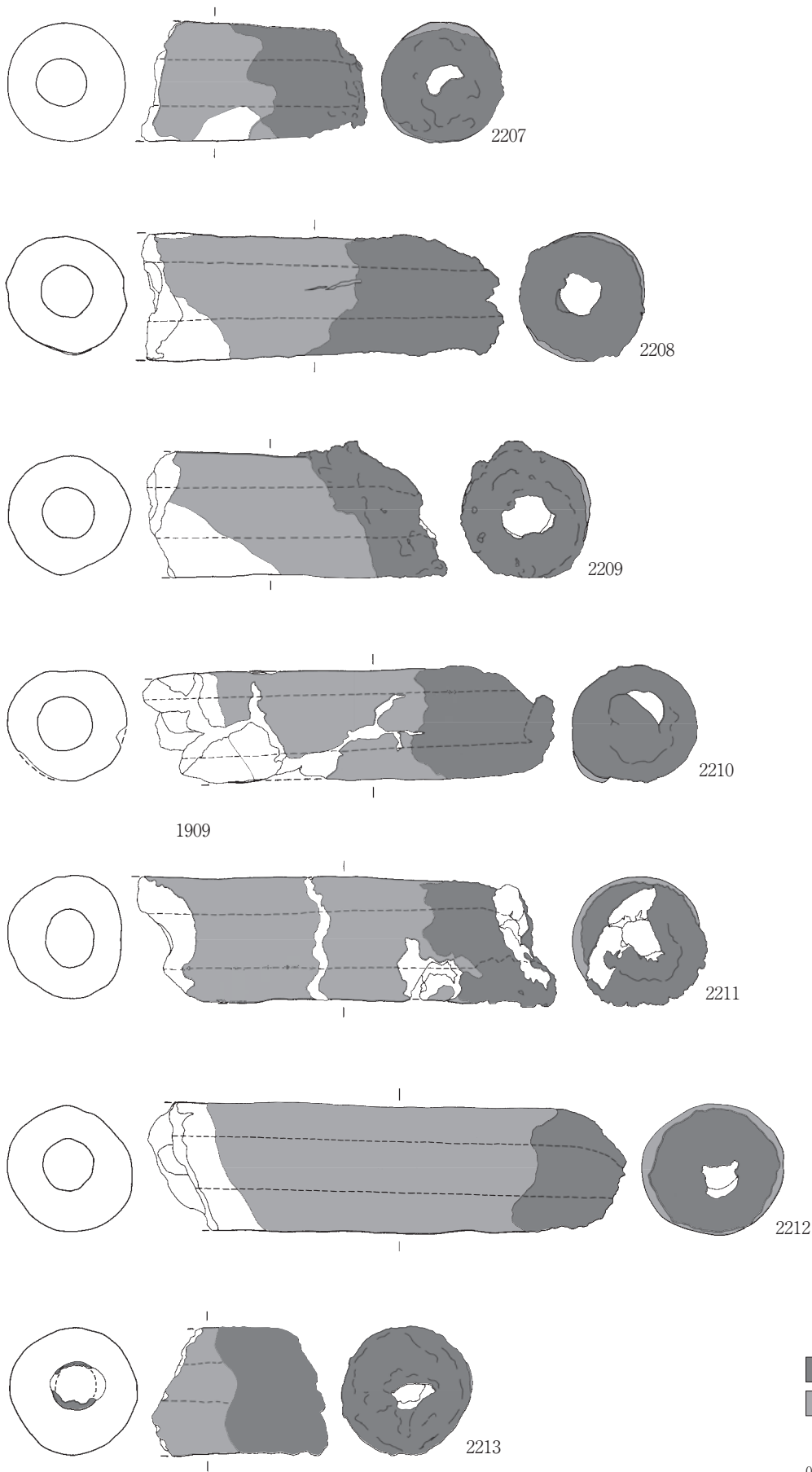

第459図 羽口（1）

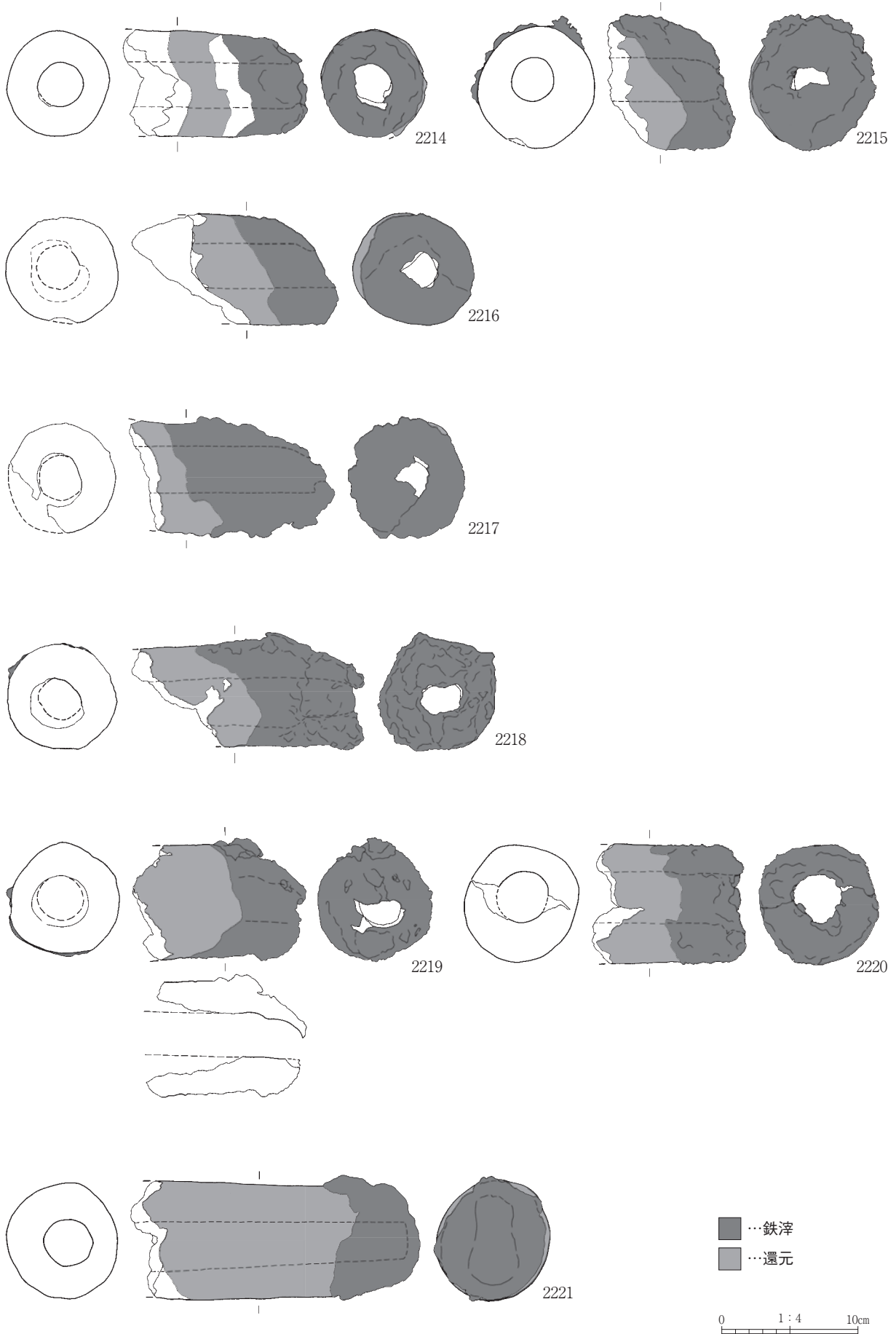

第460図 羽口 (2)

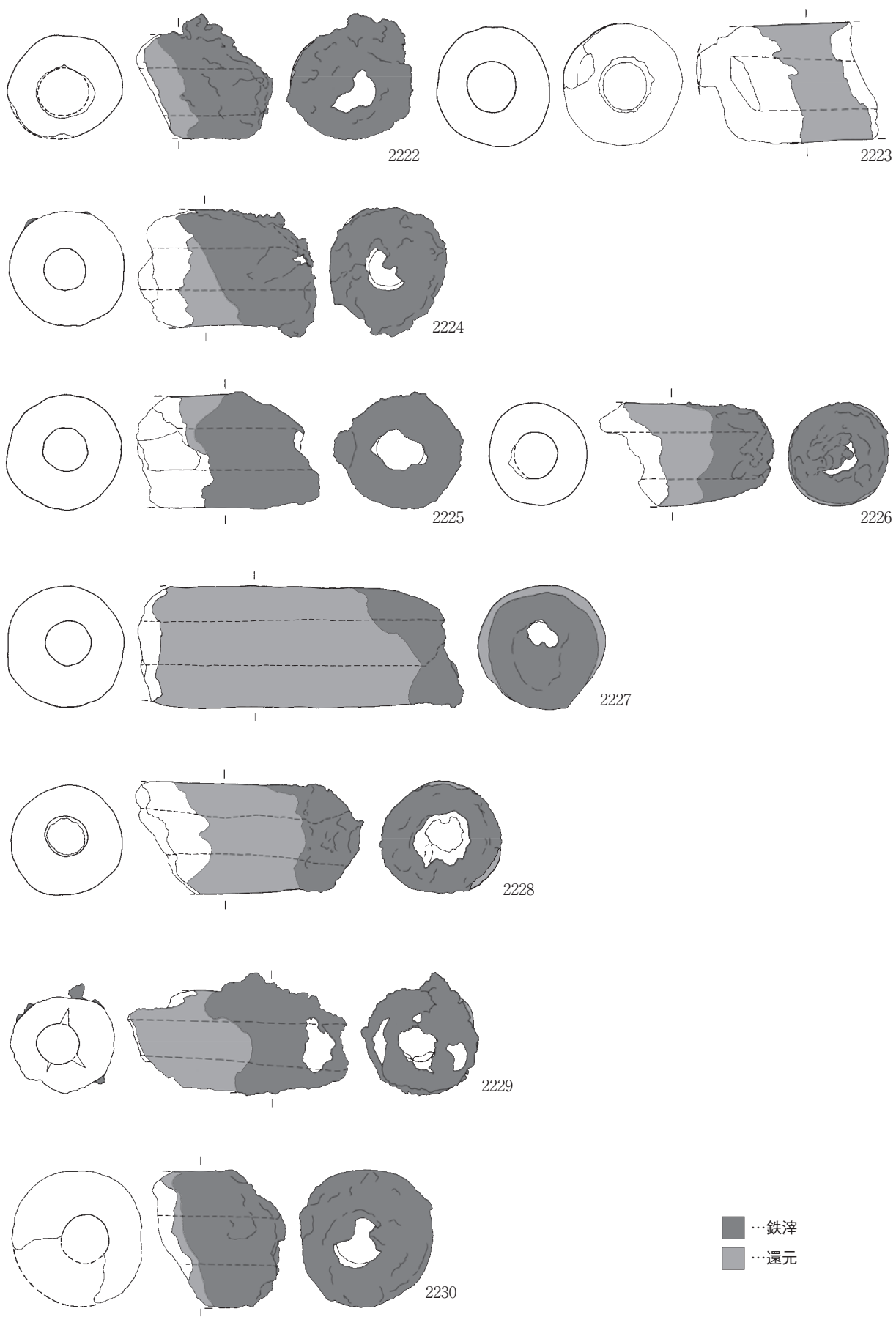

第461図 羽口 (3)

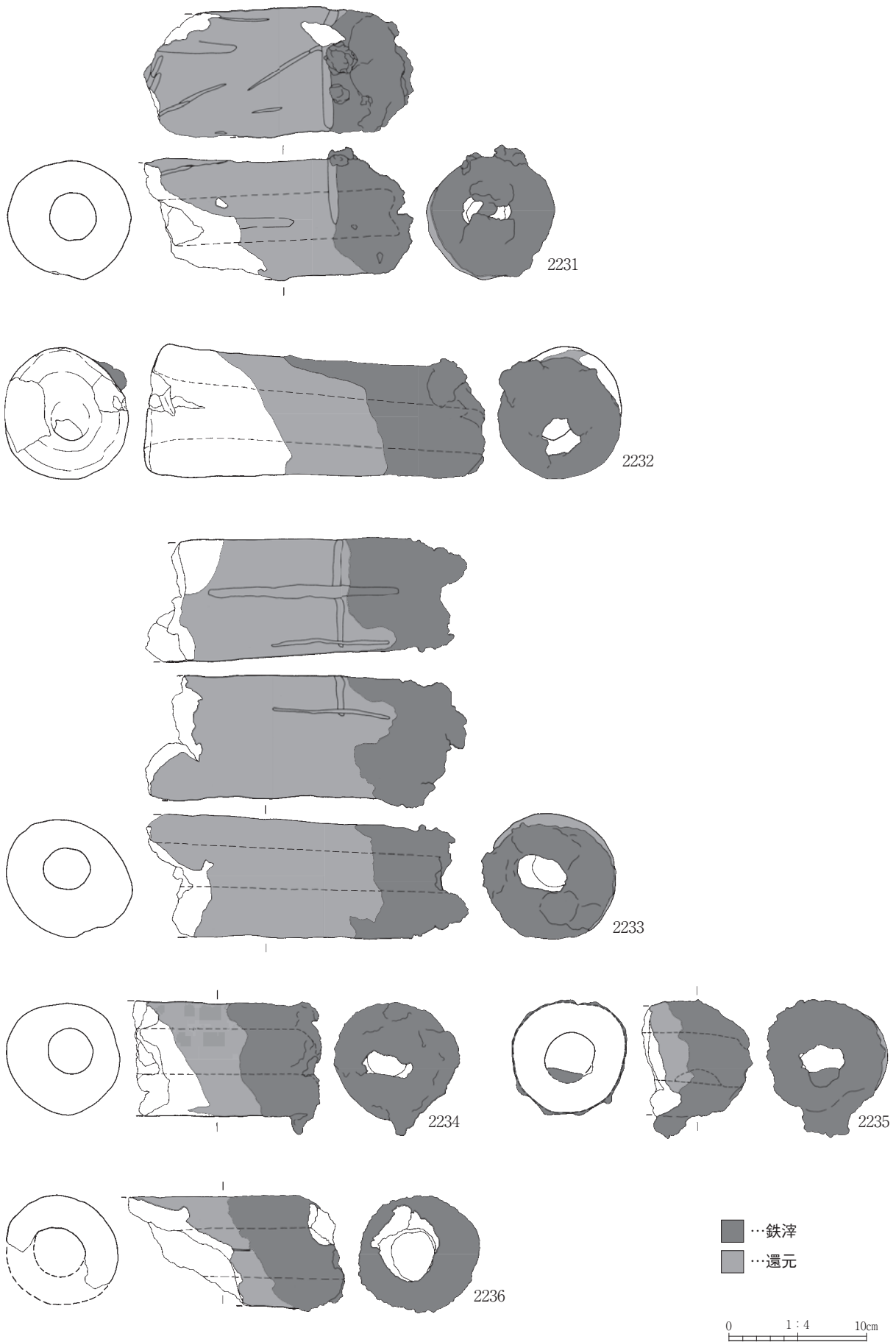

第462図 羽口（4）

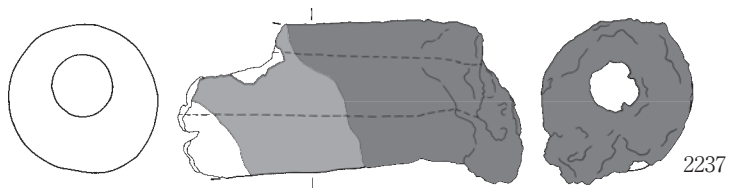

2237



2238

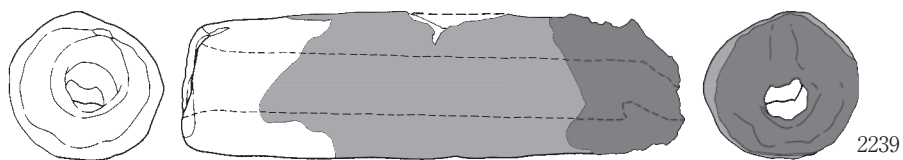

2239

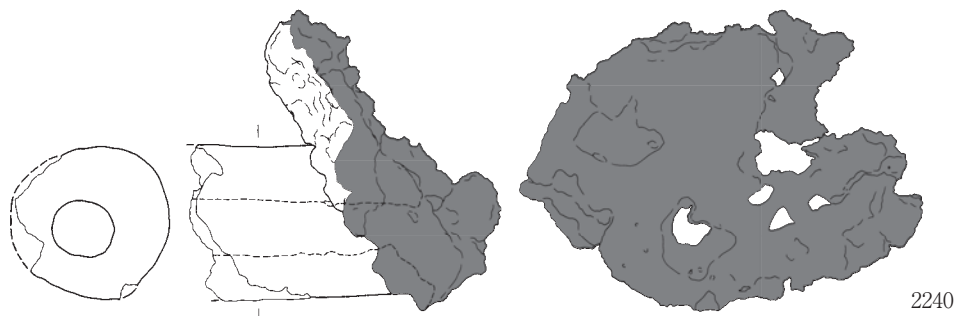

2240

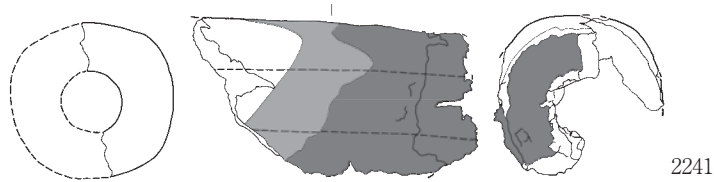

2241

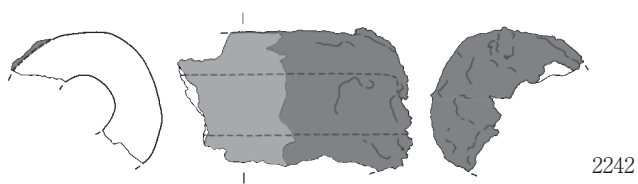

2242

■ …鉄滓  
 ■ …還元

0 1 : 4 10cm

第463図 羽口 (5)

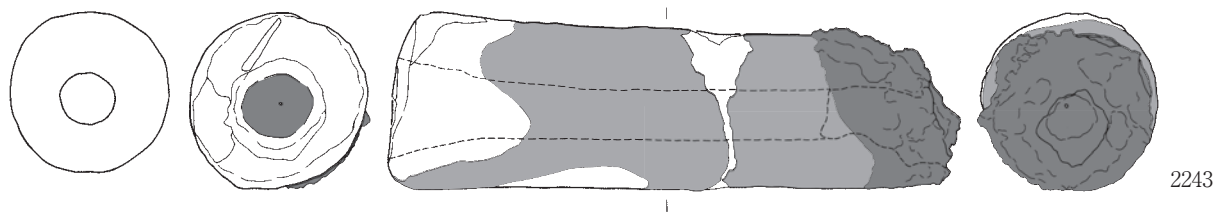

2243

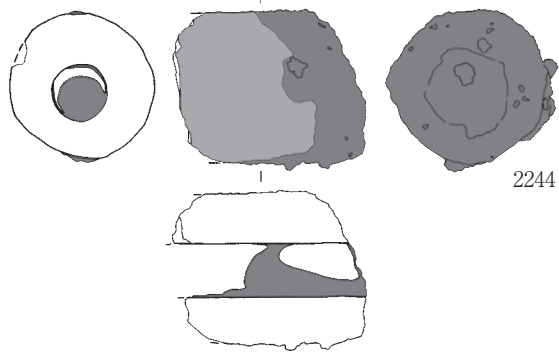

2244

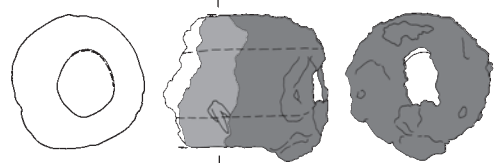

2245

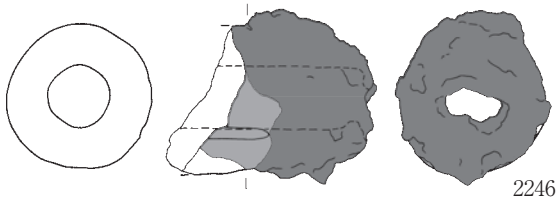

2246

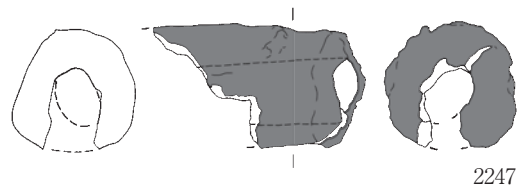

2247

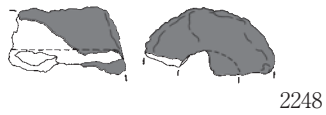

2248



2249



2250

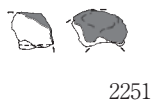

2251



2252



2253



2254

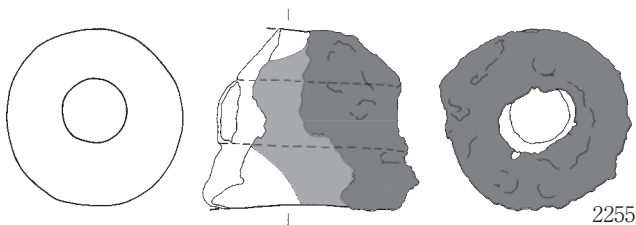

2255

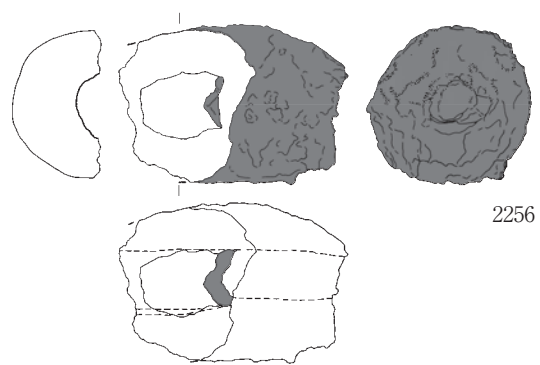

2256

■ …鉄滓  
 ■ …還元

0 1:4 10cm

第464図 羽口 (6)





2257

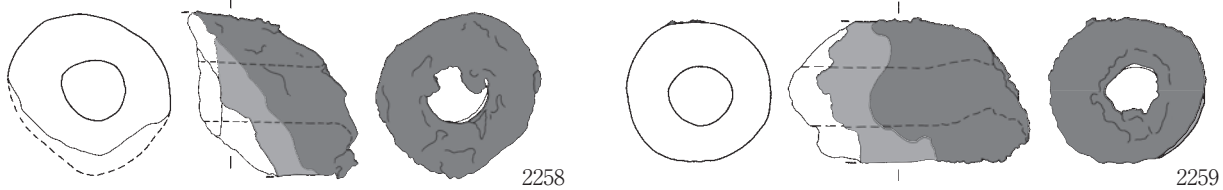

2258

2259

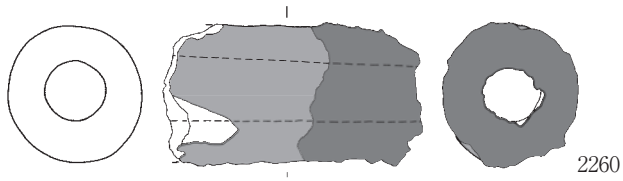

2260

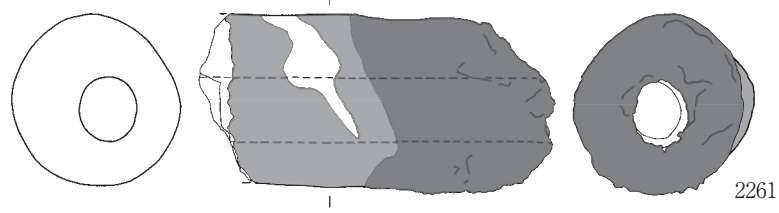

2261

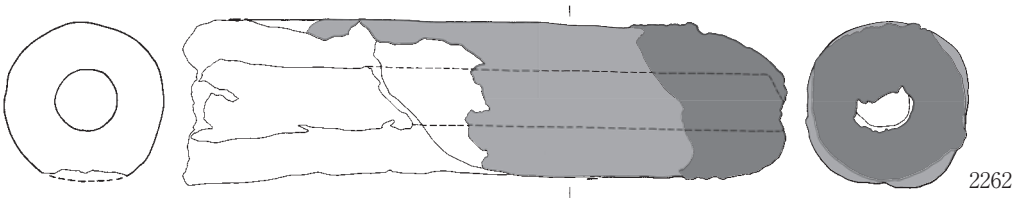

2262

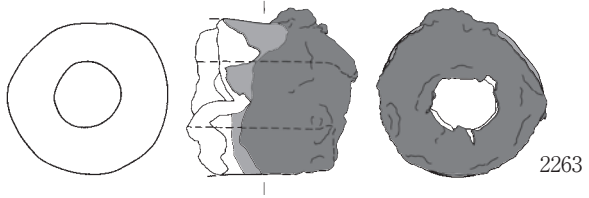

2263

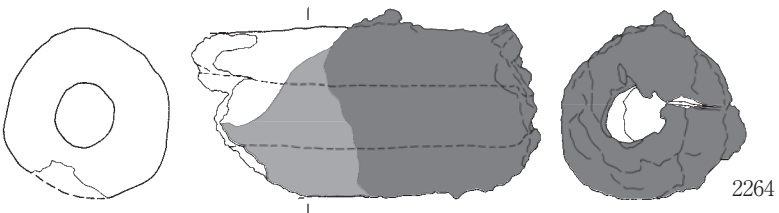

2264

■ …鉄滓  
 ■ …還元

0 1 : 4 10cm

第465図 羽口 (7)

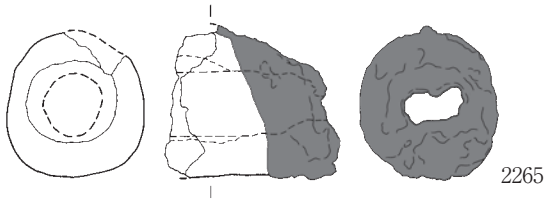

2265

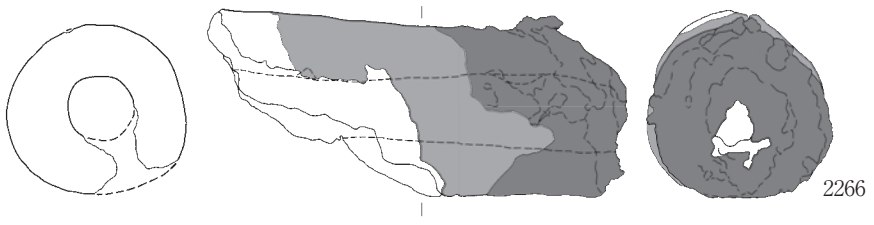

2266

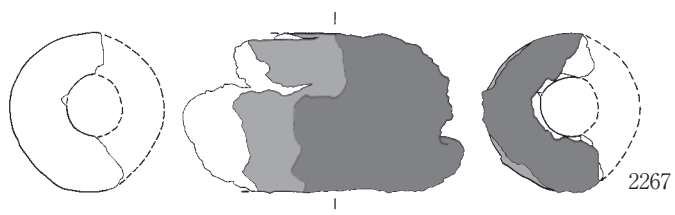

2267

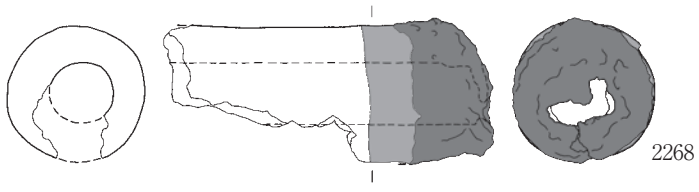

2268

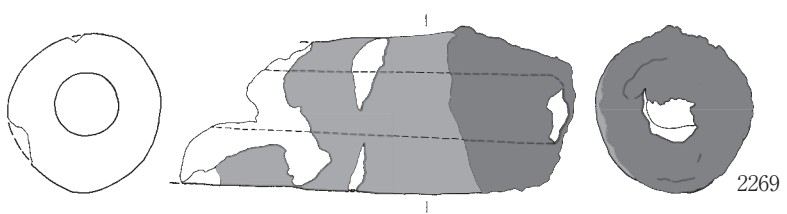

2269

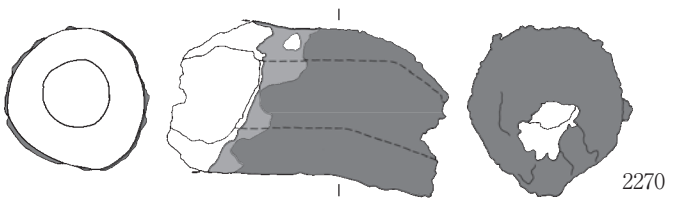

2270

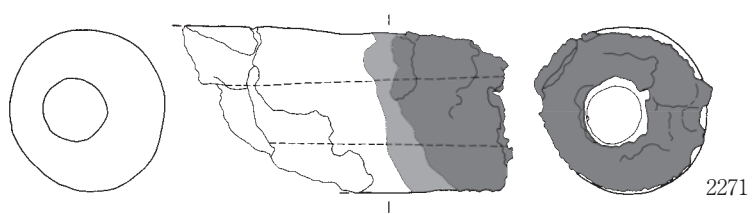

2271

■ …鉄滓  
 ■ …還元

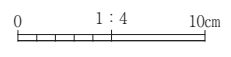

第466図 羽口 (8)

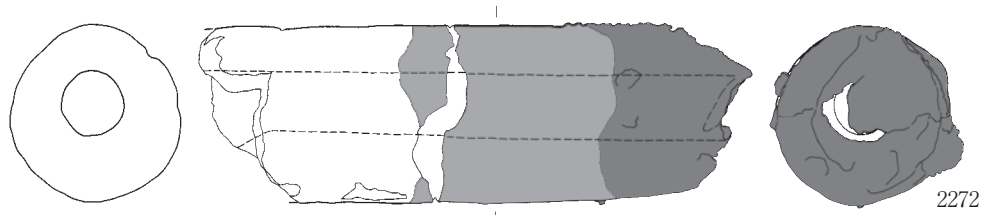

2272

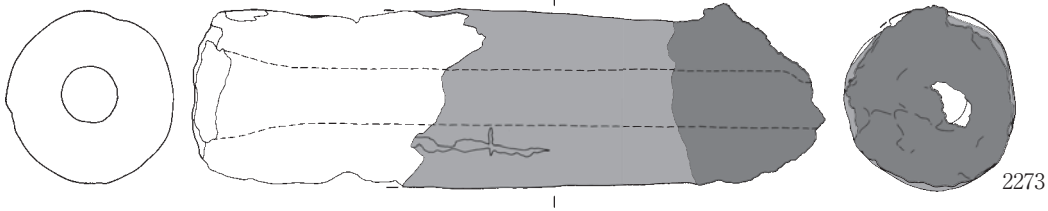

2273

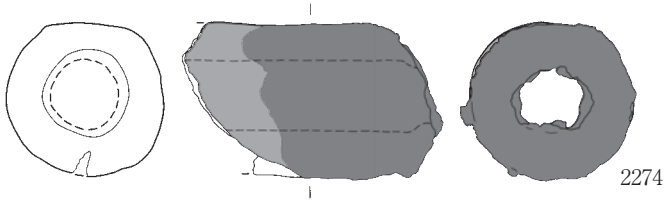

2274

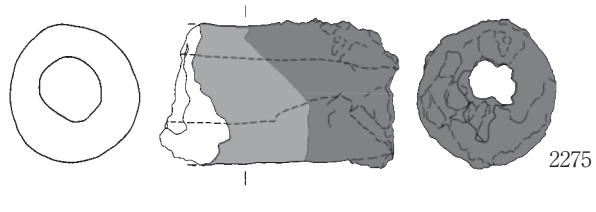

2275

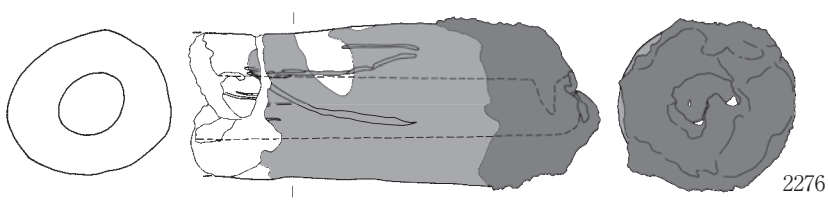

2276

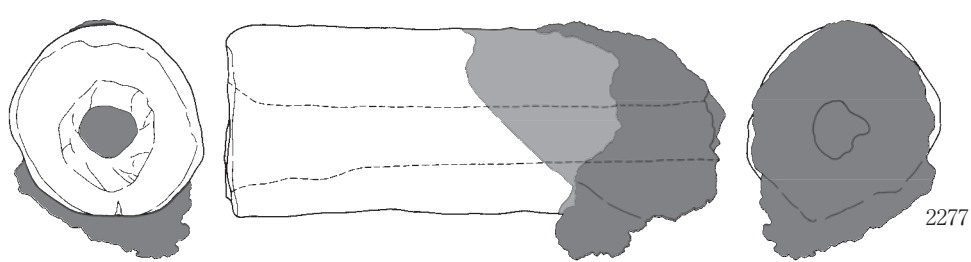

2277

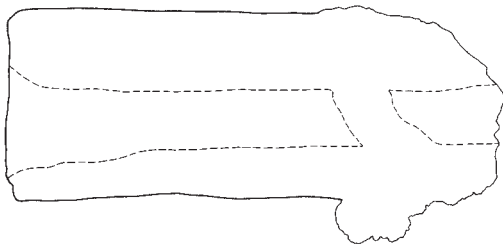

…鉄滓  
 …還元

0 1:4 10cm

第467図 羽口 (9)

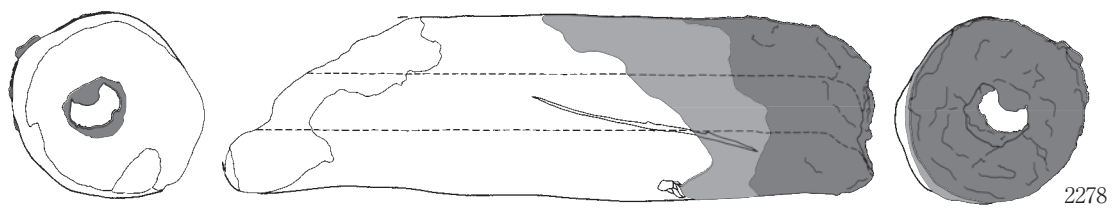

2278

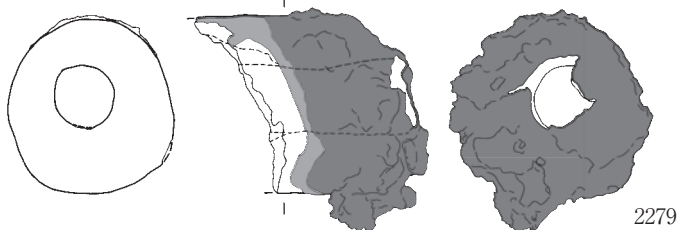

2279

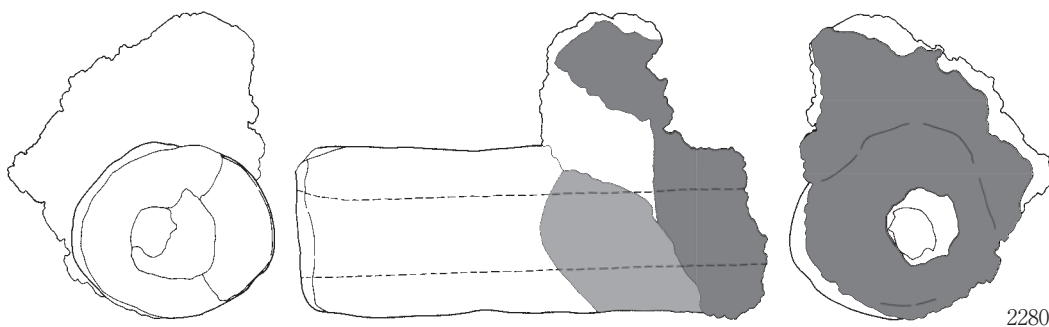

2280

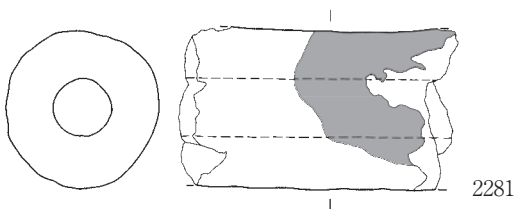

2281

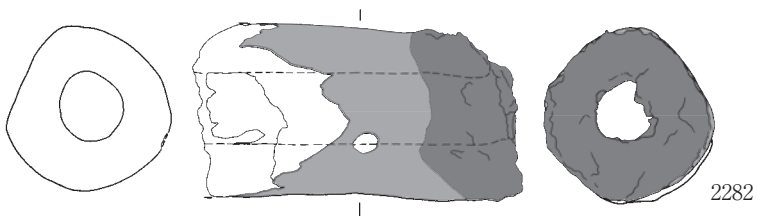

2282

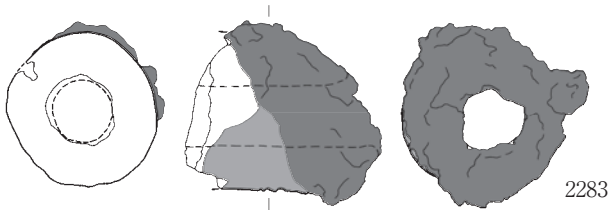

2283

■ …鉄滓  
 ■ …還元

0 1:4 10cm

第468図 羽口 (10)

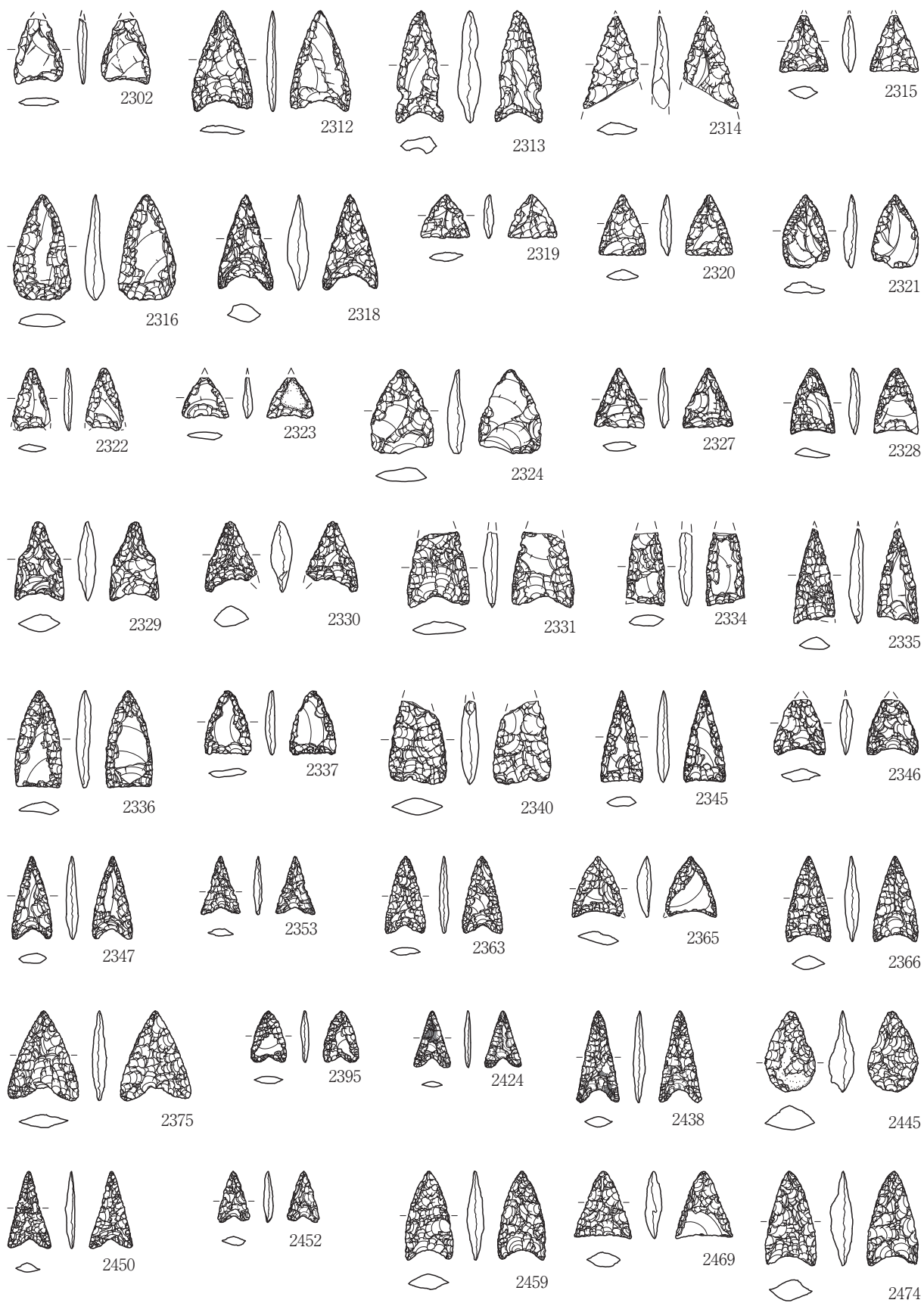

第469图 石器 (1)

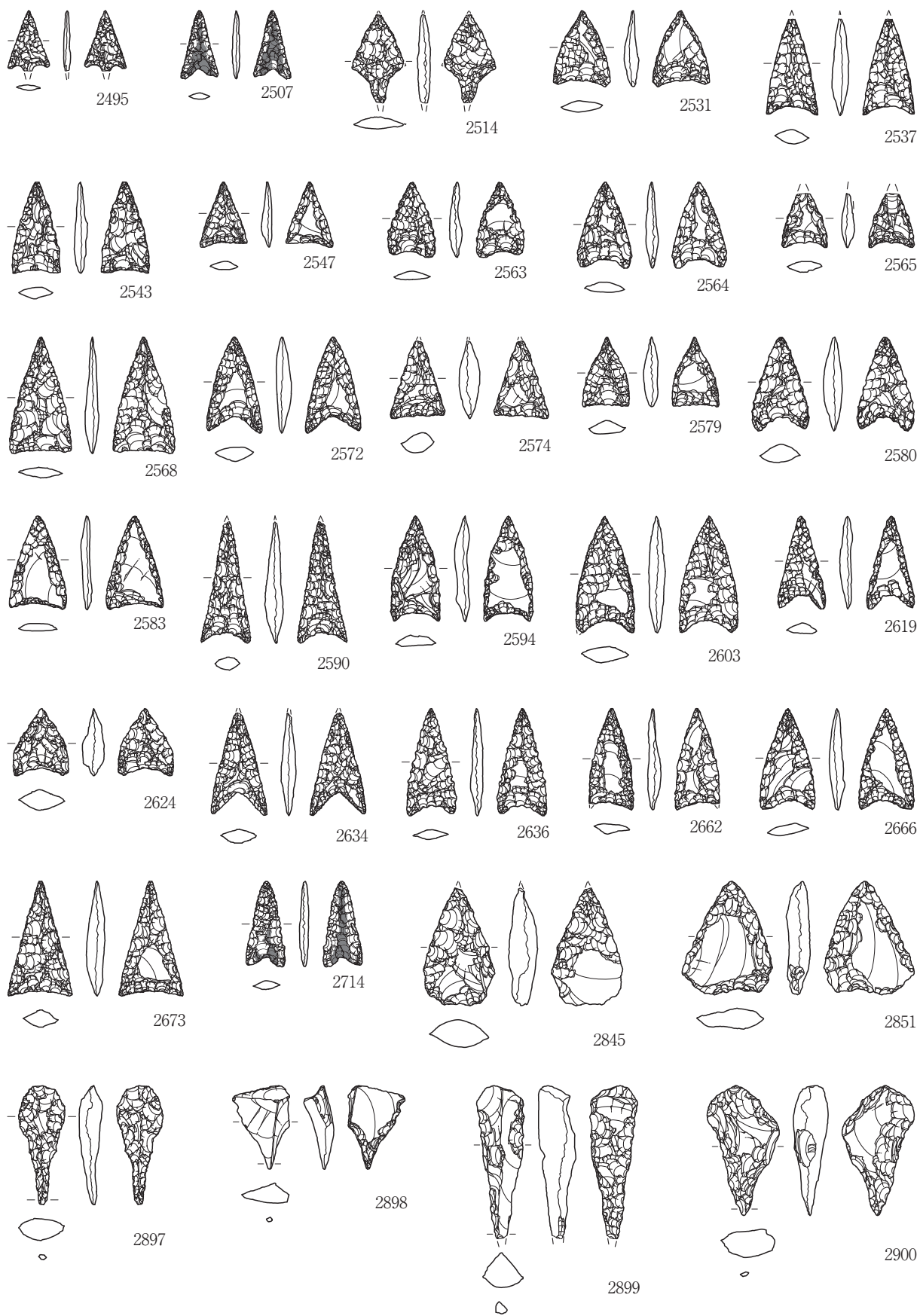

0 1:2 5cm

第470图 石器(2)

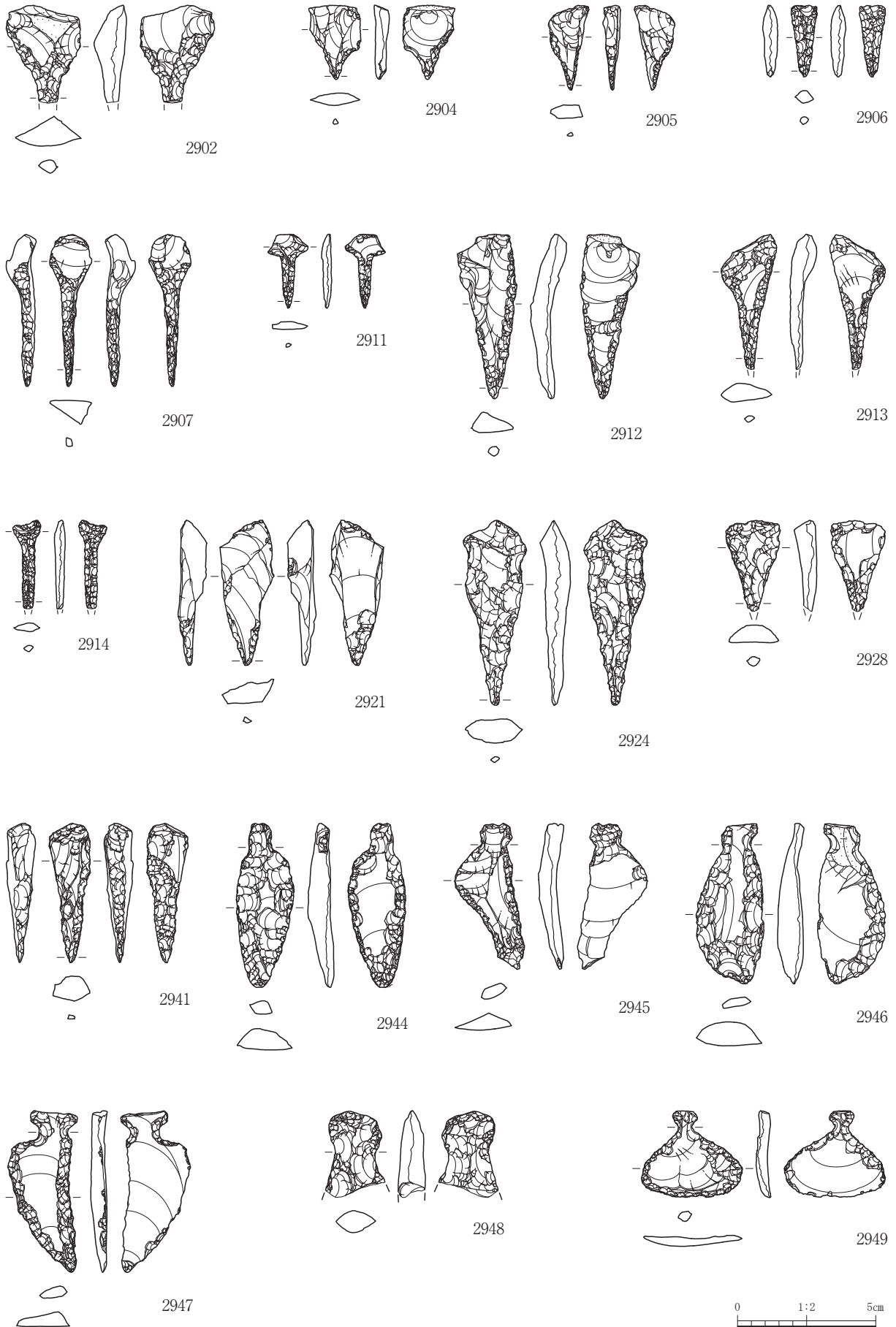

第471图 石器(3)

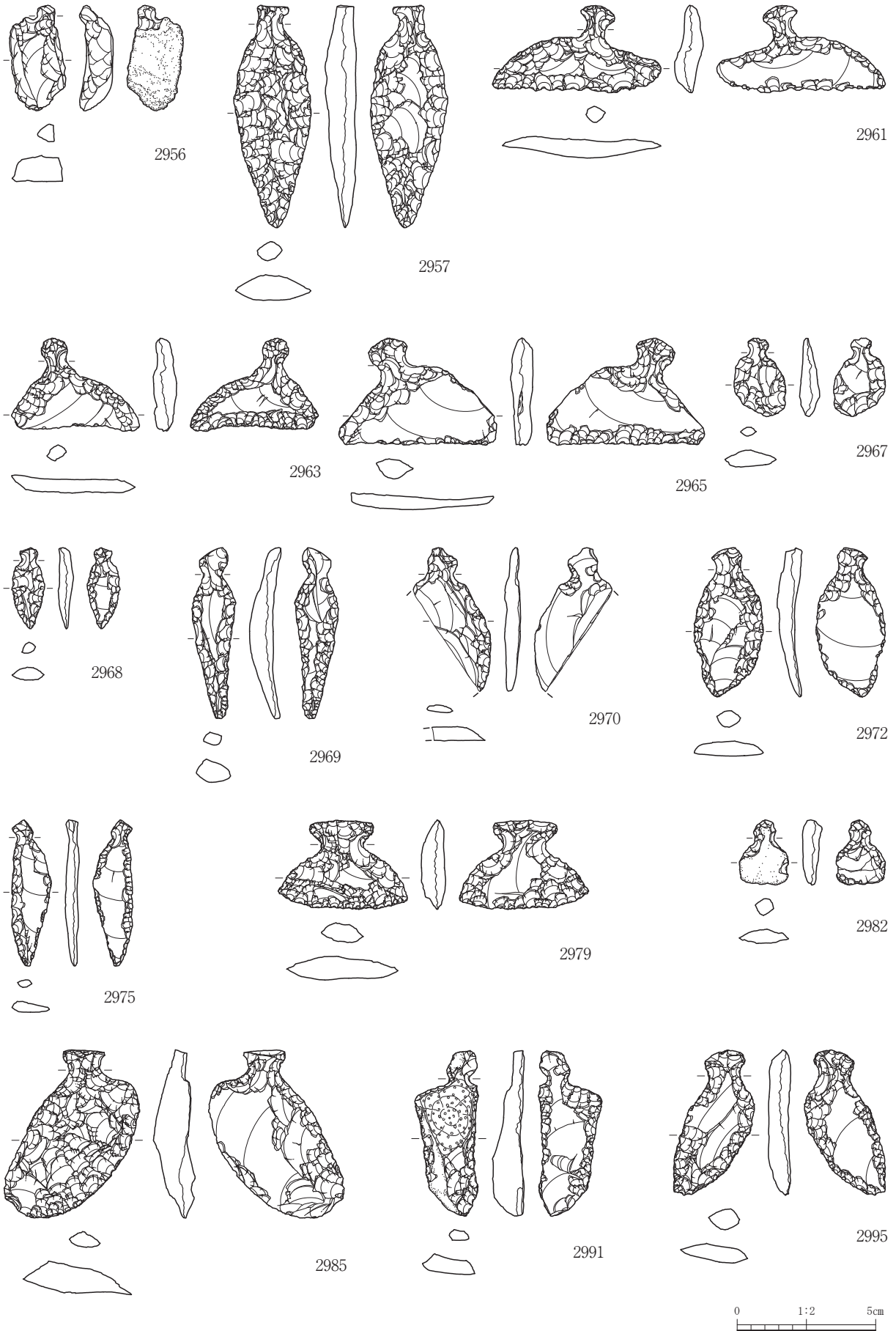

第472图 石器(4)



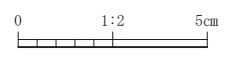
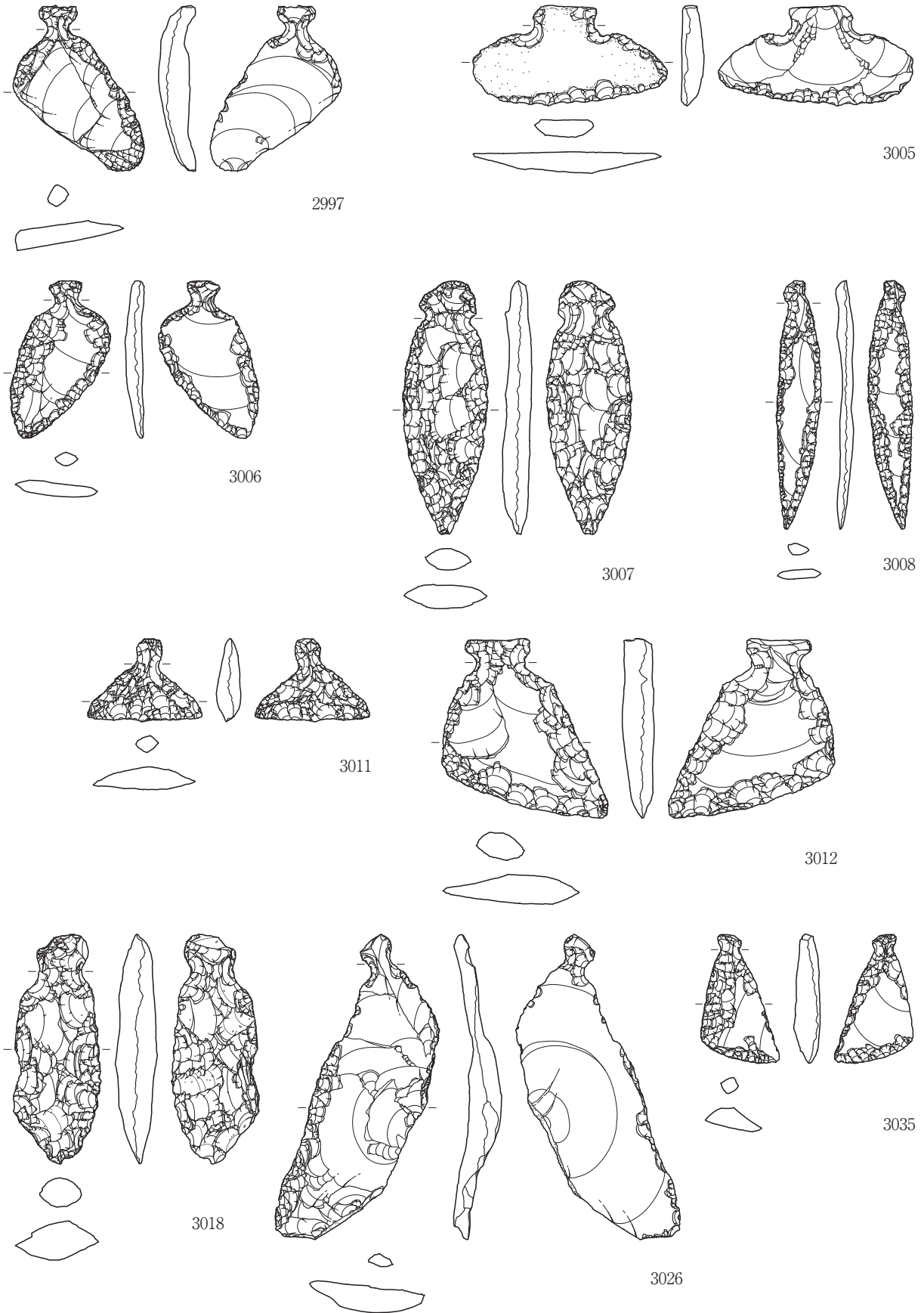

第473图 石器(5)



第474图 石器 (6)

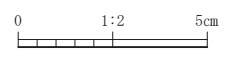
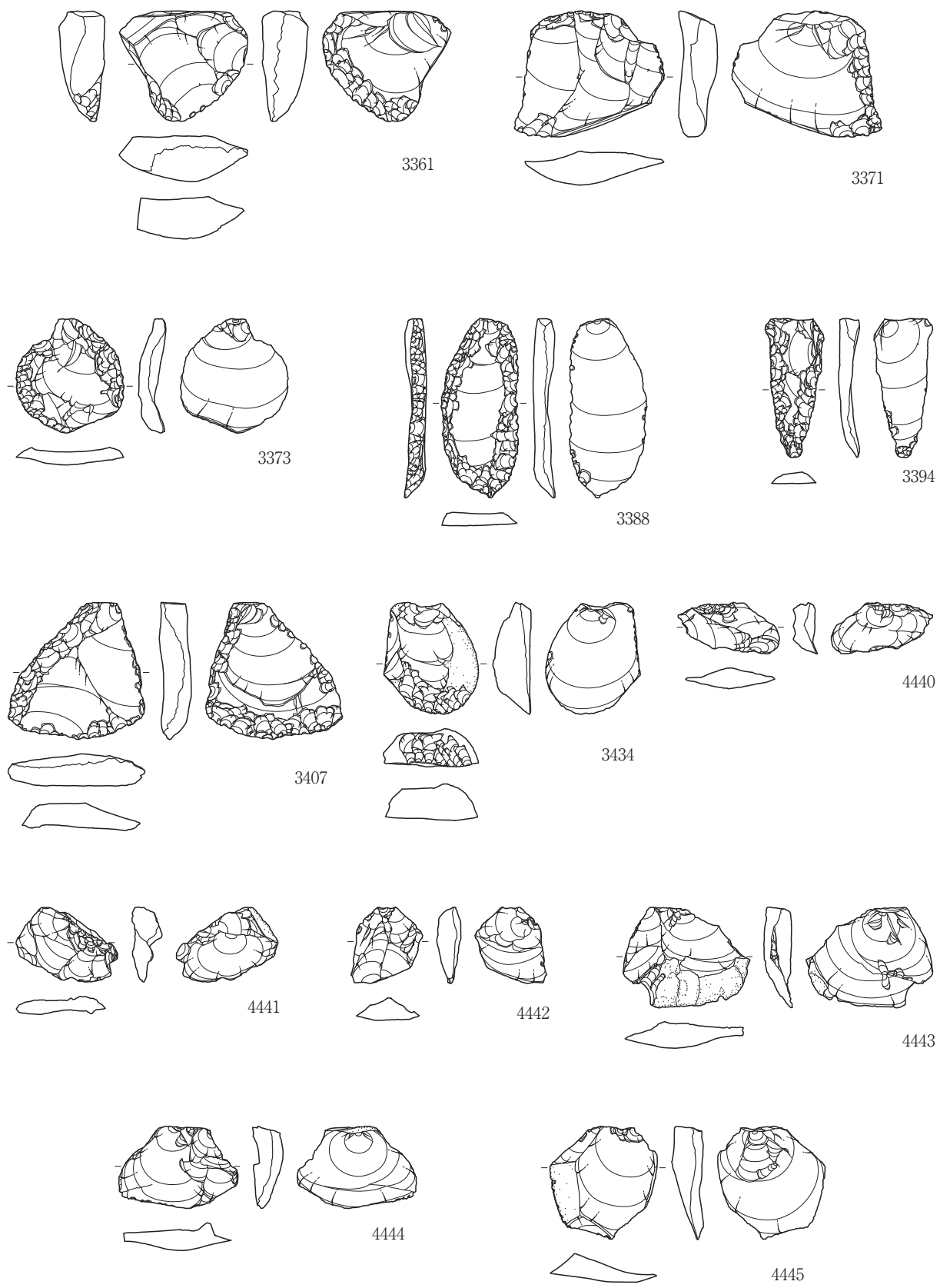

第475图 石器 (7)

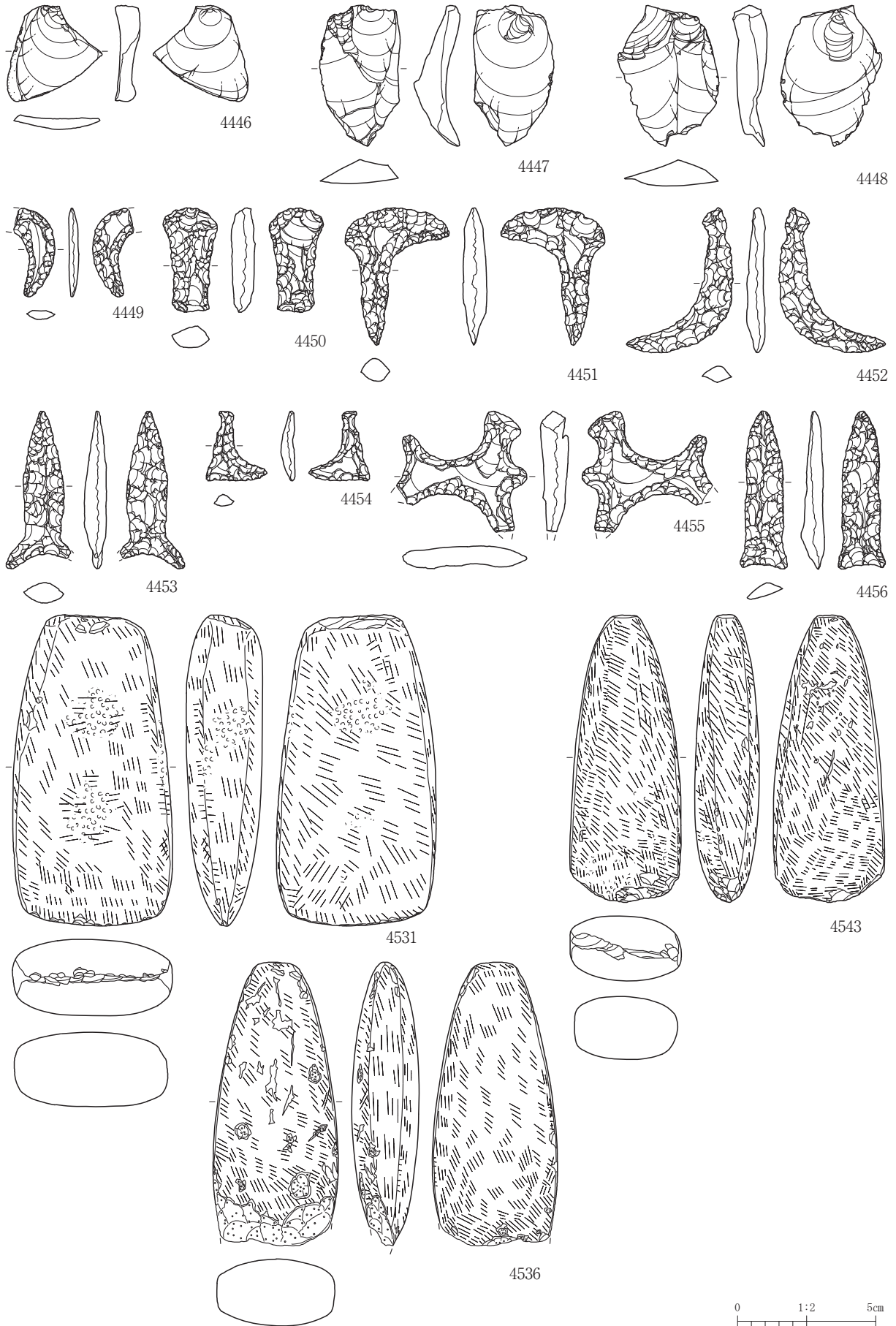

第476图 石器(8)

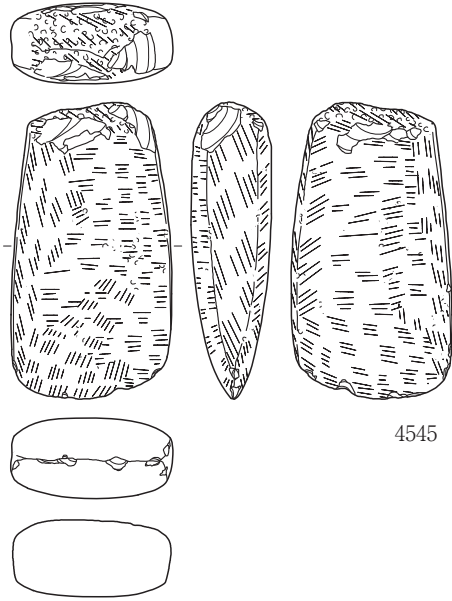

4545

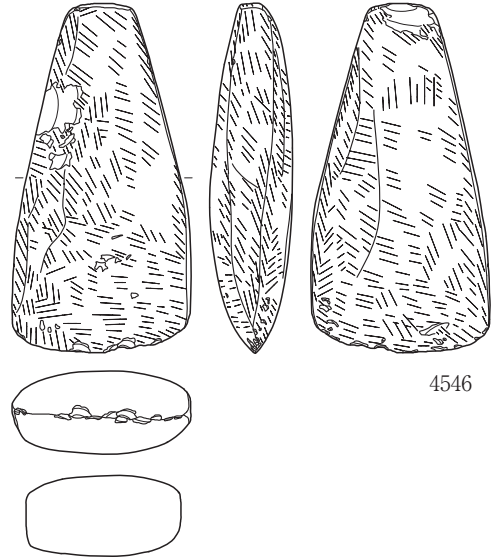

4546

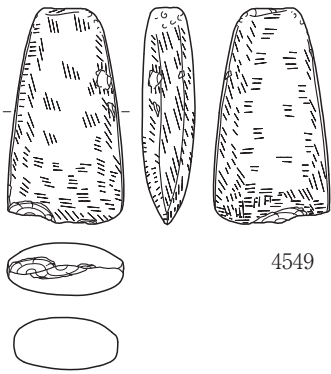

4549

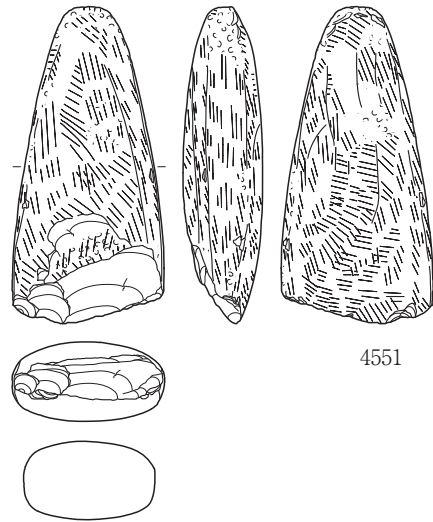

4551

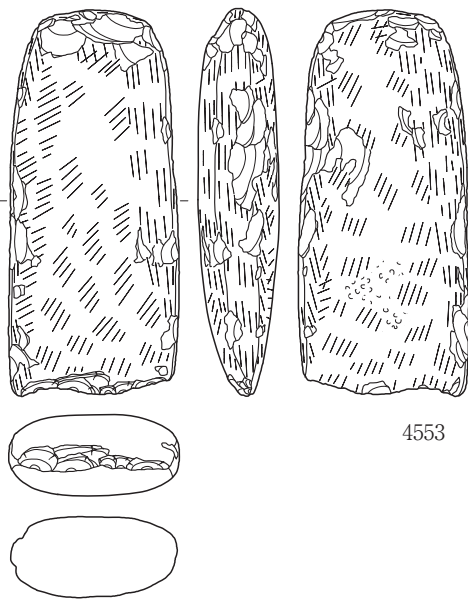

4553

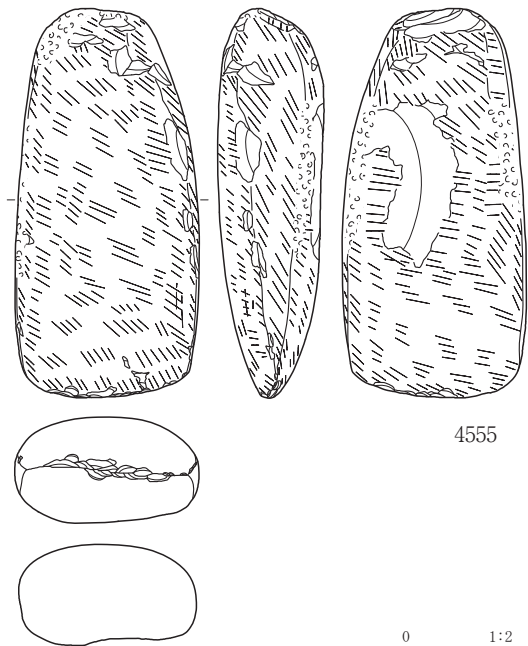

4555

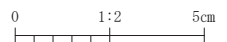

第477图 石器(9)

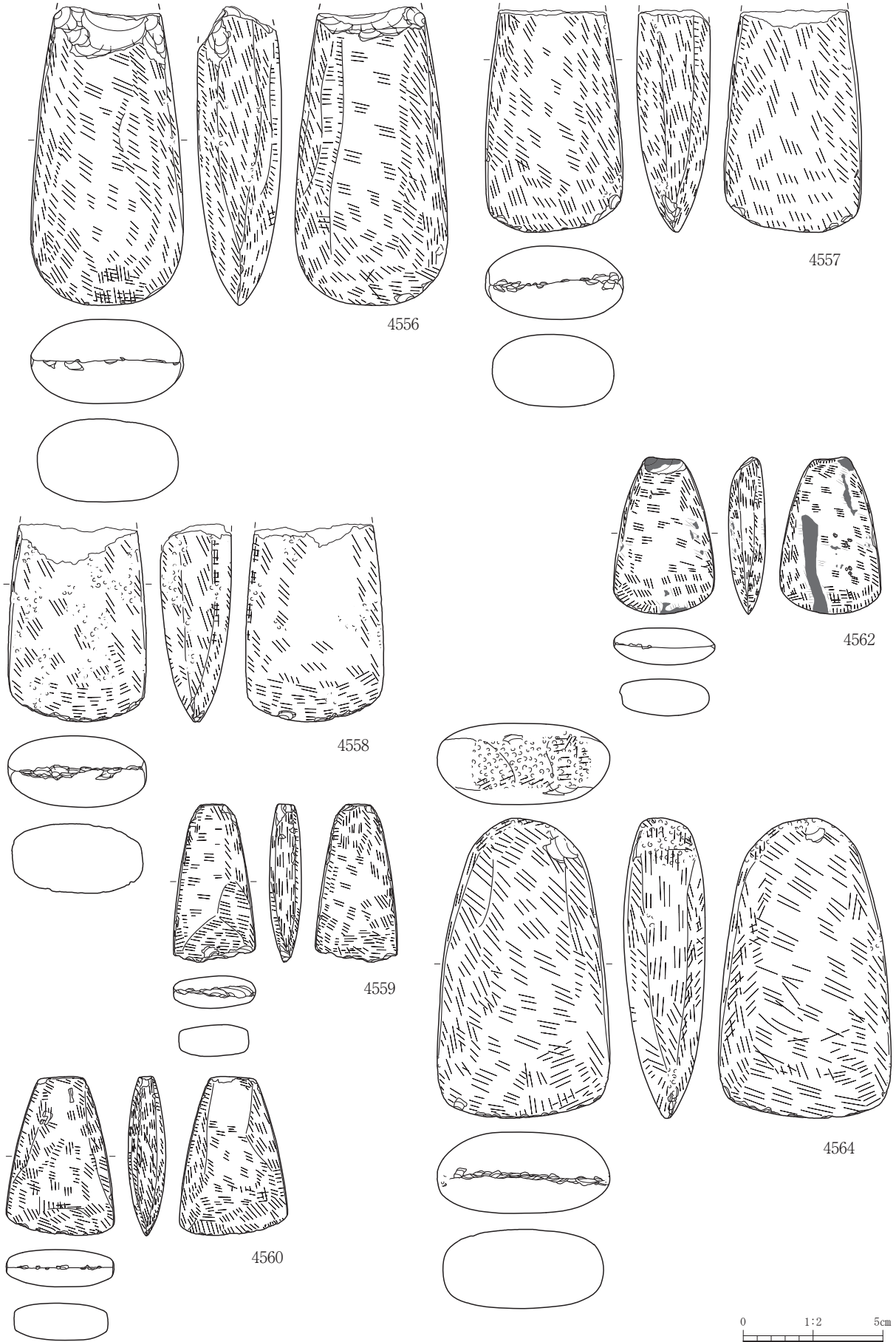

第478图 石器 (10)

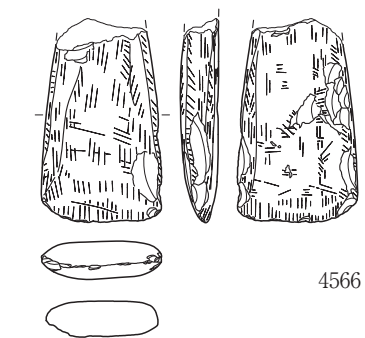

4566

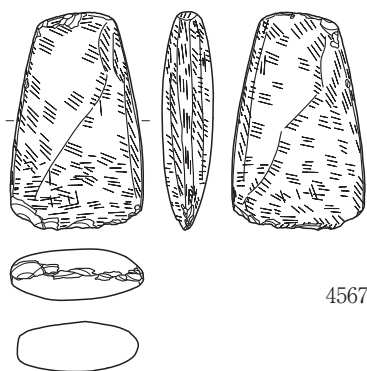

4567

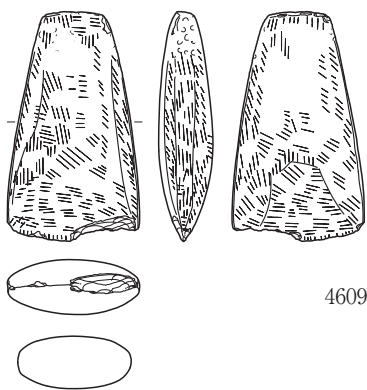

4609

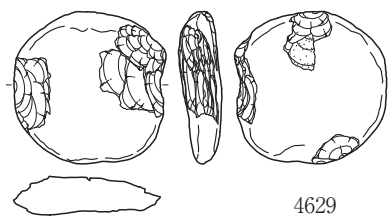

4629

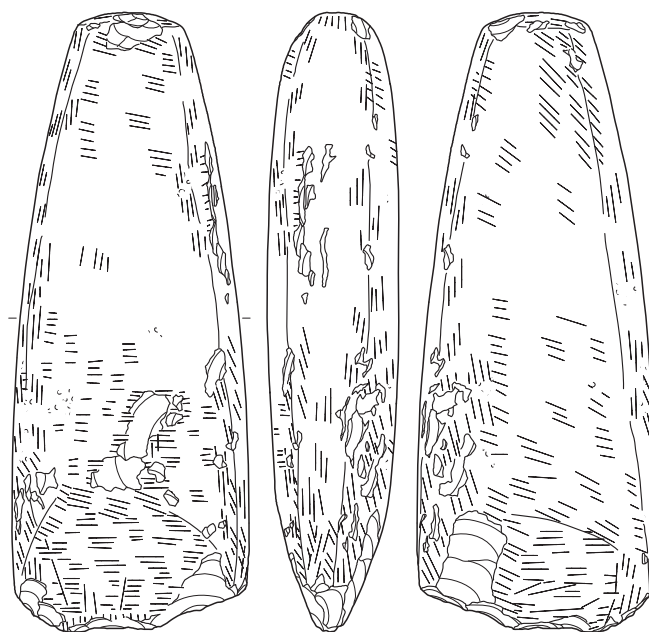

4612

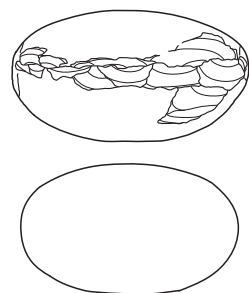

4649

0 1:3 10cm 0 1:2 5cm  
4629 · 4649

第479图 石器 (11)

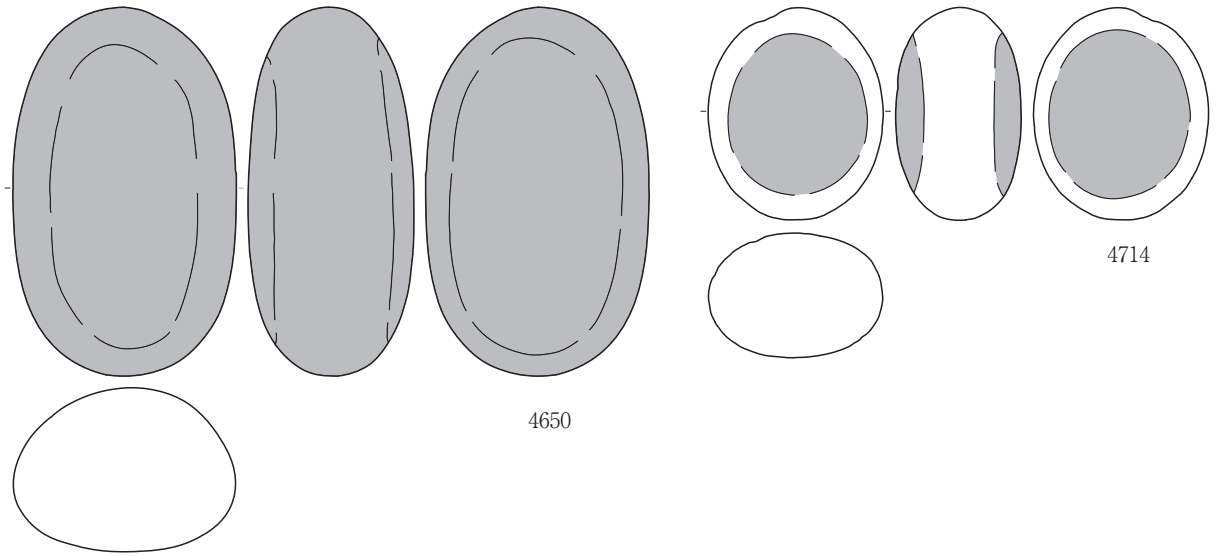

4650

4714

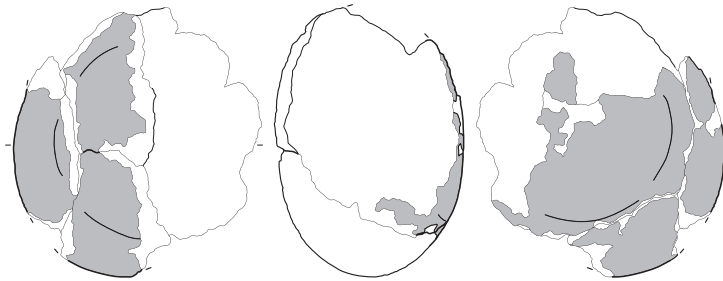

4744

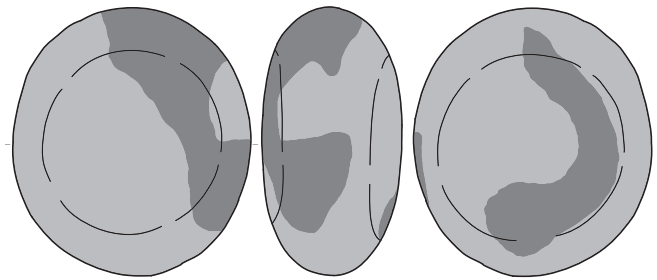
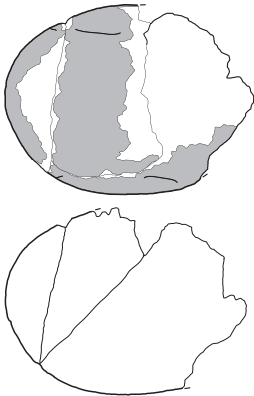

4745

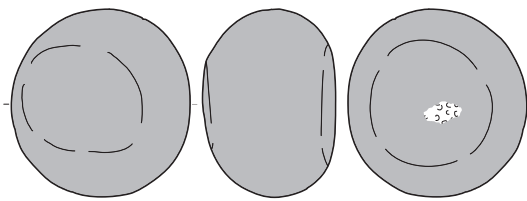
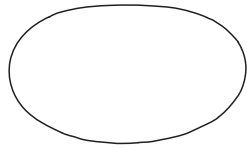

4758

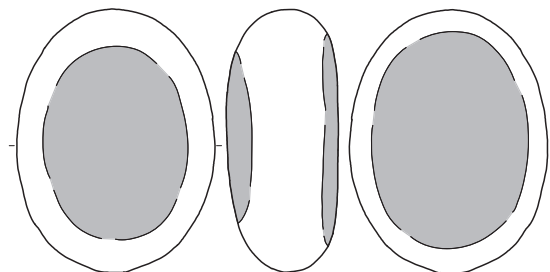
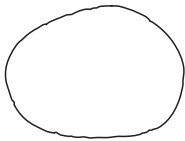

4796

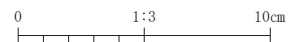

第480図 石器 (12)



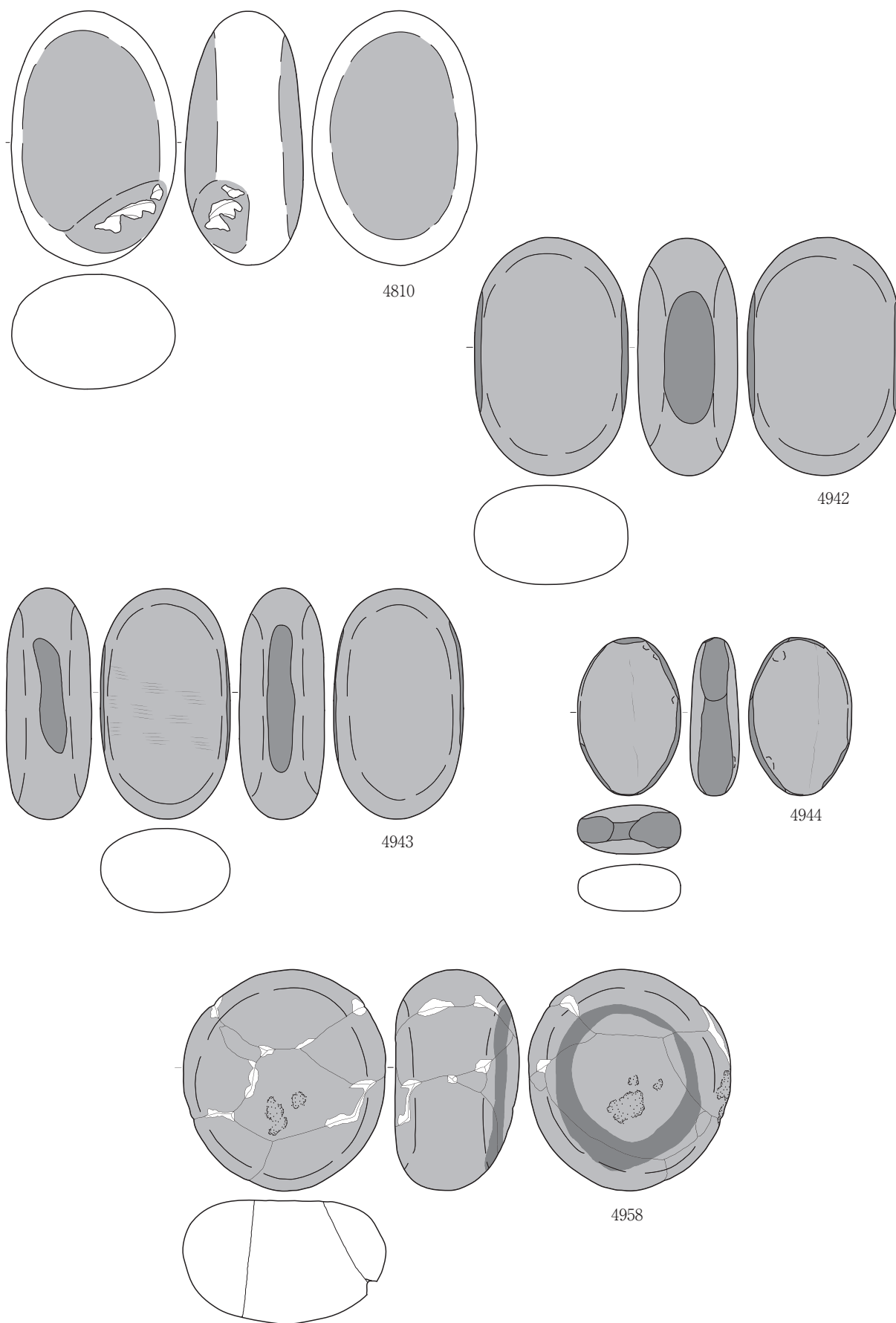

第481図 石器 (13)

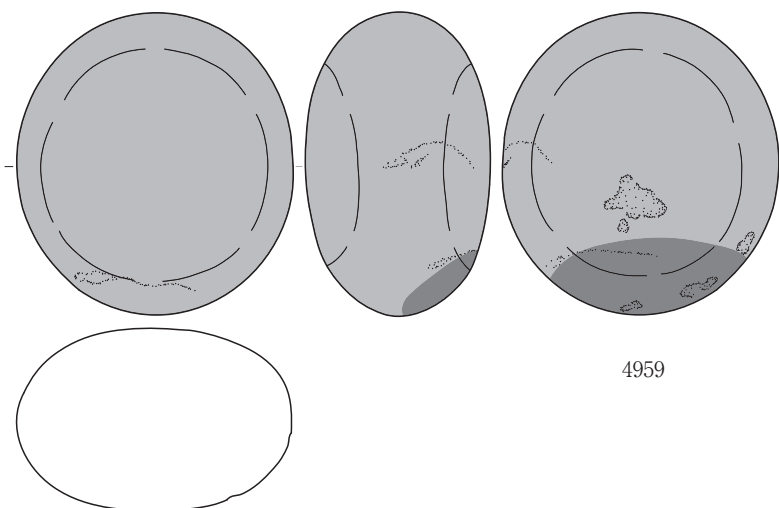

4959

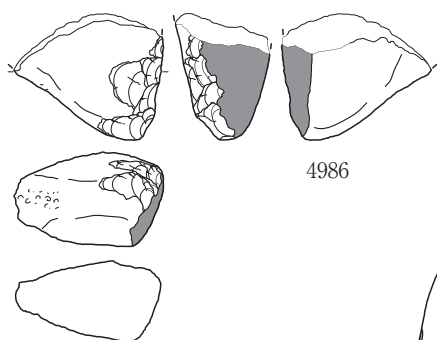

4986

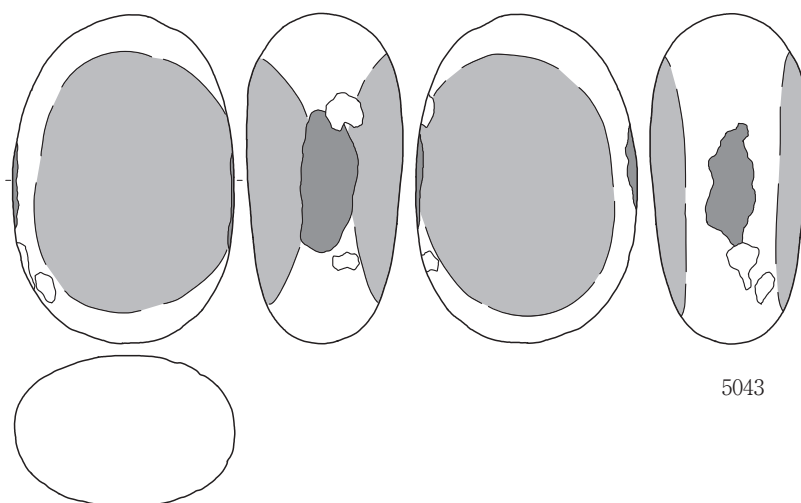

5043

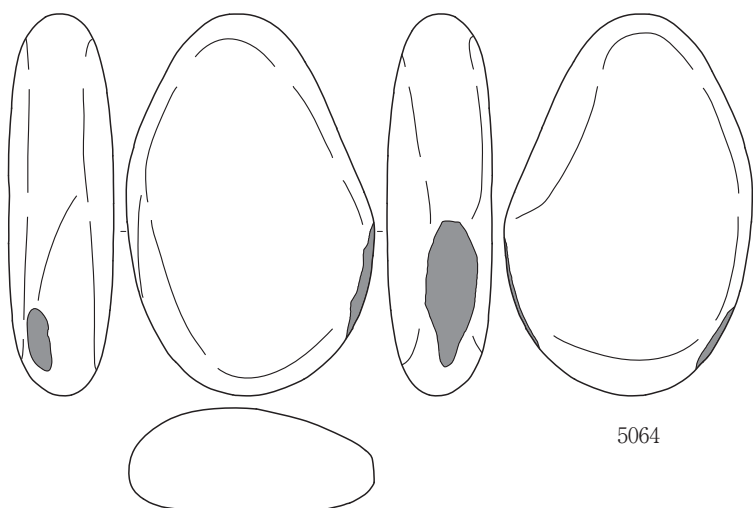

5064

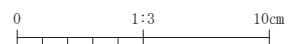

第482図 石器 (14)

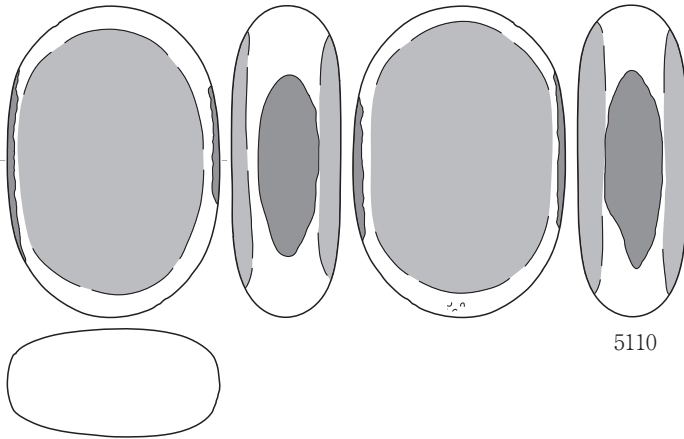

5110

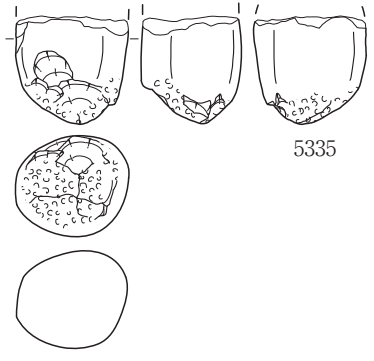

5335

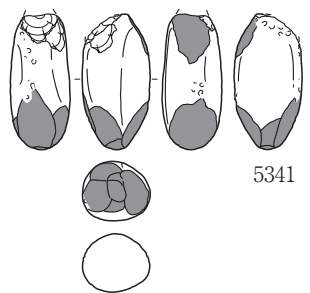
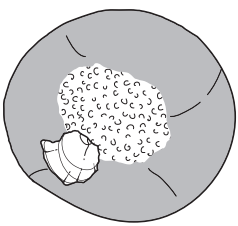

5341

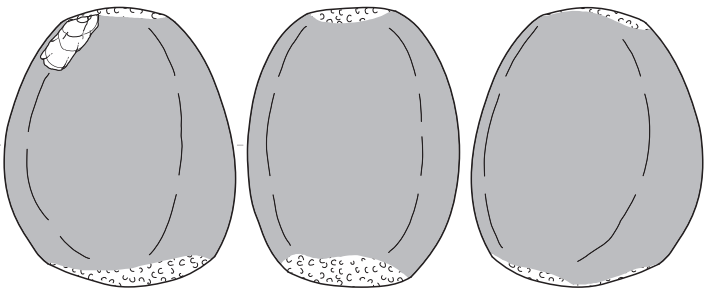

5337

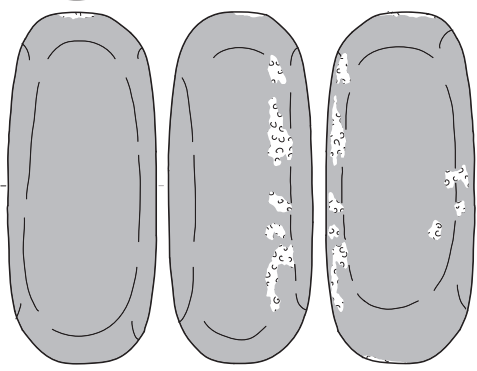
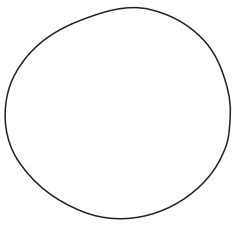
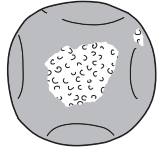
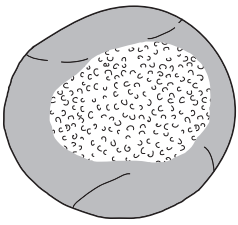

5353

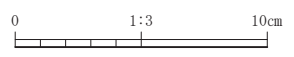
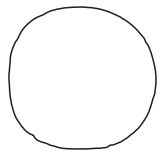
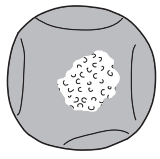

第483图 石器 (15)

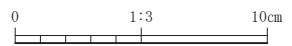
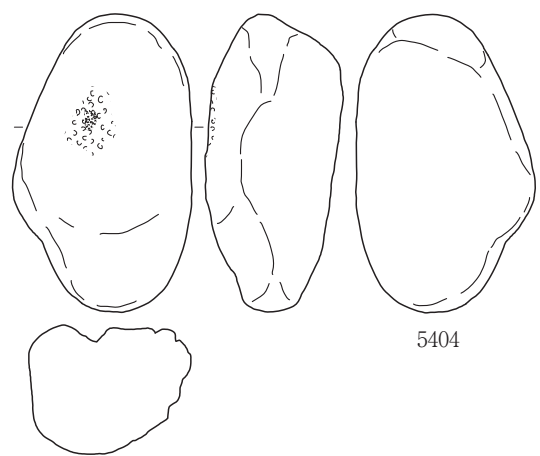
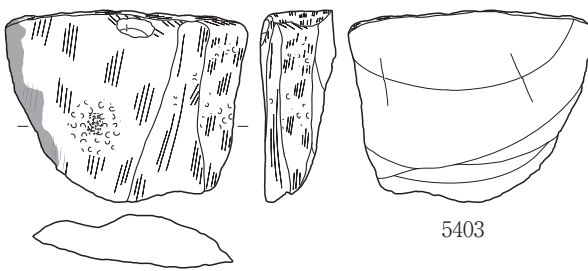
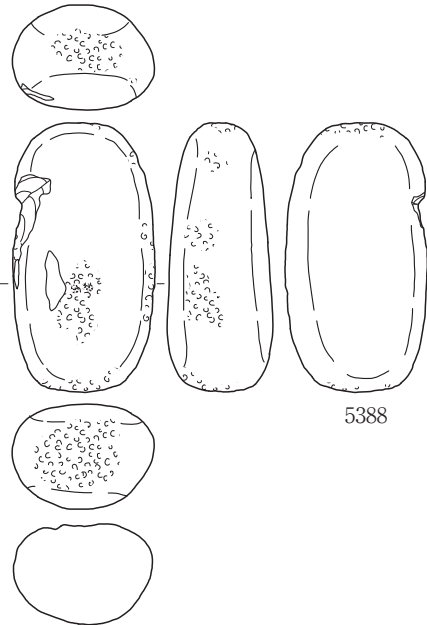
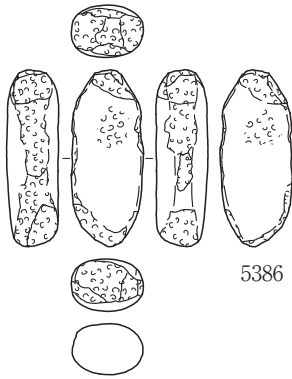
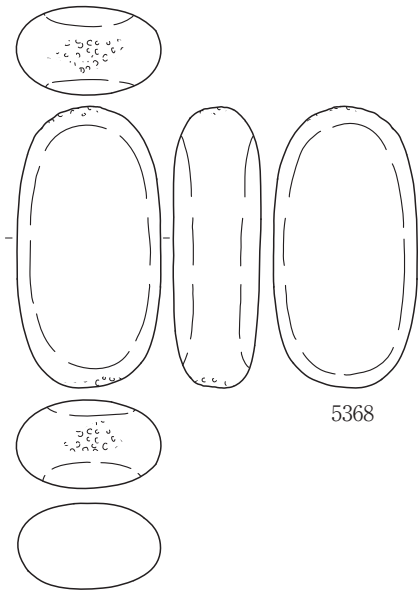
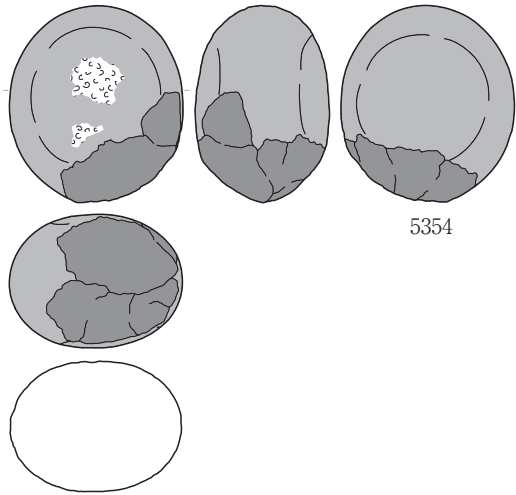

第484图 石器 (16)

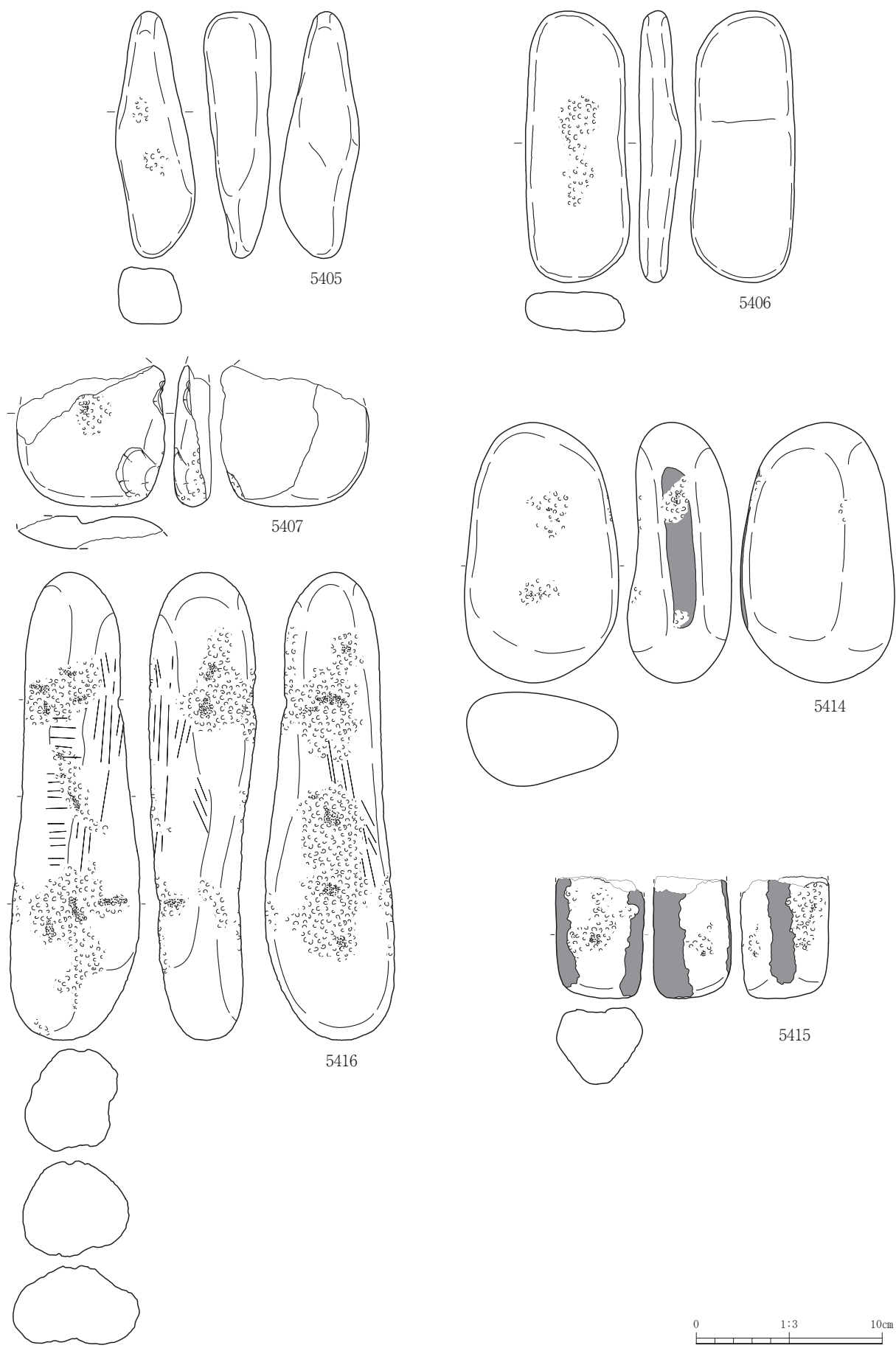

第485图 石器 (17)

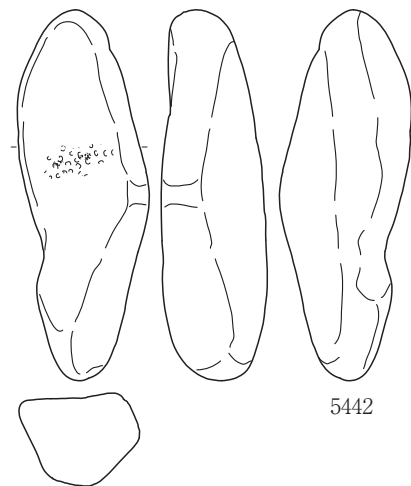
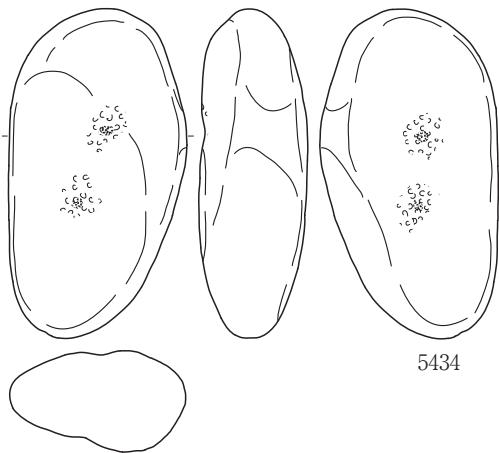
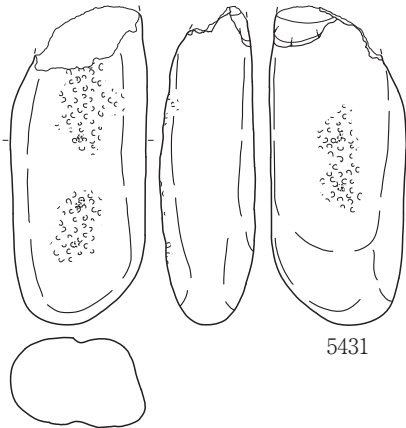
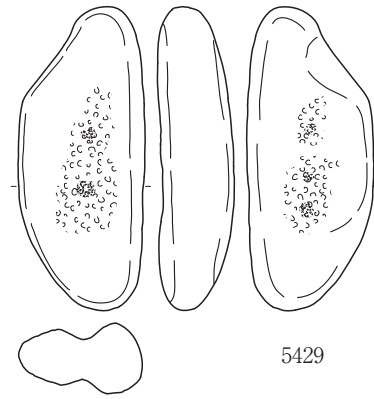
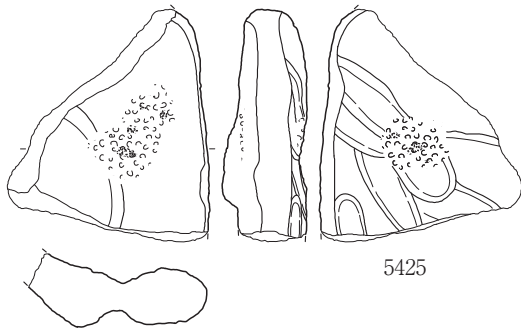
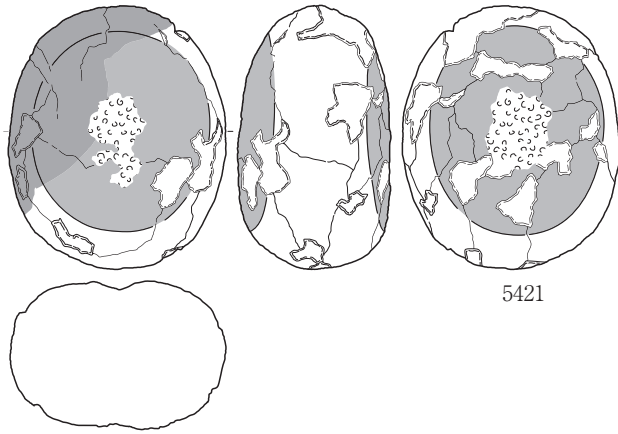

0 1:3 10cm

第486图 石器 (18)

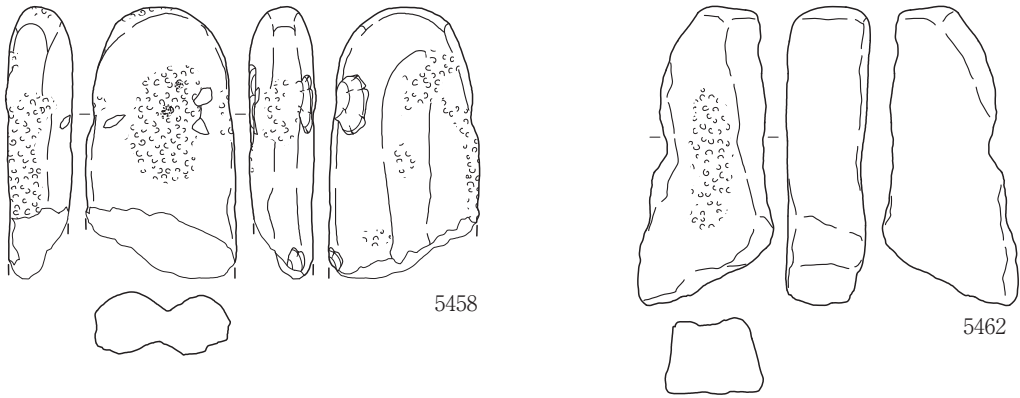
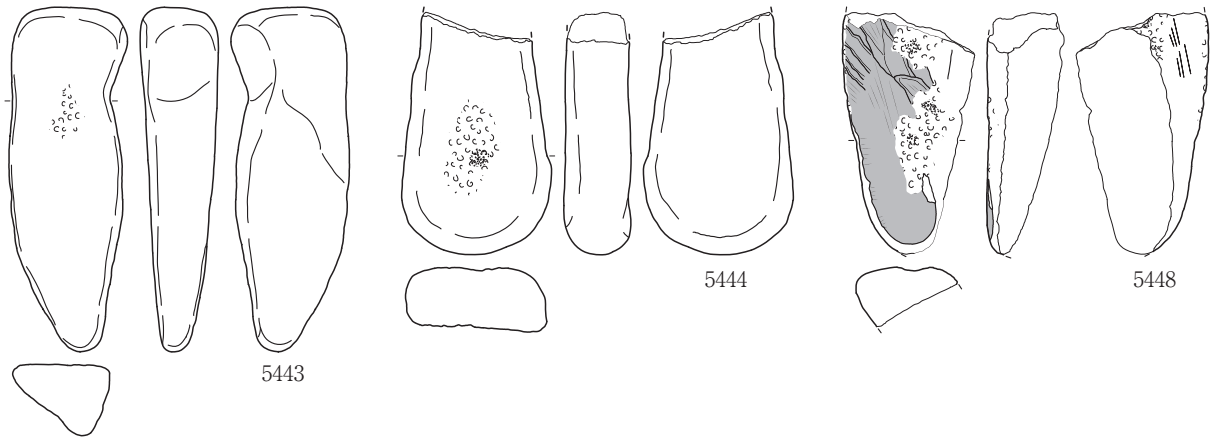

0 1:3 10cm

第487图 石器 (19)

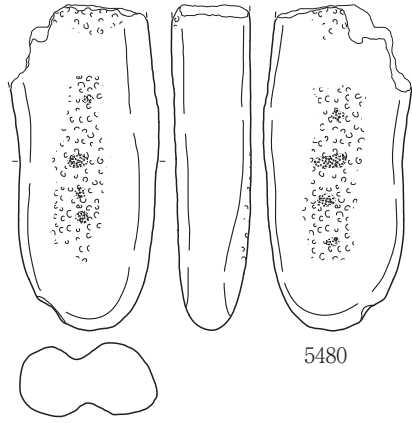

5480



5499

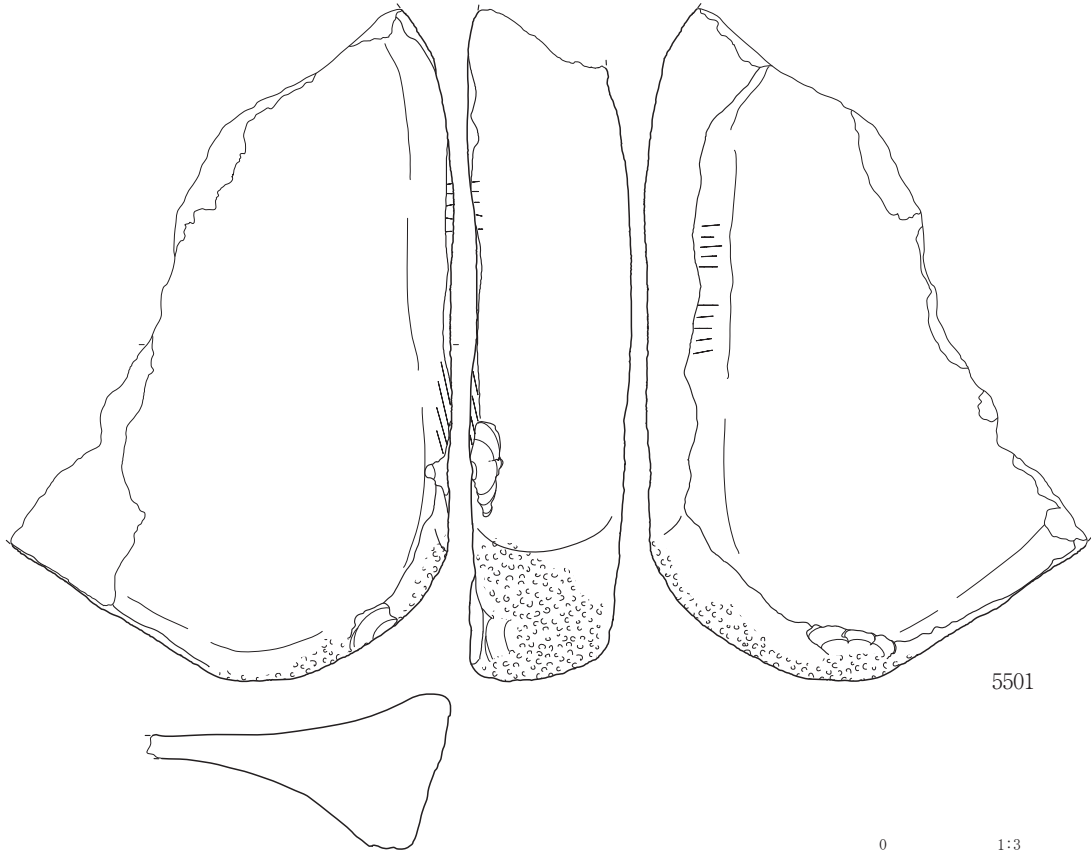

5501

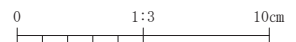

第488図 石器 (20)



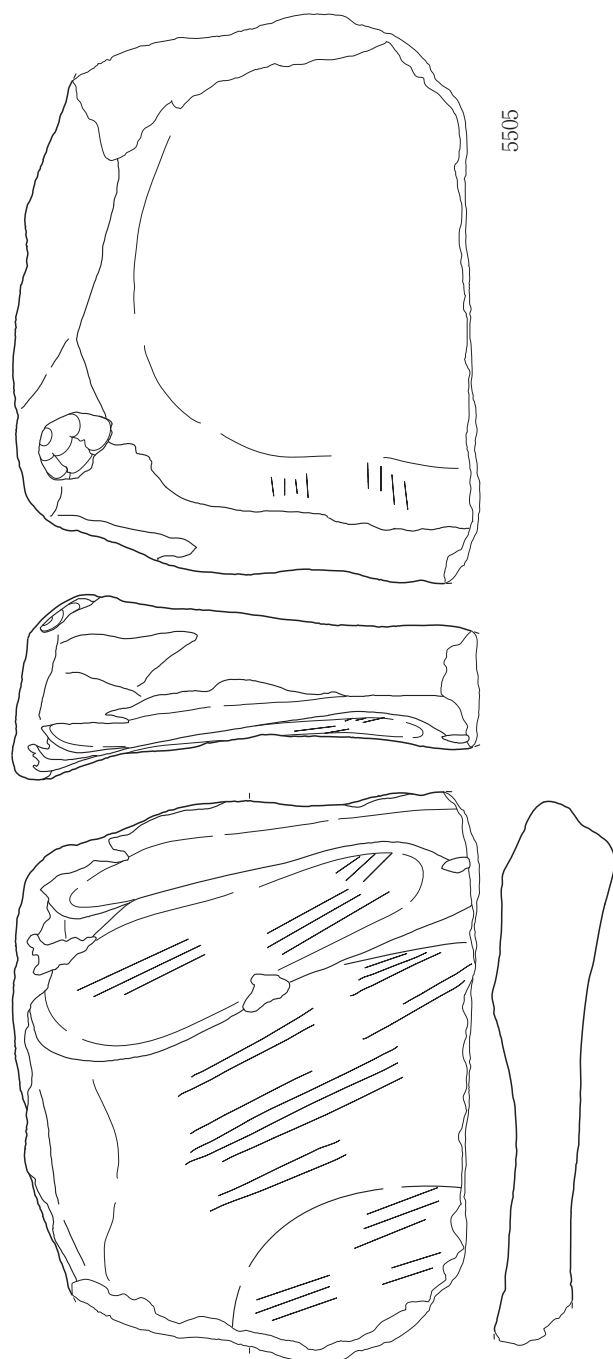

5505

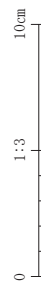

第489図 石器 (21)

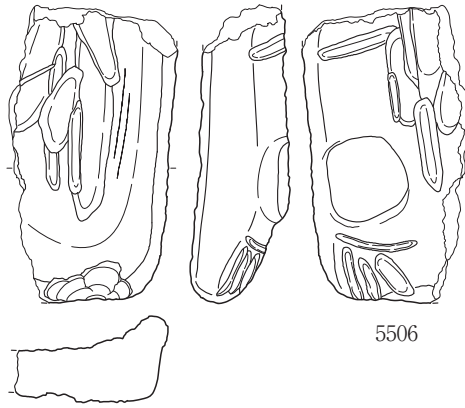

5506



5507

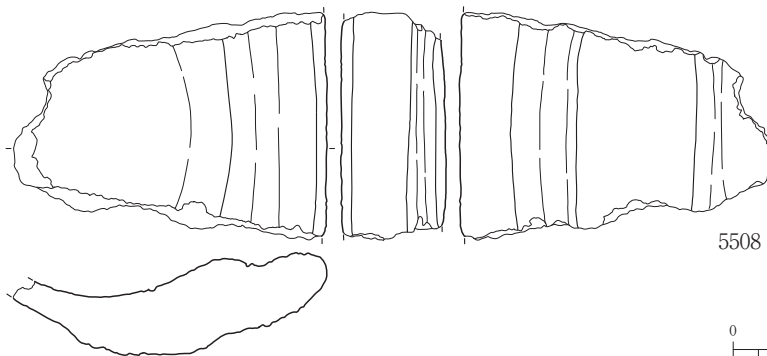

5508

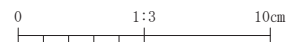

第490図 石器 (22)

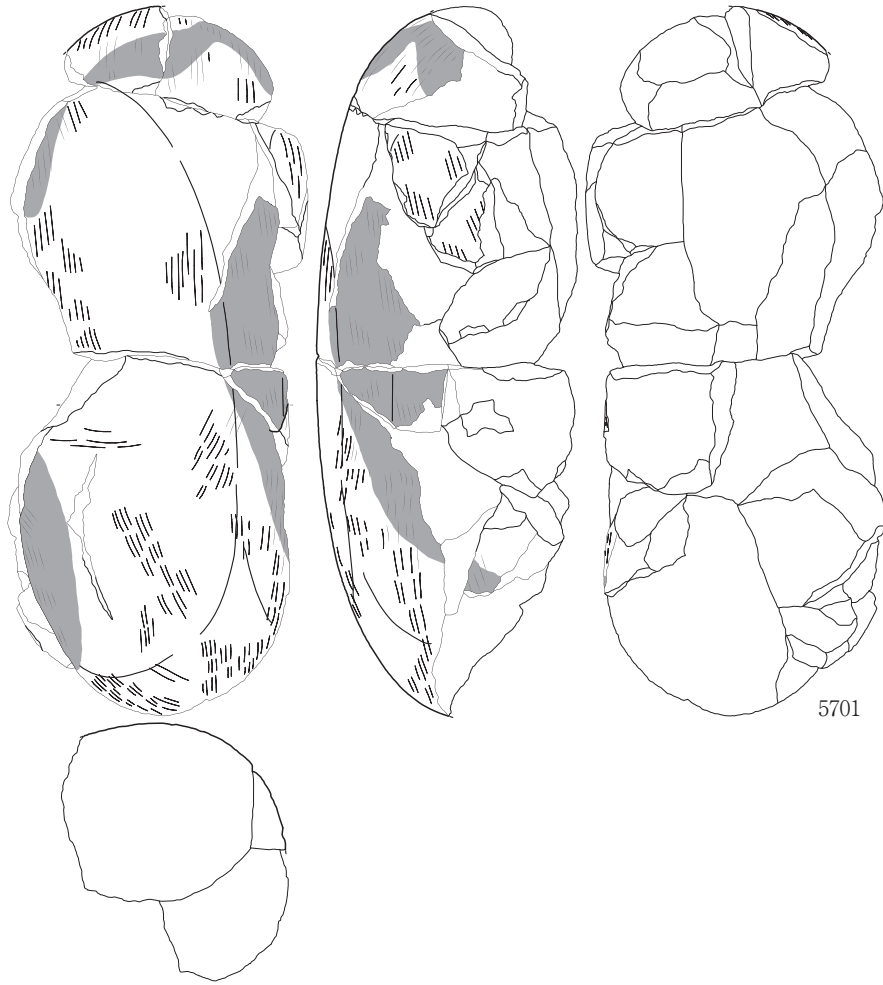

5701

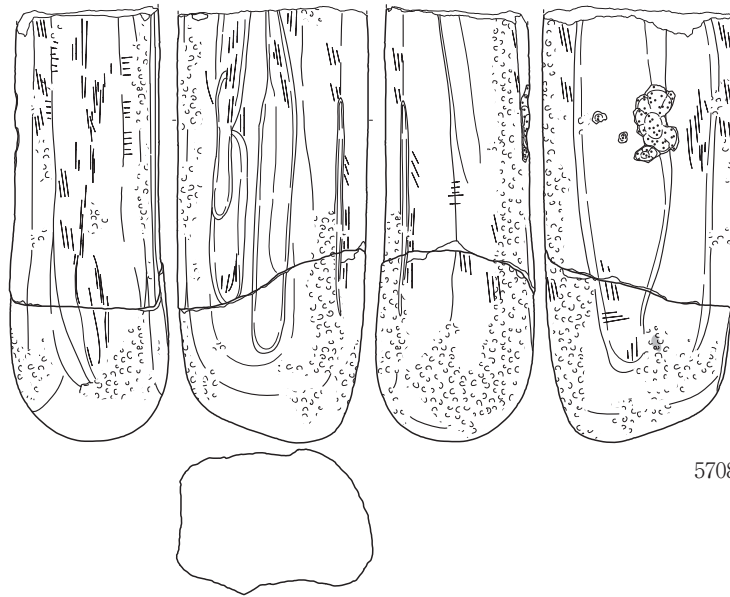

5708

0 1:5 10cm

第491図 石製品(1)

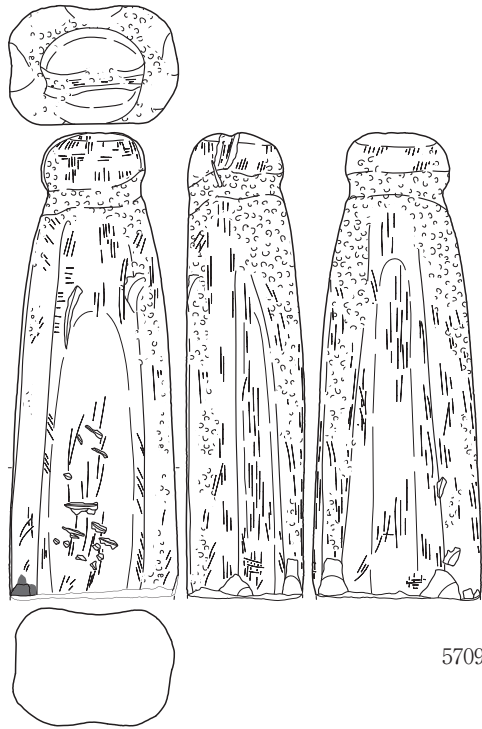

5709

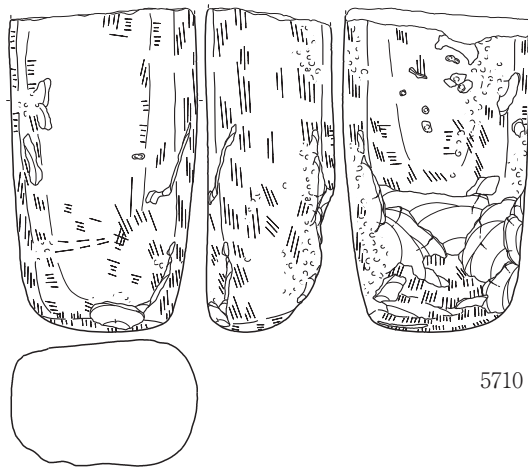

5710

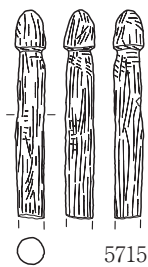

5715

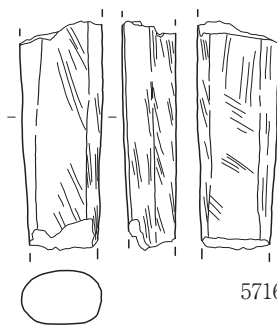

5716

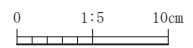

第492図 石製品 (2)

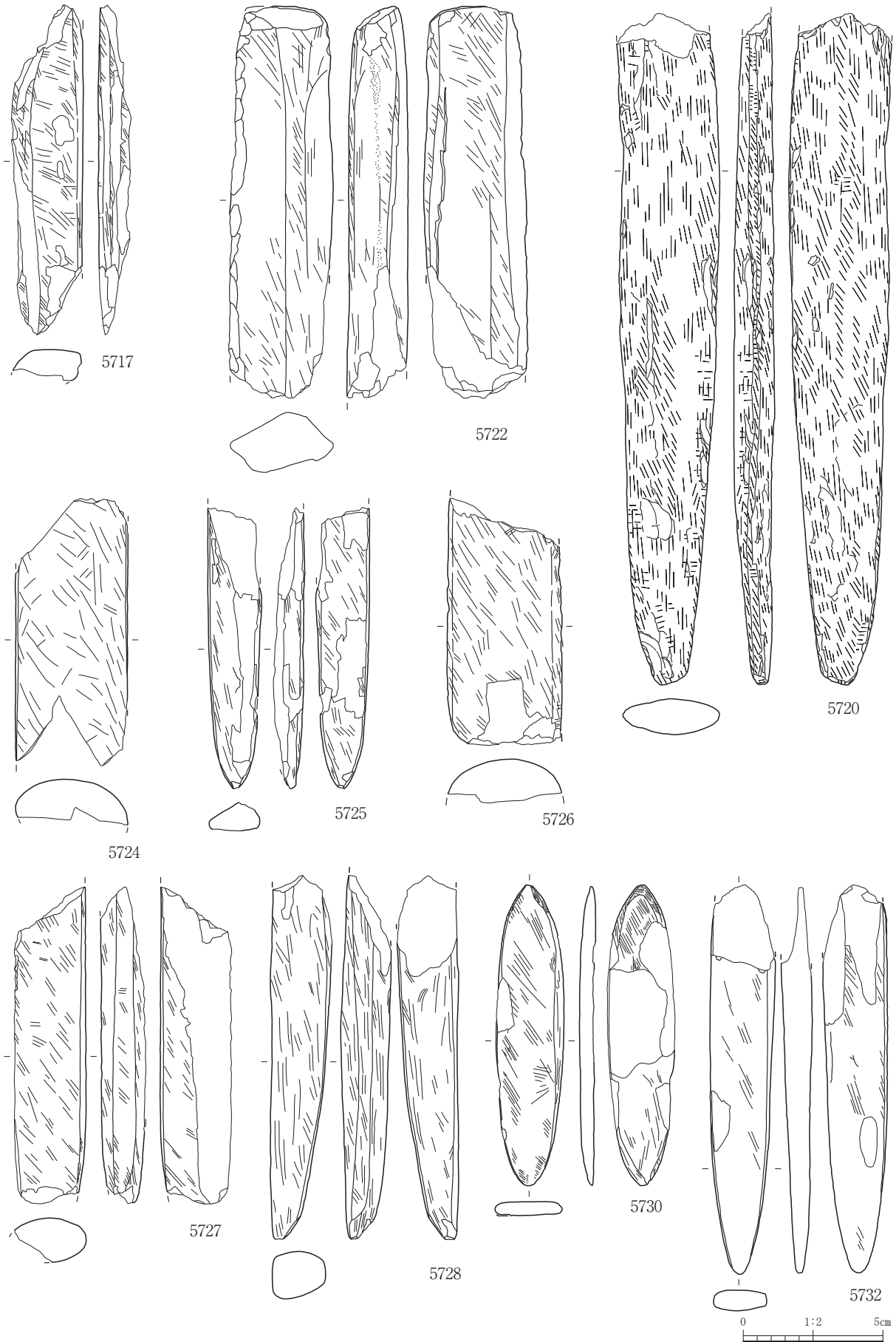

第493図 石製品 (3)

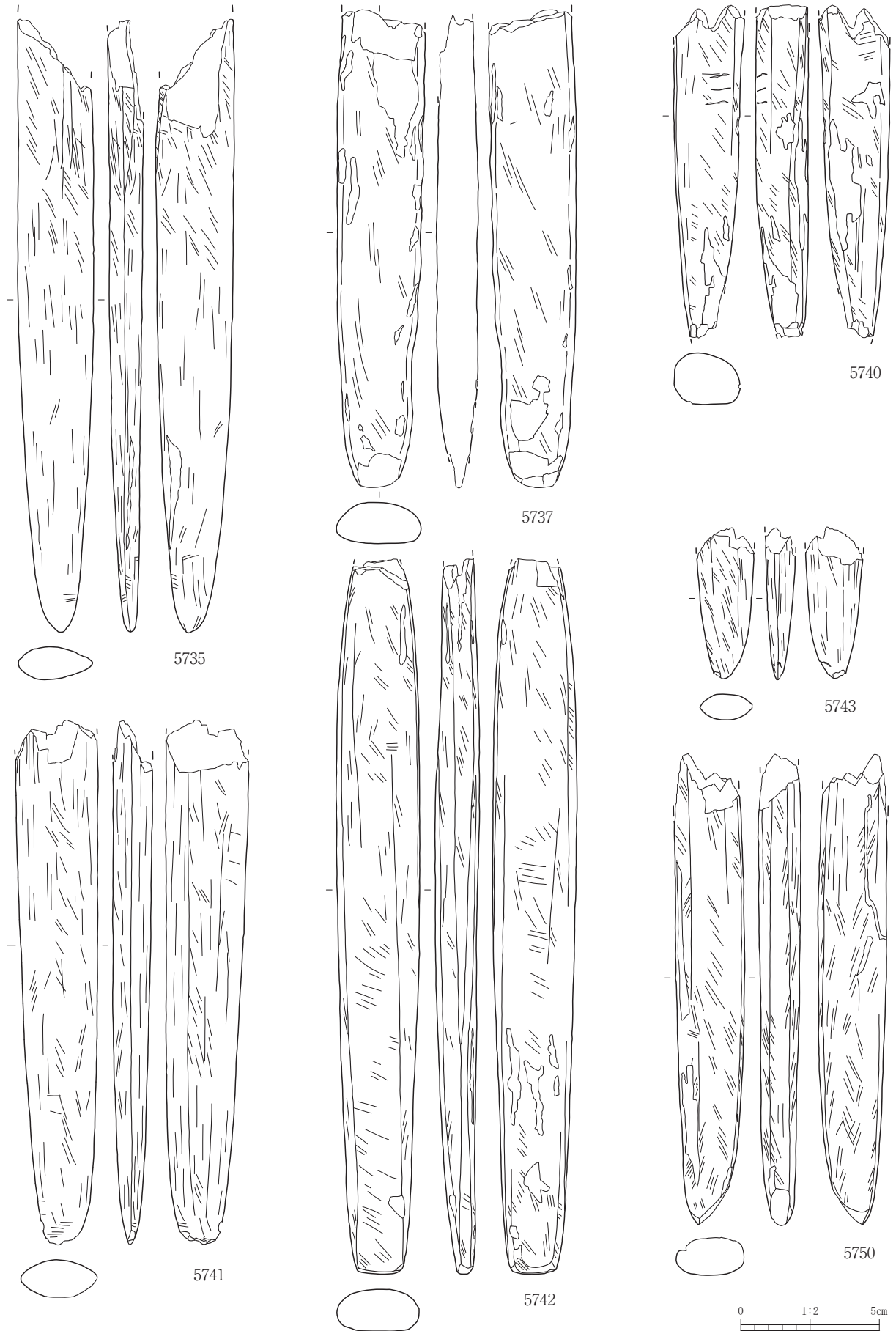

第494図 石製品（4）

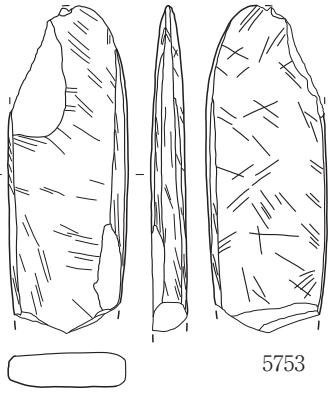

5753



5767

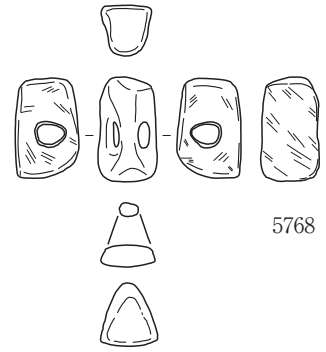

5768

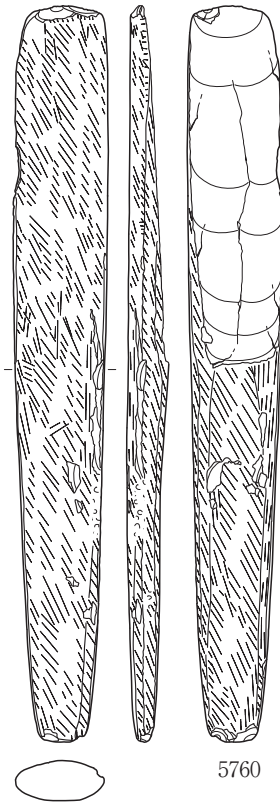

5760

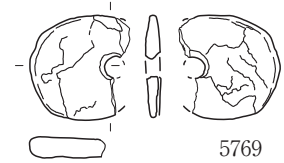

5769

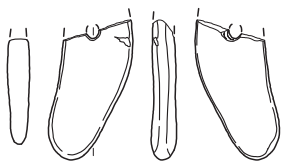

5770

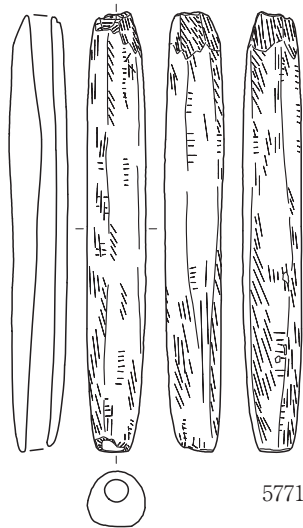

5771

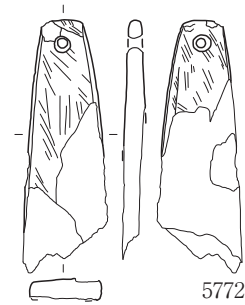

5772

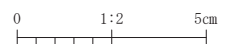

第495図 石製品 (5)

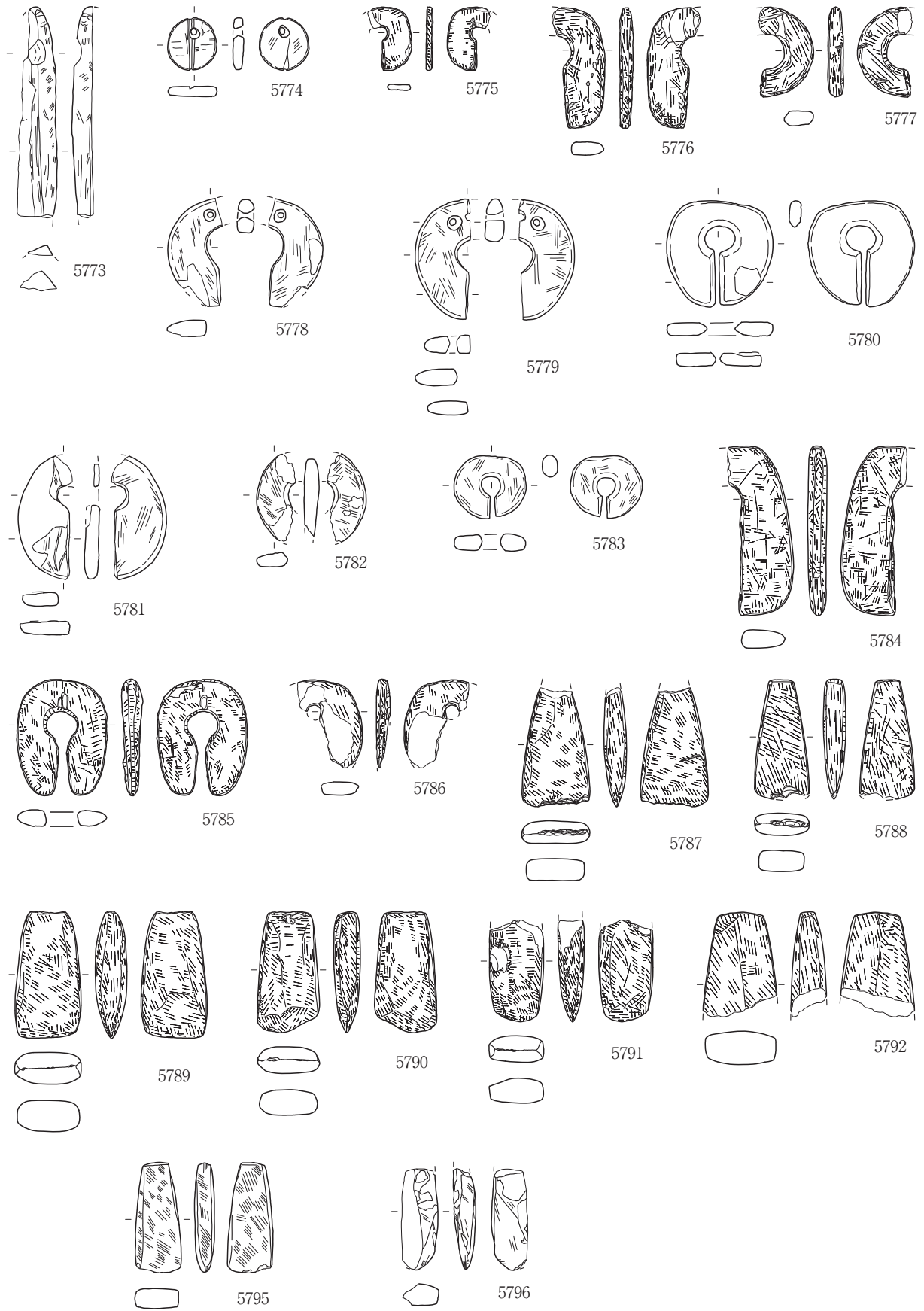

0 1:2 5cm

第496図 石製品 (6)



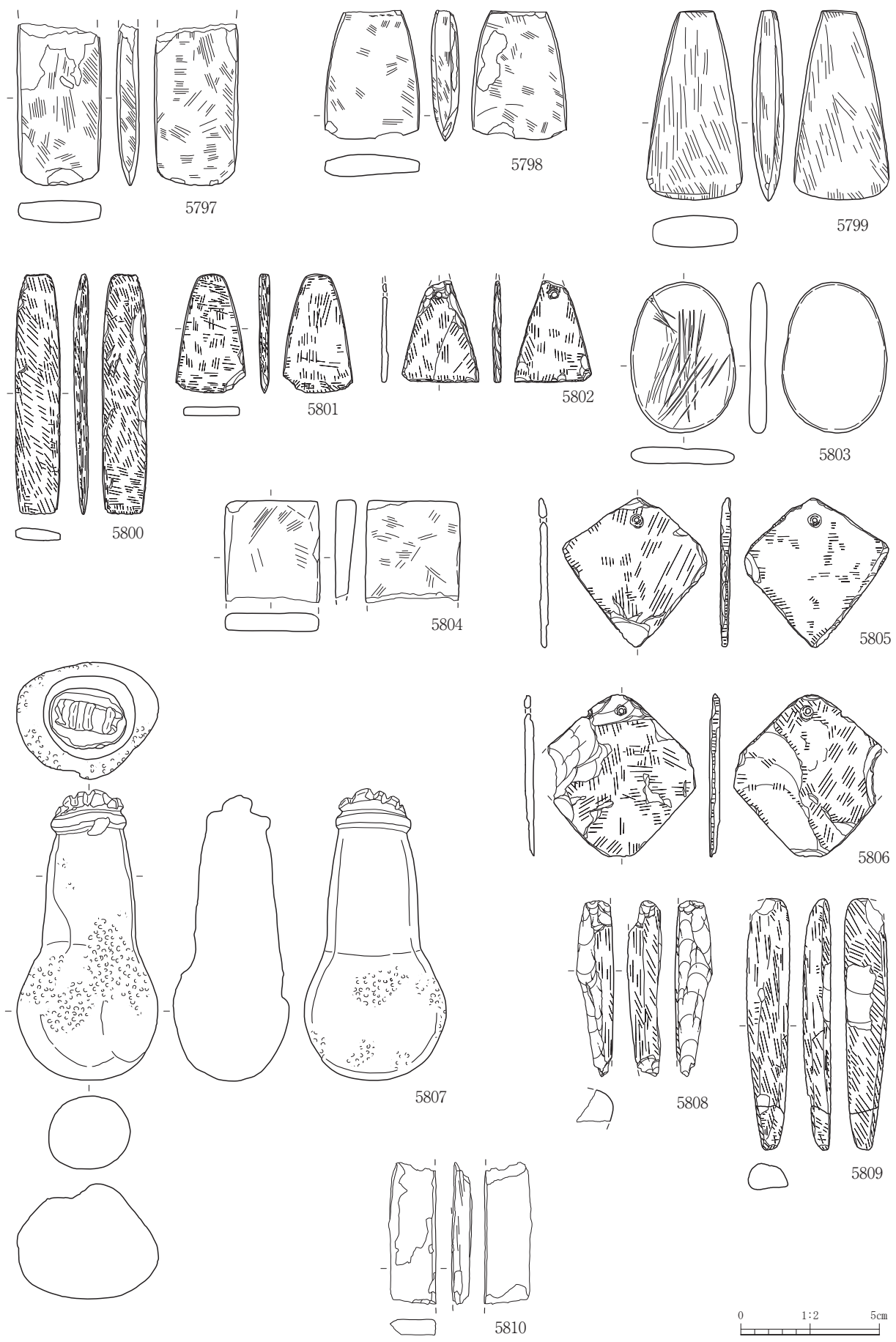

第497図 石製品 (7)

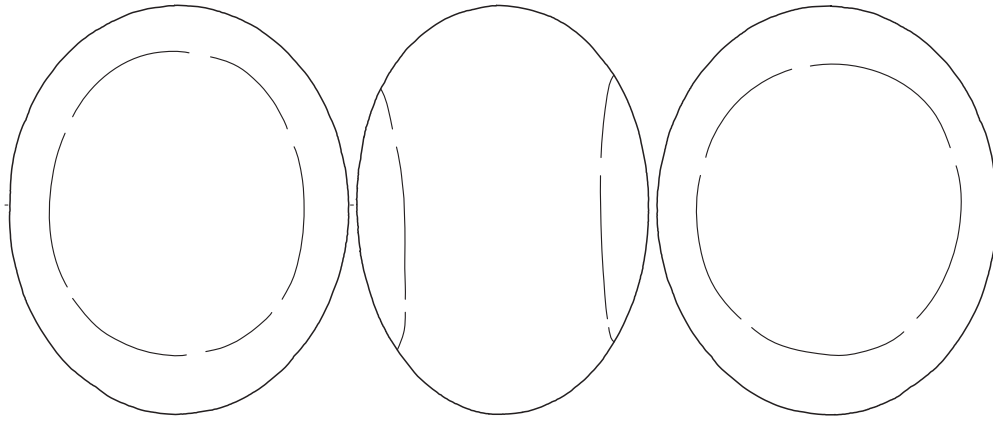

5813

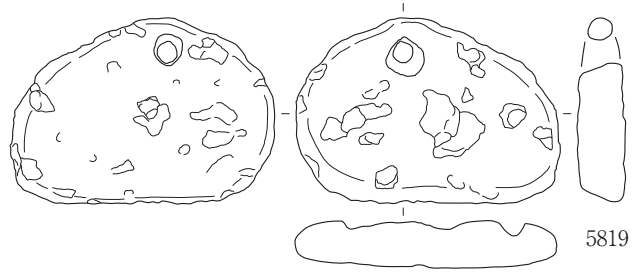
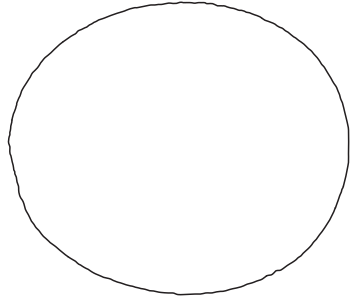

5819

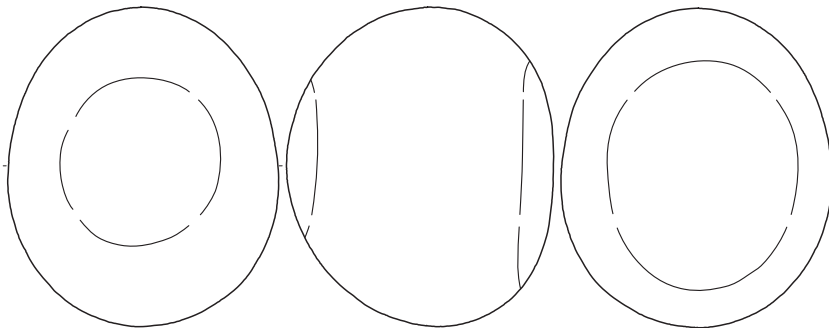

5814

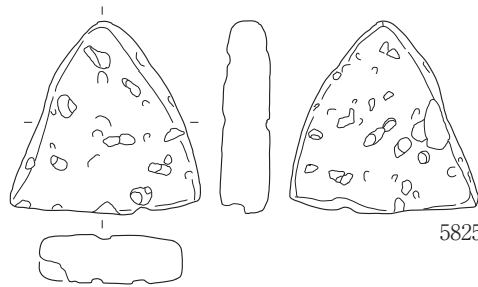
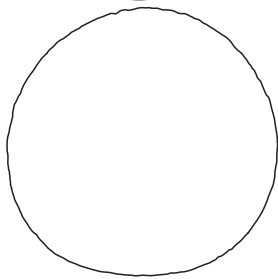

5825

0 1:5 10cm  
5813 · 5814

0 1:2 5cm

第498図 石製品 (8)

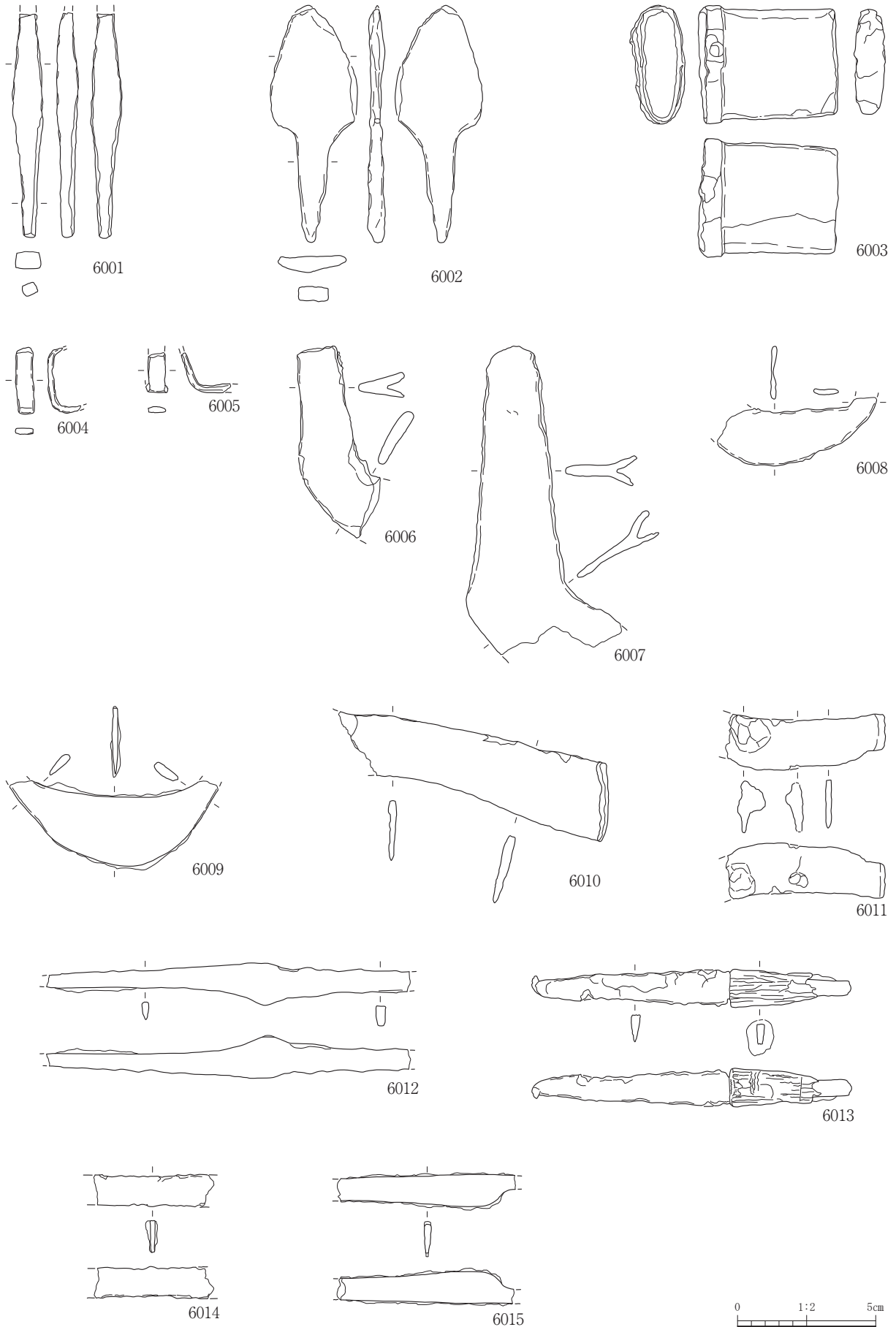

第499図 金属製品（1）

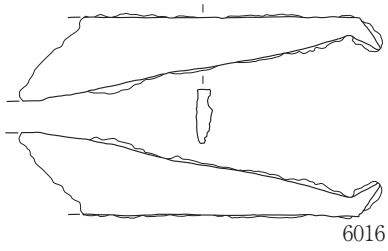

6016

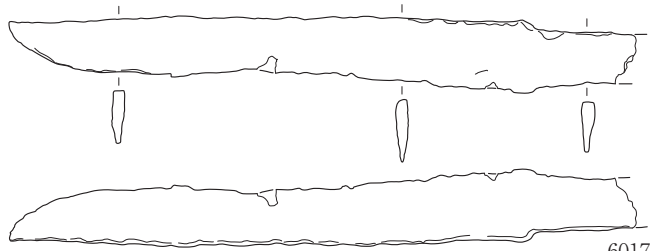

6017

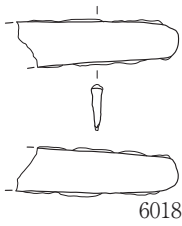

6018

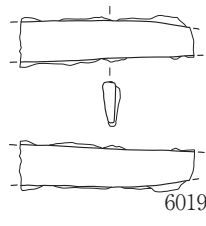

6019

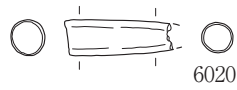

6020



6021



6022

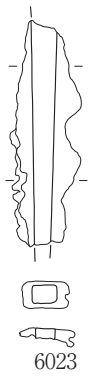

6023

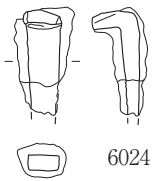

6024

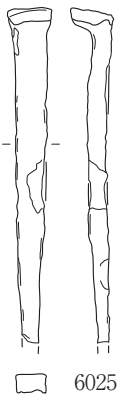

6025

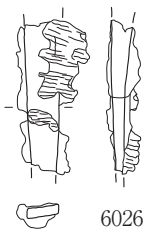

6026

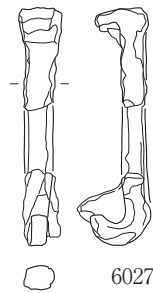

6027

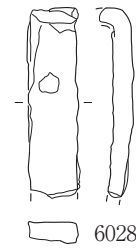

6028



6029

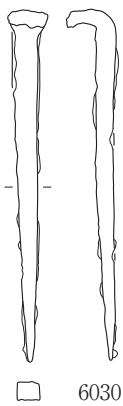

6030

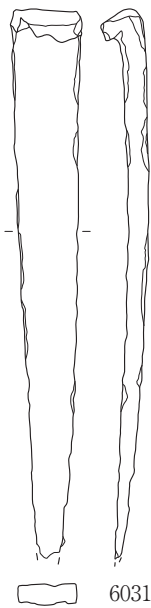

6031

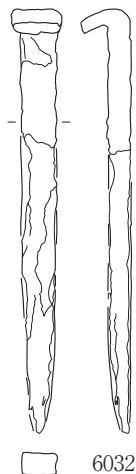

6032

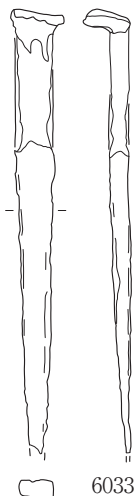

6033



6034



6035

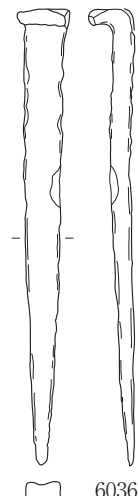

6036

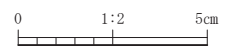

第500図 金属製品 (2)

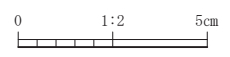
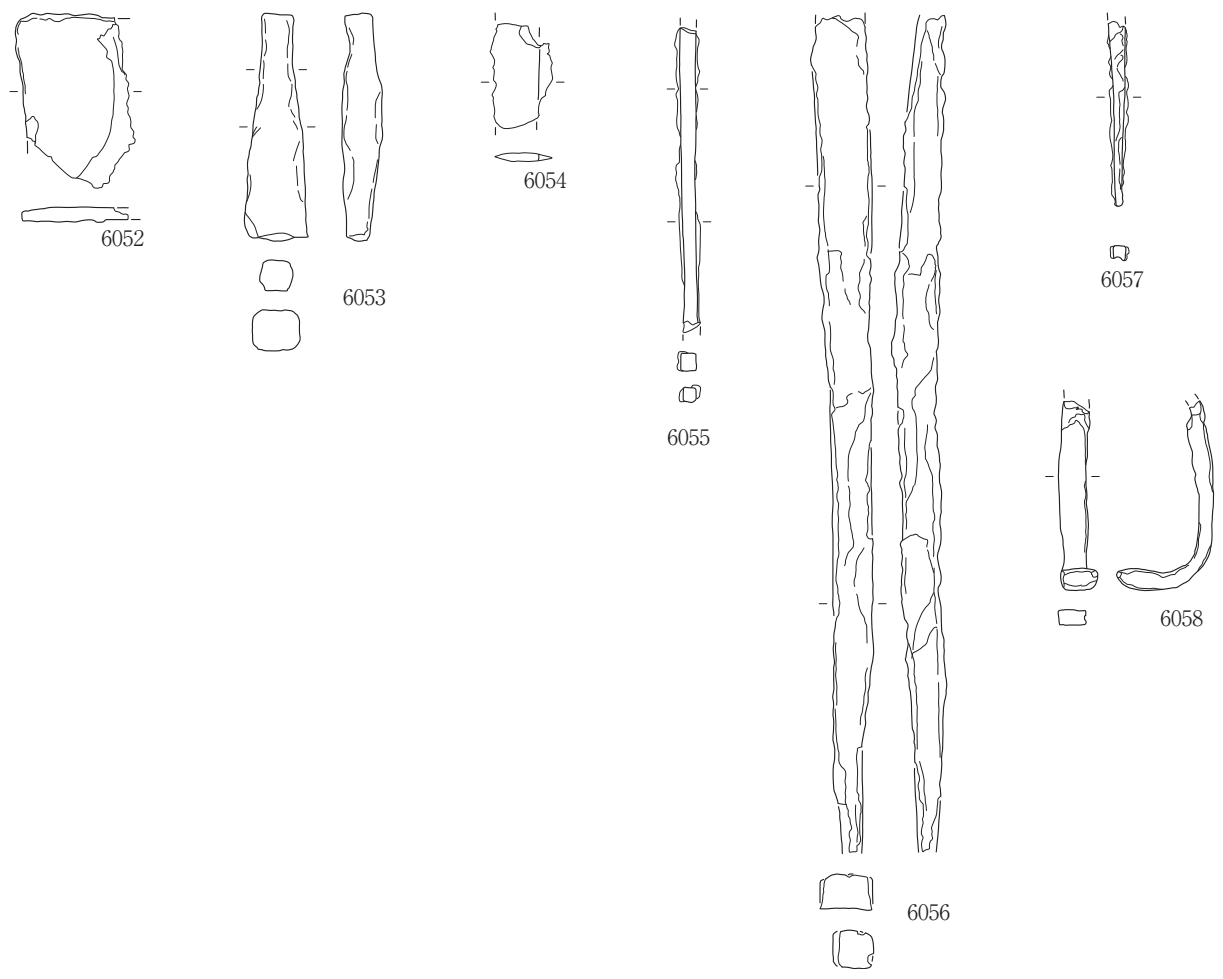
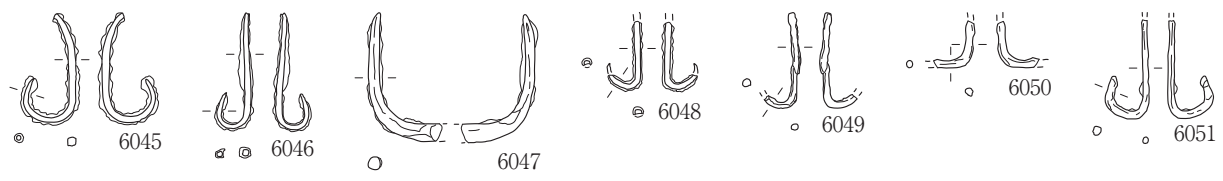
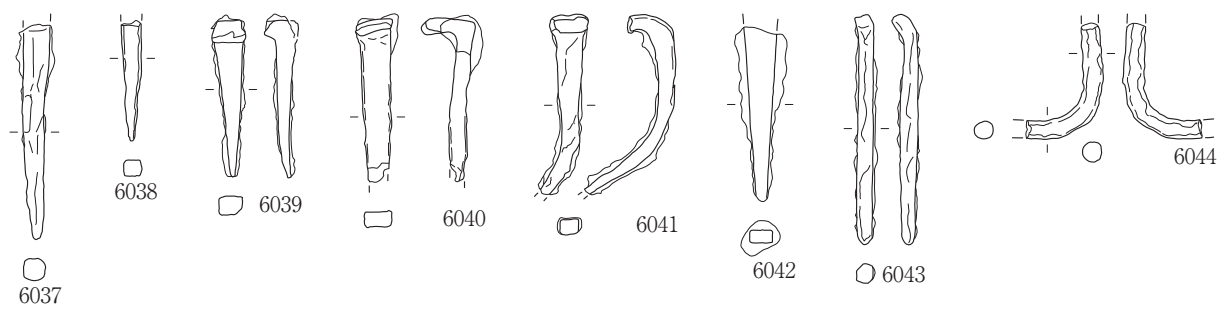

第501図 金属製品 (3)

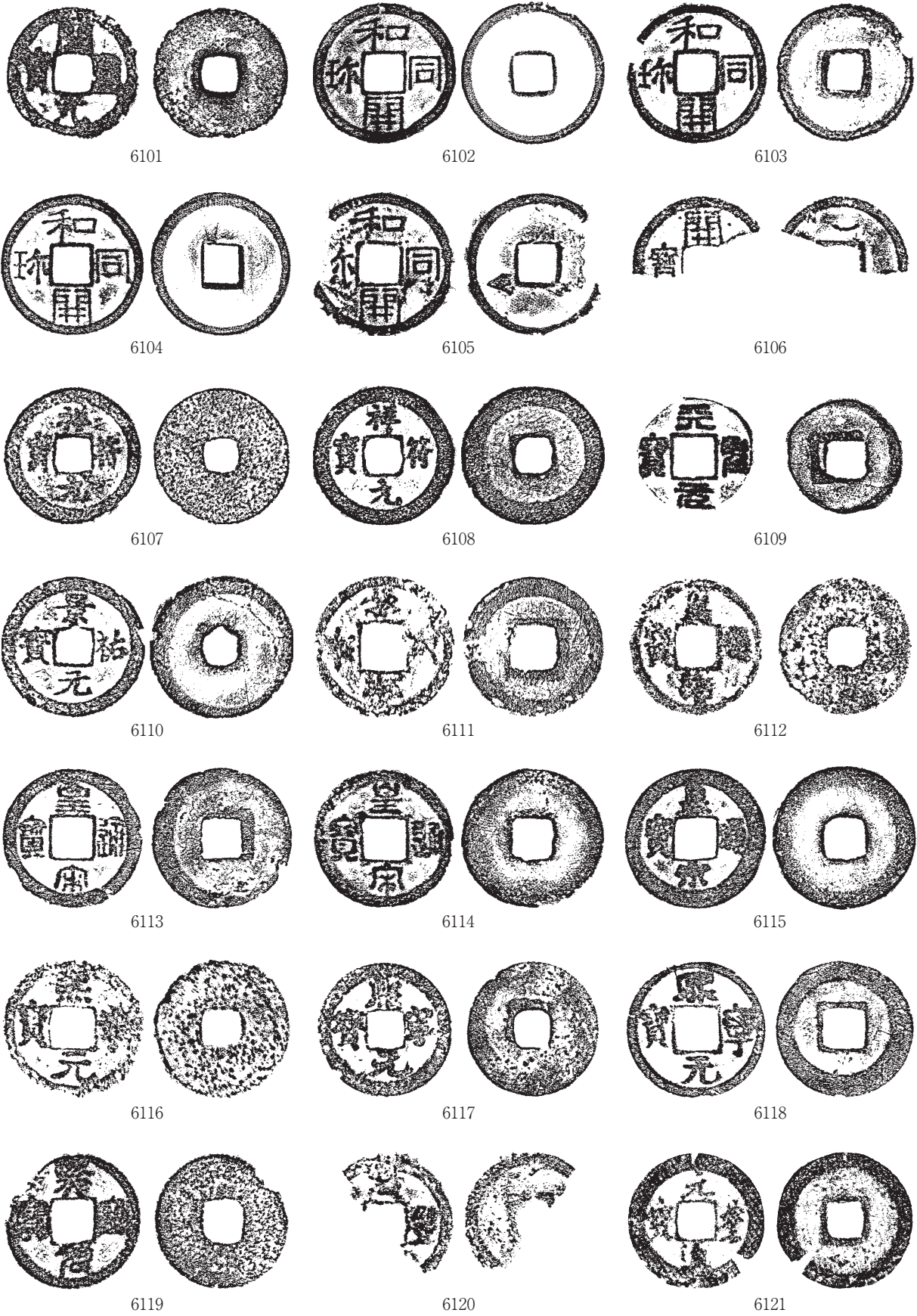

第502図 錢貨(1)

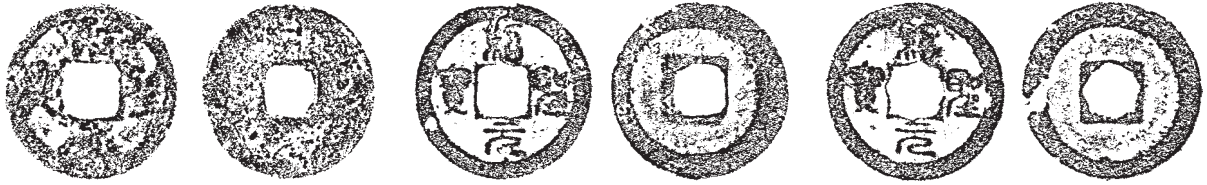

6122

6123

6124

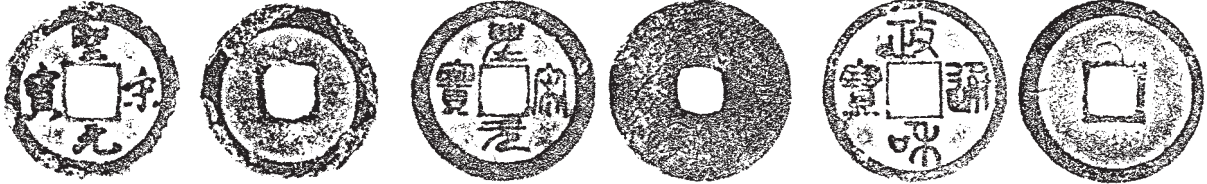

6125

6126

6127

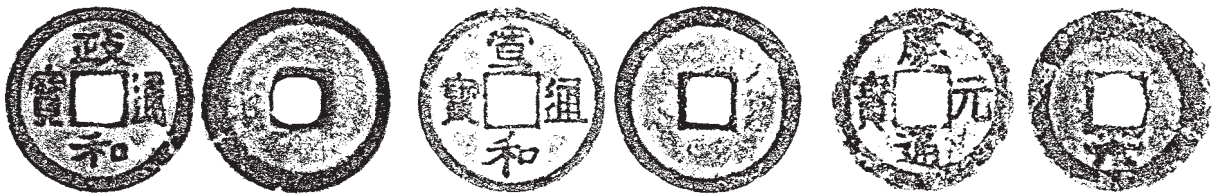

6128

6129

6130

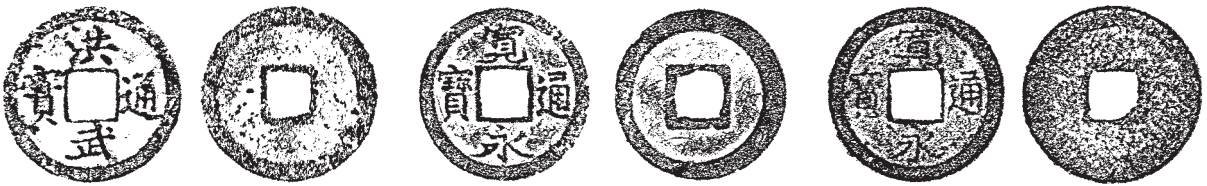

6131

6132

6133



6134

6135

6136

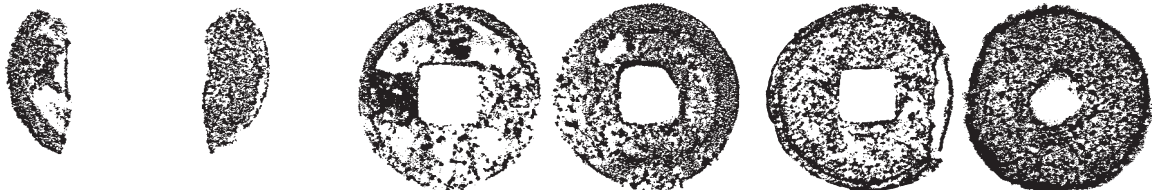

6137

6138

6139

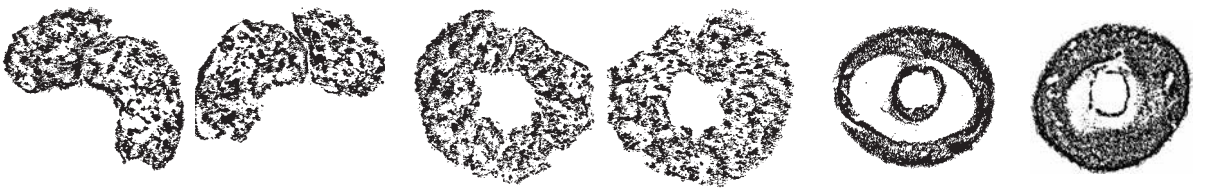

6140

6141

6142

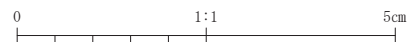

第503図 錢貨(2)

S 101



S 103 (1)

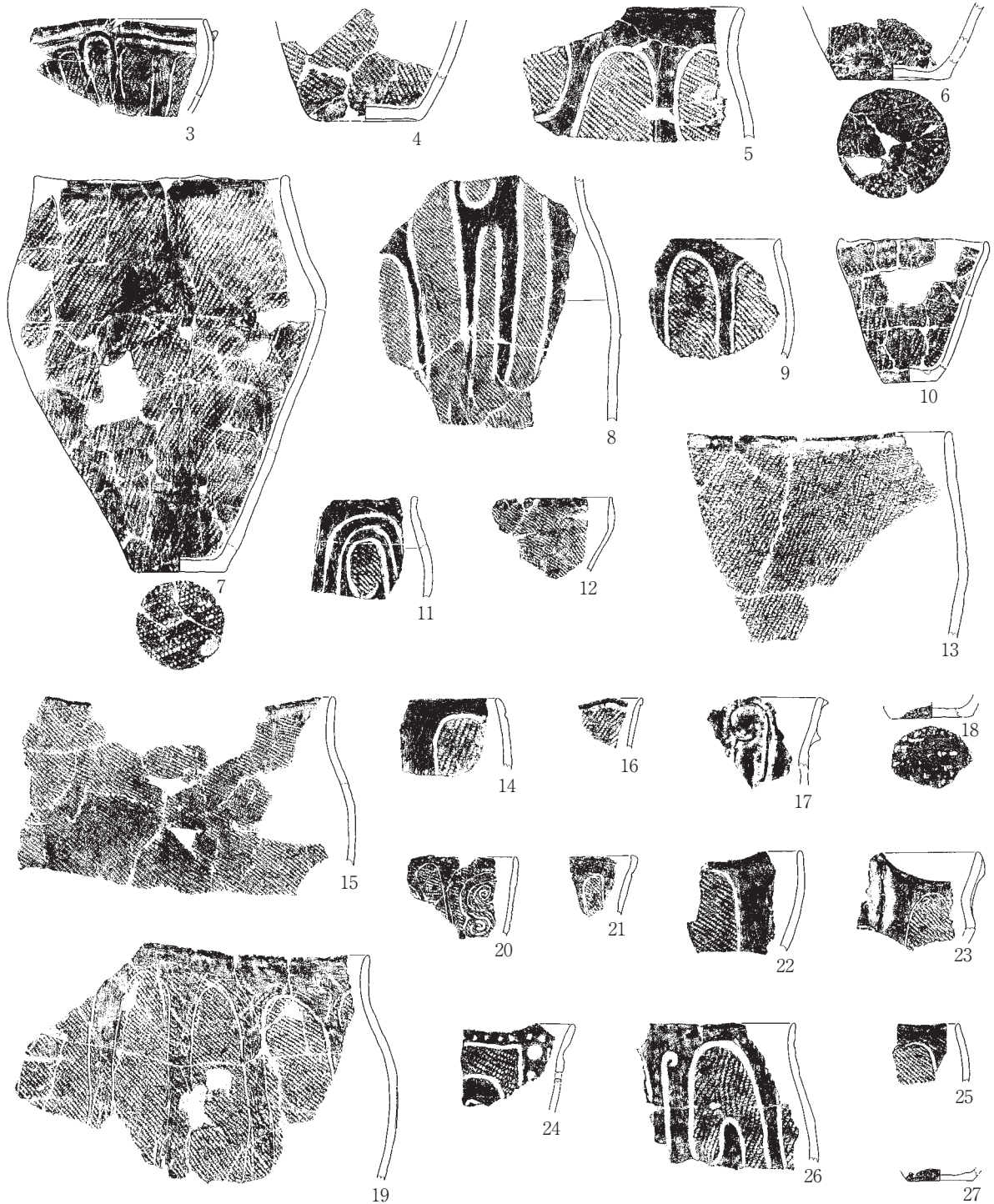

繩文土器：1/6 土製品：1/4  
剥片石器：1/4 礫石器：1/6

第504図 遺構別出土遺物集成図：S 101・03 (1)



S I 03 (2)

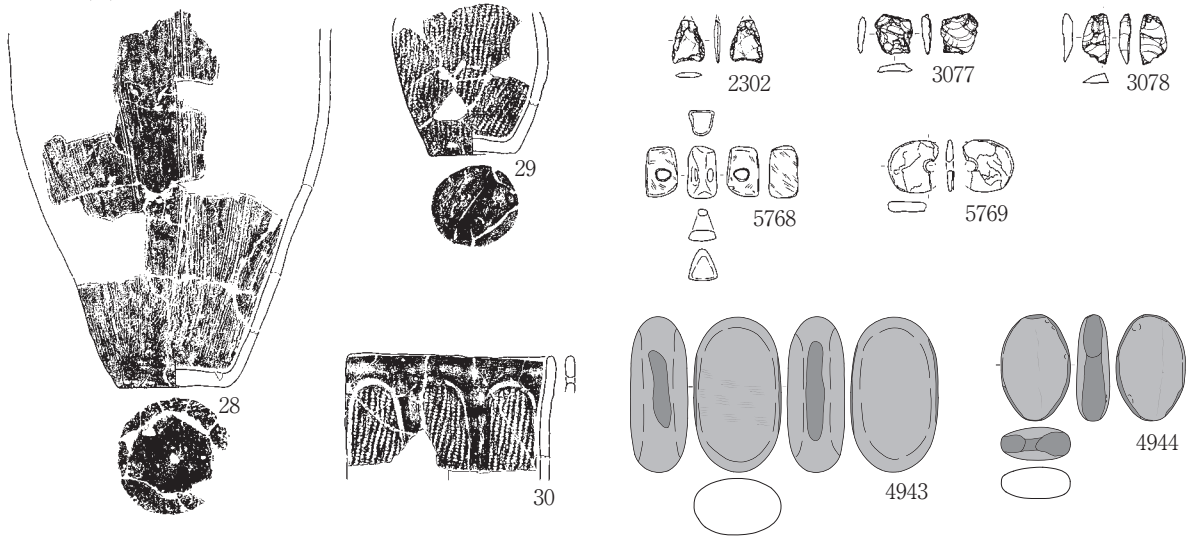

S I 12

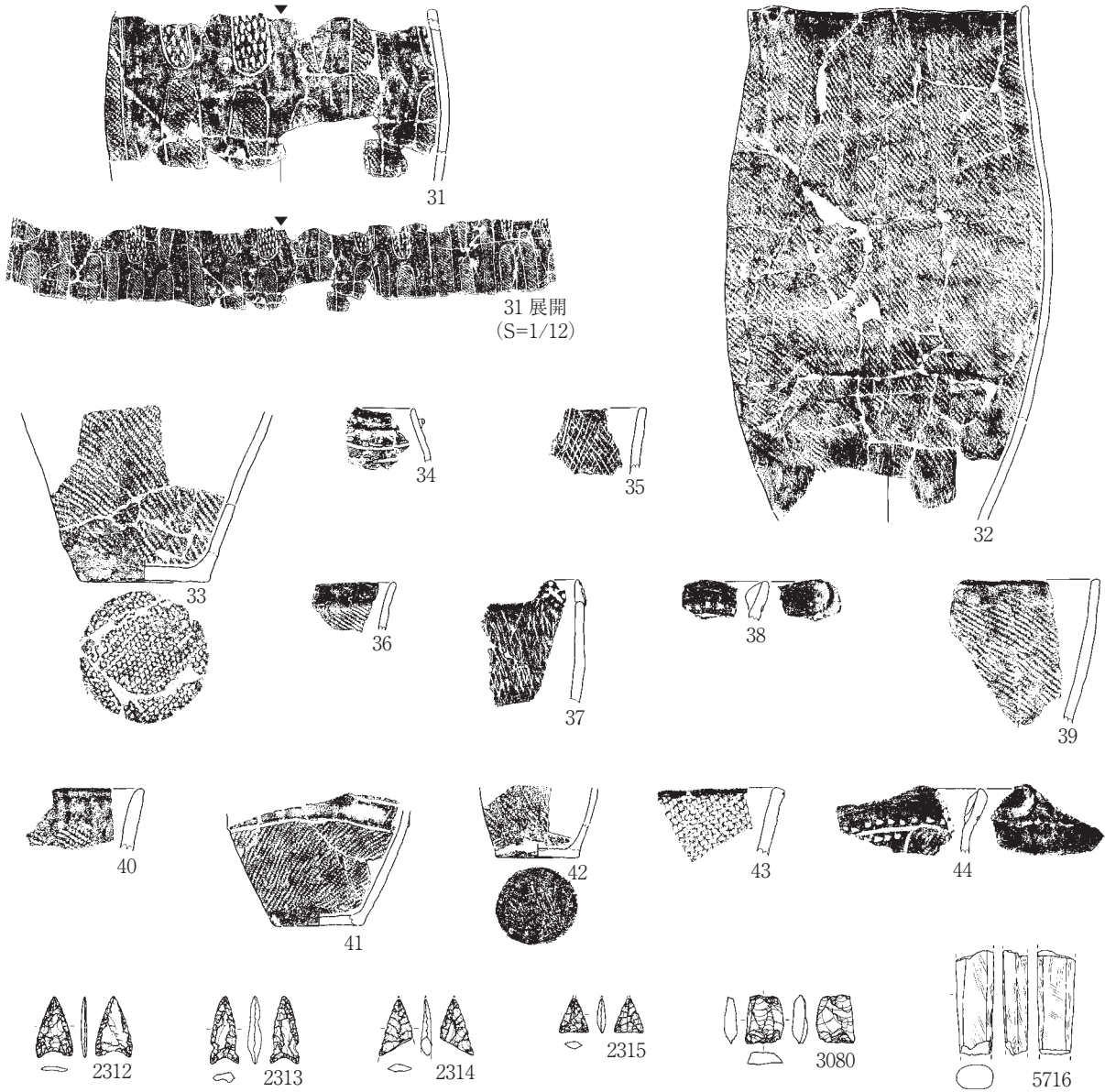

繩文土器：1/6 土製品：1/4  
剥片石器：1/4 礫石器：1/6

第505図 遺構別出土遺物集成図：S I 03 (2)・12

S I 13 (1)

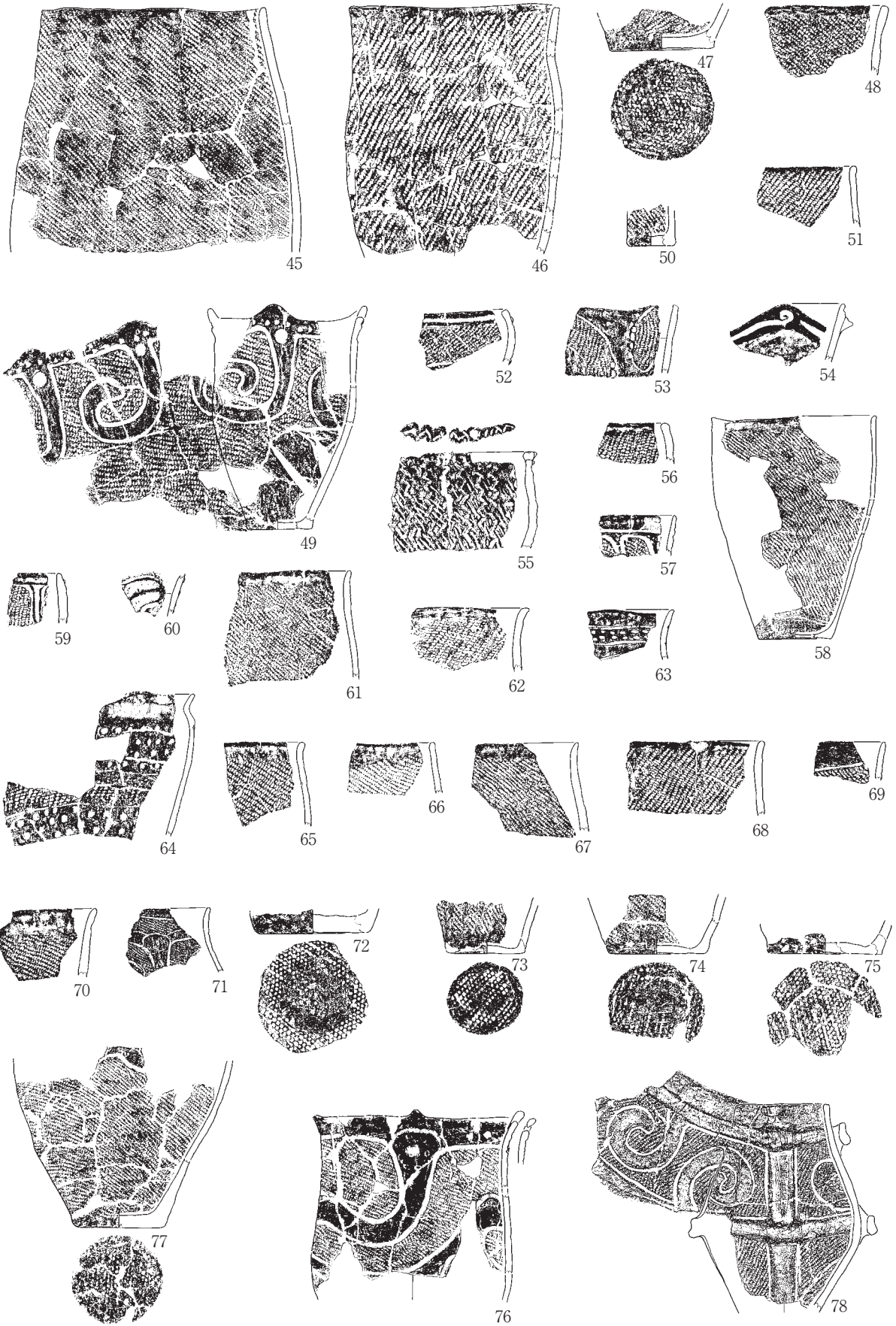

縄文土器：1/6 土製品：1/4  
剥片石器：1/4 礫石器：1/6

第506図 遺構別出土遺物集成図：S I 13 (1)

S I 13 (2)

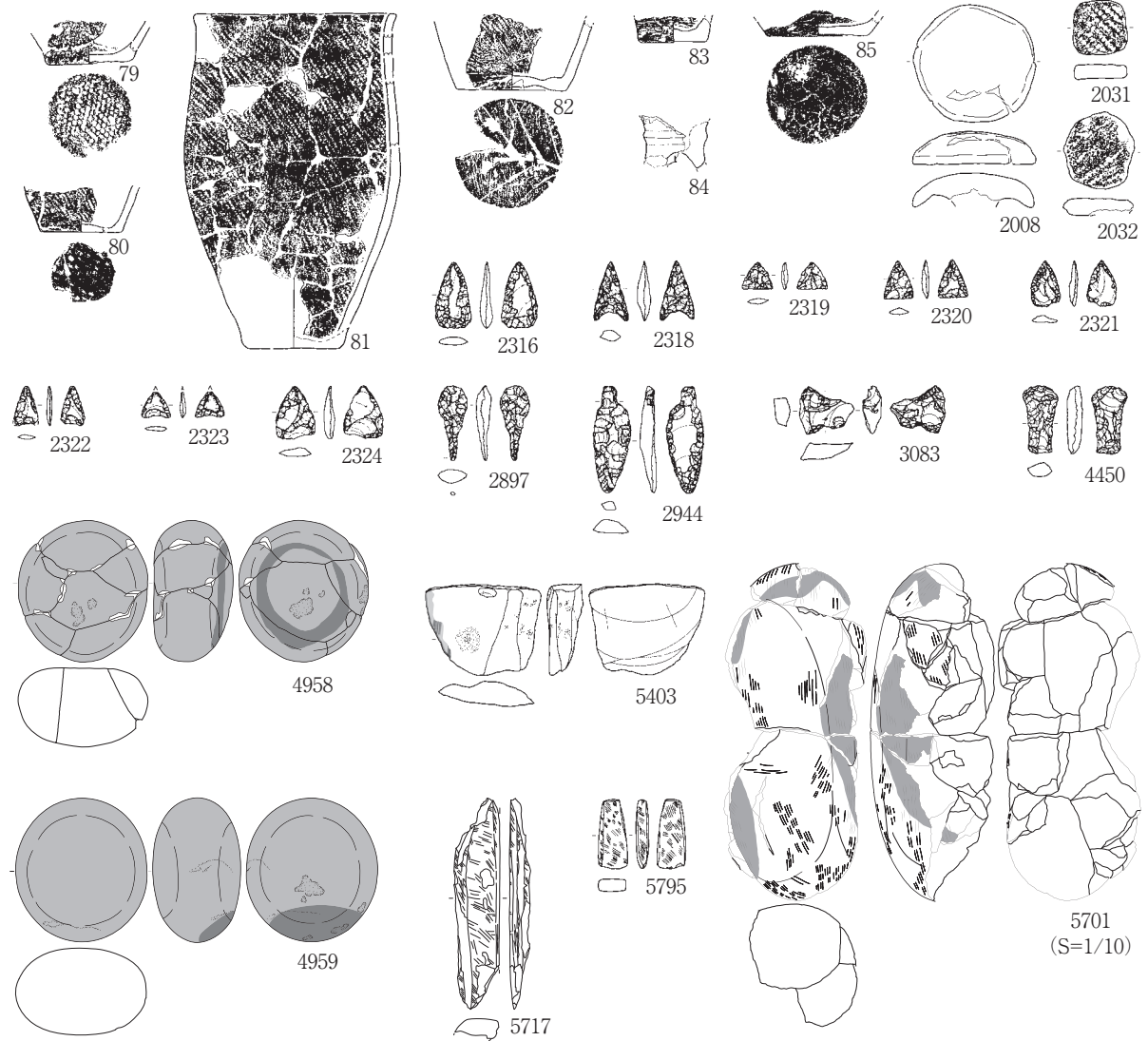

S I 14 (1)

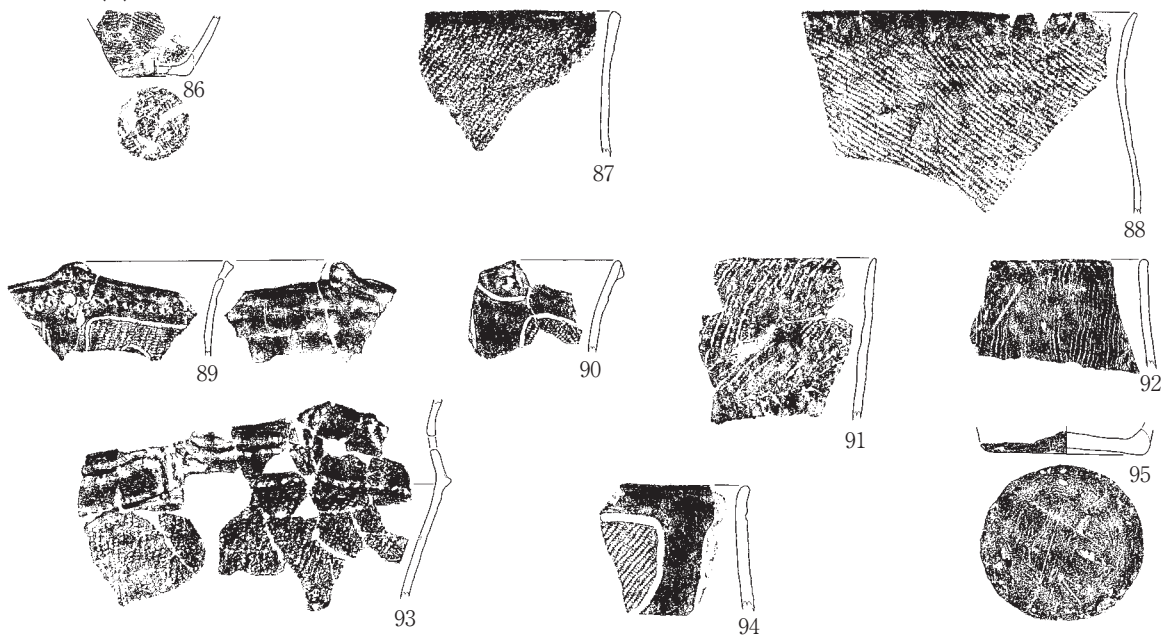

縄文土器：1/6 土製品：1/4  
剥片石器：1/4 礫石器：1/6

第507図 遺構別出土遺物集成図：S I 13 (2)・14 (1)

S I 14 (2)

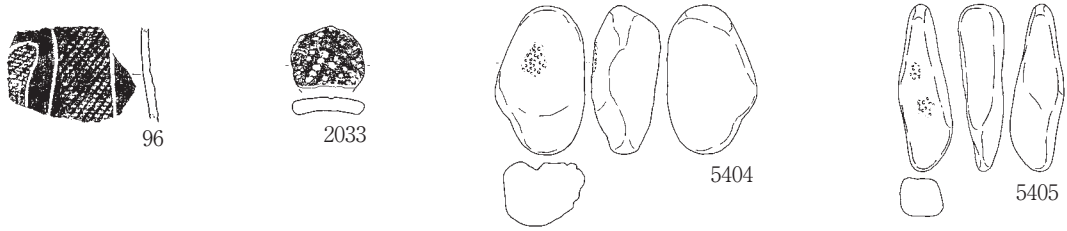

S I 14 · 15

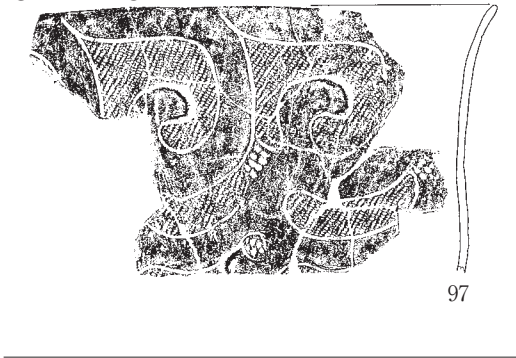

S I 15

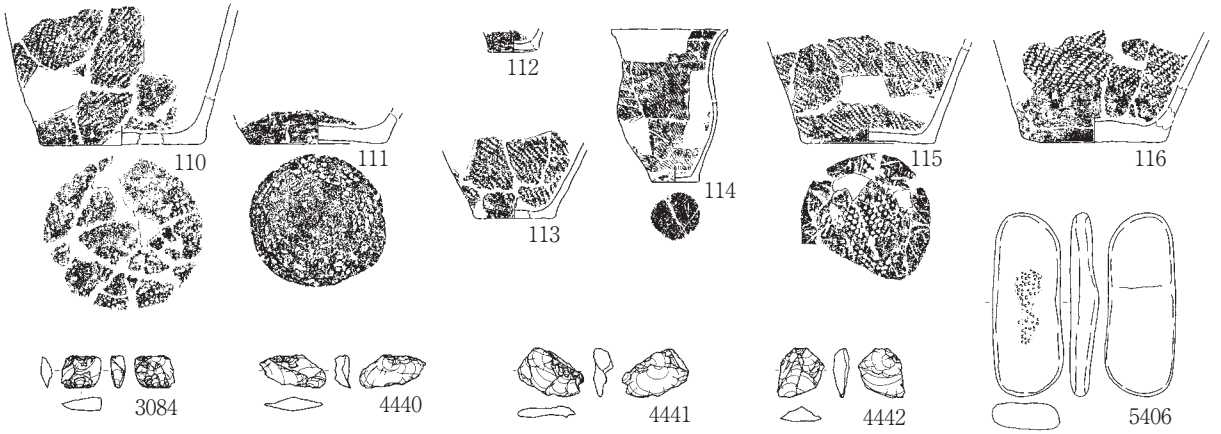
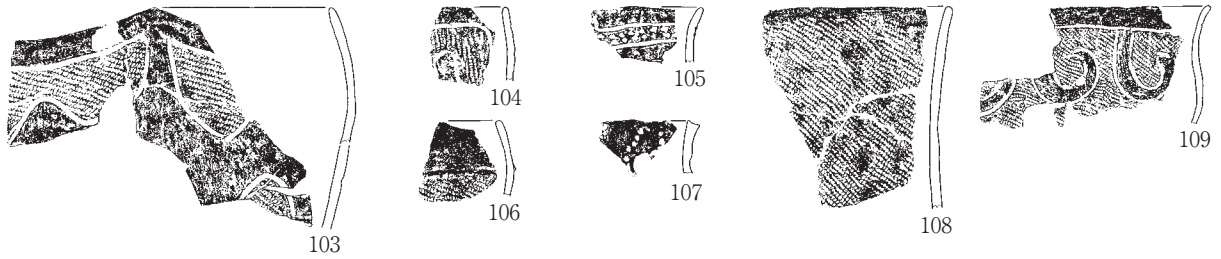
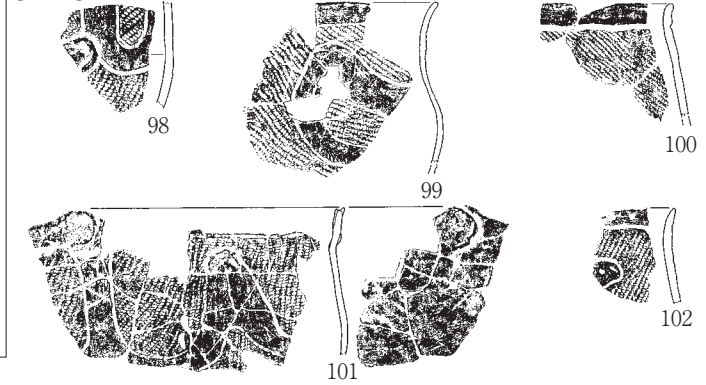

S I 18 (1)

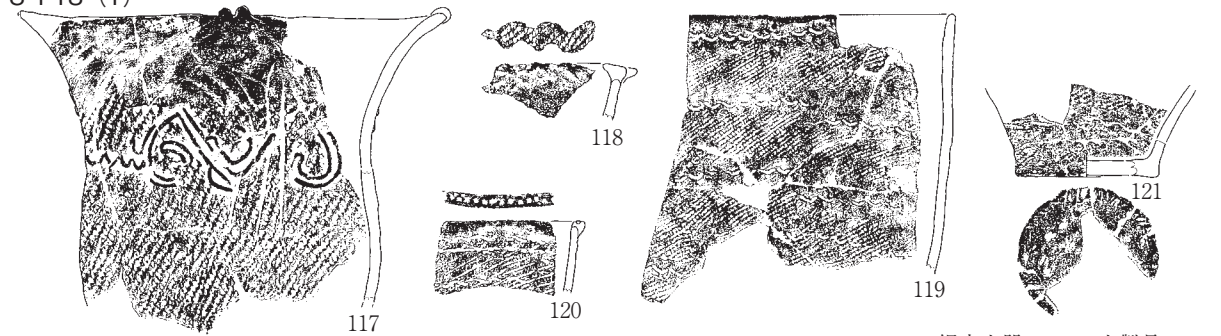

縄文土器：1/6 土製品：1/4  
剥片石器：1/4 礫石器：1/6

第508図 遺構別出土遺物集成図：S I 14 (2) · 15 · 18 (1)

S I 18 (2)

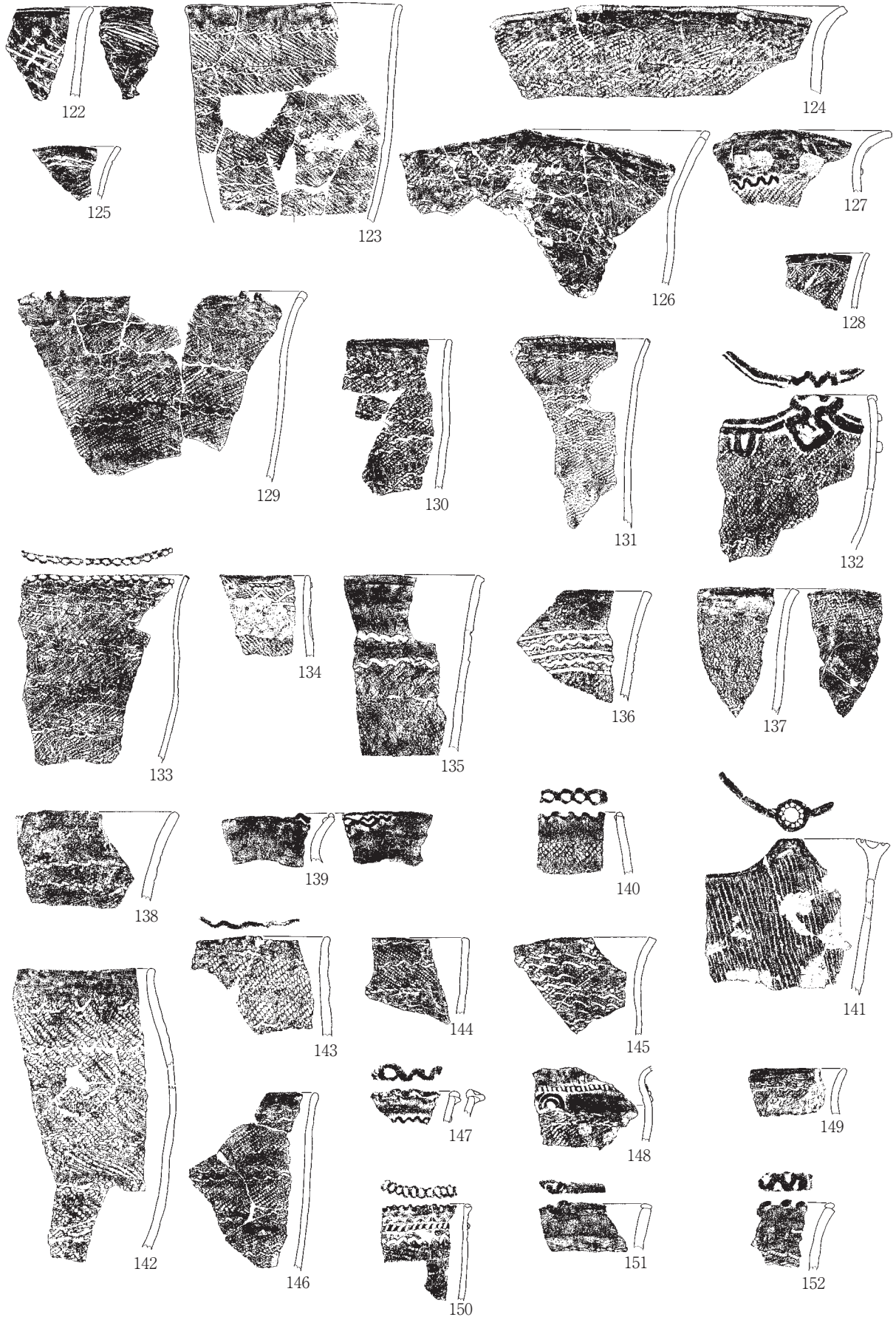

第509図 遺構別出土遺物集成図：S I 18 (2)

縄文土器：1/6 土製品：1/4  
剥片石器：1/4 礫石器：1/6

S I 18 (3)

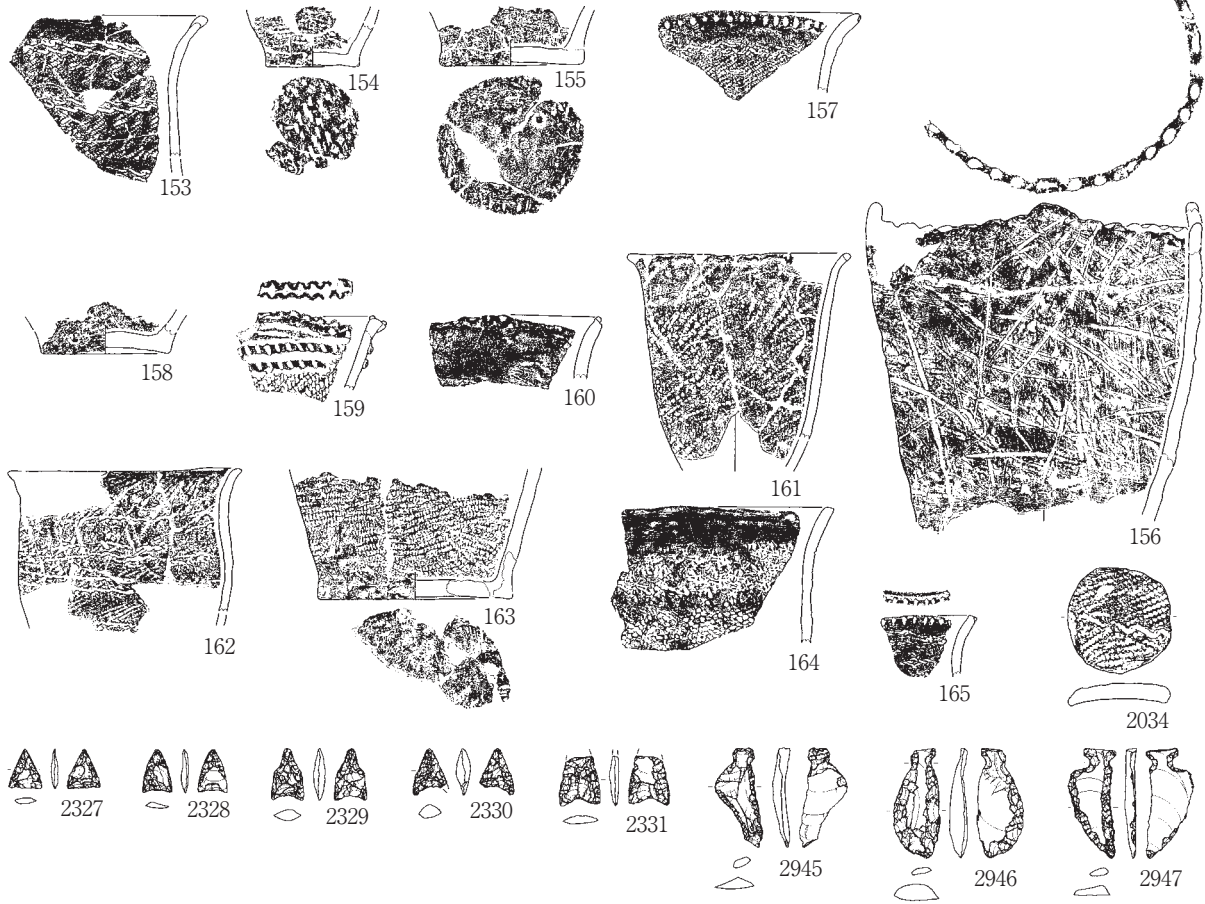

S I 19 (1)

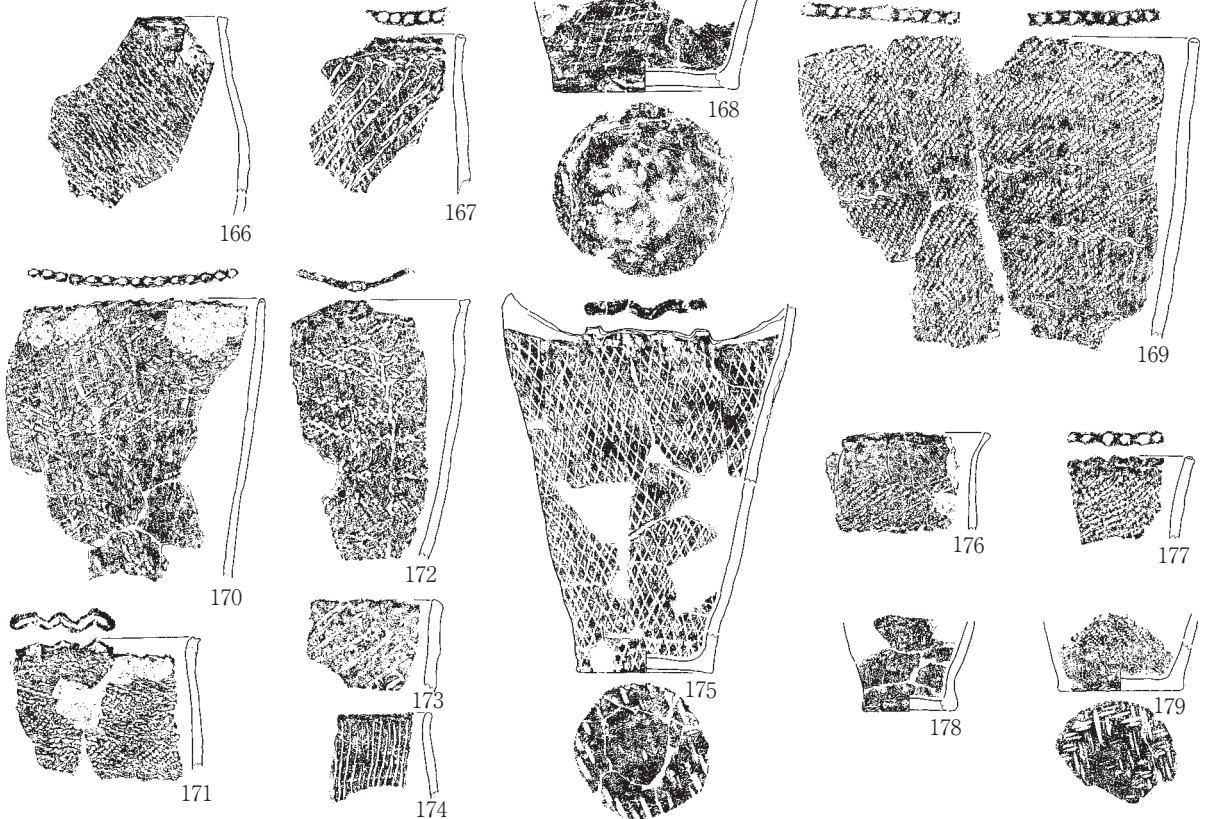

縄文土器：1/6 土製品：1/4  
 剥片石器：1/4 礫石器：1/6

第510図 遺構別出土遺物集成図：S I 18 (3)・19 (1)

S | 19 (2)

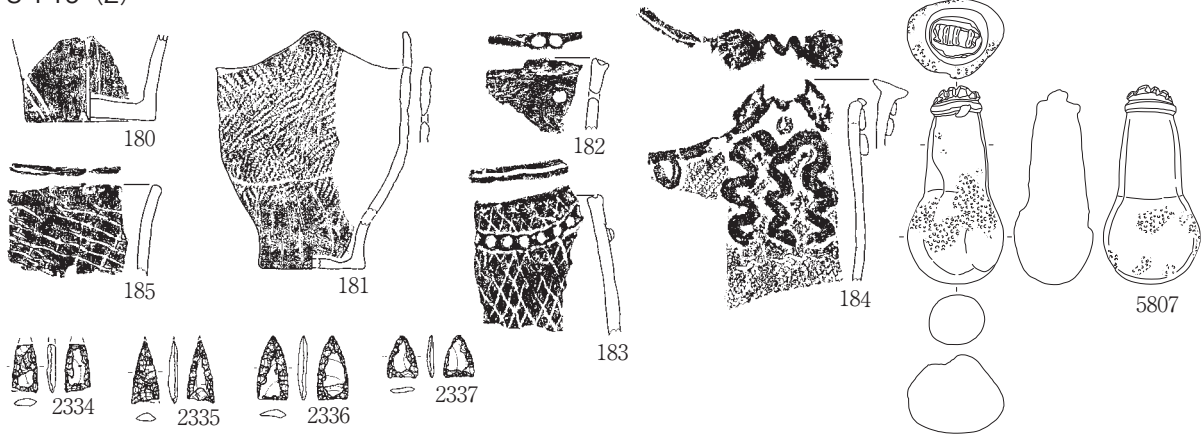

S | 20

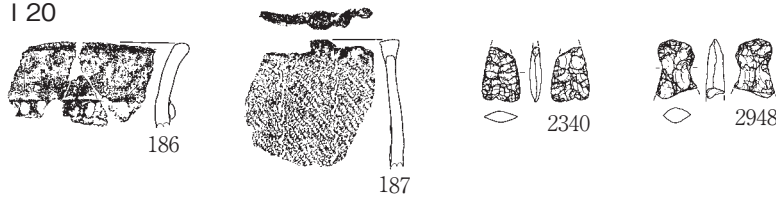

S | 23



S | 24

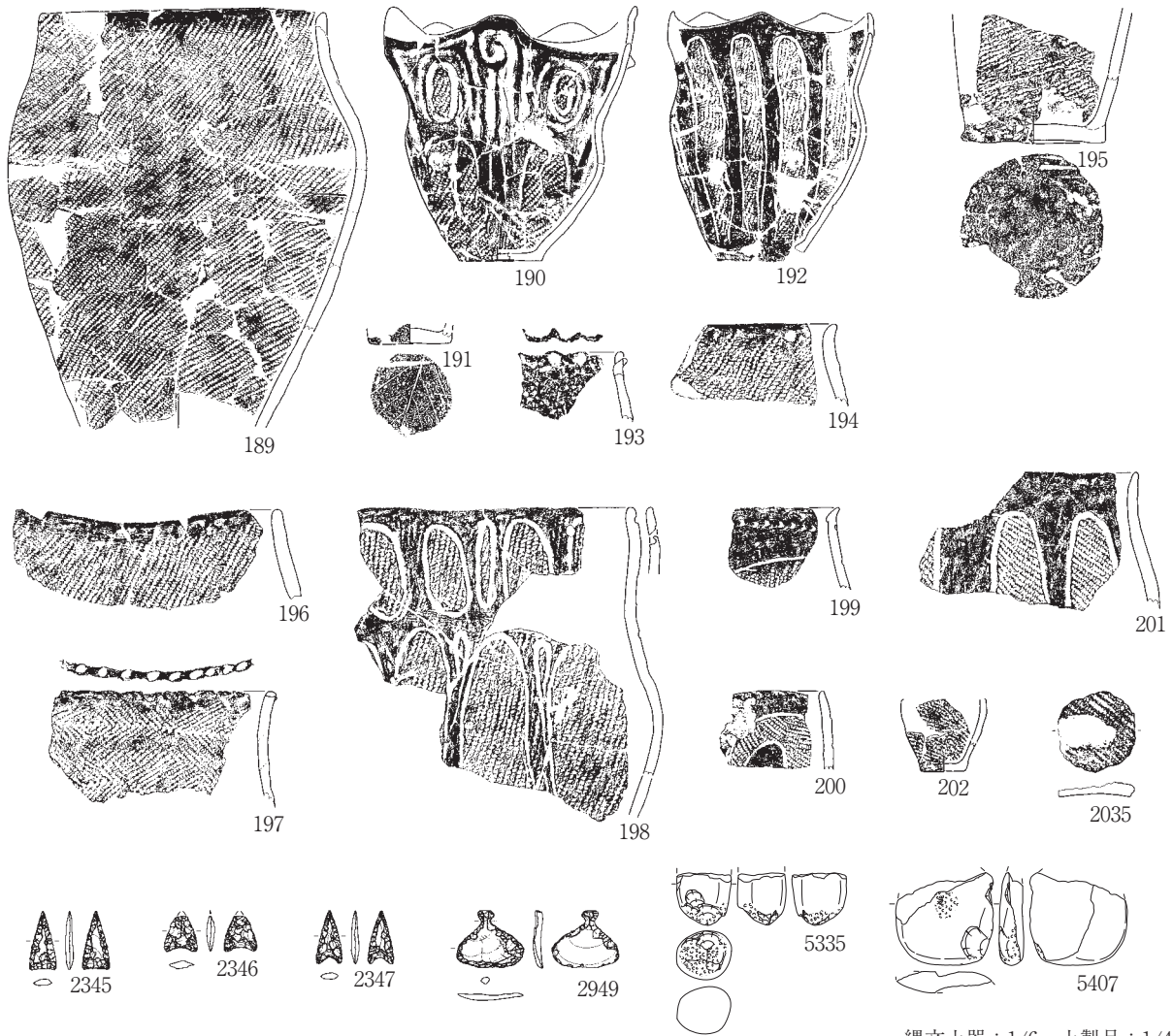

繩文土器：1/6 土製品：1/4  
剥片石器：1/4 礫石器：1/6

第511図 遺構別出土遺物集成図：S | 19 (2)・20・23・24

S I 30

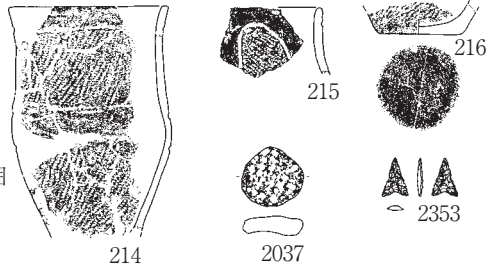
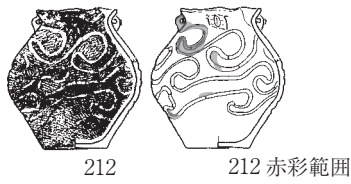

※SI30~32

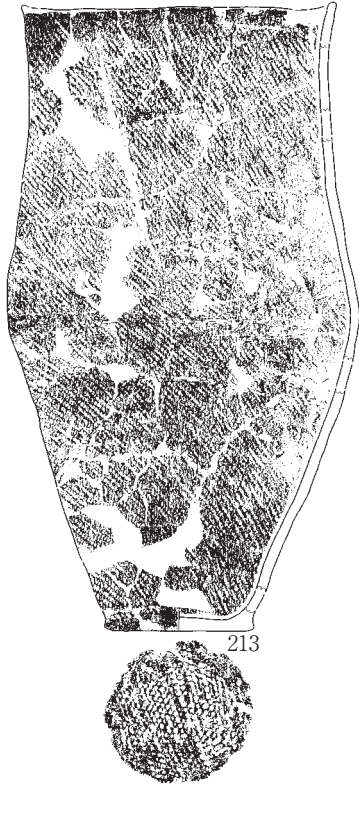
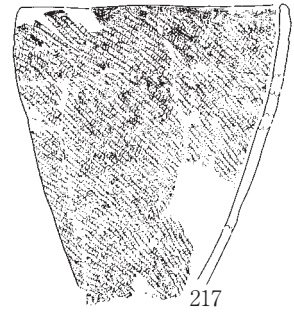

S I 31 (1)

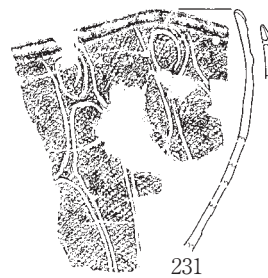
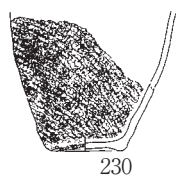
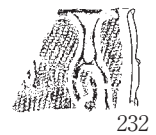
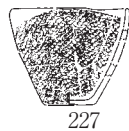
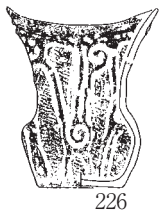
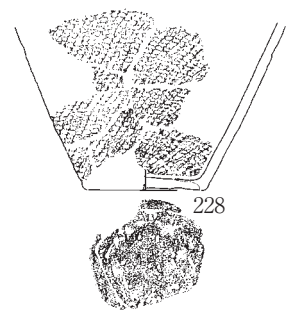
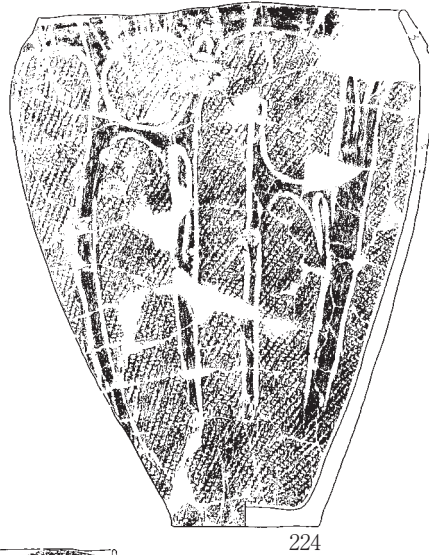
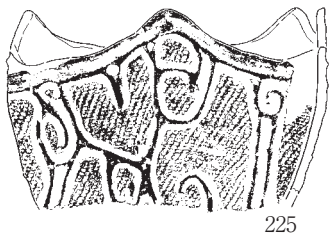
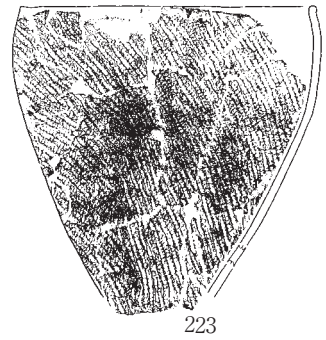
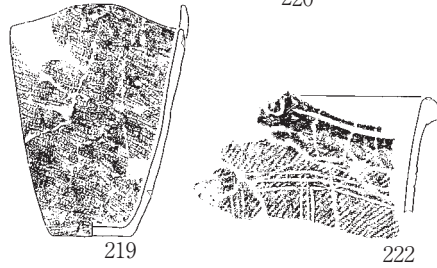
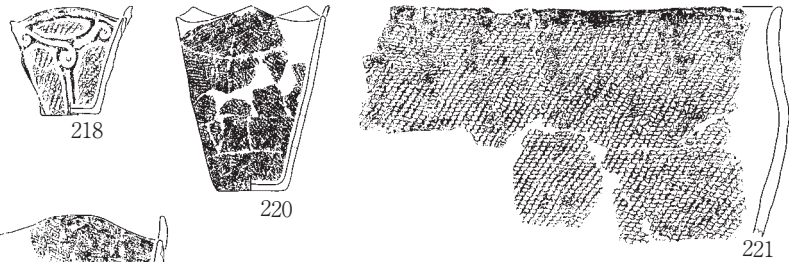

繩文土器：1/6 土製品：1/4  
剥片石器：1/4 礫石器：1/6

第512図 遺構別出土遺物集成図：S I 30・31 (1)



S | 31 (2)

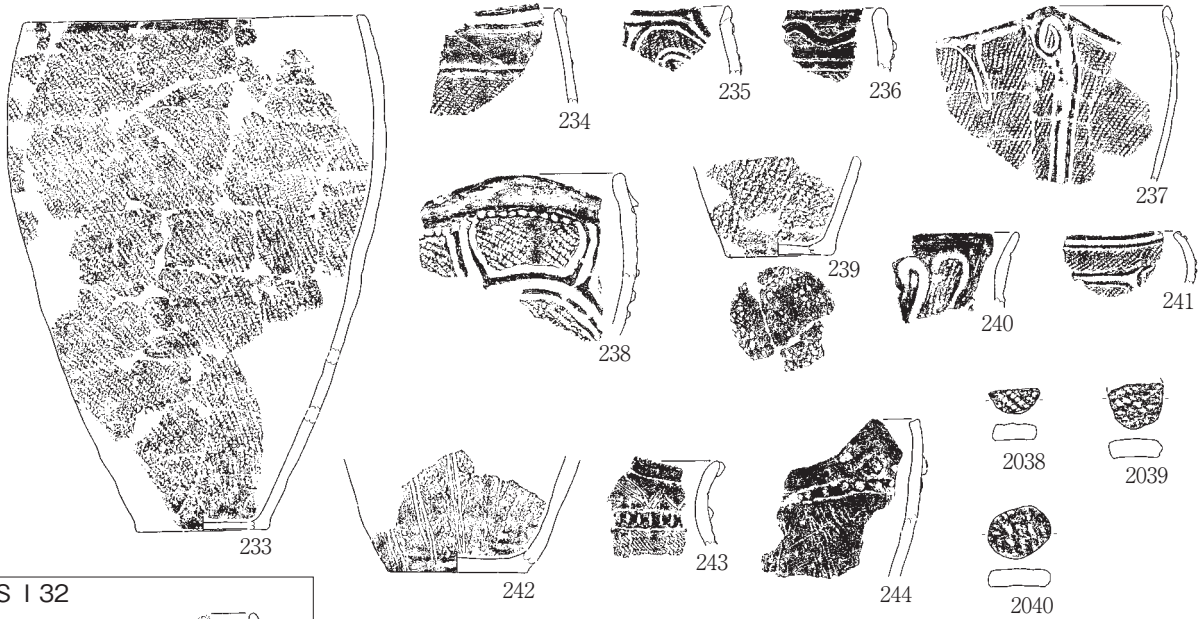

S | 32

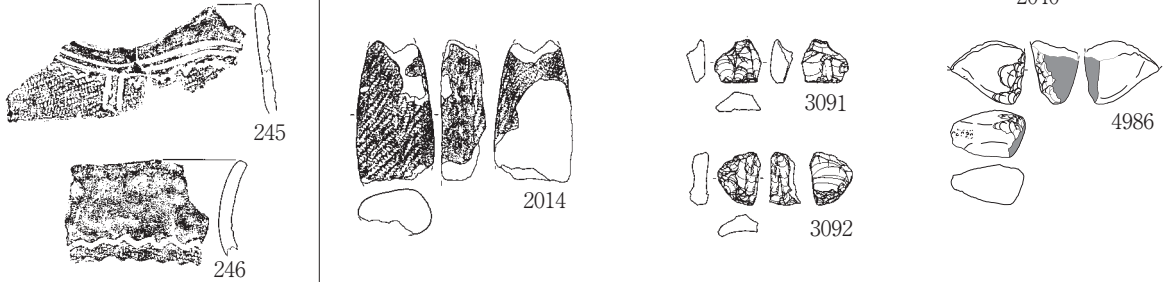

S | 34

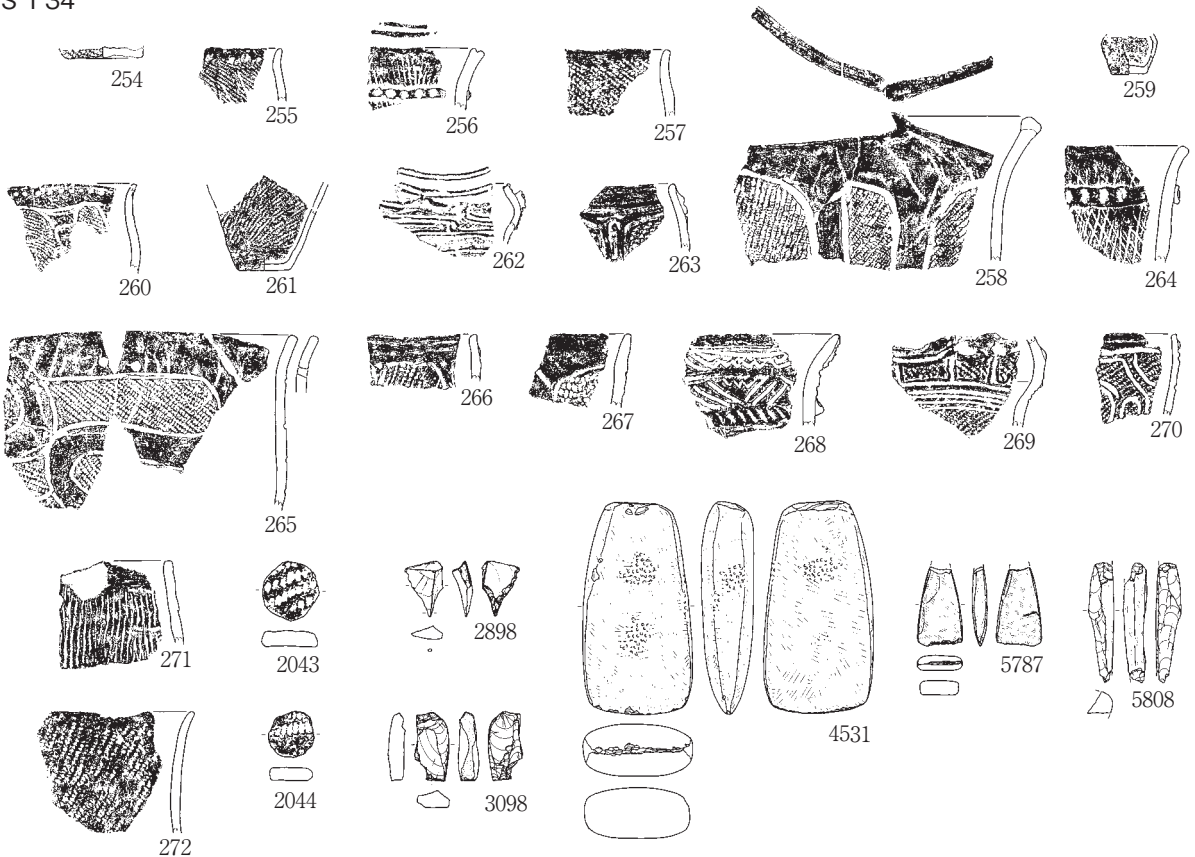

第513図 遺構別出土遺物集成図：S | 31 (2)・32・34  
 縄文土器：1/6 土製品：1/4  
 剥片石器：1/4 礫石器：1/6

S | 35

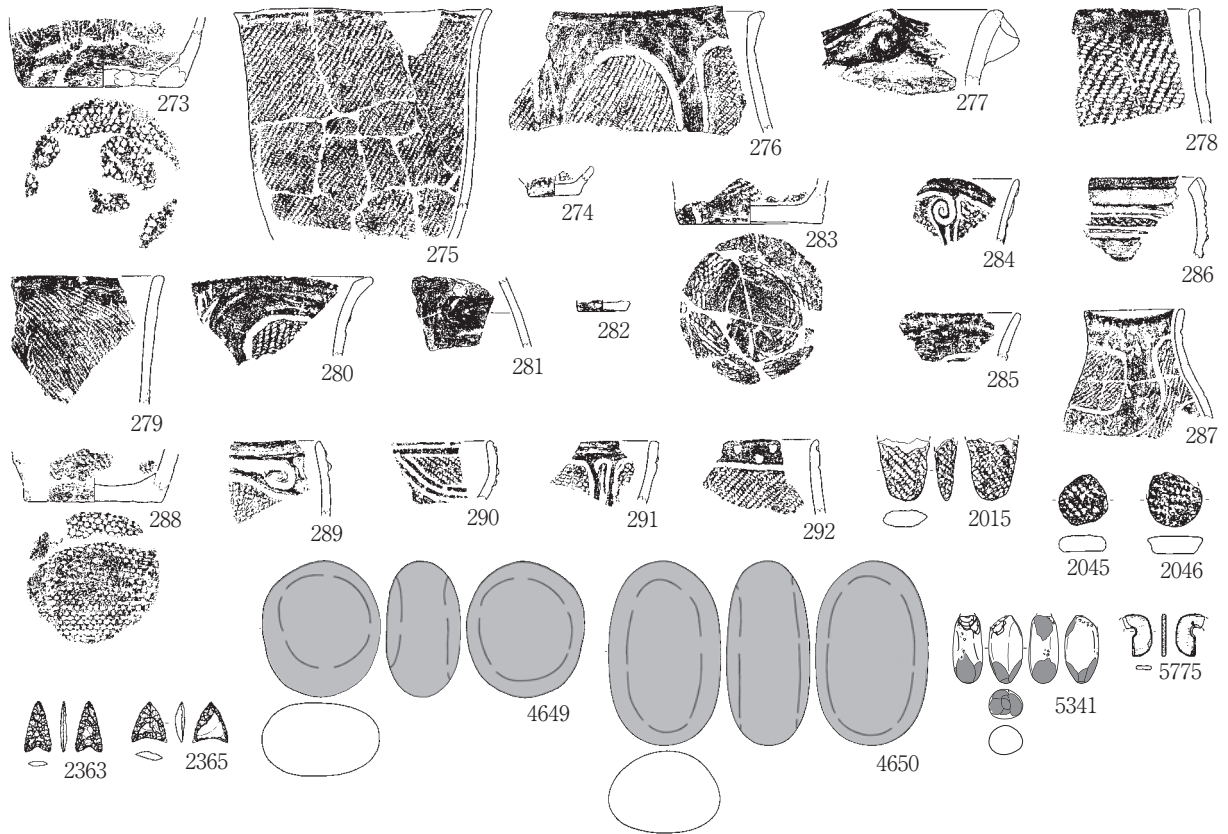

S | 37

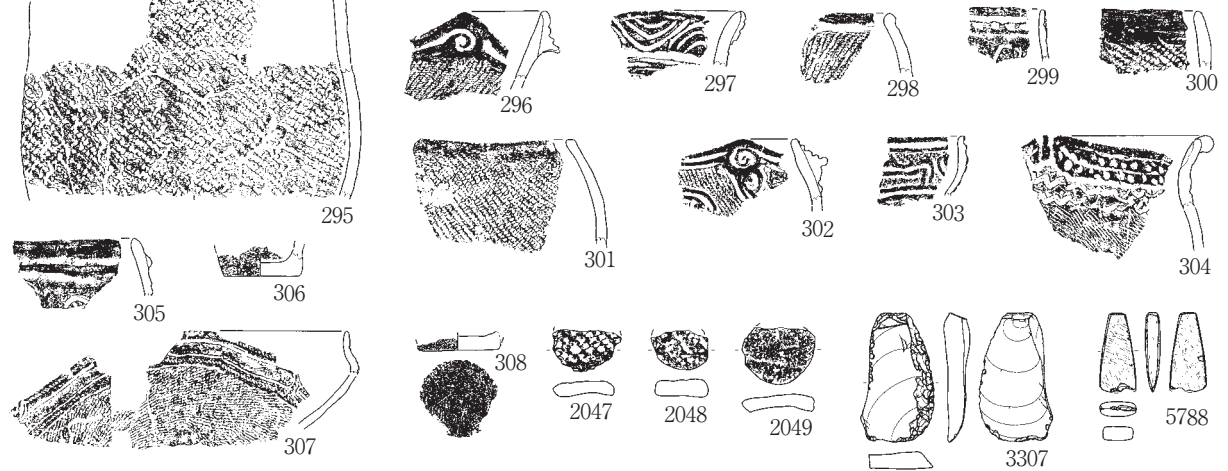

S | 38

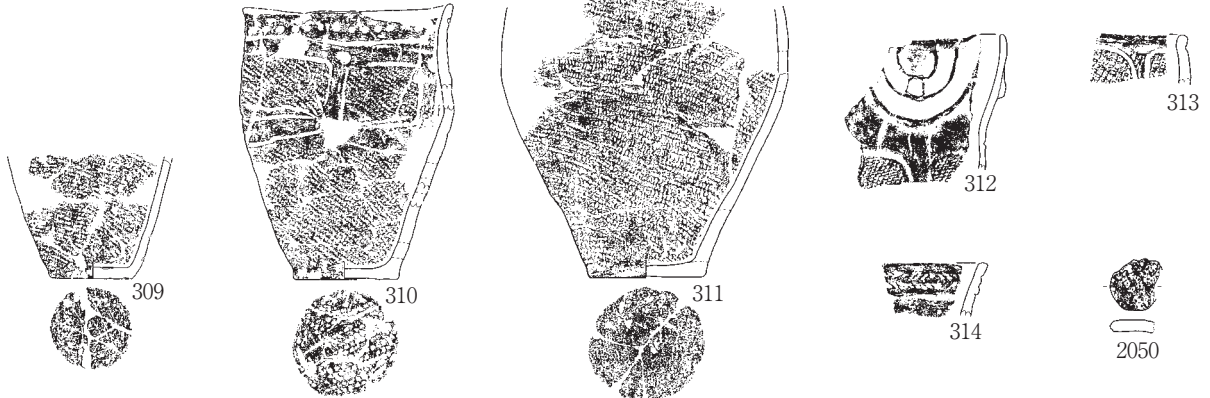

第514図 遺構別出土遺物集成図：S | 35・37・38

縄文土器：1/6 土製品：1/4  
剥片石器：1/4 礫石器：1/6

S I 39

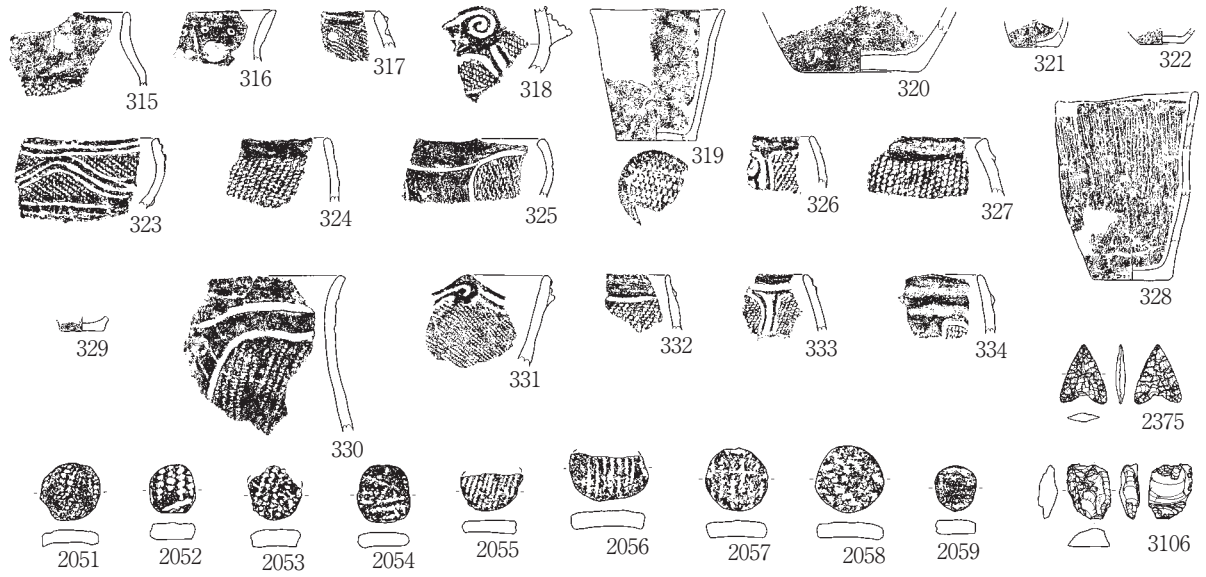

※SI39・40

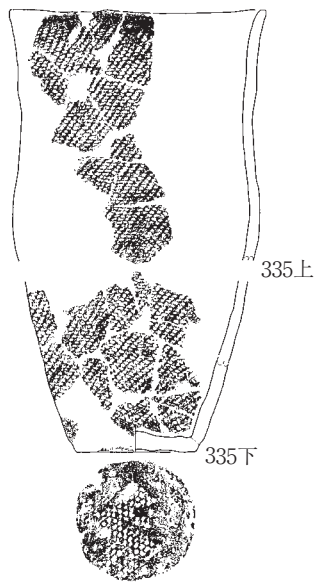

S I 40

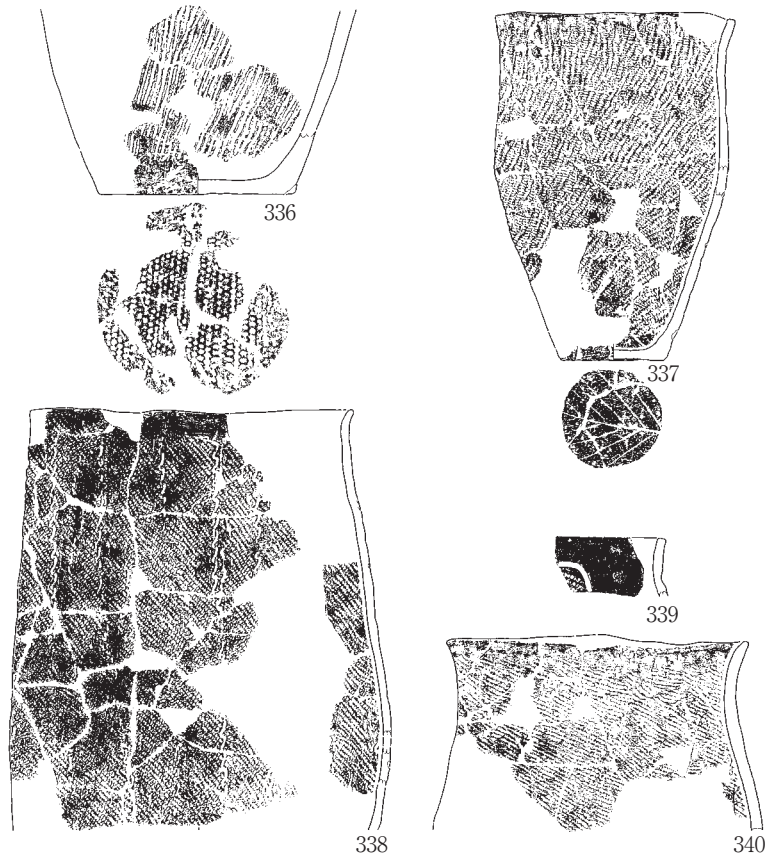

S I 41

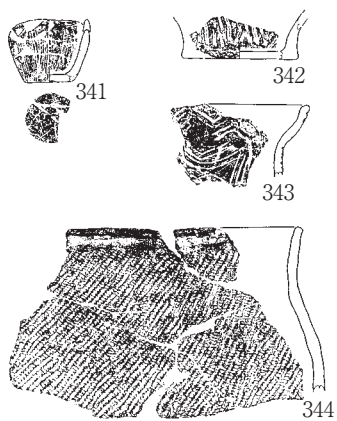

S I 43

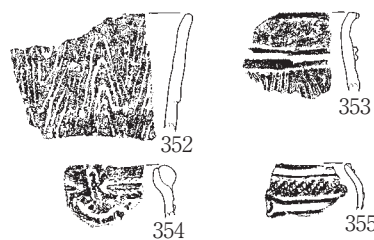

S I 45

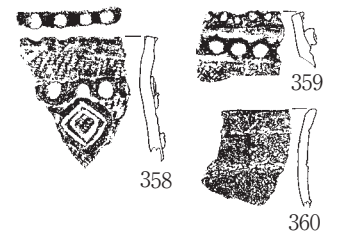

縄文土器：1/6 土製品：1/4  
剥片石器：1/4 礫石器：1/6

第515図 遺構別出土遺物集成図：S I 39・40・41・43・45

S I 46

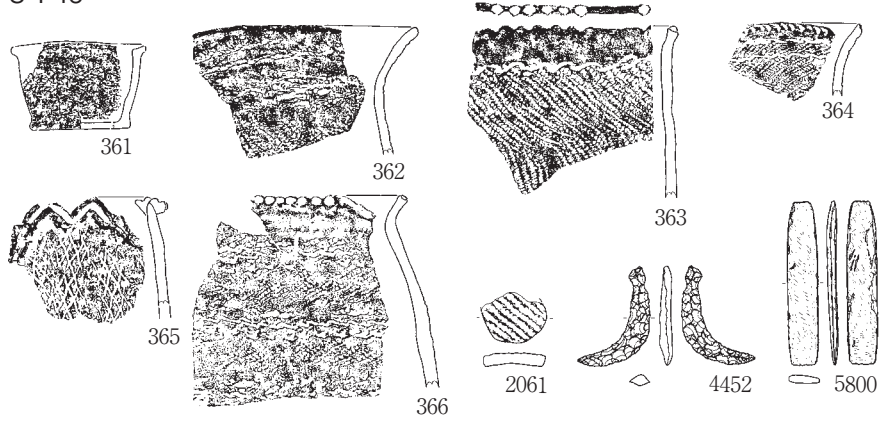

※SI46・54

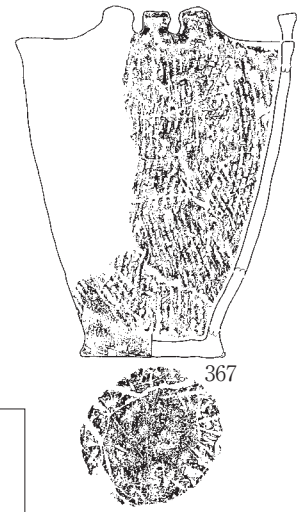

S I 47

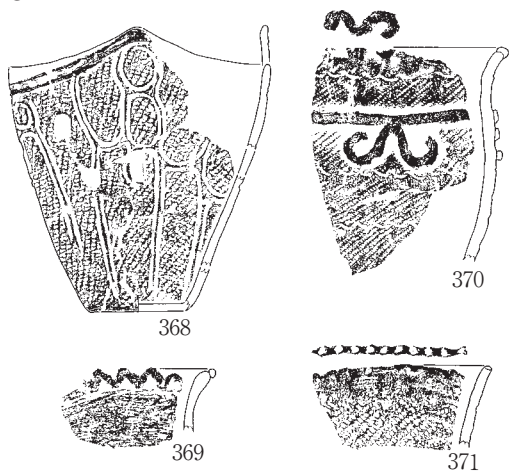

S I 49

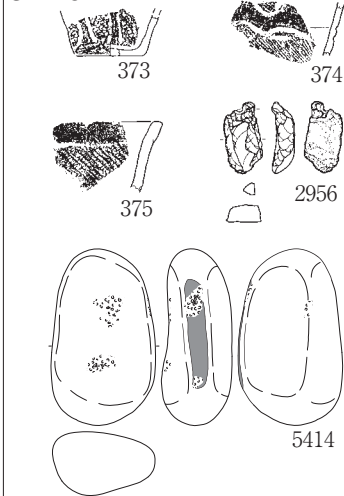

S I 51

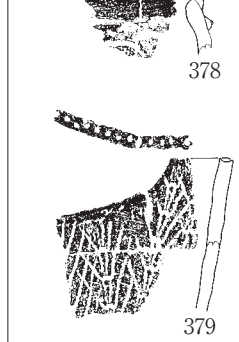

S I 53



縄文土器：1/6 土製品：1/4  
 剥片石器：1/4 礫石器：1/6

第516図 遺構別出土遺物集成図：S I 46・47・49・51・53

S I 54

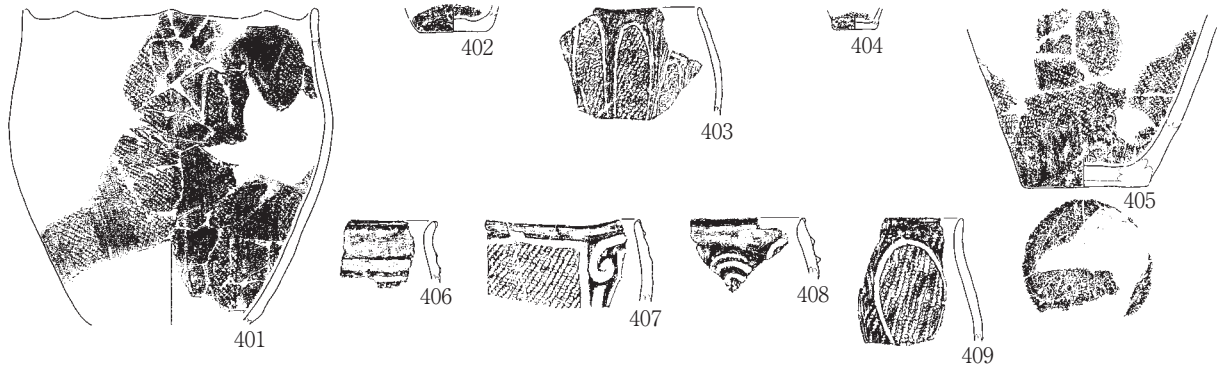

※SI54・55

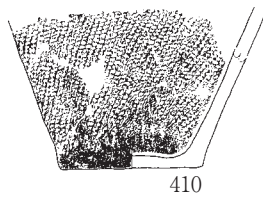

S I 55

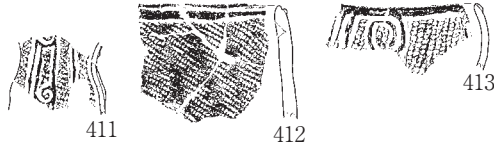

※SI55・65・73

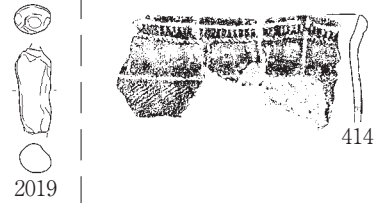

S I 56

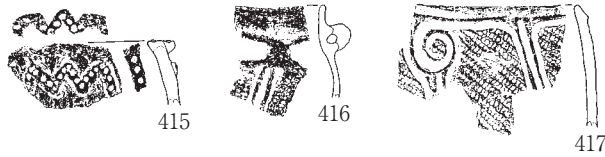

※SI56・73



S I 57

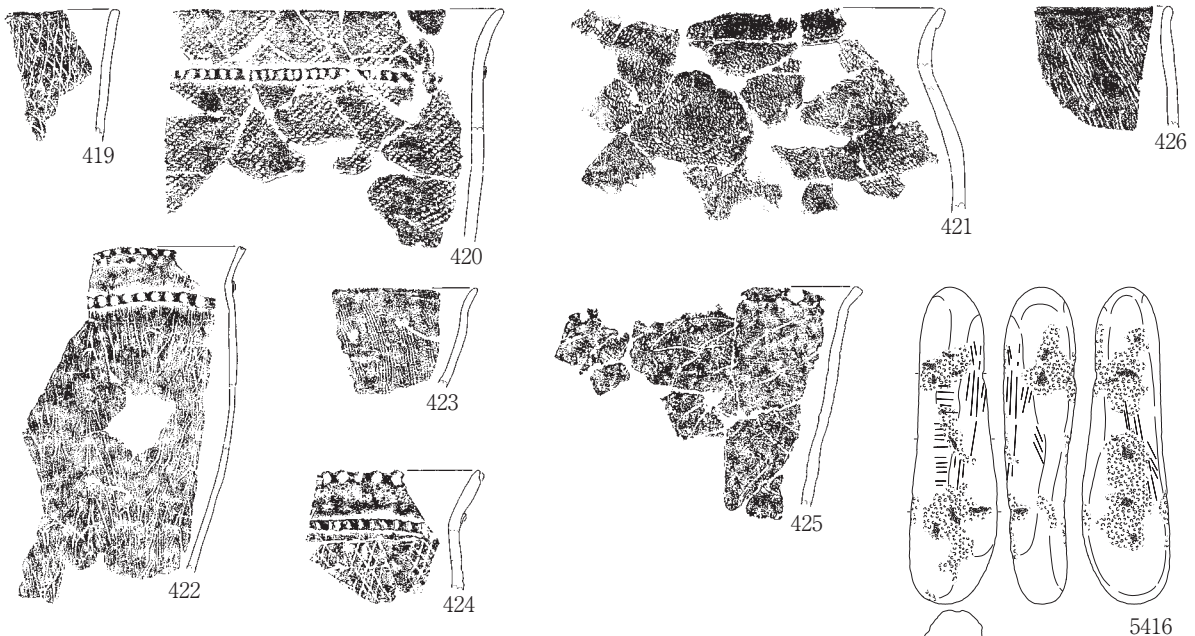

S I 58 (1)



縄文土器：1/6 土製品：1/4  
剥片石器：1/4 礫石器：1/6

第517図 遺構別出土遺物集成図：S I 54・55・56・57・58 (1)

S I 58 (2)

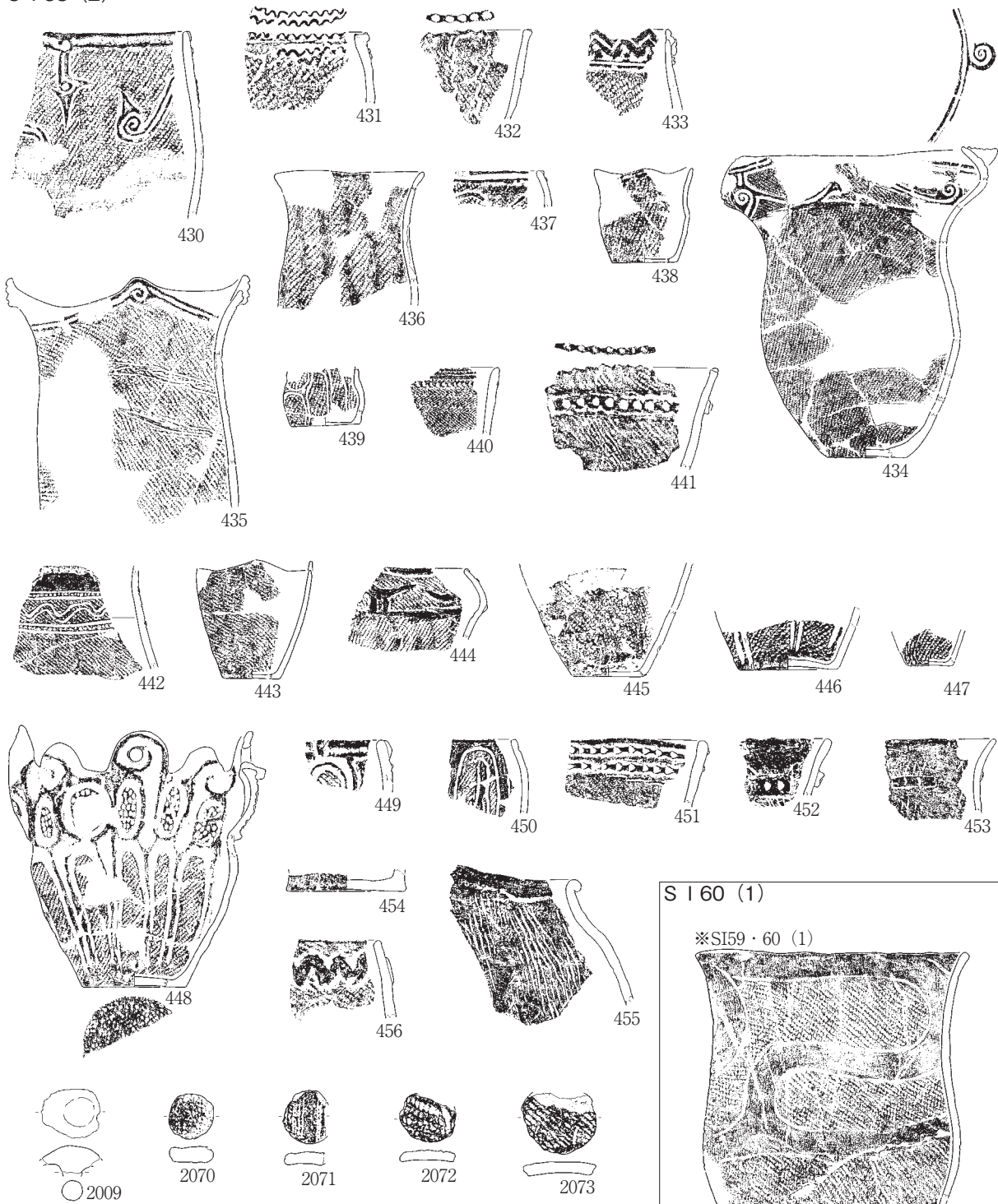

S I 59

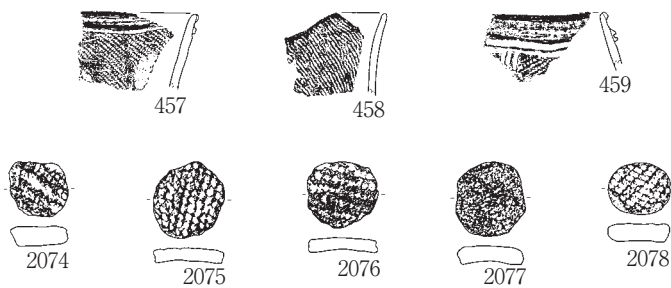

S I 60 (1)

※SI59・60 (1)

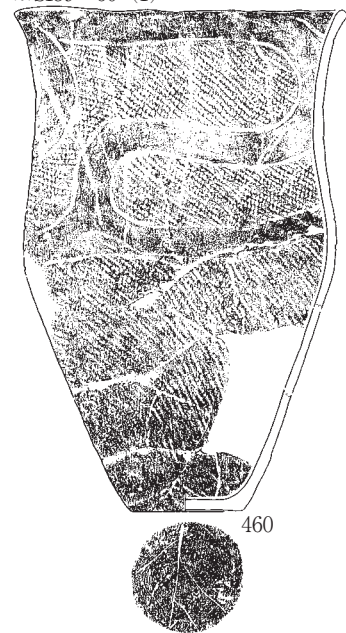

縄文土器：1/6 土製品：1/4  
剥片石器：1/4 礫石器：1/6

第518図 遺構別出土遺物集成図：S I 58 (2)・59・60 (1)

※SI59・60 (2)

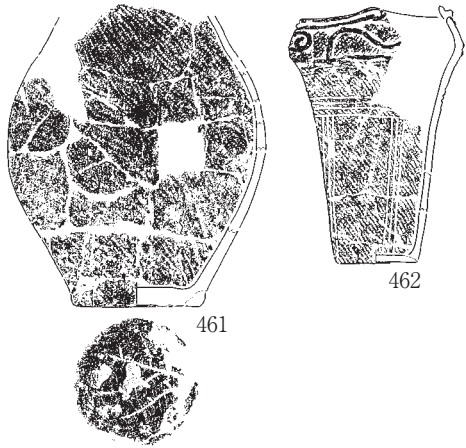

S I 60 (2)

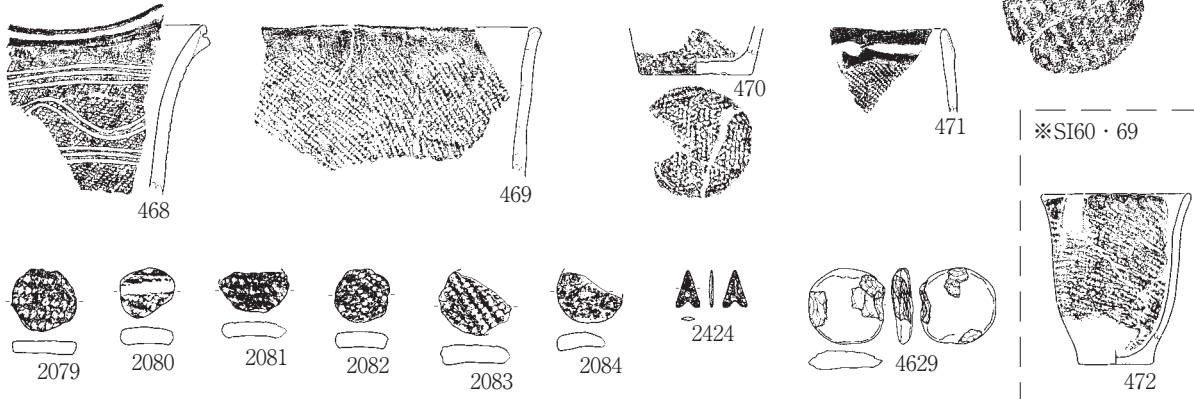
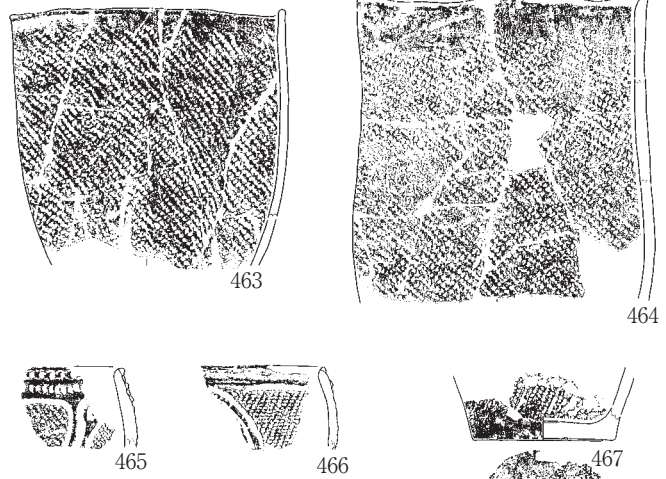

※SI60・69

S I 61 (1)

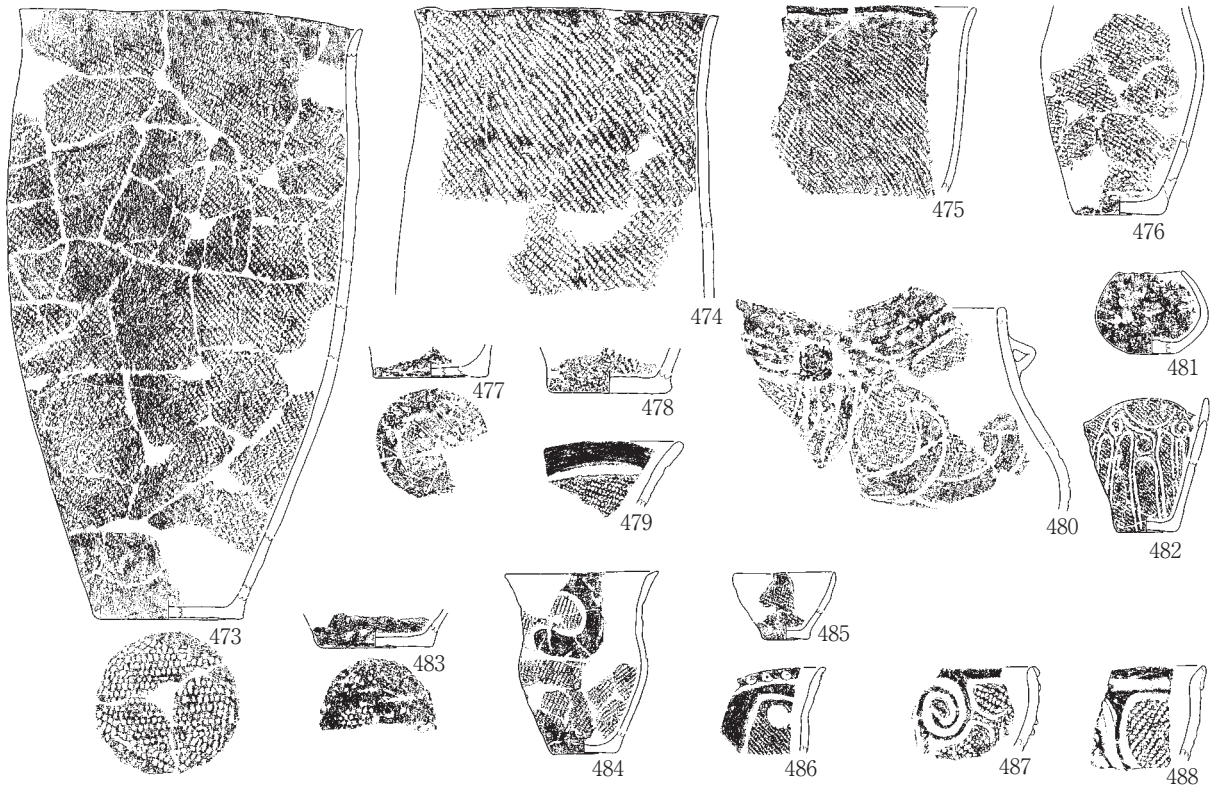

縄文土器：1/6 土製品：1/4  
剥片石器：1/4 礫石器：1/6

第519図 遺構別出土遺物集成図：S I 60 (2)・61 (1)

S I 61 (2)

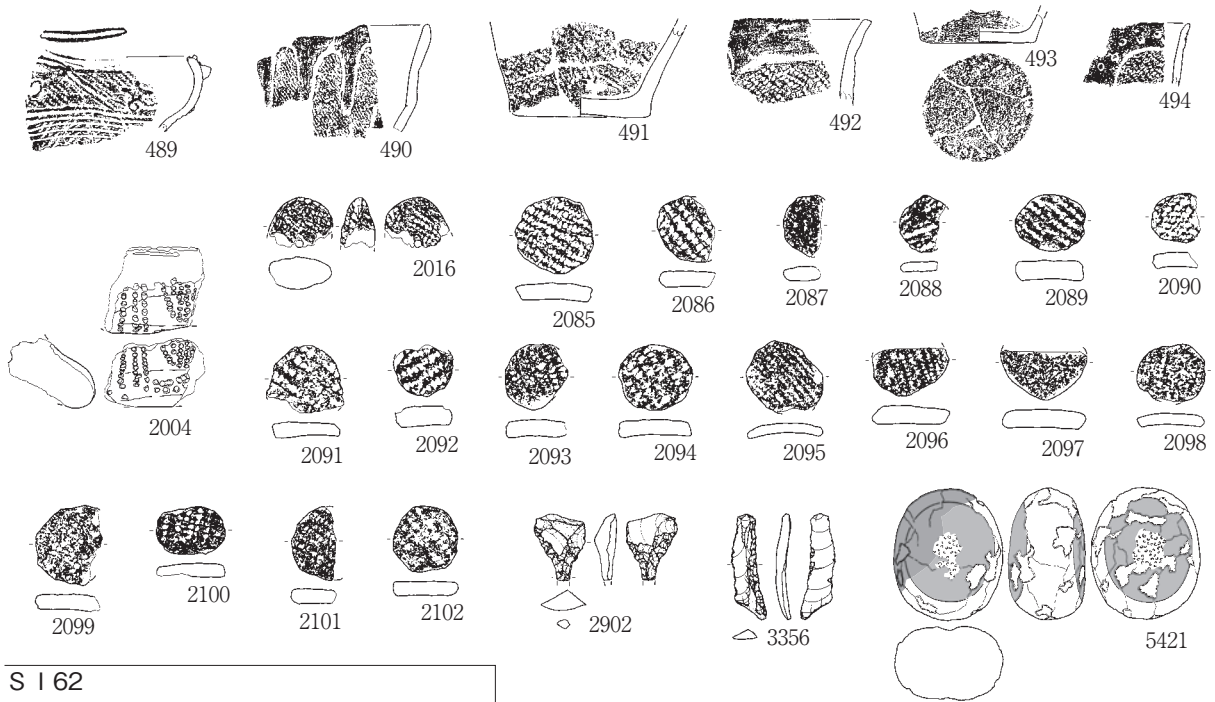

S I 62

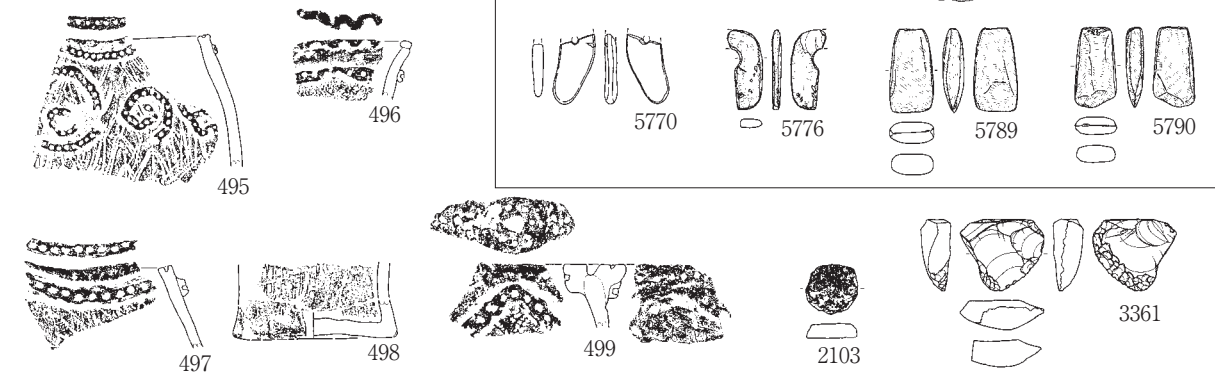

S I 64 (1)

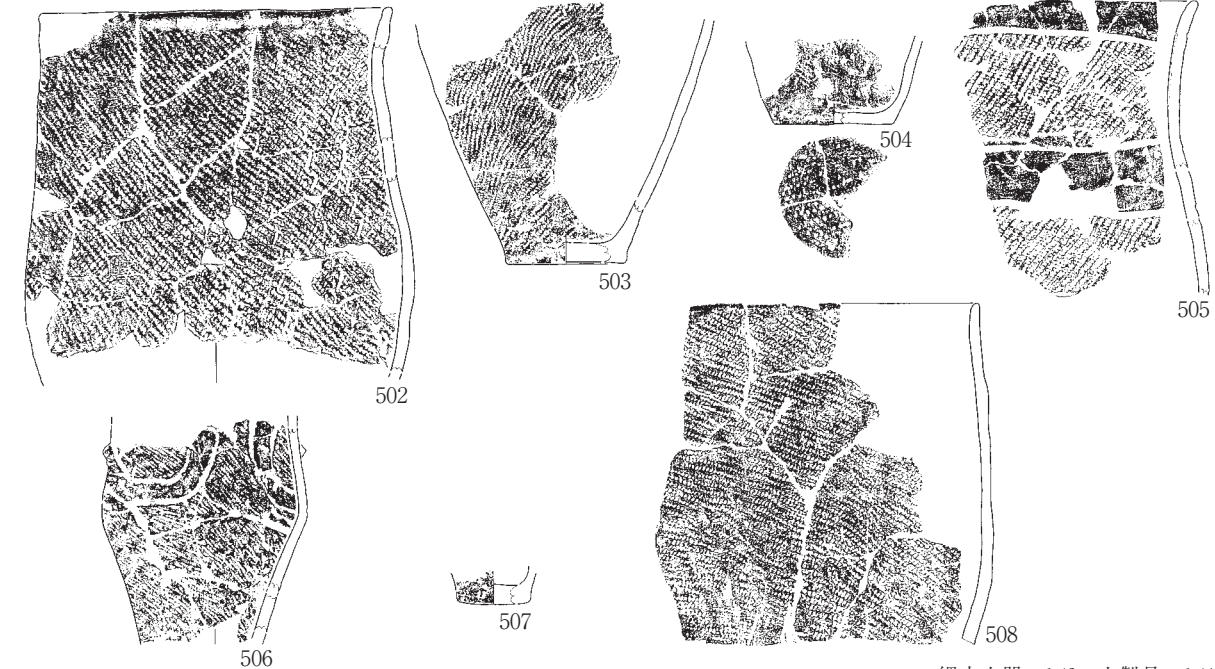

縄文土器：1/6 土製品：1/4  
剥片石器：1/4 礫石器：1/6

第520図 遺構別出土遺物集成図：S I 61 (2)・62・64 (1)



S I 64 (2)

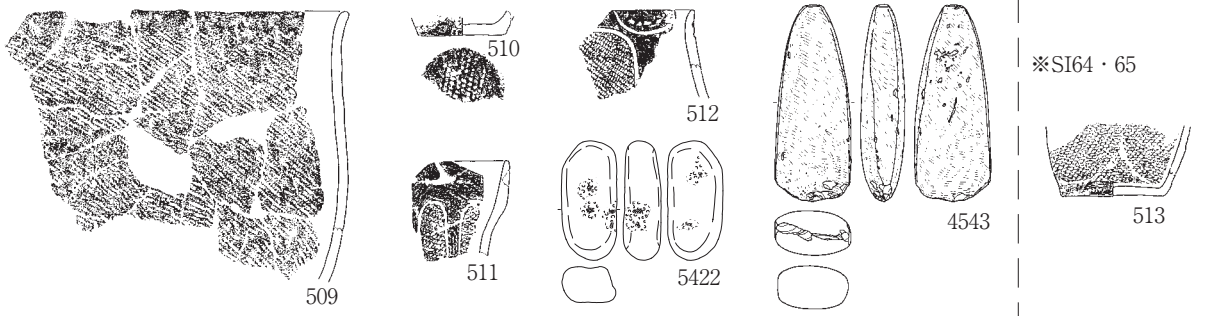

S I 65

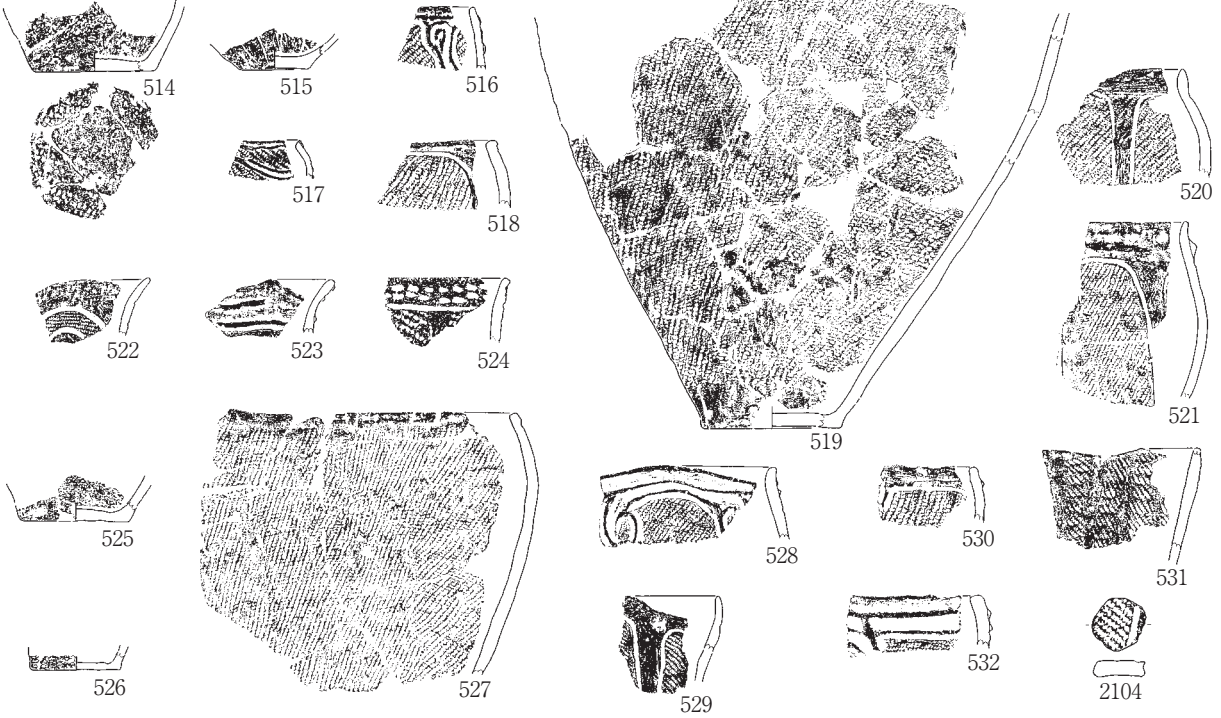

S I 66

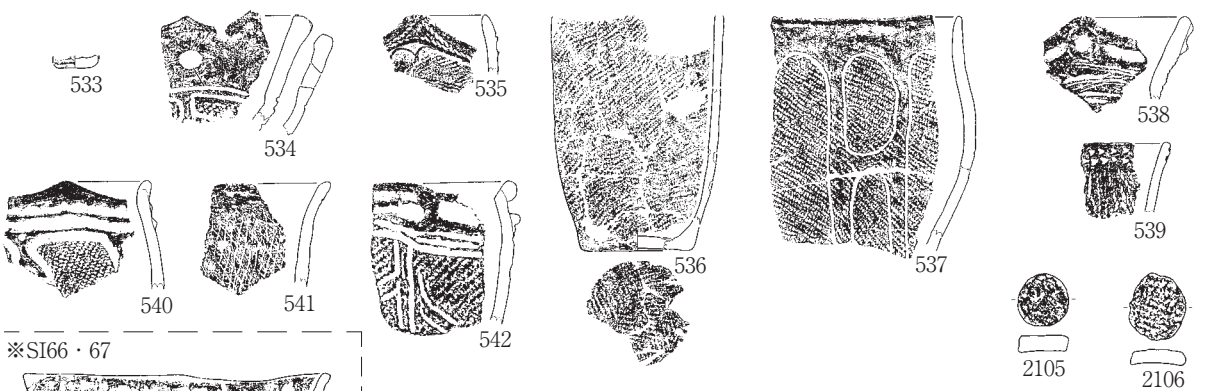

S I 67

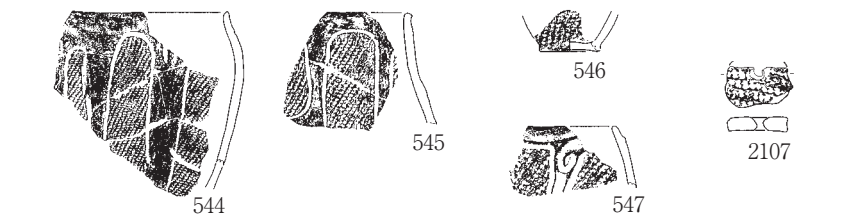

縄文土器：1/6 土製品：1/4  
剥片石器：1/4 礫石器：1/6

第521図 遺構別出土遺物集成図：S I 64 (2)・65・66・67

S I 68

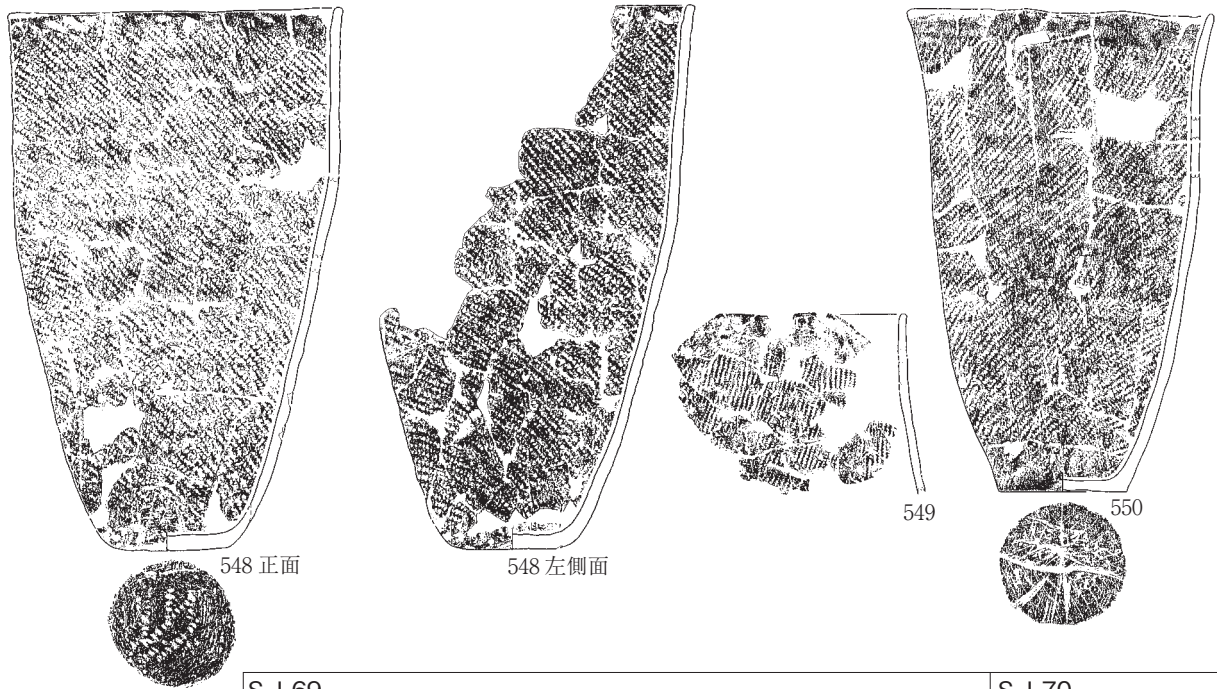

S I 69

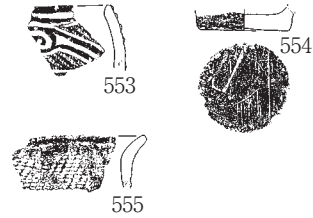
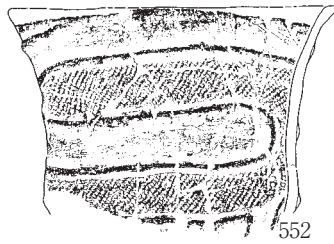

S I 70



S I 71 (1)

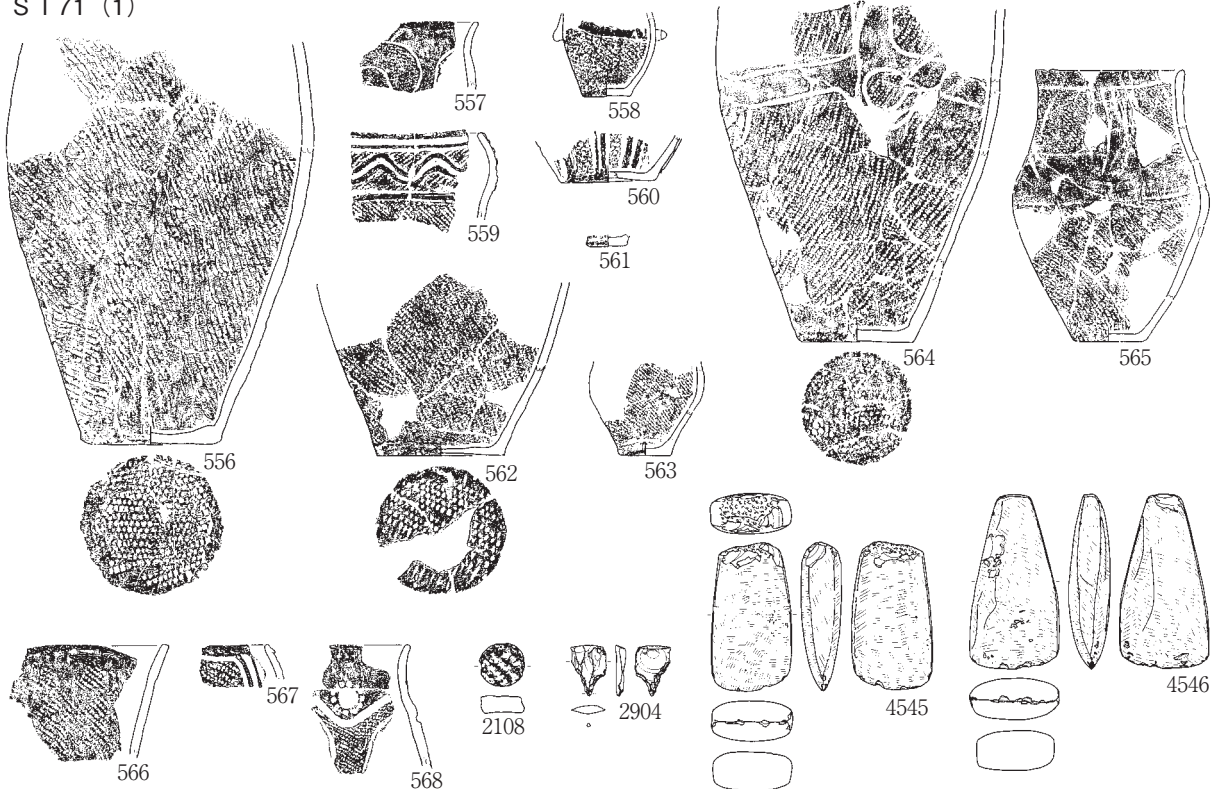

繩文土器：1/6 土製品：1/4  
剥片石器：1/4 礫石器：1/6

第522図 遺構別出土遺物集成図：S I 68・69・70・71 (1)

S 171 (2)

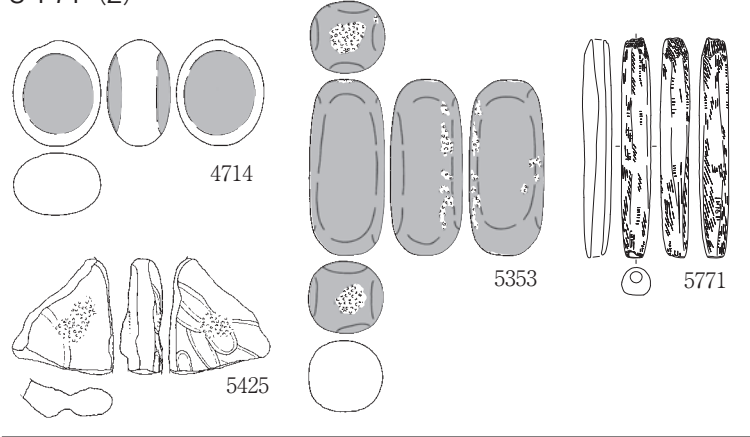

S 172

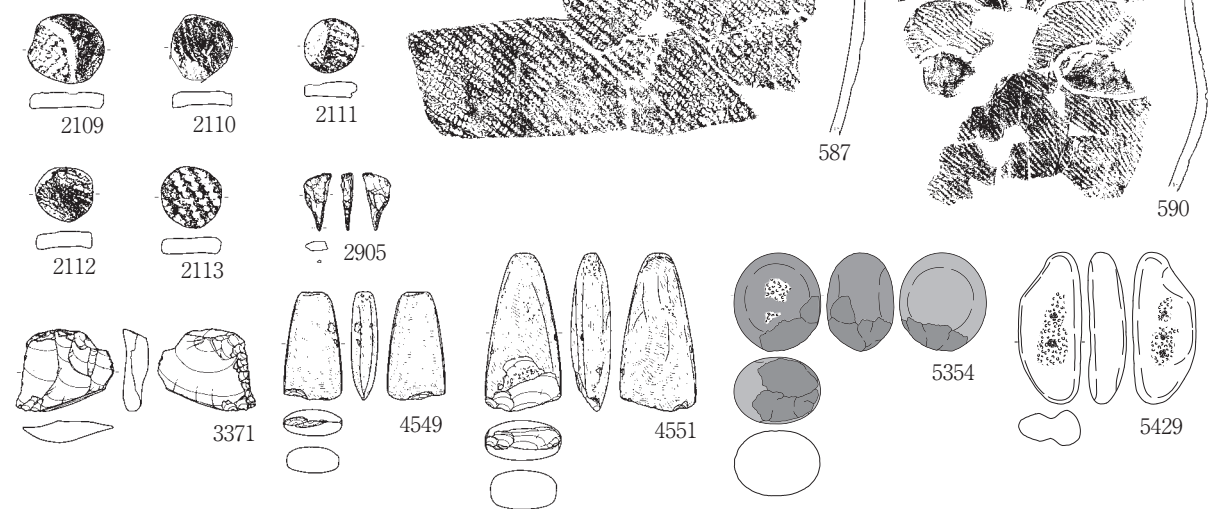
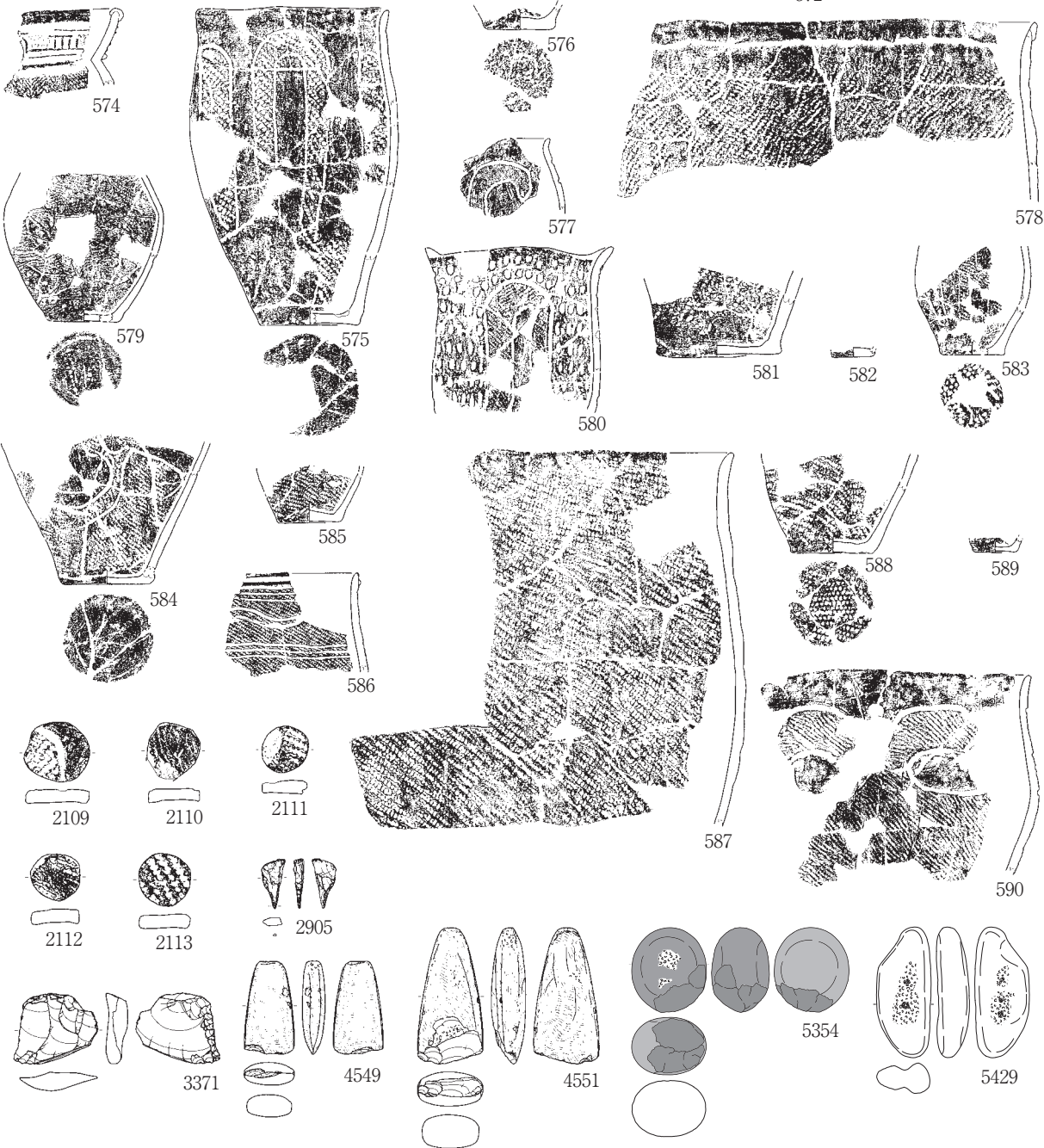
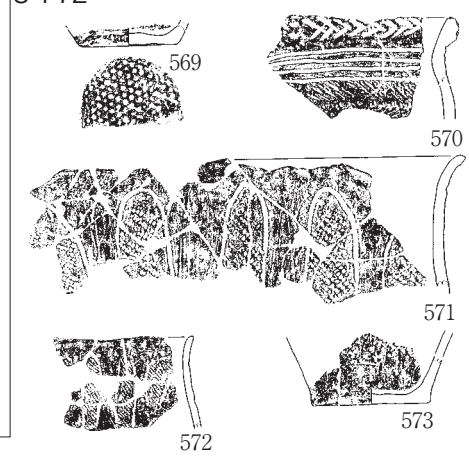

第523図 遺構別出土遺物集成図：S 171 (2)・72

縄文土器：1/6 土製品：1/4  
剥片石器：1/4 礫石器：1/6

※SI72・73

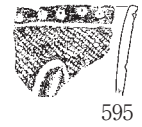
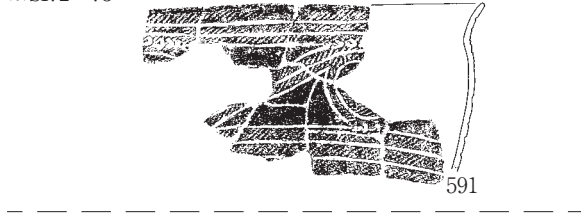

S I 73

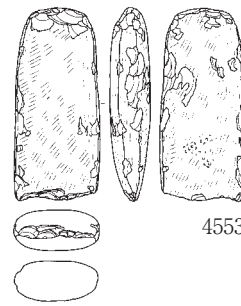
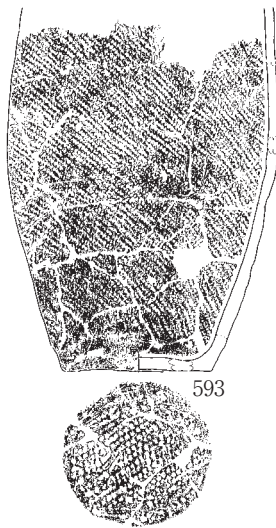
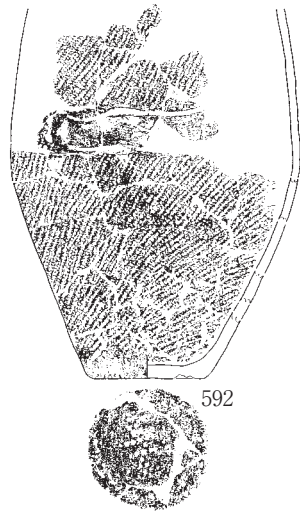

※SI73・III C9f

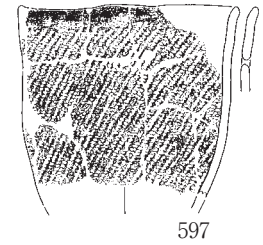

S I 75 (1)

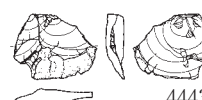
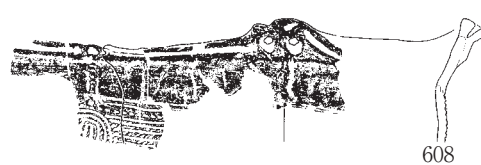
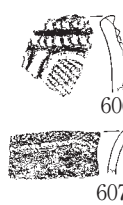
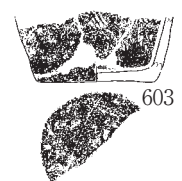
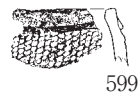
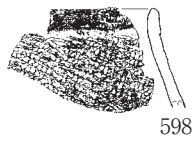

※SI52・75

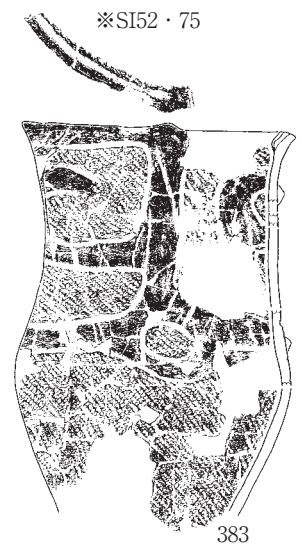

縄文土器：1/6 土製品：1/4  
剥片石器：1/4 礫石器：1/6

第524図 遺構別出土遺物集成図：S I 73・75 (1)

S I 75 (2)

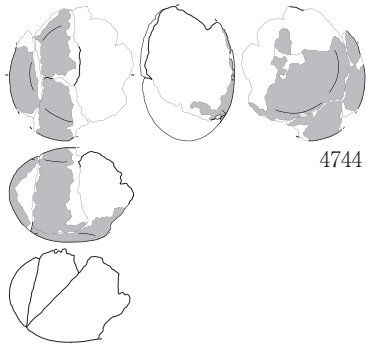

4744

4745

S I 76

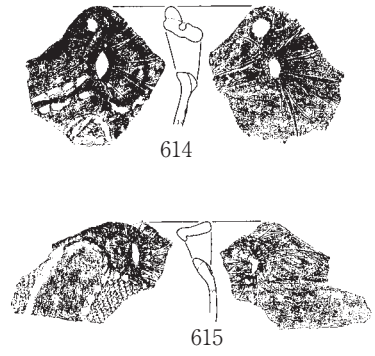

614

615

S I 77

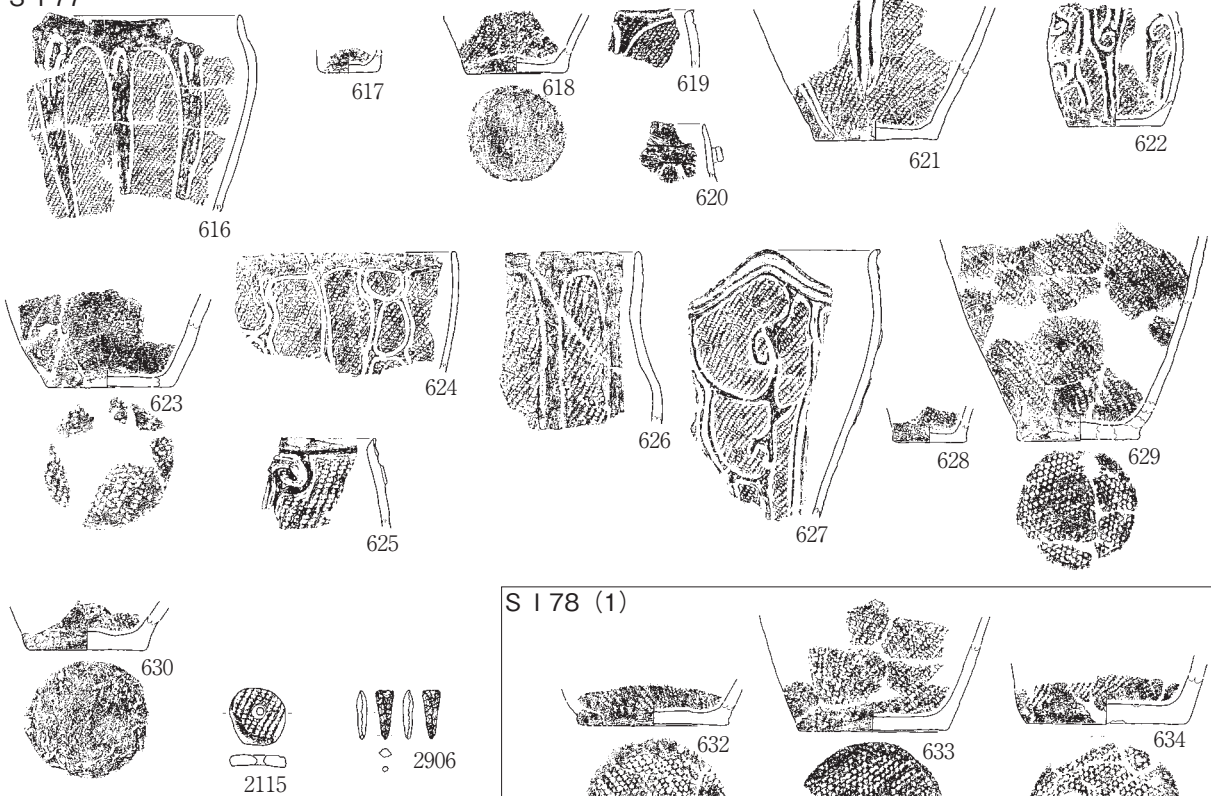

616

617

618

619

621

622

623

624

626

627

628

629

625

630

2115

2906

※SI77・IVC1d

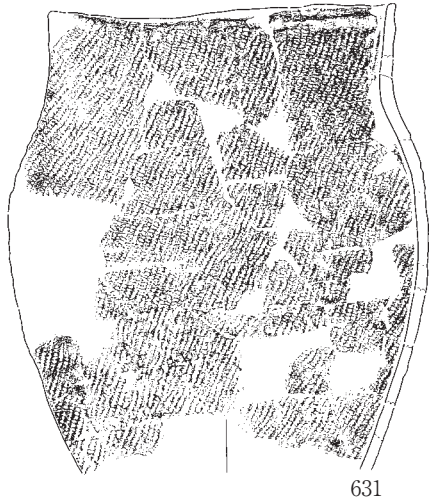

631

S I 78 (1)

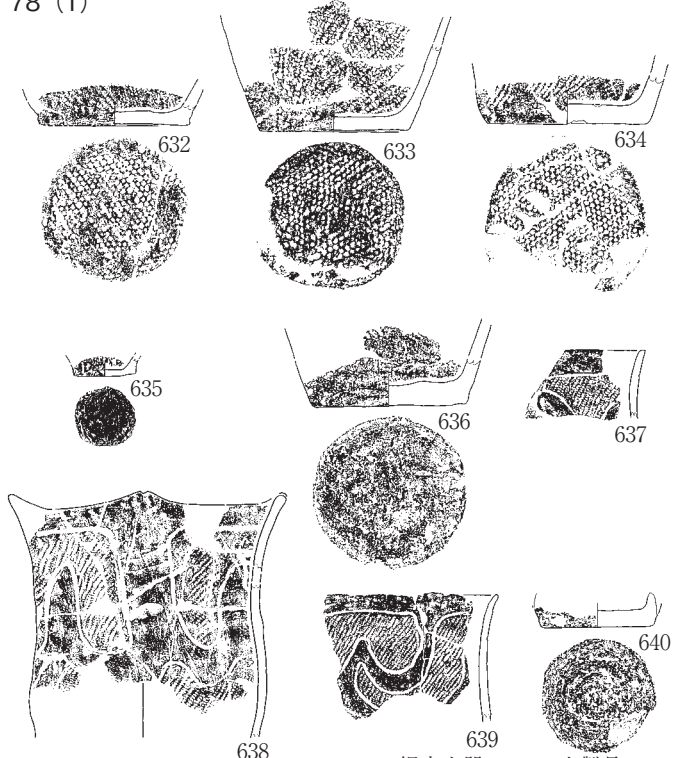

632

633

634

635

636

637

638

639

640

縄文土器：1/6 土製品：1/4  
剥片石器：1/4 礫石器：1/6

第525図 遺構別出土遺物集成図：S I 75 (2)・76・77・78 (1)

S I 78 (2)

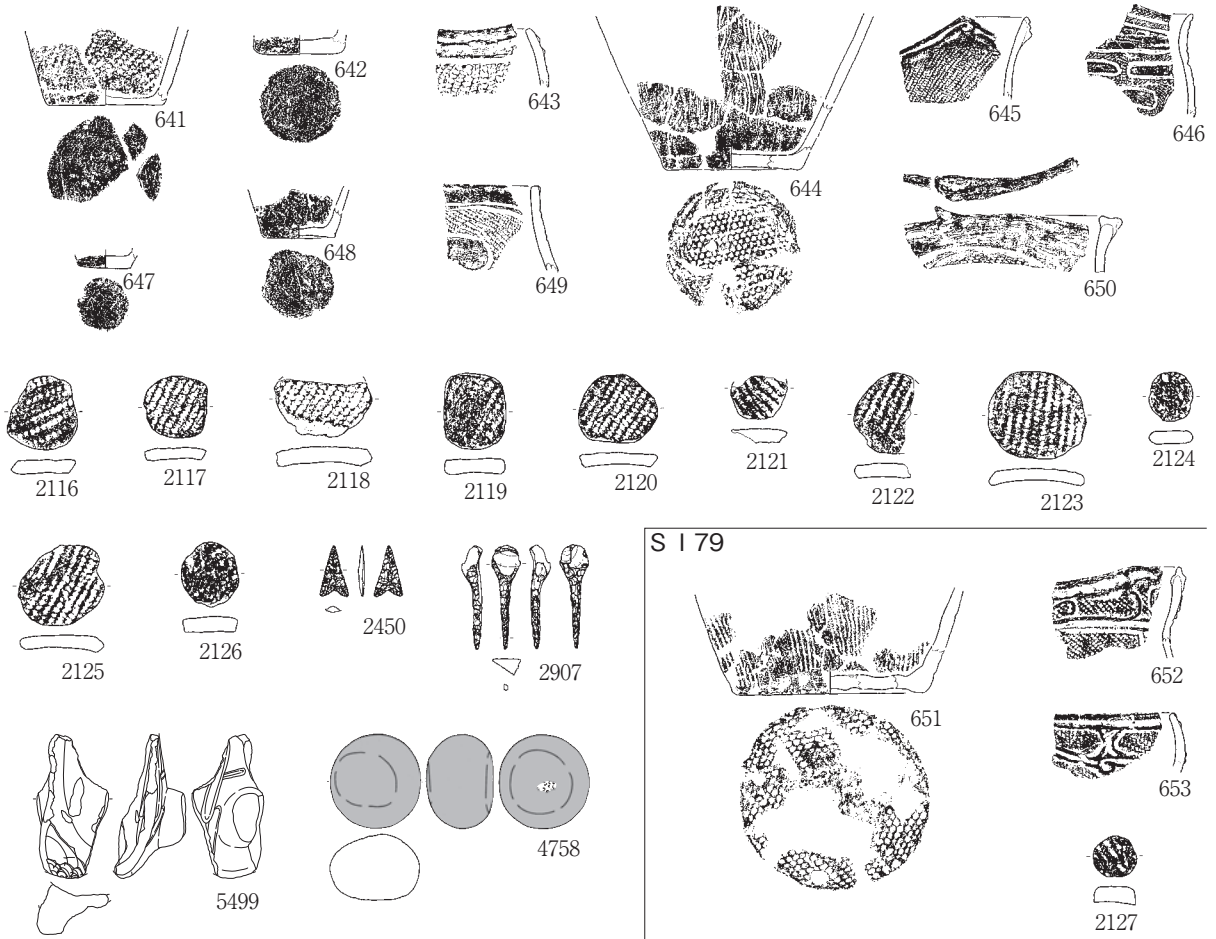

S I 80 (1)

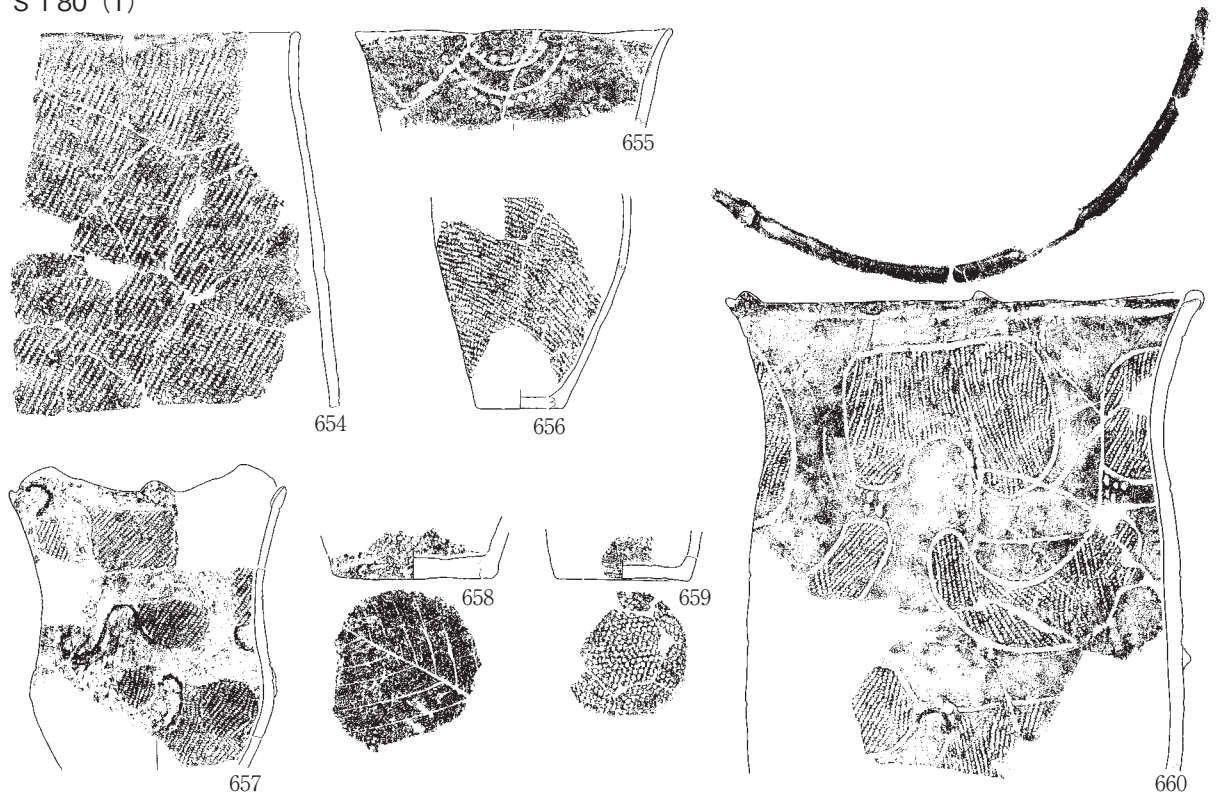

縄文土器：1/6 土製品：1/4  
剥片石器：1/4 礫石器：1/6

第526図 遺構別出土遺物集成図：S I 78 (2)・79・80 (1)

S I 80 (2)

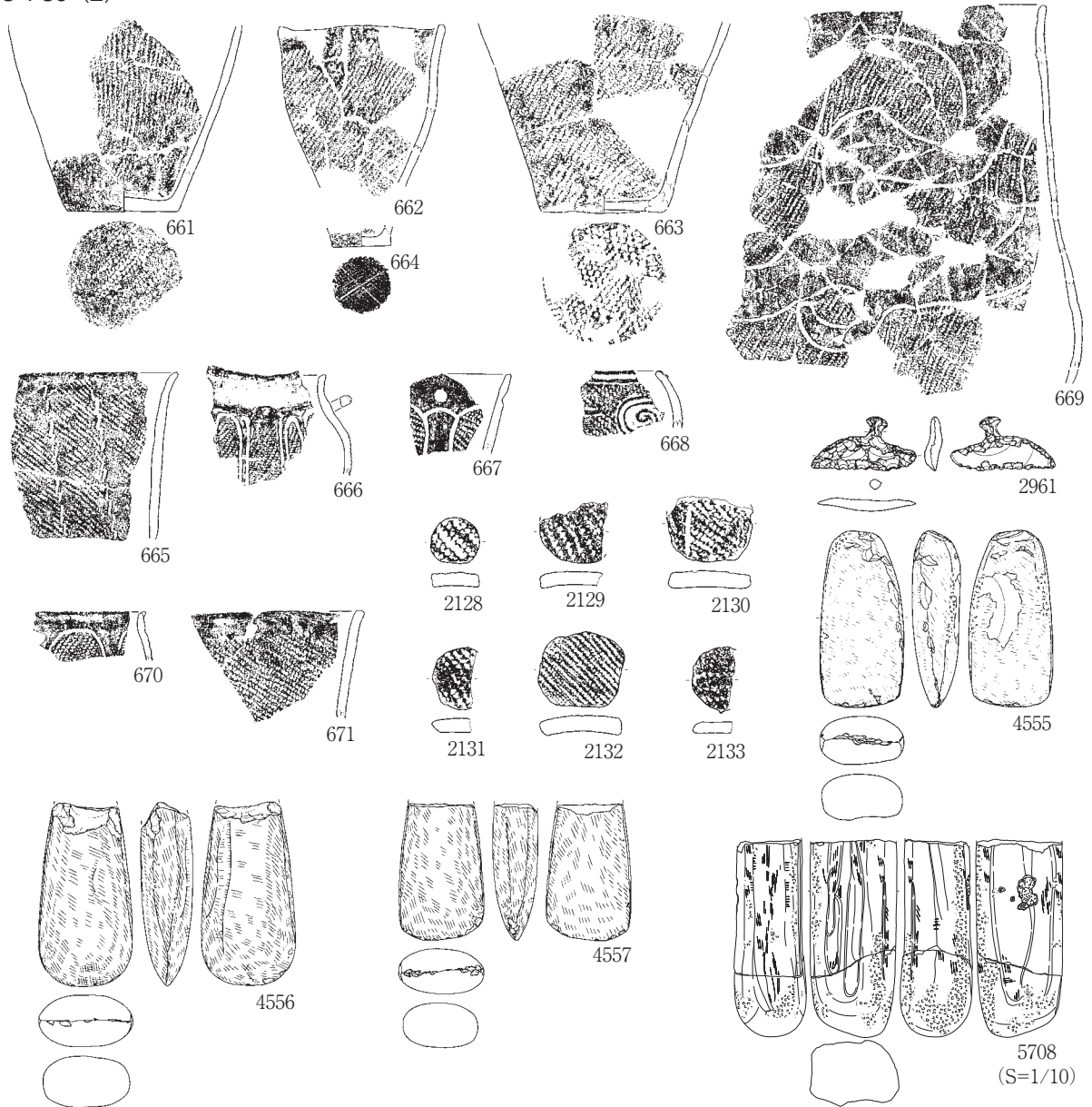

S I 81

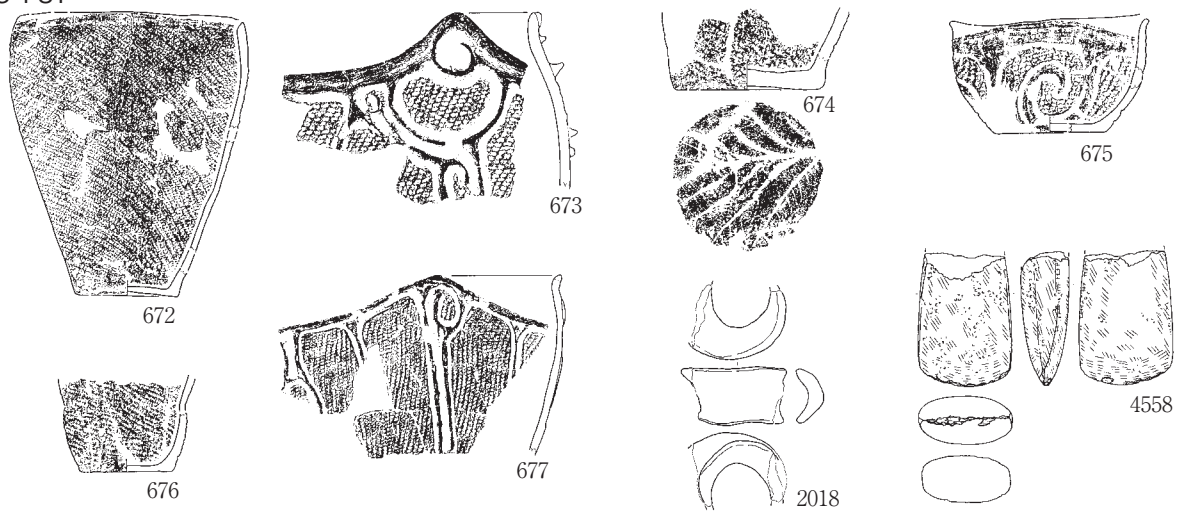

第527図 遺構別出土遺物集成図：S I 80 (2)・81

縄文土器：1/6 土製品：1/4  
剥片石器：1/4 礫石器：1/6

S I 82

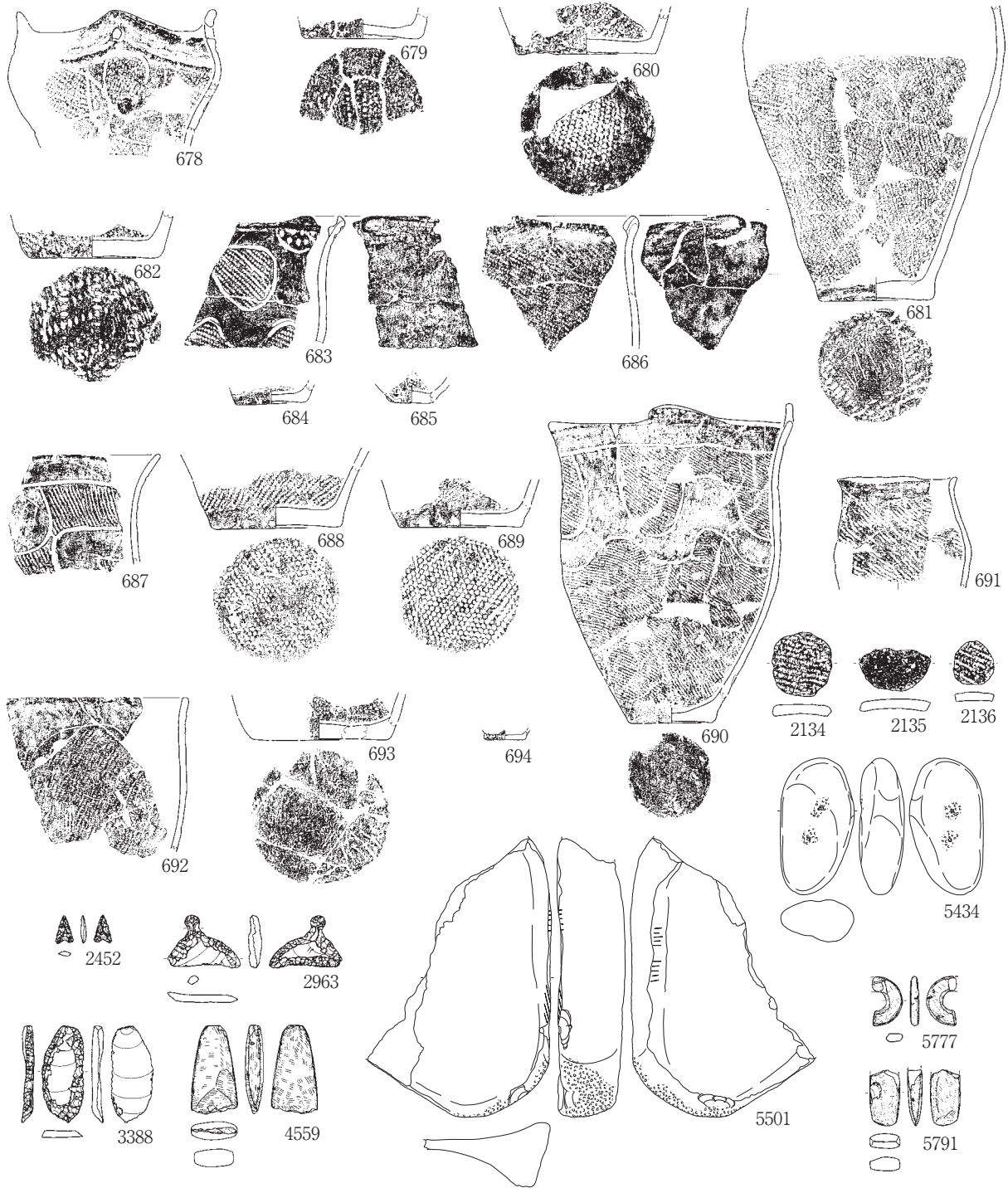

S I 83

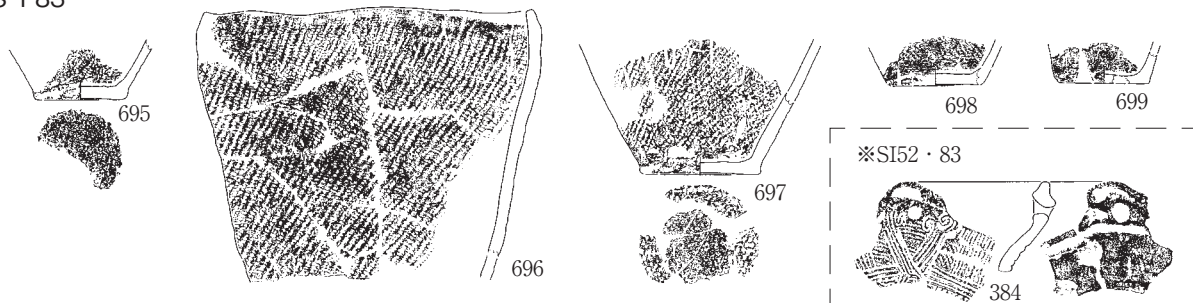

※SI52・83  
384

第528図 遺構別出土遺物集成図：S I 82・83

縄文土器：1/6 土製品：1/4  
剥片石器：1/4 礫石器：1/6



S 184

S 186

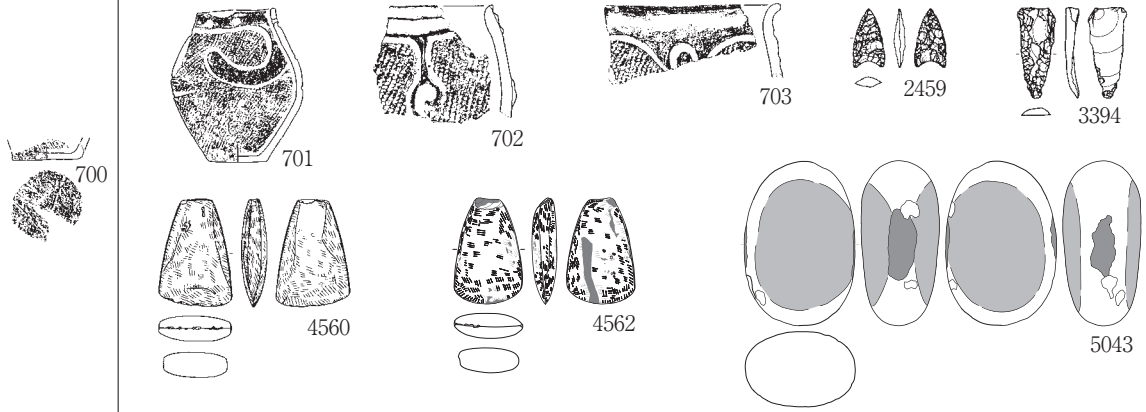

S 188 (1)

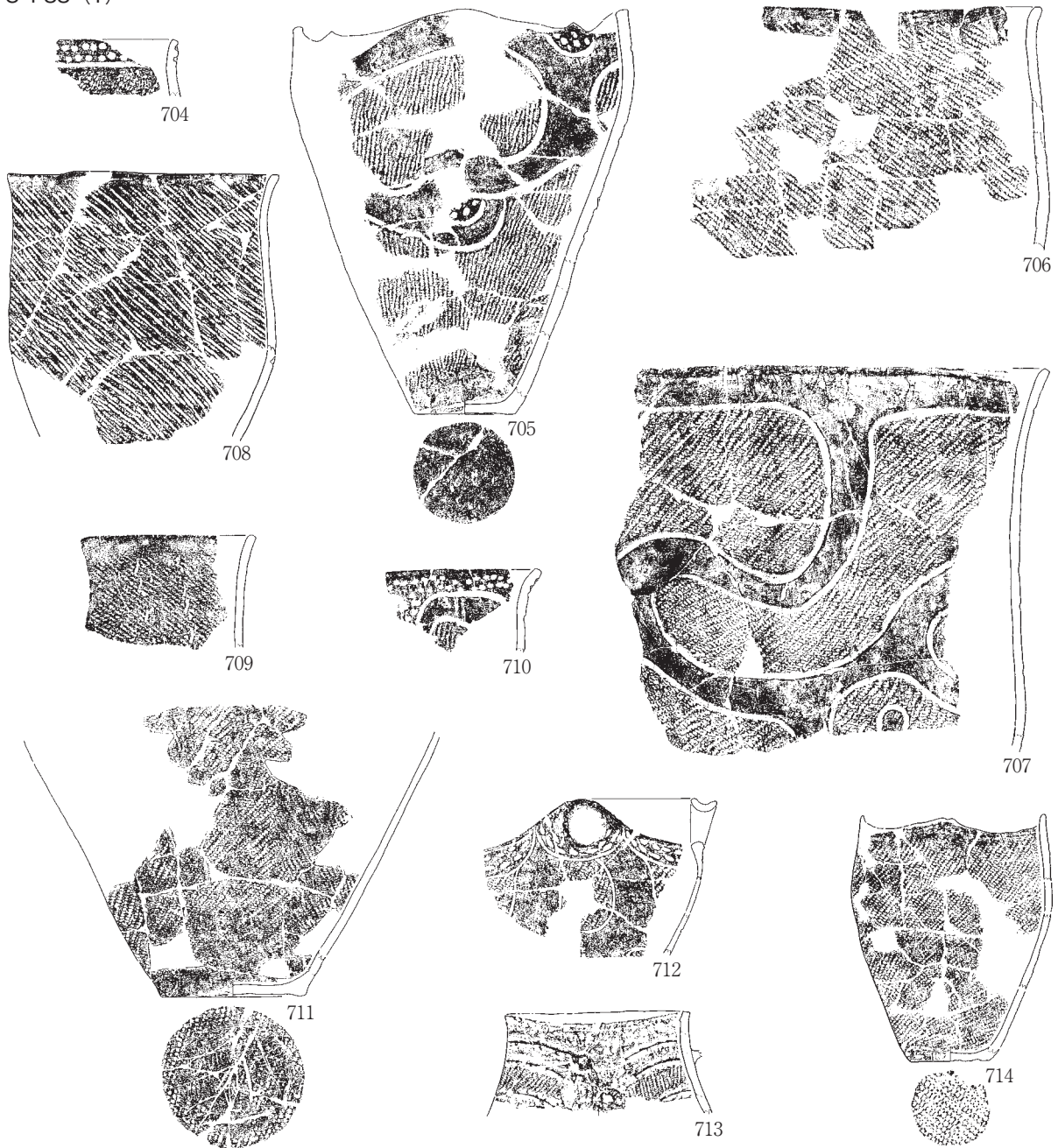

繩文土器：1/6 土製品：1/4  
 剥片石器：1/4 礫石器：1/6

第529図 遺構別出土遺物集成図：S 184・86・88 (1)

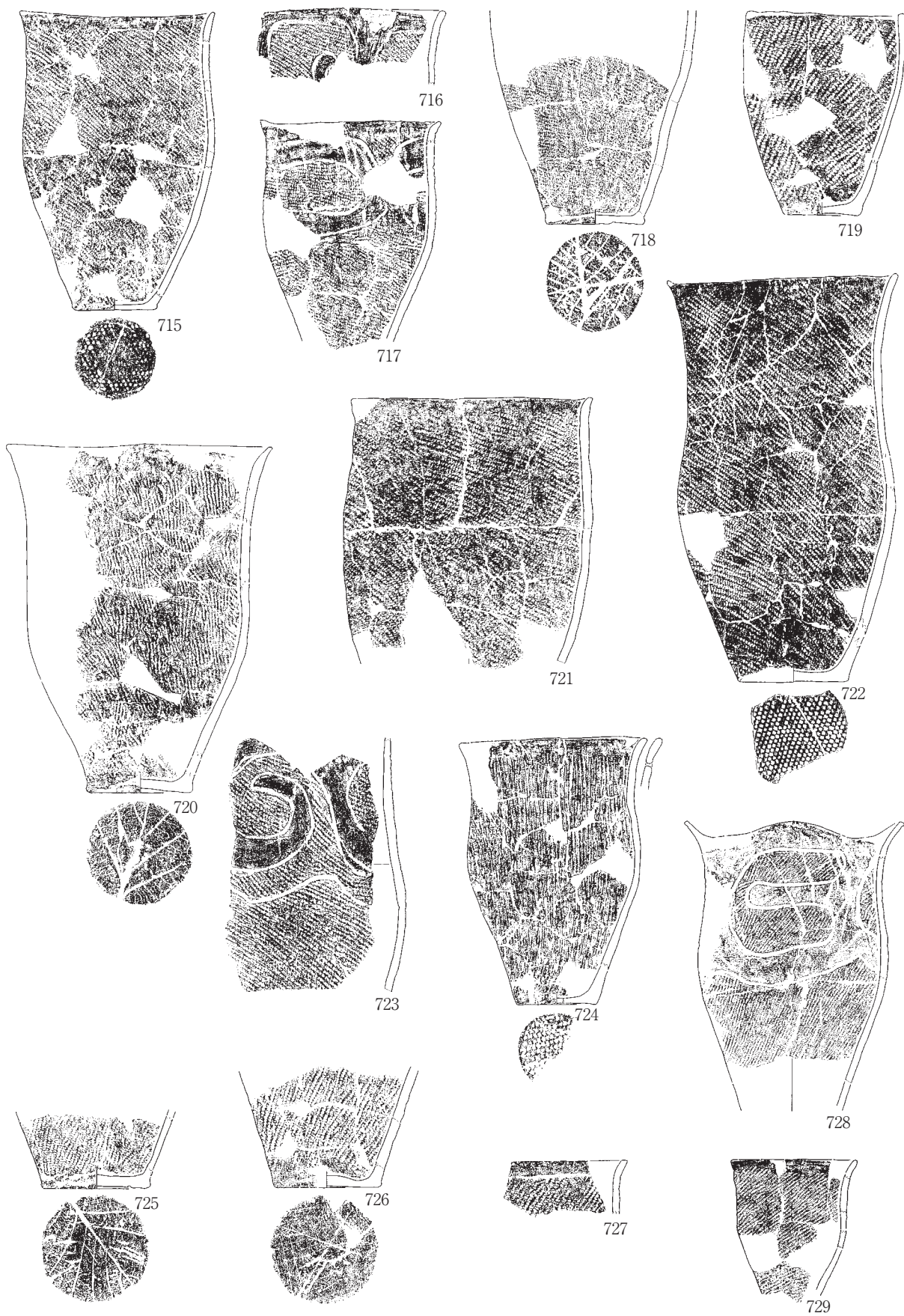

第530図 遺構別出土遺物集成図：S 188 (2)

縄文土器：1/6 土製品：1/4  
剥片石器：1/4 礫石器：1/6

S I 88 (3)

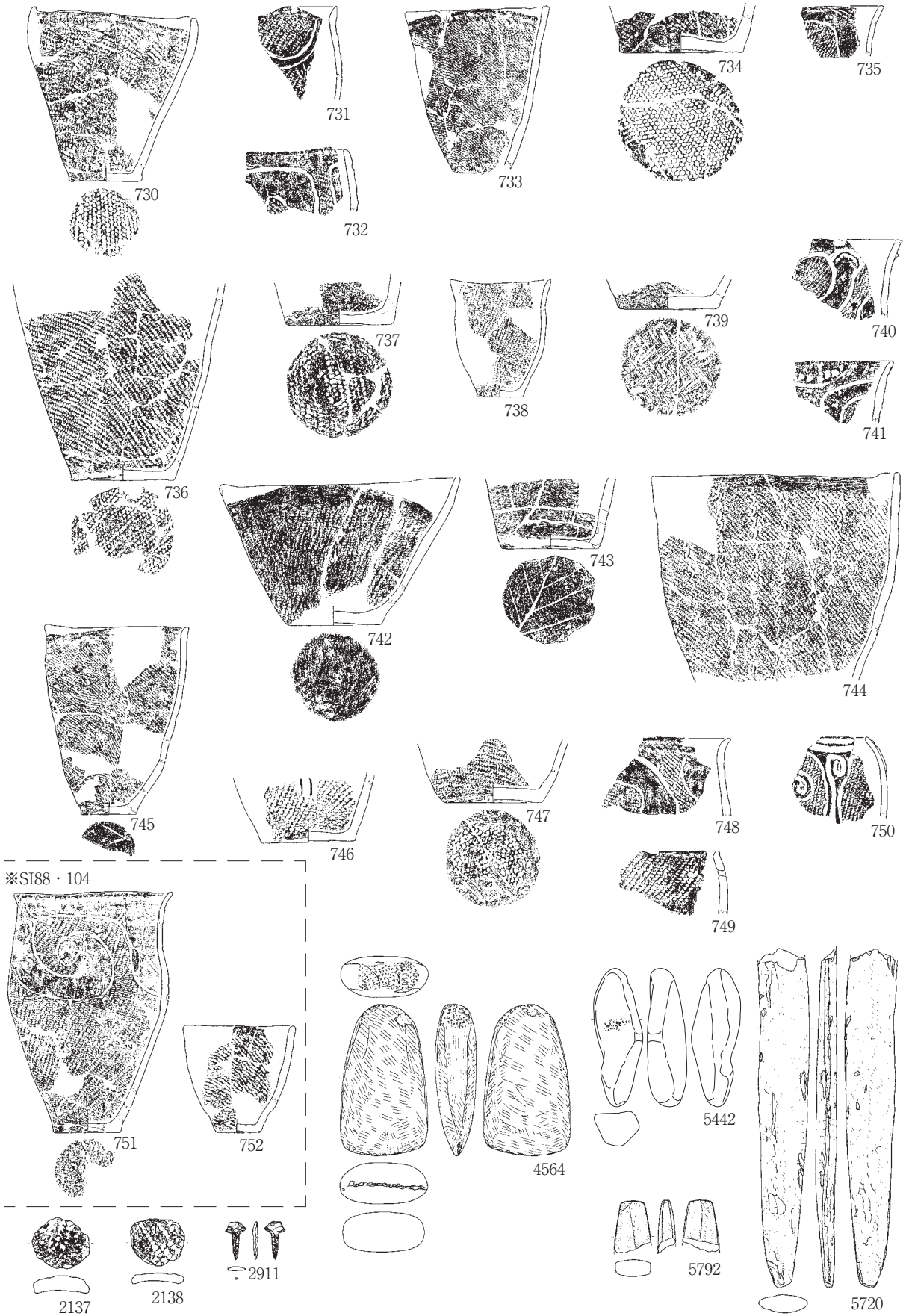

※SI88・104

第531図 遺構別出土遺物集成図：S I 88 (3)

縄文土器：1/6 土製品：1/4  
剥片石器：1/4 礫石器：1/6

S | 89

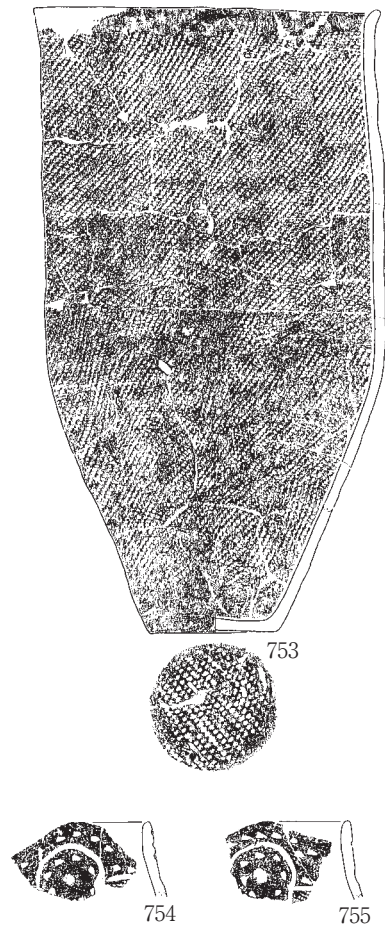

※SI89・93

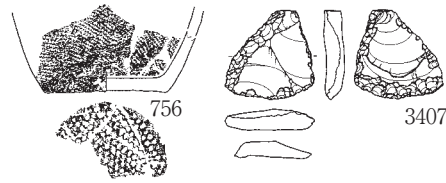

S | 90

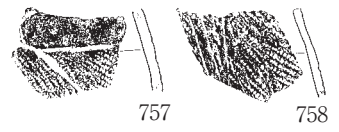

S | 91

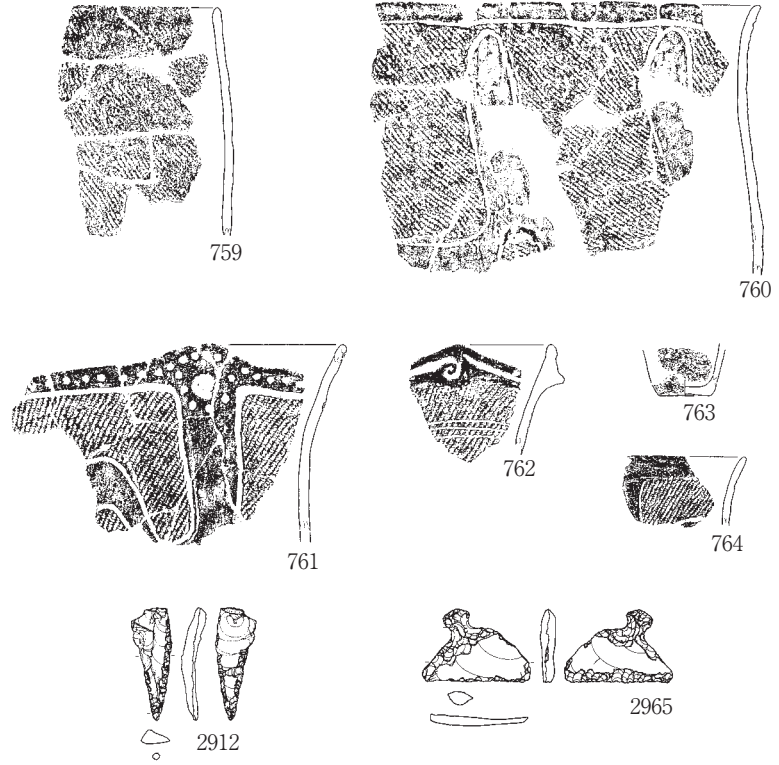

S | 92

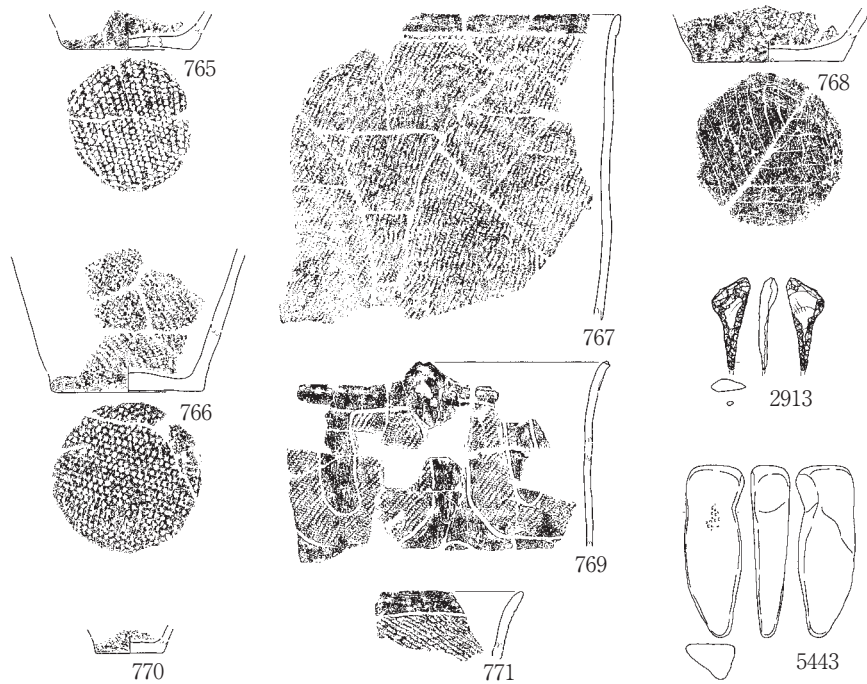

S | 93

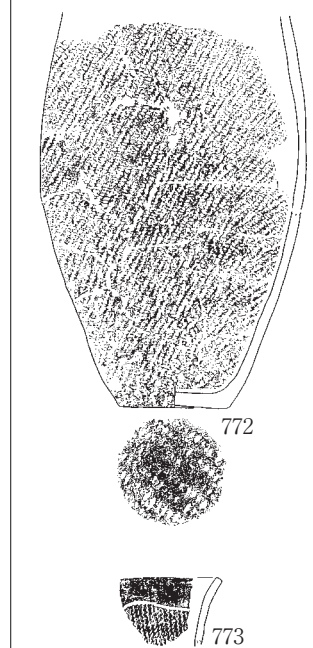

縄文土器：1/6 土製品：1/4  
剥片石器：1/4 礫石器：1/6

第532図 遺構別出土遺物集成図：S | 89・90・91・92・93

S | 94



774



776



777

S | 95

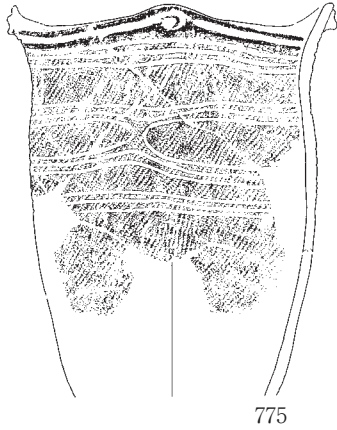

775

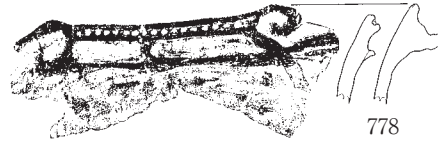

778



779

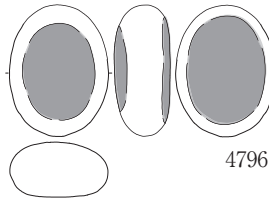

4796

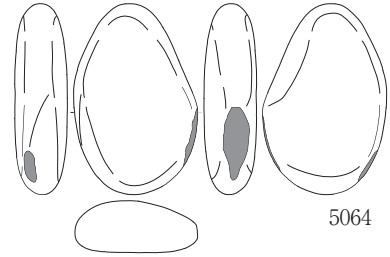

5064

S | 96

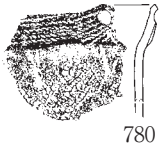

780



2967

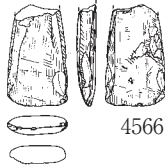

4566

S | 97

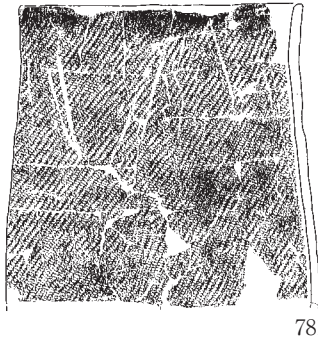

781



782

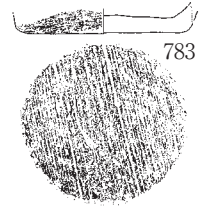

783



784



5505

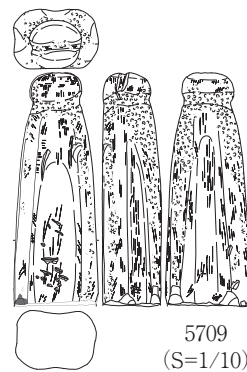

5709  
(S=1/10)

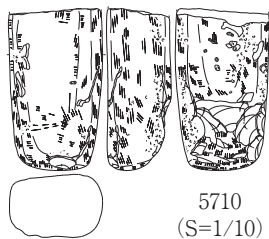

5710  
(S=1/10)

S | 98



785

繩文土器：1/6 土製品：1/4  
剥片石器：1/4 礫石器：1/6

第533図 遺構別出土遺物集成図：S | 94・95・96・97・98

S I 99

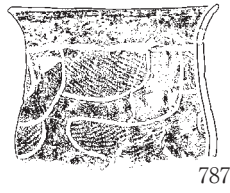
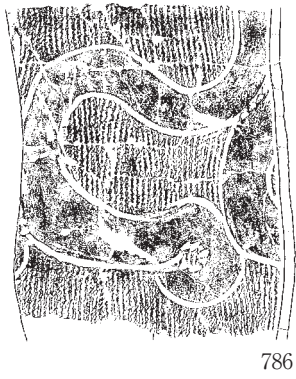

※SI99・101

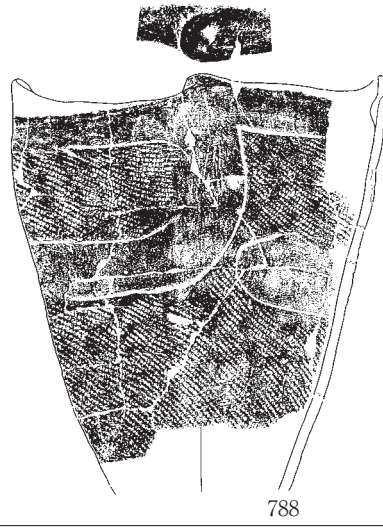

S I 100



S I 101 (1)

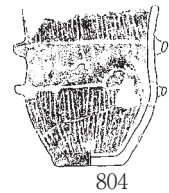
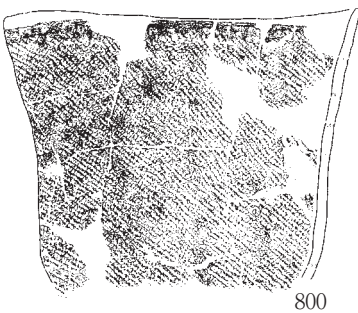
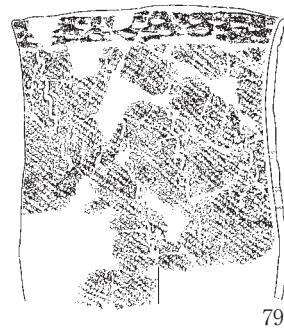
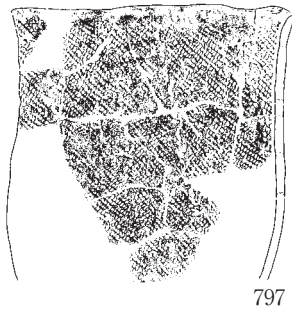
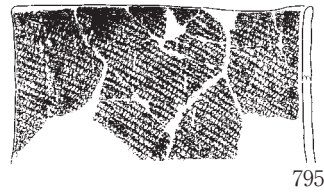
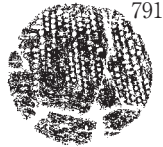
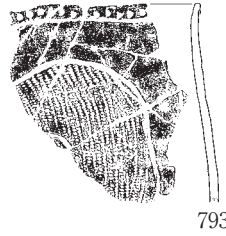

縄文土器：1/6 土製品：1/4  
剥片石器：1/4 礫石器：1/6

第534図 遺構別出土遺物集成図：S I 99・100・101 (1)

S I 101 (2)

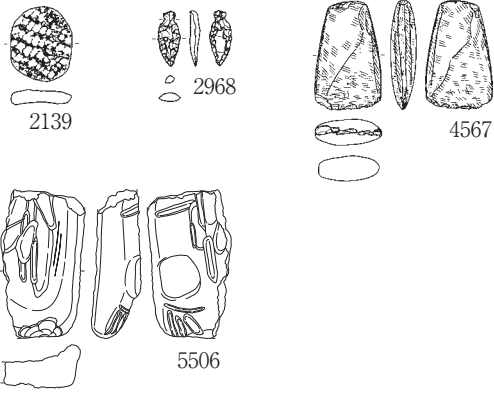

S I 102

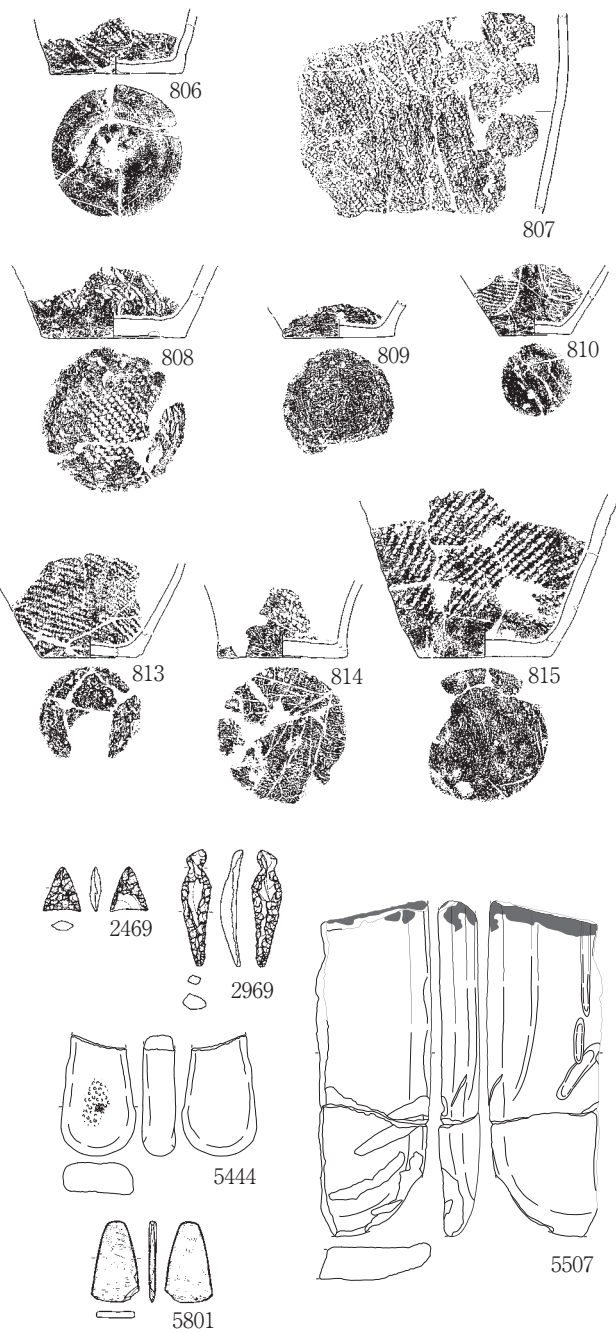

S I 103

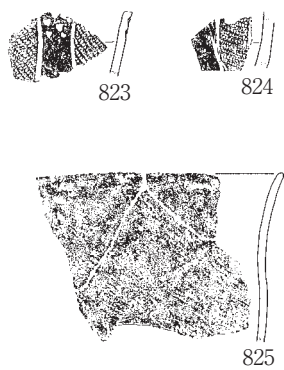

S I 104 (1)

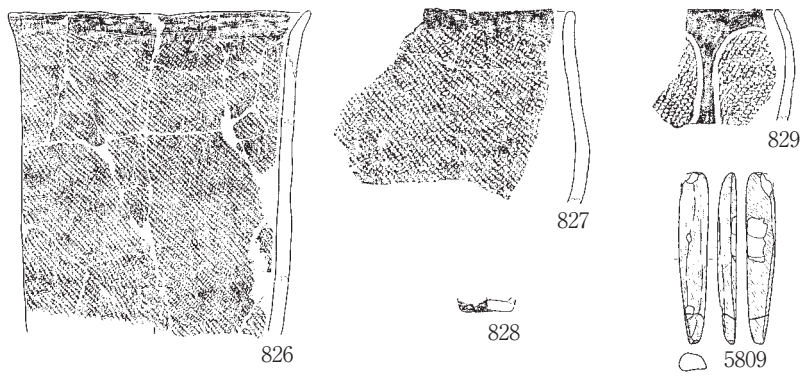

縄文土器：1/6 土製品：1/4  
剥片石器：1/4 礫石器：1/6

第535図 遺構別出土遺物集成図：S I 101 (2)・102・103・104 (1)

S I 104 (2)

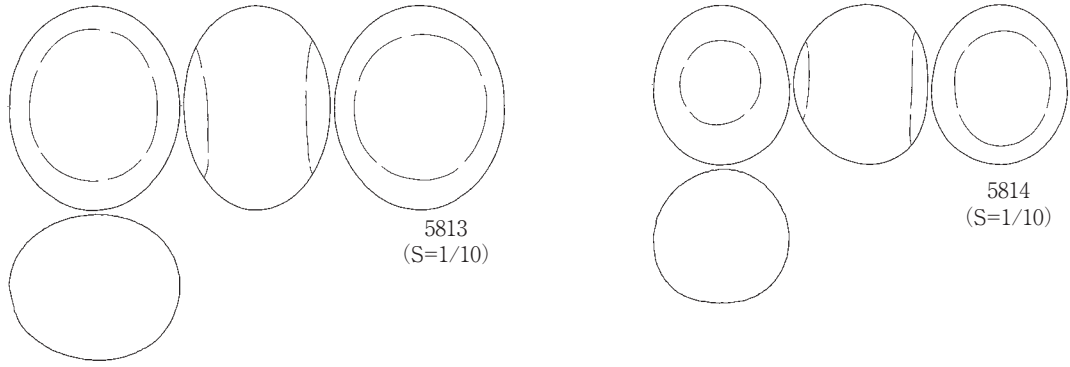

S I 106

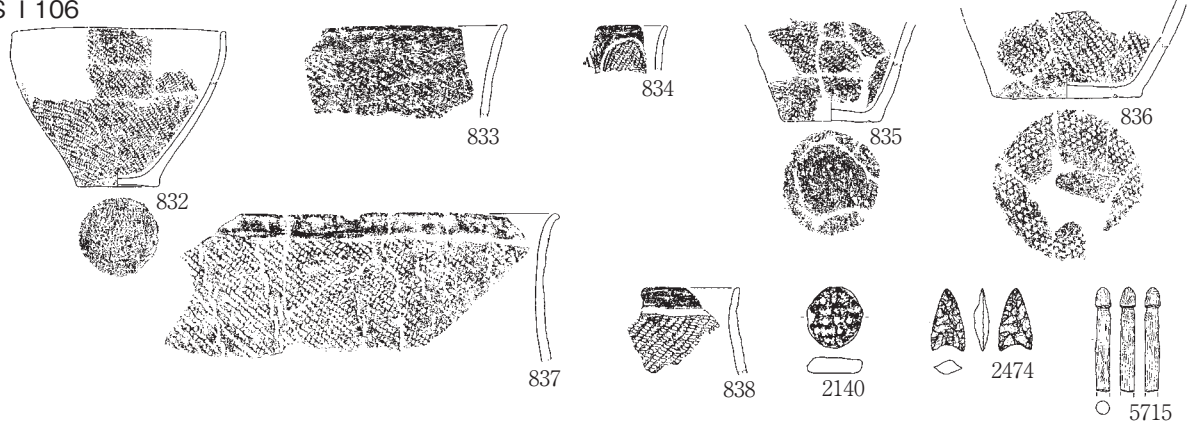

S I 107



S I 108

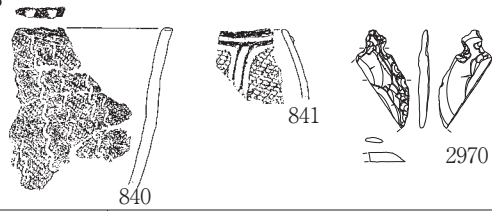

S I 109

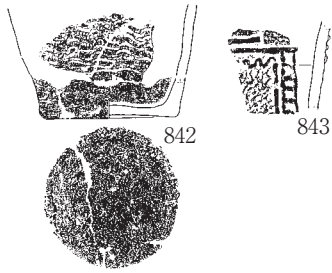

S I 110

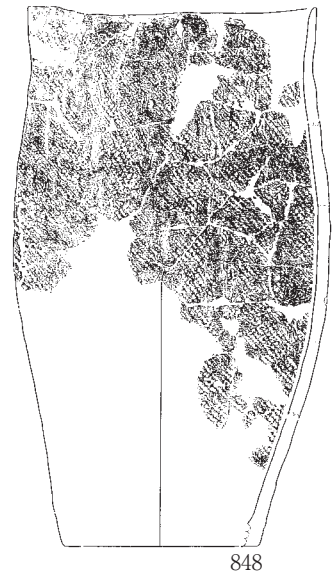
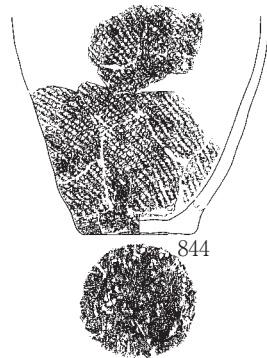

S I 111

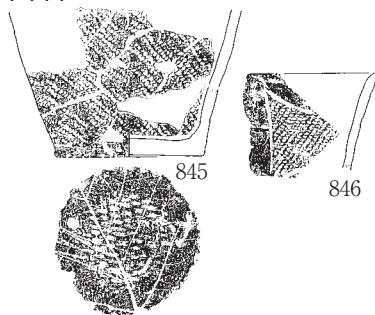

S I 112 (1)

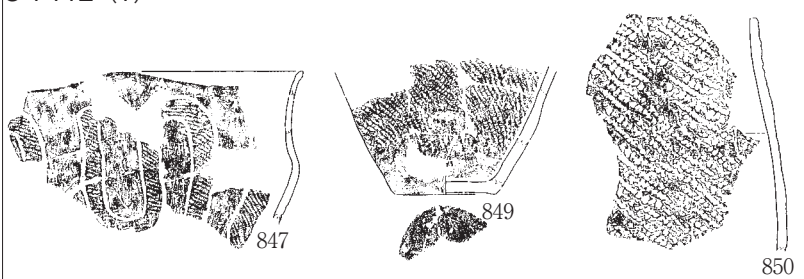

縄文土器：1/6 土製品：1/4  
剥片石器：1/4 礫石器：1/6

第536図 遺構別出土遺物集成図：S I 104 (2)・106・107・108・109・110・111・112 (1)



S I 112 (2)

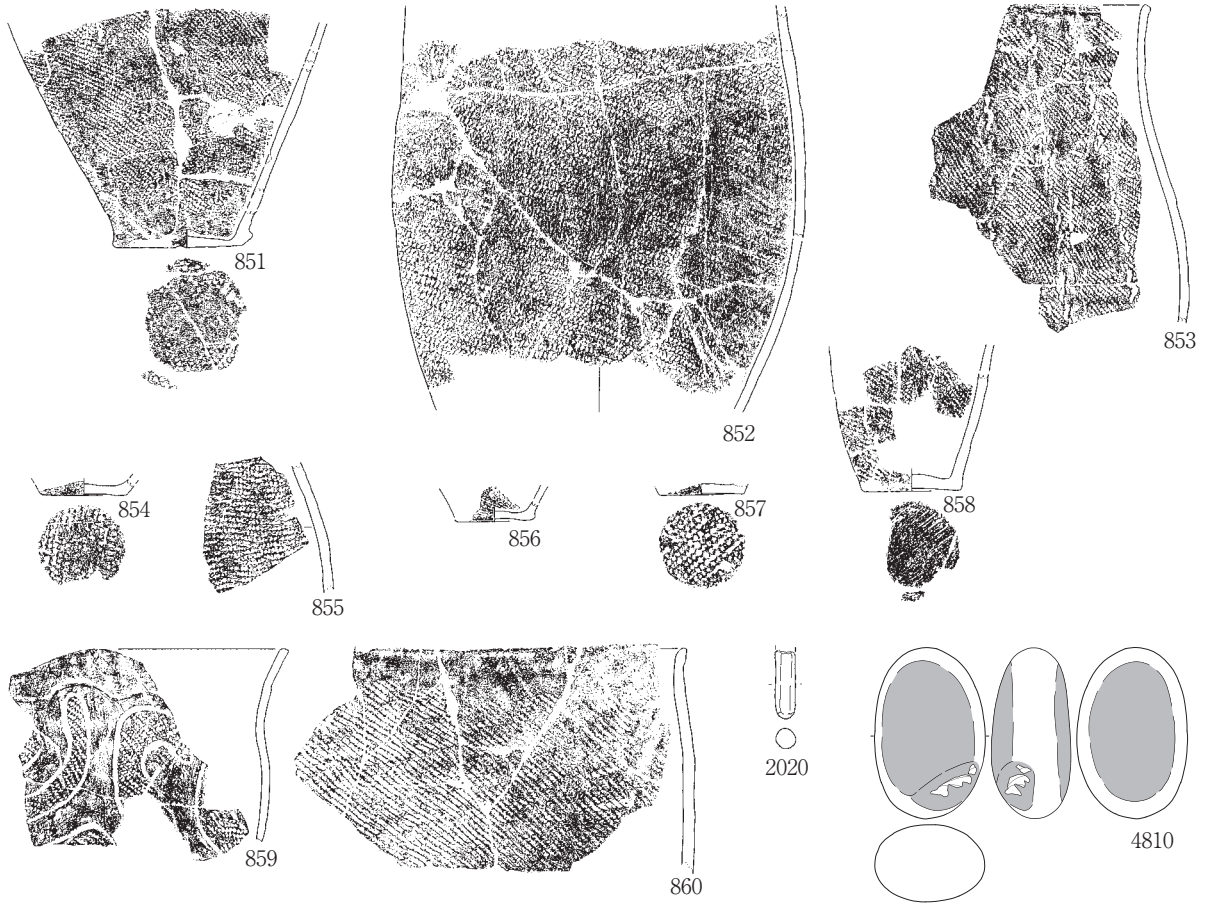

S I 113

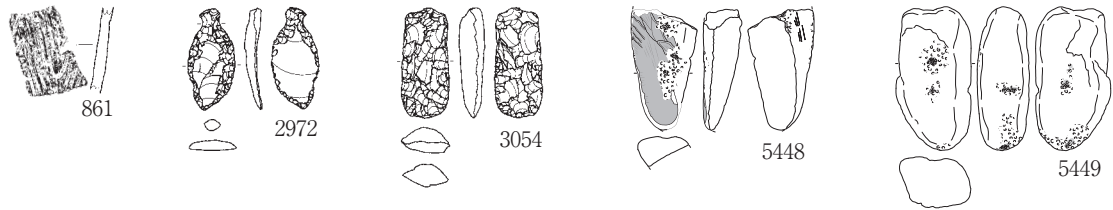

S I 114

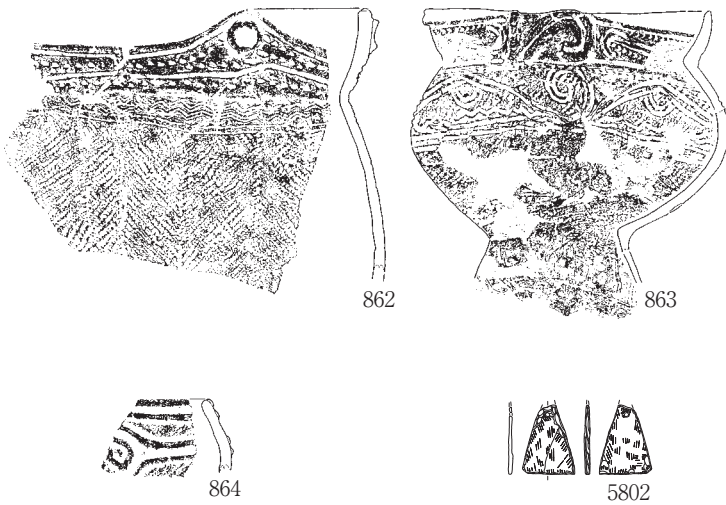

S I 115 (1)

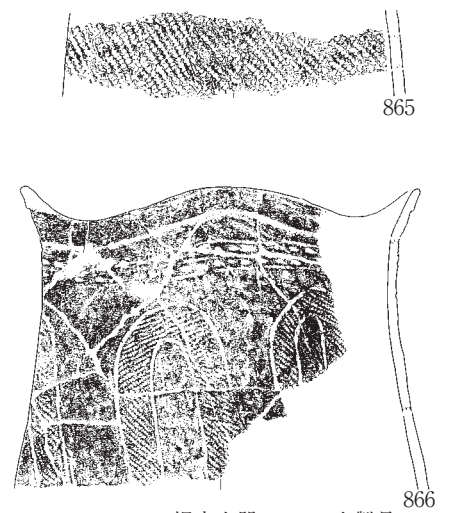

繩文土器：1/6 土製品：1/4  
剥片石器：1/4 礫石器：1/6

第537図 遺構別出土遺物集成図：S I 112 (2)・113・114・115 (1)

S I 115 (2)

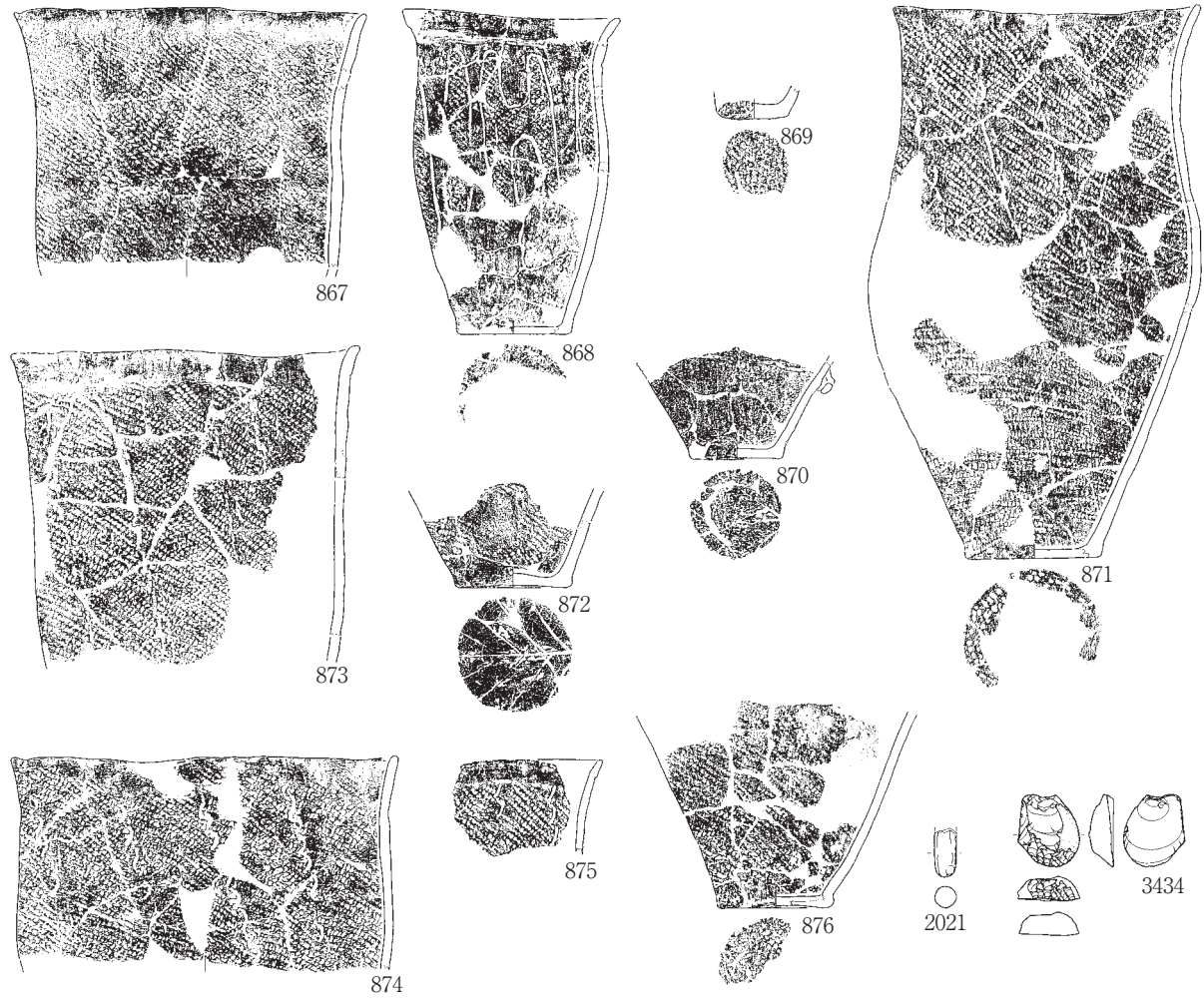

S I 116

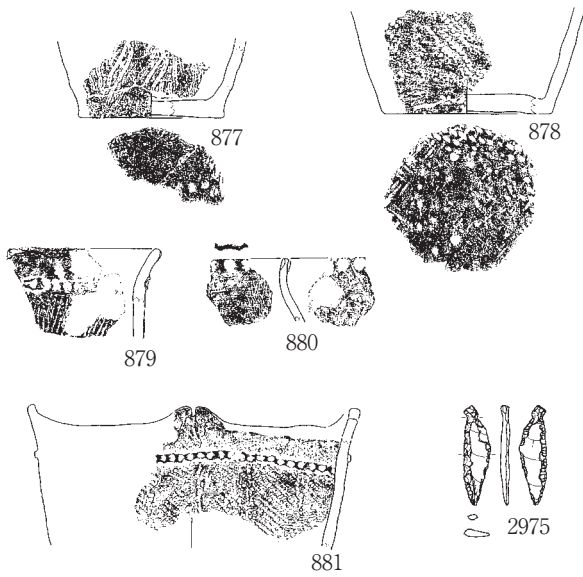

S I 117

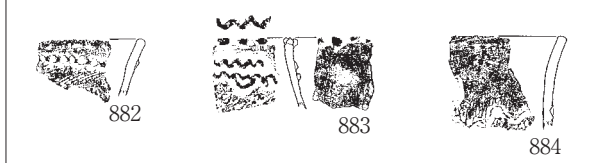

※SI118・IVC3j

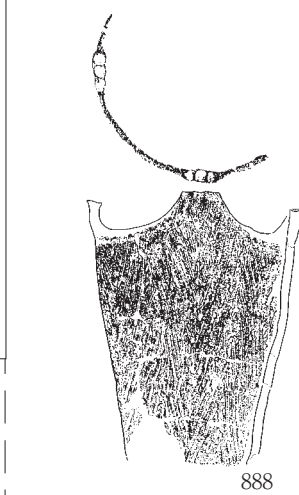

S I 120



S I 123

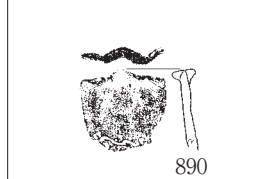

S I 118

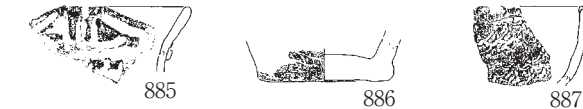

縄文土器：1/6 土製品：1/4  
剥片石器：1/4 礫石器：1/6

第538図 遺構別出土遺物集成図：S I 115 (2)・116・117・118・120・123

S K 05

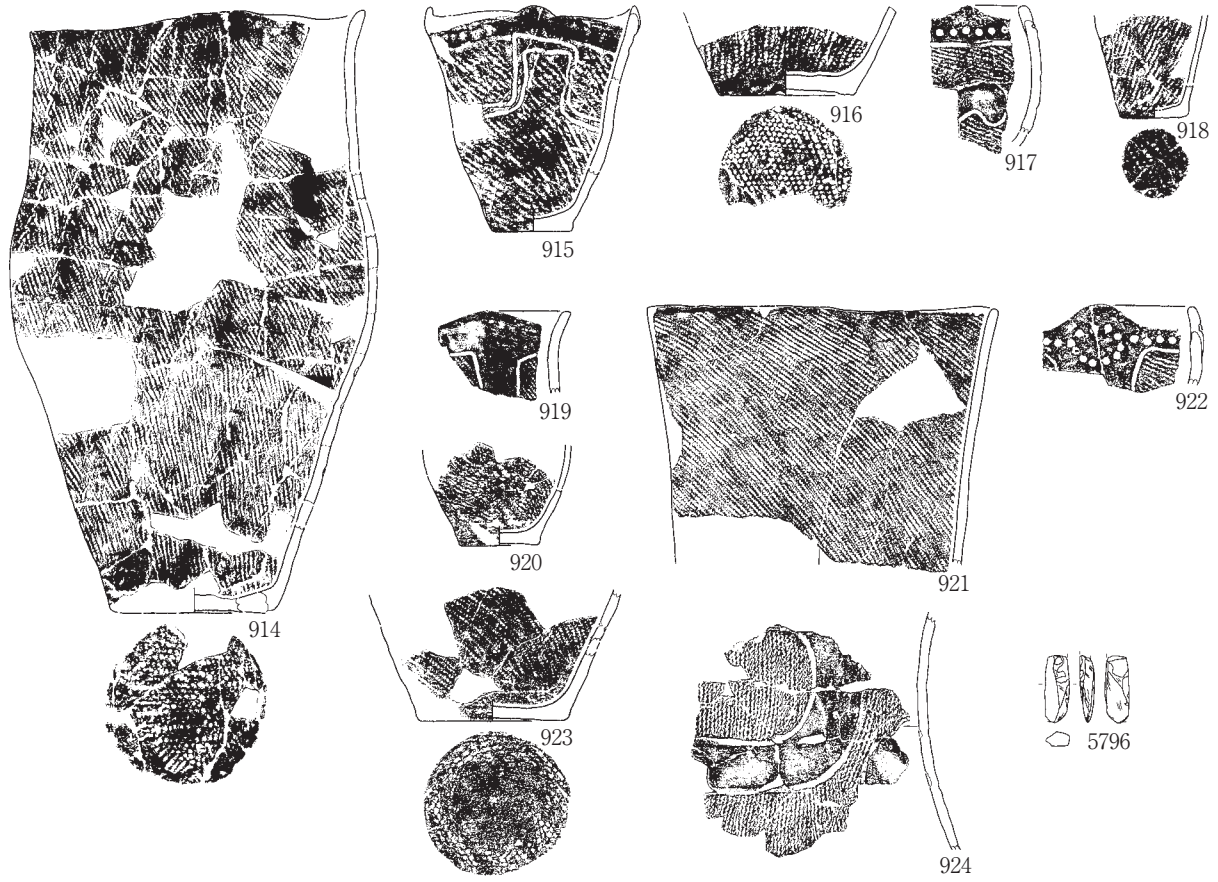

S K 27

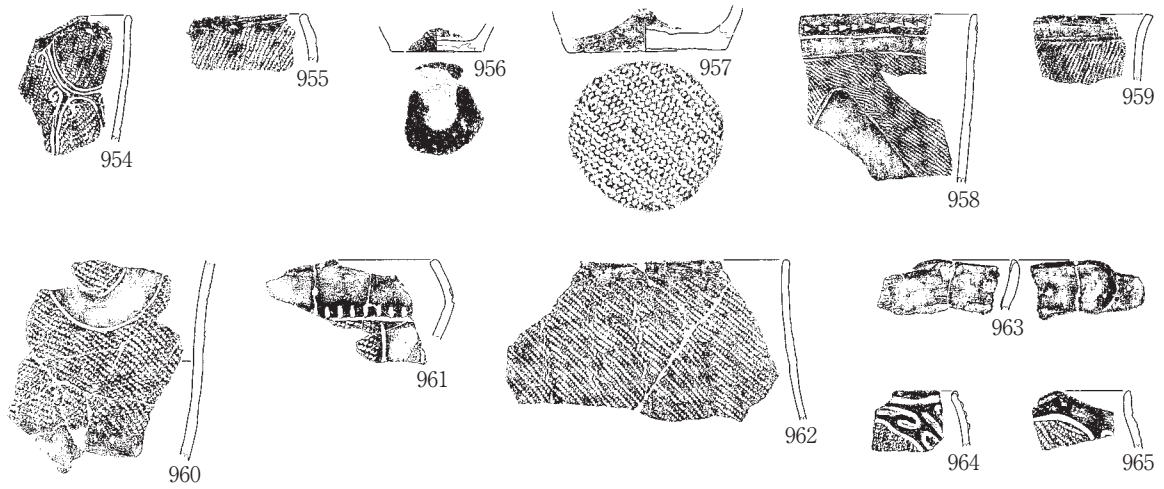

S K 29 (1)

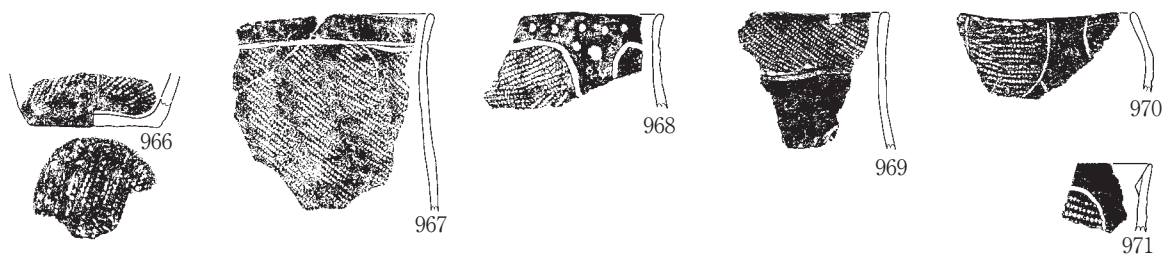

第539図 遺構別出土遺物集成図：S K 05・27・29 (1)

縄文土器：1/6 土製品：1/4  
剥片石器：1/4 礫石器：1/6

S K 29 (2)

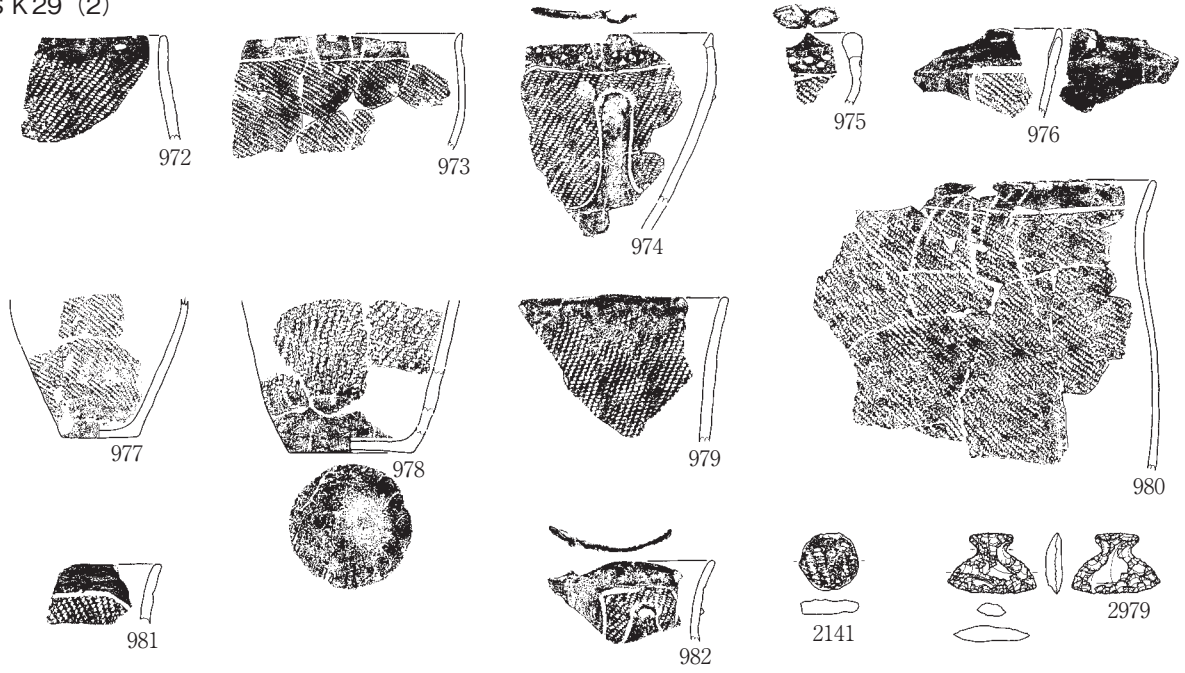

S K 32

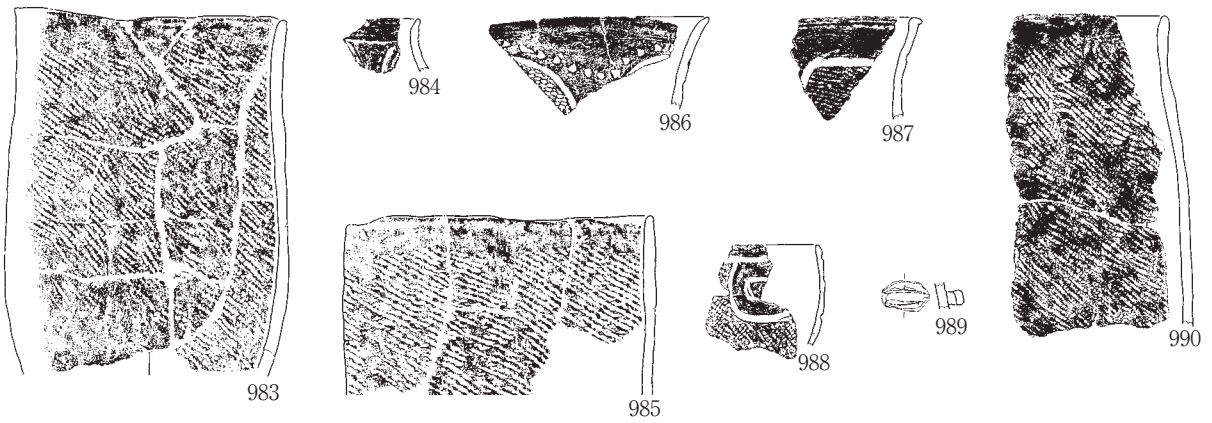

S K 35

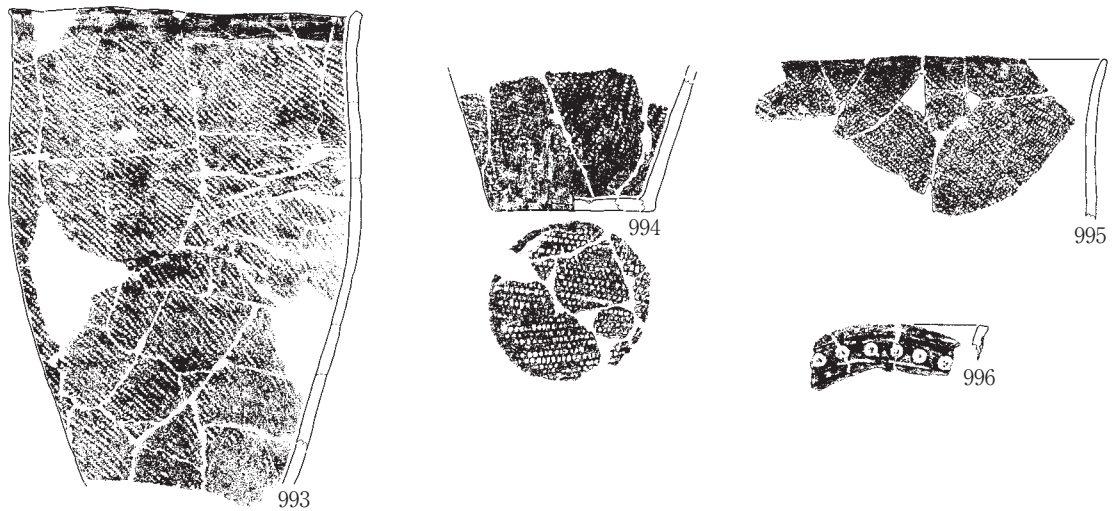

第540図 遺構別出土遺物集成図：S K 29 (2)・32・35  
 縄文土器：1/6 土製品：1/4  
 剥片石器：1/4 礫石器：1/6

S K 51

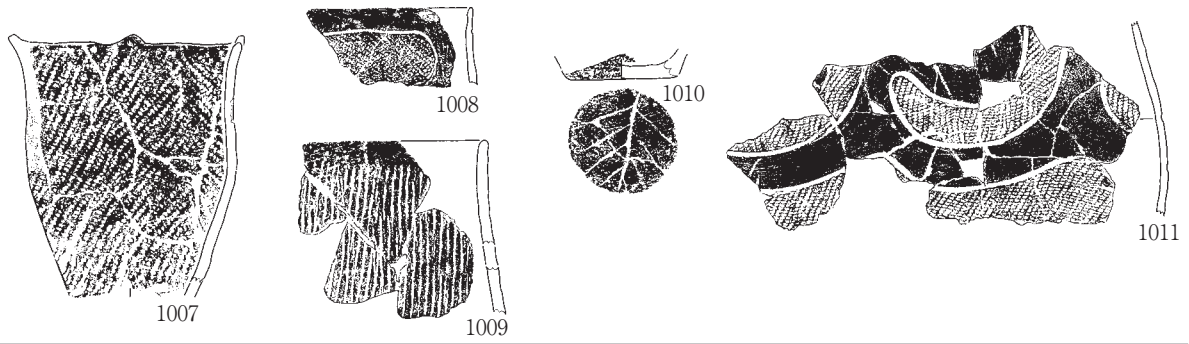

S K 52

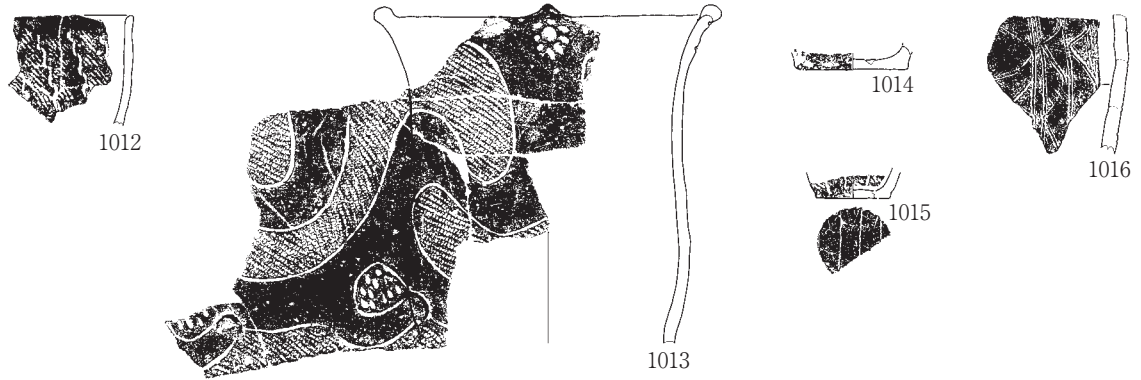

S K 71

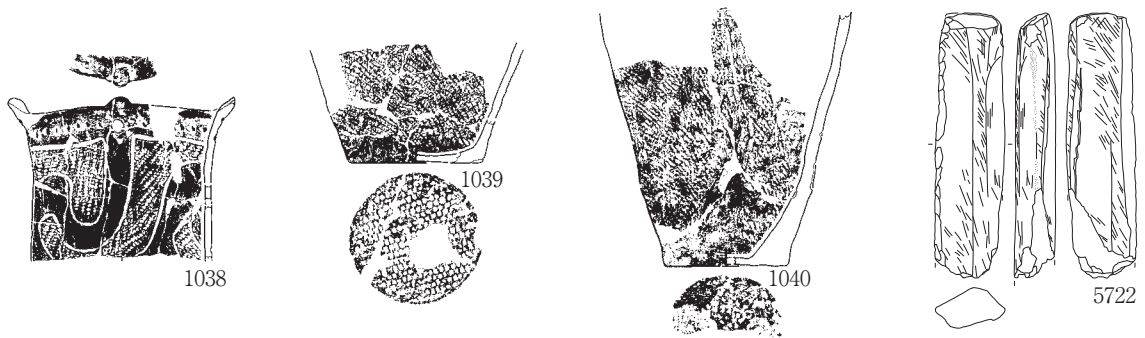

S K 83



S K 112

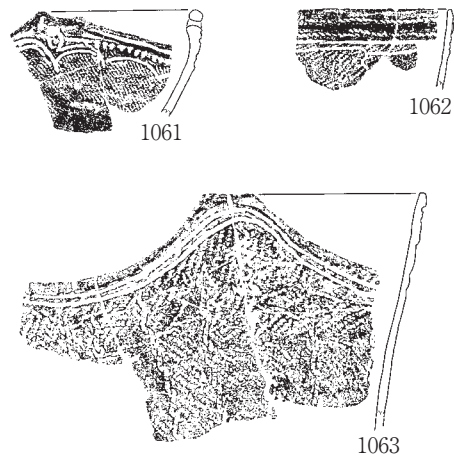

S K 131

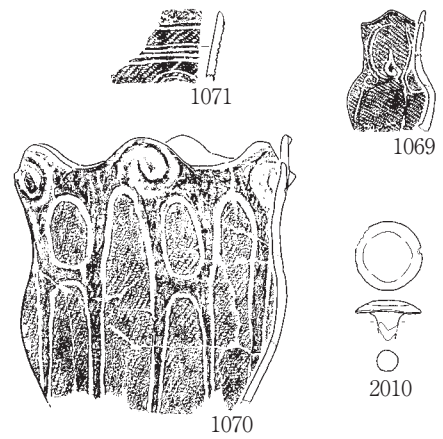

繩文土器：1/6 土製品：1/4  
剥片石器：1/4 礫石器：1/6

第541図 遺構別出土遺物集成図：S K 51・52・71・83・112・131

SN18

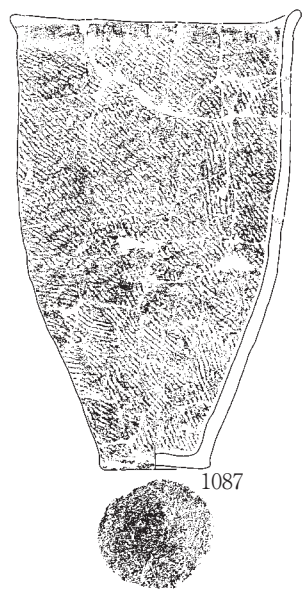

SN25

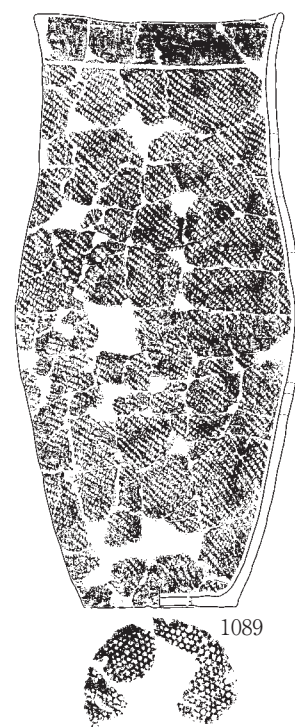

SN26

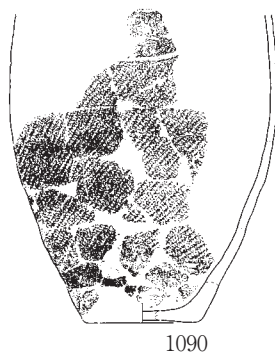

SN34

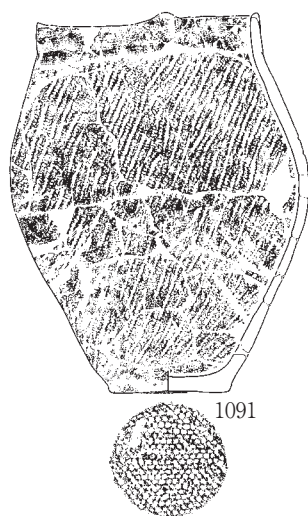

SN36

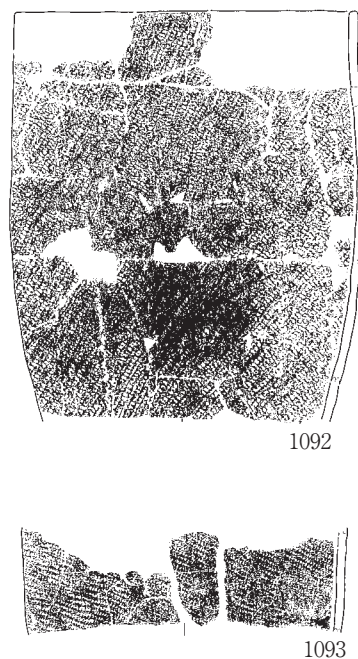

縄文土器：1/6

第542図 遺構別出土遺物集成図：SN18・25・26・34・36

II C8b

II層 (中振の上)

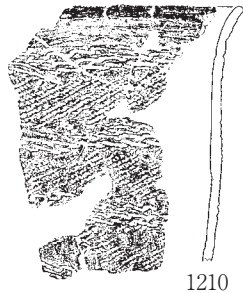

1210

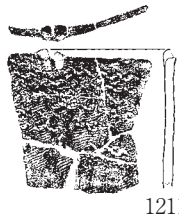

1211

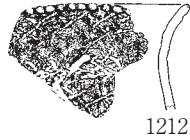

1212

包含層下位



1207



1205

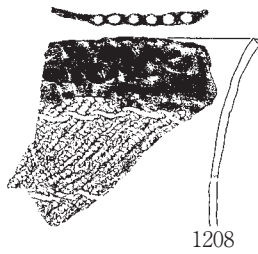

1208

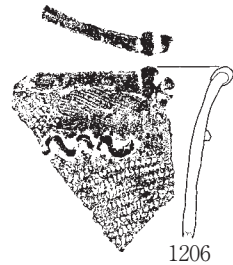

1206

II C8c

包含層下位

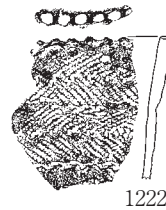

1222

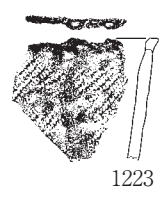

1223

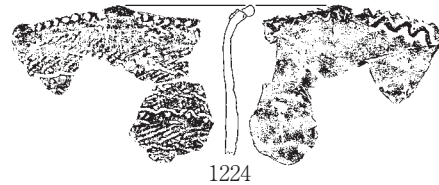

1224

南北ベルト埋土下位層



1225

包含層中位



1209

II層

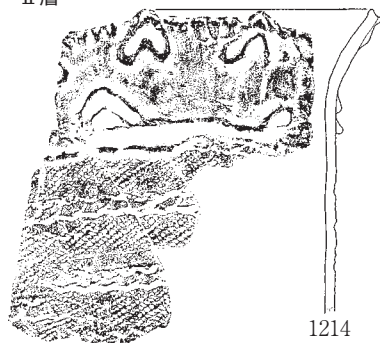

1214

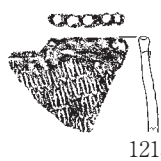

1215

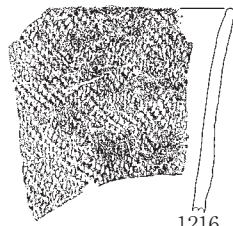

1216

II層

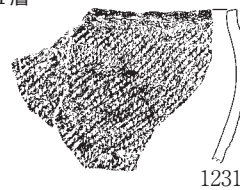

1231

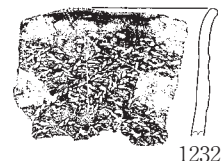

1232

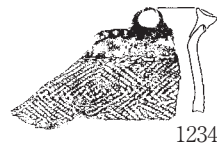

1234

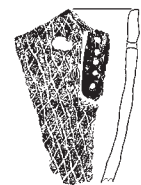

1233



1235

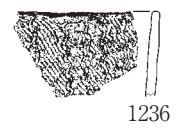

1236

縄文土器：1/6

第543図 地点別出土遺物集成図：II C8b・II C8c

II C 8d

包含層下位

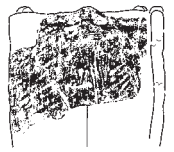

1243



1246

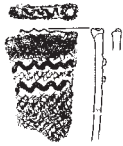

1249



1250

II層  
3層  
包含層下位

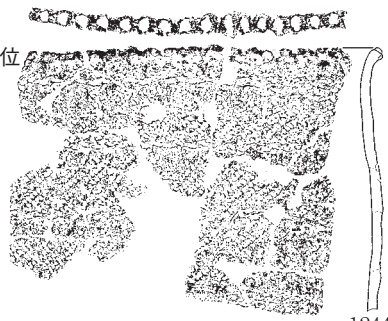

1244

II層  
3層



1245

包含層  
3層



1247

3層



1248

II層

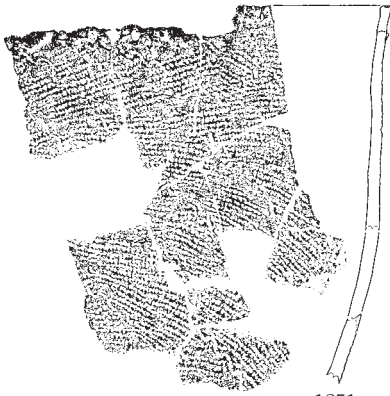

1251

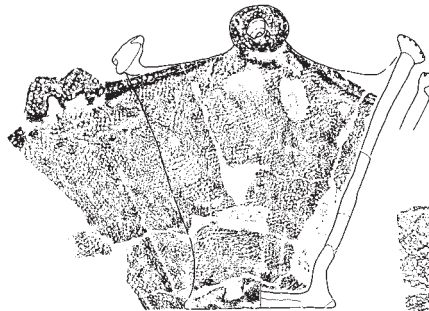

1256



1258



1260

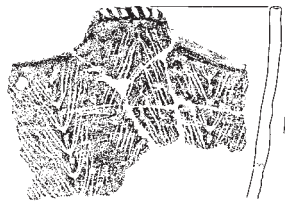

1261



1259

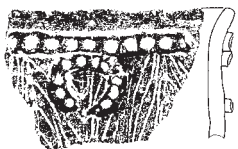

1262

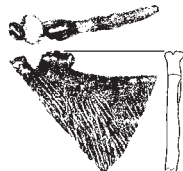

1263



1264

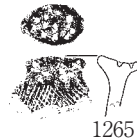

1265



1266

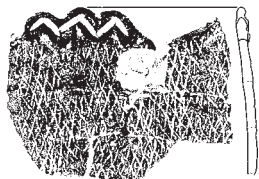

1267

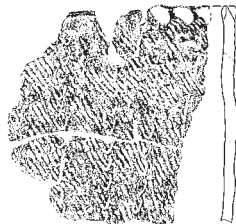

1268

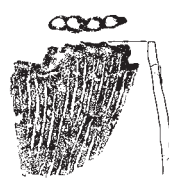

1269



1270

繩文土器：1/6

第544図 地点別出土遺物集成図：II C 8d



II C9c

包含層下位

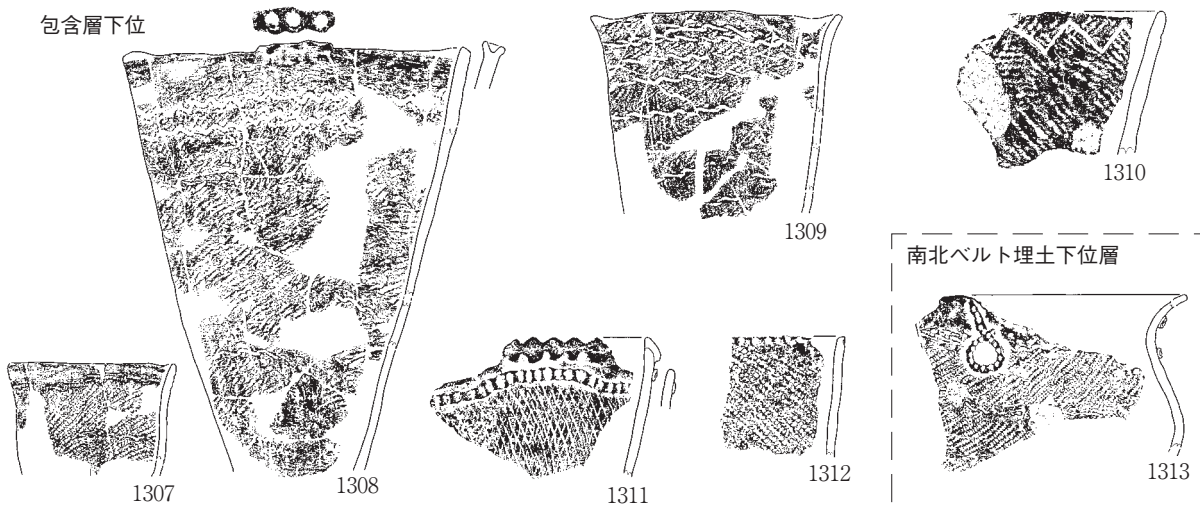

包含層中～下位

包含層中位

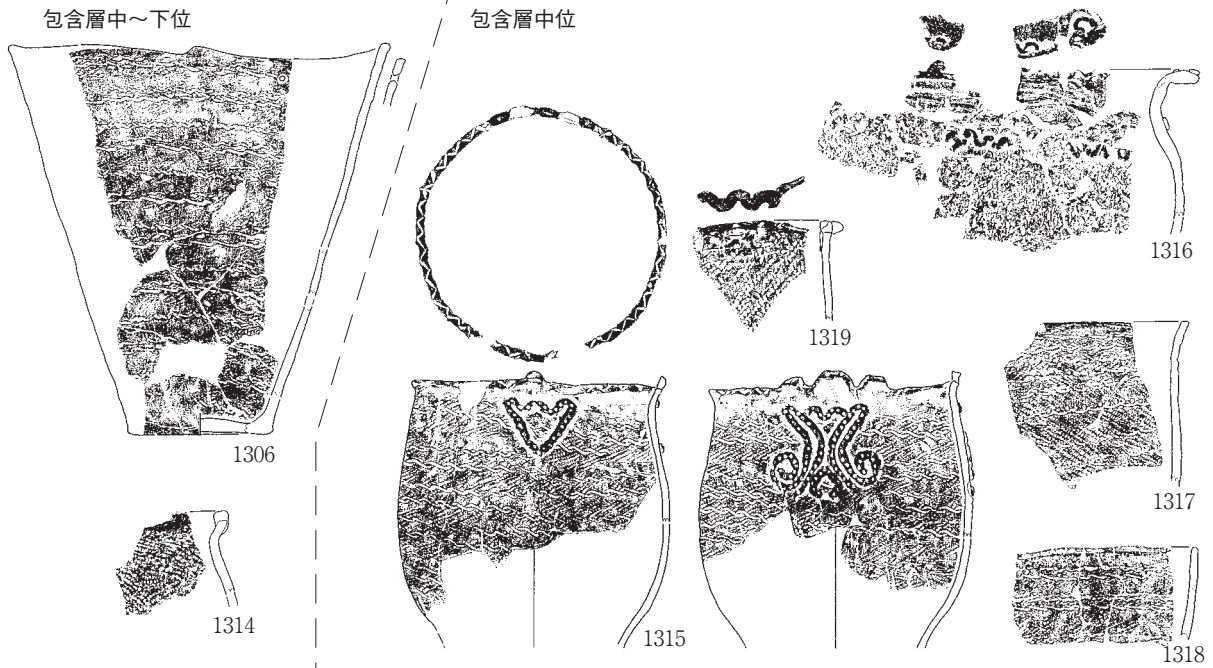

II層

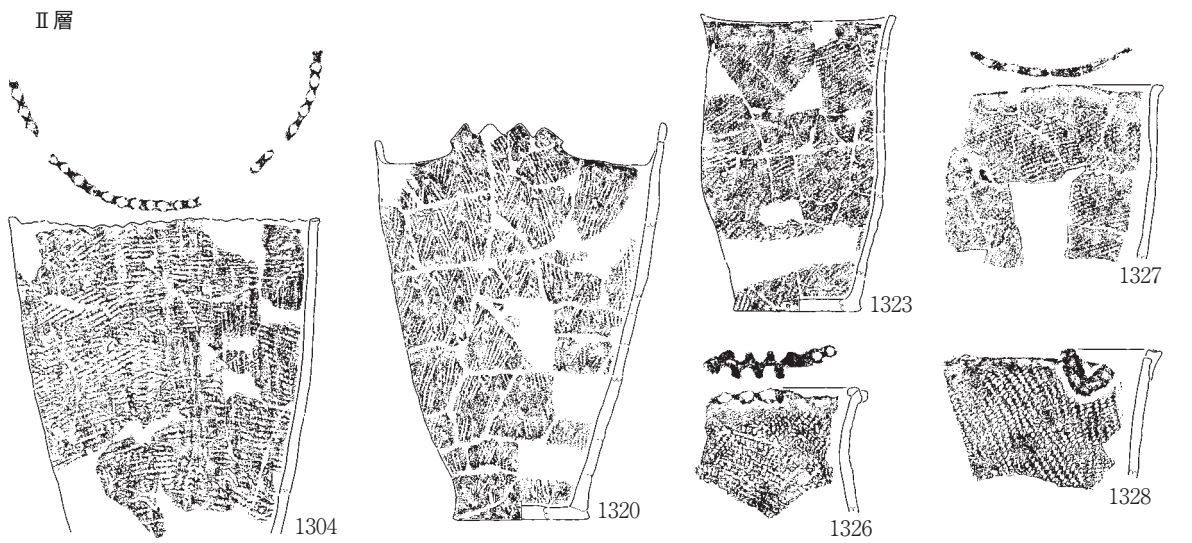

縄文土器：1/6

第545図 地点別出土遺物集成図：II C9c

II C 10c

包含層下位



包含層中位・下位

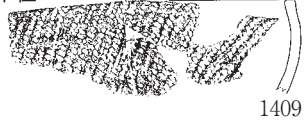

包含層中位

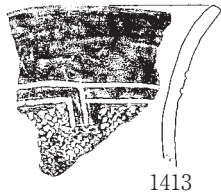

東西ベルト埋土上位層

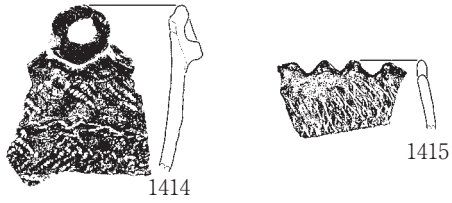

包含層上位



包含層

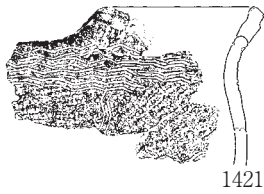

II層

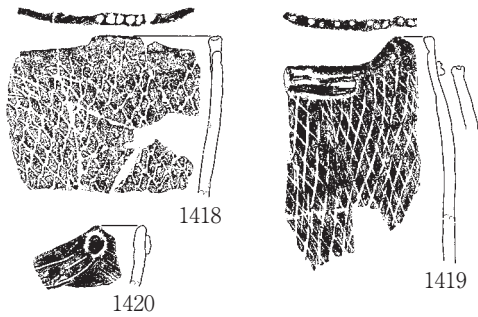

II C 10d

包含層下位

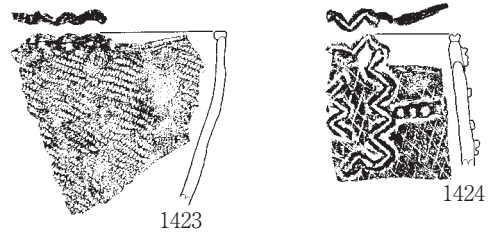

包含層中位



包含層中位  
南北ベルト上位層  
南北ベルト埋土中位層

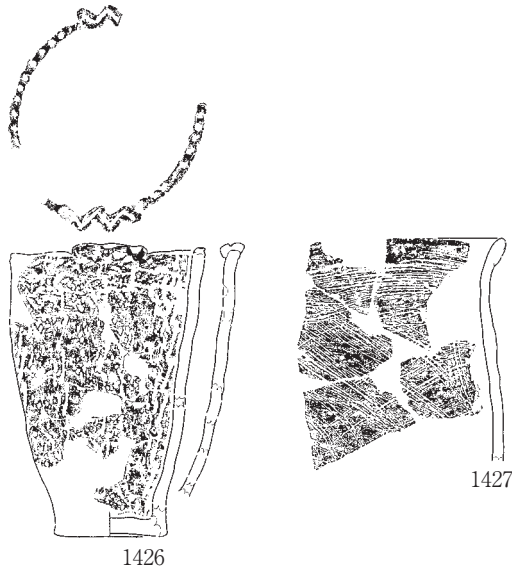

II層

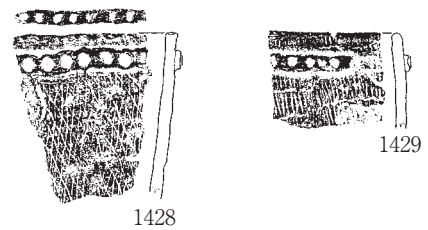

縄文土器：1/6

第546図 地点別出土遺物集成図：II C 10c・II C 10d

S I 02

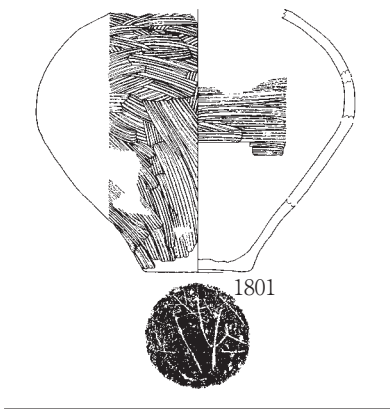

S I 04

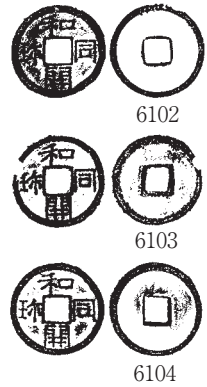
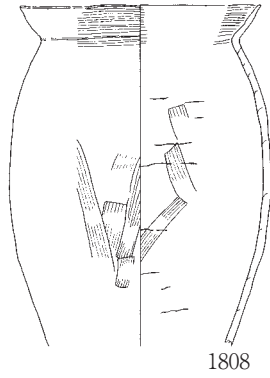
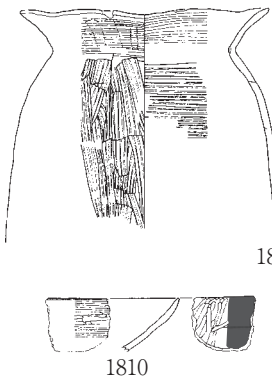
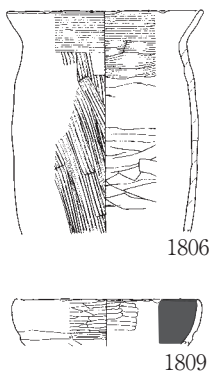
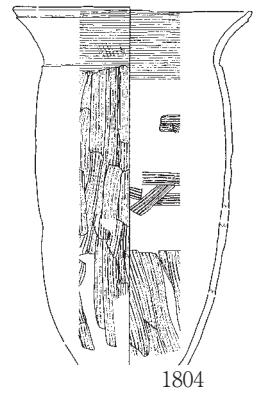
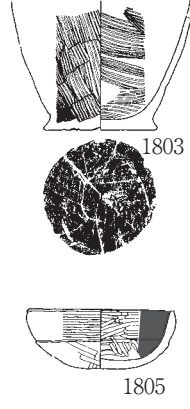
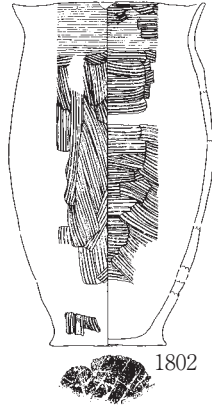

S I 05

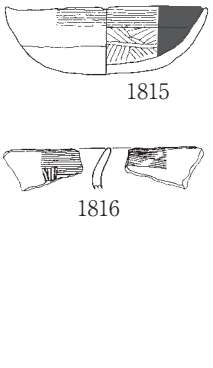
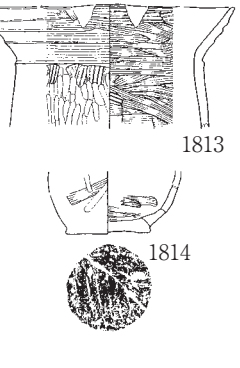
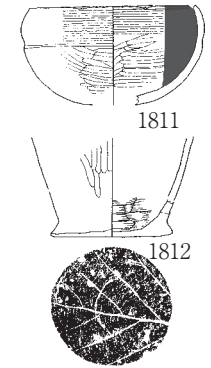

S I 09

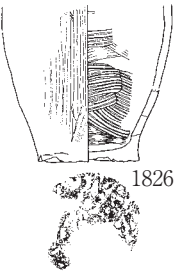
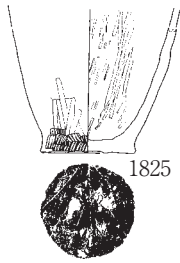
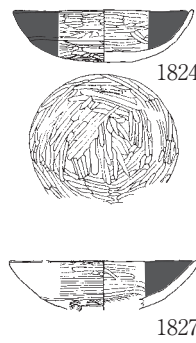

S I 06

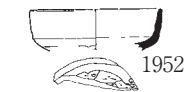
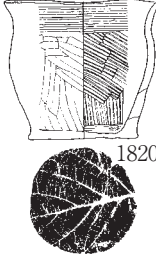
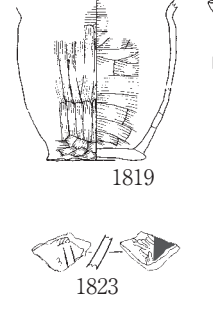
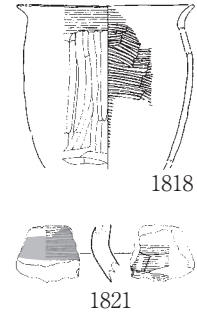
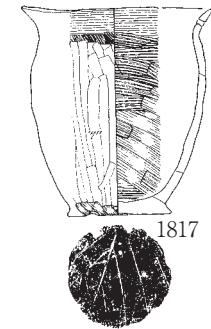

S I 10

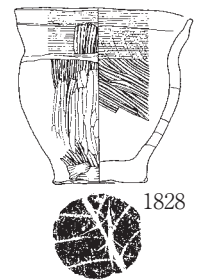

土師器・須恵器：1/6 土製品：1/4  
 金属製品：1/4 銭貨：1/2

第547図 古代の竪穴住居跡出土遺物集成図 (1)

S | 11

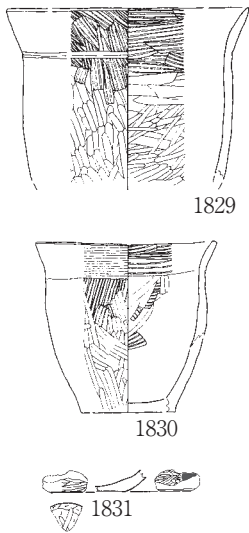

S | 16

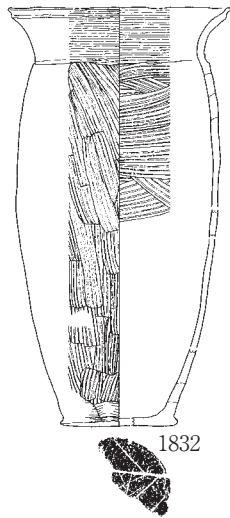

S | 17



S | 21

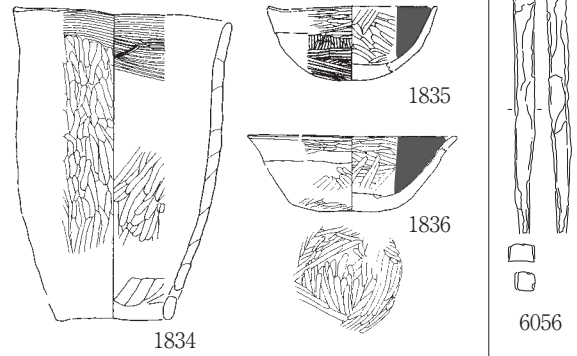

S | 22

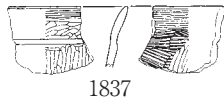

S | 25



S | 29

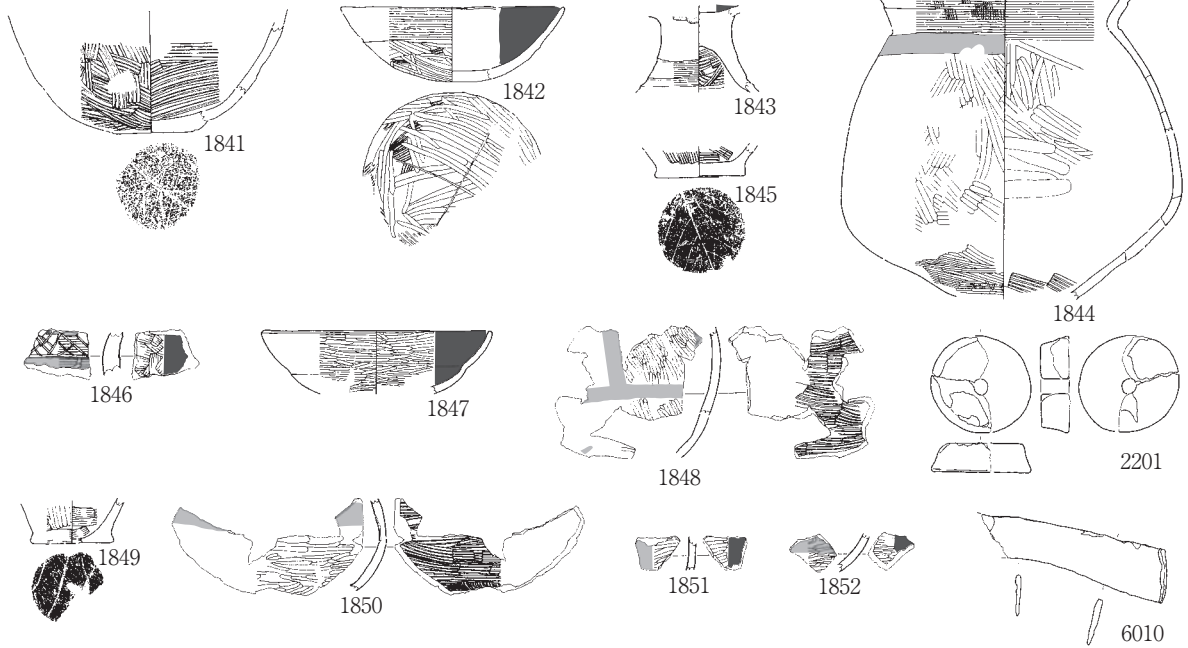

S | 33

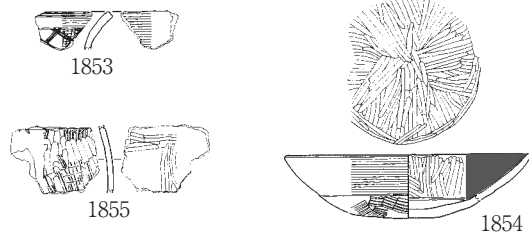

S | 36



土師器・須恵器：1/6 土製品：1/4  
金属製品：1/4 銭貨：1/2

第548図 古代の竪穴住居跡出土遺物集成図 (2)

S | 42

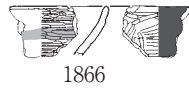
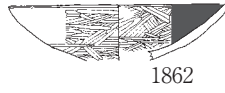
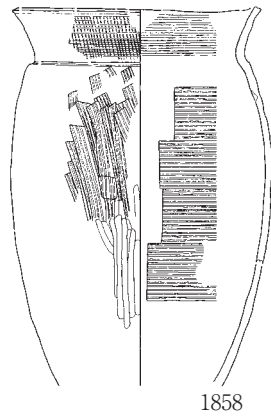

※SI42・48

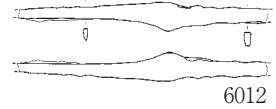
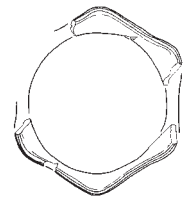
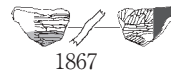

S | 44

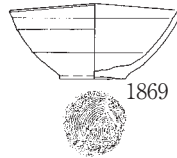
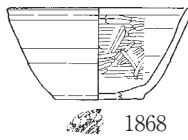

S | 48

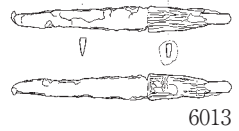
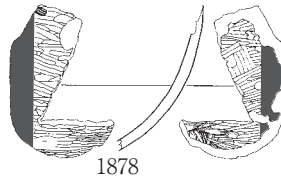
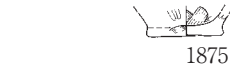
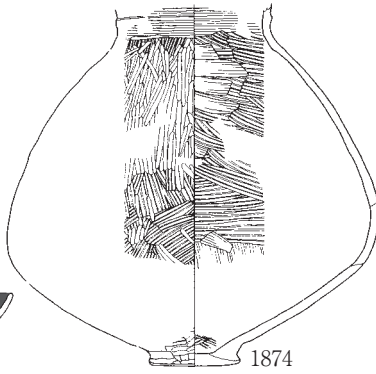
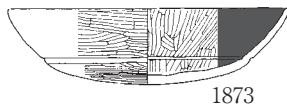
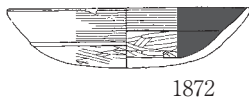
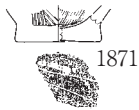

S | 50

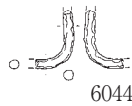
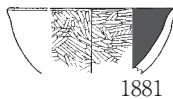
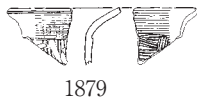

S | 52

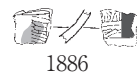

S | 63

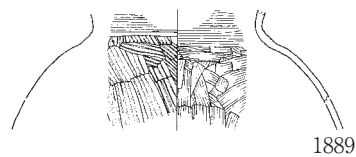
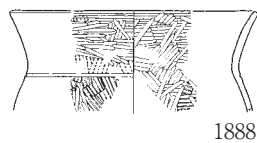
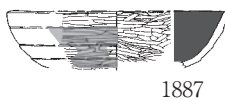

第549図 古代の竪穴住居跡出土遺物集成図 (3) 土師器・須恵器：1/6 土製品：1/4 金属製品：1/4 銭貨：1/2

S I 74 ※ S I 73・74

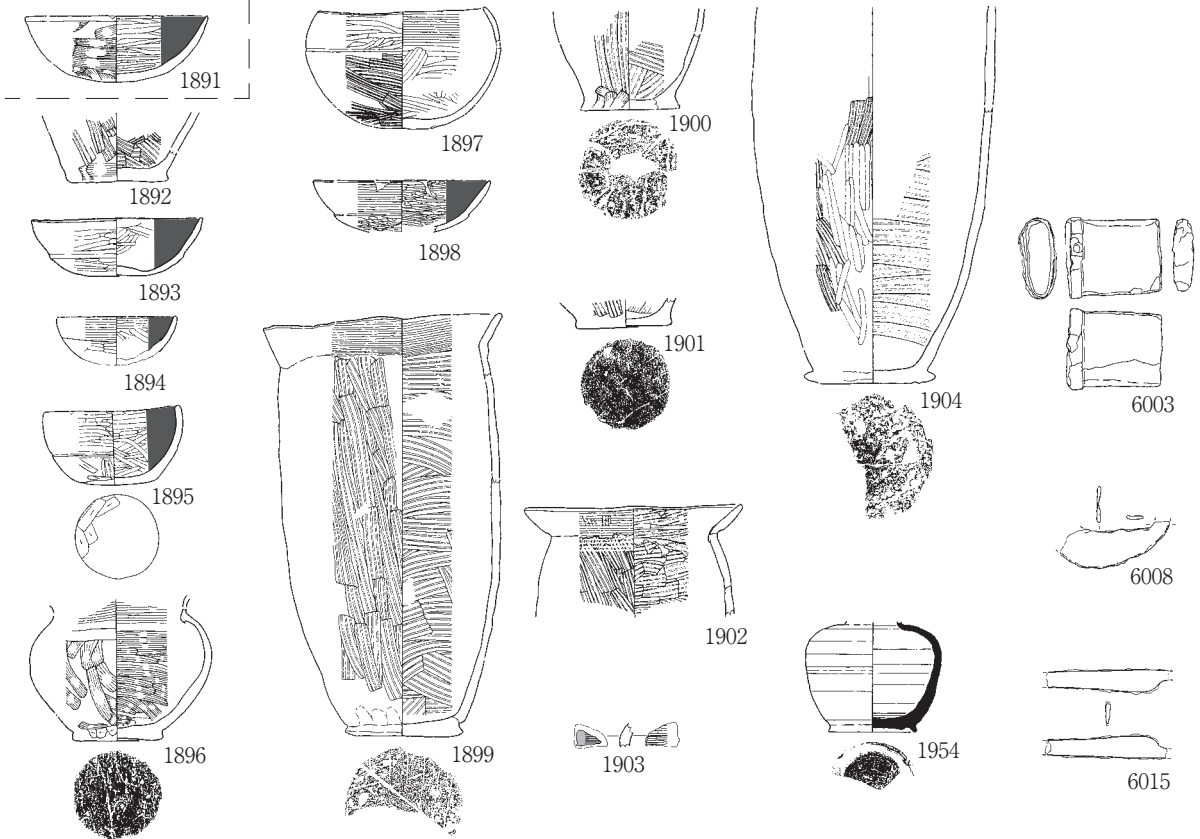

S I 87

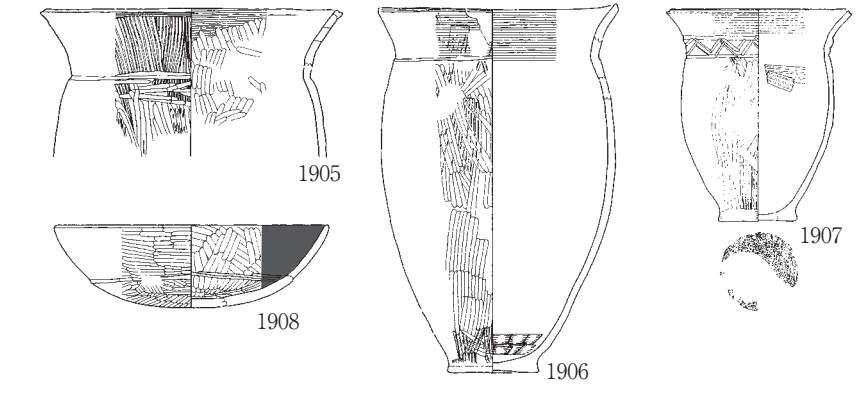

S I 105

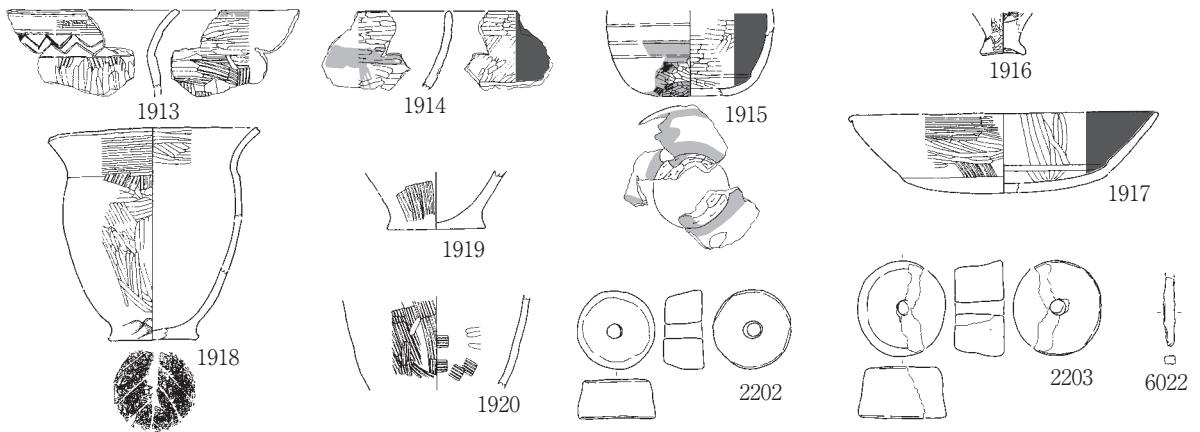
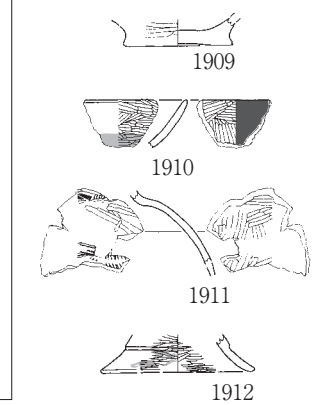

土師器・須恵器：1/6 土製品：1/4  
金属製品：1/4 銭貨：1/2

第550図 古代の竪穴住居跡出土遺物集成図 (4)

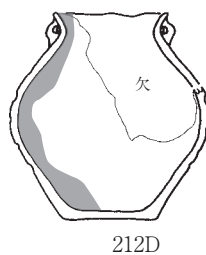
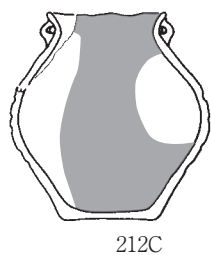
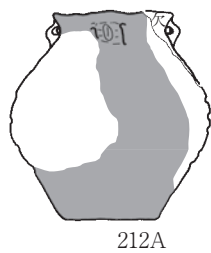
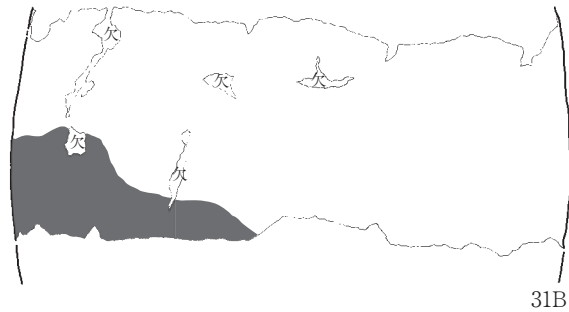
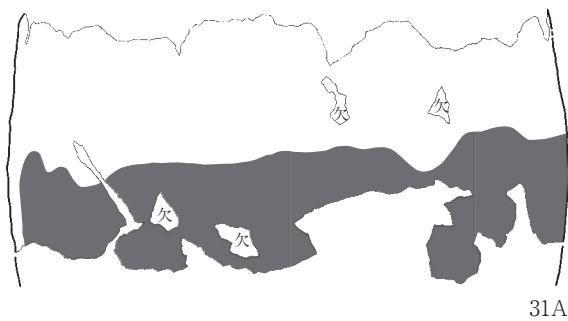

・実測部位  
 A 表側外面  
 B 裏側外面  
 C 表側内面  
 D 裏側内面  
 E 底部外面  
 F 底部内面

■ …スス・コゲ  
 ■ …被熱痕

0 1:4 10cm

第551図 縄文土器のスス・コゲ痕 (1)

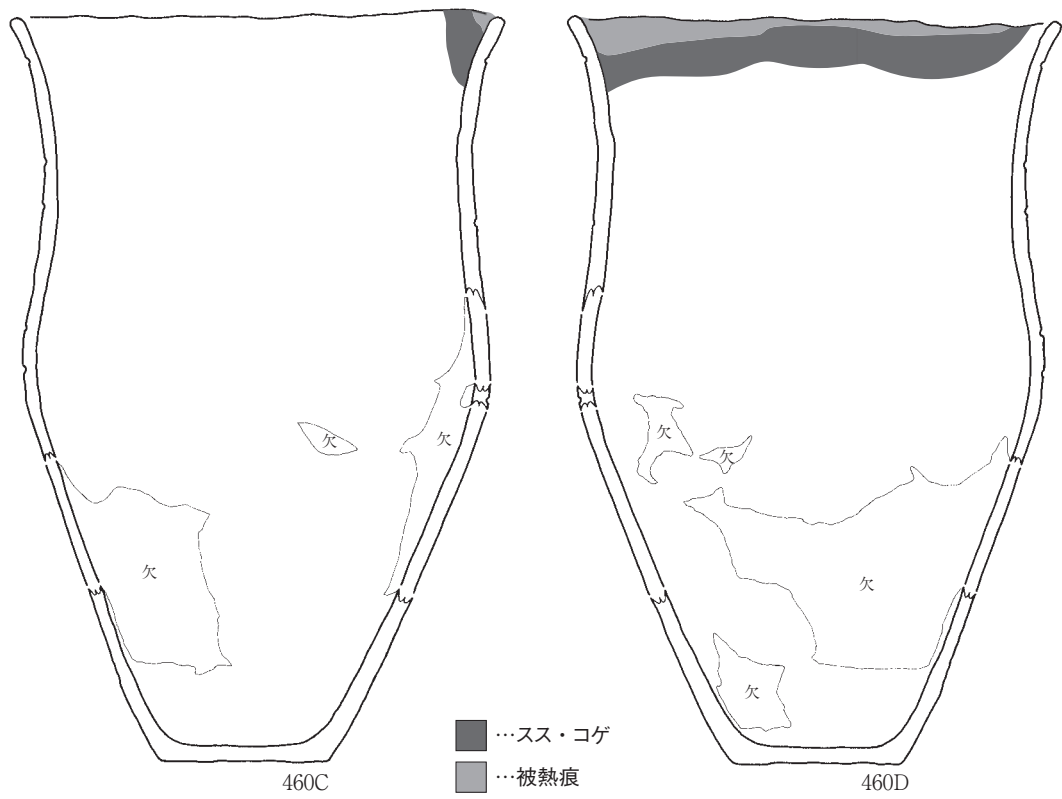
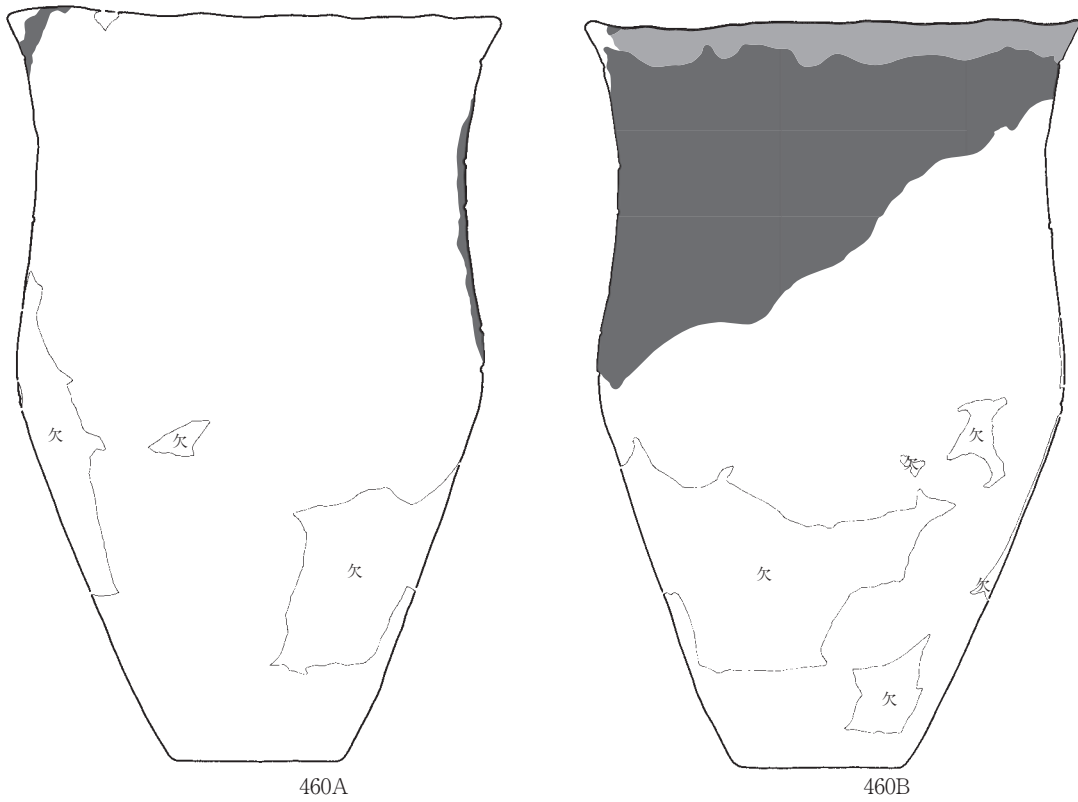

0 1:4 10cm

第552図 縄文土器のスス・コゲ痕 (2)



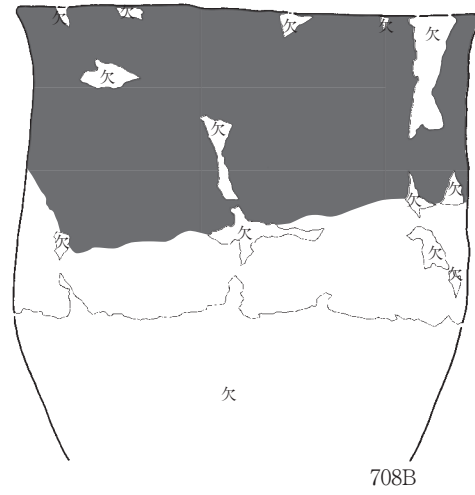
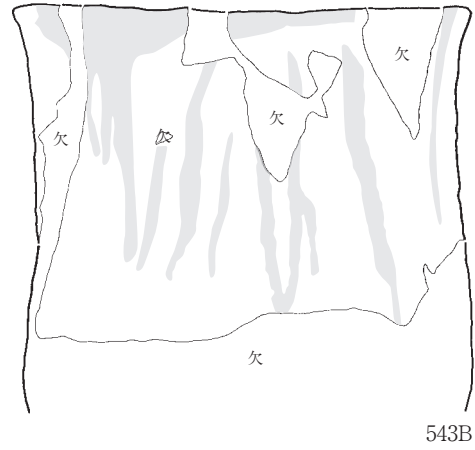

■ …スス・コゲ  
 □ …吹きこぼれ

0 1:4 10cm

第553図 縄文土器のスス・コゲ痕 (3)

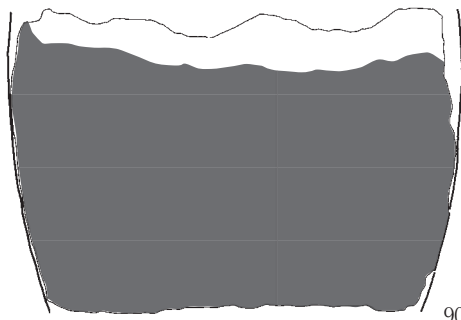

906A

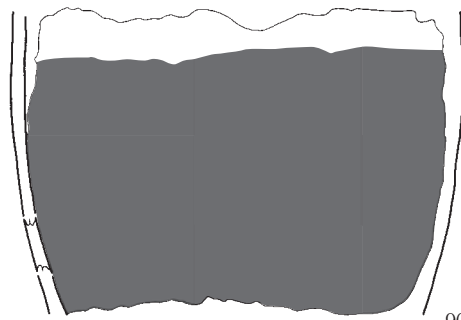

906C

■ …スス・コゲ

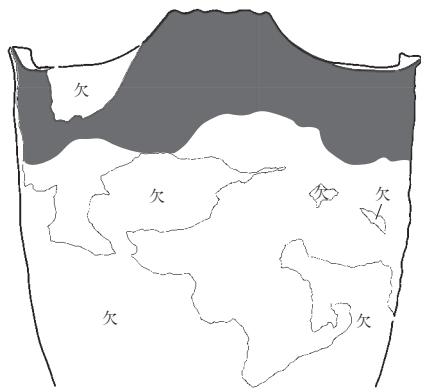

1185A

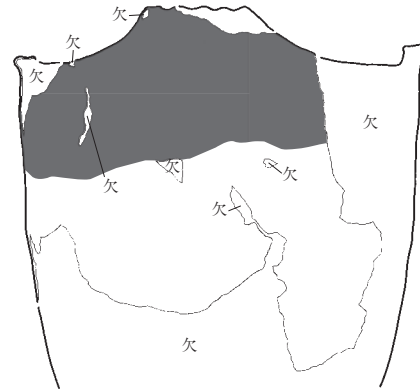

1185B



1185C

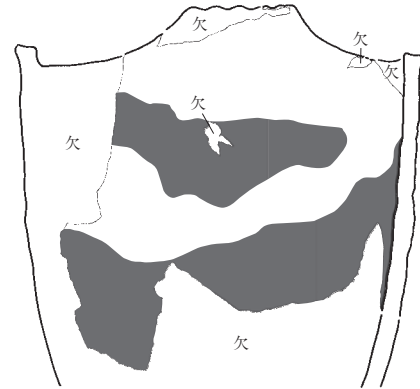

1185D

0 1 : 4 10cm

第554図 縄文土器のスス・コゲ痕 (4)

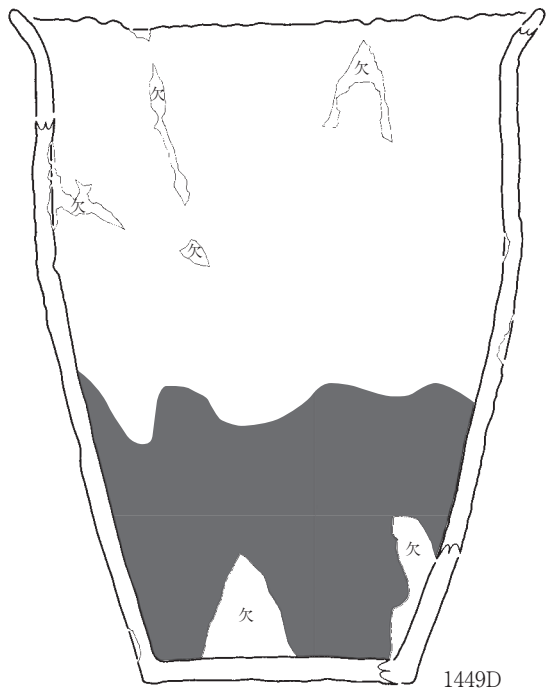
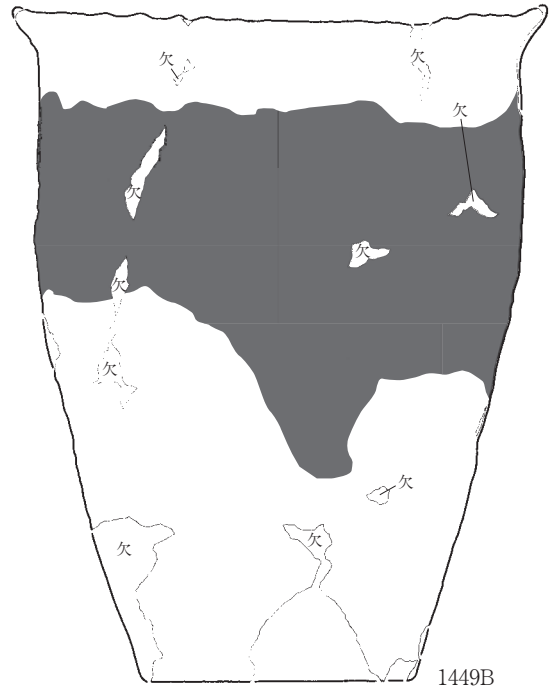
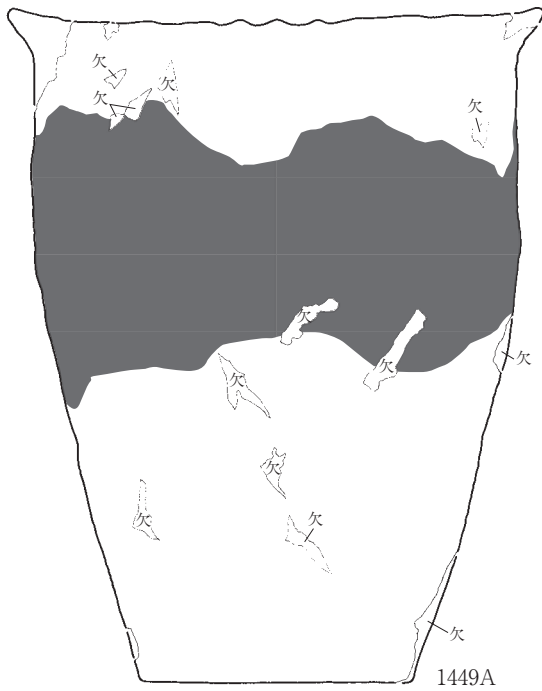

■ …ス・コゲ

0 1:4 10cm

第555図 縄文土器のス・コゲ痕 (5)

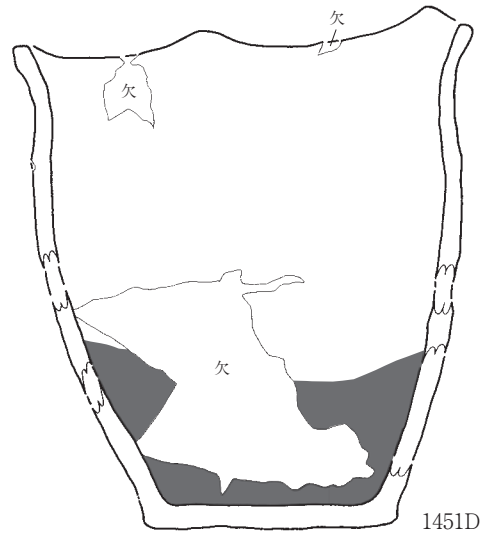
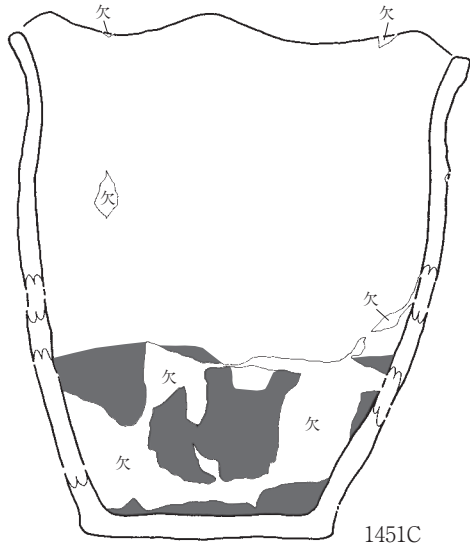
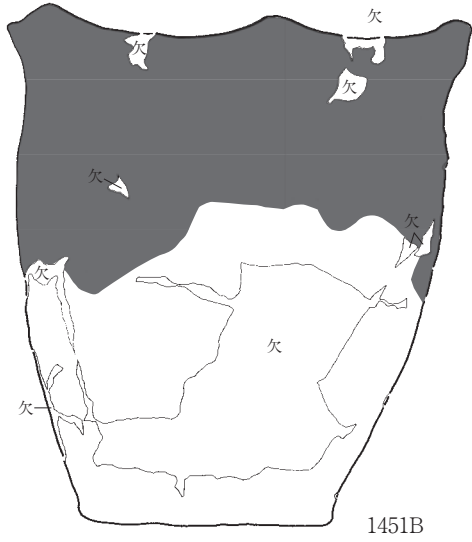
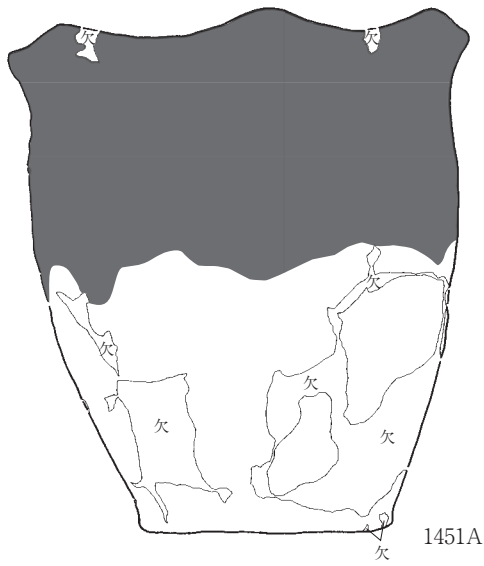

■ …スス・コゲ

0 1 : 4 10cm

第556図 縄文土器のスス・コゲ痕 (6)

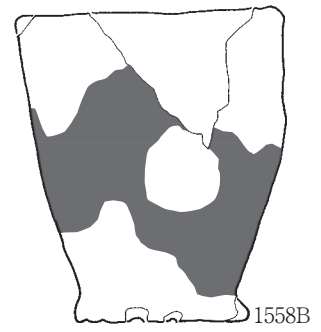
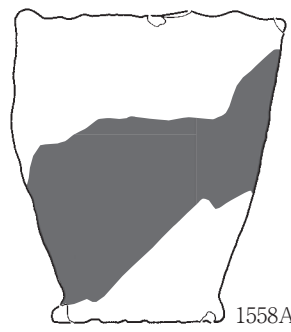
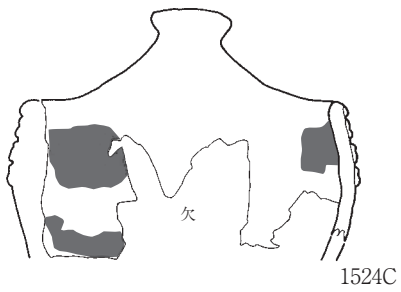
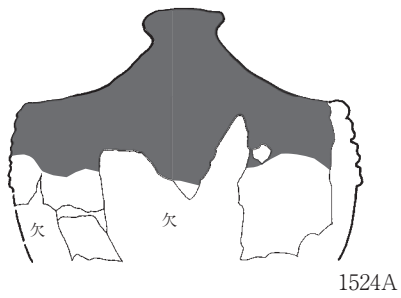
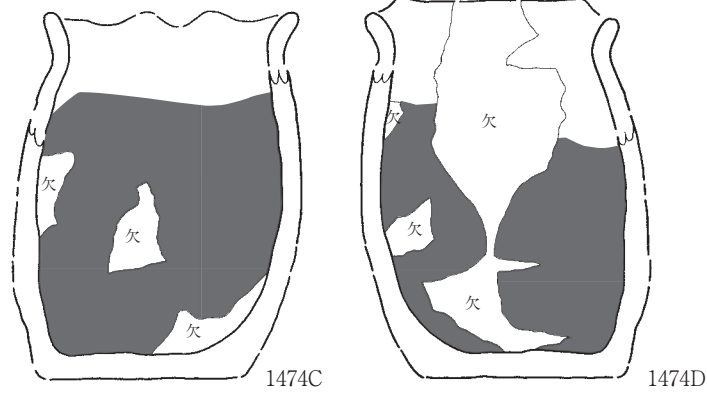
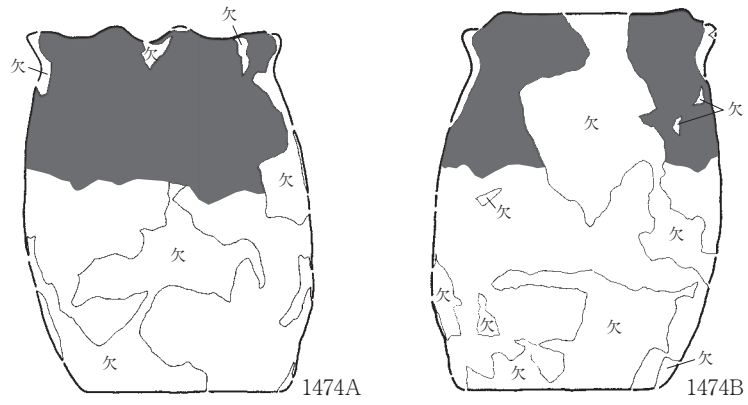

■ …スス・コゲ

0 1:4 10cm

第557図 縄文土器のスス・コゲ痕 (7)

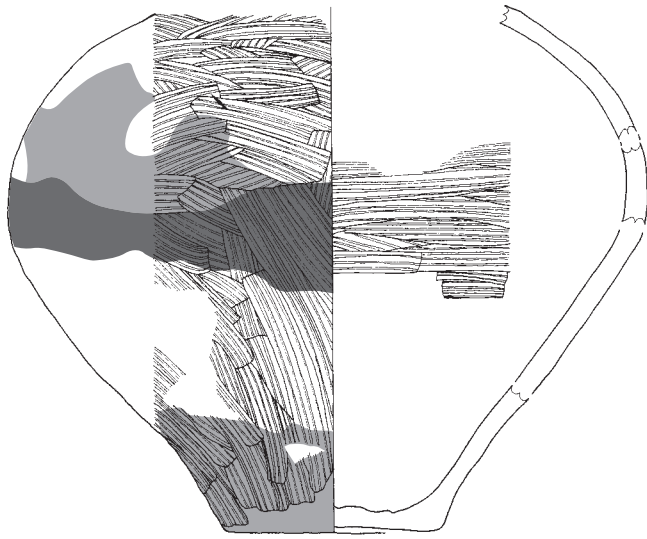

1801

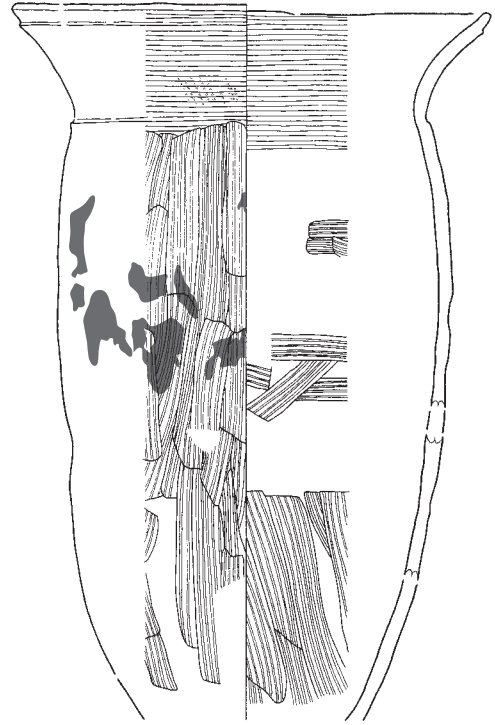

1804

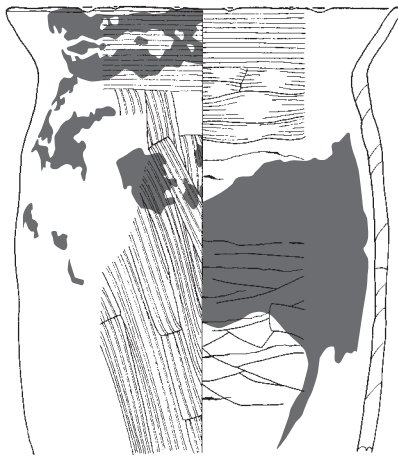

1806

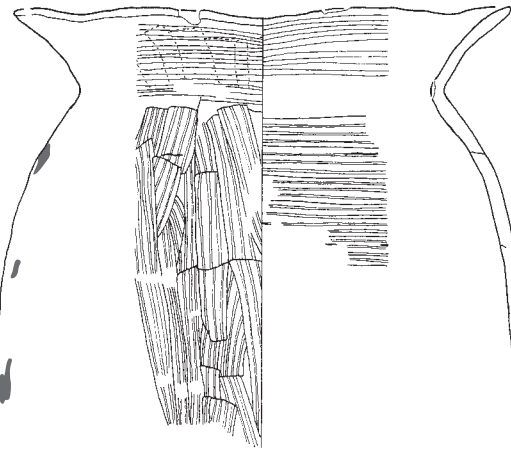

1807

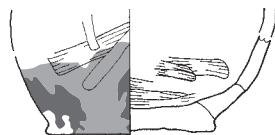

1814

- …スス・コゲ
- …スス (淡い)

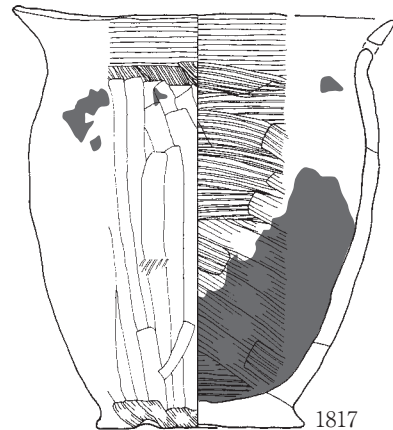

1817

0 1:3 10cm

第558図 土師器のスス・コゲ痕 (1)

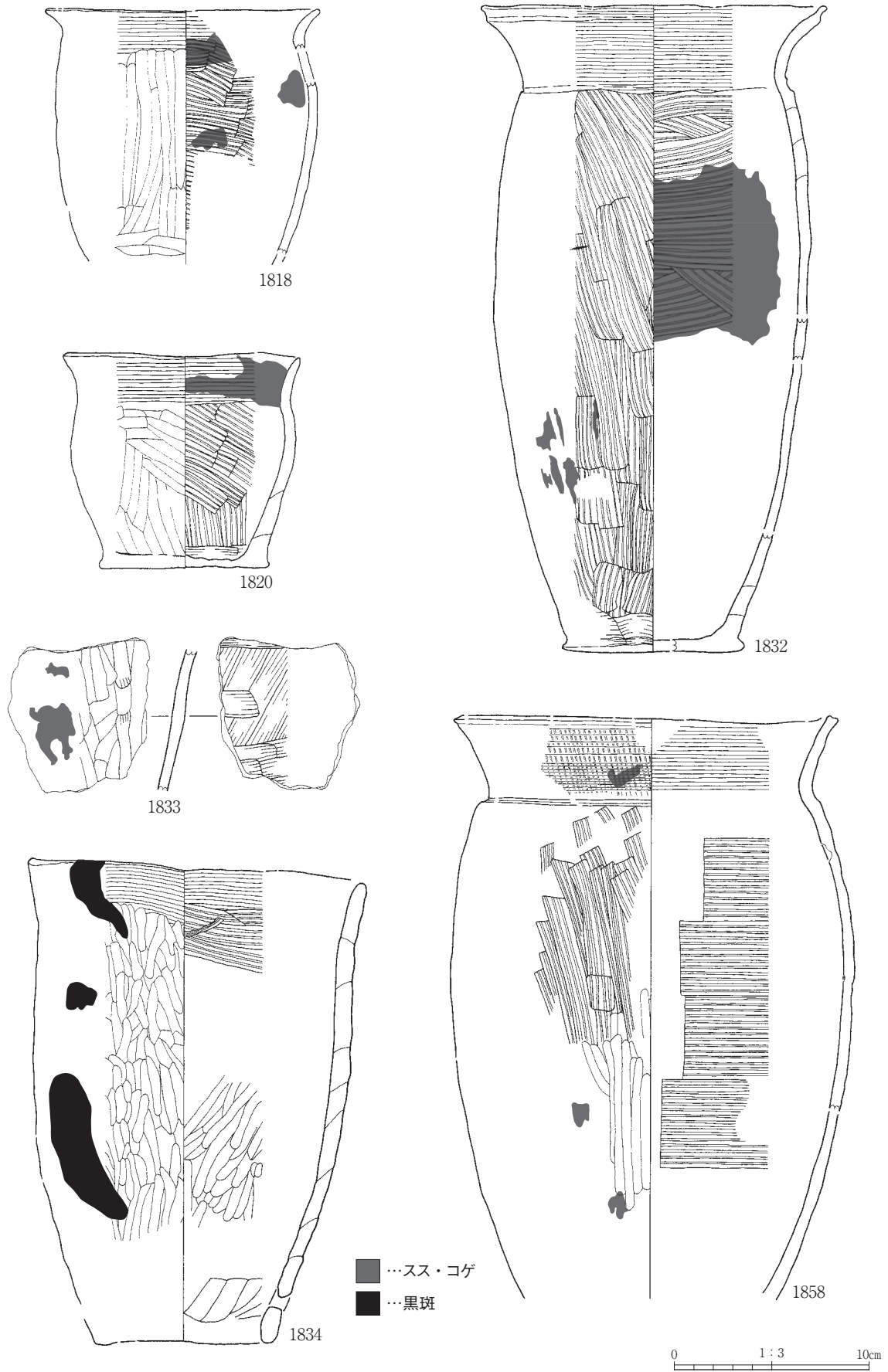

第559図 土師器のスス・コゲ痕 (2)

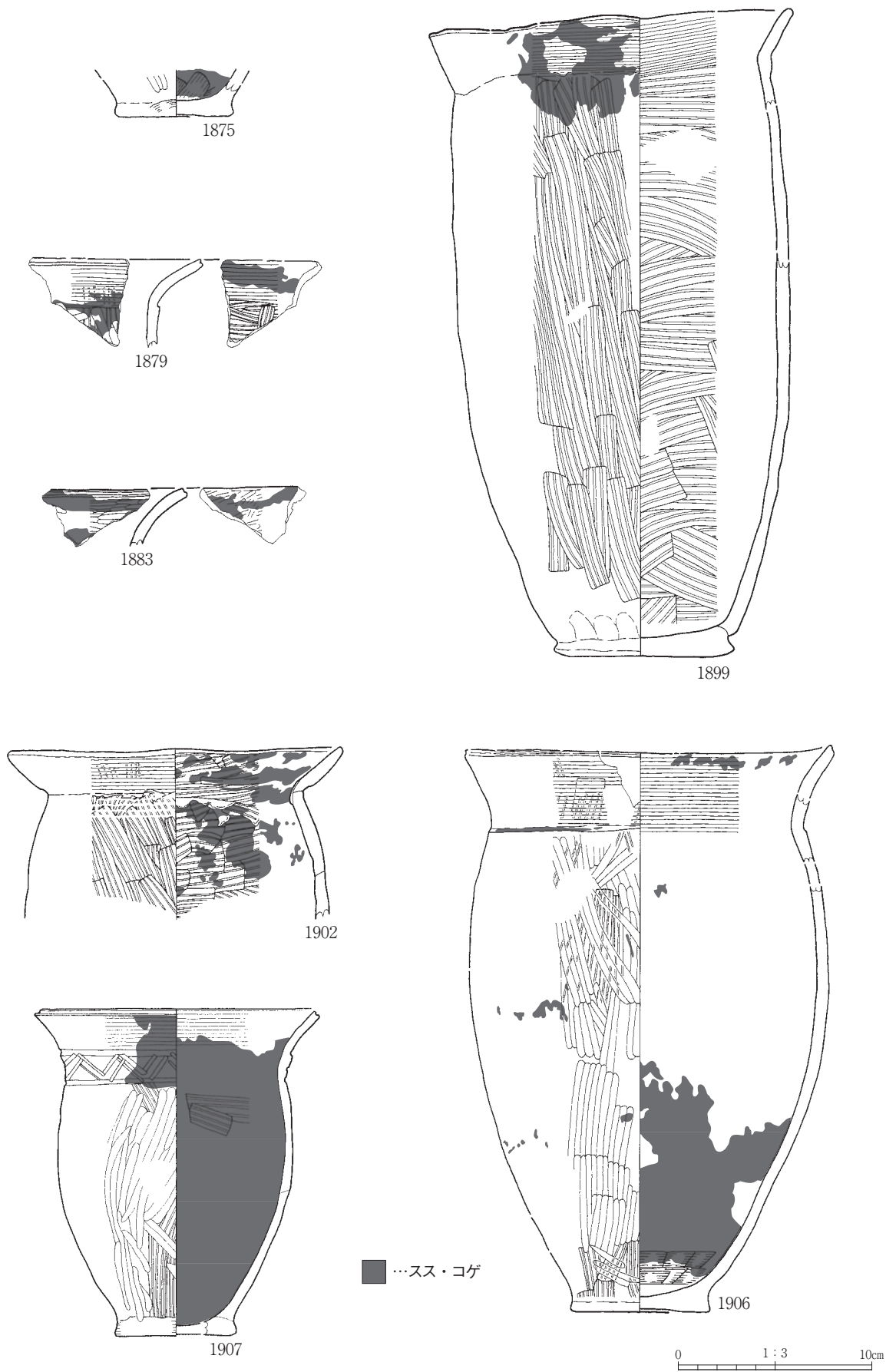

第560図 土師器のスス・コゲ痕 (3)



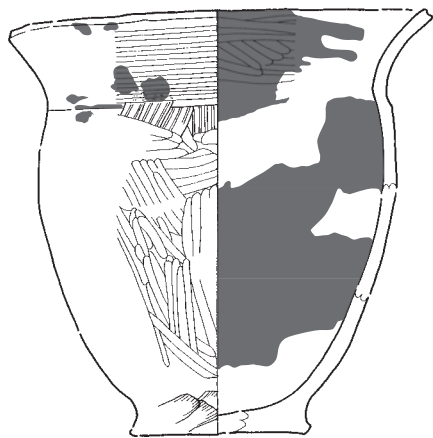

1918

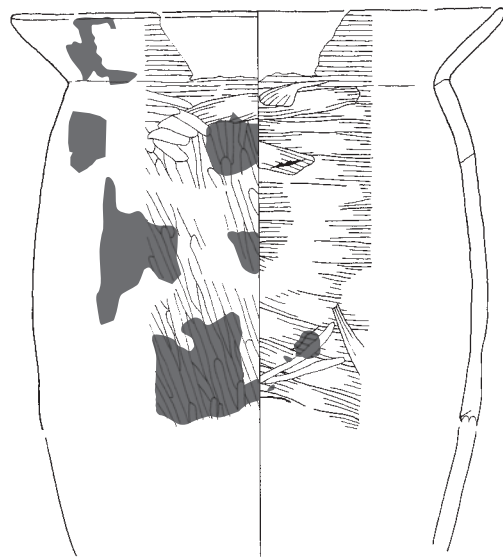

1926

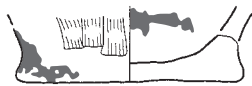

1925

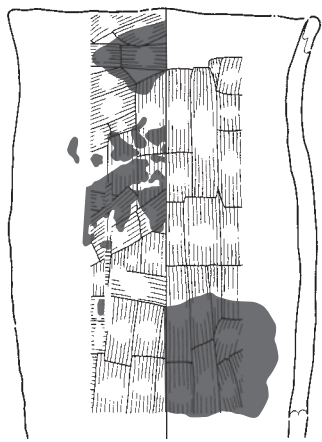

1928

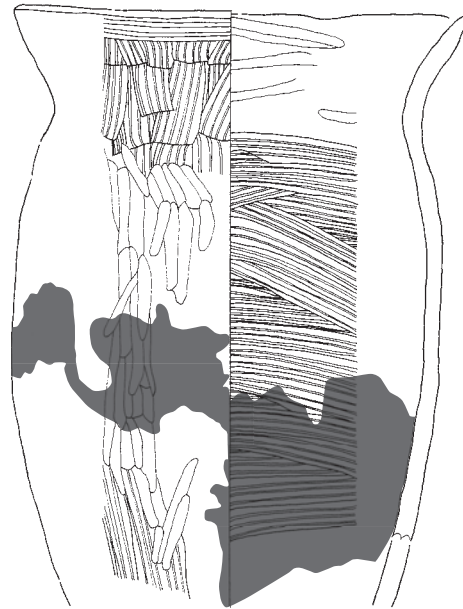

1942



1938

■ …スス・コゲ

0 1:3 10cm

第561図 土師器のスス・コゲ痕 (4)

---

岩手県文化振興事業団埋蔵文化財調査報告書第722集

## 沢田皿遺跡発掘調査報告書

三陸沿岸道路建設事業関連遺跡発掘調査  
(第2分冊 図版)

印刷 令和3年3月1日

発行 令和3年3月12日

編集 (公財)岩手県文化振興事業団埋蔵文化財センター  
〒020-0853 岩手県盛岡市下飯岡11地割185番地  
電話 (019) 638-9001

発行 国土交通省東北地方整備局三陸国道事務所  
〒027-0029 岩手県宮古市藤の川4番1号  
電話 (0193) 62-1711

(公財)岩手県文化振興事業団  
〒020-0023 岩手県盛岡市内丸13番1号  
電話 (019) 654-2235

印刷 永代印刷株式会社  
〒020-0857 岩手県盛岡市北飯岡1丁目8番30号  
電話 (019) 636-0011