

石皿・台石類

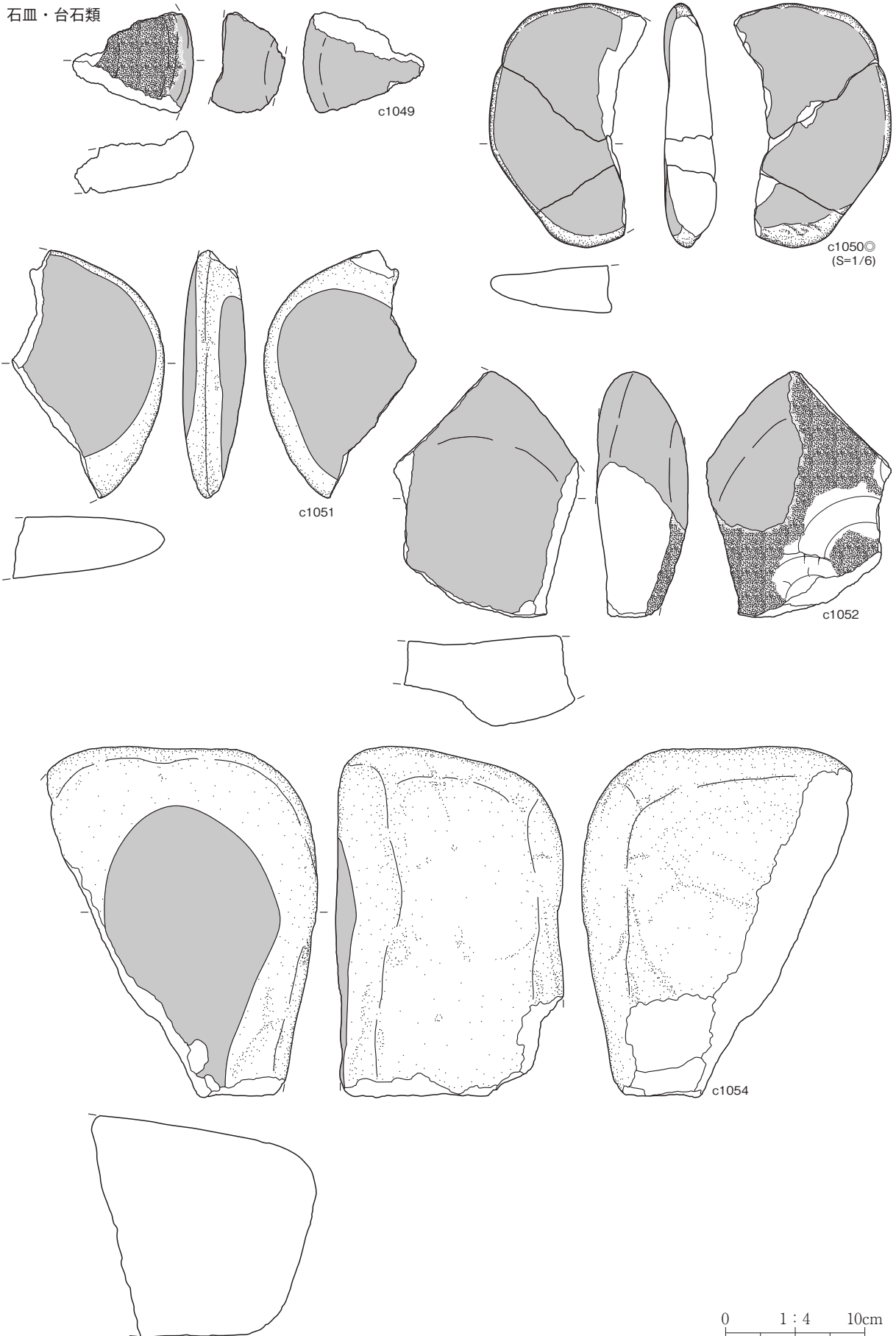

第 292 図 石器（石皿・台石類 1）

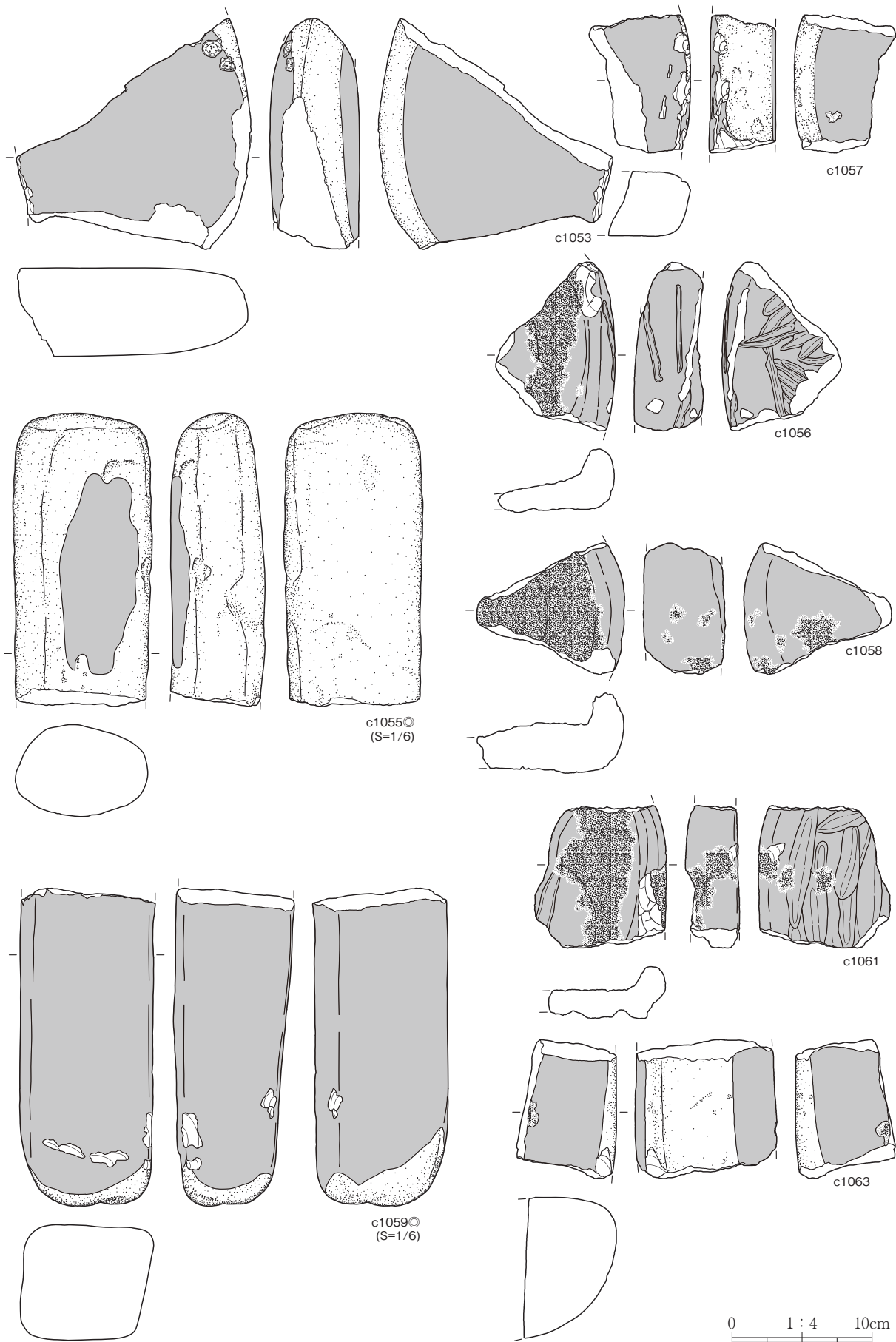

第 293 図 石器 (石皿・台石類 2)

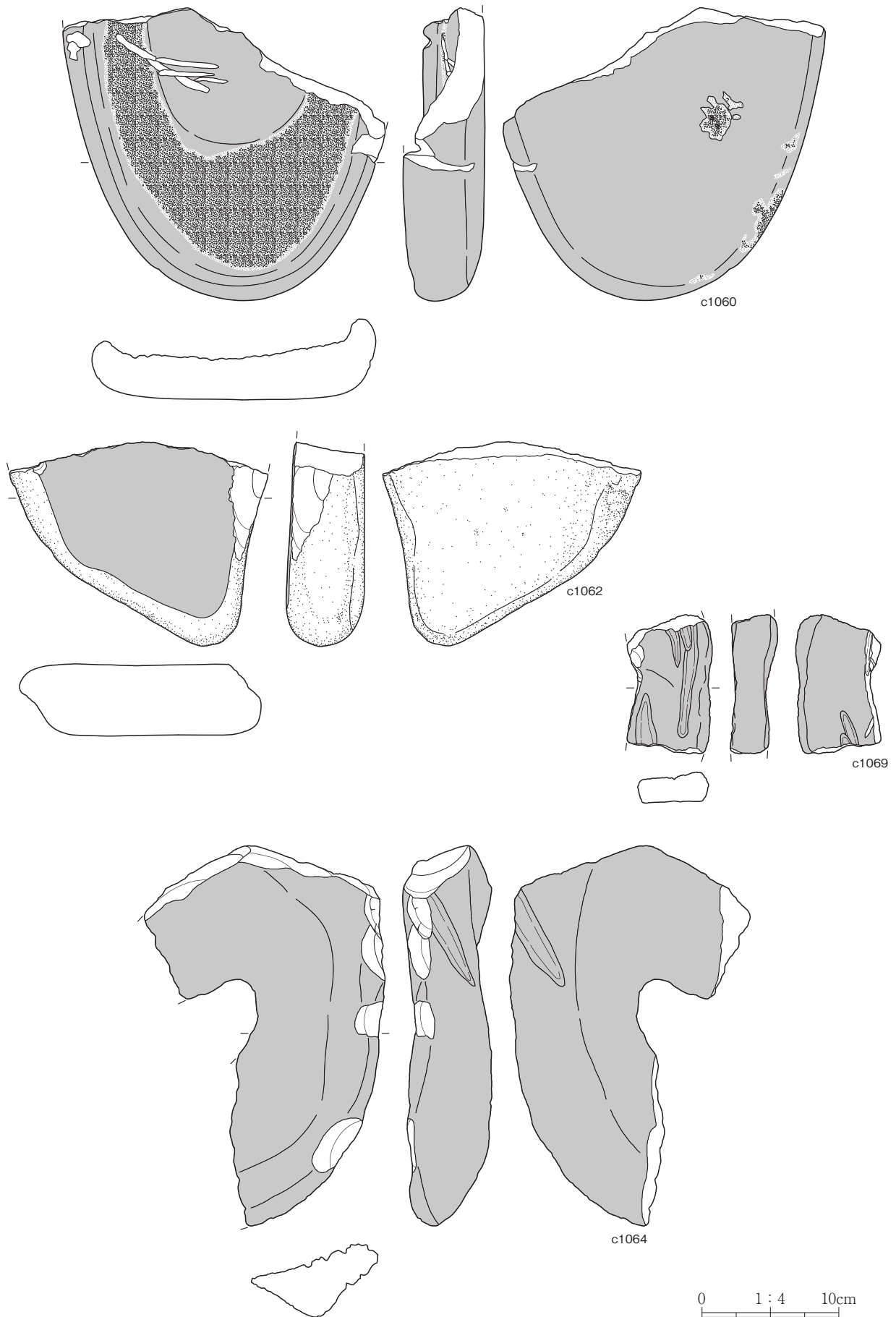

第 294 図 石器 (石皿・台石類 3)

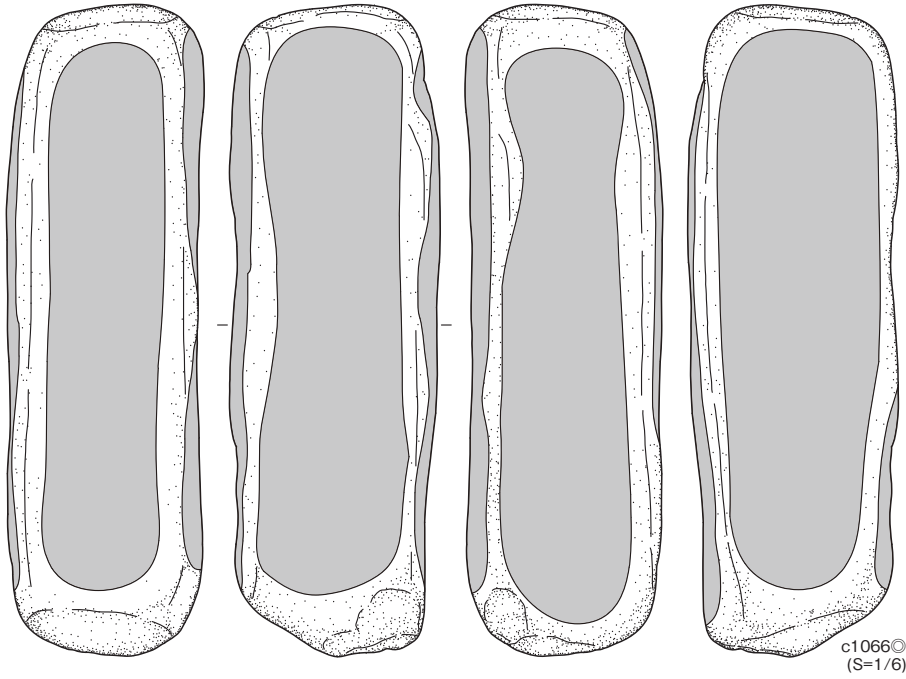

c1066◎
(S=1/6)

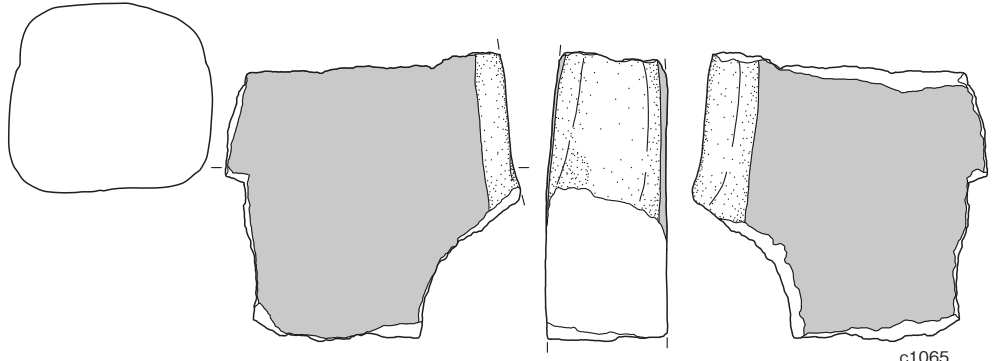

c1065

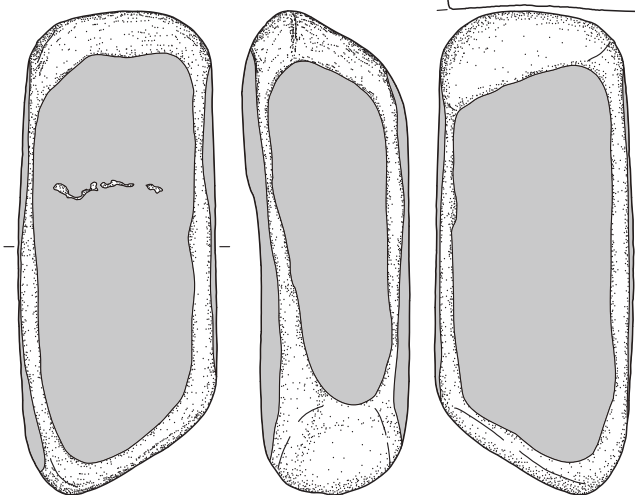

c1067◎
(S=1/6)

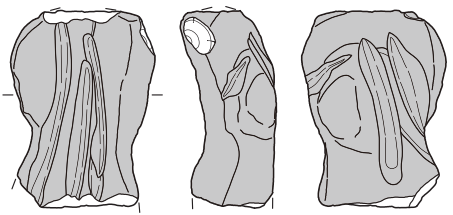
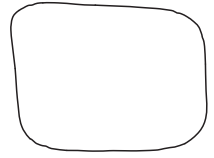

c1070

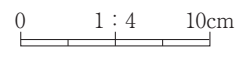

第 295 図 石器 (石皿・台石類 4)

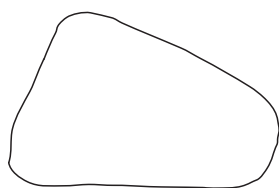
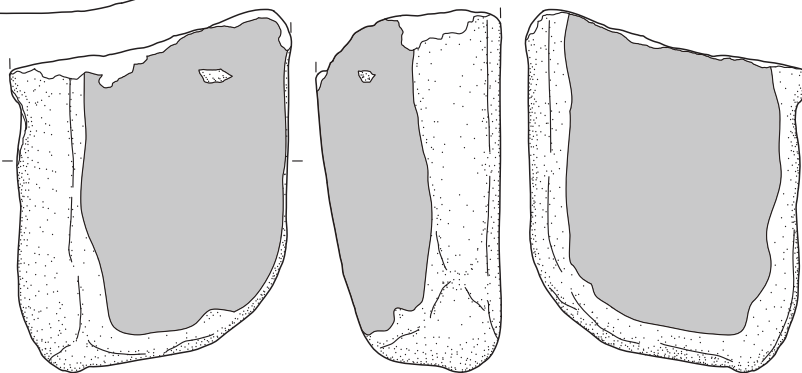
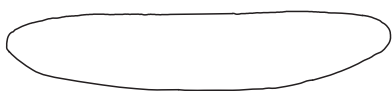
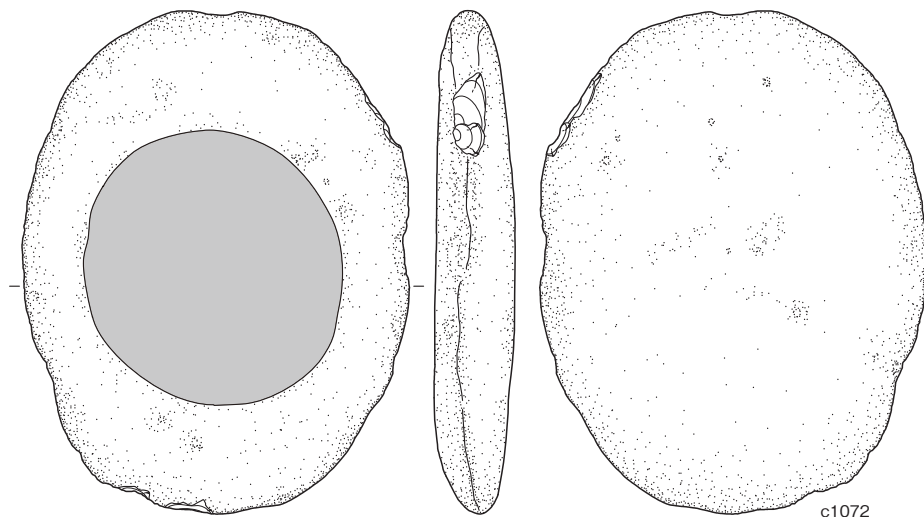
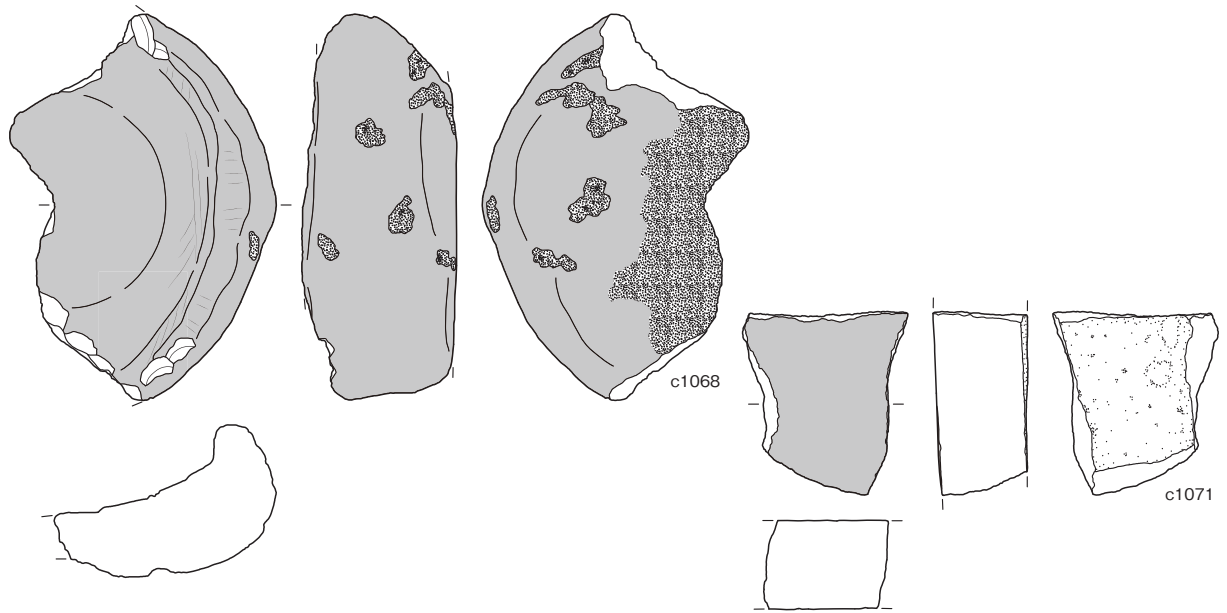

0 1 : 4 10cm

第 296 図 石器 (石皿・台石類 5)

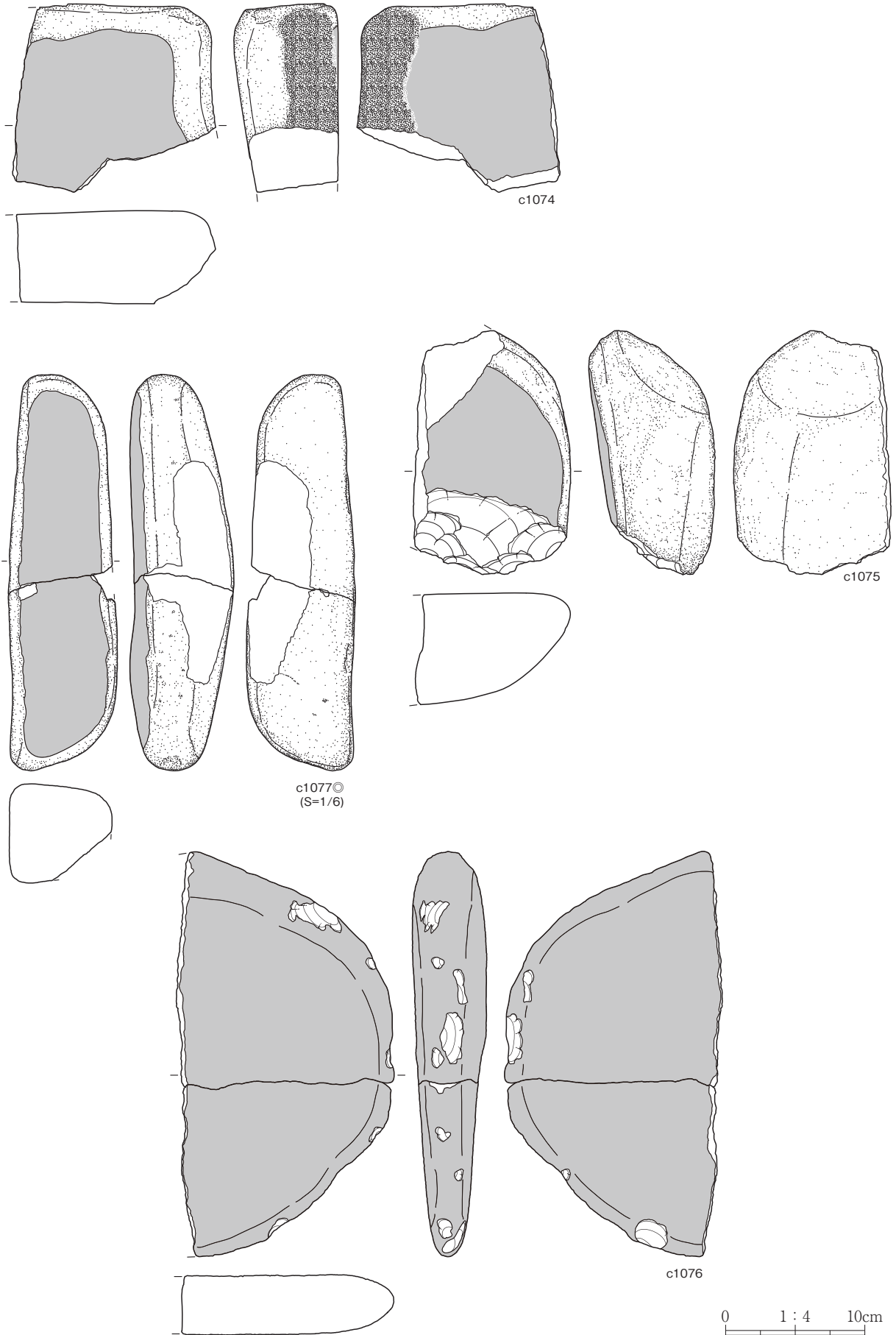

第 297 図 石器 (石皿・台石類 6)



第 298 図 石器 (石皿・台石類 7)

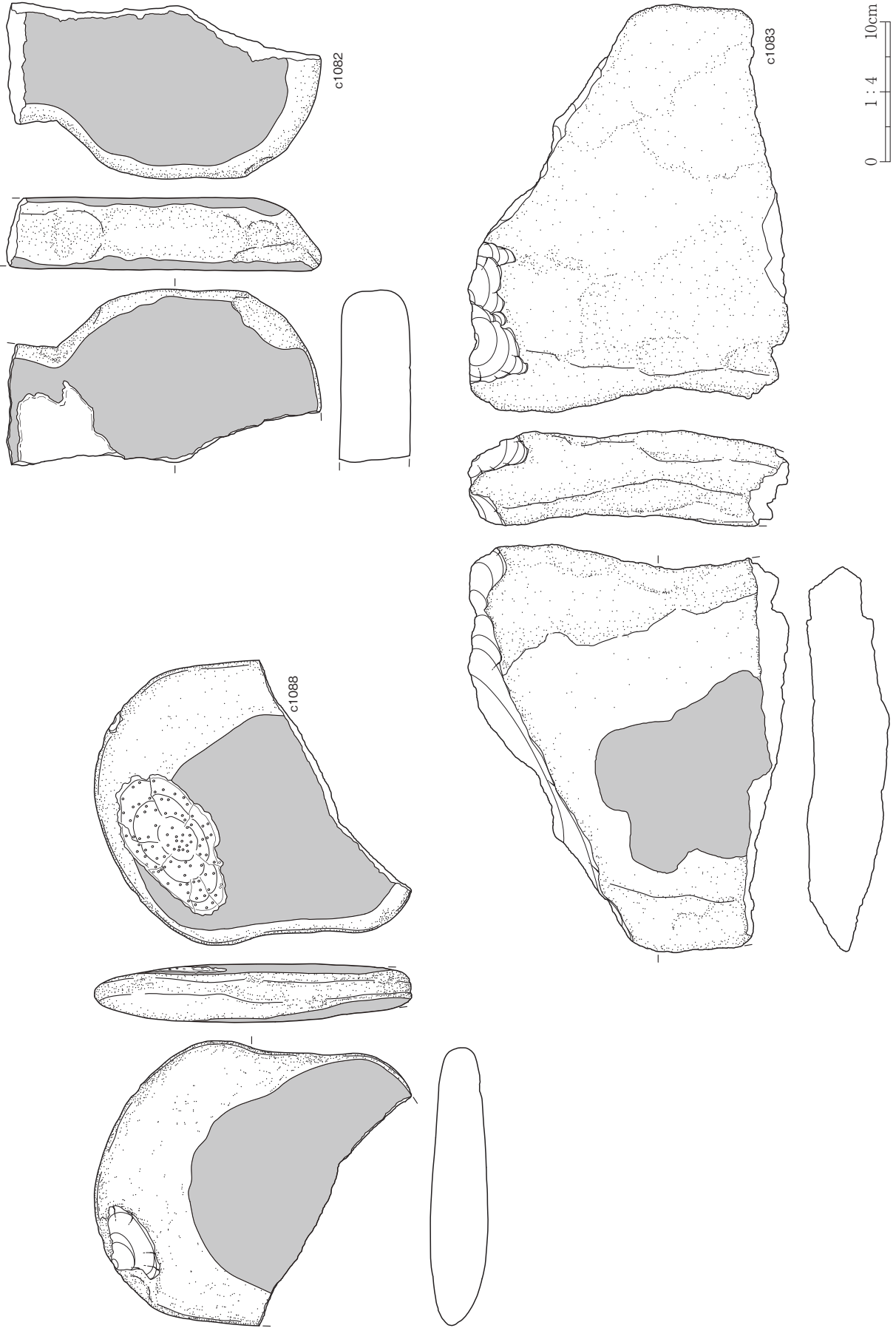

第 299 図 石器 (石皿・台石類 8)

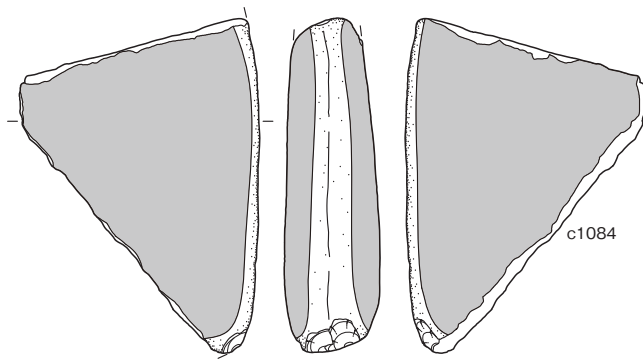

c1084

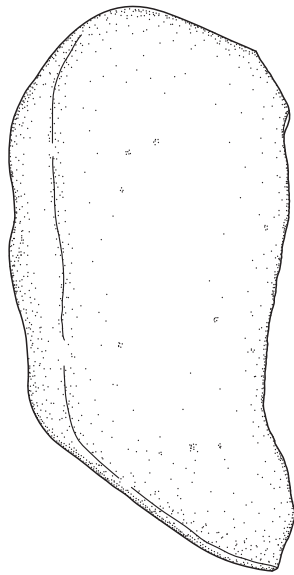
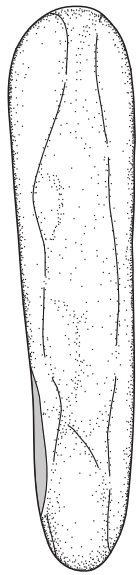
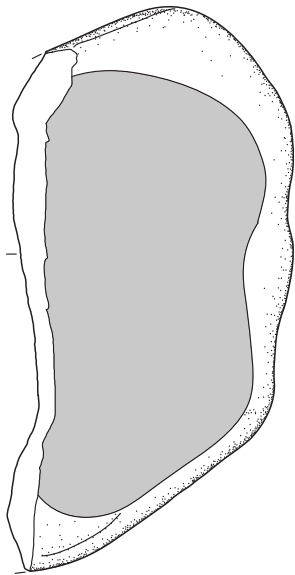

c1085

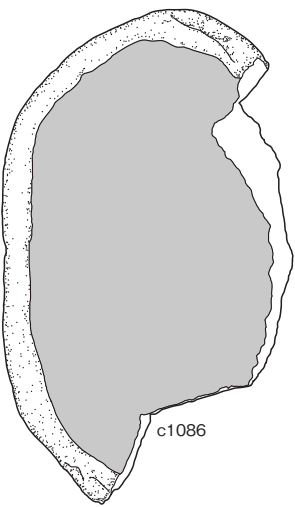
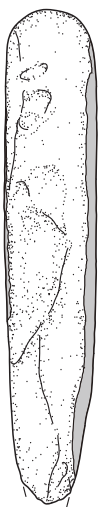
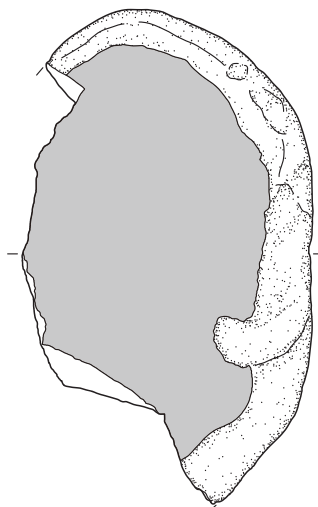

c1086

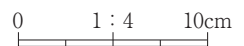

第 300 図 石器 (石皿・台石類 9)

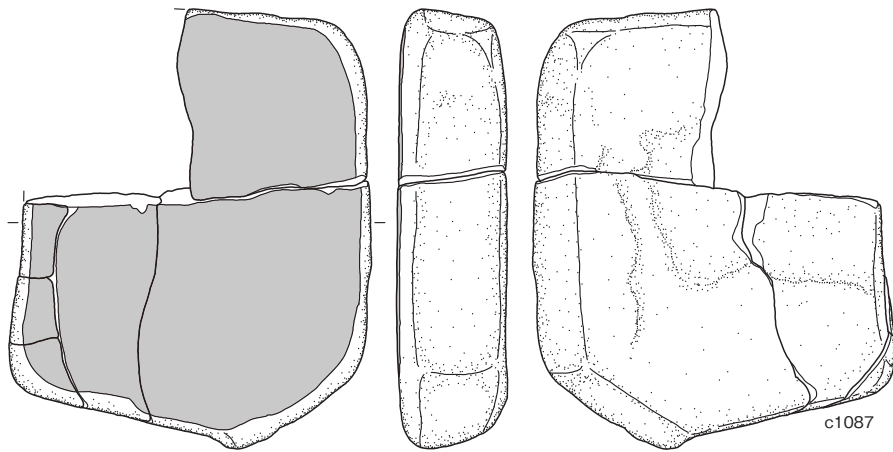

c1087

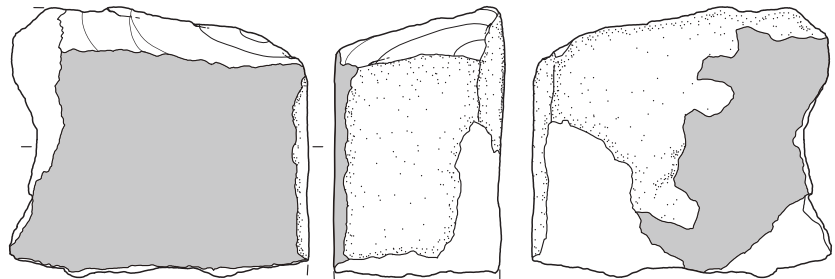
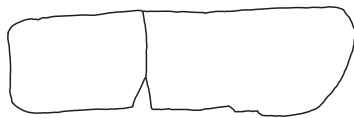

c1089

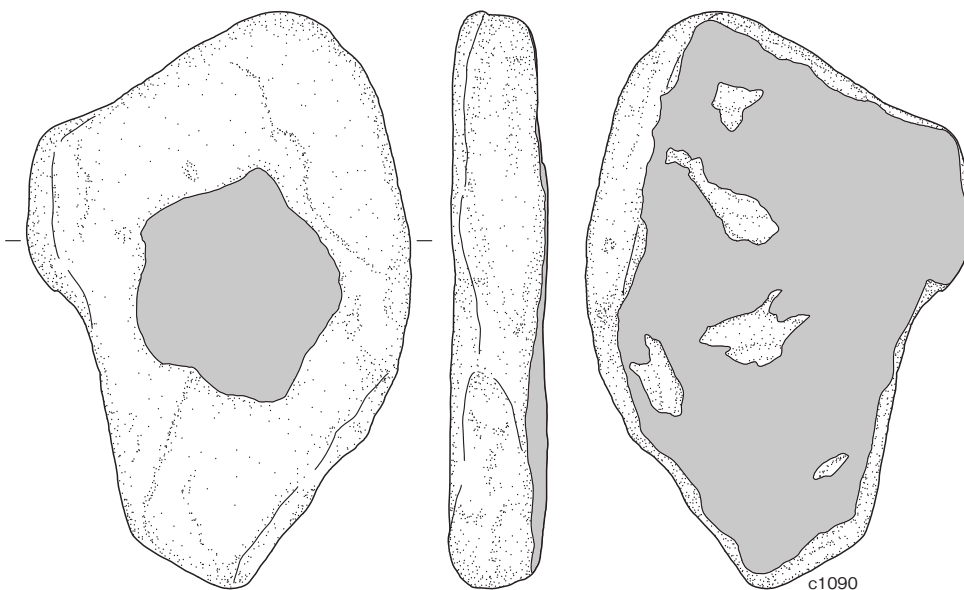
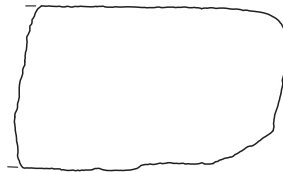

c1090

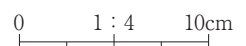

第 301 図 石器 (石皿・台石類 10)

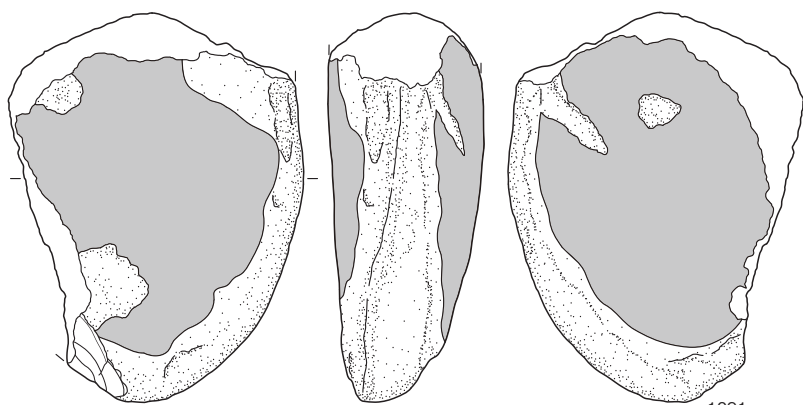

c1091

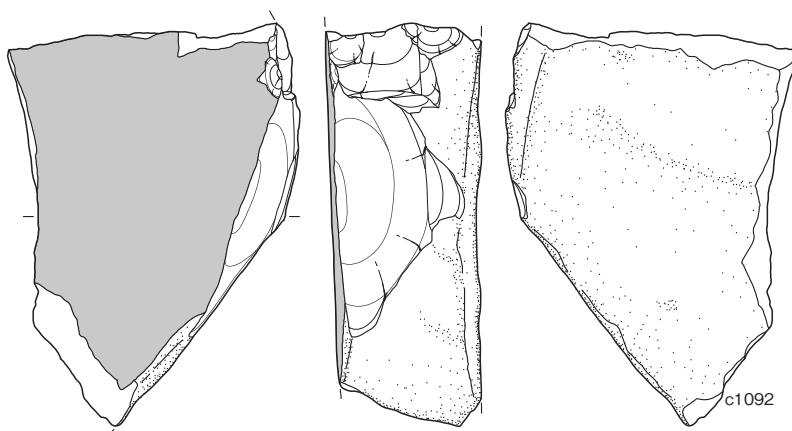
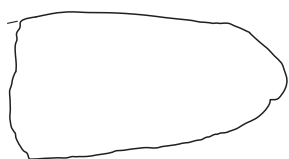

c1092

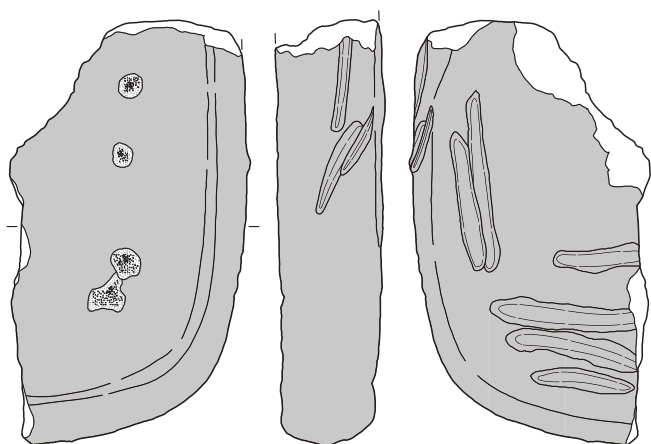
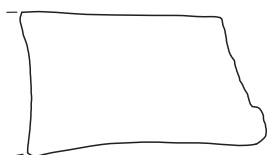

c1093



0 1 : 4 10cm

第 302 図 石器 (石皿・台石類 11)

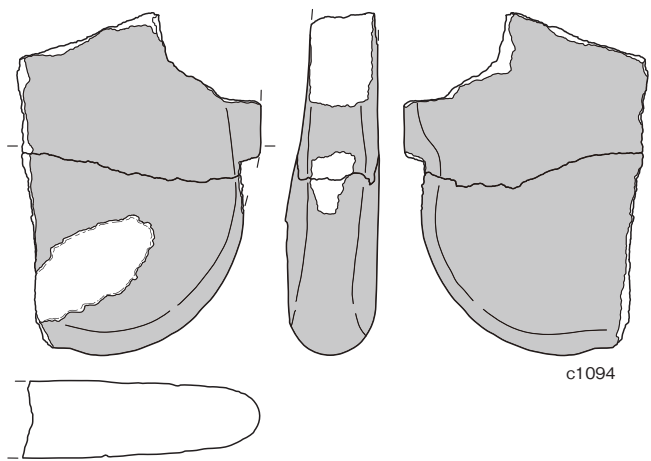

c1094

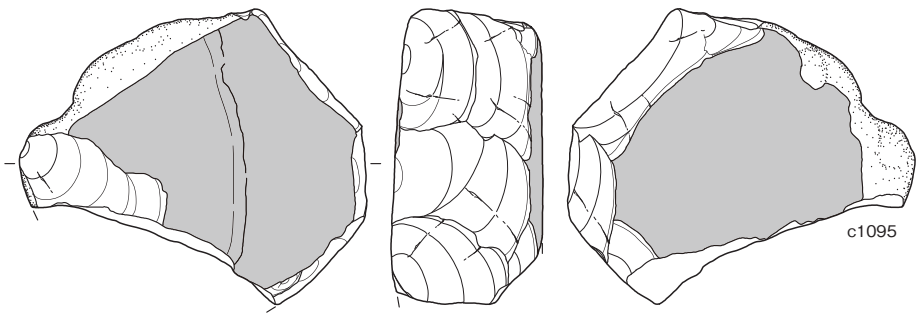

c1095

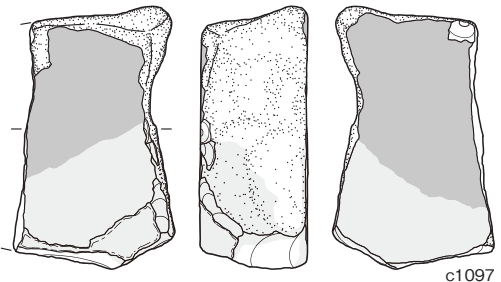
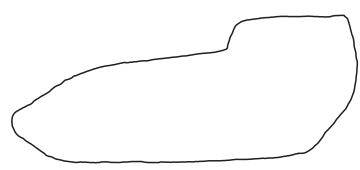

c1097

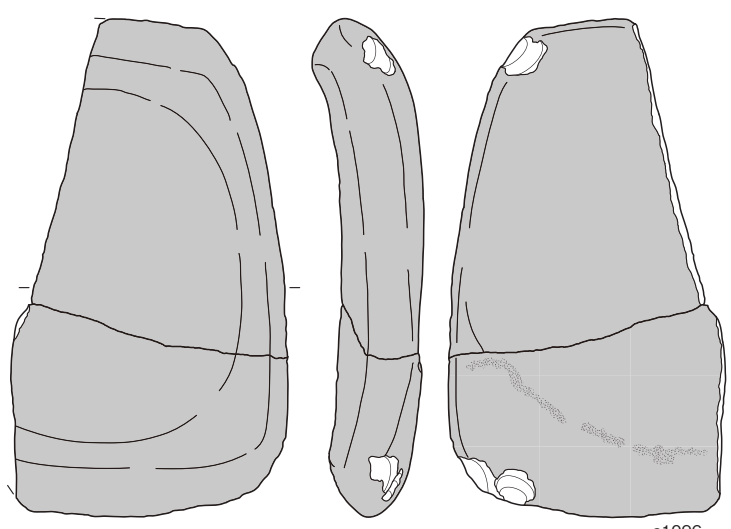
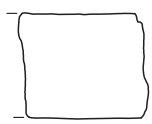

c1096

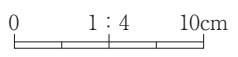

第 303 図 石器 (石皿・台石類 12)

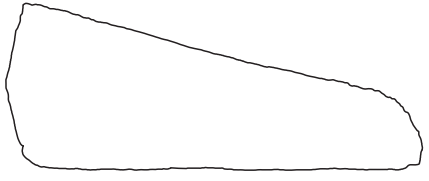
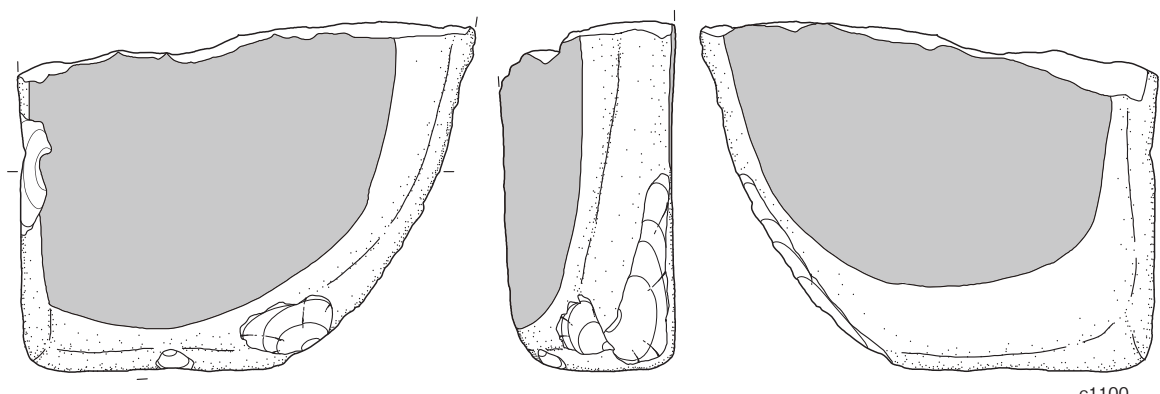
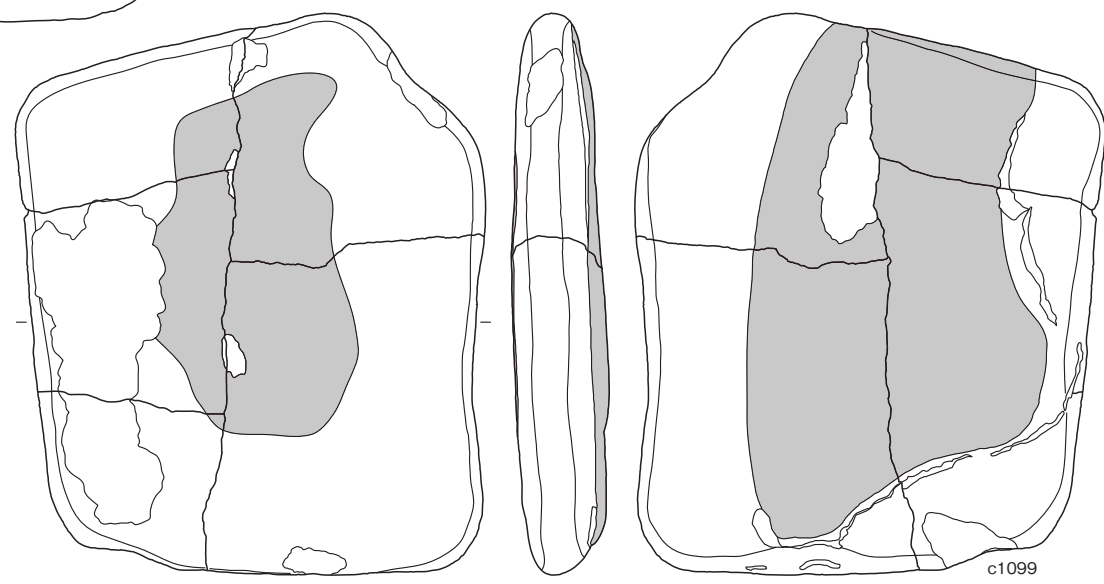
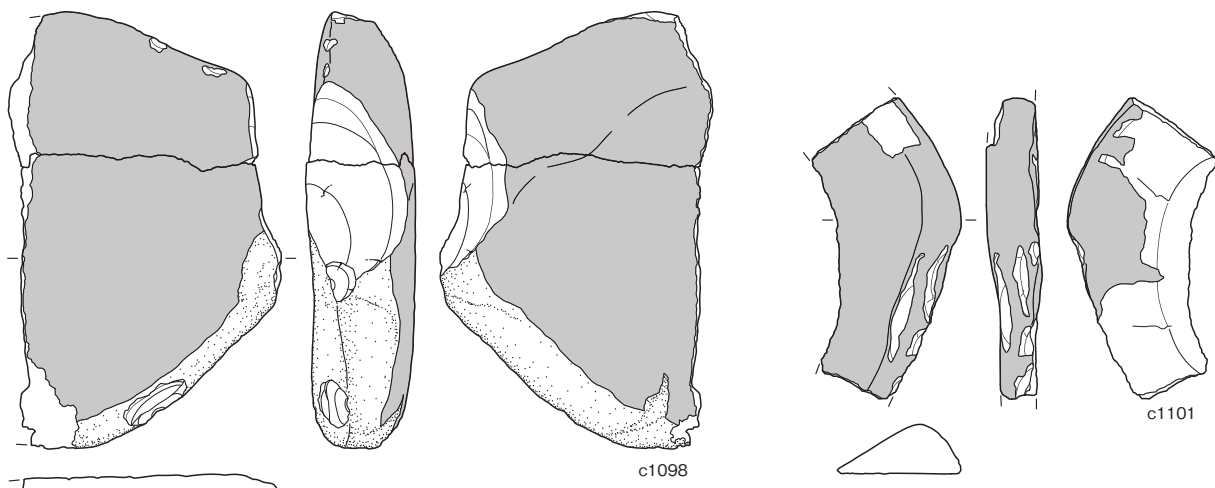

0 1 : 4 10cm

第 304 図 石器 (石皿・台石類 13)

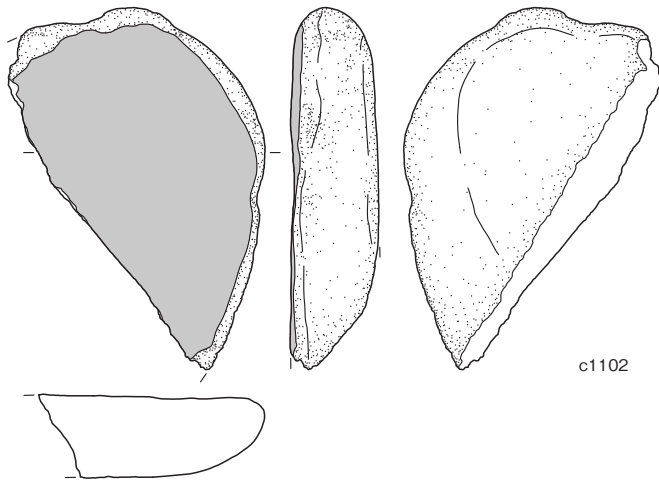

c1102

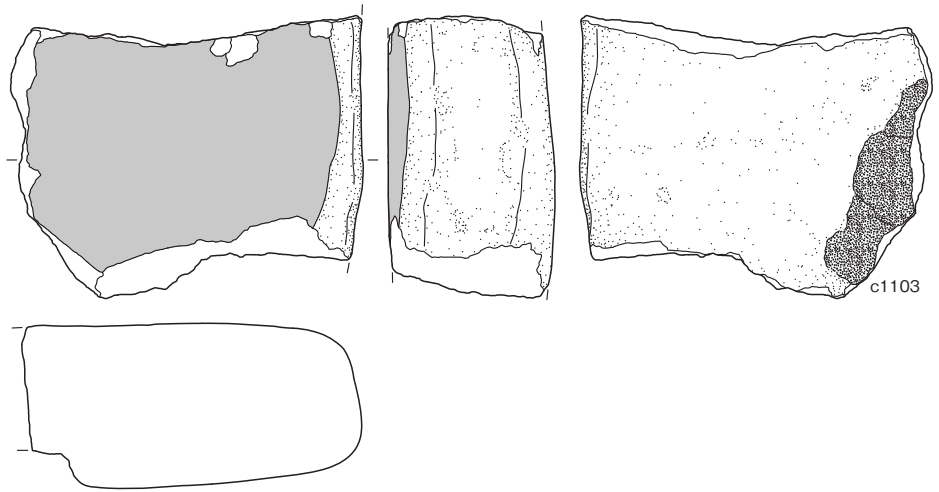

c1103

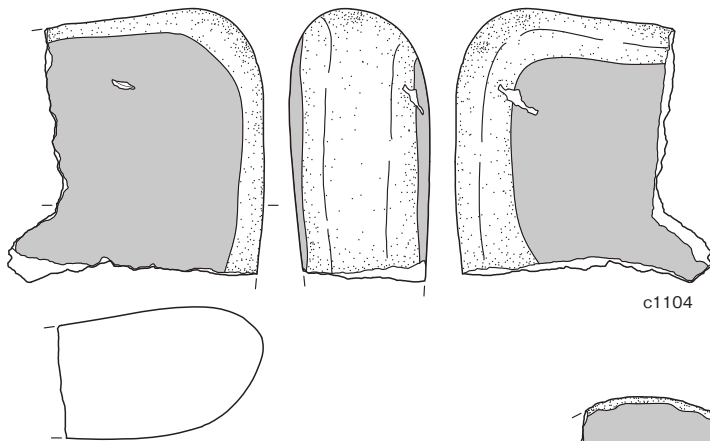

c1104

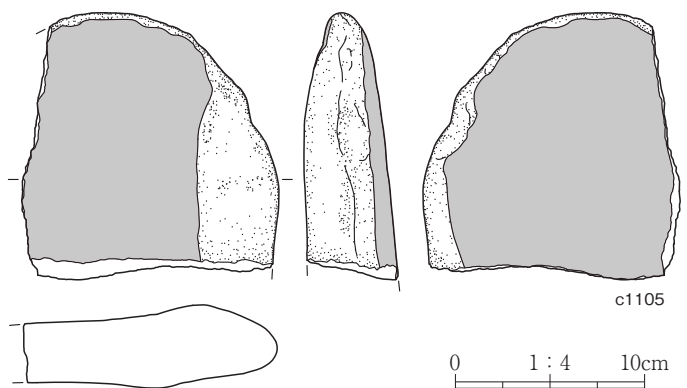

c1105

0 1:4 10cm

第 305 図 石器 (石皿・台石類 14)

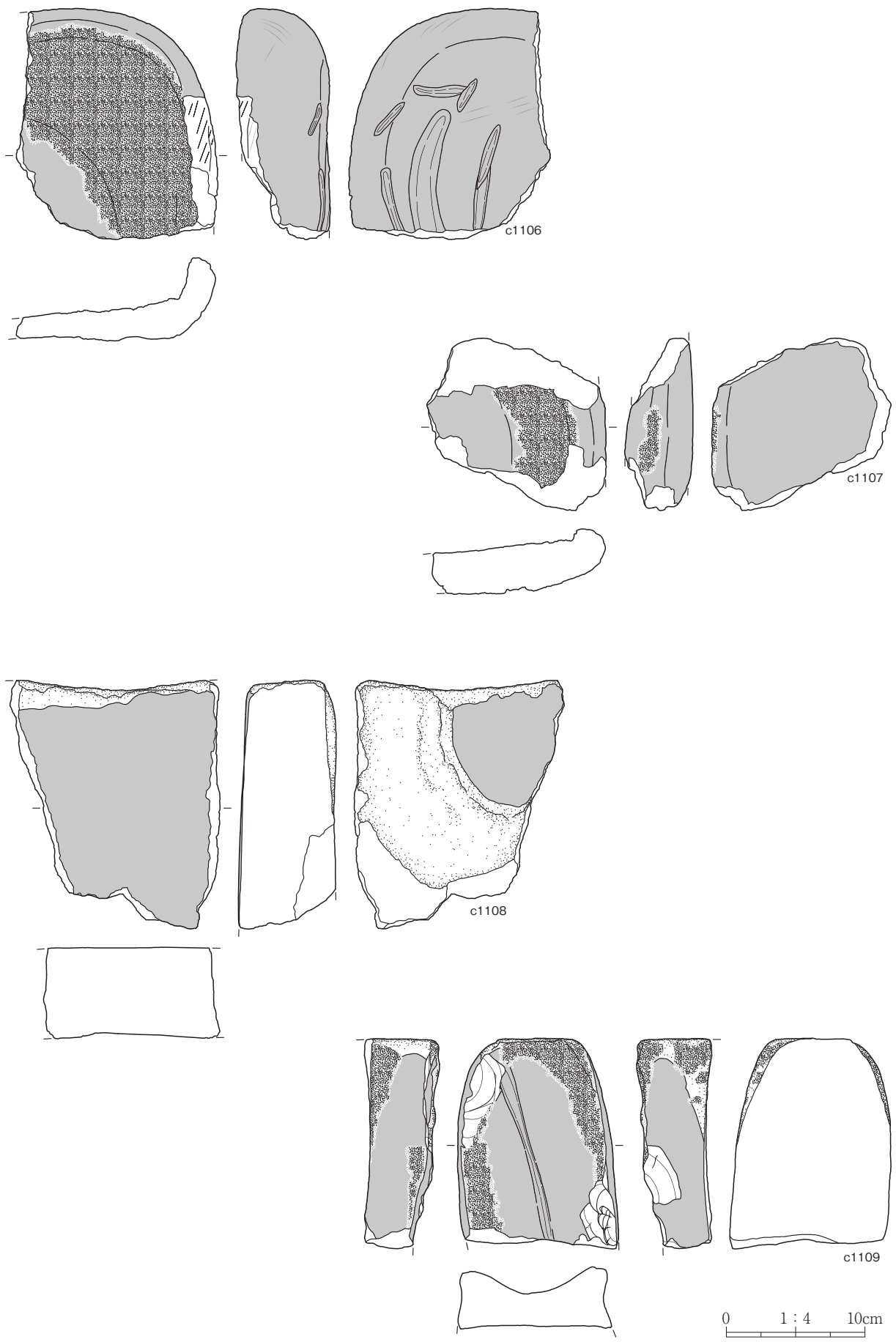

第 306 図 石器 (石皿・台石類 15)

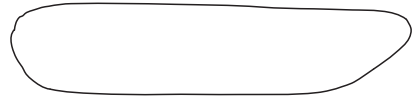
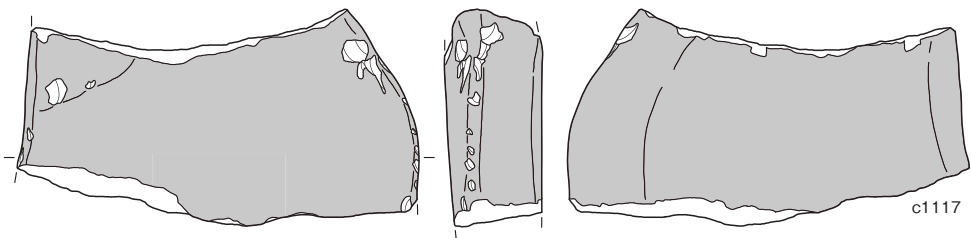
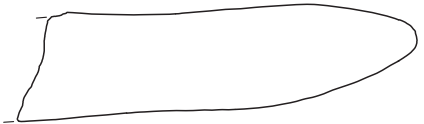
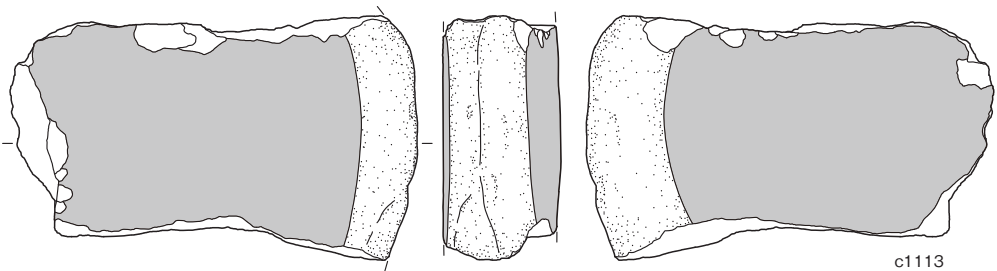
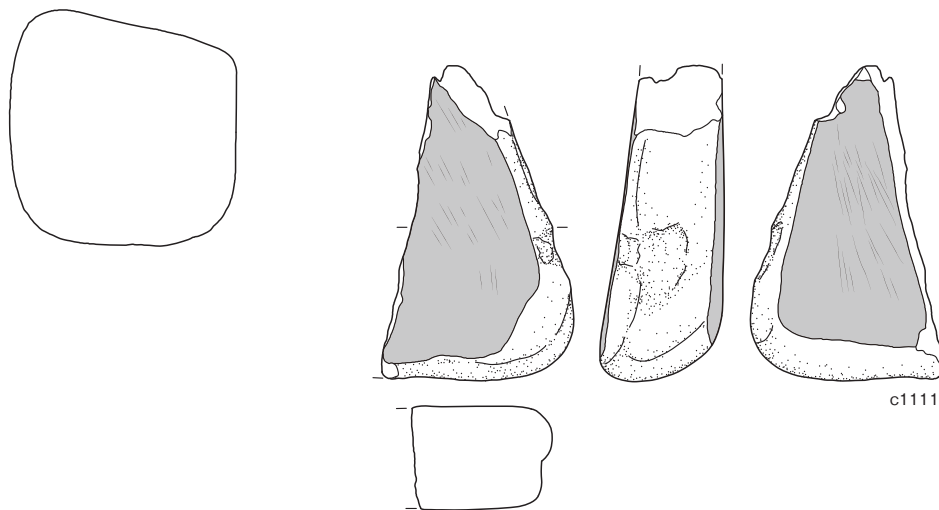
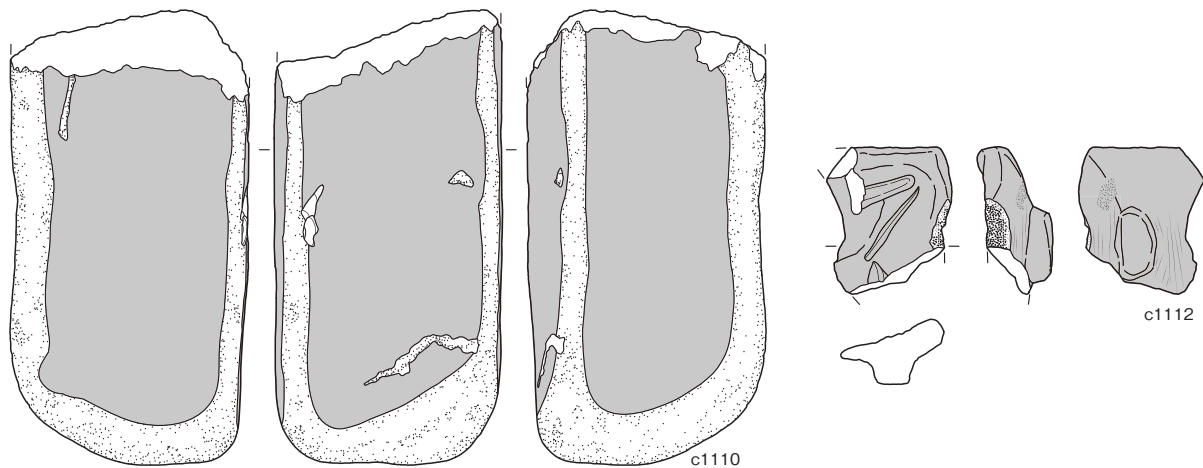

0 1:4 10cm

第 307 図 石器 (石皿・台石類 16)

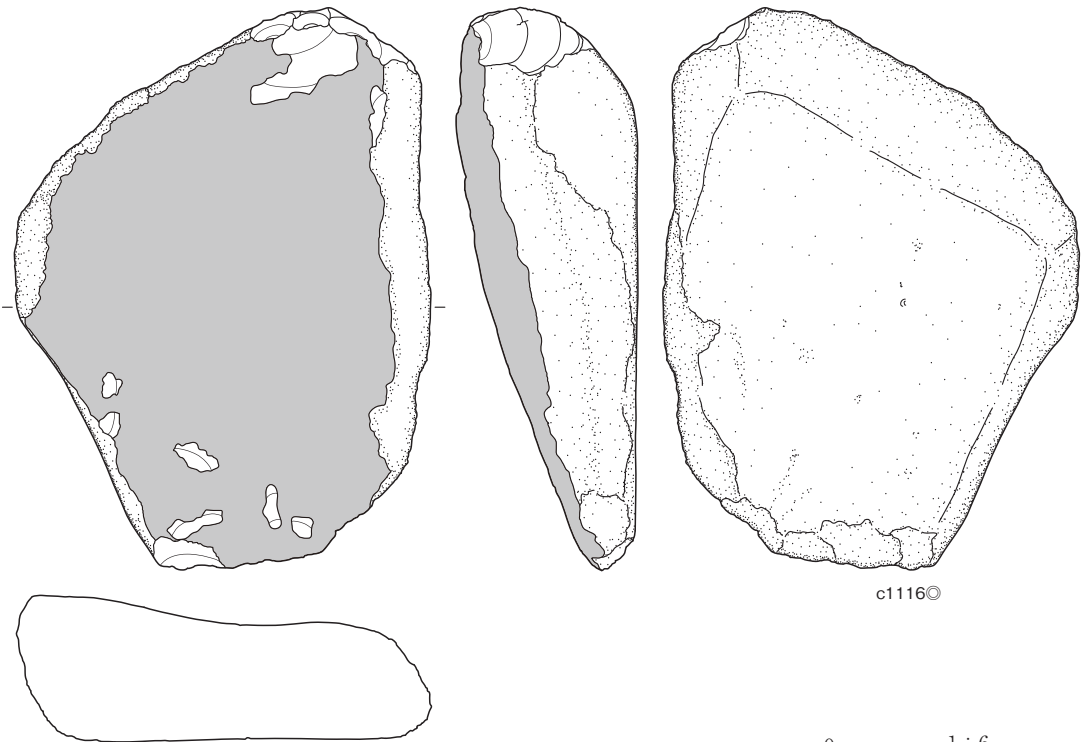
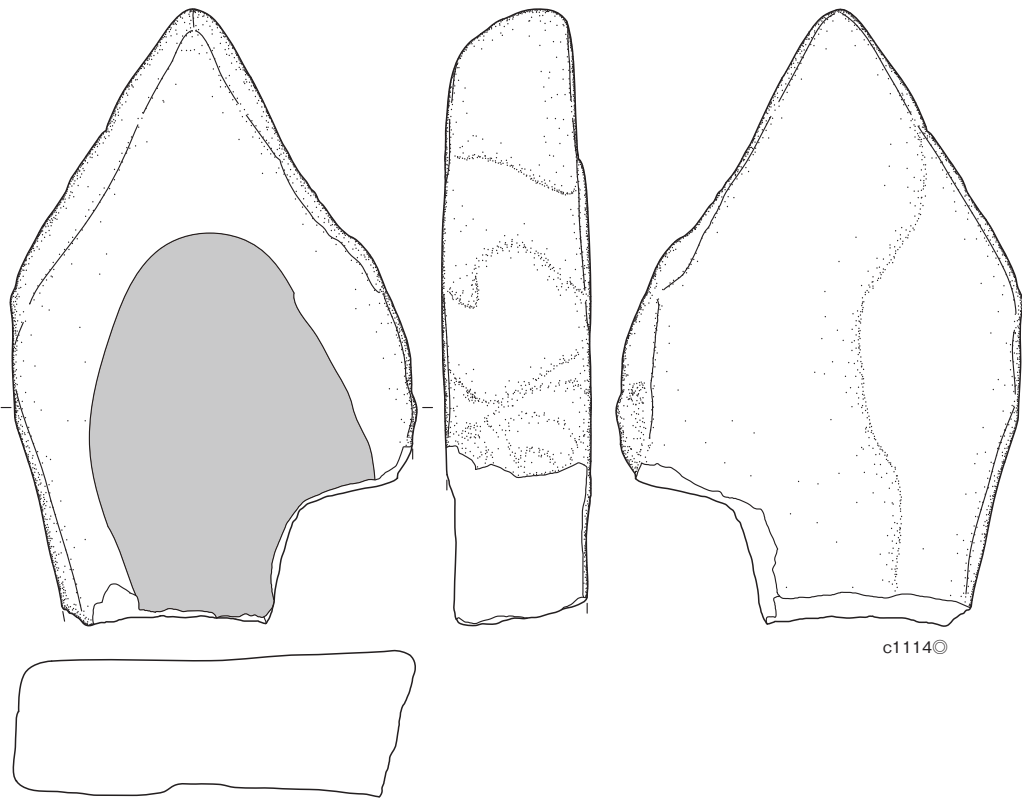

0 1:6 10cm

第 308 図 石器 (石皿・台石類 17)

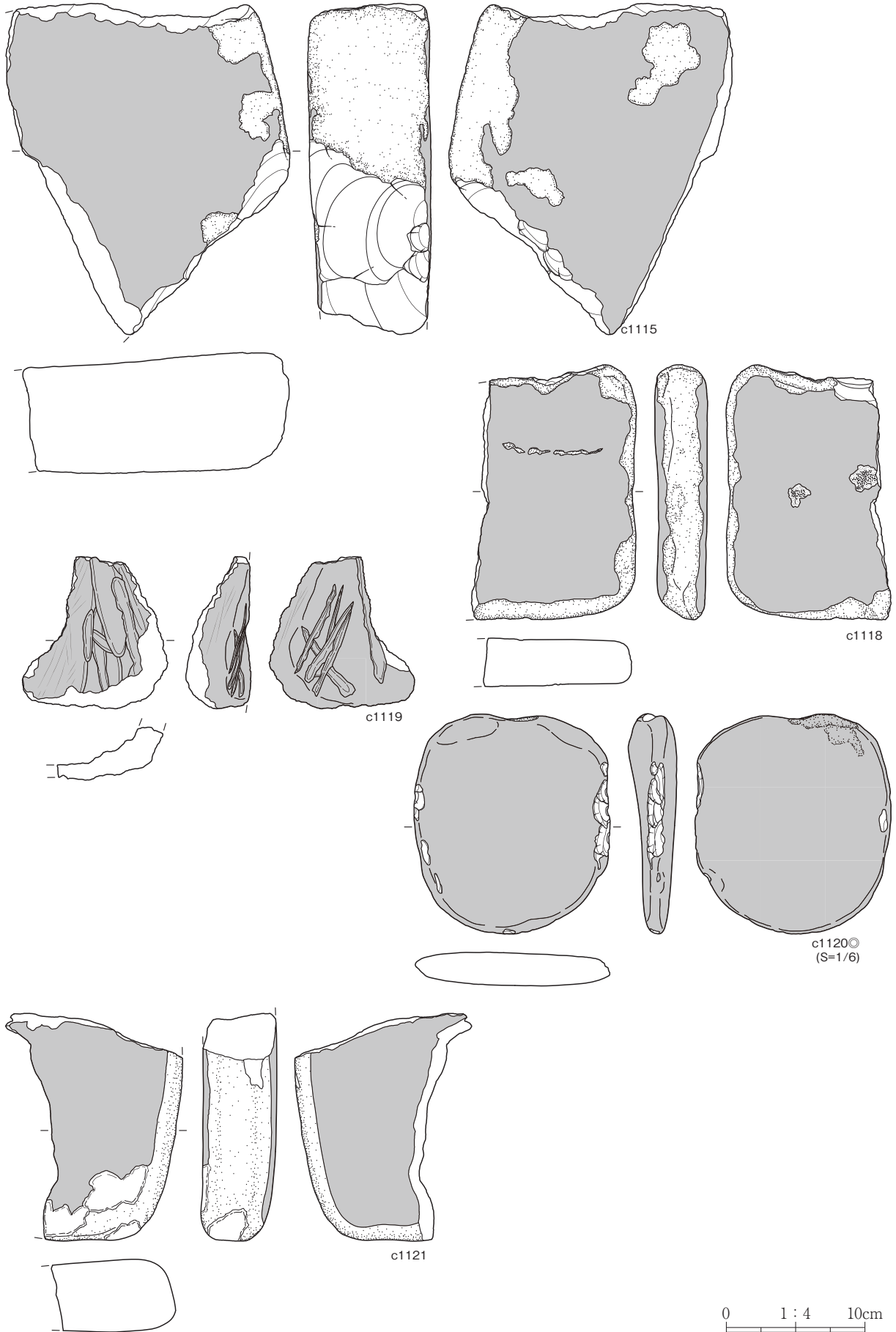

第 309 図 石器 (石皿・台石類 18)

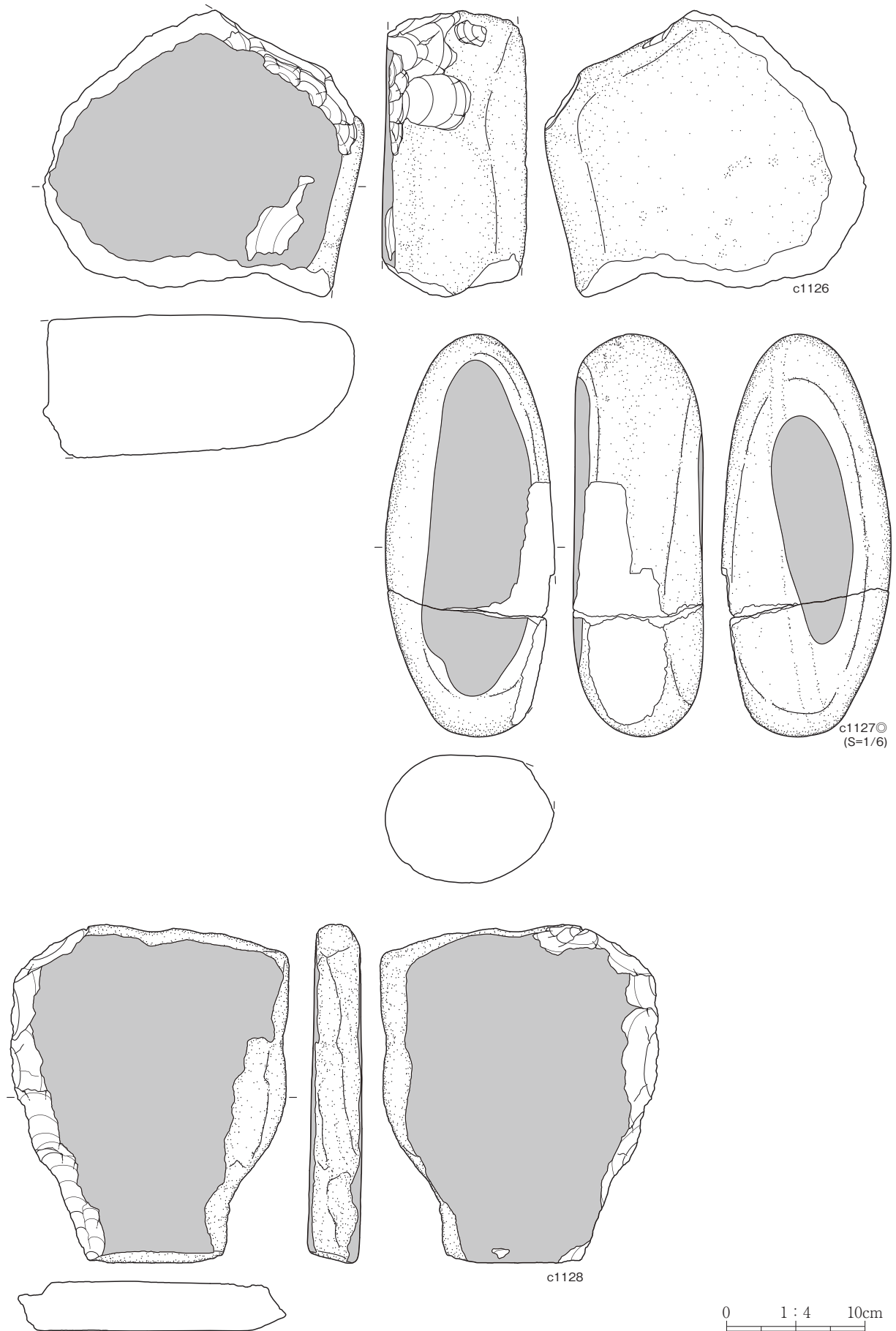

第 311 図 石器 (石皿・台石類 20)

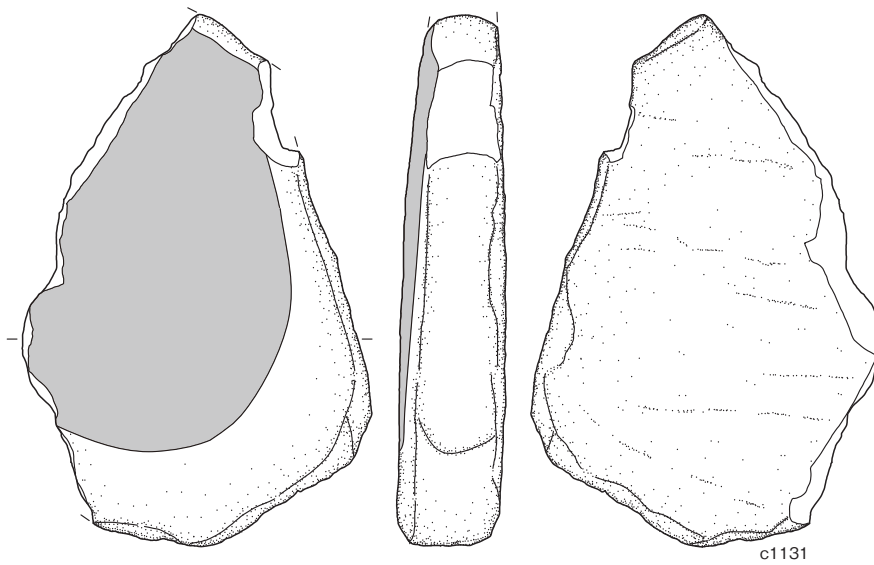
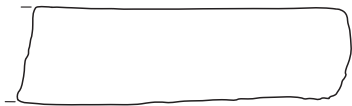
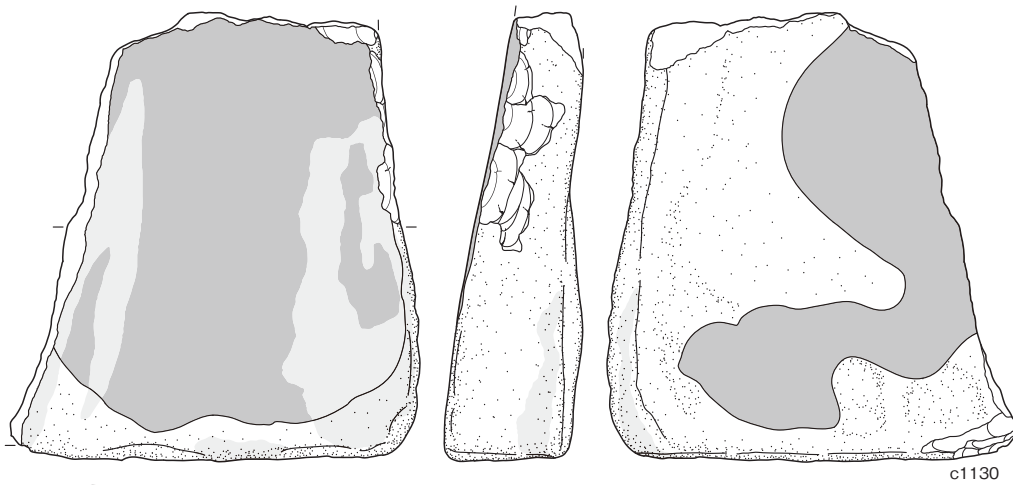
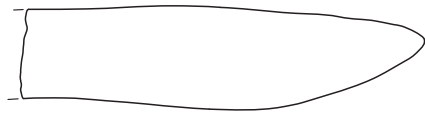
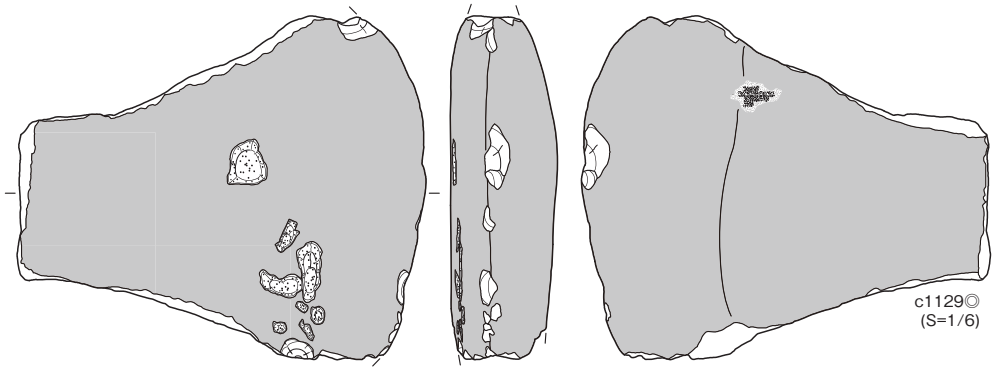

0 1 : 4 10cm

第 312 図 石器 (石皿・台石類 21)

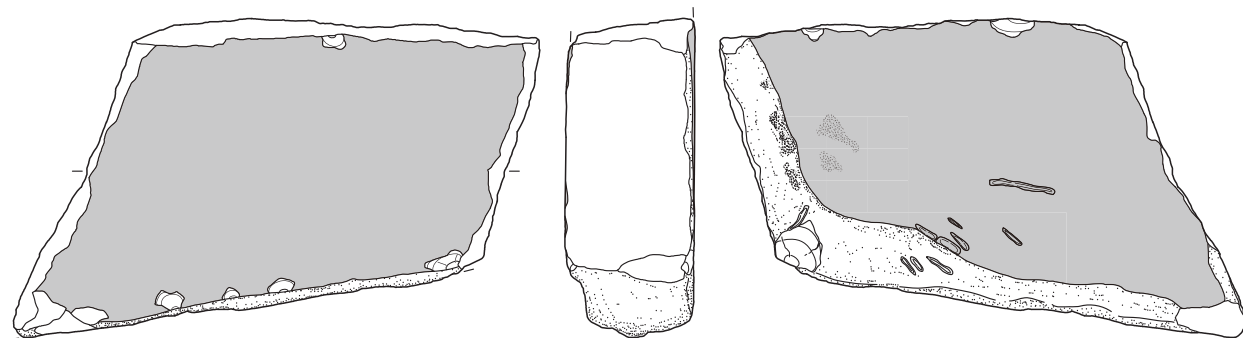

c1132

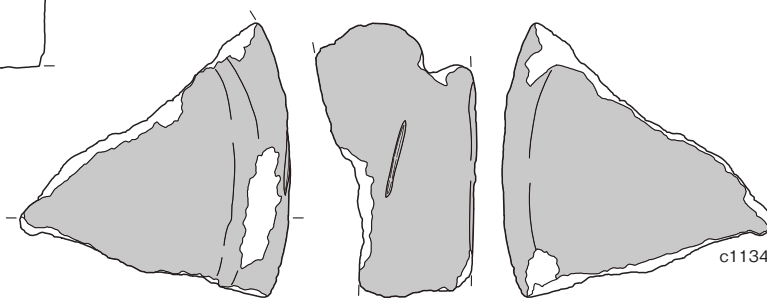

c1134

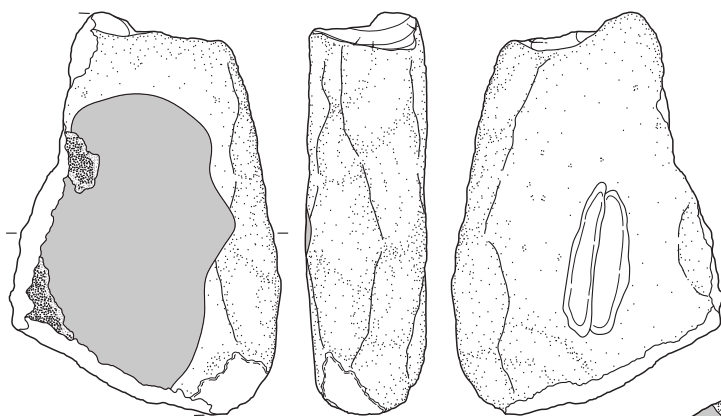

c1133

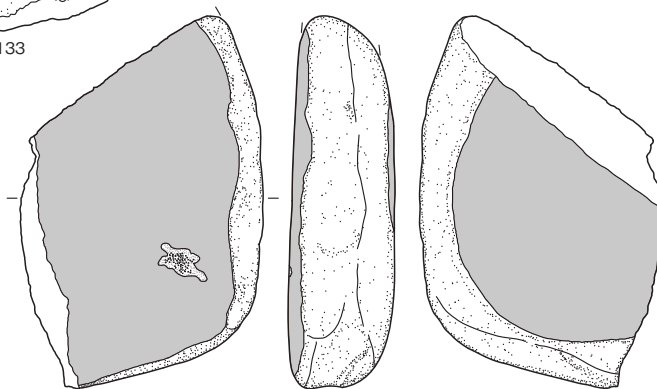

c1135



0 1 : 4 10cm

第 313 図 石器 (石皿・台石類 22)

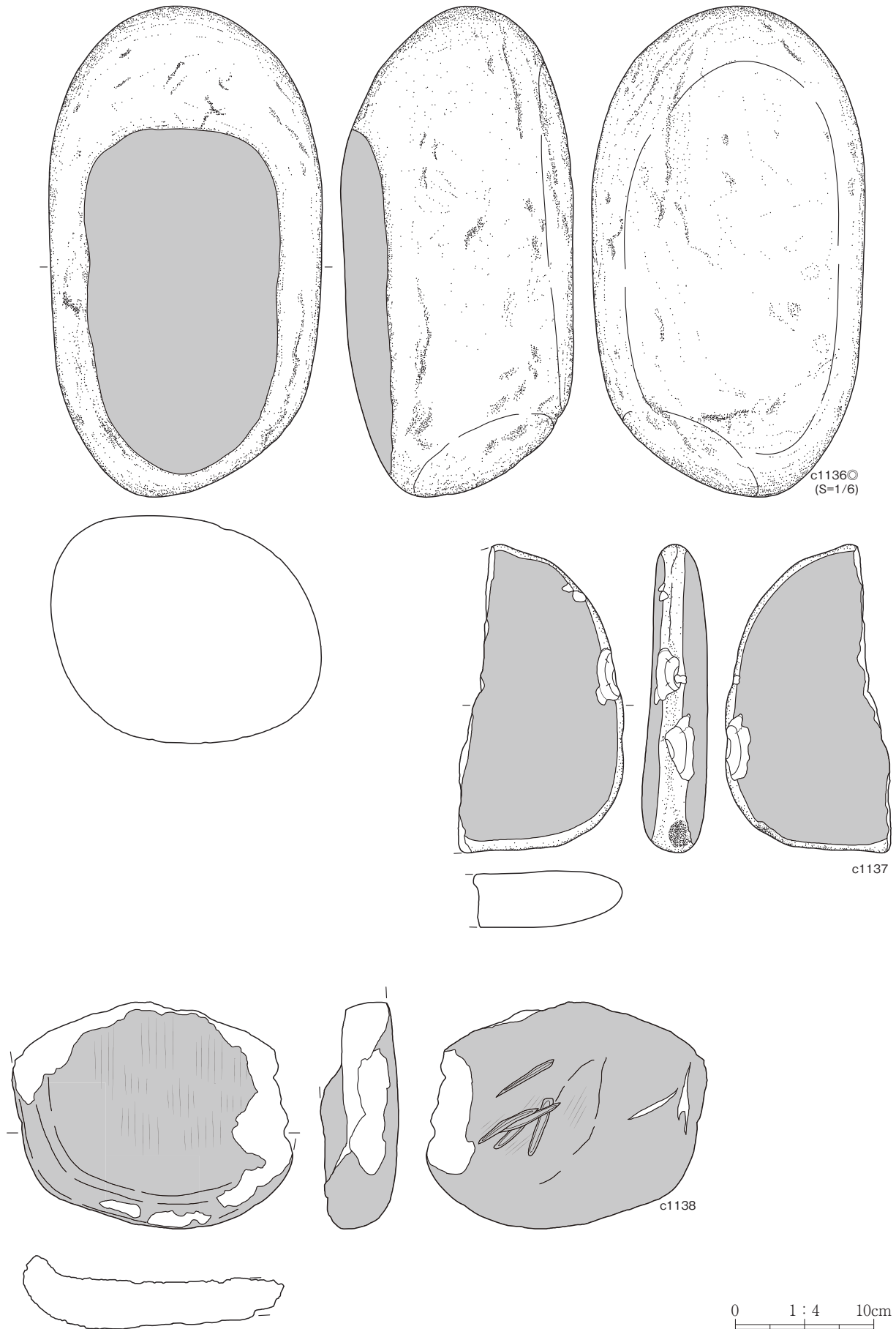

第 314 図 石器 (石皿・台石類 23)

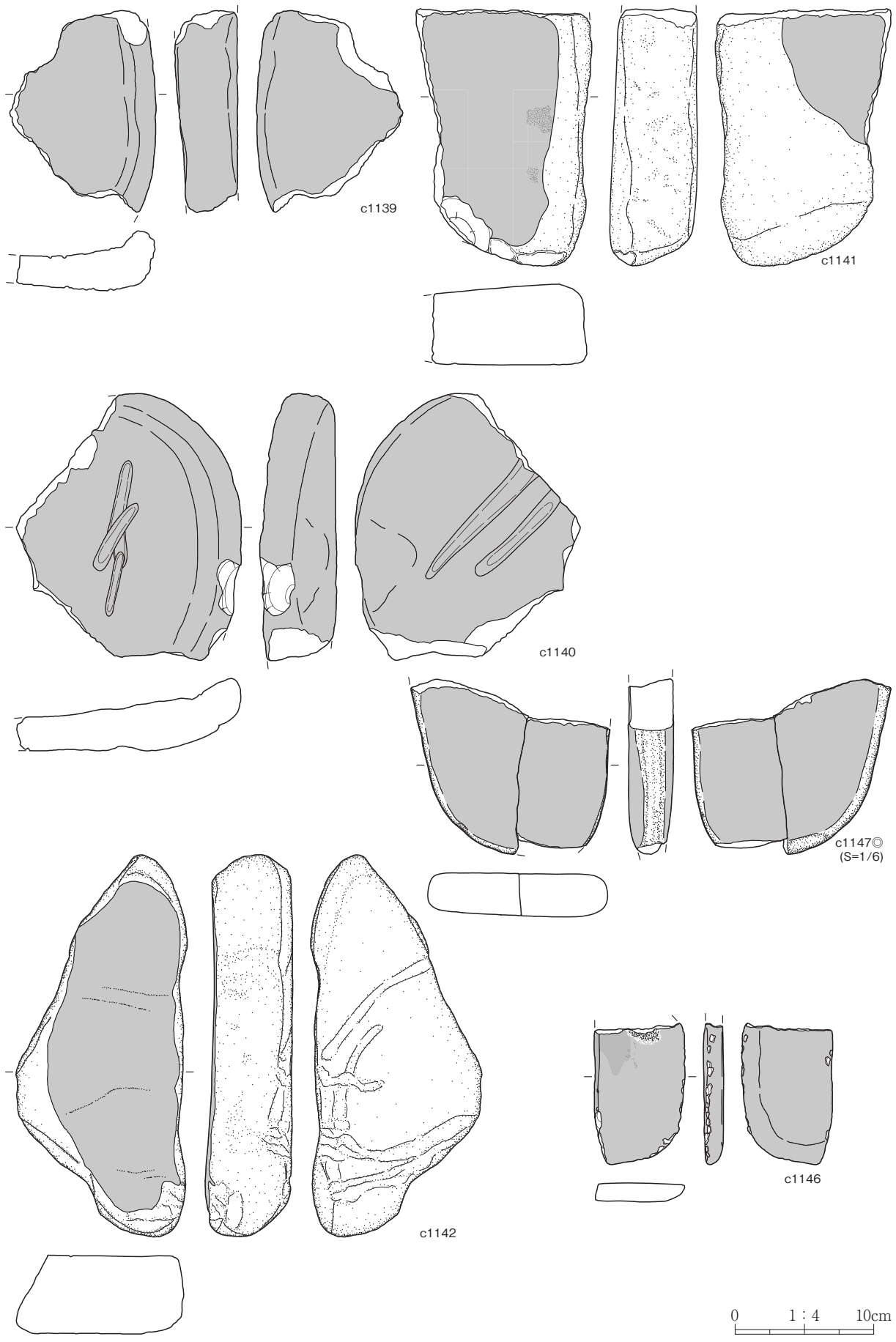

第 315 図 石器 (石皿・台石類 24)

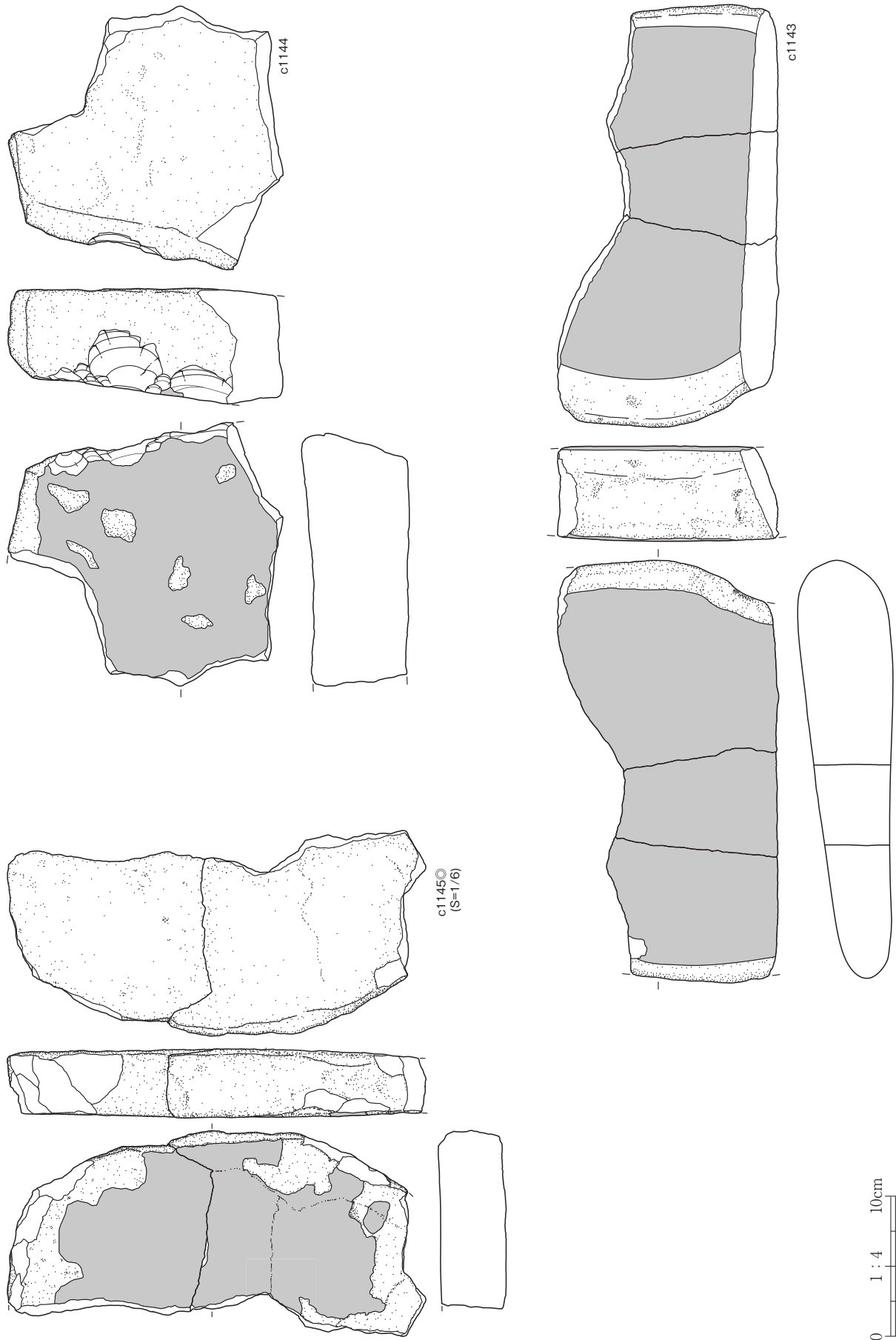

第316図 石器 (石皿・台石類 25)



第 317 図 石器 (石皿・台石類 26)

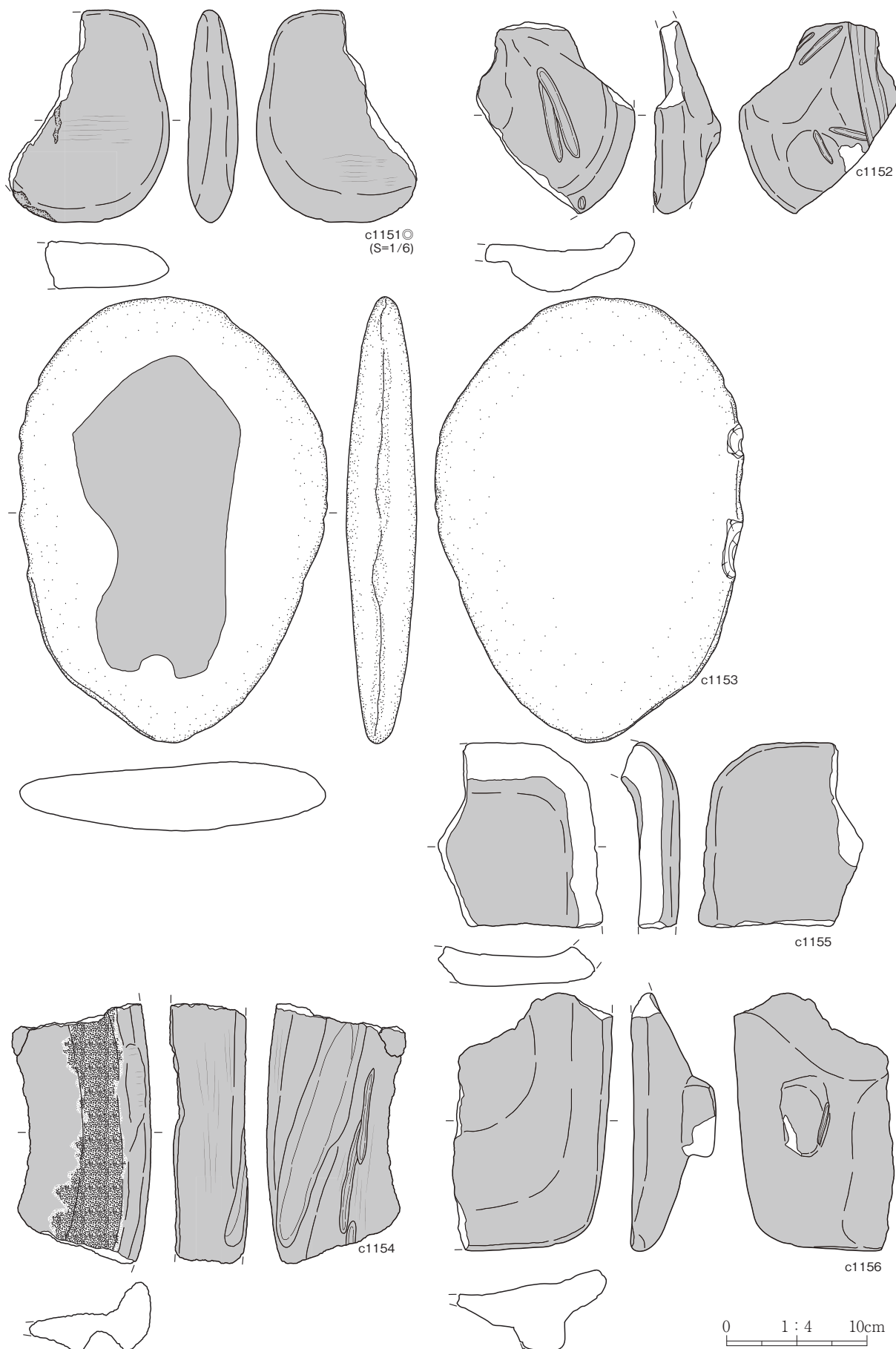

第318図 石器(石皿・台石類27)

敲磨器類

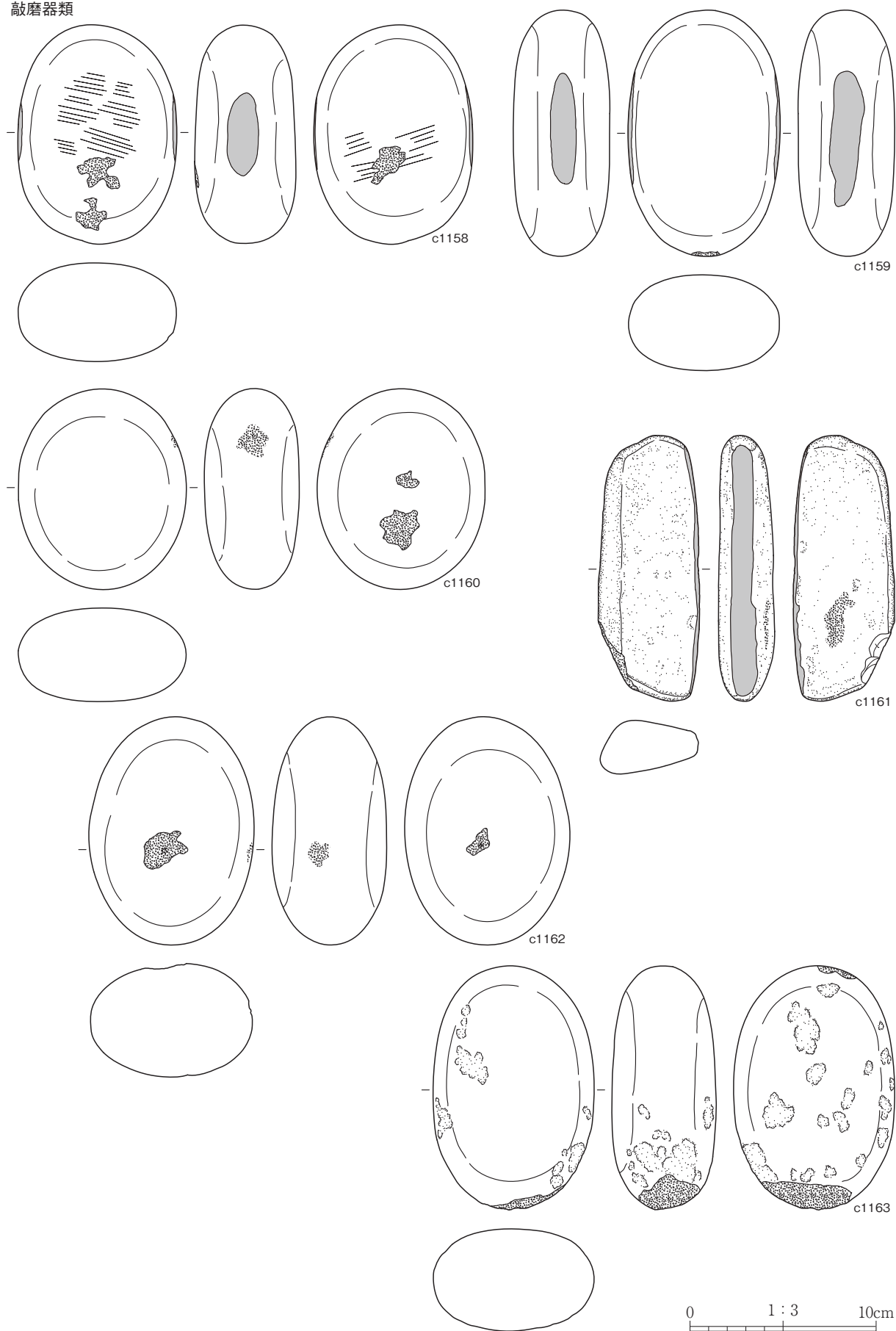

第319図 石器（敲磨器類1）

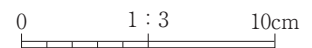
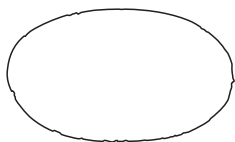
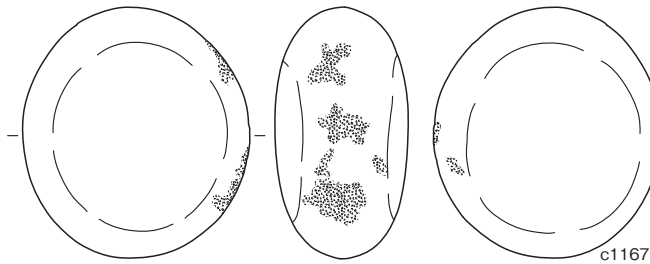
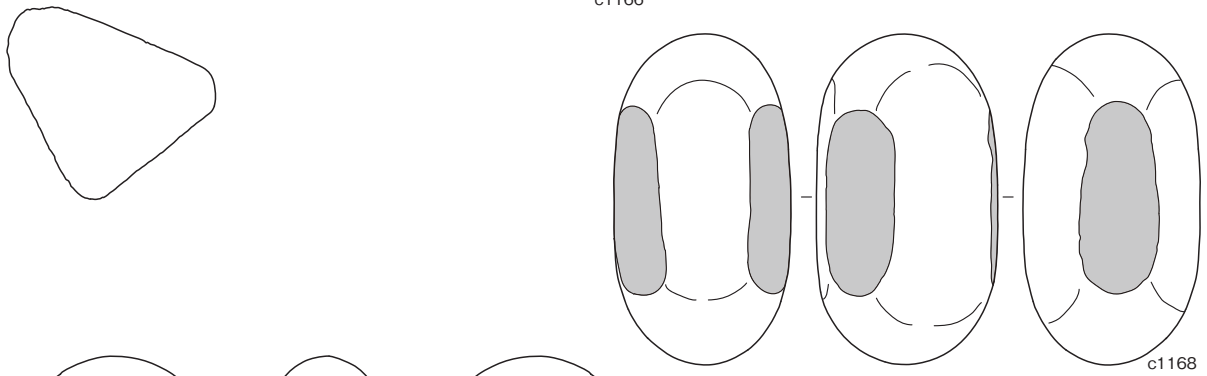
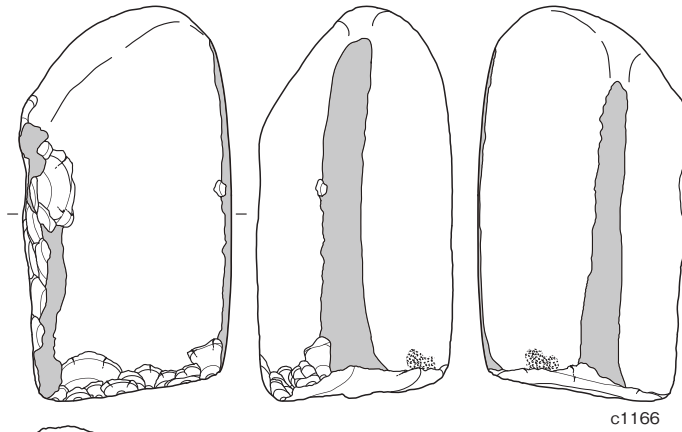
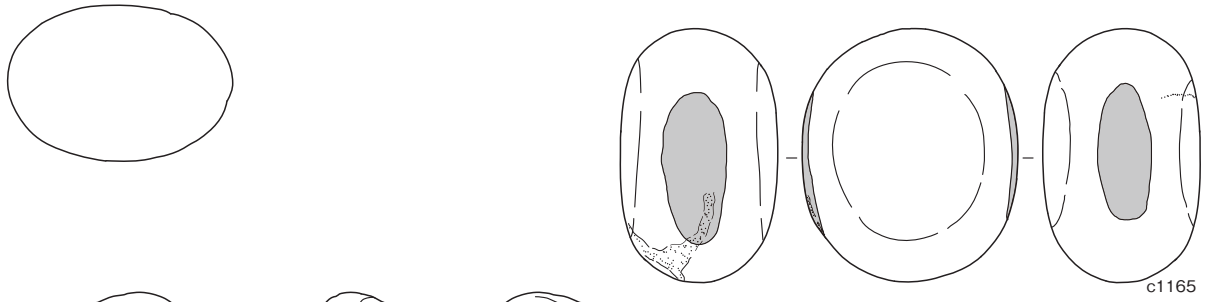
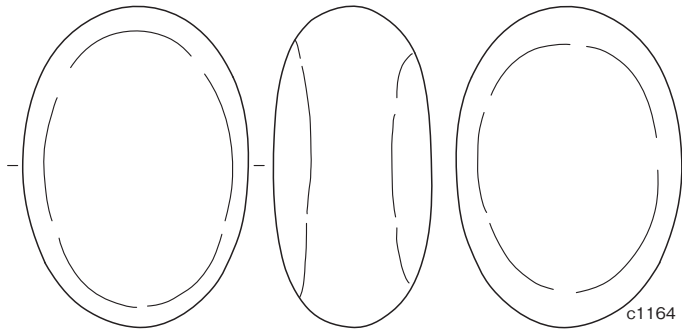

第 320 図 石器 (敲磨器類 2)

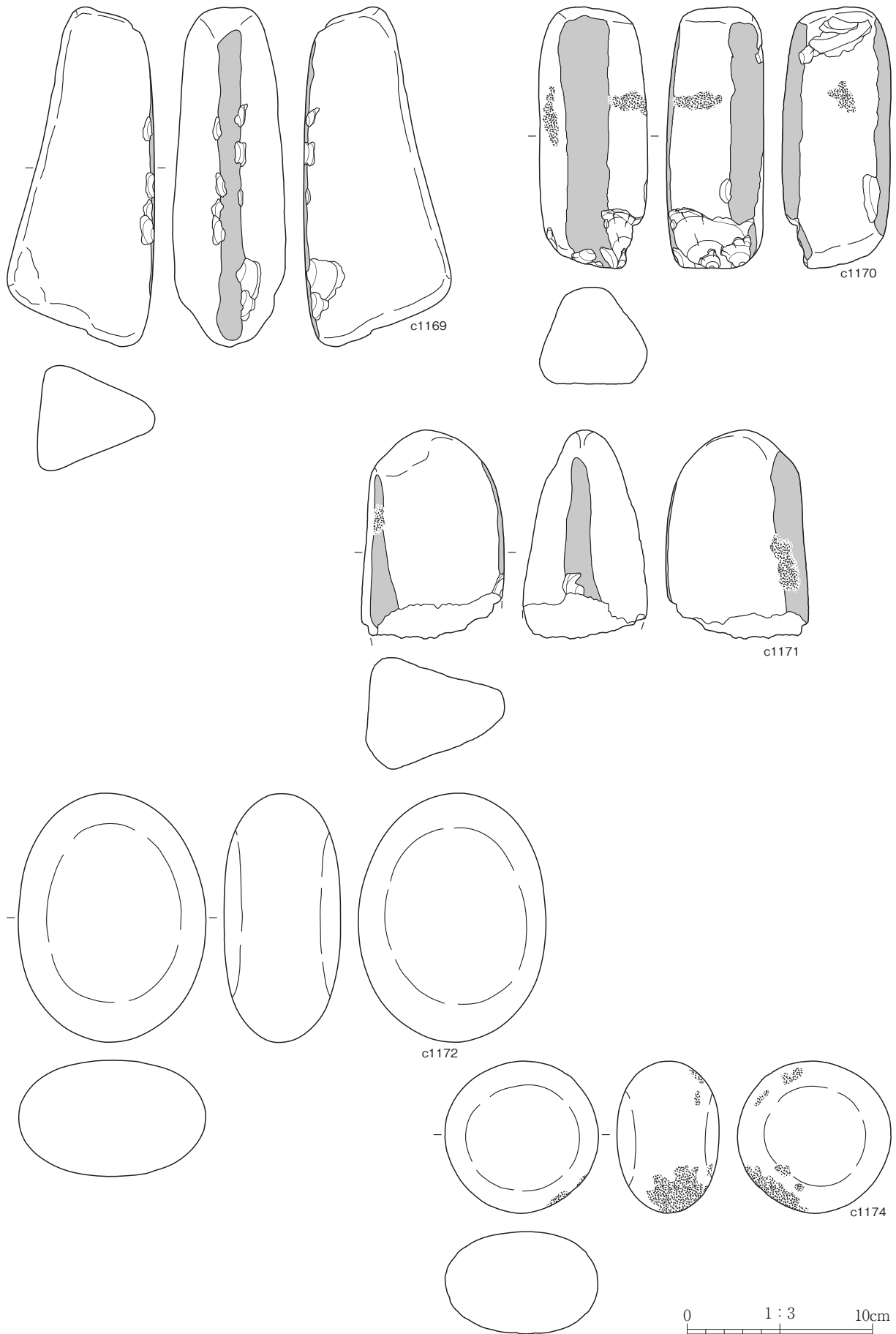

第 321 図 石器 (敲磨器類 3)

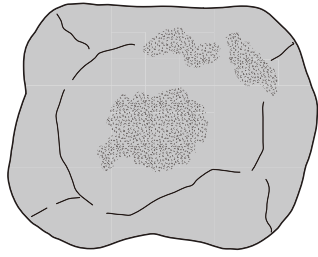

c1173

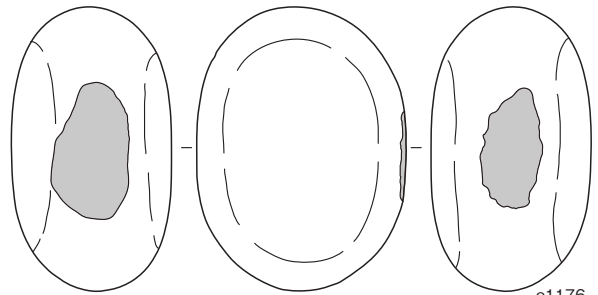
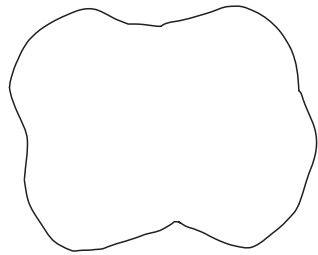

c1176

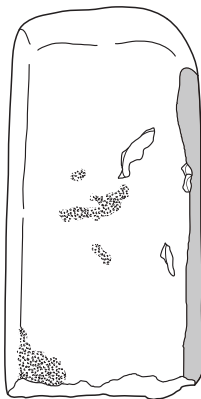
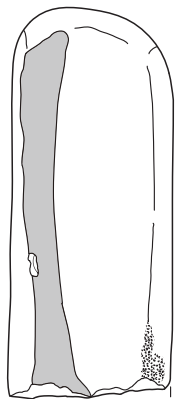
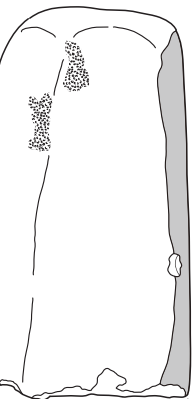

c1175

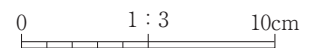
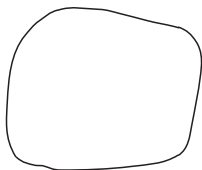
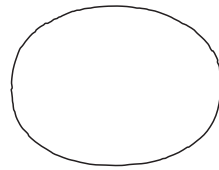

第 322 図 石器 (敲磨器類 4)



第 323 図 石器 (敲磨器類 5)

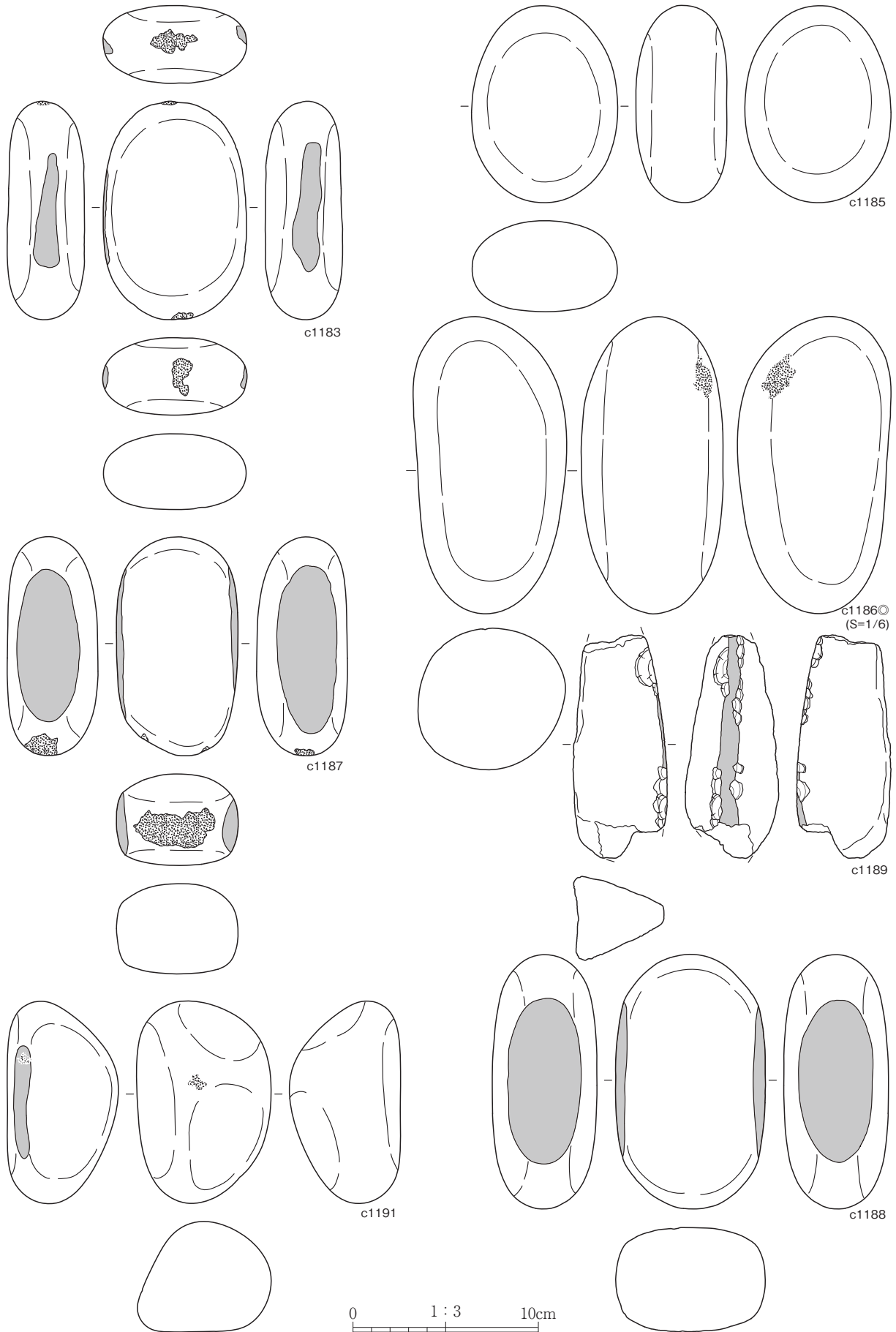

第324図 石器（敲磨器類6）

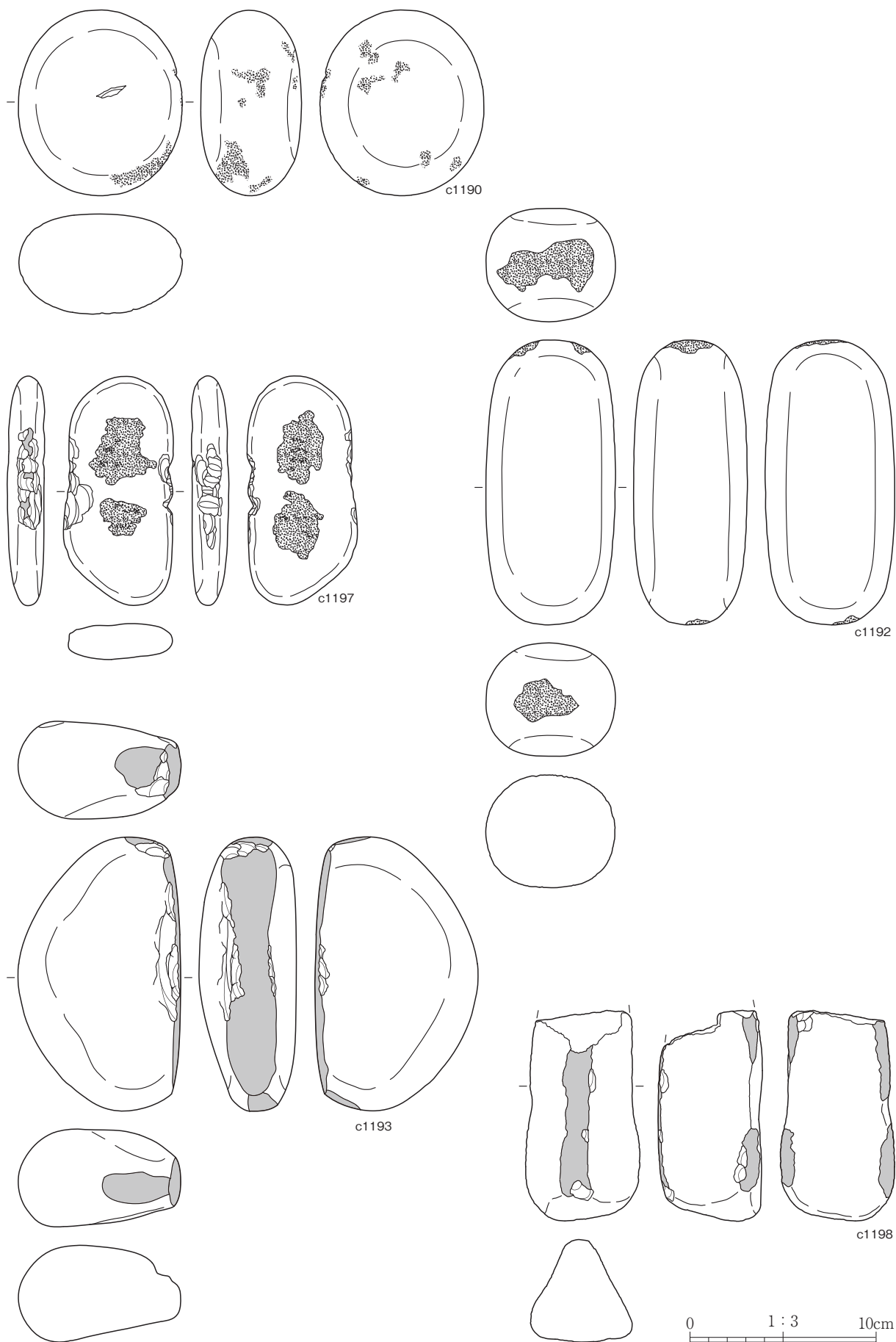

第 325 図 石器 (敲磨器類 7)

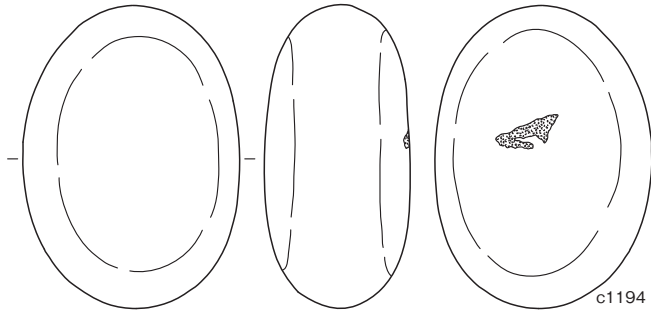

c1194

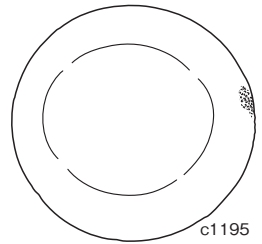
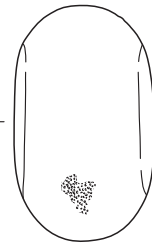
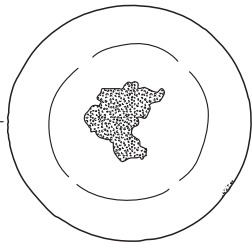
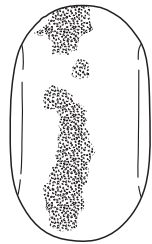
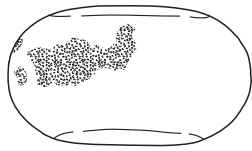
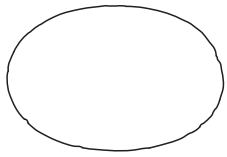

c1195

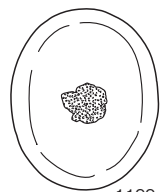
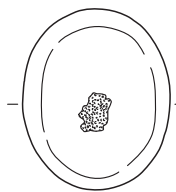

c1199

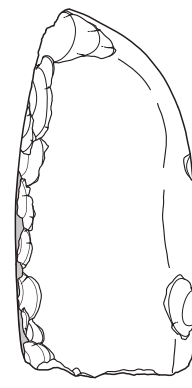
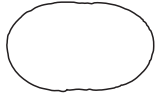
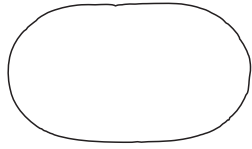
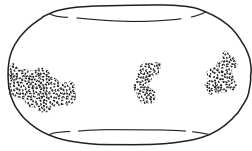

c1196

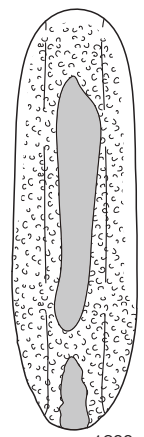
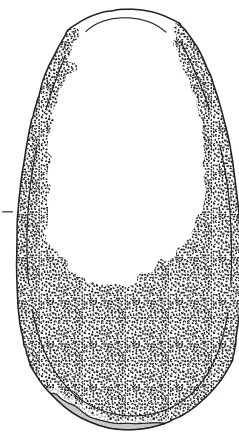
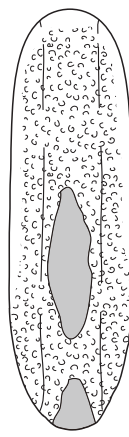

c1200

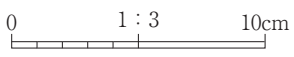
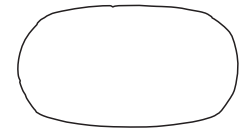
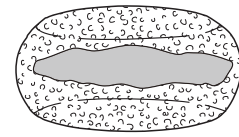

第 326 図 石器 (敲磨器類 8)

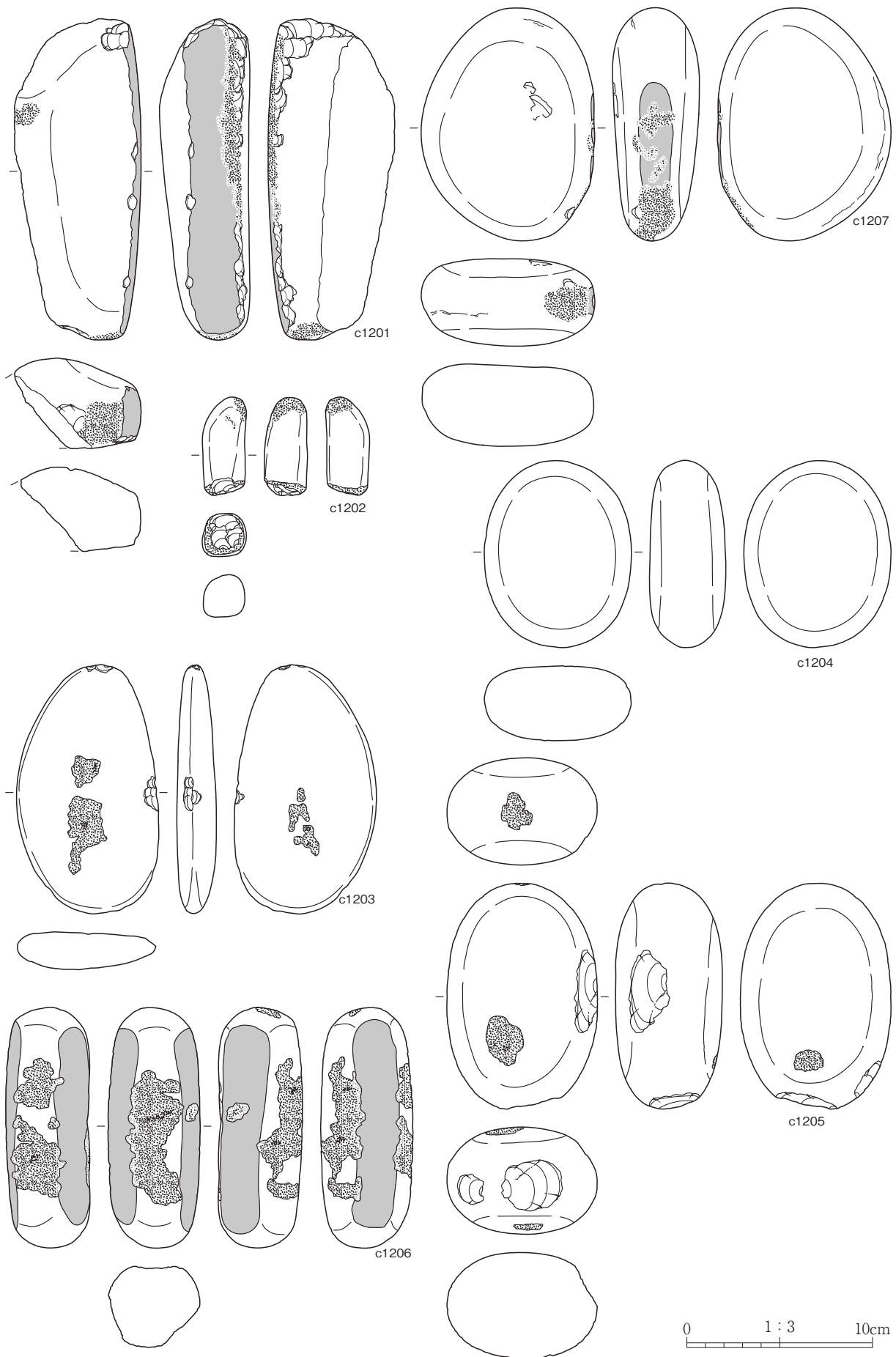

第 327 図 石器 (敲磨器類 9)

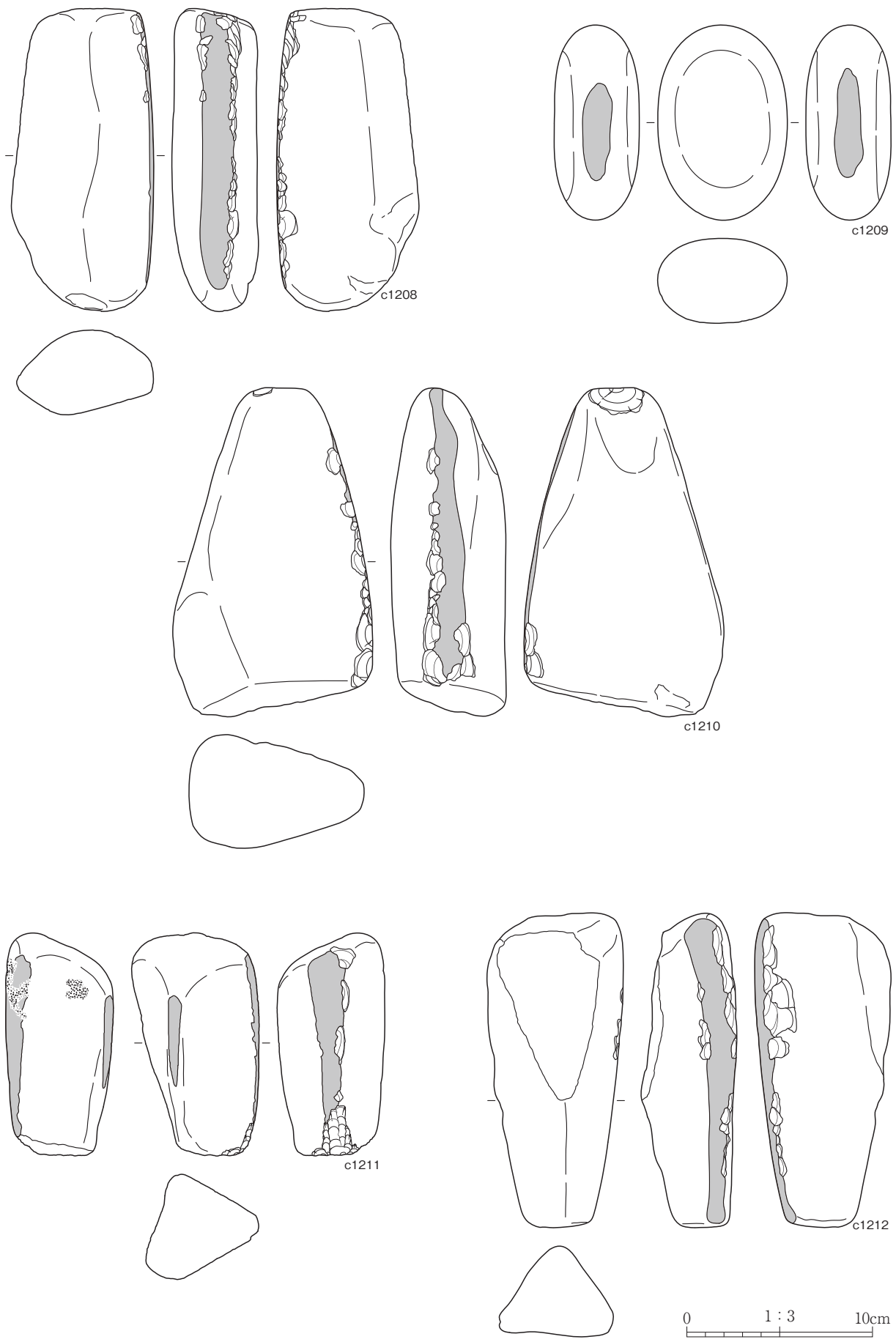

第 328 図 石器 (敲磨器類 10)

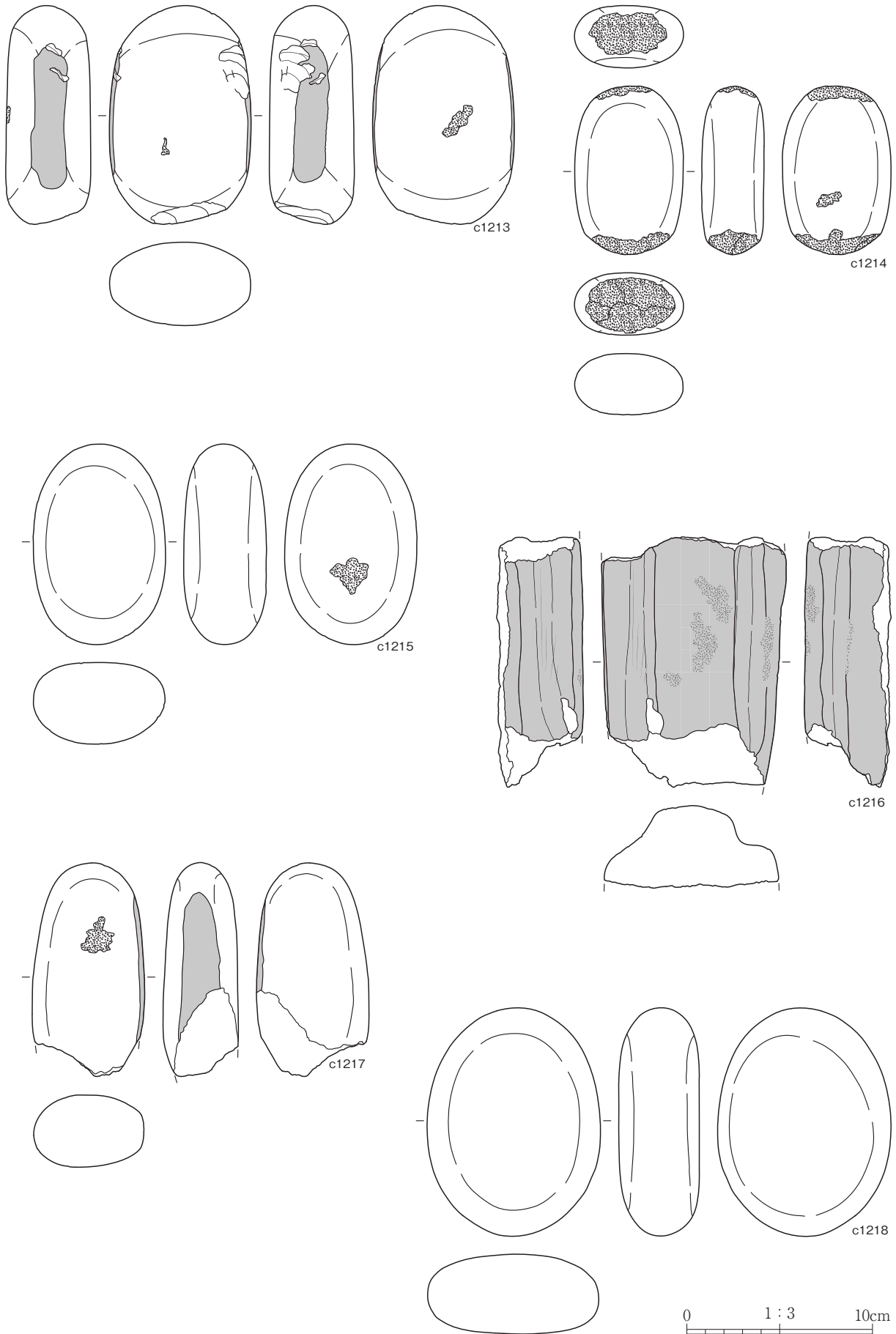

第 329 図 石器 (敲磨器類 11)

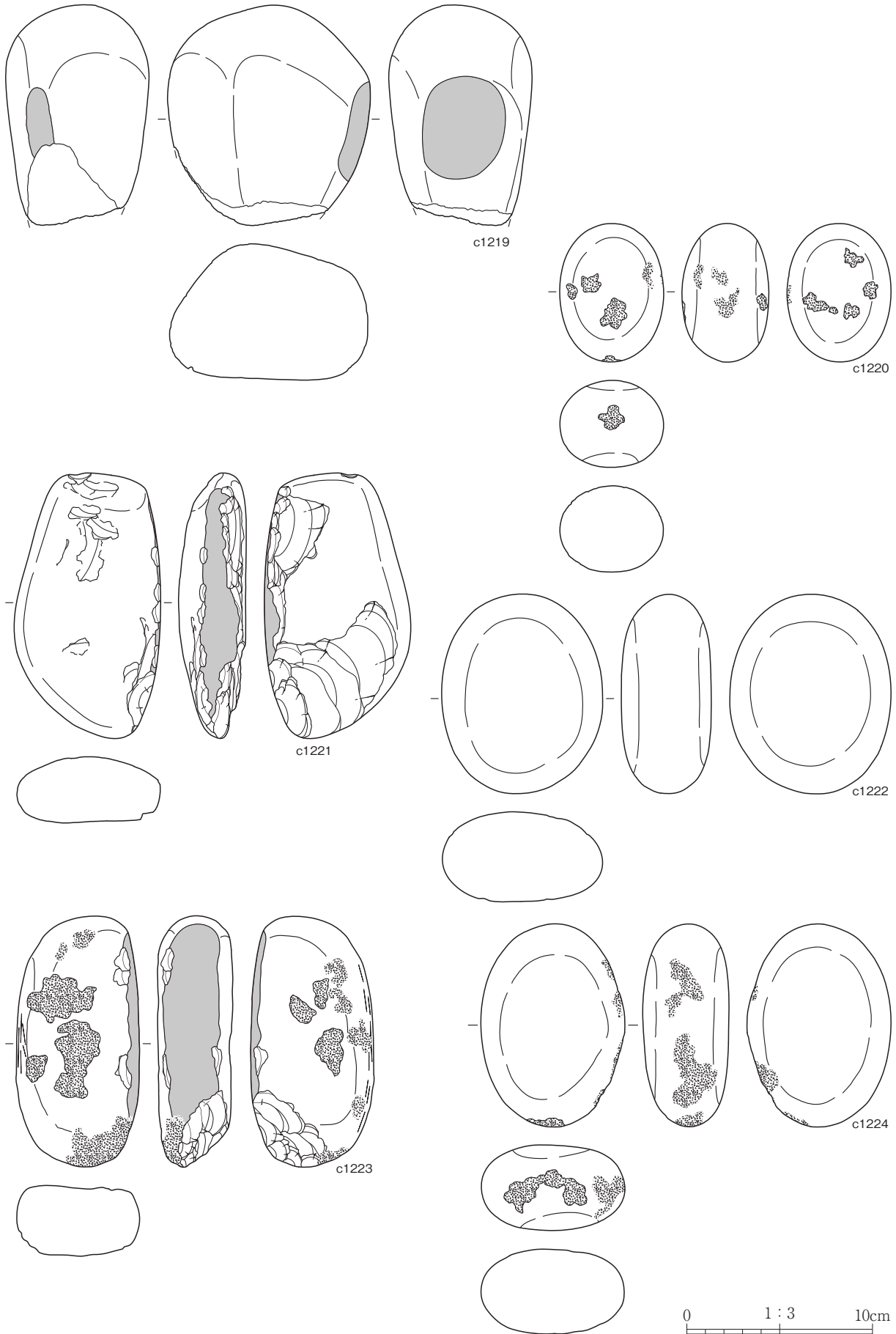

第 330 図 石器 (敲磨器類 12)

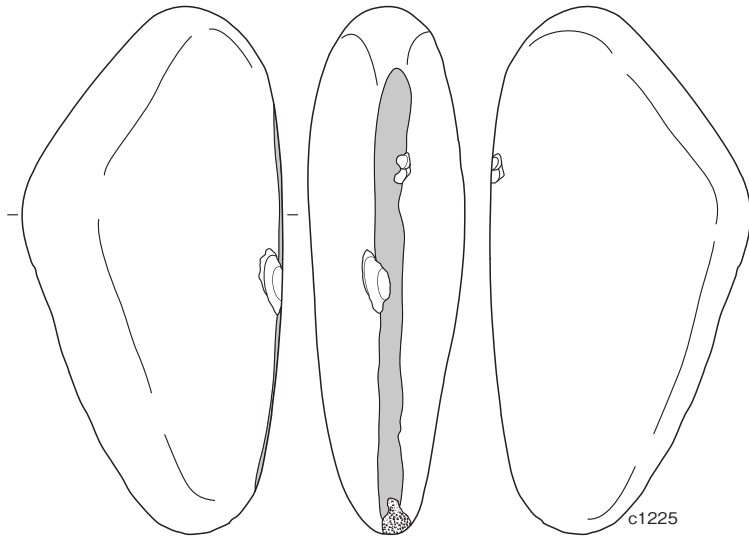

c1225

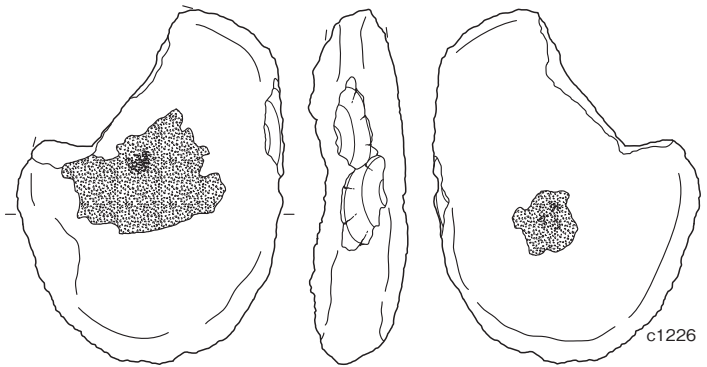
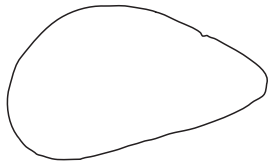
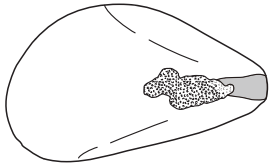

c1226

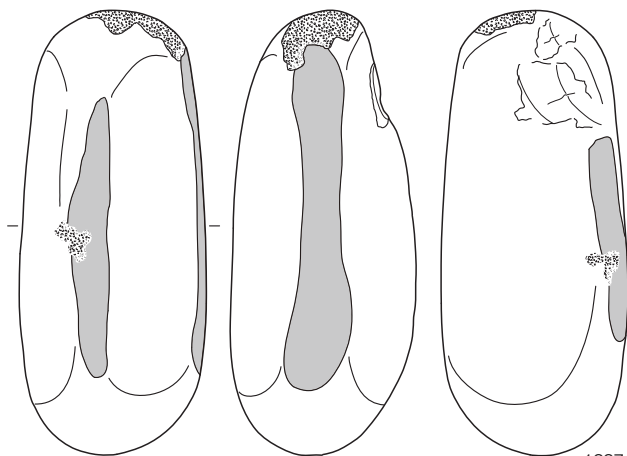

c1227

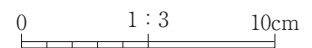
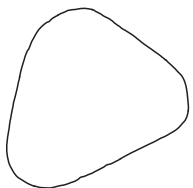

第 331 図 石器 (敲磨器類 13)

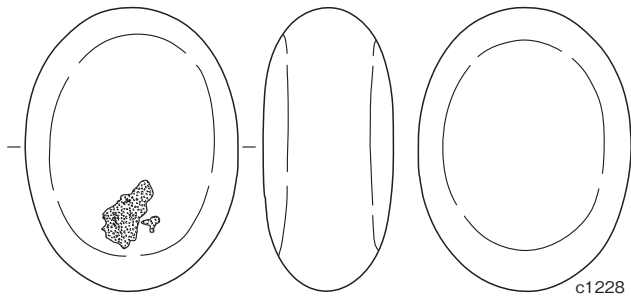

c1228

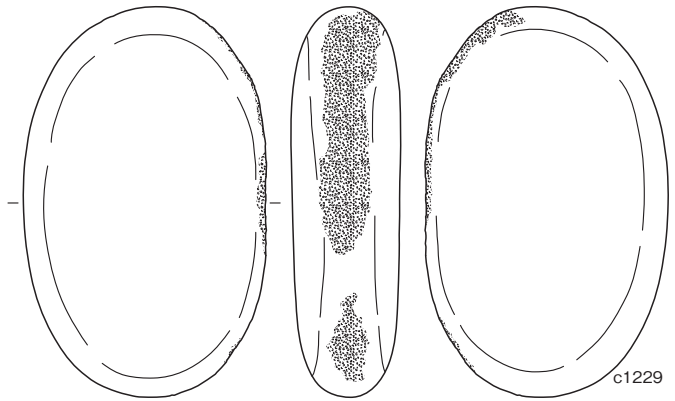
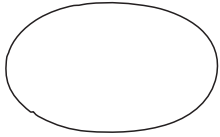

c1229

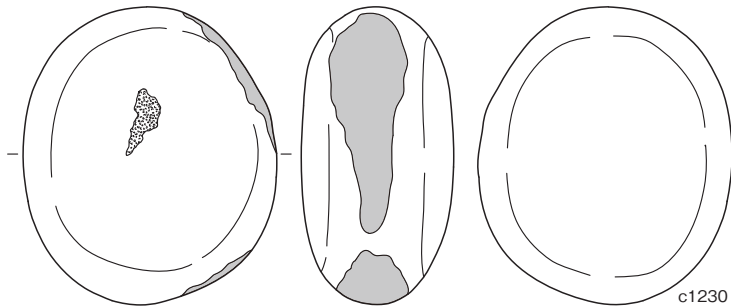
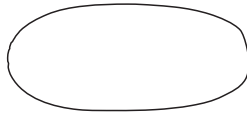
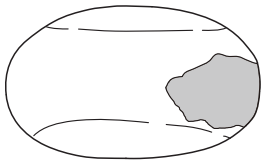

c1230

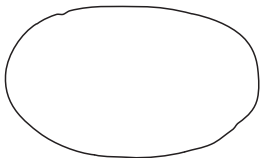
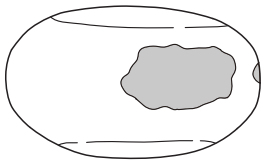

c1231

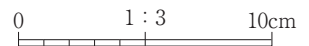

第 332 図 石器 (敲磨器類 14)

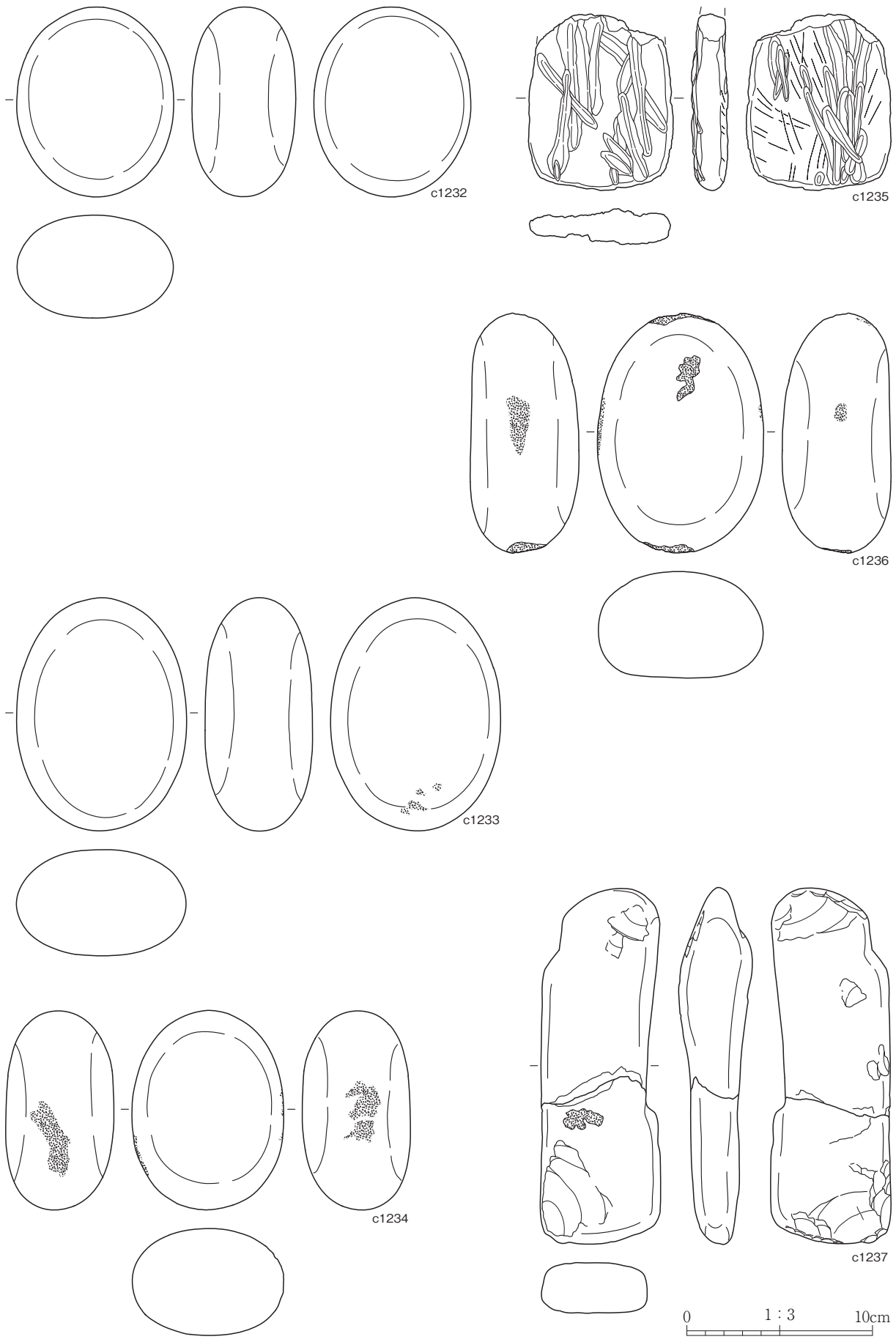

第 333 図 石器 (敲磨器類 15)

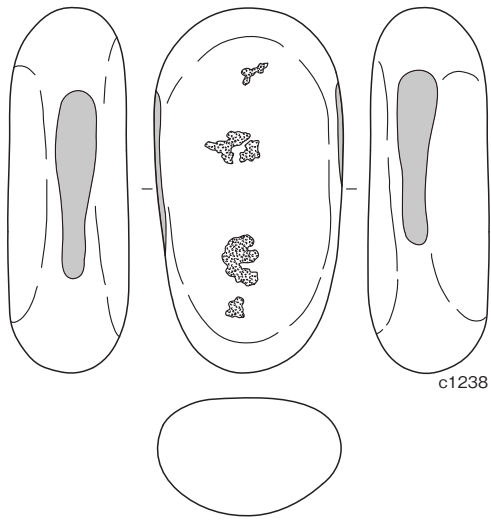

c1238

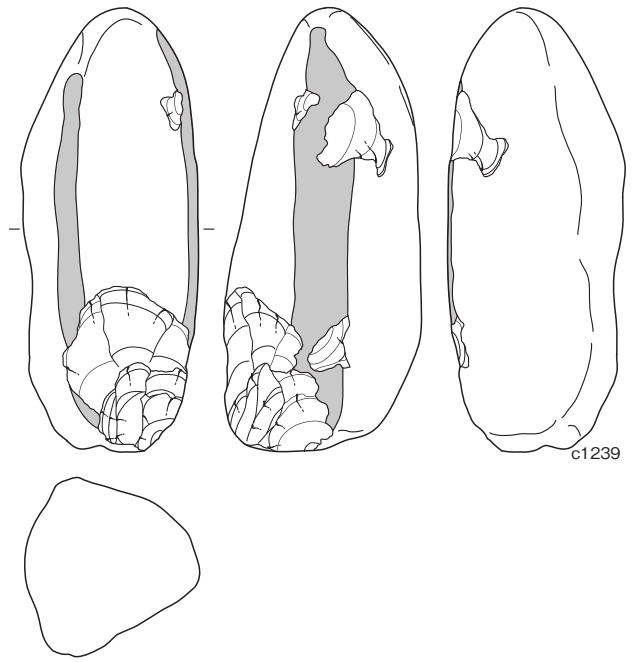

c1239

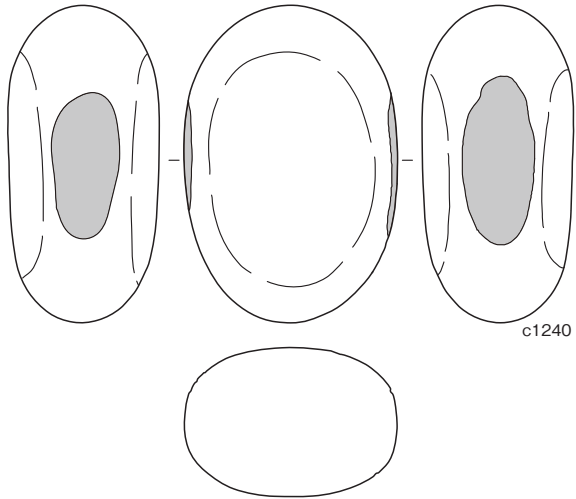

c1240

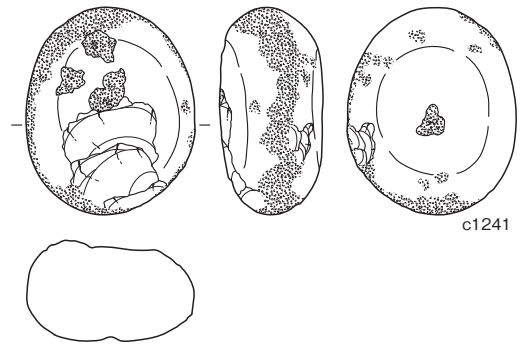

c1241

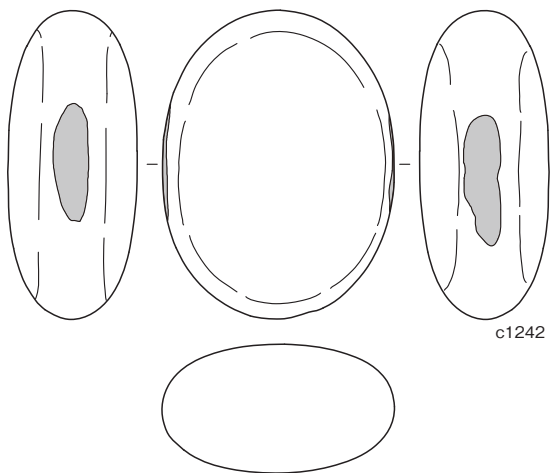

c1242

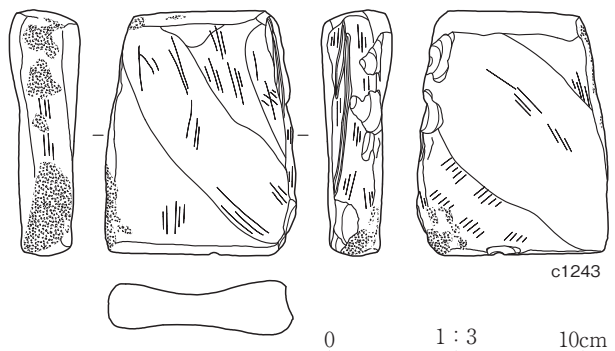

c1243

0 1:3 10cm

第 334 図 石器 (敲磨器類 16)

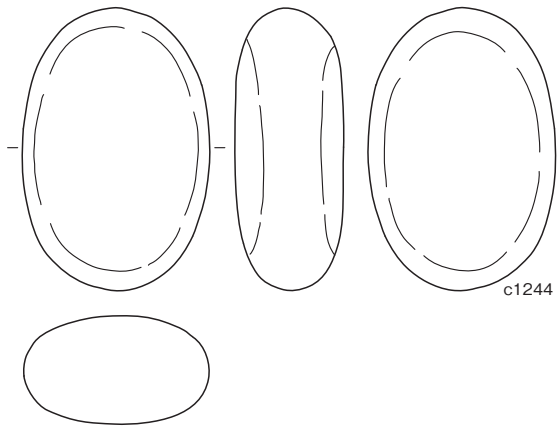

c1244

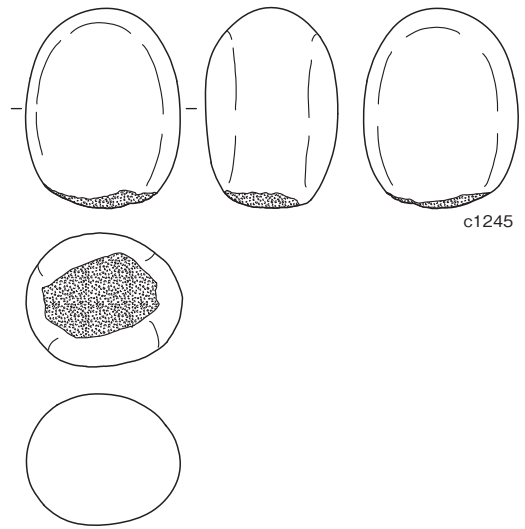

c1245

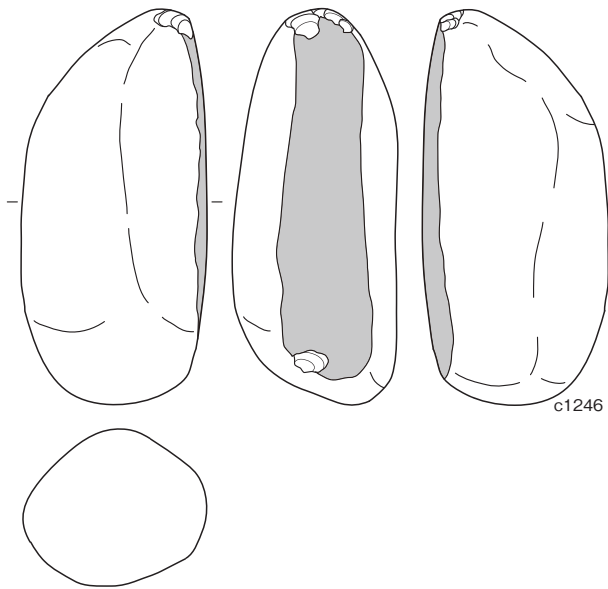

c1246

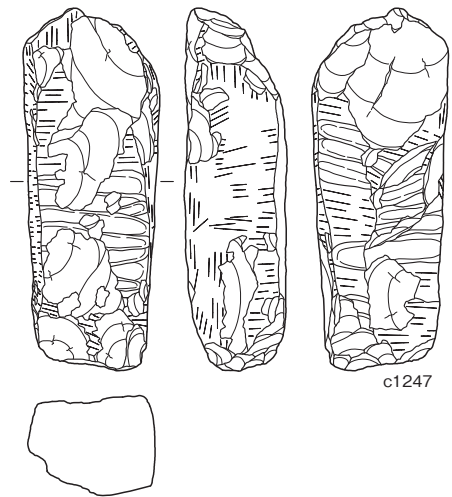

c1247

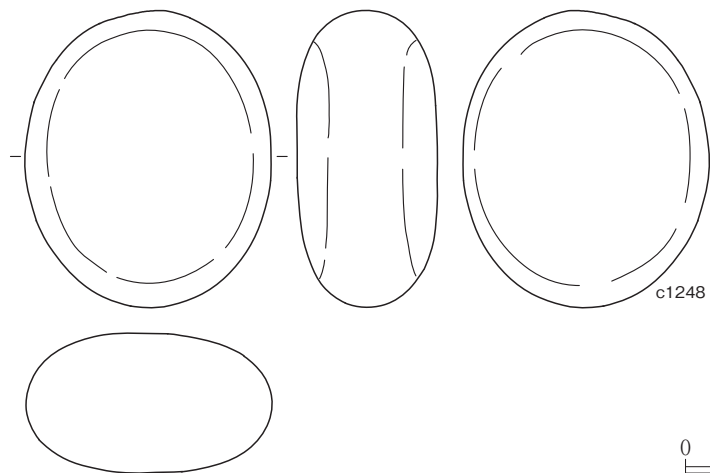

c1248

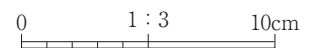

第 335 図 石器 (敲磨器類 17)



第 336 図 石器 (敲磨器類 18)

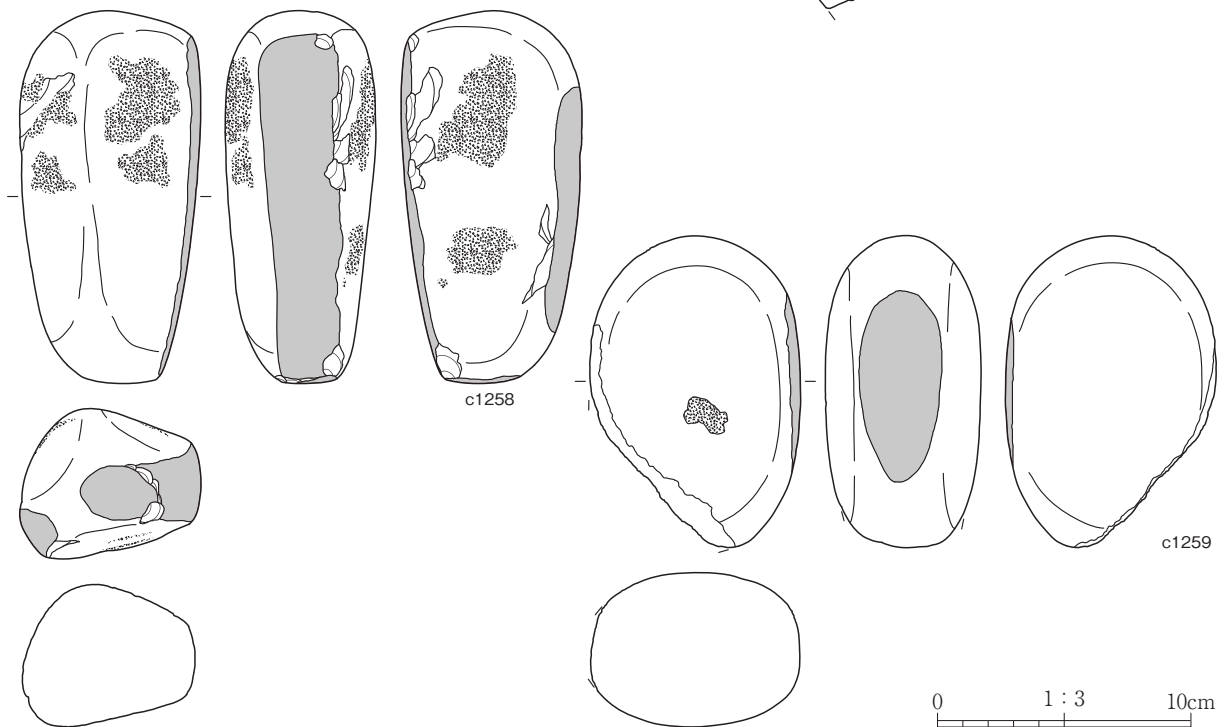
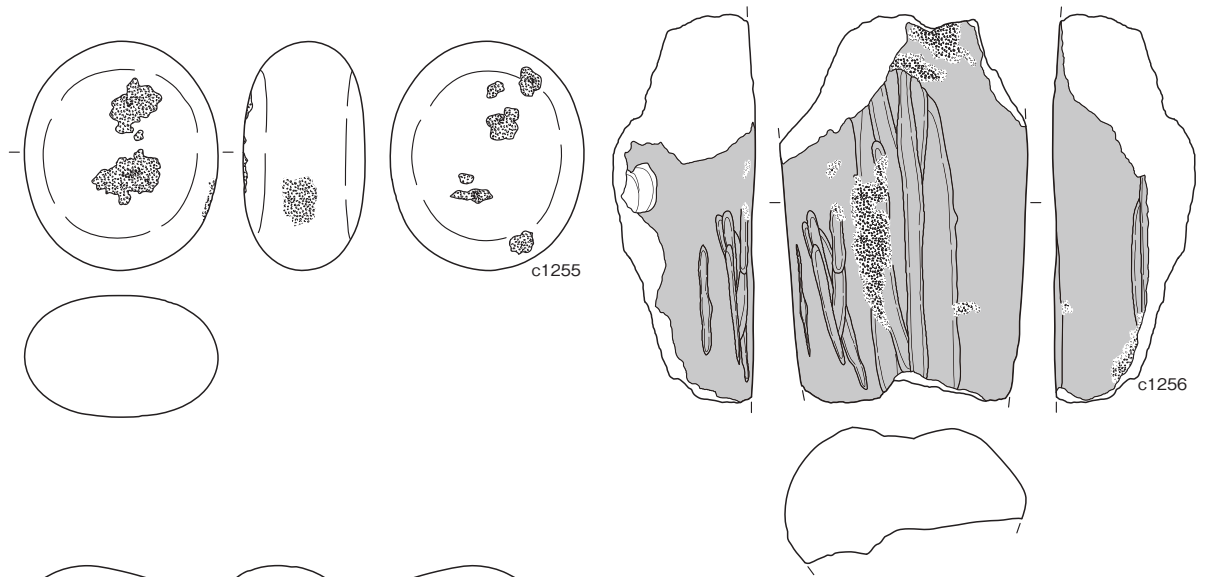
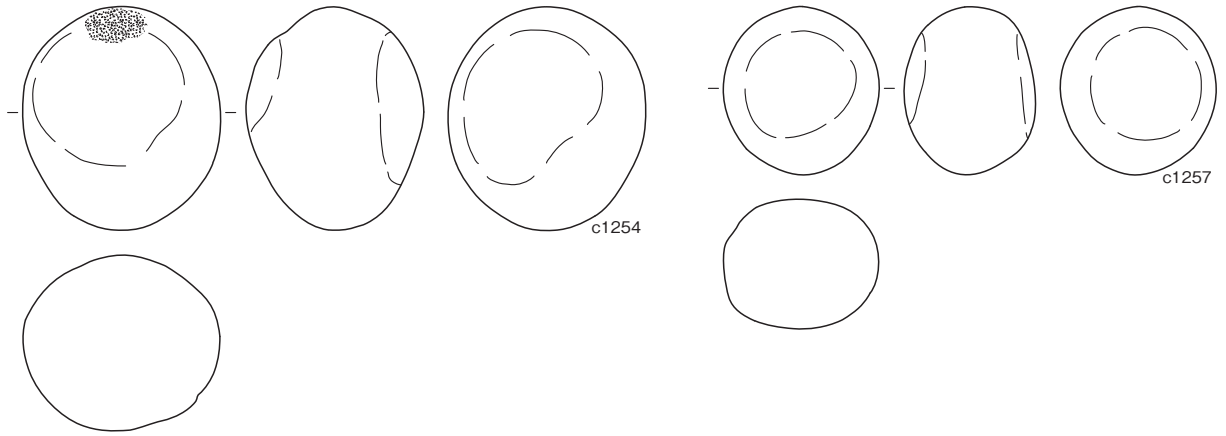

0 1:3 10cm

第 337 図 石器 (敲磨器類 19)

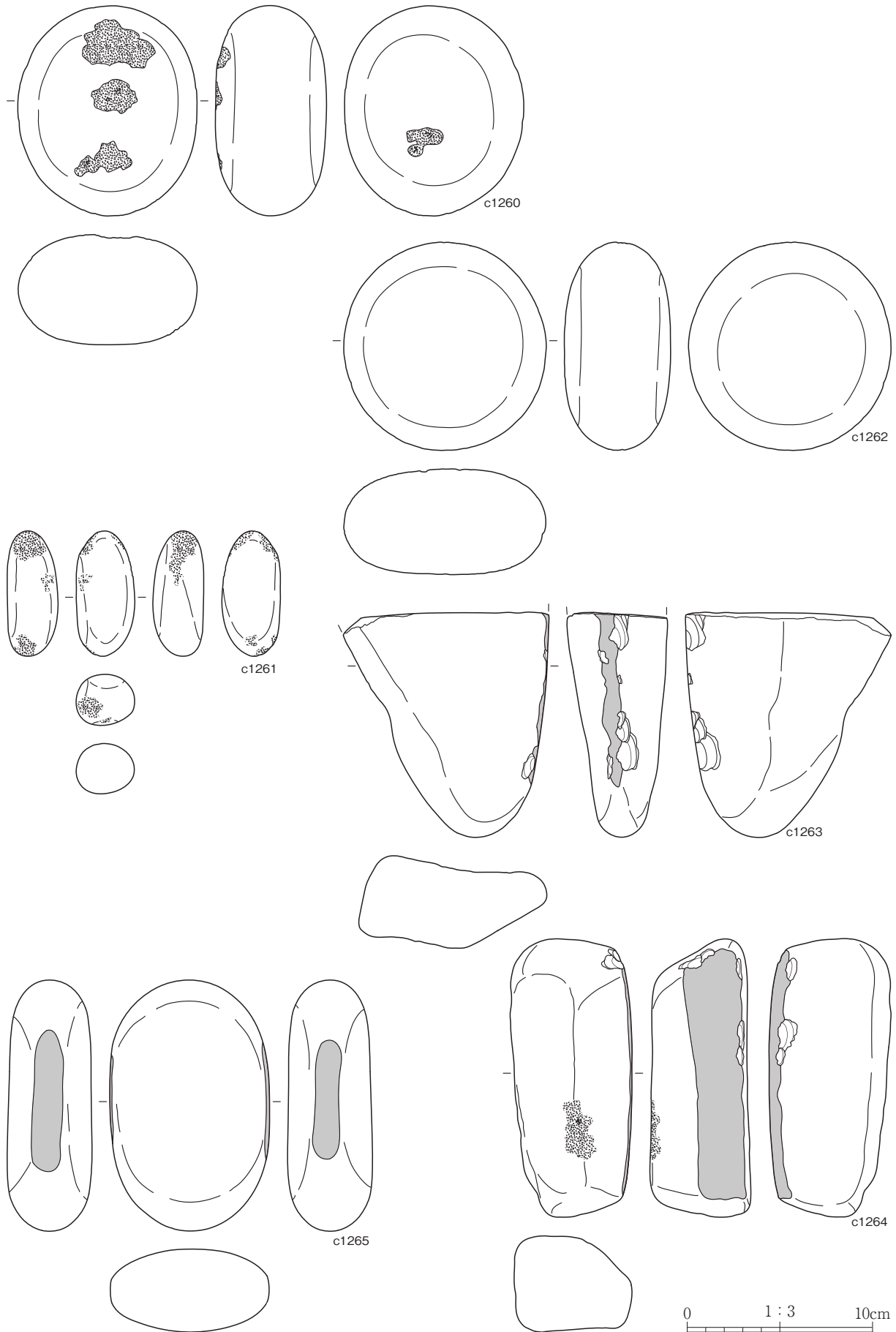

第 338 図 石器 (敲磨器類 20)



第 339 図 石器 (敲磨器類 21)

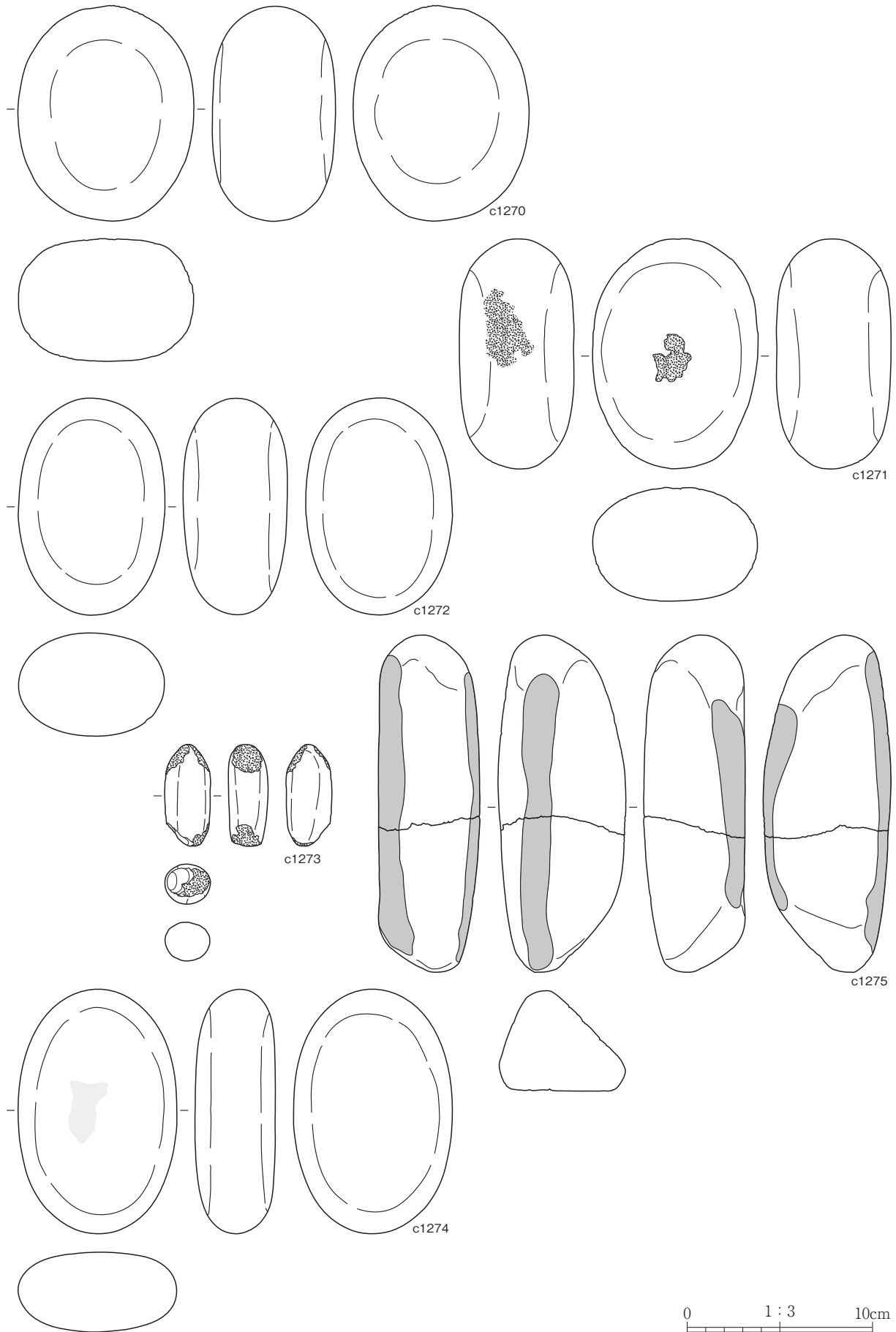

第 340 図 石器 (敲磨器類 22)

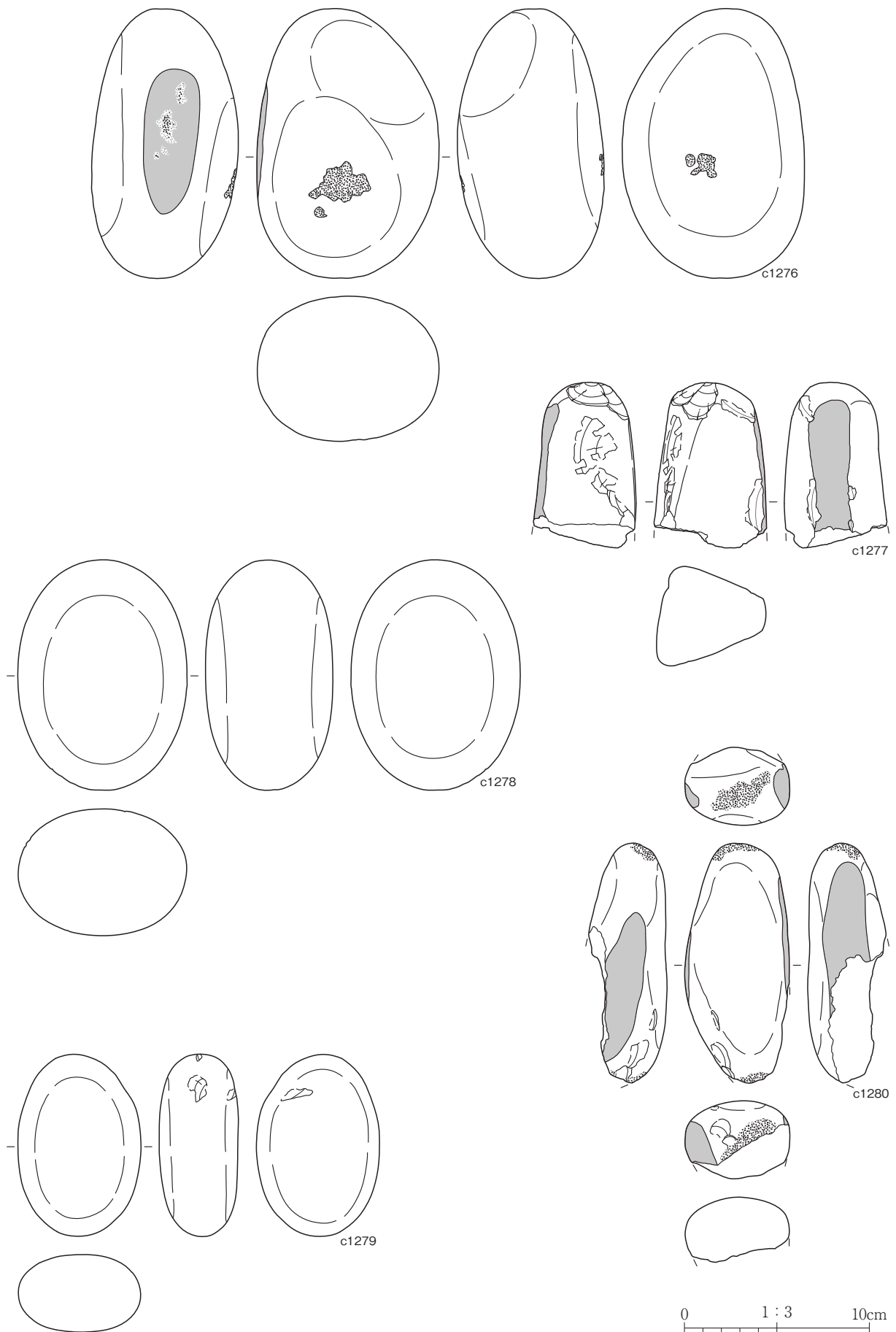

第 341 図 石器 (敲磨器類 23)

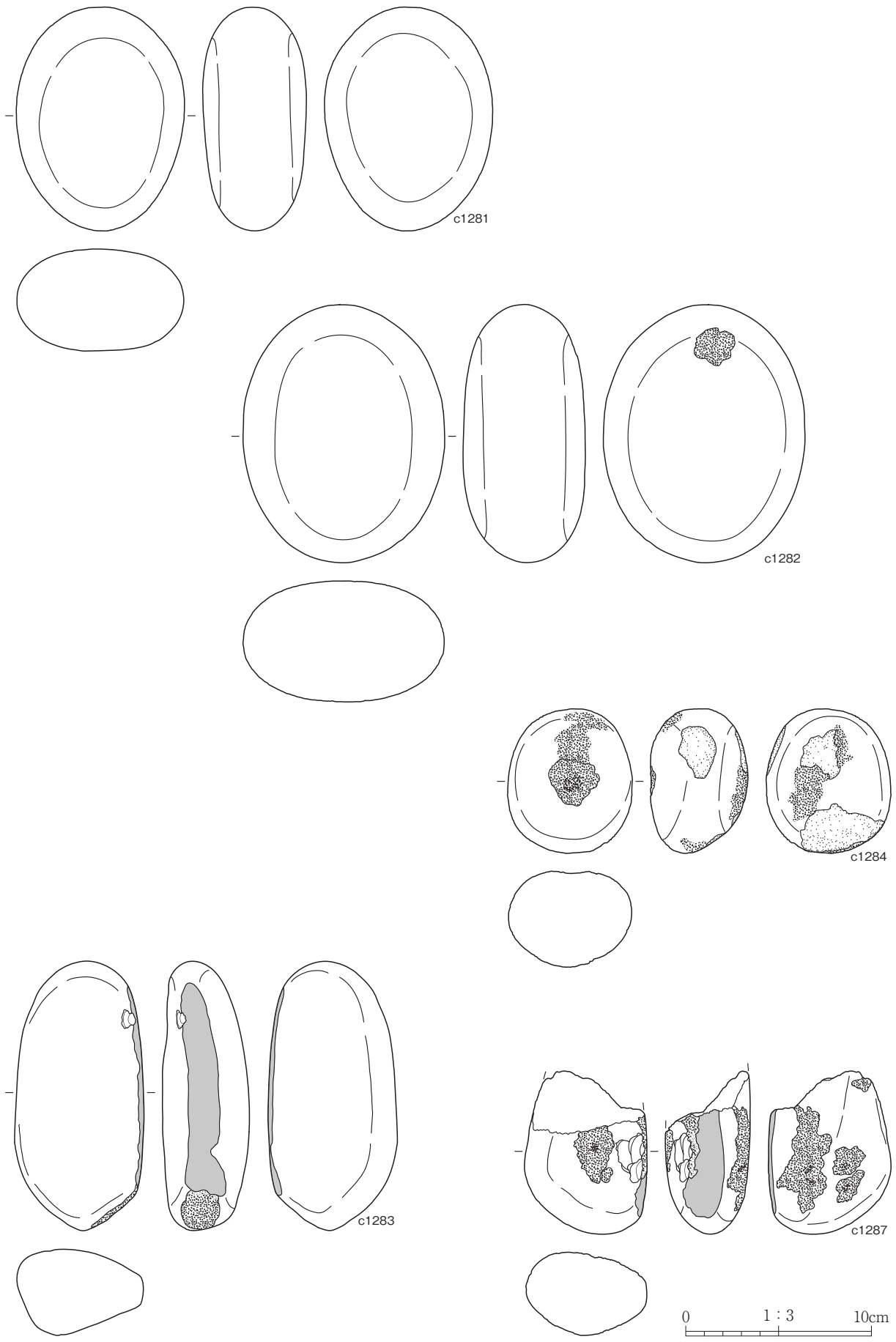

第 342 図 石器 (敲磨器類 24)

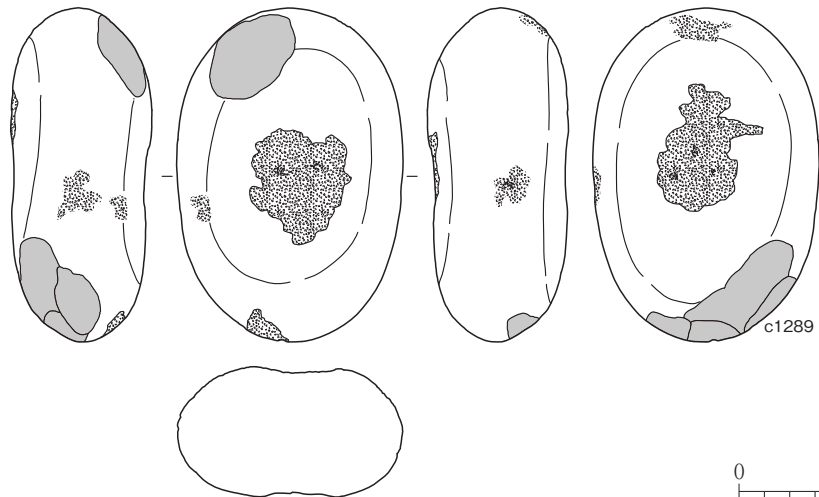
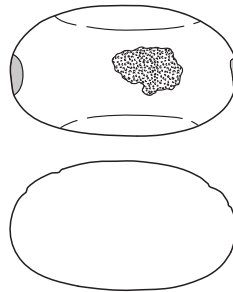
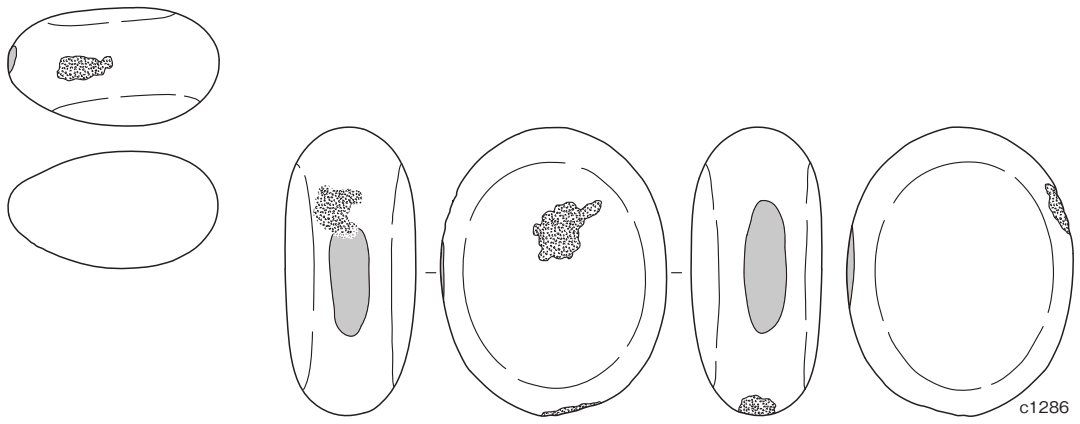
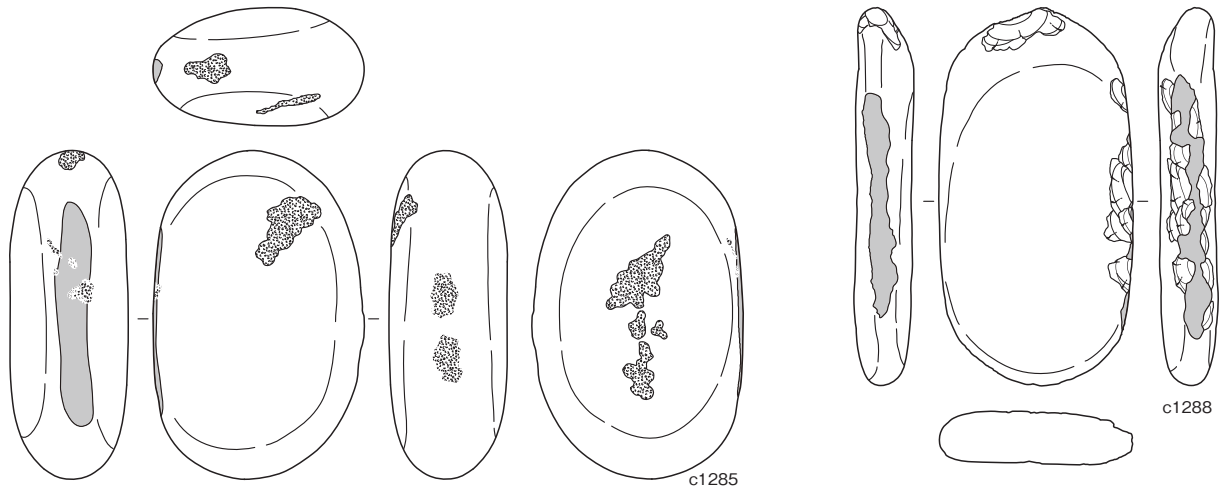

0 1 : 3 10cm

第 343 図 石器 (敲磨器類 25)

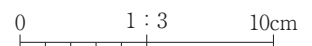
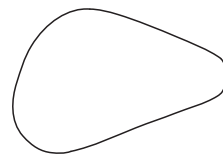
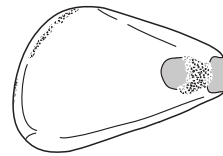
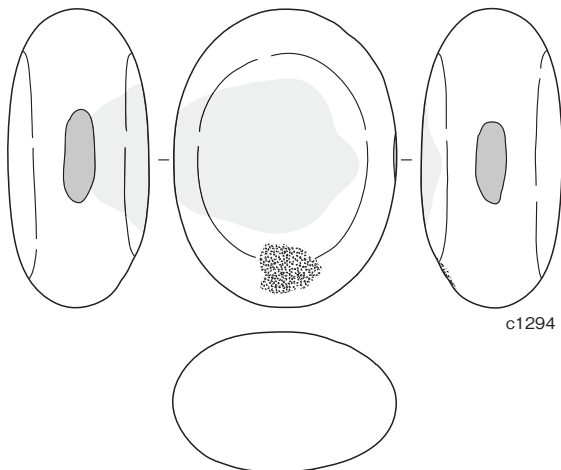
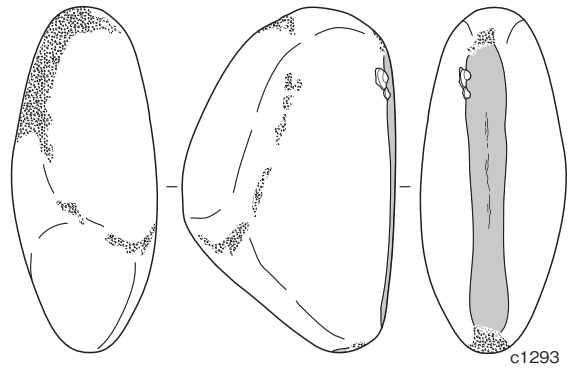
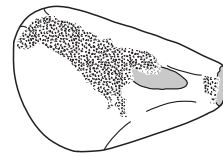
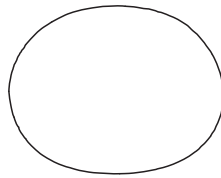
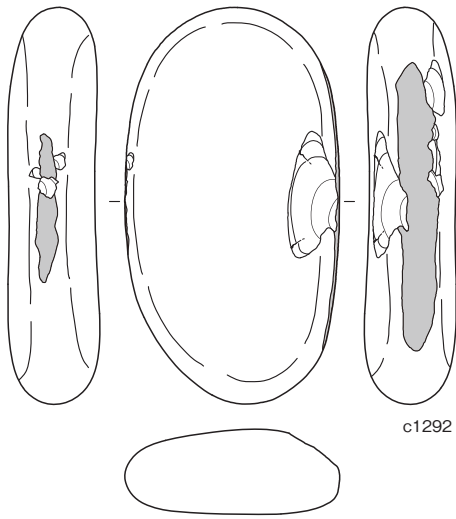
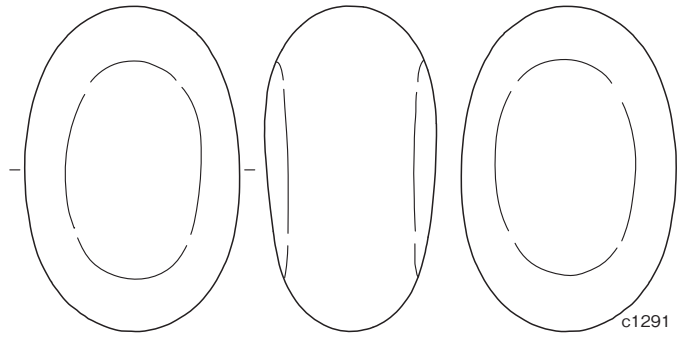
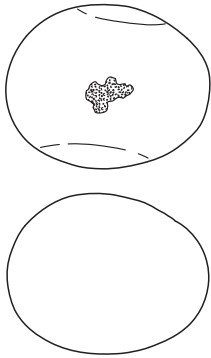
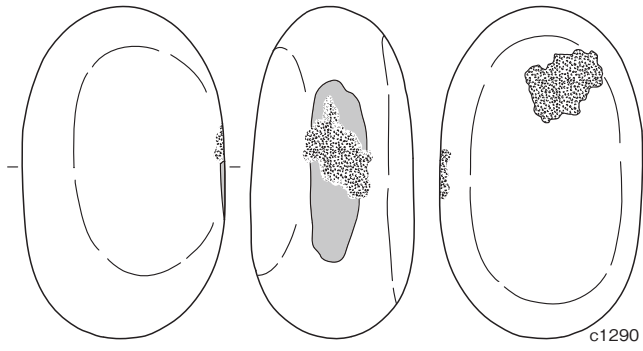

第 344 図 石器 (敲磨器類 26)

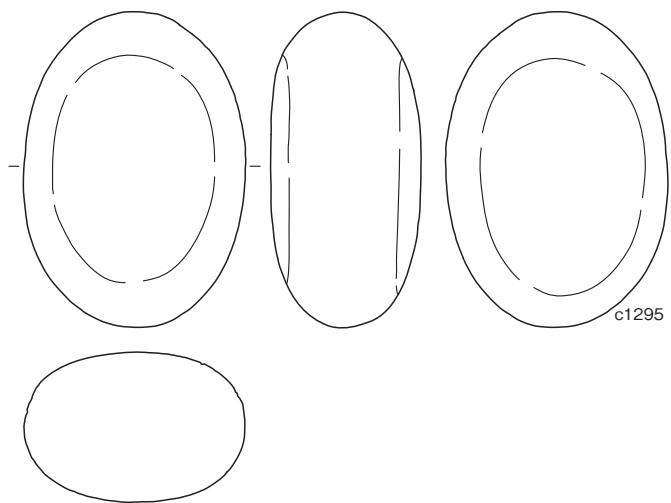

c1295

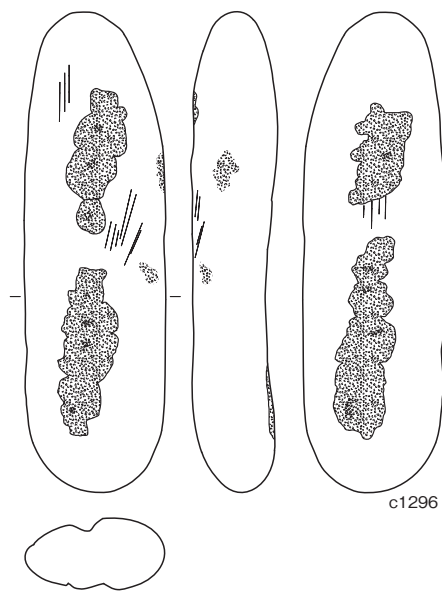

c1296

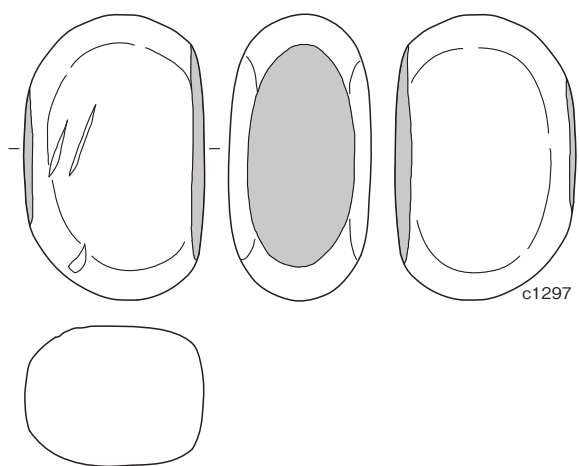

c1297

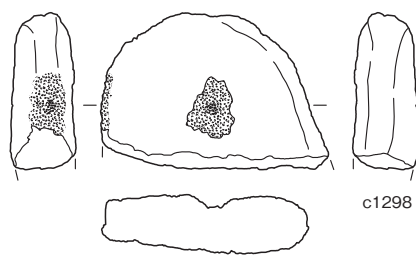

c1298

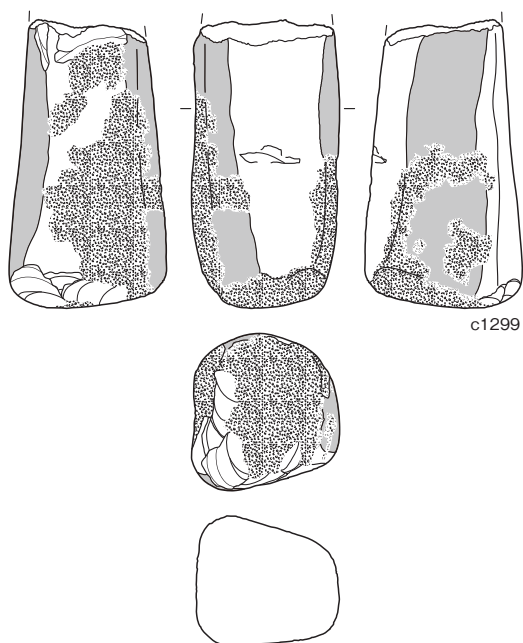

c1299

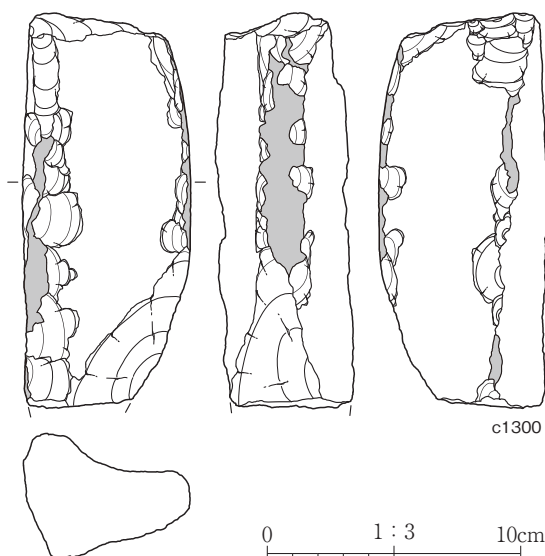

c1300

0 1:3 10cm

第 345 図 石器 (敲磨器類 27)



0 1 : 3 10cm

第 346 図 石器 (敲磨器類 28)



第 347 図 石器 (敲磨器類 29)

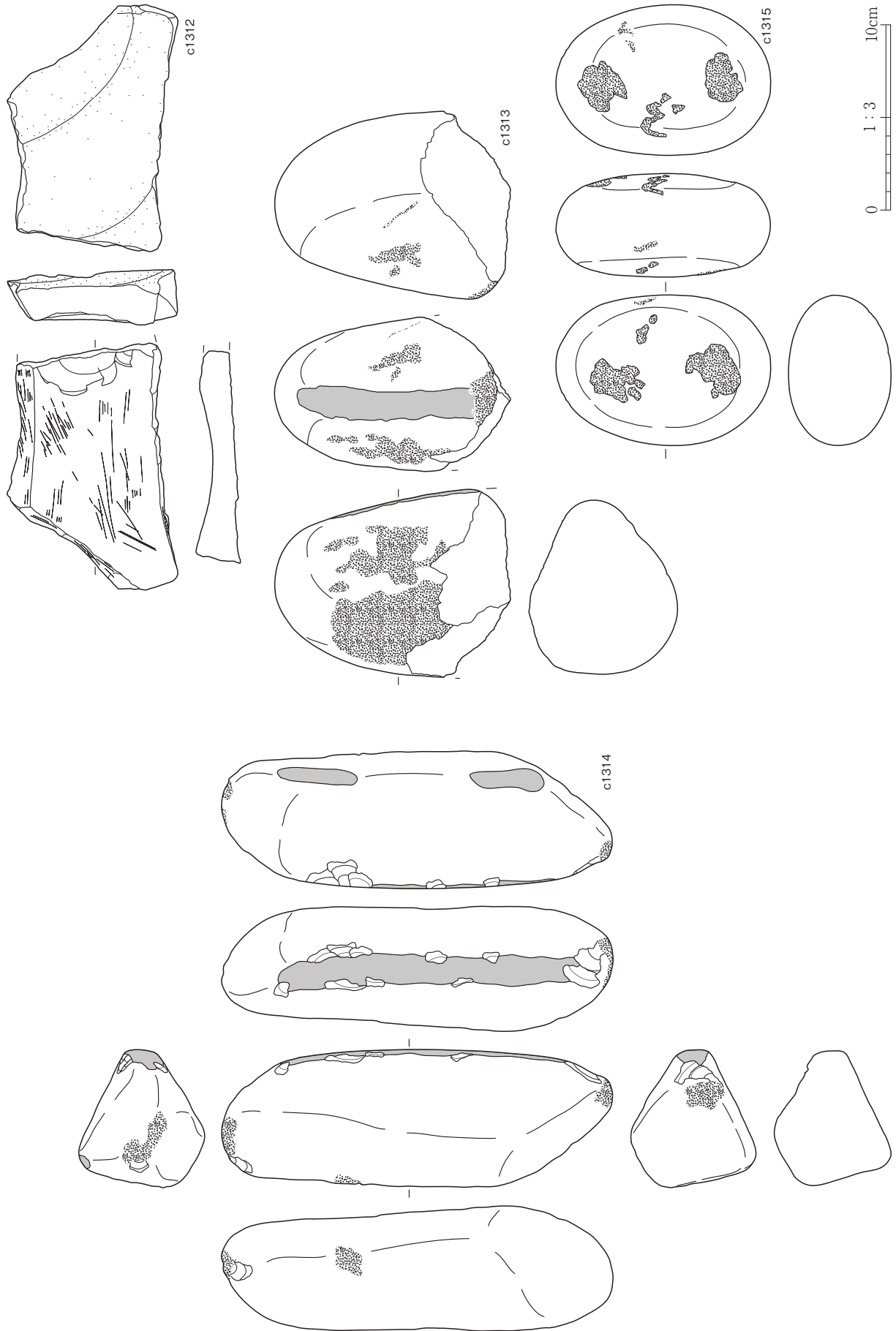

第 348 図 石器 (敲磨器類 30)

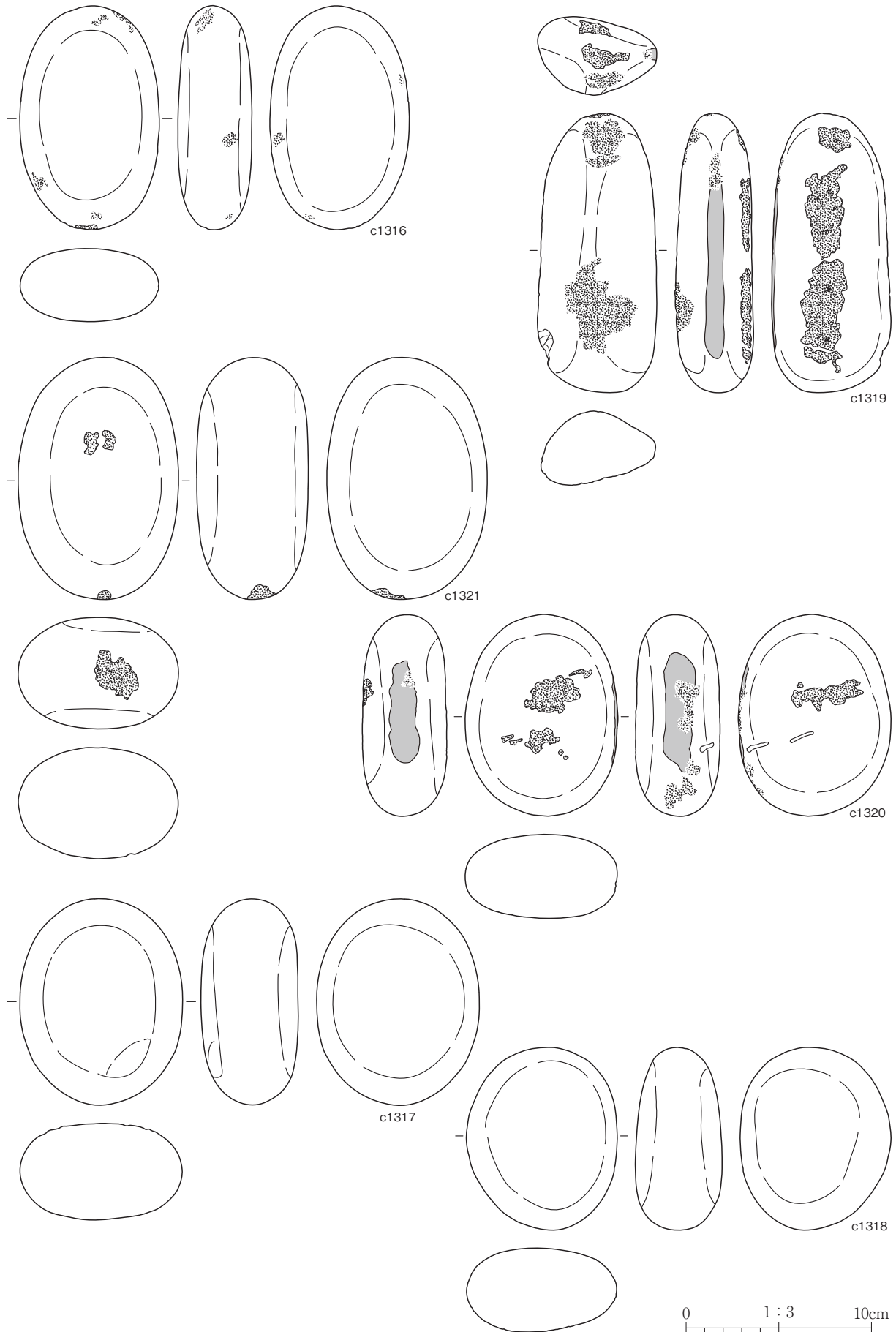

第 349 図 石器 (敲磨器類 31)

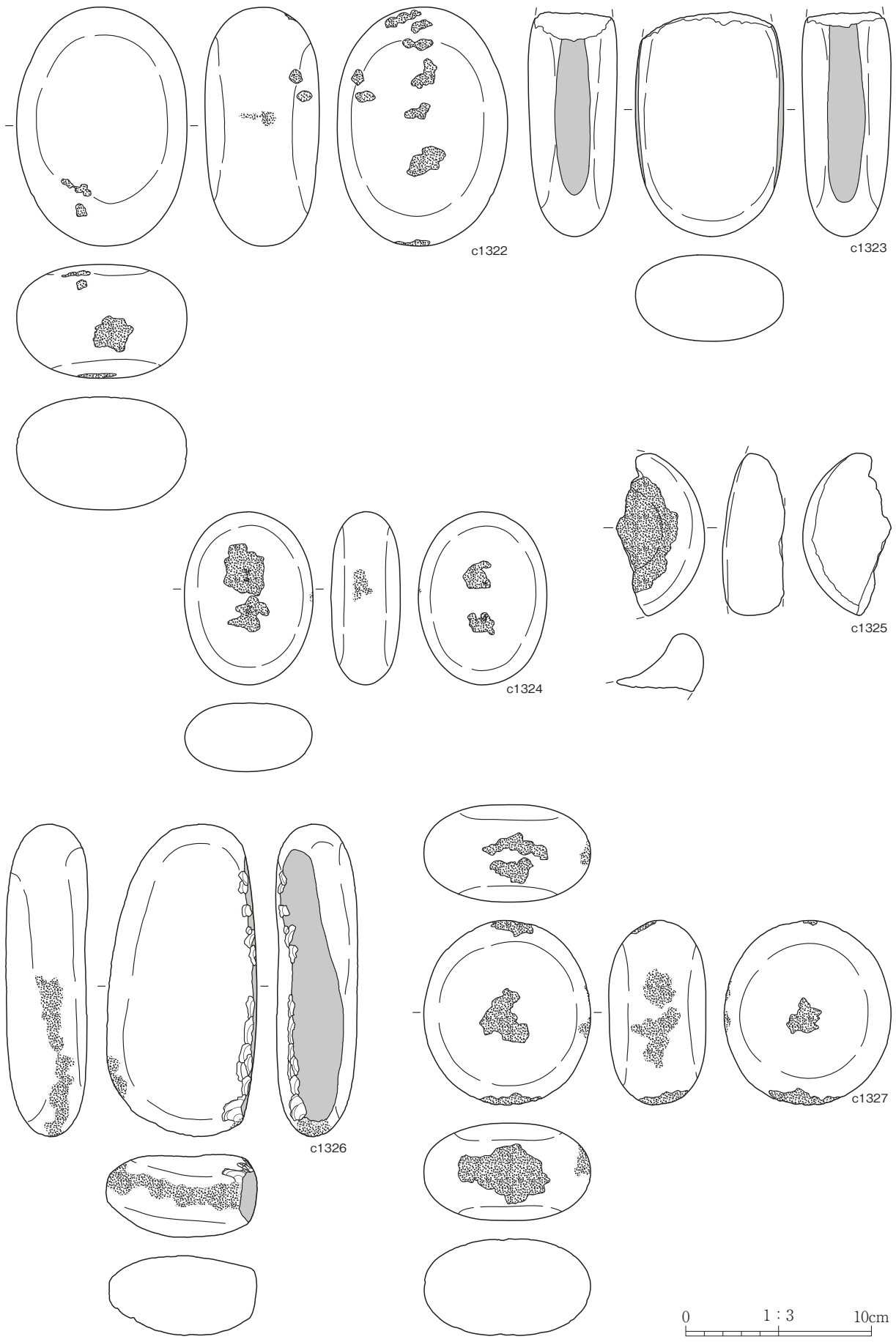

第350図 石器 (敲磨器類 32)

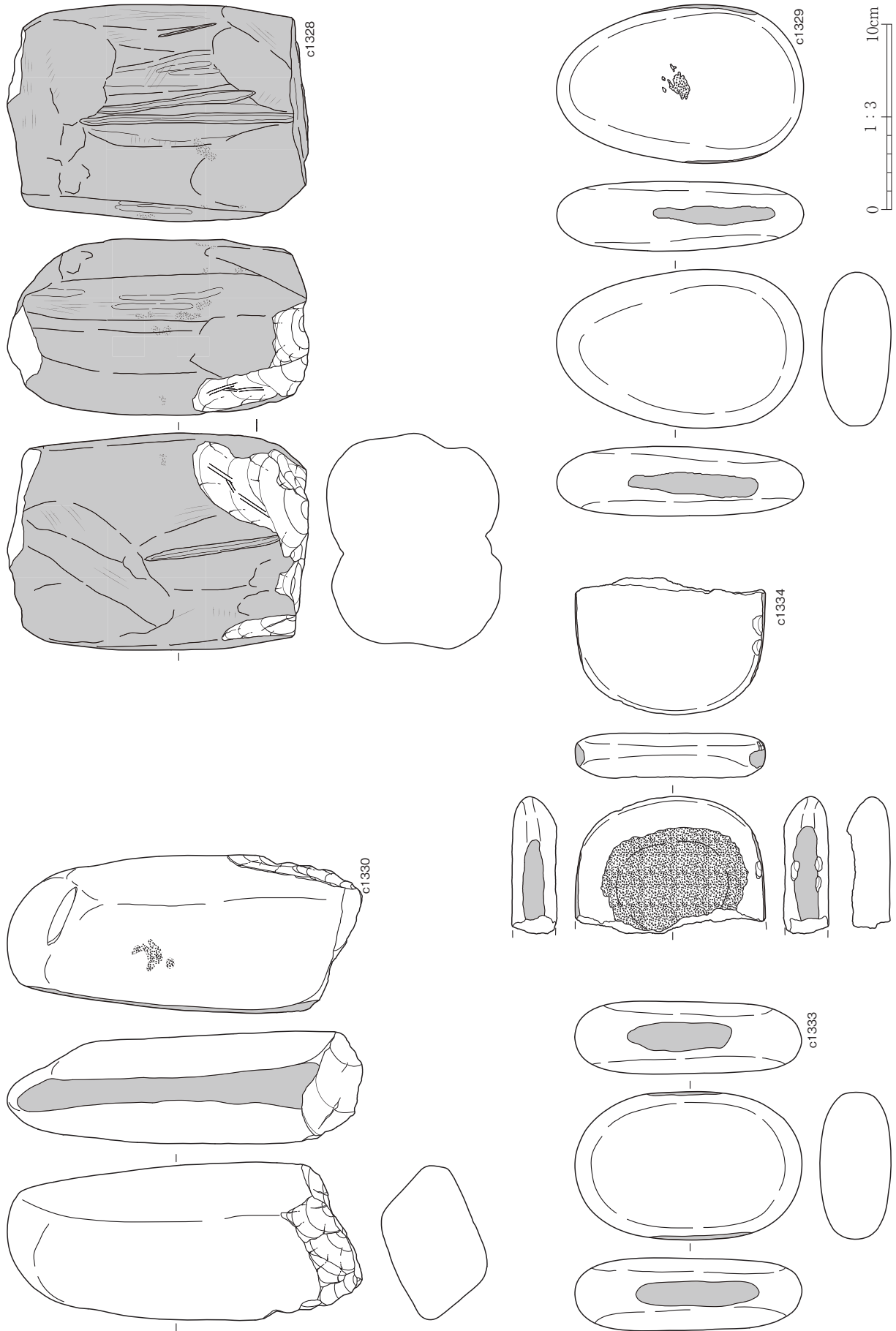

第 351 図 石器 (敲磨器類 33)



c1331

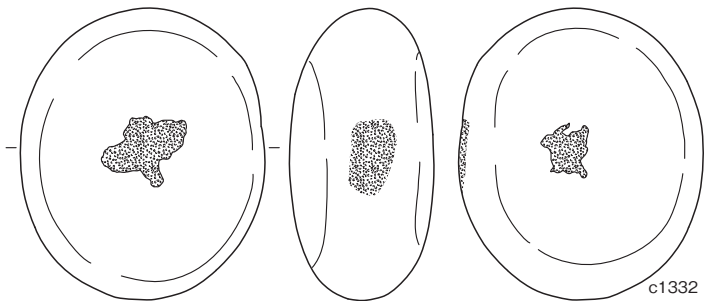
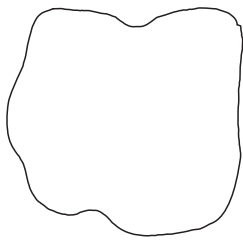

c1332

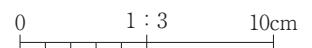
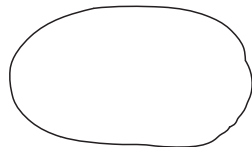

第 352 図 石器 (敲磨器類 34)

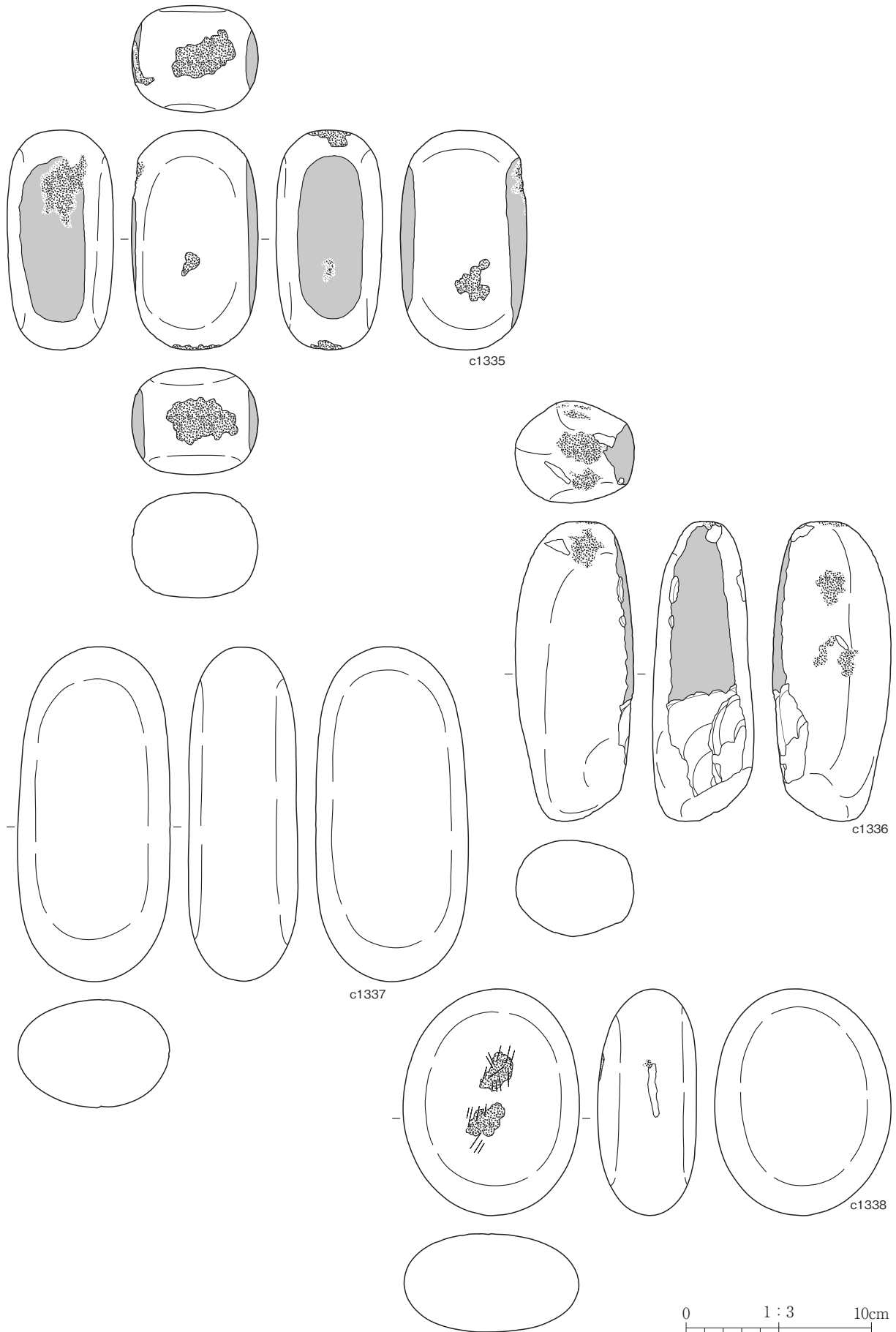

第 353 図 石器 (敲磨器類 35)

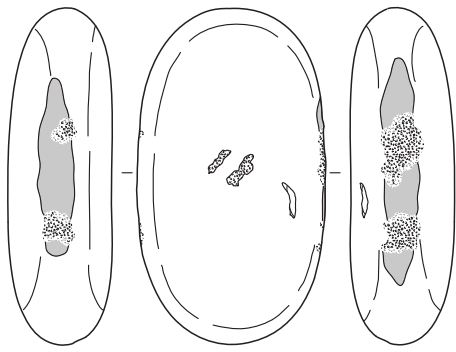

c1339

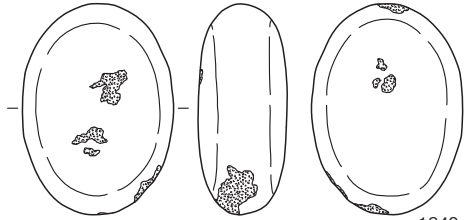
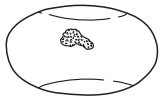
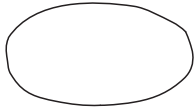

c1340

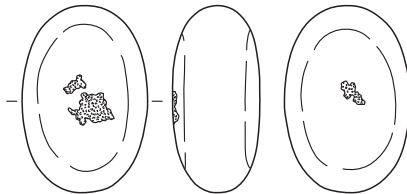
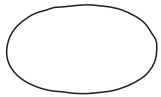
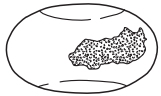

c1341

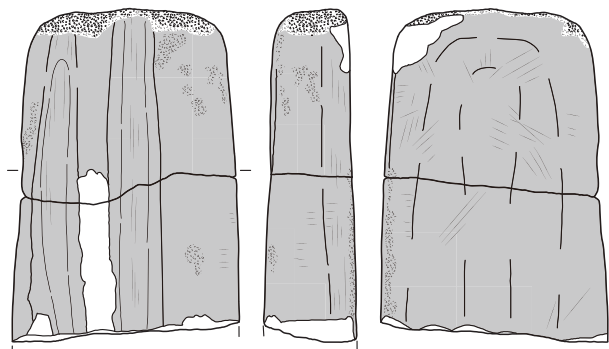
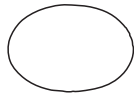

c1342

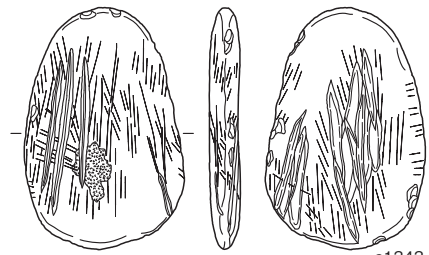

c1343

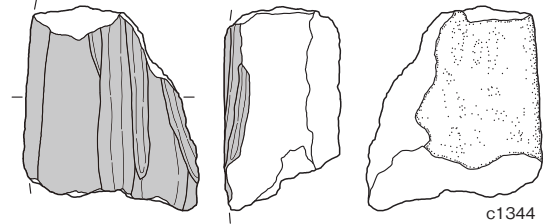

c1344

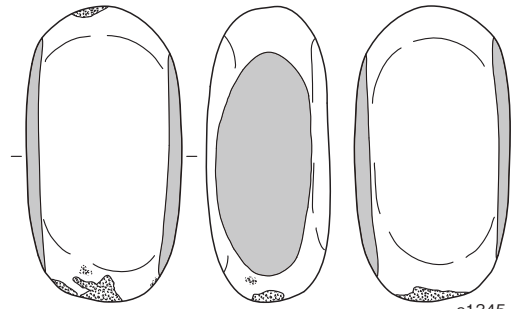

c1345

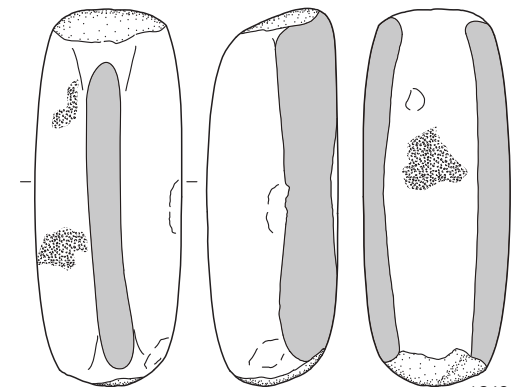
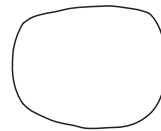

c1346

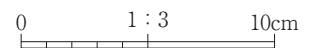
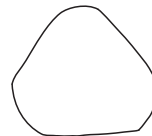

第 354 図 石器 (敲磨器類 36)

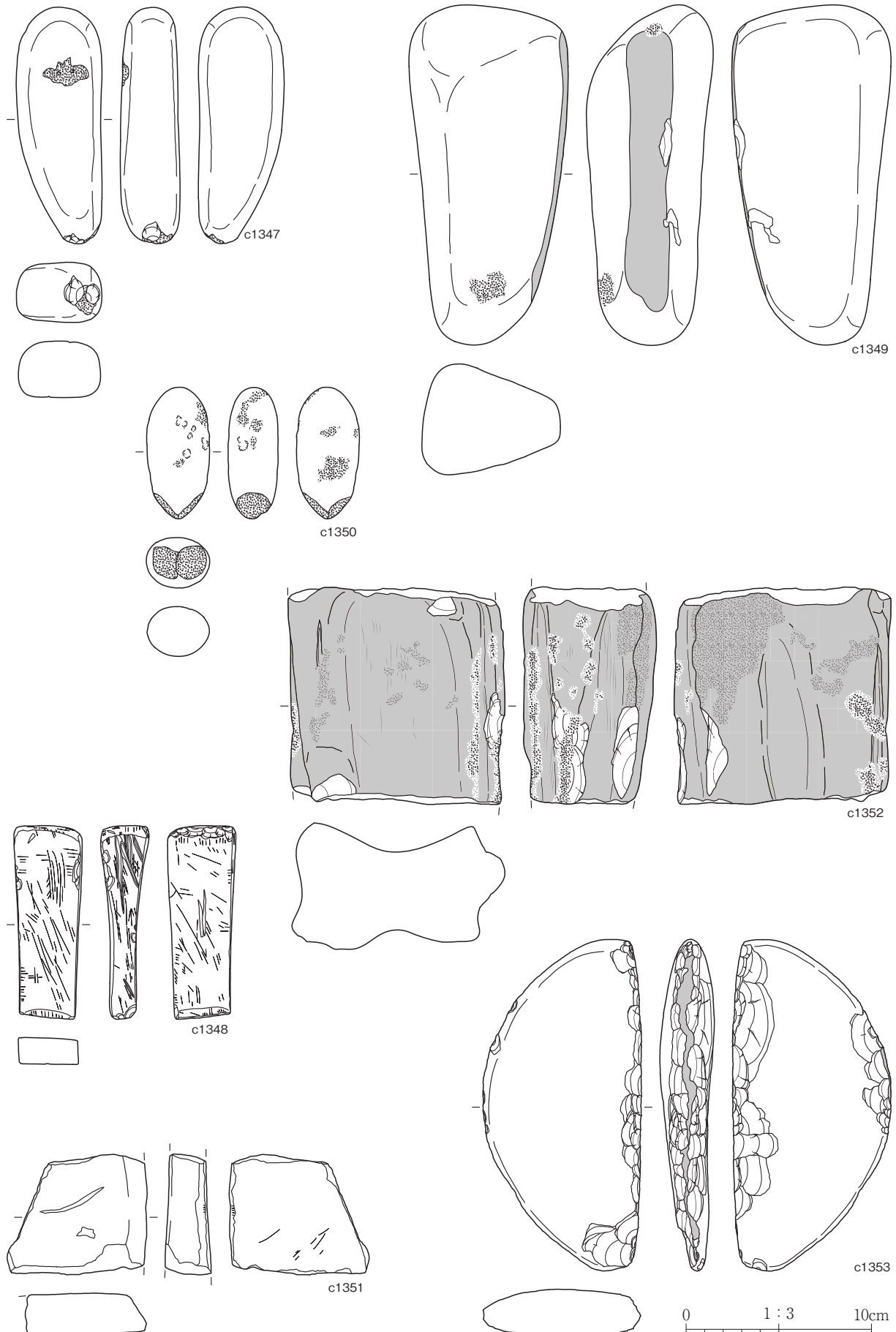

第 355 図 石器 (敲磨器類 37)

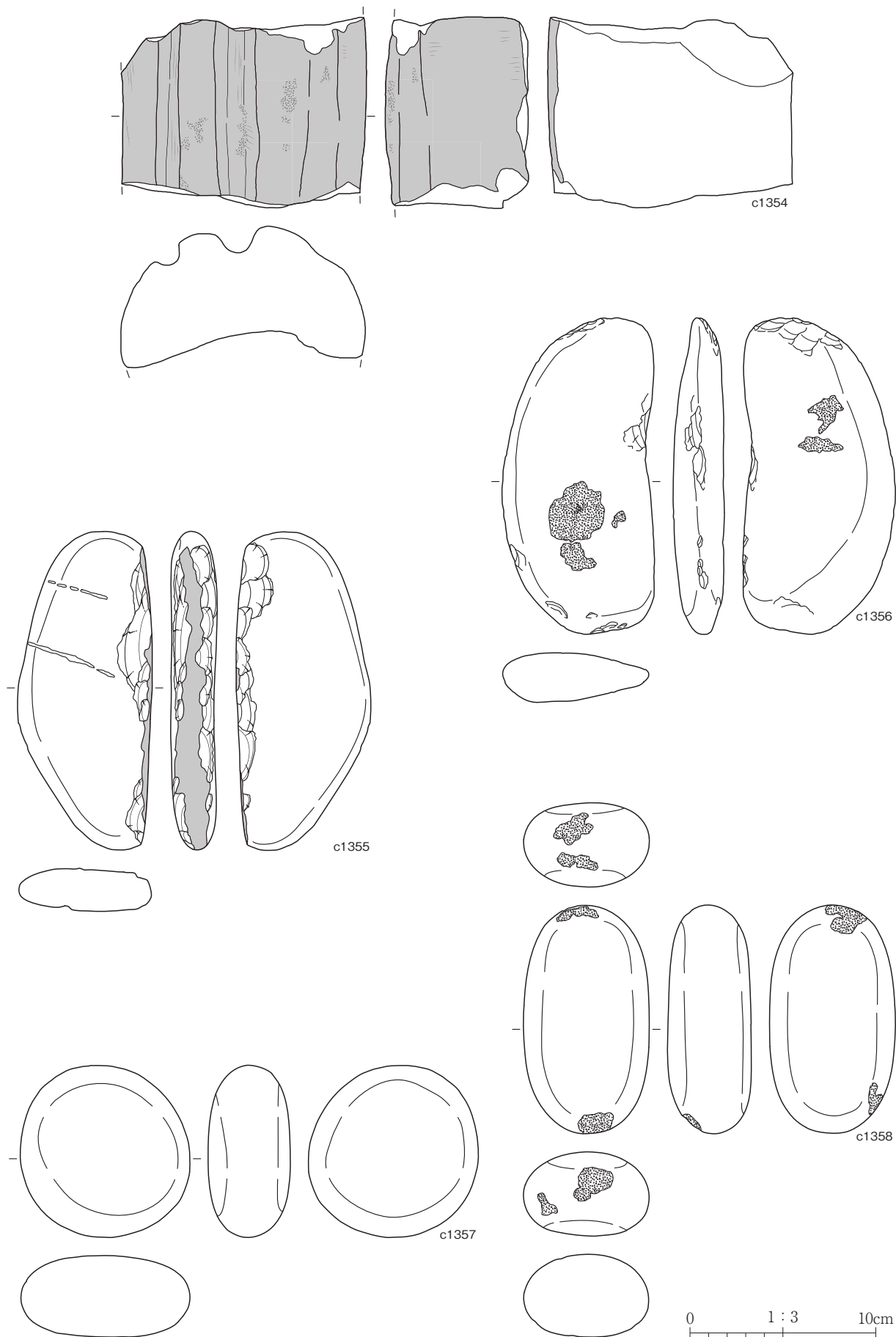

第 356 図 石器 (敲磨器類 38)

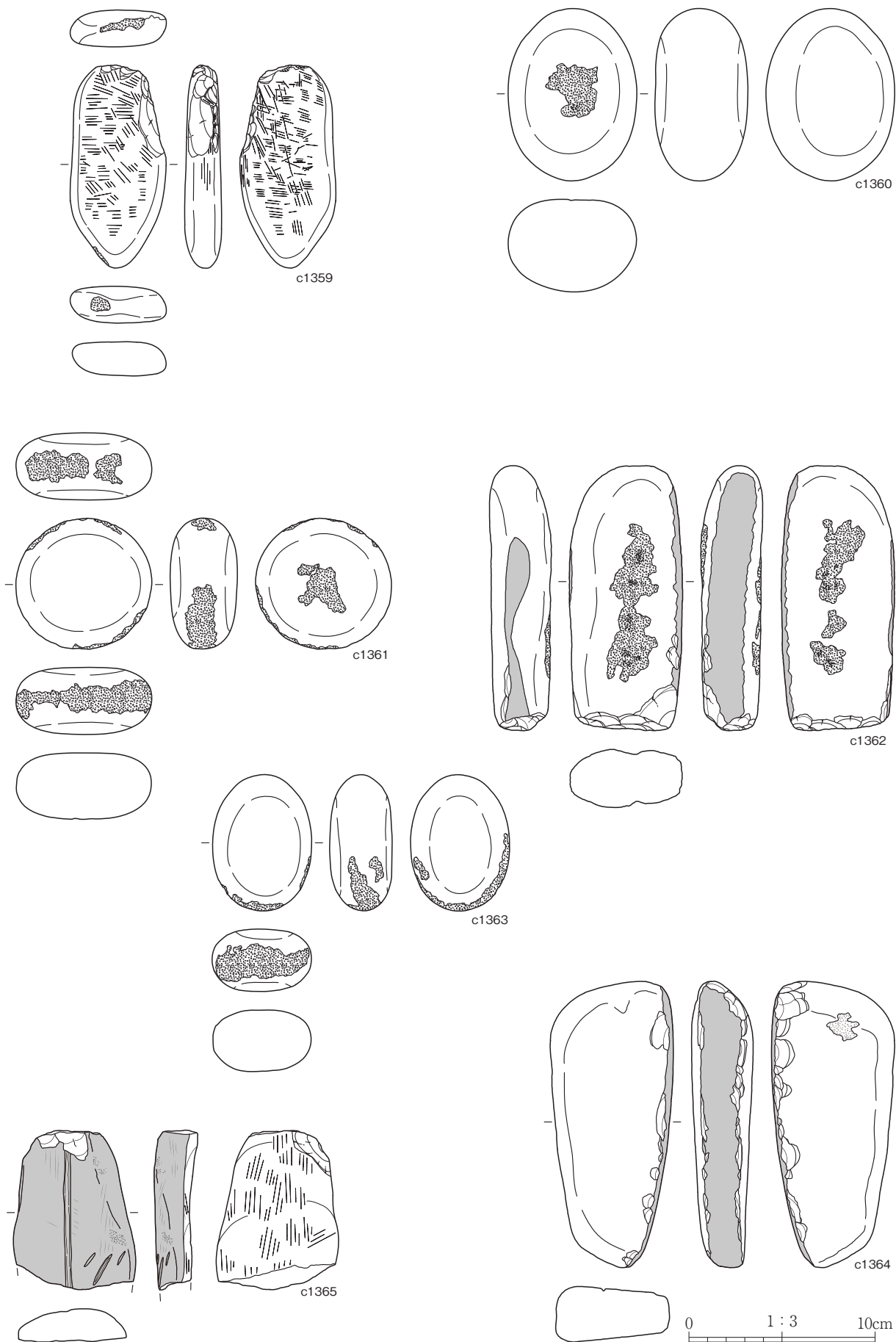

第 357 图 石器 (敲磨器類 39)

円盤状石器

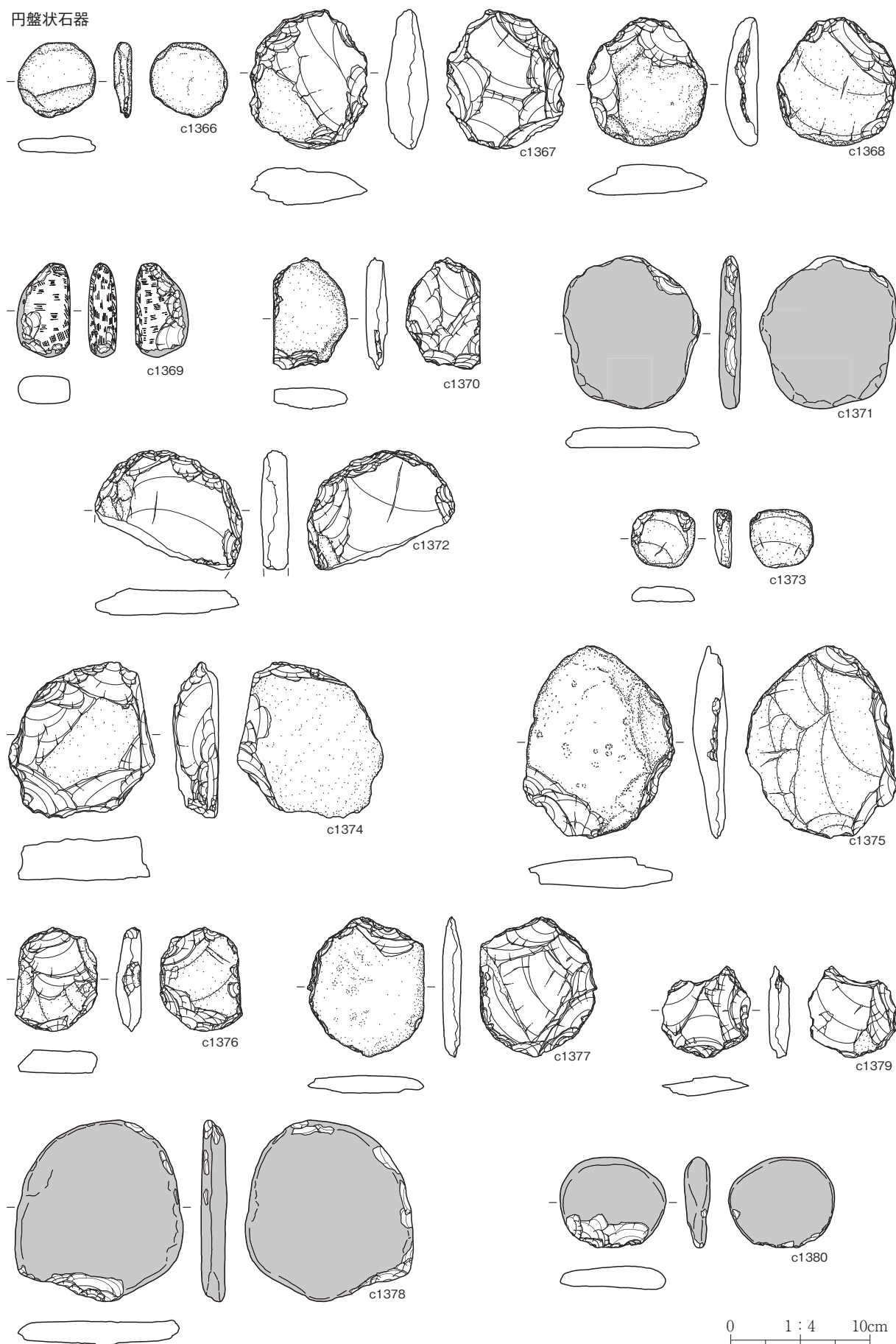

第 358 図 石器 (円盤状石器)

有孔垂飾具

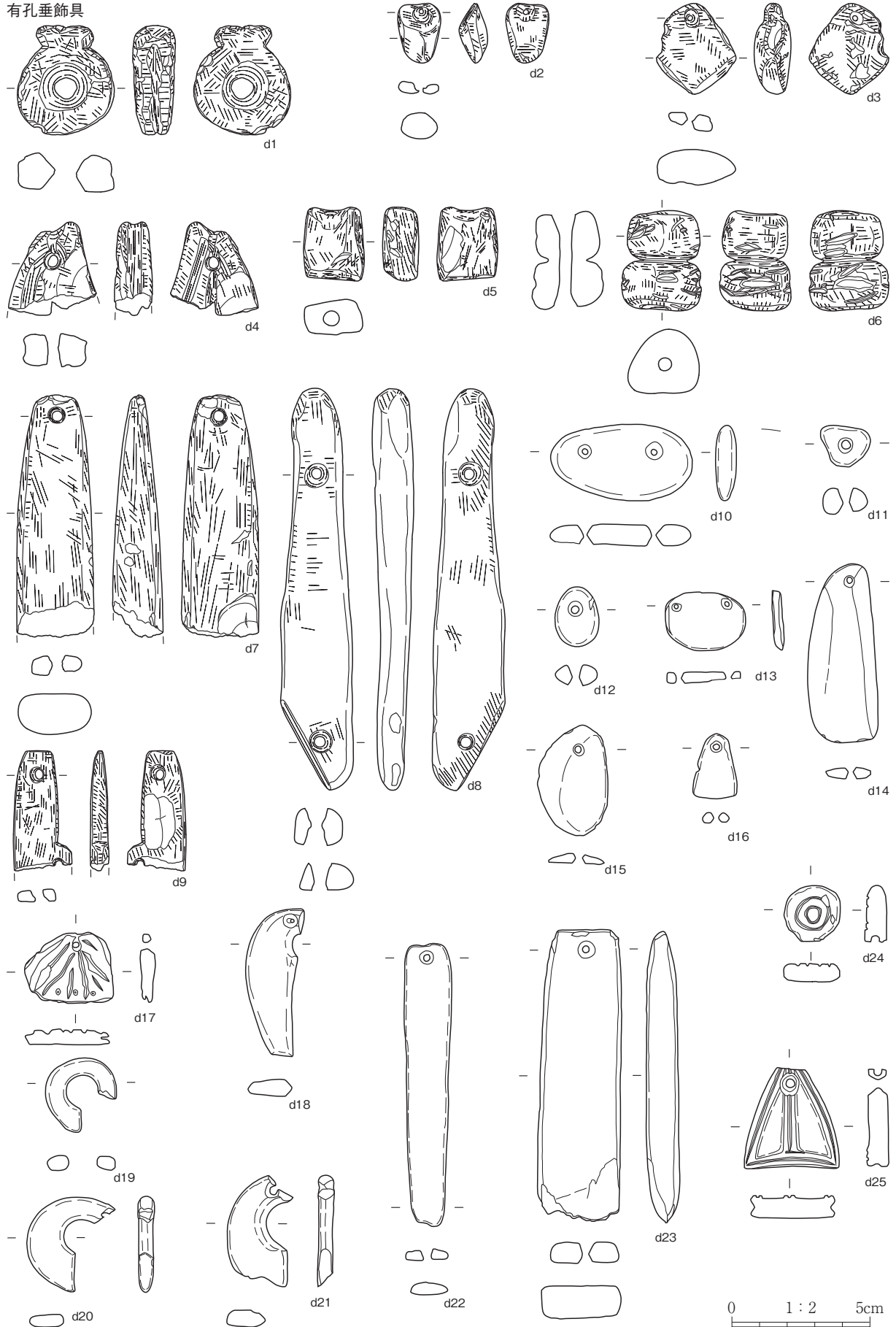

第 359 図 石器 (石製品 1)

三角壩形石製品

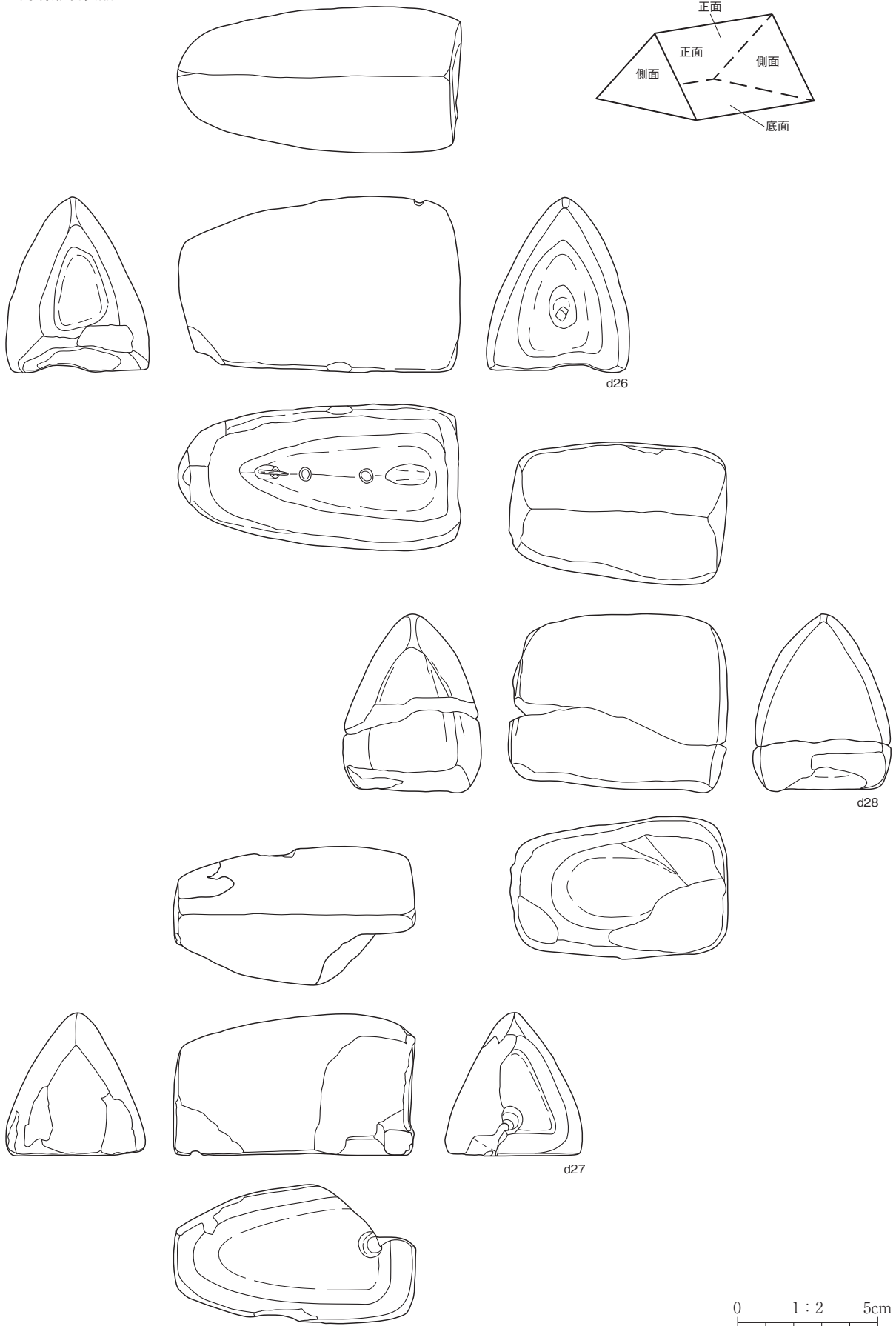

第 360 図 石器 (石製品 2)

石棒・石刀類

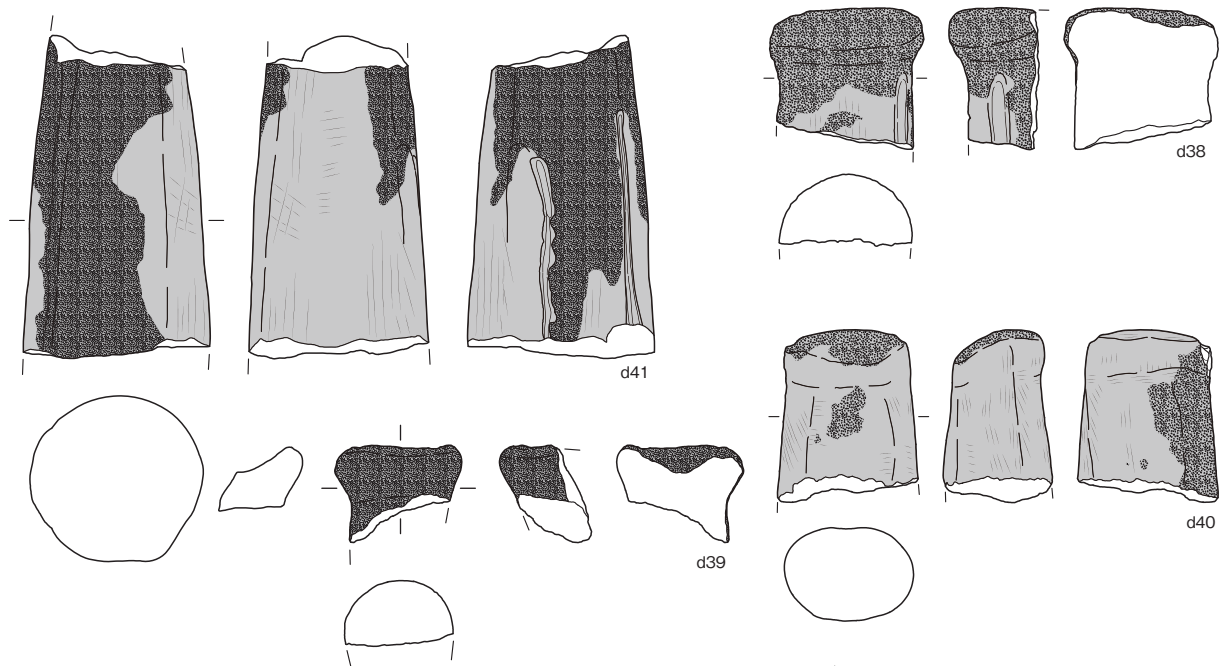
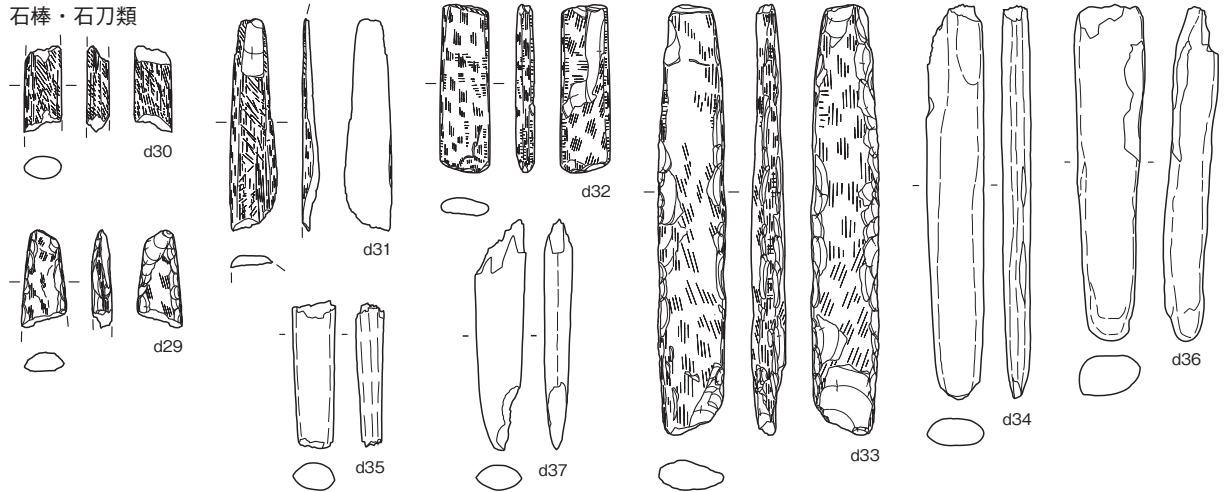

大形石棒・棒状礫

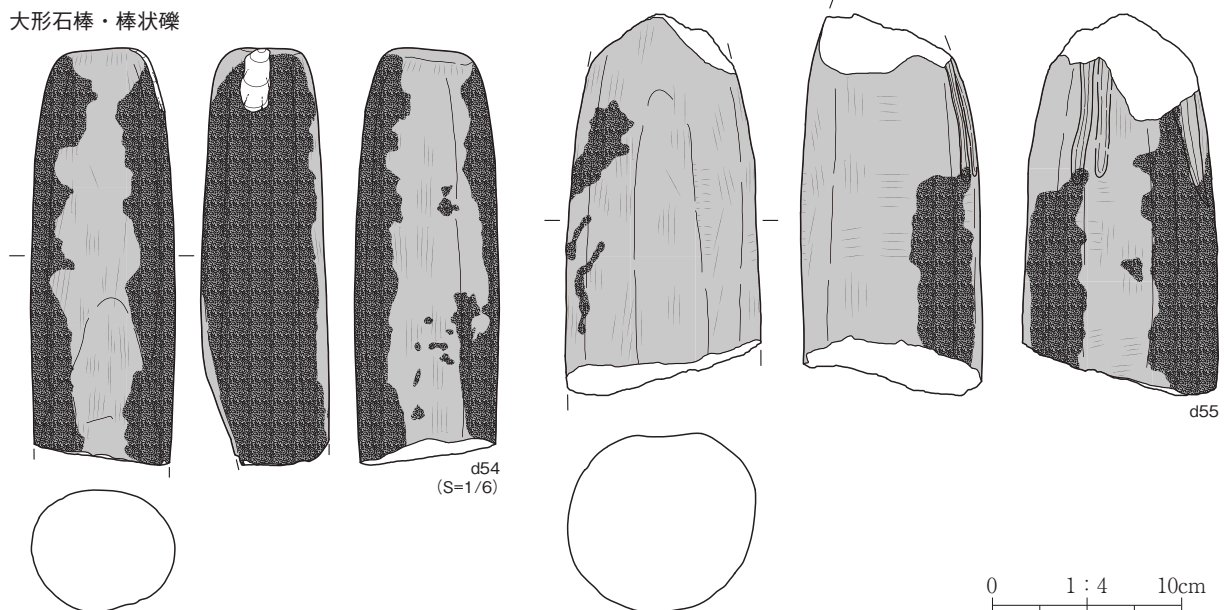

0 1 : 4 10cm

第 361 図 石器 (石製品 3)

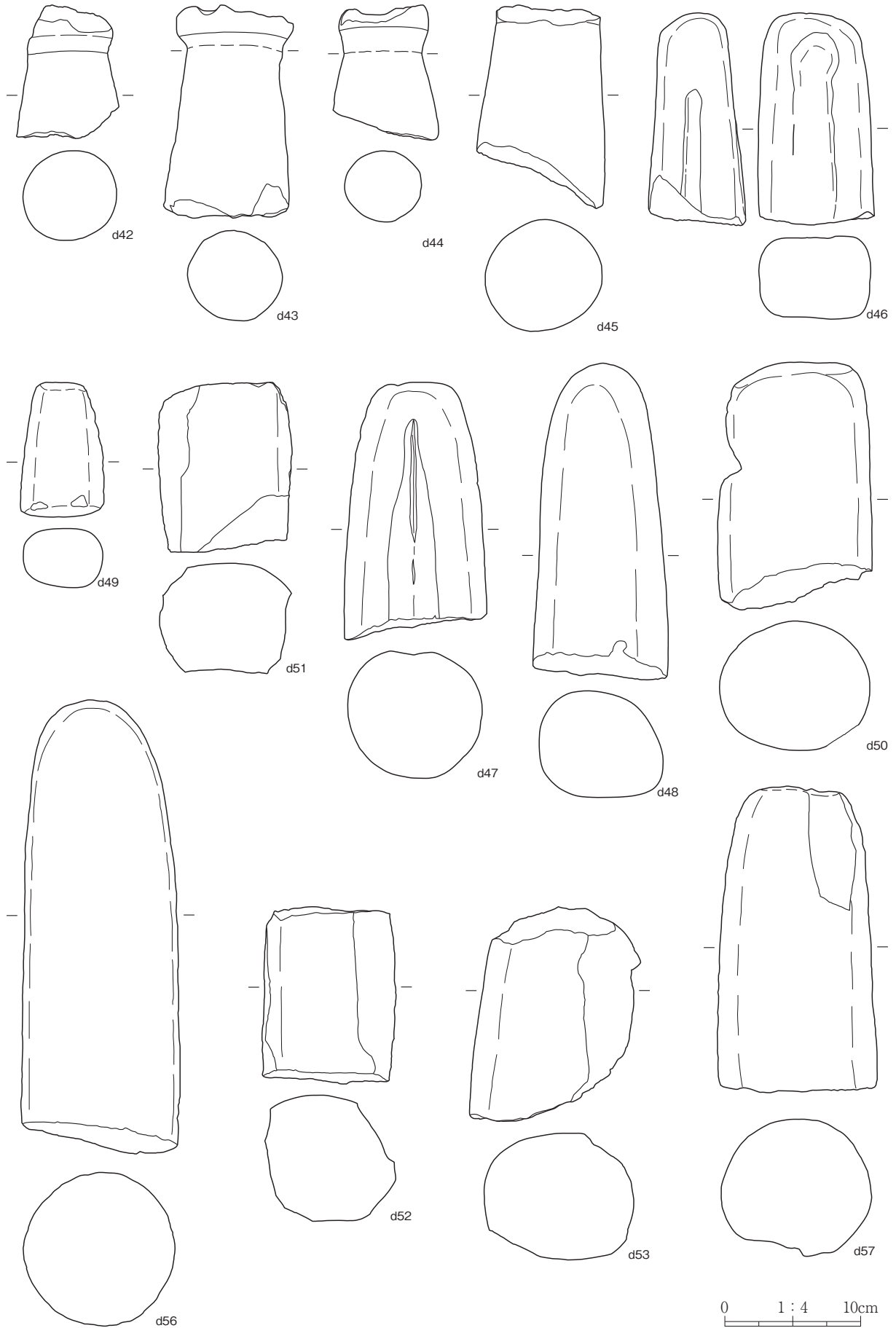

第 362 図 石器 (石製品 4)

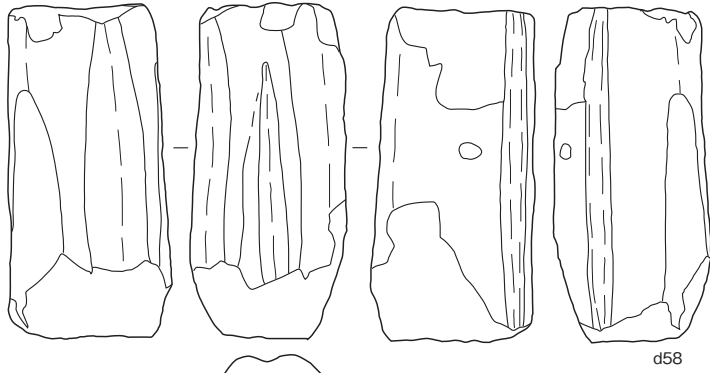

d58

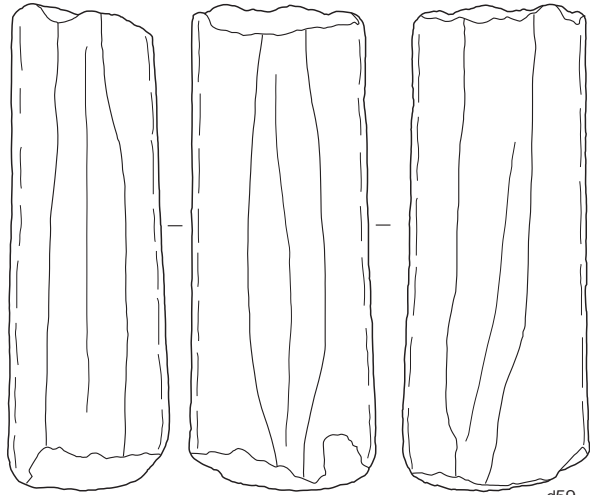
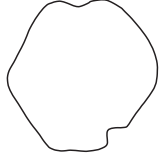

d59

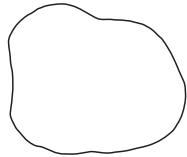

d62

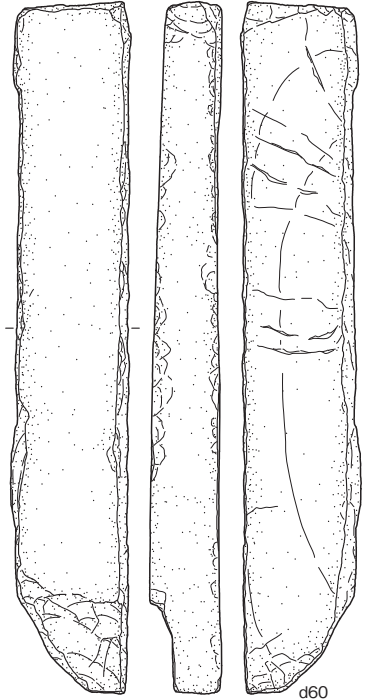

d60

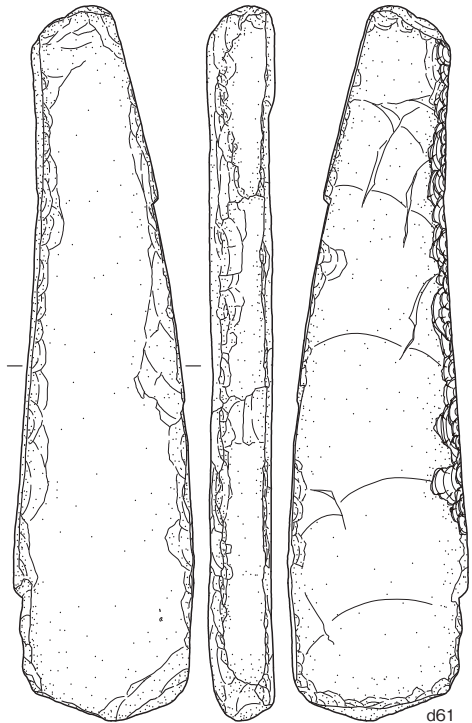

d61



0 1 : 4 10cm

第 363 図 石器 (石製品 5)



軽石製品

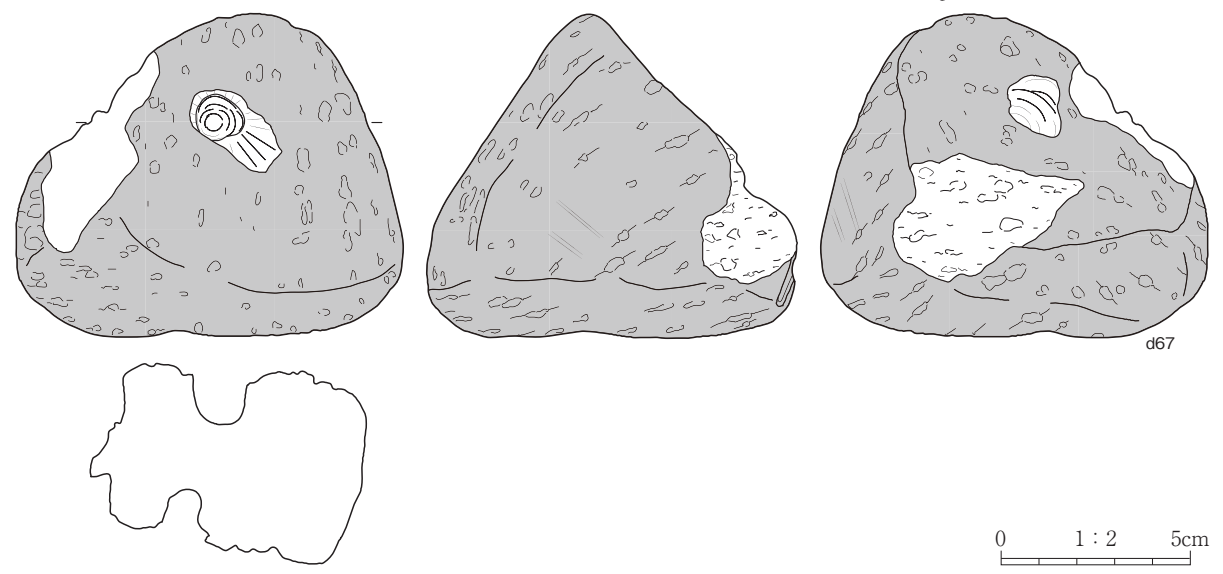
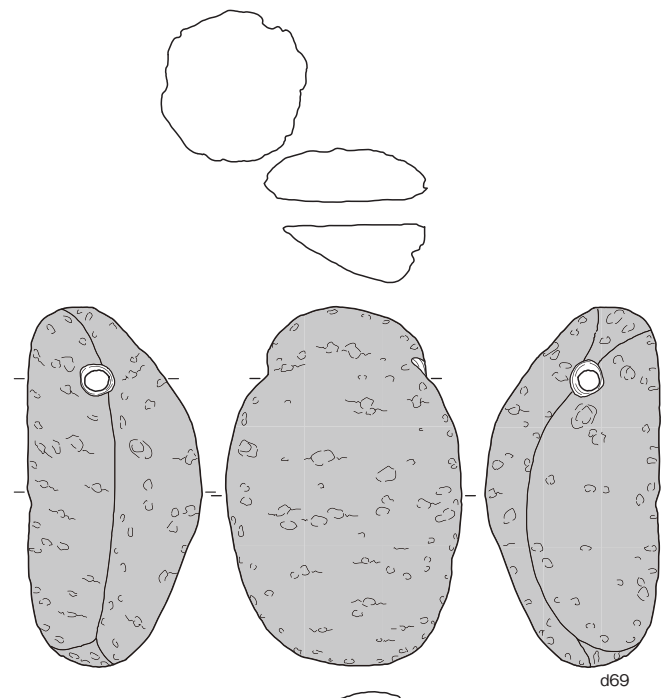
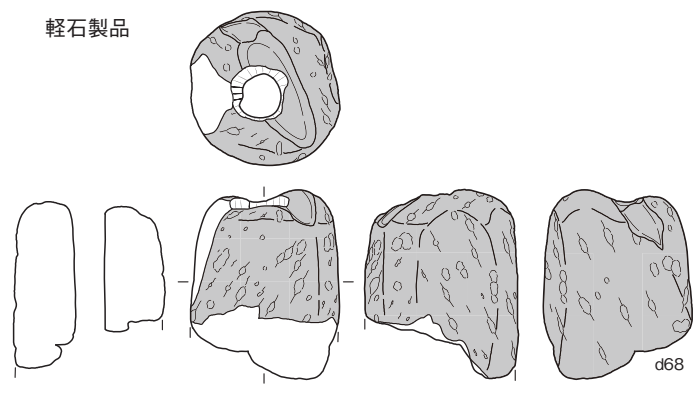

第 364 図 石器 (石製品 6)

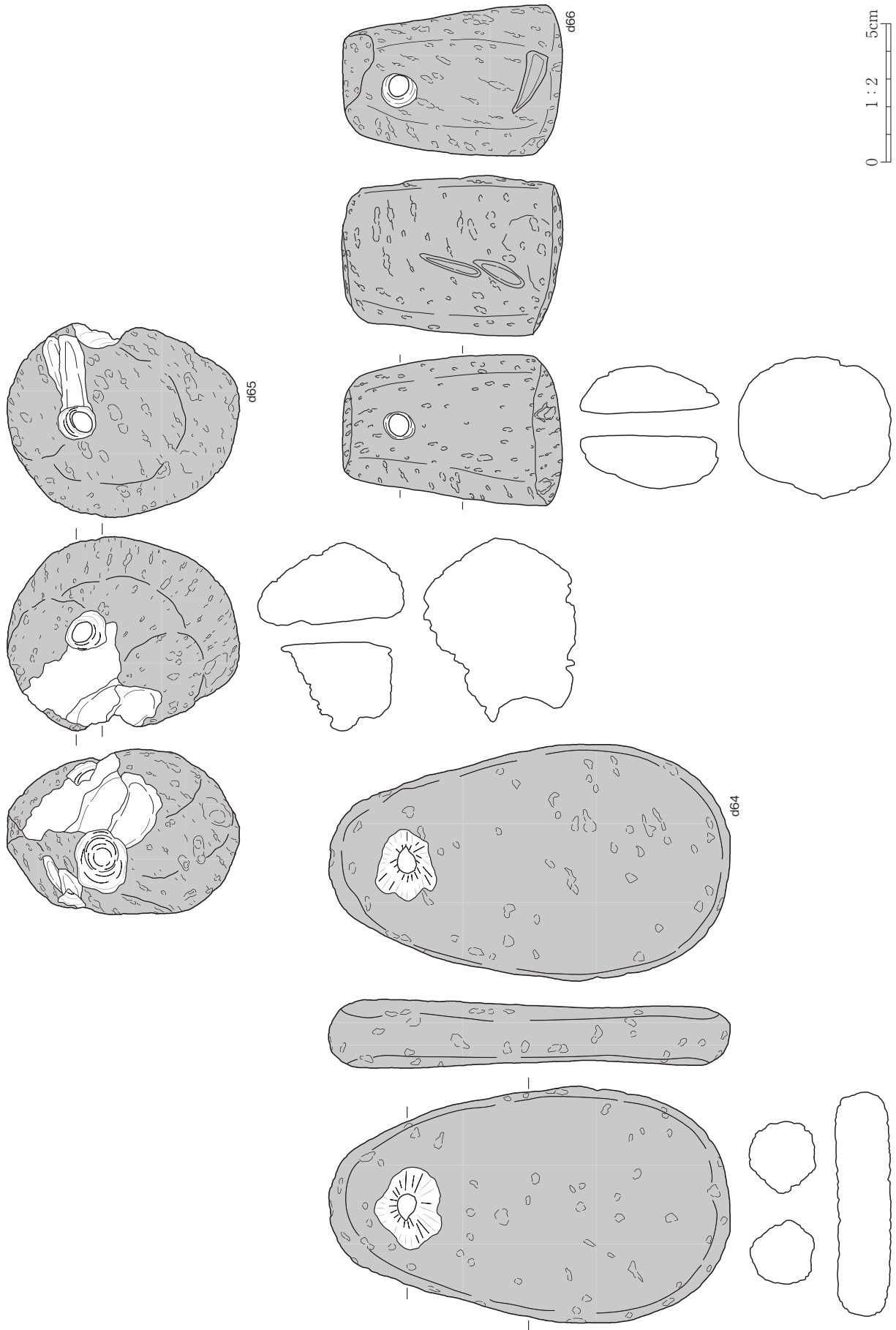

第 365 図 石器 (石製品 7)

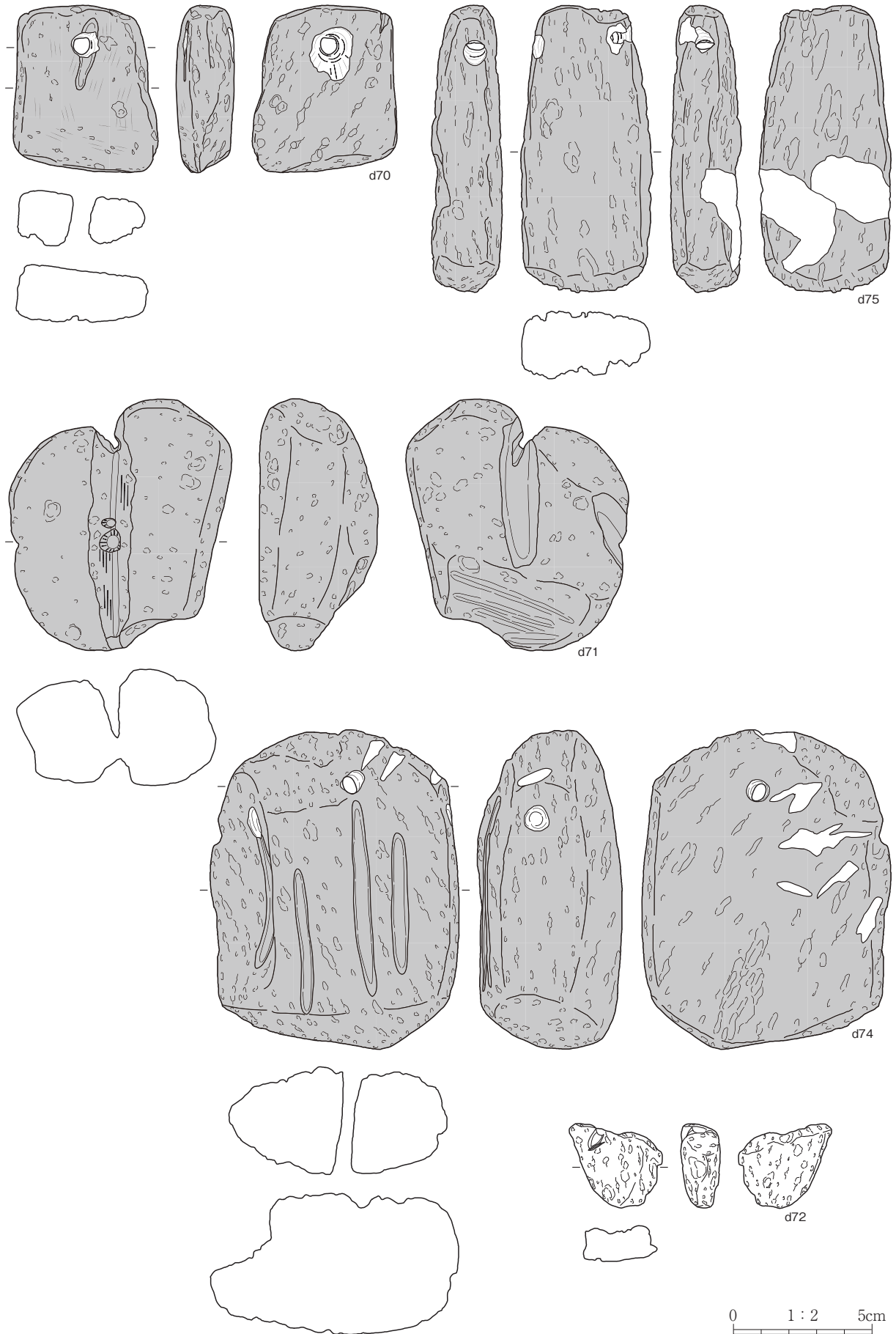

第 366 図 石器 (石製品 8)

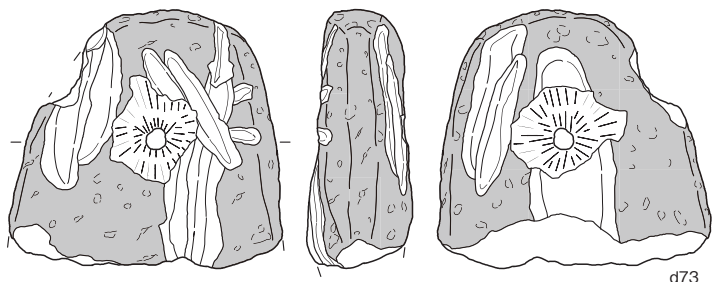

d73



d76

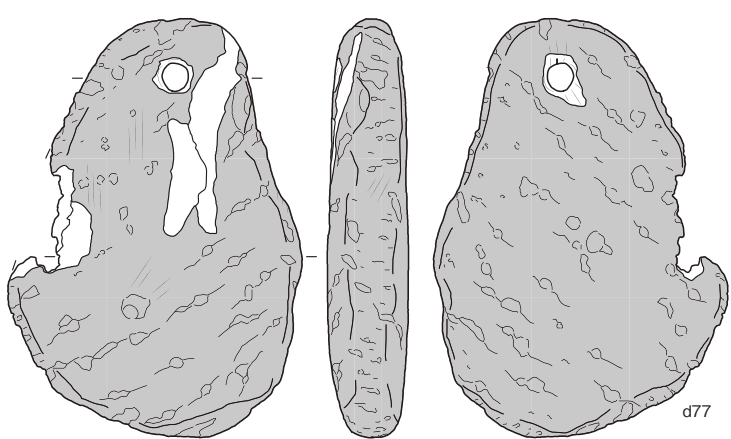

d77

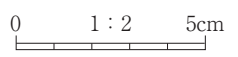

第 367 図 石器 (石製品 9)

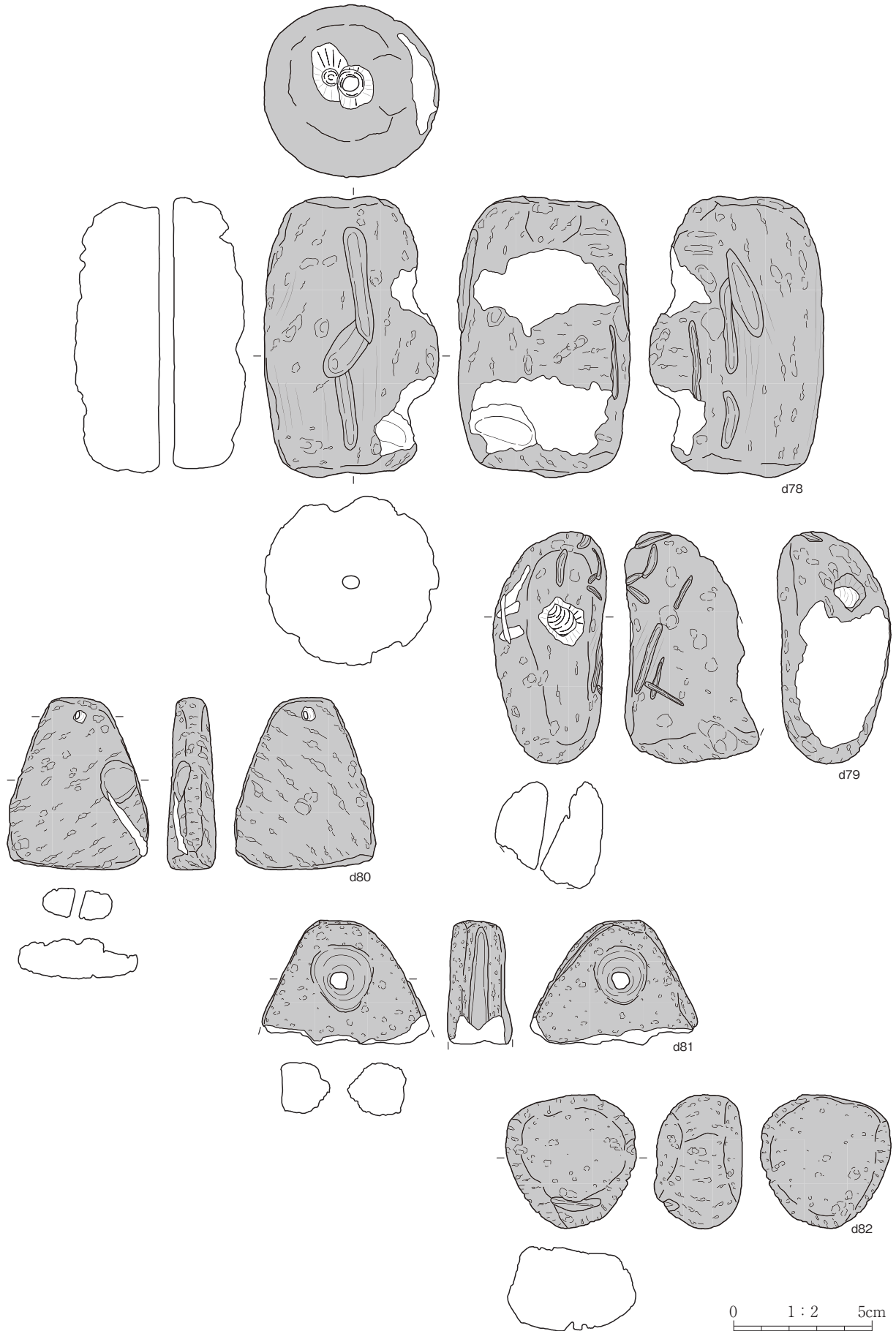

第 368 図 石器 (石製品 10)

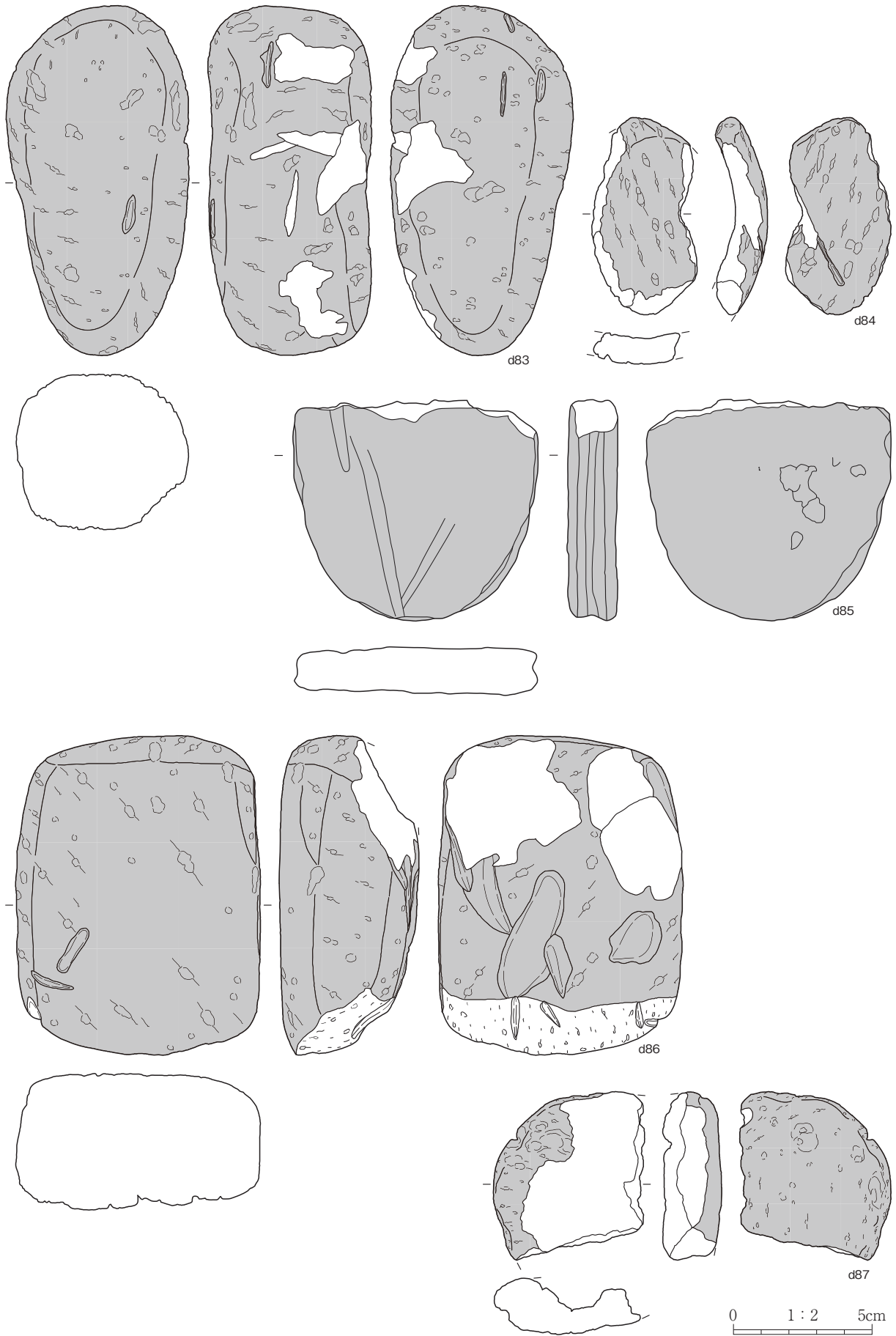

第 369 図 石器 (石製品 11)

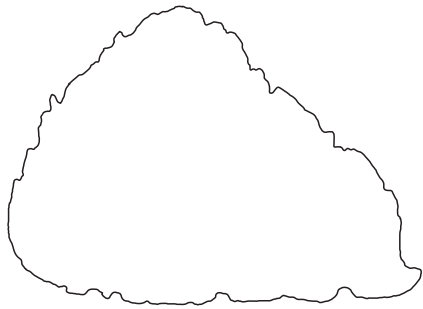
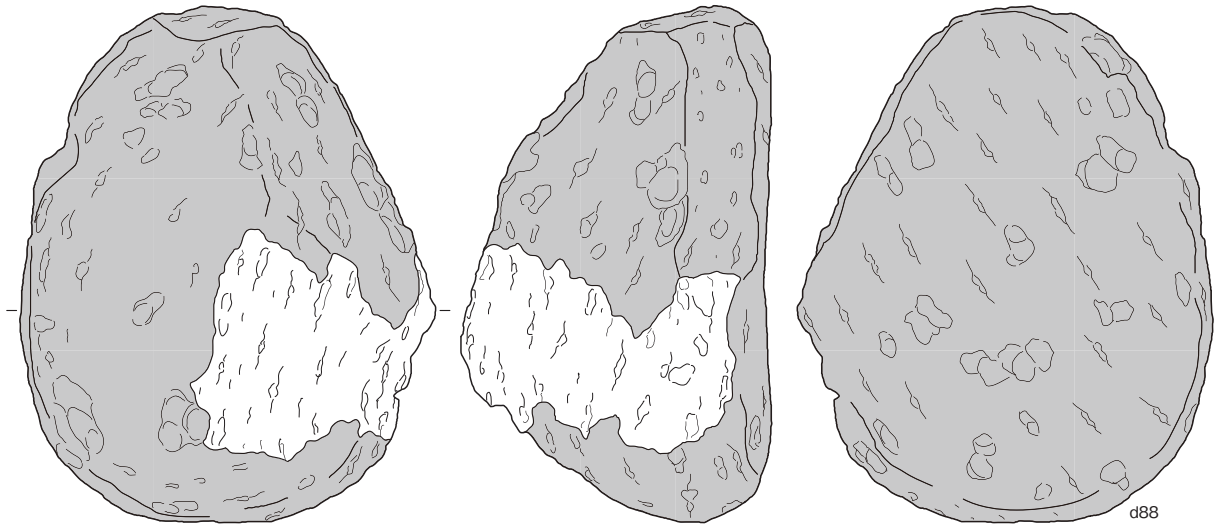

不明石製品

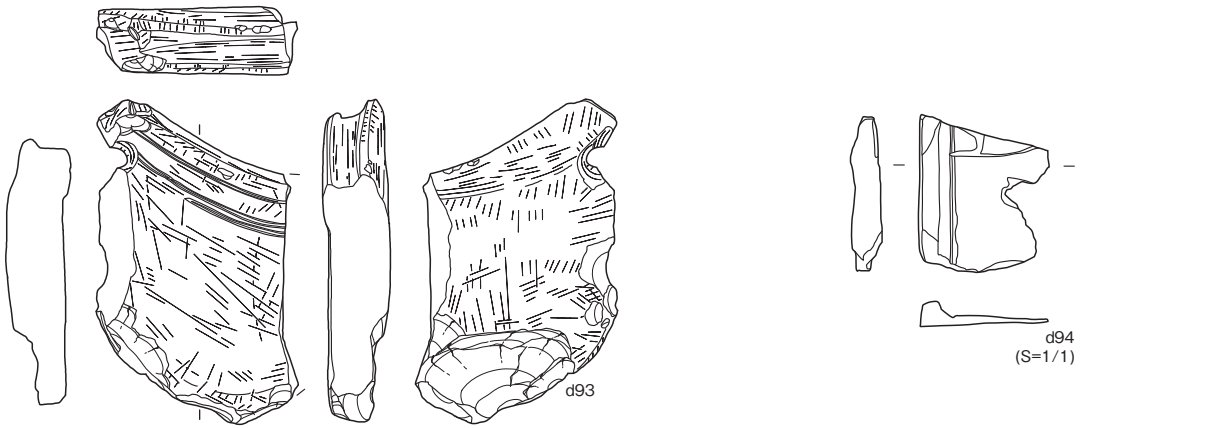
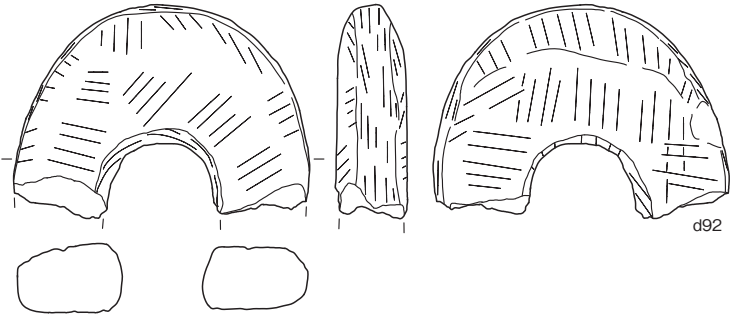

玉石

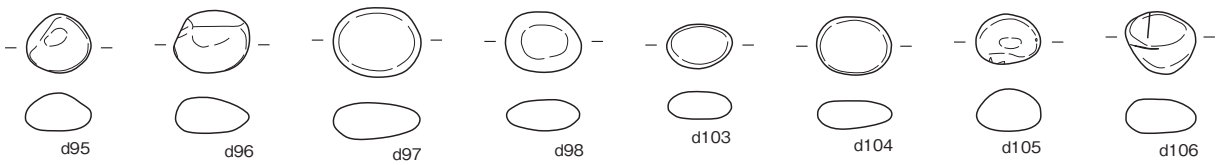

0 1:2 5cm

第 370 図 石器 (石製品 12)

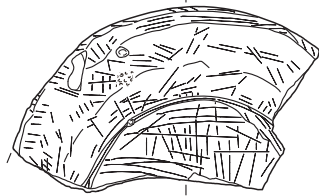
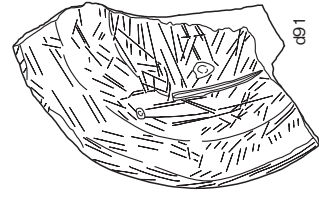
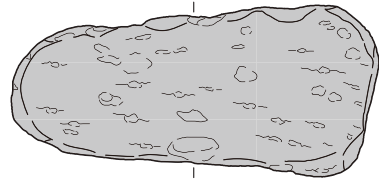
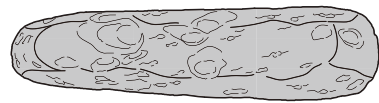
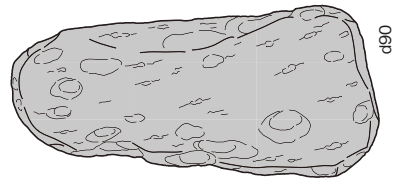
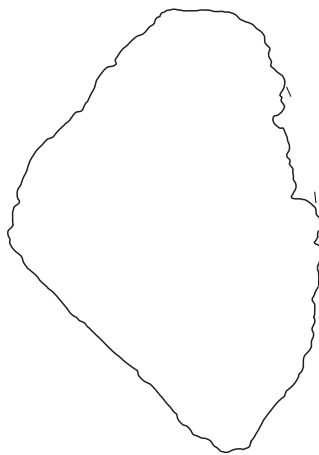
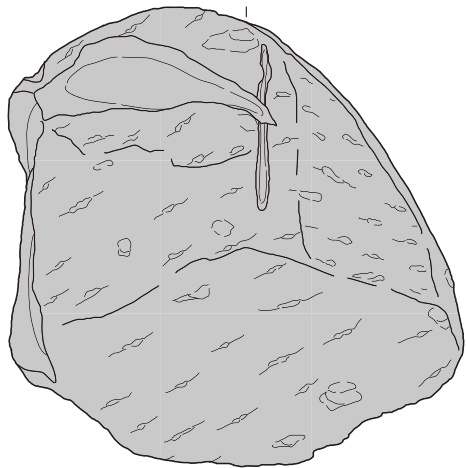
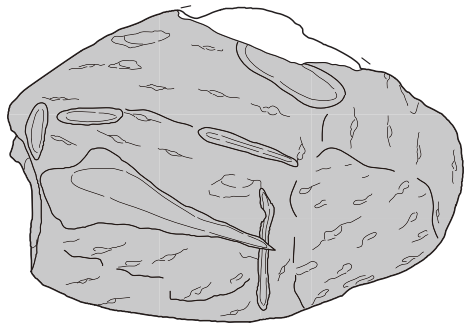
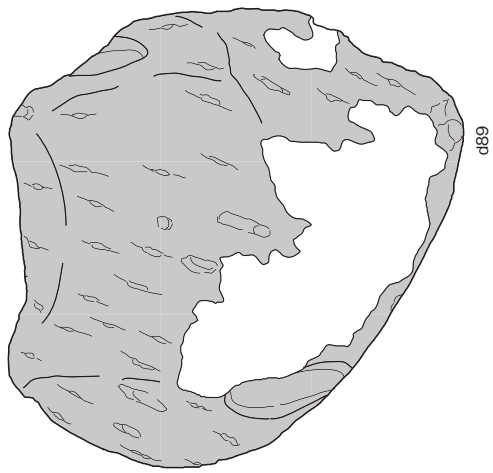

不明石製品

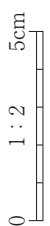

第 371 図 石器 (石製品 13)

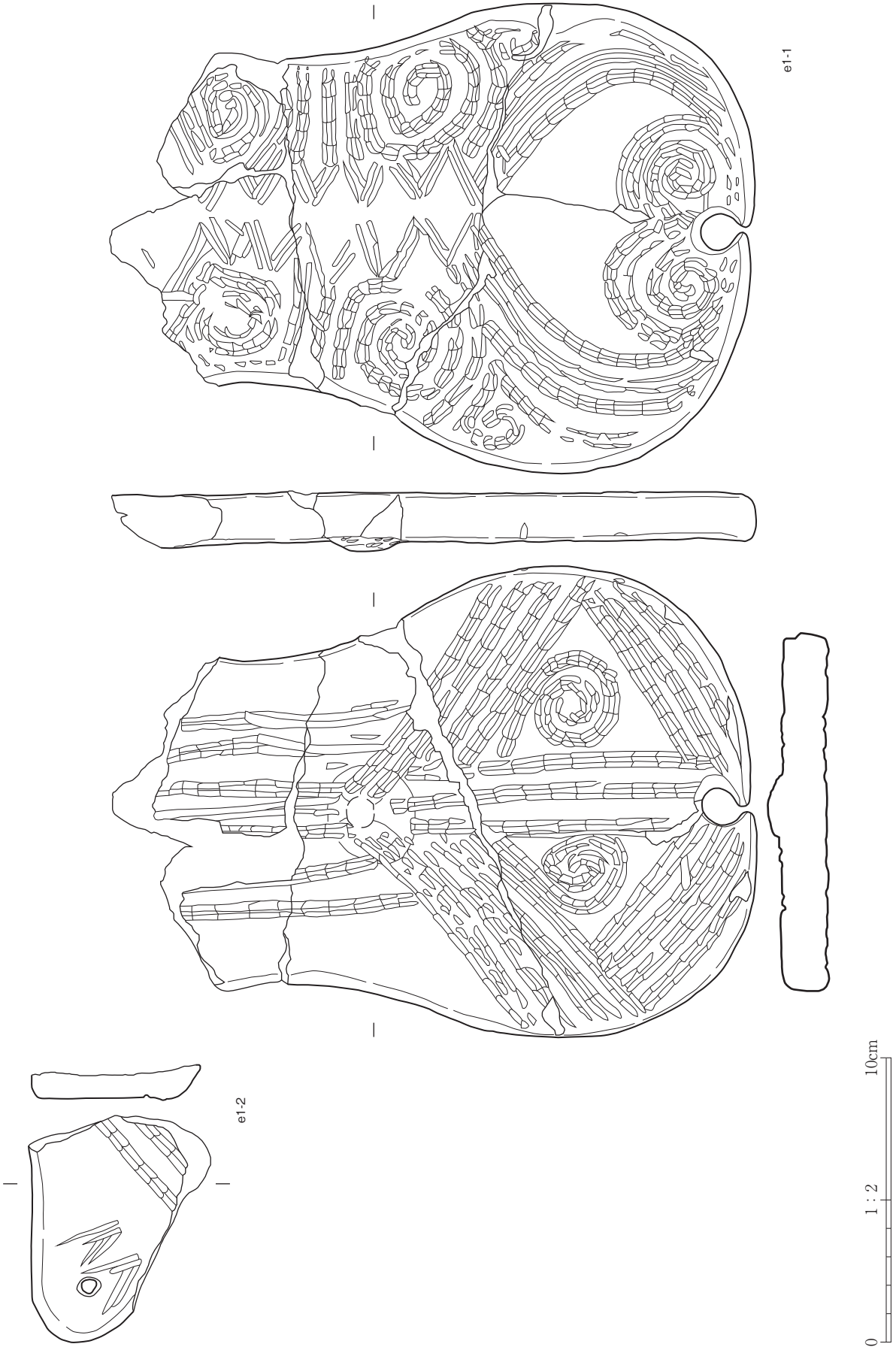

第 372 図 土製品 (1)

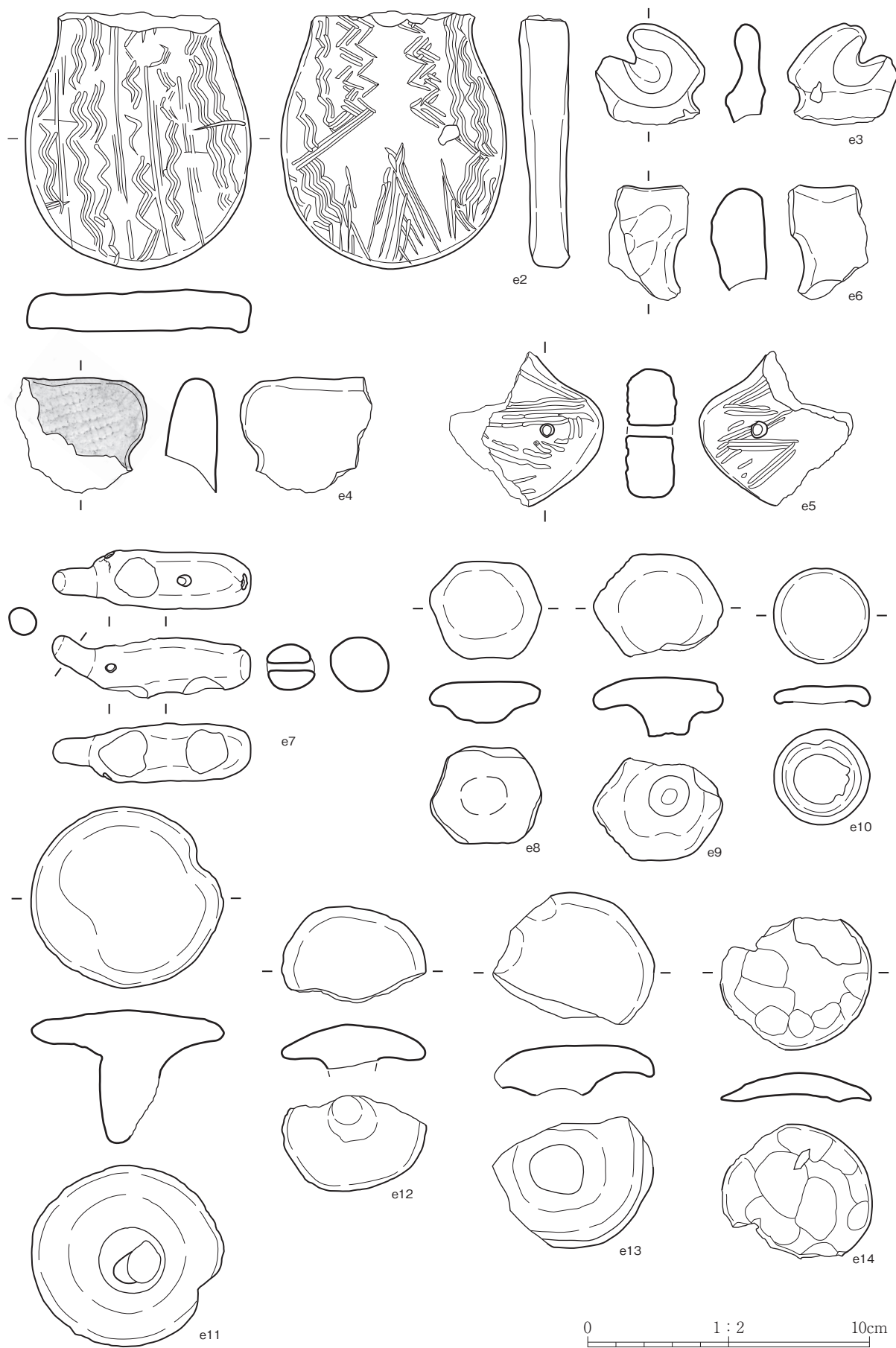

第 373 図 土製品 (2)

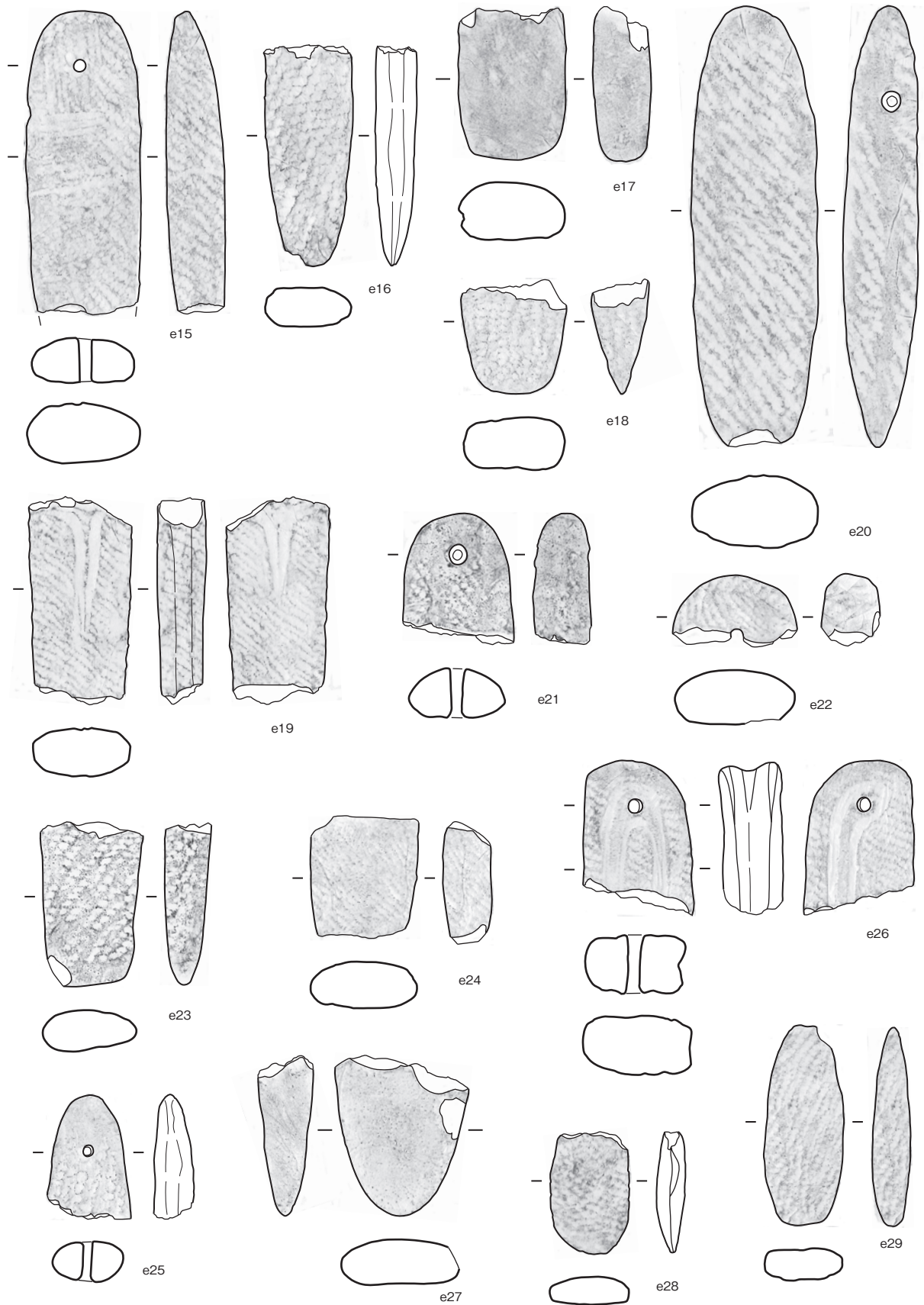

0 1 : 2 10cm

第 374 図 土製品 (3)

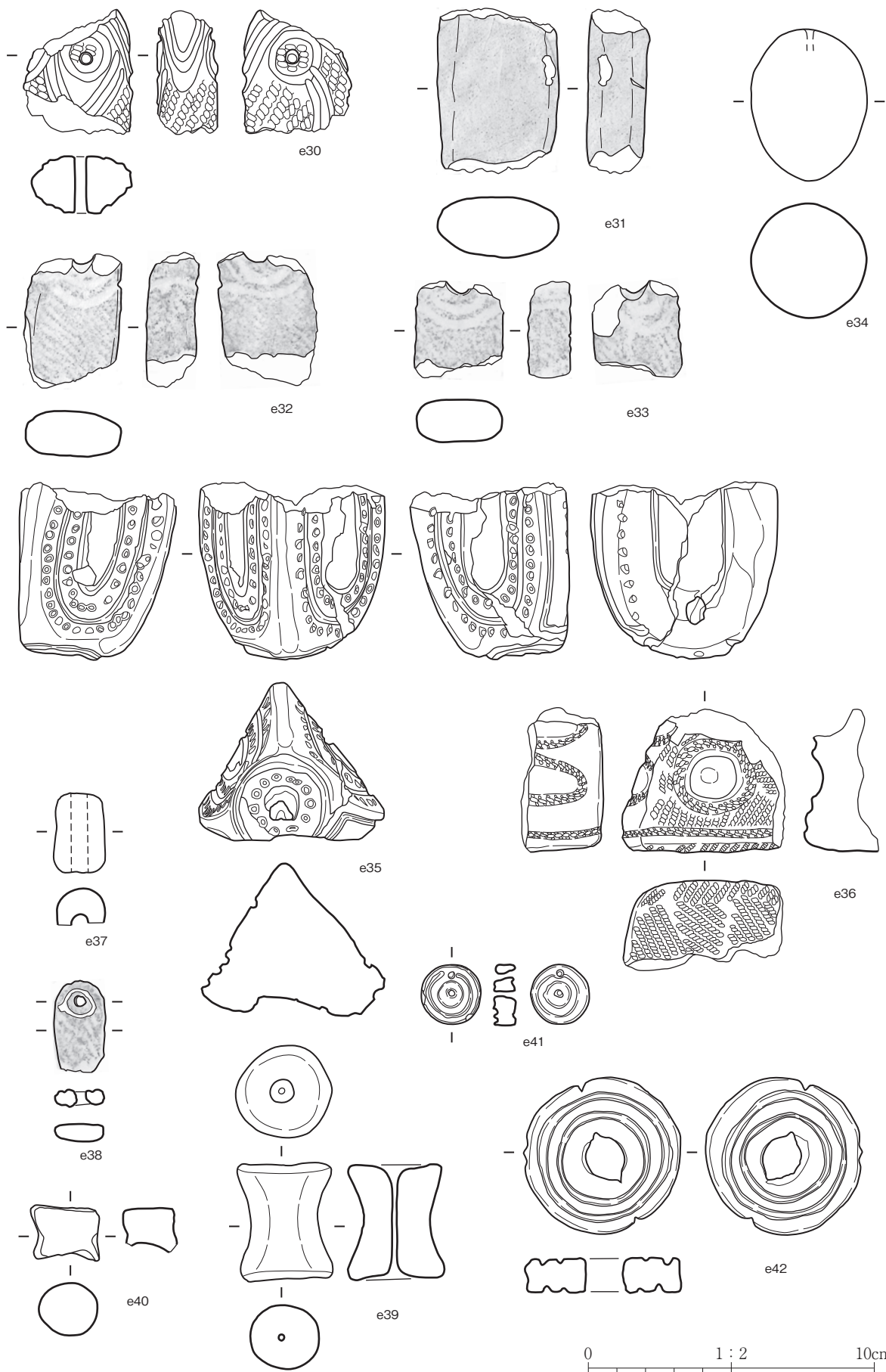

第 375 図 土製品 (4)

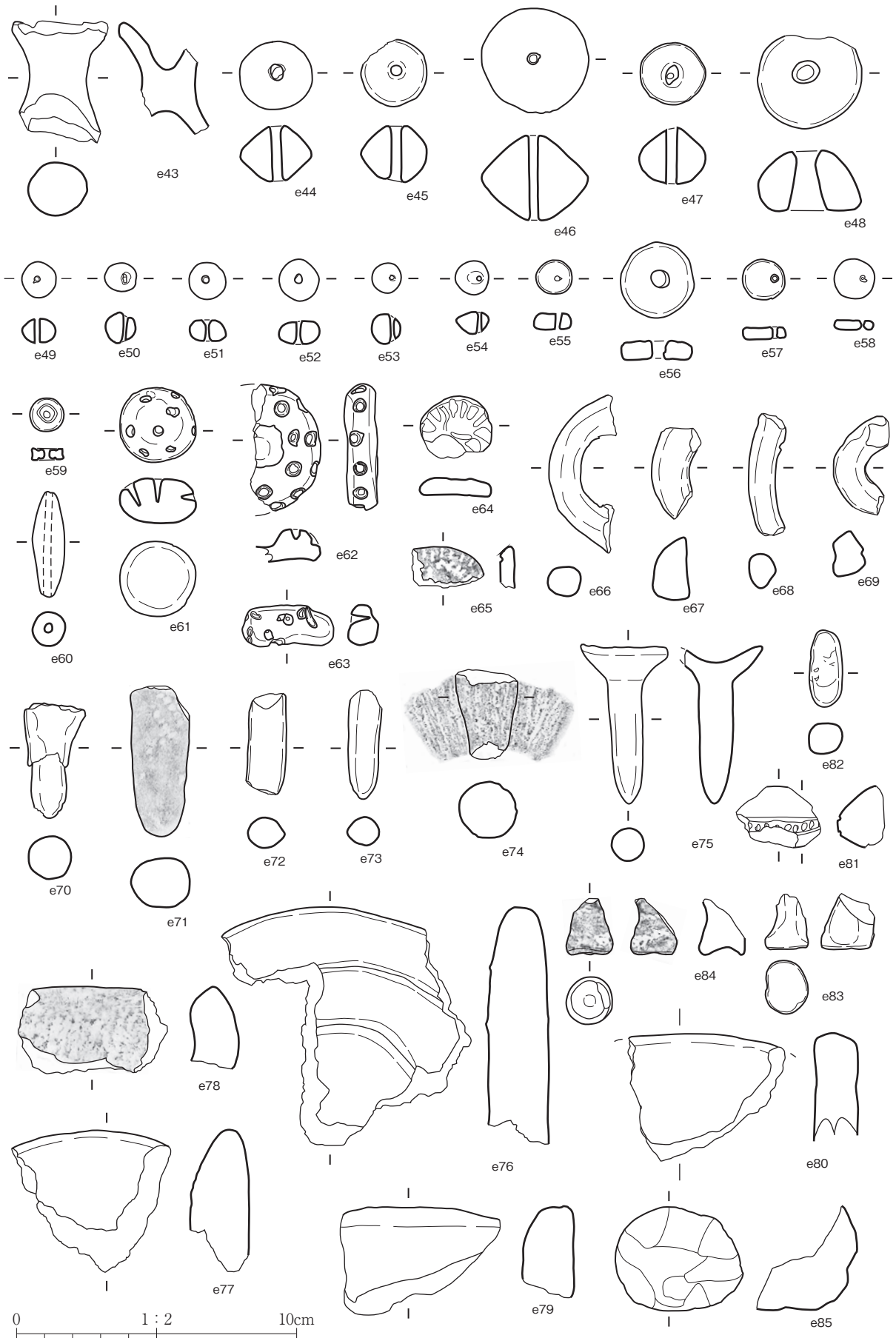

第 376 図 土製品 (5)

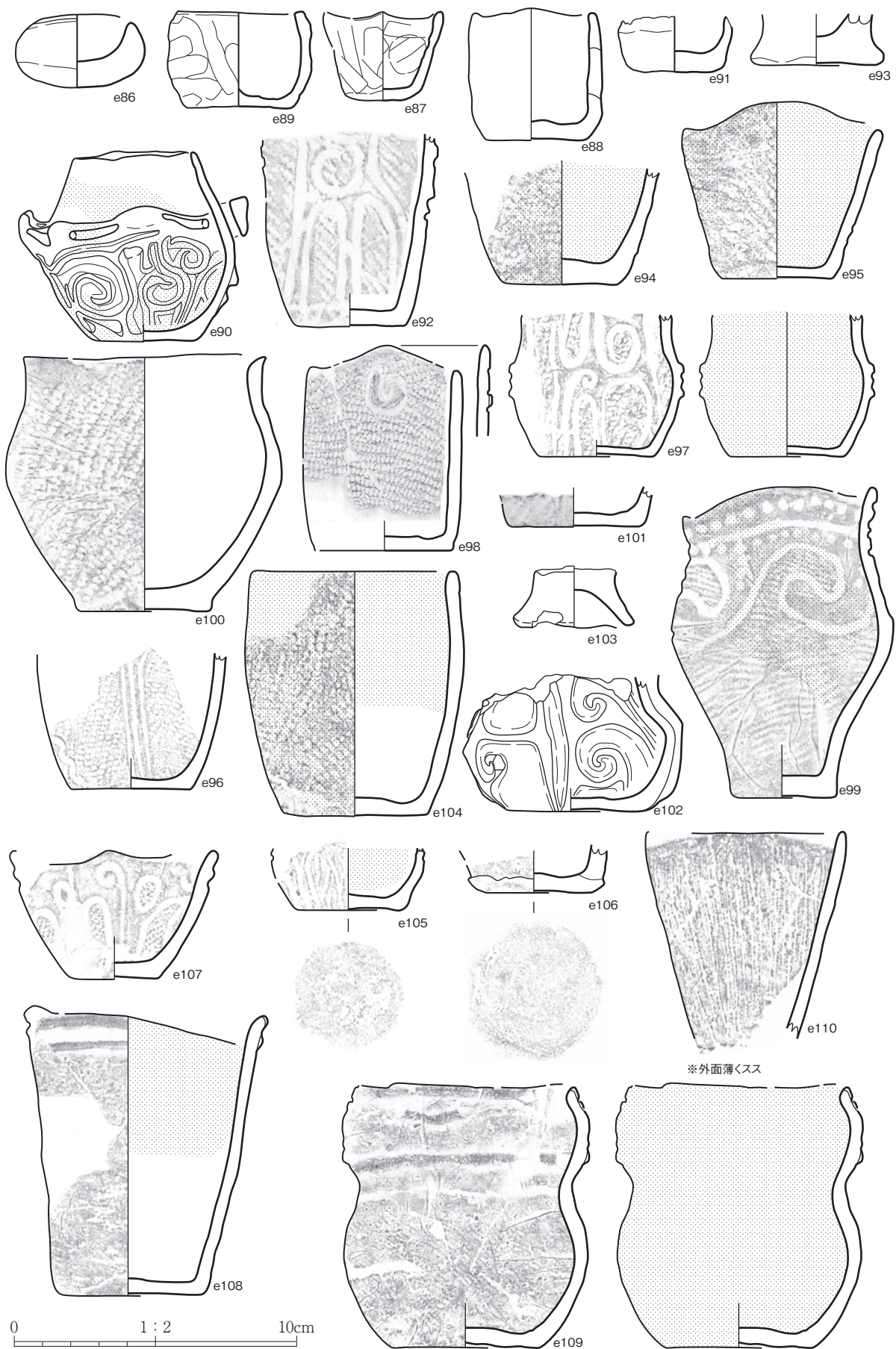

第 377 図 土製品 (6)

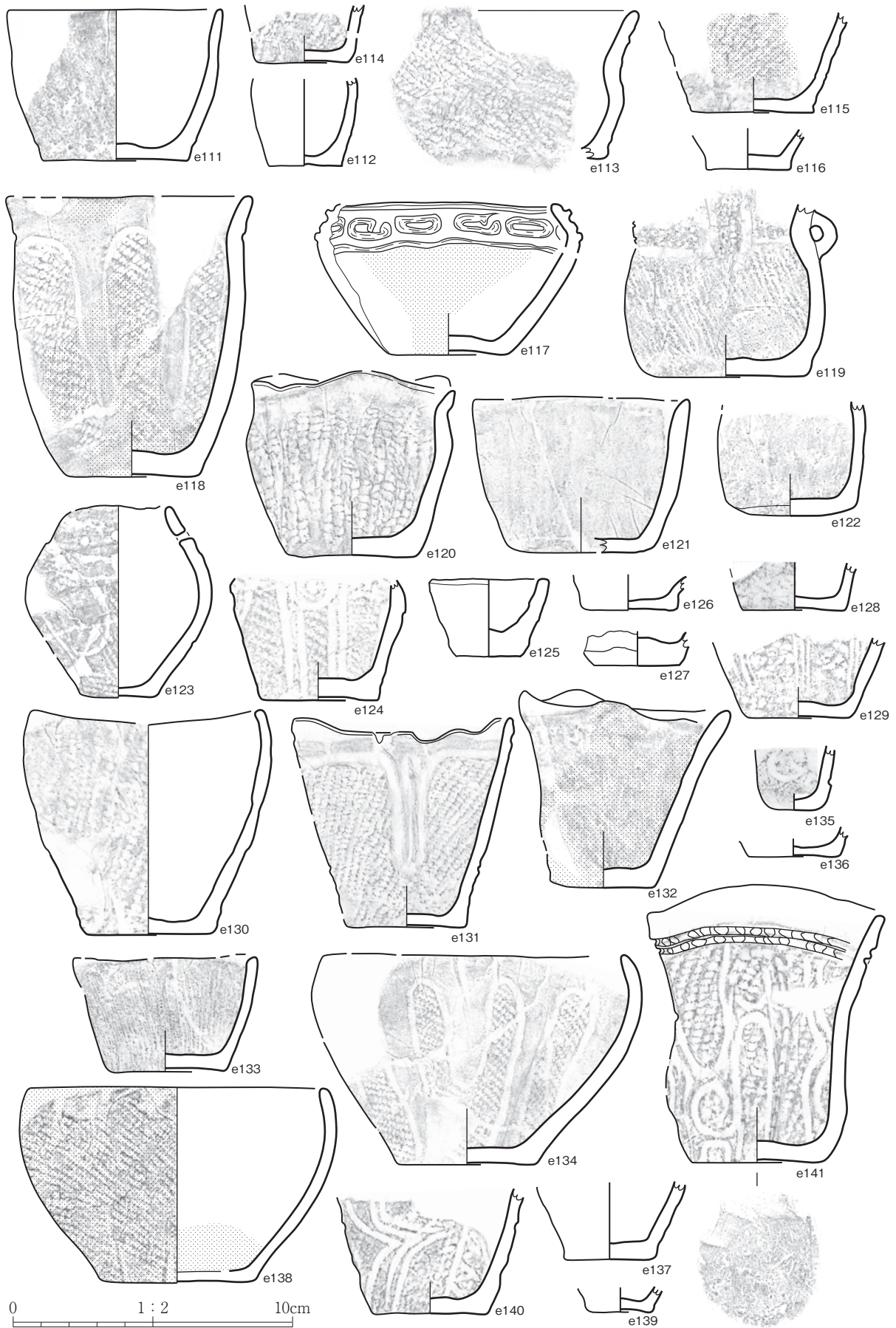

第 378 図 土製品 (7)

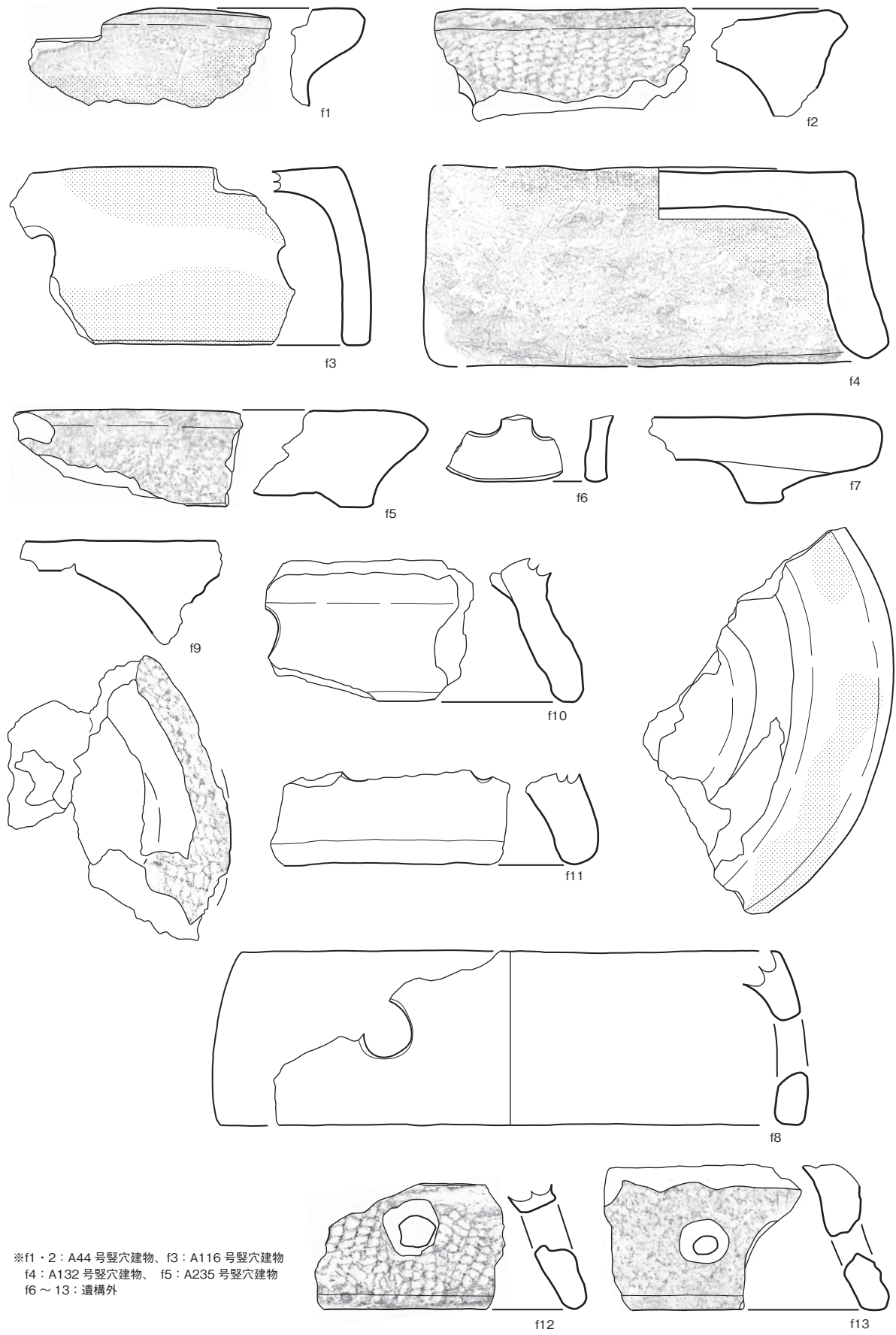

※f1・2：A44号竖穴建物、f3：A116号竖穴建物
 f4：A132号竖穴建物、f5：A235号竖穴建物
 f6～13：遺構外

0 1:2 10cm

第379图 台形土器(1)

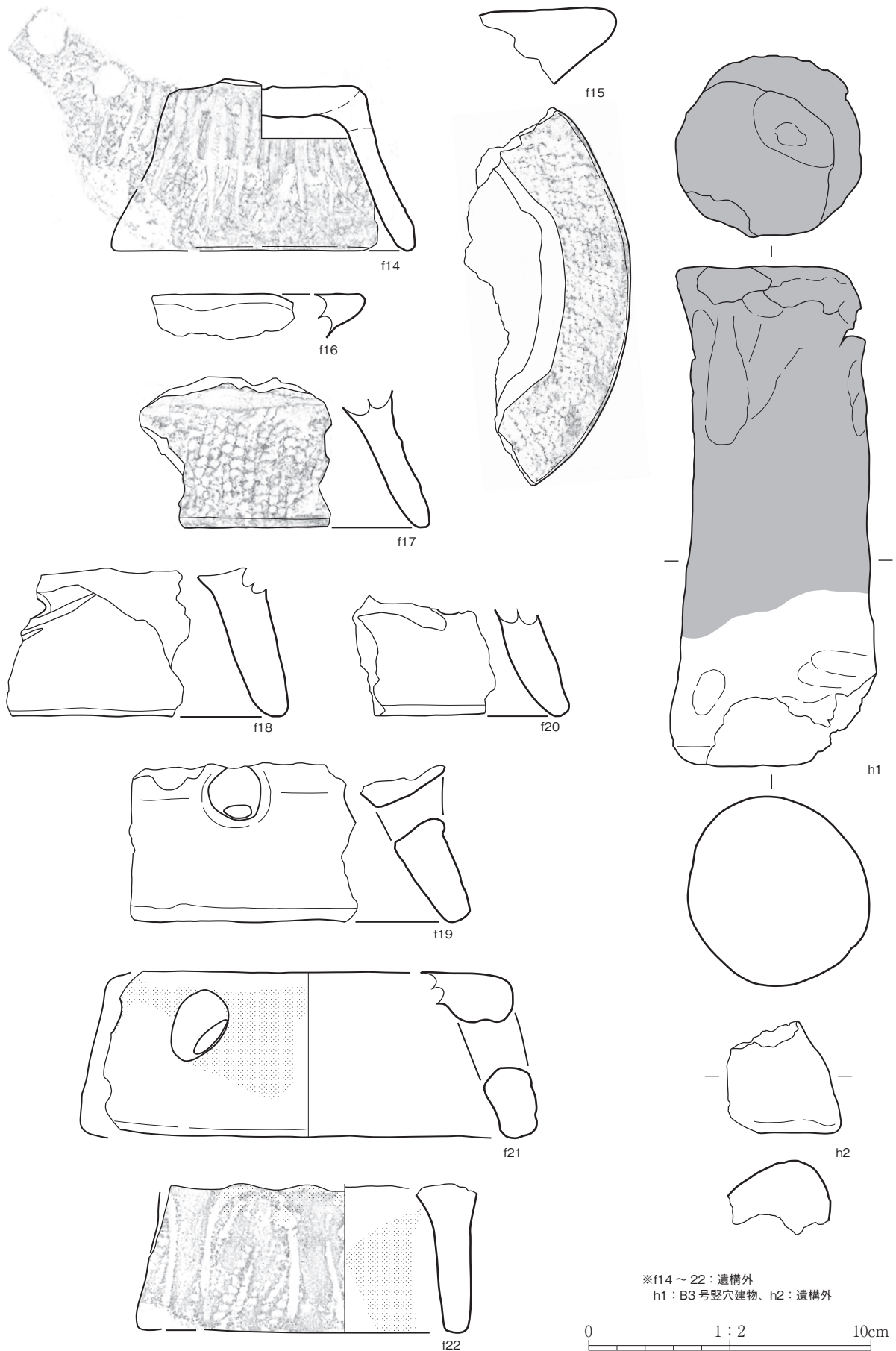

第 380 図 台形土器 (2)、土製支脚

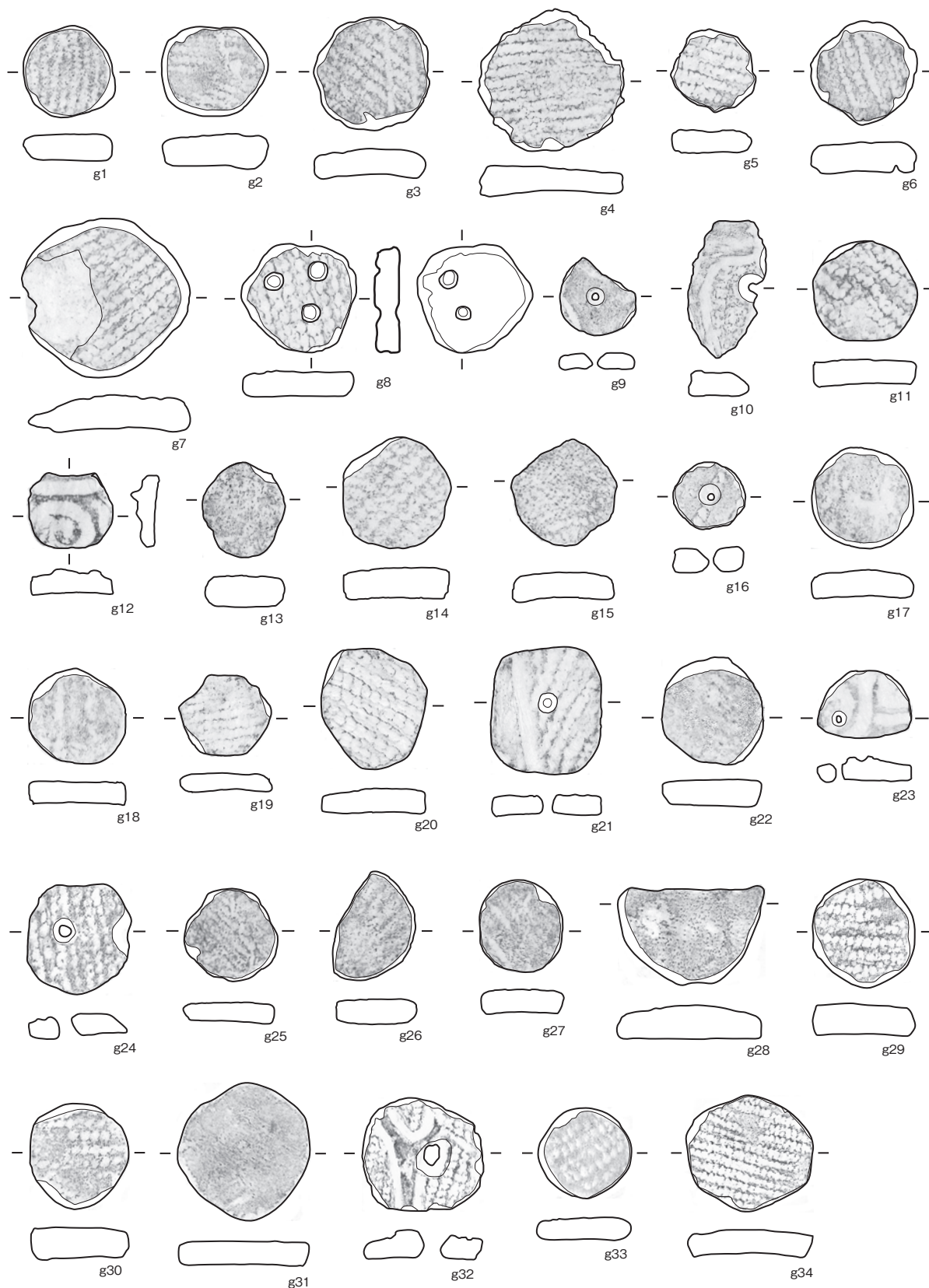

0 1:2 10cm

g1 ~ 10: A1 号竖穴建物、g11: A9 号竖穴建物、g12: A19 号竖穴建物、g13・14: A27 号竖穴建物
 g15・16: A28 号竖穴建物、g17: A33 号竖穴建物、g18・19: A36 号竖穴建物、g20: A37 号竖穴建物
 g21: A38 号竖穴建物、g22: A43 号竖穴建物、g23: A44 号竖穴建物、g24: A47 号竖穴建物
 g25: A72 号竖穴建物、g26: A93 号竖穴建物、g27: A97 号竖穴建物、g28: A105 号竖穴建物
 g29: A110 号竖穴建物、g30・31: A111 号竖穴建物、g32: A113 号竖穴建物、g33・34: A114 号竖穴建物

第 381 图 土器片円盤 (1)

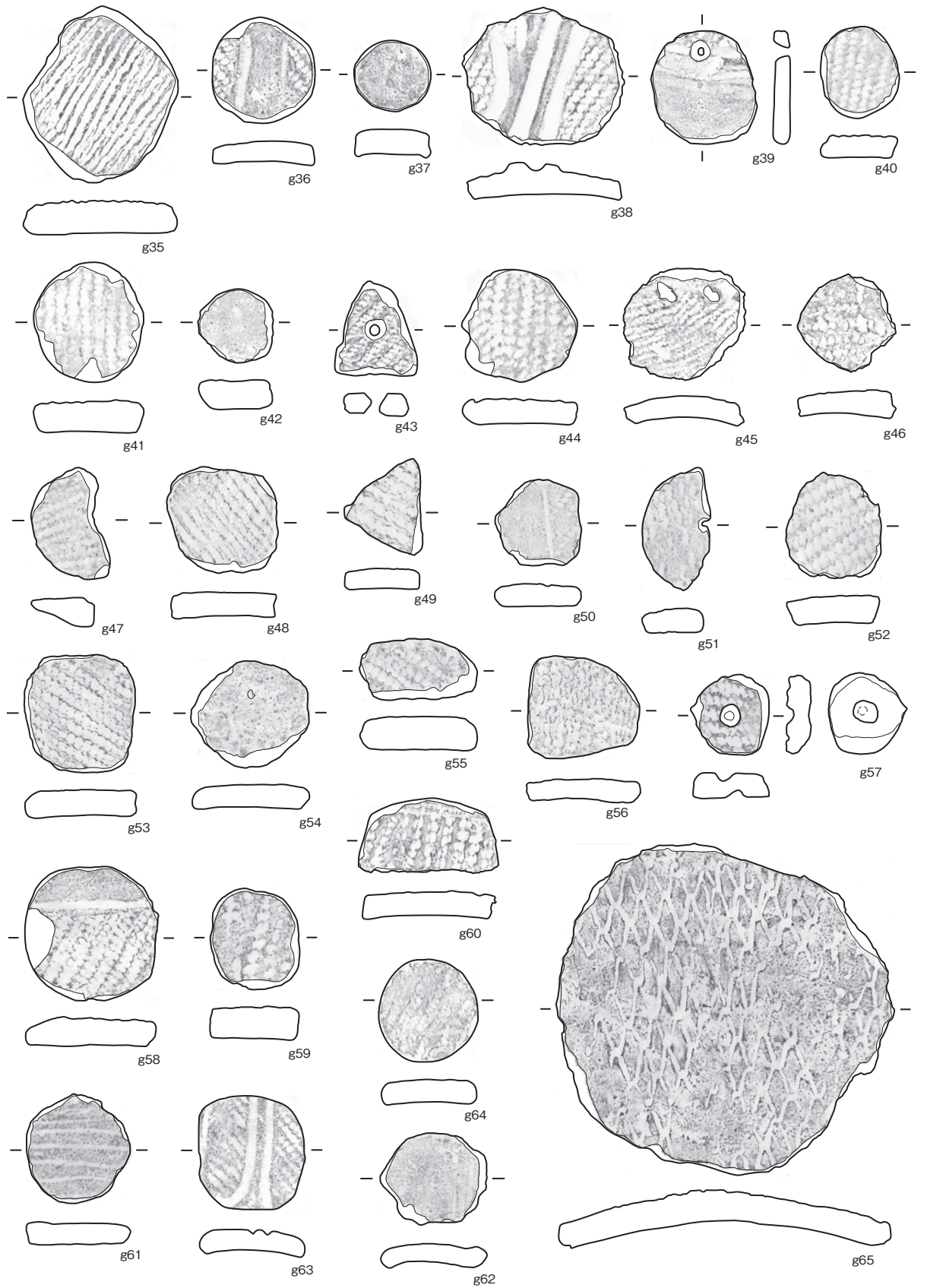

g35 : A116 号豎穴建物、g36 : A117 号豎穴建物、g37 : A123 号豎穴建物、g38 : A125 号豎穴建物
 g39 : A127 号豎穴建物、g40・41 : A151 号豎穴建物、g42 : A153 号豎穴建物、g43 : A157 号豎穴建物
 g44 : A158 号豎穴建物、g45 : A162 号豎穴建物、g46 : A167 号豎穴建物、g47 : A201 号豎穴建物
 g48 : A221 号豎穴建物、g49・50 : A231 号豎穴建物、g51～54 : A235 号豎穴建物、g55 : A239 号豎穴建物
 g56 : A251 号豎穴建物、g57 : 3 号土坑、g58 : 11 号土坑、g59 : 95 号土坑、g60 : 139 号土坑
 g61 : 270 号土坑、g62 : 1 号盛土整地、g63 : T5～8 間遺物包含層、g64 : B14 号豎穴建物、g65 : 遺構外

0 1:2 10cm

第 382 図 土器片円盤 (2)

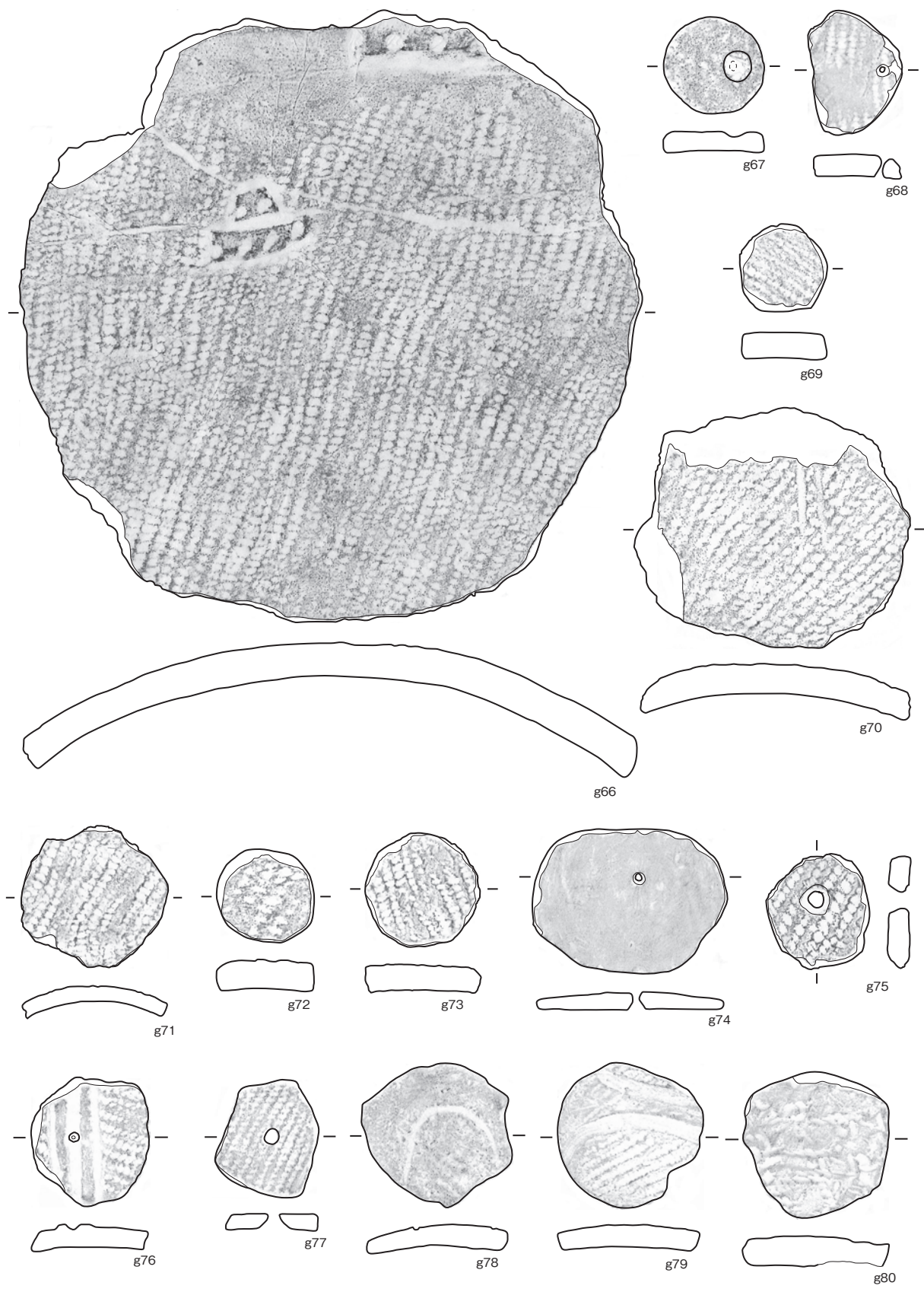

g66 ~ 80 : 遺構外

0 1 : 2 10cm

第 383 図 土器片円盤 (3)

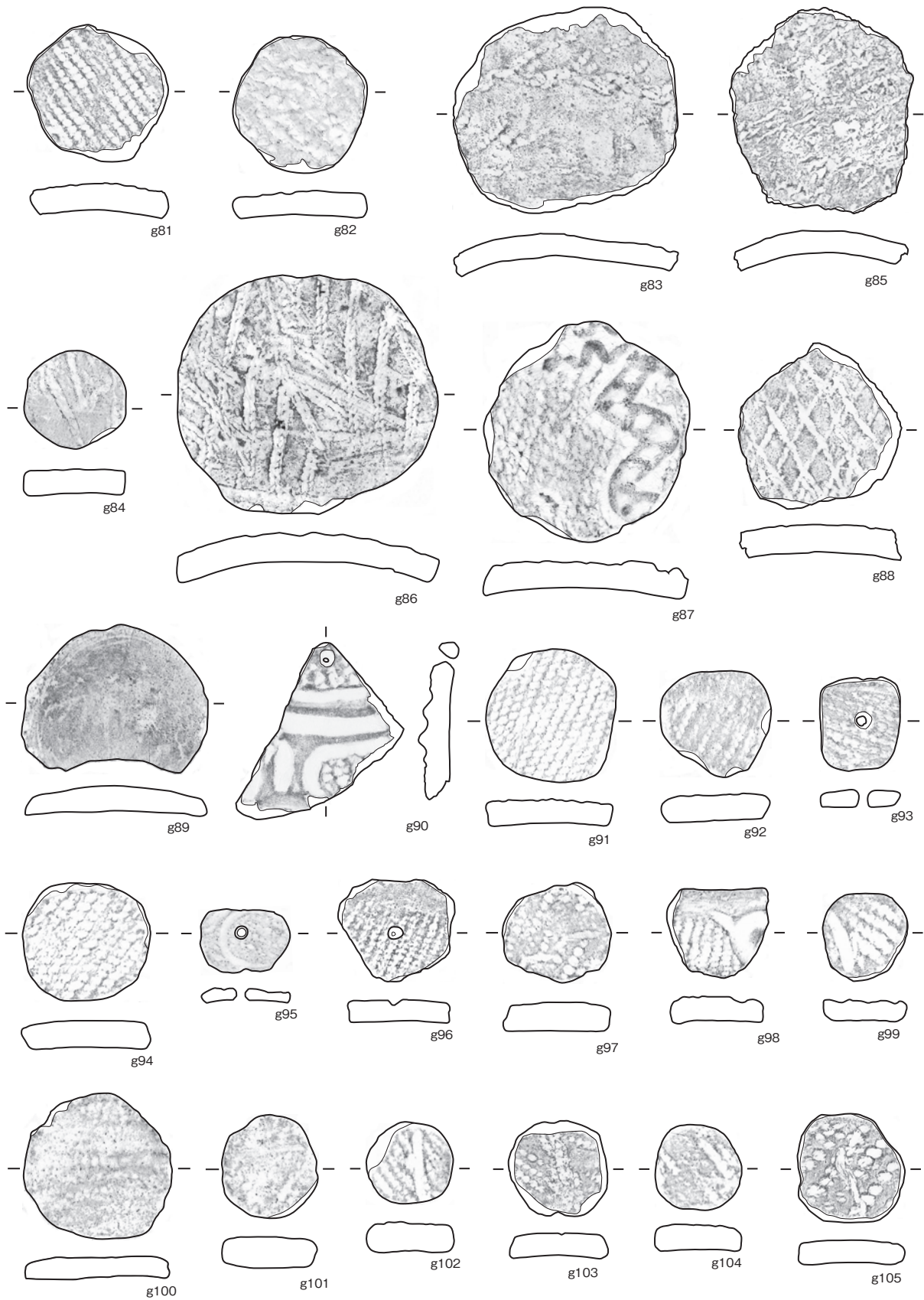

g81 ~ 105 : 遺構外

0 1 : 2 10cm

第 384 図 土器片円盤 (4)

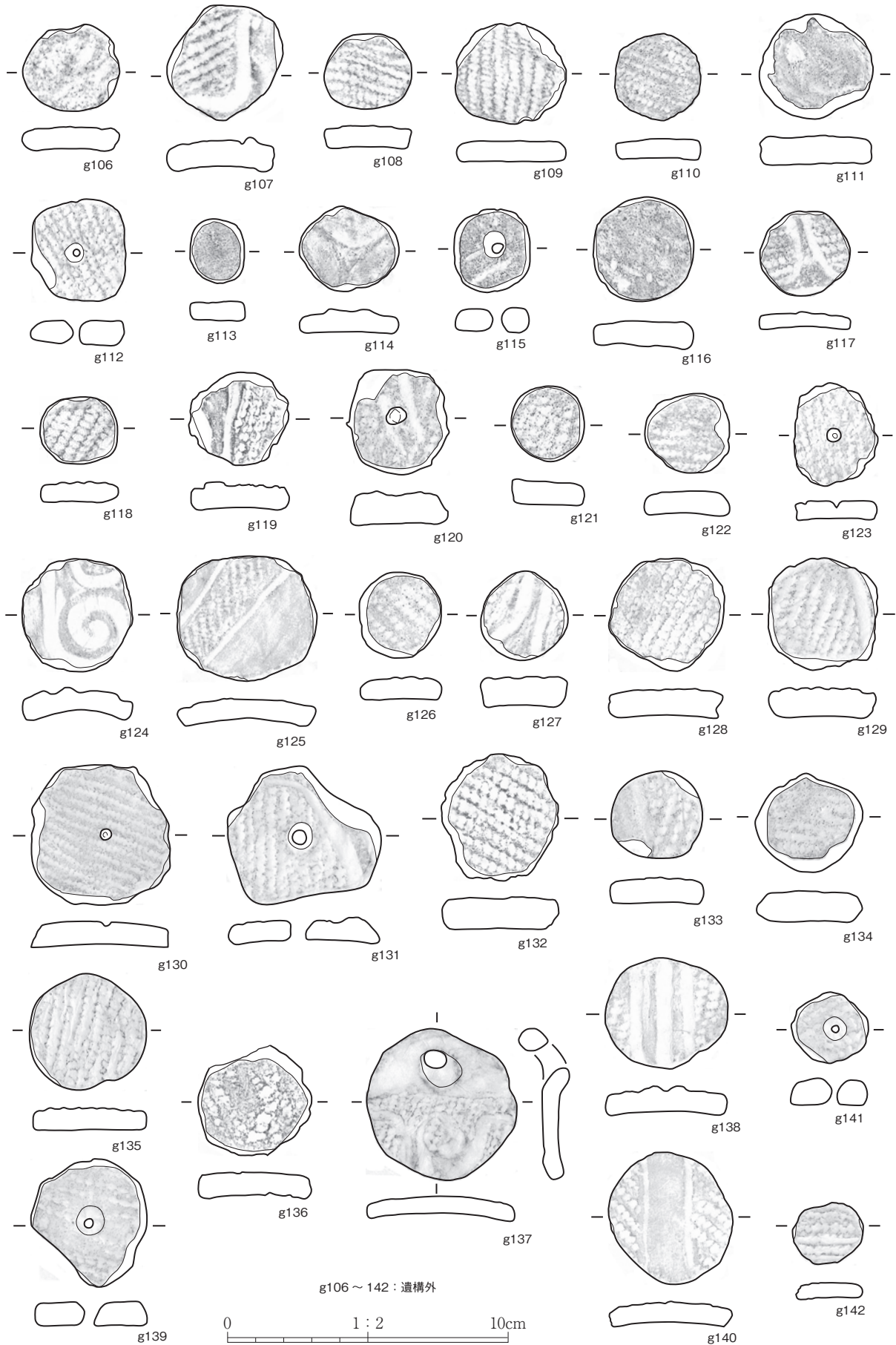

第 385 図 土器片円盤 (5)

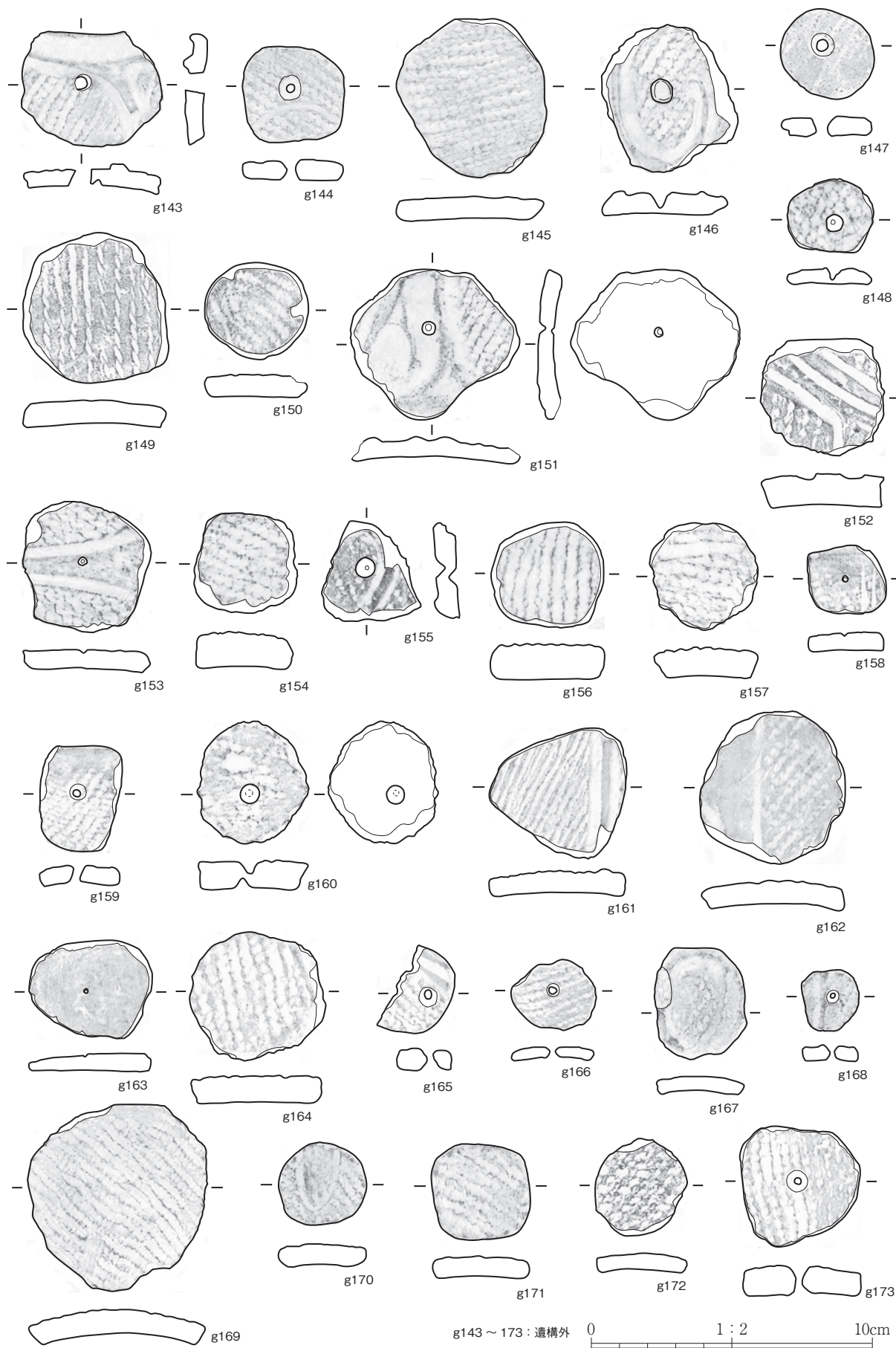

第 386 図 土器片円盤 (6)

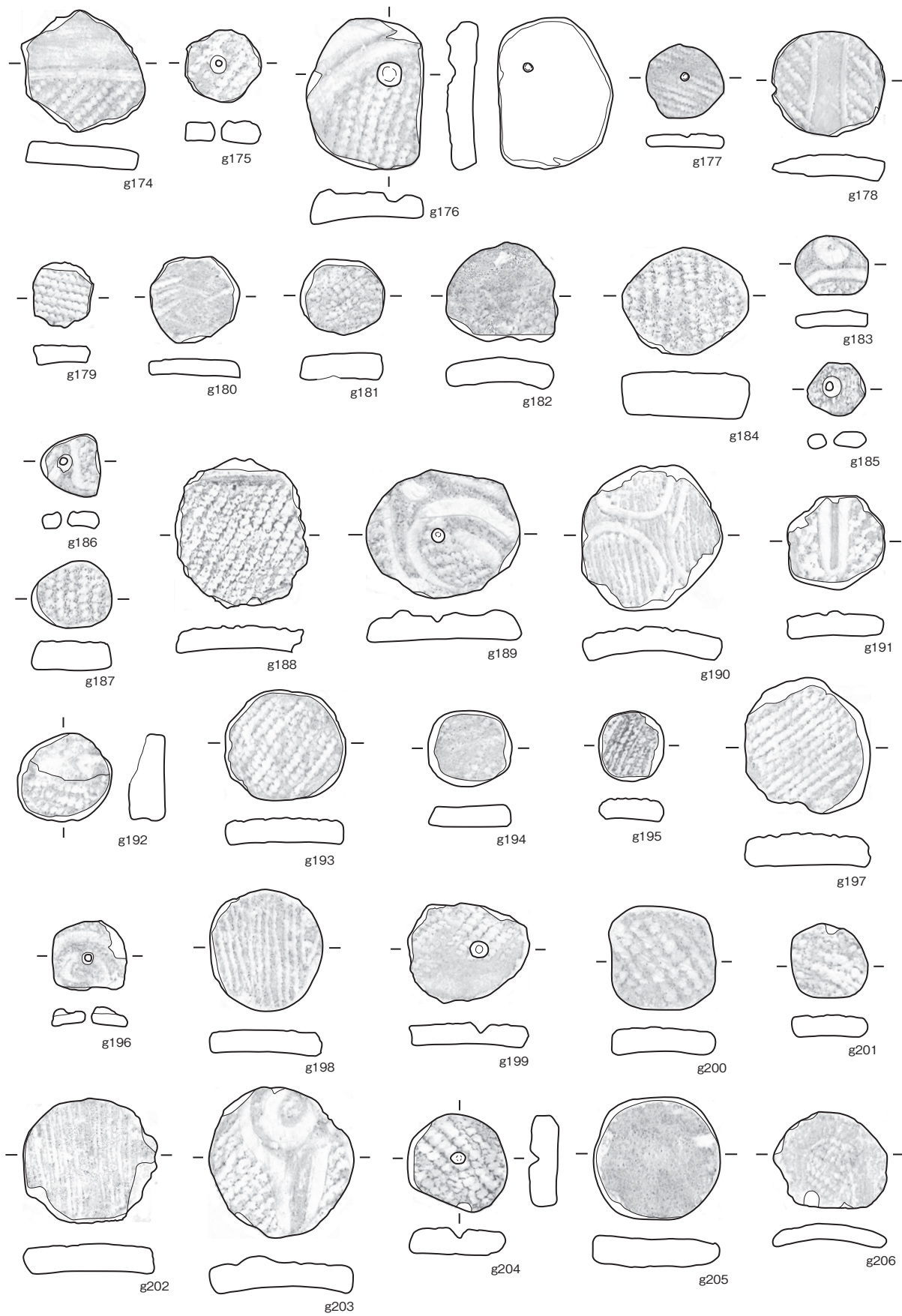

※g174～206：遺構外

0 1:2 10cm

第 387 図 土器片円盤 (7)

B 4号竖穴建物

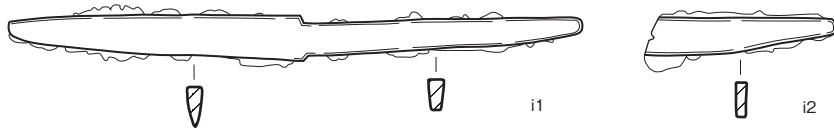

B 8号竖穴建物

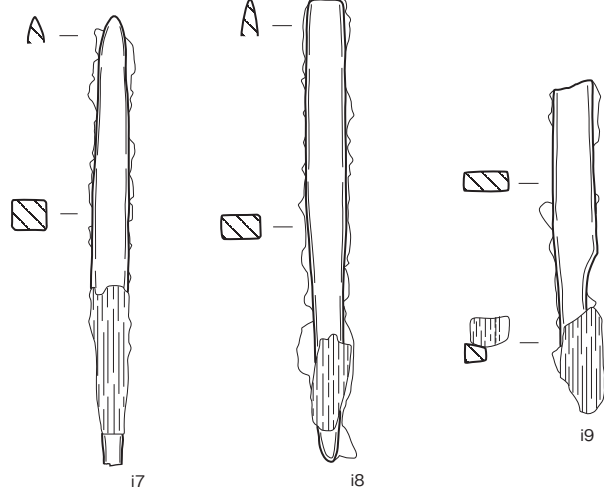
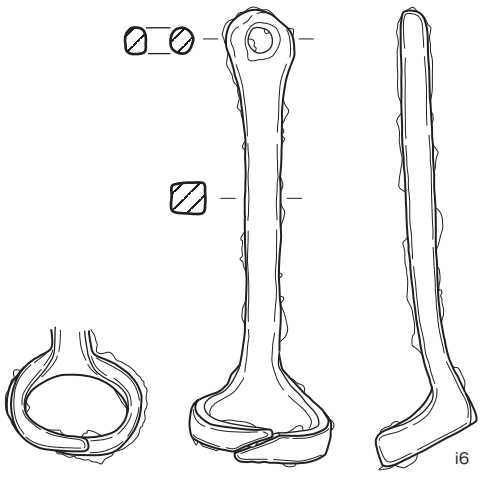
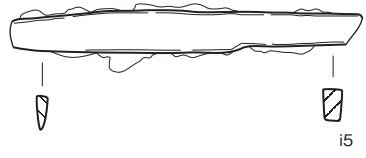
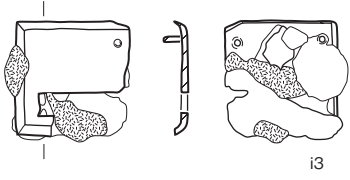
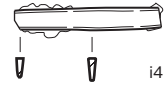

B 9号竖穴建物

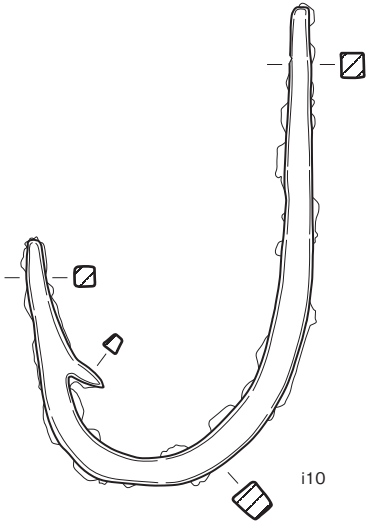

B 15号竖穴建物

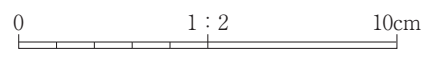
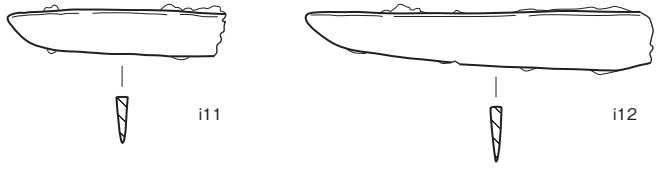
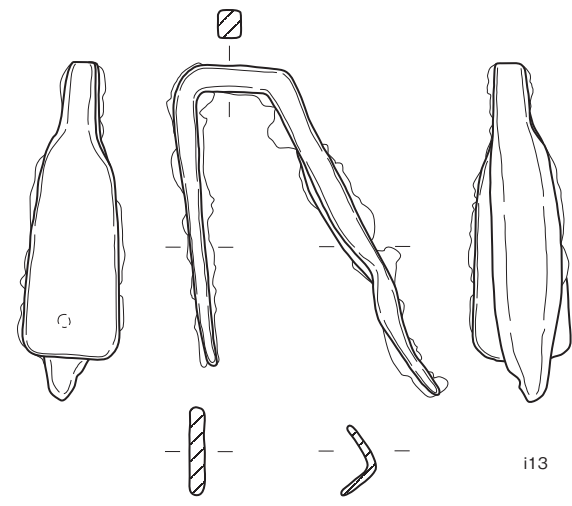

第 388 图 金属製品 (1)

B20号竖穴建物

4号溝

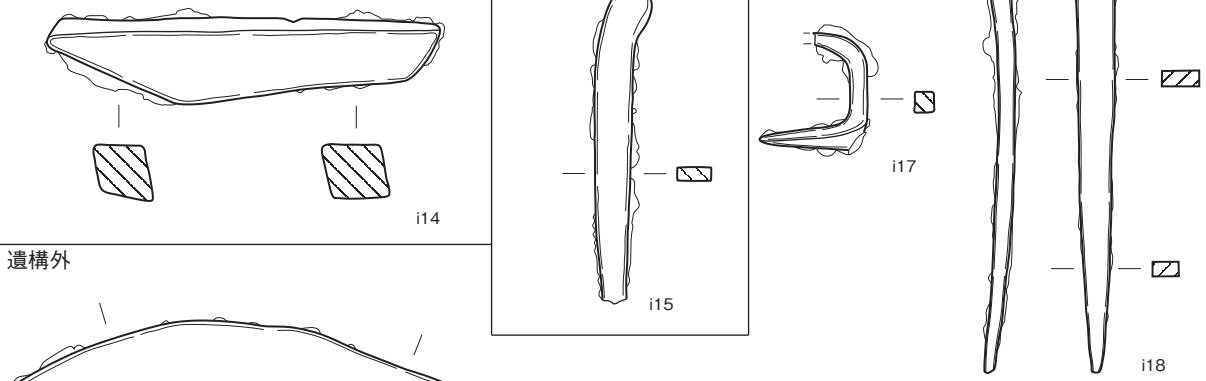

遺構外

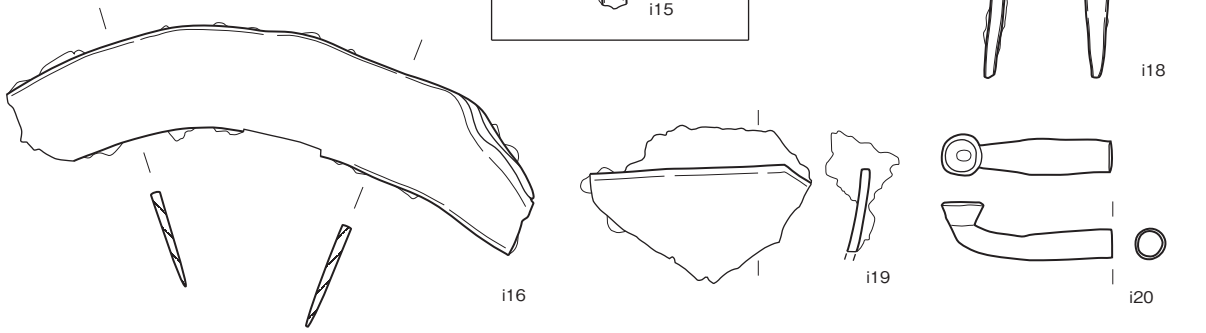

i14 ~ 20 : 0 1 : 2 10cm

i21 ~ 24 : 0 1 : 1 5cm

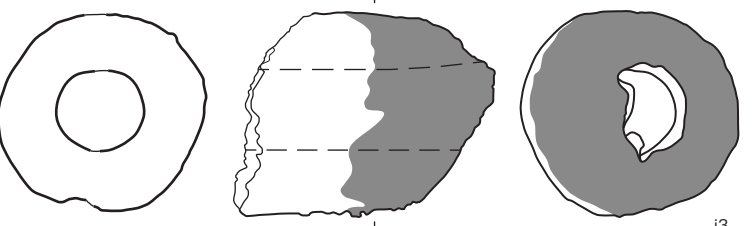
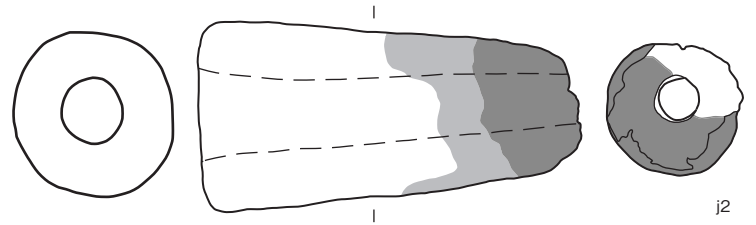

※j1 : B5号竖穴建物
 j2 : B8号竖穴建物
 j3 : B9号竖穴建物

j1 ~ 3 : 0 1 : 3 10cm

第389图 金属製品(2)・羽口(1)

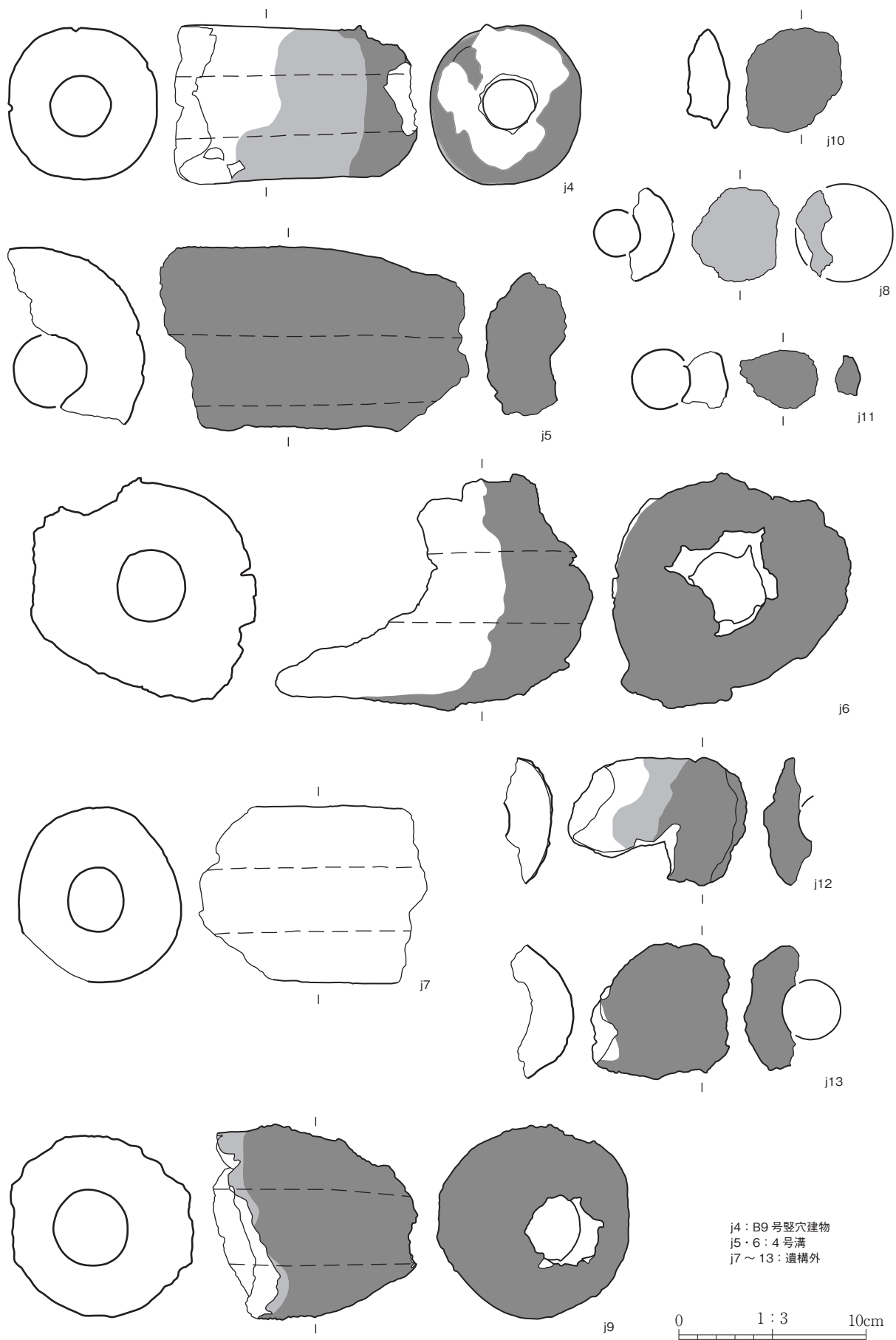

第 390 図 羽口 (2)

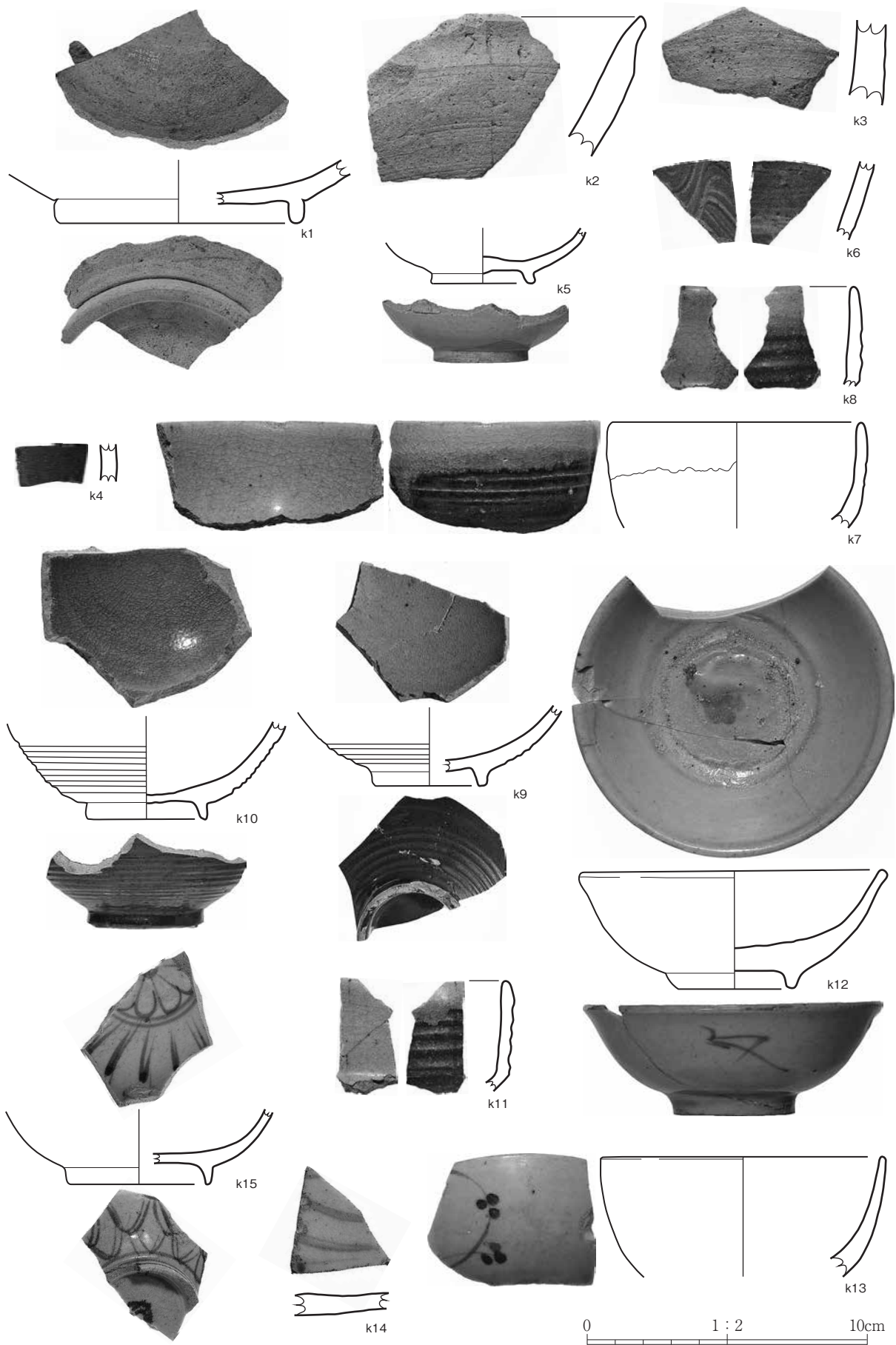

第 391 図 陶磁器・ガラス製品 (1)

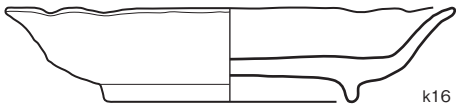

k16



k17



k18

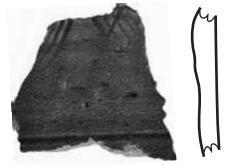

k21



k19

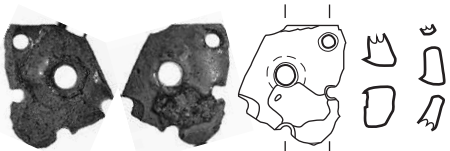

k22

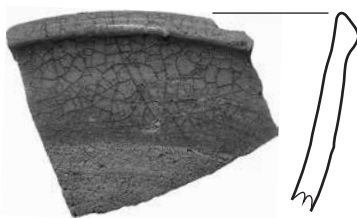

k20

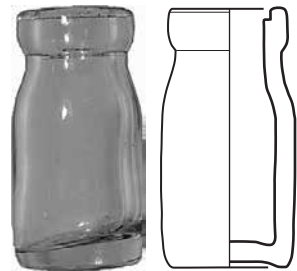

k24

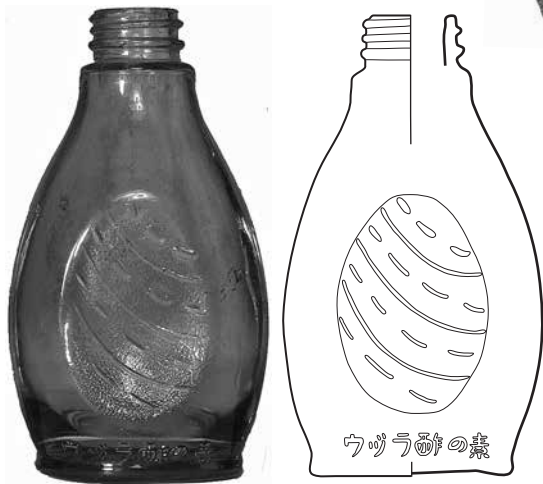

k23

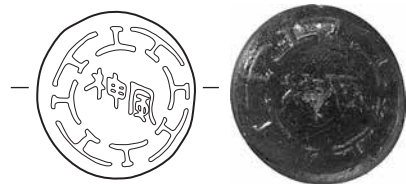

k25

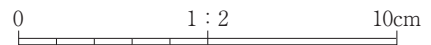

第 392 図 陶磁器・ガラス製品 (2)

岩手県文化振興事業団埋蔵文化財調査報告書第 723 集

間木戸 I 遺跡発掘調査報告書

三陸沿岸道路建設事業関連遺跡発掘調査
(第 2 分冊 遺物図版編)

印刷 令和 3 年 3 月 1 日

発行 令和 3 年 3 月 12 日

編集 (公財)岩手県文化振興事業団埋蔵文化財センター
〒 020-0853 岩手県盛岡市下飯岡 11 地割 185 番地
電話 (019) 638-9001

発行 国土交通省東北地方整備局三陸国道事務所
〒 027-0029 岩手県宮古市藤の川町 4 番 1 号
電話 (0193) 62-1711

(公財)岩手県文化振興事業団
〒 020-0023 岩手県盛岡市内丸 13 番 1 号
電話 (019) 654-2235

印刷 (株)杜陵印刷
〒 020-0122 岩手県盛岡市みたけ二丁目 22 番地 50 号
電話 (019) 641-8000