

神戸市西区

玉津田中遺跡

— 第5分冊〔図版編〕—

(竹添地区・池ノ内地区の調査)

— 田中特定土地区画整理事業に伴う埋蔵文化財調査報告書 —

1996.3

兵庫県教育委員会

神戸市西区

たま つ た なか
玉津田中遺跡

— 第5分冊〔図版編〕—

たけぞえ いけのうち
(竹添地区・池ノ内地区の調査)



図版編 目次

西微高地 遺構図面 : 図版 1 ~ 61

東微高地 遺構図面 : 図版 62 ~ 73

溝・旧河道 遺構図面 : 図版 74 ~ 79

西微高地 遺物図面 : 図版 80 ~ 195

東微高地 遺物図面 : 図版 196 ~ 209

溝・旧河道 遺物図面 : 図版 210 ~ 437

西微高地 遺構図面

図版 1 調査区配置図

図版 2 弥生時代前期～中期上層全体図

図版 3 弥生時代後期～鎌倉時代全体図

図版 4 土層堆積状況図 (竹添 1 区)

図版 5 弥生時代中期下層全体図

図版 6 弥生中期下層 竪穴住居 1 (SH36001)

図版 7 弥生中期下層 竪穴住居 2' (SH36002/36003)

図版 8 弥生中期下層 竪穴住居 3 (SH36004/36005/36006/36007)

図版 9 弥生中期下層 竪穴住居 4 (SH36008/36009)

図版 10 弥生中期下層 竪穴住居 5 (SH36010)

図版 11 弥生中期下層 土坑 1 (SK36001/36005/36006/36007)

図版 12 弥生中期下層 土坑 2 (SK36010/36011/36012/36013/36014)

図版 13 弥生中期下層 土坑 3 (SK36016/36018/36019/36020/36021)

図版 14 弥生中期下層 土坑 4 (SK36022/36023/36025/36027/36029)

図版 15 弥生中期下層 土坑 5 (SK36030/36032/36033/36037/36039/36041)

図版 16 弥生中期下層 土坑 6 (SK36043/36044/36048/36052/36054/36055/36058)

図版 17 弥生時代中期上層全体図 (西半)

図版 18 弥生時代中期上層全体図 (東半)

図版 19 弥生中期上層 竪穴住居 1 (SH46001/46002)

図版 20 弥生中期上層 竪穴住居 2 (SH46003/46004)

図版 21 弥生中期上層 竪穴住居 3 (SH46005/46006)

図版 22 弥生中期上層 竪穴住居 4 (SH46007/46008)

図版 23 弥生中期上層 竪穴住居 5 (SH46007/46008)

図版 24 弥生中期上層 竪穴住居 6 (SH46009/46010)

図版 25 弥生中期上層 竪穴住居 7 (SH46011/46012)

図版 26 弥生中期上層 竪穴住居 8 (SH46013/46014)

図版 27 弥生中期上層 竪穴住居 9 (SH46015/46016)

図版 28 弥生中期上層 竪穴住居 10 (SH46017/46018)

- 図版29 弥生中期上層 竪穴住居11 (SH46019)
- 図版30 弥生中期上層 竪穴住居12・掘立柱建物1 (SH46020/SB46001)
- 図版31 弥生中期上層 竪穴住居13 (SH46021/46022)
- 図版32 弥生中期上層 竪穴住居14 (SH46023)
- 図版33 弥生中期上層 竪穴住居15 (SH46024/46025)
- 図版34 弥生中期上層 竪穴住居16 (SH46026/46027/46028)
- 図版35 弥生中期上層 竪穴住居17 (SH46029/46030/46031/46032/46033)
- 図版36 弥生中期上層 竪穴住居18 (SH46034/46035)
- 図版37 弥生中期上層 竪穴住居19 (SH46036)
- 図版38 弥生中期上層 竪穴住居20 (SH46037/46038)
- 図版39 弥生中期上層 竪穴住居21 (SH46039)
- 図版40 弥生中期上層 方形周溝墓1 (SX46001)
- 図版41 弥生中期上層 方形周溝墓2 (ST46001/46002)
- 図版42 弥生中期上層 方形周溝墓3 (ST46003/46004)
- 図版43 弥生中期上層 方形周溝墓4 (SX46002)
- 図版44 弥生中期上層 方形周溝墓5 (SX46002)
- 図版45 弥生中期上層 方形周溝墓6 (SX46002)
- 図版46 弥生中期上層 土器棺墓1 (SP46001/46002/46003/46004)
- 図版47 弥生中期上層 土器棺墓2 (SP46005/46006/46007/46008)
- 図版48 弥生中期上層 土坑1 (SK46001/46003/46004/46005/46006)
- 図版49 弥生中期上層 土坑2 (SK46007/46008/46010/46011/46012/46013)
- 図版50 弥生中期上層 土坑3 (SK46014/46015/46016/46019)
- 図版51 弥生中期上層 土坑4 (SK46021/46022/46024/46026/46028)
- 図版52 弥生中期上層 土坑5 (SK46029/46032/46035/46039/46040/46044)
- 図版53 弥生中期上層 土坑6 (SK46047/46049/46050/46052/46055)
- 図版54 弥生中期上層 土坑7 (SK46056/46057/46059/46061/46063/46064/46065)
- 図版55 弥生中期上層 土坑8 (SK46066/46067/46068/46069/46070)
- 図版56 弥生中期上層 土坑9 (SK46073/46076/46077/46078/46079/46082)
- 図版57 弥生中期上層 土坑10 (SK46084/46085/46089/46092/46094/46095)
- 図版58 弥生中期上層 土坑11 (SK46098/46099/46107/46110/46111/46112/46113)
- 図版59 弥生中期上層 土坑12 (SK46114/46117/46120/46122/46125)
- 図版60 弥生中期上層 土坑13 (SK46126/46128/46131/46132/46133/46134)
- 図版61 鎌倉時代 掘立柱建物1 (SB86001/86002/86003)

東微高地 遺構図面

- 図版62 弥生中期上層 水田
- 図版63 弥生中期上層 竪穴住居1 (SH46040/46041/46042)
- 図版64 弥生中期上層 竪穴住居2 (SH46043)

- 図版65 弥生中期上層 竪穴住居 3 (SH46044)
- 図版66 弥生中期上層 竪穴住居 4 (SH46045/46046)
- 図版67 弥生中期上層 木棺墓 1 (ST46005)
- 図版68 弥生中期上層 土坑 1 (SK46136/46138/46139/46140/46142)
- 図版69 弥生中期上層 土坑 2 (SK46143/46144/46147/46149/46150/46151/46152)
- 図版70 弥生中期上層 土坑 3 (SK46153/46156/46157/46158/46159/46160/46161)
- 図版71 弥生中期上層 土坑 4 (SK46162/46163/46164/46165/46166/46167/46168/46170)
- 図版72 弥生中期上層 土坑 5 (SK46171/46172/46173/46174/46176/46178/46181)
- 図版73 弥生中期上層 土坑 6 (SK46184/46185/46186/46187/46188)

溝・旧河道 遺構図面

- 図版74 溝・旧河道全体図・断面図 (1)
- 図版75 溝・旧河道断面図 (2)
- 図版76 溝・旧河道断面図 (3)
- 図版77 弥生時代中期上層旧河道 (SR46001)
- 図版78 弥生時代中期上層旧河道 (SR46002)
- 図版79 弥生時代中期上層旧河道 (SR46002)

西微高地 遺物図面

- 図版80 弥生前期 土坑他出土土器 (SK26002/西微高地縁辺堆積層/包含層)
- 図版81 弥生中期下層 竪穴住居出土土器 1 (SH36001/36002/36003/36007/36008/36010)
- 図版82 弥生中期下層 土坑出土土器 1 (SK36001/36002/36003/36004/36005)
- 図版83 弥生中期下層 土坑出土土器 2 (SK36006/36007/36008/36009/36010/36011)
- 図版84 弥生中期下層 土坑出土土器 3 (SK36011/36012/36013/36014/36015)
- 図版85 弥生中期下層 土坑出土土器 4 (SK36015/36016/36018/36020/36021)
- 図版86 弥生中期下層 土坑出土土器 5 (SK36022/36023/36024/36025/36026/36027/36029)
- 図版87 弥生中期下層 土坑出土土器 6 (SK36030/36031/36032/36033/36034/36035/36036/
SK36037/36038/36040/36041)
- 図版88 弥生中期下層 土坑出土土器 7 (SK36042/36043/36044/36045/36047/36049/36050/
SK36051/36052/36053)
- 図版89 弥生中期下層 土坑出土土器 8 (SK36048/36054/36055/36056/36057)
- 図版90 弥生中期下層 西微高地縁辺堆積層出土土器 1
- 図版91 弥生中期下層 西微高地縁辺堆積層出土土器 2
- 図版92 弥生中期下層 西微高地縁辺堆積層出土土器 3
- 図版93 弥生中期下層 西微高地縁辺堆積層出土土器 4
- 図版94 弥生中期下層 西微高地縁辺堆積層出土土器 5
- 図版95 弥生中期下層 西微高地縁辺堆積層出土土器 6
- 図版96 弥生中期下層 西微高地縁辺堆積層出土土器 1

- 图版97 弥生中期下層 出土石器 1 (SH36001/36003/36004/36007/36008/SK36010/36034/36039)
- 图版98 弥生中期下層 出土石器 2 (SK36002/36008/36029/西微高地縁辺堆積層)
- 图版99 弥生中期下層 出土石器 3 (SH36007/36008/SK36009/36023/36026/西微高地縁辺堆積層)
- 图版100 弥生中期下層 出土石器 4 (SH36006/36008/SK36038)
- 图版101 弥生中期下層 出土石器 5 (SH36007/SK36001/西微高地縁辺堆積層)
- 图版102 弥生中期下層 出土石器 6 (SH36004/36007/36008)
- 图版103 弥生中期下層 出土石器 7 (SH36001/36008/SK36057)
- 图版104 弥生中期下層 出土石器 8 (SH36004/36008/SK36002/36055/西微高地縁辺堆積層)
- 图版105 弥生中期上層 竪穴住居出土土器 1 (SH46001/46003/46004/46006)
- 图版106 弥生中期上層 竪穴住居出土土器 2 (SH46007/46008/46009/46010/46011)
- 图版107 弥生中期上層 竪穴住居出土土器 3 (SH46012/46014/46016/46019/46020)
- 图版108 弥生中期上層 竪穴住居出土土器 4 (SH46021/46023/46024/46027/46031/46032
/46033/46034/46036/46037/46038)
- 图版109 弥生中期上層 方形周溝墓出土土器 1 (SX46001)
- 图版110 弥生中期上層 方形周溝墓出土土器 2 (SX46001)
- 图版111 弥生中期上層 方形周溝墓出土土器 3 (SX46001)
- 图版112 弥生中期上層 方形周溝墓出土土器 4 (SX46002)
- 图版113 弥生中期上層 土器棺墓出土土器 1 (SP46001)
- 图版114 弥生中期上層 土器棺墓出土土器 2 (SP46002)
- 图版115 弥生中期上層 土器棺墓出土土器 3 (SP46003/46004)
- 图版116 弥生中期上層 土器棺墓出土土器 4 (SP46005/46006/46007/46008)
- 图版117 弥生中期上層 土坑出土土器 1 (SK46001/46002/46006/46007/46008/46009/46010
/46011/46012/46014/46015/46016/46017)
- 图版118 弥生中期上層 土坑出土土器 2 (SK46019)
- 图版119 弥生中期上層 土坑出土土器 3 (SK46022/46024/46025/46026/46028)
- 图版120 弥生中期上層 土坑出土土器 4 (SK46029/46031/46032/46034/46035/46036)
- 图版121 弥生中期上層 土坑出土土器 5 (SK46037/46038/46040/46043/46045/46047/46049
/46050/46052/46053/46054/46055)
- 图版122 弥生中期上層 土坑出土土器 6 (SK46056/46057/46059/46060/46061)
- 图版123 弥生中期上層 土坑出土土器 7 (SK46061)
- 图版124 弥生中期上層 土坑出土土器 8 (SK46063/46066/46067/46068/46069/46070)
- 图版125 弥生中期上層 土坑出土土器 9 (SK46073/46075/46076/46077/46079/46080)
- 图版126 弥生中期上層 土坑出土土器10 (SK46081/46082/46083/46084/46085/46088/46090)
- 图版127 弥生中期上層 土坑出土土器11 (SK46093/46098/46099/46100/46101/46106/46108/46109)
- 图版128 弥生中期上層 土坑出土土器12 (SK46110/46111/46112/46113)
- 图版129 弥生中期上層 土坑出土土器13 (SK46114/46117/46118/46120/46121)
- 图版130 弥生中期上層 土坑出土土器14 (SK46122/46126/46128/46129/46130/46131/46132
/46133/46134)

- 图版131 弥生中期上層 柱穴出土土器 1 (P46001/46002/46003/46004/46006/46008/46009
/46011/46012/46013/46014/46016/46018/46019)
- 图版132 弥生中期上層 柱穴出土土器 2 (P46020/46022/46024/46026/46027/46028/46029
/46034/46038/46039/46040/46041/46042/46045)
- 图版133 弥生中期上層 包含層出土土器 1
- 图版134 弥生中期上層 包含層出土土器 2
- 图版135 弥生中期上層 包含層出土土器 3
- 图版136 弥生中期上層 包含層出土土器 4
- 图版137 弥生中期上層 包含層出土土器 5
- 图版138 弥生中期上層 包含層出土土器 6
- 图版139 弥生中期上層 包含層出土土器 7
- 图版140 弥生中期上層 遺構出土木器 1 (SH46025/SK46066/SX46001)
- 图版141 弥生中期上層 遺構出土木器 2 (SX46002)
- 图版142 弥生中期上層 遺構出土木器 3 (SX46002)
- 图版143 弥生中期上層 遺構出土木器 4 (SX46002)
- 图版144 弥生中期上層 遺構出土木器 5 (SX46002)
- 图版145 弥生中期上層 遺構出土木器 6 (SX46002)
- 图版146 弥生中期上層 遺構出土木器 7 (SX46002)
- 图版147 弥生中期上層 出土石器 1 (SH46006/46009/46010/46012/46013/46020/46024/46025/46027
/46034/SK46004/46024/46077/46082/46089/46095/46096/46102
/46180/P46031)
- 图版148 弥生中期上層 出土石器 2 (SH46010/46011/46012/46024/46025/46034/SK46004/46012
/46023/46032/46041/46055/46067/46095/ST46004/包含層)
- 图版149 弥生中期上層 出土石器 3 (SH46012/46021/46024~46027/SK46046/46067/46093
/SX46001/P46032)
- 图版150 弥生中期上層 出土石器 4 (SK46065)
- 图版151 弥生中期上層 出土石器 5 (SK46065)
- 图版152 弥生中期上層 出土石器 6 (SK46065)
- 图版153 弥生中期上層 出土石器 7 (SK46065)
- 图版154 弥生中期上層 出土石器 8 (SH46010/SK46066/46070/46099/46103/46119/46120)
- 图版155 弥生中期上層 出土石器 9 (SH46010/46012/46019/SK46062/46115/46126)
- 图版156 弥生中期上層 出土石器10 (SH46006/46013/46024/46025/46026/46027/46034/46039
/46115/46126/SK46066/46068/46071/46080/46089/46119
/P46007/P46033)
- 图版157 弥生中期上層 出土石器11 (SH46002/46039/SK46050/SX46002/P46030)
- 图版158 弥生中期上層 出土石器12 (SH46004/46006/46009/46023/46024/SX46001)
- 图版159 弥生中期上層 出土石器13 (SH46001/46004/SK46003/46098)
- 图版160 弥生中期上層 出土石器14 (SH46008/46014/SK46086/46087)

- 図版161 弥生中期上層 出土石器15 (SK46039)
 図版162 弥生中期上層 出土石器16 (SK46039)
 図版163 弥生中期上層 出土石器17 (SK46125)
 図版164 弥生中期上層 出土石器18 (SK46125)
 図版165 弥生中期上層 出土石器19 (SK46125)
 図版166 弥生中期上層 出土石器20 (包含層)
 図版167 弥生中期上層 出土石器21 (包含層)
 図版168 弥生中期上層 出土石器22 (包含層)
 図版169 弥生中期上層 出土石器23 (包含層)
 図版170 弥生中期上層 出土石器24 (包含層)
 図版171 弥生中期上層 出土石器25 (包含層)
 図版172 弥生中期上層 出土石器26 (包含層)
 図版173 弥生中期上層 出土石器27 (包含層)
 図版174 弥生中期上層 出土石器28 (包含層)
 図版175 弥生中期上層 出土石器29 (包含層)
 図版176 弥生中期上層 出土石器30 (包含層)
 図版177 弥生中期上層 出土石器31 (包含層)
 図版178 弥生中期上層 出土石器32 (SH46011/46012/46019/46023/46025/46039)
 図版179 弥生中期上層 出土石器33 (SK46089/46105/46111/P46015/46025/46035/包含層)
 図版180 弥生中期上層 出土石器34 (包含層)
 図版181 弥生中期上層 出土石器35 (包含層)
 図版182 弥生中期上層 出土石器36 (包含層)
 図版183 弥生中期上層 出土石器37 (SH46025/46034/46036/46067/46072/P46017/包含層)
 図版184 弥生中期上層 出土石器38 (包含層)
 図版185 弥生中期上層 出土石器39 (SH46008/46010/46011/46012/46025/46042)
 図版186 弥生中期上層 出土石器40 (包含層)
 図版187 弥生中期上層 出土石器41 (包含層)
 図版188 弥生中期上層 出土石器42 (包含層)
 図版189 弥生中期上層 出土石器43 (SH46023/46024/46025/46034/包含層)
 図版190 弥生中期上層 出土石器44 (SH46024/SK46092/包含層)
 図版191 弥生中期上層 出土石器45 (包含層)
 図版192 弥生中期上層 出土石器46 (SH46024)
 図版193 弥生中期上層 出土石器47 (包含層)
 図版194 弥生中期上層 出土石器48 (SH46009/46024/SK46031/46049/包含層)
 図版195 鎌倉時代掘立柱建物他出土土器 1 (SB86001/86002/SK86001/86002/P86001/ 包含層)

東微高地 遺物図面

- 図版196 弥生中期上層 竪穴住居出土土器 1 (SH46041/46043/46044/46045)

- 図版197 弥生中期上層 土坑出土土器 1 (SK46135/46136/46138)
- 図版198 弥生中期上層 土坑出土土器 2 (SK46138/46139/46140/46141/46143)
- 図版199 弥生中期上層 土坑出土土器 3 (SK46143/46145/46146/46147/46148/46149/46150/46151)
- 図版200 弥生中期上層 土坑出土土器 4 (SK46152/46153/46154/46155/46158/46159/46162)
- 図版201 弥生中期上層 土坑出土土器 5 (SK46165/46166/46167/46168/46169/46172/46174)
- 図版202 弥生中期上層 土坑出土土器 6 (SK46175/46177/46178/46179/46180/46181/46182/46183)
- 図版203 弥生中期上層 土坑出土土器 7 (SK46184)
- 図版204 弥生中期上層 土坑出土土器 8 (SK46184/46185/46188/46189/46190)
- 図版205 弥生中期上層 遺構出土木器 1 (SK46138/46164)
- 図版206 弥生中期上層 出土石器 1 (SK46138/46144/46151/46188/ST46005/上層水田/包含層)
- 図版207 弥生中期上層 出土石器 2 (SH46041/SK46137/46156/46180/ST46005/包含層)
- 図版208 弥生中期上層 出土石器 3 (SH46040)
- 図版209 弥生中期上層 出土石器 4 (包含層)

溝・旧河道遺物図面

- 図版210 弥生中期下層 旧河道出土土器 1 (SR46001)
- 図版211 弥生中期下層 旧河道出土土器 2 (SR46001)
- 図版212 弥生中期下層 旧河道出土土器 3 (SR46001)
- 図版213 弥生中期下層 溝出土土器 1 (SD36001)
- 図版214 弥生中期下層 溝出土土器 2 (SD36001)
- 図版215 弥生中期下層 溝出土土器 3 (SD36001)
- 図版216 弥生中期下層 溝出土土器 4 (SD36001/36002)
- 図版217 弥生中期下層 旧河道出土土器 4 (SR46002)
- 図版218 弥生中期下層 旧河道出土土器 5 (SR46002)
- 図版219 弥生中期下層 旧河道出土土器 6 (SR46002)
- 図版220 弥生中期下層 旧河道出土土器 7 (SR46002)
- 図版221 弥生中期下層 溝出土石器 1 (SD36001)
- 図版222 弥生中期下層 溝出土石器 2 (SD36001)
- 図版223 弥生中期下層 溝出土石器 3 (SD36001)
- 図版224 弥生中期上層 旧河道出土土器 1 (SR46001)
- 図版225 弥生中期上層 旧河道出土土器 2 (SR46001)
- 図版226 弥生中期上層 旧河道出土土器 3 (SR46001)
- 図版227 弥生中期上層 旧河道出土土器 4 (SR46001)
- 図版228 弥生中期上層 旧河道出土土器 5 (SR46001)
- 図版229 弥生中期上層 旧河道出土土器 6 (SR46001)
- 図版230 弥生中期上層 旧河道出土土器 7 (SR46001)
- 図版231 弥生中期上層 旧河道出土土器 8 (SR46002)
- 図版232 弥生中期上層 旧河道出土土器 9 (SR46002)

图版233 弥生中期上層 旧河道出土土器10 (SR46002)
图版234 弥生中期上層 旧河道出土土器11 (SR46002)
图版235 弥生中期上層 旧河道出土土器12 (SR46002)
图版236 弥生中期上層 旧河道出土土器13 (SR46002)
图版237 弥生中期上層 旧河道出土土器14 (SR46002)
图版238 弥生中期上層 旧河道出土土器15 (SR46002)
图版239 弥生中期上層 旧河道出土土器16 (SR46002)
图版240 弥生中期上層 旧河道出土土器17 (SR46002)
图版241 弥生中期上層 旧河道出土土器18 (SR46002)
图版242 弥生中期上層 旧河道出土土器19 (SR46002)
图版243 弥生中期上層 旧河道出土土器20 (SR46002)
图版244 弥生中期上層 旧河道出土土器21 (SR46002)
图版245 弥生中期上層 旧河道出土土器22 (SR46002)
图版246 弥生中期上層 旧河道出土土器23 (SR46002)
图版247 弥生中期上層 旧河道出土土器24 (SR46002)
图版248 弥生中期上層 旧河道出土土器25 (SR46002)
图版249 弥生中期上層 旧河道出土土器26 (SR46002)
图版250 弥生中期上層 旧河道出土土器27 (SR46002)
图版251 弥生中期上層 旧河道出土土器28 (SR46002)
图版252 弥生中期上層 旧河道出土土器29 (SR46002)
图版253 弥生中期上層 旧河道出土土器30 (SR46002)
图版254 弥生中期上層 旧河道出土土器31 (SR46002)
图版255 弥生中期上層 旧河道出土土器32 (SR46002)
图版256 弥生中期上層 旧河道出土土器33 (SR46002)
图版257 弥生中期上層 旧河道出土土器34 (SR46002)
图版258 弥生中期上層 旧河道出土土器35 (SR46002)
图版259 弥生中期上層 旧河道出土土器36 (SR46002)
图版260 弥生中期上層 旧河道出土土器37 (SR46002)
图版261 弥生中期上層 旧河道出土土器38 (SR46002)
图版262 弥生中期上層 旧河道出土土器39 (SR46002)
图版263 弥生中期上層 旧河道出土土器40 (SR46002)
图版264 弥生中期上層 旧河道出土土器41 (SR46002)
图版265 弥生中期上層 旧河道出土土器42 (SR46002)
图版266 弥生中期上層 旧河道出土土器43 (SR46002)
图版267 弥生中期上層 旧河道出土土器44 (SR46002)
图版268 弥生中期上層 旧河道出土土器45 (SR46002)
图版269 弥生中期上層 旧河道出土土器46 (SR46002)
图版270 弥生中期上層 旧河道出土土器47 (SR46002)

- 图版271 弥生中期上層 旧河道出土土器48 (SR46002)
- 图版272 弥生中期上層 旧河道出土土器49 (SR46002)
- 图版273 弥生中期上層 旧河道出土土器50 (SR46002)
- 图版274 弥生中期上層 旧河道出土土器51 (SR46002)
- 图版275 弥生中期上層 旧河道出土土器52 (SR46002)
- 图版276 弥生中期上層 旧河道出土土器53 (SR46002)
- 图版277 弥生中期上層 旧河道出土土器54 (SR46002)
- 图版278 弥生中期上層 旧河道出土土器55 (SR46002)
- 图版279 弥生中期上層 旧河道出土土器56 (SR46002)
- 图版280 弥生中期上層 旧河道出土土器57 (SR46002)
- 图版281 弥生中期上層 旧河道出土土器58 (SR46002)
- 图版282 弥生中期上層 旧河道出土土器59 (SR46002)
- 图版283 弥生中期上層 旧河道出土土器60 (SR46002)
- 图版284 弥生中期上層 旧河道出土土器61 (SR46002)
- 图版285 弥生中期上層 旧河道出土土器62 (SR46002)
- 图版286 弥生中期上層 旧河道出土土器63 (SR46002)
- 图版287 弥生中期上層 旧河道出土土器64 (SR46002)
- 图版288 弥生中期上層 旧河道出土土器65 (SR46002)
- 图版289 弥生中期上層 旧河道出土土器66 (SR46002)
- 图版290 弥生中期上層 旧河道出土土器67 (SR46002)
- 图版291 弥生中期上層 旧河道出土土器68 (SR46002)
- 图版292 弥生中期上層 旧河道出土土器69 (SR46002)
- 图版293 弥生中期上層 旧河道出土土器70 (SR46002)
- 图版294 弥生中期上層 旧河道出土土器71 (SR46002)
- 图版295 弥生中期上層 旧河道出土土器72 (SR46002)
- 图版296 弥生中期上層 旧河道出土土器73 (SR46002)
- 图版297 弥生中期上層 旧河道出土土器74 (SR46002)
- 图版298 弥生中期上層 旧河道出土土器75 (SR46002)
- 图版299 弥生中期上層 旧河道出土土器76 (SR46002)
- 图版300 弥生中期上層 旧河道出土土器77 (SR46002)
- 图版301 弥生中期上層 旧河道出土土器78 (SR46002)
- 图版302 弥生中期上層 旧河道出土土器79 (SR46002)
- 图版303 弥生中期上層 旧河道出土土器80 (SR46002)
- 图版304 弥生中期上層 旧河道出土土器81 (SR46002)
- 图版305 弥生中期上層 旧河道出土土器82 (SR46002)
- 图版306 弥生中期上層 旧河道出土土器83 (SR46002)
- 图版307 弥生中期上層 旧河道出土土器84 (SR46002)
- 图版308 弥生中期上層 旧河道出土土器85 (SR46002)

- 图版309 弥生中期上層 旧河道出土土器86 (SR46002)
- 图版310 弥生中期上層 旧河道出土土器87 (SR46002)
- 图版311 弥生中期上層 溝出土土器 1 (SD46001/46002)
- 图版312 弥生中期上層 溝出土土器 2 (SD46003/46004/46005/46007/46008)
- 图版313 弥生中期上層 溝出土土器 3 (SD46008)
- 图版314 弥生中期上層 溝出土土器 4 (SD46008)
- 图版315 弥生中期上層 溝出土土器 5 (SD46008)
- 图版316 弥生中期上層 溝出土土器 6 (SD46008/46009/46010/46011/56002)
- 图版317 弥生中期上層 旧河道出土木器 1 (SR46001)
- 图版318 弥生中期上層 旧河道出土木器 2 (SR46001)
- 图版319 弥生中期上層 旧河道出土木器 3 (SR46001)
- 图版320 弥生中期上層 旧河道出土木器 4 (SR46002)
- 图版321 弥生中期上層 旧河道出土木器 5 (SR46002)
- 图版322 弥生中期上層 旧河道出土木器 6 (SR46002)
- 图版323 弥生中期上層 旧河道出土木器 7 (SR46002)
- 图版324 弥生中期上層 旧河道出土木器 8 (SR46002)
- 图版325 弥生中期上層 旧河道出土木器 9 (SR46002)
- 图版326 弥生中期上層 旧河道出土木器10 (SR46002)
- 图版327 弥生中期上層 旧河道出土木器11 (SR46002)
- 图版328 弥生中期上層 旧河道出土木器12 (SR46002)
- 图版329 弥生中期上層 旧河道出土木器13 (SR46002)
- 图版330 弥生中期上層 旧河道出土木器14 (SR46002)
- 图版331 弥生中期上層 旧河道出土木器15 (SR46002)
- 图版332 弥生中期上層 旧河道出土木器16 (SR46002)
- 图版333 弥生中期上層 旧河道出土木器17 (SR46002)
- 图版334 弥生中期上層 旧河道出土木器18 (SR46002)
- 图版335 弥生中期上層 旧河道出土木器19 (SR46002)
- 图版336 弥生中期上層 旧河道出土木器20 (SR46002)
- 图版337 弥生中期上層 旧河道出土木器21 (SR46002)
- 图版338 弥生中期上層 旧河道出土木器22 (SR46002)
- 图版339 弥生中期上層 旧河道出土木器23 (SR46002)
- 图版340 弥生中期上層 旧河道出土木器24 (SR46002)
- 图版341 弥生中期上層 旧河道出土木器25 (SR46002)
- 图版342 弥生中期上層 旧河道出土木器26 (SR46002)
- 图版343 弥生中期上層 旧河道出土木器27 (SR46002)
- 图版344 弥生中期上層 旧河道出土木器28 (SR46002)
- 图版345 弥生中期上層 旧河道出土木器29 (SR46002)
- 图版346 弥生中期上層 旧河道出土木器30 (SR46002)

- 图版347 弥生中期上層 旧河道出土木器31 (SR46002)
- 图版348 弥生中期上層 旧河道出土木器32 (SR46002)
- 图版349 弥生中期上層 旧河道出土木器33 (SR46002)
- 图版350 弥生中期上層 旧河道出土木器34 (SR46002)
- 图版351 弥生中期上層 旧河道出土木器35 (SR46002)
- 图版352 弥生中期上層 旧河道出土木器36 (SR46002)
- 图版353 弥生中期上層 旧河道出土木器37 (SR46002)
- 图版354 弥生中期上層 旧河道出土木器38 (SR46002)
- 图版355 弥生中期上層 旧河道出土木器39 (SR46002)
- 图版356 弥生中期上層 旧河道出土木器40 (SR46002)
- 图版357 弥生中期上層 旧河道出土木器41 (SR46002)
- 图版358 弥生中期上層 旧河道出土木器42 (SR46002)
- 图版359 弥生中期上層 旧河道出土木器43 (SR46002)
- 图版360 弥生中期上層 旧河道出土木器44 (SR46002)
- 图版361 弥生中期上層 旧河道出土木器45 (SR46002)
- 图版362 弥生中期上層 旧河道出土木器46 (SR46002)
- 图版363 弥生中期上層 旧河道出土木器47 (SR46002)
- 图版364 弥生中期上層 旧河道出土木器48 (SR46002)
- 图版365 弥生中期上層 旧河道出土木器49 (SR46002)
- 图版366 弥生中期上層 旧河道出土木器50 (SR46002)
- 图版367 弥生中期上層 旧河道出土木器51 (SR46002)
- 图版368 弥生中期上層 旧河道出土木器52 (SR46002)
- 图版369 弥生中期上層 旧河道出土木器53 (SR46002)
- 图版370 弥生中期上層 旧河道出土木器54 (SR46002)
- 图版371 弥生中期上層 旧河道出土木器55 (SR46002)
- 图版372 弥生中期上層 旧河道出土木器56 (SR46002)
- 图版373 弥生中期上層 旧河道出土木器57 (SR46002)
- 图版374 弥生中期上層 旧河道出土木器58 (SR46002)
- 图版375 弥生中期上層 旧河道出土木器59 (SR46002)
- 图版376 弥生中期上層 旧河道出土木器60 (SR46002)
- 图版377 弥生中期上層 旧河道出土木器61 (SR46002)
- 图版378 弥生中期上層 旧河道出土木器62 (SR46002)
- 图版379 弥生中期上層 旧河道出土木器63 (SR46002)
- 图版380 弥生中期上層 旧河道出土木器64 (SR46002)
- 图版381 弥生中期上層 旧河道出土木器65 (SR46002)
- 图版382 弥生中期上層 旧河道出土木器66 (SR46002)
- 图版383 弥生中期上層 旧河道出土木器67 (SR46002)
- 图版384 弥生中期上層 旧河道出土木器68 (SR46002)

- 图版385 弥生中期上層 旧河道出土木器69 (SR46002)
- 图版386 弥生中期上層 旧河道出土木器70 (SR46002)
- 图版387 弥生中期上層 旧河道出土木器71 (SR46002)
- 图版388 弥生中期上層 旧河道出土木器72 (SR46002)
- 图版389 弥生中期上層 旧河道出土木器73 (SR46002)
- 图版390 弥生中期上層 旧河道出土木器74 (SR46002)
- 图版391 弥生中期上層 旧河道出土木器75 (SR46002)
- 图版392 弥生中期上層 旧河道出土木器76 (SR46002)
- 图版393 弥生中期上層 旧河道出土木器77 (SR46002)
- 图版394 弥生中期上層 旧河道出土木器78 (SR46002)
- 图版395 弥生中期上層 旧河道出土木器79 (SR46002)
- 图版396 弥生中期上層 旧河道出土木器80 (SR46002)
- 图版397 弥生中期上層 旧河道出土木器81 (SR46002)
- 图版398 弥生中期上層 旧河道出土木器82 (SR46002/SD56002)
- 图版399 弥生中期上層 旧河道出土木器83 (SR46003)
- 图版400 弥生中期上層 旧河道·溝出土石器 1 (SR46002)
- 图版401 弥生中期上層 旧河道·溝出土石器 2 (SR46002/SD56002)
- 图版402 弥生中期上層 旧河道·溝出土石器 3 (SR46002/SD56002/SD56005)
- 图版403 弥生中期上層 旧河道·溝出土石器 4 (SR46002/SD46008)
- 图版404 弥生中期上層 旧河道·溝出土石器 5 (SR46001/46002/SD46006)
- 图版405 弥生中期上層 旧河道·溝出土石器 6 (SR46001/46002)
- 图版406 弥生中期上層 旧河道·溝出土石器 7 (SR46001/46002)
- 图版407 弥生中期上層 旧河道·溝出土石器 8 (SR46001/46002)
- 图版408 弥生中期上層 旧河道·溝出土石器 9 (SR46001/46002/SD56002)
- 图版409 弥生中期上層 旧河道·溝出土石器10 (SR46001/46002/SD66002)
- 图版410 弥生中期上層 旧河道·溝出土石器11 (SR46001/46002/SD46002/46008)
- 图版411 弥生中期上層 旧河道·溝出土石器12 (SR46002/SD46008)
- 图版412 弥生中期上層 旧河道·溝出土石器13 (SR46001/46002/SD56002)
- 图版413 弥生中期上層 旧河道·溝出土石器14 (SR46001/46002/SD46008)
- 图版414 弥生中期上層 旧河道·溝出土石器15 (SR46001/46002)
- 图版415 弥生中期上層 旧河道·溝出土石器16 (SR46001/46002/SD46008/56005)
- 图版416 弥生中期上層 旧河道·溝出土石器17 (SR46002)
- 图版417 弥生中期上層 旧河道·溝出土石器18 (SR46001/46002)
- 图版418 弥生中期上層 旧河道·溝出土石器19 (SR46002)
- 图版419 弥生中期上層 旧河道·溝出土石器20 (SR46001/46002)
- 图版420 弥生中期上層 旧河道·溝出土石器21 (SR46002)
- 图版421 弥生中期上層 旧河道·溝出土石器22 (SR46002)
- 图版422 弥生中期上層 旧河道·溝出土石器23 (SR46002)

- 図版423 弥生中期上層 旧河道・溝出土石器24 (SR46002)
- 図版424 弥生中期上層 旧河道・溝出土石器25 (SR46002)
- 図版425 弥生中期上層 旧河道・溝出土石器26 (SR46002)
- 図版426 弥生中期上層 旧河道・溝出土石器27 (SR46002)
- 図版427 弥生中期上層 旧河道・溝出土石器28 (SR46002)
- 図版428 弥生中期上層 旧河道・溝出土石器29 (SR46002/SD46008/SD56002)
- 図版429 弥生中期上層 旧河道・溝出土石器30 (SR46001/46002/SD46001/46002)
- 図版430 弥生中期上層 旧河道・溝出土石器31 (SR46002)
- 図版431 弥生中期上層 旧河道・溝出土石器32 (SR46002)
- 図版432 弥生中期上層 旧河道・溝出土石器33 (SR46002)
- 図版433 弥生時代後期 溝出土土器 1 (SD56001/56002)
- 図版434 弥生時代後期 溝出土土器 2 (SD56002)
- 図版435 弥生時代後期 溝出土土器 3 (SD56002/56004/56005/56006/SR46002/46003)
- 図版436 弥生時代後期 溝出土土器 4 (SR46003/SD66001/66002/66003)
- 図版437 古墳時代後期 溝出土土器 1 (SD66001/66002/66003/56002/56005/46002/確認調査)

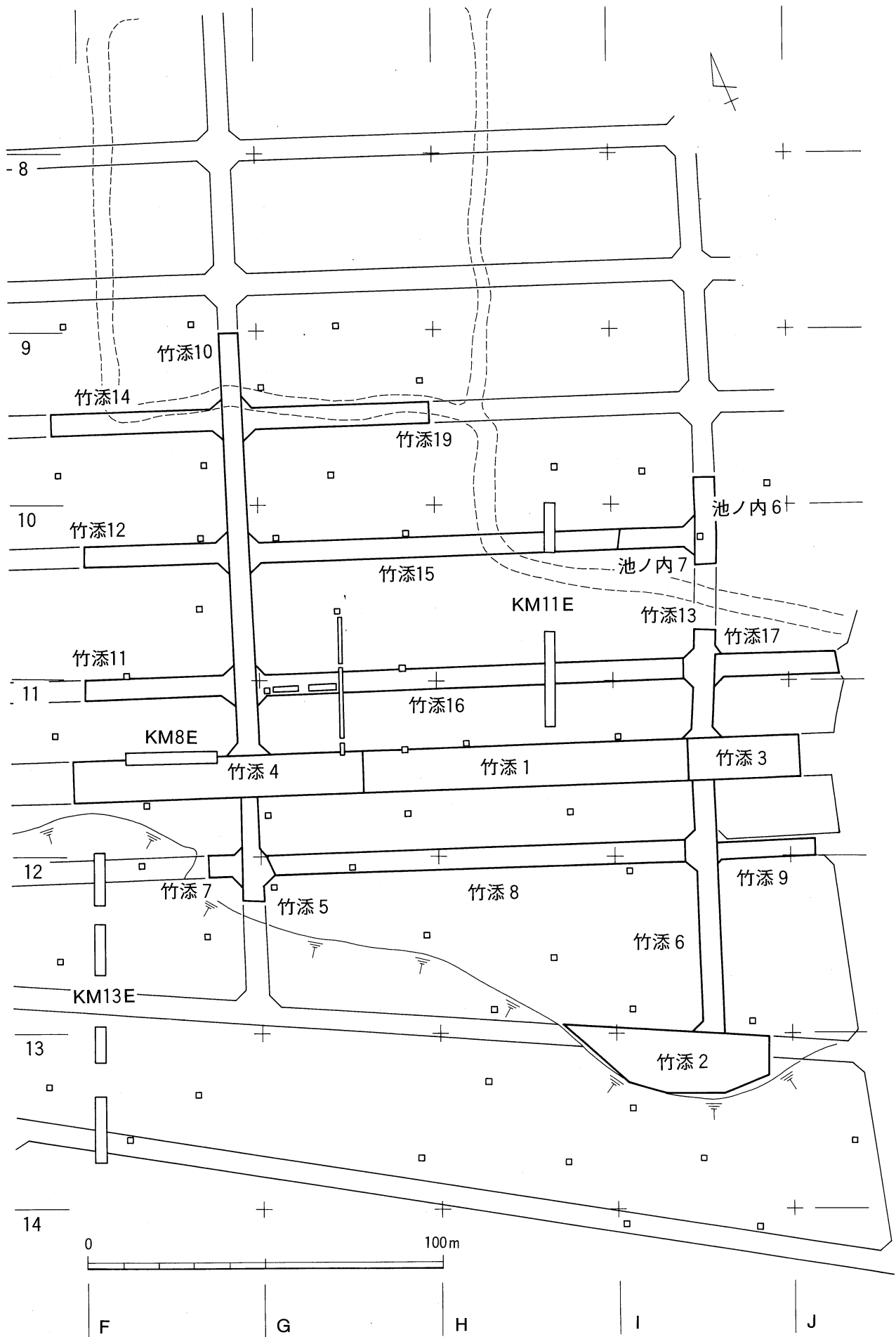

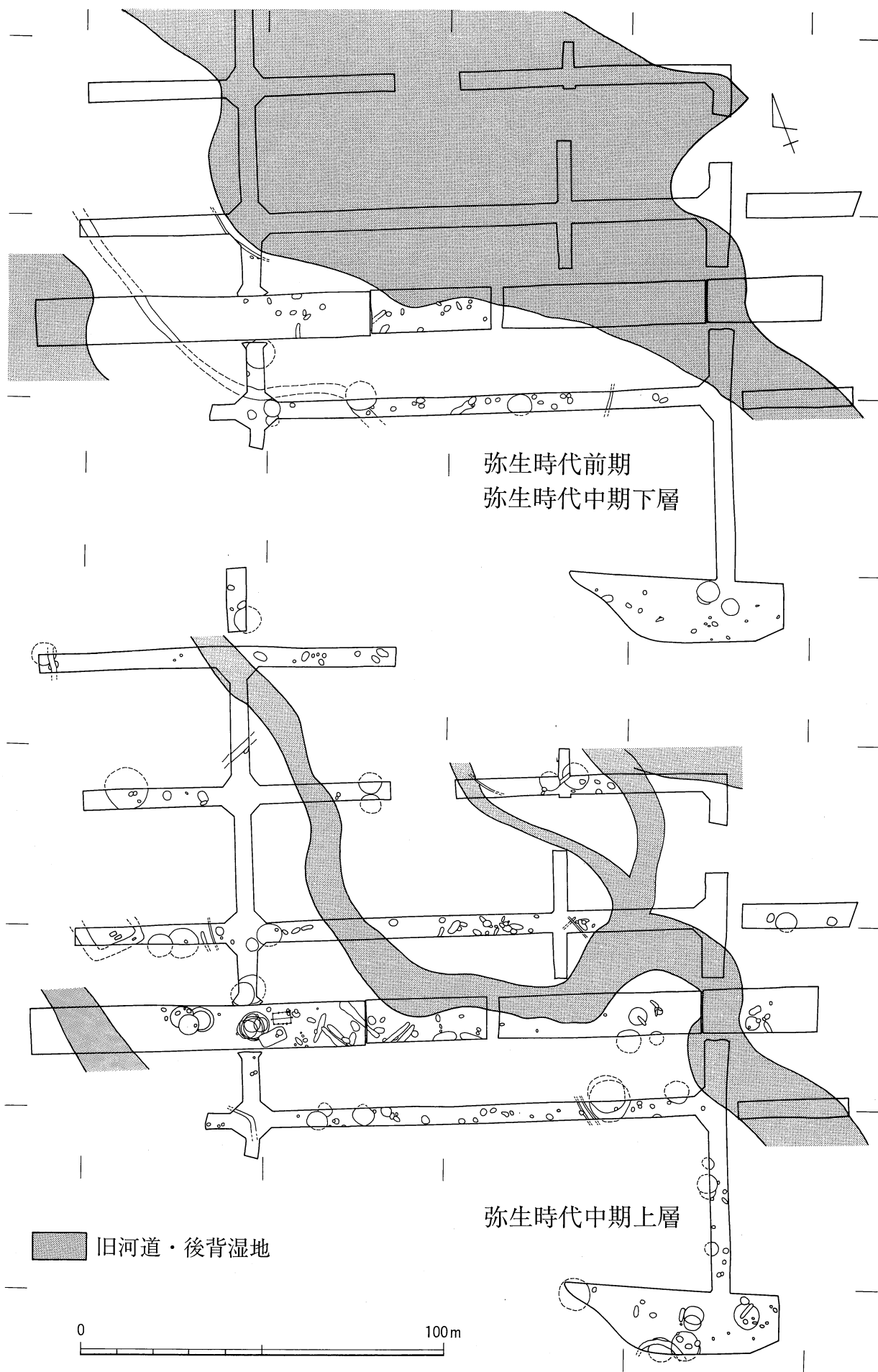

弥生時代前期～中期上層全体図

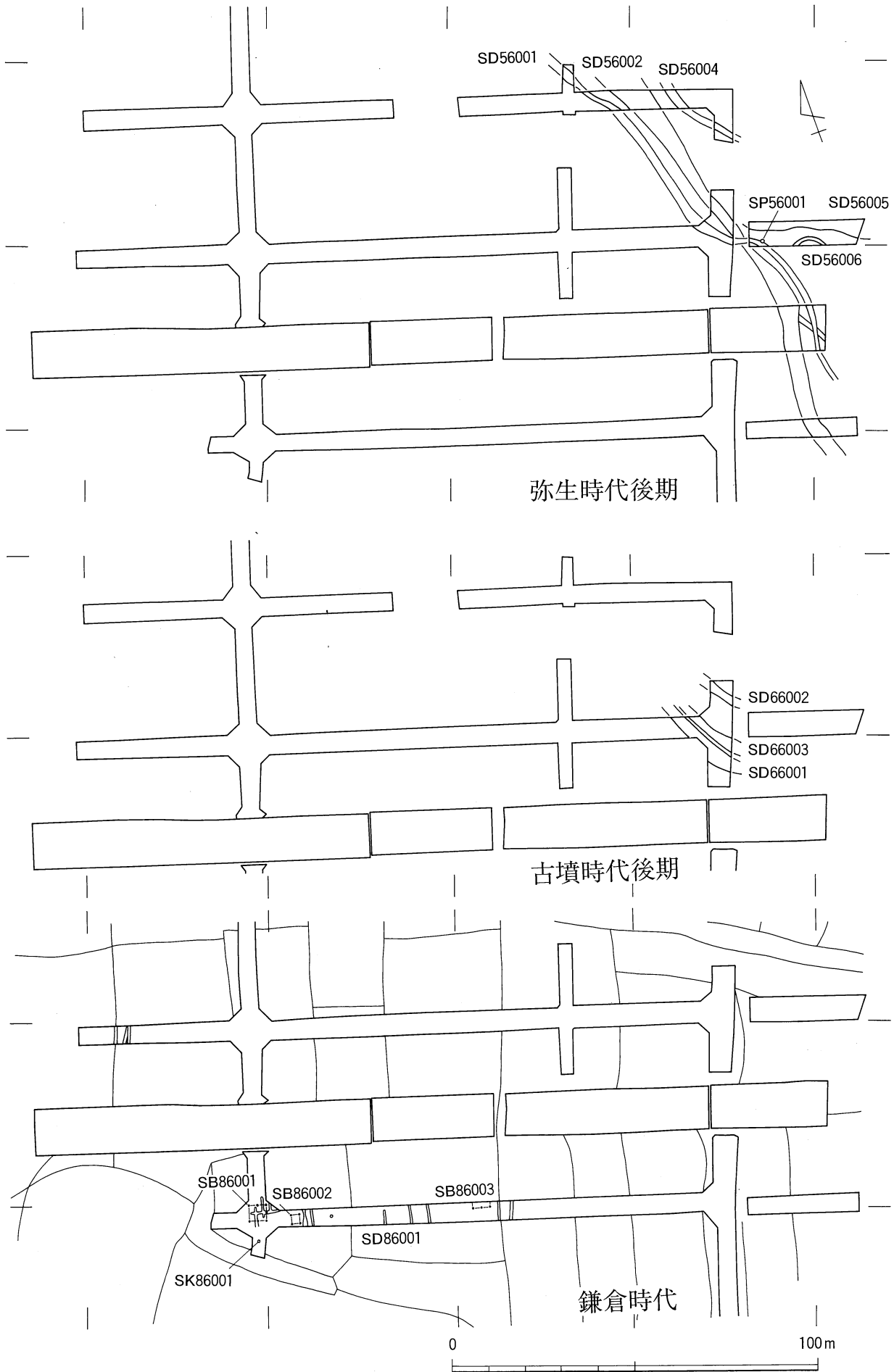

弥生時代後期～鎌倉時代全体図

17.0m

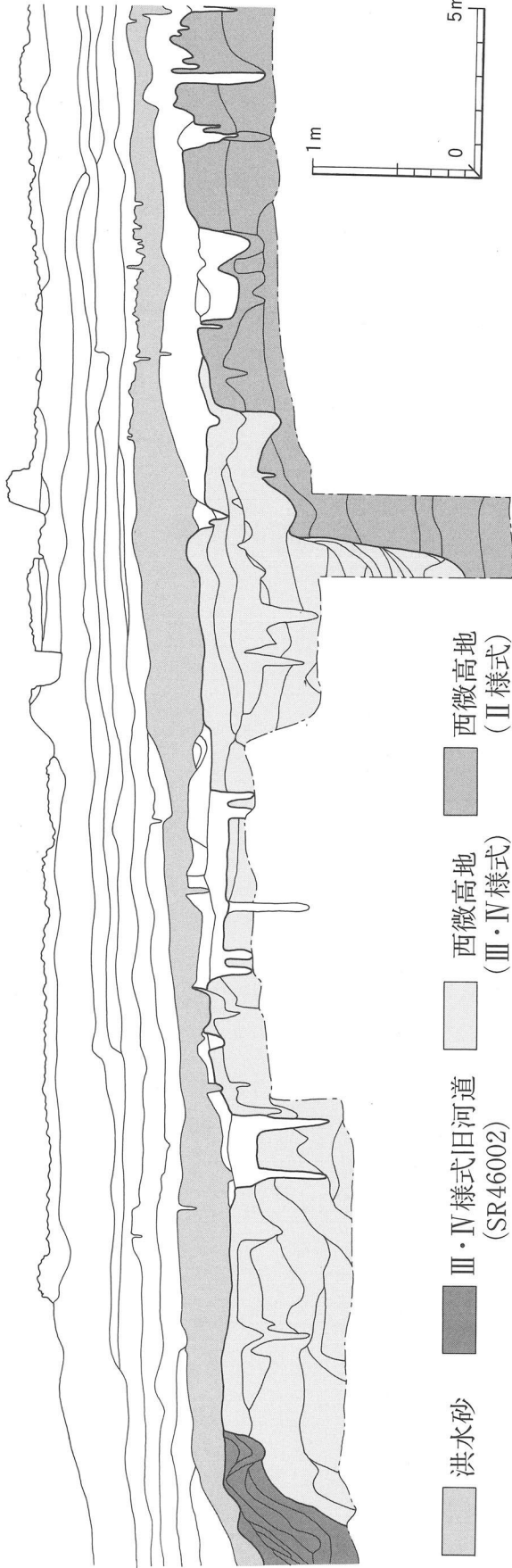

- 洪水砂
- Ⅲ・Ⅳ様式旧河道 (SR46002)
- 西微高地 (Ⅲ・Ⅳ様式)
- 西微高地 (Ⅱ様式)

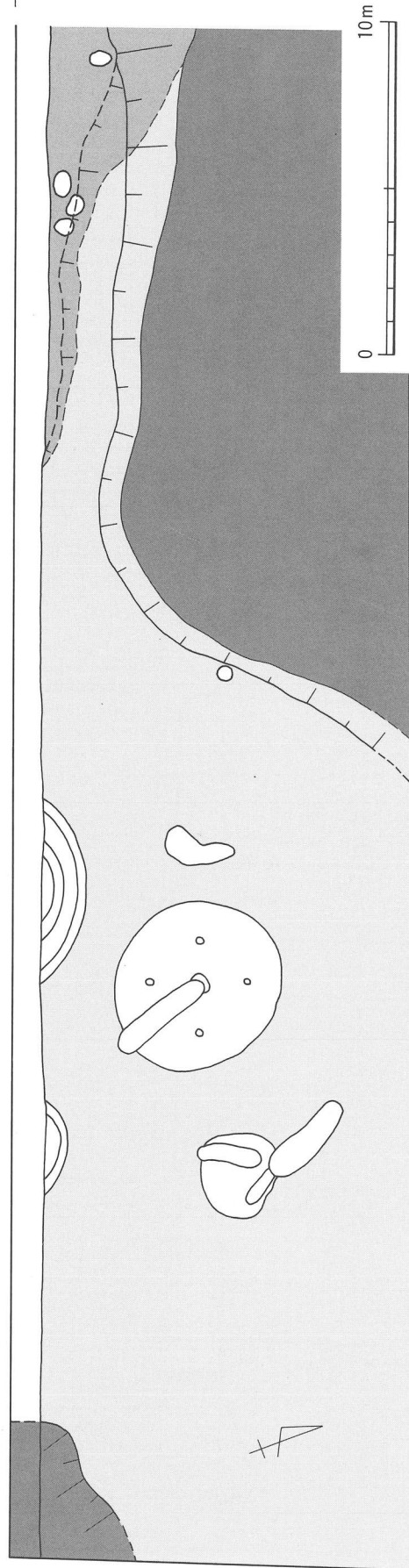

土層堆積状況図 (竹添1区)

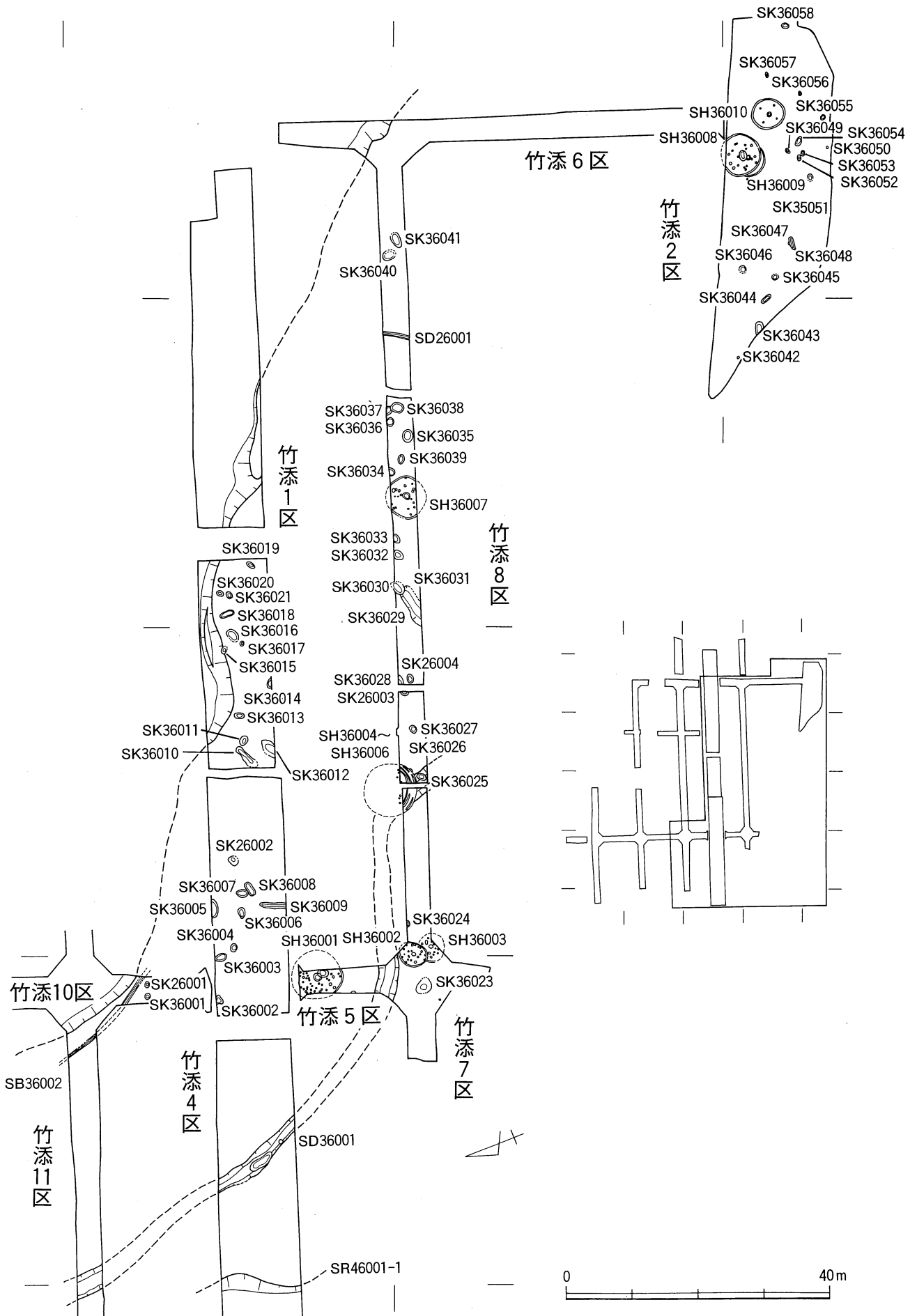

弥生時代中期下層全体図

炭化材検出状況



完掘状況

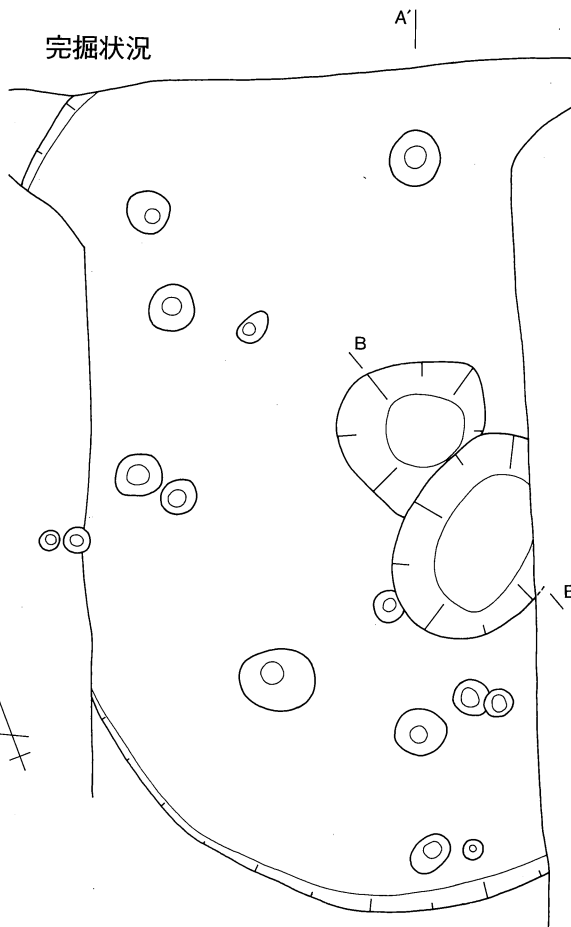

A

A'

16.6m

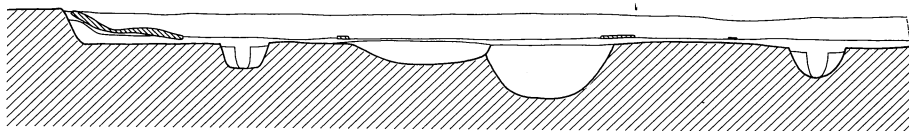

0 3m

B

B'

16.2m

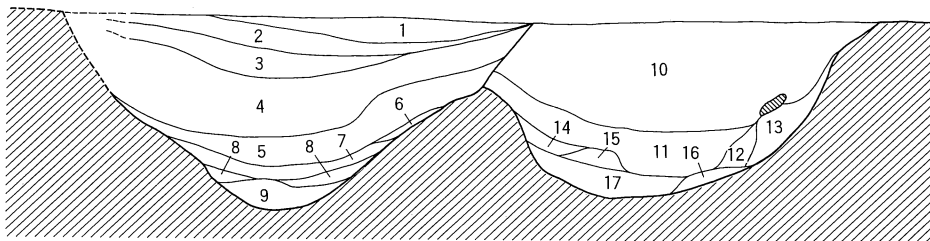

0 1m

- | | | | |
|----------------|----------------|------------------|------------|
| 1. 7.5YR4/1 褐灰 | シルト質極細砂 | 13. 7.5Y4/1 灰 | シルト質極細砂 |
| 2. 7.5YR4/1 褐灰 | シルト質極細砂 | 14. 5Y4/1 灰 | 砂質シルト |
| 3. 2.5Y8/3 淡黄 | 細砂 | 15. 2.5Y2/1 黒 | シルト質極細砂~中砂 |
| 4. 10YR4/1 褐灰 | 極細砂 | 16. 5Y8/1 灰白 | 極細砂~粗砂 |
| 5. 5Y4/1 灰 | 炭層 (極細砂ブロック含む) | 17. 2.5Y6/4 にぶい黄 | 砂質シルト |
| 6. 2.5Y6/1 黄灰 | 細砂 | | |
| 7. 5Y4/1 灰 | 炭層 (シルト質極細砂含む) | | |
| 8. 10Y8/1 灰白 | 極細砂 | | |
| 9. 7.5Y5/1 灰 | 極細砂 | | |
| 10. 5YR5/1 褐灰 | シルト | | |
| 11. 5Y4/1 灰 | 炭層 | | |
| 12. 5YR5/1 褐灰 | シルト | | |

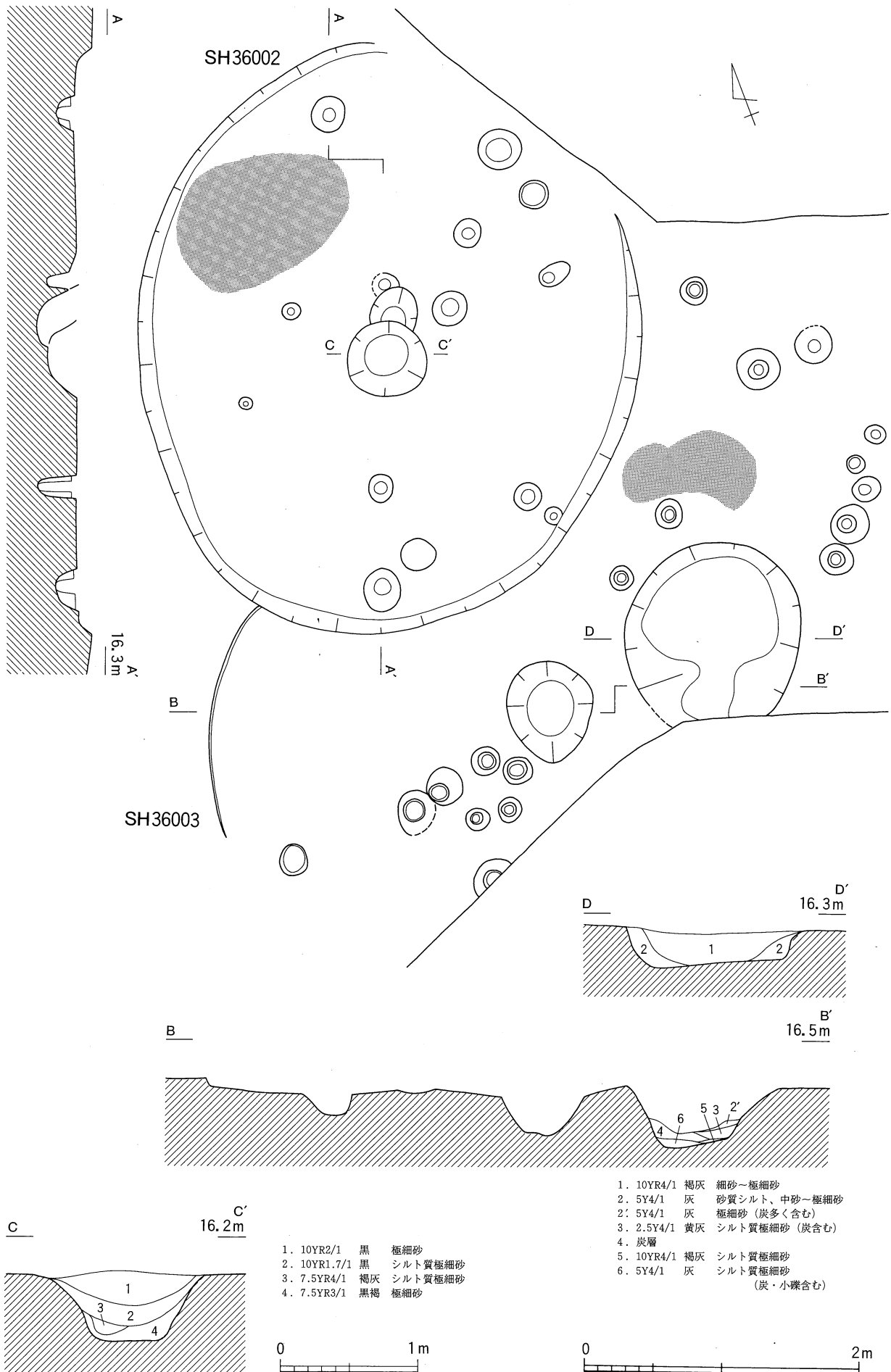

図版 8

SH36004/36005/36006/36007

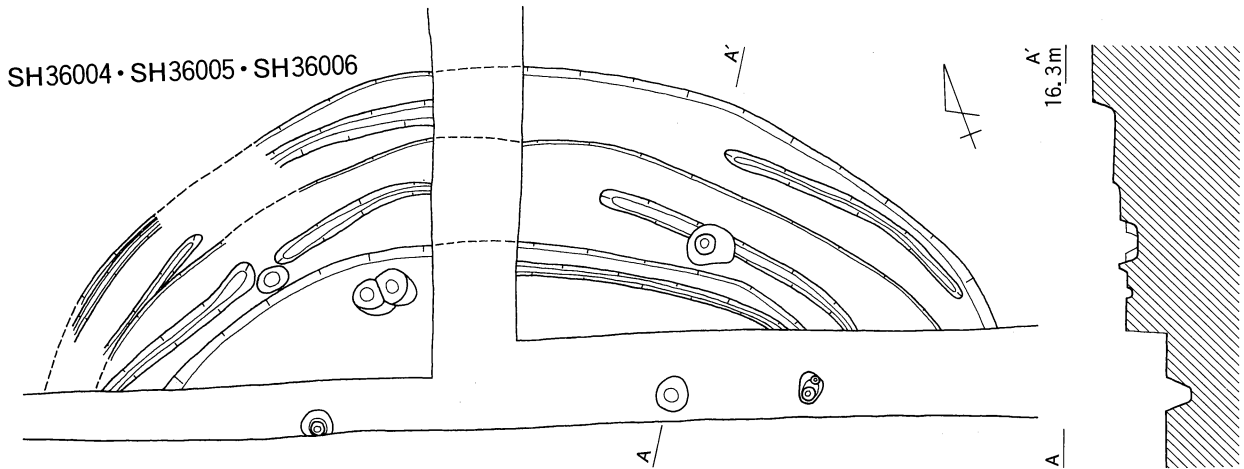

SH36007

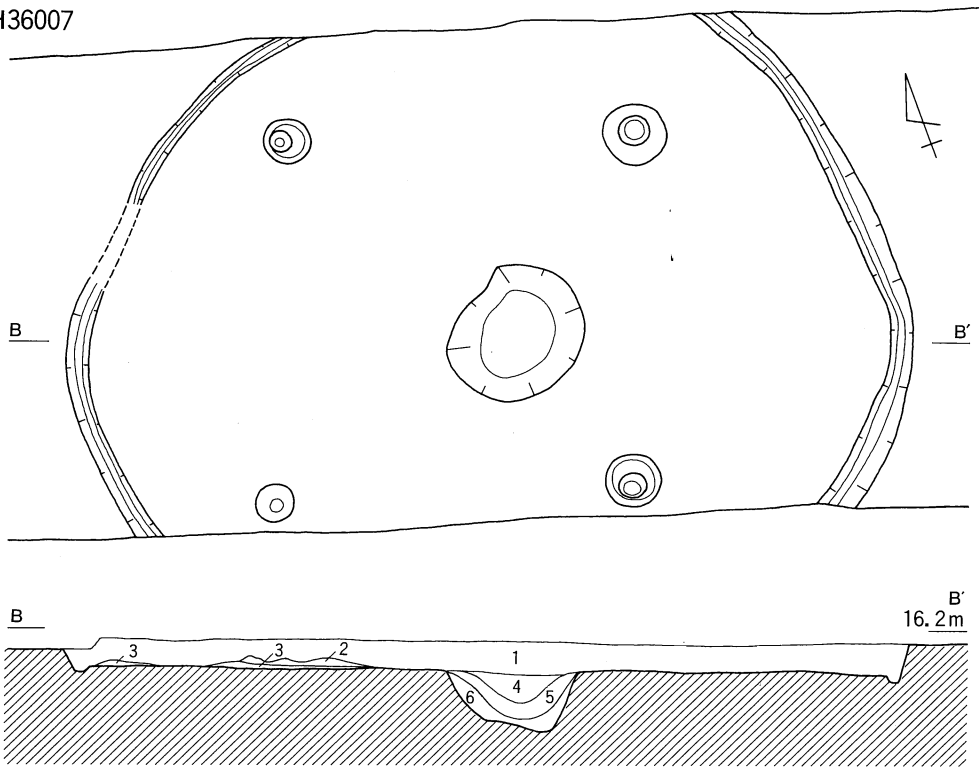

- | | | |
|-------------------|------------------------|--------------------|
| 1. 2.5Y4/1 黄灰 極細砂 | 3. 2.5Y5/1 黄灰 シルト | 5. 2.5Y5/2 暗黄灰 シルト |
| 2. 5Y4/1 灰 シルト | 4. 7.5YR4/1 褐灰 シルト質極細砂 | 6. 炭層 |



SH36008

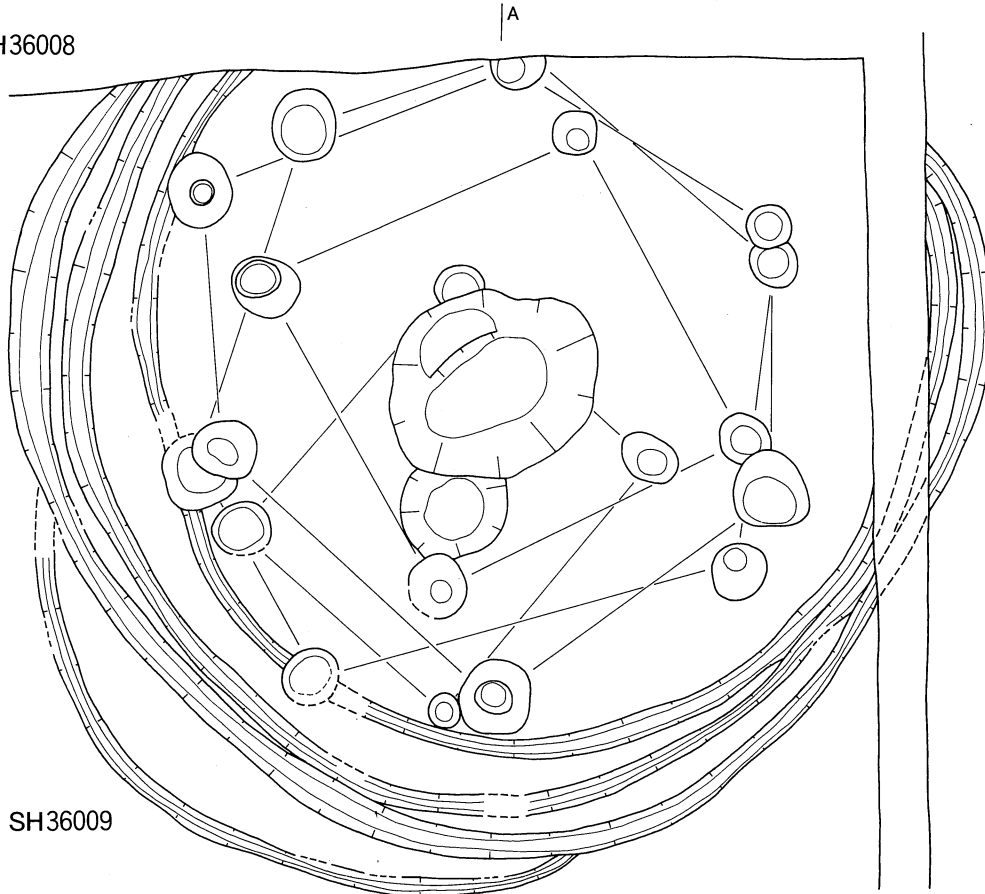

SH36009

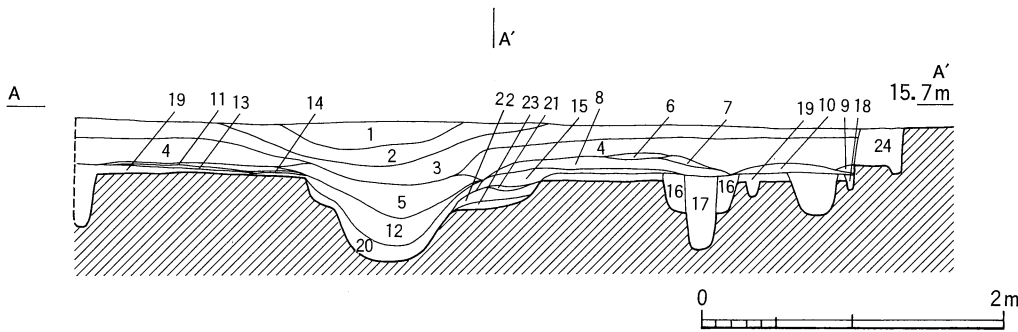

- | | | | |
|----------|--------------------|----------|-------------------|
| 1. 淡灰褐色 | シルト質極細砂 (マンガン多く含む) | 17. 暗黒灰色 | 極細砂質シルト |
| 2. 淡褐色 | シルト質極細砂 (マンガン多く含む) | 18. 褐灰色 | シルト質極細砂 |
| 3. 淡褐色 | シルト質極細砂 | 19. 暗褐色 | シルト質極細砂 (炭片多く含む) |
| 4. 褐灰色 | シルト質極細砂 | 20. 炭層 | |
| 5. 暗褐色 | 極細砂質シルト (炭片多く含む) | 21. 灰色 | 細砂～極細砂 (炭片少量含む) |
| 6. 淡黄灰色 | シルト混じり極細砂 | 22. 淡黄褐色 | 細砂～極細砂 (シルト・炭片含む) |
| 7. 褐灰色 | 細砂～極細砂 (炭片含む) | 23. 炭層 | |
| 8. 暗褐色 | シルト質極細砂 (炭片多く含む) | 24. 淡褐色 | シルト質極細砂 |
| 9. 褐灰色 | 極細砂質シルト | | |
| 10. 淡黄灰色 | シルト質極細砂 | | |
| 11. 暗褐色 | シルト質極細砂 (炭と焼土の互層) | | |
| 12. 淡灰色 | 極細砂質シルト | | |
| 13. 淡黄灰色 | シルト質極細砂 | | |
| 14. 褐灰色 | 極細砂質シルト | | |
| 15. 淡黄褐色 | 極細砂混じりシルト (炭片含む) | | |
| 16. 暗灰色 | シルト質極細砂 (炭片含む) | | |
- SH36009中央土坑
 SH36009埋土

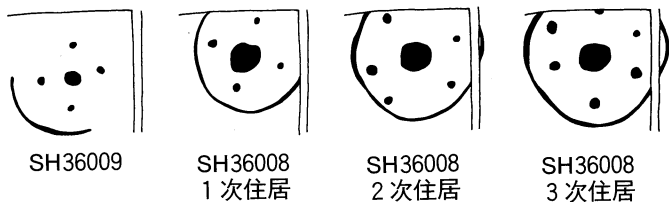

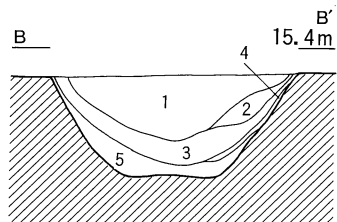
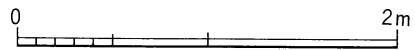
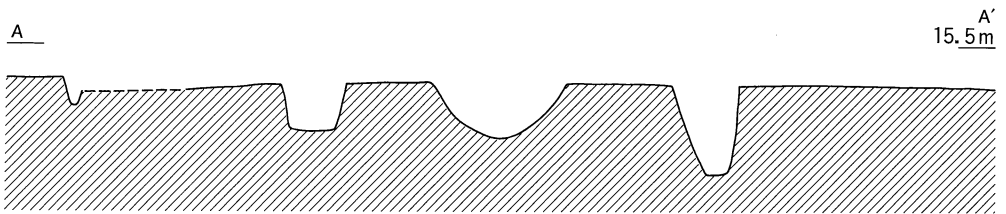
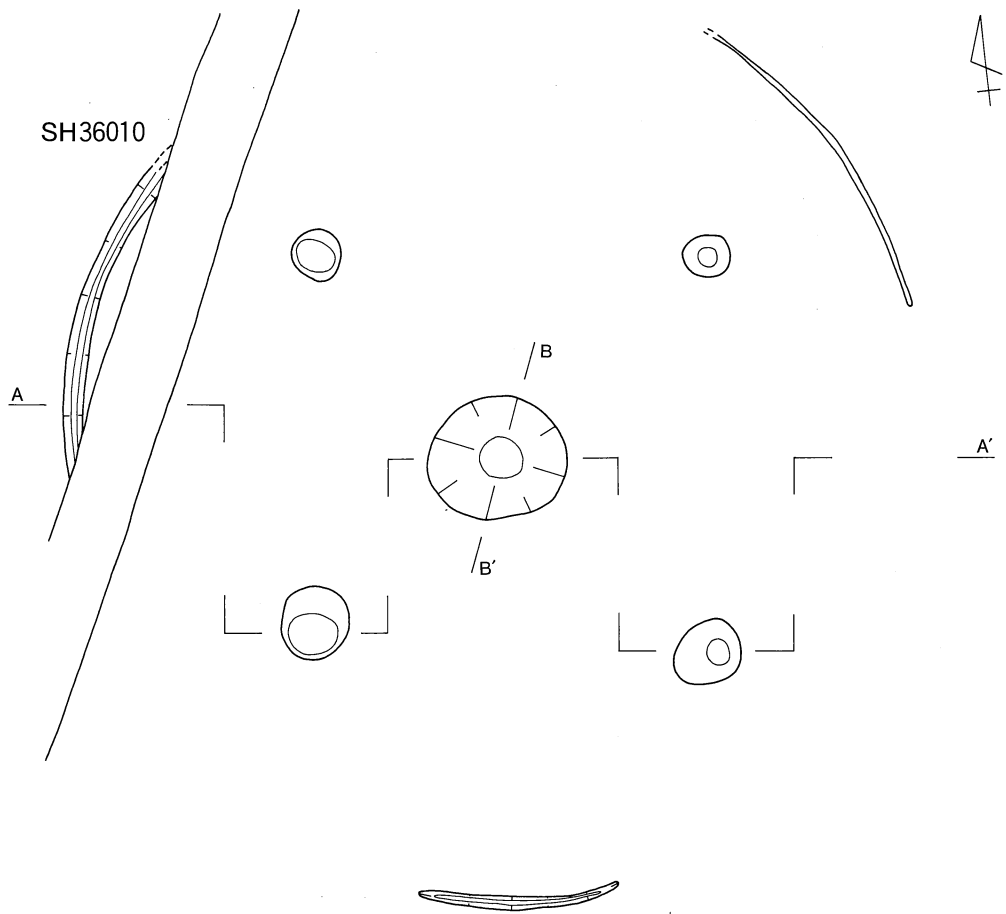

- 1. 暗灰色 粗粒シルト
- 2. 茶灰色 極細砂質シルト
- 3. 黒灰色 粗粒シルト (炭片を多く含む)
- 4. 淡黄褐色 シルト質極細砂
- 5. 炭層

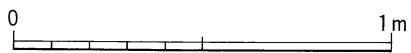

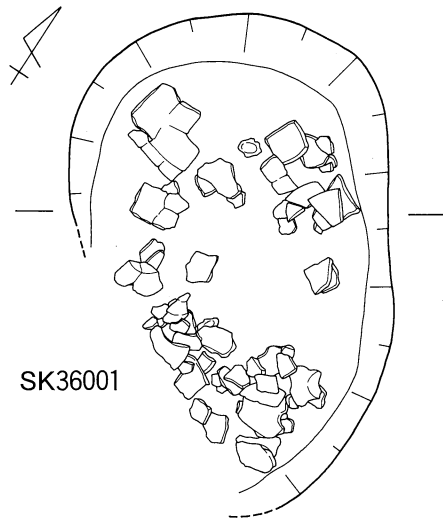

SK36001

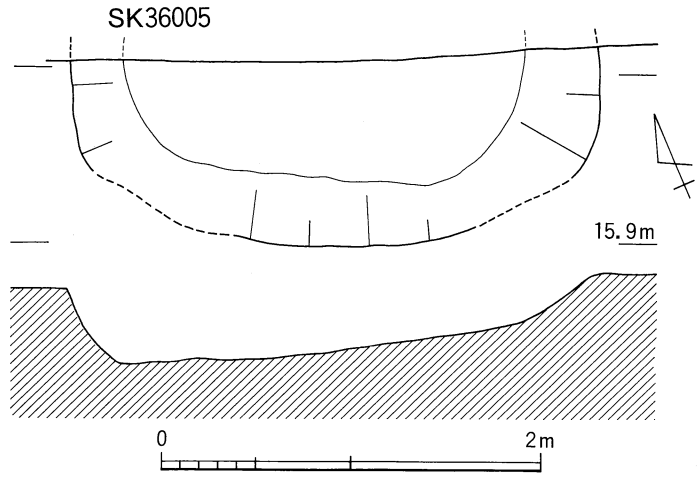

SK36005

15.9m

0 2m

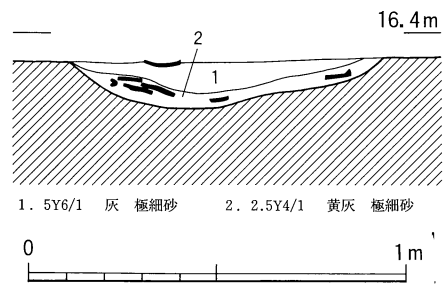

16.4m

1. 5Y6/1 灰 極細砂 2. 2.5Y4/1 黄灰 極細砂

0 1m

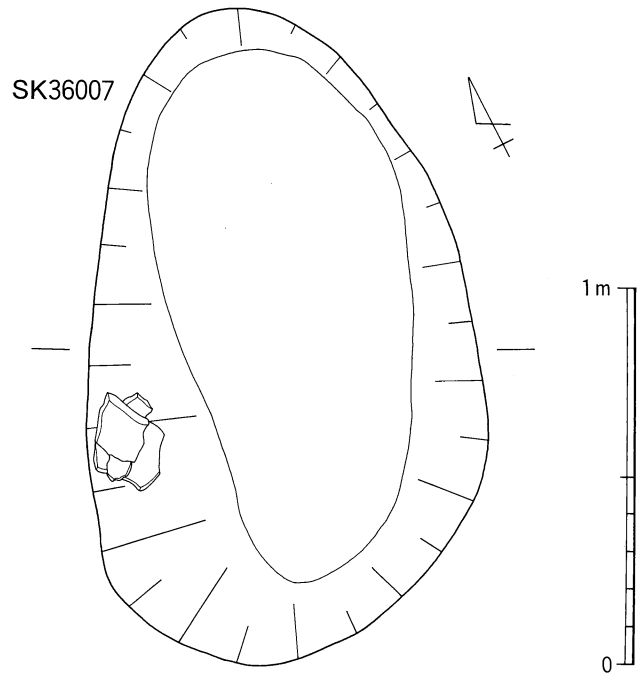

SK36007

1m

0

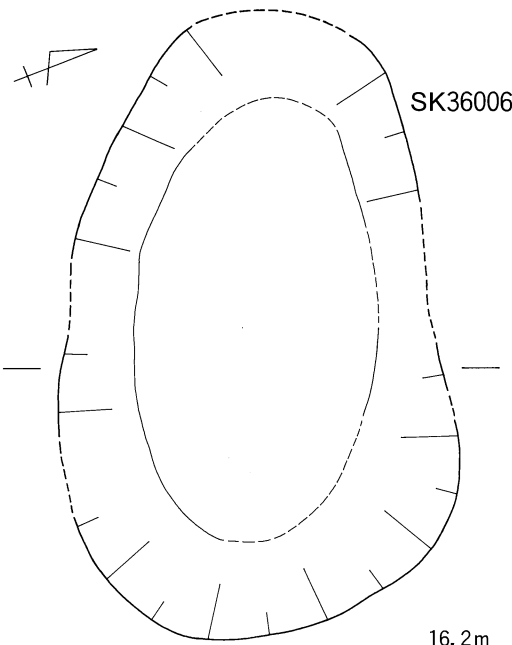

SK36006

16.2m

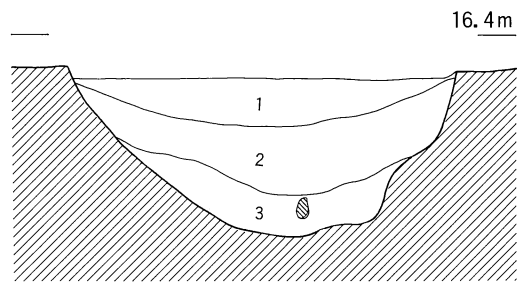

16.4m

1. 暗茶灰色 シルト質極細砂
2. 暗灰色 シルト質極細砂
3. 灰色 極細砂質シルト

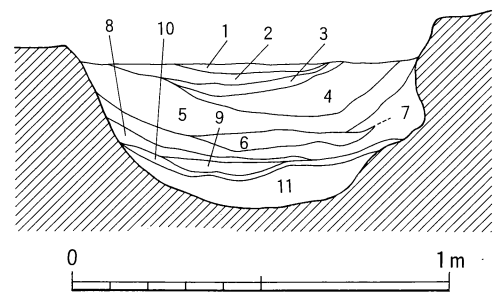

1. 暗灰色 シルト質極細砂
2. 灰色 極細砂質シルト
3. 黒色 シルト質極細砂
4. 灰色 極細砂質シルト
5. 明灰色 シルト質極細砂
6. 黄白色 中砂
7. 明灰色 極細砂質シルト
8. 暗灰色 極細砂質シルト
9. 明灰色 極細砂質シルト
10. 黒色 炭層
11. 灰色 極細砂質シルト

0 1m

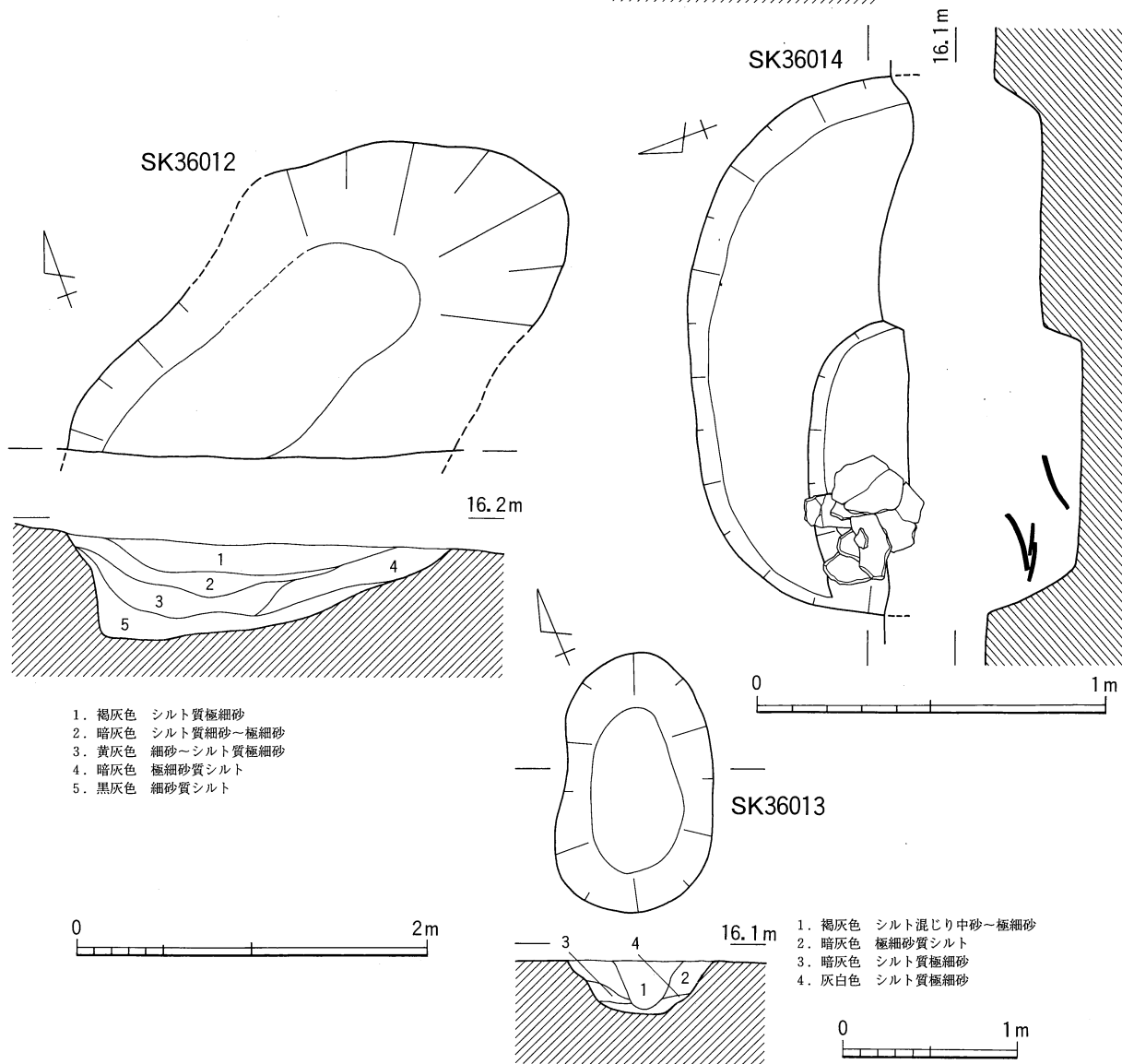
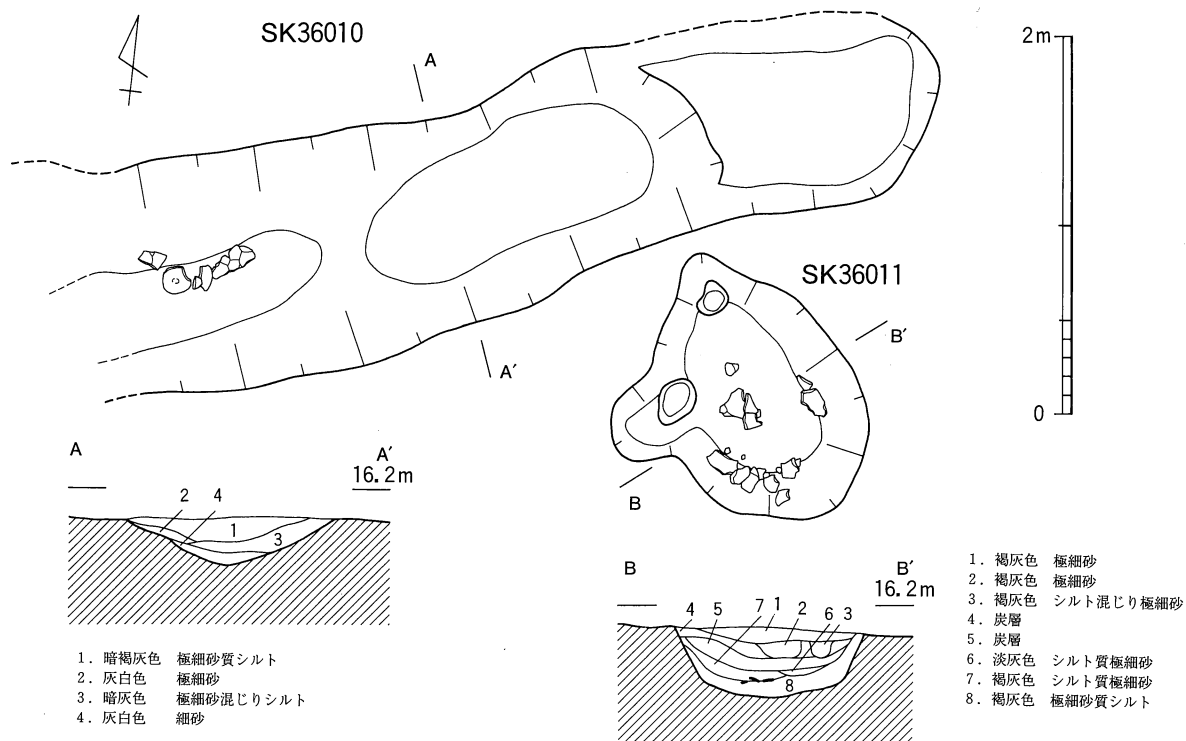

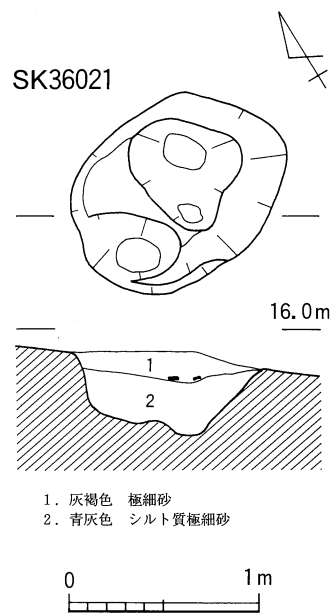
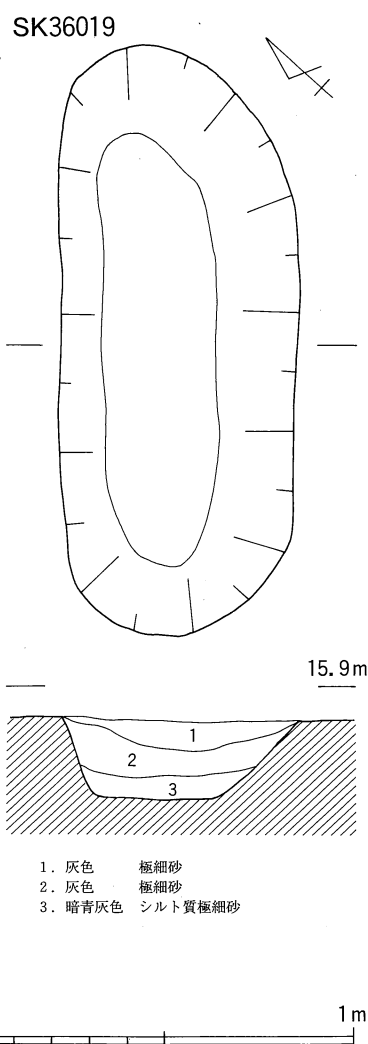
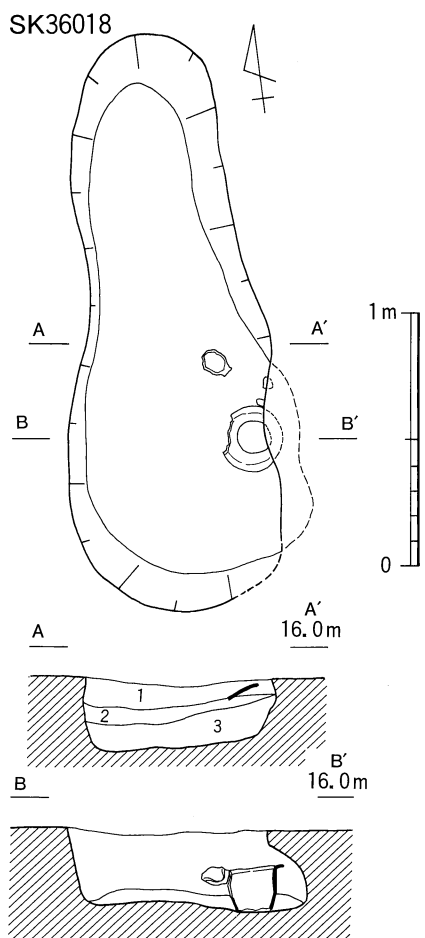
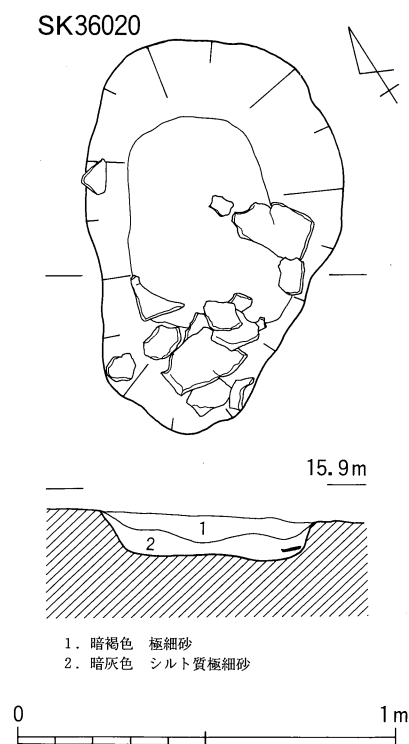
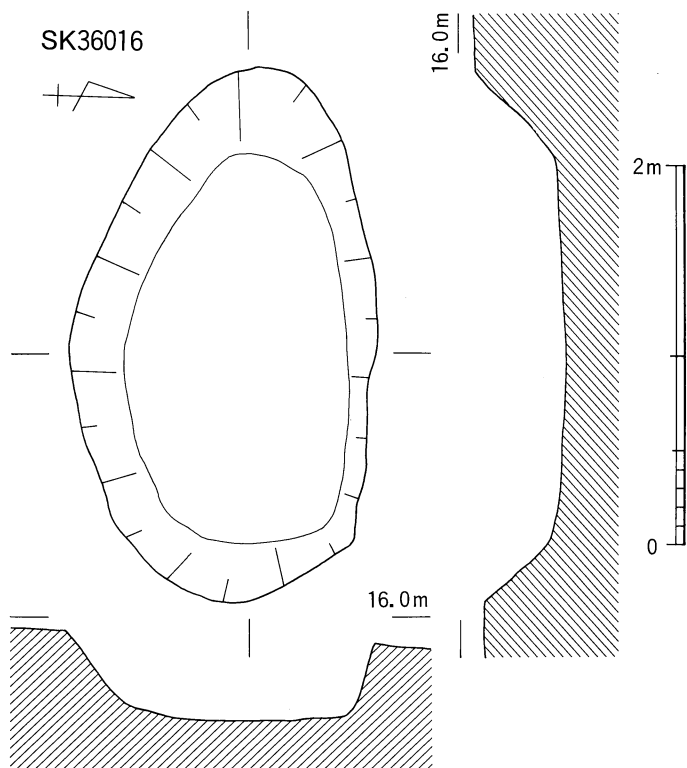

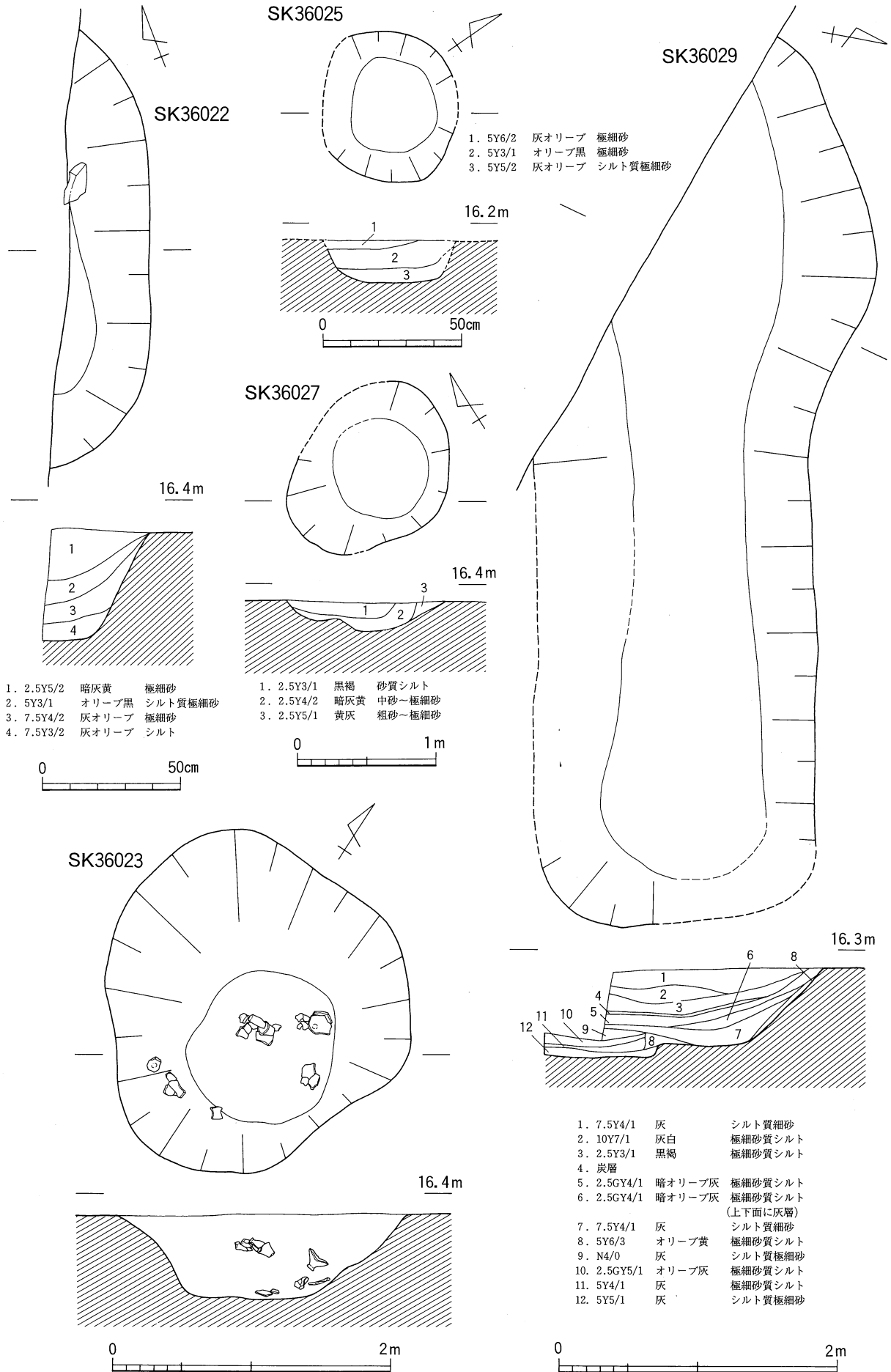

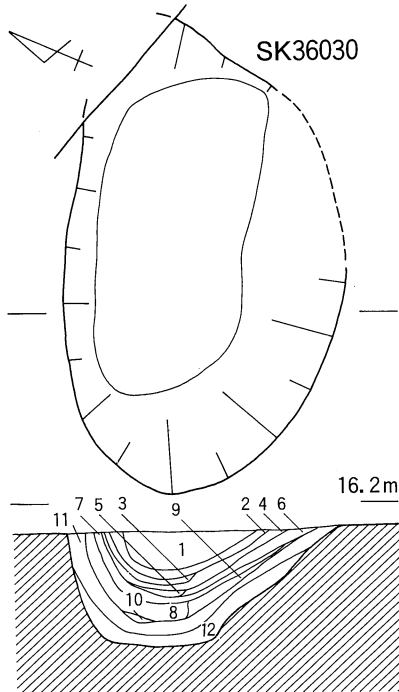

- 1. 2.5Y3/1 黒褐 細砂質シルト
- 2. 7.5Y4/1 灰 細砂質シルト
- 3. 10Y5/1 灰 細砂
- 4. 10Y4/1 灰 細砂質シルト
- 5. 10Y5/1 灰 細砂
- 6. 7.5Y4/1 灰 細砂質シルト
- 7. 10Y4/1 灰 シルト質極細砂
- 8. 10Y5/1 灰 シルト質極細砂
- 9. 7.5Y4/1 灰 細砂質シルト
- 10. 5Y4/1 灰 細砂-小礫 (炭を多く含む)
- 11. 2.5Y2/1 黒 シルト質極細砂 (炭を含む)
- 12. 5Y5/1 灰 シルト質極細砂 (炭を含む)

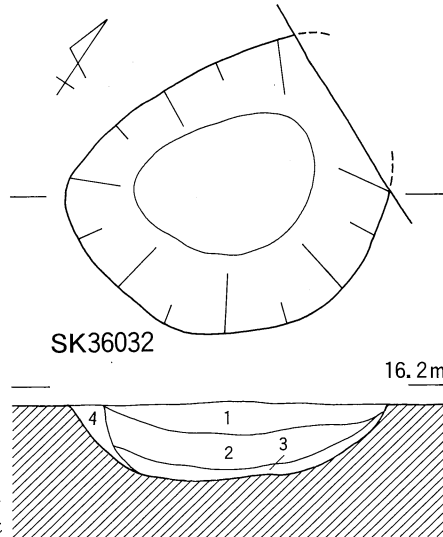
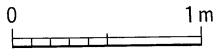

- 1. 10YR2/1 黒 細砂質シルト
- 2. N3/0 暗灰 細砂質シルト
- 3. 7.5Y4/1 灰 細砂質シルト
- 4. 10Y4/1 灰 シルト質極細砂

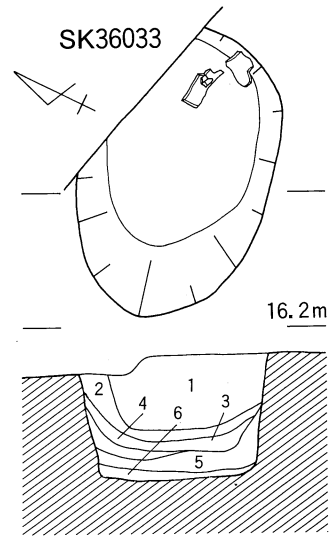

- 1. 10YR5/2 灰黄褐 細砂質シルト
- 2. 2.5Y5/1 黄灰 シルト
- 3. 5Y3/1 オリーブ黒 極細砂 (炭を多く含む)
- 4. 2.5Y6/2 灰黄 シルト
- 5. 2.5Y5/1 黄灰 シルト
- 6. 炭層

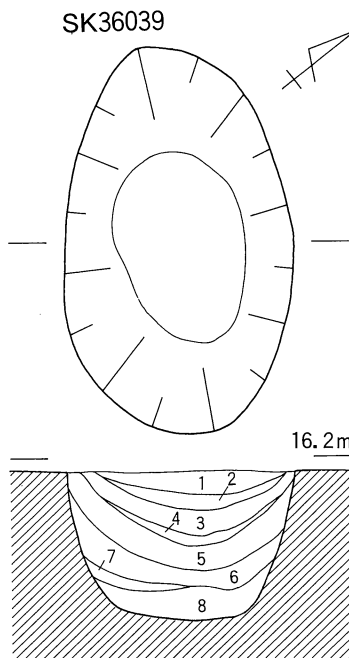
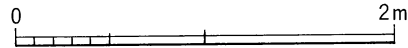

- 1. 10YR6/1 褐灰 シルト質極細砂
- 2. 2.5Y7/6 明黄褐 シルト
- 3. 7.5YR6/1 褐灰 シルト質極細砂
- 4. 7.5YR5/1 褐灰 シルト質極細砂
- 5. 2.5Y5/1 黄灰 極細砂
- 6. 5PB4/1 暗青灰 シルト質極細砂 (炭を多く含む)
- 7. 5R3/1 暗赤灰 シルト質極細砂 (炭を多く含む)
- 8. 10YR5/1 褐灰 シルト

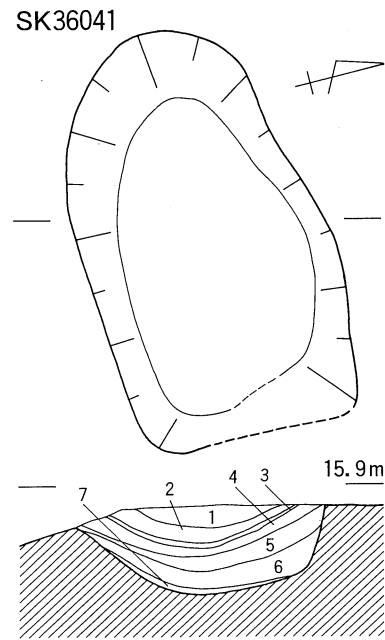

- 1. N6/0 灰 極細砂
- 2. 5BG4/1 暗青灰 シルト
- 3. 10Y8/2 灰白 細砂
- 4. N4/0 灰 極細砂
- 5. 2.5GY8/1 灰白 シルト
- 6. 10GY4/1 暗緑灰 シルト
- 7. 5GY6/1 オリーブ灰 極細砂

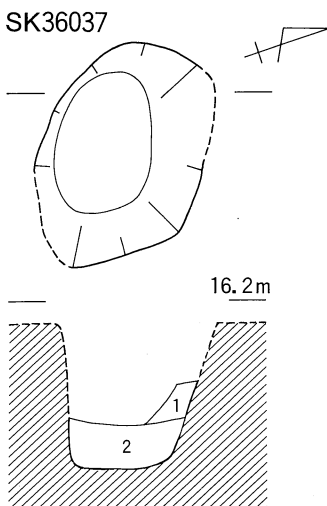
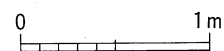

- 1. 5Y5/1 灰 シルト質極細砂
- 2. 2.5Y4/1 黄灰 シルト

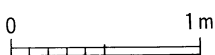

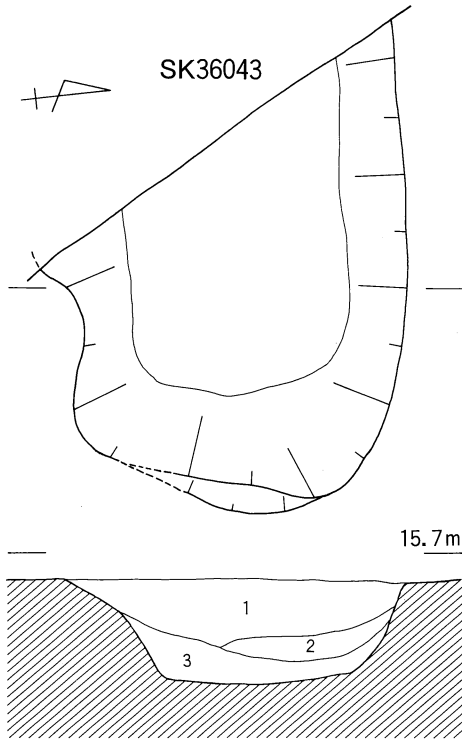

- 1. 茶灰色 シルト質極細砂～粗粒シルト
- 2. 淡黄褐色 シルト質極細砂
- 3. 青灰色 粗粒シルト (炭を多く含む)

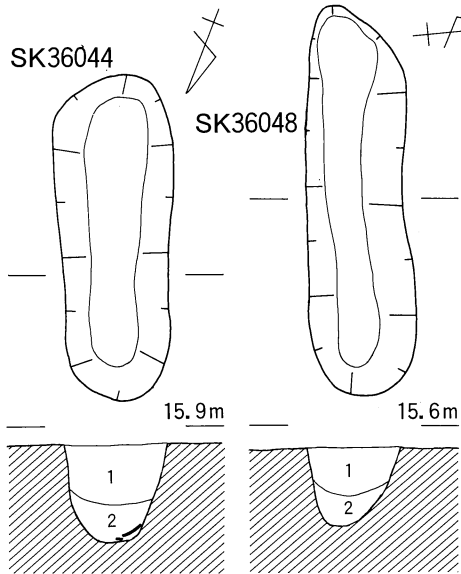
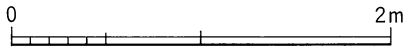

- 1. 茶灰色 極細砂質シルト
- 2. 暗灰色 粗粒シルト
- 1. 灰色 シルト質極細砂
- 2. 黄灰色 シルト質極細砂

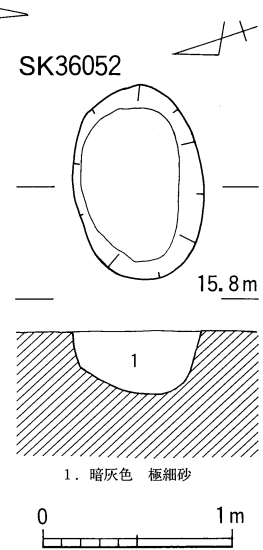
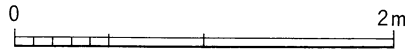

- 1. 暗灰色 極細砂

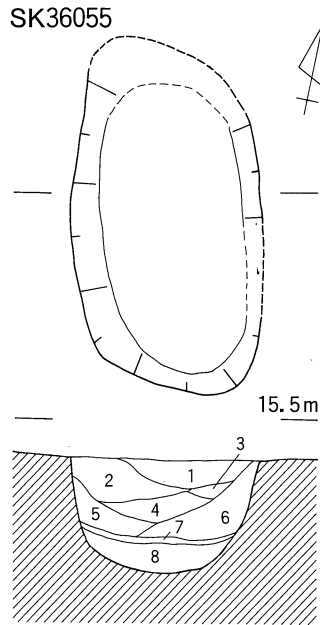
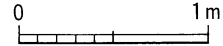

- 1. 暗茶灰色 シルト質極細砂
- 2. 暗灰色 シルト質極細砂
- 3. 灰色 シルト質極細砂
- 4. 灰白色 中砂
- 5. 茶褐色 シルト質極細砂
- 6. 淡褐色 シルト質極細砂
- 7. 黒色 中砂 (炭片を多く含む)
- 8. 黄褐色 中砂

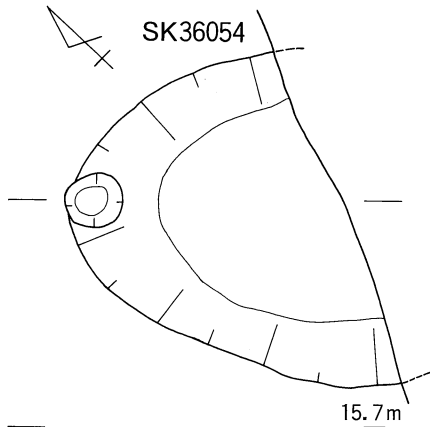
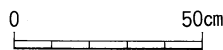

- 1. 黄褐色 シルト質極細砂
- 2. 暗灰色 粗粒シルト (炭を多く含む)
- 3. 暗灰色 粗粒シルト
- 4. 暗灰色 シルト質極細砂
- 5. 黒褐色 シルト (炭を多く含む)
- 6. 明灰色 シルト質極細砂
- 7. 茶灰色 シルト質極細砂
- 8. 茶褐色 シルト

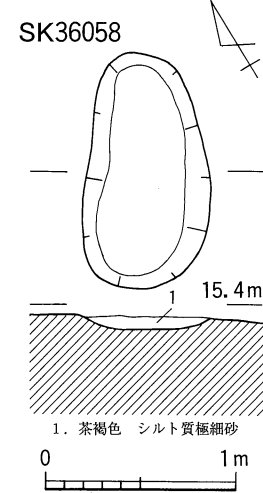
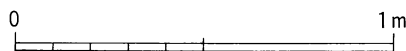

- 1. 茶褐色 シルト質極細砂

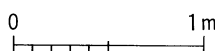

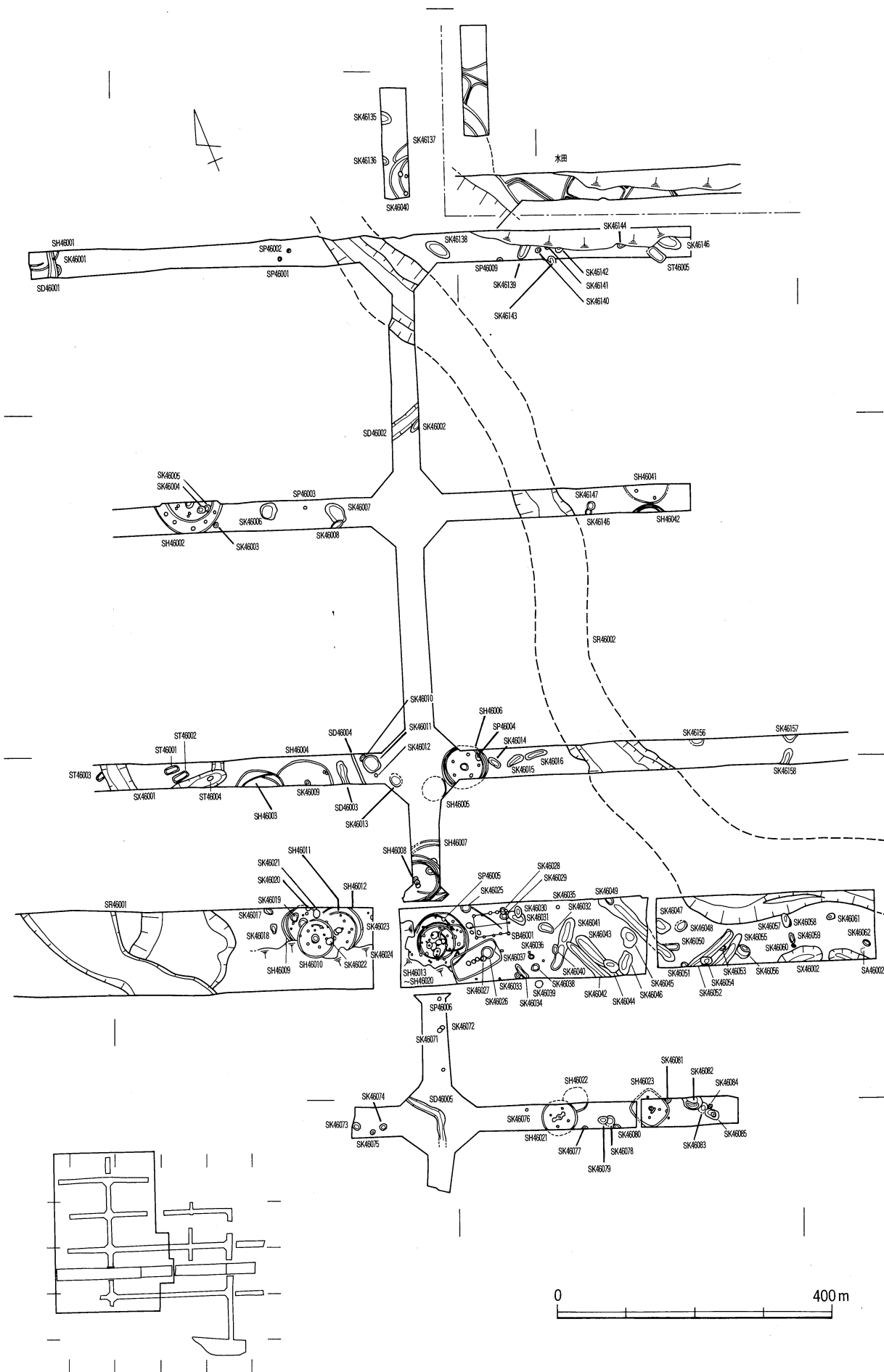

弥生時代中期上層全体図 (西半)

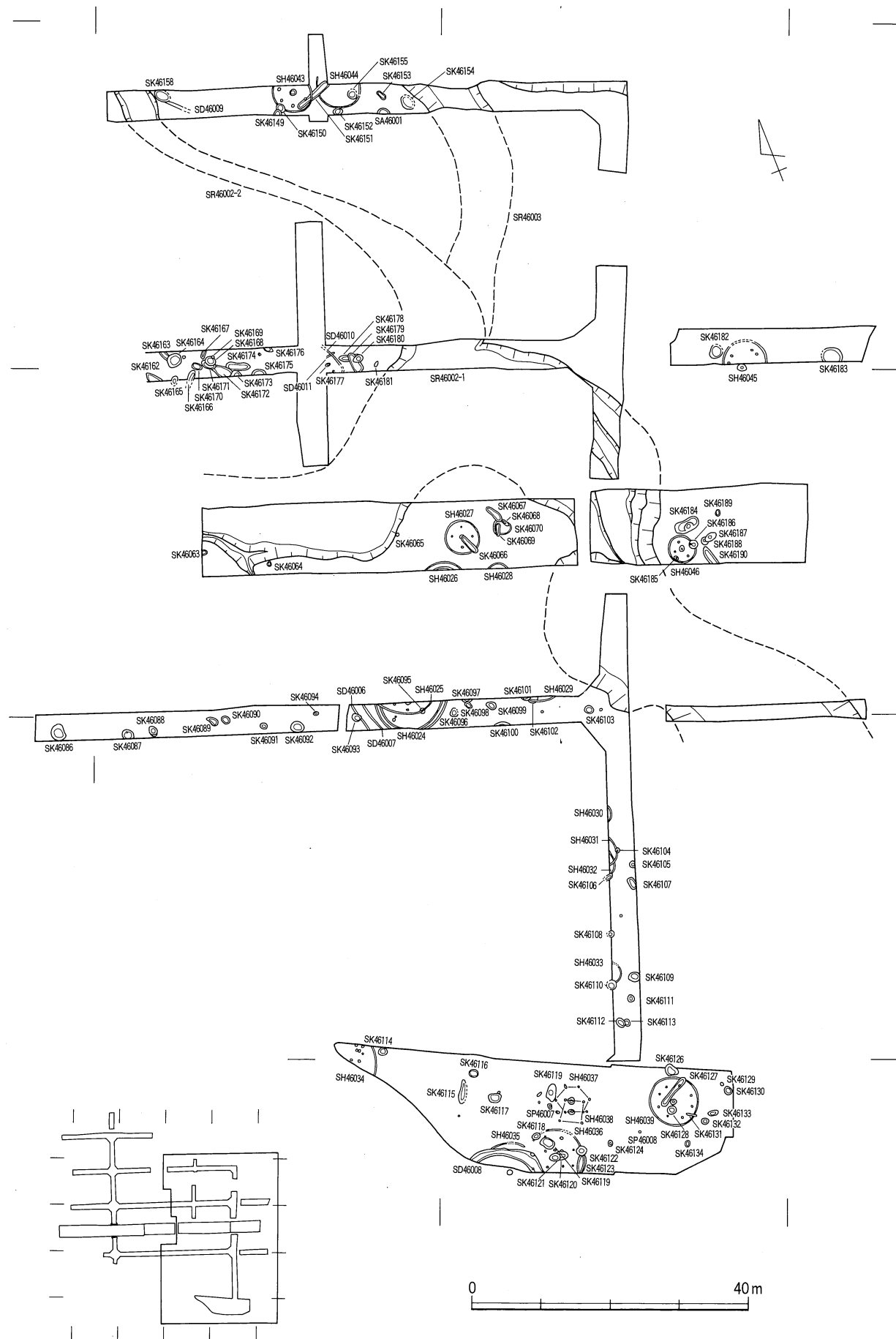

弥生時代中期上層全体図（東半）

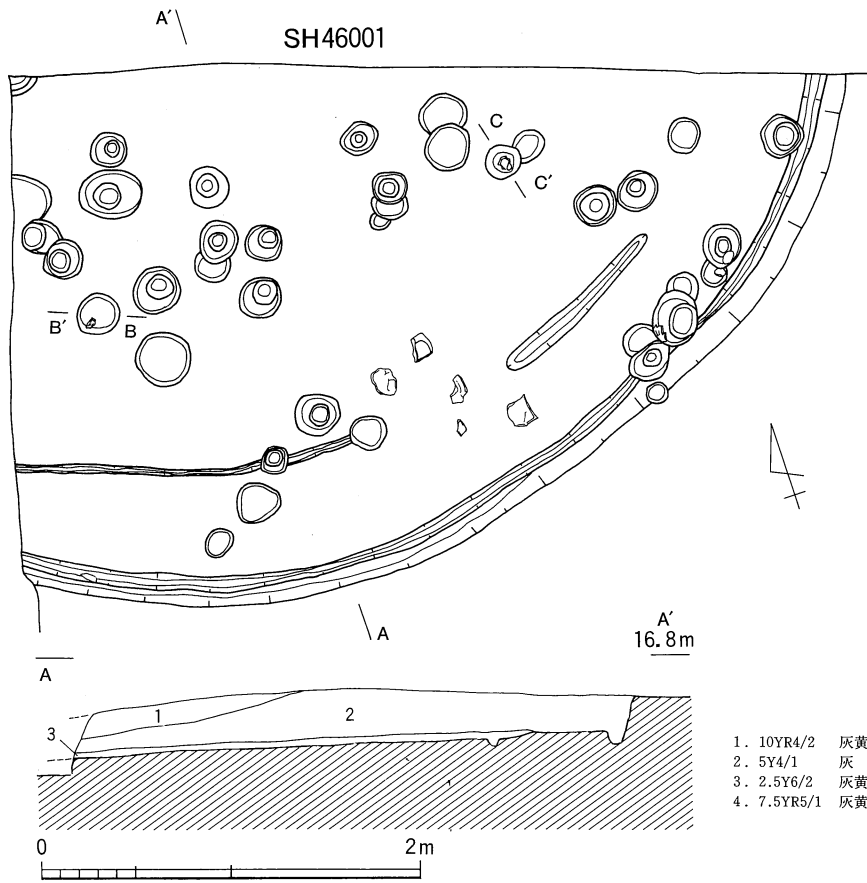

- 1. 10YR4/2 灰黄褐 砂質シルト
- 2. 5Y4/1 灰 砂質シルト
- 3. 2.5Y6/2 灰黄 シルト質細砂
- 4. 7.5YR5/1 灰黄 シルト質細砂

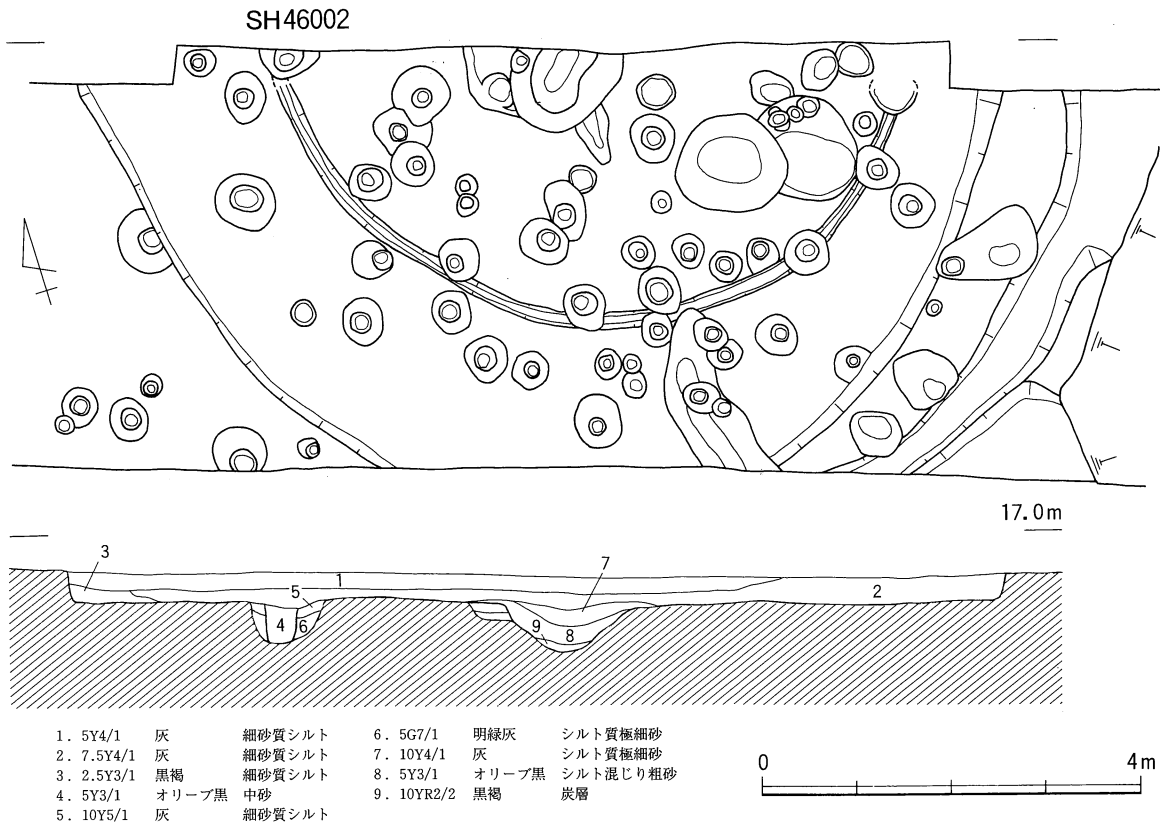

- 1. 5Y4/1 灰 細砂質シルト
- 2. 7.5Y4/1 灰 細砂質シルト
- 3. 2.5Y3/1 黒褐 細砂質シルト
- 4. 5Y3/1 オリーブ黒 中砂
- 5. 10Y5/1 灰 細砂質シルト
- 6. 5G7/1 明緑灰 シルト質極細砂
- 7. 10Y4/1 灰 シルト質極細砂
- 8. 5Y3/1 オリーブ黒 シルト混じり粗砂
- 9. 10YR2/2 黒褐 炭層

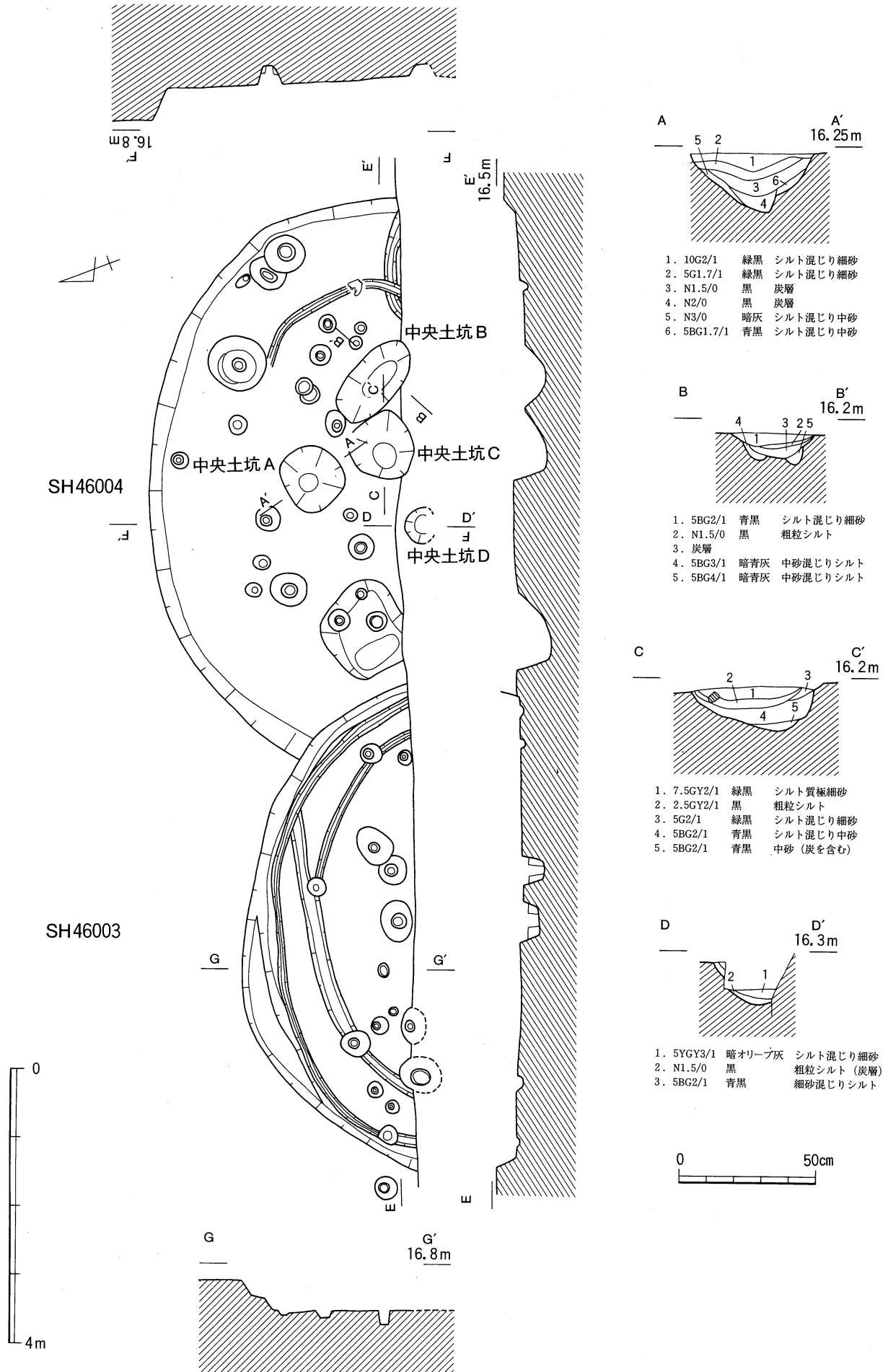

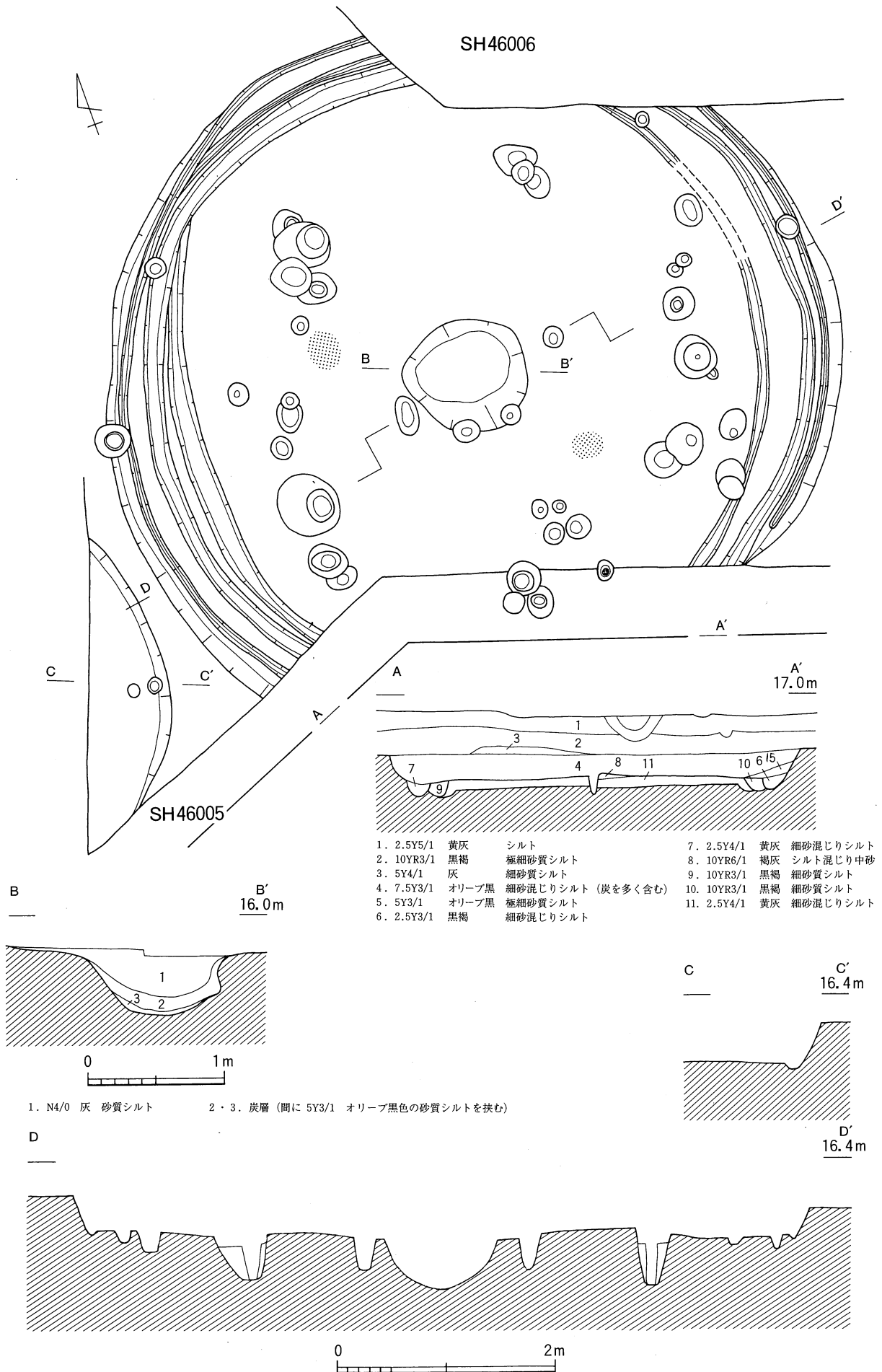

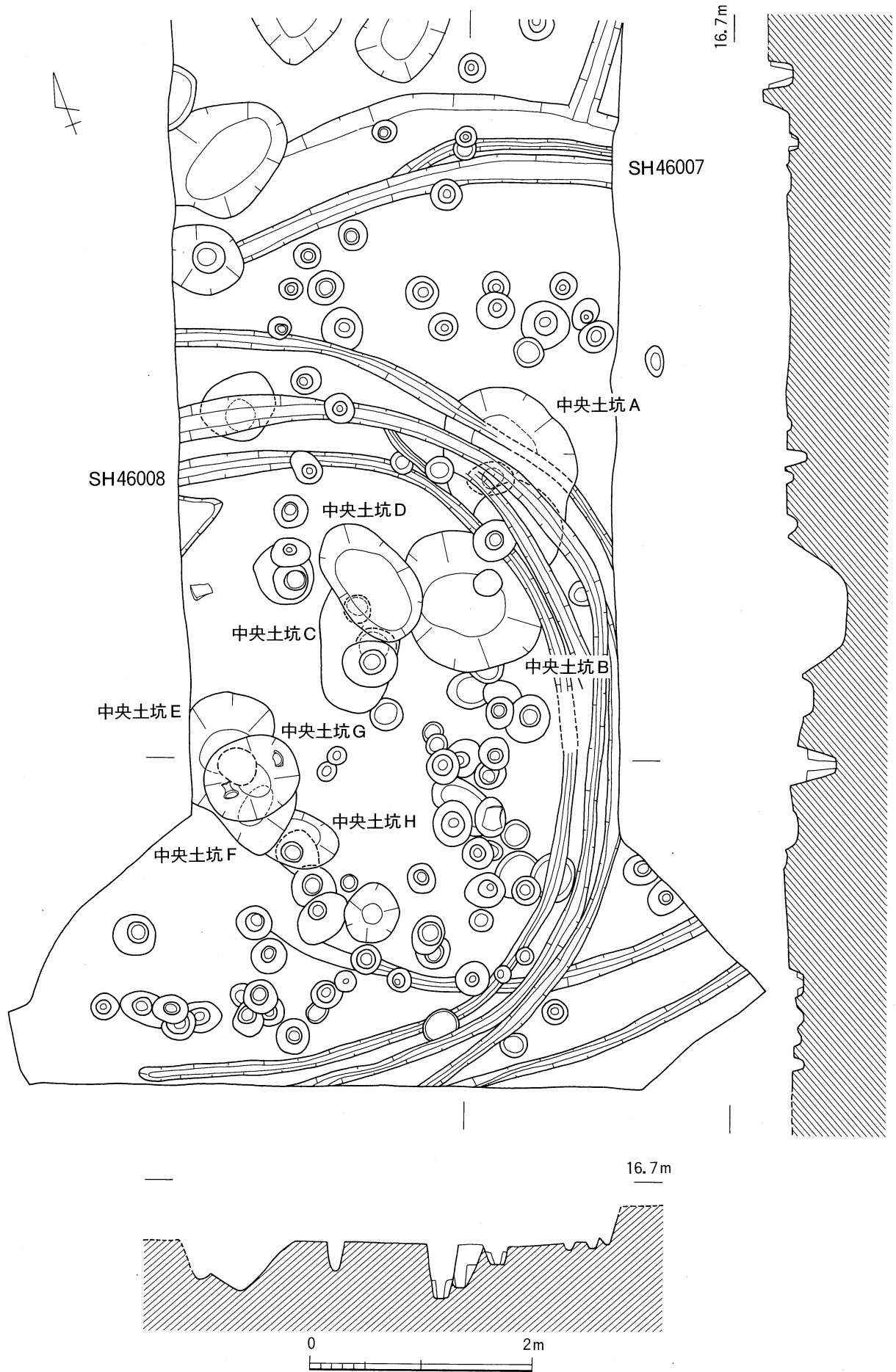

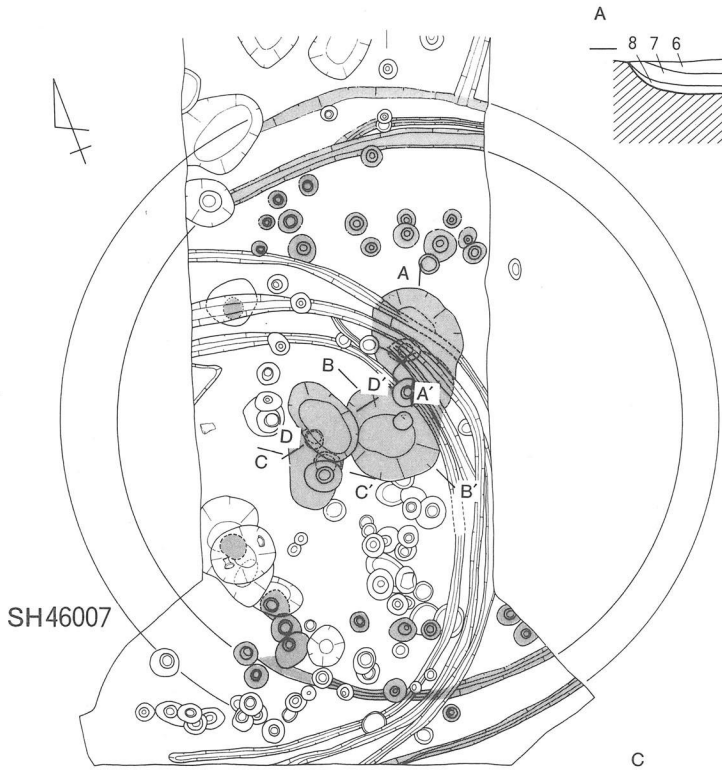

SH46007

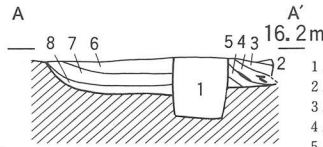

- | | | | |
|----|----------|------|-----------------|
| 1. | N3/0 | 暗灰 | 細砂 (柱穴埋土) |
| 2. | N2/0 | 黒 | 細砂混じりシルト (炭層) |
| 3. | 7.5GY4/1 | 暗緑灰 | 極細砂 |
| 4. | N1.5/0 | 黒 | 極細砂質シルト |
| 5. | 2.5GY5/1 | オリブ灰 | 細砂 (炭を多く含む) |
| 6. | 10Y4/1 | 灰 | シルト質極細砂 |
| 7. | 7.5Y4/1 | 灰 | シルト質極細砂 (炭を含む) |
| 8. | 7.5Y5/1 | 灰 | シルト混じり細砂 (炭を含む) |

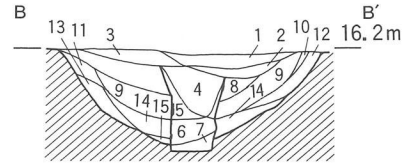

- | | | | |
|-----|------------|-------|--------------------|
| 1. | 2.5YR1.7/1 | 赤黒 | シルト質極細砂 |
| 2. | 5Y2/2 | オリブ黒 | シルト質極細砂 |
| 3. | 2.5Y2/1 | 黒 | シルト質極細砂 |
| 4. | 5Y7/3 | 浅黄 | 細砂 |
| 5. | N3/0 | 暗灰 | 極細砂質シルト |
| 6. | N2/0 | 黒 | シルト混じり細砂 |
| 7. | 5GY7/1 | 明オリブ灰 | 細砂 |
| 8. | N3/0 | 暗灰 | シルト質極細砂 |
| 9. | N2/0 | 黒 | シルト質極細砂 |
| 10. | 中砂 | | |
| 11. | 2.5Y2/1 | 黒 | シルト質極細砂 |
| 12. | 5G3/1 | 暗緑灰 | シルト質極細砂 (炭と白色砂の互層) |
| 13. | 5G2/1 | 緑黒 | 極細砂質シルト (炭と白色砂の互層) |
| 14. | N1.5/0 | 黒 | 粗粒シルト (炭層) |
| 15. | 5G2/1 | 緑黒 | シルト混じり細砂 (炭層) |

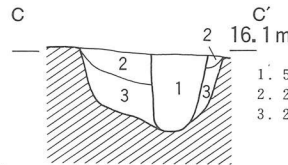

- | | | | |
|----|----------|-------|---------|
| 1. | 5BG3/1 | 暗青灰 | シルト質極細砂 |
| 2. | 2.5GY3/1 | 暗オリブ灰 | シルト質極細砂 |
| 3. | 2.5GY8/1 | 灰白 | 極細砂 |

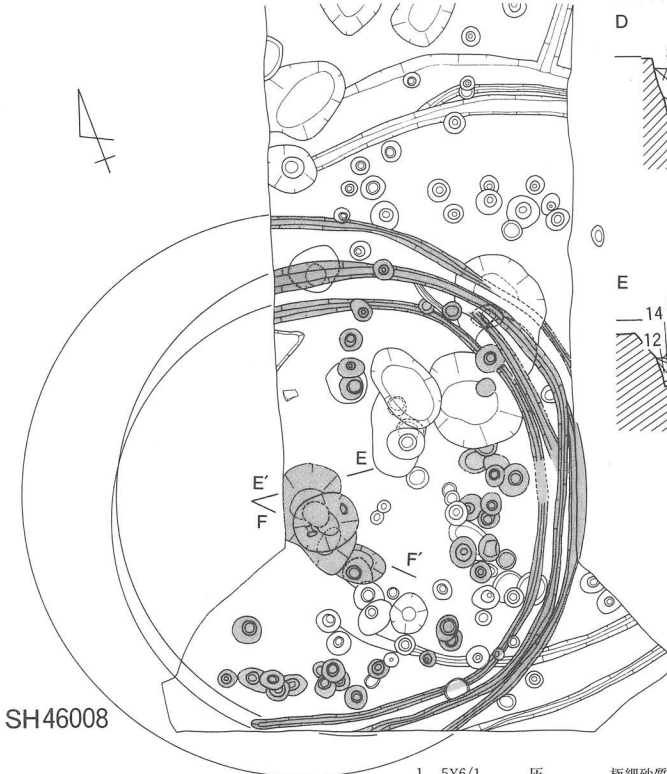

SH46008

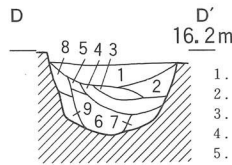

- | | | | |
|----|----------|----|---------------|
| 1. | 5B1.7/1 | 青黒 | シルト質極細砂 |
| 2. | 10G2/1 | 緑黒 | シルト質極細砂 |
| 3. | 小礫 | | |
| 4. | 5G2/1 | 緑黒 | 細砂~シルト質極細砂、小礫 |
| 5. | 2.5GY8/1 | 灰白 | 極細砂とシルトのラミナ |
| 6. | N1.5/0 | 黒 | 極細砂質シルト (炭層) |
| 7. | 小礫 | | |
| 8. | 小礫 | | |

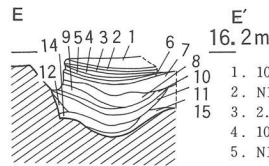

- | | | | |
|-----|------------|-------|------------|
| 1. | 10YR3/1 | 黒褐 | 極細砂 |
| 2. | N1.5/0 | 黒 | 極細砂 (炭層) |
| 3. | 2.5GY8/1 | 灰白 | 極細砂 |
| 4. | 10YR3/1 | 黒褐 | 極細砂 |
| 5. | N1.5/0 | 黒 | 極細砂 (炭層) |
| 6. | 2.5GY8/1 | 灰白 | 極細砂 |
| 7. | 10YR3/1 | 黒褐 | 極細砂 |
| 8. | 2.5GY2/1 | 黒 | 粗粒シルト (炭層) |
| 9. | 7.5YR1.7/1 | 黒 | 粗砂混じりシルト |
| 10. | 10G2/1 | 緑黒 | 極細砂質シルト |
| 11. | N1.5/0 | 黒 | 粗粒シルト (炭層) |
| 12. | 2.5GY7/1 | 明オリブ灰 | 細砂 |

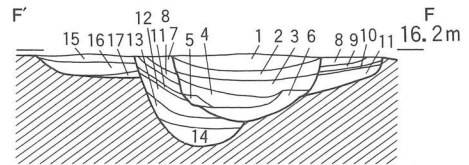

- | | | | |
|-----|------------|------|-----------------|
| 1. | 5Y6/1 | 灰 | 極細砂質シルト |
| 2. | 10YR1.7/1 | 黒 | シルト質極細砂 |
| 3. | 2.5YR1.7/1 | 赤黒 | シルト質極細砂 |
| 4. | 5Y2/1 | 黒 | シルト質極細砂 |
| 5. | 5Y2/2 | オリブ黒 | シルト質極細砂 |
| 6. | N1.5/0 | 黒 | 粗粒シルト (炭層) |
| 7. | 2.5YR1.7/1 | 赤黒 | シルト質極細砂 |
| 8. | N1.5/0 | 黒 | 極細砂質シルト (炭層) |
| 9. | 5YR3/1 | 黒褐 | シルト質極細砂 (下面に炭層) |
| 10. | 2.5GY8/1 | 灰白 | 細砂 |
| 11. | N2/0 | 黒 | 極細砂質シルト |
| 12. | N4/0 | 灰 | シルト質極細砂 |
| 13. | N2/0 | 黒 | 極細砂質シルト |
| 14. | N1.5/0 | 黒 | 粗粒シルト (炭層) |
| 15. | N2/0 | 黒 | 極細砂質シルト (炭層) |
| 16. | 10Y4/1 | 灰 | シルト質極細砂 |

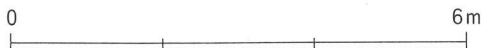

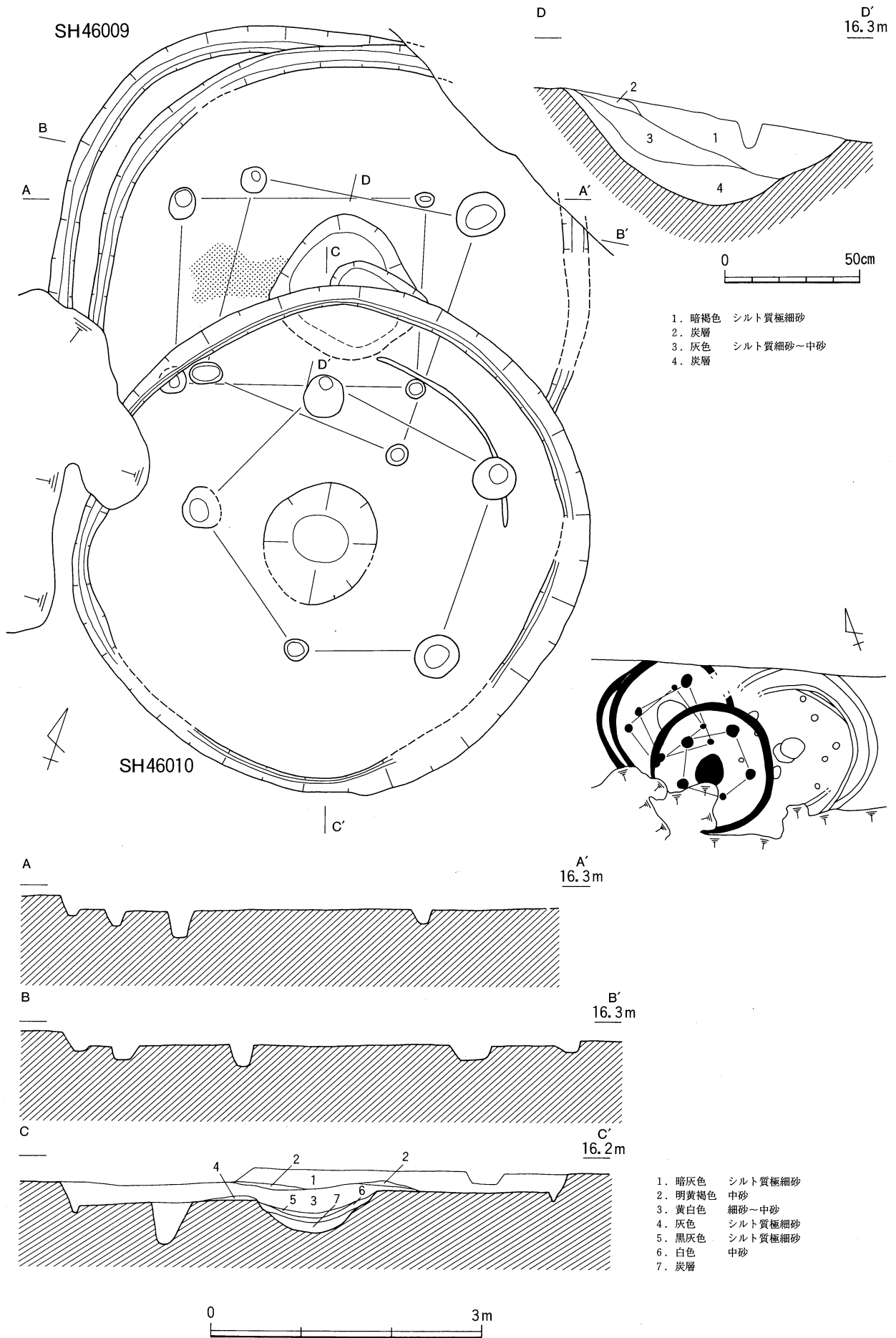

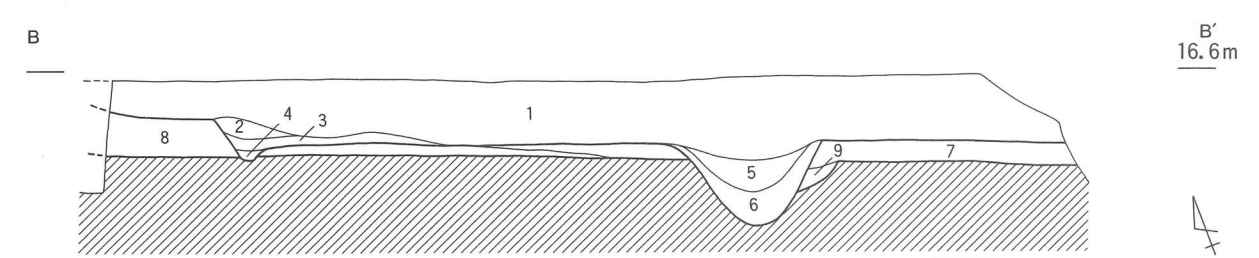
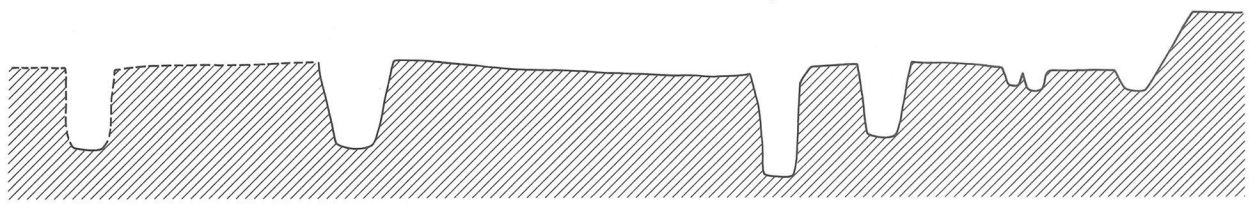
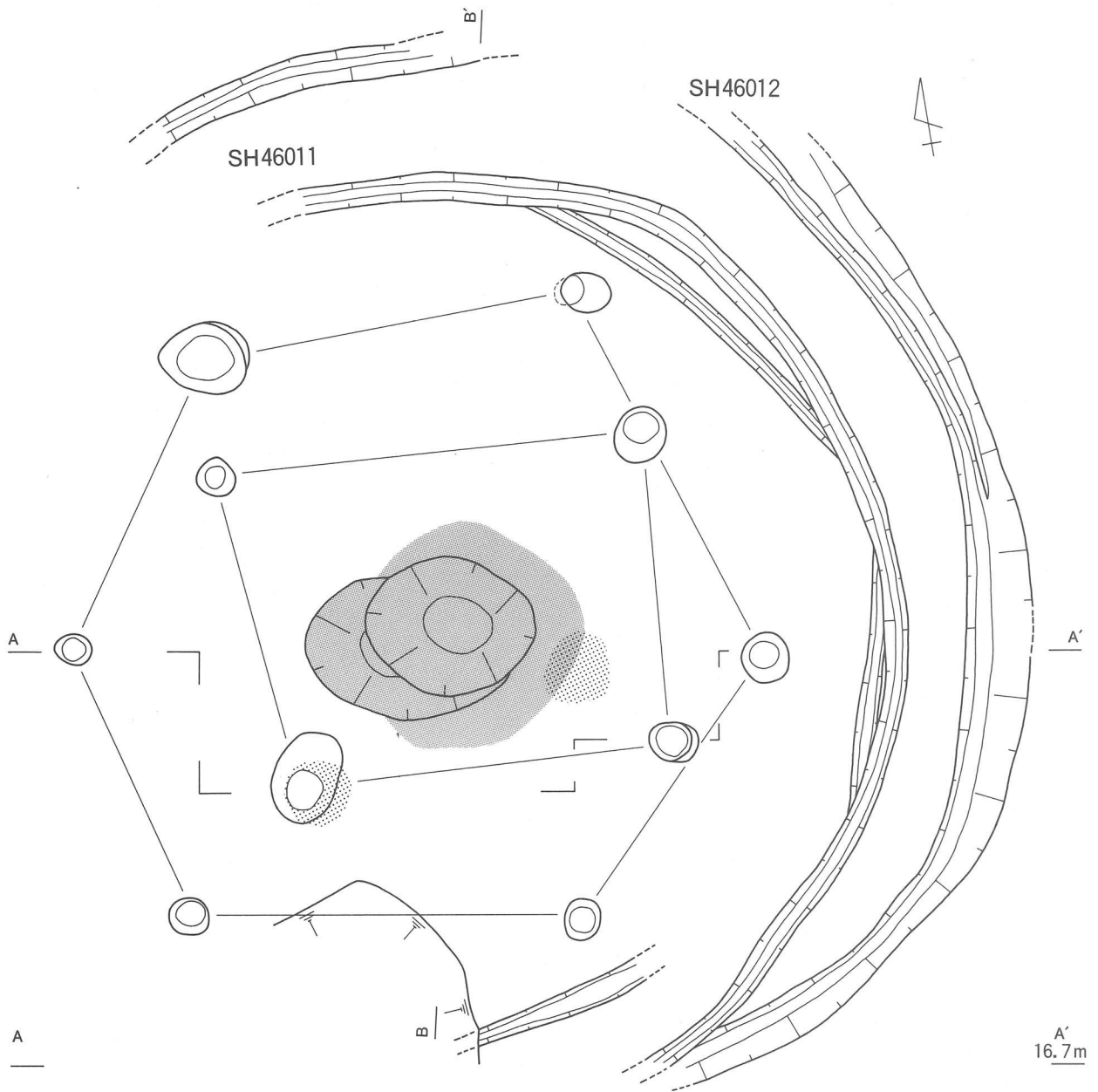

SH46011埋土

- | | |
|--------|-------------------|
| 1. 黒褐色 | 極細砂 |
| 2. 暗褐色 | シルト質極細砂 (上面に薄い炭層) |
| 3. 暗褐色 | 極細砂 |
| 4. 黒灰色 | 極細砂 |
| 5. 暗灰色 | 極細砂 |
| 6. 炭層 | |
| | SH46012埋土 |
| 7. 暗灰色 | 極細砂 |
| 8. 黒褐色 | シルト質極細砂 |
| 9. 暗褐色 | 極細砂 (炭を多く含む) |



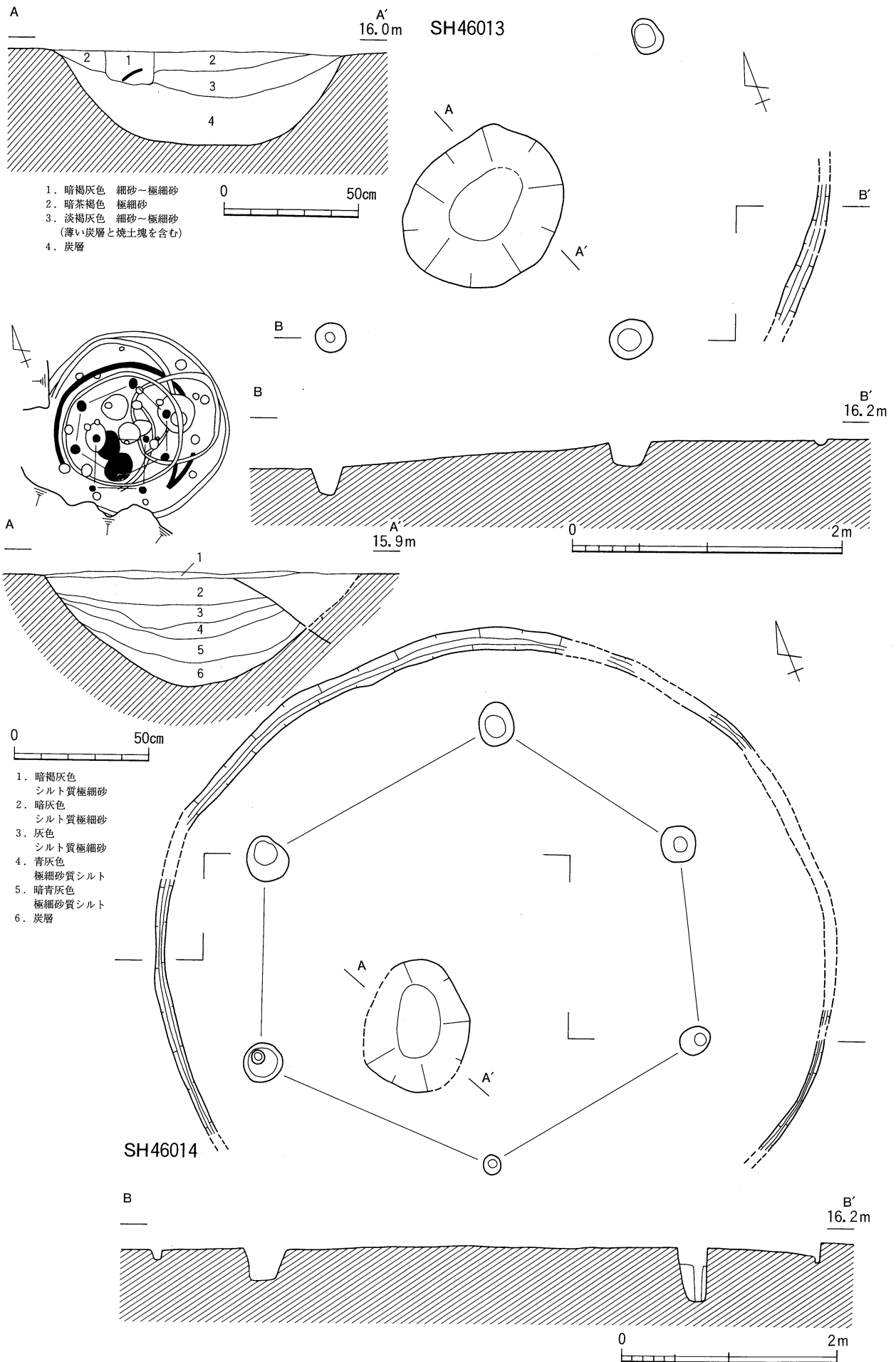

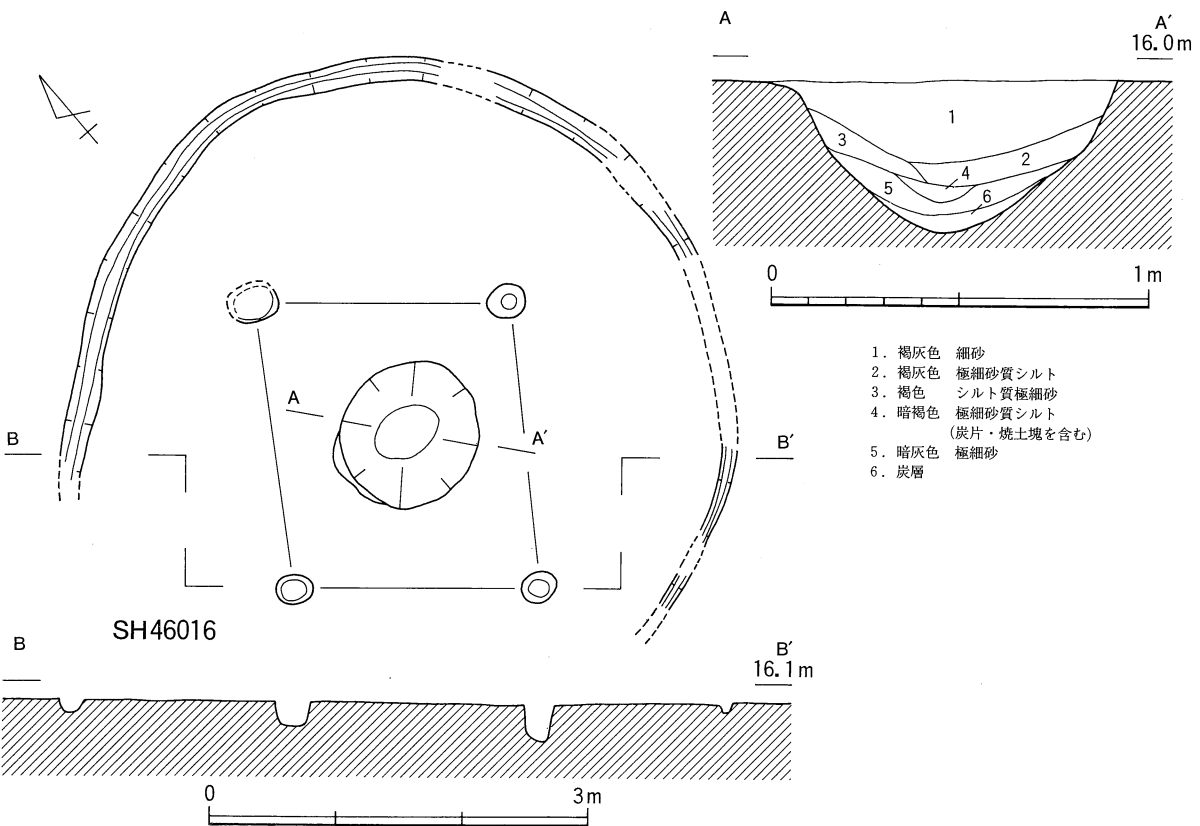
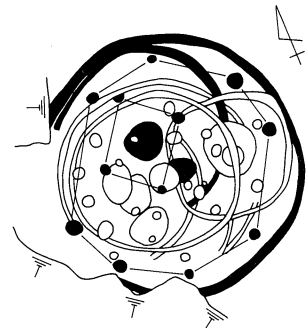
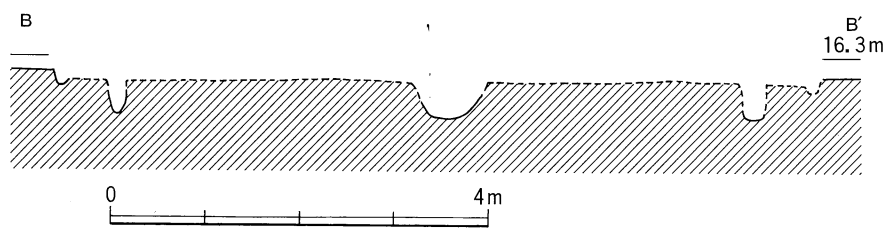
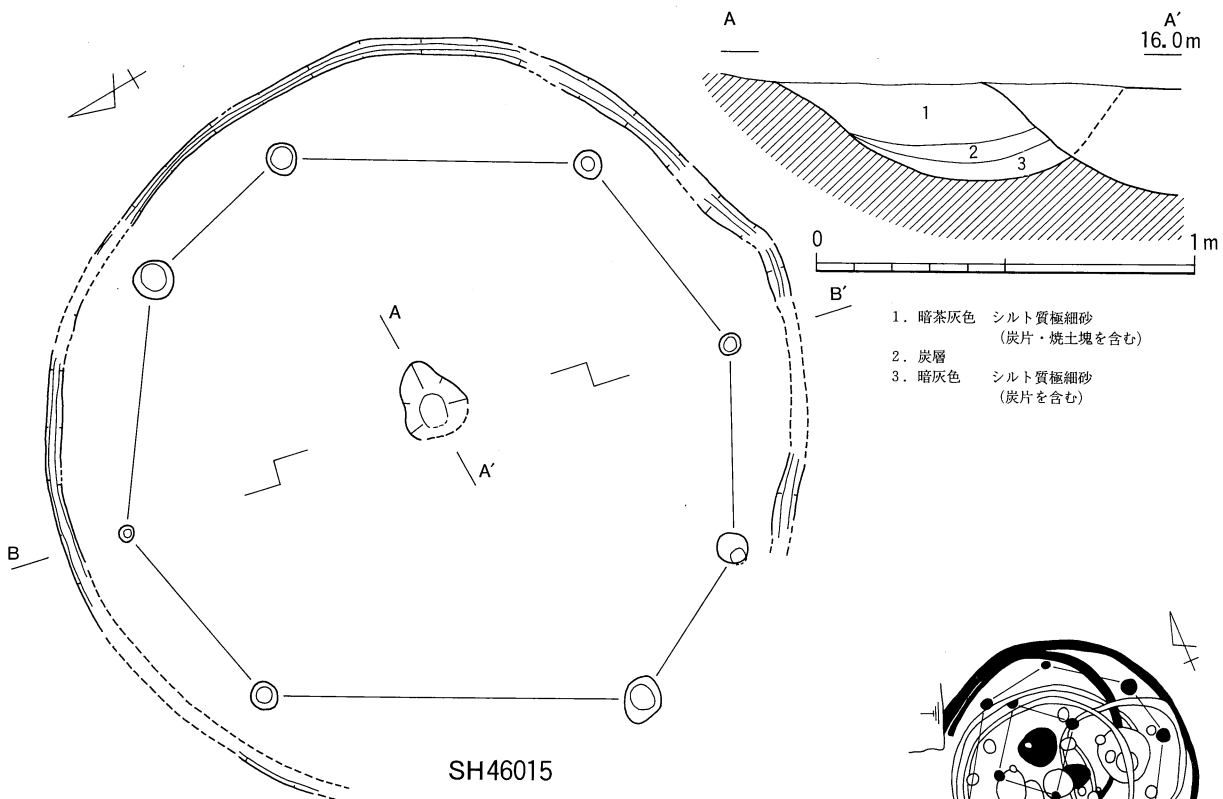

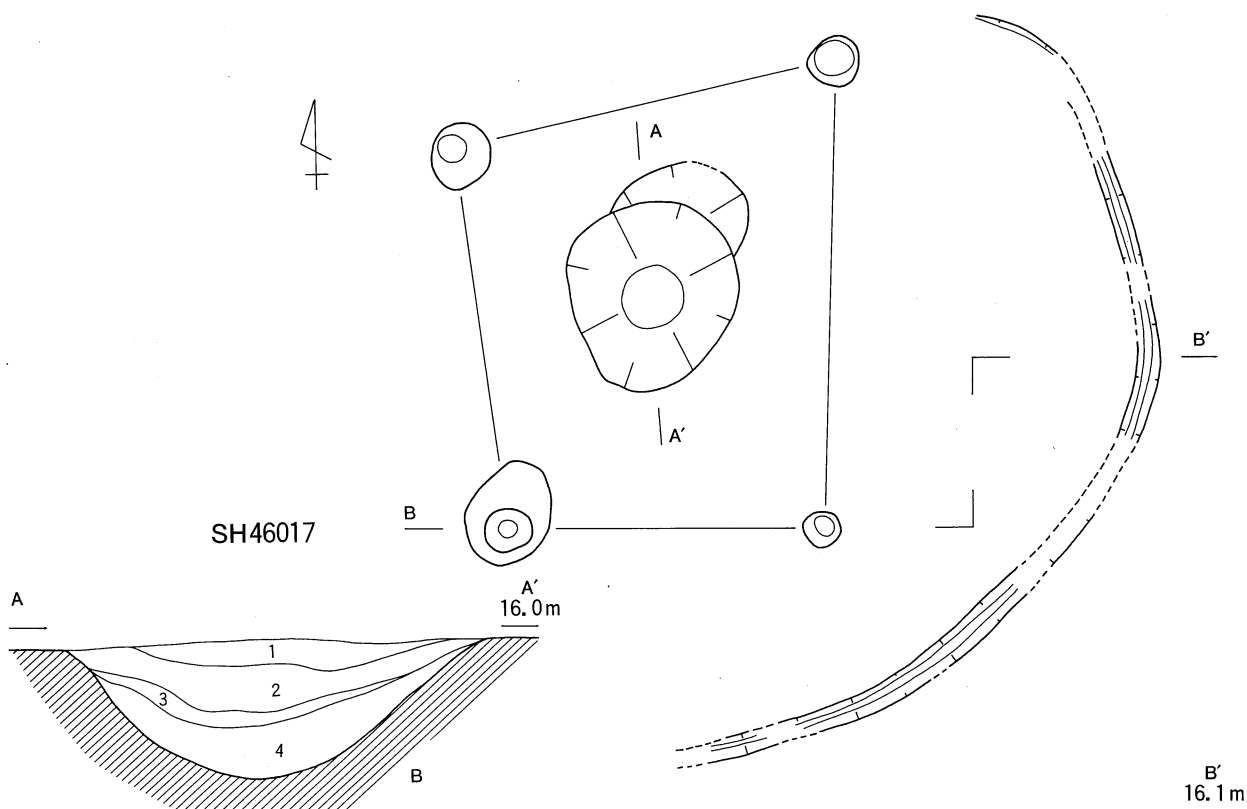

SH46017

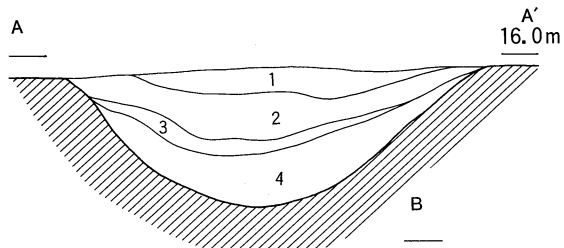

- 1. 灰褐色 シルト質極細砂
- 2. 黒灰色 シルト質極細砂
- 3. 黄褐色 細砂混じりシルト
- 4. 炭層

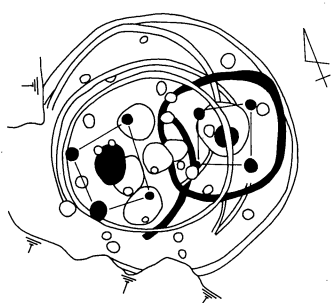
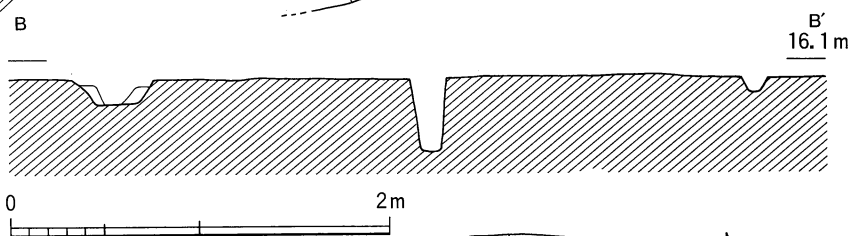

SH46018

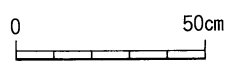
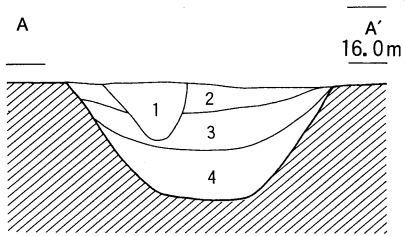
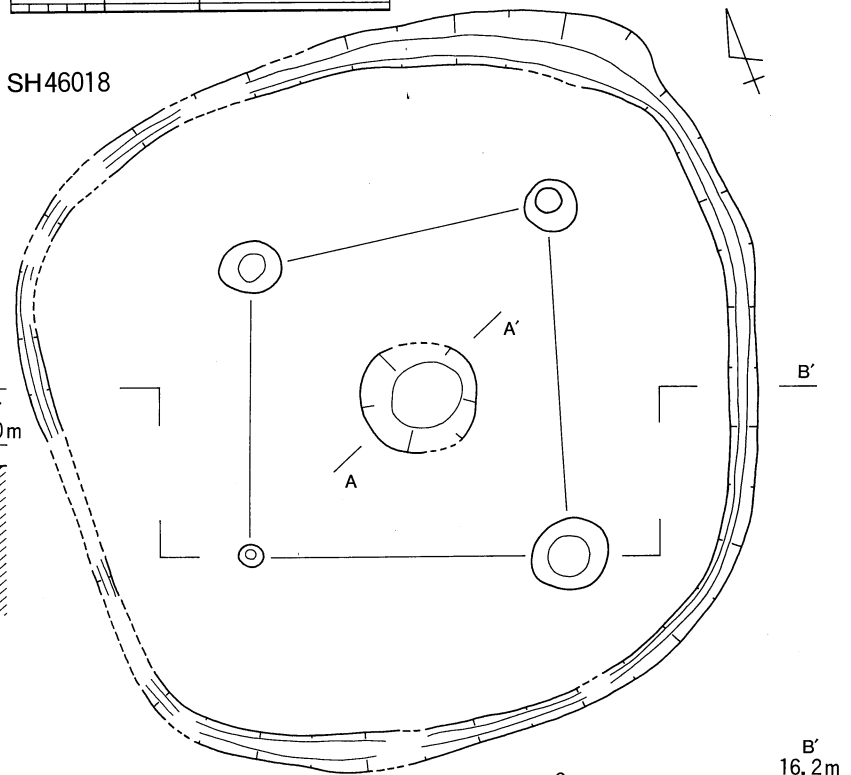

- 1. 暗灰色 シルト質極細砂 (SH46020周壁溝埋土)
- 2. 濁灰色 シルト質極細砂
- 3. 濁灰色 中砂混じり細砂 (上面に薄い炭層あり)
- 4. 炭層

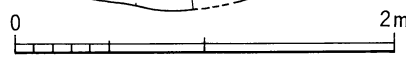
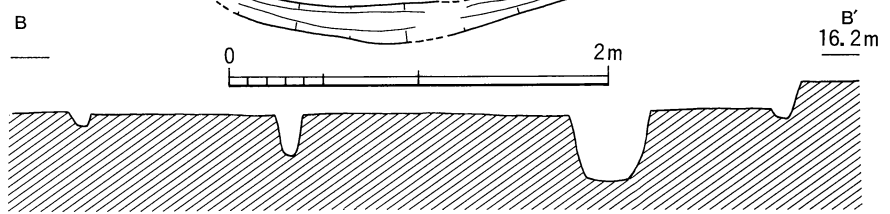

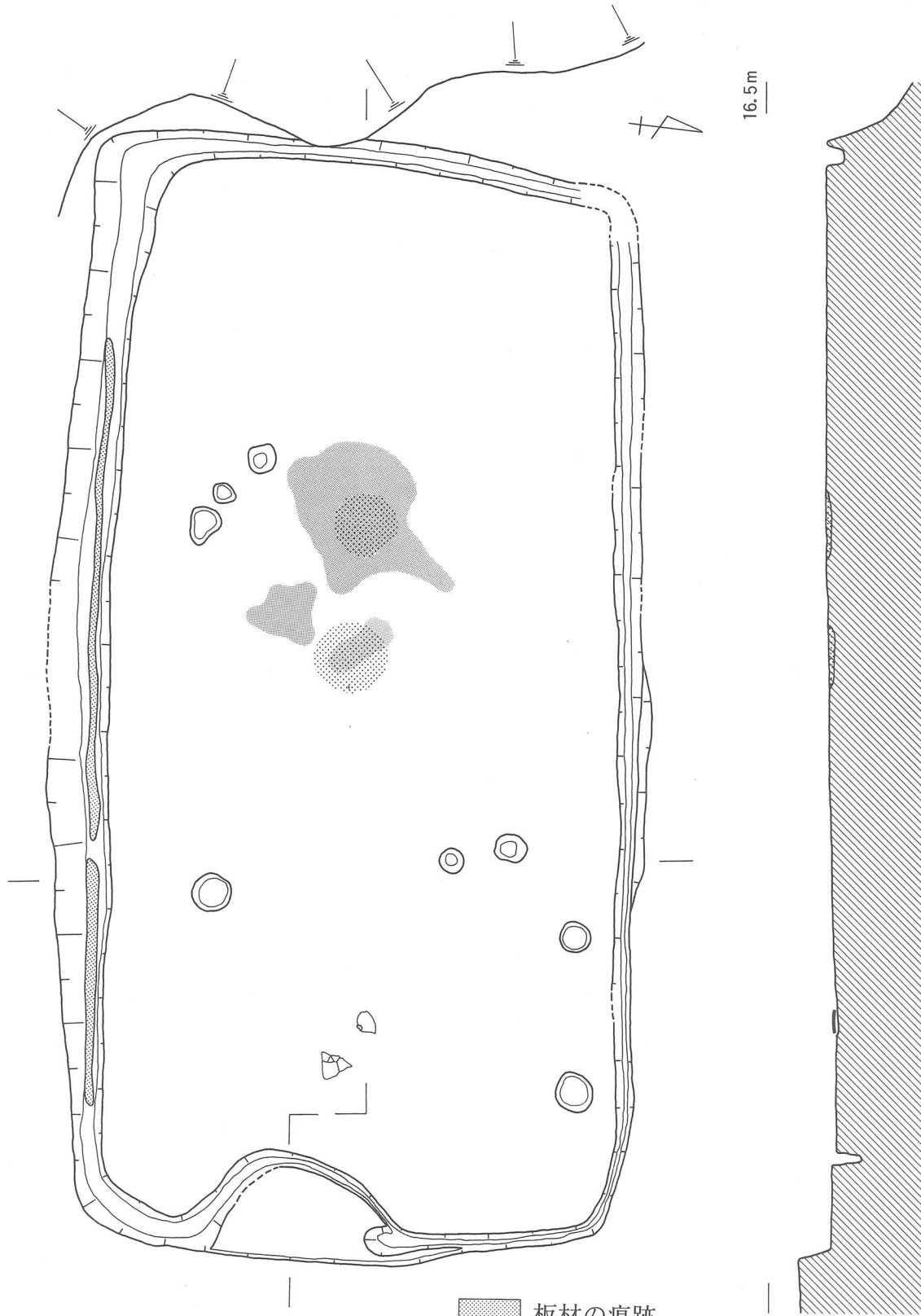

板材の痕跡

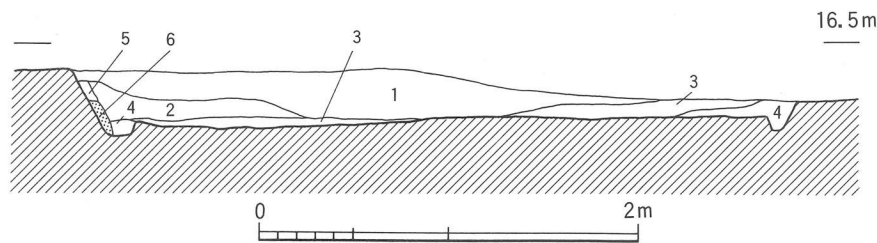

- 1. 灰褐色 極細砂
- 2. 黒褐色 極細砂
- 3. 灰白色 細砂
- 4. 黄灰色 シルト質極細砂
- 5. 黒褐色 極細砂
- 6. 黒灰色 シルト質極細砂 (板材の痕跡)

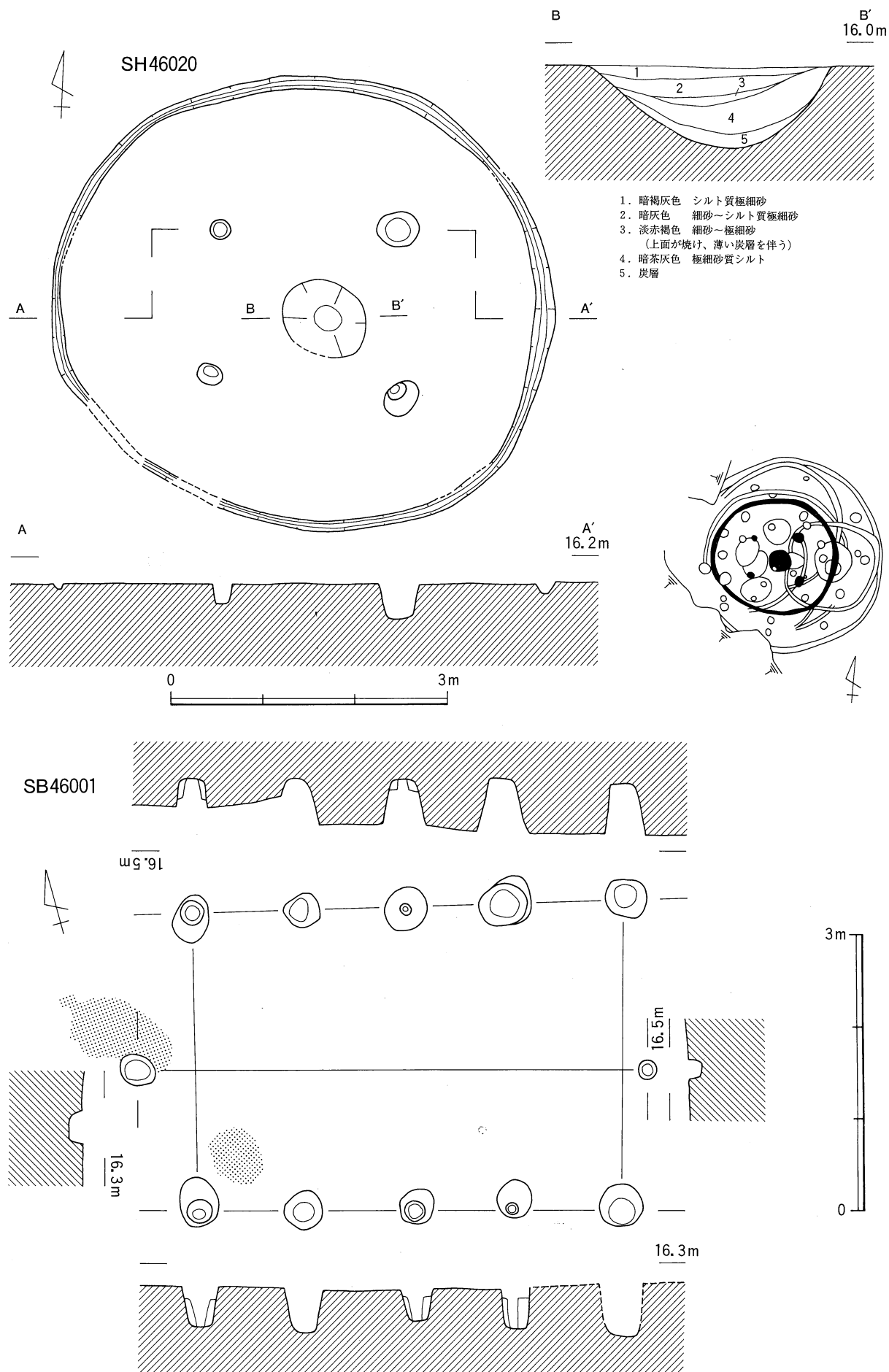

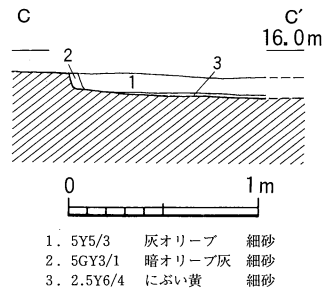
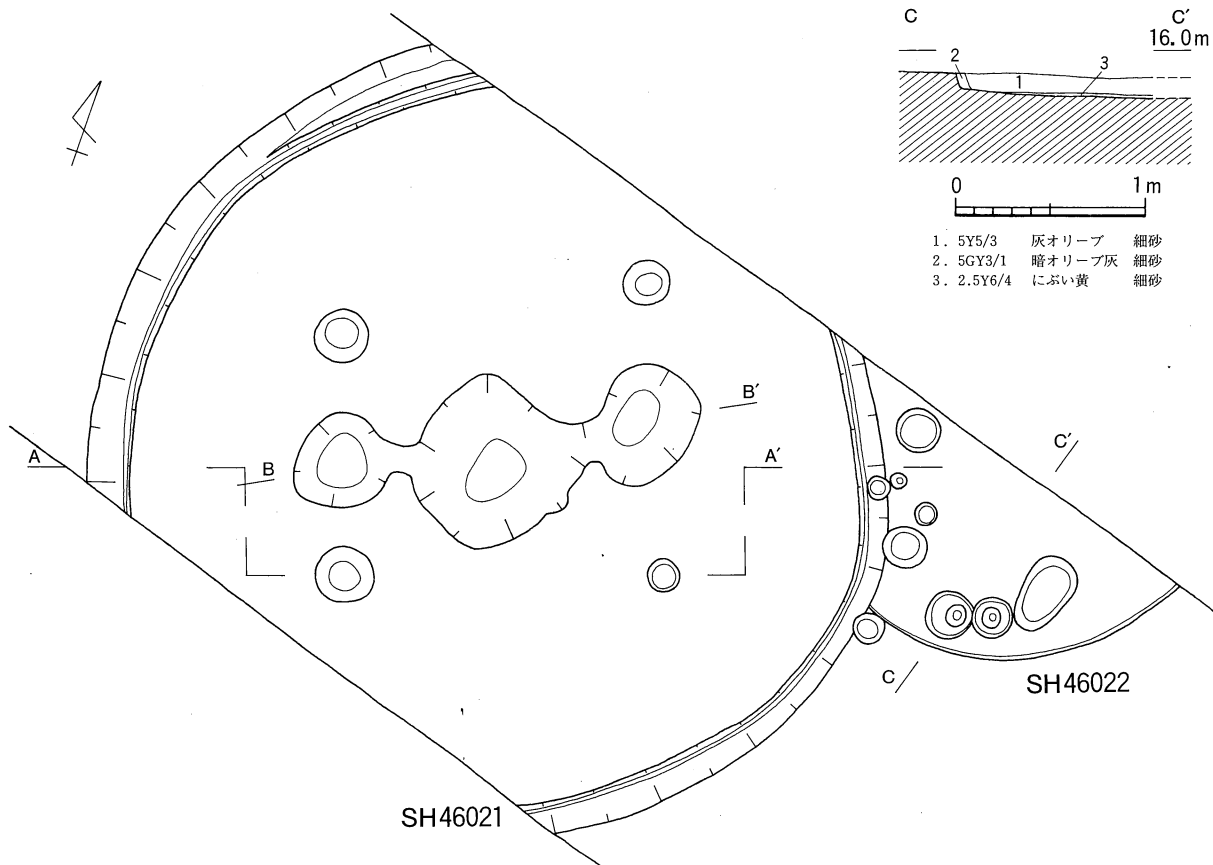

- 1. 5Y5/3 灰オリーブ 細砂
- 2. 5GY3/1 暗オリーブ灰 細砂
- 3. 2.5Y6/4 にぶい黄 細砂

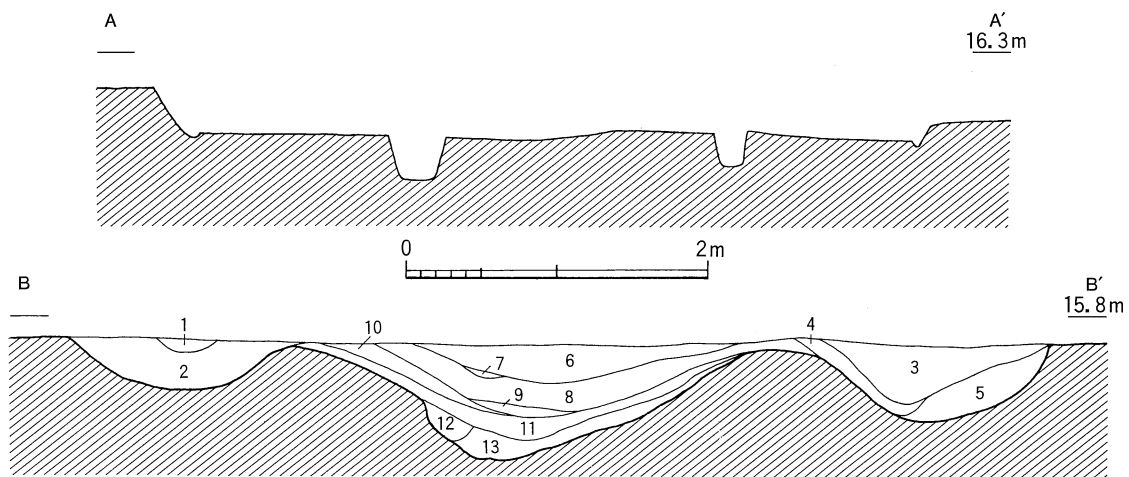

- | | |
|-------------------------|------------------------|
| 1. 7.5Y5/2 灰オリーブ 細砂~極細砂 | 6. 5Y7/3 浅黄 砂質シルト |
| 2. 7.5Y6/2 灰オリーブ 極細砂 | 7. 7.5Y7/2 灰白 砂質シルト |
| 3. 10Y7/2 灰白 極細砂 | 8. 5Y3/1 オリーブ黒 極細砂質シルト |
| 4. 5Y4/1 灰 砂質シルト | 9. 5GY5/1 オリーブ灰 細砂~中砂 |
| 5. 5Y6/2 灰オリーブ 細砂~極細砂 | 10. 5Y2/1 黒 シルト |
| | 11. 炭層 |
| | 12. 5GY7/1 明オリーブ灰 極細砂 |
| | 13. 5GY6/1 オリーブ灰 細砂~中砂 |

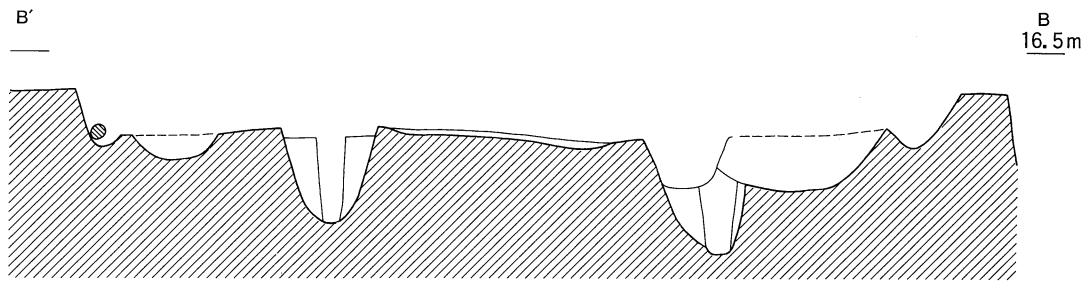
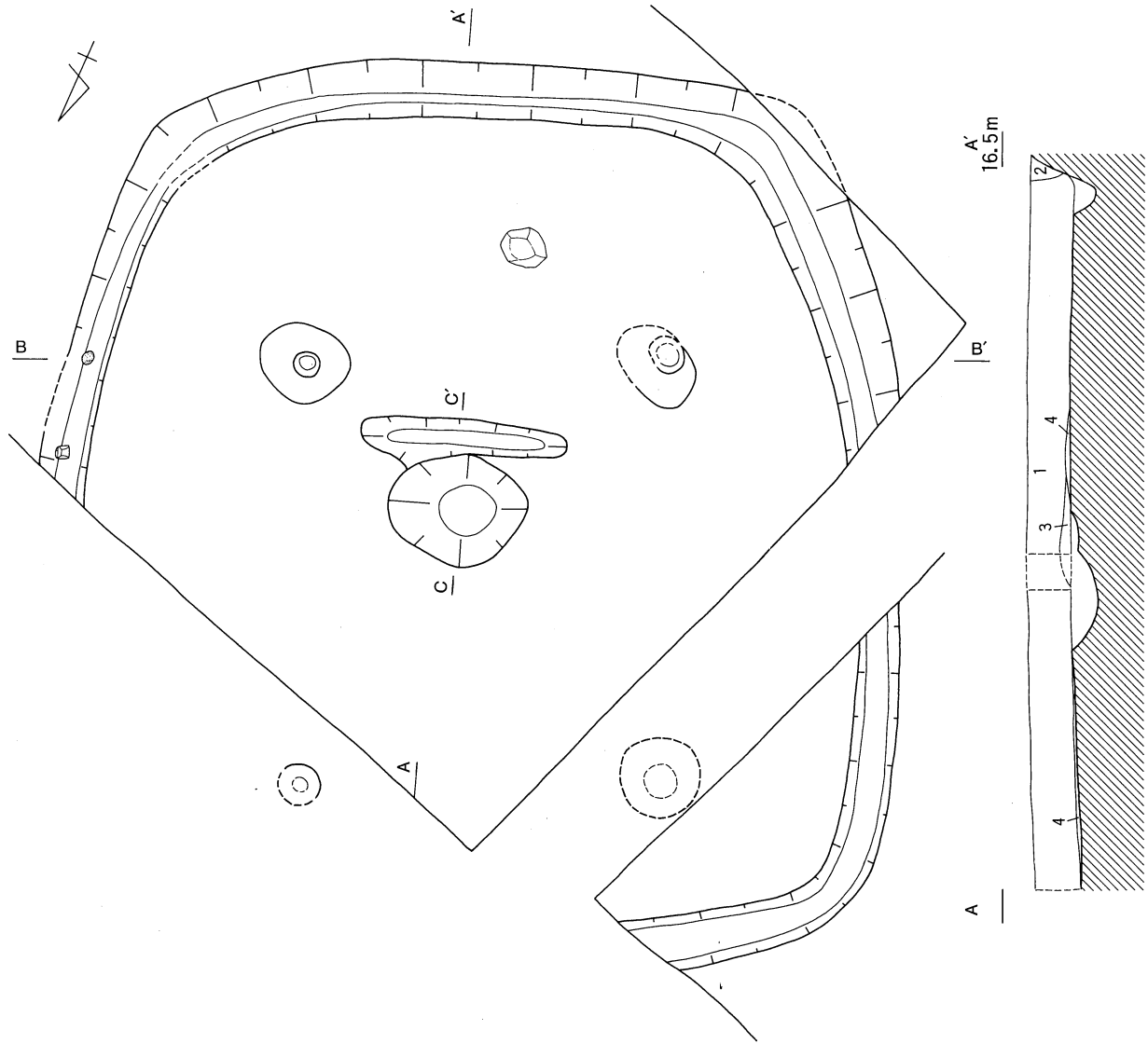

- | | |
|--------------------|-----------------------------|
| 1. 10YR4/2 灰黄褐 極細砂 | 3. 2.5Y5/2 暗灰黄 極細砂 |
| 2. 5Y4/1 灰 極細砂 | 4. 10YR4/2 灰黄褐 極細砂 (炭を多く含む) |

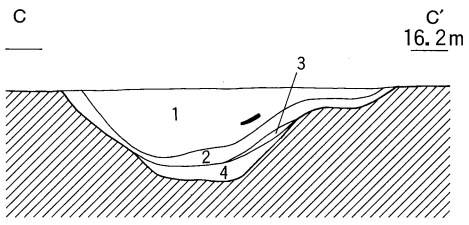
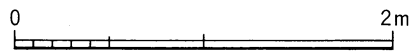

- | |
|---------------------------|
| 1. 10YR2/3 黒褐 極細砂~極粗砂 |
| 2. 10YR3/1 黒褐 極細砂 (炭層) |
| 3. 10YR5/1 褐灰 極細砂 |
| 4. 2.5Y4/1 黄灰 シルト質極細砂~シルト |

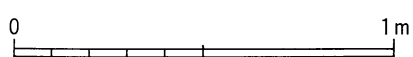

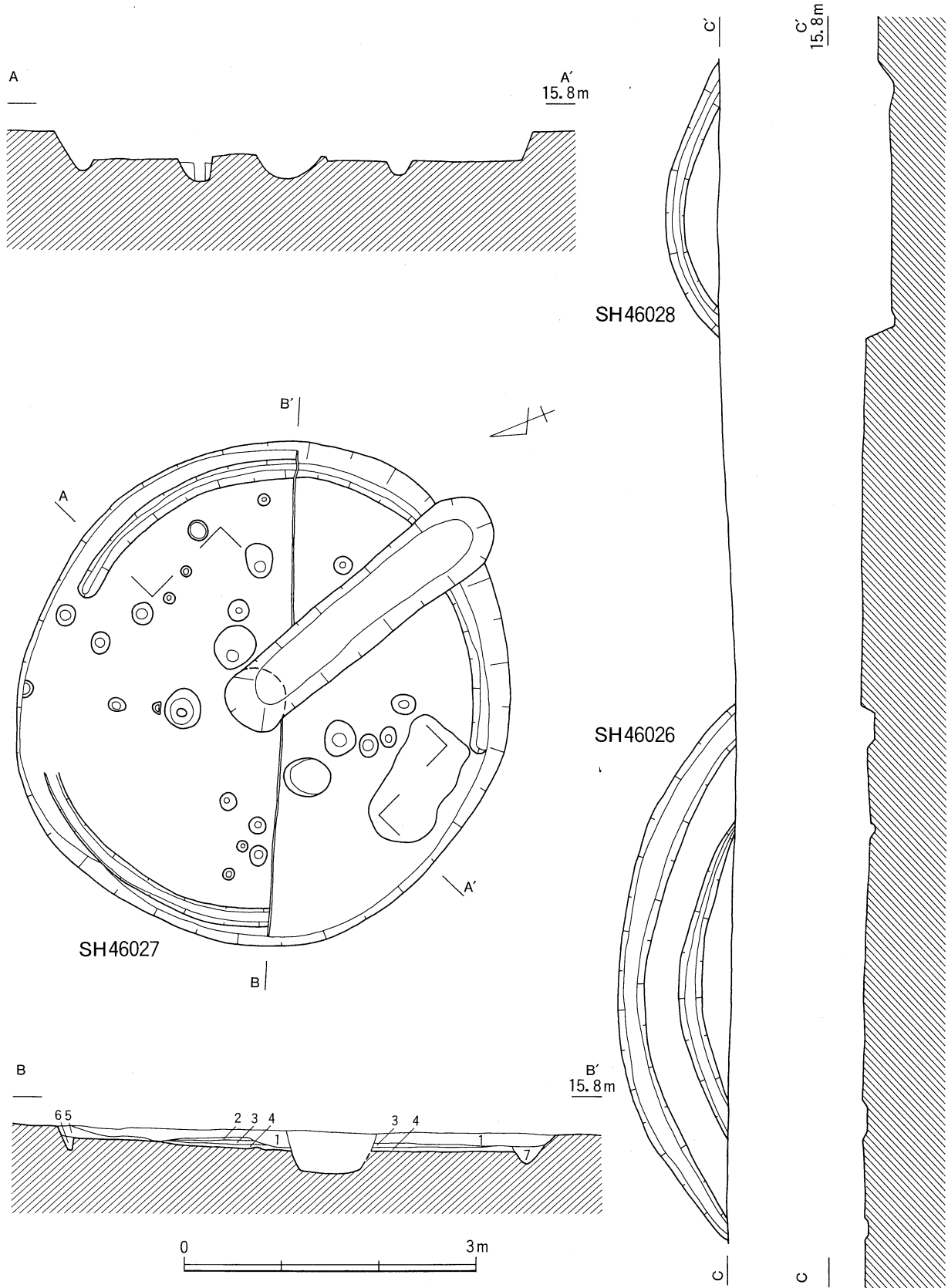

- | | | | |
|---------|-------------------------|---------|--------------------|
| 1. 暗灰色 | シルト質極細砂
(下面に薄い炭層) | 4. 淡黄灰色 | 中砂～細砂
(下面に薄い炭層) |
| 2. 暗褐灰色 | シルト質極細砂～細砂 | 5. 淡黄灰色 | 中砂～細砂 |
| 3. 淡黄灰色 | シルト質極細砂～中砂
(下面に薄い炭層) | 6. 灰色 | シルト混じり中砂～粗砂 |
| | | 7. 灰色 | 細礫 |

SH46029

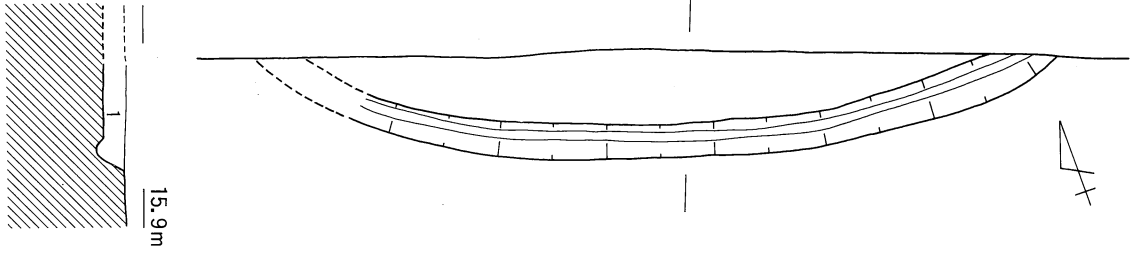

1. 10YR5/1 褐灰 シルト質極細砂

SH46030

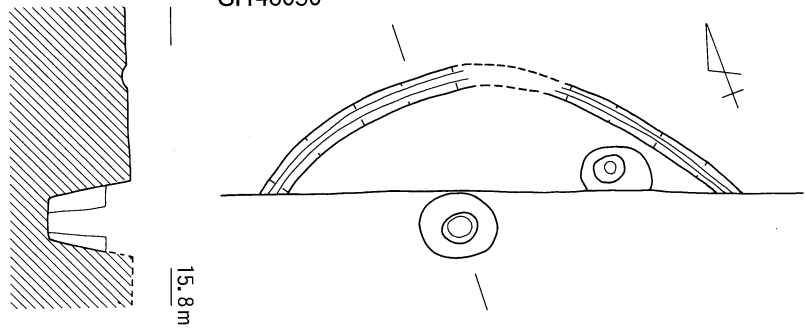

SH46031

SH46032

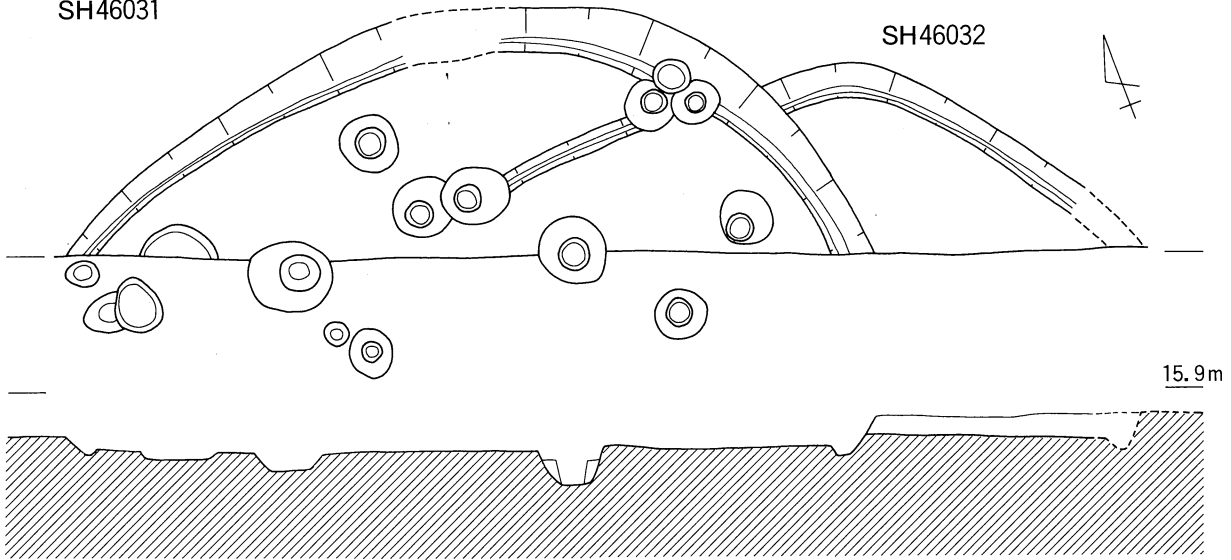

SH46033

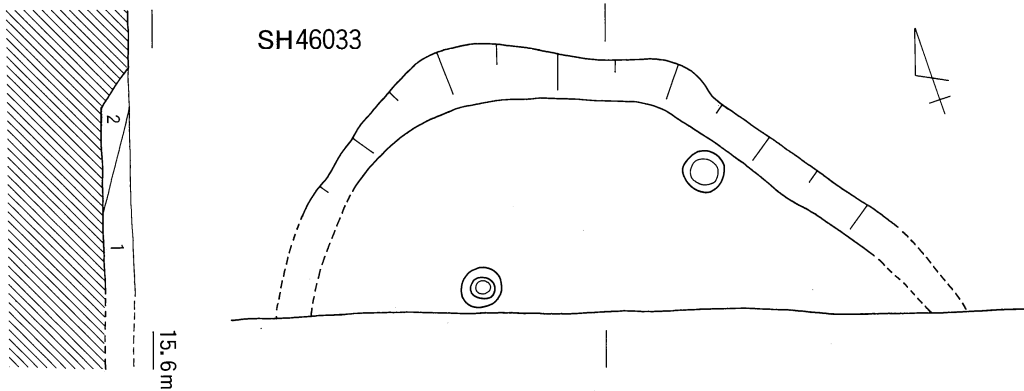

1. 2.5Y6/3 にぶい黄 シルト質極細砂
 2. 2.5Y4/2 暗灰黄 シルト

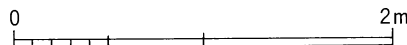

SH46034

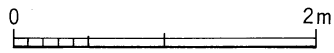

SH46035

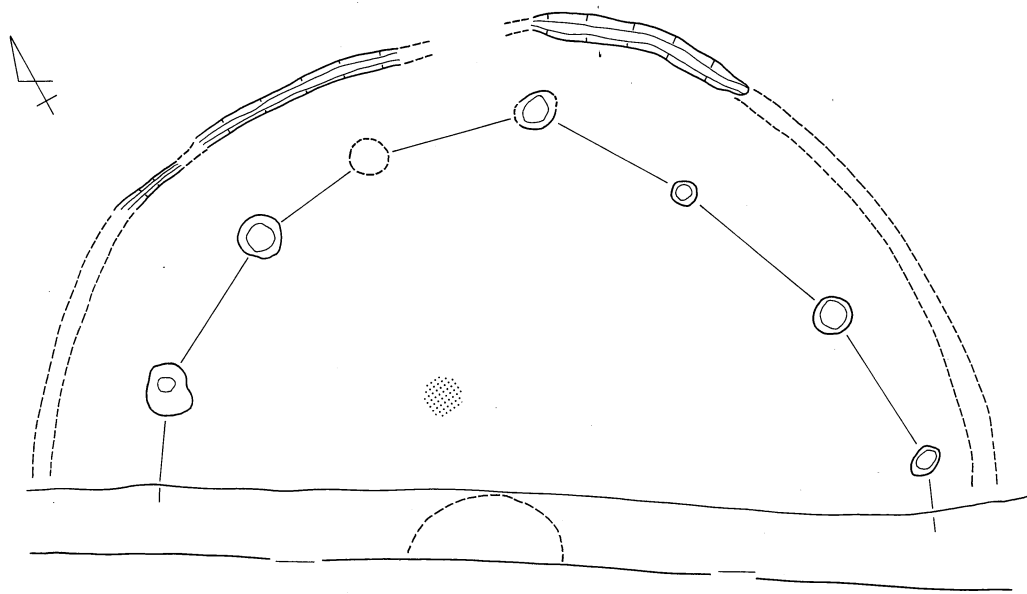

15.8m

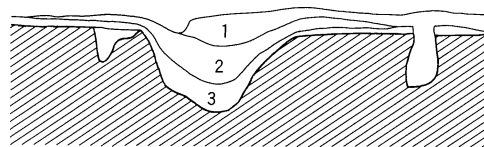

- 1. 暗灰色 シルト質極細砂
- 2. 暗灰色 シルト質極細砂
(粗粒シルトのブロックを含む)
- 3. 炭層



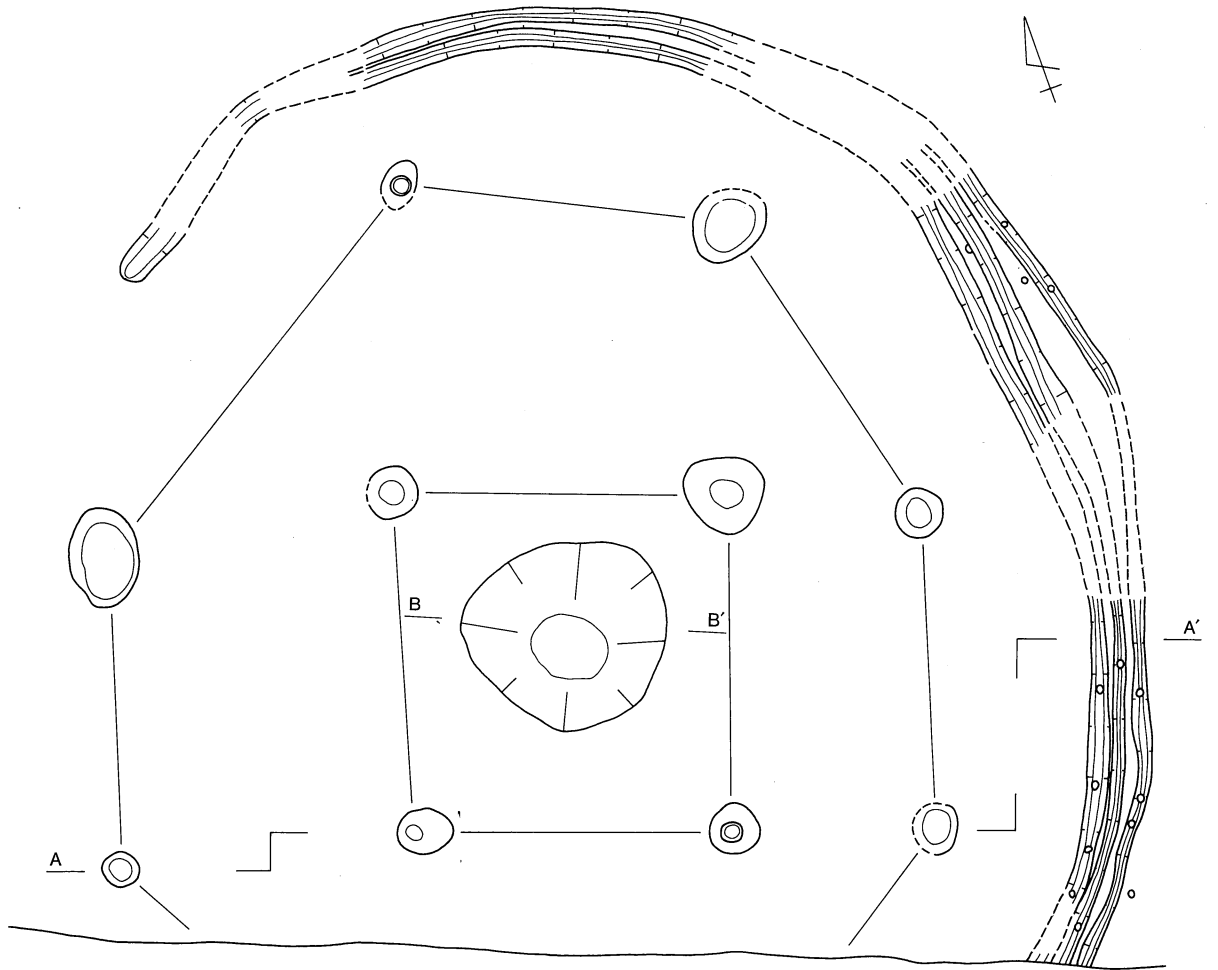

A A'
15.8m

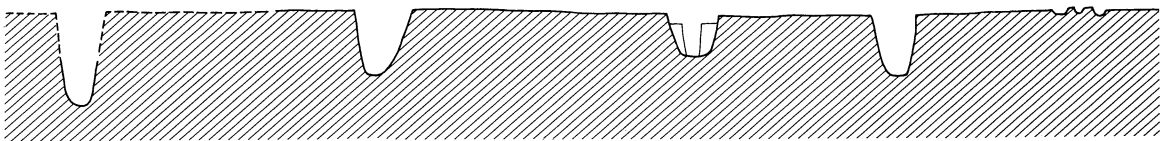

0 2m

B B'
15.5m

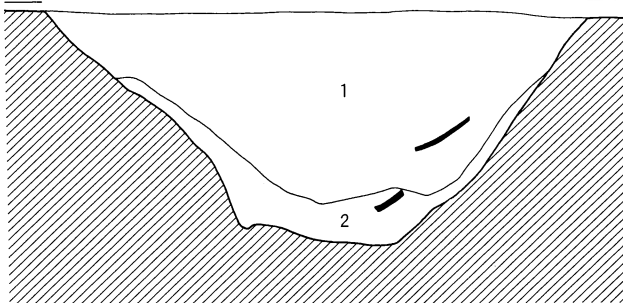

- 1. 暗灰色 シルト質極細砂
- 2. 炭層 (黄褐色シルトのブロックを含む)

0 1m

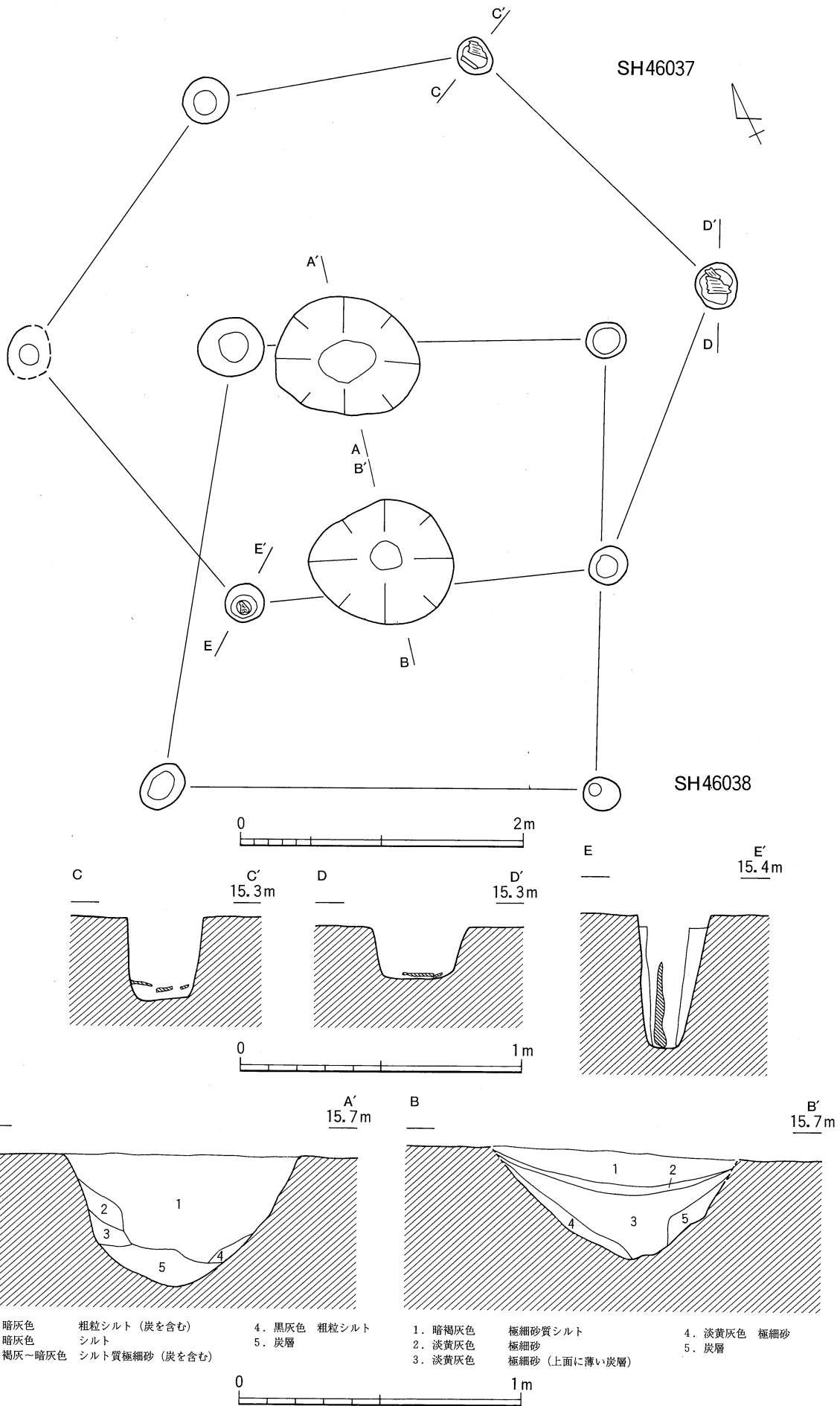

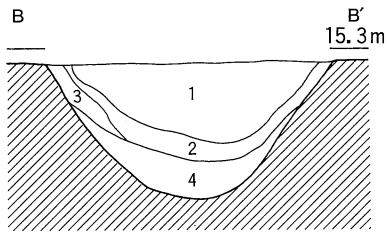
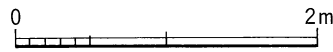
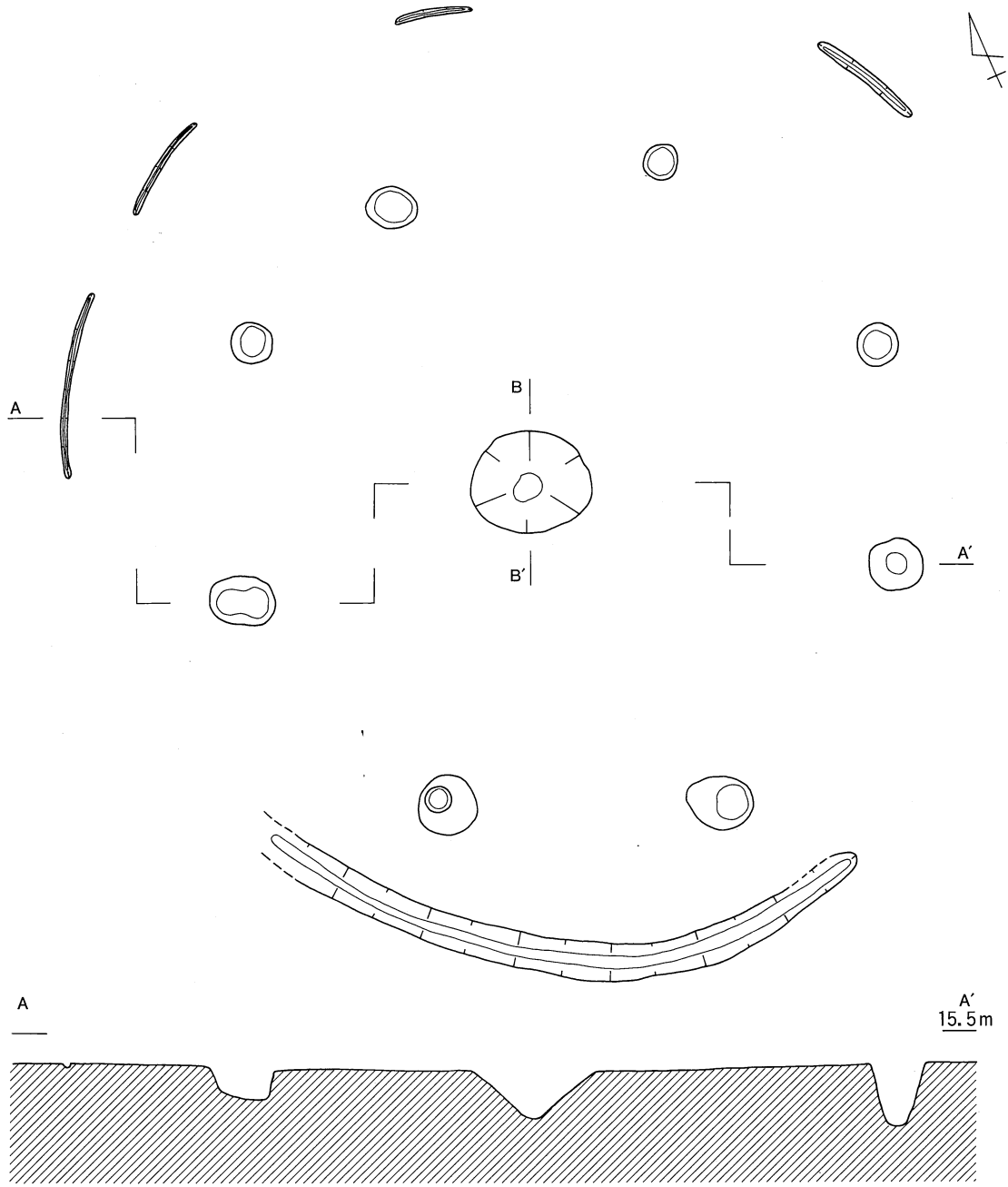

- 1. 暗灰色 シルト質極細砂
- 2. 炭層 (黄褐色シルトのブロックを含む)
- 3. 黄褐色 シルト質極細砂
- 4. 炭層 (細礫をわずかに含む)



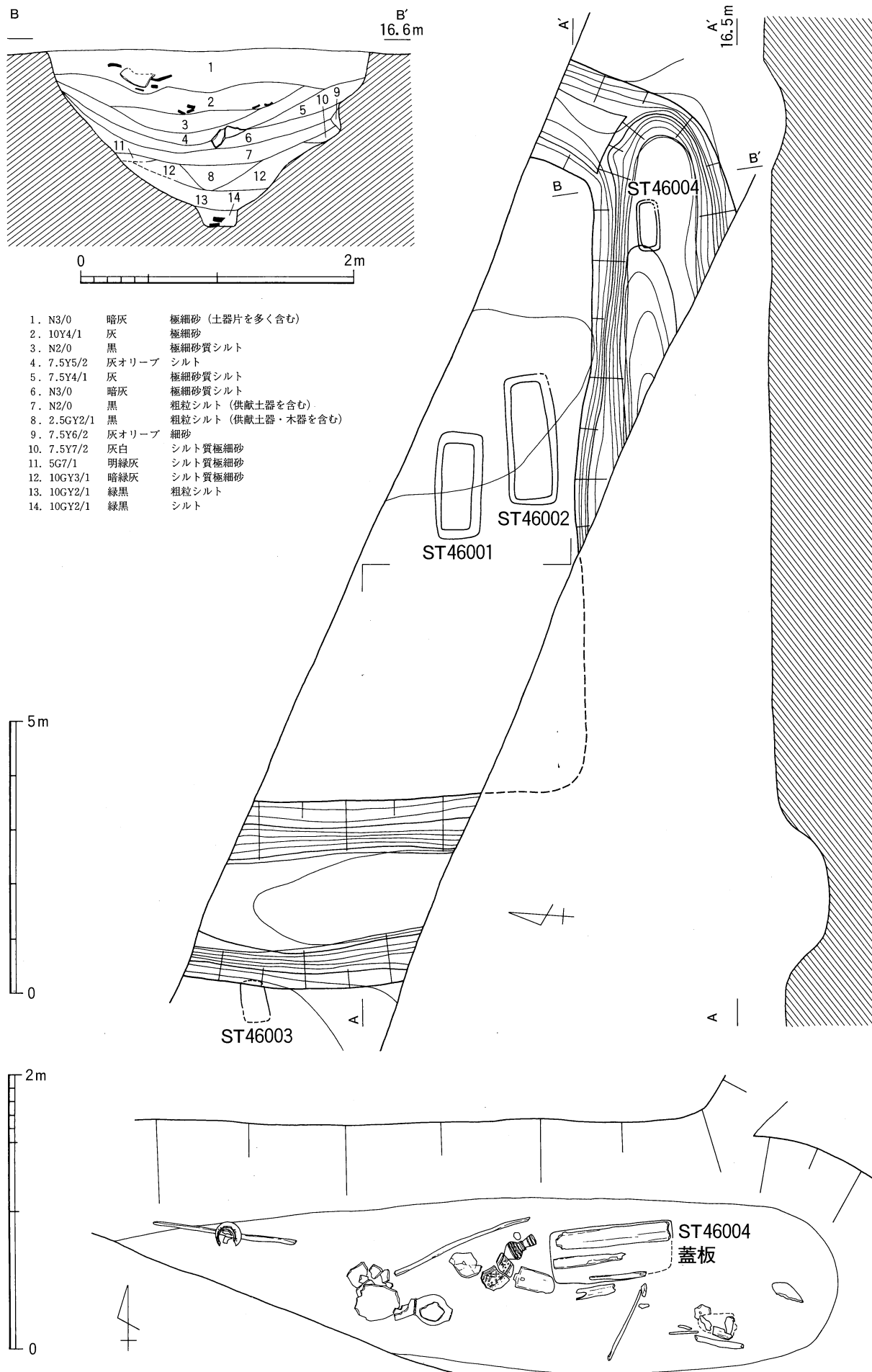

弥生中期上層 方形周溝墓 1

ST46001

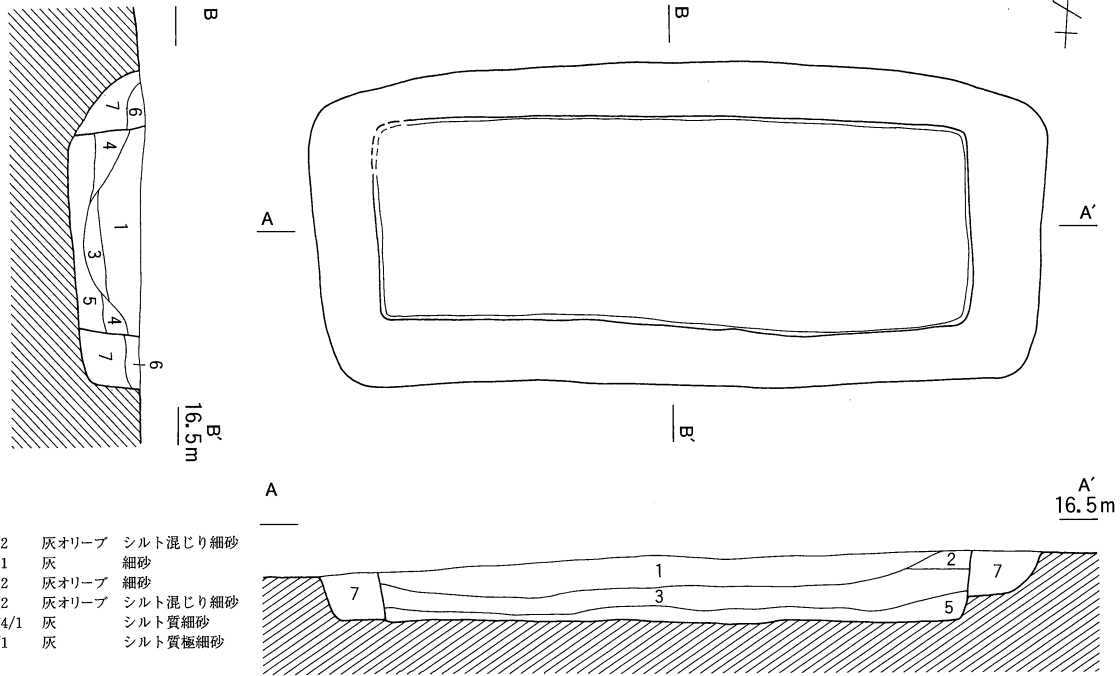

- 1. 5Y5/2 灰オリーブ シルト混じり細砂
- 2. 5Y5/1 灰 細砂
- 3. 5Y6/2 灰オリーブ 細砂
- 4. 5Y4/2 灰オリーブ シルト混じり細砂
- 5. 7.5Y4/1 灰 シルト質細砂
- 6. 5Y4/1 灰 シルト質極細砂

ST46002

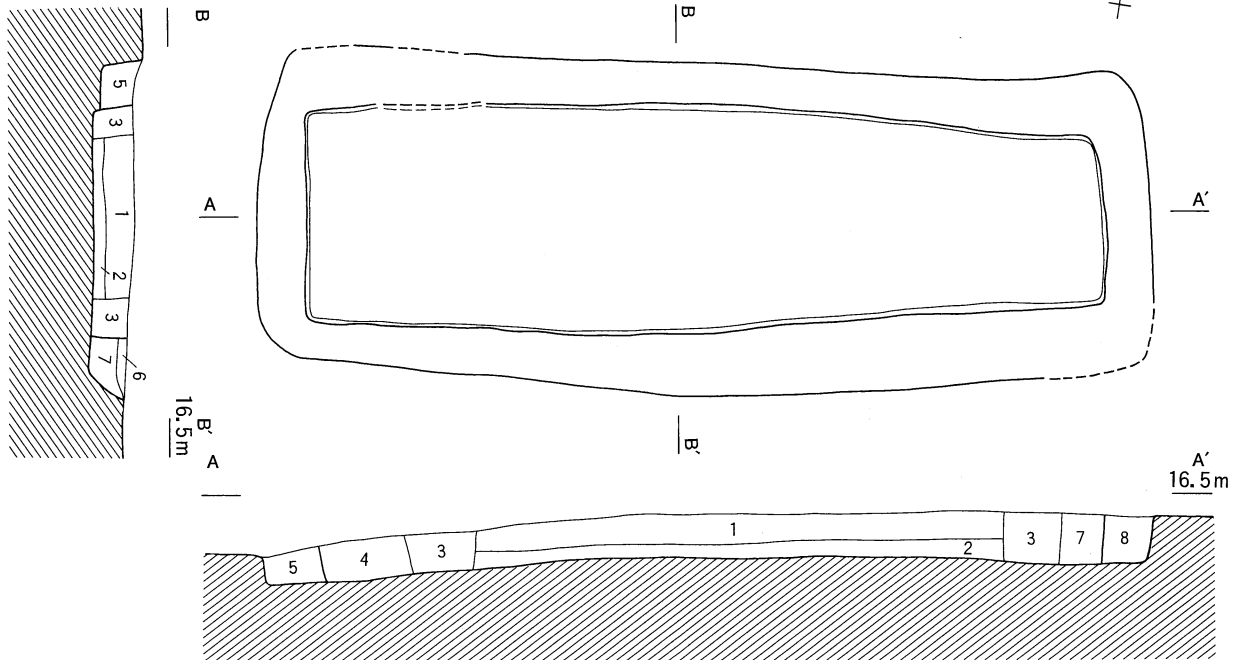

- 1. 5GY5/1 オリーブ灰 シルト質極細砂
- 2. 2.5GY6/1 オリーブ灰 シルト混じり細砂
- 3. 5GY4/1 暗オリーブ灰 シルト混じり細砂 (木棺痕跡)
- 4. 5GY4/1 暗オリーブ灰 シルト混じり細砂
- 5. 5GY5/1 オリーブ灰 シルト質極細砂
- 6. 7.5GY4/1 暗緑灰 シルト混じり細砂
- 7. 5GY4/1 暗オリーブ灰 シルト混じり細砂
- 8. 10Y4/1 灰 シルト質極細砂



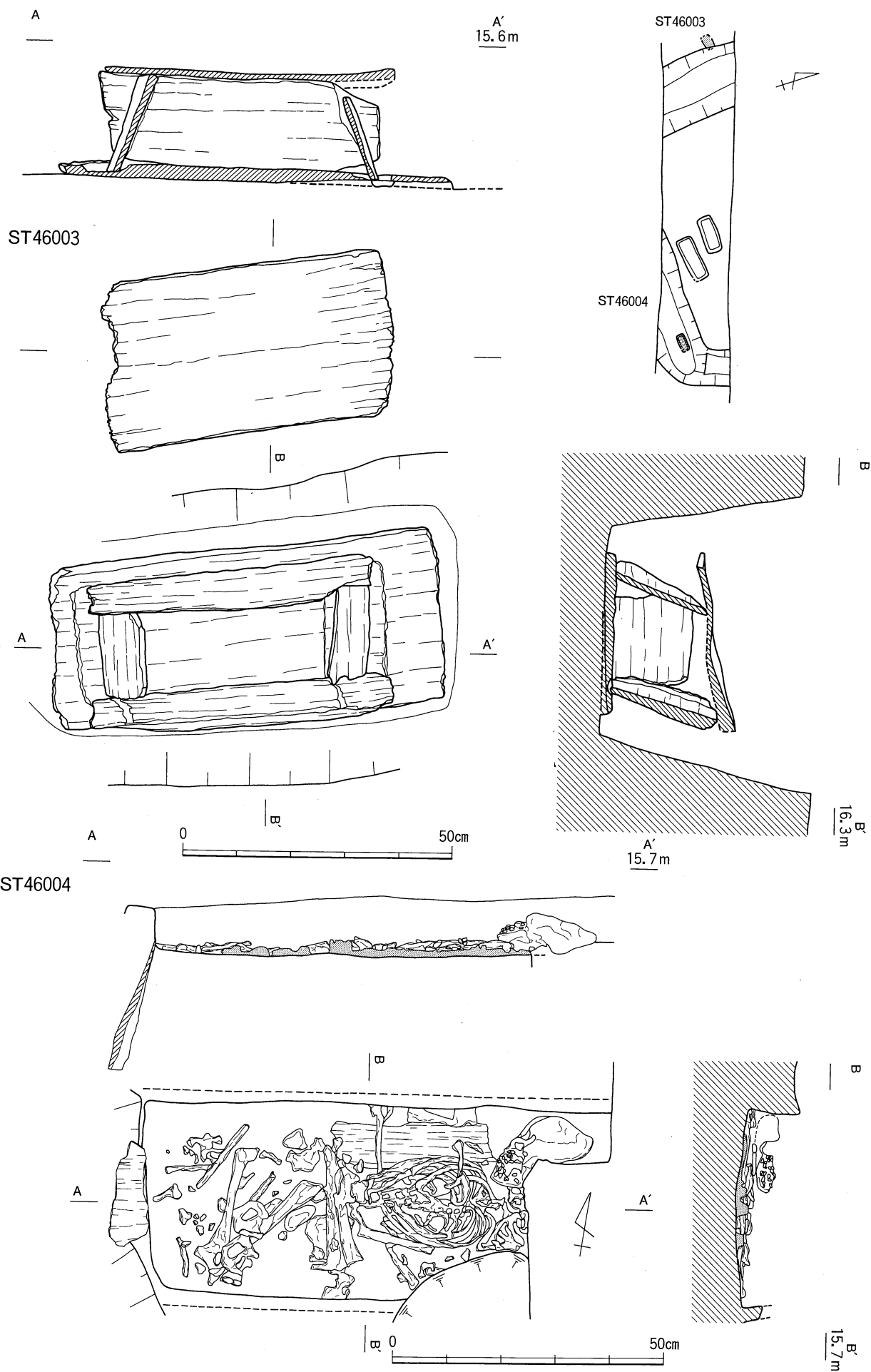

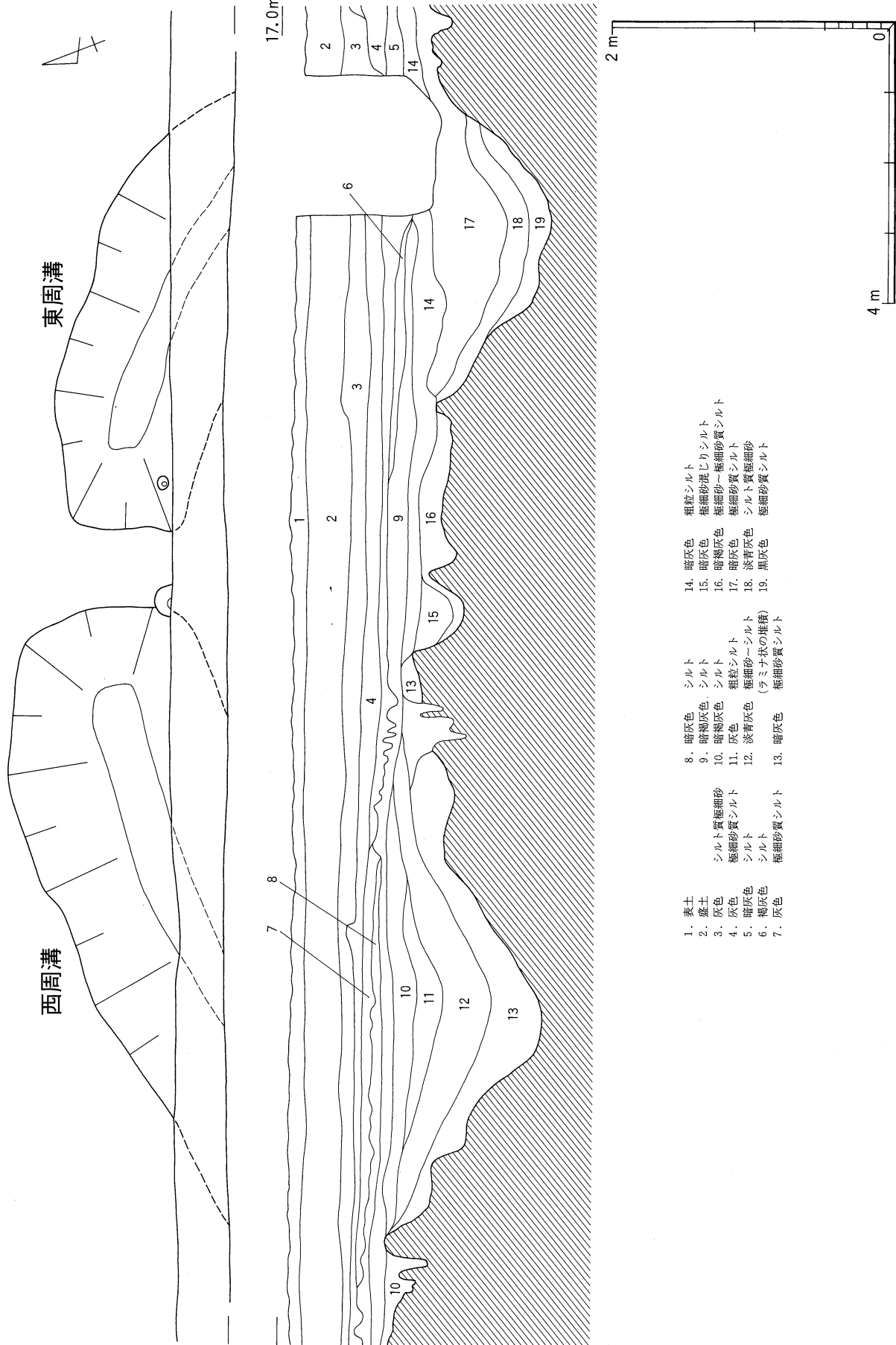

- 1. 表土
 - 2. 礫土
 - 3. 灰色
 - 4. 灰色
 - 5. 暗灰色
 - 6. 褐色
 - 7. 灰色
 - 8. 暗灰色
 - 9. 暗褐色
 - 10. 暗褐色
 - 11. 灰色
 - 12. 淡青灰色
 - 13. 暗灰色
 - 14. 暗灰色
 - 15. 暗褐色
 - 16. 暗褐色
 - 17. 暗褐色
 - 18. 淡青灰色
 - 19. 黒灰色
- 粗粒シルト
 - 極細砂混じりシルト
 - 極細砂～極細砂質シルト
 - 極細砂質シルト
 - シルト質極細砂
 - シルト
 - 極細砂質シルト
 - シルト
 - 粗粒シルト
 - 極細砂～シルト (ラミナ状の堆積)
 - 極細砂質シルト
 - 粗粒シルト
 - 極細砂混じりシルト
 - 極細砂～極細砂質シルト
 - 極細砂質シルト
 - シルト質極細砂
 - 極細砂質シルト

弥生中期上層 方形周溝墓 4

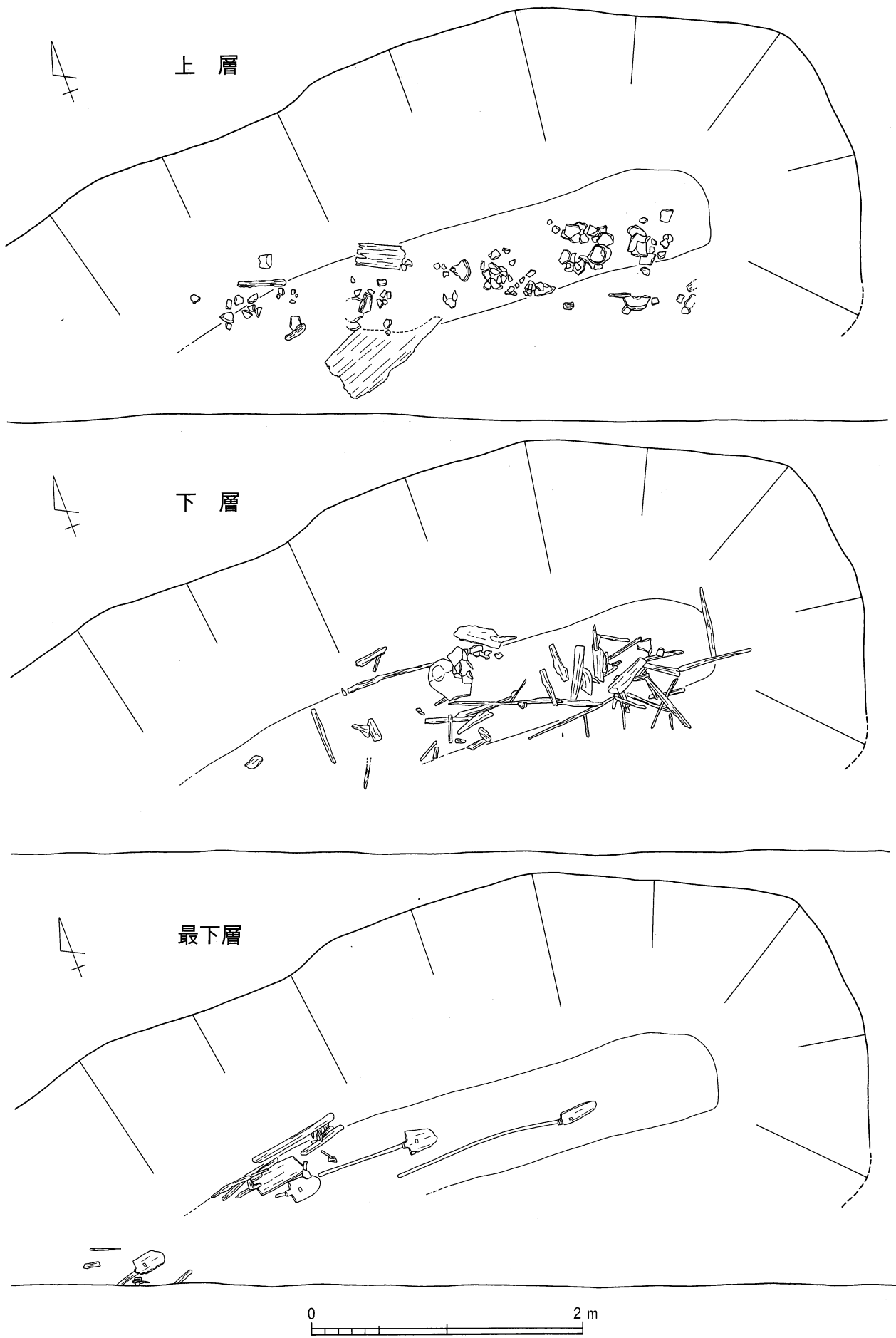

弥生中期上層 方形周溝墓5

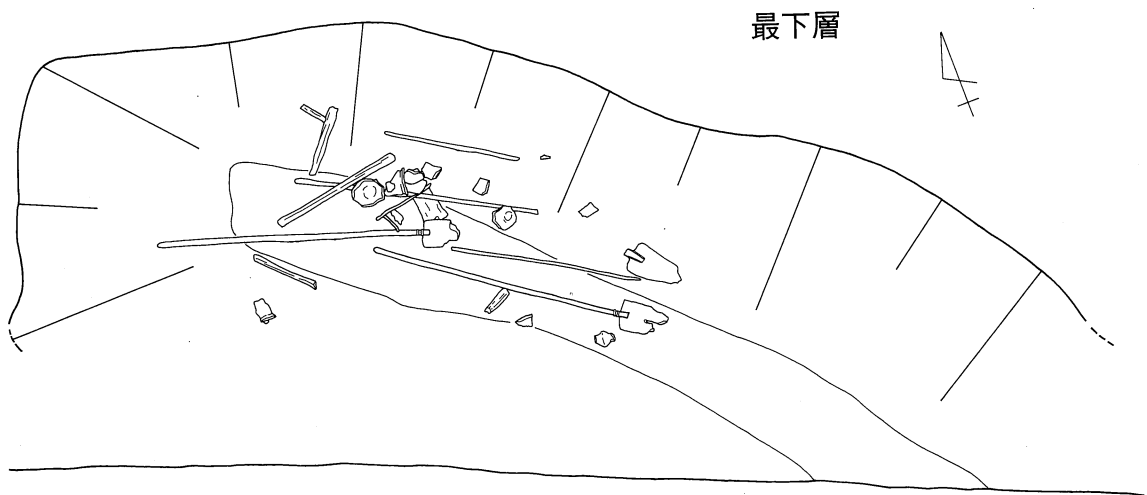
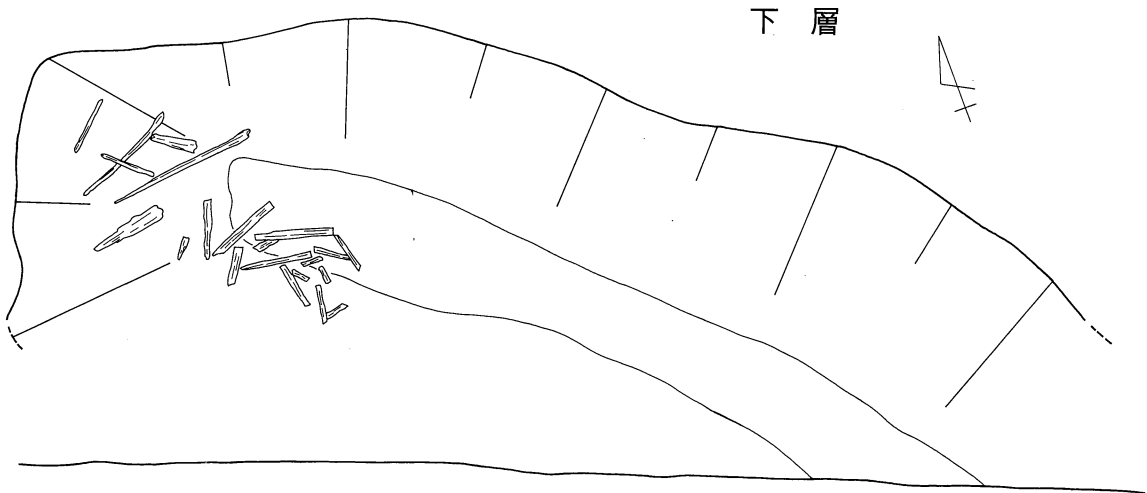
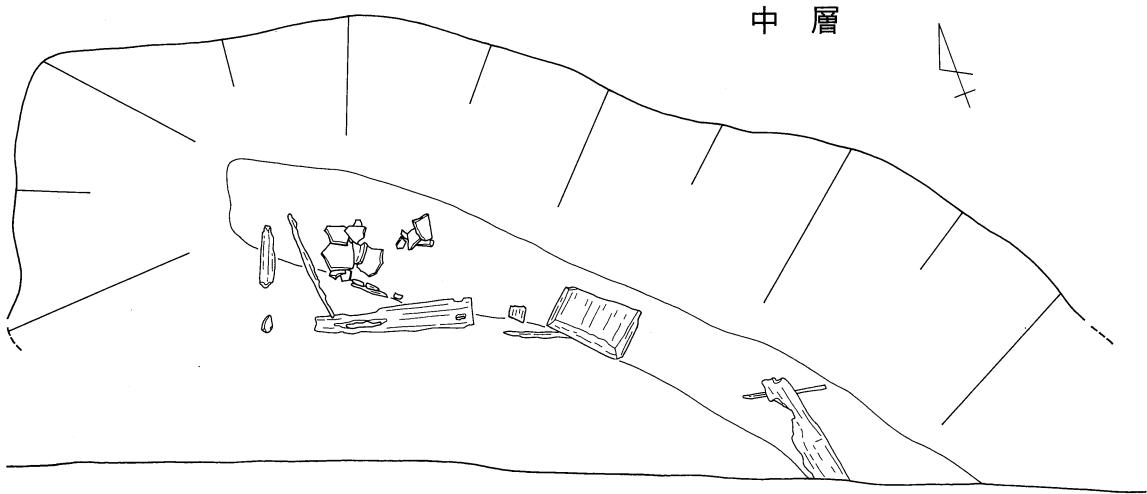

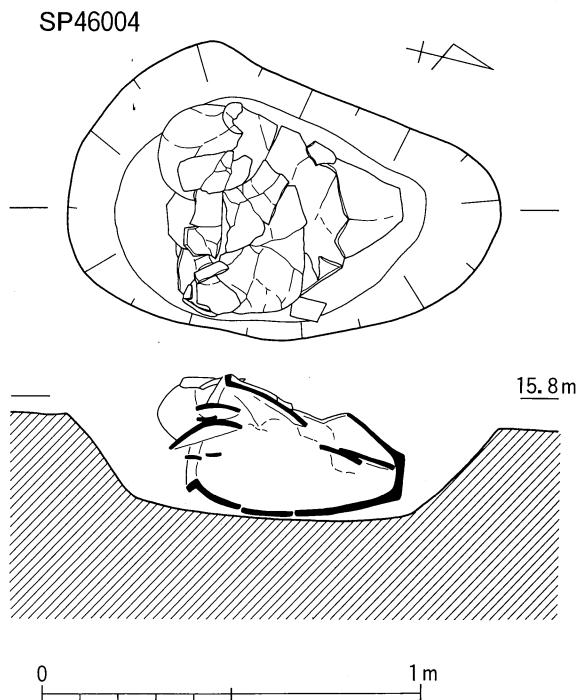
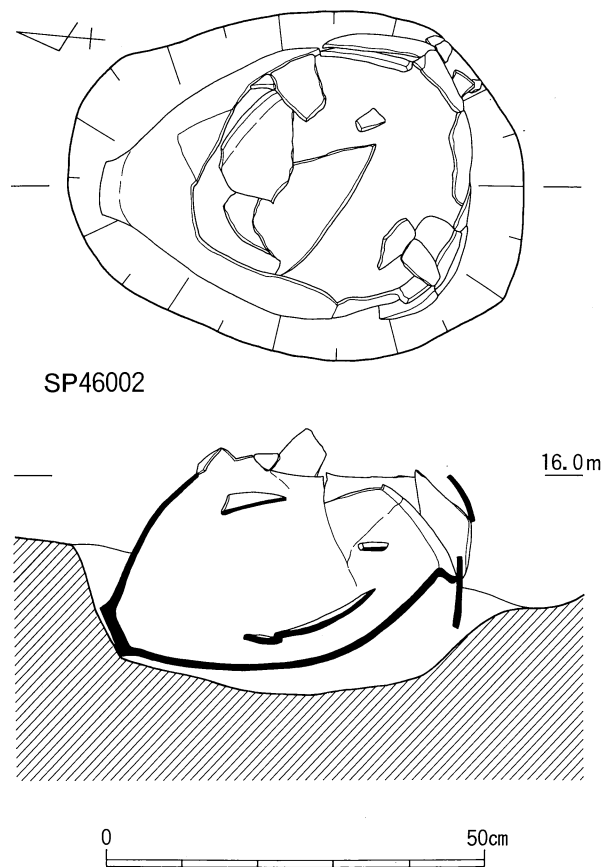
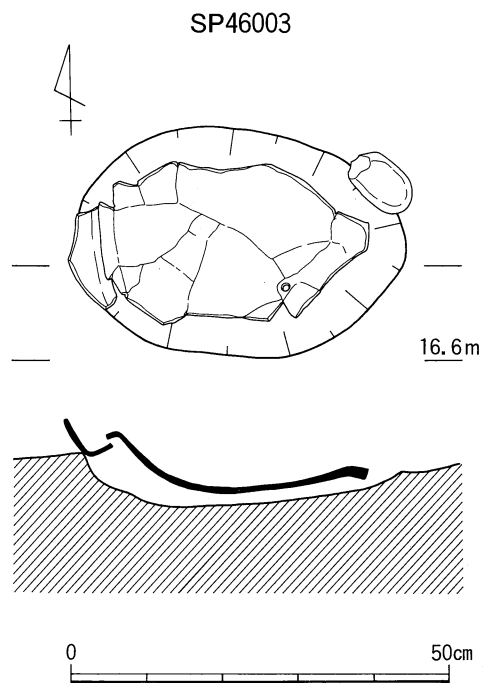
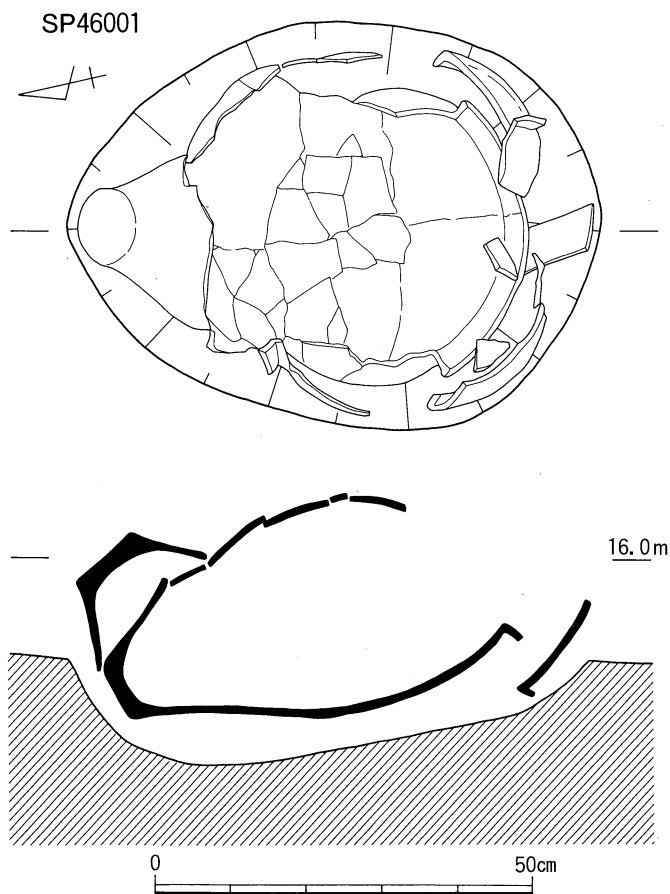

SP46005

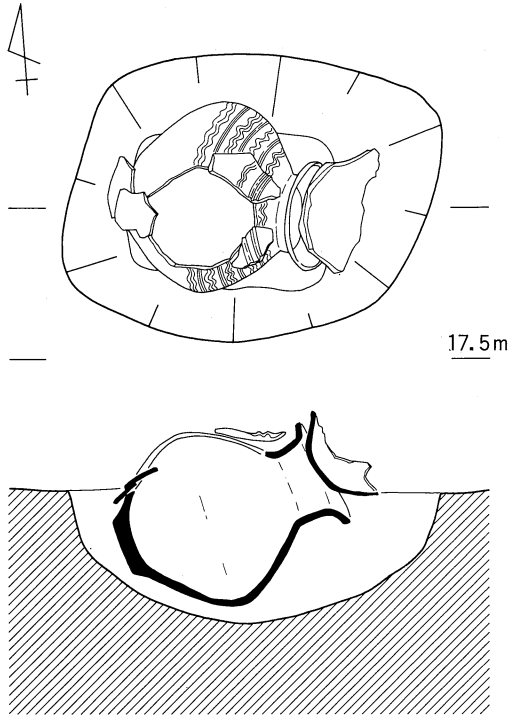

SP46007

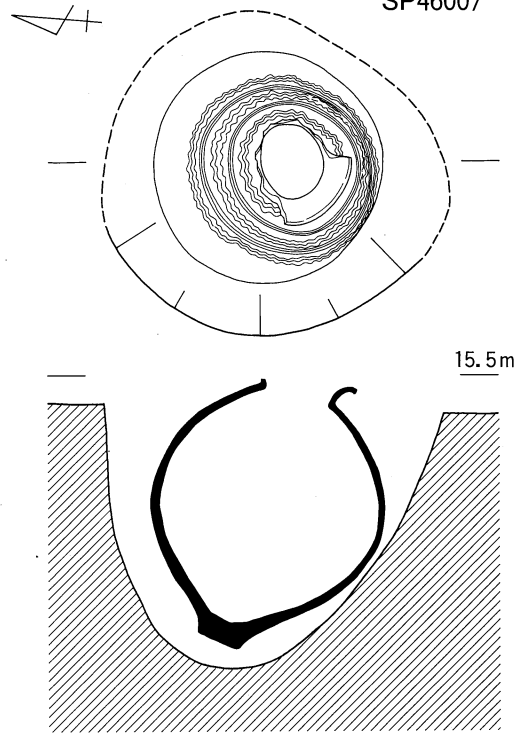

SP46006

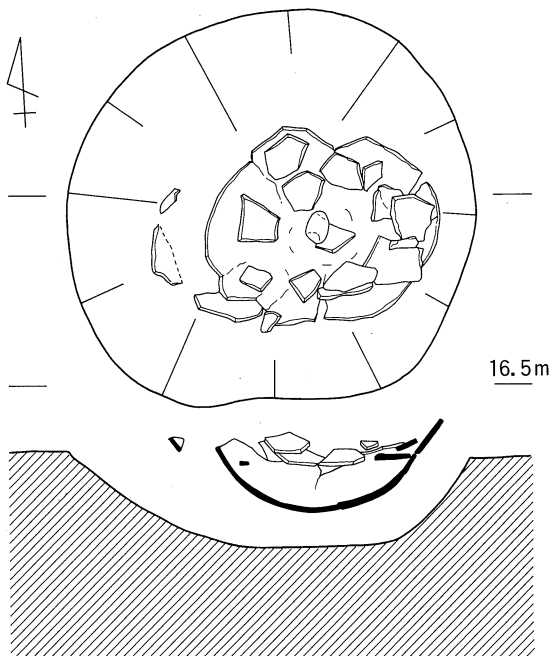

SP46008

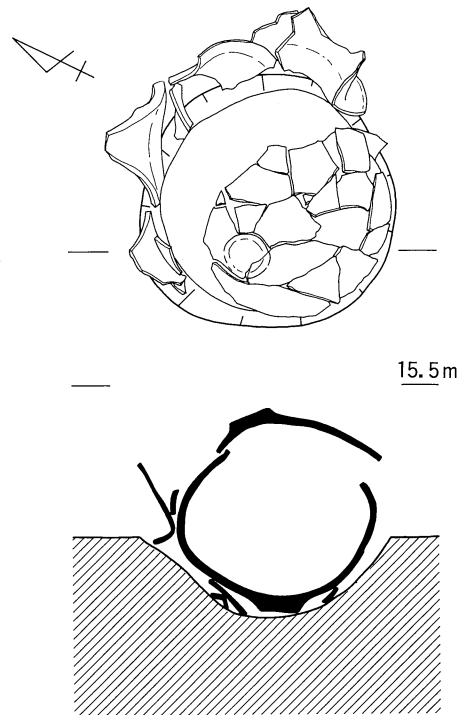

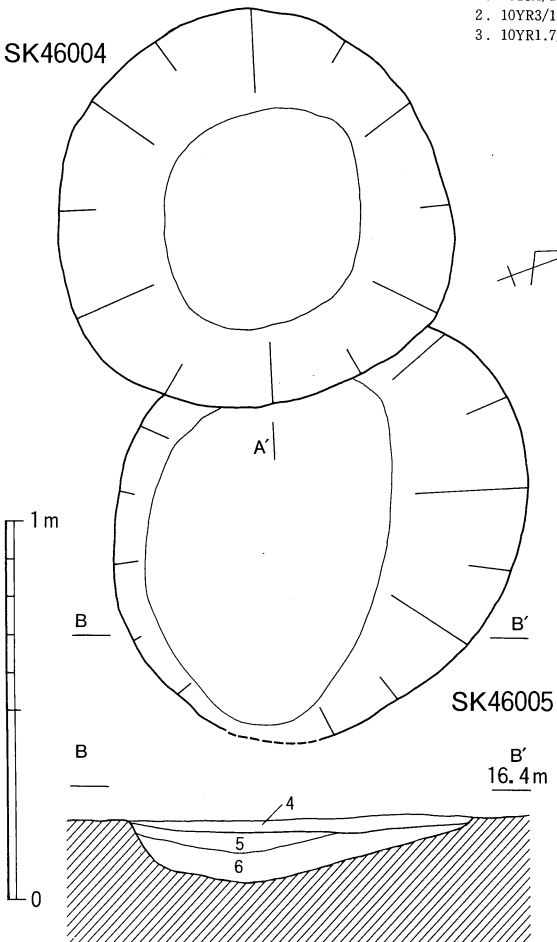
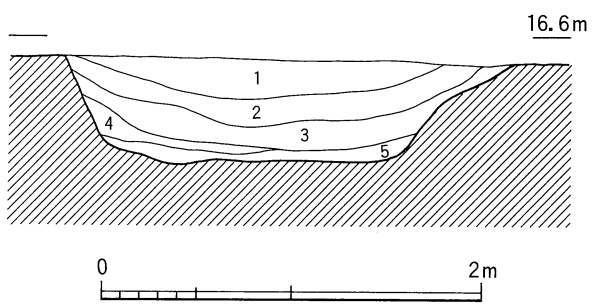
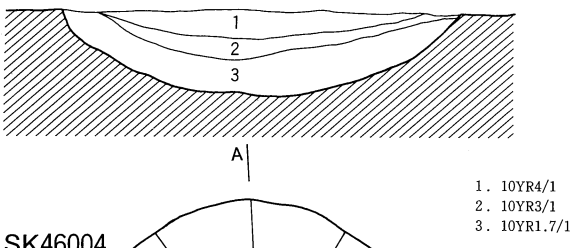
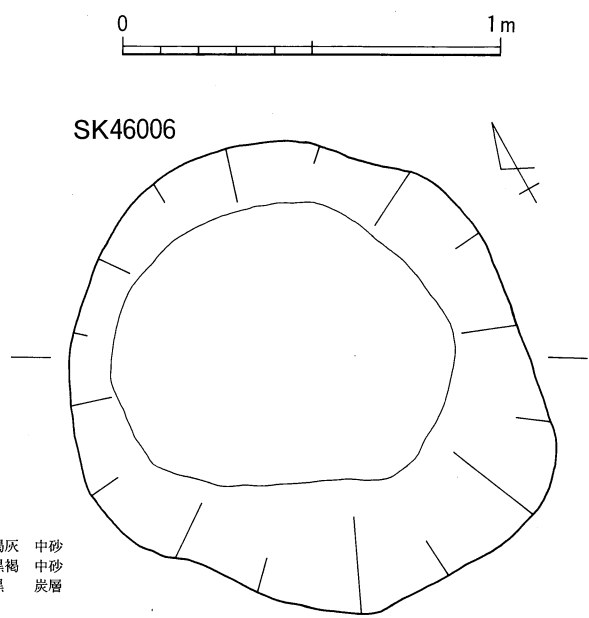
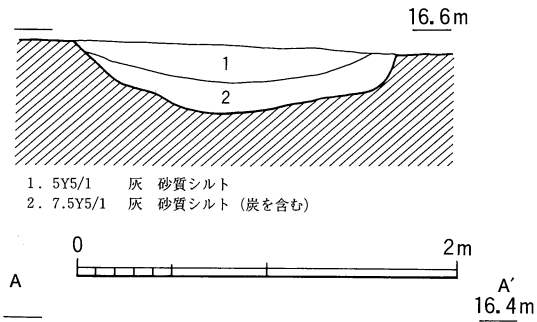
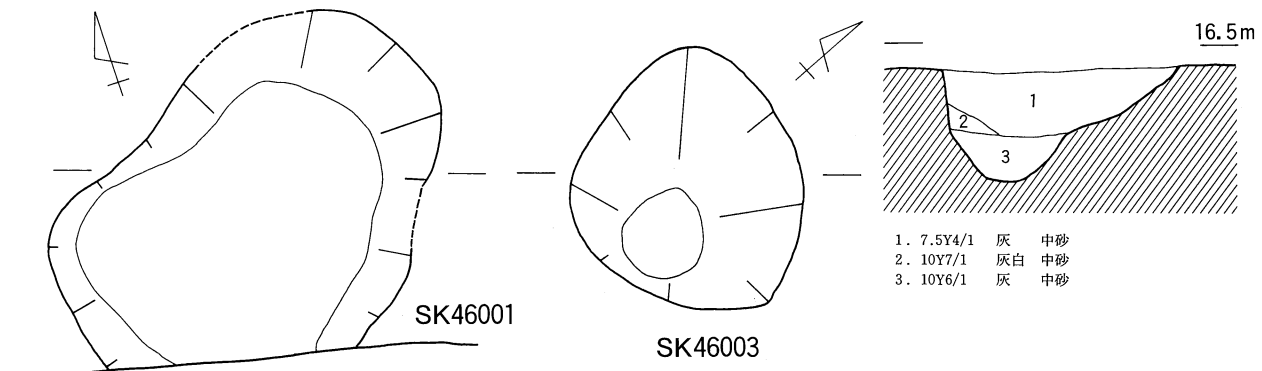

1. 10Y7/1 灰白 極細砂質シルト
2. 5Y4/1 灰 中砂質シルト
3. 10Y4/1 灰 中砂質シルト
4. 7.5Y2/1 黒 炭層
5. 10Y5/1 灰 粗砂 (炭を少量含む)
4. 10YR4/1 褐灰 中砂
5. 10YR2/1 黒 炭層
6. 2.5Y2/1 黒 炭層

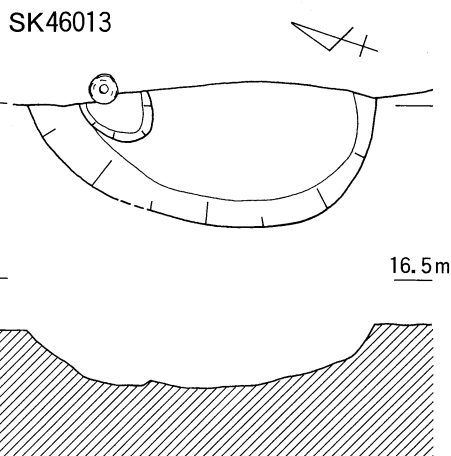
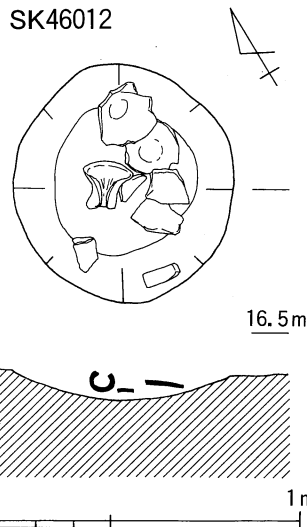
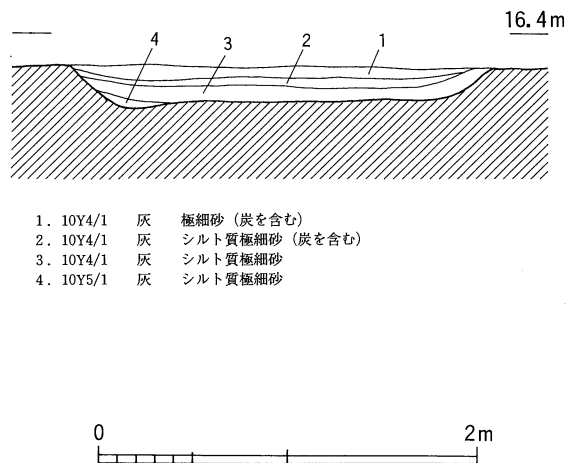
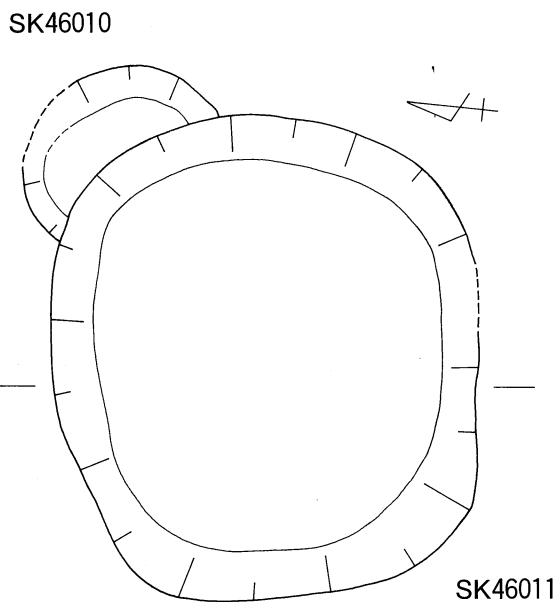
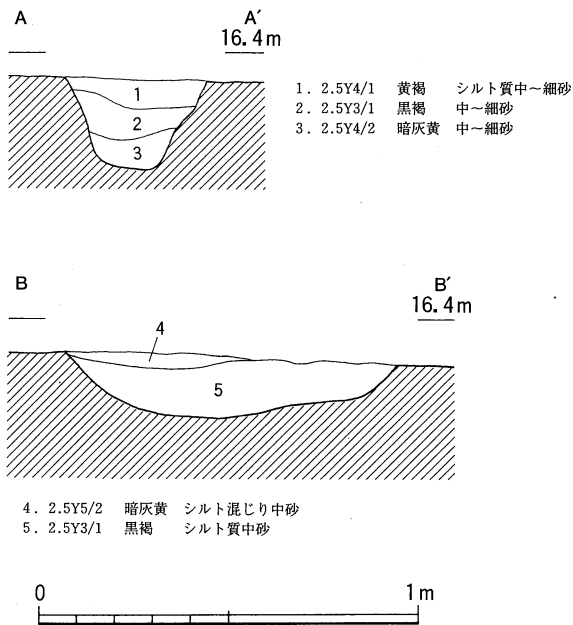
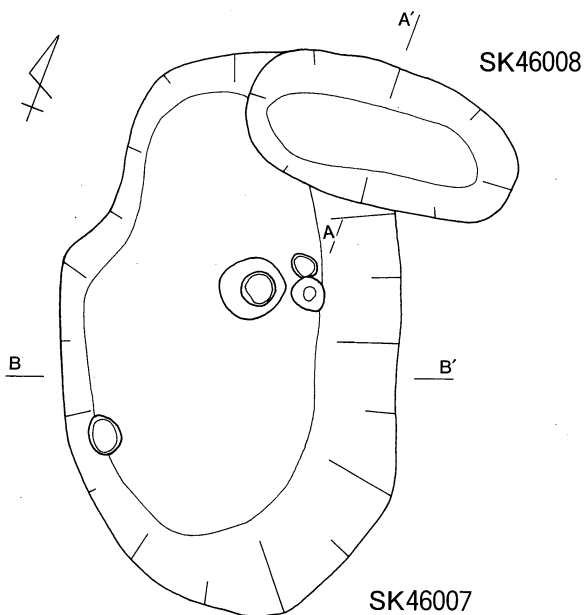

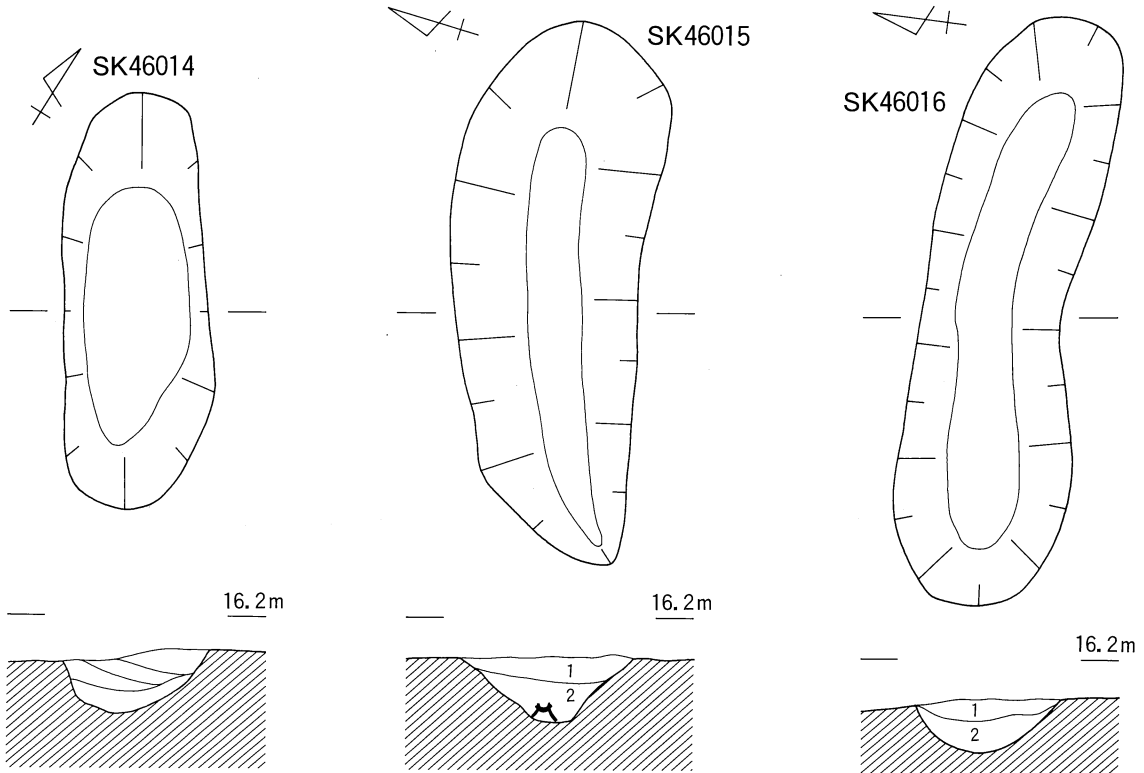

- 1. 7.5Y5/1 灰 砂質シルト
- 2. N4/0 灰 砂混じりシルト

- 1. N4/0 灰 砂質シルト
- 2. 10Y5/1 灰 砂質シルト

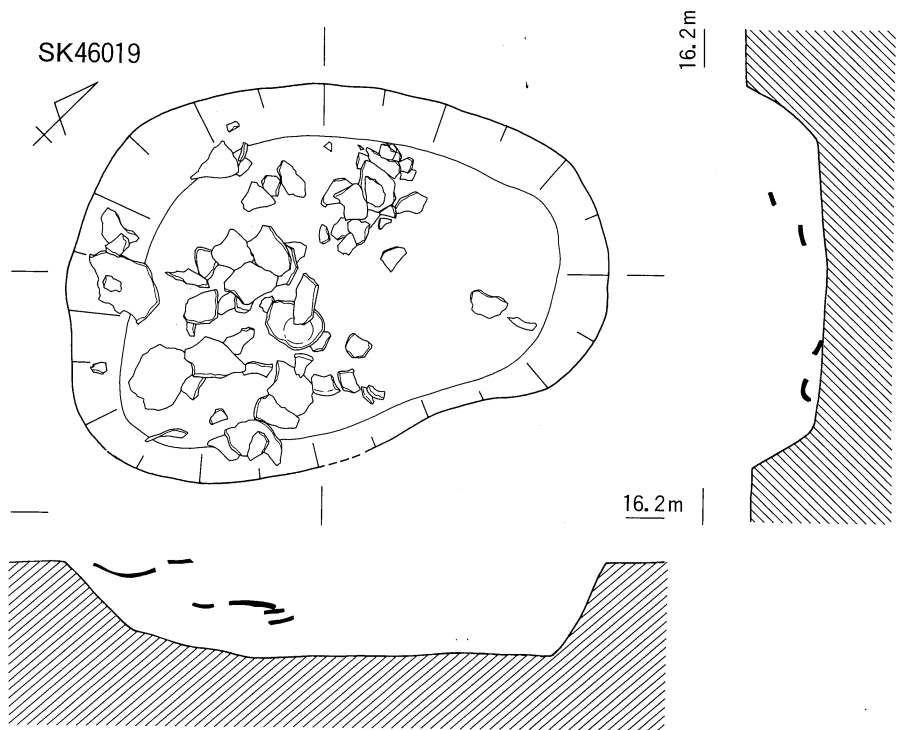

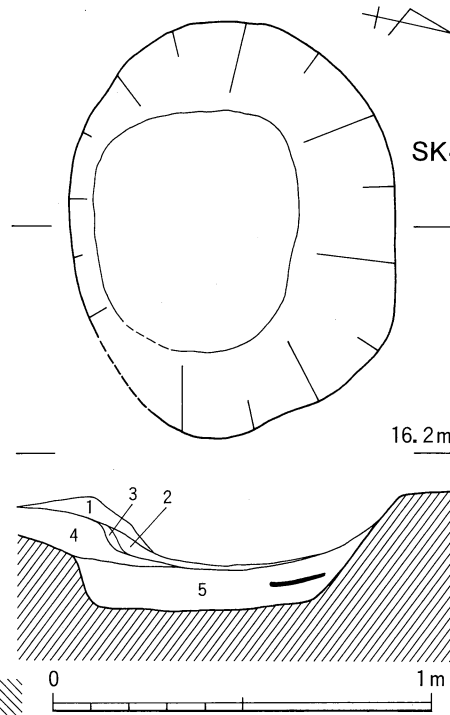
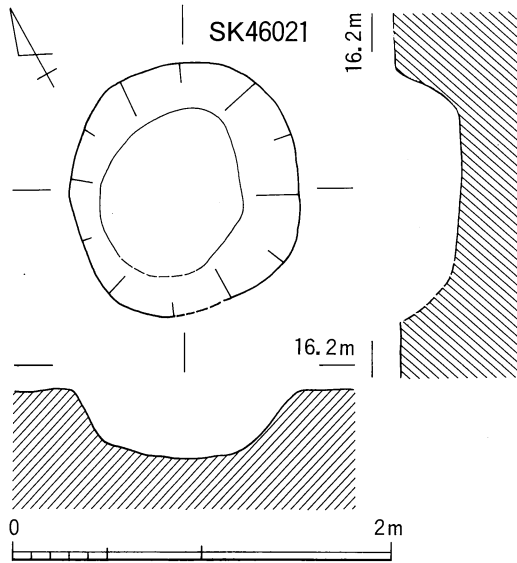

- 1. 淡黄灰色 シルト質極細砂
- 2. 炭層 (火を受けて赤変)
- 3. 炭層
- 4. 暗灰色 シルト質極細砂
- 5. 炭層

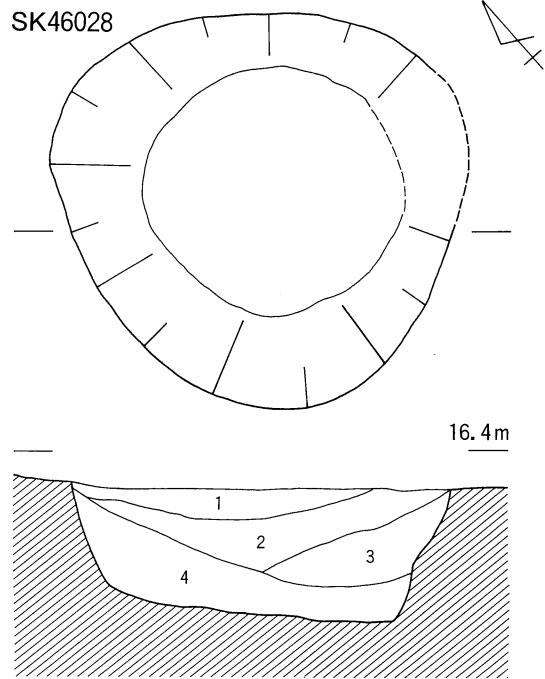
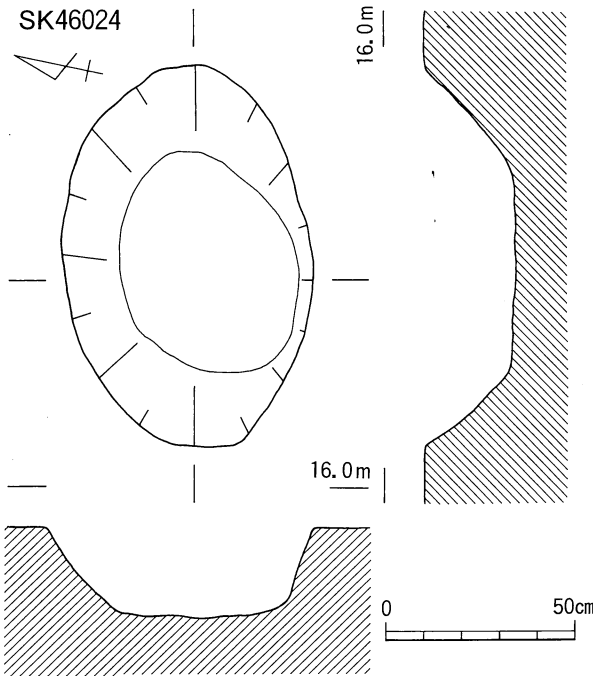

- 1. 茶灰色 シルト質極細砂
- 2. 黒灰色 シルト質極細砂
- 3. 黄褐色 細砂～極細砂
- 4. 暗灰色 シルト質極細砂 (中砂混じり)

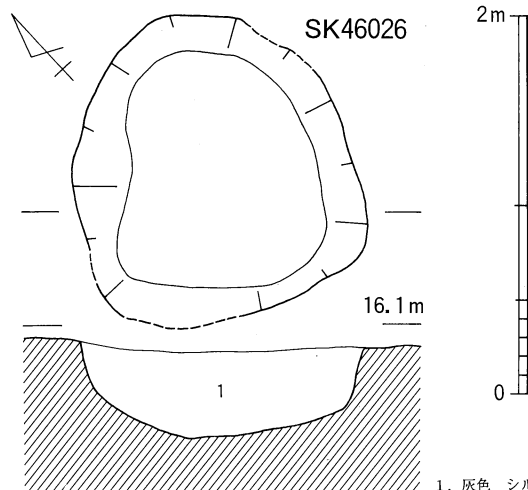

- 1. 灰色 シルト質極細砂 (炭を含む、厚さ5mmの炭の間層あり)

SK46029

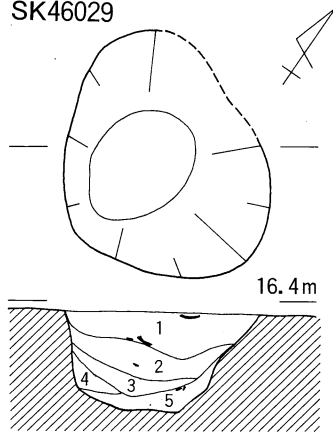

- 1. 茶灰色 シルト質極細砂
- 2. 濁灰色 シルト質極細砂
- 3. 黄褐色 細砂～極細砂
- 4. 暗灰色 極細砂混じりシルト
- 5. 灰色 粗粒シルト

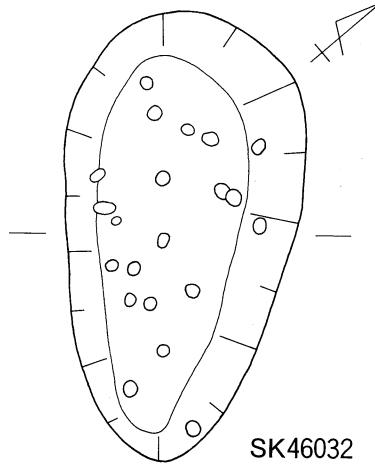

SK46032
16.4m

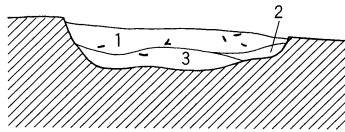

- 1. 灰色 シルト質極細砂～中砂
- 2. 明褐色 細砂～極細砂
- 3. 暗灰色 シルト質極細砂～中砂

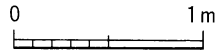

SK46035

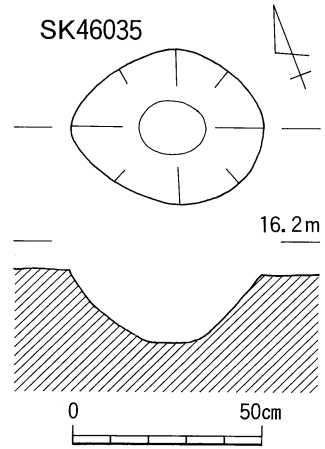

SK46039

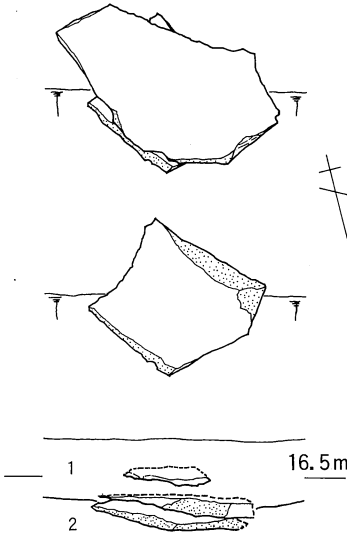
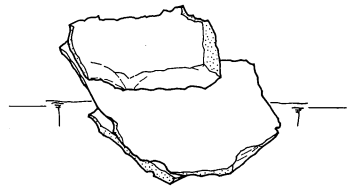

- 1. 暗灰色 極細砂混じりシルト (IV様式の洪水砂)
- 2. 暗灰色 シルト質極細砂～細砂 (III・IV様式の包含層)

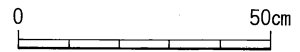

SK46040

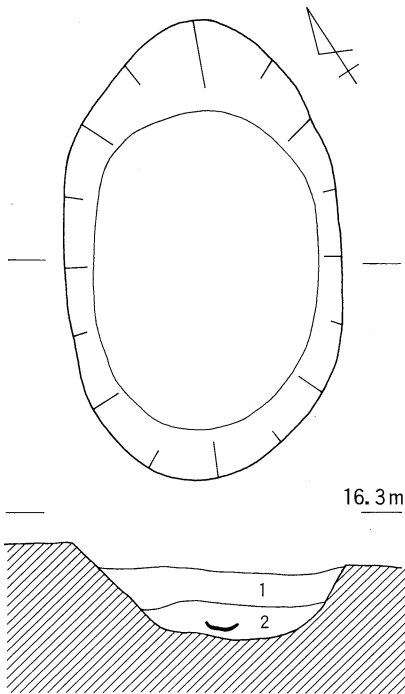

- 1. 暗灰色 シルト質極細砂
- 2. 灰色 極細砂質シルト (上面に厚さ5mmの炭層)



SK46044

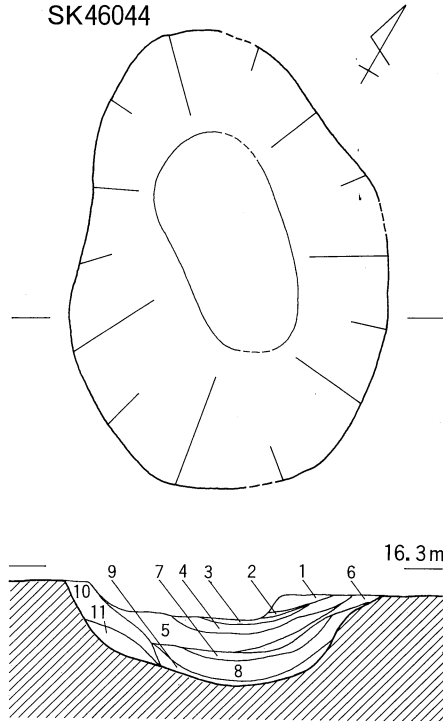

- 1. 淡明灰色 シルト質極細砂
- 2. 明灰色 シルト質細砂～中砂
- 3. 白色 細砂～極細砂
- 4. 淡明灰色 シルト質極細砂
- 5. 淡明灰色 粗粒シルト
- 6. 濁白色 粗粒シルト
- 7. 白色 細砂～極細砂
- 8. 青灰色 細砂混じりシルト
- 9. 黒灰色 シルト (炭を多く含む)
- 10. 灰色 細砂～極細砂
- 11. 灰白色 細砂～極細砂 (上面に薄い炭層)

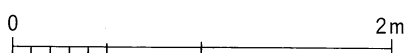

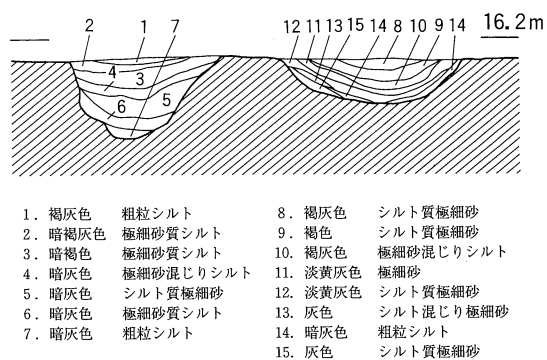
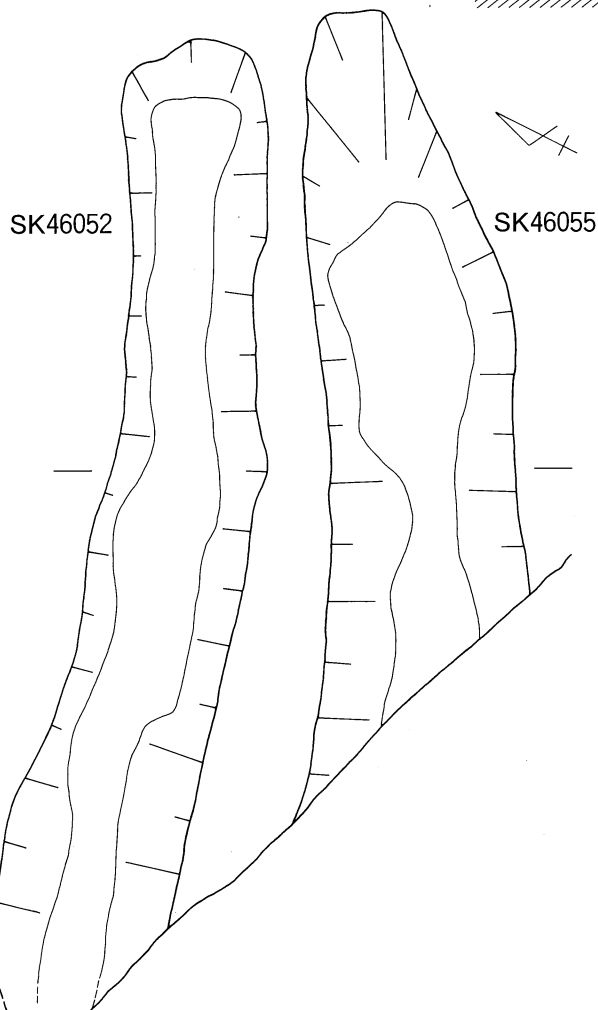
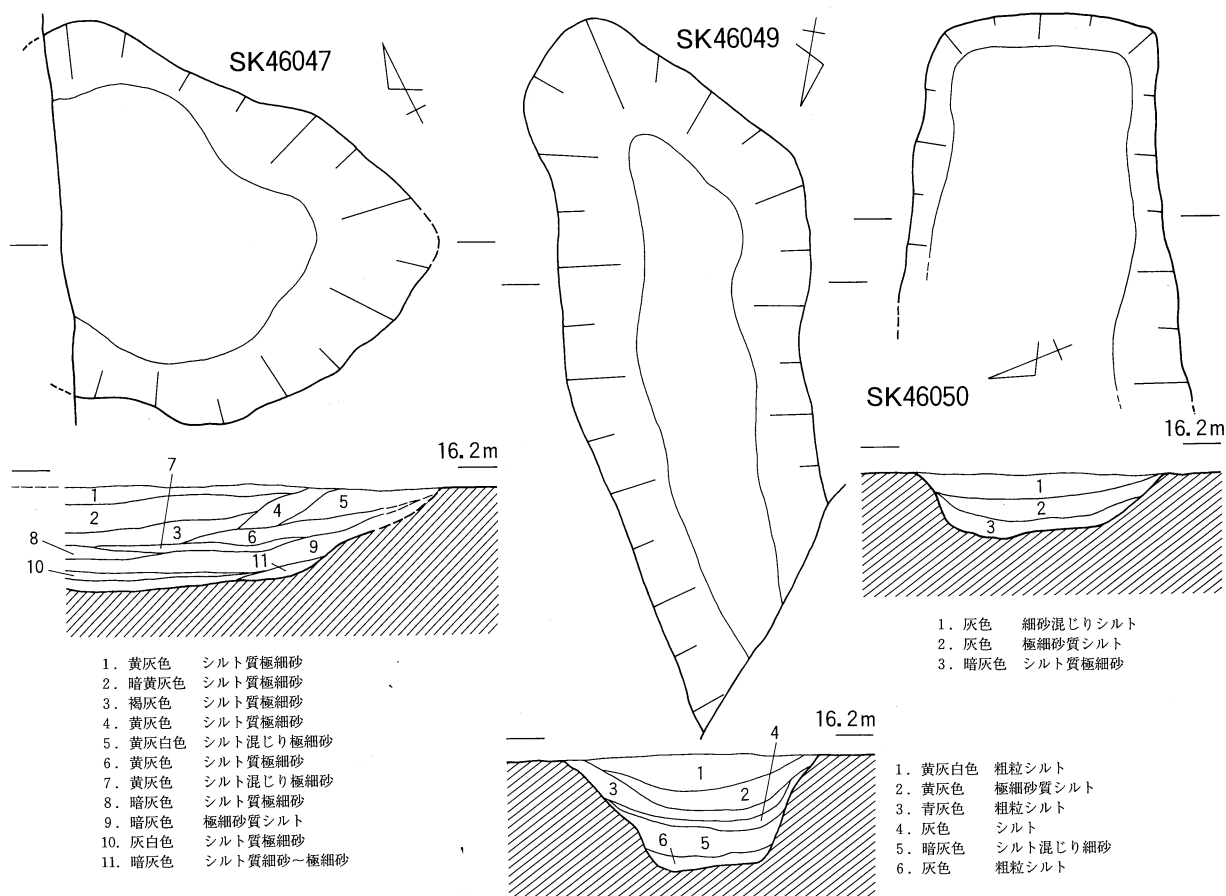

図版54

SK46056/46057/46059/46061/46063/46064/46065

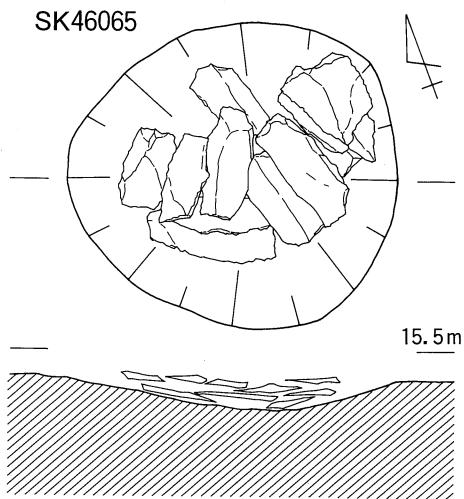
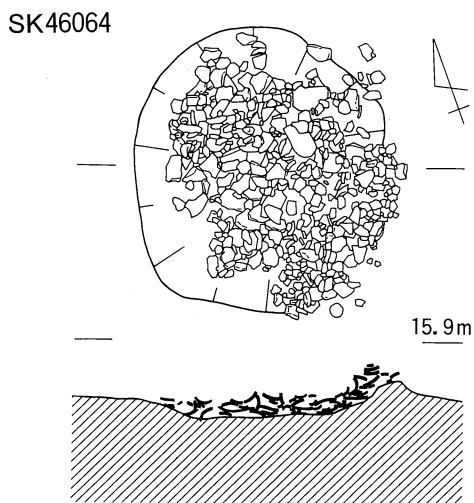
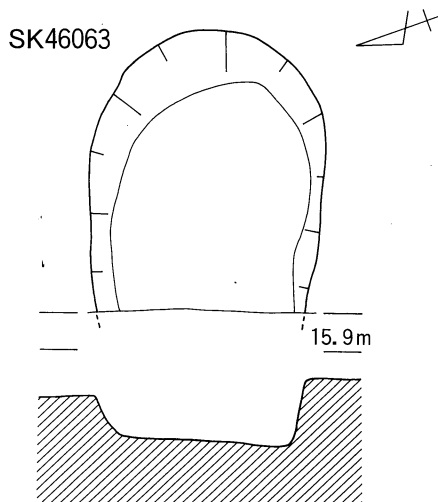
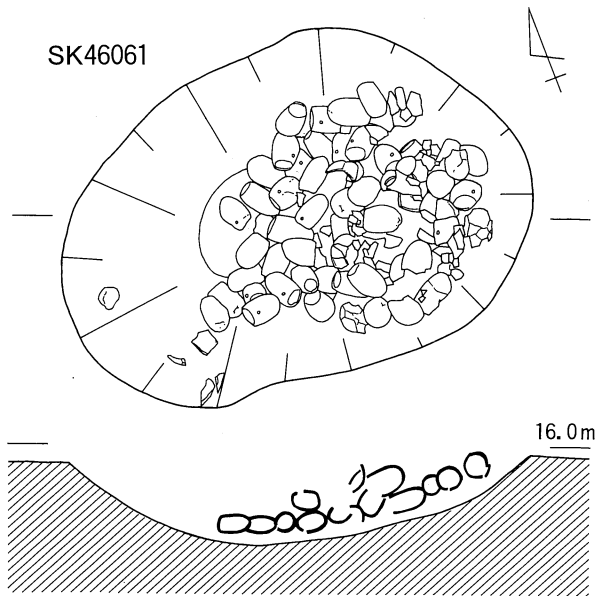
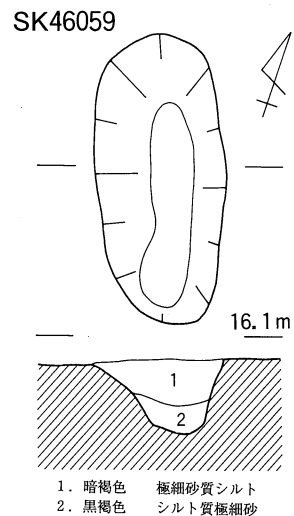
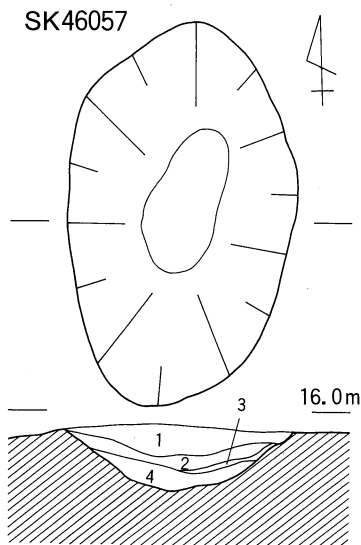
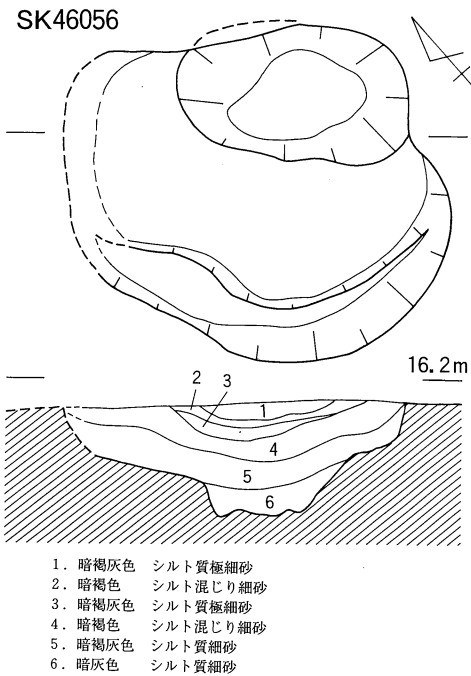

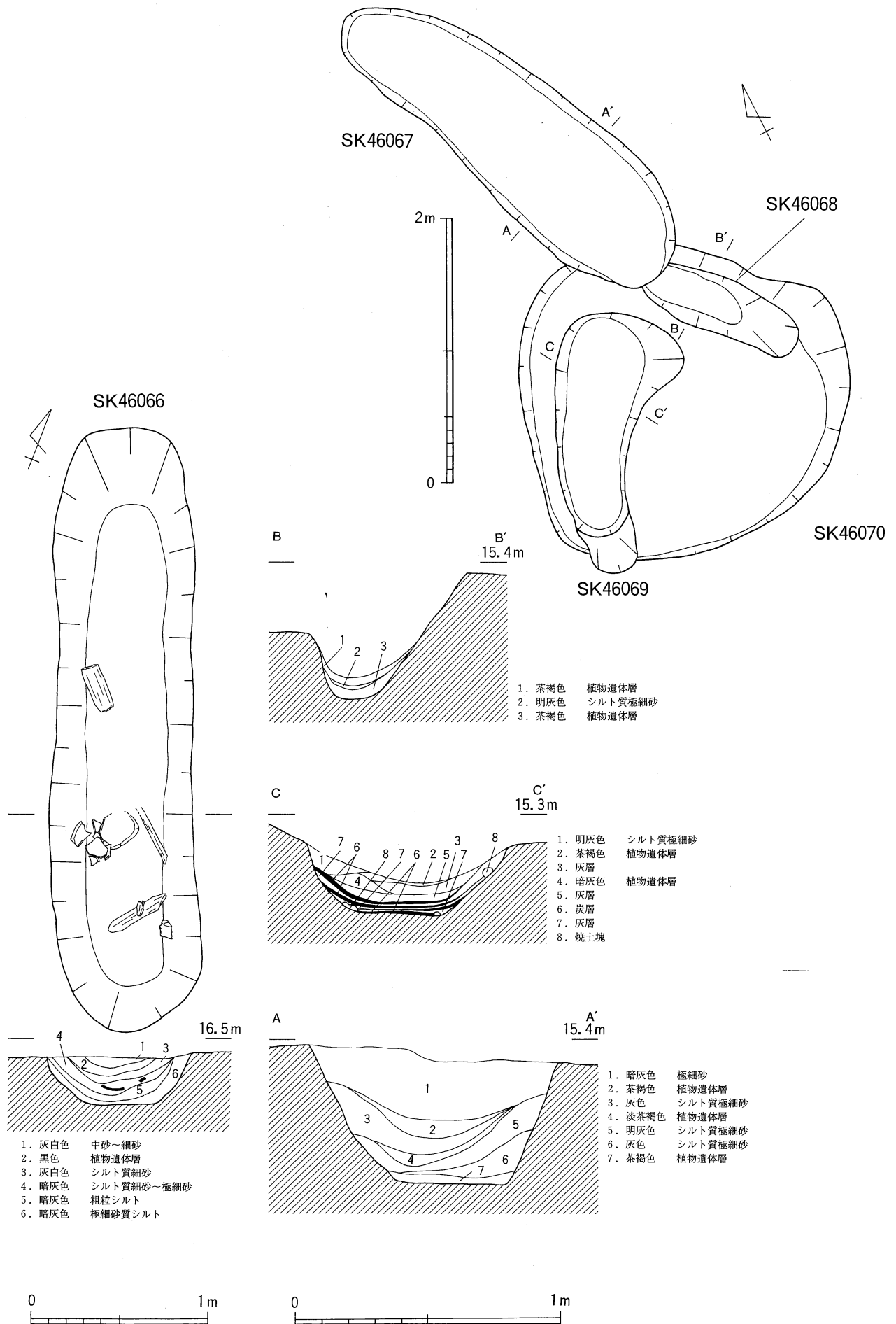

SK46073

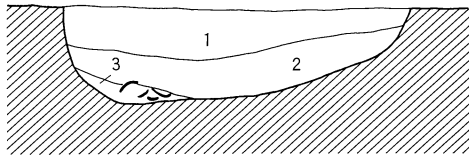
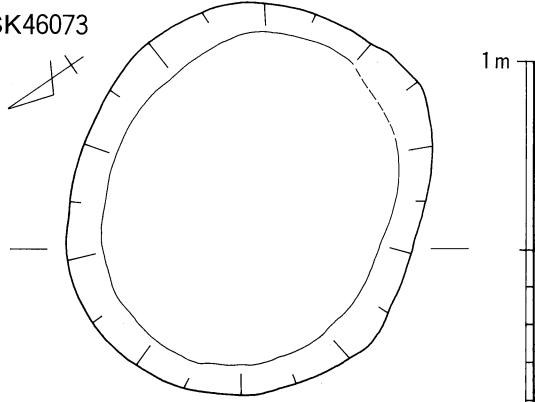

- 1. 2.5Y4/1 黄灰 極細砂
- 2. 10YR4/1 褐灰 シルト質極細砂
- 3. 10YR4/1 褐灰 シルト質極細砂

SK46079

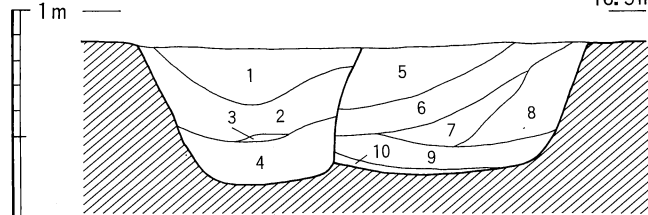
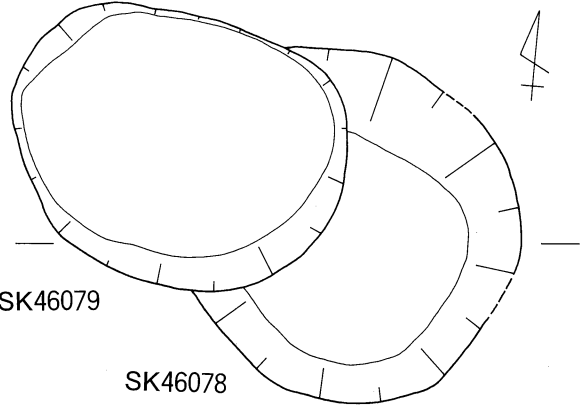

- 1. 7.5YR2/1 黒 極細砂
- 2. 10YR2/1 黒 極細砂
- 3. 10YR1.7/1 黒 シルト質極細砂
- 4. 10YR4/2 灰黄褐 シルト質極細砂
- 5. 10YR2/2 黒褐 極細砂
- 6. 2.5Y4/2 暗灰黄 極細砂~中砂
- 7. 2.5Y3/1 黒褐 砂質シルト
- 8. 7.5YR3/1 黒褐 砂質シルト
- 9. 2.5Y4/1 黄灰 砂質シルト
- 10. 2.5Y2/1 黒 炭層

SK46076

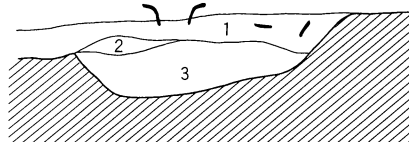
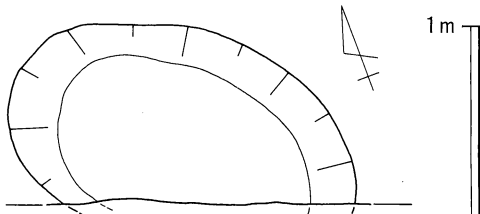
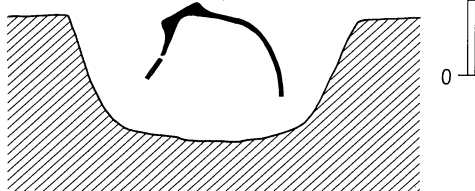
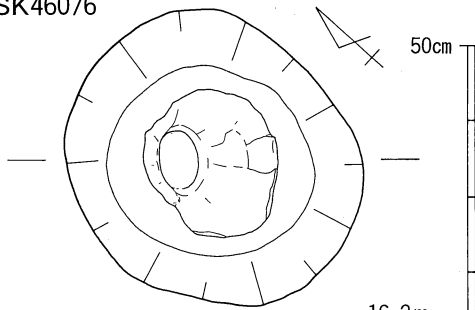

- 1. 2.5Y4/1 黄灰 シルト質極細砂
- 2. 5Y3/1 オリーブ黒 シルト質極細砂
- 3. 10YR3/1 黒褐 シルト質極細砂

SK46082

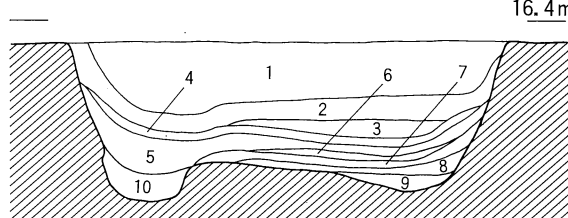
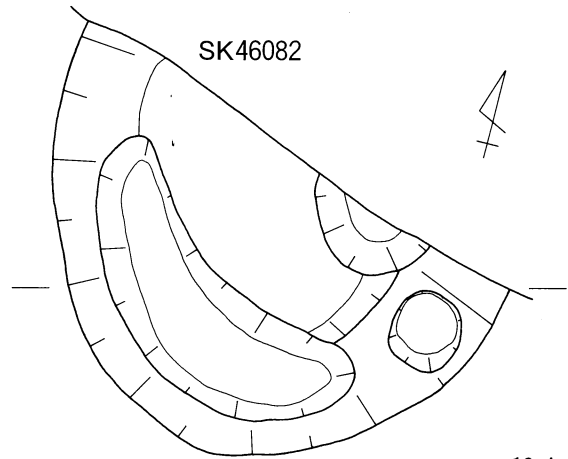

- 1. 10YR2/2 黒褐 極細砂~細砂
- 2. 2.5Y3/1 黒褐 シルト質極細砂
- 3. 10YR5/1 褐灰 シルト質極細砂
- 4. 5Y2/1 黒 シルト質極細砂
- 5. 2.5Y4/1 黄灰 シルト質極細砂
- 6. 2.5Y7/1 灰白 灰層
- 7. 10YR2/1 黒 シルト質極細砂
- 8. N1.5/0 黒 炭層
- 9. N3/0 暗灰 灰層
- 10. 10YR3/1 黒褐 シルト質極細砂

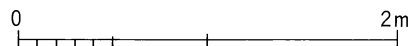

SK46084

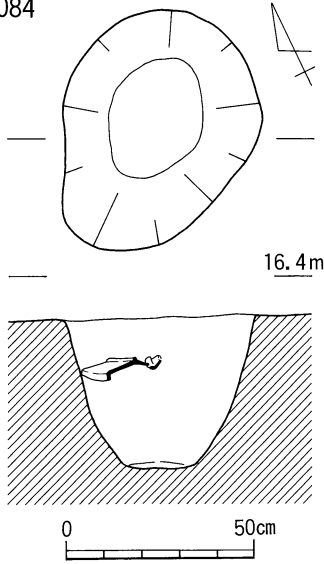

SK46089

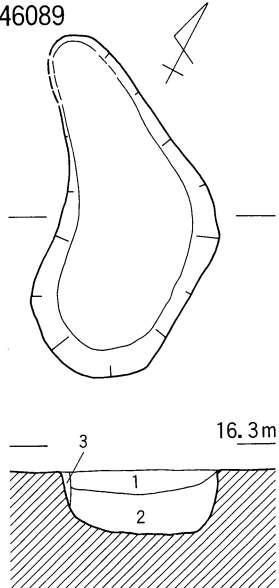

SK46092

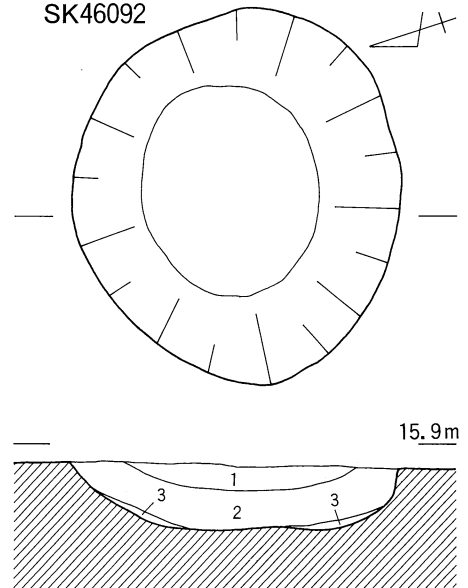

SK46085

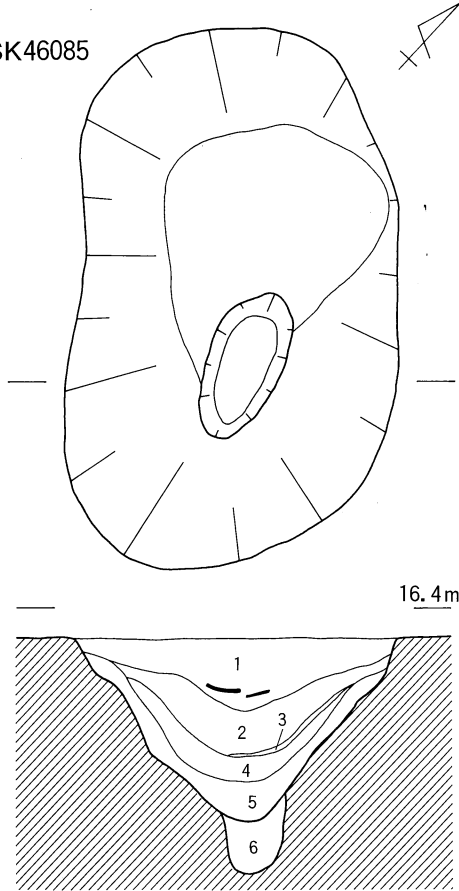

SK46094

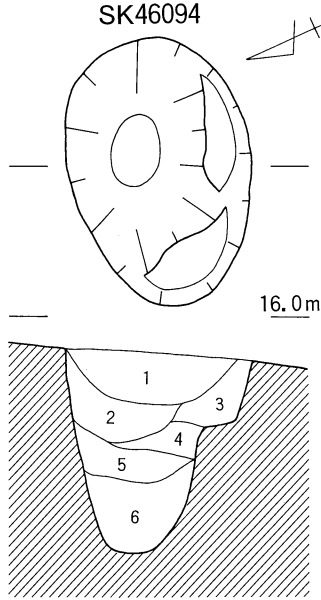

SK46095

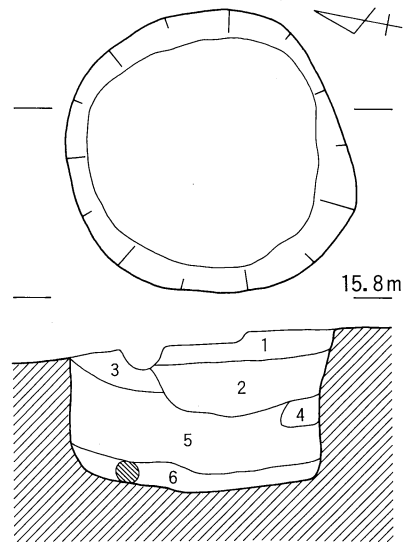

- 1. 10YR2/1 黒 シルト質極細砂
- 2. 7.5Y4/1 灰 シルト質極細砂
- 3. 10Y5/1 灰 シルト質極細砂

- 1. 10YR3/1 黒褐 極細砂
- 2. 2.5Y4/1 黄灰 極細砂
- 3. 7.5Y2/1 黒 炭層

- 1. 7.5YR4/1 褐灰 砂質シルト
- 2. 10YR4/1 褐灰 砂質シルト
- 3. 10YR2/1 黒 砂質シルト
- 4. 2.5Y4/1 黄灰 砂質シルト
- 5. 10YR3/1 黒褐 シルト質極細砂～中砂
- 6. 2.5Y3/1 黒褐 シルト質極細砂～粗粒シルト

- 1. 10YR4/1 褐灰 極細砂
- 2. 10YR4/1 褐灰 シルト質極細砂
- 3. 2.5Y6/2 灰黄 極細砂
- 4. 2.5Y7/2 灰黄 シルト
- 5. 7.5YR4/1 褐灰 シルト
- 6. 5Y5/1 灰 シルト

- 1. 5Y3/1 オリーブ黒 シルト質極細砂
- 2. 7.5Y4/1 灰 極細砂質シルト (焼土を含む)
- 3. 5Y3/1 オリーブ黒 極細砂
- 4. 10YR2/3 黒褐 極細砂
- 5. 7.5YR3/1 黒褐 極細砂
- 6. 2.5Y2/1 黒 極細砂

SK46098

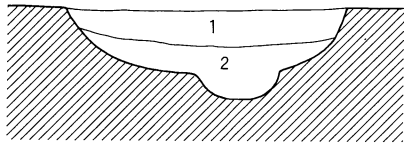
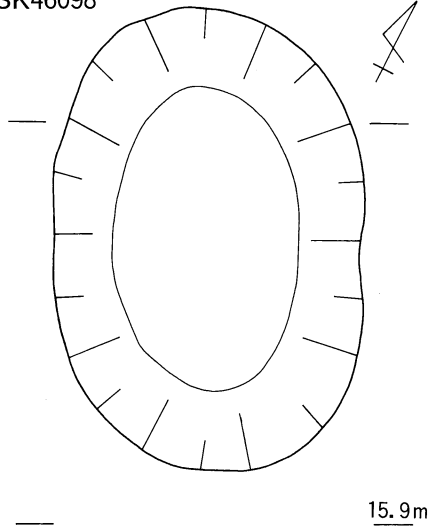

- 1. 2.5Y5/1 黄灰 シルト質極細砂
- 2. 2.5Y3/1 黒褐 シルト質極細砂 (炭を多く含む)

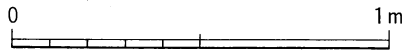

SK46107

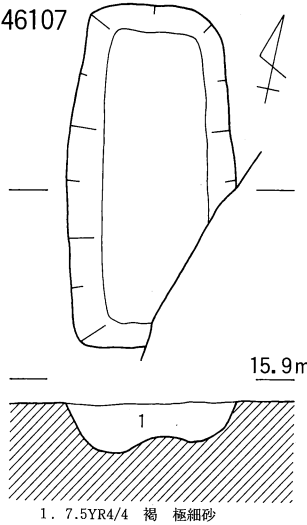

- 1. 7.5YR4/4 褐 極細砂

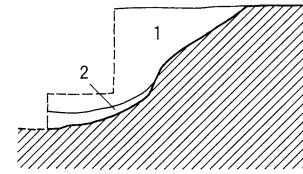
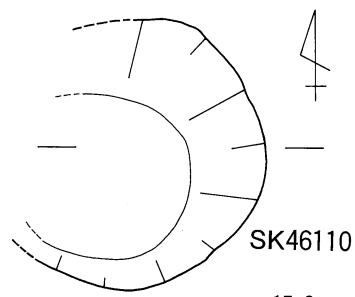
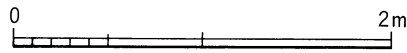

- 1. 7.5Y4/1 灰 極細砂
- 2. N2/0 黒 シルト質極細砂

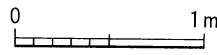
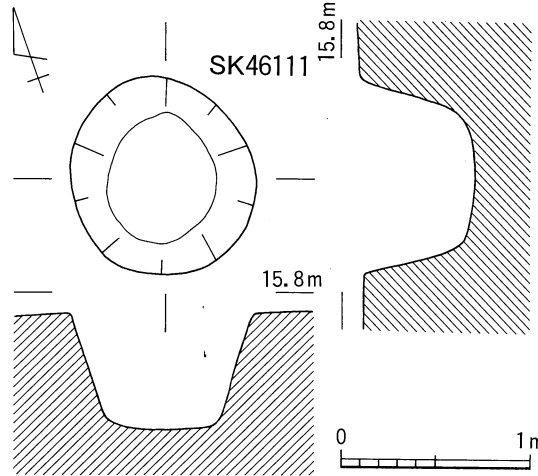

SK46099

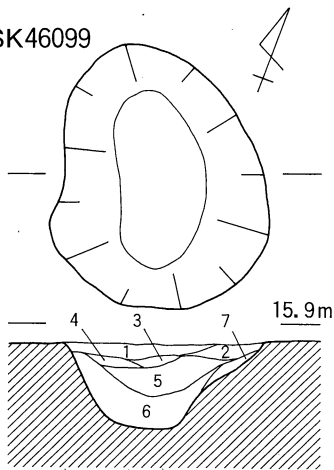

- 1. 7.5Y5/1 灰 シルト質極細砂
- 2. 2.5Y5/1 黄灰 極細砂
- 3. 10YR2/1 黒 極細砂 (炭を多く含む)
- 4. 2.5Y5/1 黄灰 シルト質極細砂
- 5. 2.5Y4/1 黄灰 極細砂 (ラミナ)
- 6. 5Y3/1 オリーブ黒 極細砂 (炭を多く含む)
- 7. 2.5Y7/3 浅黄 シルト質極細砂



SK46112

SK46113

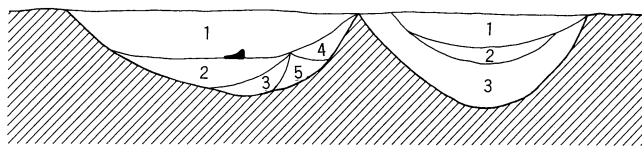
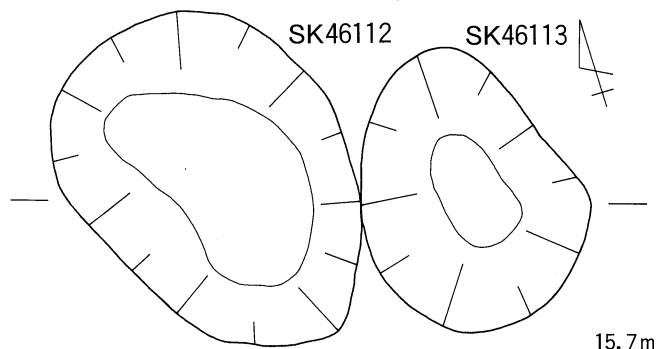

- 1. 7.5YR2/3 暗褐 極細砂
- 2. 7.5YR3/3 暗褐 極細砂
- 3. 2.5Y5/4 黄褐 シルト質極細砂
- 4. 7.5YR3/1 黒褐 シルト質極細砂
- 5. 2.5Y5/4 黄褐 シルト質極細砂

- 1. 10YR3/3 暗褐 極細砂
- 2. 10YR3/1 黒褐 極細砂
- 3. 10YR2/3 黒褐 極細砂



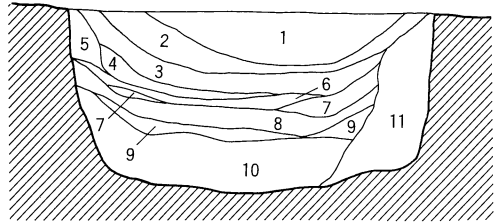
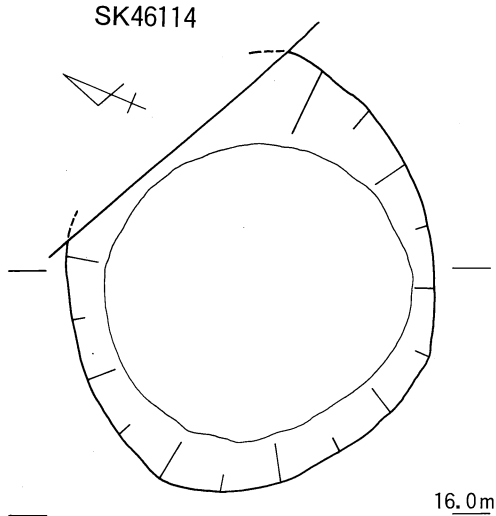

- | | | | |
|--------|---------|----------|-----------|
| 1. 暗灰色 | シルト質極細砂 | 6. 暗灰色 | シルト混じり極細砂 |
| 2. 灰褐色 | 極細砂 | 7. 灰褐色 | 極細砂 |
| 3. 暗灰色 | シルト質極細砂 | 8. 暗灰色 | シルト質極細砂 |
| 4. 灰褐色 | 極細砂 | 9. 灰褐色 | 極細砂 |
| 5. 暗灰色 | シルト質極細砂 | 10. 暗茶灰色 | 粗粒シルト |
| | | 11. 茶灰色 | 粗粒シルト |

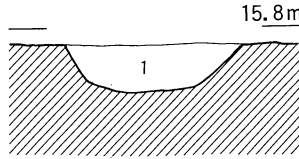
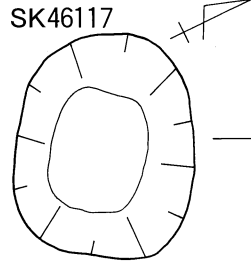
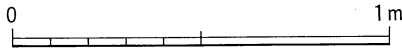

1. 暗灰色 シルト質極細砂

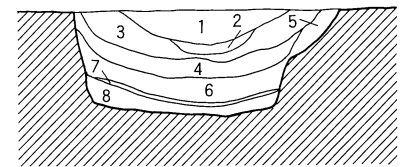
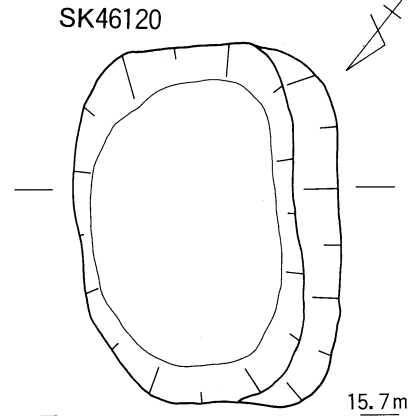
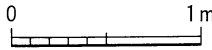

- | | |
|--------|---------------------|
| 1. 茶灰色 | シルト質極細砂 |
| 2. 茶灰色 | シルト質極細砂
(炭を多く含む) |
| 3. 茶褐色 | シルト質極細砂 |
| 4. 茶褐色 | 粗粒シルト |
| 5. 茶灰色 | 極細砂 |
| 6. 暗灰色 | シルト |
| 7. | 植物遺体層 |
| 8. | 暗茶灰色 極細砂混じりシルト |

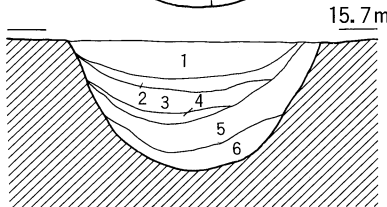
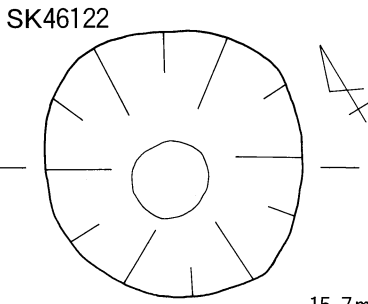
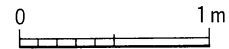

- | | |
|---------|---------------|
| 1. 暗灰色 | 粗粒シルト |
| 2. 暗茶灰色 | シルト質極細砂～粗粒シルト |
| 3. 黄灰色 | 極細砂 |
| 4. 暗茶灰色 | シルト |
| 5. 灰色 | 粗粒シルト |
| 6. 茶灰色 | シルト |

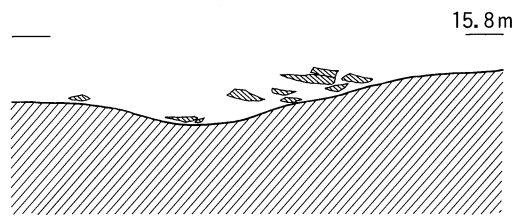
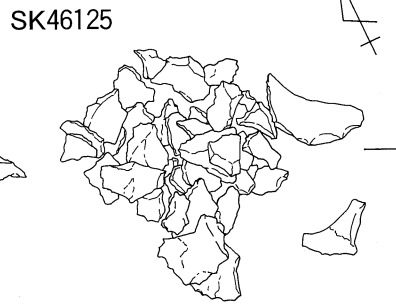

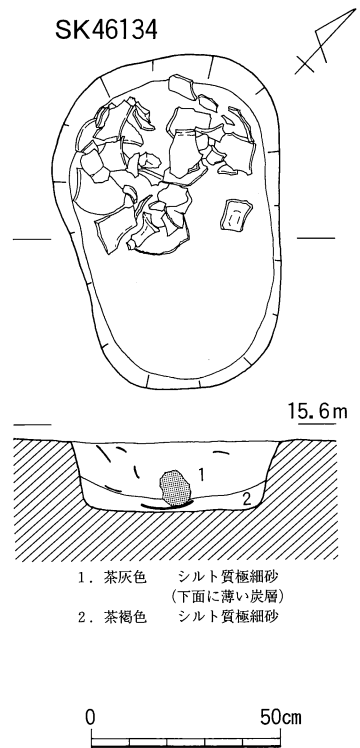
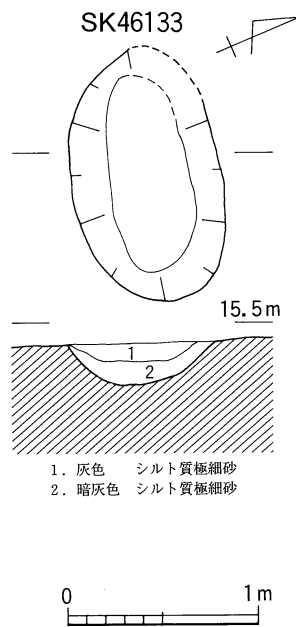
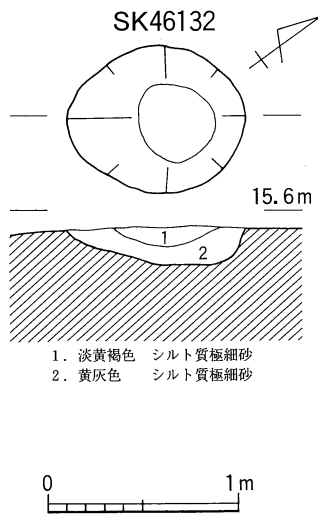
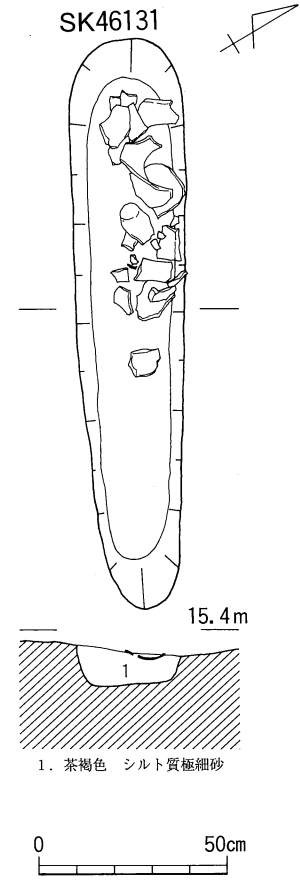
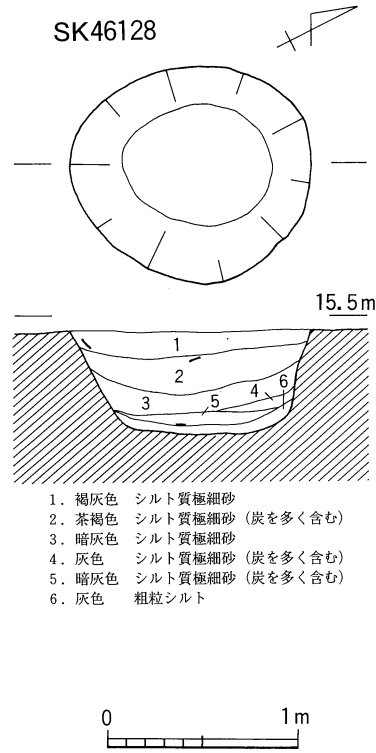
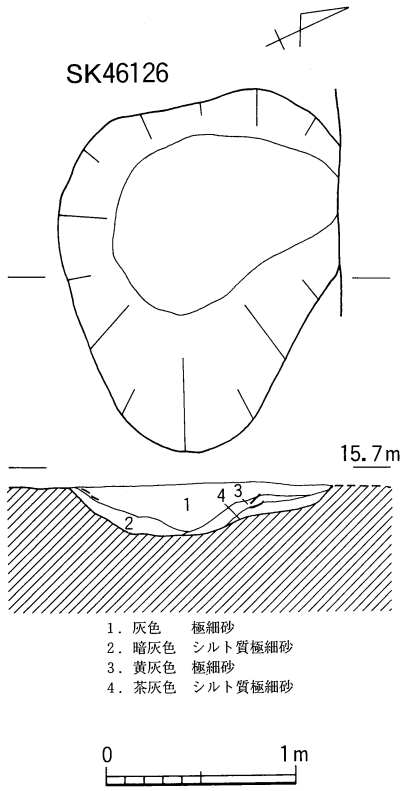

SB86001

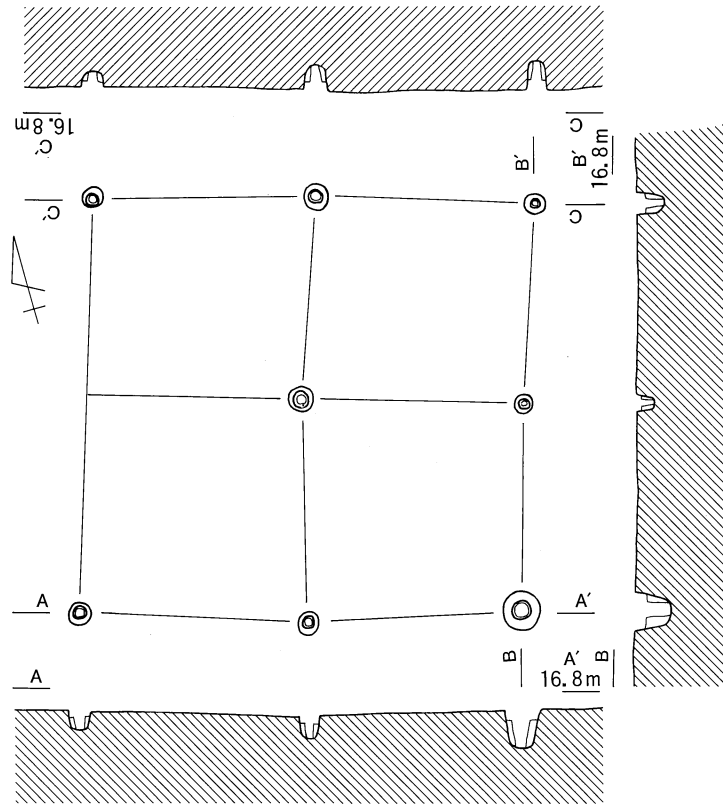

SB86002

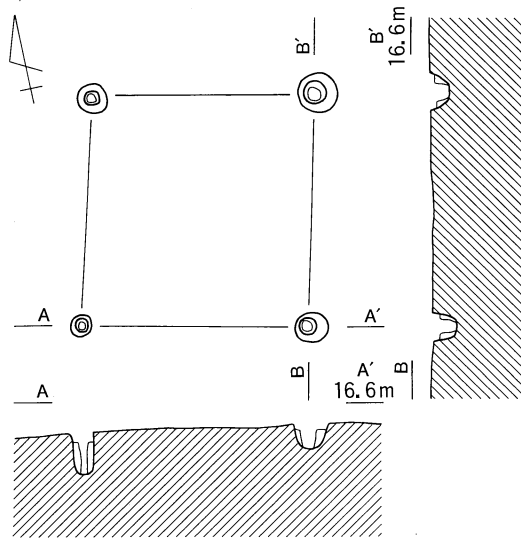

SB86003

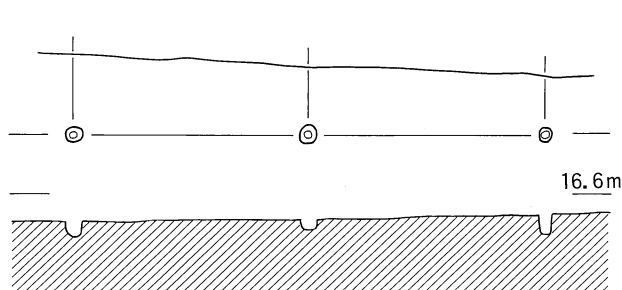

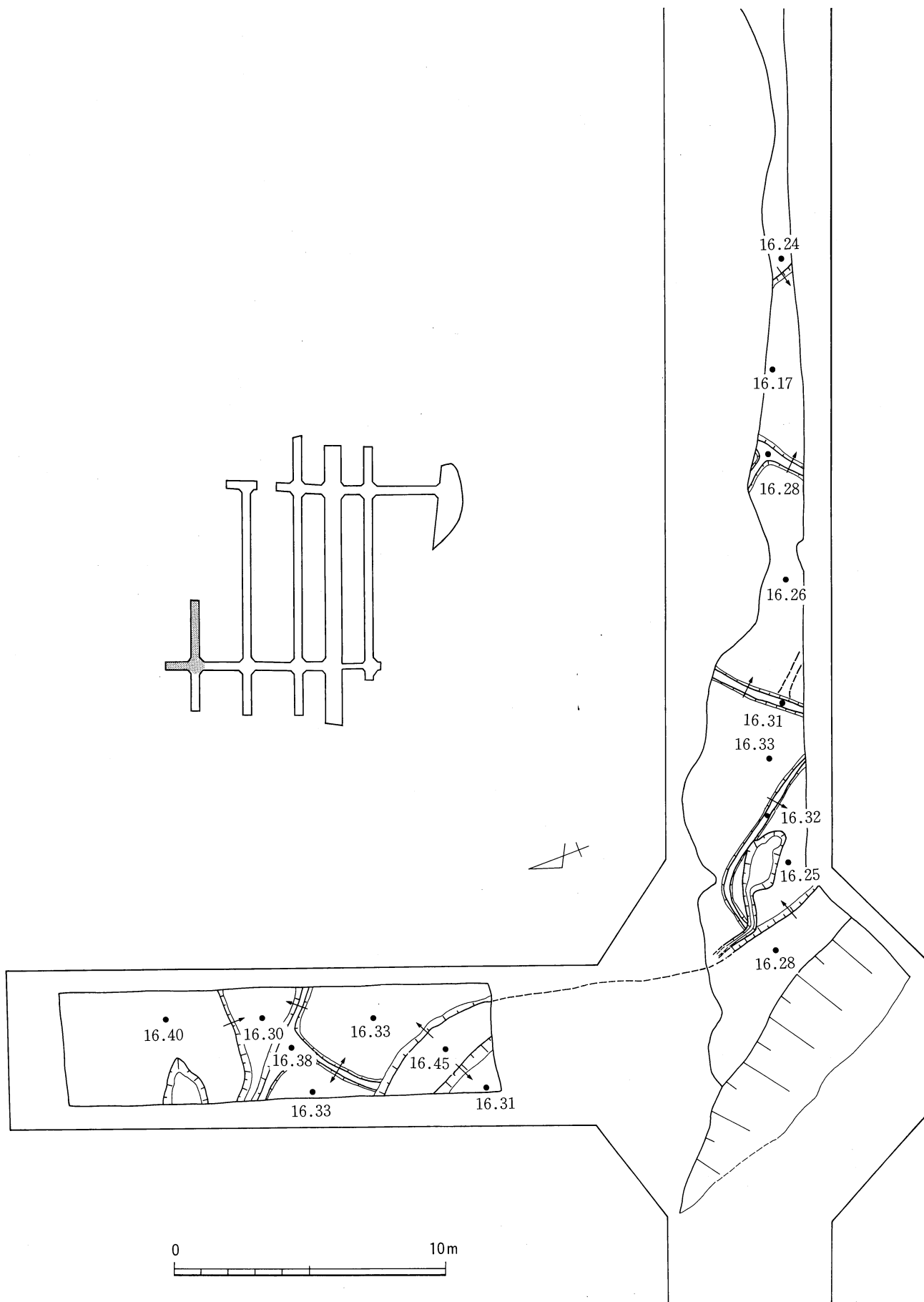

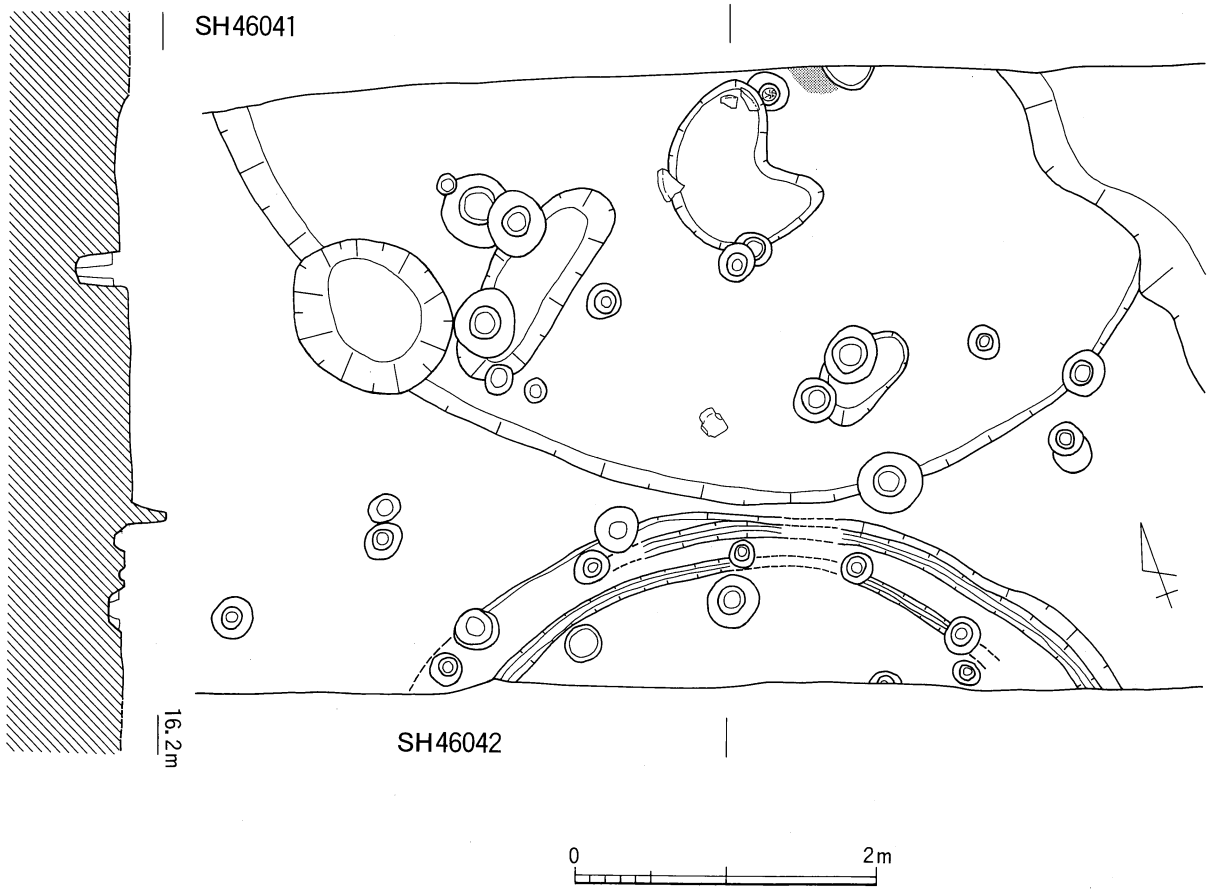
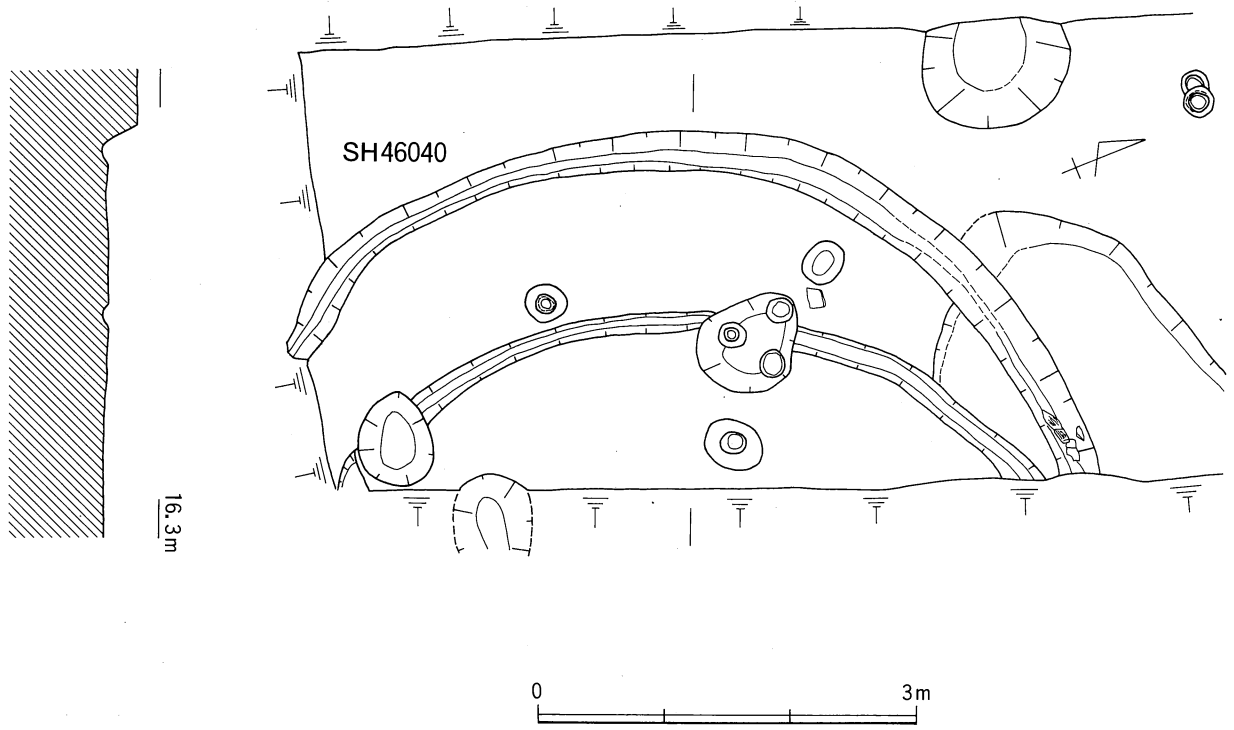

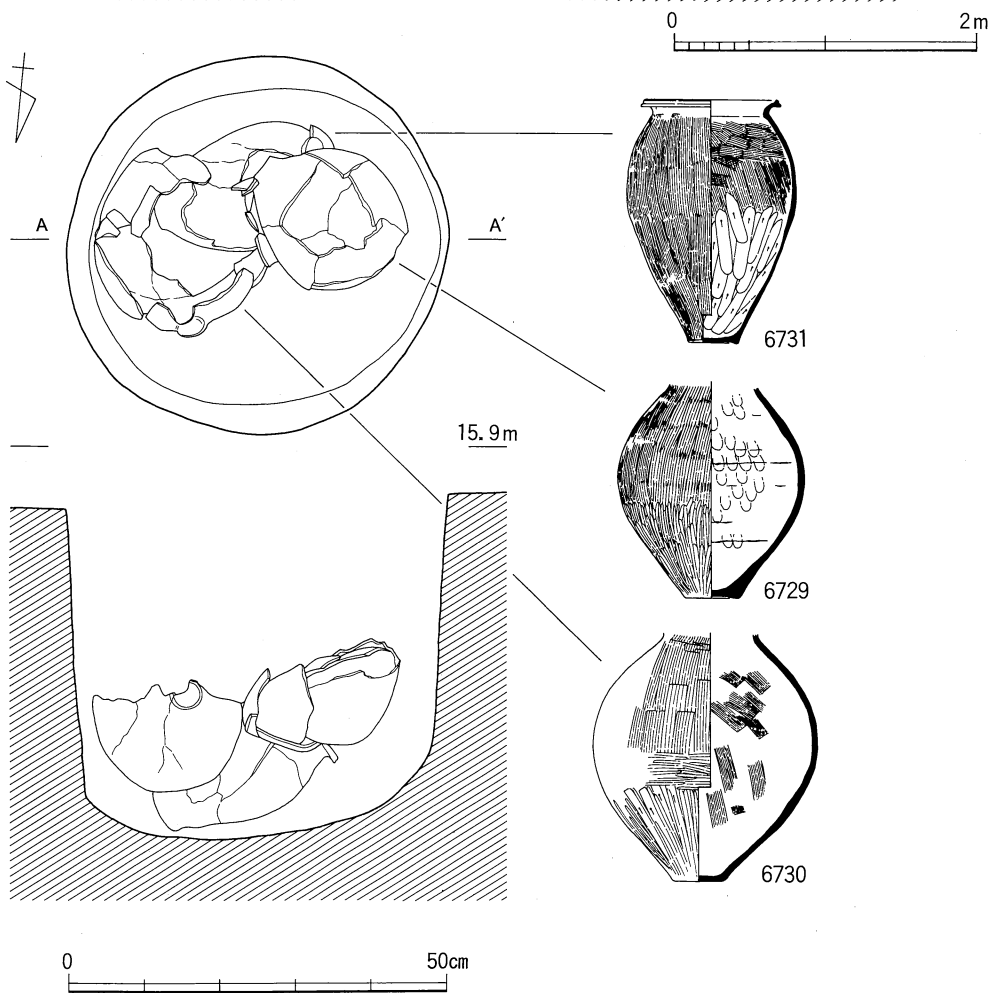
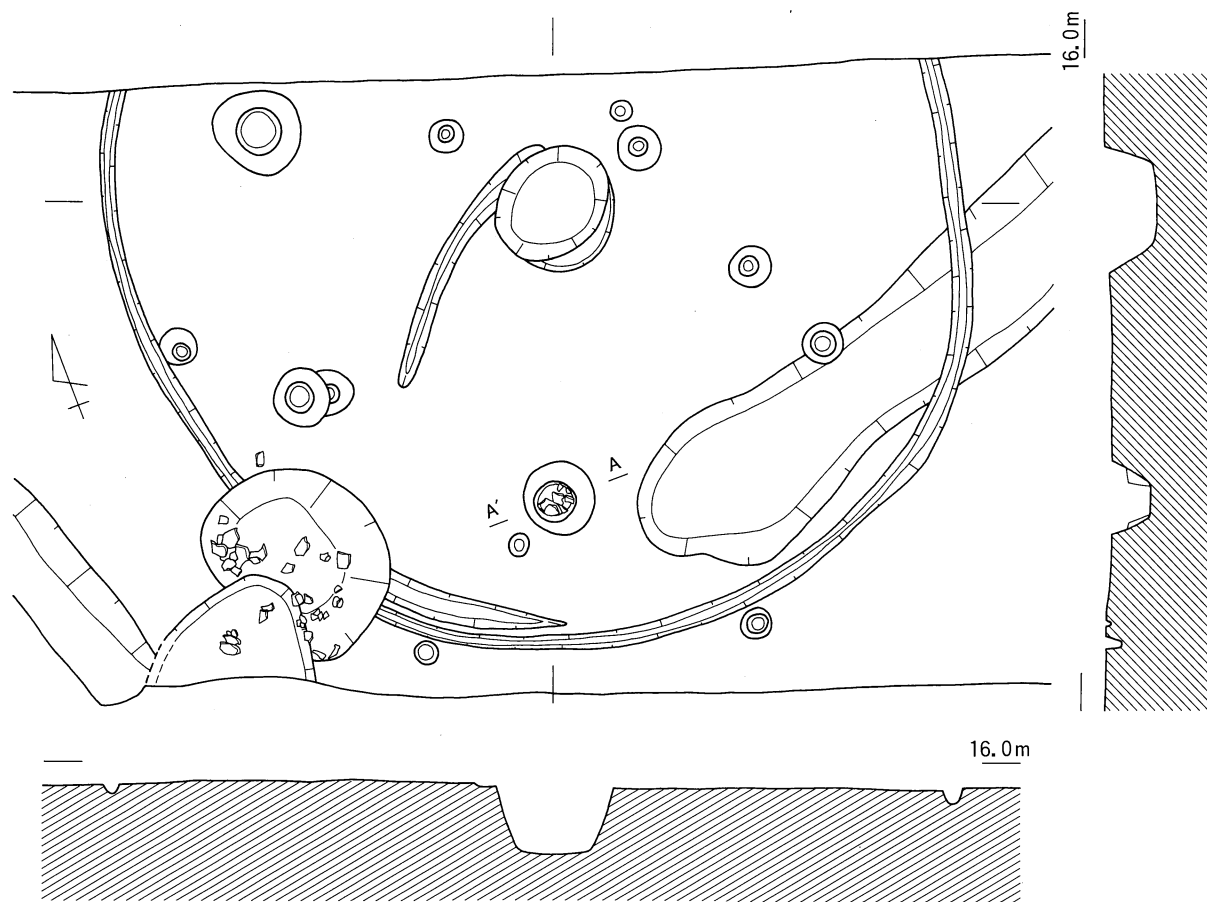

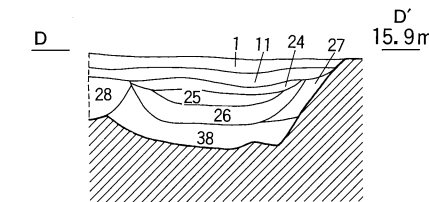
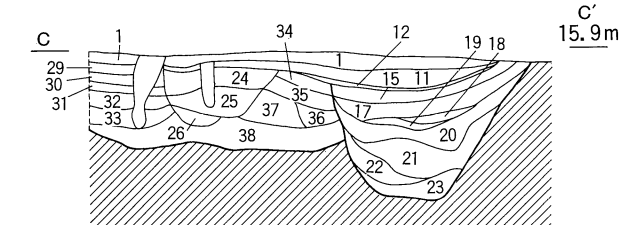
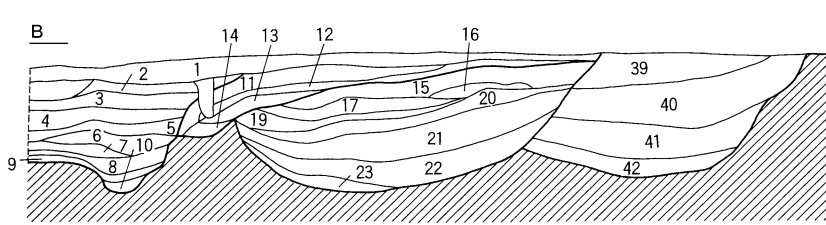
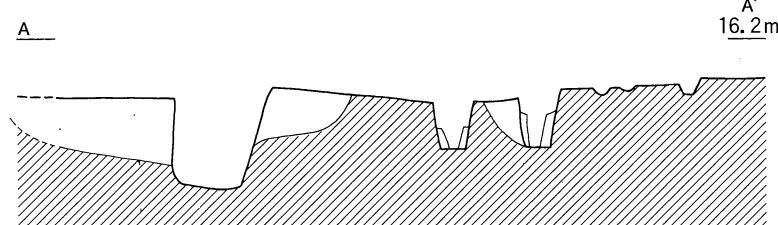
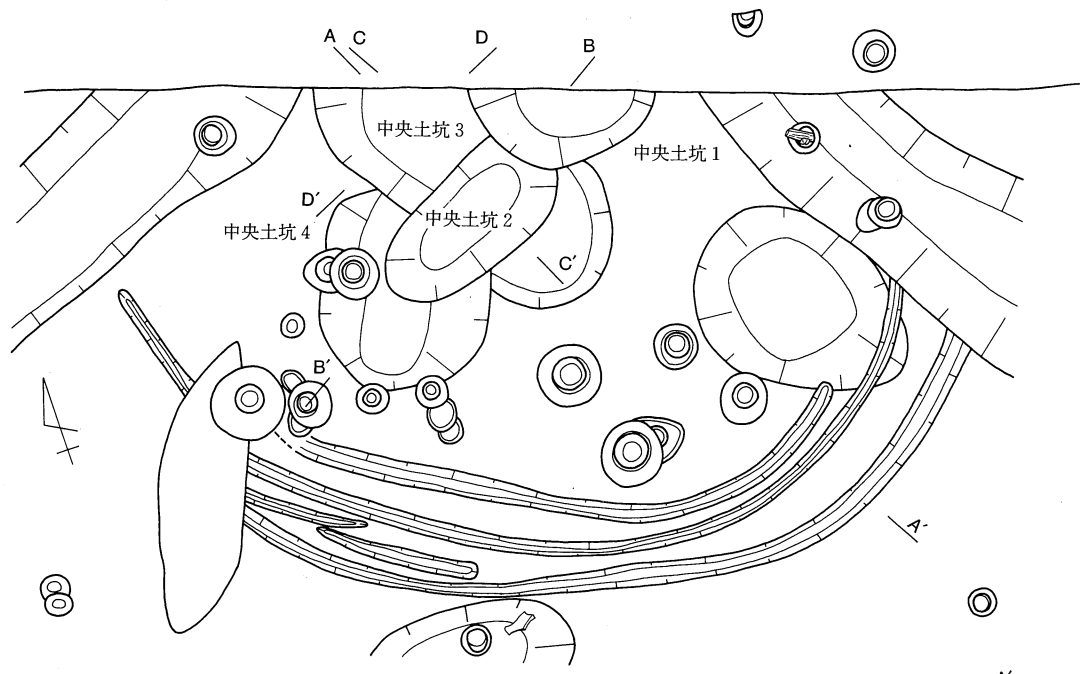

- | | |
|---------------------|------------------------|
| 1. 7.5Y5/1 灰 | シルト質極細砂 |
| 中央土坑 1 埋土 | |
| 2. 2.5GY4/1 暗オリーブ灰 | 粗粒シルト |
| 3. 10Y4/1 | 極細砂質シルト |
| 4. 5G3/1 暗緑灰 | 極細砂質シルト |
| 5. 10G2/1 緑黒 | 極細砂質シルト |
| 6. N1.5/0 黒 | 粗粒シルト (炭層) |
| 7. 5G5/1 緑灰 | 極細砂質シルト |
| 8. 10GY4/1 暗緑灰 | 極細砂質シルト |
| 9. 10GY3/1 暗緑灰 | 砂混じりシルト |
| 10. 7.5GY4/1 暗緑灰 | 中砂混じりシルト |
| 11. 10Y5/1 灰 | 極細砂質シルト |
| 12. 7.5Y6/1 灰 | シルト質極細砂
(白色砂ブロック含む) |
| 13. 5G1.7/1 緑黒 | 粗粒シルト |
| 14. 5G3/1 暗緑灰 | 砂混じりシルト |
| 中央土坑 2 埋土 | |
| 15. 7.5Y5/1 灰 | シルト質極細砂
(白色砂ブロック含む) |
| 16. 7.5Y5/1 灰 | 中砂 |
| 17. 7.5GY6/1 緑灰 | 極細砂質シルト |
| 18. 7.5Y5/1 灰 | 中砂 |
| 19. 5GY6/1 オリーブ灰 | 極細砂質シルト |
| 20. 5BG3/1 暗青灰 | 粗粒シルト (炭層) |
| 21. 10G5/1 緑灰 | シルト質極細砂 |
| 22. 5G4/1 暗緑灰 | |
| 23. 2.5GY3/1 暗緑 | |
| 中央土坑 3 埋土 | |
| 24. N2/0 黒 | 極細砂質シルト (炭層) |
| 25. 5BG3/1 暗青灰 | 極細砂質シルト |
| 26. 5G5/1 緑灰 | 砂混じりシルト |
| 27. 10Y7/2 灰白 | シルト質極細砂 |
| 28. 5Y5/1 灰 | 極細砂質シルト |
| 29. 7.5GY3/1 暗緑灰 | 極細砂質シルト
(白色砂ブロック含む) |
| 30. 5GY4/1 暗オリーブ灰 | 極細砂質シルト |
| 31. 2.5GY2/1 黒 | 粗粒シルト |
| 32. 7.5Y5/1 灰 | 極細砂質シルト
(白色砂ブロック含む) |
| 33. 10Y6/1 灰 | 極細砂質シルト |
| 34. 5GY4/1 暗オリーブ灰 | 極細砂質シルト |
| 35. 2.5GY4/1 暗オリーブ灰 | 極細砂質シルト
(白色砂ブロック含む) |
| 36. 7.5GY5/1 緑灰 | 極細砂質シルト |
| 37. 7.5Y5/1 灰 | 極細砂質シルト |
| 38. 5GY6/1 オリーブ灰 | 砂混じりシルト |
| 中央土坑 4 埋土 | |
| 39. 5Y6/1 灰 | 細砂質シルト |
| 40. 5Y5/1 灰 | 極細砂質シルト |
| 41. 10Y4/1 灰 | シルト質極細砂 |
| 42. 5BG6/1 青灰 | シルト質極細砂 |

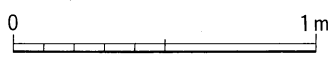

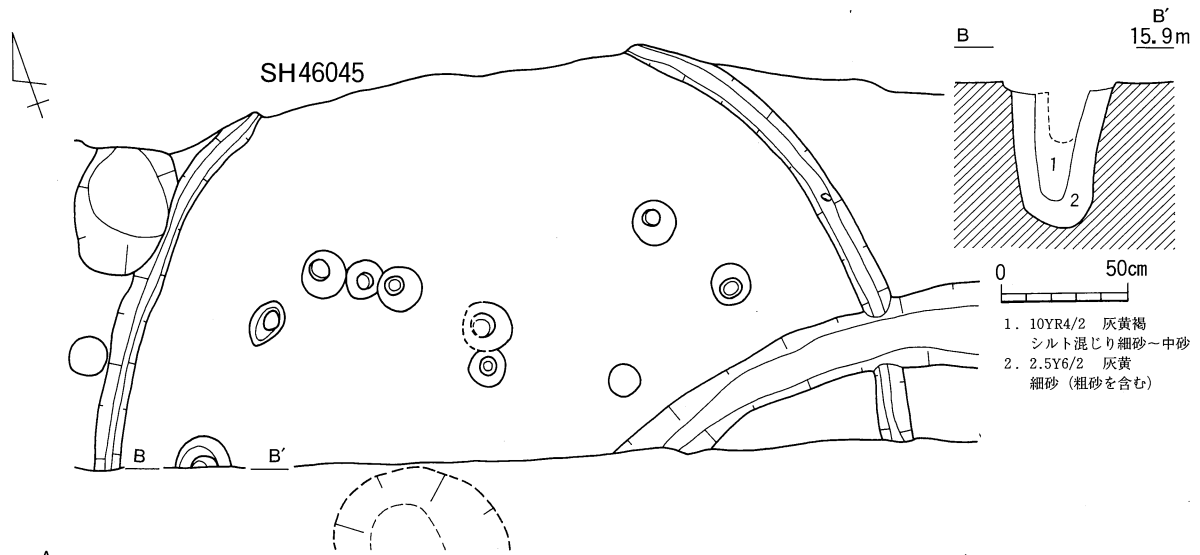

1. 10YR4/2 灰黄褐
シルト混じり細砂~中砂
2. 2.5Y6/2 灰黄
細砂 (粗砂を含む)

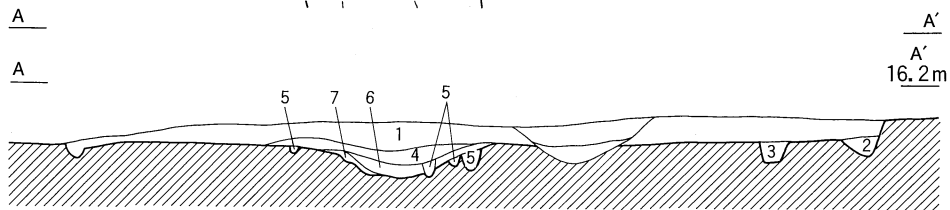

1. 2.5Y5/2 暗灰黄 シルト質細砂
2. 2.5Y5/1 黄灰 シルト質細砂
3. 2.5Y5/1 黄灰 シルト質細砂
4. 2.5Y4/1 黄灰 シルト質細砂
5. 2.5Y5/1 黄灰 シルト質細砂
6. 2.5Y4/2 暗灰黄 シルト質細砂
(下面に炭層)
7. 2.5Y6/1 黄灰 シルト質細砂

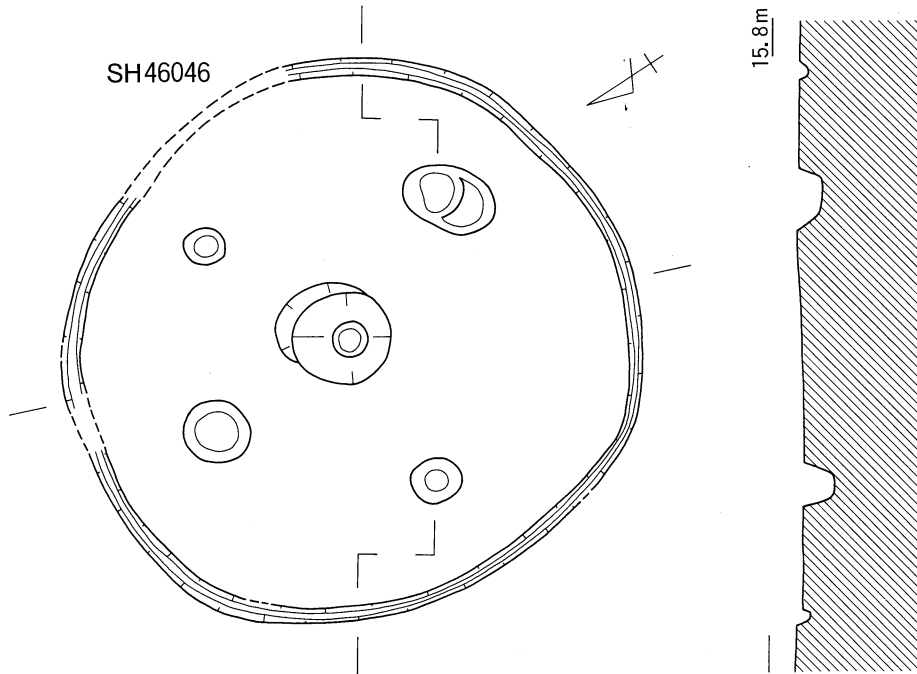

1. 暗灰色 シルト質極細砂
2. 炭層
3. 青灰色 粗粒シルト (炭を含む)
4. 黄灰色 シルト混じり極細砂

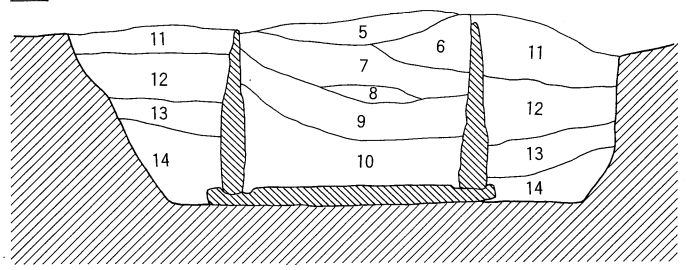
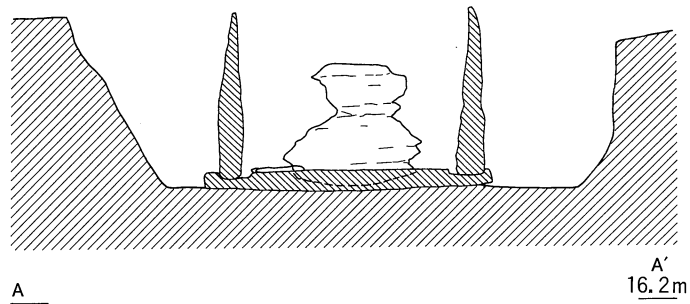
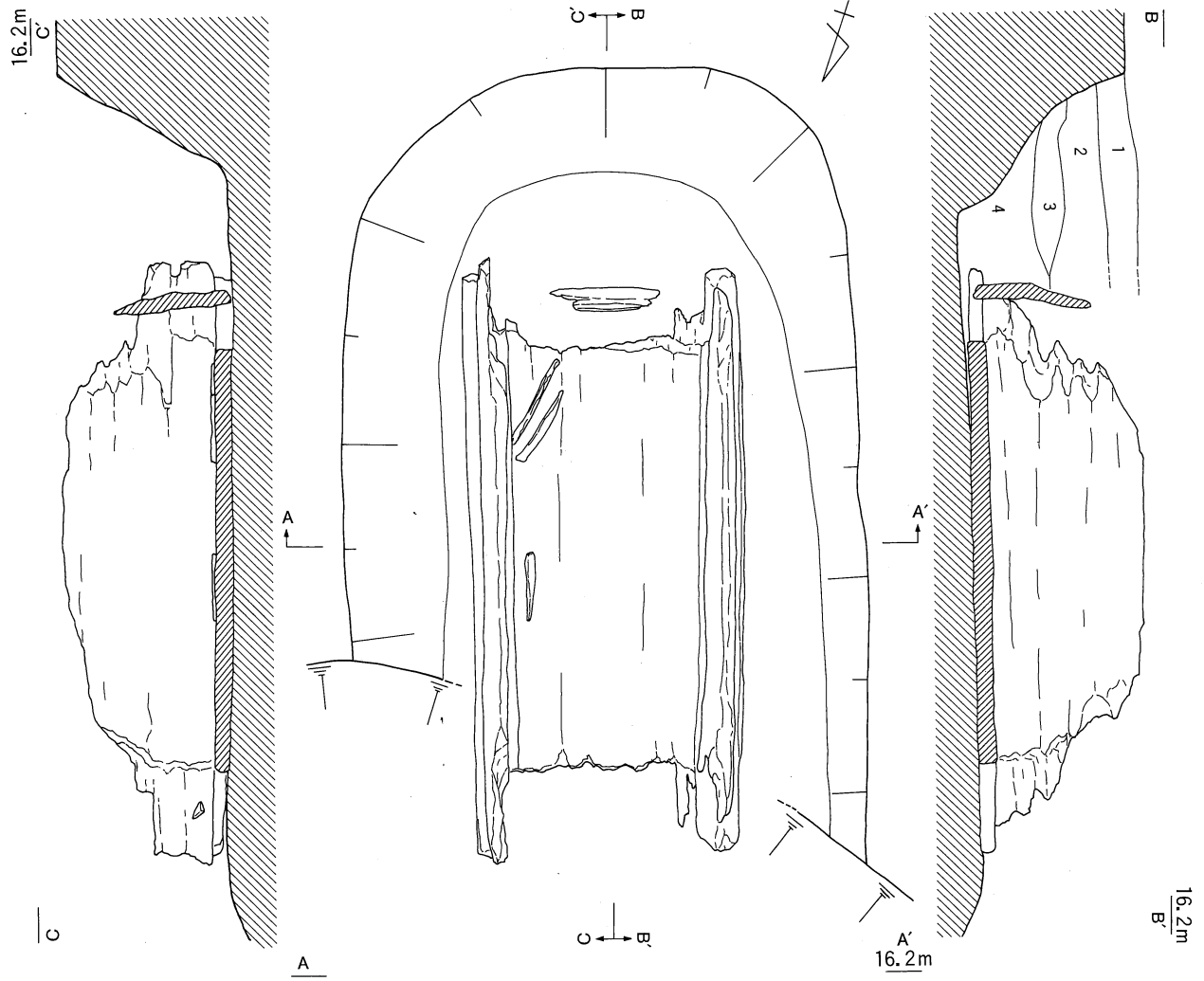

- | | | | |
|-----------------|--------|----------------|---------|
| 1. 7.5Y6/1 灰 | シルト質細砂 | 8. 7.5GY5/1 緑灰 | シルト質細砂 |
| 2. 10Y5/1 灰 | シルト質細砂 | 9. N5/0 灰 | シルト質細砂 |
| 3. 10Y6/1 灰 | シルト質細砂 | 10. 10GY5/1 緑灰 | シルト質細砂 |
| 4. 10BG5/1 青灰 | シルト質細砂 | 11. 10Y5/1 灰 | シルト質細砂 |
| 5. 7.5Y6/1 灰 | シルト質細砂 | 12. 10Y6/1 灰 | シルト質細砂 |
| 6. 5Y6/1 灰 | シルト質細砂 | 13. 5BG5/1 青灰 | シルト質細砂 |
| 7. 5GY6/1 オリーブ灰 | シルト質細砂 | 14. 5BG5/1 青灰 | シルト質極細砂 |

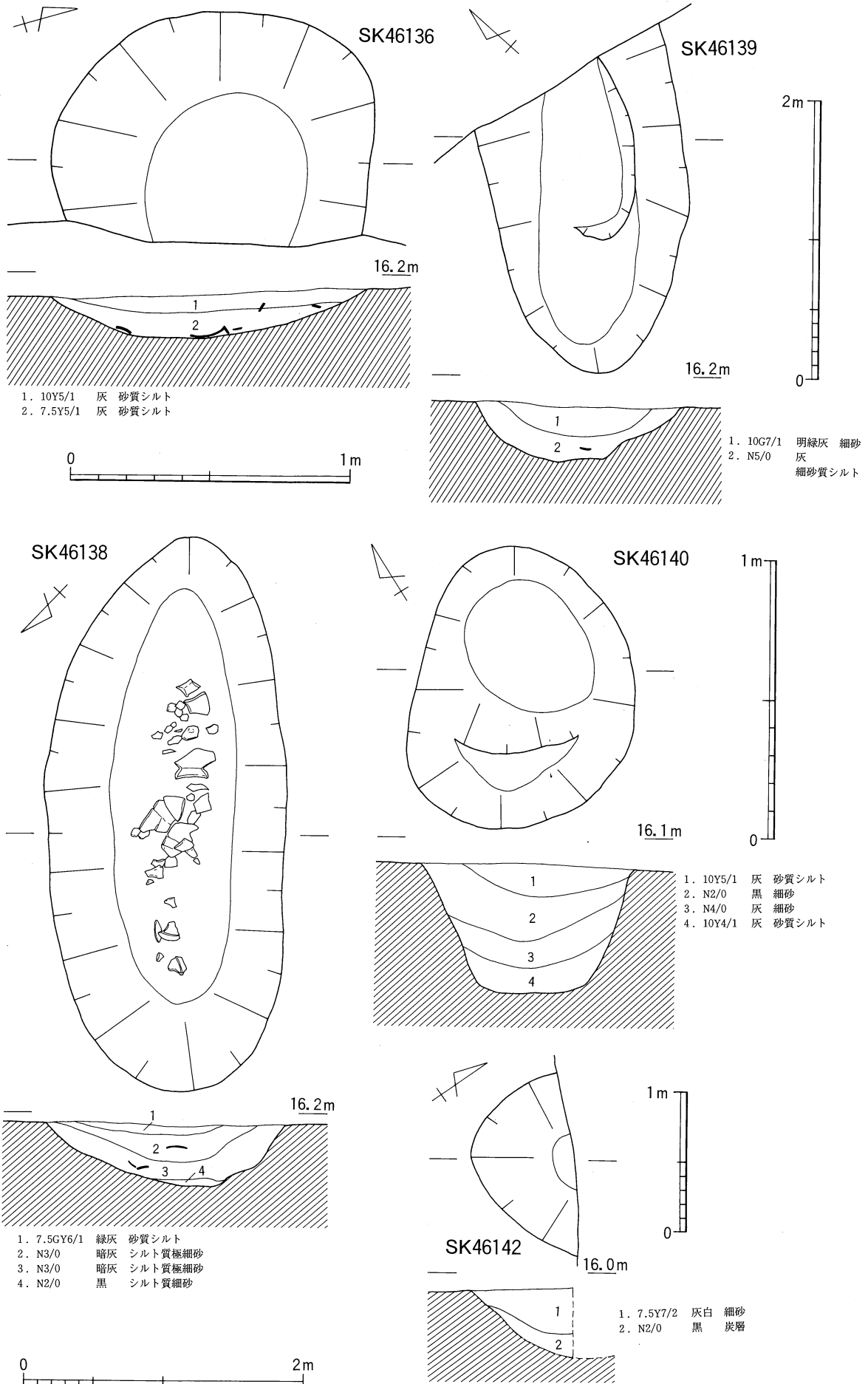

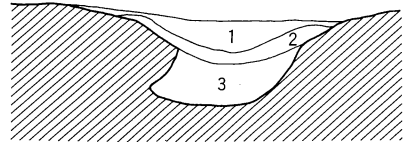
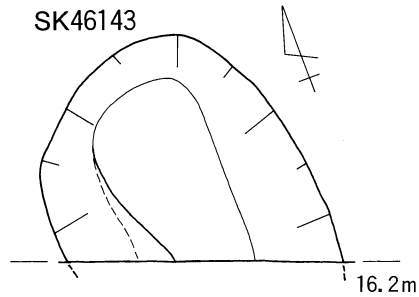

- 1. 10Y6/1 灰 細砂質シルト
- 2. N4/0 灰 シルト質極細砂
- 3. N2/0 黒 炭層

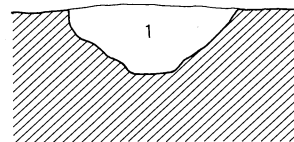
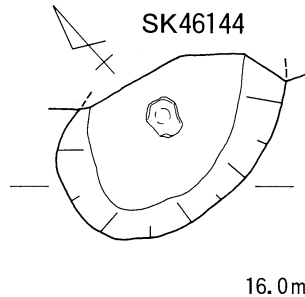

- 1. 5Y3/1 オリーブ黒 砂質シルト

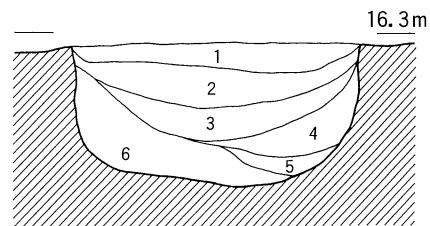
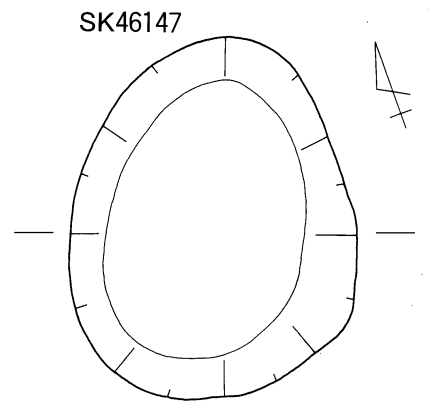

- 1. 7.5Y6/1 灰 極細砂
- 2. 2.5GY6/1 オリーブ灰 シルト質極細砂
- 3. 2.5GY5/1 オリーブ灰 シルト質極細砂 (下面に炭層)
- 4. 7.5GY4/1 暗緑灰 シルト質極細砂 (小礫含む)
- 5. 7.5GY7/1 明緑灰 細砂
- 6. 7.5GY5/1 緑灰 極細砂質シルト (小礫含む)

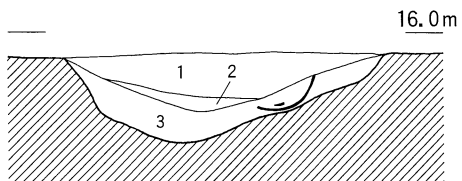
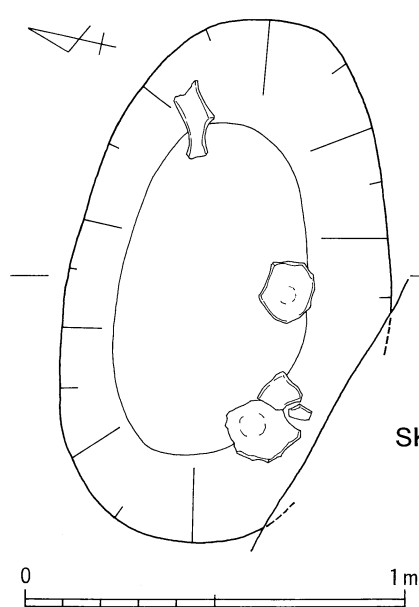
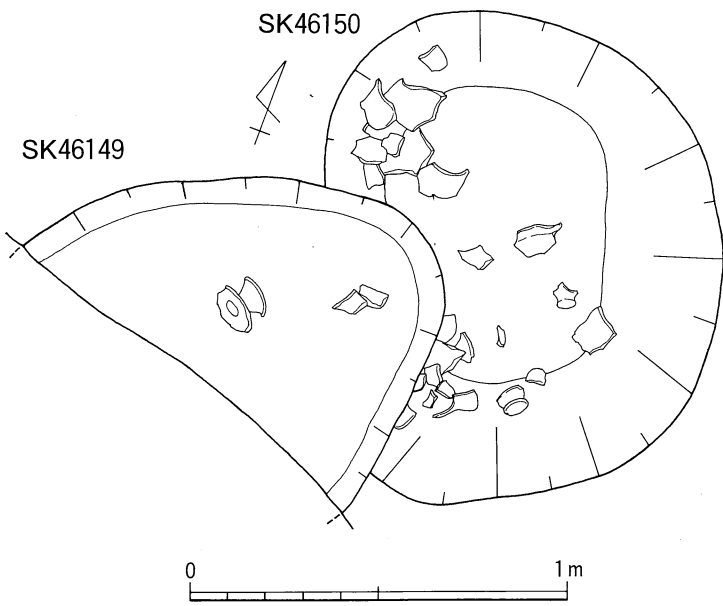
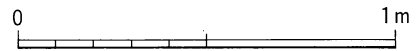

- 1. 2.5GY5/1 オリーブ灰 シルト質極細砂
- 2. 2.5GY4/1 暗オリーブ灰 極細砂質シルト
- 3. 7.5GY3/1 暗緑灰 極細砂質シルト

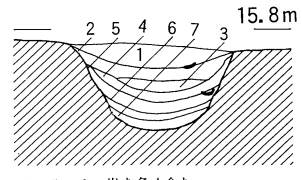

4・5・6. 炭を多く含む

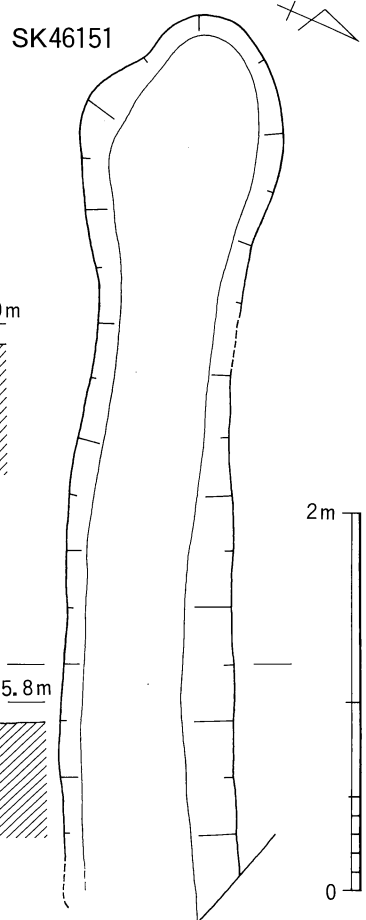

SK46153

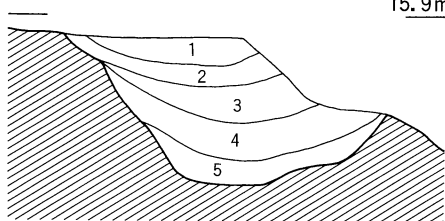
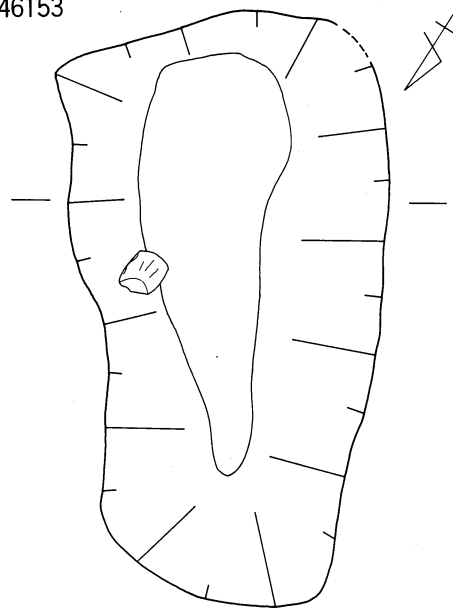

- 1. 7.5Y4/1 灰 極細砂質シルト
- 2. 7.5Y4/1 灰 シルト質極細砂
- 3. 5Y5/1 灰 極細砂質シルト
- 4. 10GY4/1 暗緑灰 極細砂質シルト
- 5. 5B4/1 暗青灰 極細砂質シルト



SK46158

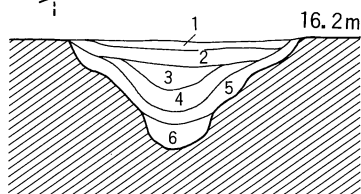
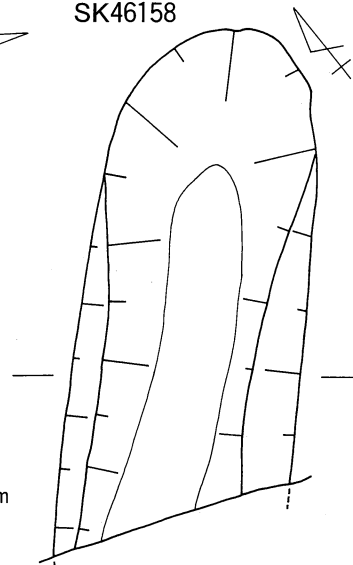

- 1. 10Y6/1 灰 シルト質極細砂
- 2. 7.5Y6/1 灰 細砂質シルト
- 3. 10Y5/1 灰 細砂質シルト
- 4. 7.5Y5/1 灰 シルト質細砂
- 5. N3/0 暗灰 シルト質中砂
- 6. 10Y5/1 灰 シルト質細砂



SK46156

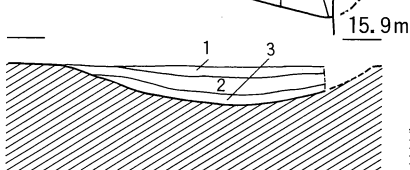

- 1. 7.5Y5/1 灰 細砂 (ラミナ)
- 2. 10Y4/1 灰 シルト質細砂
- 3. 2.5Y2/1 黒 シルト質極細砂 (炭・焼土を含む)

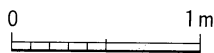

SK46159

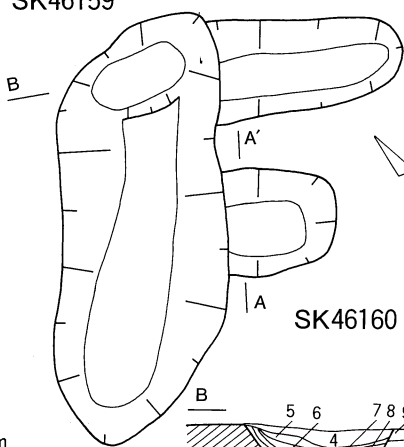

SK46161

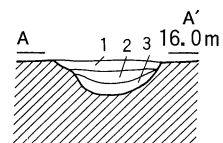

SK46160

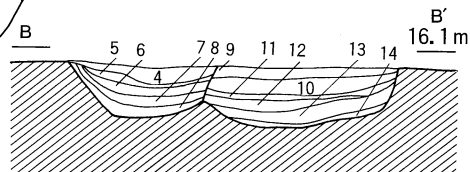

- 1. 2.5Y5/1 黄灰 シルト質極細砂
- 2. N2/0 黒 細砂質シルト
- 3. 2.5GY5/1 オリブ灰 シルト質中砂
- 4. 5Y5/1 灰 シルト質細砂
- 5. 10Y5/1 灰 細砂質シルト
- 6. 7.5Y4/1 灰 シルト質細砂
- 7. N4/0 灰 シルト質細砂
- 8. N4/0 灰 細砂質シルト
- 9. 7.5Y5/1 灰 シルト質細砂
- 10. 7.5Y5/1 灰 細砂質シルト
- 11. 7.5Y6/1 灰 シルト質中砂
- 12. 10GY5/1 緑灰 細砂混じりシルト
- 13. N2/0 黒 シルト質細砂
- 14. 10YR3/2 黒褐 細砂混じりシルト (炭を多く含む)



SK46157

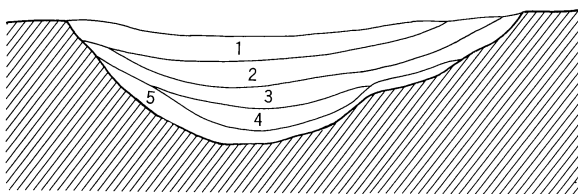
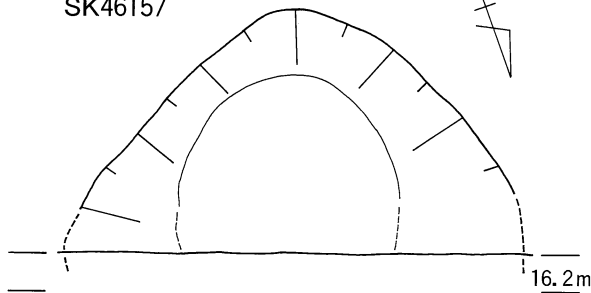

- 1. 5Y6/1 灰 極細砂質シルト
- 2. 10Y5/1 灰 細砂質シルト
- 3. 7.5Y5/1 灰 シルト質細砂 (細礫を含む)
- 4. 7.5Y4/1 灰 シルト質細砂
- 5. 5Y3/1 オリブ黒 砂質シルト (有機物を多く含む)



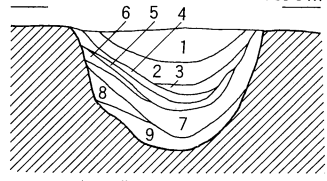
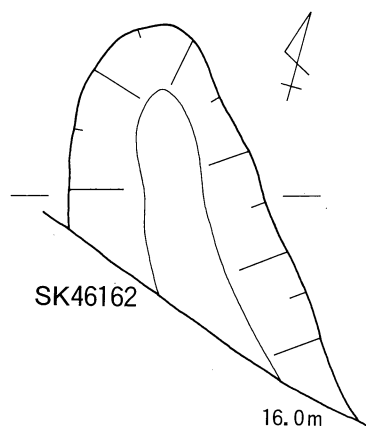

- 1. 2.5Y4/1 黄灰 シルト質細砂
- 2. 5Y5/1 灰 極細砂質シルト
- 3. N4/0 灰 細砂質シルト
- 4. 2.5GY4/1 暗オリーブ灰 中砂
- 5. 2.5GY5/1 オリーブ灰 極細砂質シルト
- 6. 2.5GY5/1 オリーブ灰 中砂
- 7. N3/0 暗灰 細砂質シルト
- 8. N4/0 灰 シルト質極細砂
- 9. 2.5Y3/1 黒褐 細砂質シルト

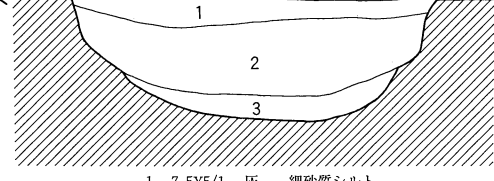
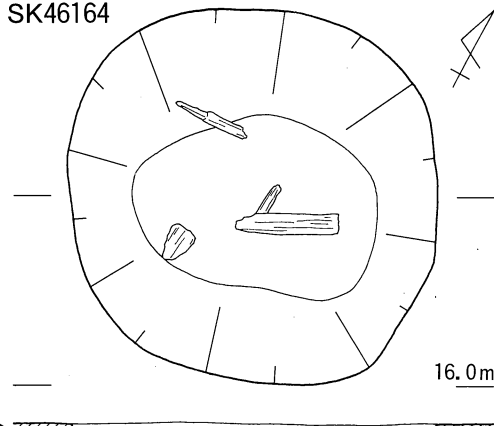
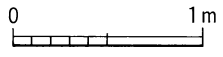

- 1. 7.5Y5/1 灰 細砂質シルト
- 2. N3/0 暗灰 シルト質細砂
- 3. 7.5Y4/1 灰 シルト質細砂

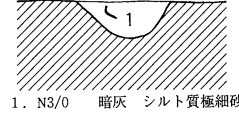
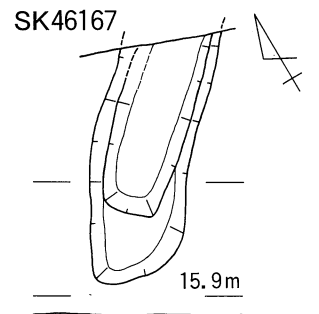
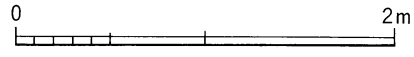

- 1. N3/0 暗灰 シルト質極細砂

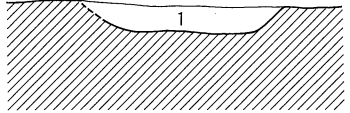
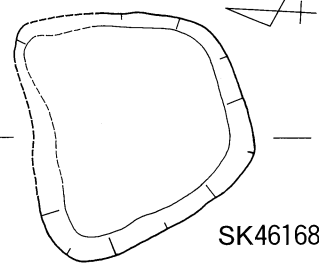
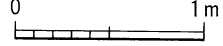

- 1. 10Y4/1 灰 シルト質細砂

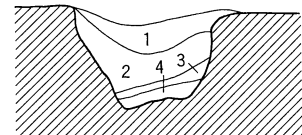
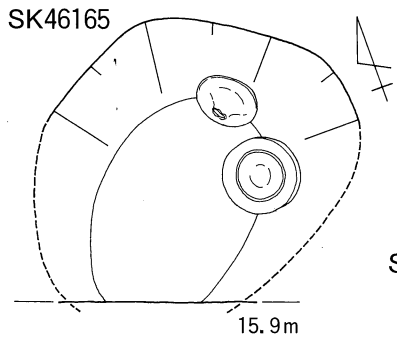
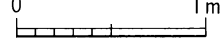

- 1. N3/0 暗灰 細砂質シルト
- 2. N3/0 暗灰 中砂質シルト
- 3. 5Y3/1 オリーブ黒 シルト質細砂
- 4. 7.5GY5/1 緑灰 シルト質細砂

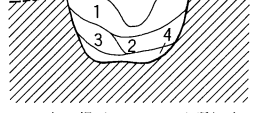
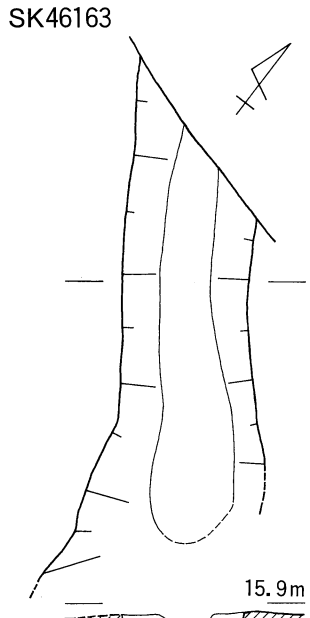

- 1. 10YR4/1 褐灰 シルト質細砂
- 2. 2.5Y6/3 におい黄 細砂混じりシルト
- 3. 2.5Y4/1 黄灰 シルト
- 4. 7.5Y4/1 灰 細砂混じりシルト

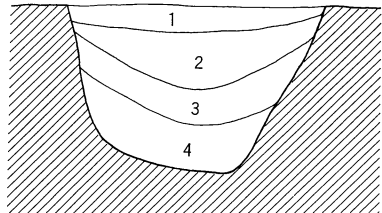
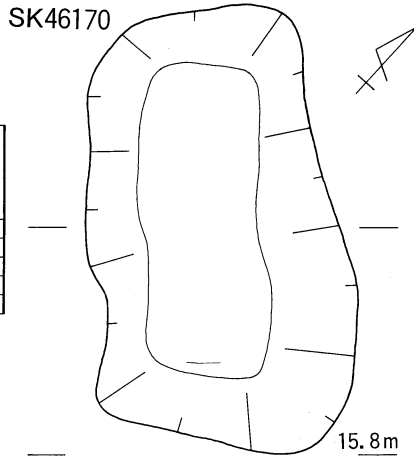
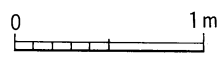

- 1. 7.5Y5/1 灰 細砂質シルト
- 2. 7.5Y4/1 灰 細砂混じりシルト
- 3. N4/0 灰 極細砂質シルト
- 4. 5Y3/1 オリーブ黒 細砂質シルト

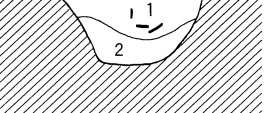
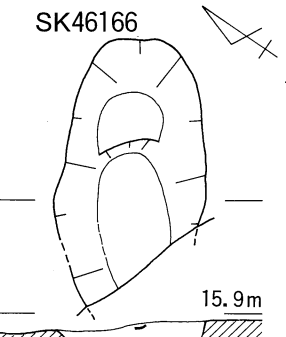

- 1. 7.5Y4/1 灰 細砂質シルト
- 2. 10Y4/1 灰 シルト質細砂

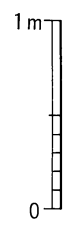

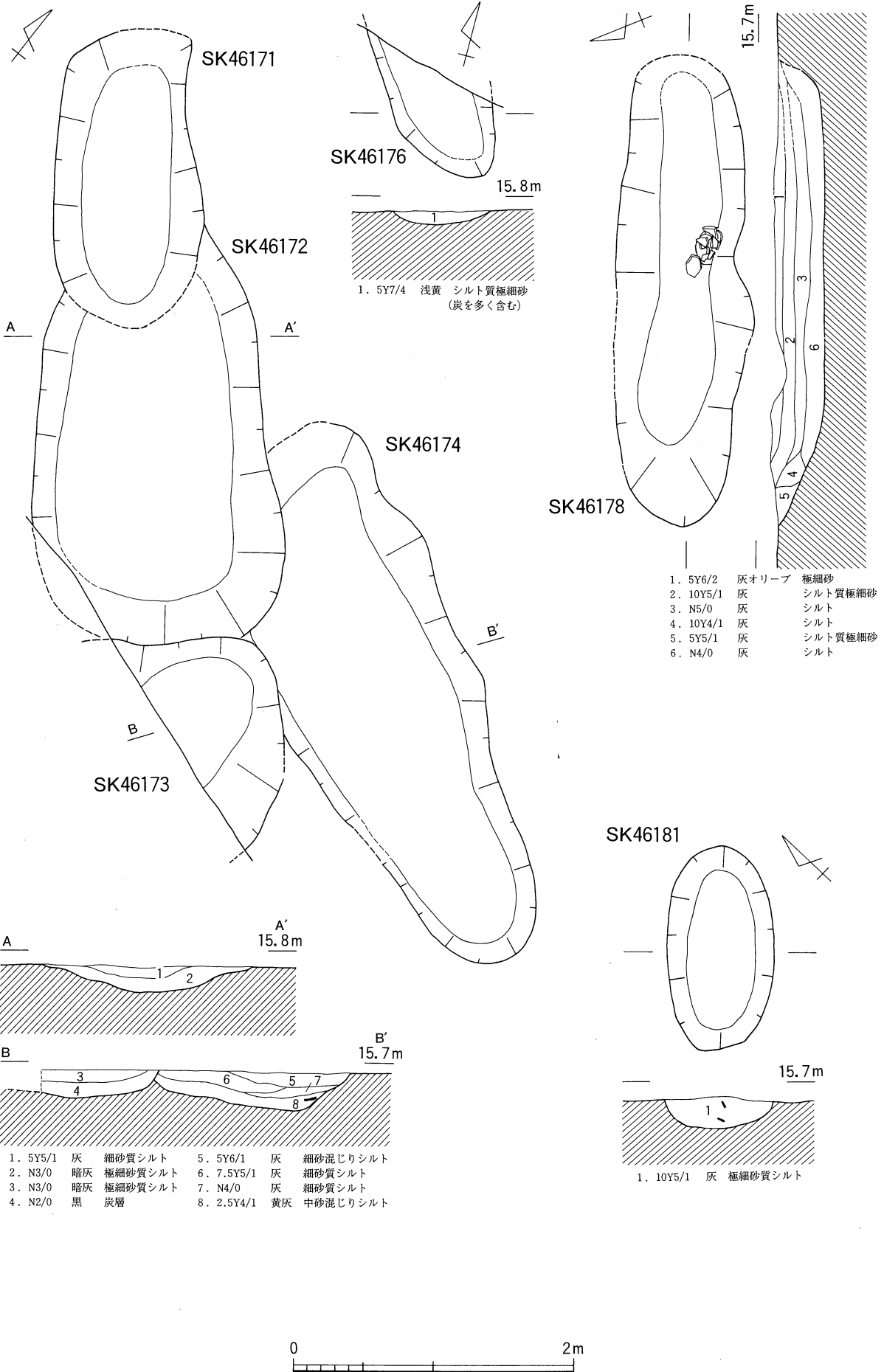

SK46184

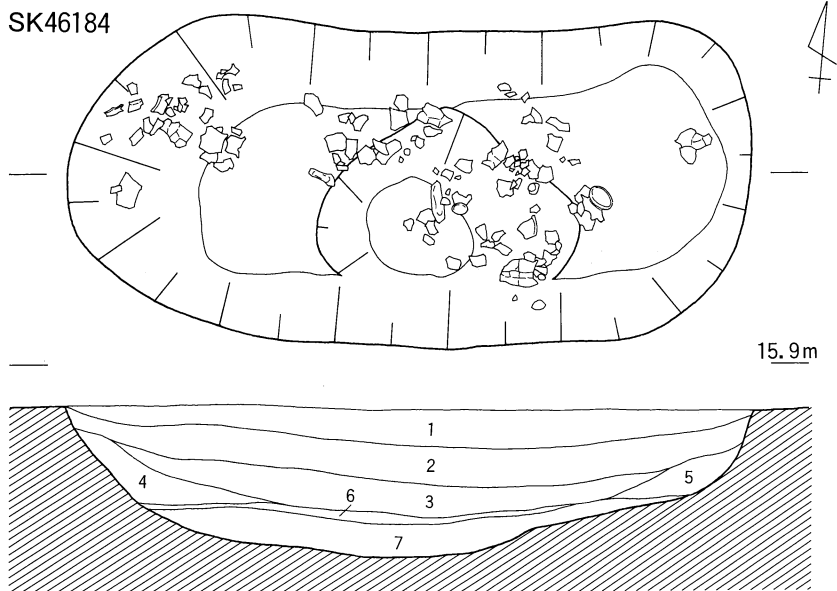

SK46185

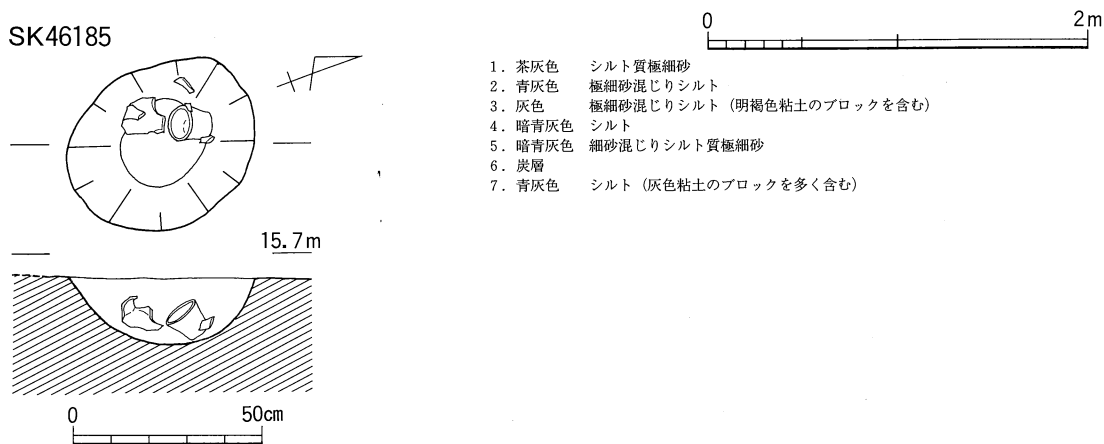

SK46186

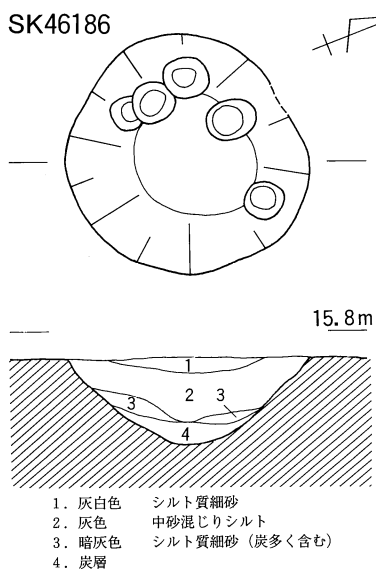

SK46188

SK46187

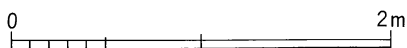
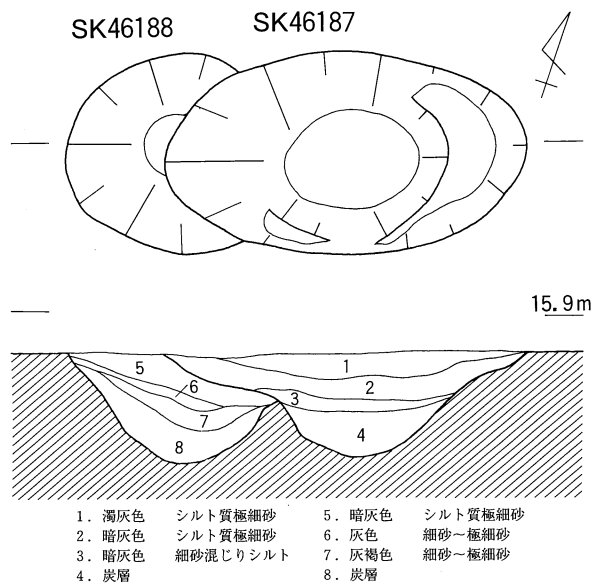

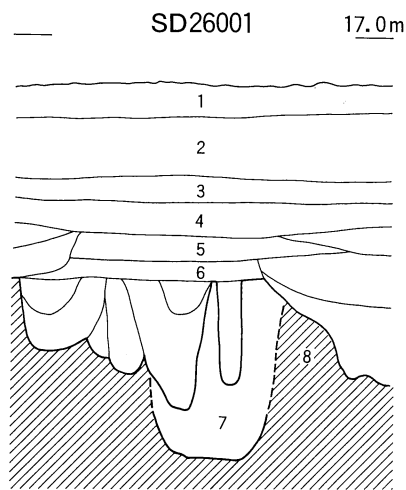
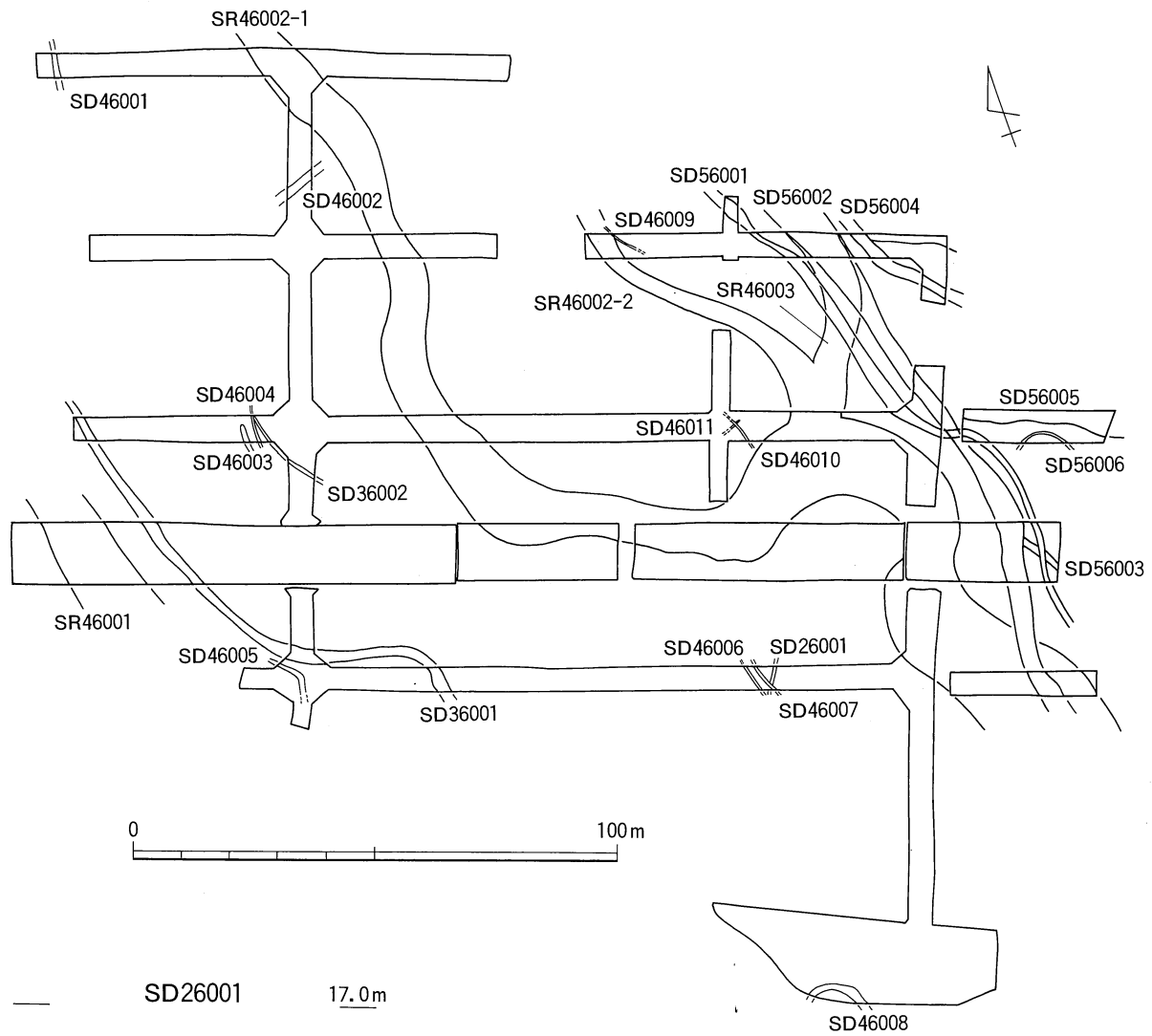

- 1. 耕土
- 2. 10YR7/6 明黄褐 細砂
- 3. 7.5Y6/2 灰オリーブ シルト
- 4. 10Y5/1 灰 シルト
- 5. 10YR4/2 灰黄褐 極細砂
- 6. 2.5Y4/2 暗灰黄 極細砂 (炭片を含む)
- 7. 7.5GY6/1 緑灰 中砂
- 8. 5Y4/1 暗オリーブ 細砂

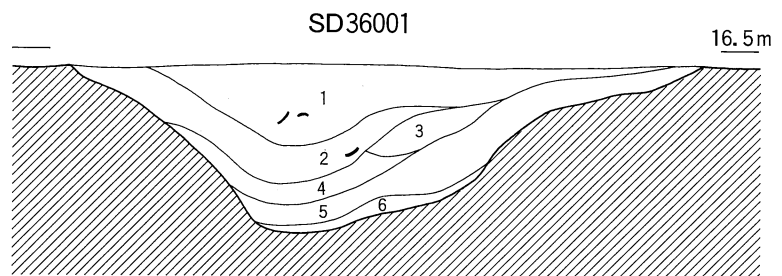

- 1. 10YR4/1 褐灰 極細砂
- 2. 10YR6/3 にぶい黄橙 シルト
- 3. 2.5Y8/4 淡黄 極細砂
- 4. 2.5Y5/2 淡灰黄 シルト質極細砂
- 5. 2.5Y4/2 暗灰黄 極細砂
- 6. 5Y6/3 オリーブ黄 細砂

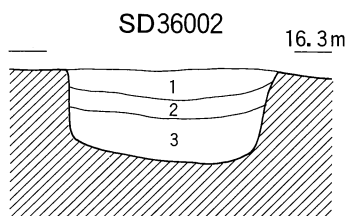
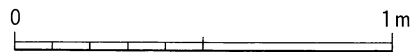

- 1. 2.5Y6/2 灰黄 細砂
- 2. 10Y6/1 灰 細砂
- 3. 10Y4/1 灰 シルト混じり細砂

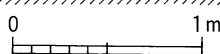

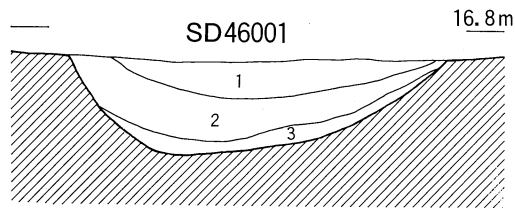

- 1. 5Y6/1 灰 中砂
- 2. 5Y3/1 オリーブ黒 細砂質シルト
- 3. N1.5/0 黒 炭層

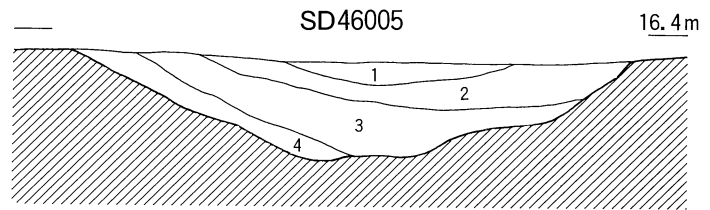
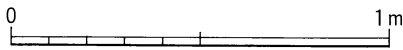

- 1. 10YR5/1 褐灰 極細砂 (小礫含む)
- 2. 10YR4/1 褐灰 シルト質極細砂 (細砂ブロック・細礫含む)
- 3. 2.5Y4/1 黄灰 シルト質極細砂 (細礫含む)
- 4. 5YR3/1 黒褐 シルト質極細砂

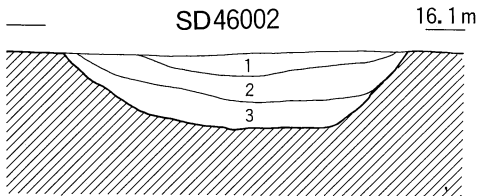
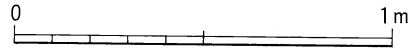

- 1. 5Y3/1 オリーブ黒 細礫混じりシルト
- 2. 2.5Y3/1 黒褐 細礫混じりシルト (炭を多く含む)
- 3. 5Y3/1 オリーブ黒 シルト質細砂

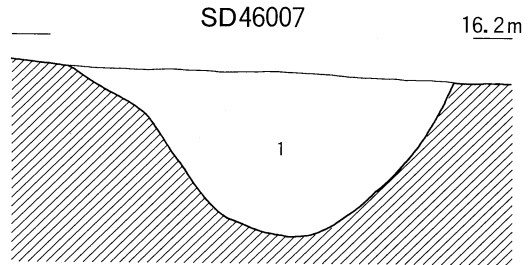
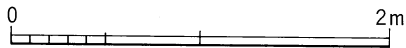

- 1. 2.5Y3/1 黒褐 シルト質極細砂

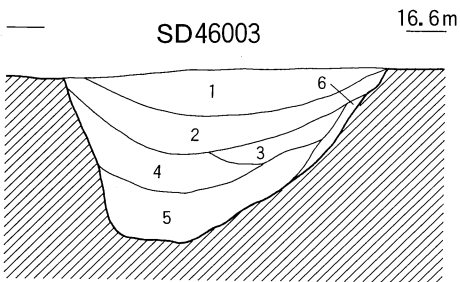

- 1. 7.5YR3/1 黒褐 極細砂
- 2. 7.5YR2/1 黒 極細砂 (下面に薄い炭層あり)
- 3. 7.5YR1.7/1 黒 シルト質極細砂 (下面に薄い炭層あり)
- 4. 7.5YR1.7/1 黒 シルト質極細砂
- 5. 10R1.7/1 赤黒 極細砂質シルト
- 6. 10Y5/1 灰 シルト混じり細砂

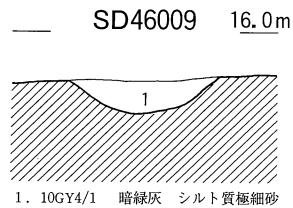

- 1. 10GY4/1 暗緑灰 シルト質極細砂

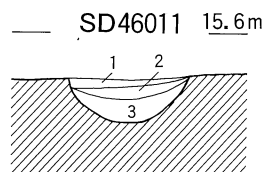

- 1. 10Y4/1 灰 極細砂質シルト
- 2. 10Y5/1 灰 極細砂質シルト
- 3. 7.5Y4/1 灰 極細砂質シルト

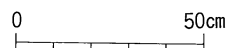

SD56001

16.1m

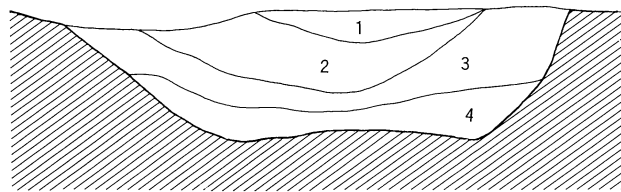

- | | | | |
|--------|--------|--------|------------|
| 1. 暗灰色 | 細砂～極細砂 | 3. 黄褐色 | 中砂混じり粗粒シルト |
| 2. 黄灰色 | 細砂～極細砂 | 4. 暗灰色 | 中砂混じりシルト |

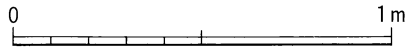

SD56002

16.0m

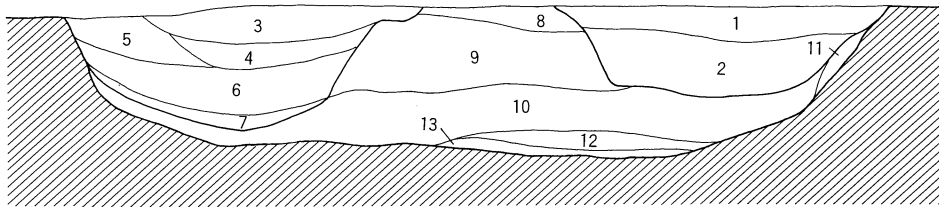

- | | | | |
|----------|-------------------|----------|---------------|
| 1. 褐灰色 | 極細砂質シルト | 8. 黄灰色 | シルト質極細砂 |
| 2. 暗灰色 | シルト (炭化物とのラミナ) | 9. 暗灰色 | シルト混じり細砂 |
| 3. 褐灰色 | 極細砂質シルト (下面に炭が多い) | 10. 淡青灰色 | シルト質極細砂 (ラミナ) |
| 4. オリーブ色 | 粘土 (炭化物とのラミナ) | 11. 暗灰色 | シルト質細砂～極細砂 |
| 5. 褐灰色 | 細砂～極細砂混じりシルト | 12. 淡青灰色 | 細礫混じり細砂～中砂 |
| 6. 淡灰色 | シルト質極細砂 (ラミナ) | 13. 緑青灰色 | シルト |
| 7. 暗灰色 | シルト質極細砂 | | |



SD56004

16.0m

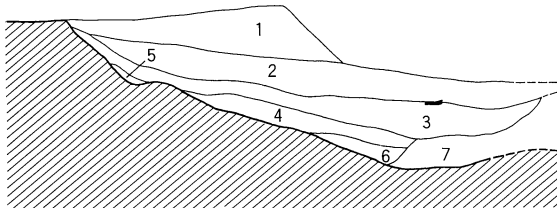

- | | | |
|-------------|--------|-------------------|
| 1. 5Y6/1 | 灰 | シルト質細砂 |
| 2. 2.5Y7/1 | 灰白 | 細砂 |
| 3. 2.5Y7/2 | 灰黄 | シルト質極細砂～中砂 (ラミナ) |
| 4. 2.5GY5/1 | オリーブ灰 | シルト質極細砂～極細砂 (ラミナ) |
| 5. 2.5GY5/1 | オリーブ灰 | 細砂質シルト |
| 6. 5GY4/1 | 暗オリーブ灰 | 細砂質シルト (細礫含む) |
| 7. 7.5GY4/1 | 暗緑灰 | シルト質細砂 (細礫含む) |

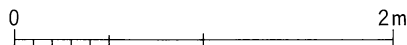

SD56005

16.1m

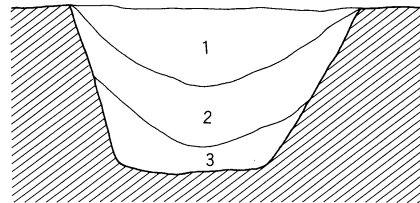

- | | | |
|------------|-------|--------------|
| 1. 10YR4/2 | 灰黄褐 | 洪水砂 |
| 2. 2.5Y5/2 | 暗黄灰 | シルト混じり細砂 |
| 3. 5Y5/2 | 灰オリーブ | シルト混じり細砂～極細砂 |

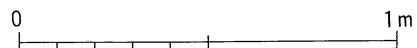

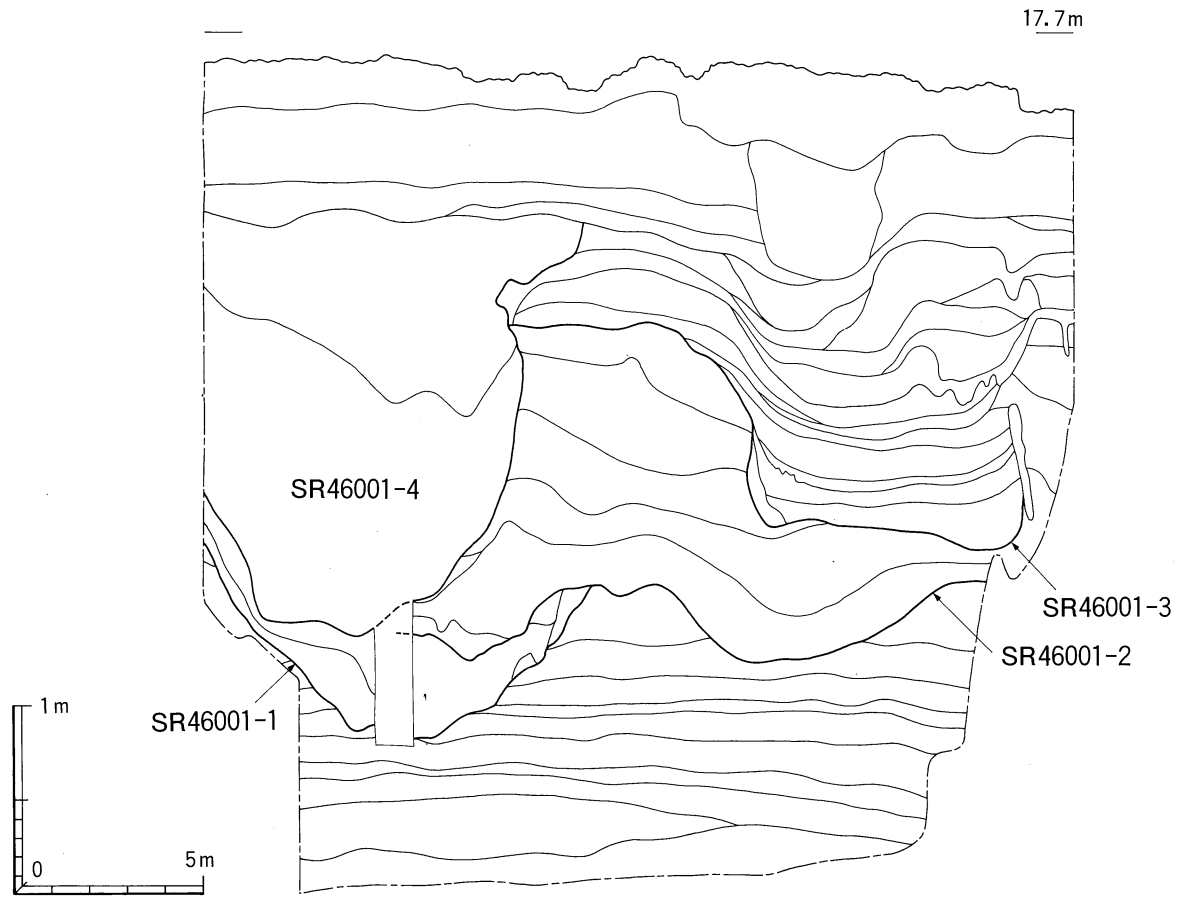

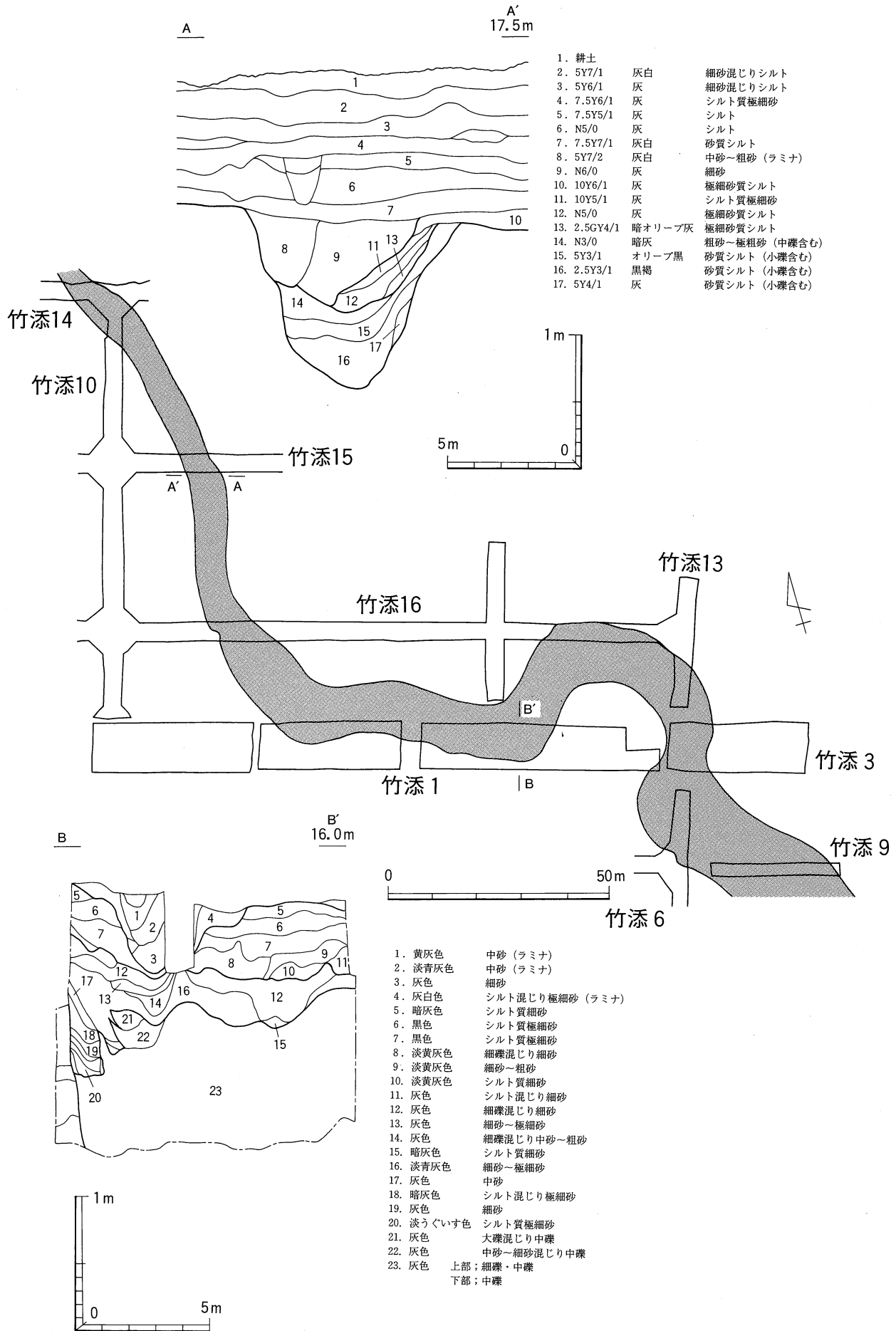

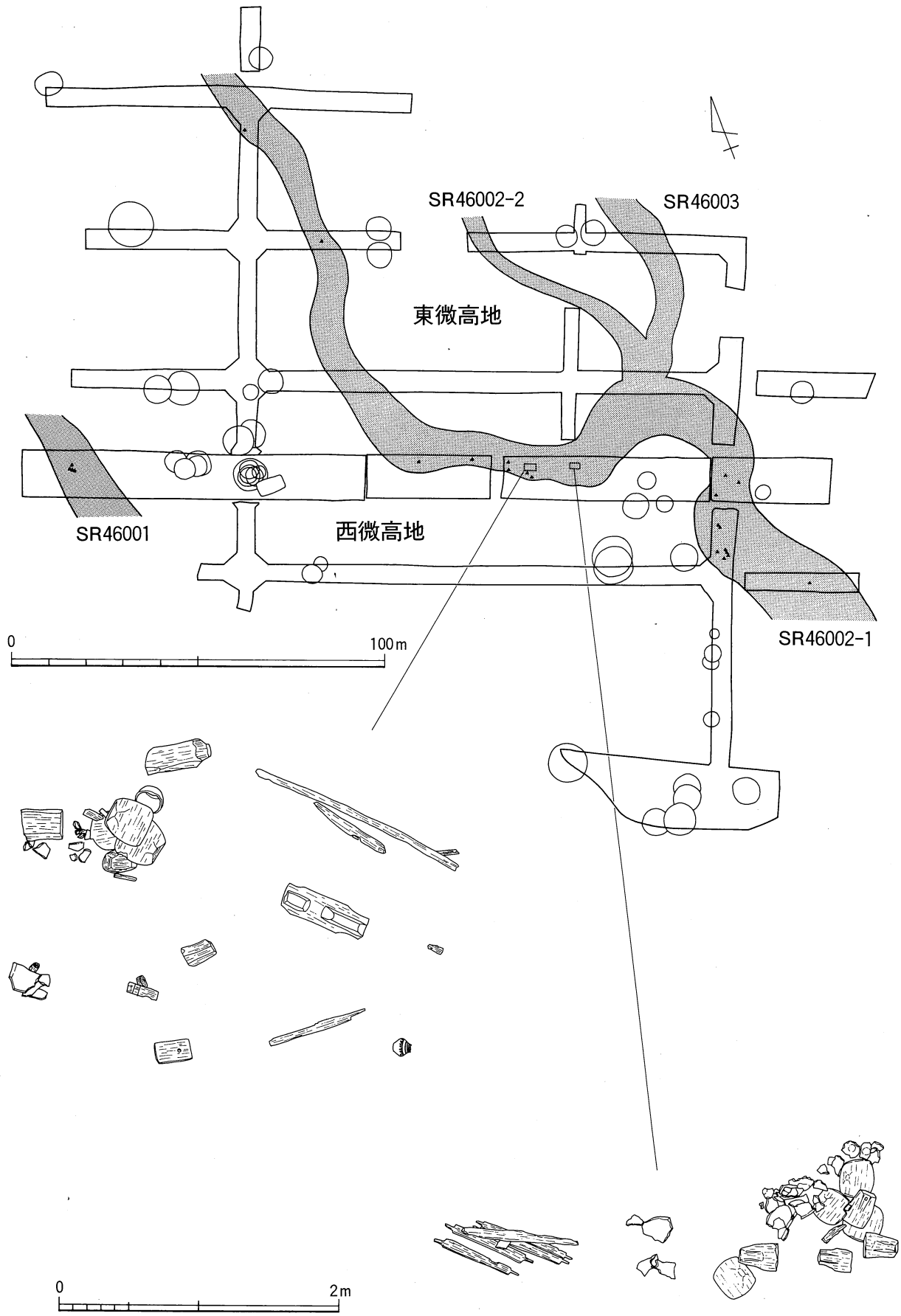

弥生時代中期上層旧河道 (SR46002)

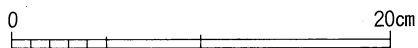
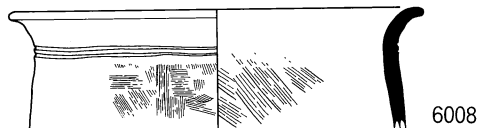
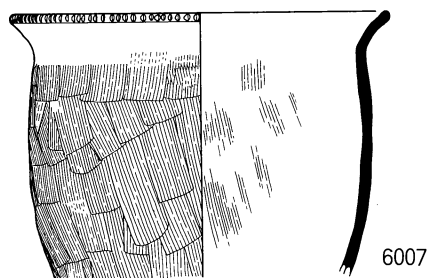
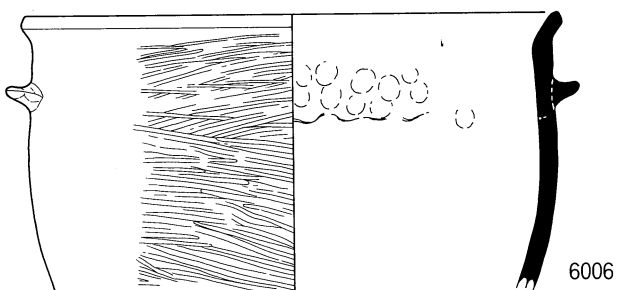
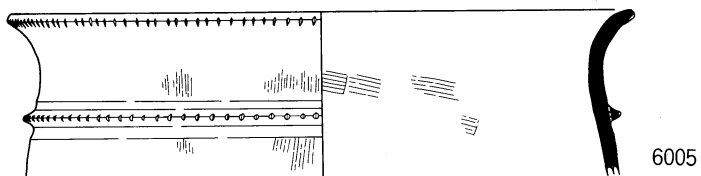
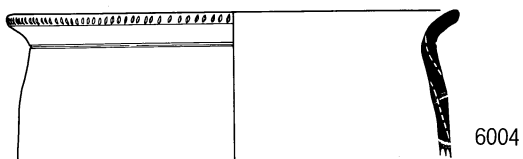
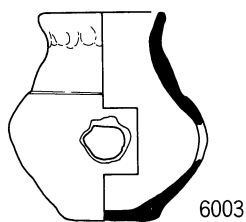
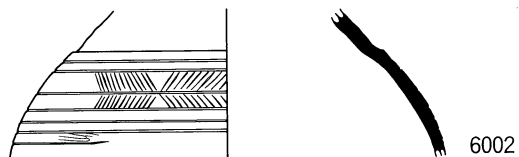

土坑 SK26002 (6001·6002)
西微高地緣辺堆積層 (6003~6006)
包含層 (6007·6008)

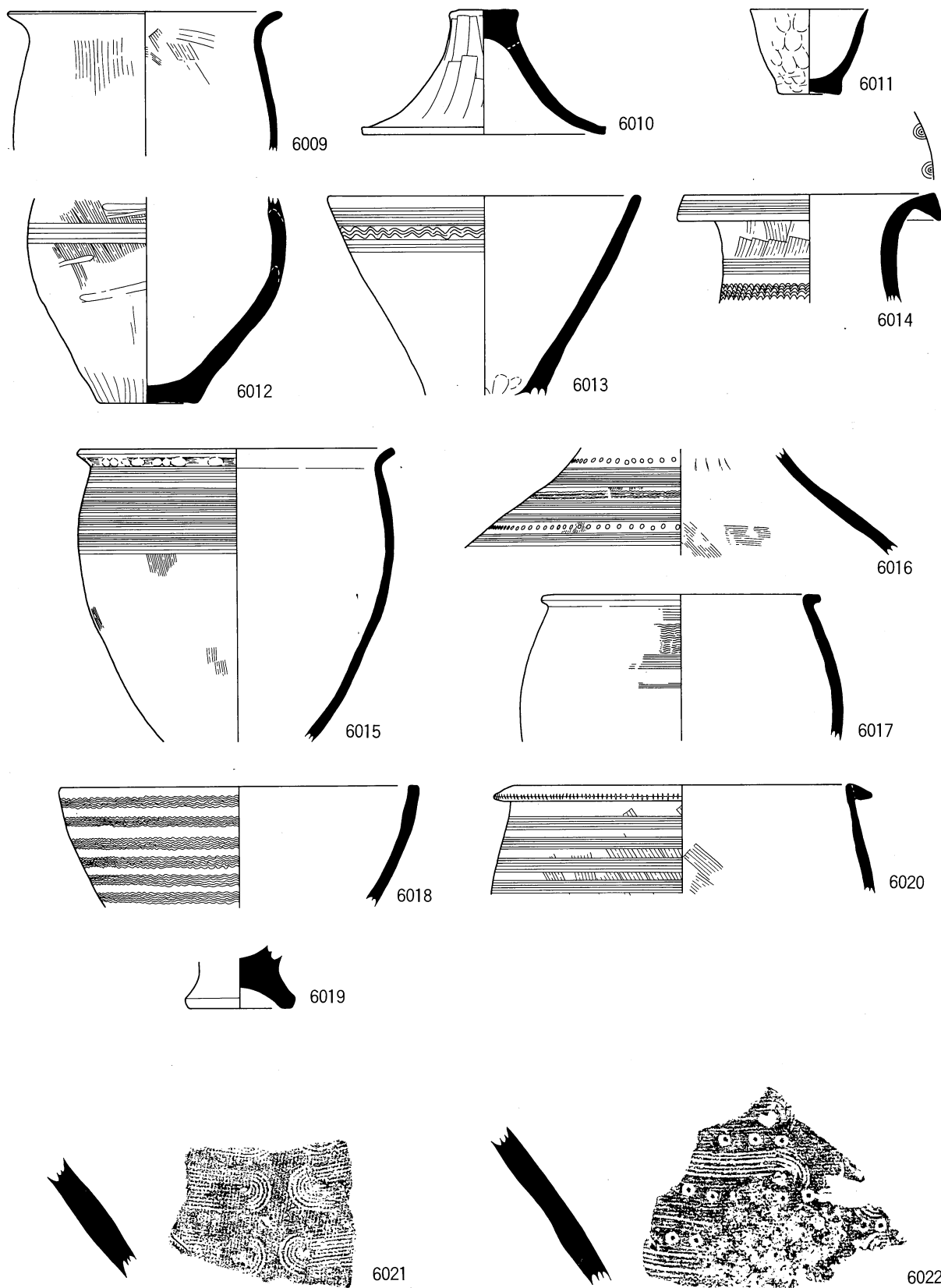

竖穴住居 SH36001 (6009) SH36002 (6010 · 6011)
SH36003 (6012 · 6013) SH36007 (6014 · 6015)
SH36008 (6016~6019 · 6021 · 6022) SH36010 (6020)

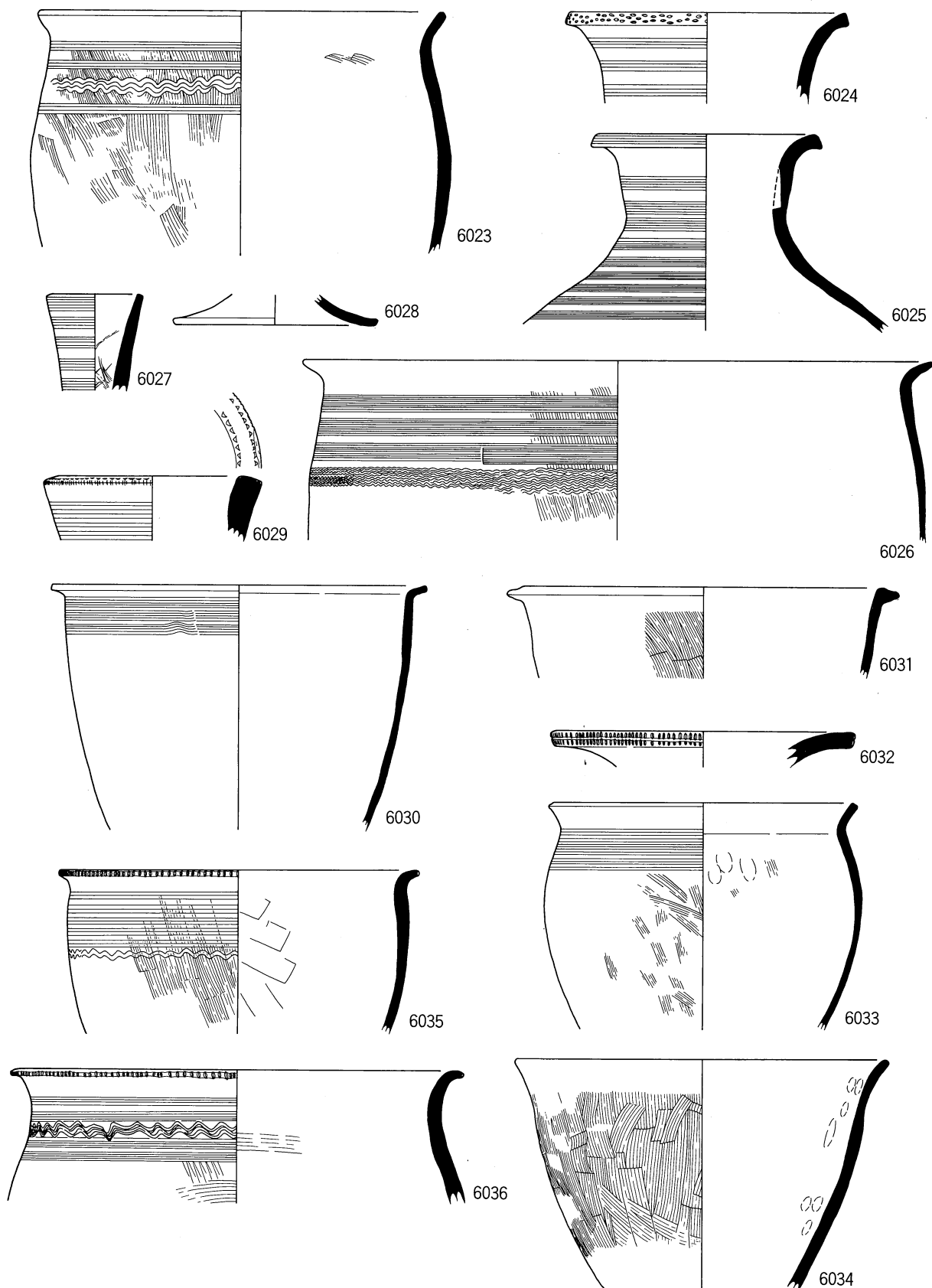

土坑 SK36001 (6023) SK36002 (6024~6026)
 SK36003 (6027~6031) SK36004 (6032~6034)
 SK36005 (6035·6036)

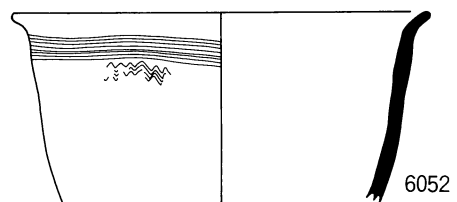
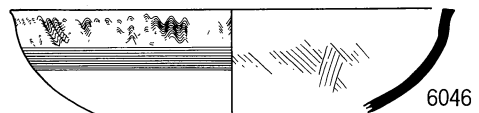
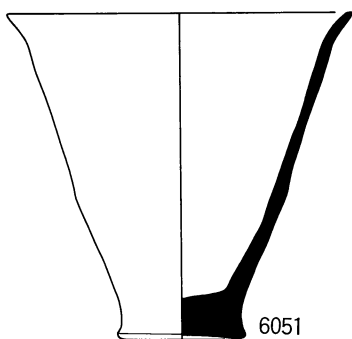
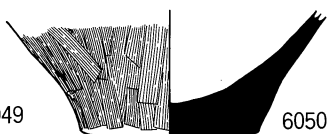
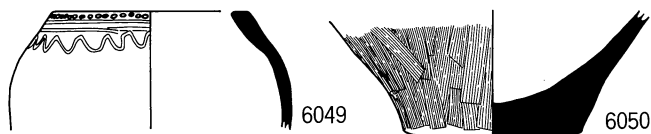
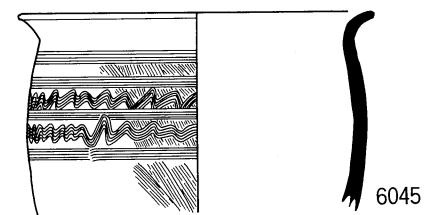
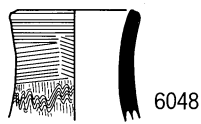
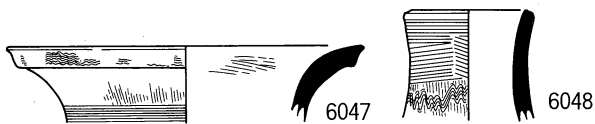
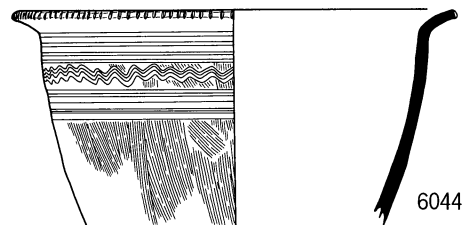
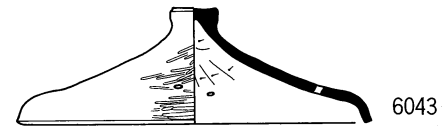
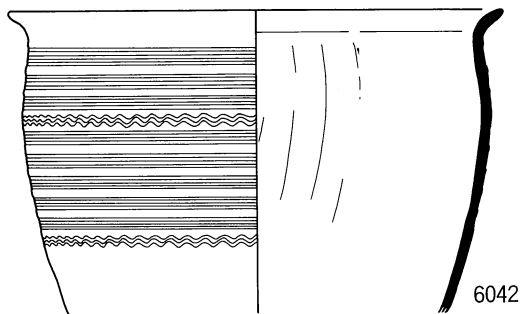
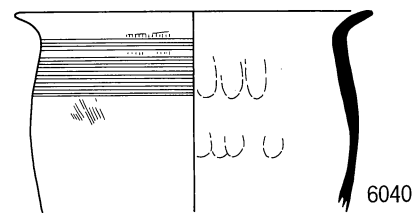
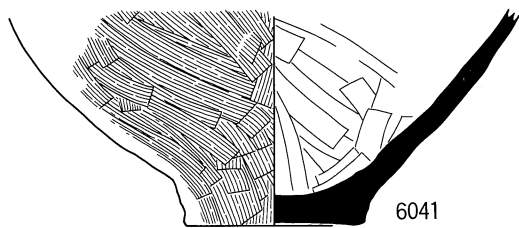
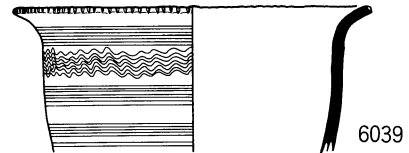
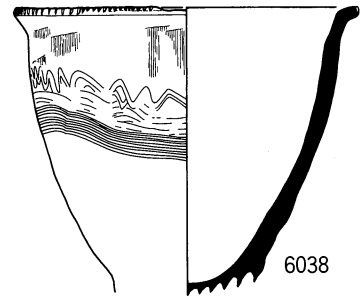
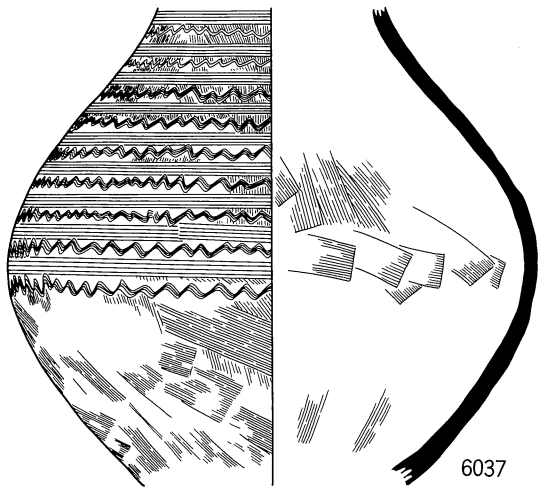

土坑 SK36006 (6037~6040) SK36007 (6041·6042)
 SK36008 (6043~6046) SK36009 (6047·6048)
 SK36010 (6049·6050) SK36011 (6051·6052)

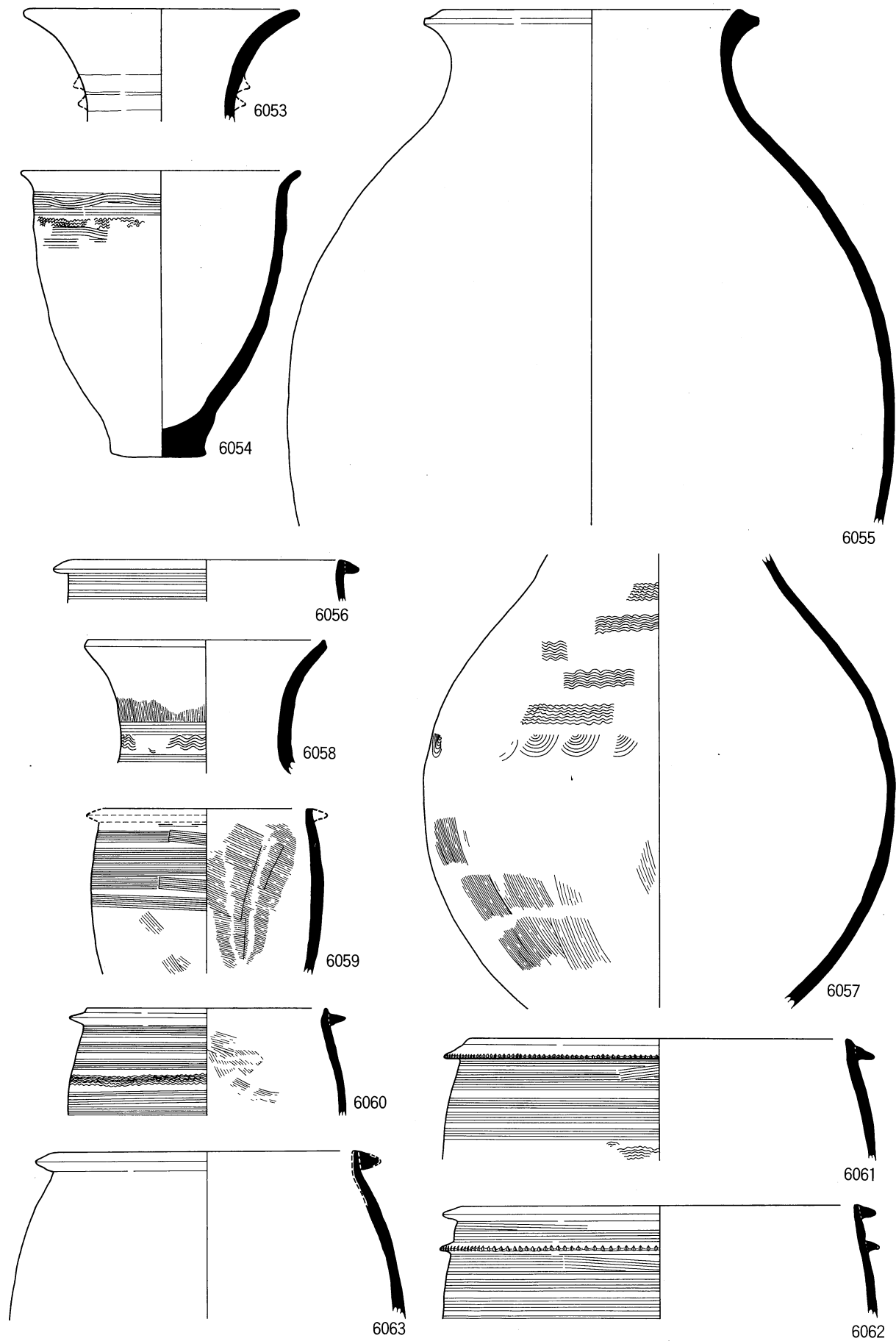

土坑 SK36011 (6053·6054) SK36012 (6055) SK36013 (6056)
SK36014 (6057) SK36015 (6058~6063)

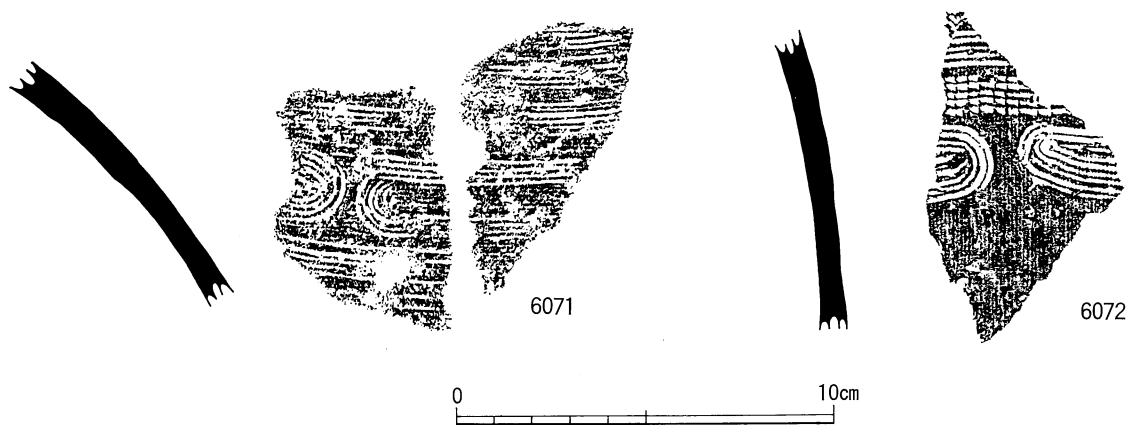
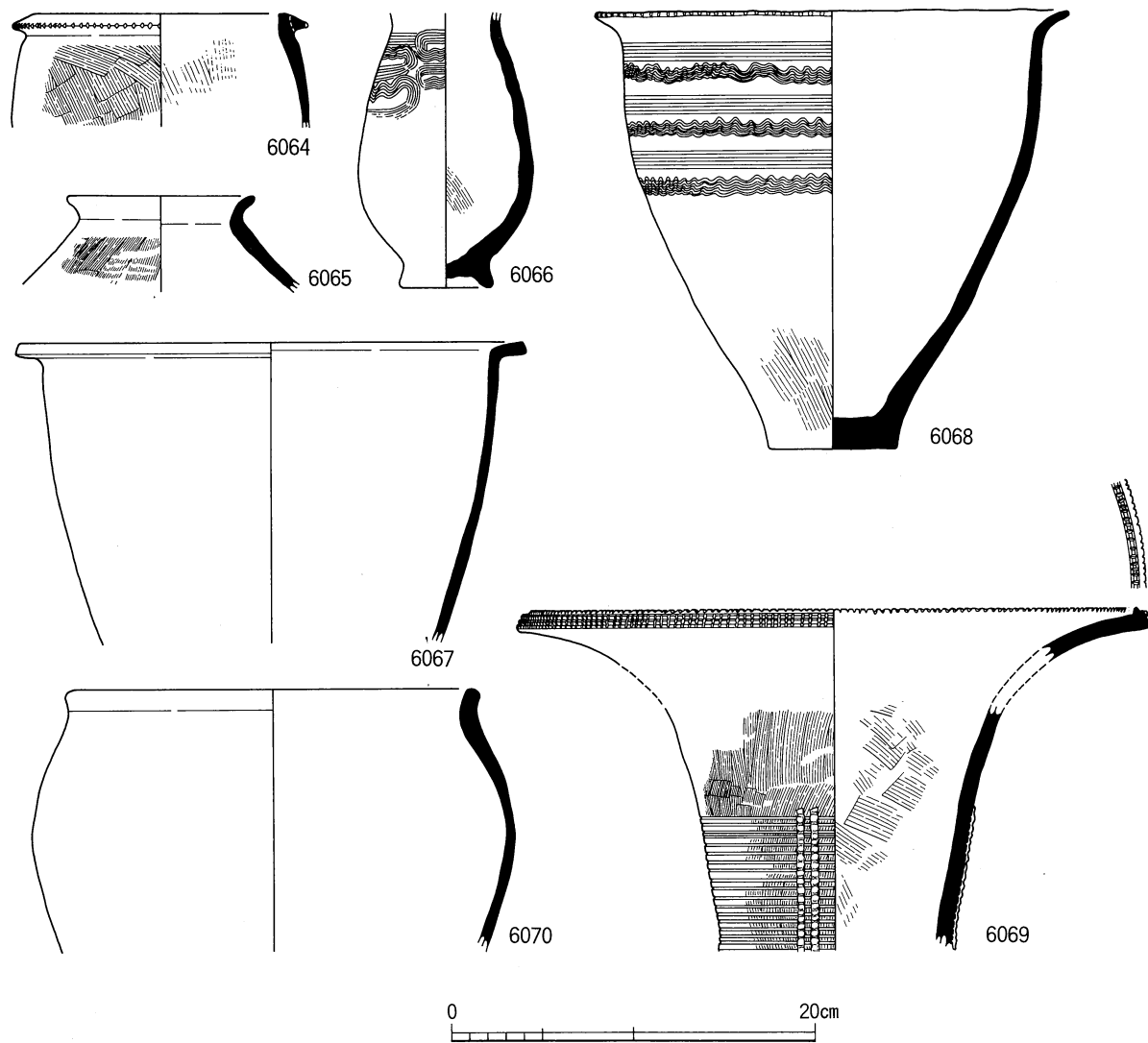

土坑 SK36016 (6064) SK36018 (6065~6067·6072)
SK36020 (6068) SK36021 (6069·6070)
SK36015 (6071)

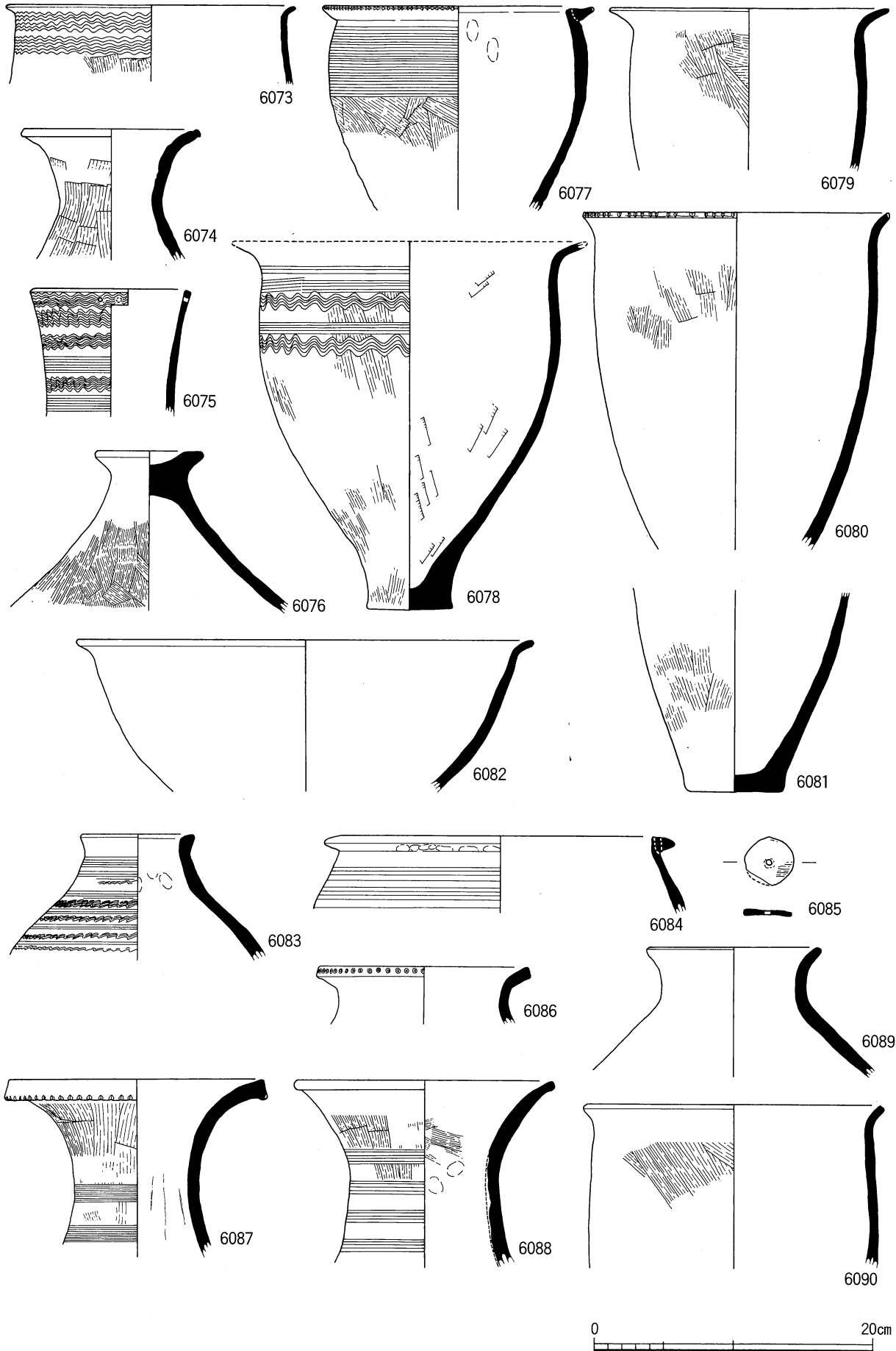

土坑 SK36022 (6073) SK36023 (6074~6082) SK36024 (6083)
 SK36025 (6084·6085) SK36026 (6086) SK36027 (6087)
 SK36029 (6088~6090)

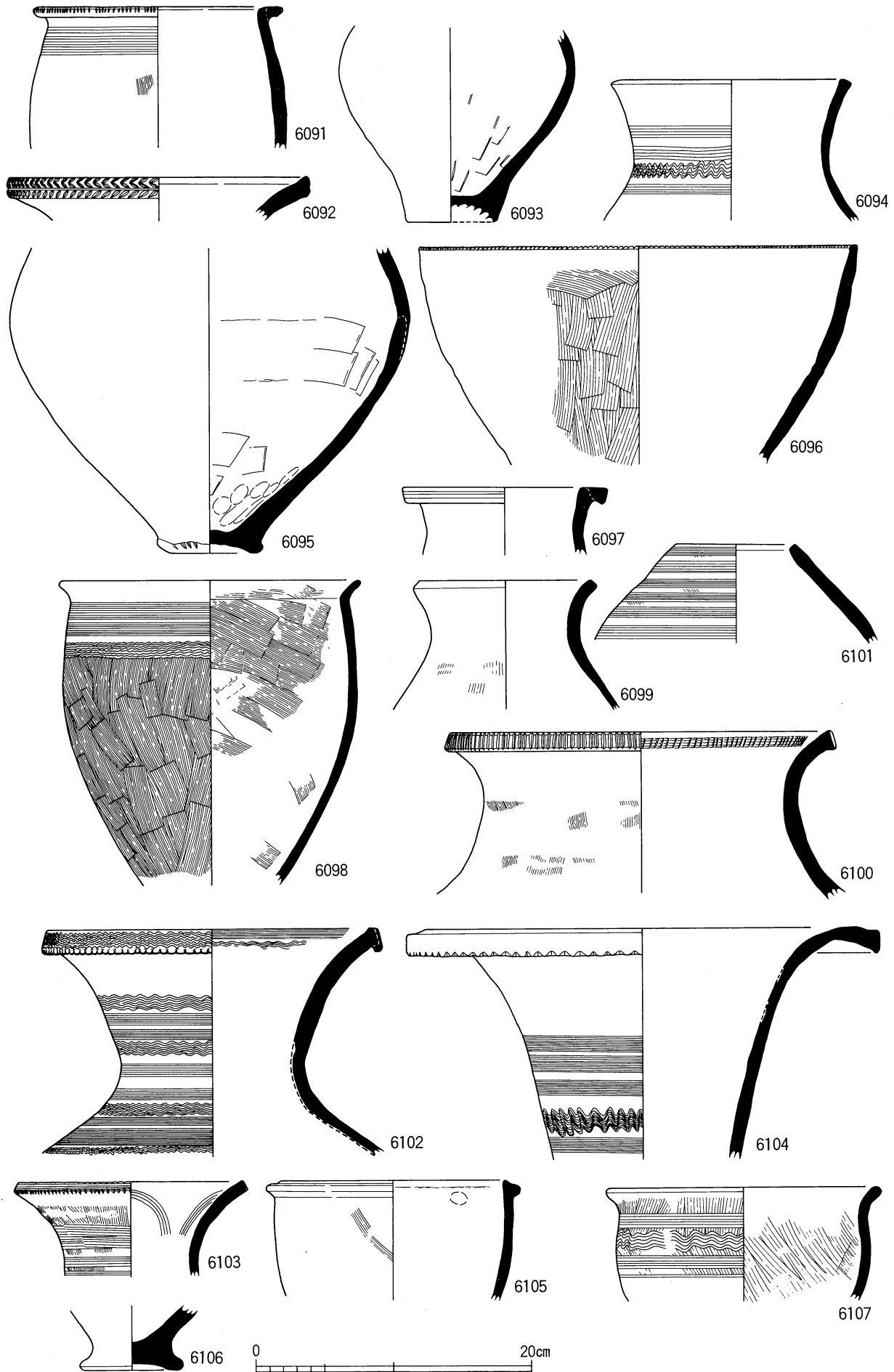

土坑 SK36030 (6091) SK36031 (6092) SK36032 (6093) SK36033 (6094~6096)
 SK36034 (6097) SK36035 (6098) SK36036 (6099) SK36037 (6100·6101)
 SK36038 (6102~6105) SK36040 (6106) SK36041 (6107)

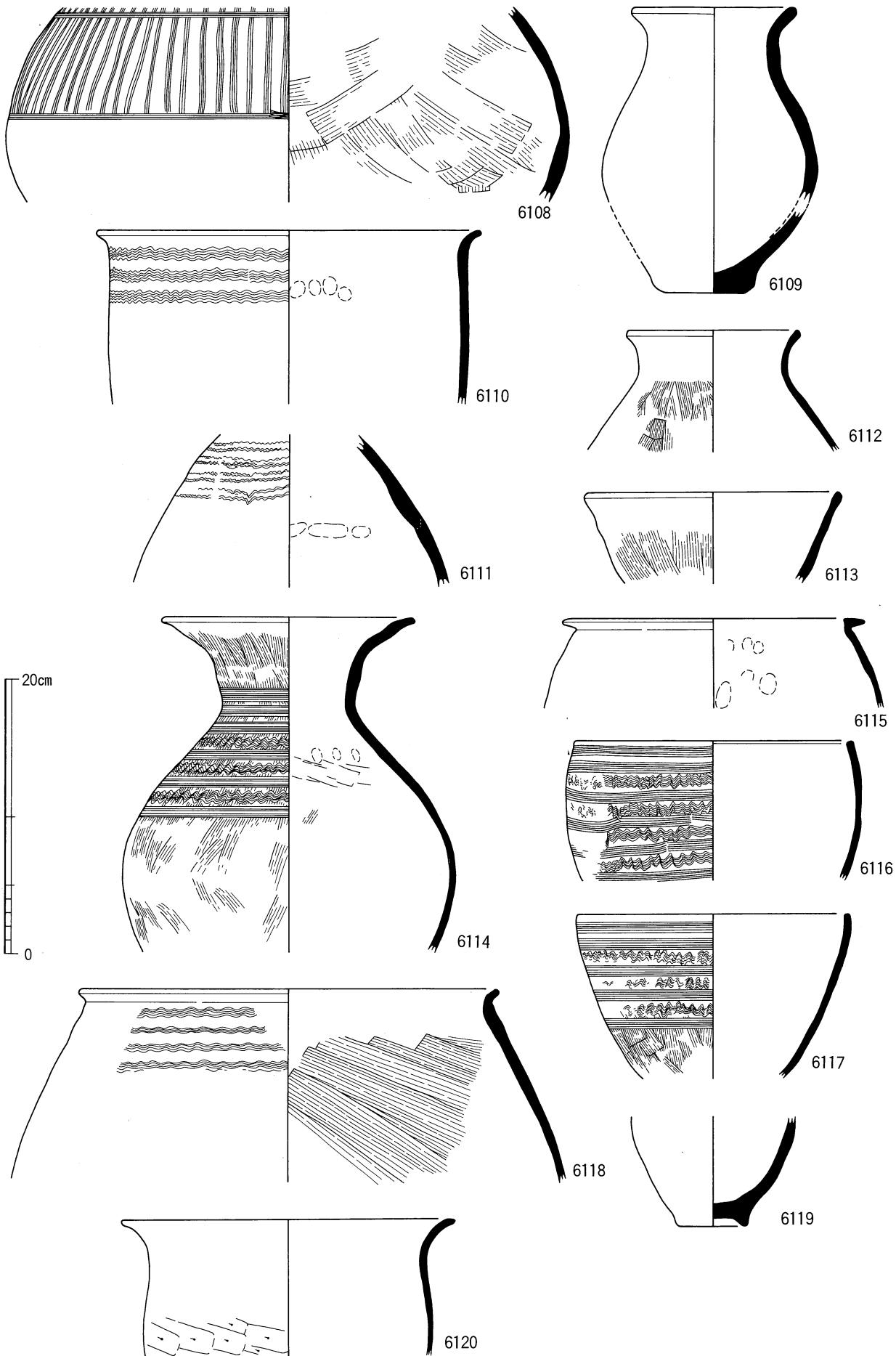

土坑 SK36042 (6108)	SK36043 (6109 · 6110)	SK36044 (6111)
SK36045 (6112)	SK36047 (6113)	SK36049 (6114)
SK36050 (6115~6117)	SK36051 (6118)	SK36052 (6119)
SK36053 (6120)		

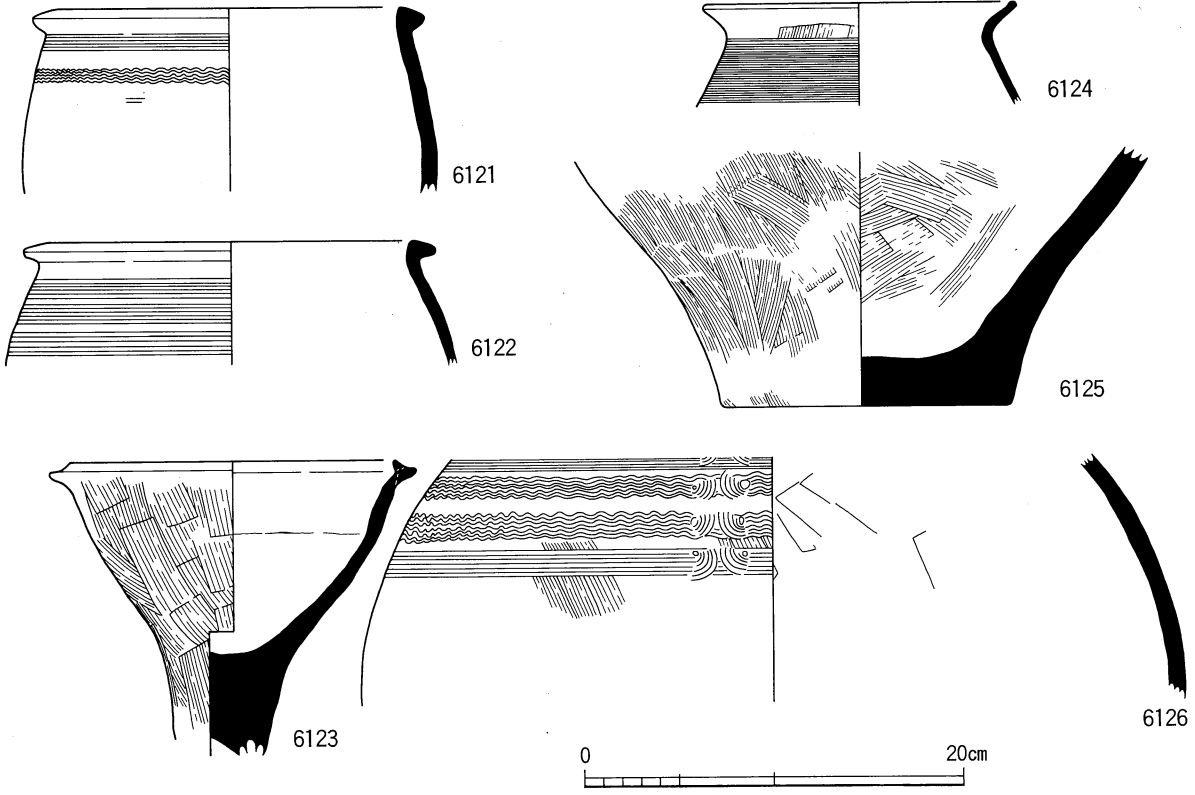

土坑 SK36054 (6121 · 6128 · 6129)
 SK36056 (6124 · 6125)
 SK36048 (6127)

SK36055 (6122 · 6123)
 SK36057 (6126)

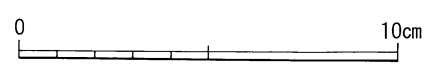
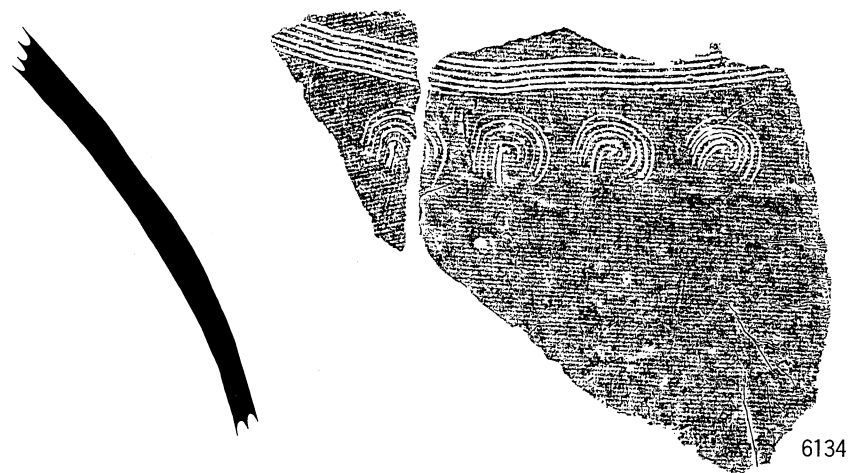
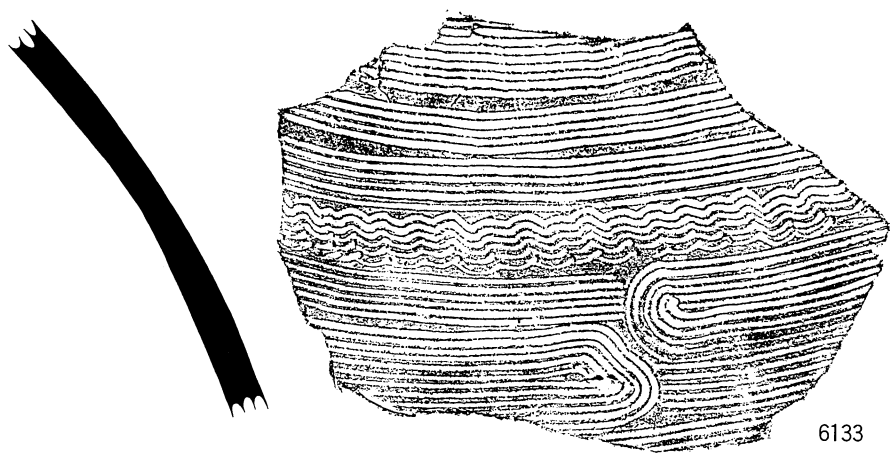
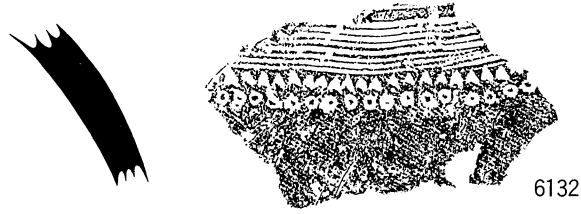
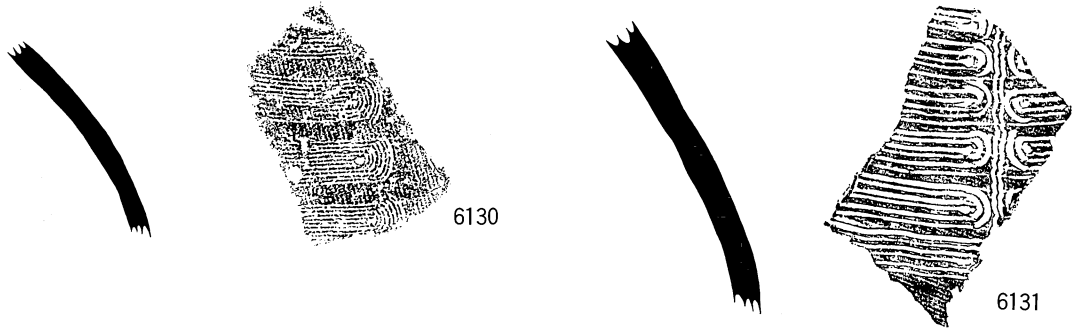

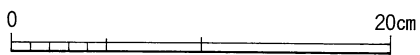
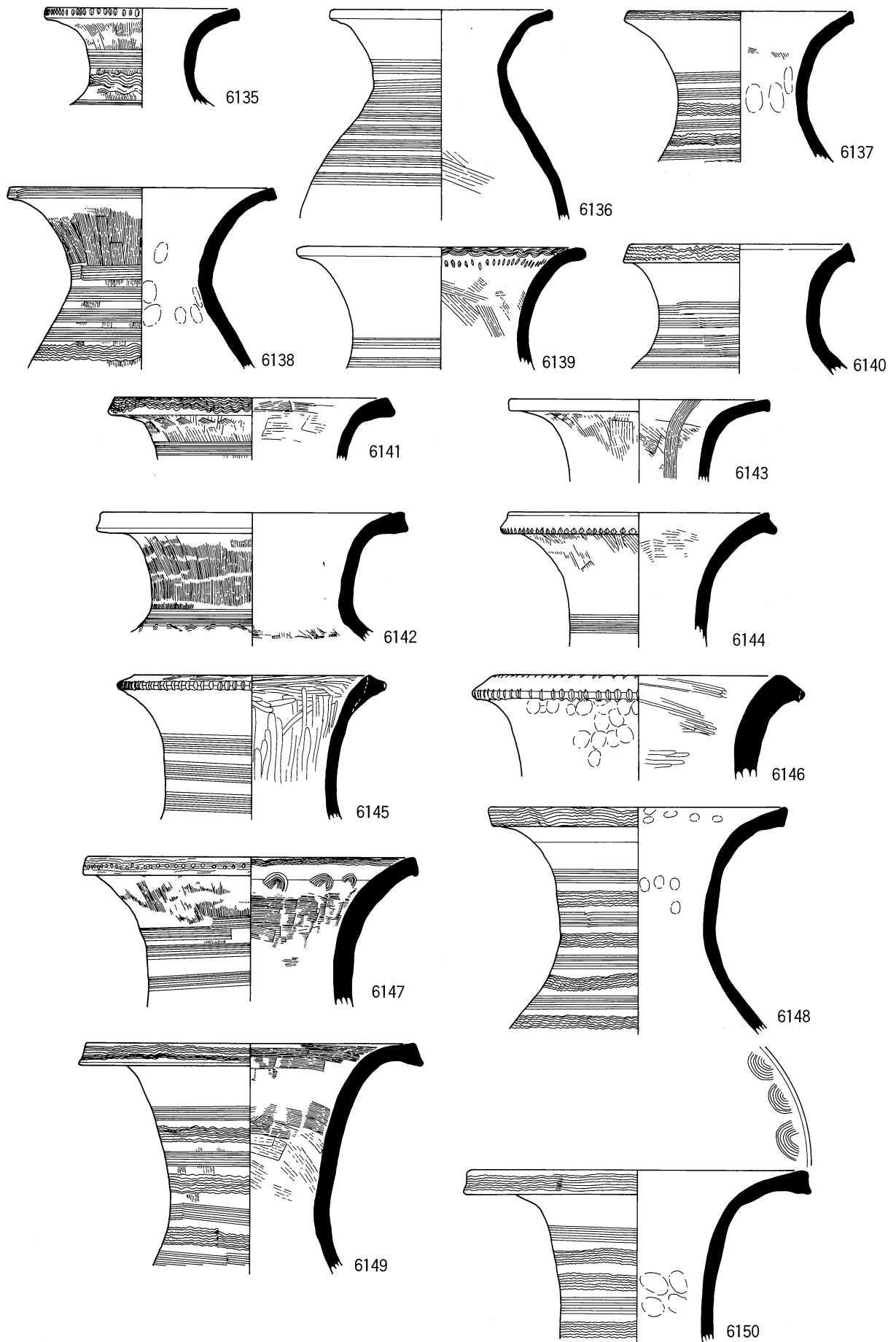

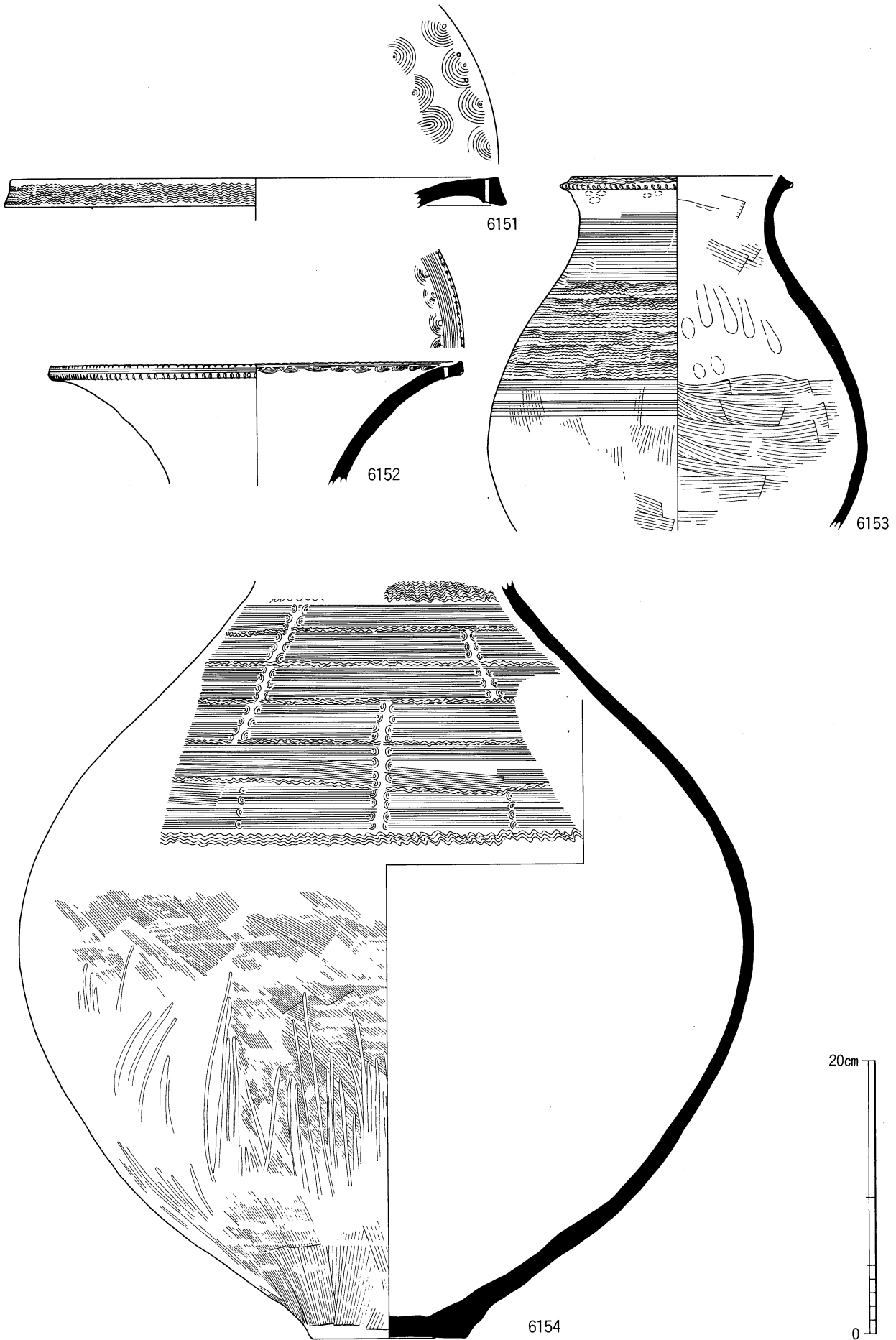

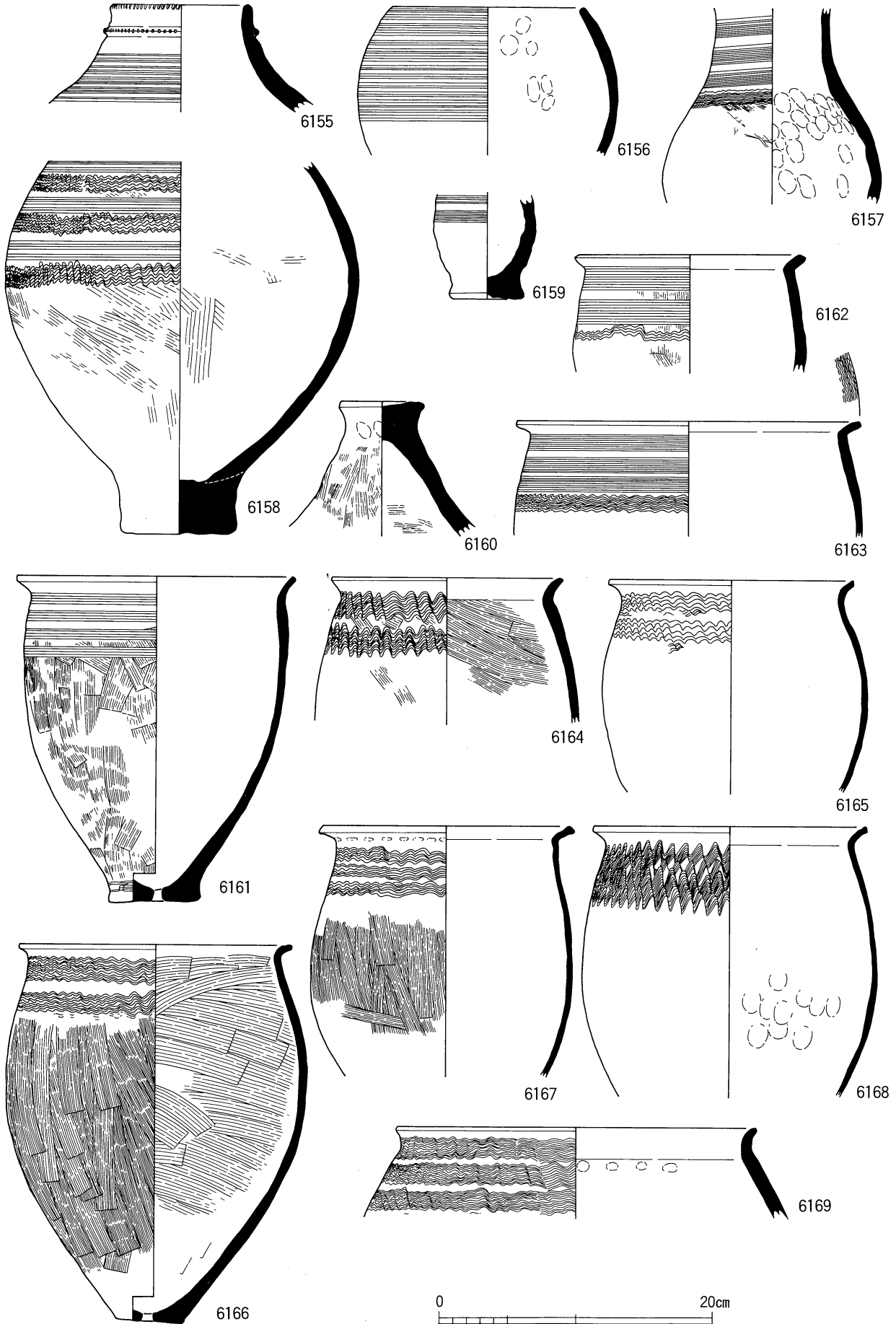

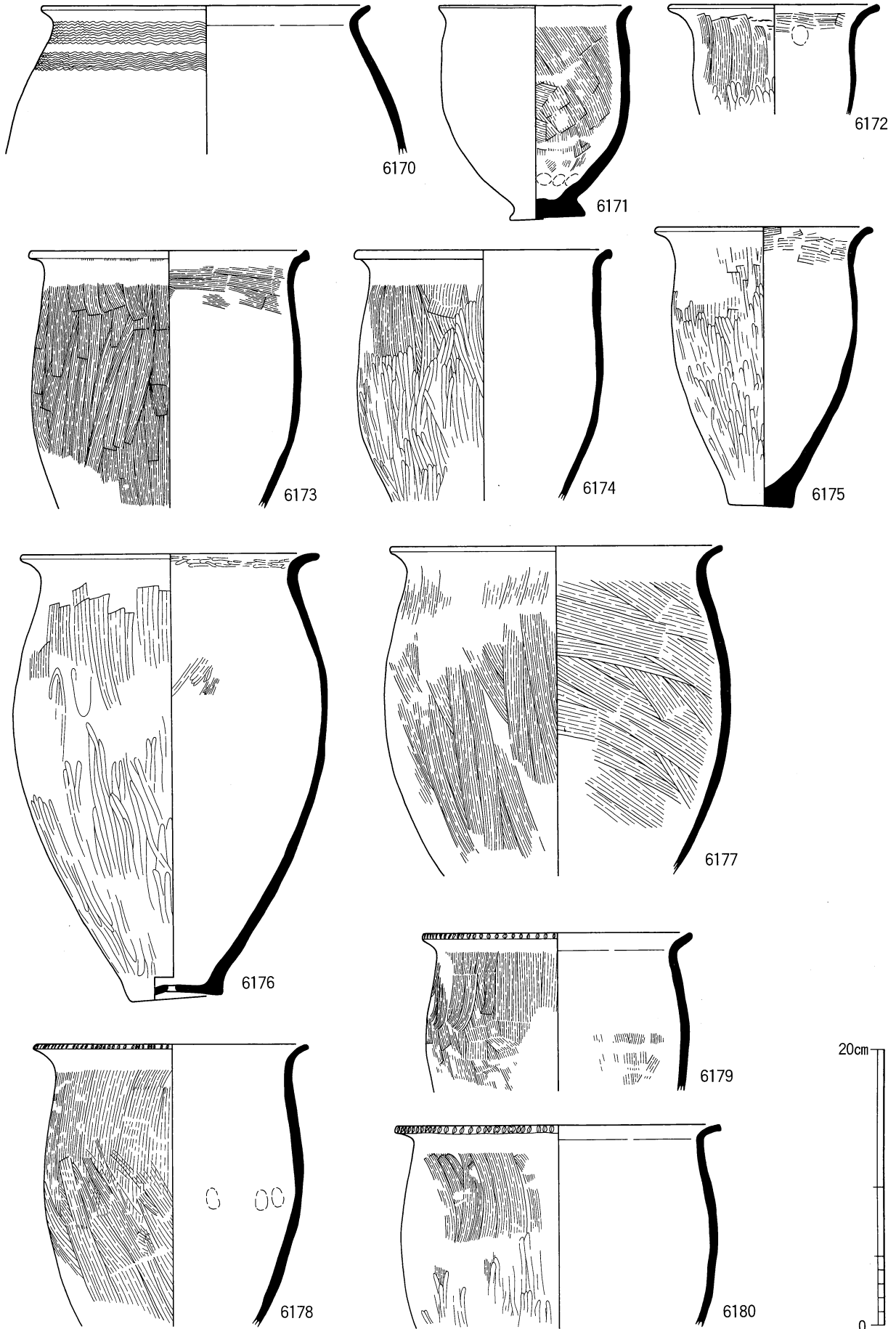

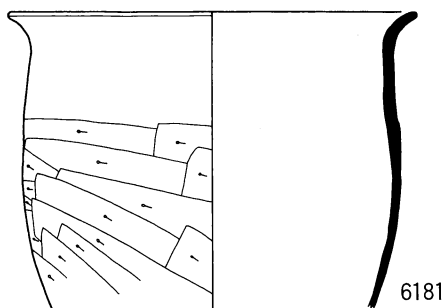

6181



6184

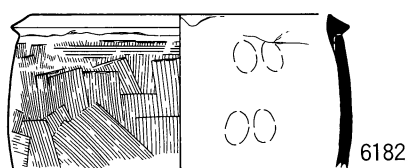

6182

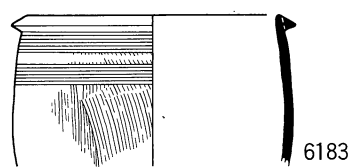

6183

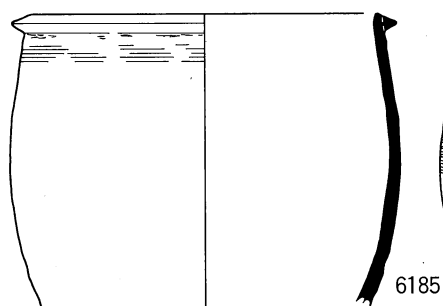

6185

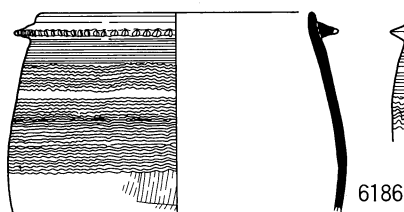

6186

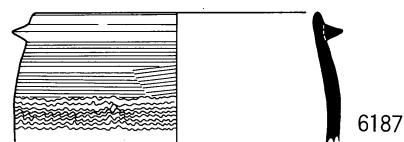

6187

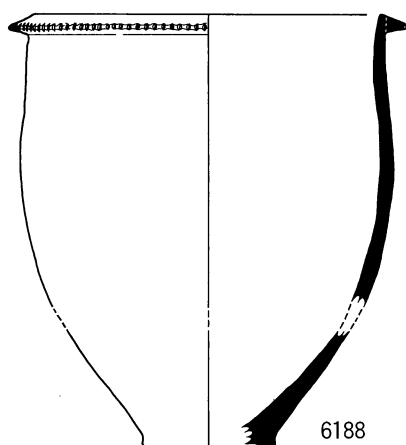

6188

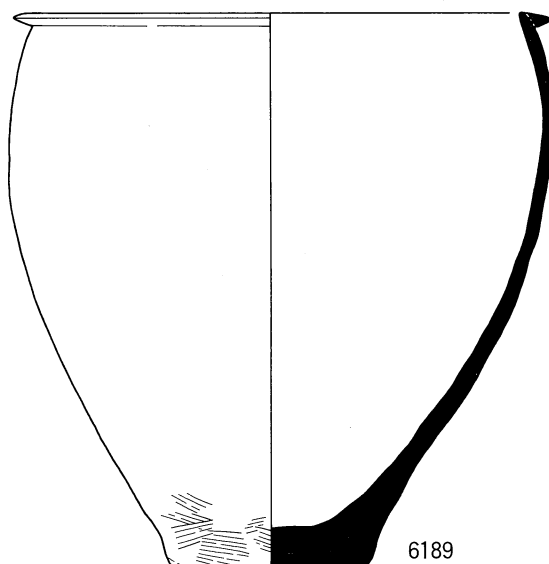

6189

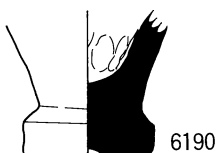

6190

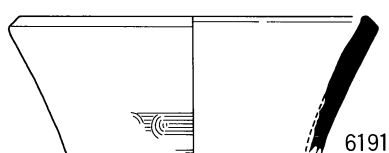

6191

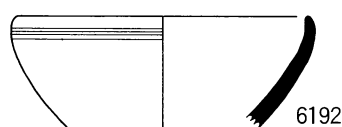

6192



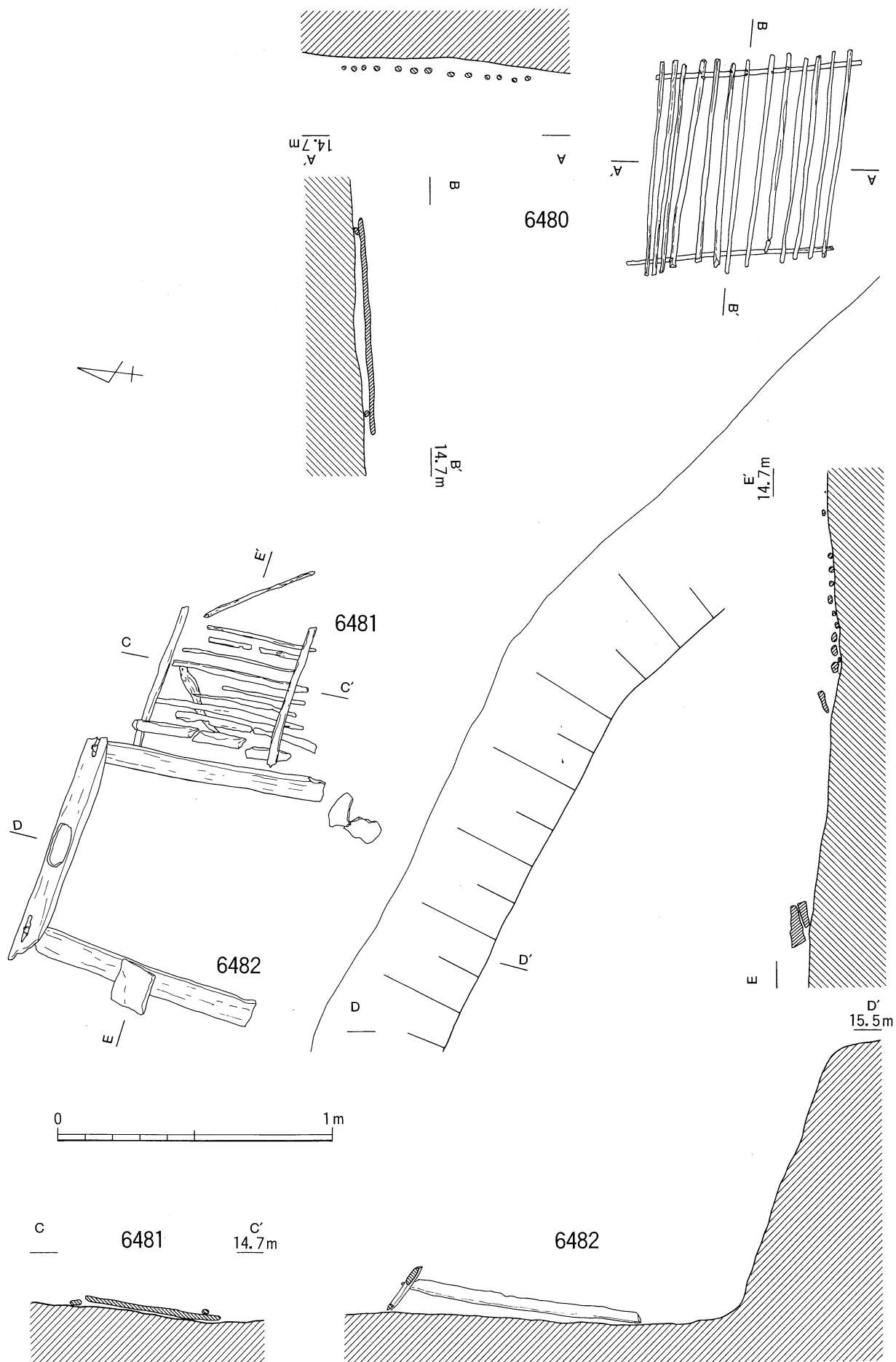

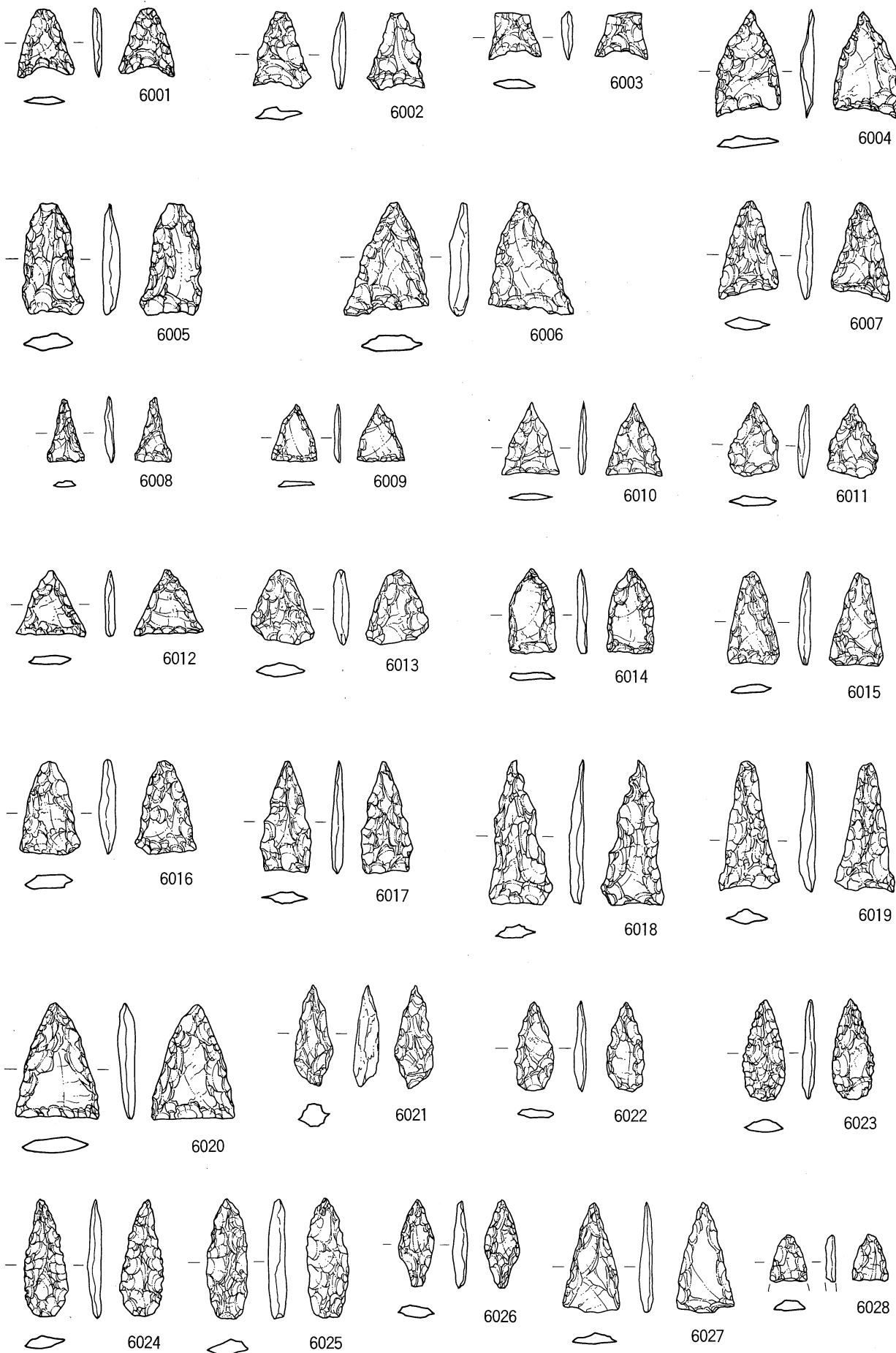

豎穴住居 SH36001 (6004 · 6007 · 6009 · 6011 · 6013 · 6015 · 6022 · 6024 · 6028) SH36003 (6018)

SH36004 (6020) SH36007 (6002 · 6003 · 6008 · 6010 · 6016 · 6019 · 6021 · 6026 · 6027)

SH36008 (6001 · 6005 · 6012 · 6014 · 6023)

土坑 SK36010 (6017) SK36034 (6025) SK36039 (6006)

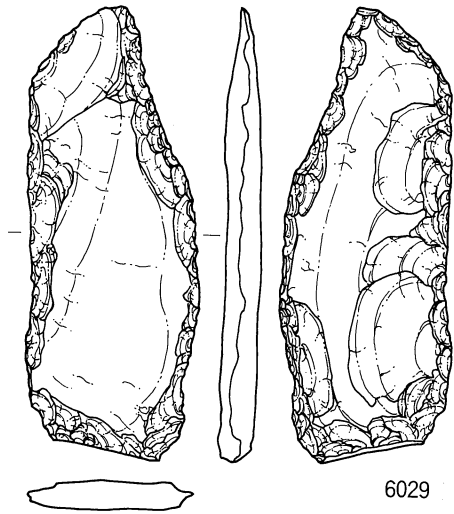

6029

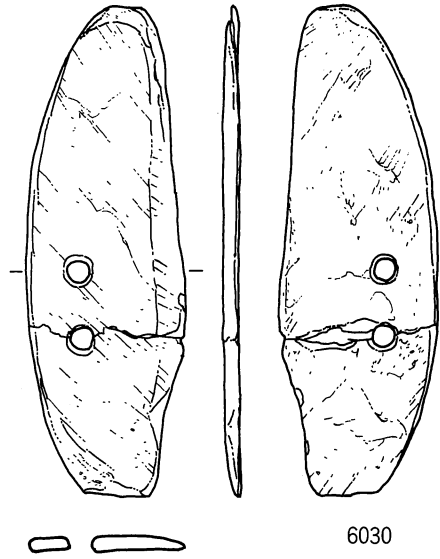

6030

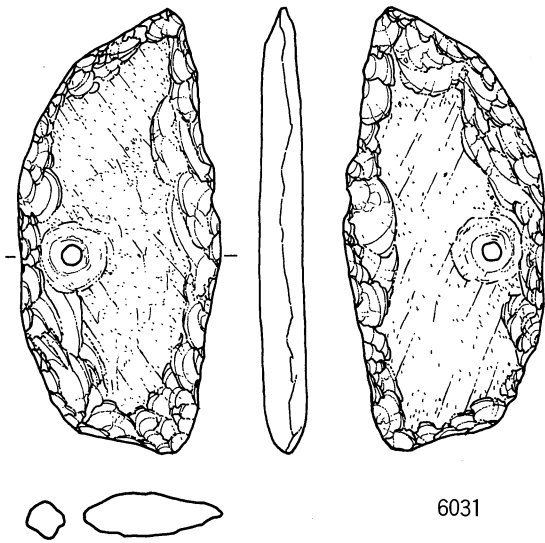

6031

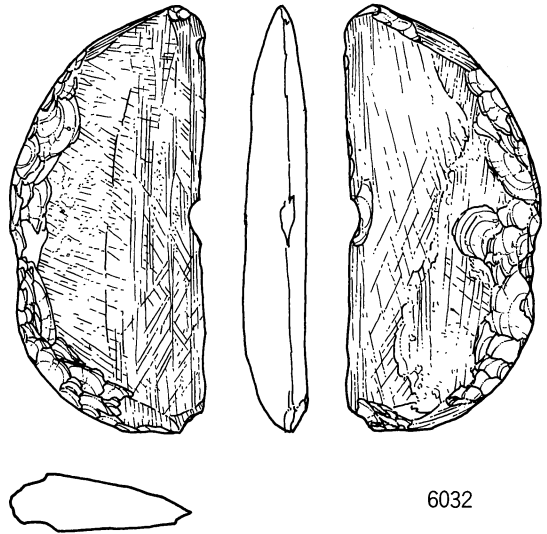

6032

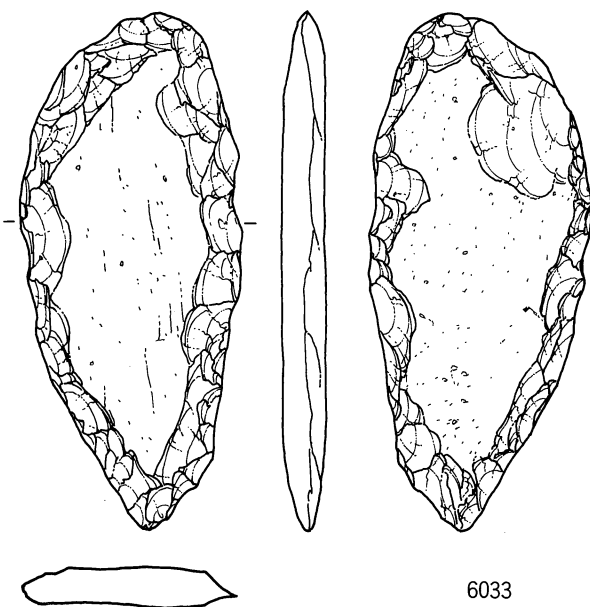

6033

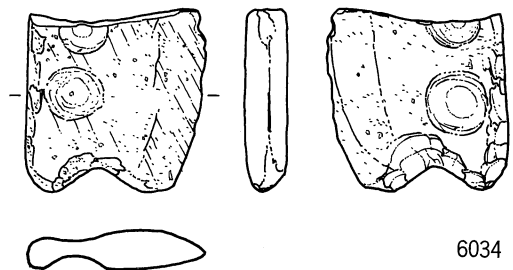

6034



土坑 SK36002 (6030) SK36008 (6034) SK36029 (6029)
 西微高地缘边堆积层 (6032·6033) 包含层 (6031)

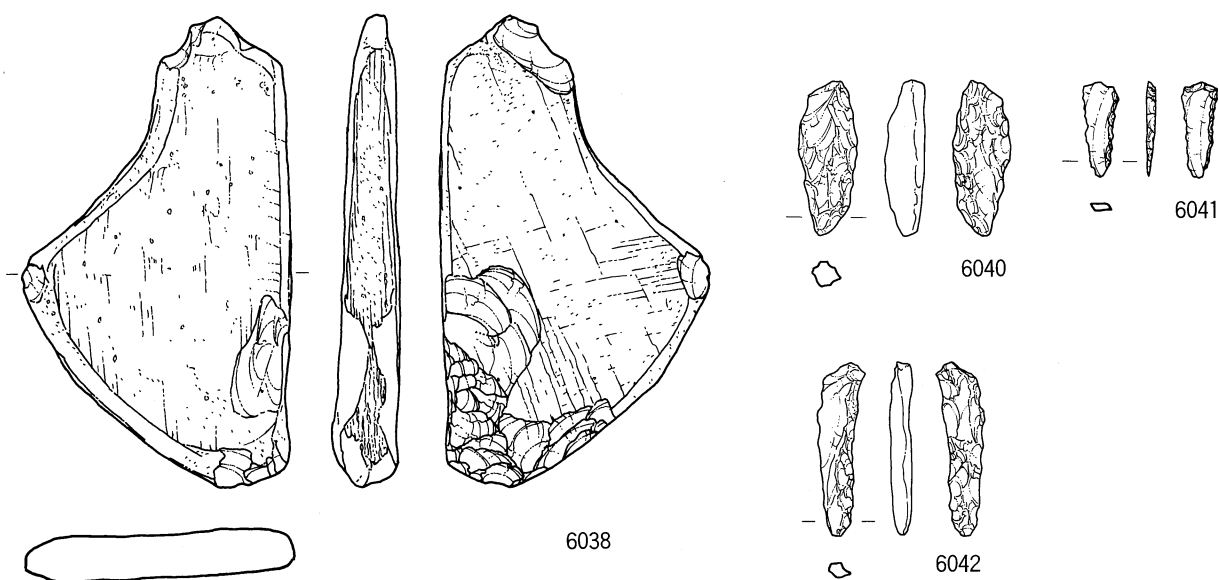
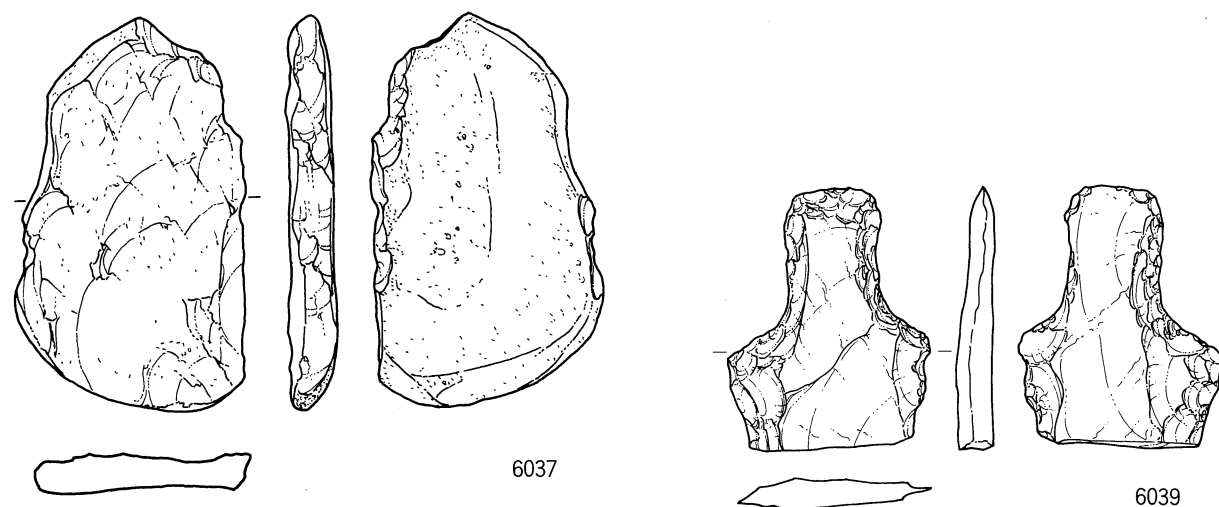
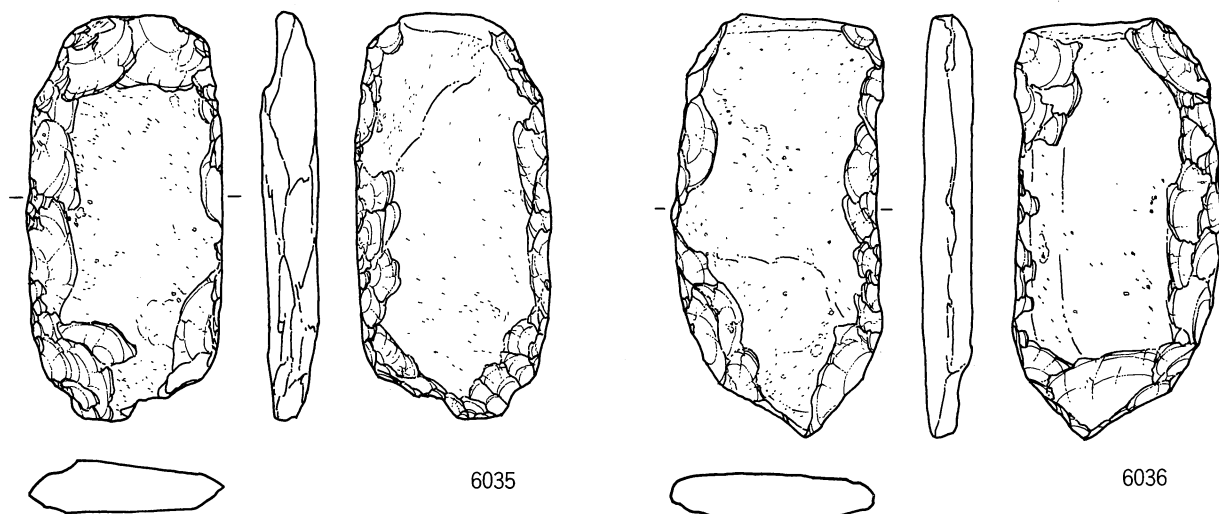

0 10cm

0 5cm

竖穴住居 SH36007 (6040·6042) SH36008 (6038·6041)
土坑 SK36009 (6036) SK36023 (6039) SK36026 (6037)
西微高地縁辺堆積層 (6035)

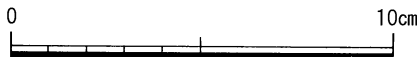
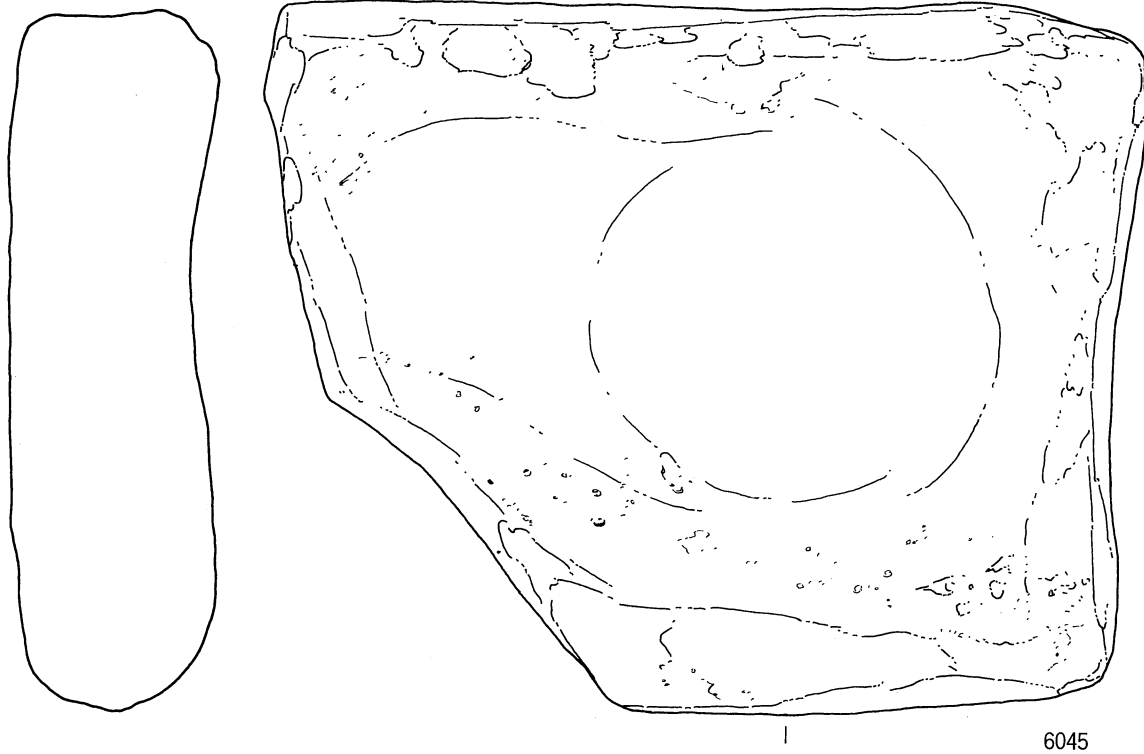
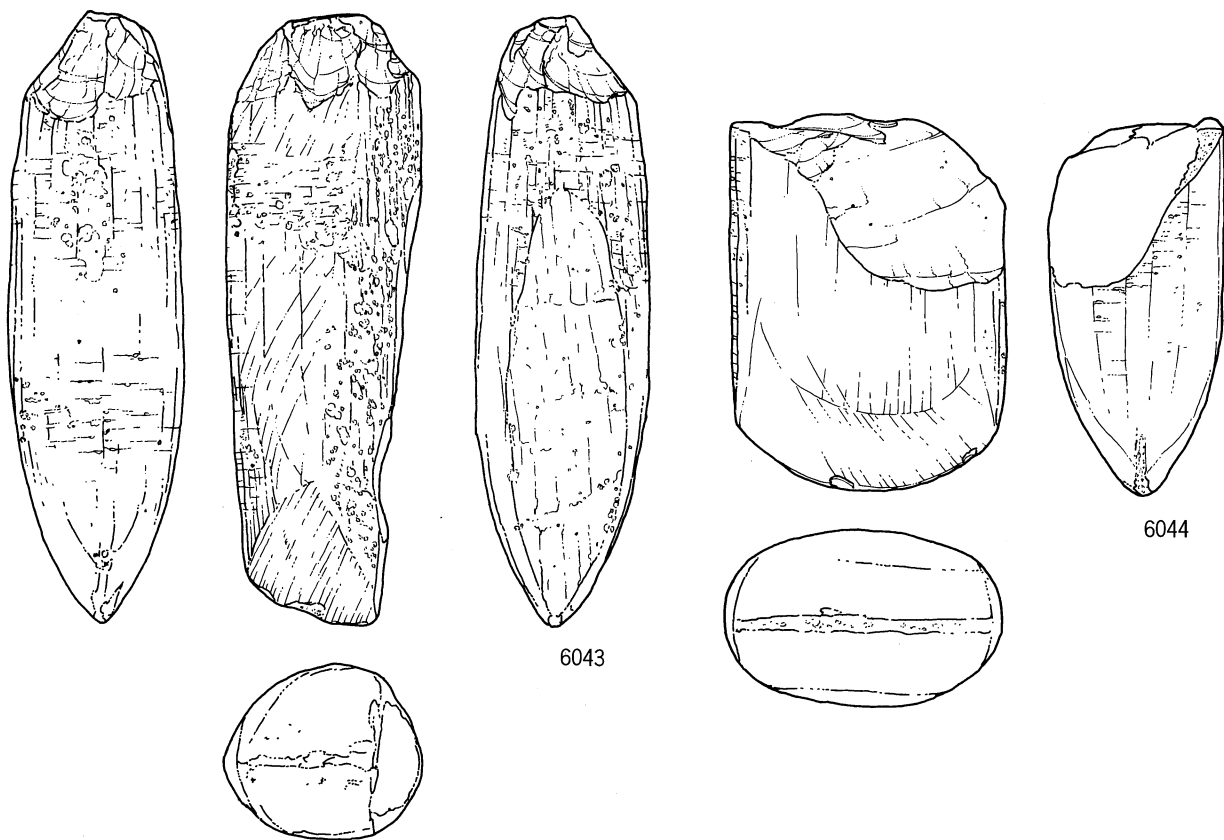

竖穴住居 SH36006 (6043) SH36008 (6044)
土坑 SK36038 (6045)

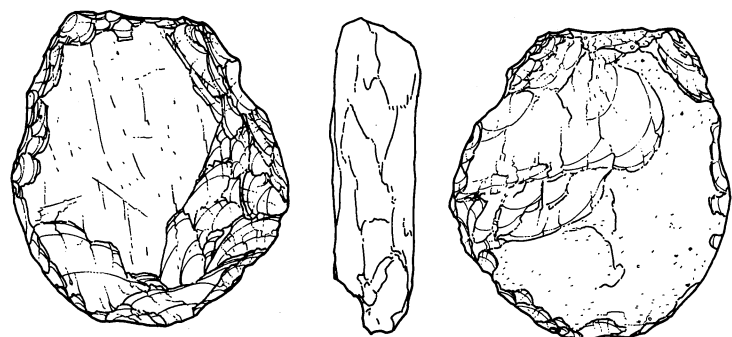

6046

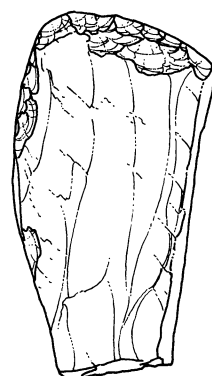
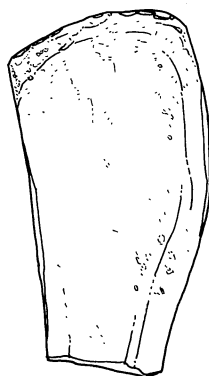

6047

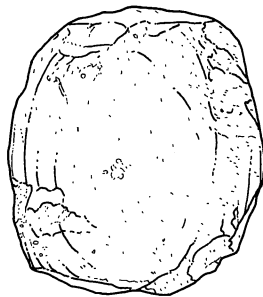
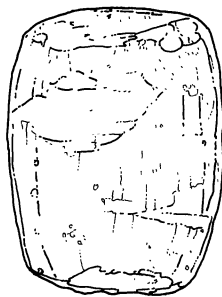
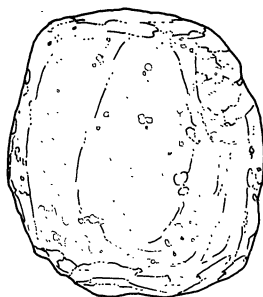

6048

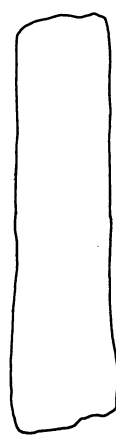
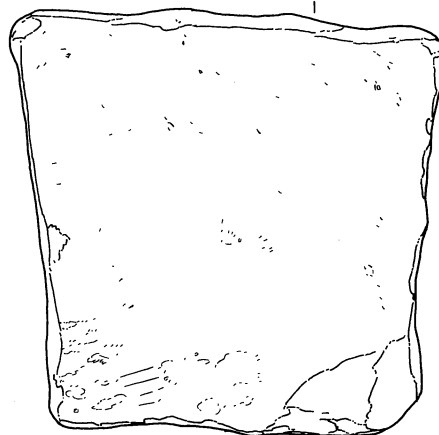
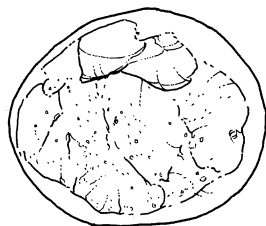

6049



竖穴住居 SH36007 (6047)

土坑 SK36001 (6046)

西微高地縁辺堆積層 (6048・6049)

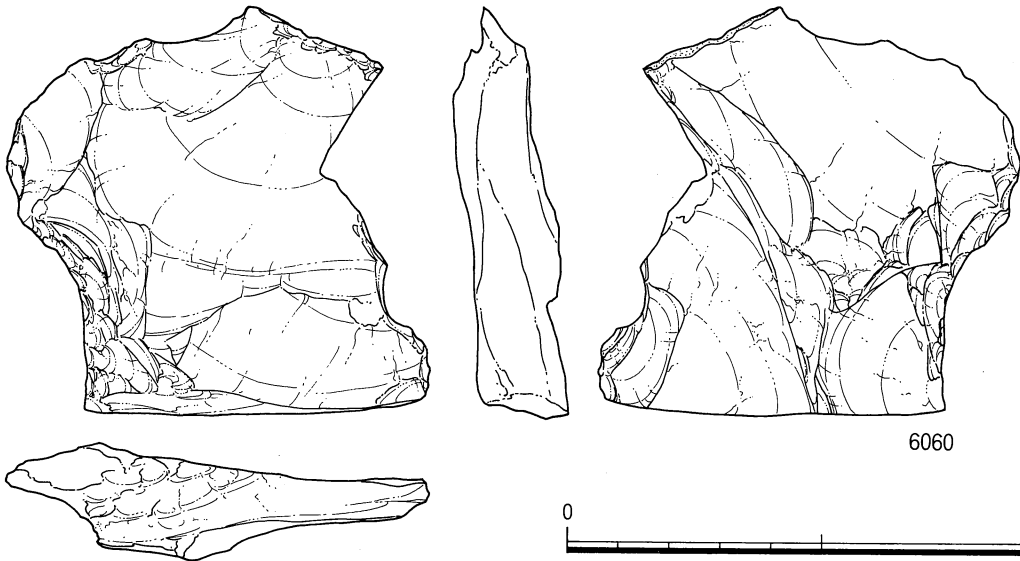
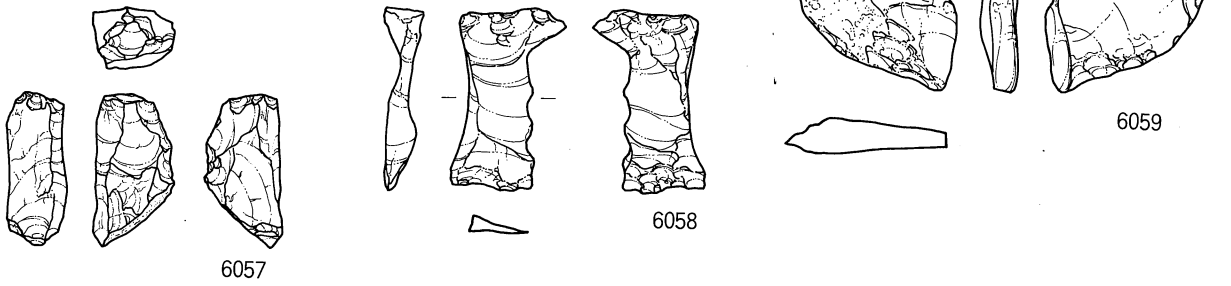
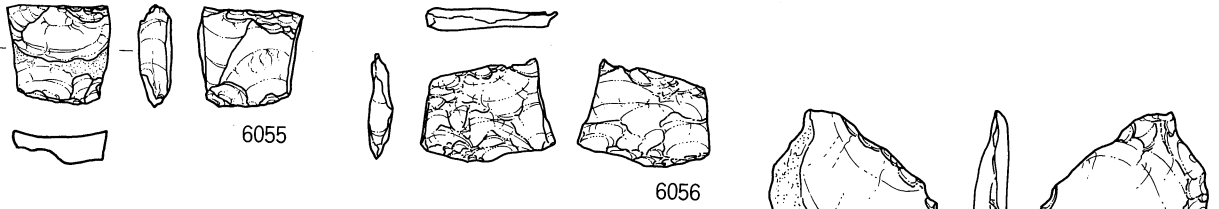
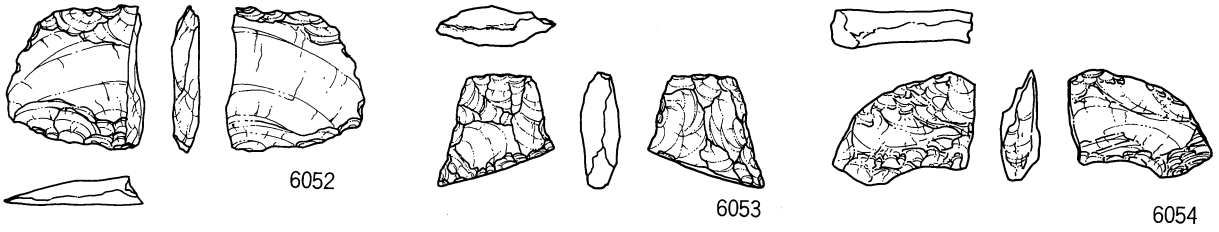
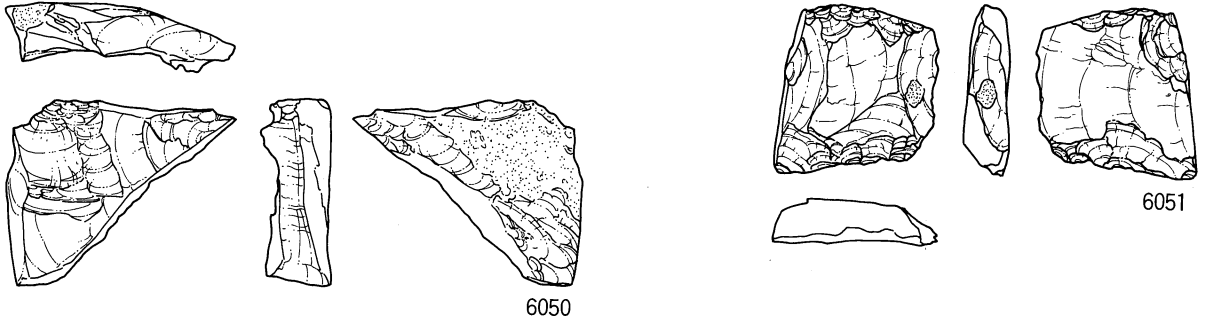

竖穴住居 SH36004 (6050) SH36007 (6051·6052) SH36008 (6053~6060)

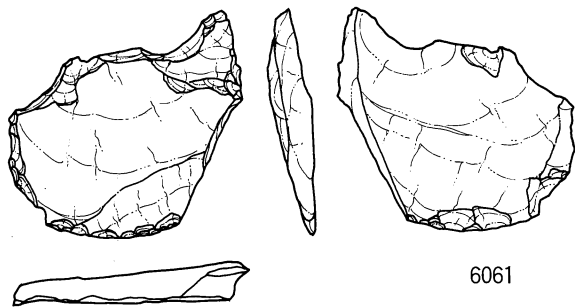

6061

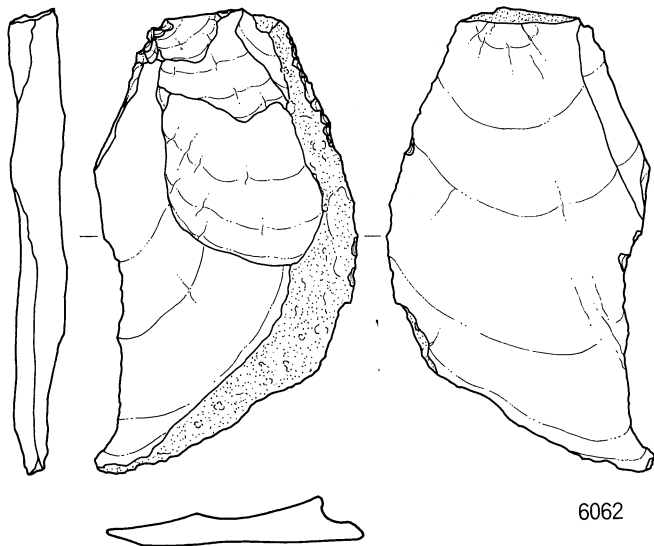
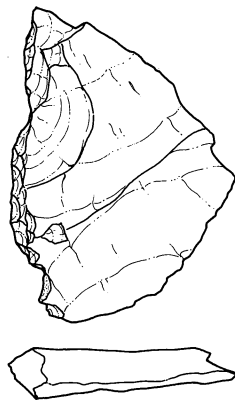

6063

6062

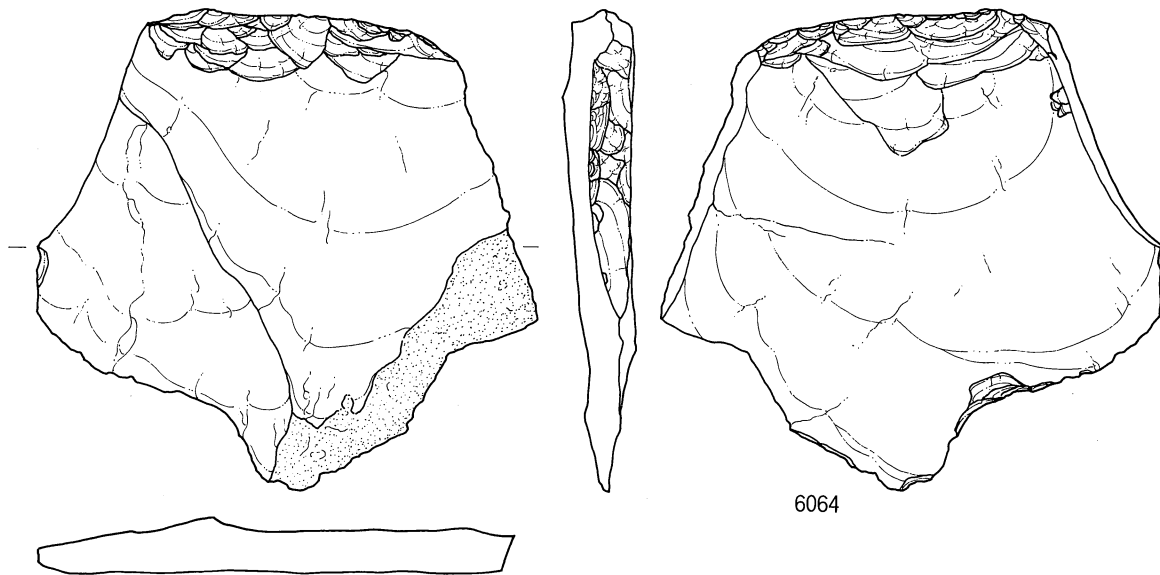

6064



竖穴住居 SH36001 (6062·6064) SH36008 (6061)
 土坑 SK36057 (6063)

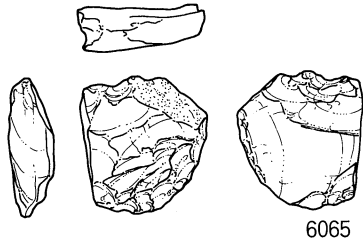

6065

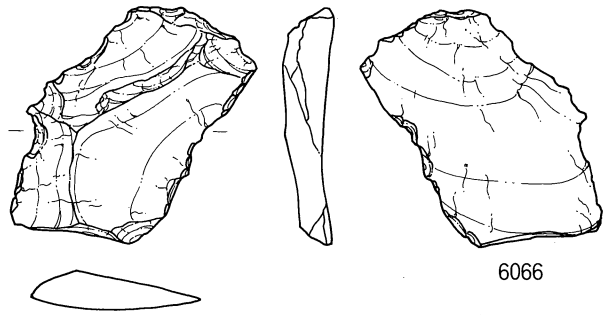

6066

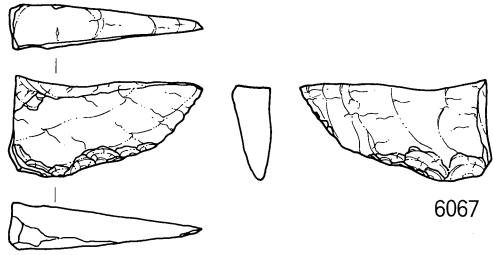

6067

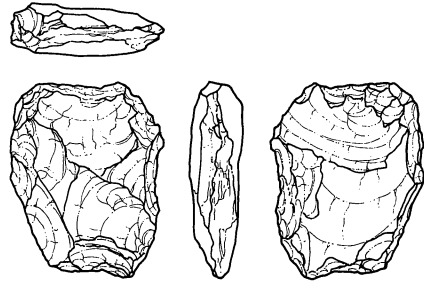

6068

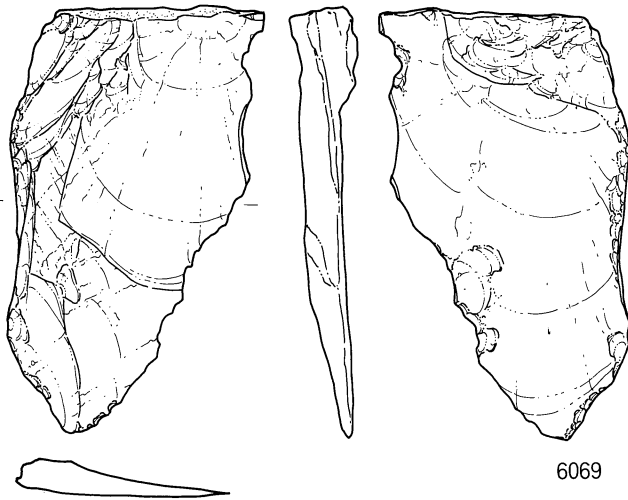

6069

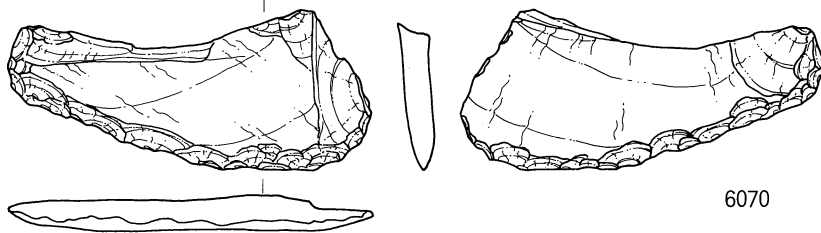

6070

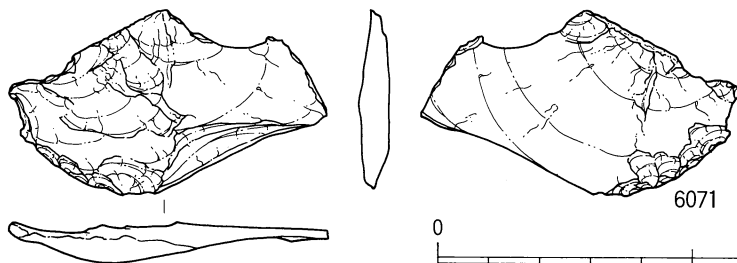

6071

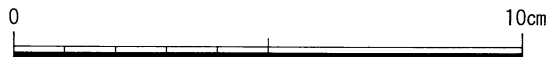

竖穴住居 SH36004 (6065) SH36008 (6066)
 土坑 SK36002 (6067) SK36055 (6070)
 西微高地縁辺堆積層 (6071) 包含層 (6068・6069)

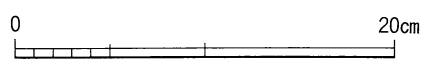
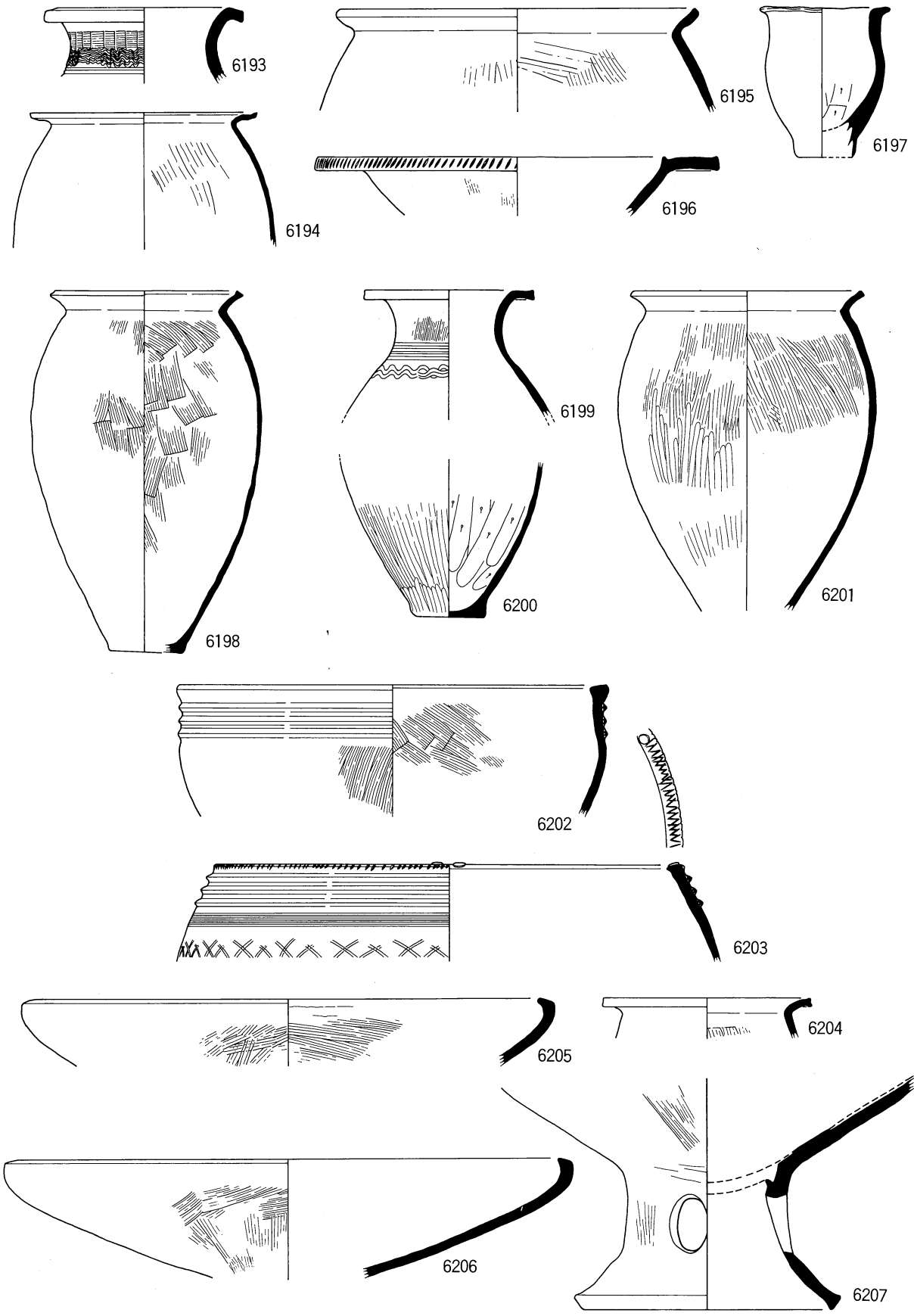

竖穴住居 SH46001 (6193~6197) SH46003 (6198)
 SH46004 (6199~6202) SH46006 (6203~6207)

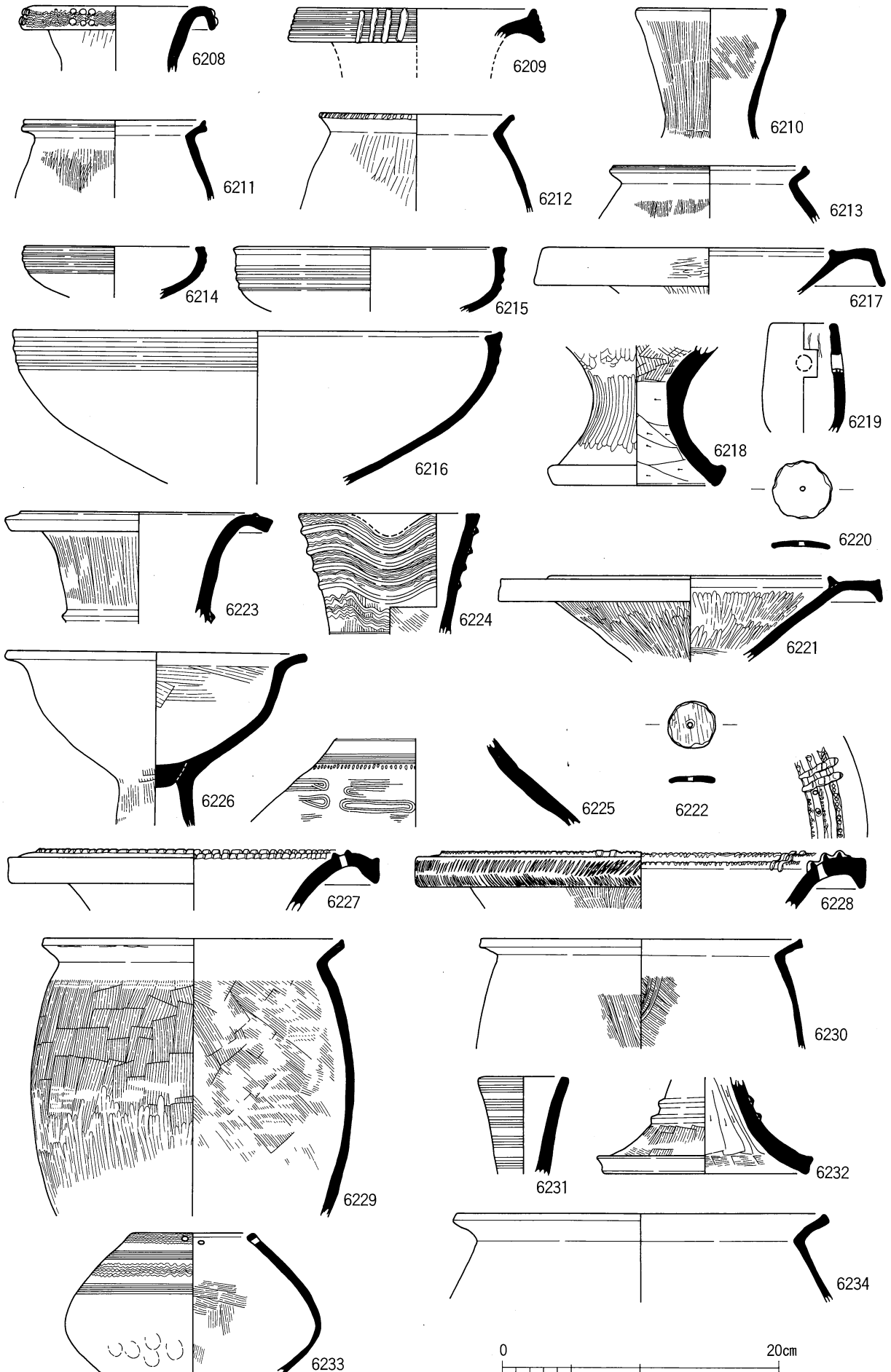

竖穴住居 SH46008 (6208~6220) SH46007 (6221·6222)
 SH46009 (6223~6226) SH46010 (6227~6232)
 SH46011 (6233·6234)

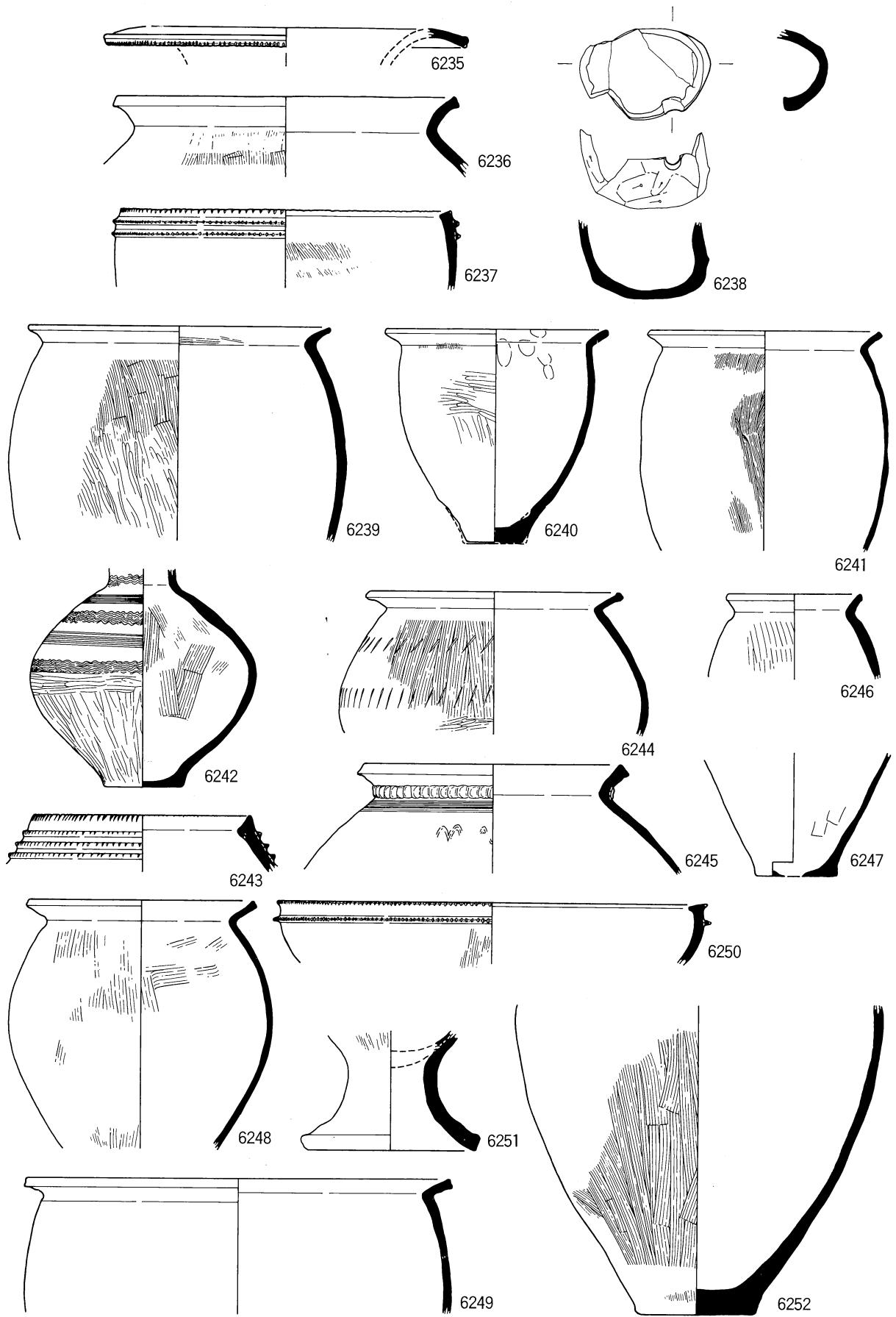

竖穴住居 SH46012 (6235~6238) SH46014 (6239)
 SH46016 (6240·6241) SH46019 (6242~6251)
 SH46020 (6252)

0 20cm

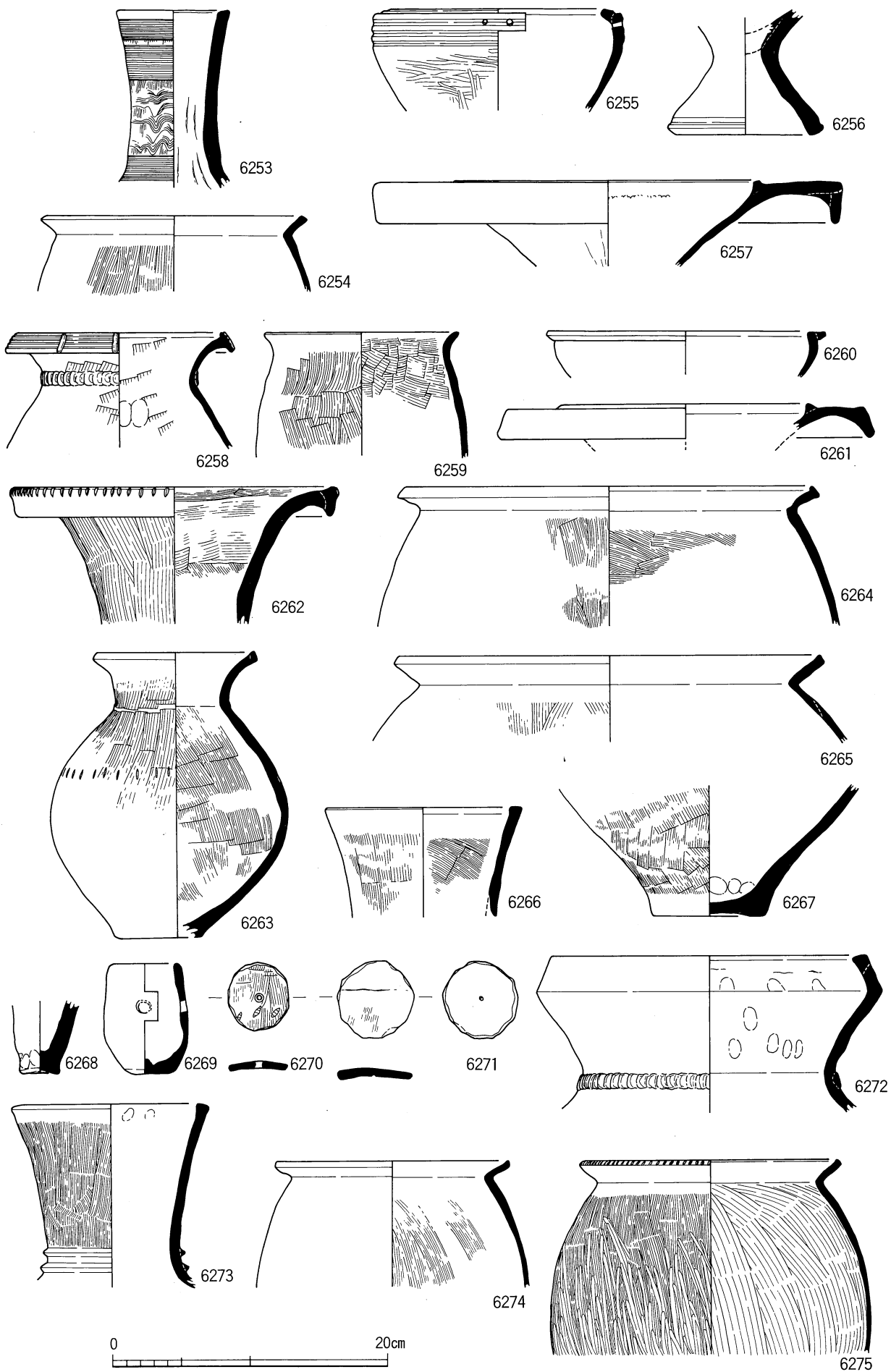

竖穴住居 SH46021 (6253 · 6254) SH46023 (6255~6257) SH46024 (6258~6261)
 SH46027 (6262~6264) SH46031 (6265) SH46032 (6266)
 SH46033 (6267) SH46034 (6268~6271) SH46036 (6272)
 SH46037 (6273) SH46038 (6274 · 6275)

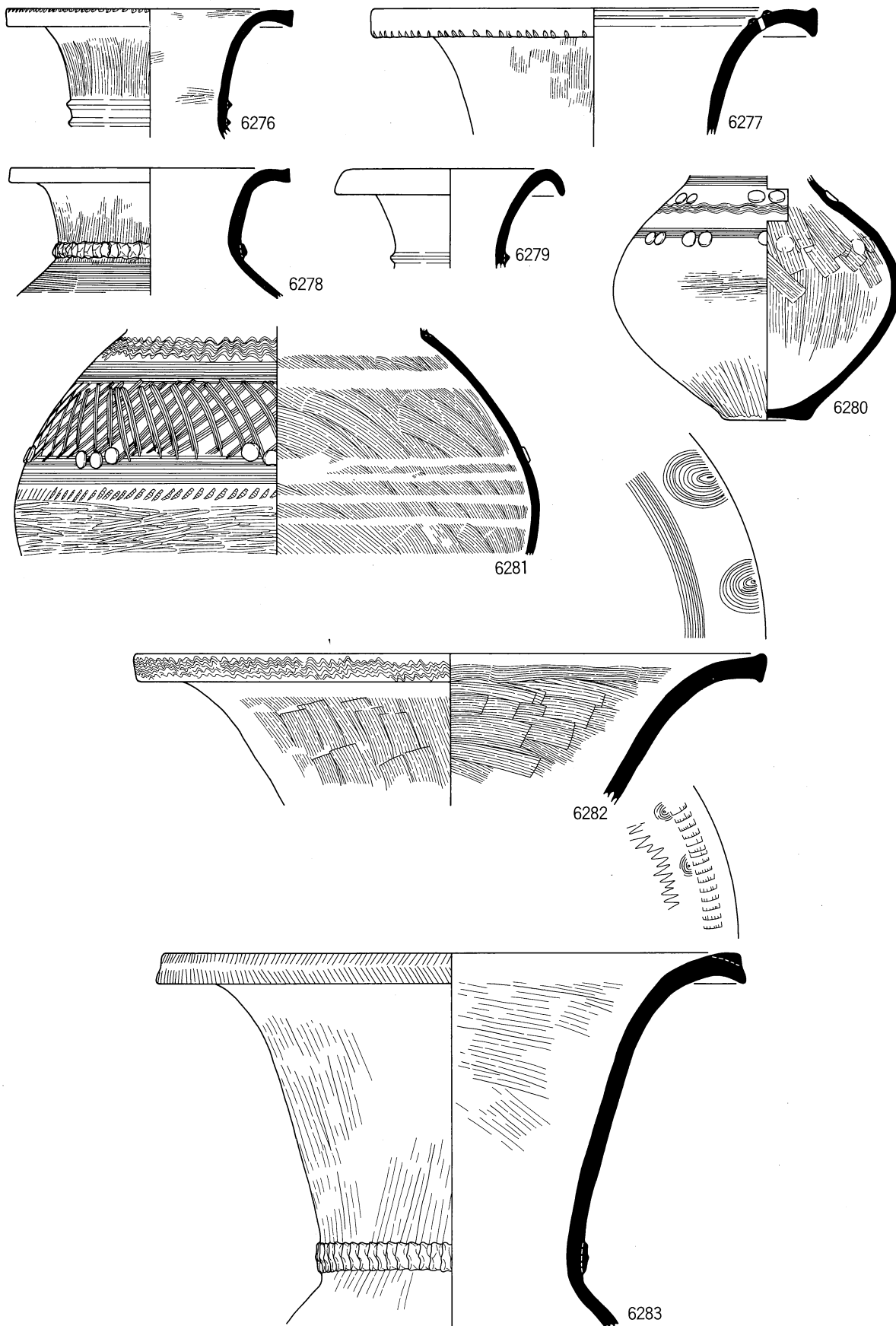

0 20cm

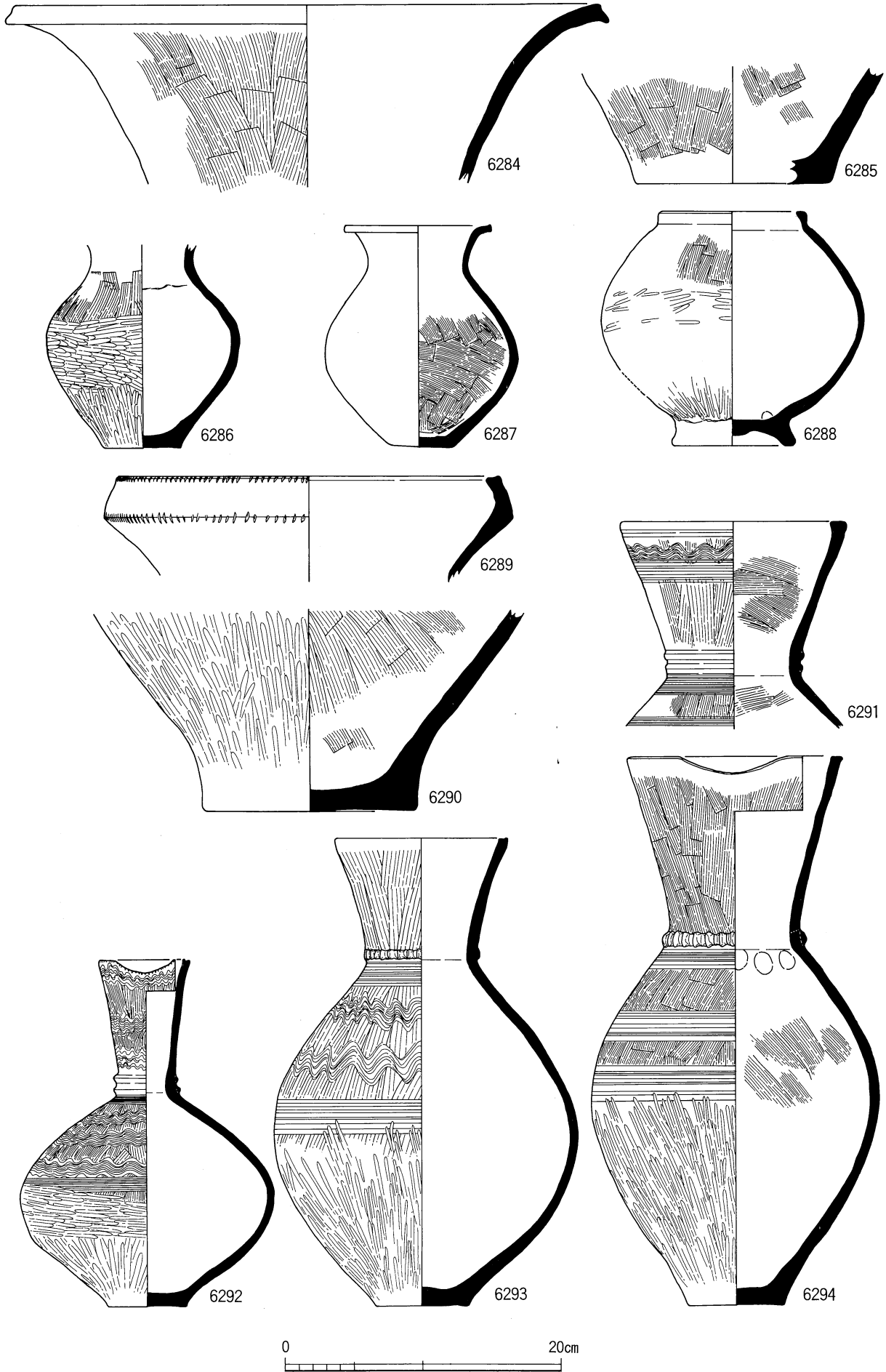

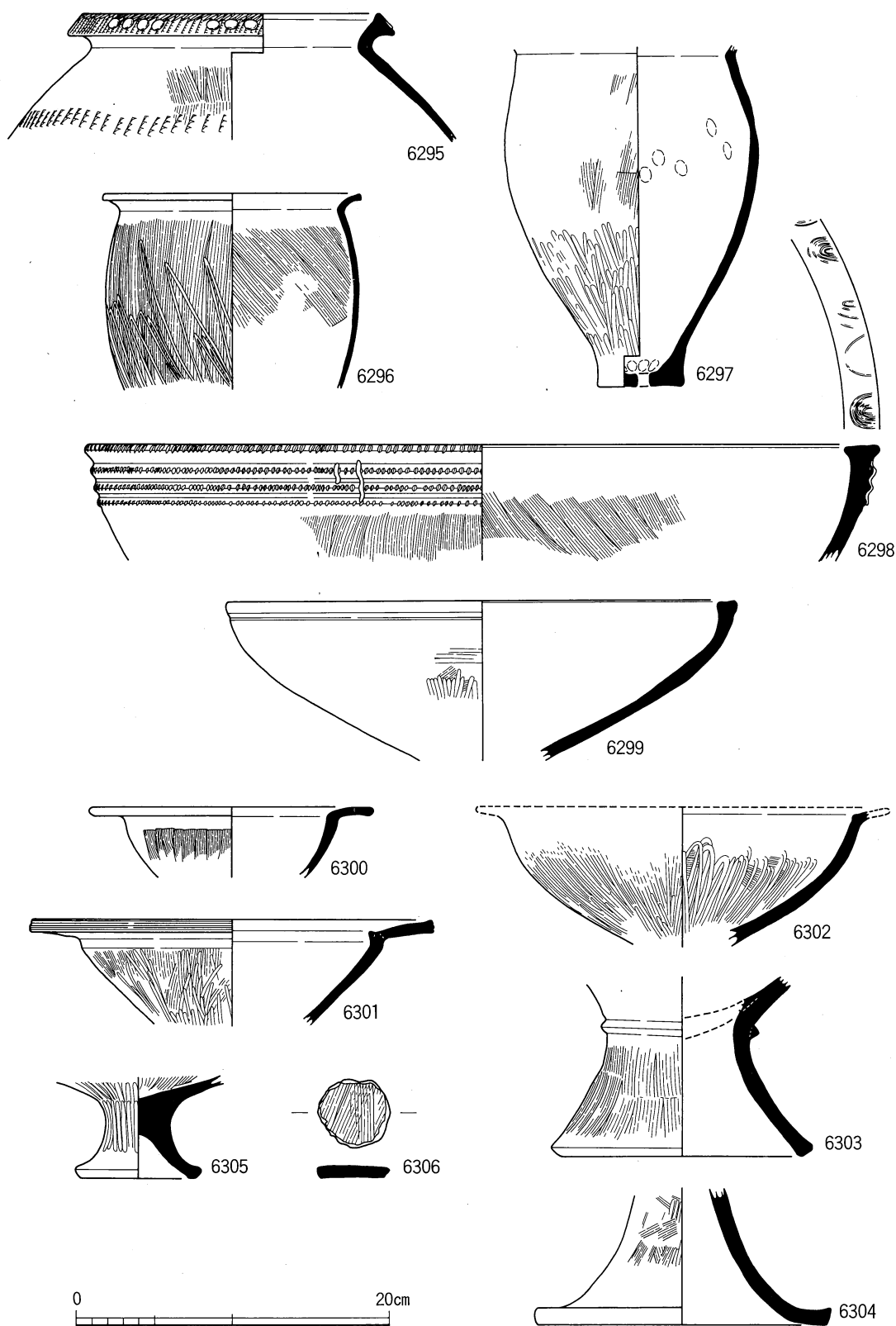

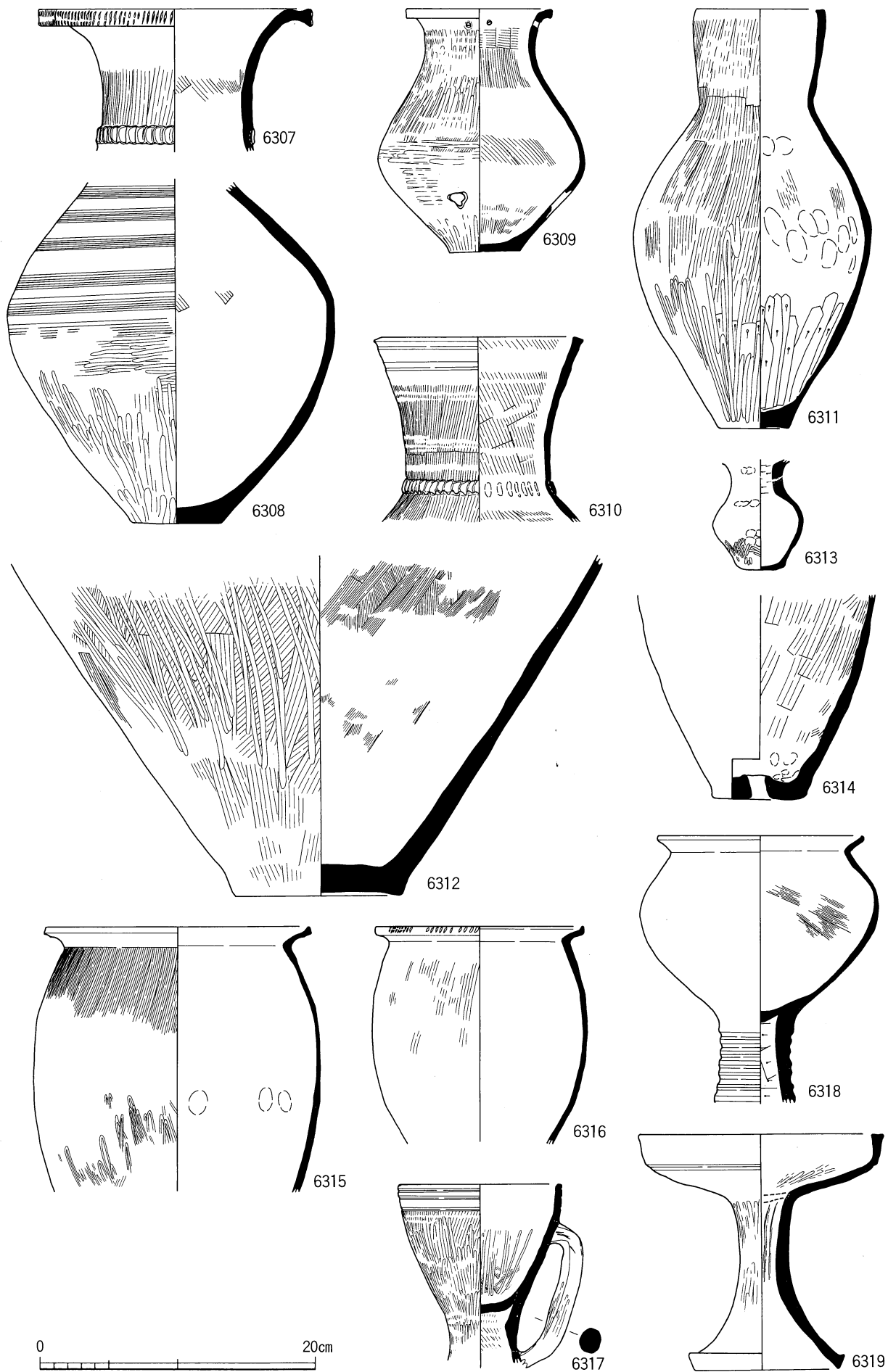

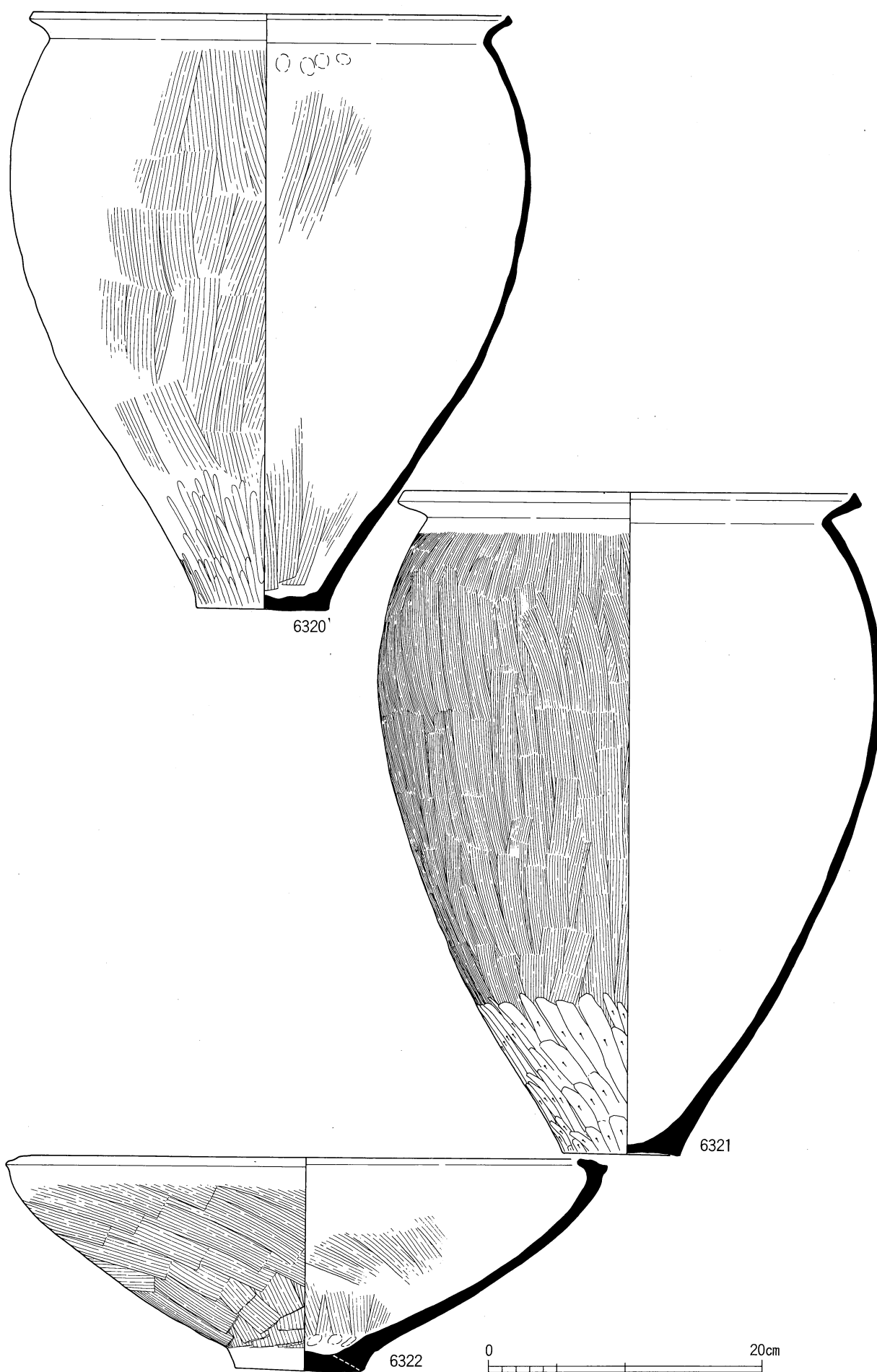

弥生中期上層 土器棺墓出土土器 1 (SP46001)

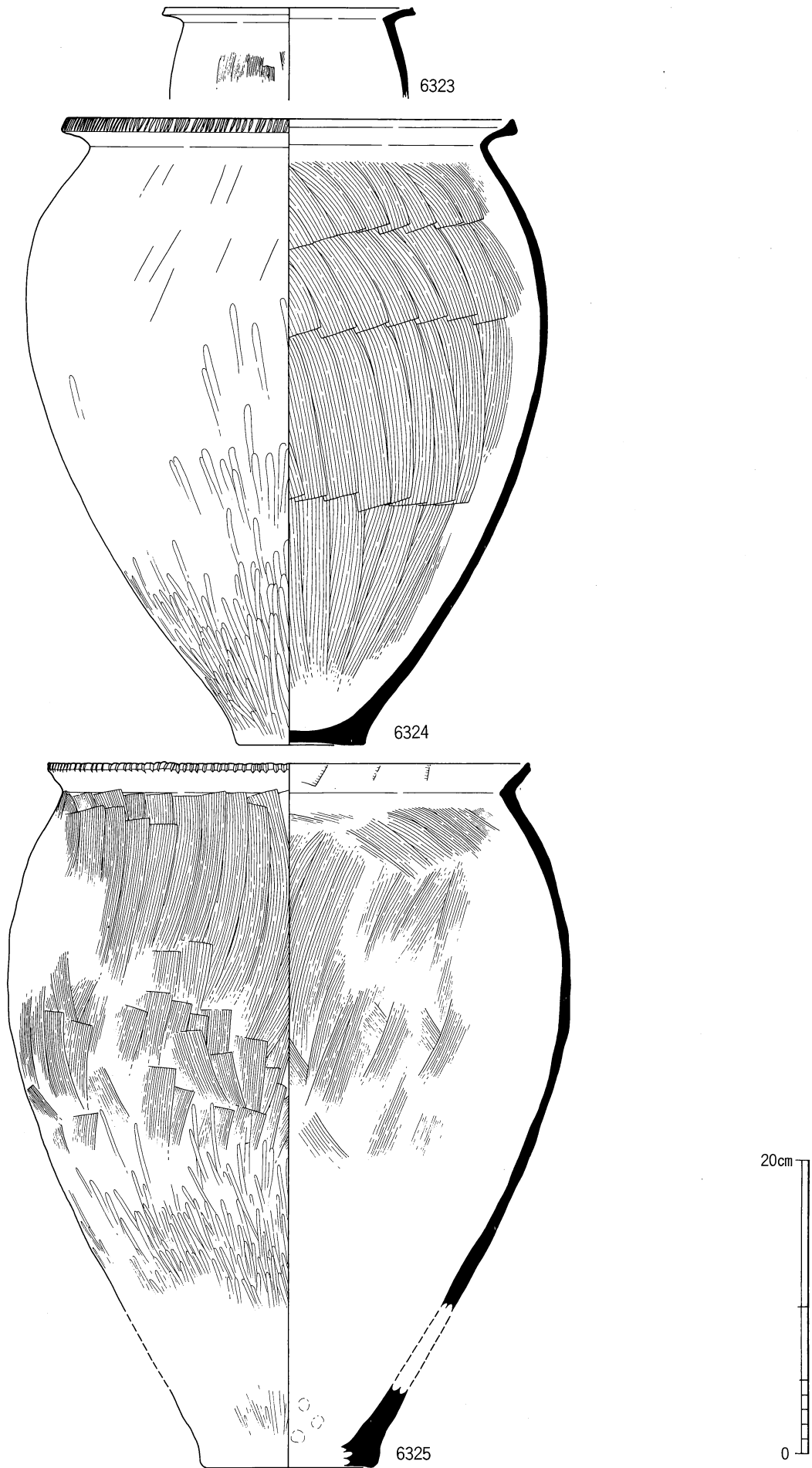

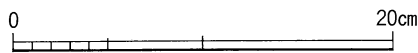
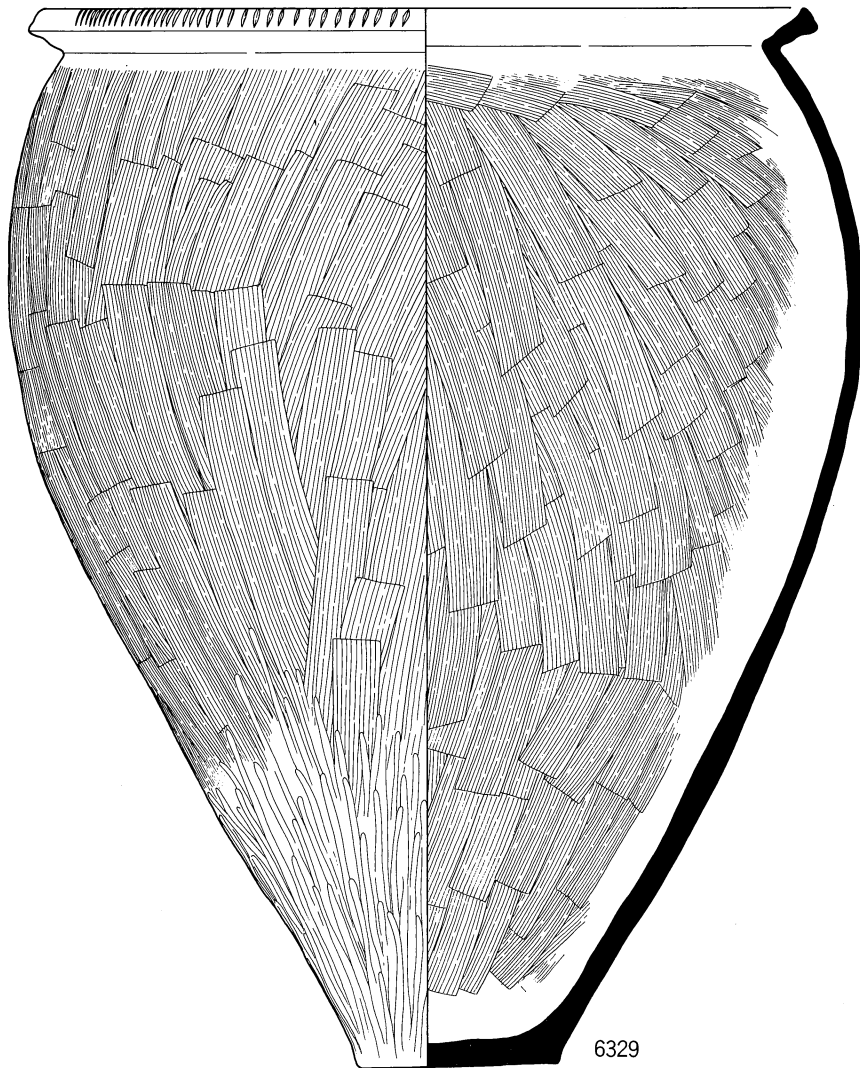
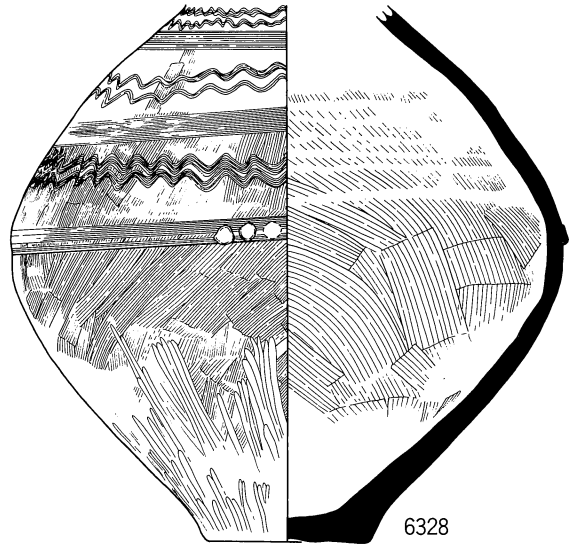
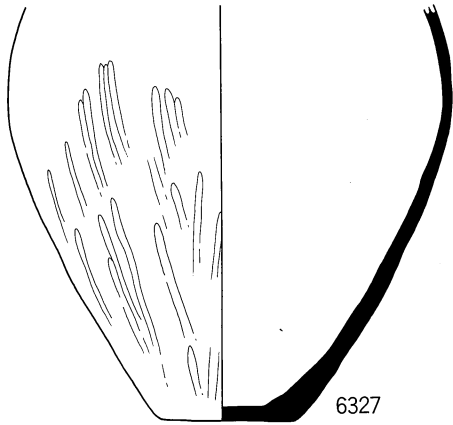
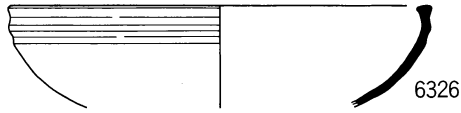

土器棺墓 SP46003 (6326) SP46004 (6327~6329)

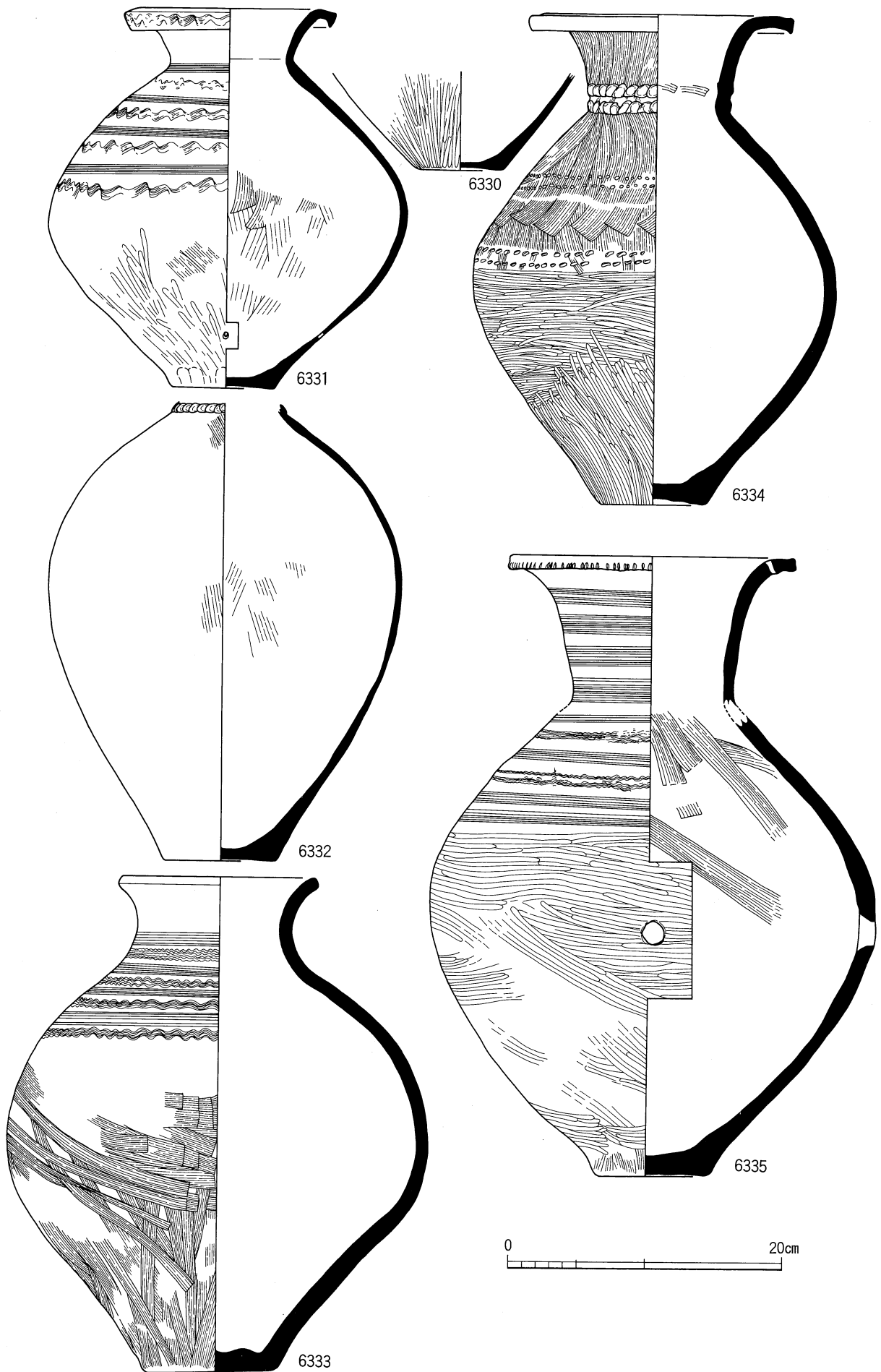

土器棺墓 SP46005 (6330・6331) SP46006 (6332)
 SP46007 (6333) SP46008 (6334・6335)

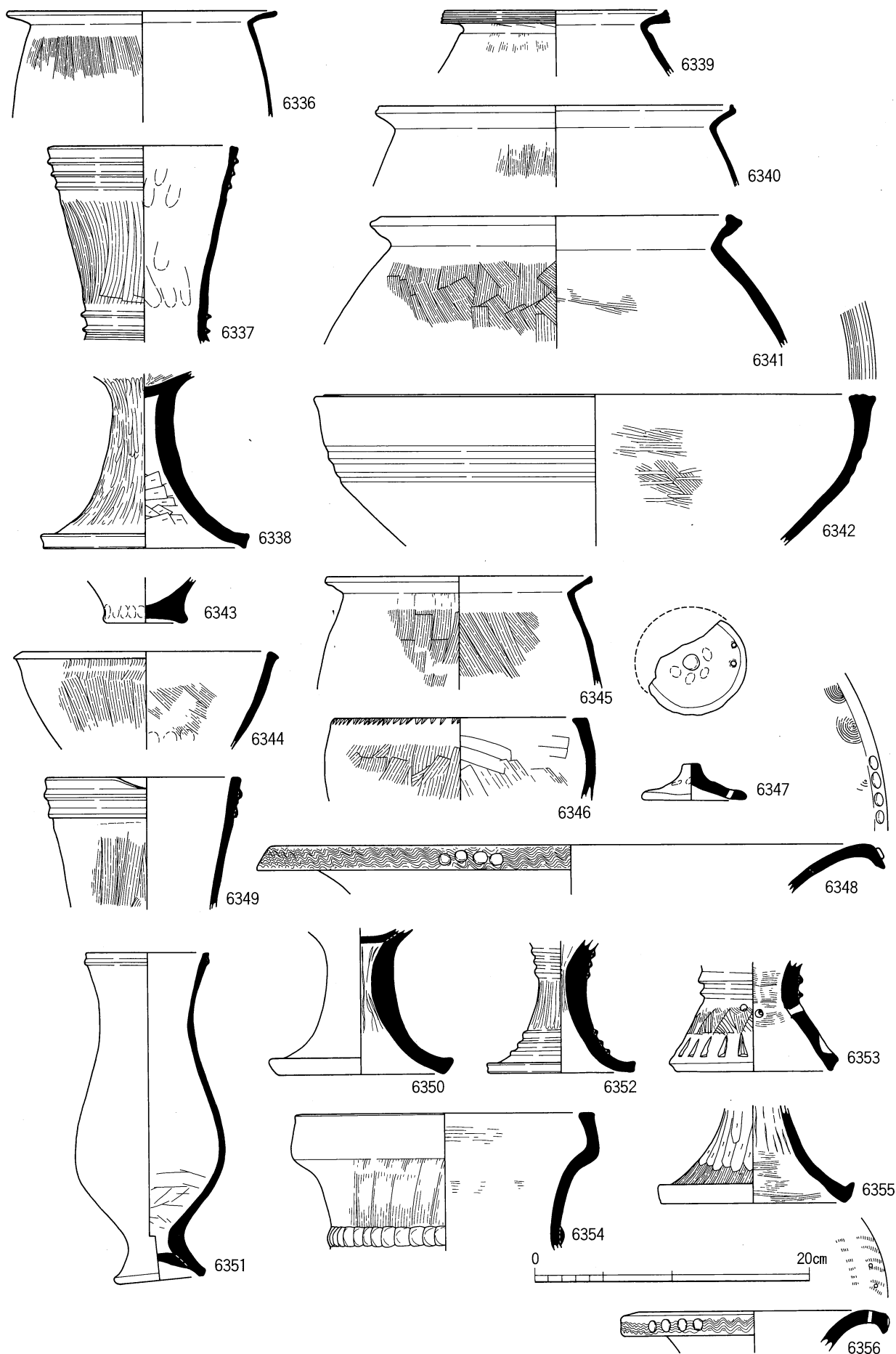

- | | | |
|-------------------|-----------------------|-----------------------|
| 土坑 SK46001 (6336) | SH46002 (6337 · 6338) | SH46006 (6339~6342) |
| SH46007 (6343) | SH46008 (6344) | SH46009 (6345~6347) |
| SH46010 (6348) | SH46011 (6349) | SH46012 (6350) |
| SH46014 (6351) | SH46015 (6352 · 6353) | SH46016 (6354 · 6355) |
| SH46017 (6356) | | |

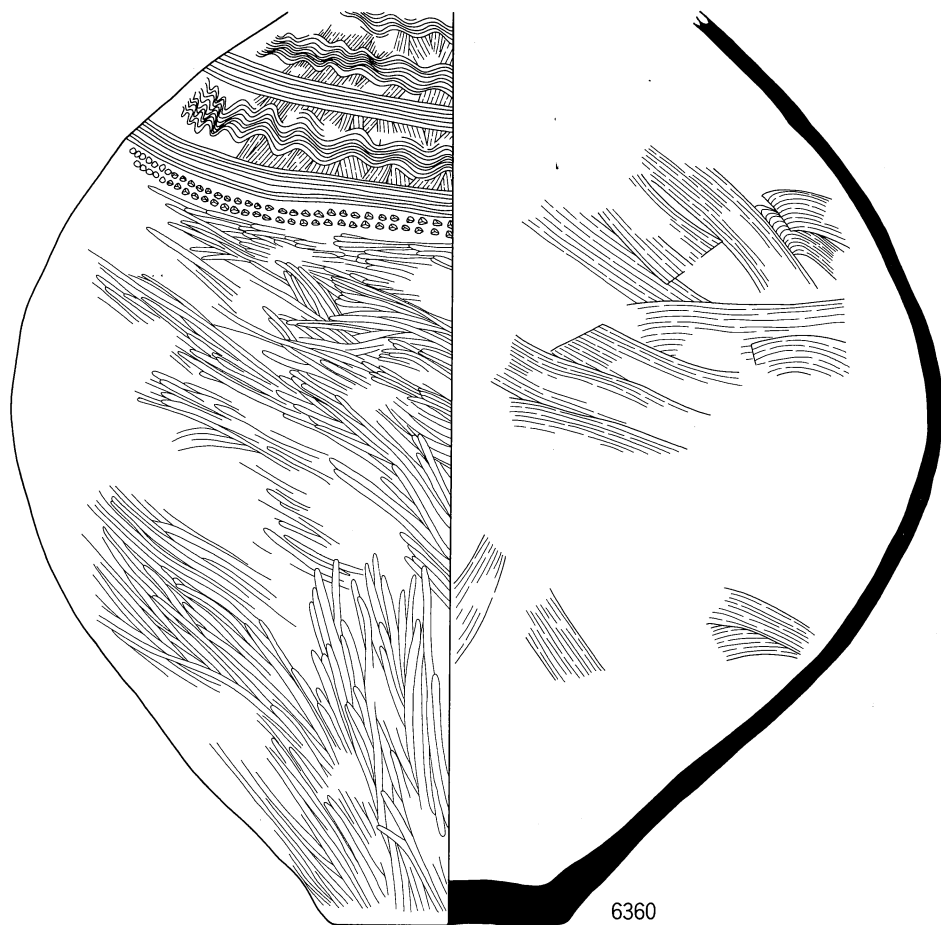
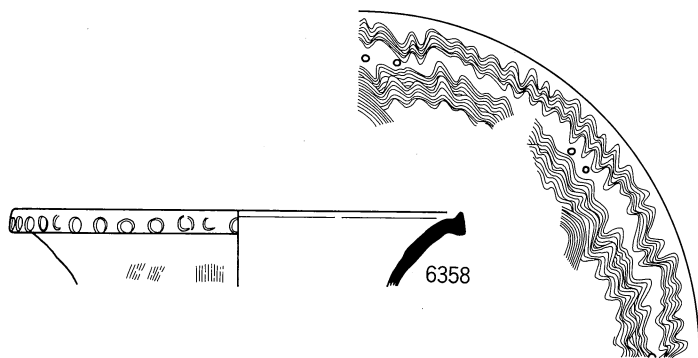
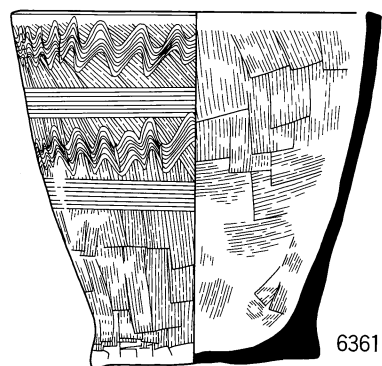
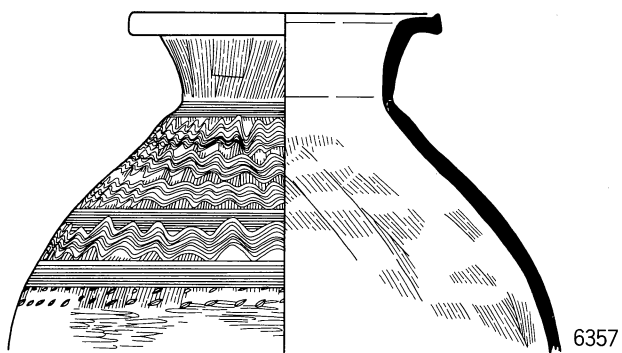

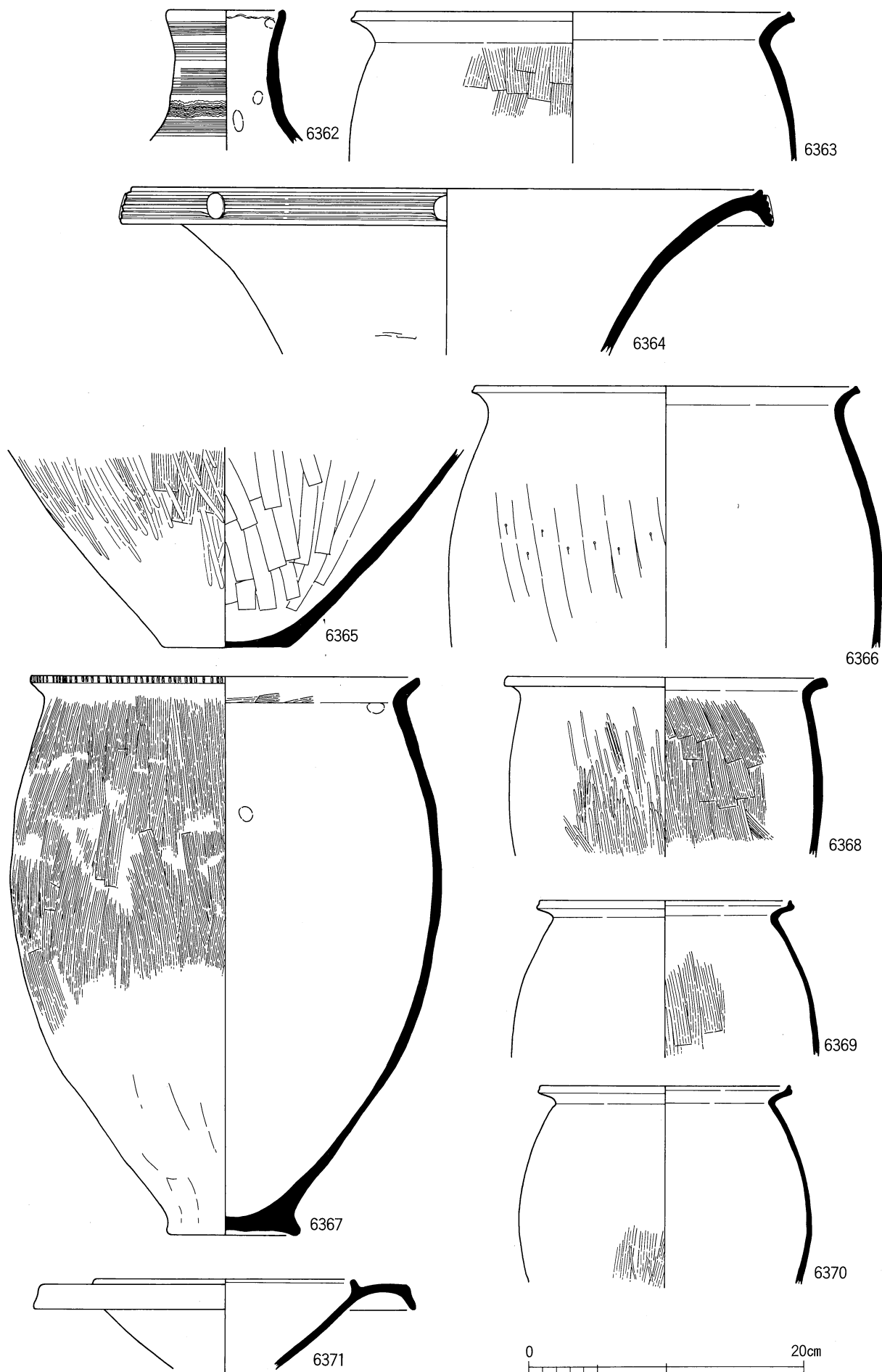

土坑 SK46022 (6362·6363) SK46024 (6364·6365) SK46025 (6366)
 SK46026 (6367·6368) SK46028 (6369~6371)

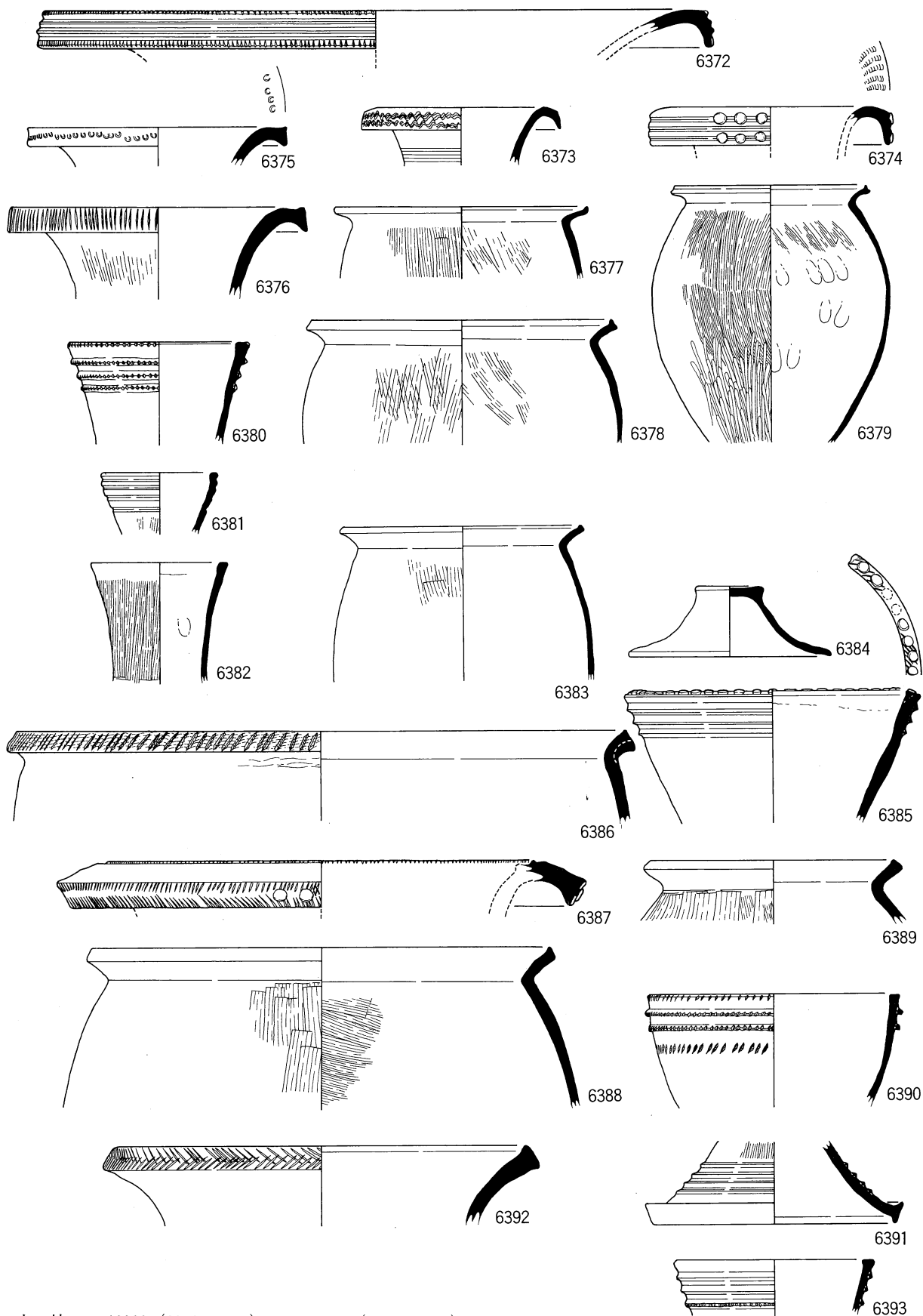

土坑 SK46029 (6372~6379) SK46031 (6380~6383)
 SK46032 (6384~6386) SK46034 (6387~6389)
 SK46035 (6390·6391) SK46036 (6392·6393)

0 20cm

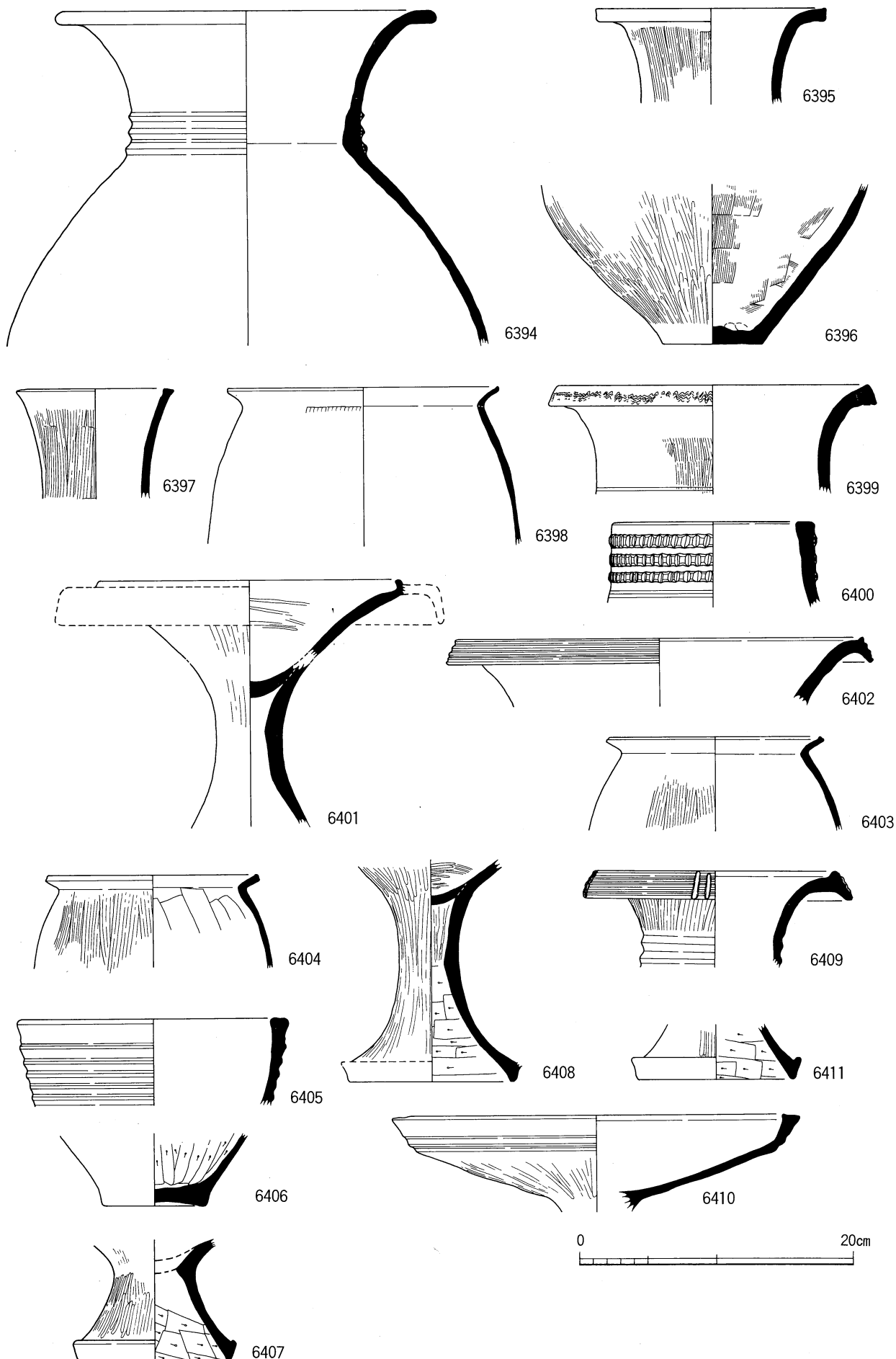

土坑 SK46037 (6394) SK46038 (6395) SK46040 (6396) SK46043 (6397·6398)
 SK46045 (6399·6400) SK46047 (6401) SK46049 (6402·6403) SK46050 (6404)
 SK46052 (6405~6407) SK46053 (6408)
 SK46054 (6409·6410) SK46055 (6411)

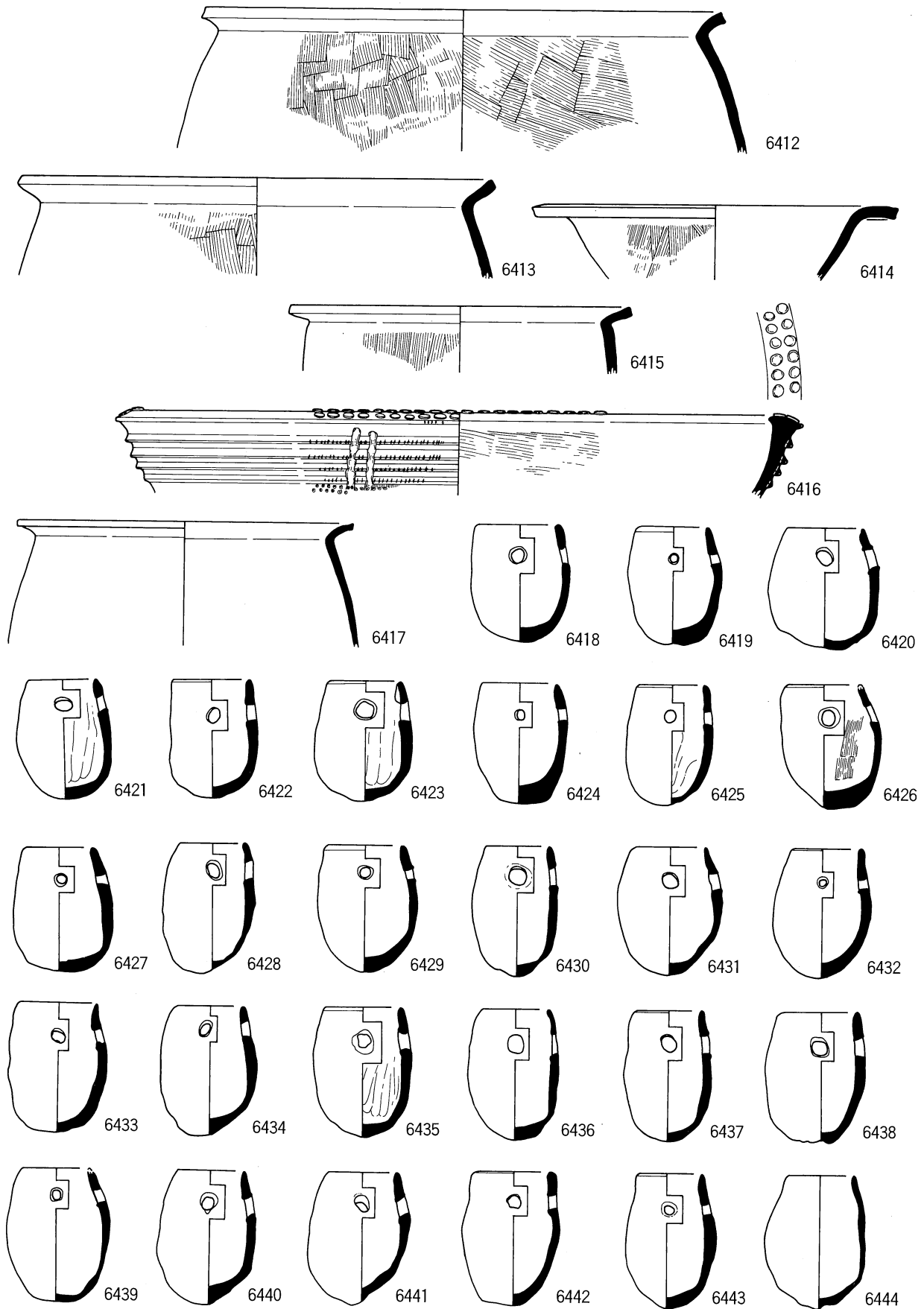

土坑 SK46056 (6412) SK46057 (6413·6414) SK46059 (6415·6416)
 SK46060 (6417) SK46061 (6418~6444)

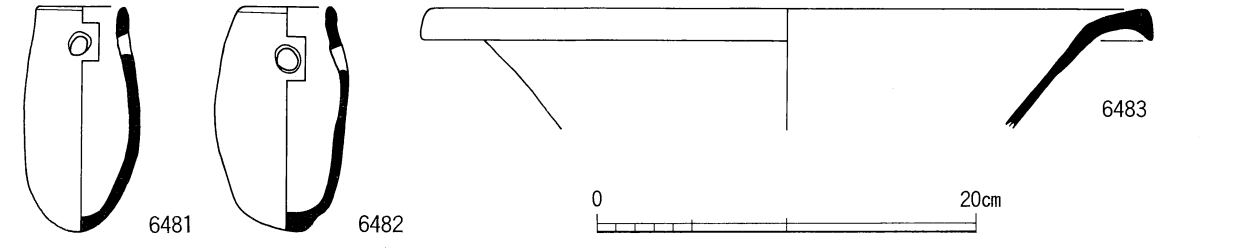
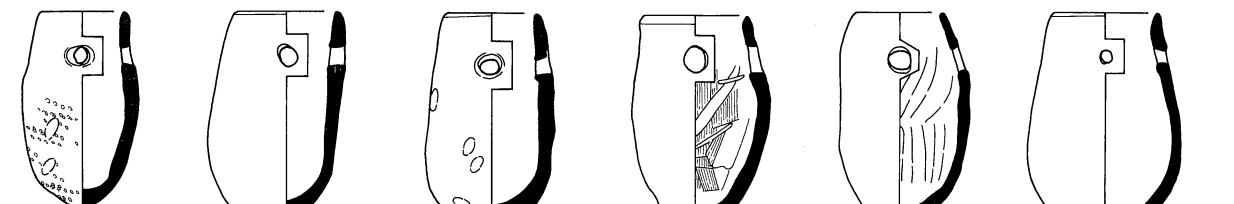
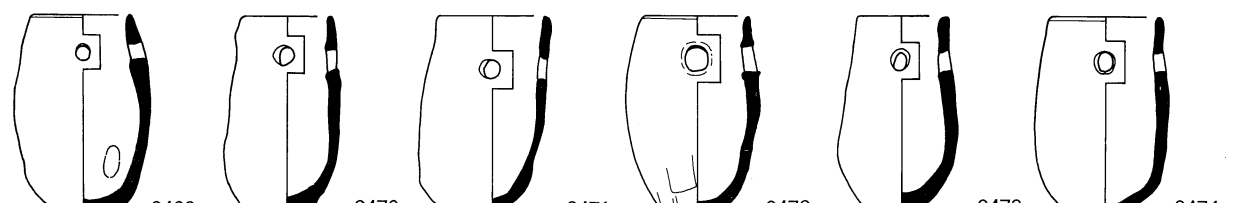
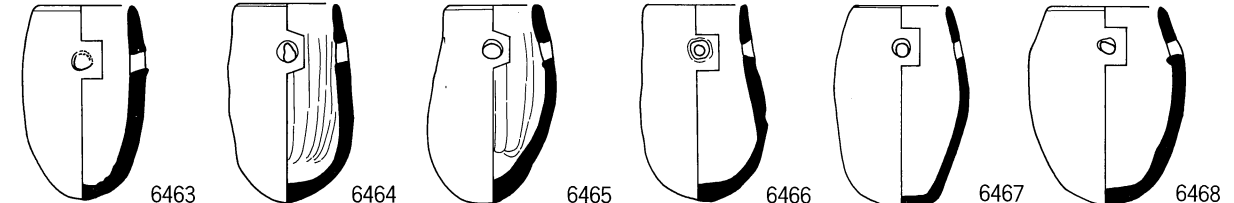
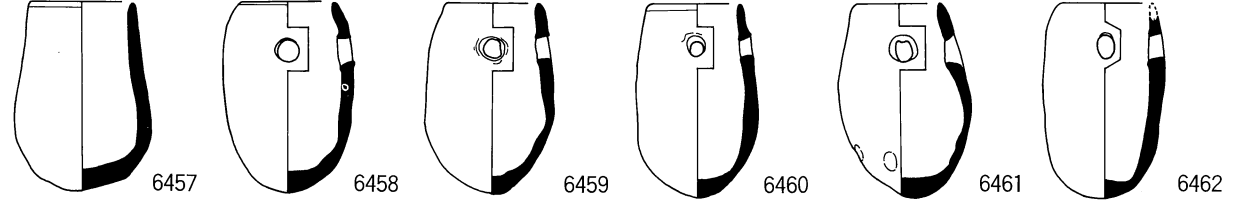
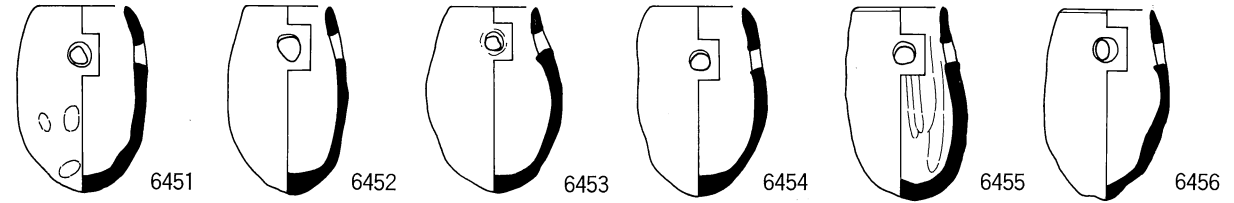
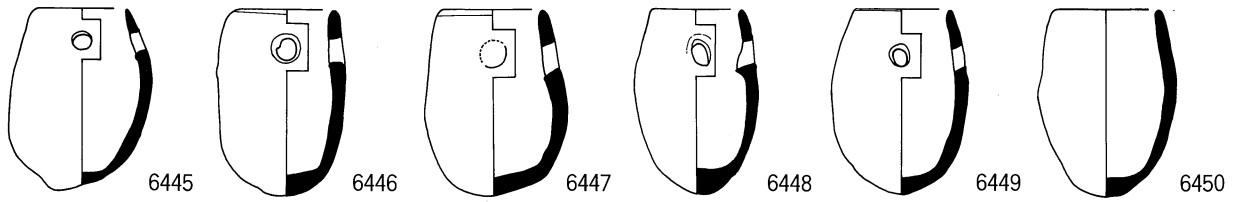

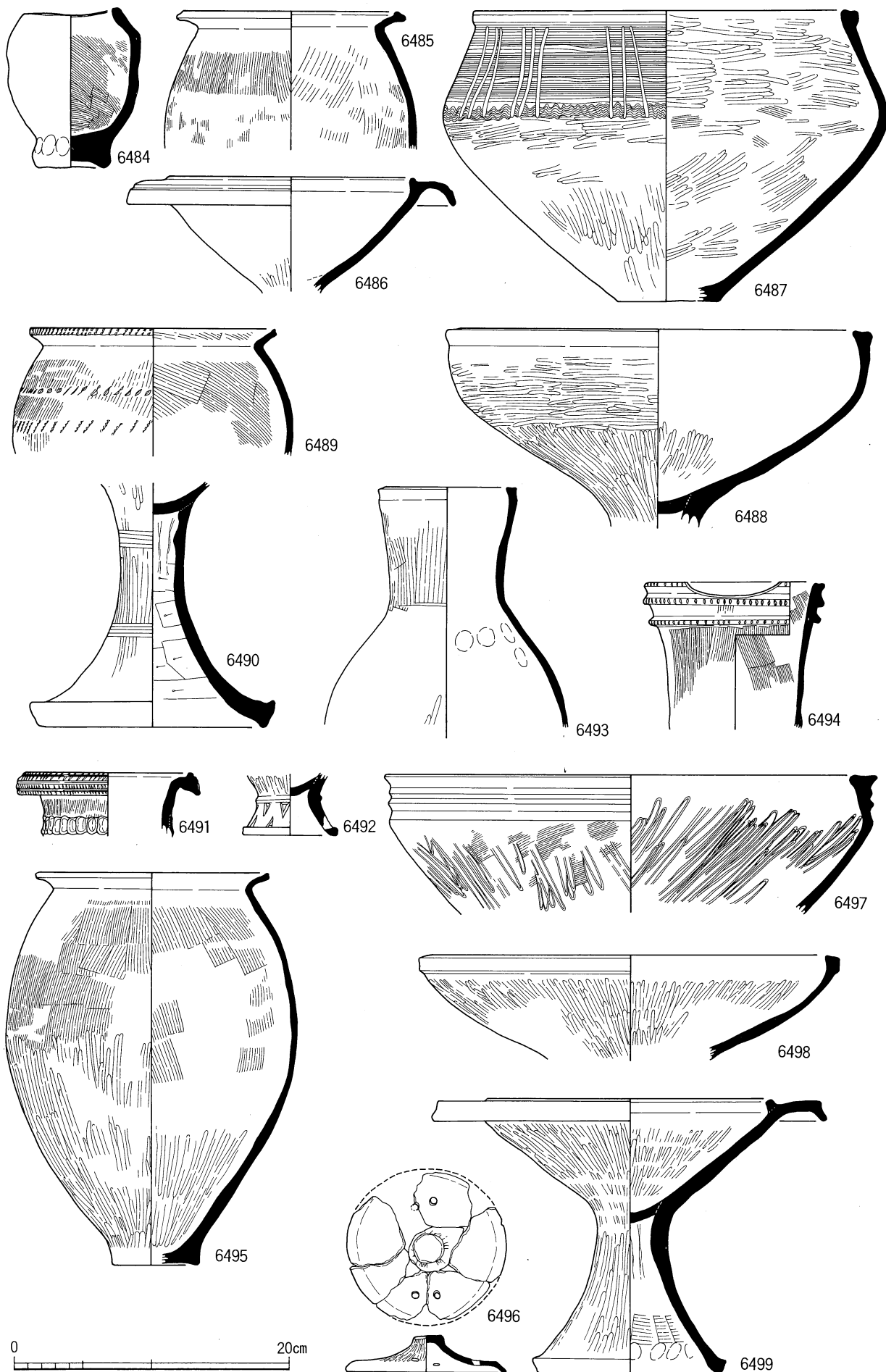

土坑 SK46063 (6484) SK46066 (6485~6488)
 SK46067 (6489·6490) SK46068 (6491·6492)
 SK46069 (6493) SK46070 (6494~6499)

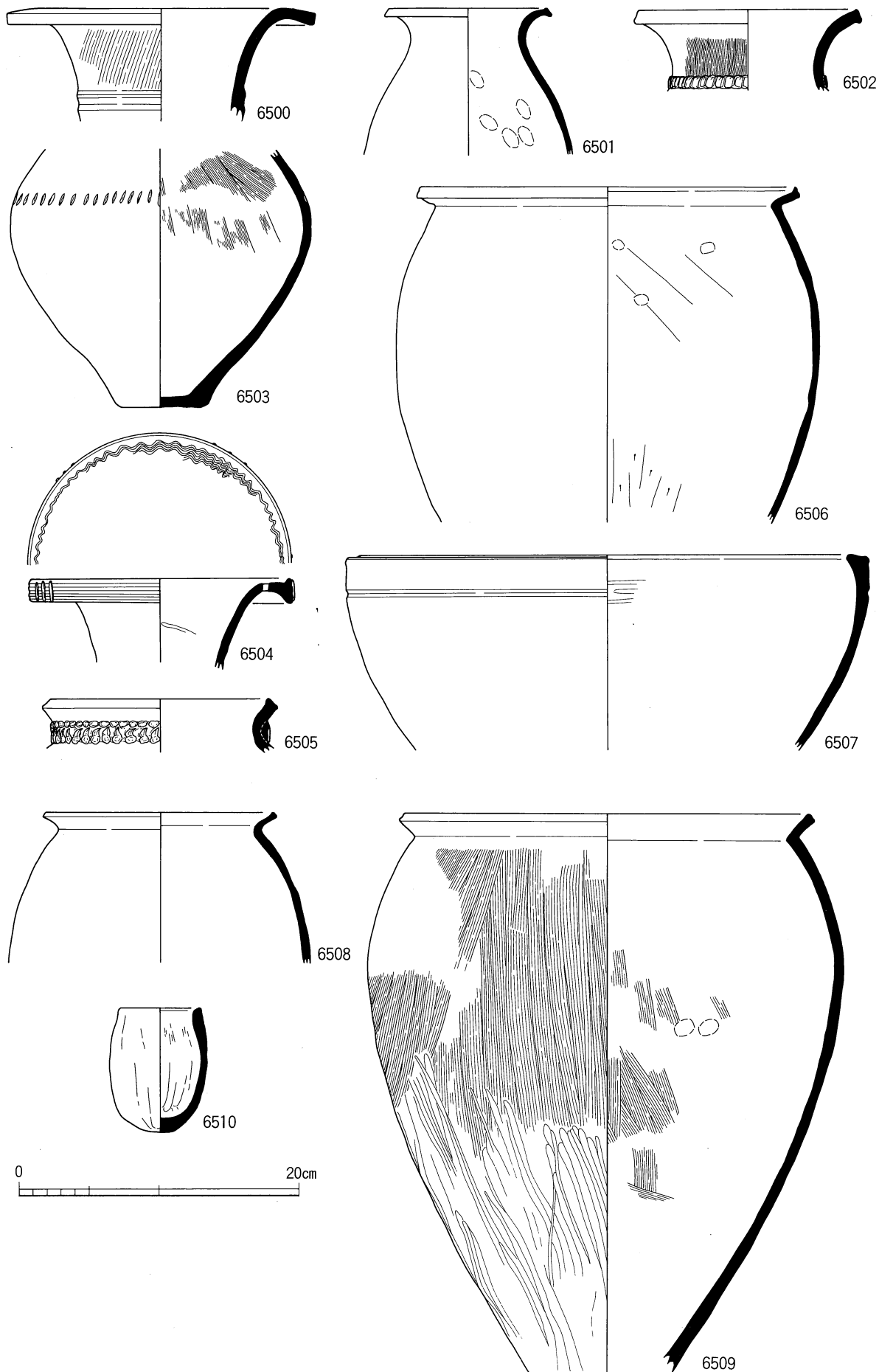

土坑 SK46073 (6500·6501) SK46075 (6502) SK46076 (6503)
 SK46077 (6504~6507) SK46079 (6508·6509) SK46080 (6510)

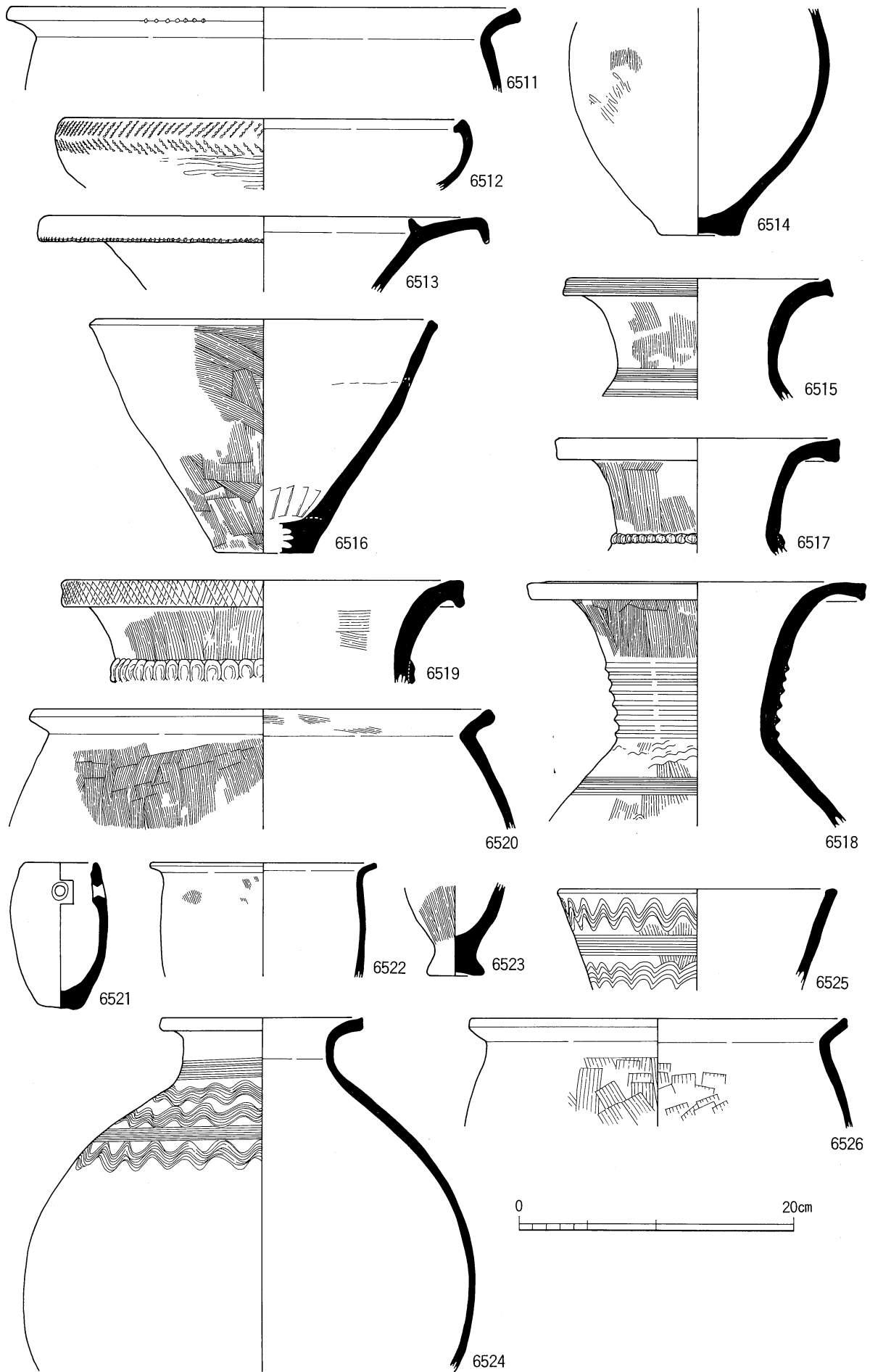

土坑 SK46081 (6511~6513) SK46082 (6514)
 SK46083 (6515) SK46084 (6516)
 SK46085 (6517~6520) SK46088 (6521~6523)
 SK46090 (6524~6526)

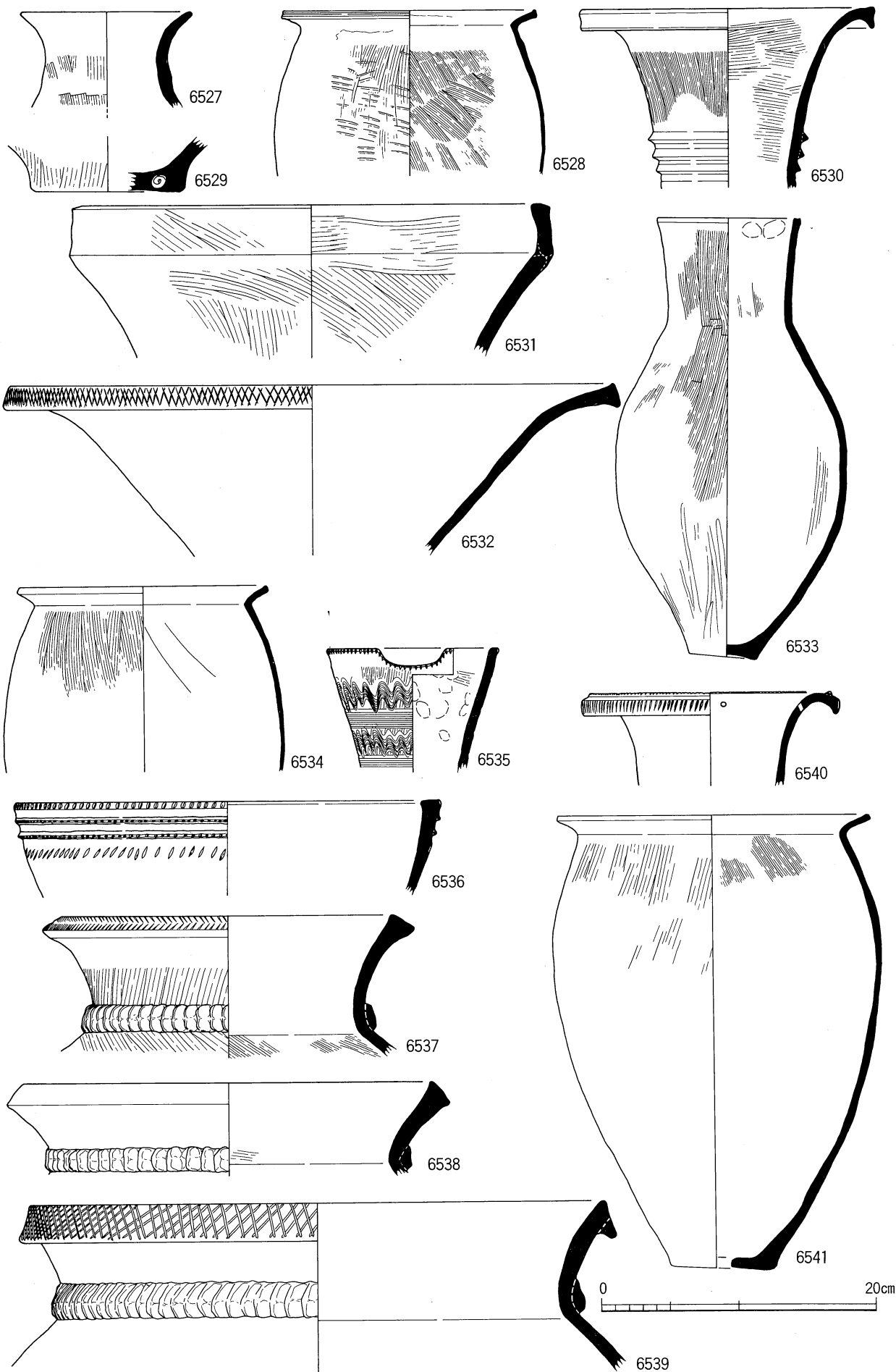

土坑 SK46093 (6527 · 6528) SK46098 (6529) SK46099 (6530)
 SK46100 (6531) SK46101 (6532 · 6533) SK46106 (6534)
 SK46108 (6535~6539) SK46109 (6540 · 6541)

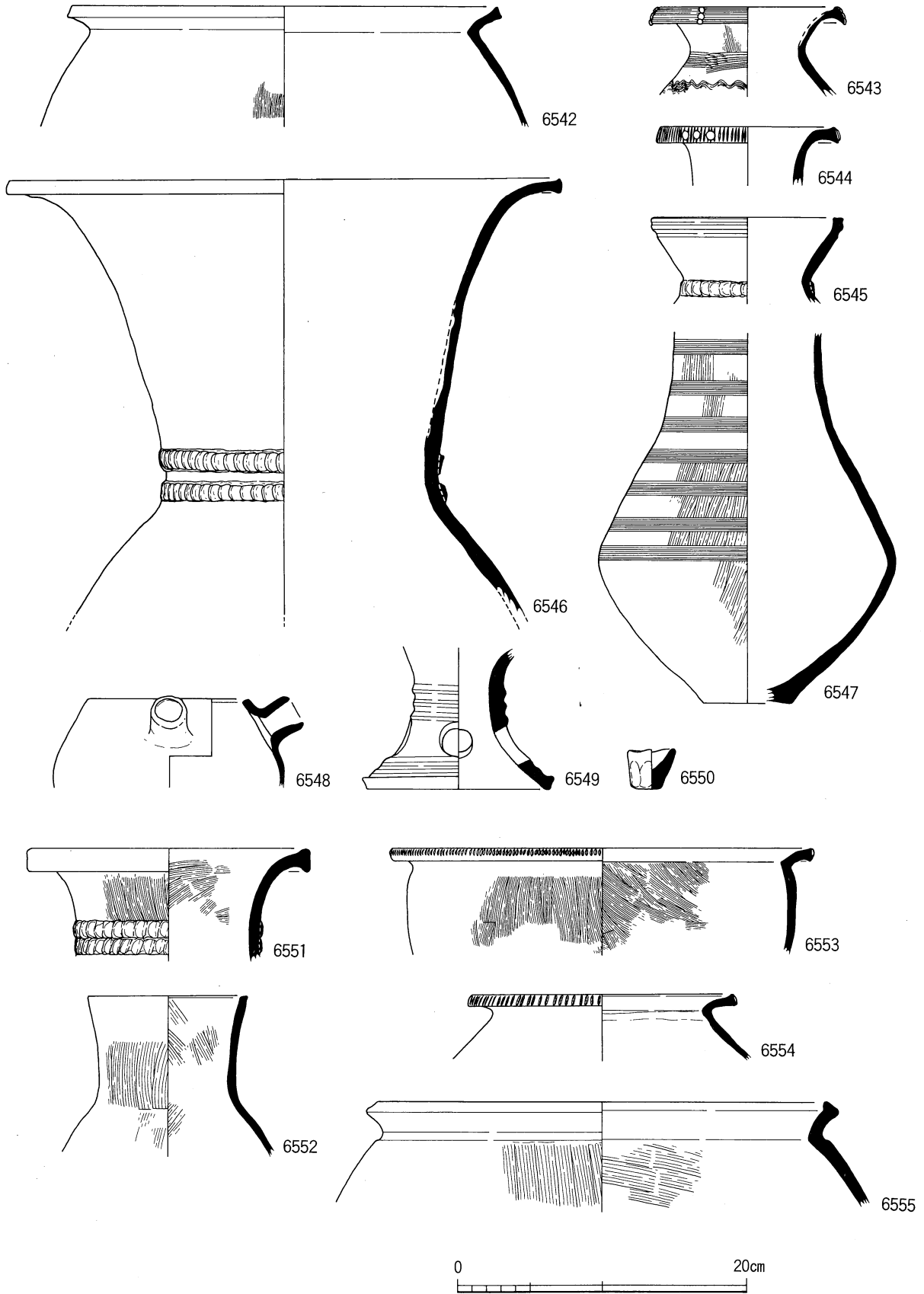

土坑 SK46110 (6542) SK46111 (6543~6550)
 SK46112 (6551~6553) SK46113 (6554·6555)

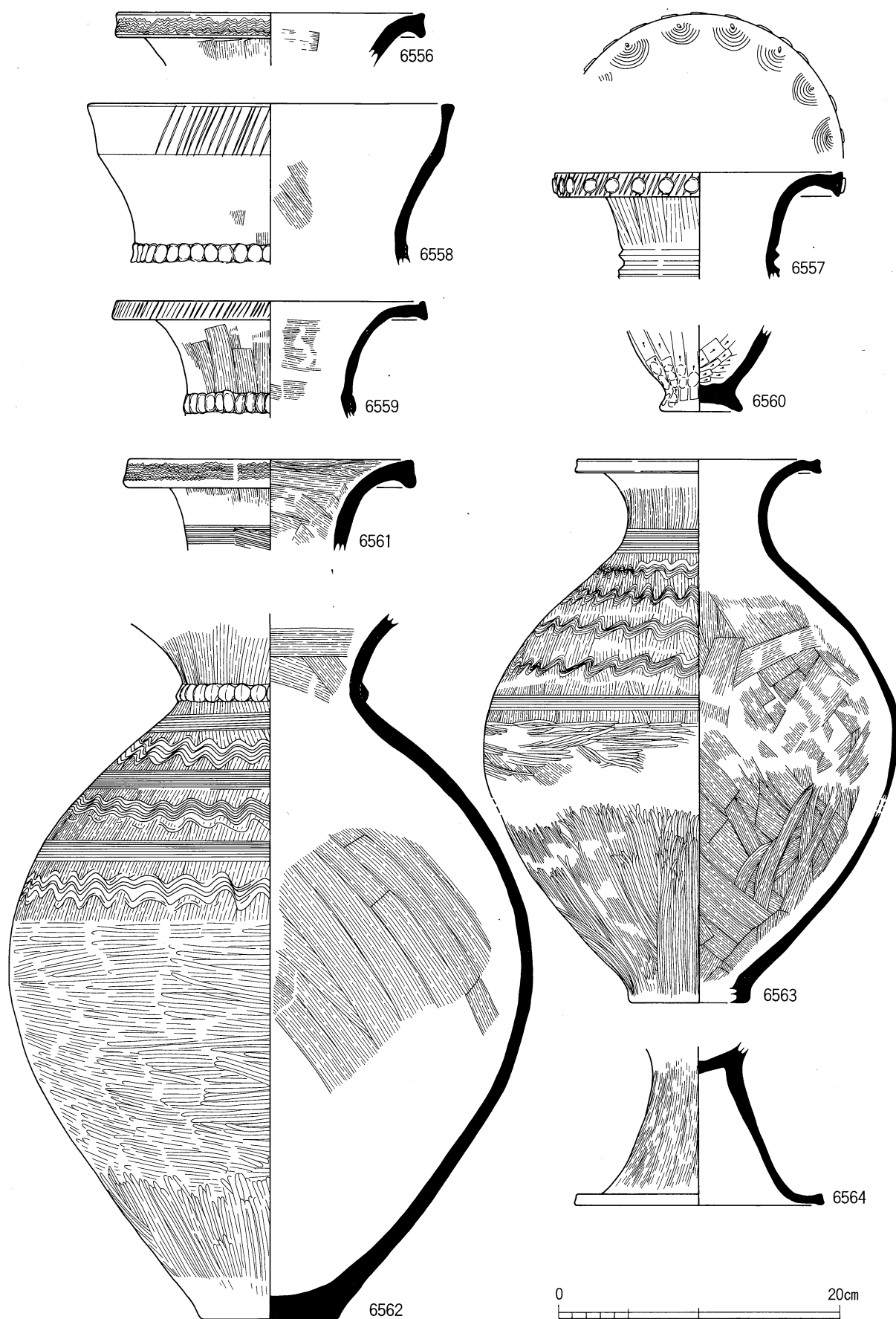

土坑 SK46114 (6556)

SK46117 (6557)

SK46118 (6558)

SK46120 (6559 · 6560)

SK46121 (6561~6564)

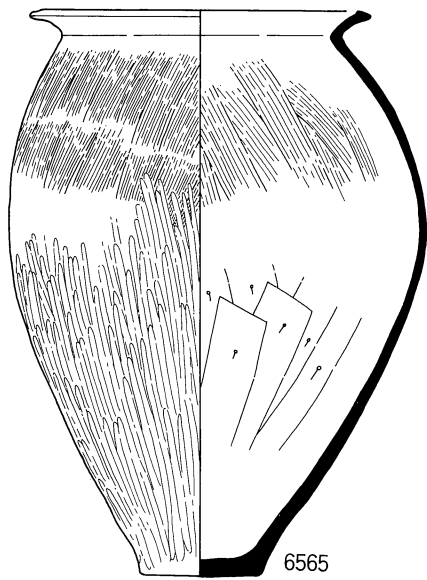

6565

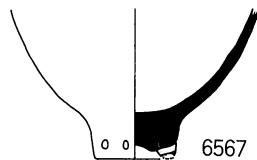

6567

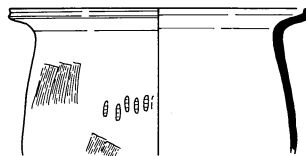

6568

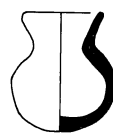

6569

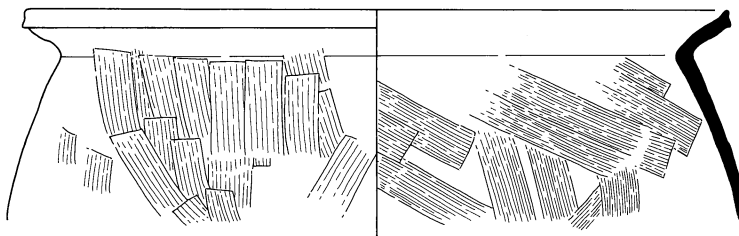

6566

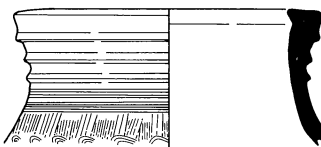

6570

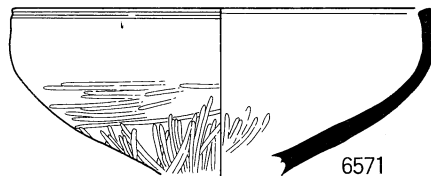

6571

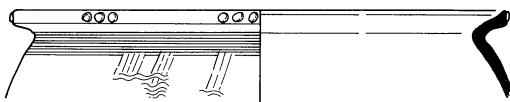

6572



6574

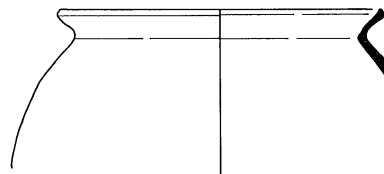

6573

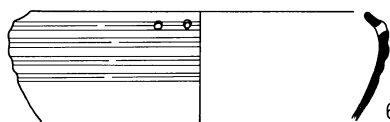

6575

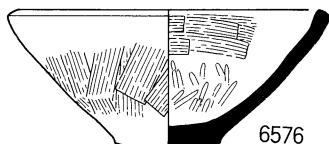

6576

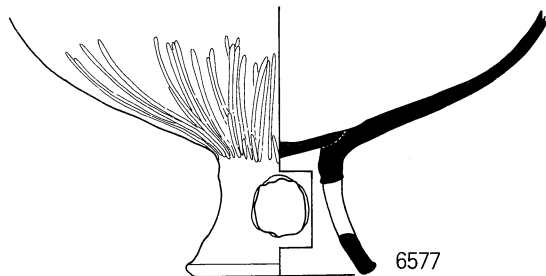

6577

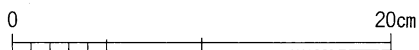

土坑 SK46122 (6565) SK46126 (6566) SK46128 (6567~6569)
 SK46129 (6570) SK46130 (6571) SK46131 (6572)
 SK46132 (6573) SK46133 (6574) SK46134 (6575~6577)

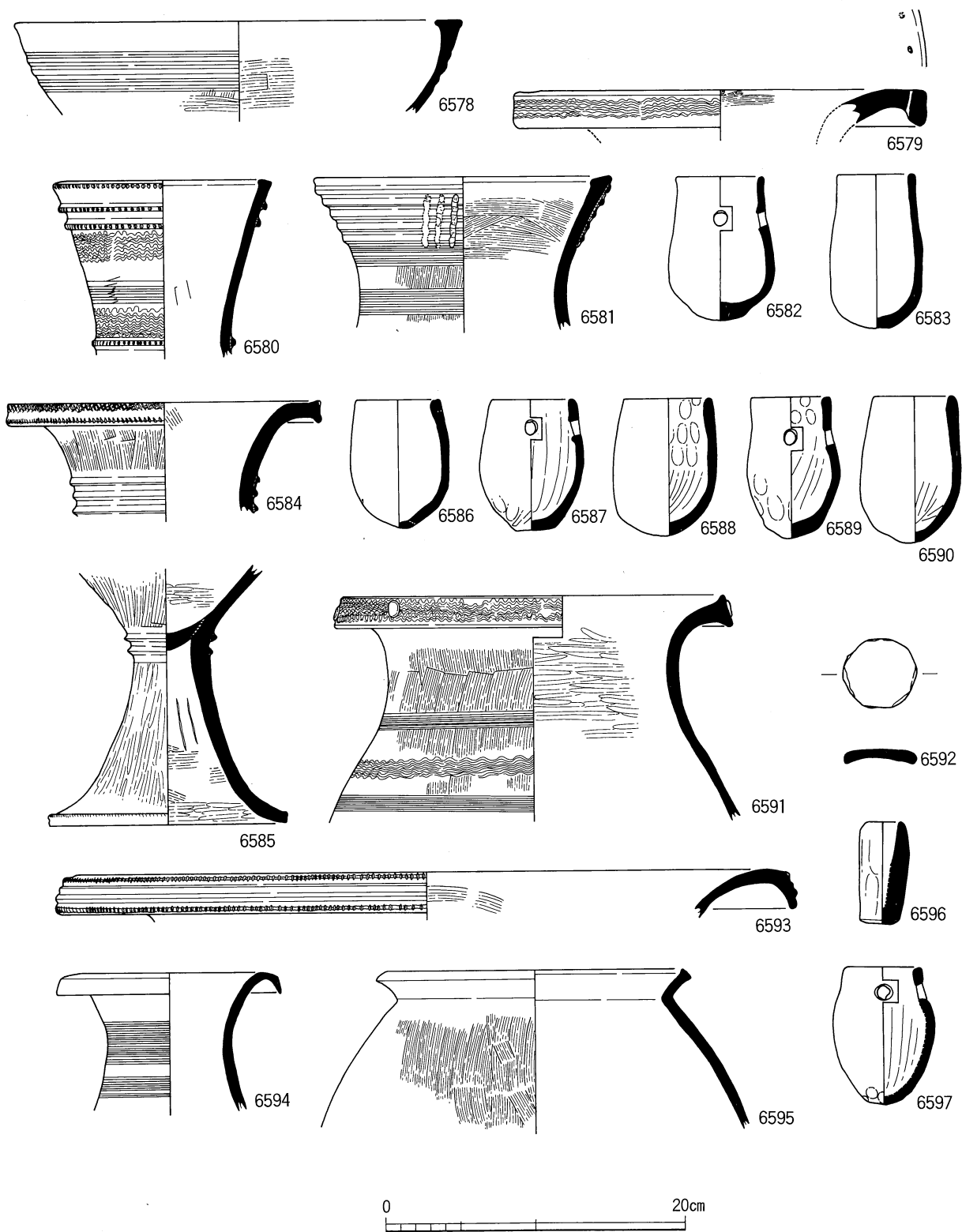

- | | | | |
|-----|---------------|----------------------|---------------|
| 柱 穴 | P46001 (6578) | P46002 (6579) | P46003 (6580) |
| | P46004 (6581) | P46006 (6582 · 6583) | P46008 (6584) |
| | P46009 (6585) | P46011 (6586~6590) | P46012 (6591) |
| | P46013 (6592) | P46014 (6593 · 6594) | P46016 (6595) |
| | P46018 (6596) | P46019 (6597) | |

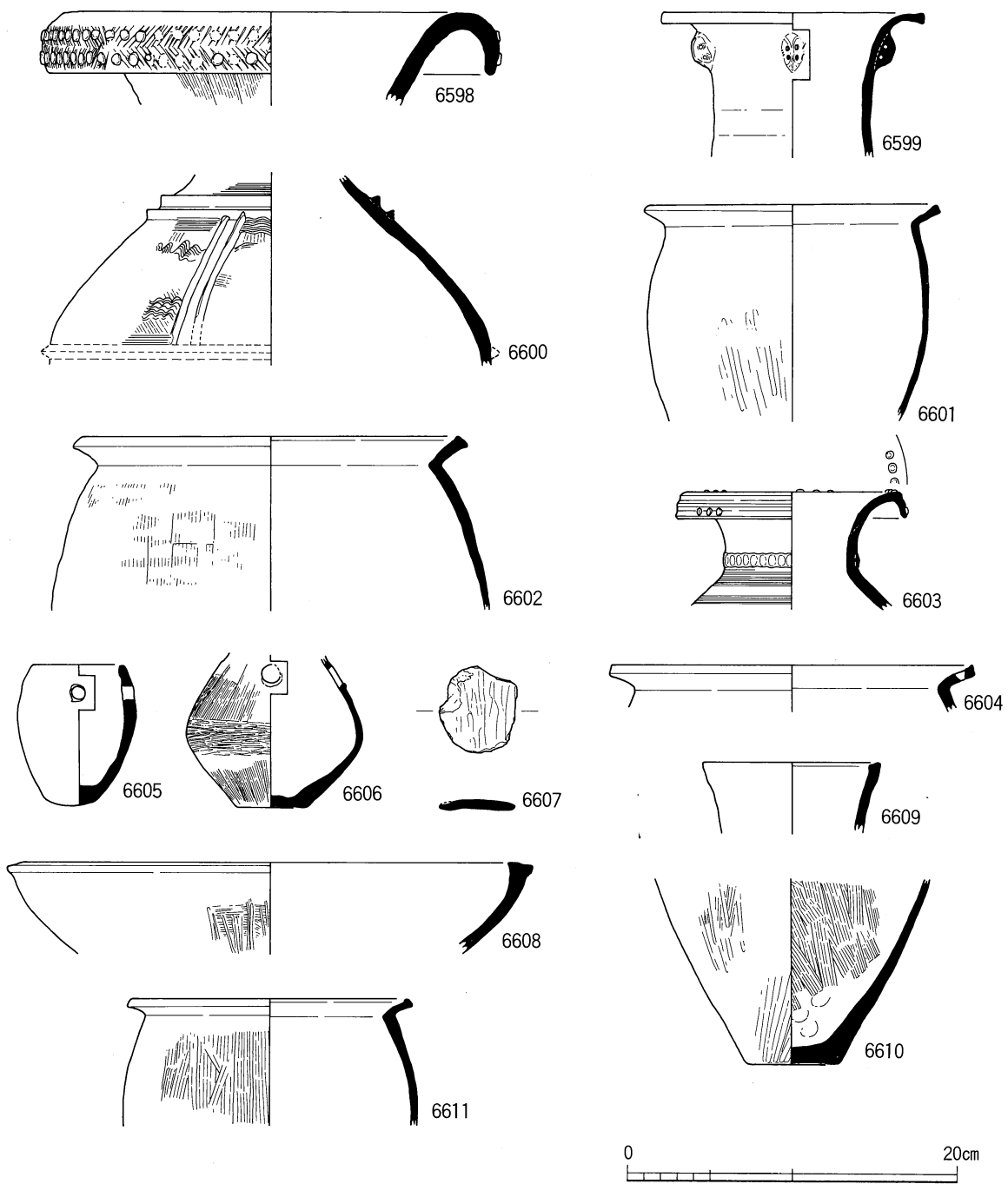

柱 穴	P46020 (6598)	P46022 (6599)	P46024 (6600)	P46026 (6601)
	P46027 (6602)	P46028 (6603)	P46029 (6604)	P46034 (6605)
	P46038 (6606)	P46039 (6607)	P46040 (6608)	P46041 (6609)
	P46045 (6611)			P46042 (6610)

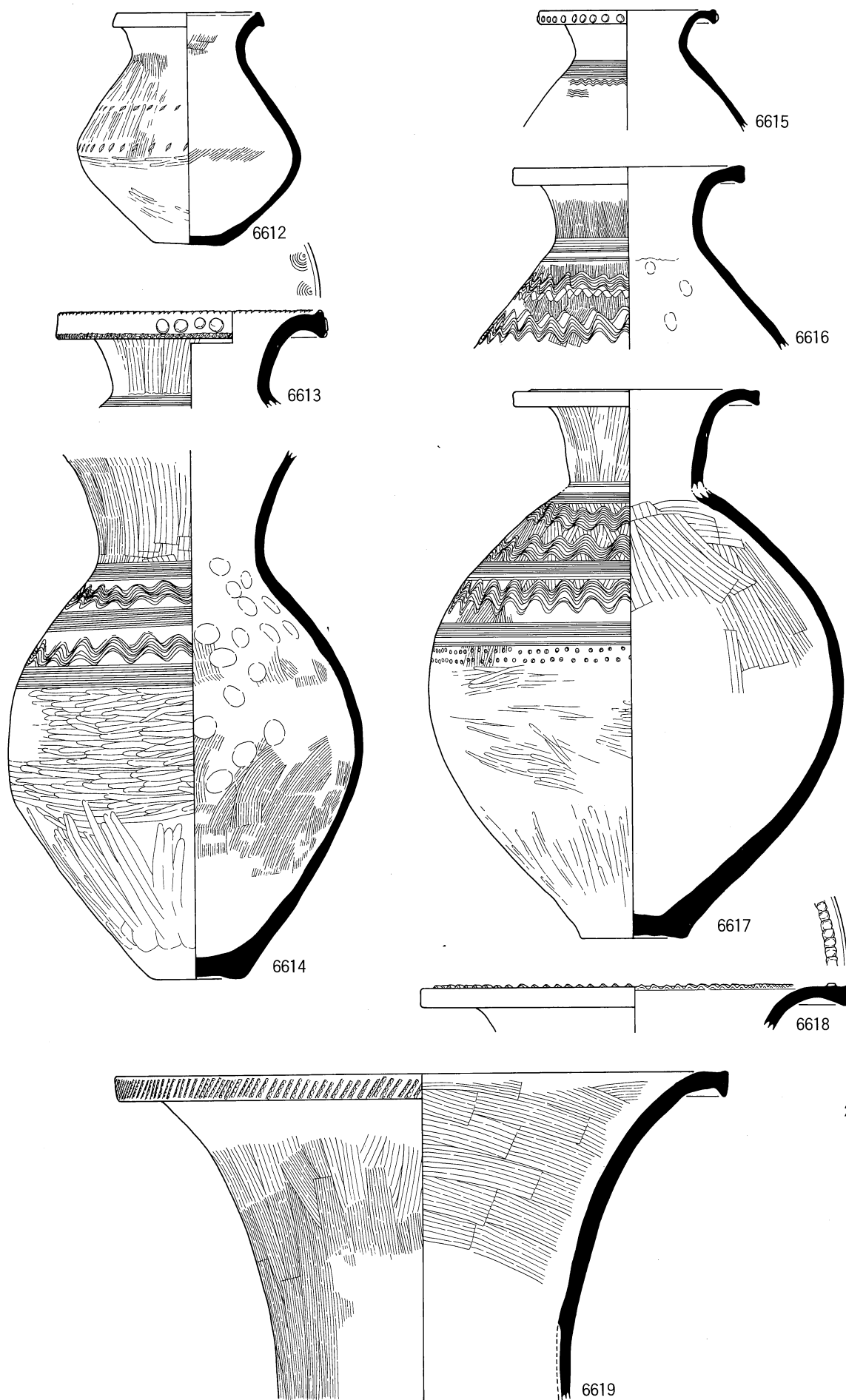

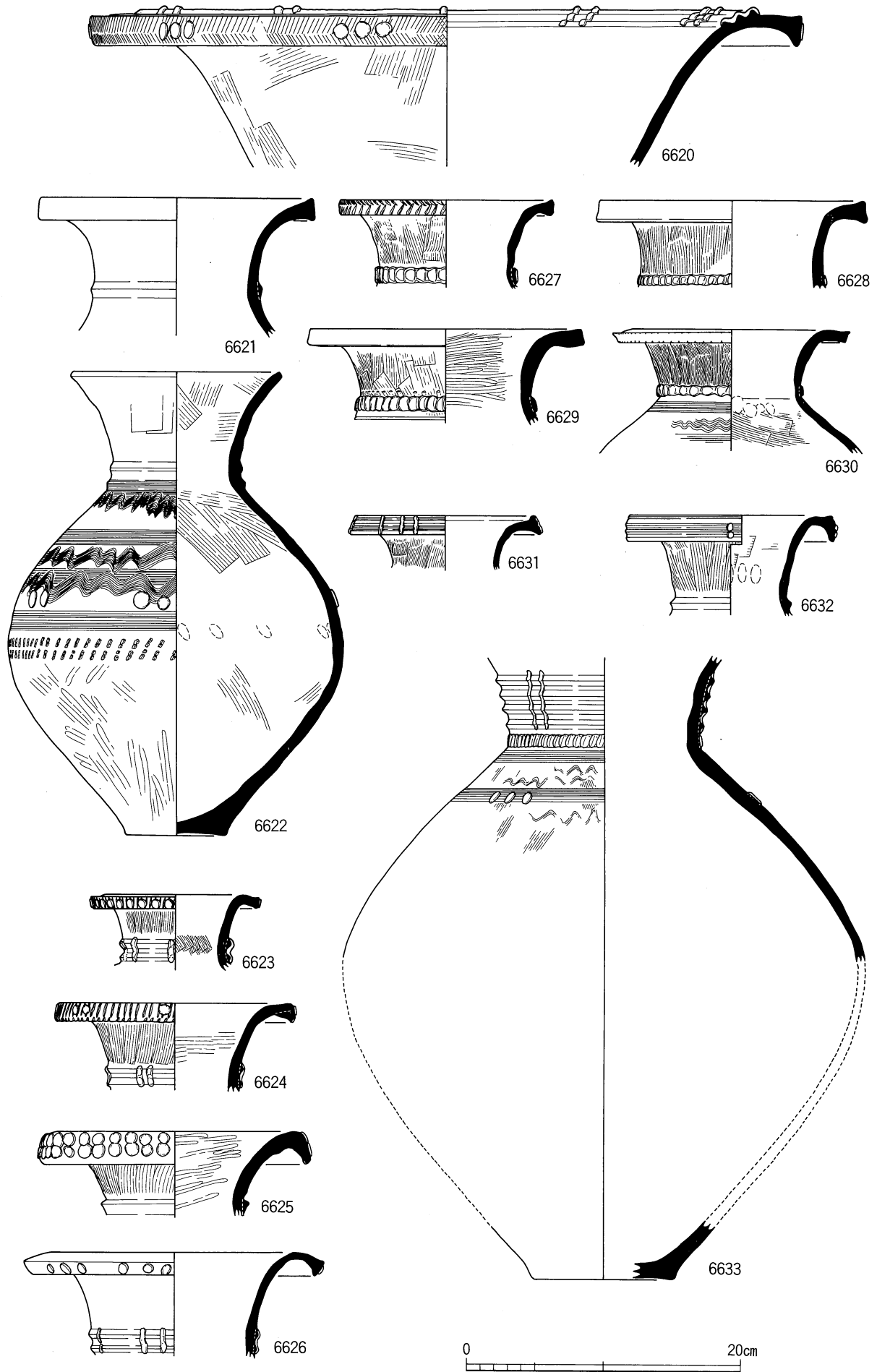

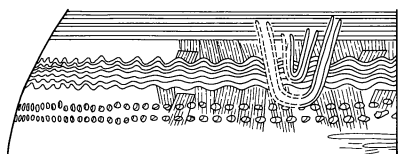

6634

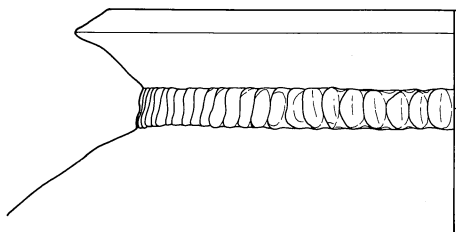

6635

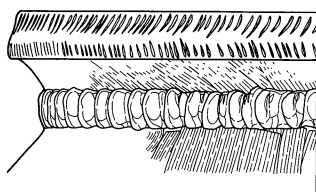

6636

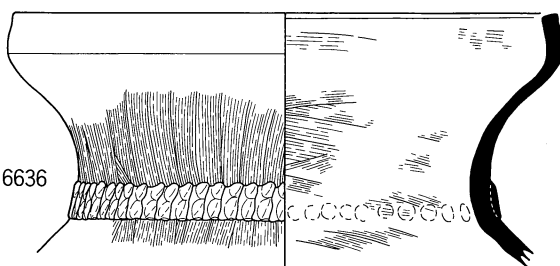

6640

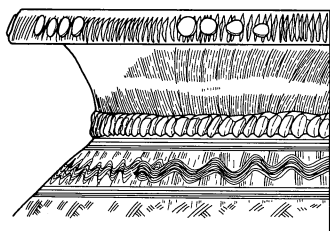

6637

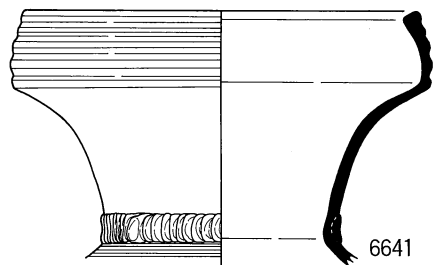

6641

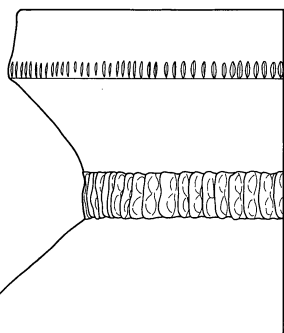

6638

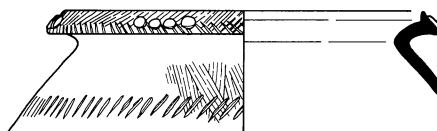

6642

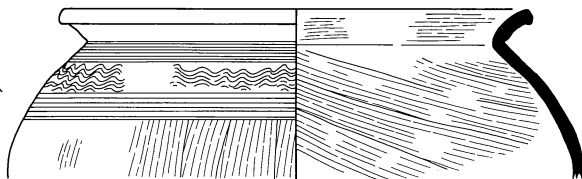

6643

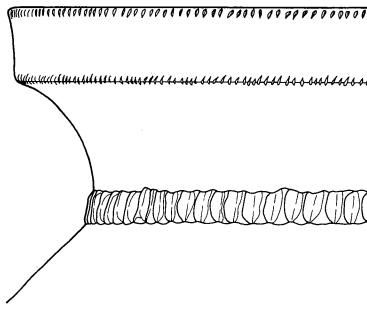

6639

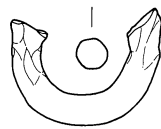

6644

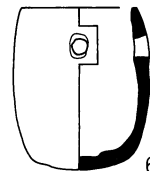

6645

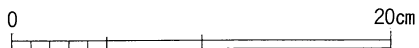

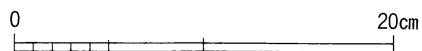
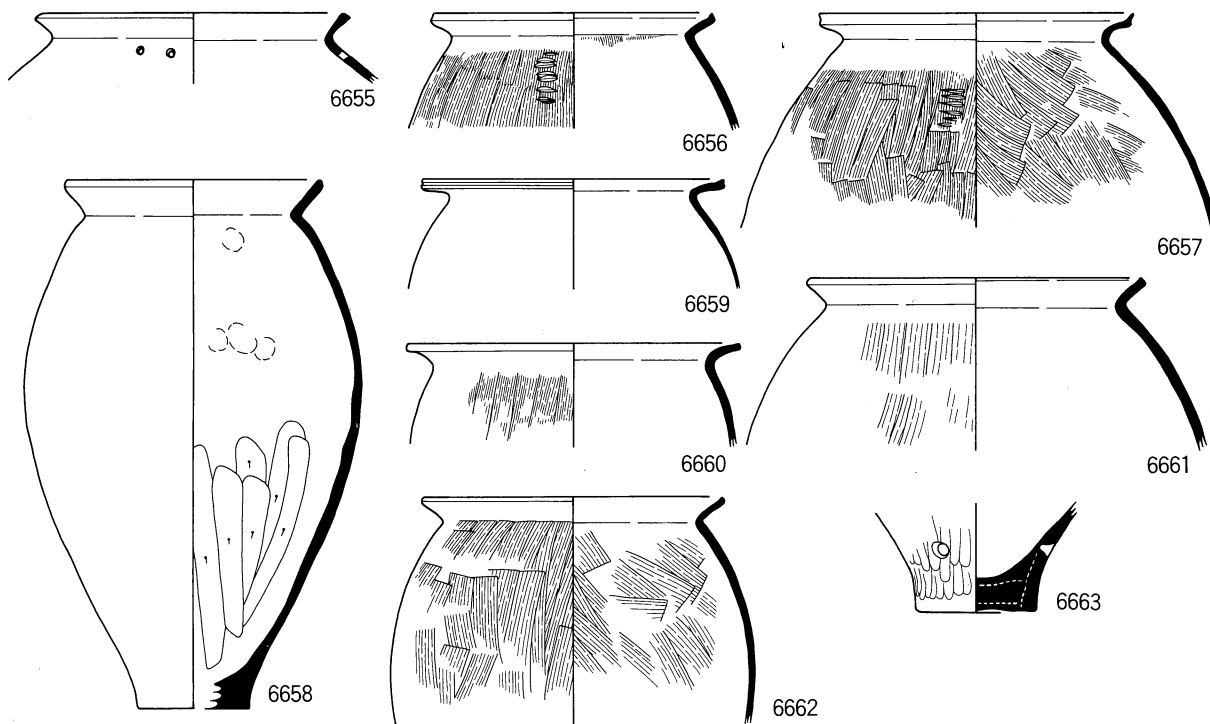
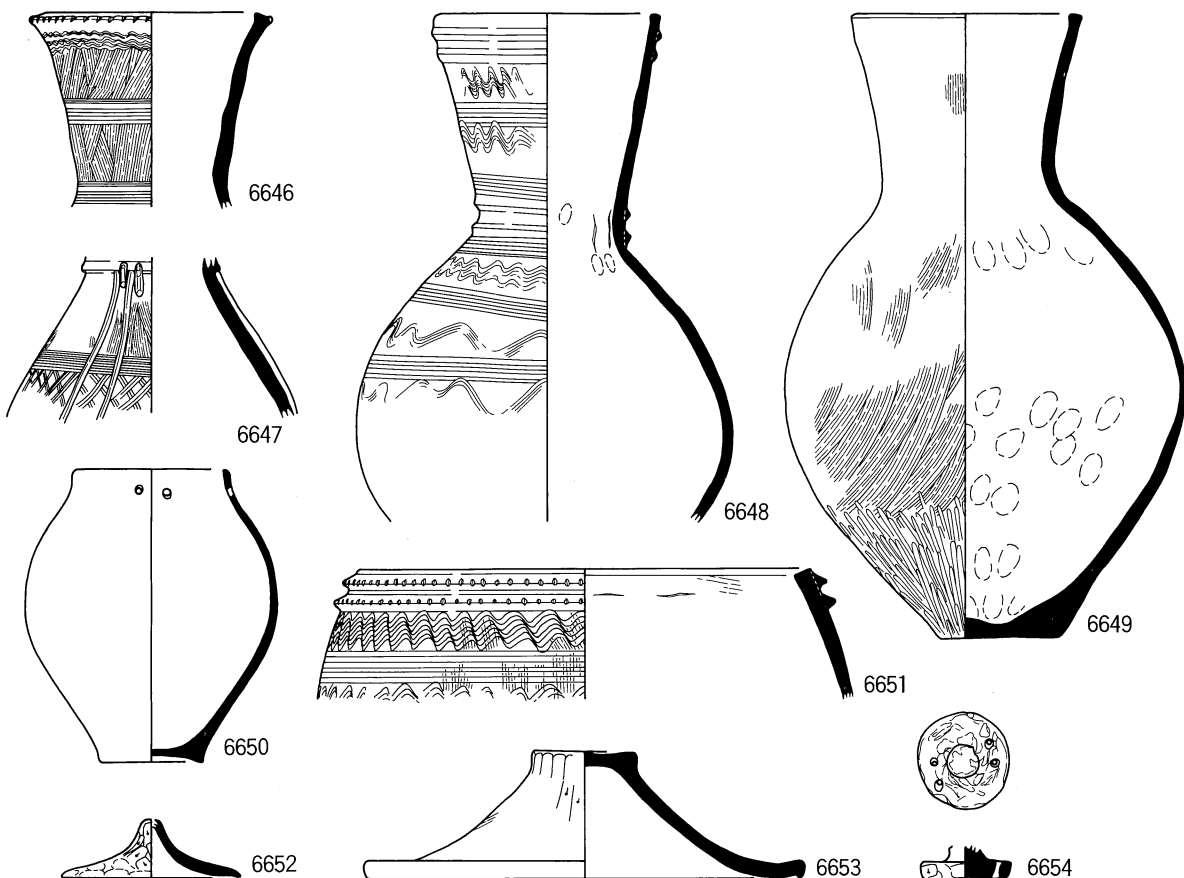

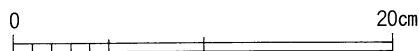
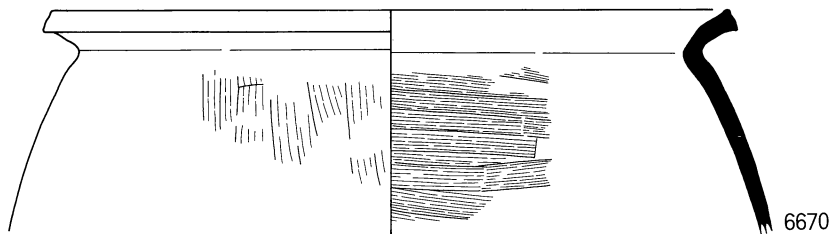
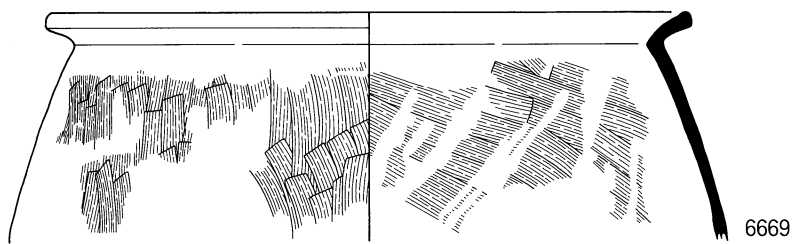
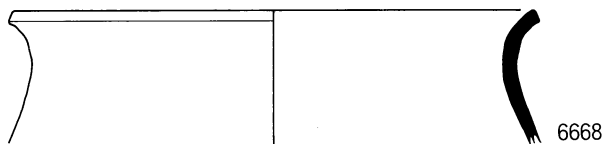
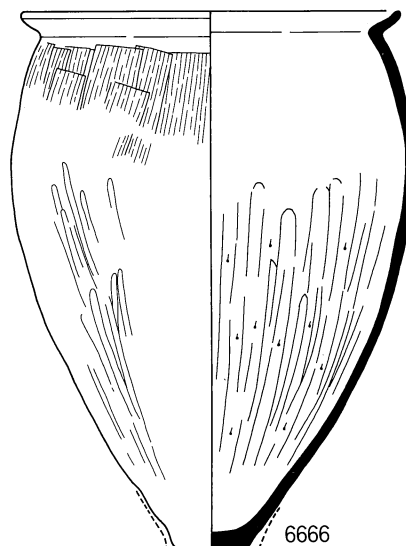
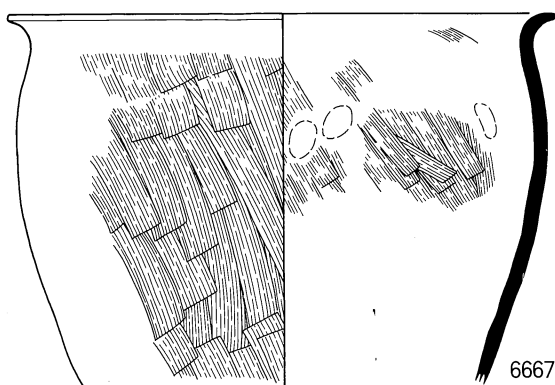
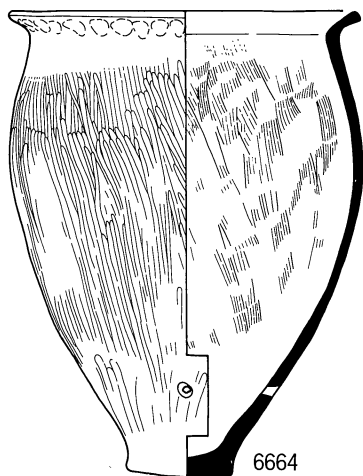

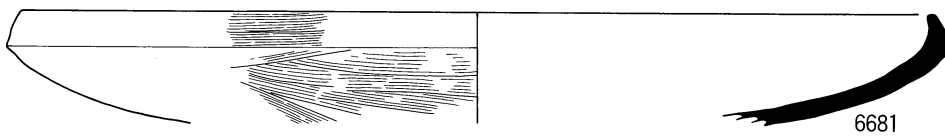
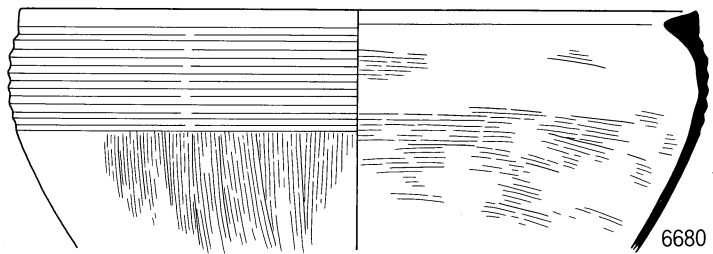
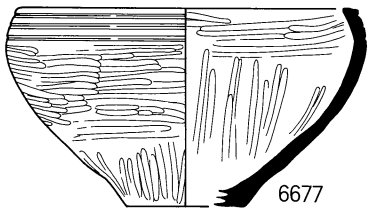
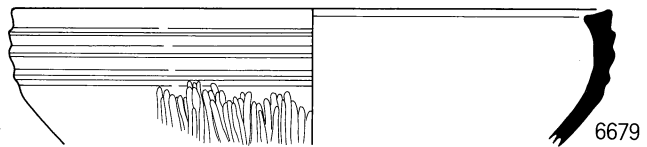
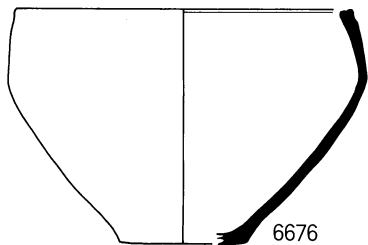
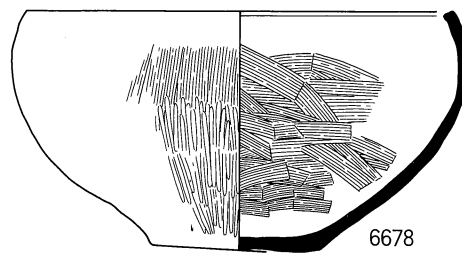
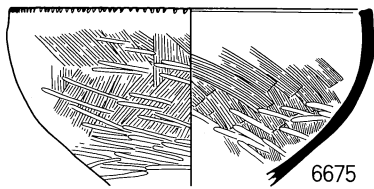
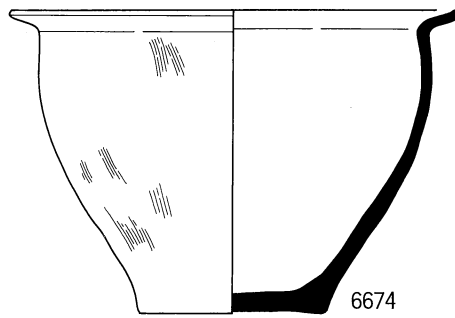
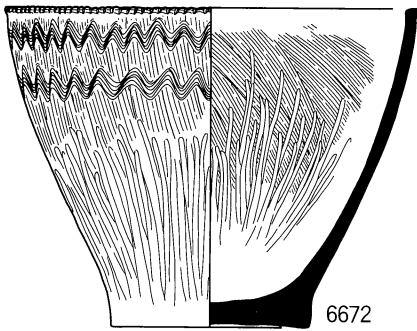
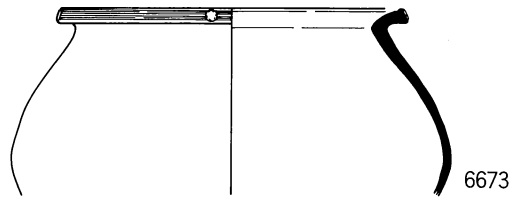
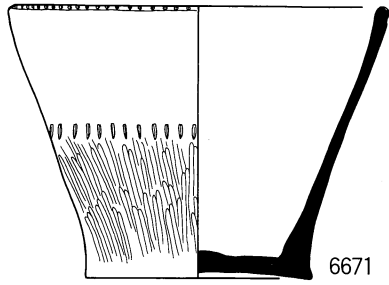

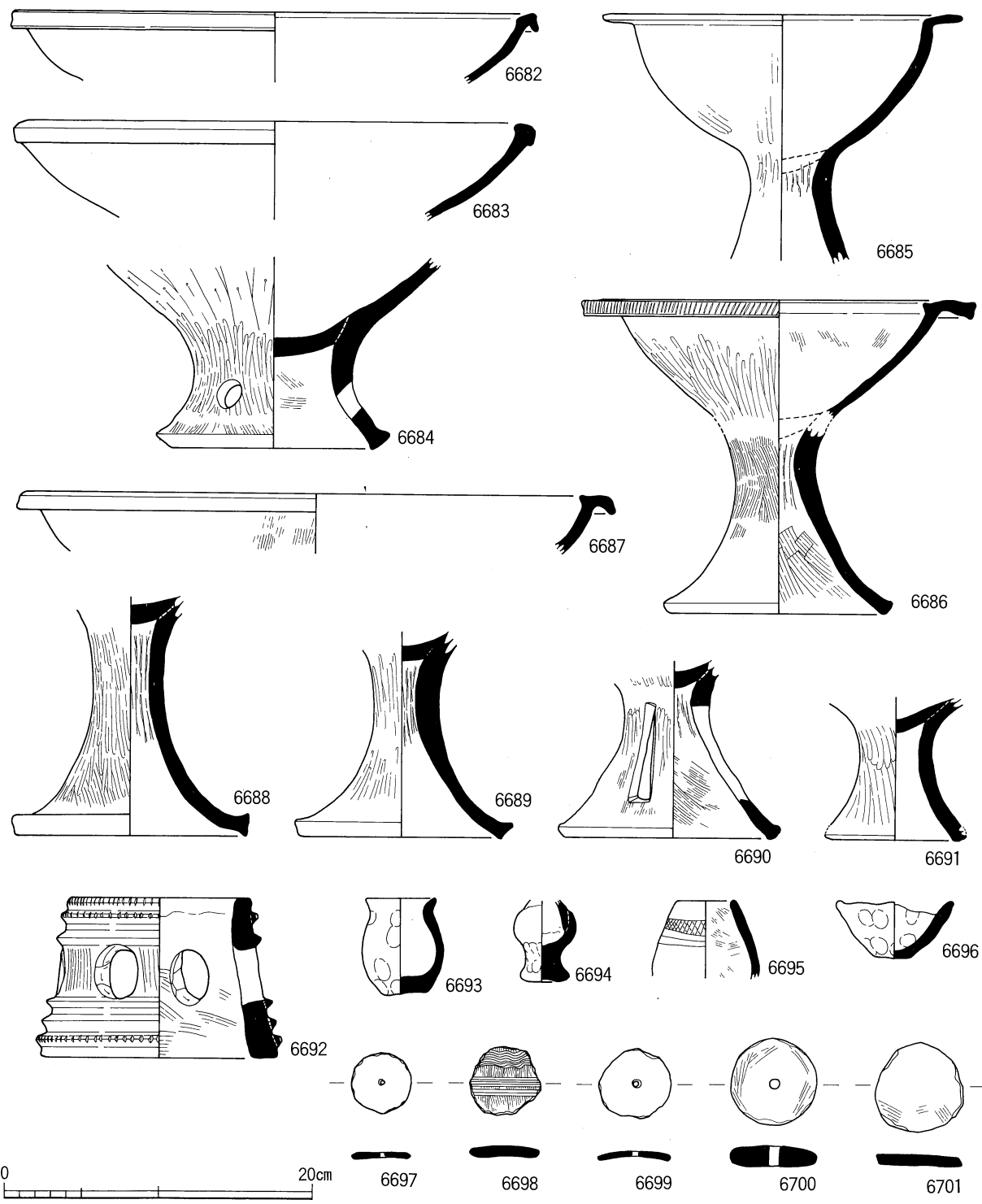

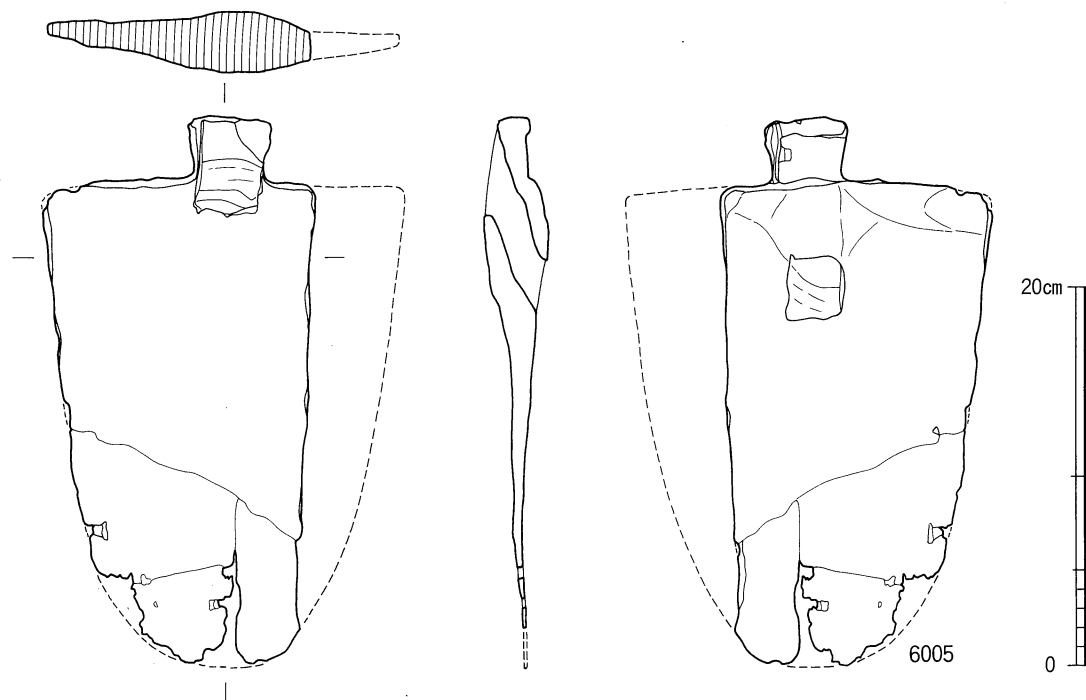
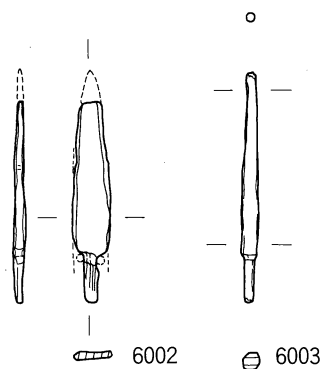
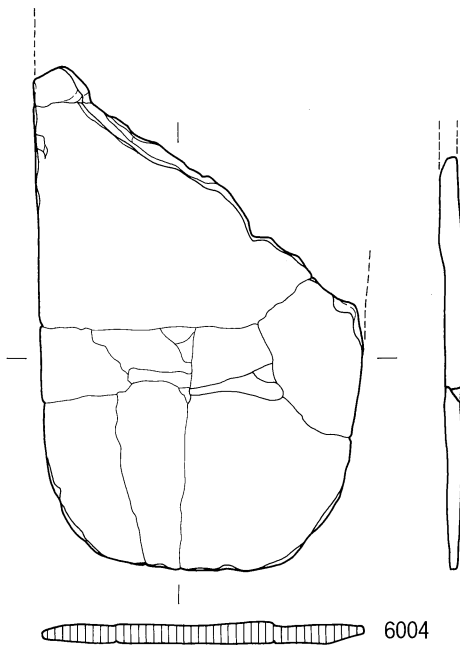
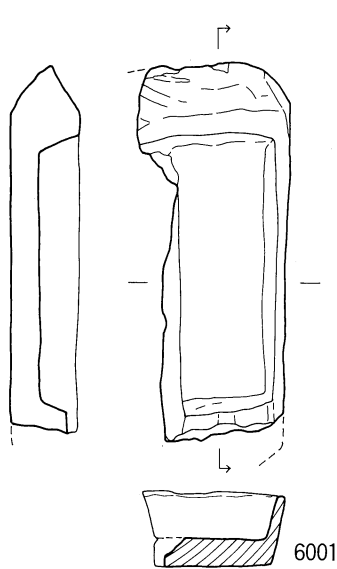

竖穴住居 SH46025 (6001·6002)
土坑 SK46066 (6003)
方形周溝墓 SX46001 (6004·6005)

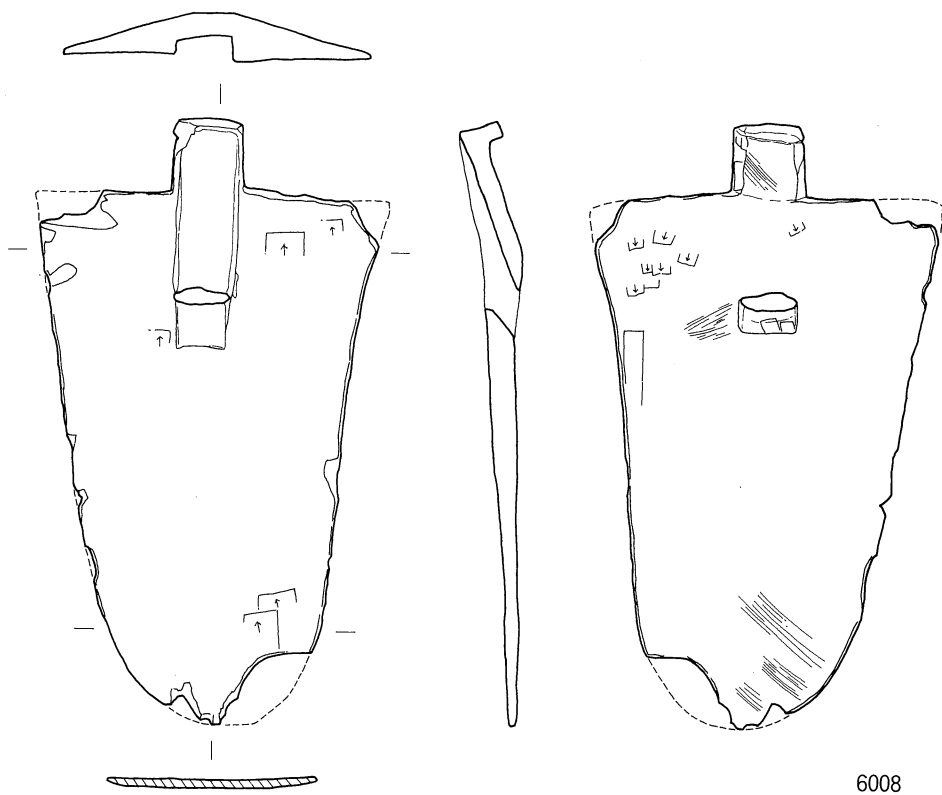
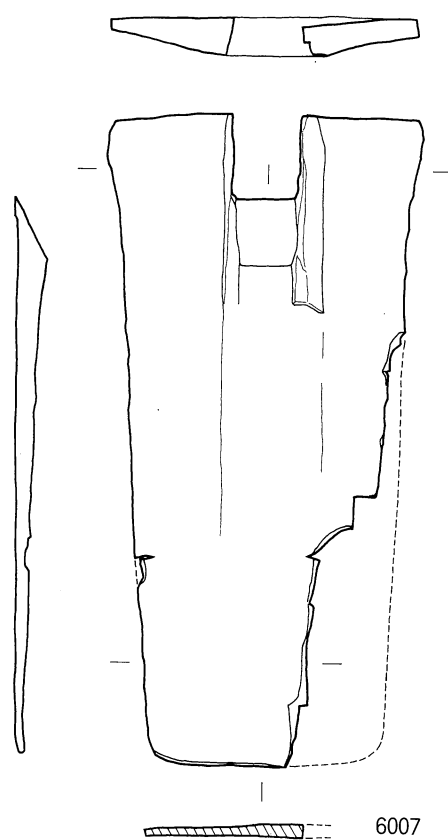
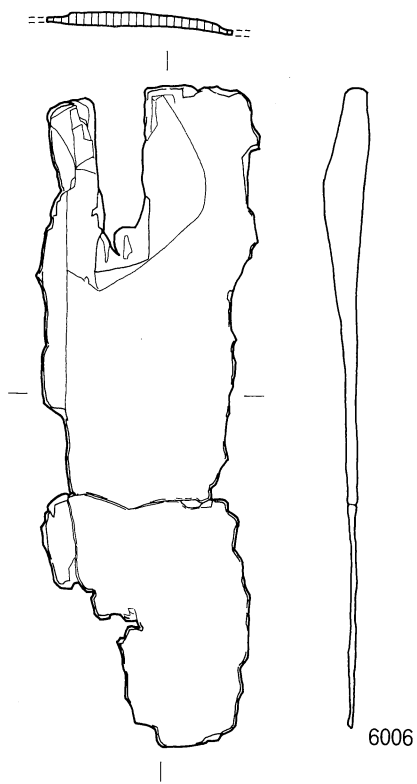

0 20cm

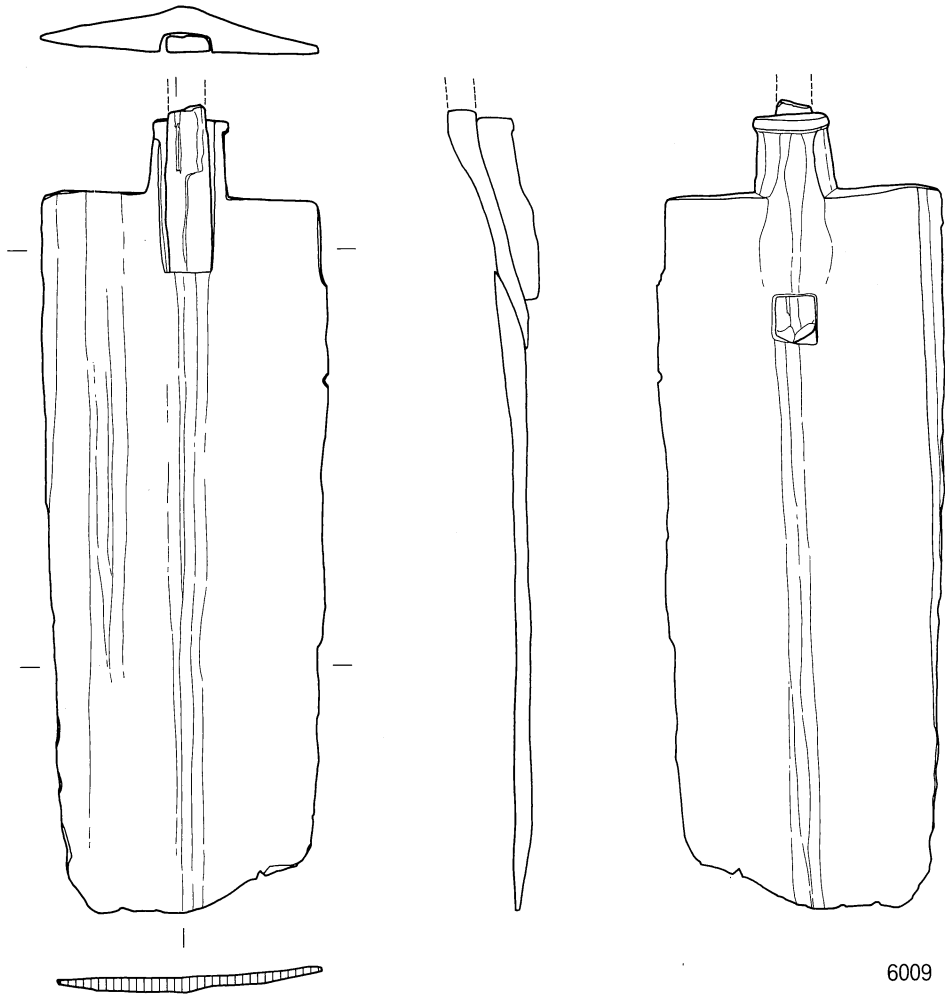

6009

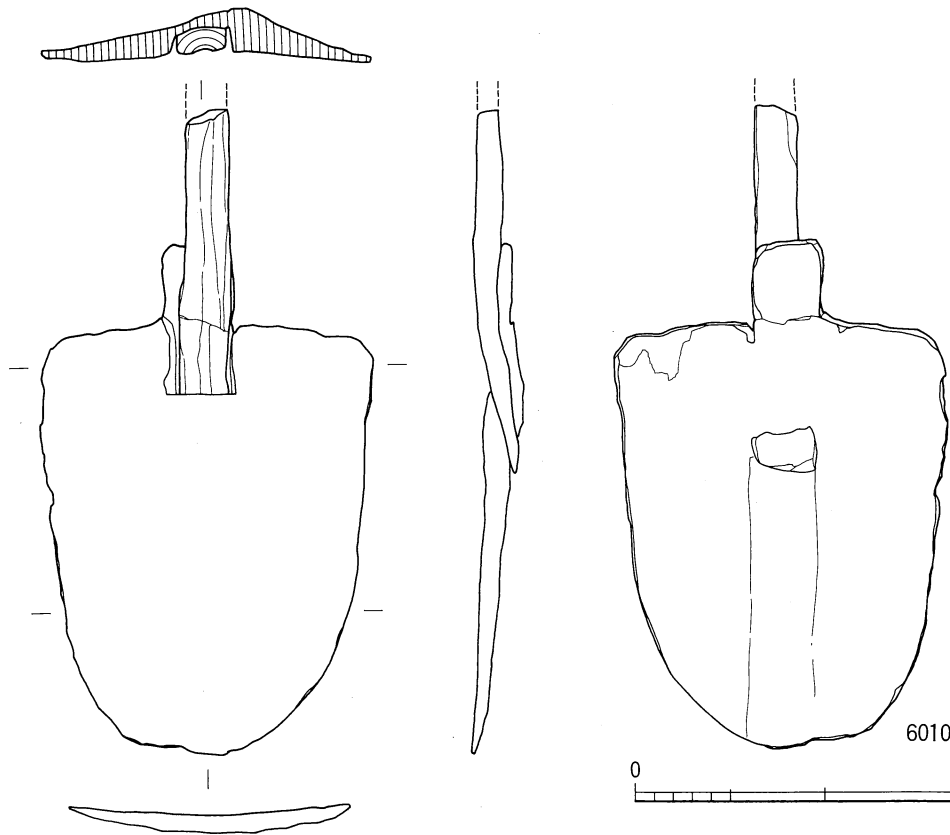

6010

0 20cm

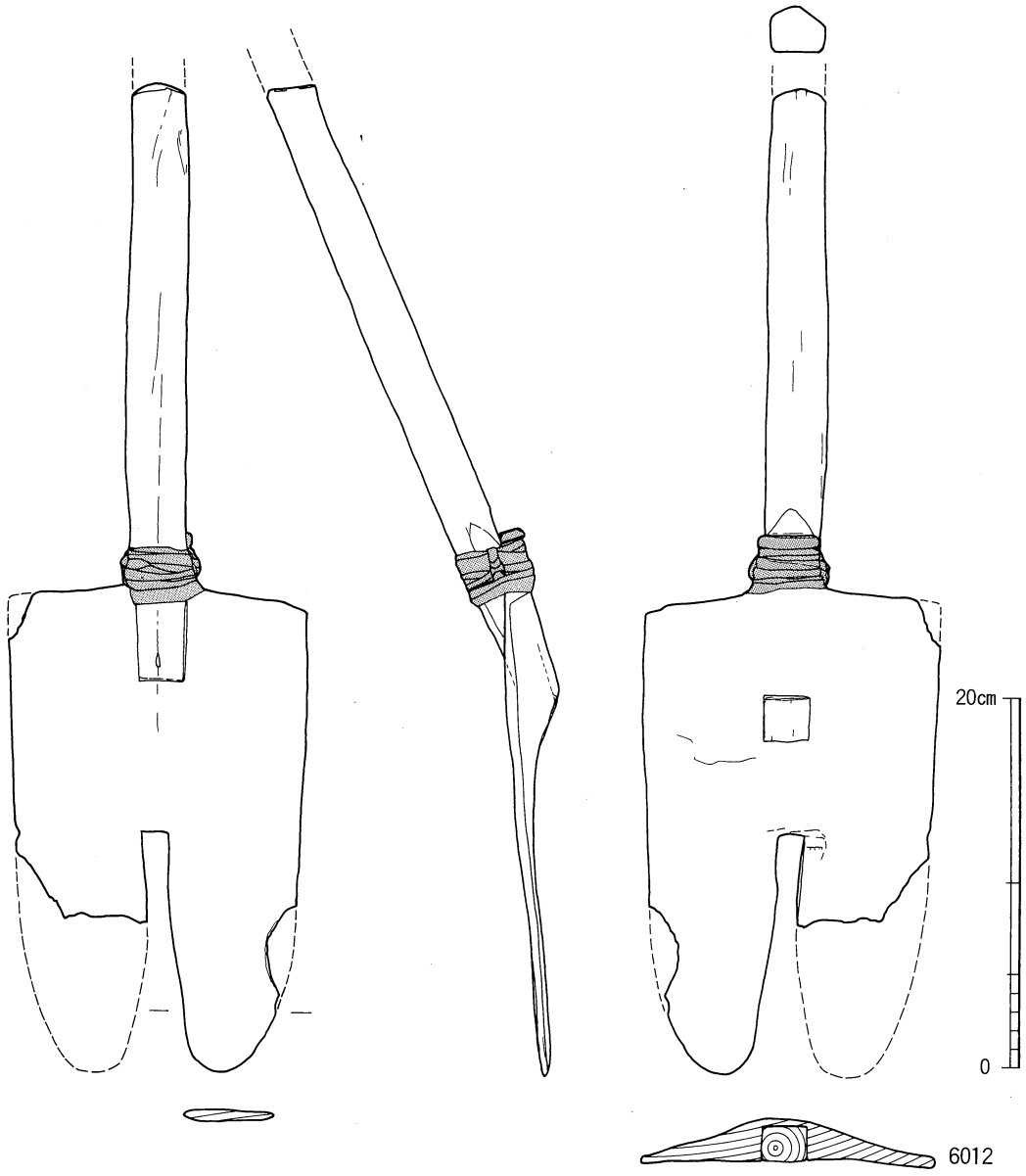
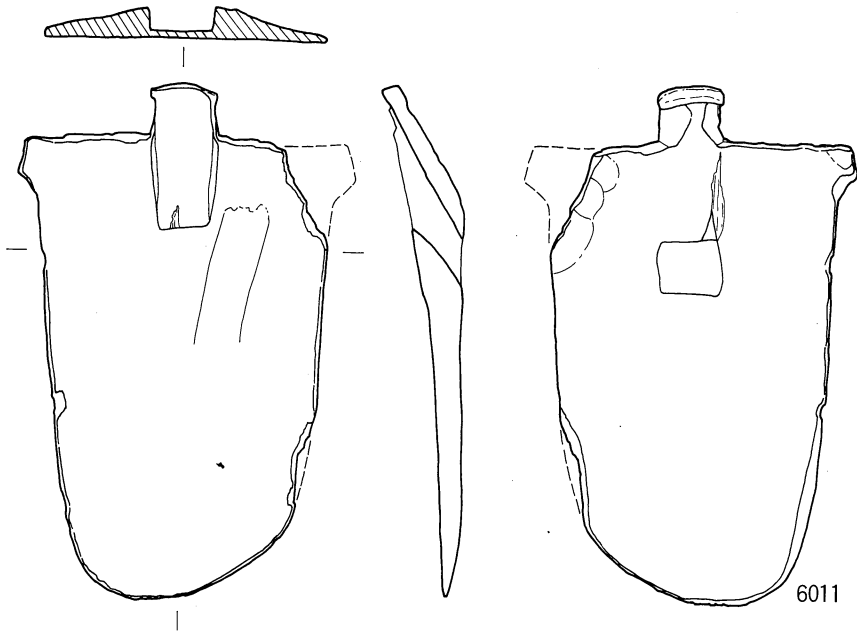

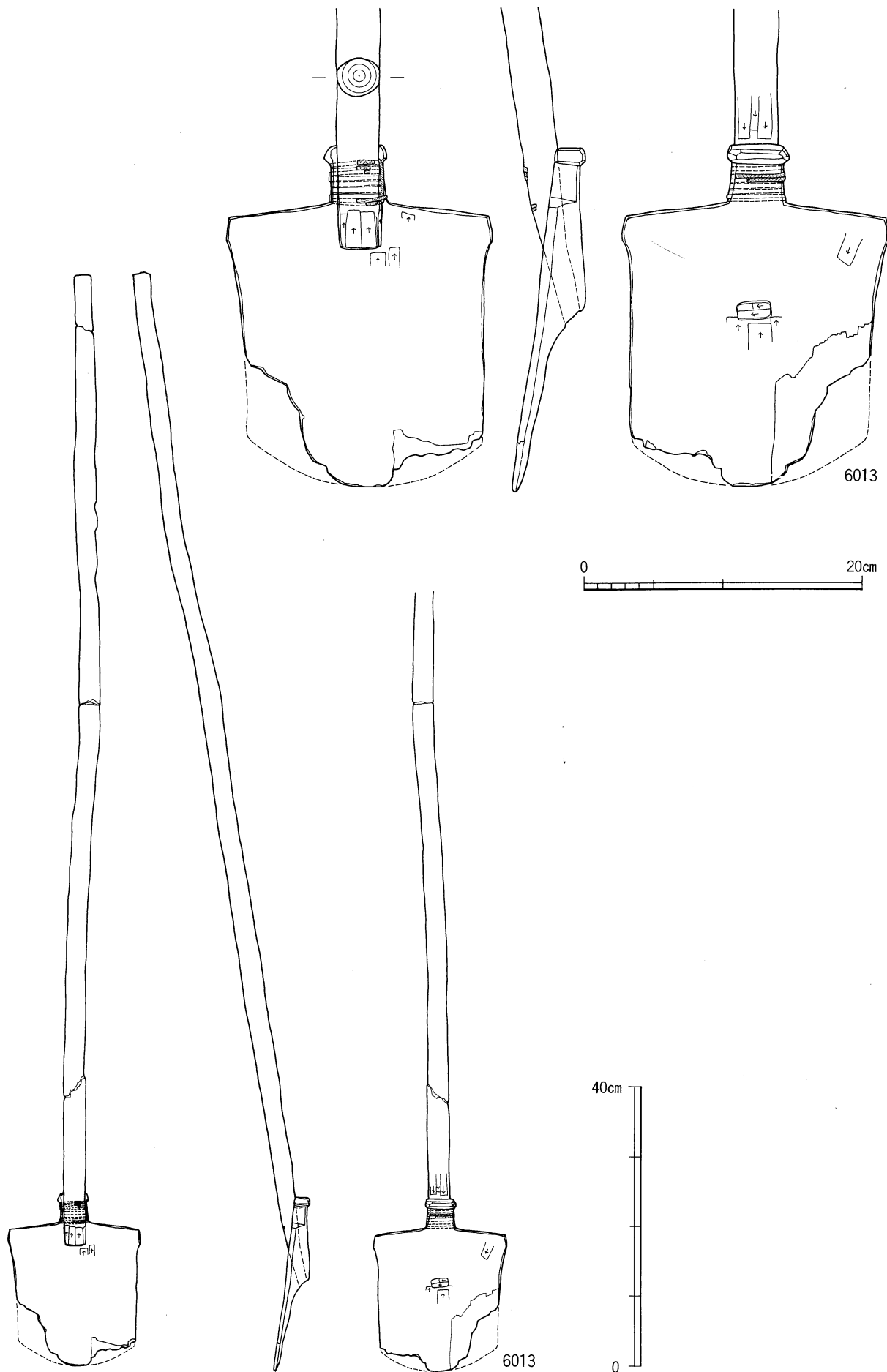

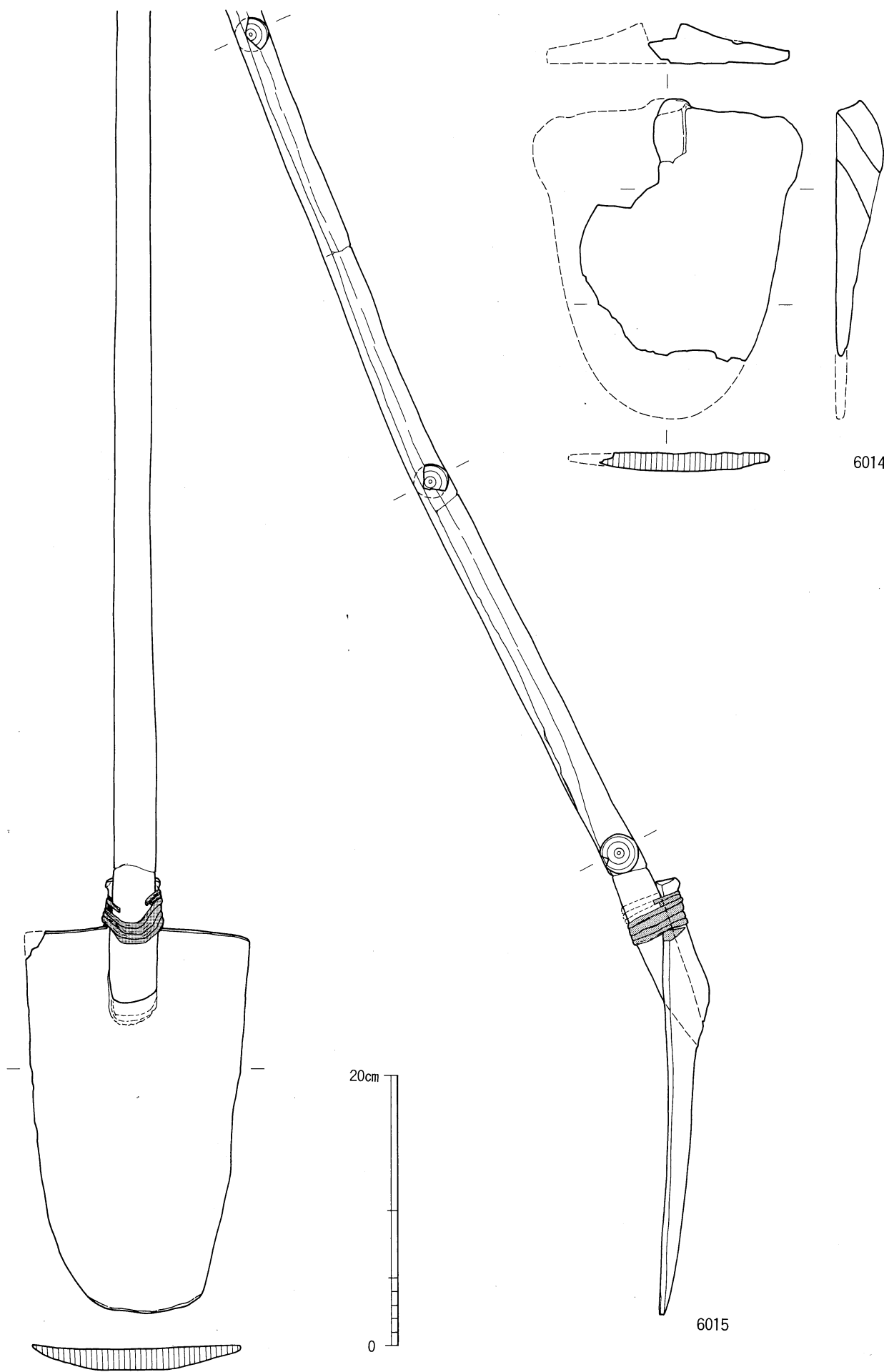

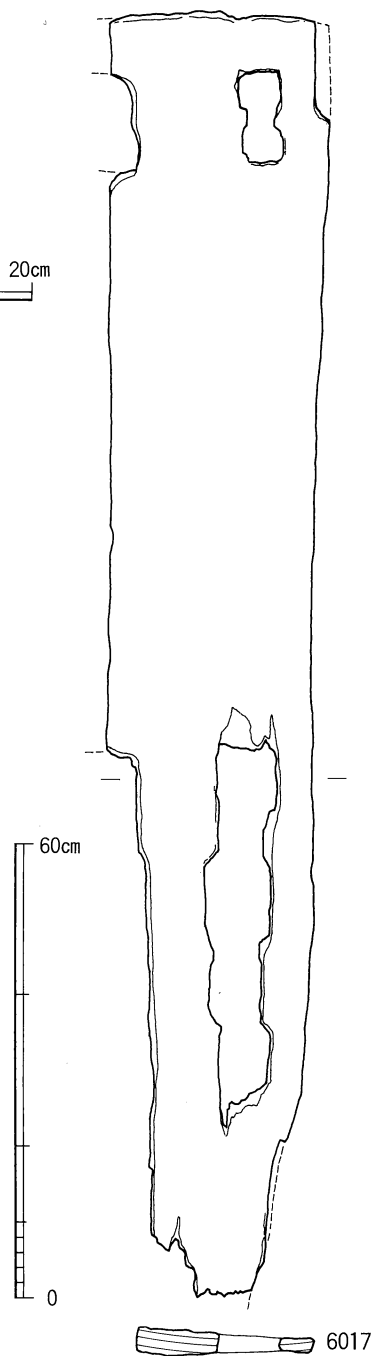
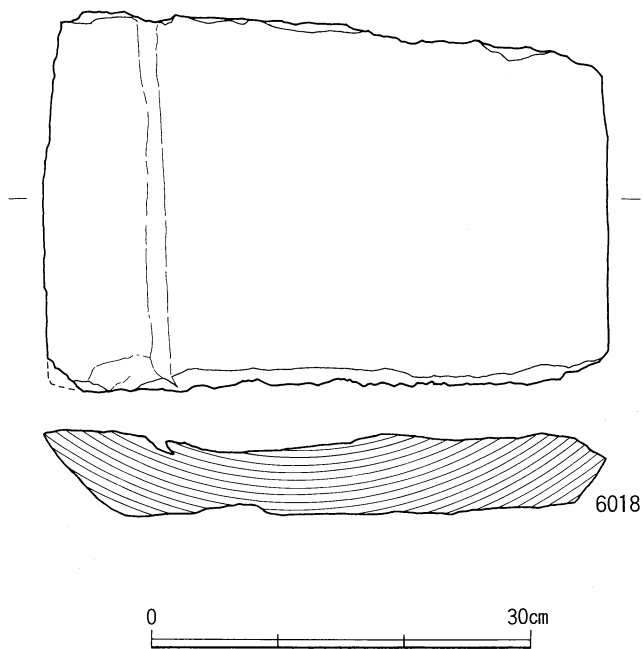
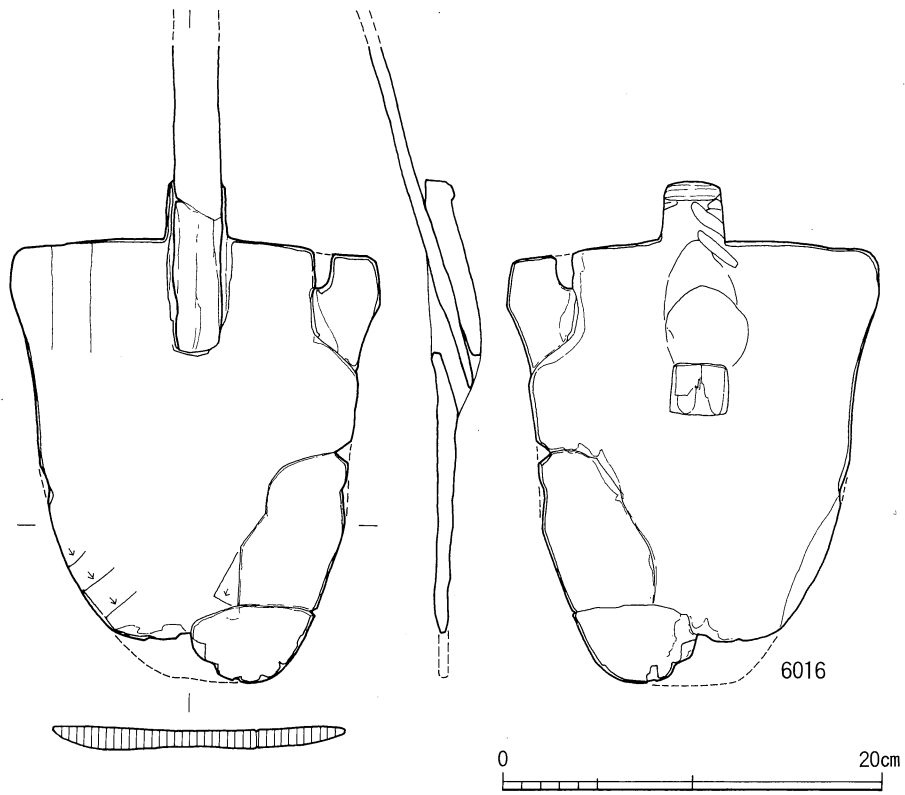

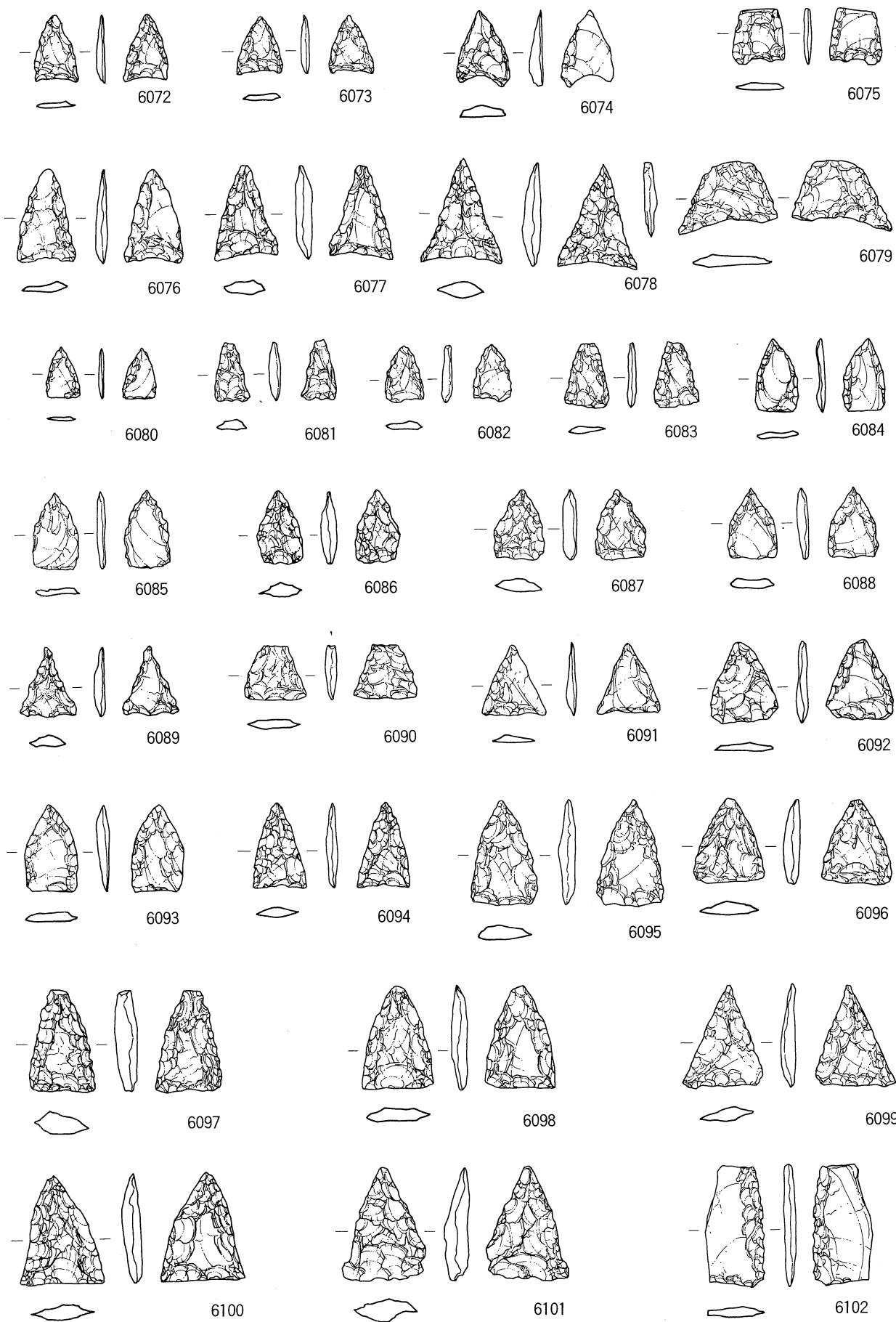

竖穴住居	SH46006 (6102)	SH46009 (6072 · 6100)	SH46010 (6080 · 6084)
	SH46012 (6075 · 6099)	SH46013 (6079)	SH46020 (6093)
	SH46024 (6083 · 6087 · 6098)	SH46025 (6085 · 6089)	SH46027 (6096)
	SH46034 (6074 · 6097 · 6101)		
土坑	SK46004 (6081 · 6082)	SK46077 (6076)	SK46082 (6077 · 6090)
	SK46089 (6088 · 6091 · 6095)	SK46095 (6073)	SK46096 (6078)
	SK46102 (6086)	SK46180 (6092)	
柱穴	P46031 (6094)		



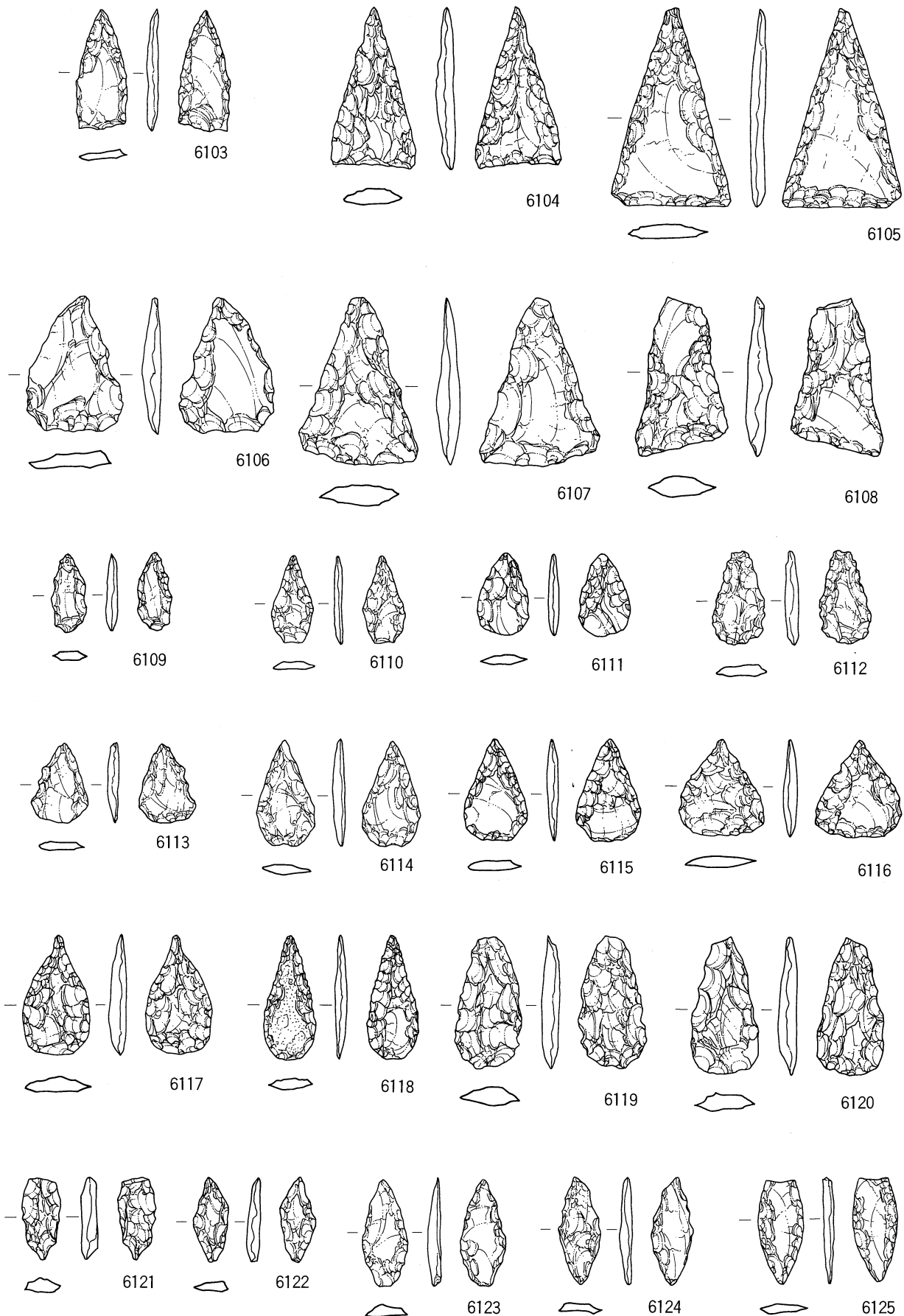

竖穴住居	SH46010 (6125)	SH46011 (6118 · 6121)	SH46012 (6115 · 6119 · 6120 · 6122)
	SH46024 (6106)	SH46025 (6108 · 6110)	SH46034 (6116)
土坑	SK46004 (6113)	SK46023 (6111)	SK46032 (6117) SK46041 (6107)
	SK46055 (6109)	SK46067 (6114 · 6123)	SK46095 (6112) SK46102 (6103)
木棺墓	ST46004 (6124)	包含層 (6104 · 6105)	

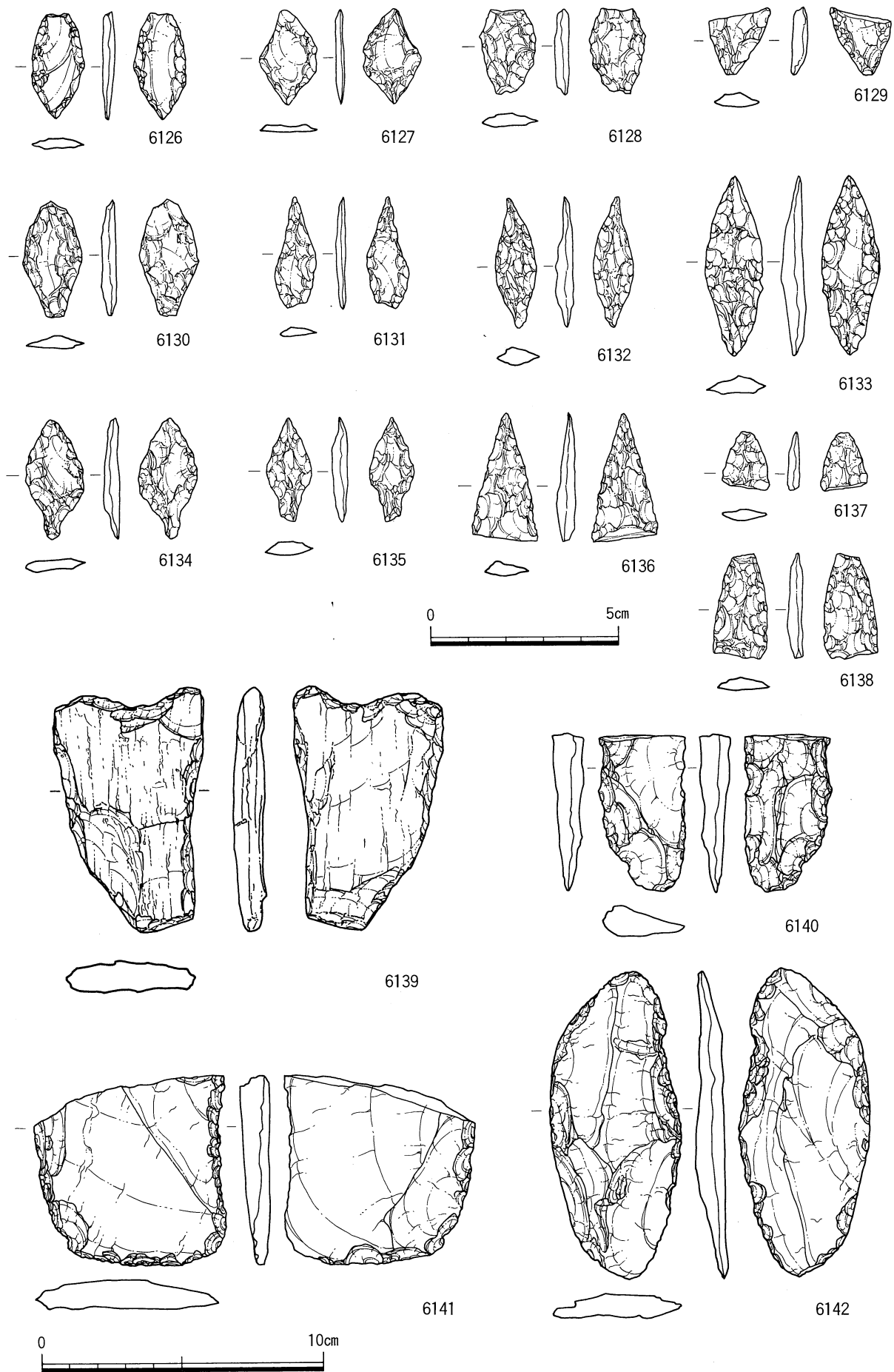

竖穴住居	SH46012 (6135)	SH46021 (6133)	SH46024 (6131)	SH46025 (6128 · 6134)
	SH46026 (6127 · 6129 · 6132 · 6138)	SH46027 (6130 · 6141)		
土坑	SK46046 (6126)	SK46067 (6136 · 6137)	SK46093 (6142)	
方形周溝墓	SX46001 (6139)			
柱穴	P46032 (6140)			

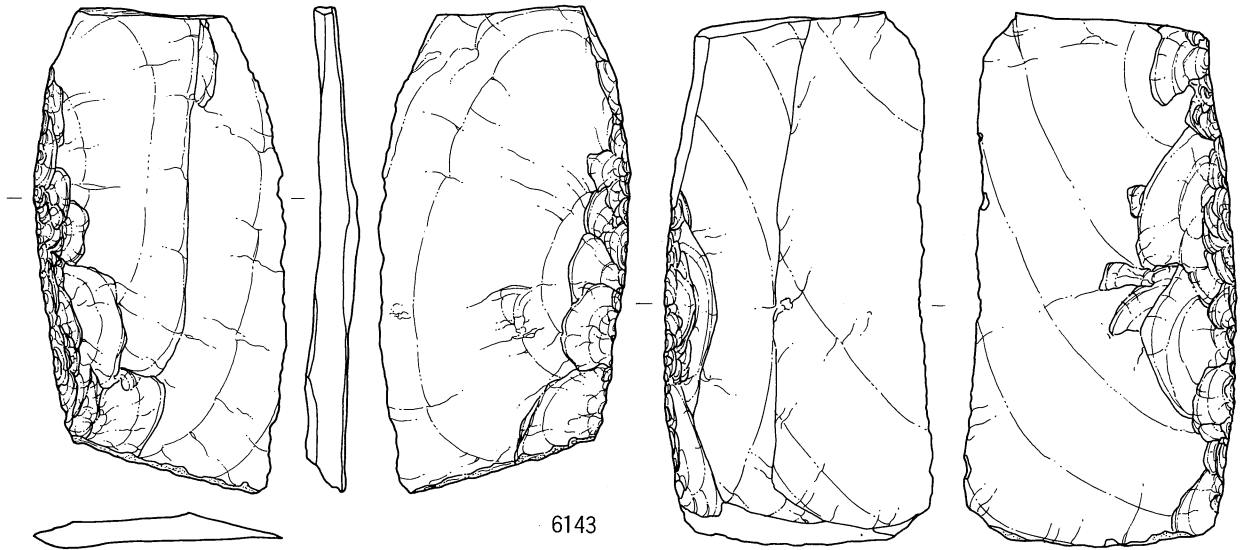

6143

6146

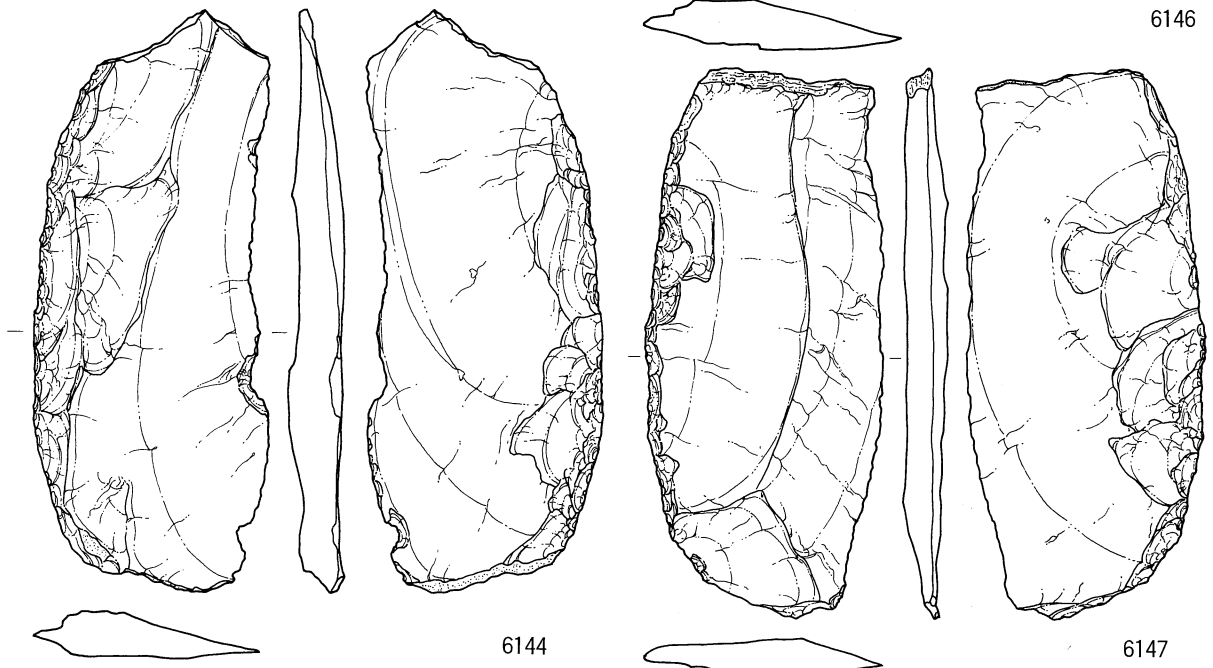

6144

6147

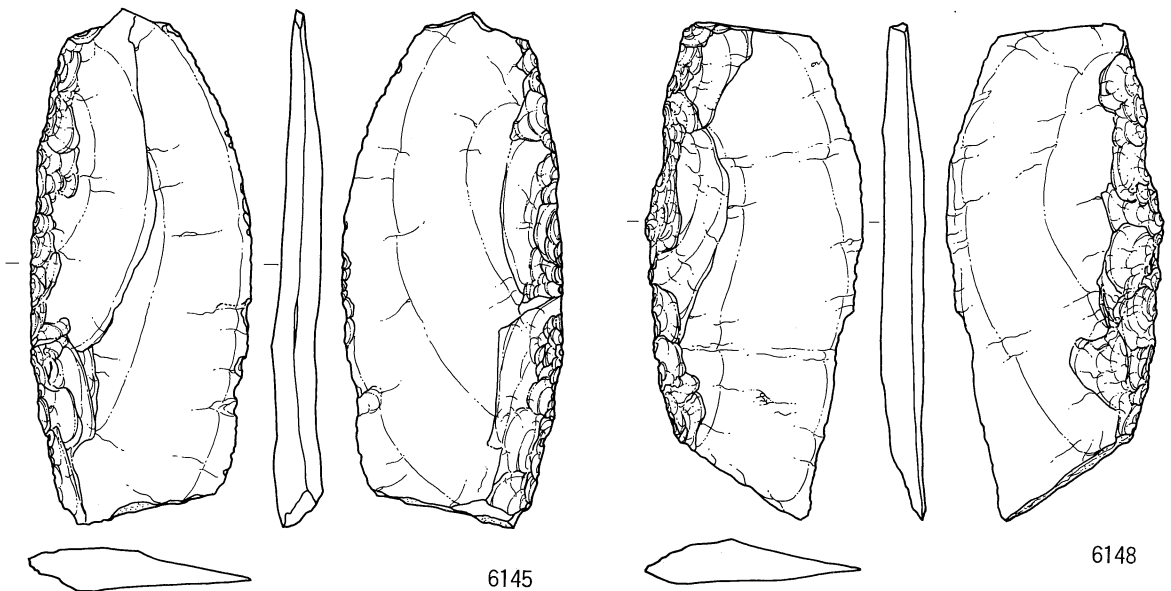

6145

6148

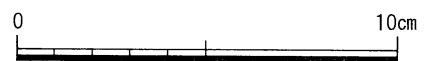

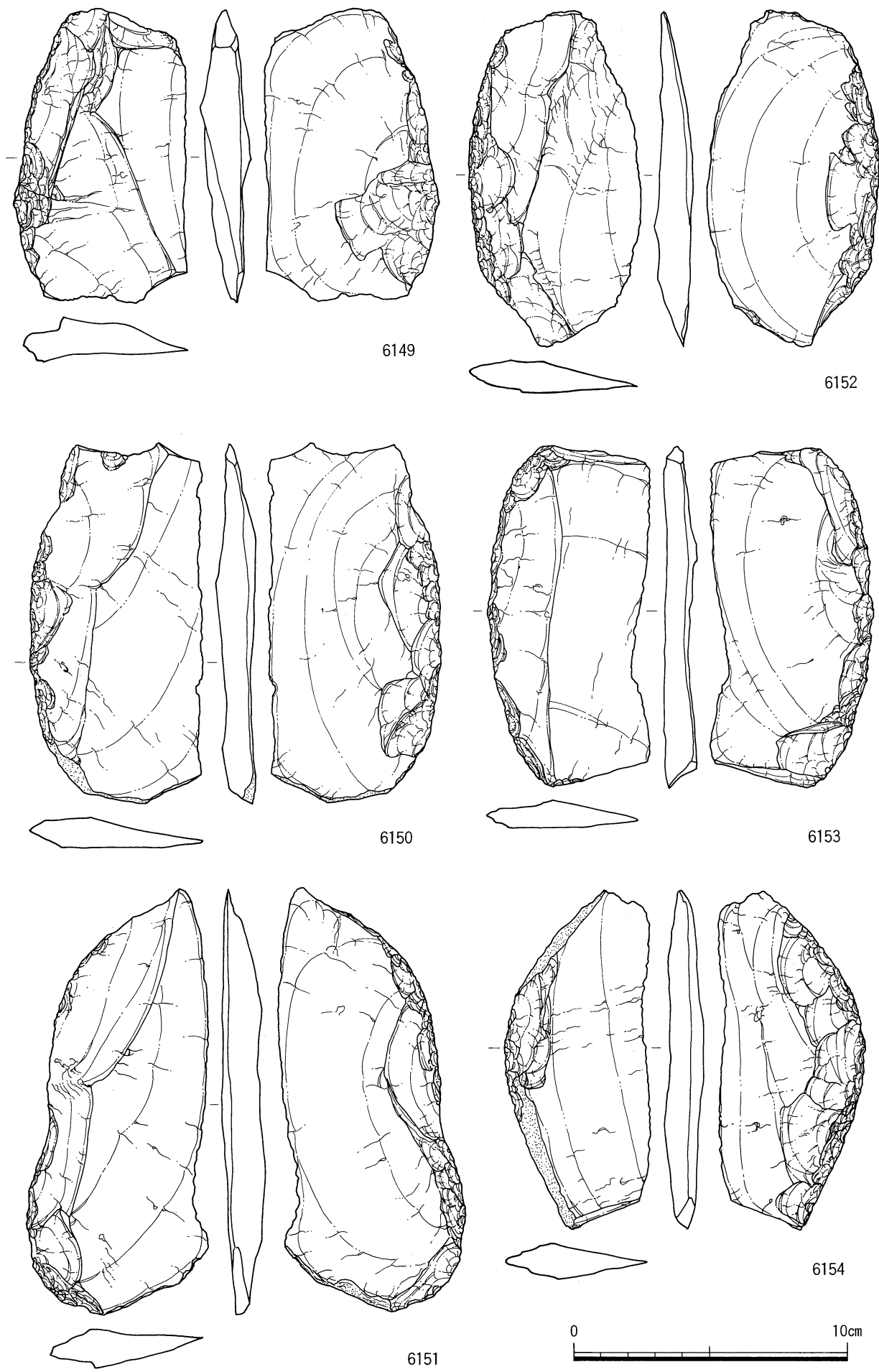

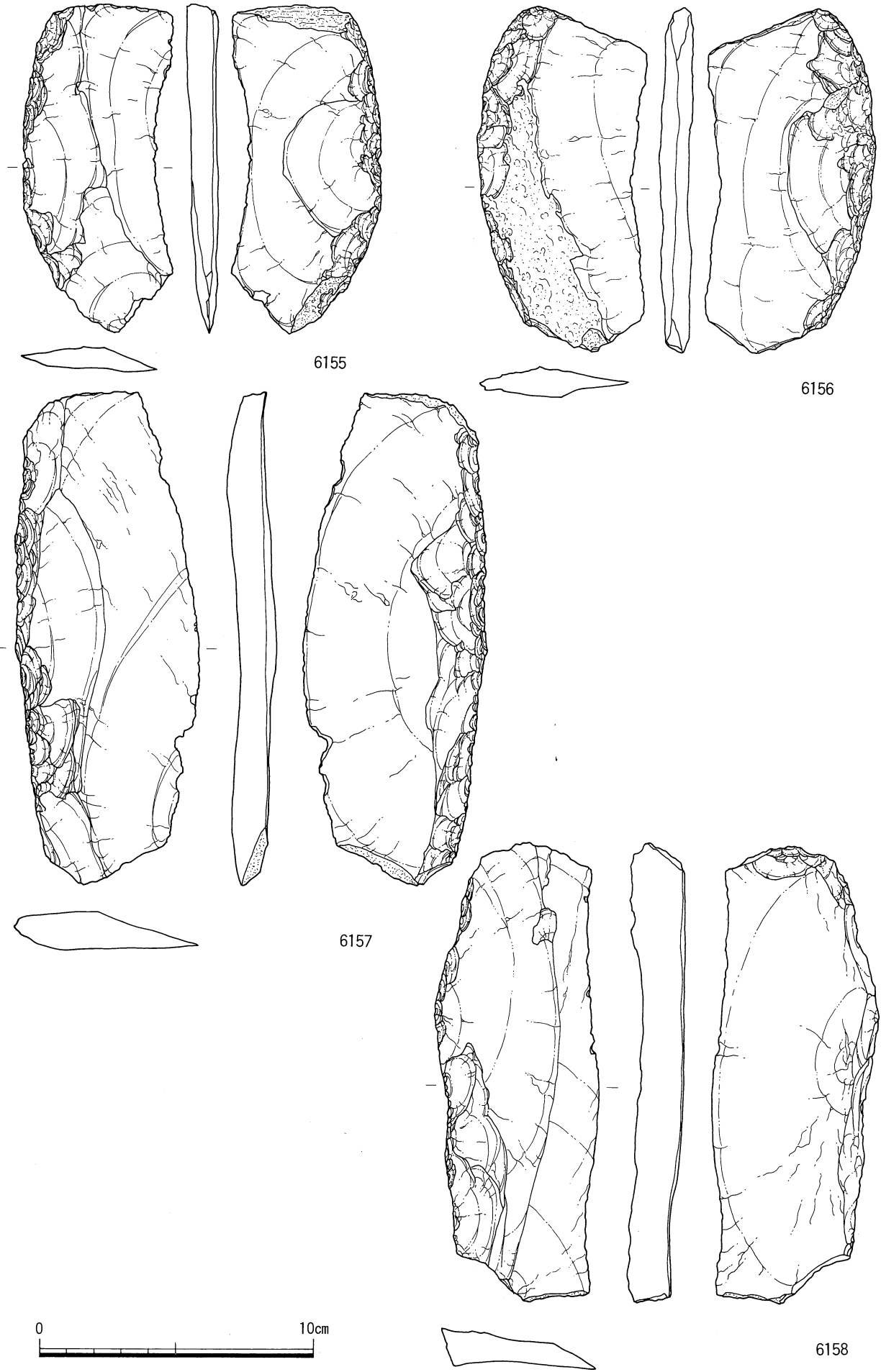

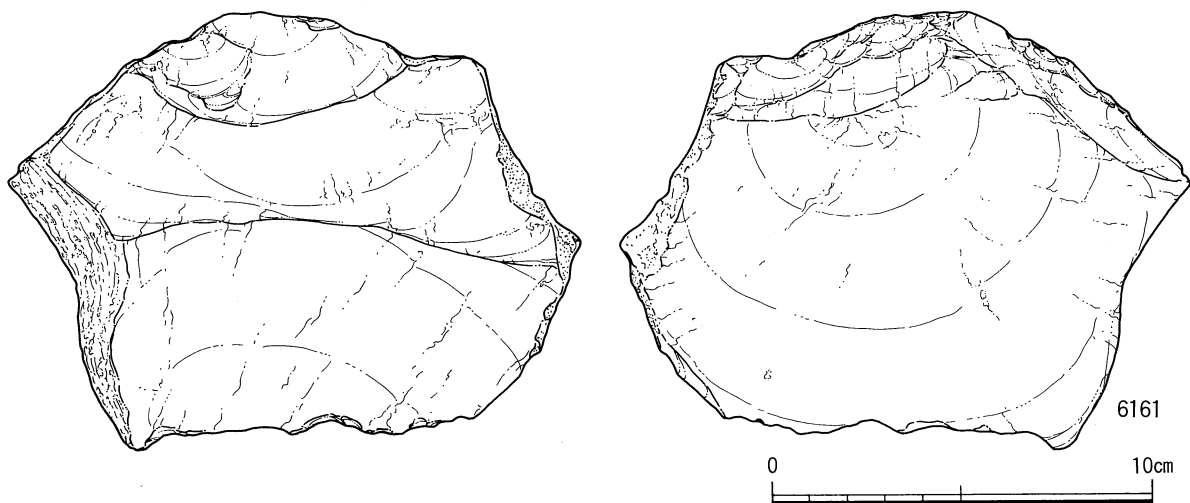
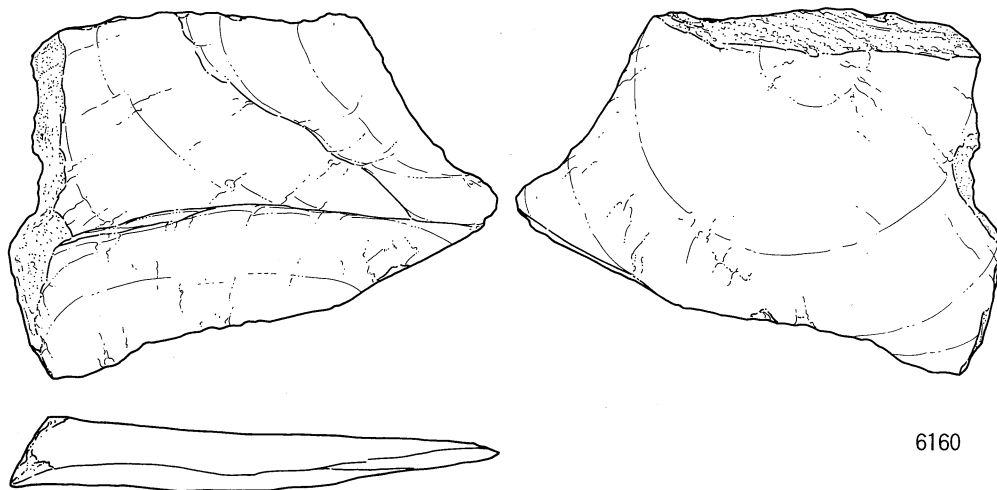
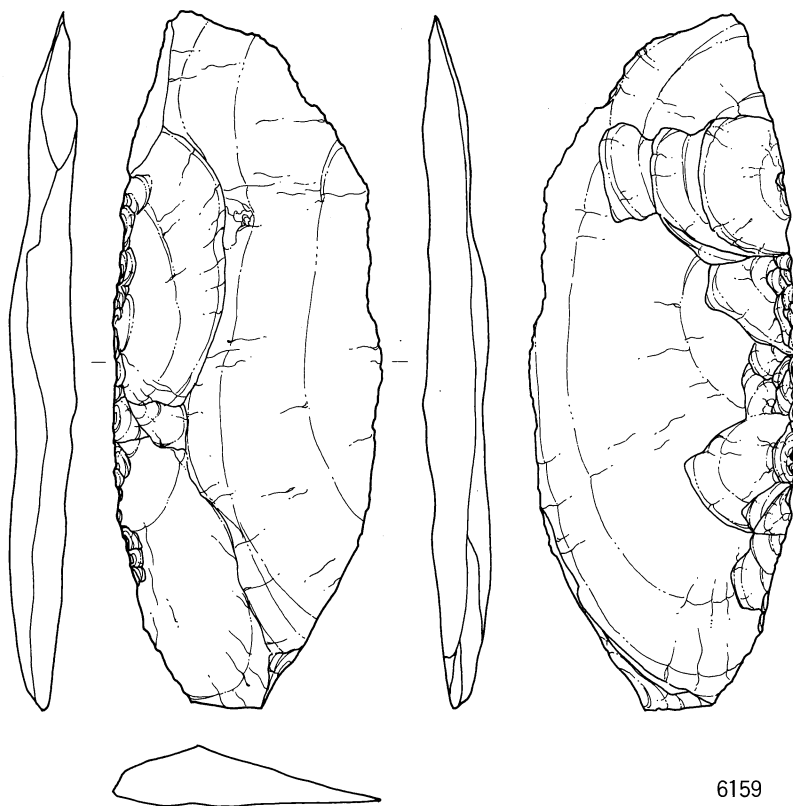

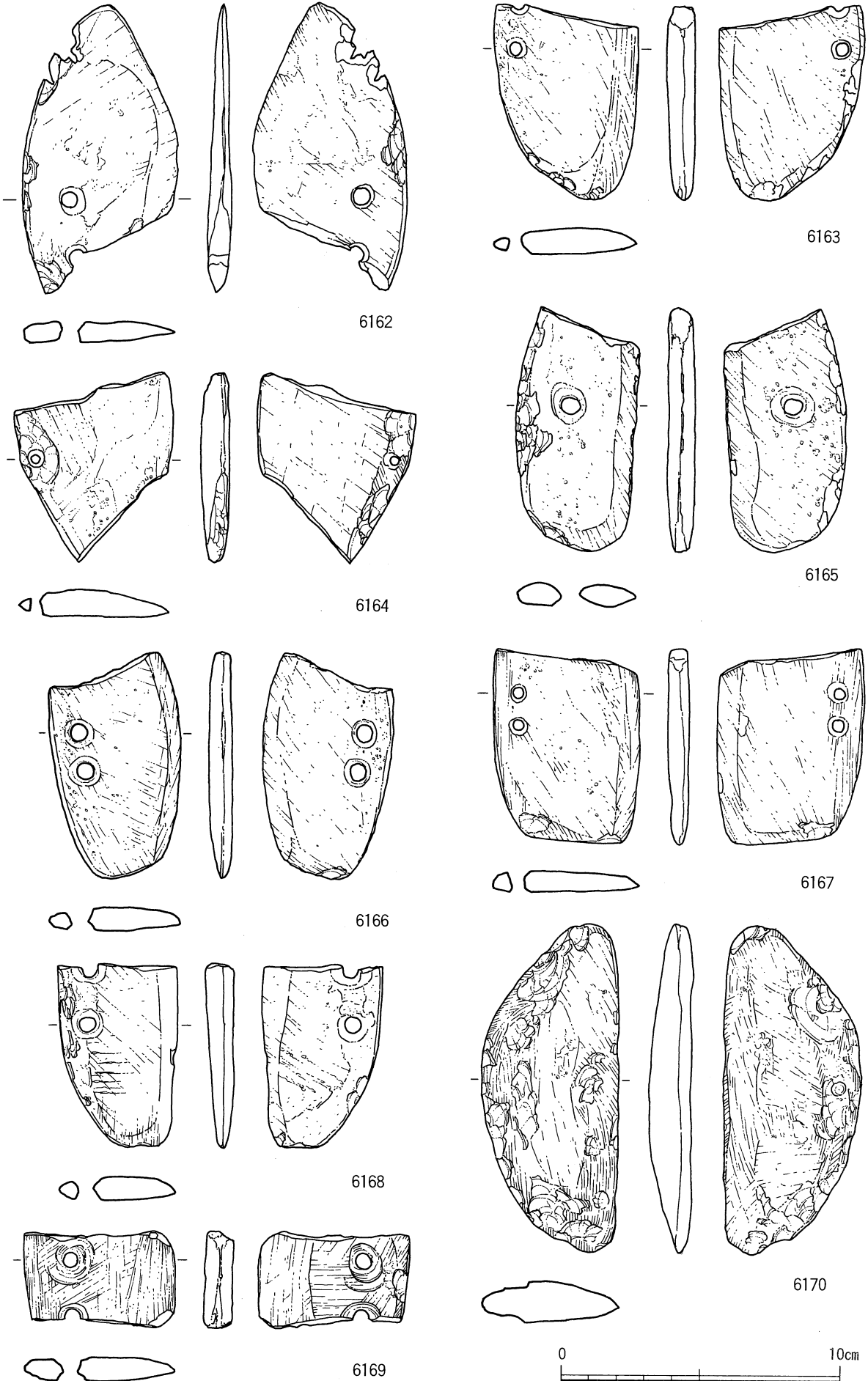

竖穴住居 SH46010 (6162 · 6163)
 土坑 SK46066 (6166) SK46070 (6165) SK46099 (6167)
 SK46103 (6170) SK46119 (6164 · 6169) SK46120 (6168)

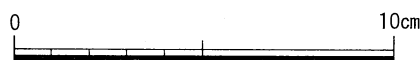
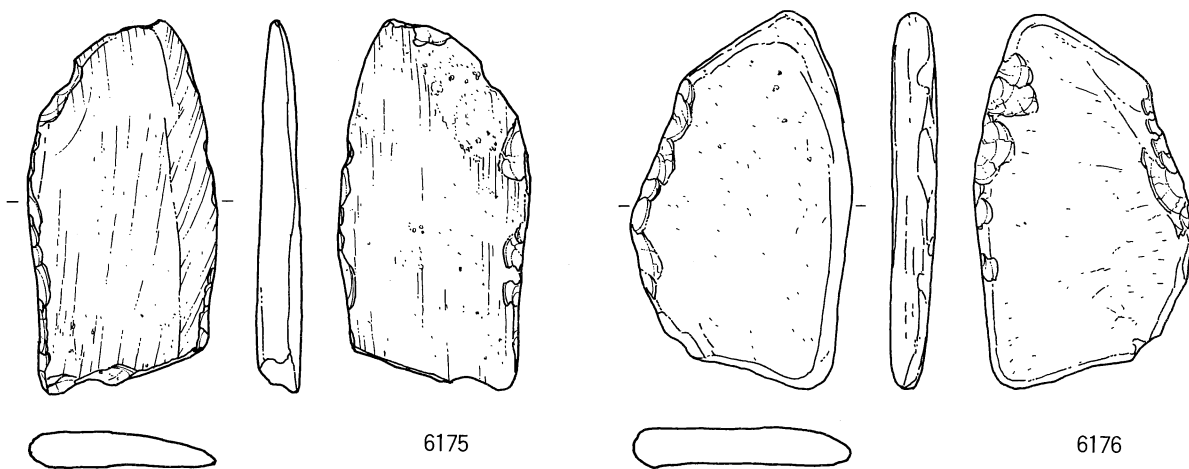
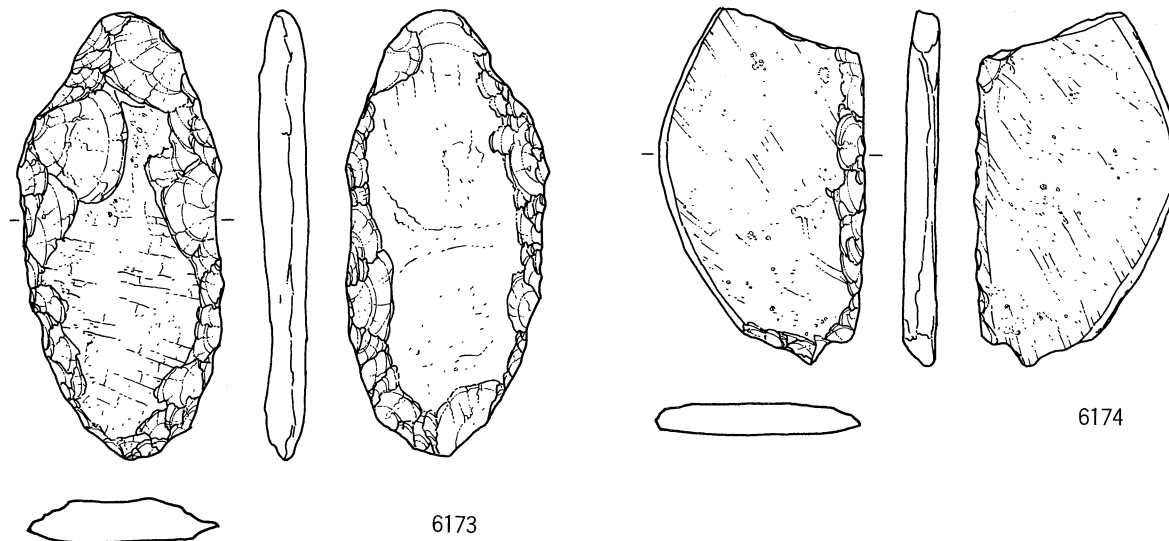
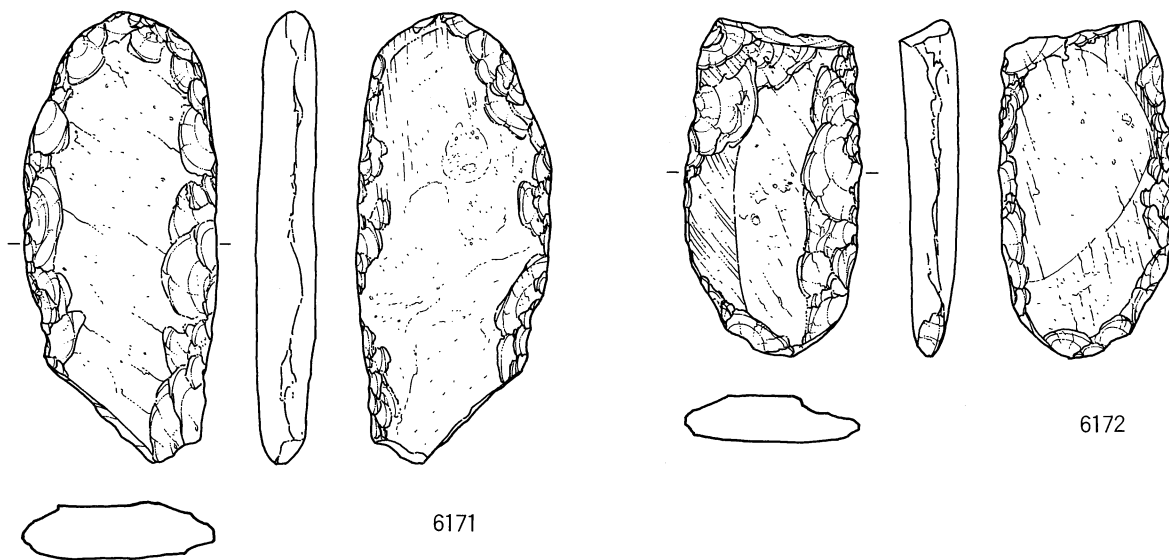

竖穴住居 SH46010 (6176) SH46012 (6174) SH46019 (6175)
 土坑 SK46062 (6171) SK46115 (6173) SK46126 (6172)

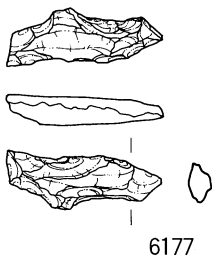

6177

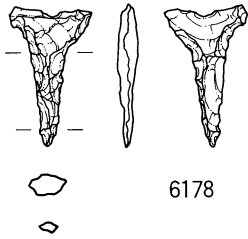

6178

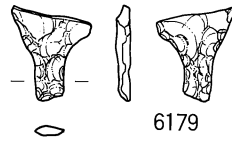

6179



6180



6181

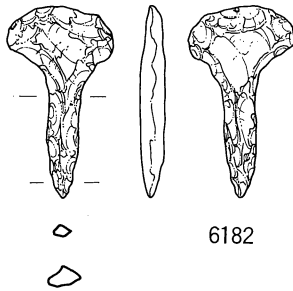

6182

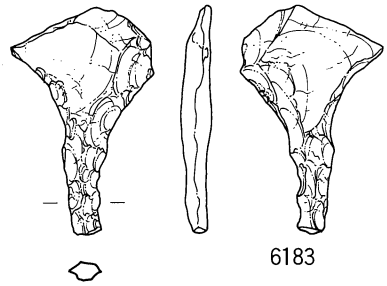

6183

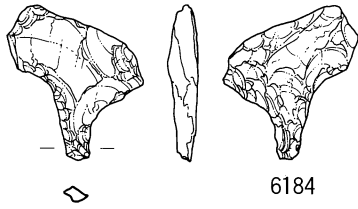

6184

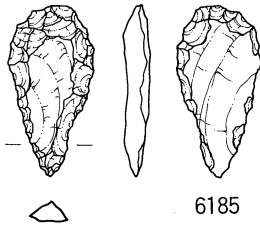

6185

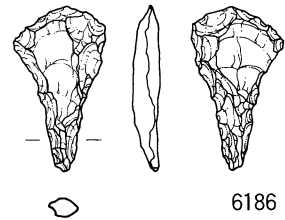

6186

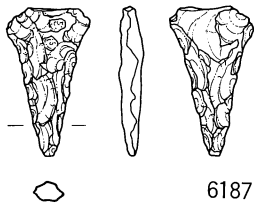

6187

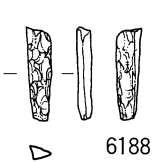

6188



6189



6190



6191



6192

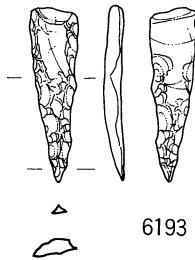

6193

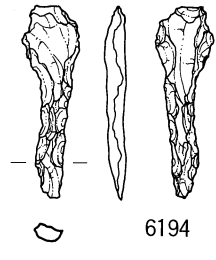

6194

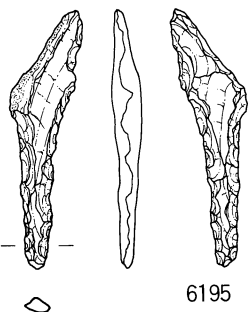

6195

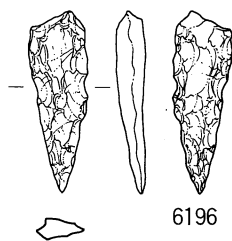

6196

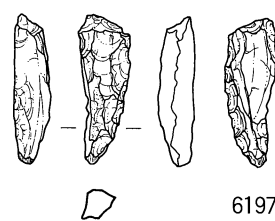

6197

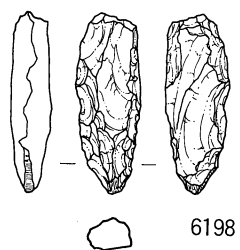

6198



竖穴住居	SH46006 (6183)	SH46010 (6177)	SH46013 (6193)	SH46024 (6182)
	SH46025 (6196)	SH46026 (6179)	SH46027 (6180 · 6190)	
	SH46034 (6178 · 6197 · 6198)	SH46039 (6192)		
土坑	SK46066 (6188 · 6191)	SK46068 (6181)	SK46071 (6195)	SK46080 (6184)
	SK46089 (6189)	SK46119 (6194)		
柱穴	P46007 (6186)	P46033 (6187)	包含层 (6185)	

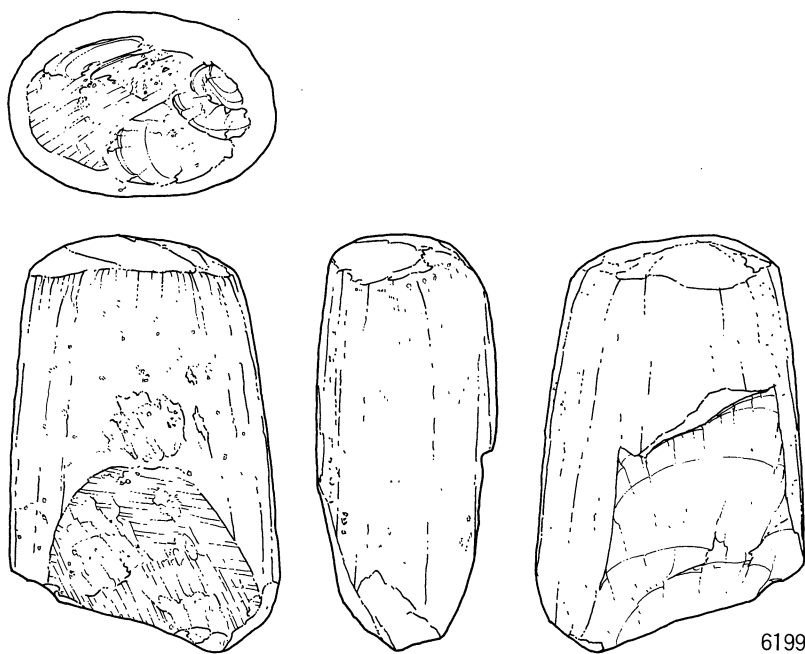

6199

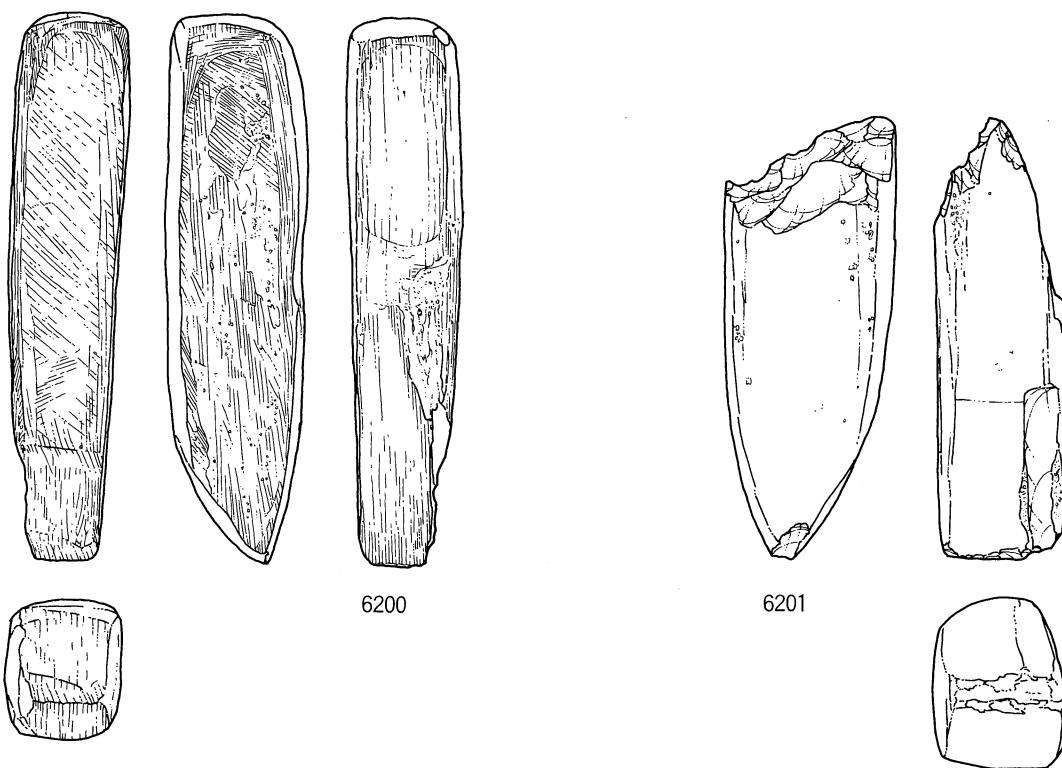

6200

6201

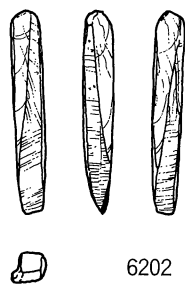

6202

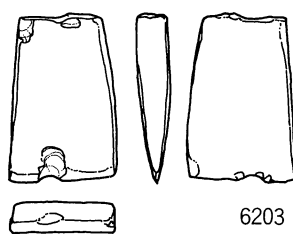

6203



竖穴住居 SH46002 (6202) SH46039 (6200)
 土坑 SK46050 (6203)
 方形周溝墓 SX46002 (6201)
 柱穴 P46030 (6199)

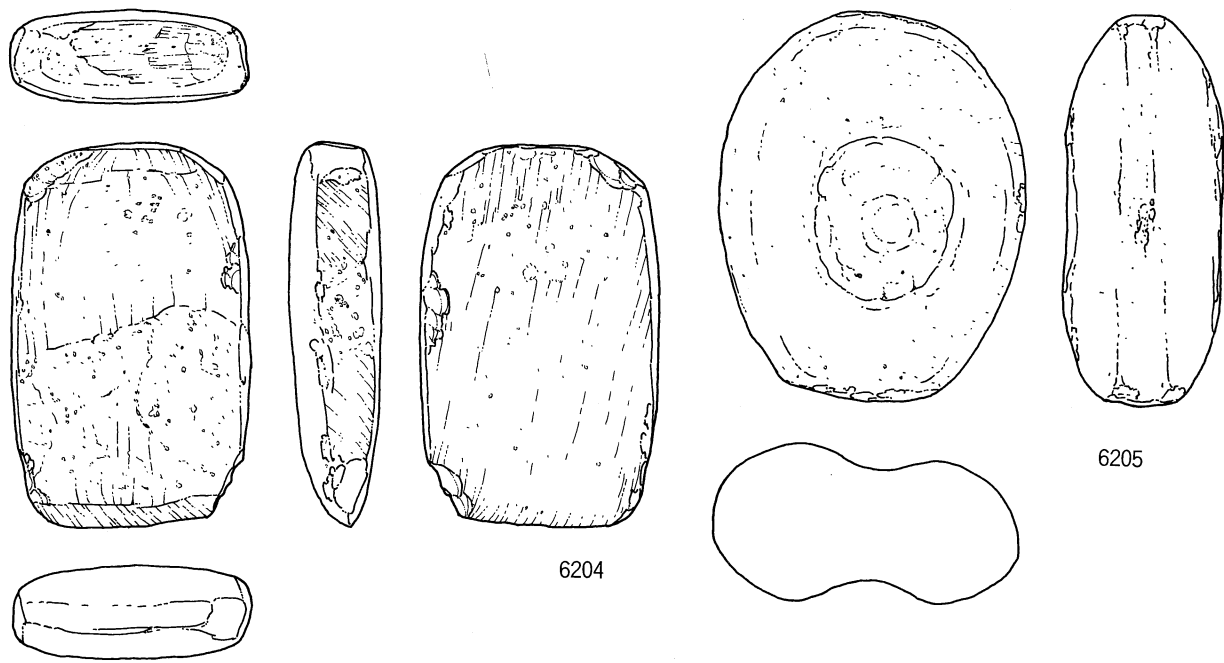

6204

6205

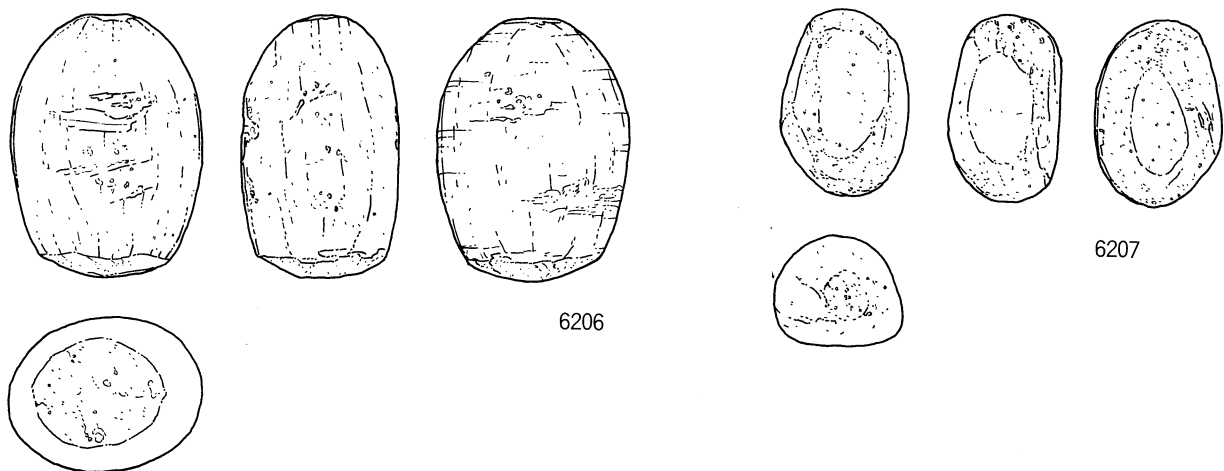

6206

6207

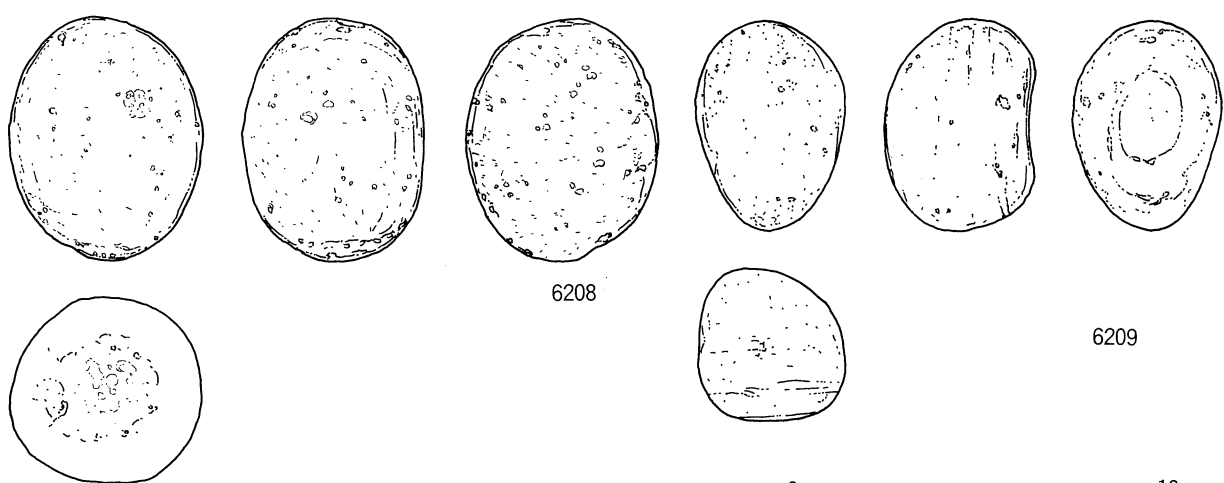

6208

6209

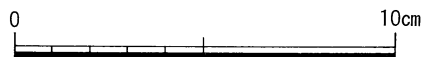

竖穴住居 SH46004 (6204) SH46006 (6209) SH46009 (6207)
 SH46023 (6208) SH46024 (6205)
 方形周溝墓 SX46001 (6206)

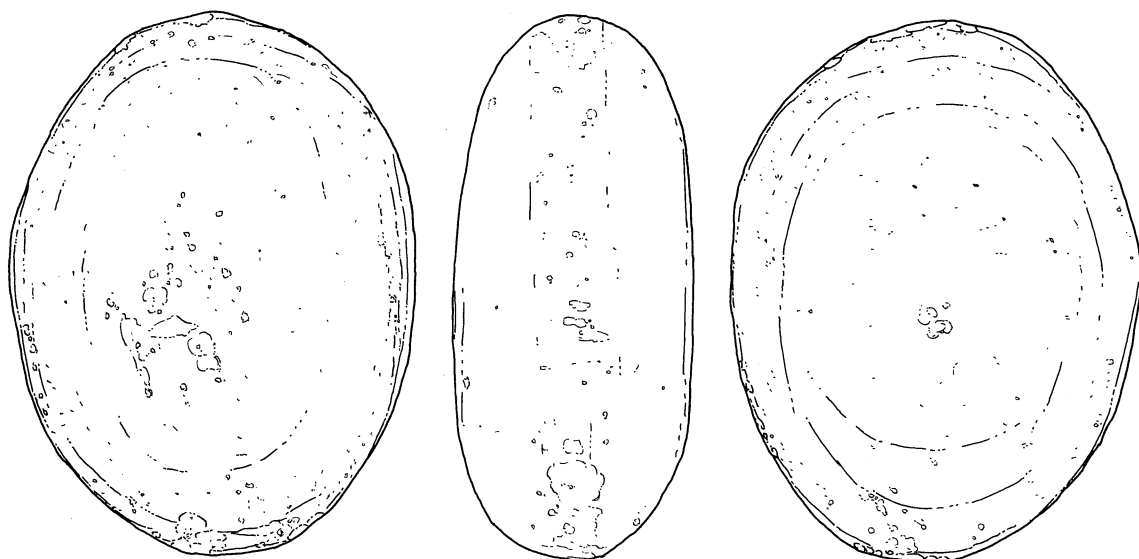

6210

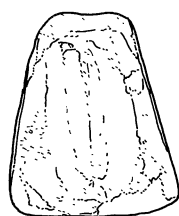
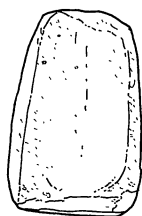
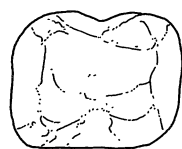
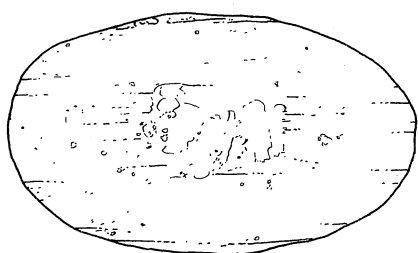

6211

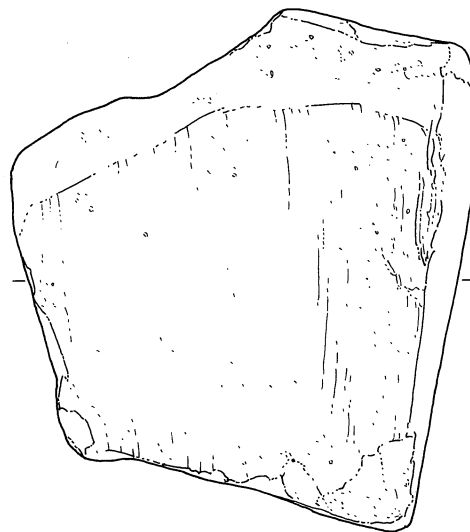

6212

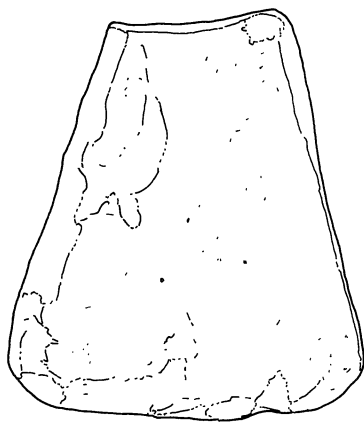

6213



竖穴住居 SH46001 (6213) SH46004 (6211)
 土坑 SK46003 (6210) SK46098 (6212)

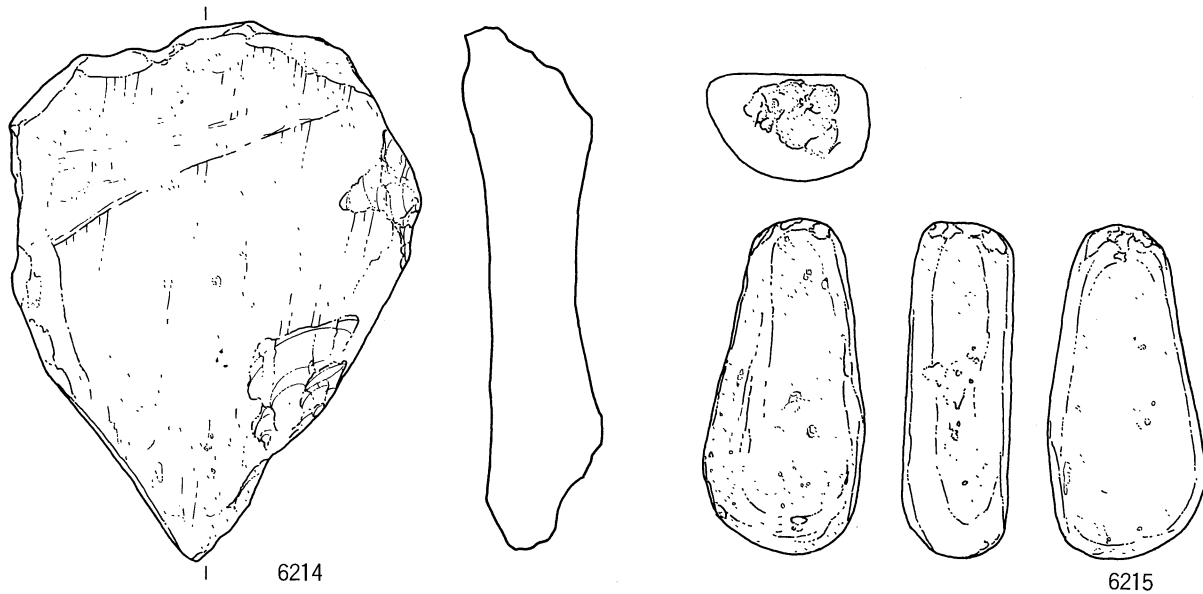

6214

6215

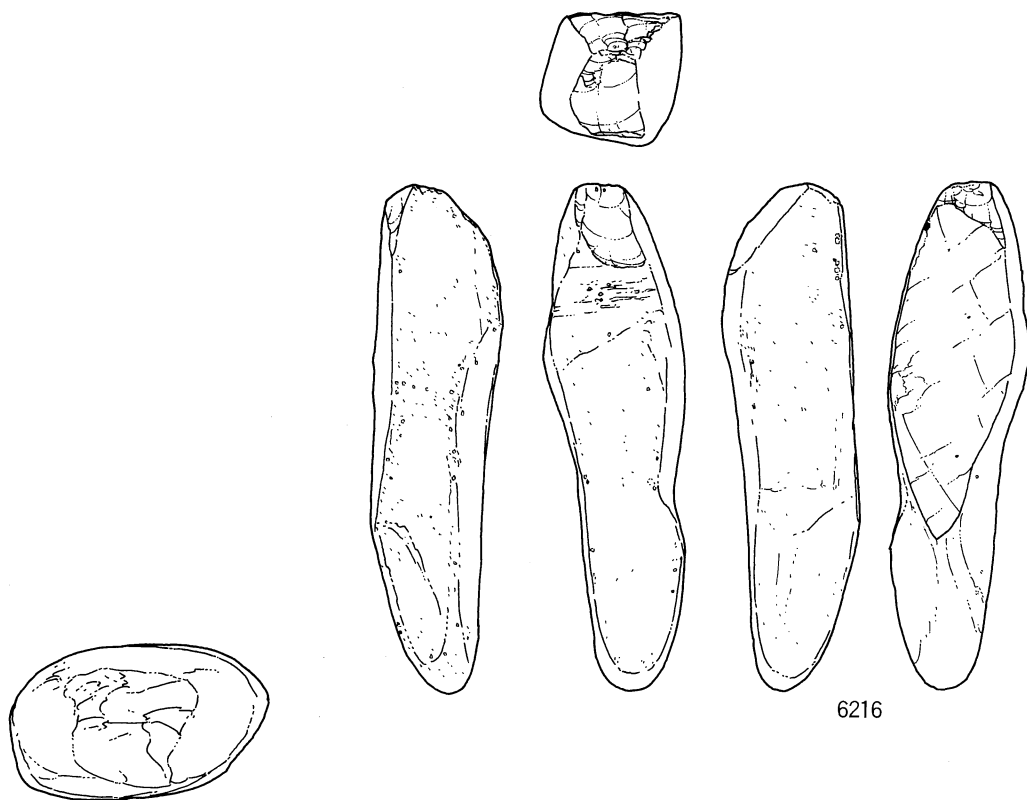

6216

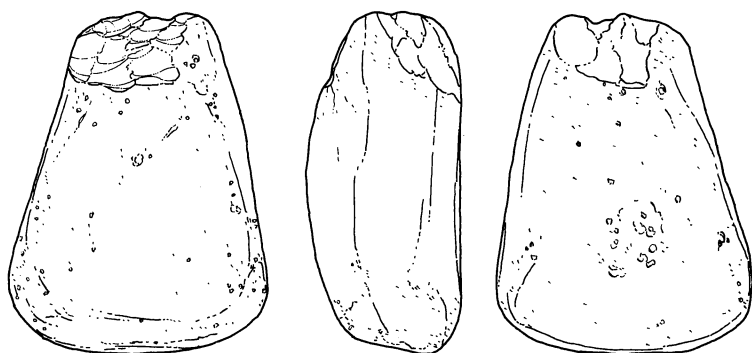

6217

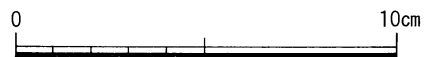

竖穴住居 SH46008 (6217) SH46014 (6214)
 土坑 SK46086 (6216) SK46087 (6215)

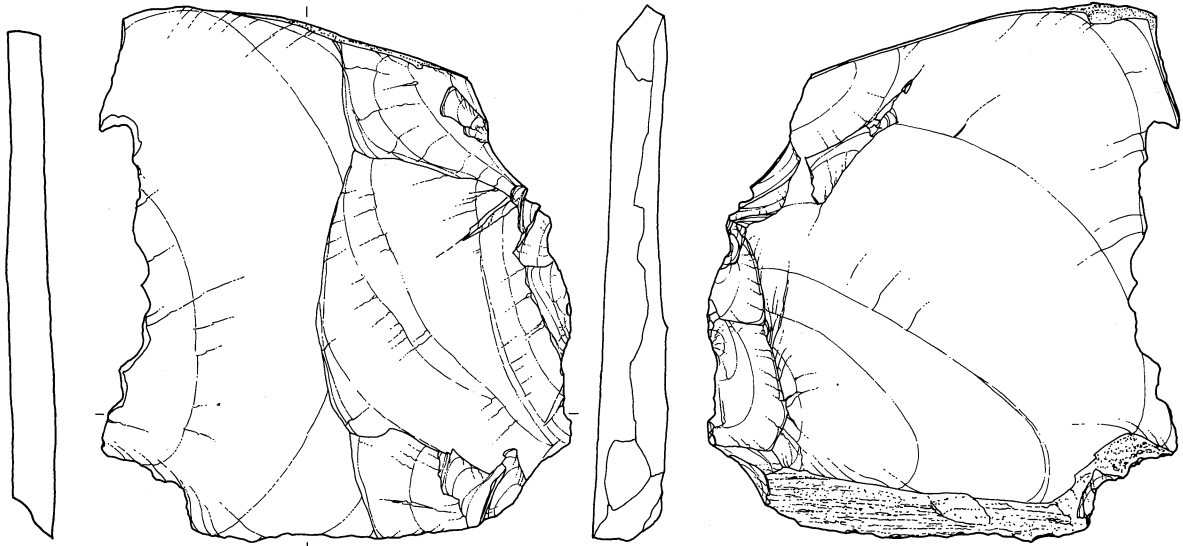

6218

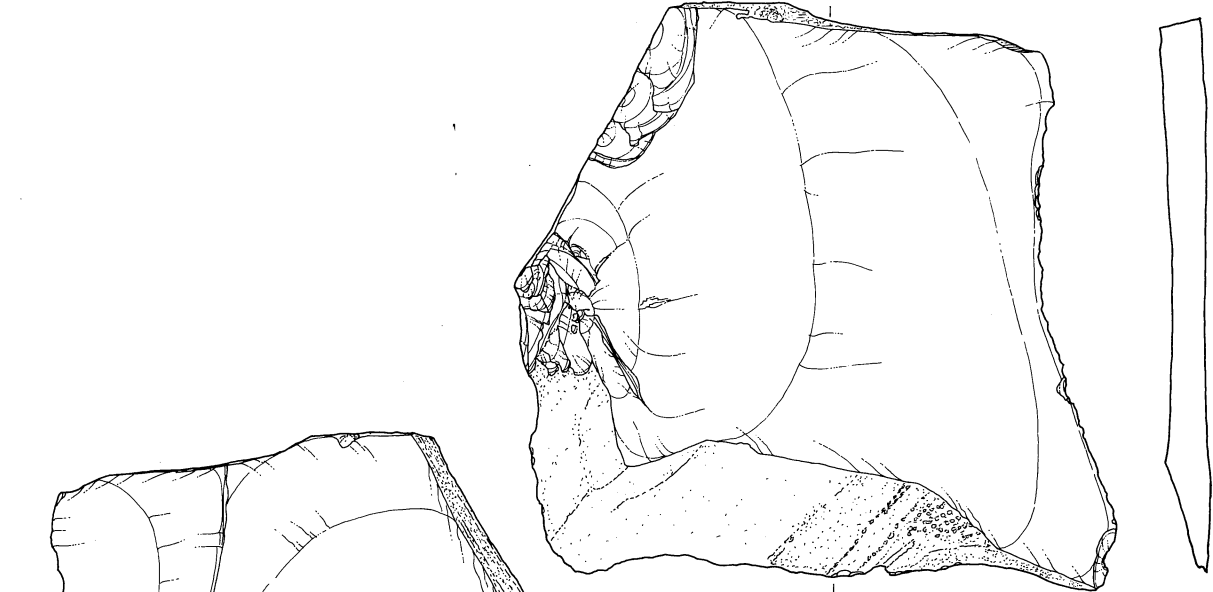

6219

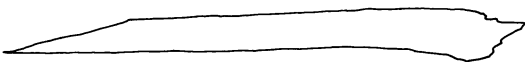

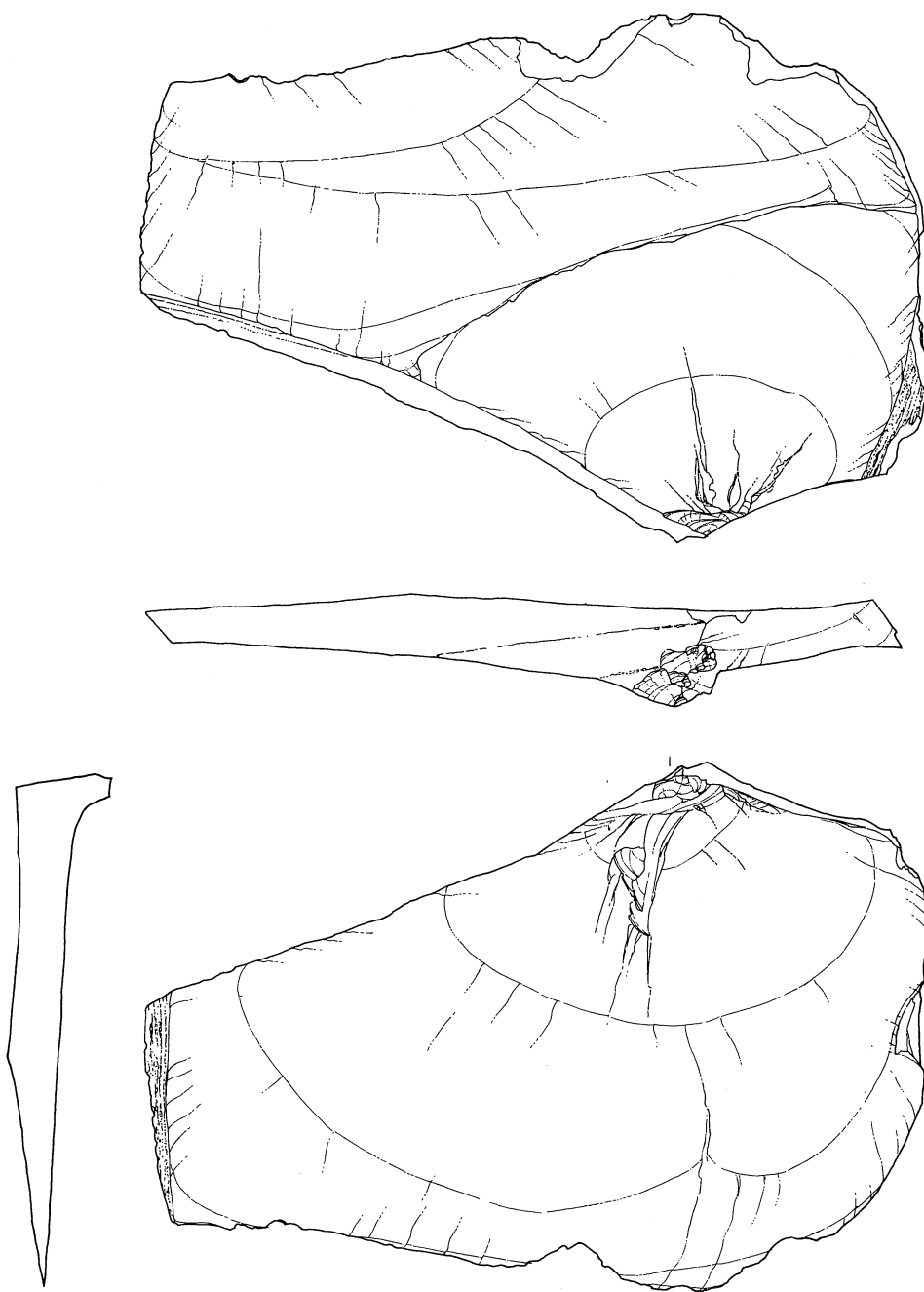

6220



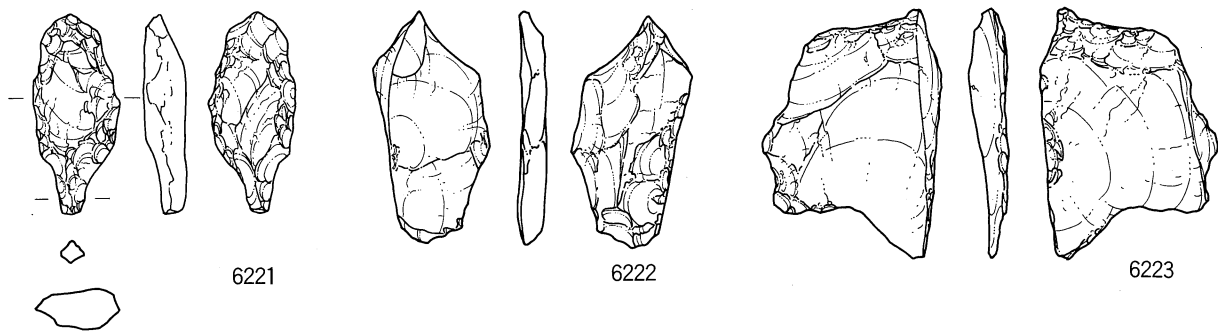

6221

6222

6223

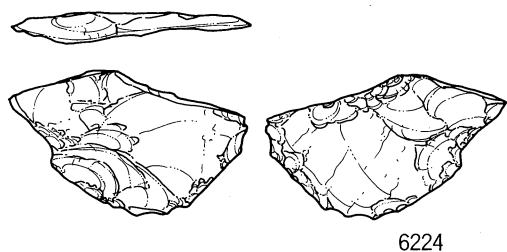

6224

6225

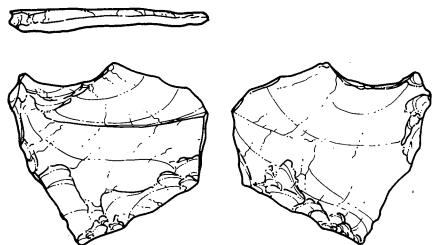

6226

6227

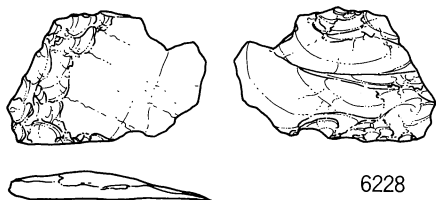

6228

6229

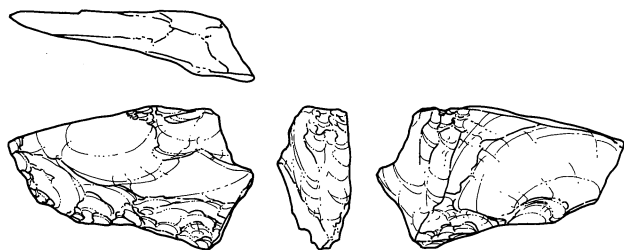

6230

6231

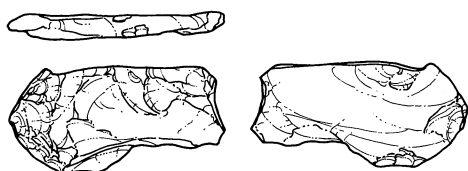

6232

6233

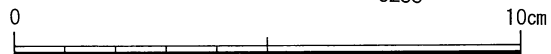

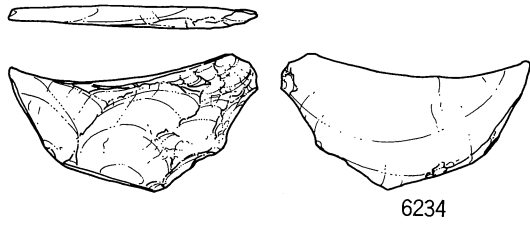

6234

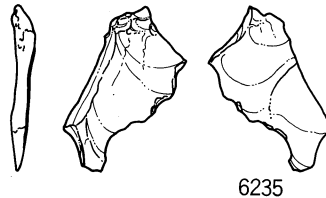

6235

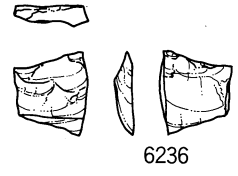

6236

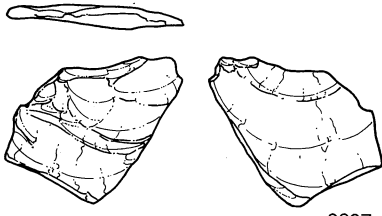

6237

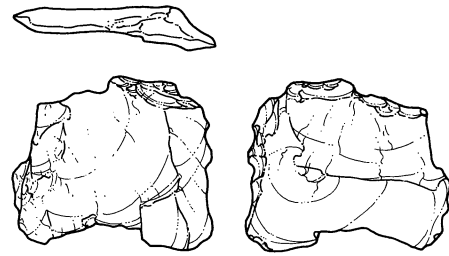

6238

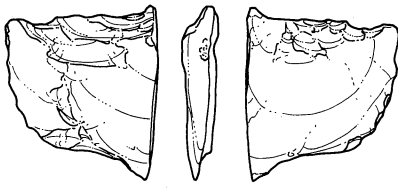

6239

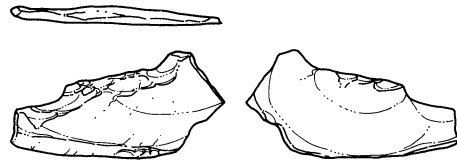

6240

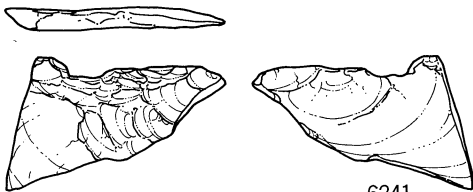

6241



6242

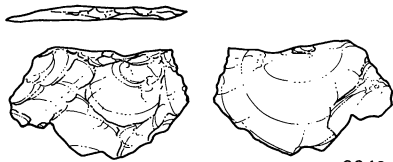

6243

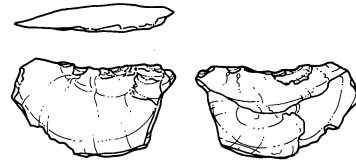

6244

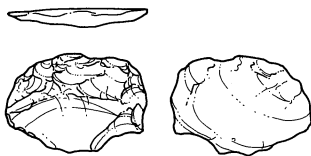

6245

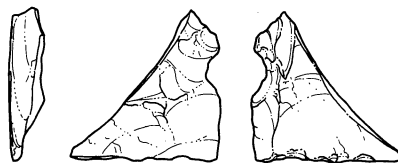

6246

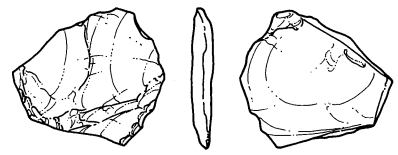

6247



6248

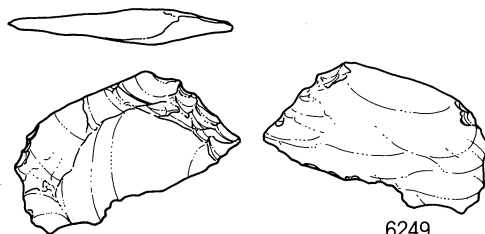

6249

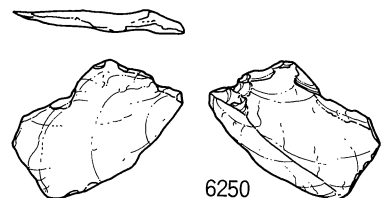

6250



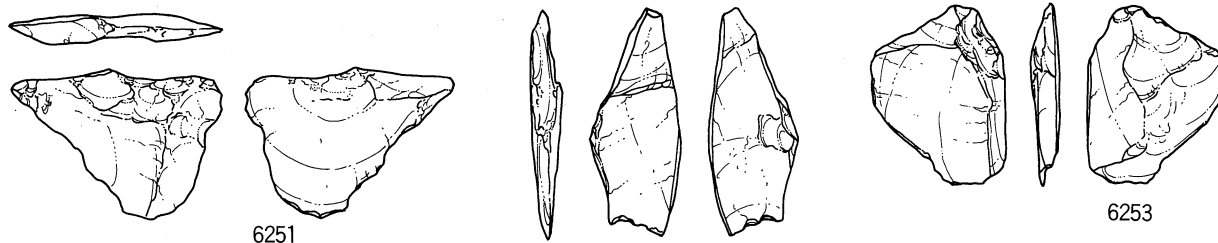

6251

6252

6253

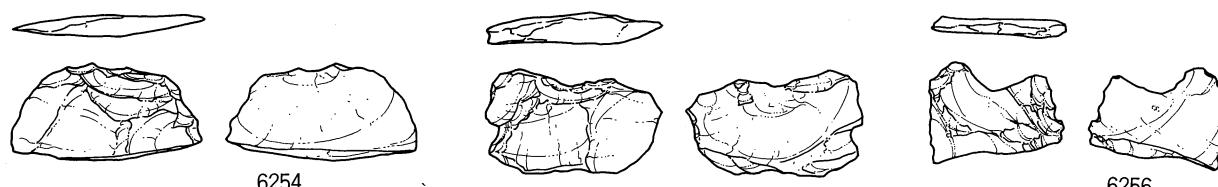

6254

6255

6256

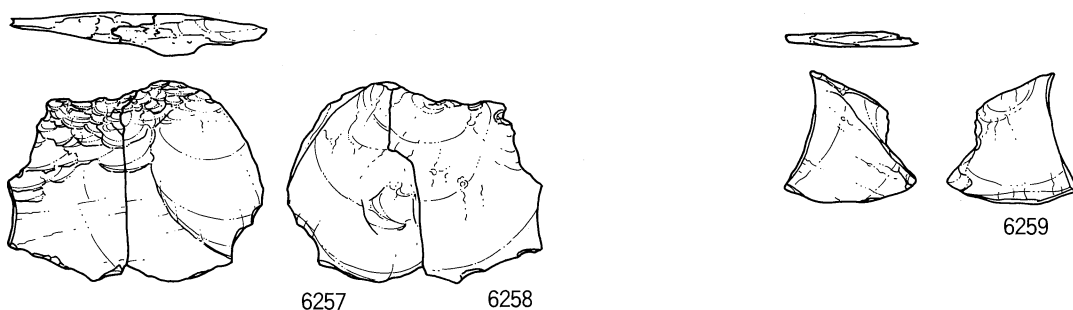

6257

6258

6259

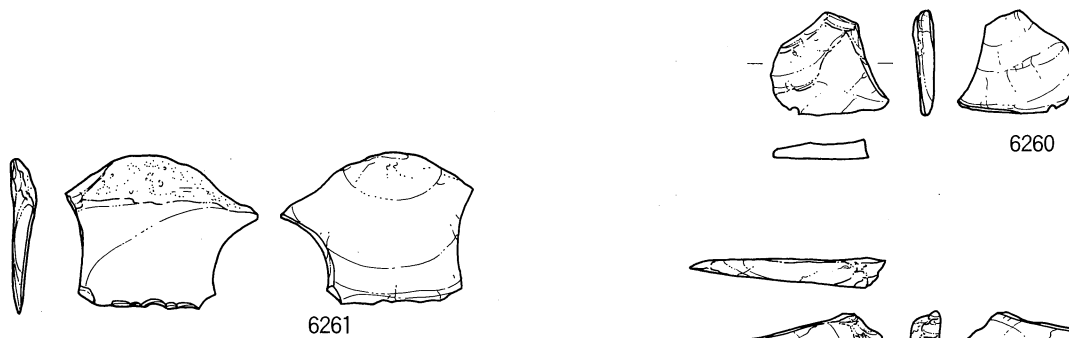

6260

6261

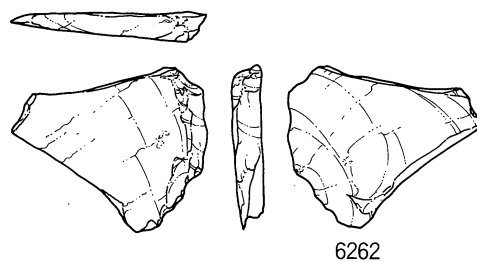

6262

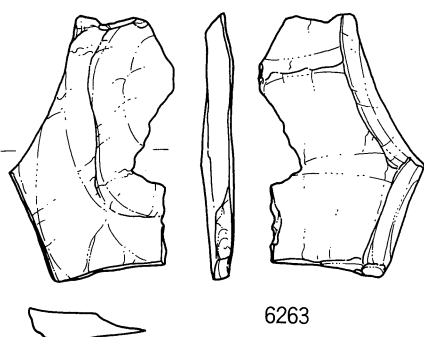

6263

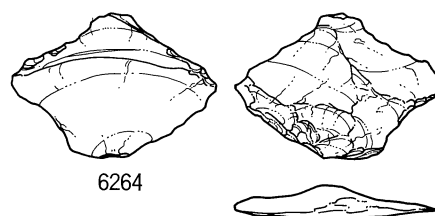

6264

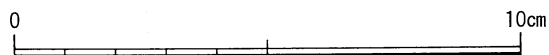

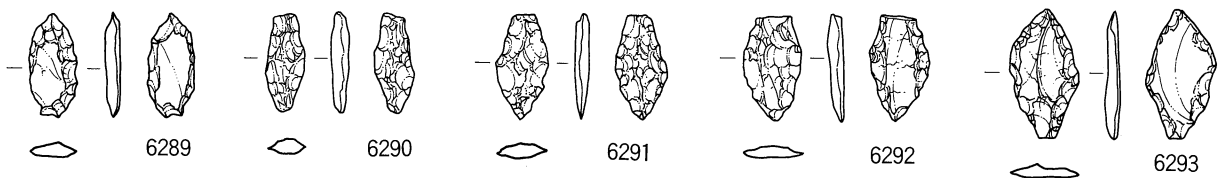
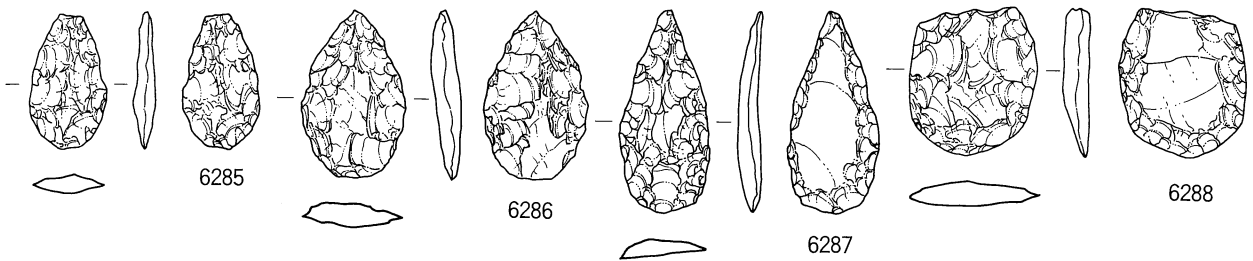
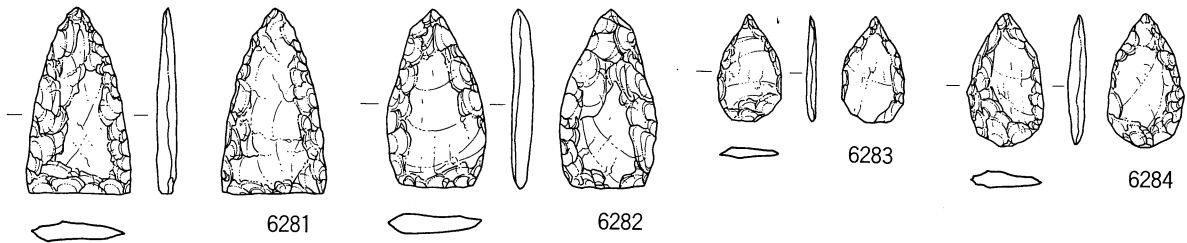
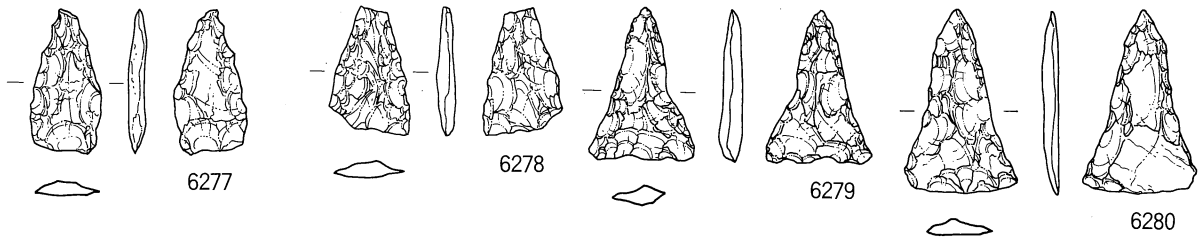
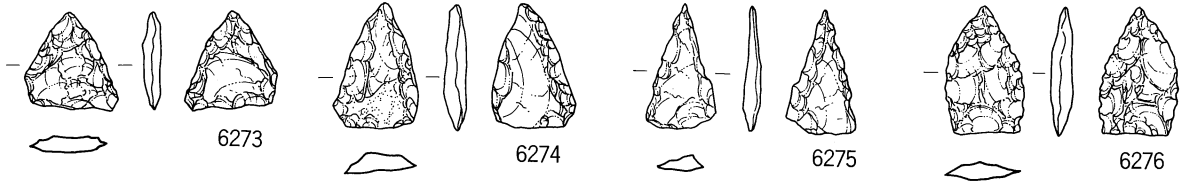
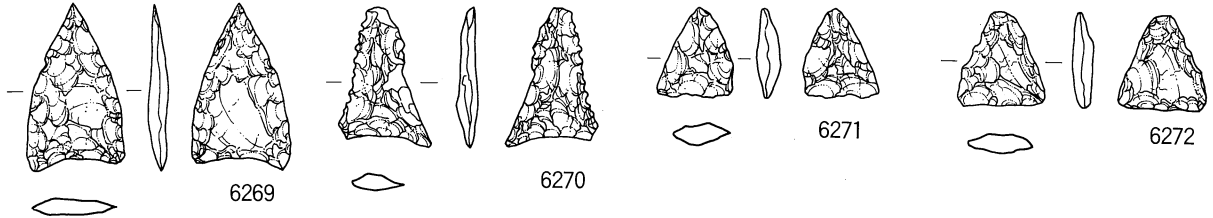
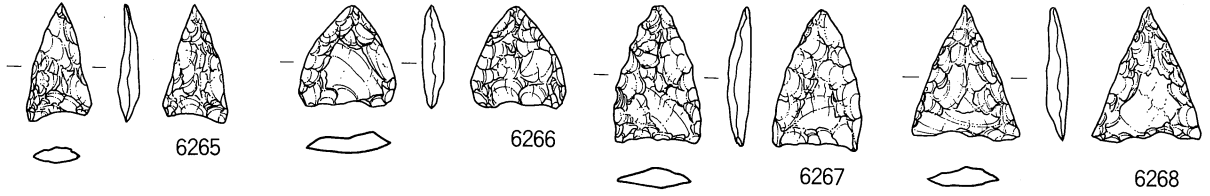

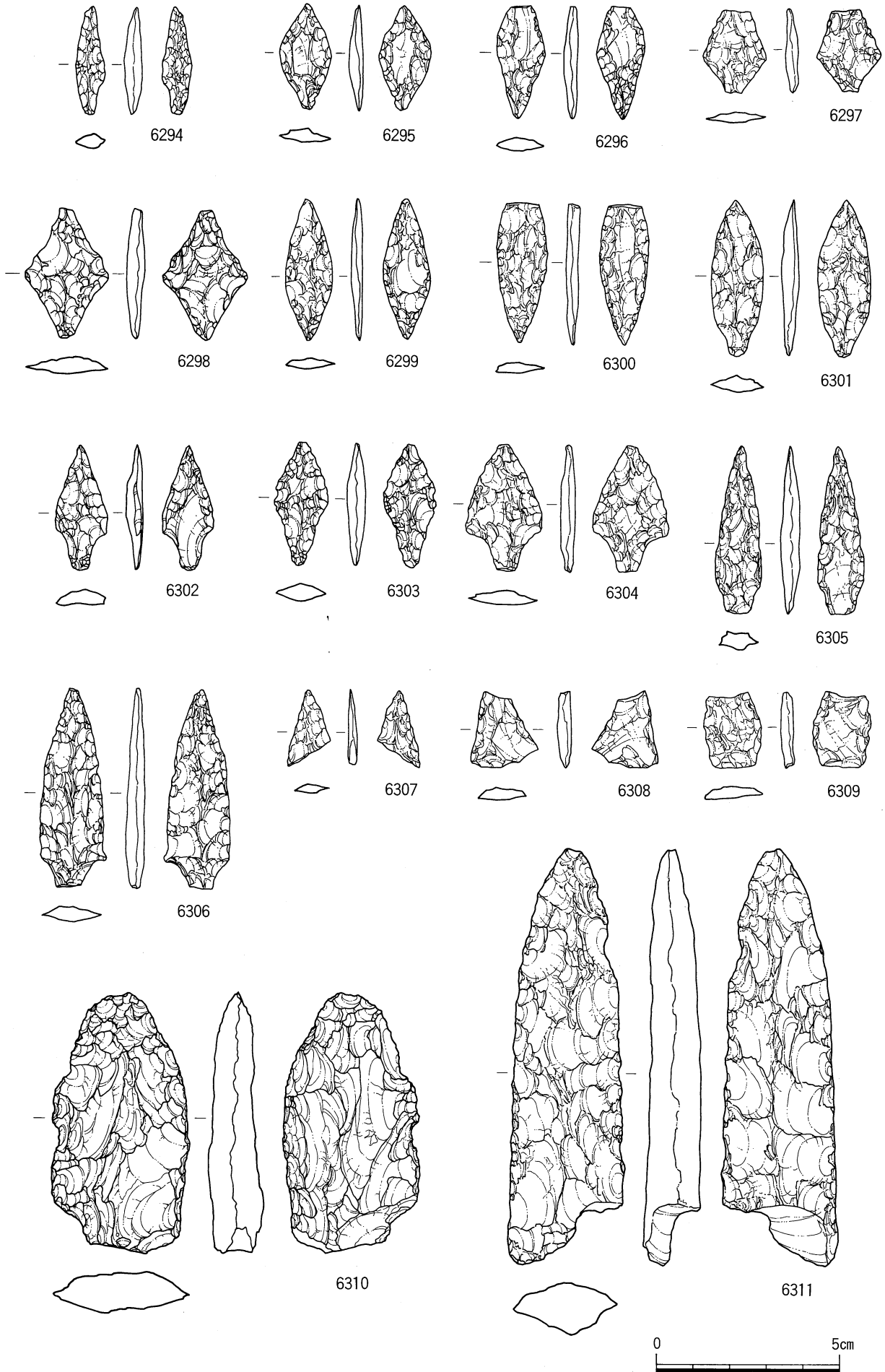

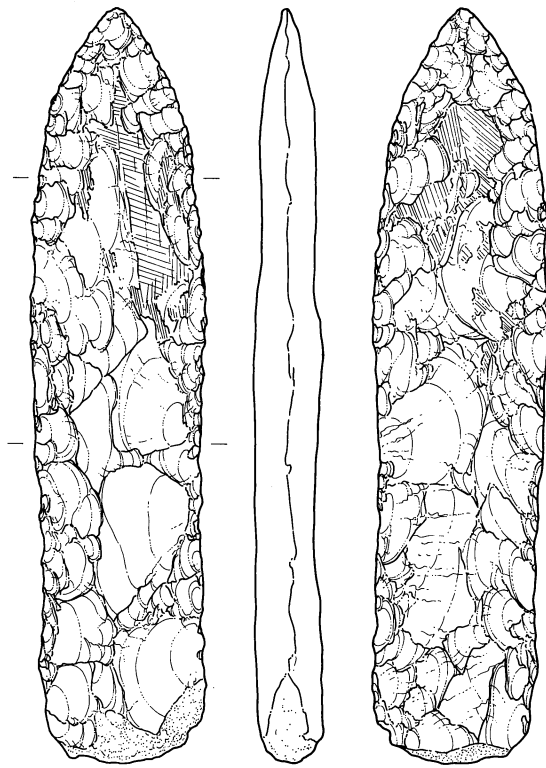

6312

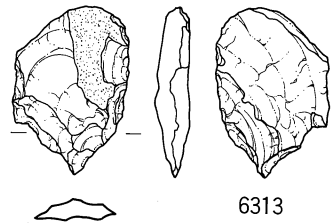
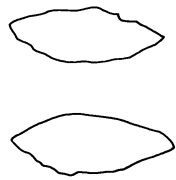

6313

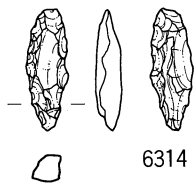

6314



6316

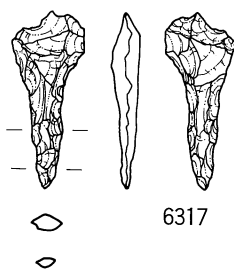

6317

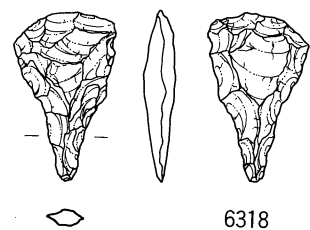

6318

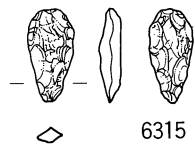

6315

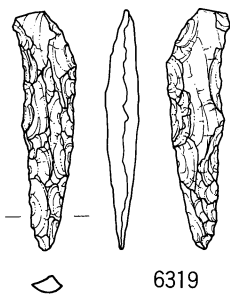

6319

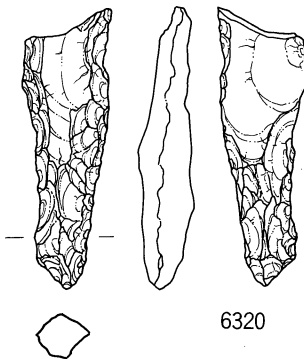

6320

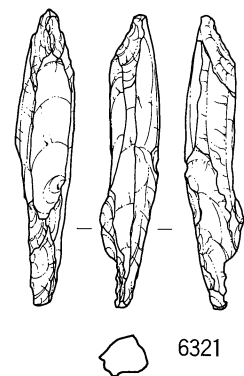

6321



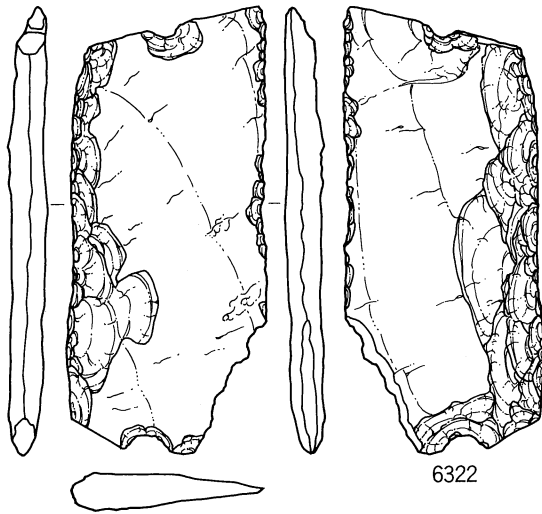

6322

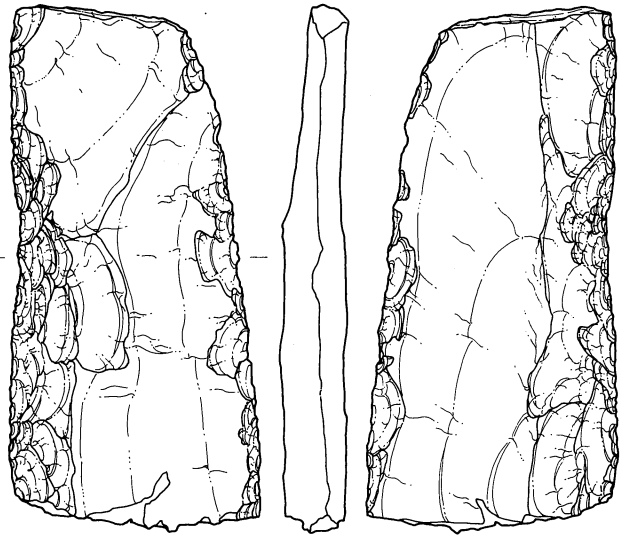

6323

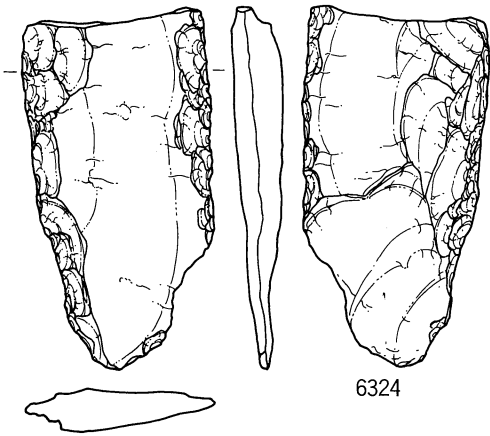

6324

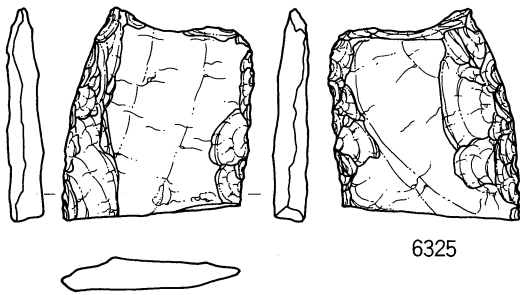

6325

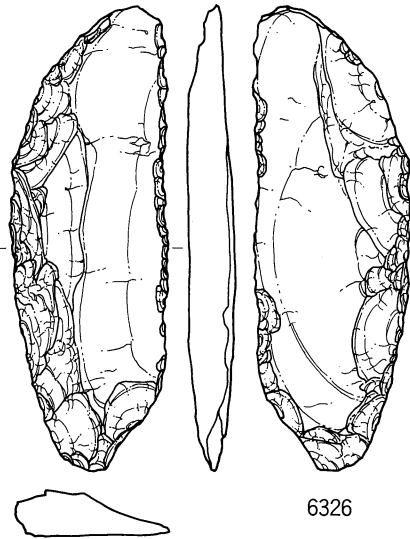

6326

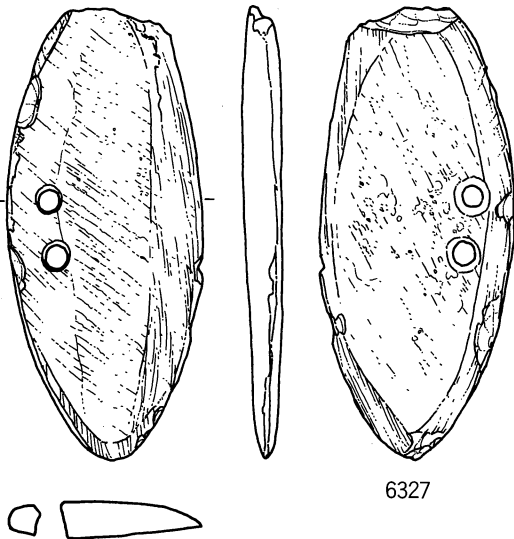

6327

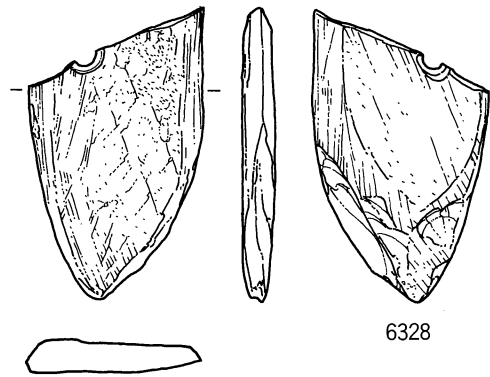

6328



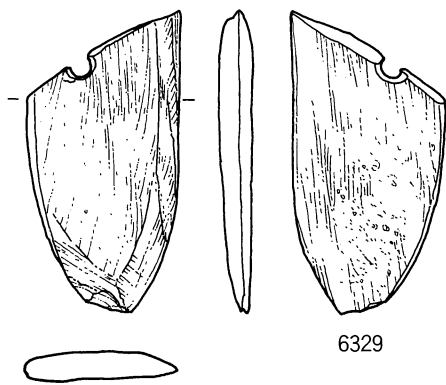

6329

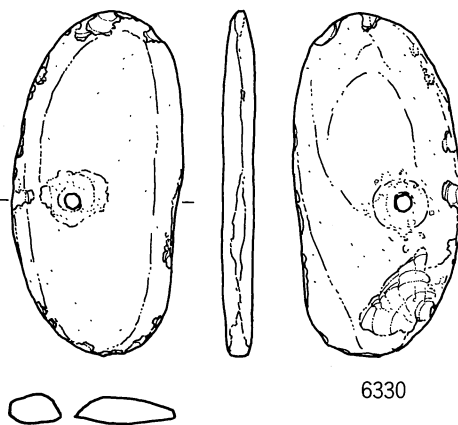

6330

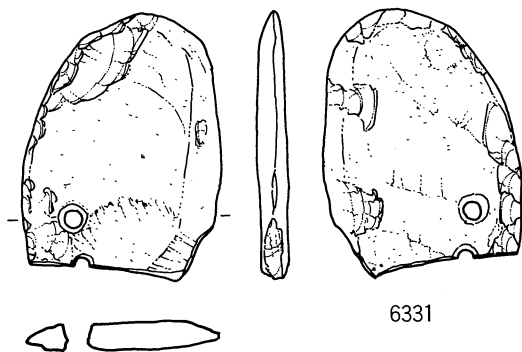

6331

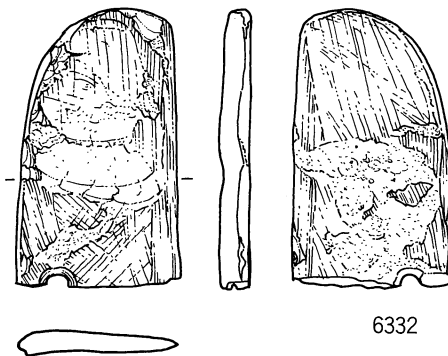

6332

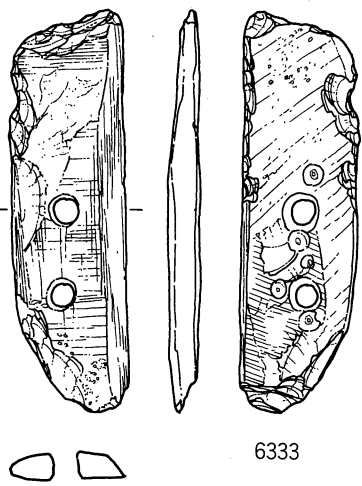

6333

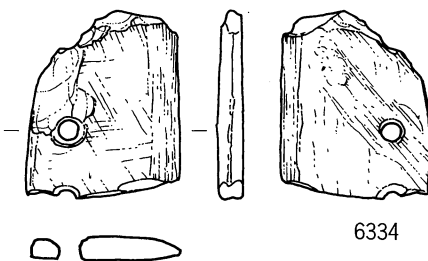

6334

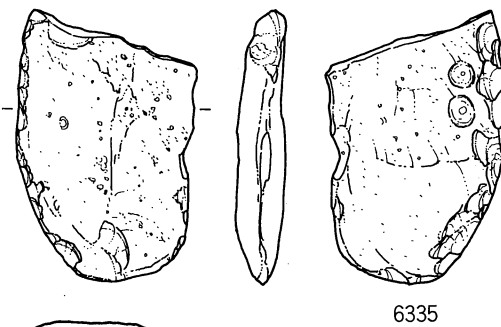

6335

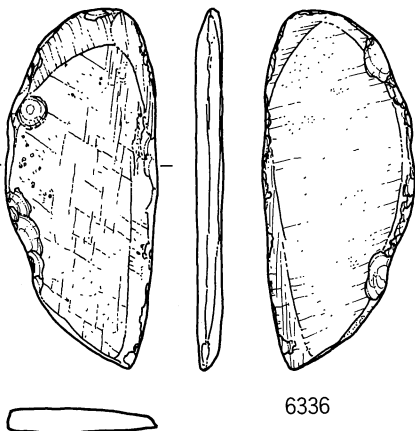

6336

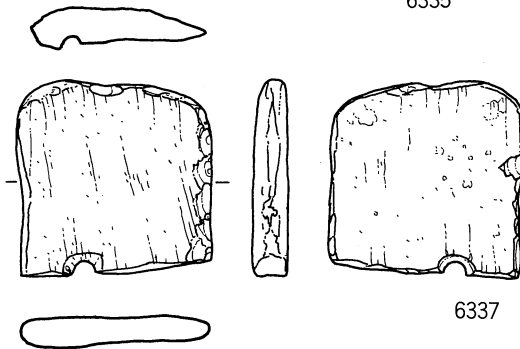

6337



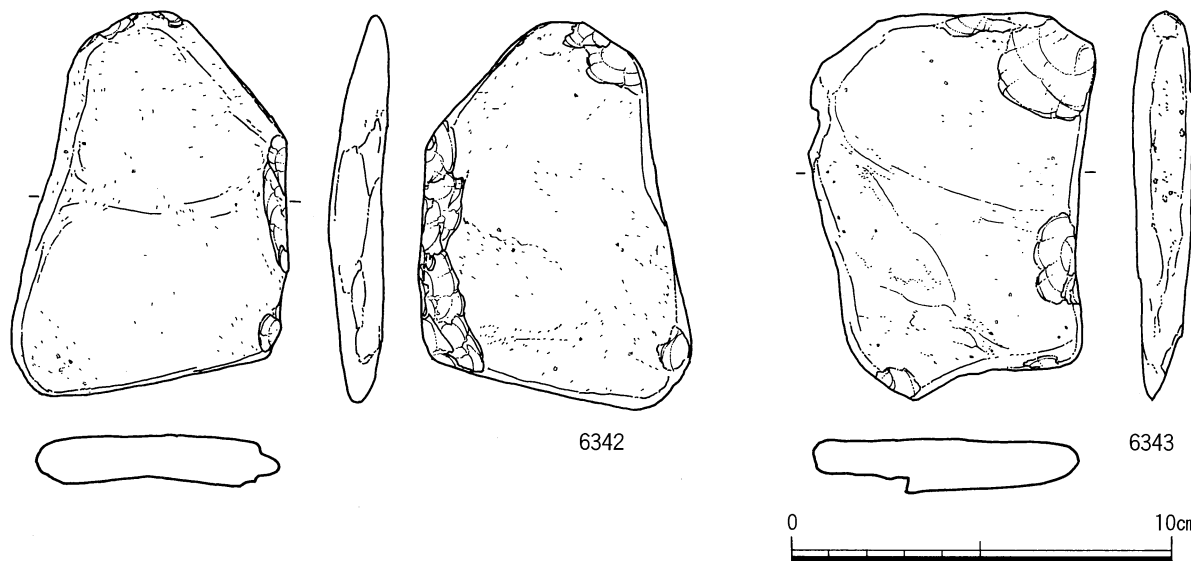
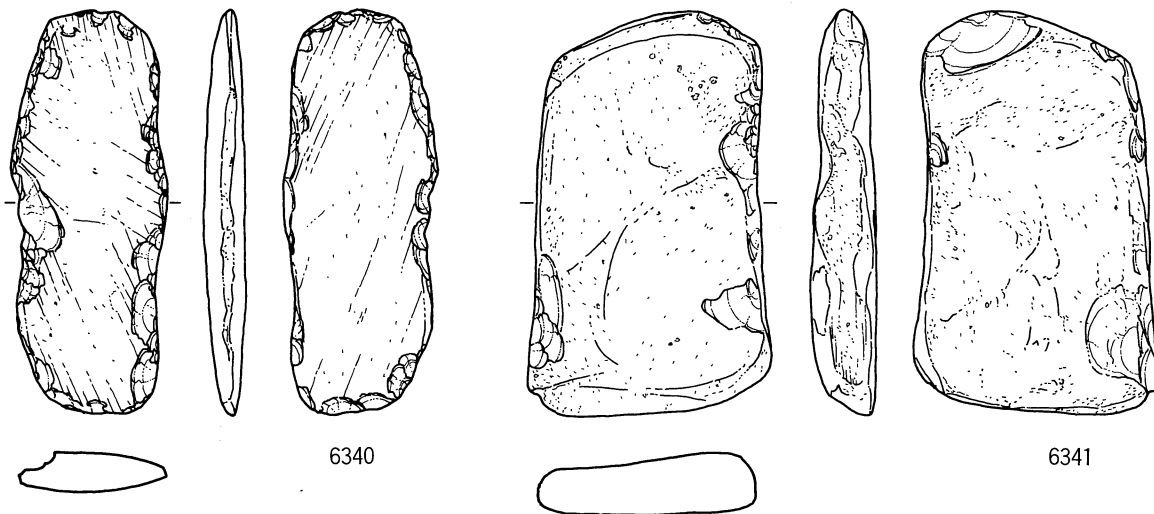
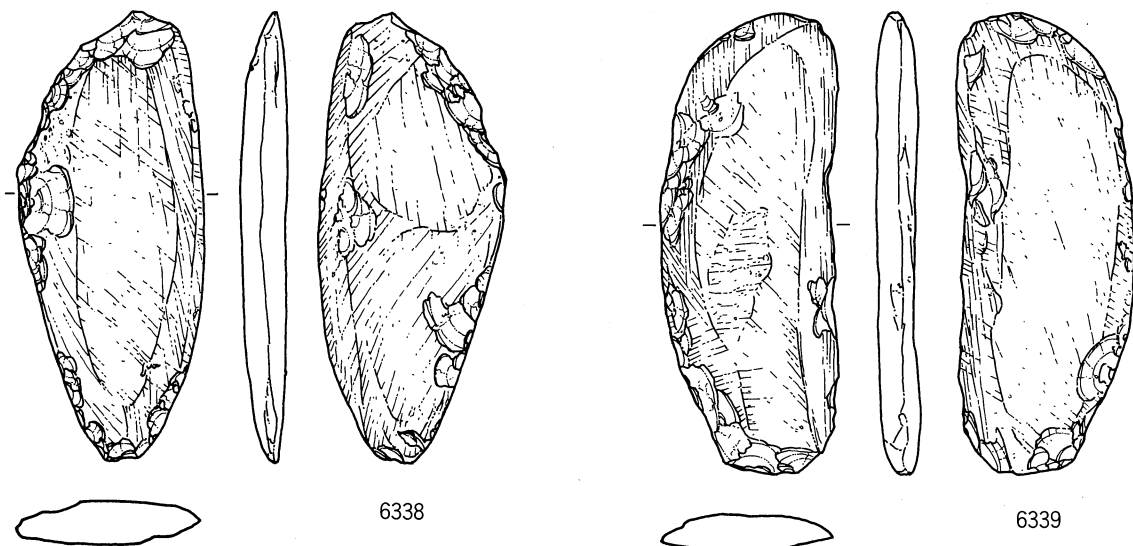

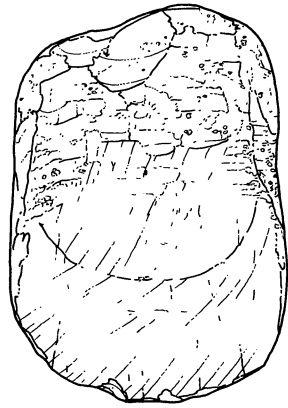
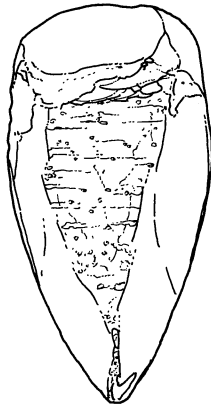
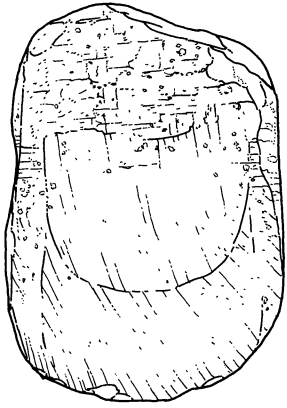
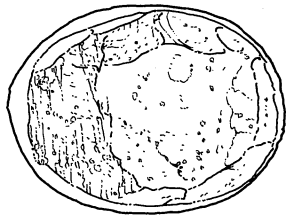

6344

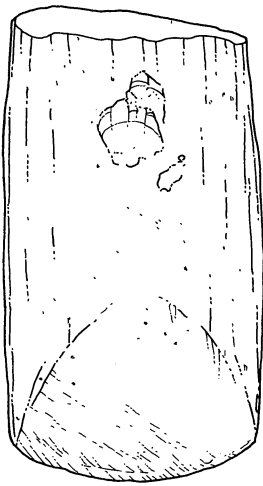
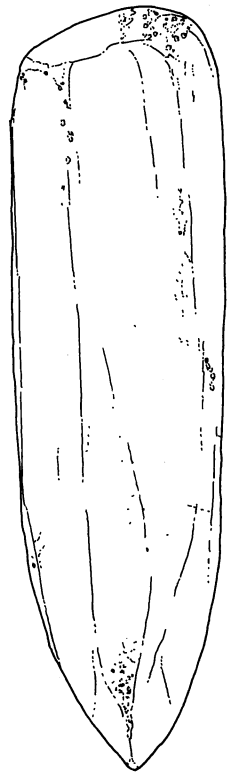
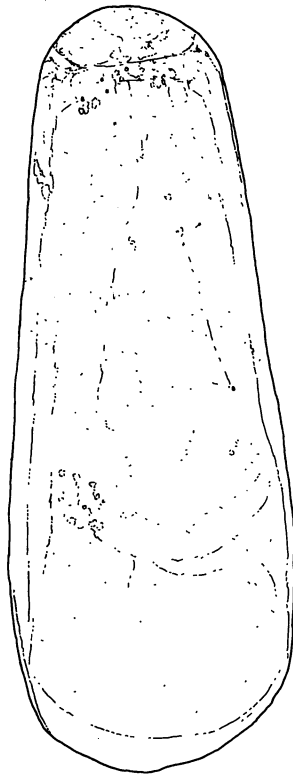
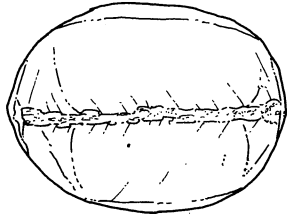

6345

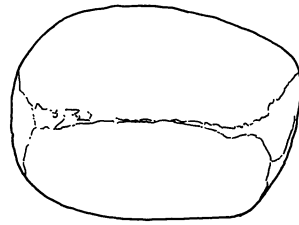
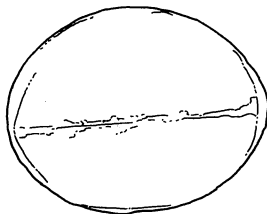

6346



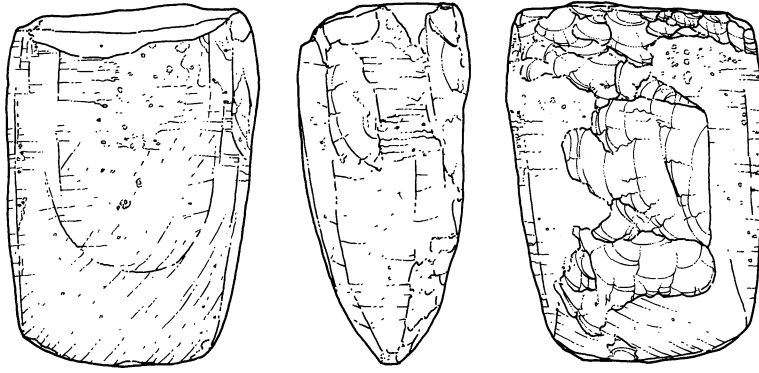

6347

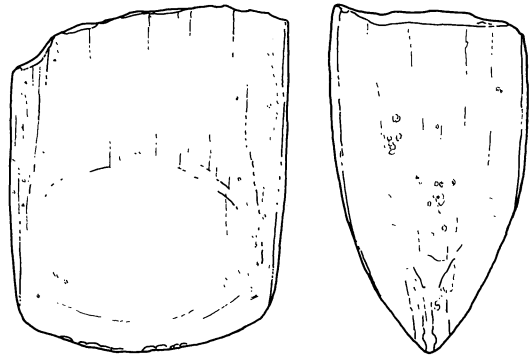
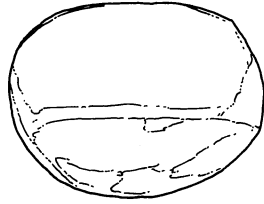

6349

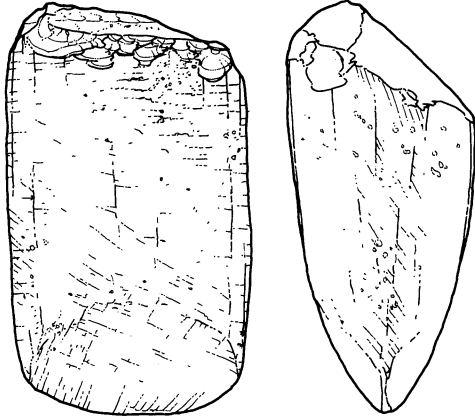

6348

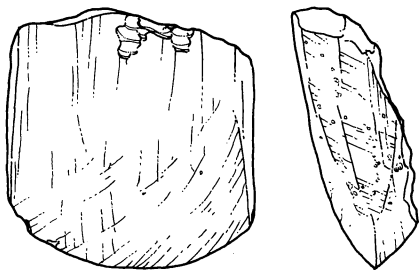
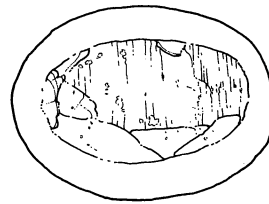
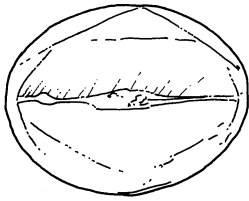
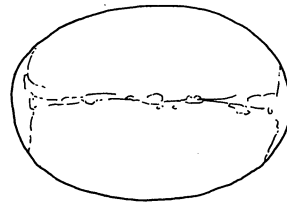

6350

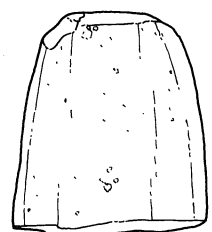
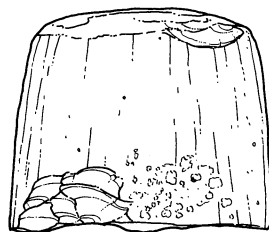

6351

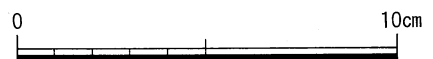

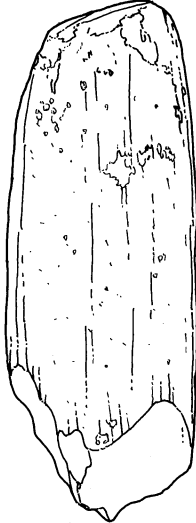
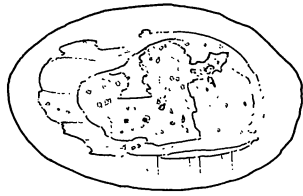

6352



6354

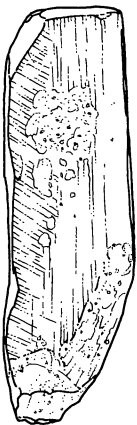

6357

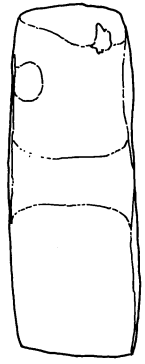

6353

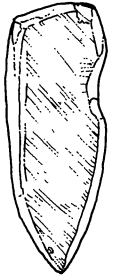
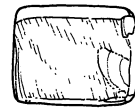

6356

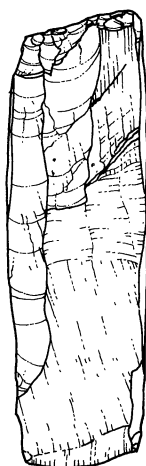
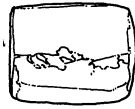

6358



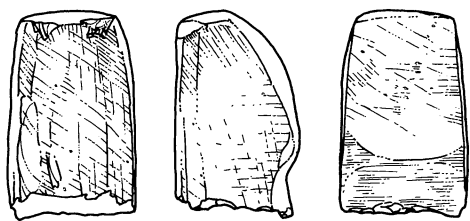

6359

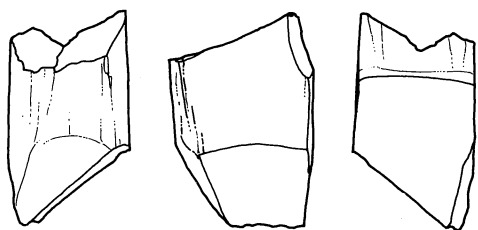

6360

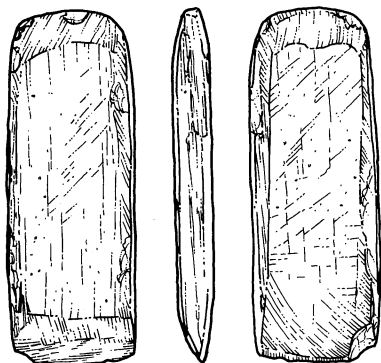

6362

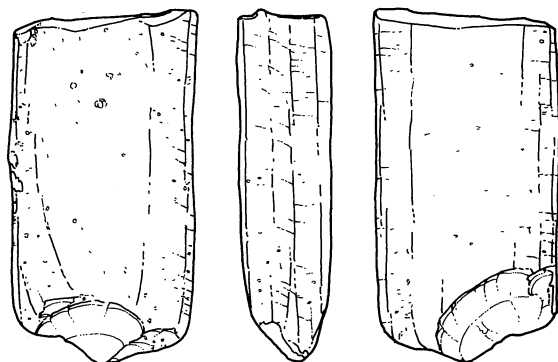
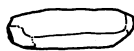

6364

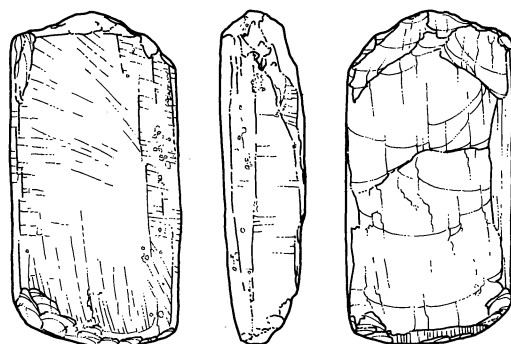
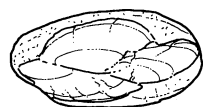

6361

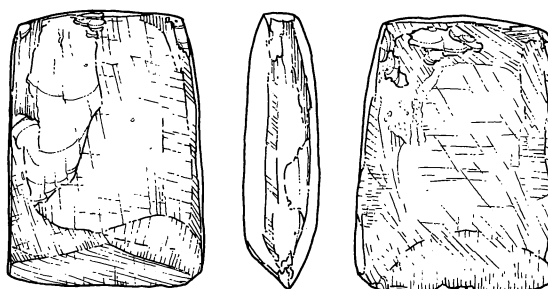

6363

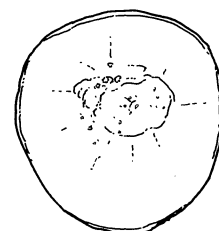
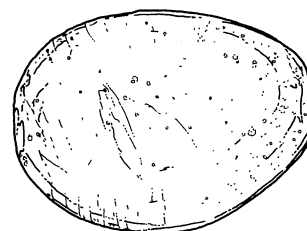
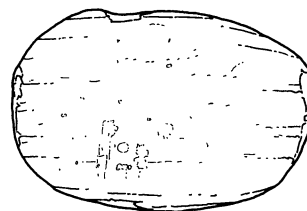
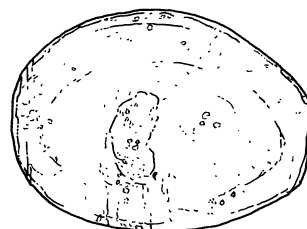
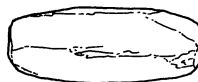

6365



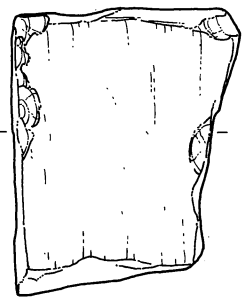
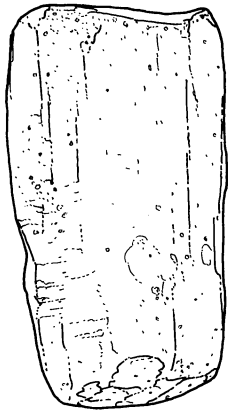

6368

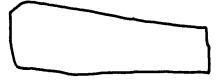

6366

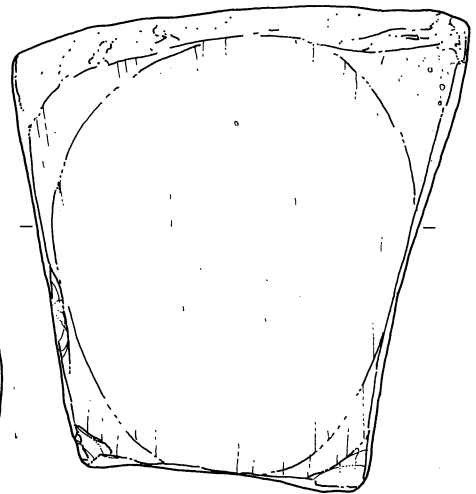
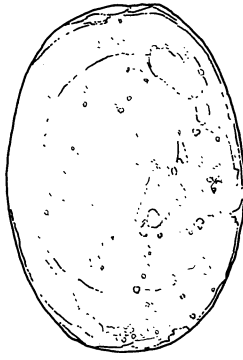
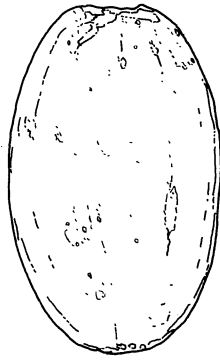
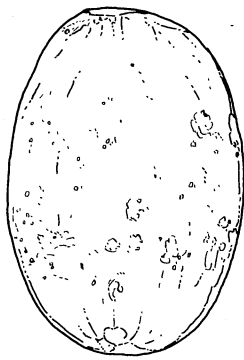
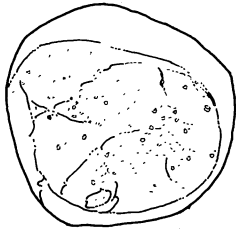

6367

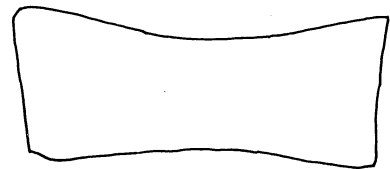
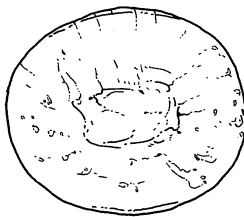

6369

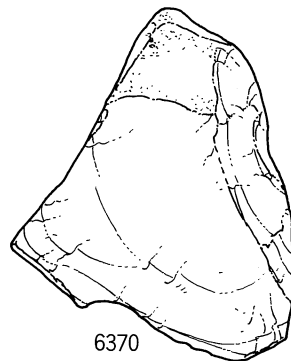
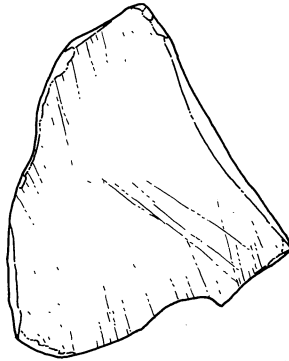

6370



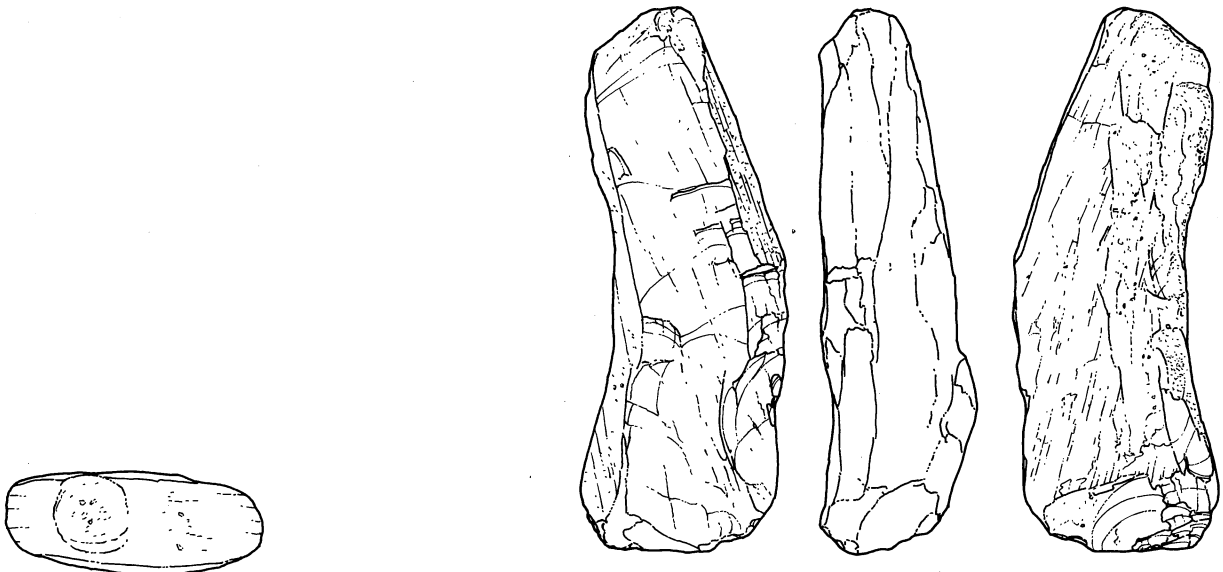

6371

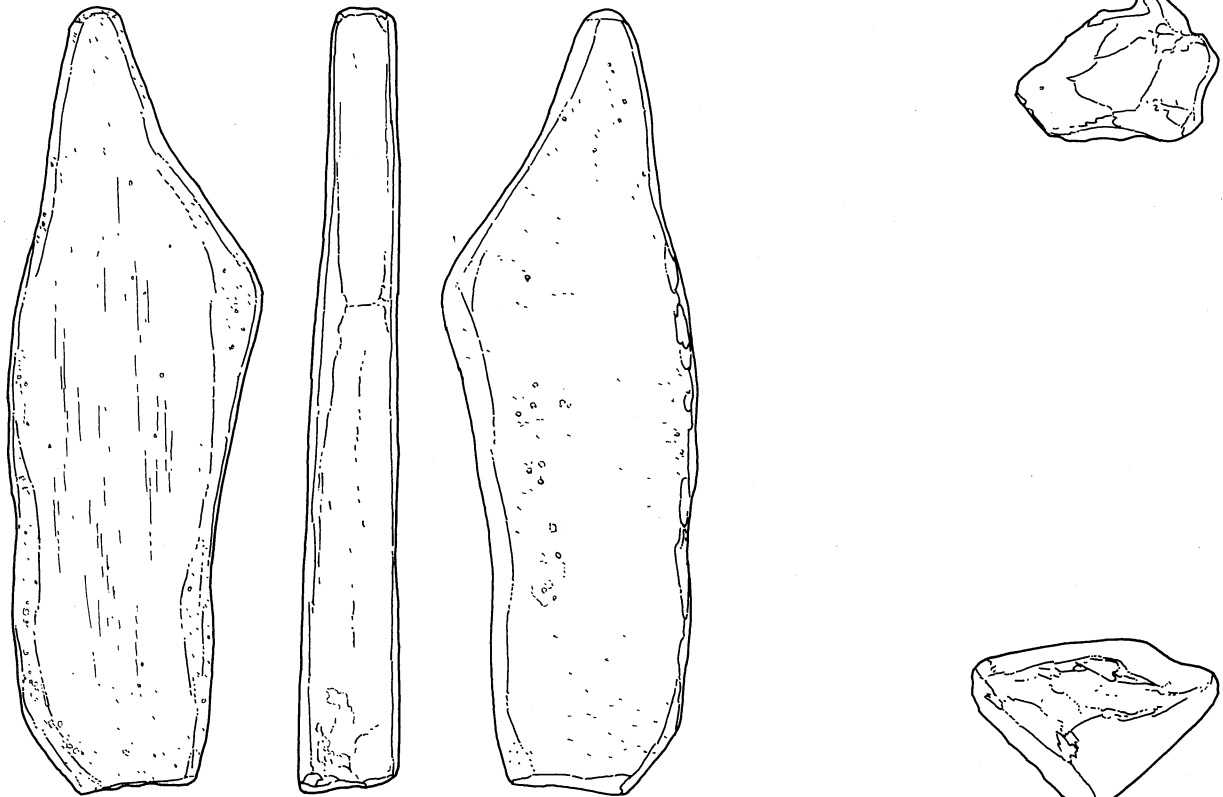

6372

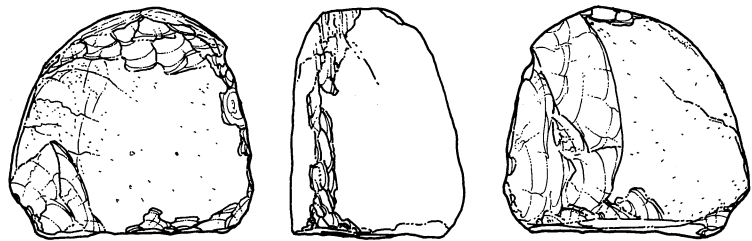

6373

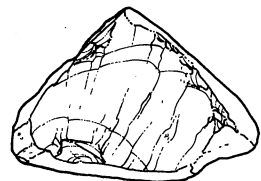

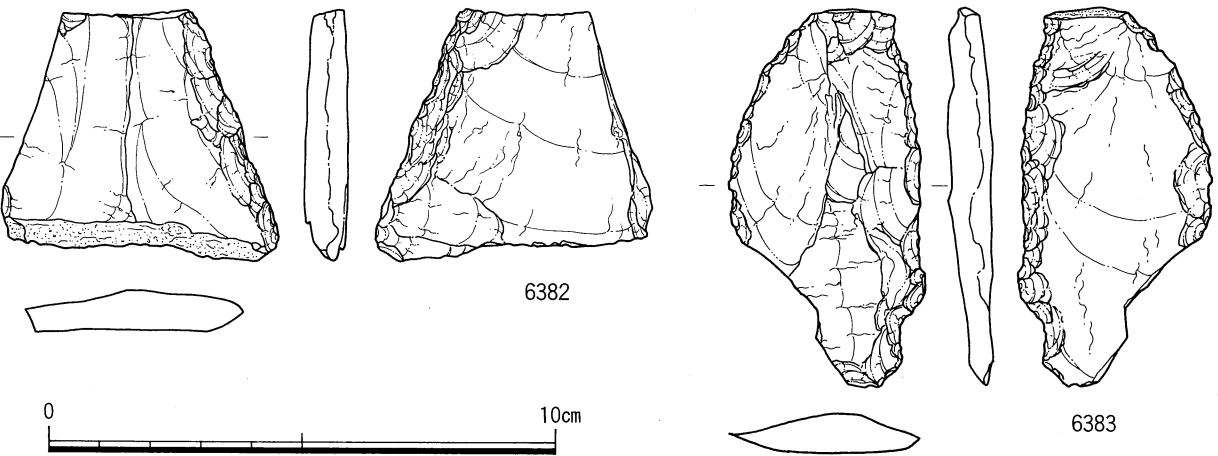
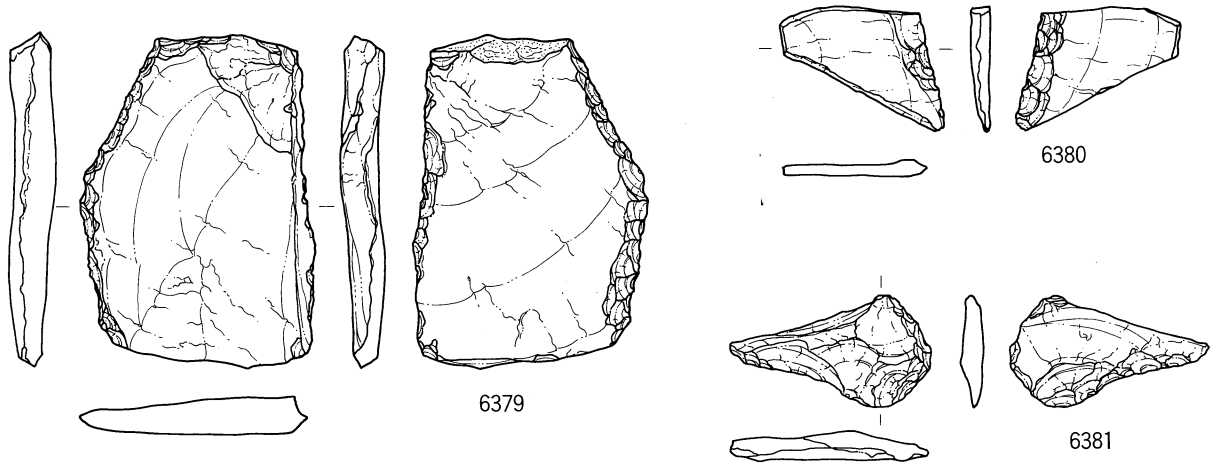
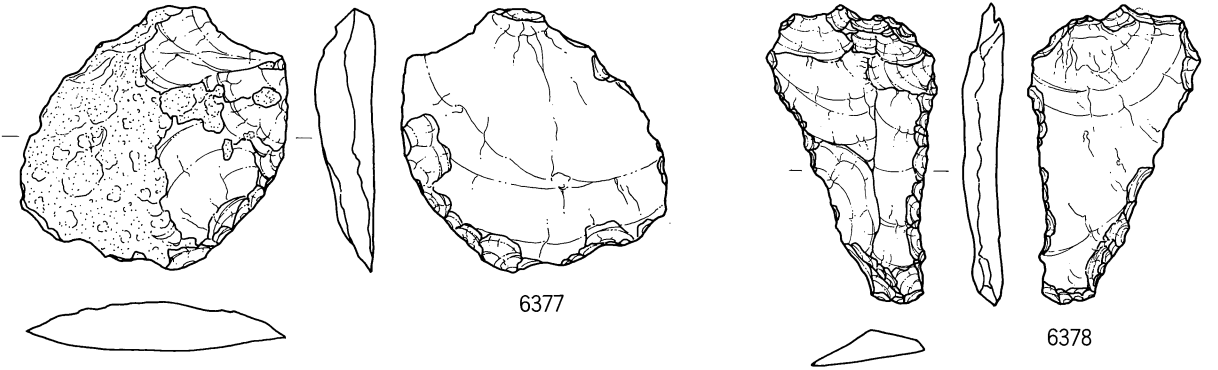
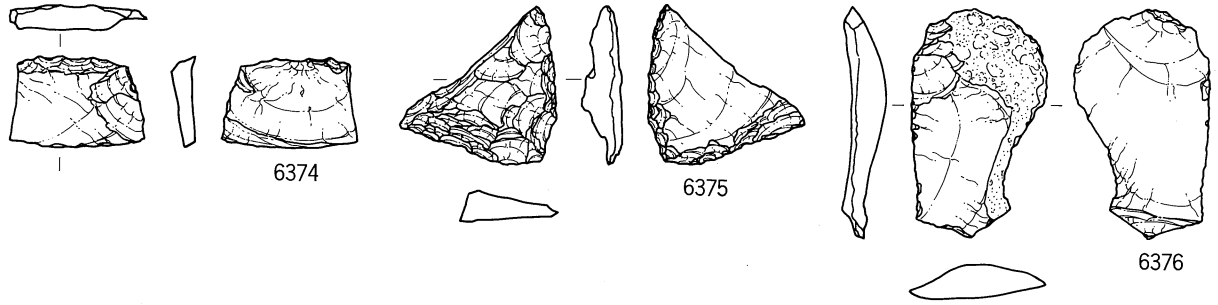

竖穴住居 SH46011 (6374) SH46012 (6374) SH46019 (6377)
 SH46023 (6375 · 6379) SH46024 (6376 · 6378 · 6381 · 6382)
 SH46025 (6380 · 6381) SH46039 (6383)

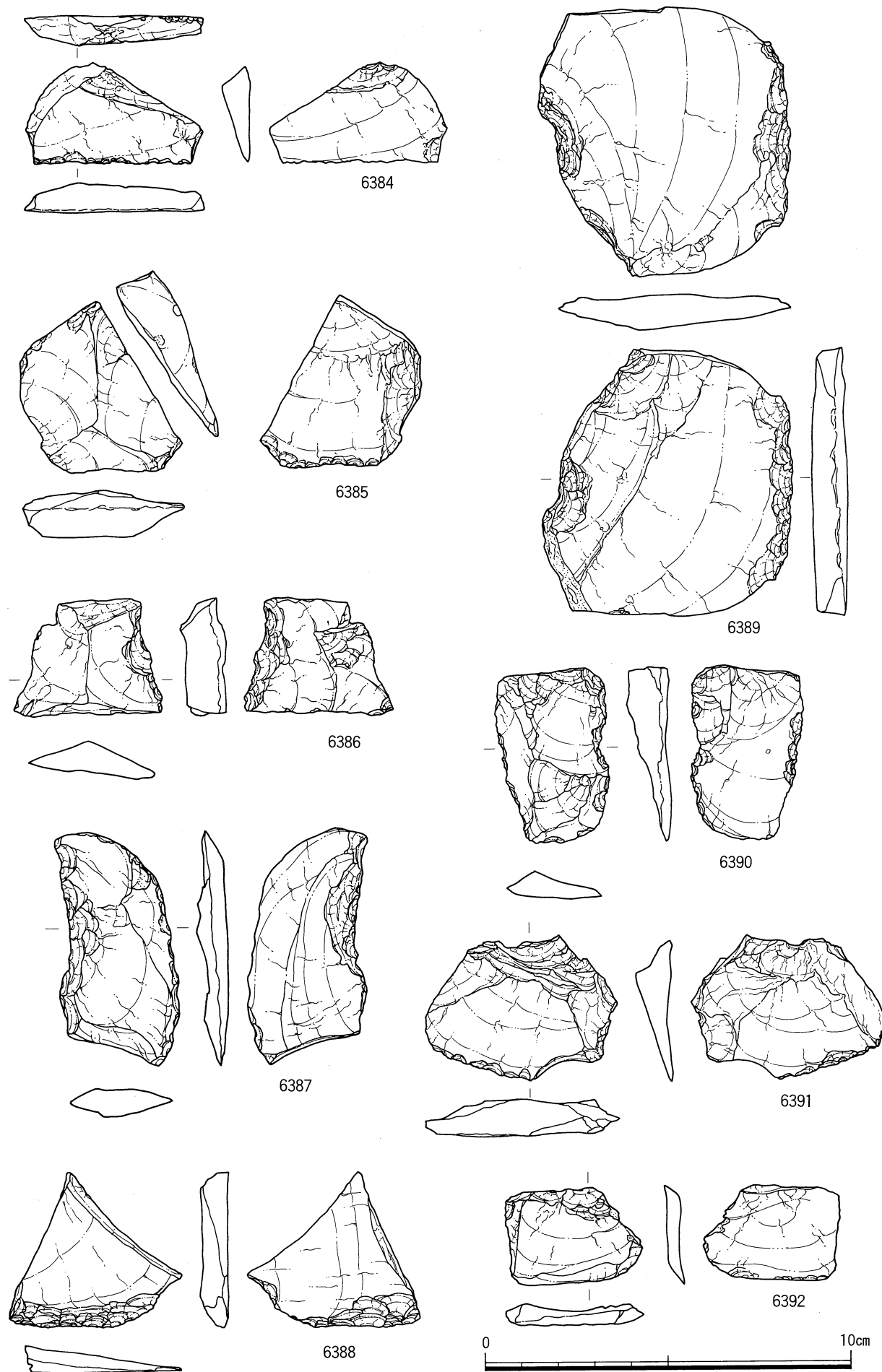

土坑 SK46089 (6385) SK46105 (6384) SK46111 (6389)
 柱穴 P46015 (6386) P46025 (6390) P46035 (6387)
 包含层 (6388 · 6391 · 6392)

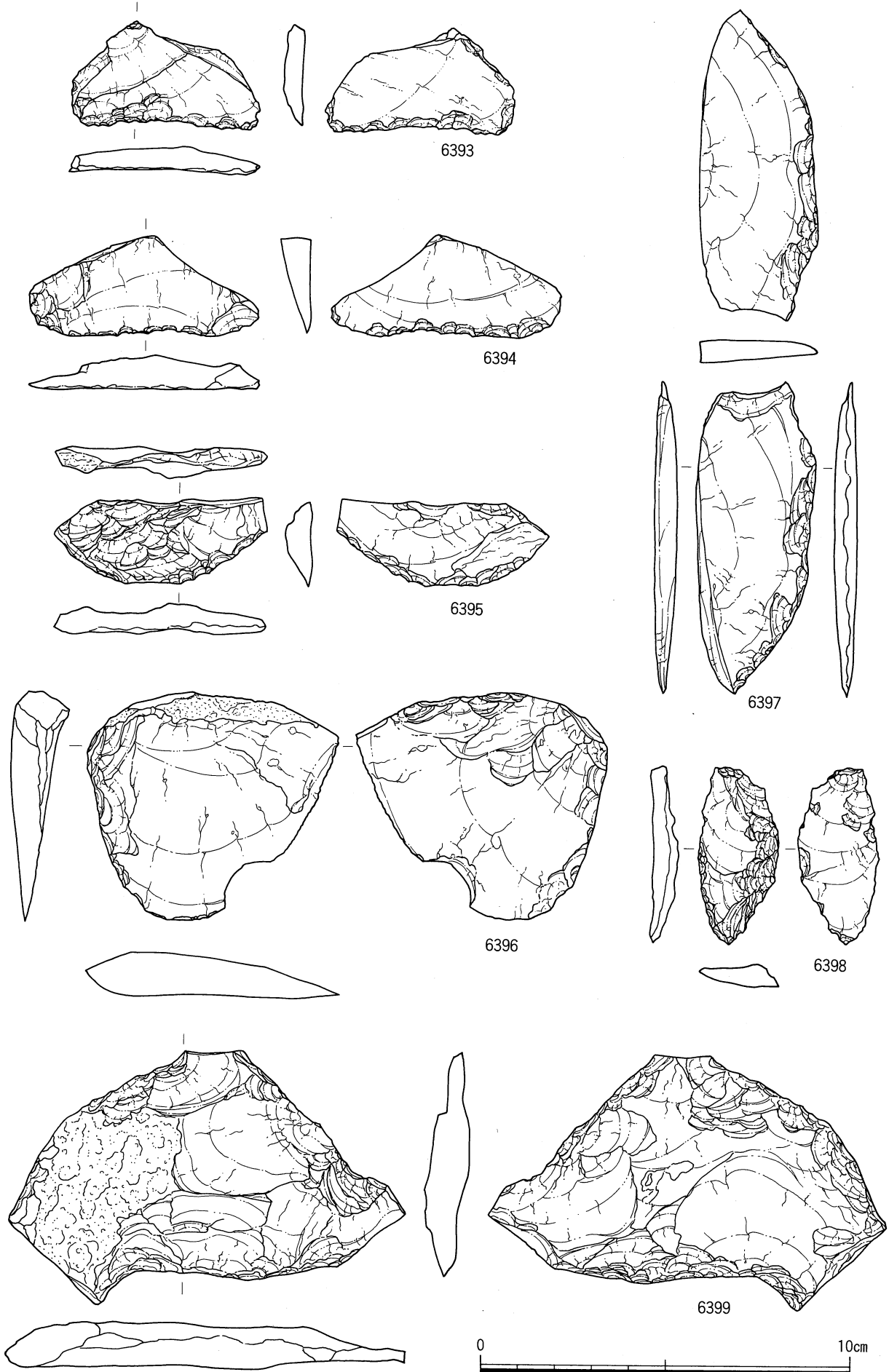

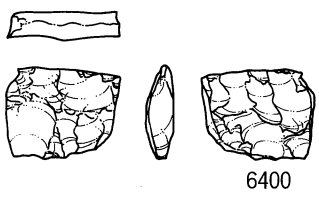

6400

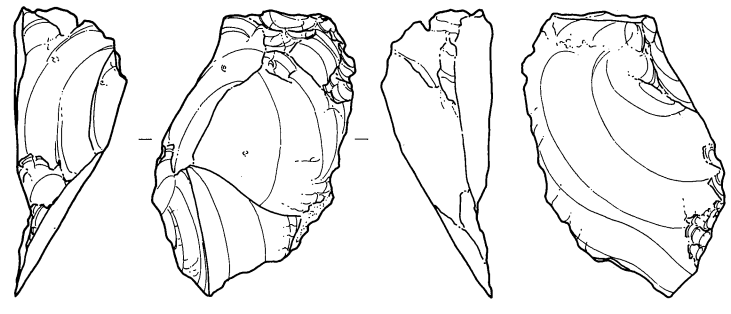

6401

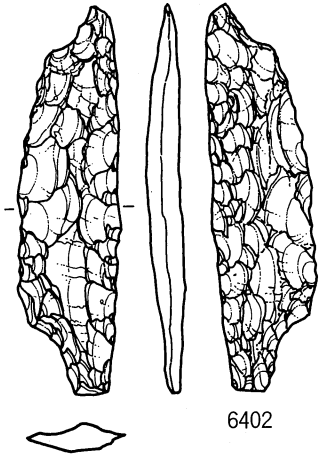

6402

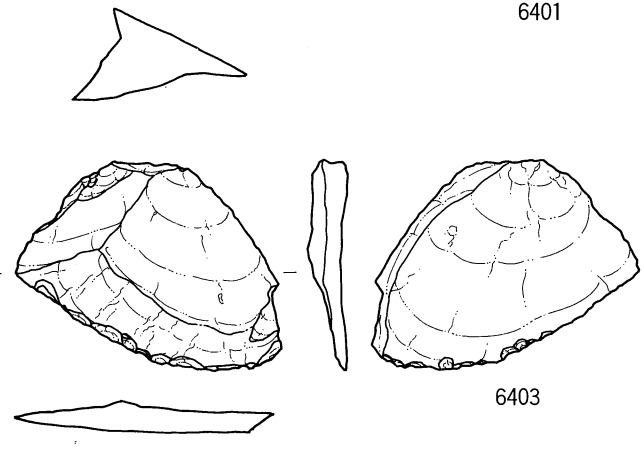

6403

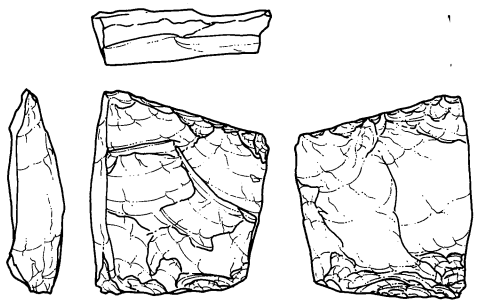

6404

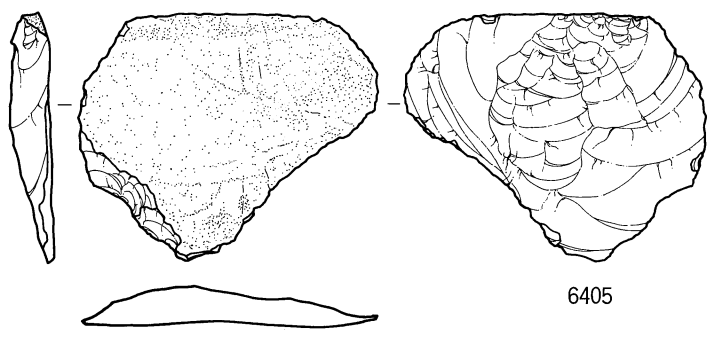

6405

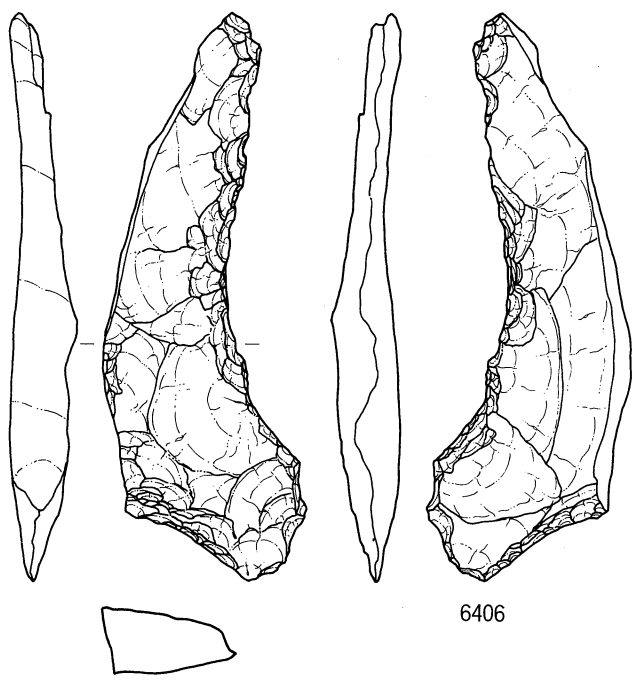

6406

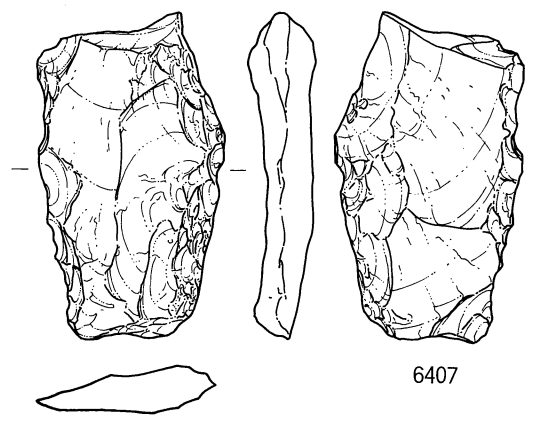

6407



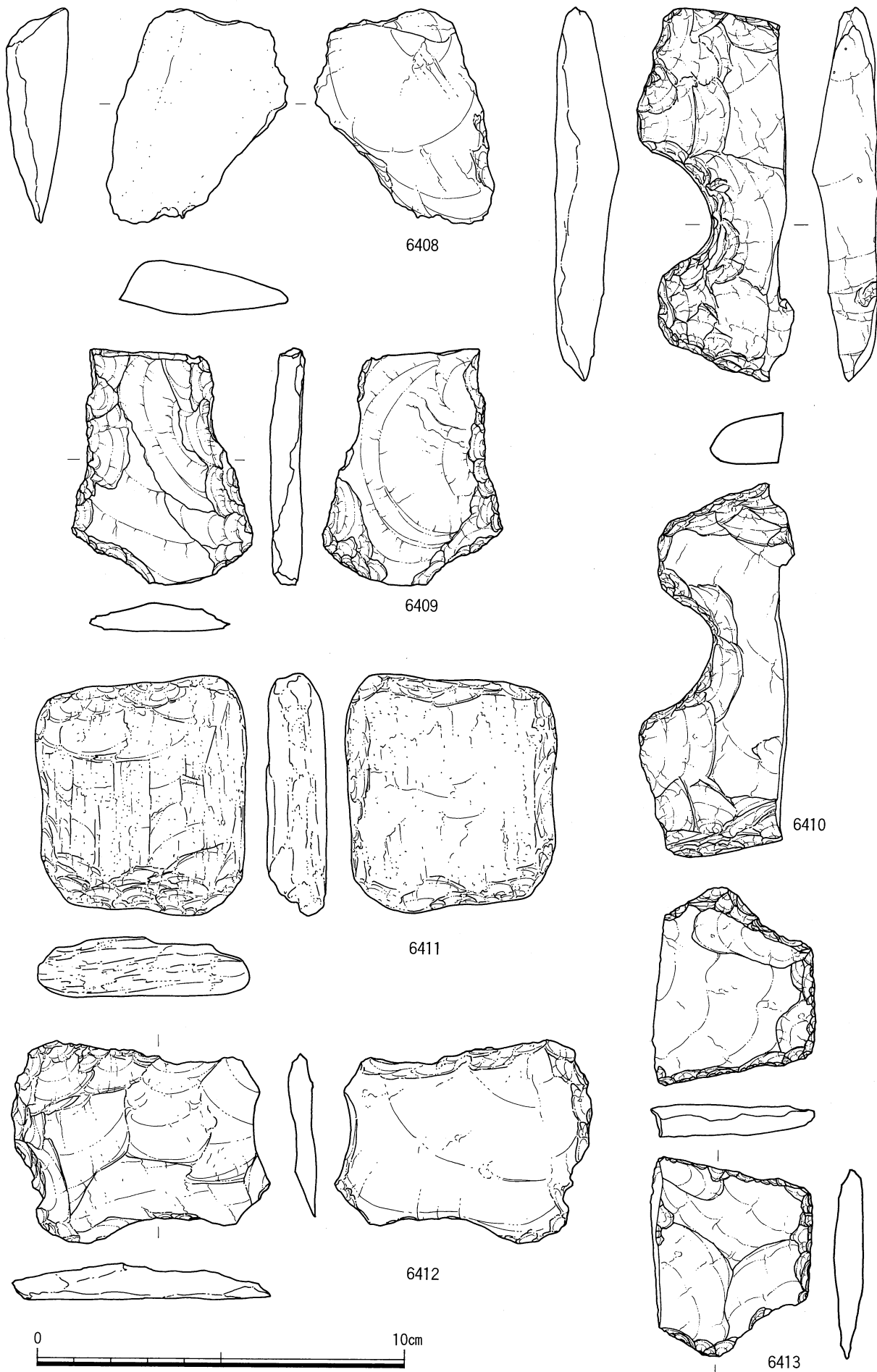

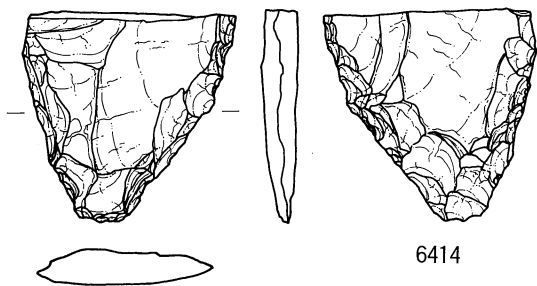

6414

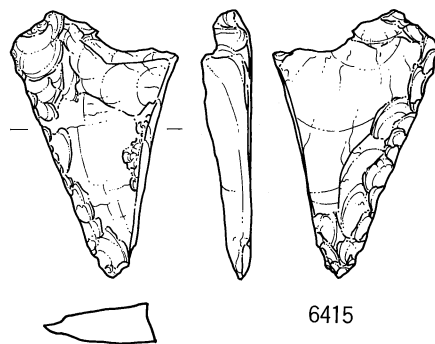

6415

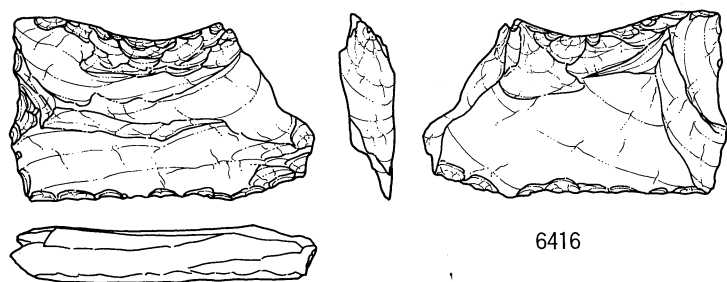

6416



6417

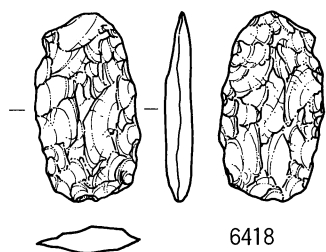

6418

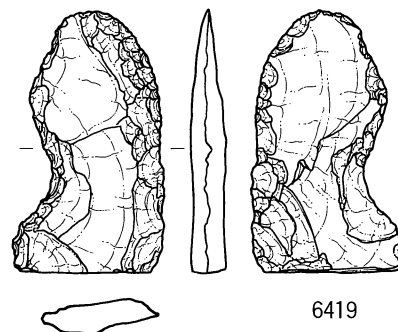

6419

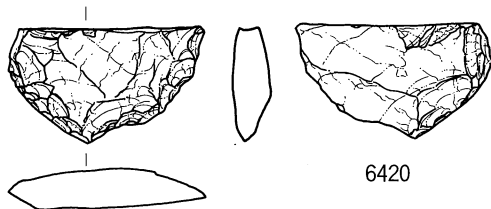

6420

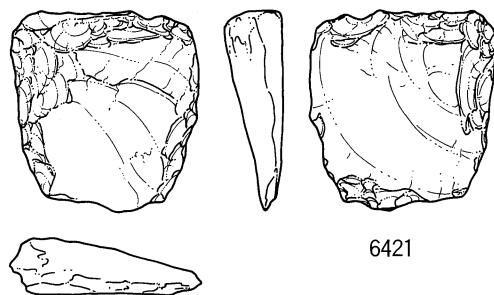

6421



竖穴住居 SH46025 (6414 · 6417) SH46034 (6416) SH46036 (6415)
 土坑 SK46067 (6418) SK46072 (6419)
 柱穴 P46017 (6420)
 包含层 (6421)

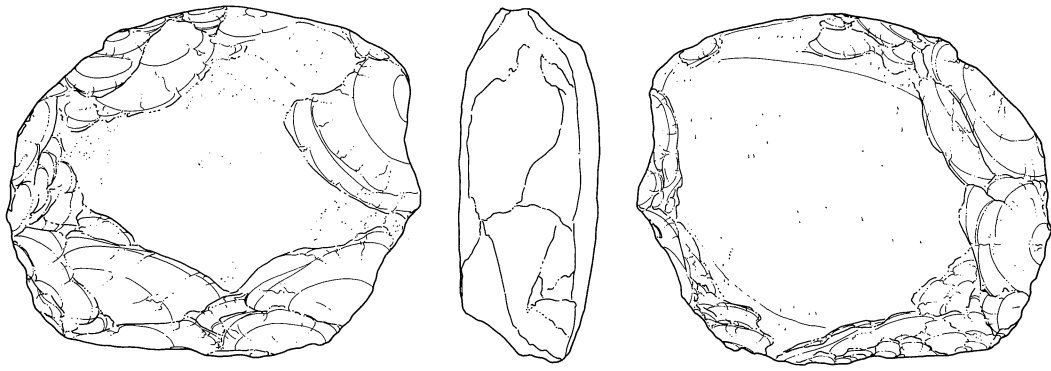

6422

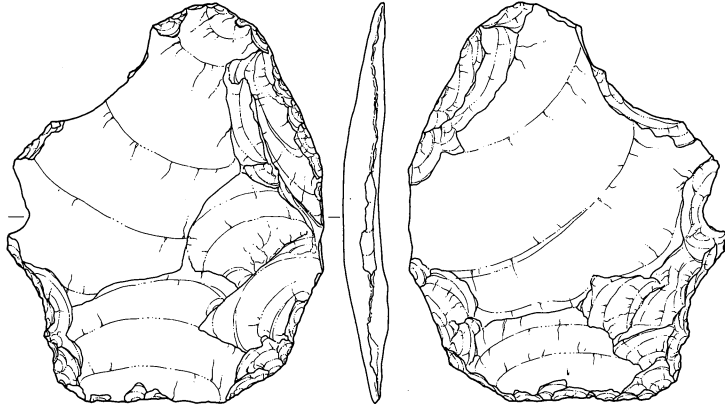
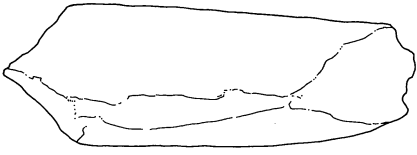

6423

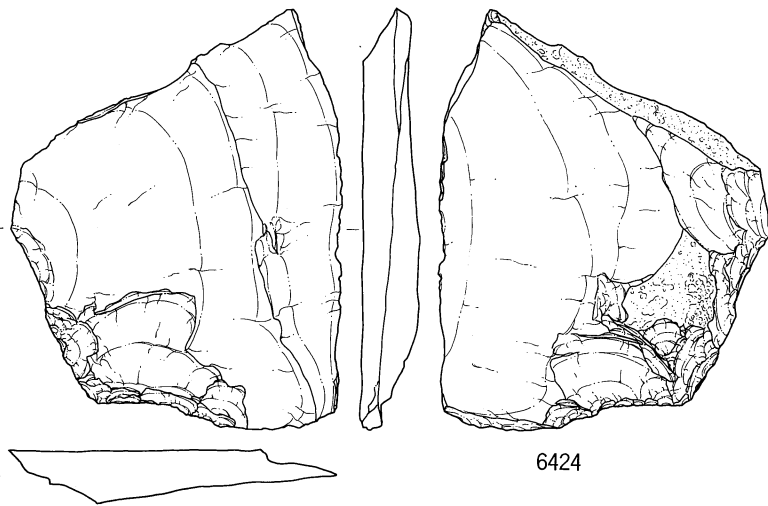

6424



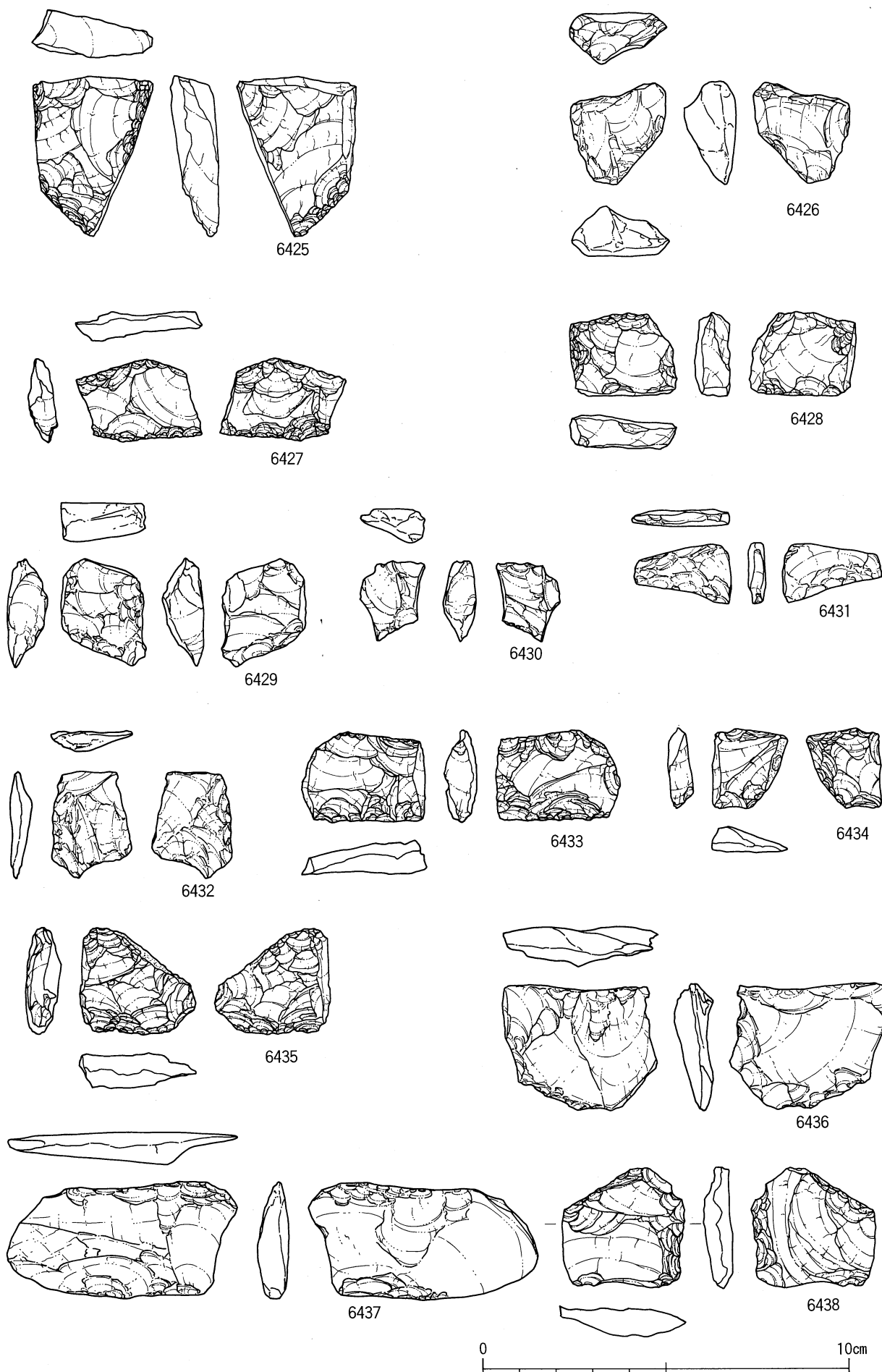

竖穴住居 SH46008 (6425 · 6426) SH46010 (6427) SH46011 (6428 · 6429)
 SH46012 (6430~6433) SH46025 (6434 · 6436~6438)
 SH46042 (6435)

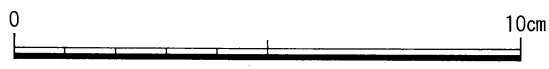
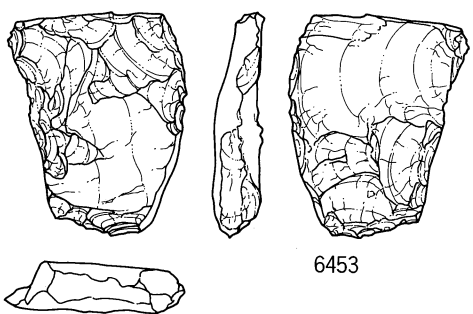
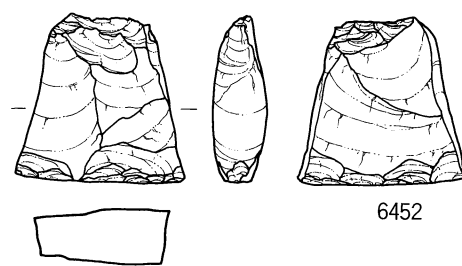
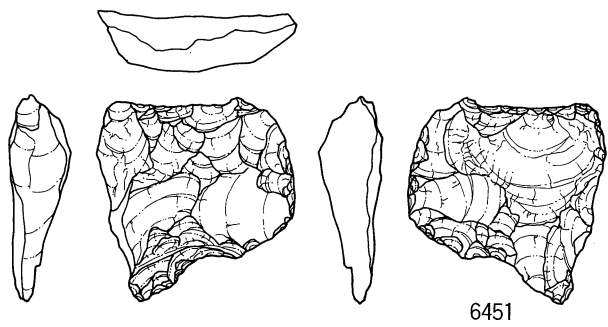
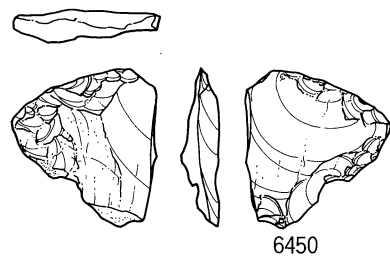
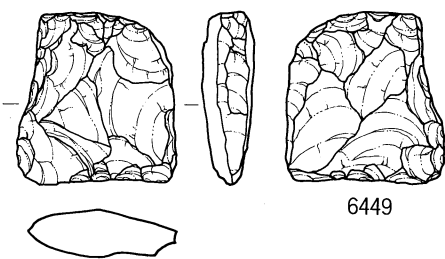
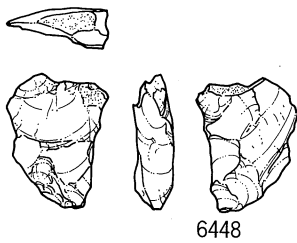
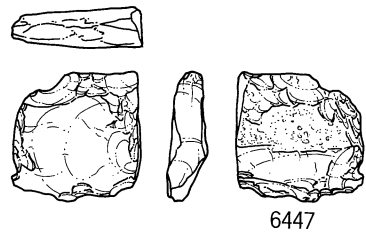
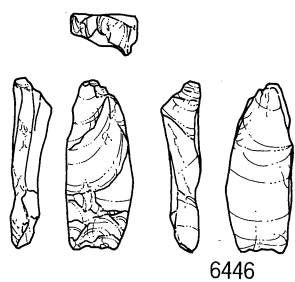
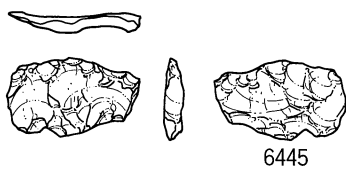
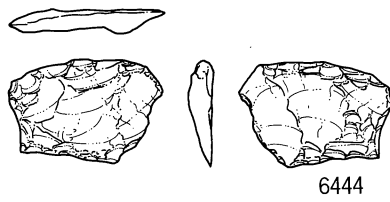
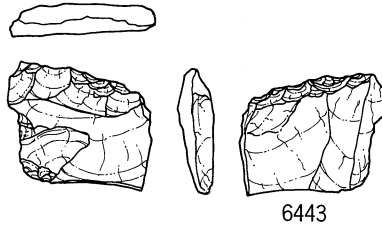
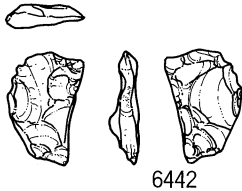
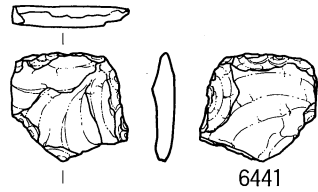
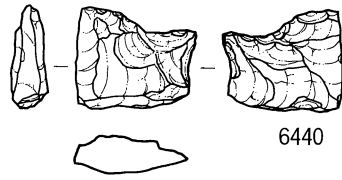

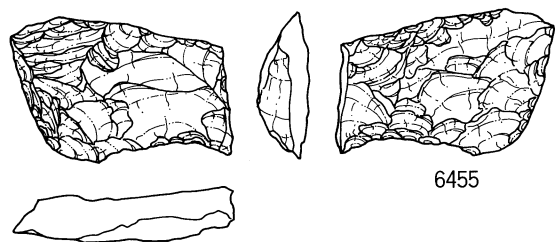

6455

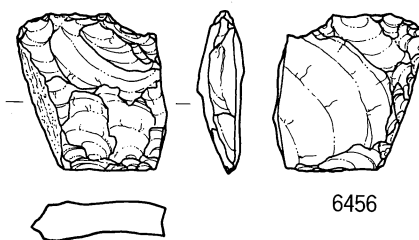

6456

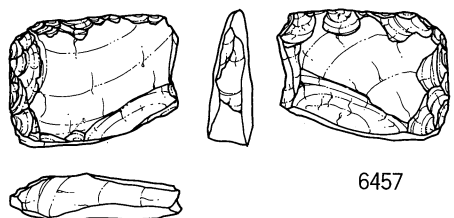

6457

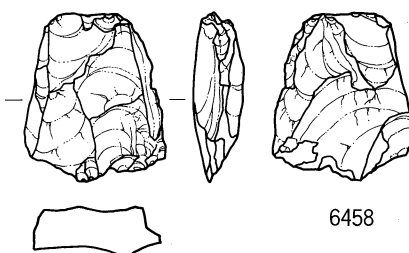

6458

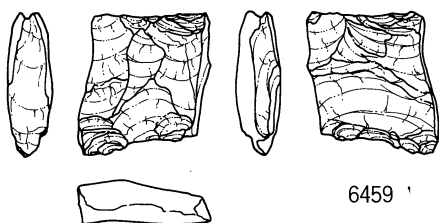

6459

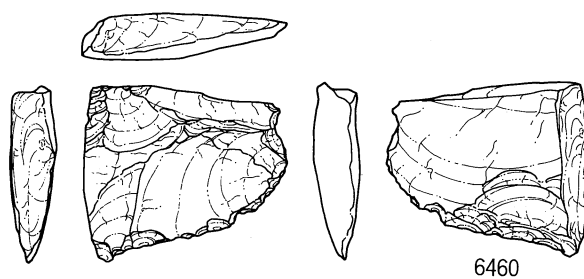

6460

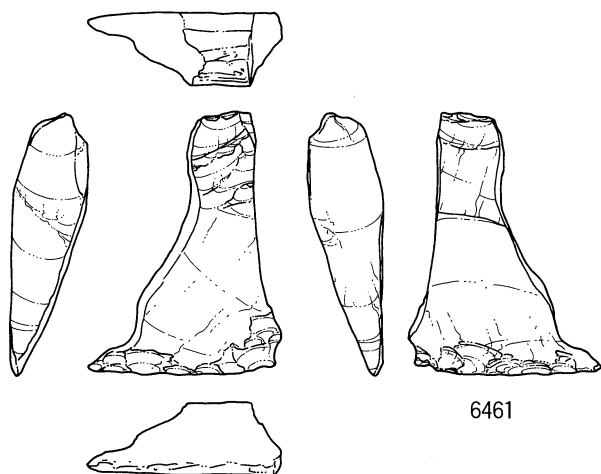

6461

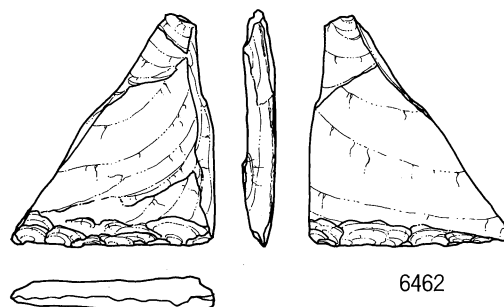

6462

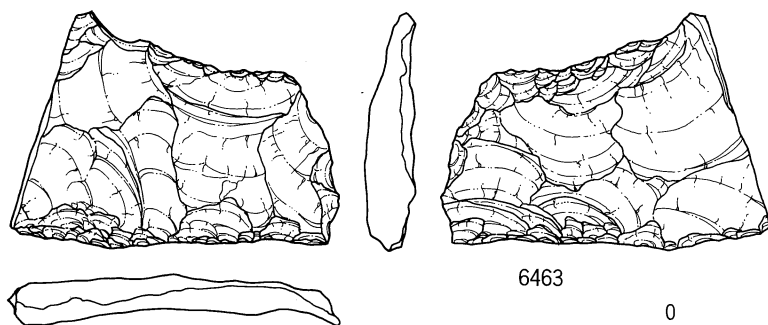

6463

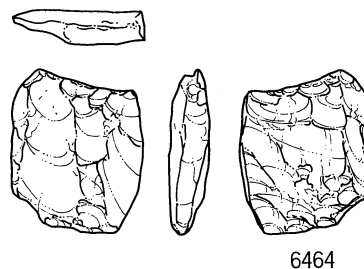

6464



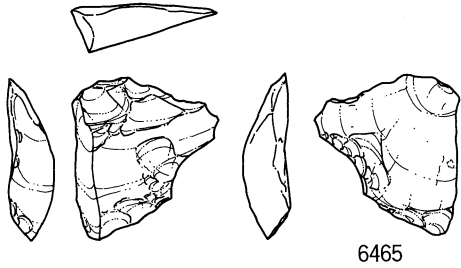

6465

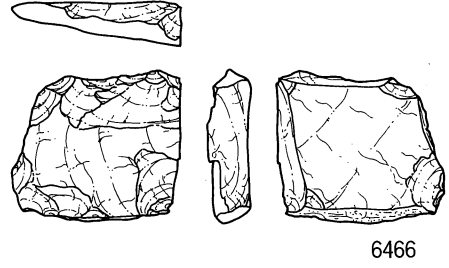

6466

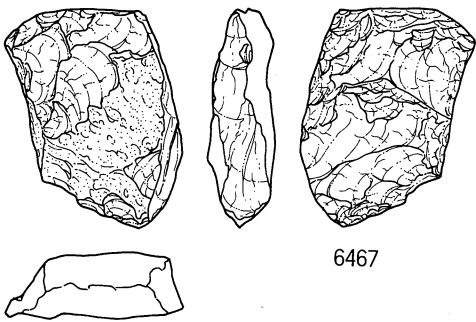

6467

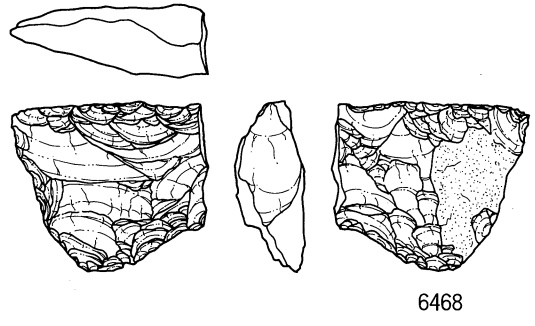

6468

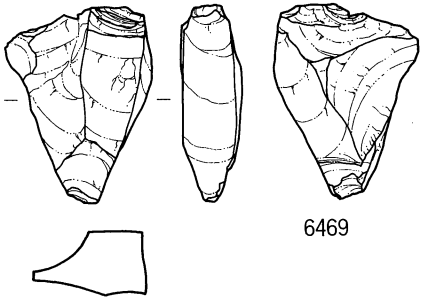

6469

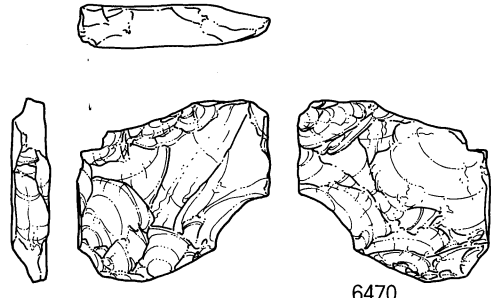

6470

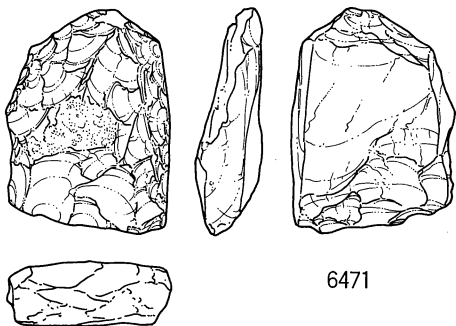

6471

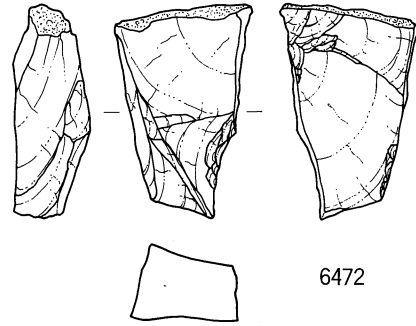

6472





6473

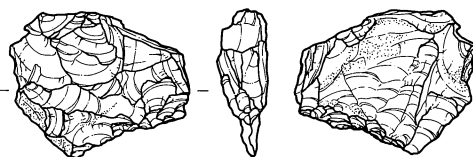

6474

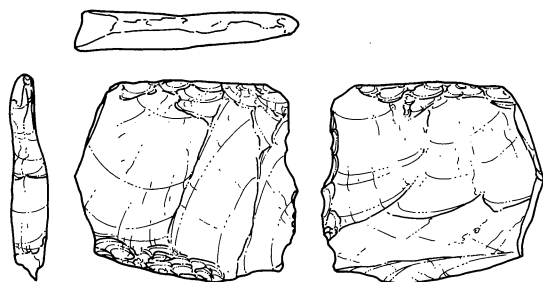

6475

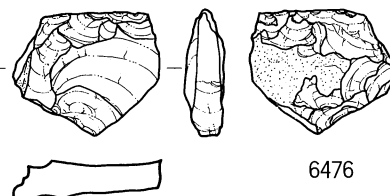

6476

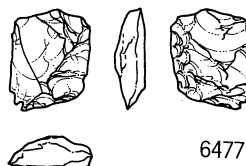

6477

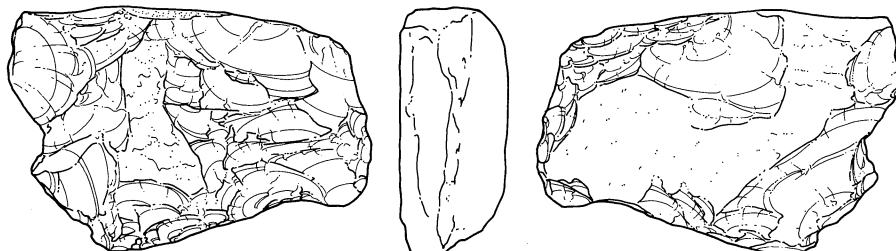
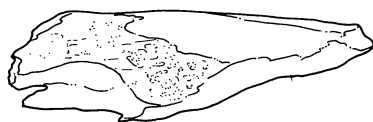

6478

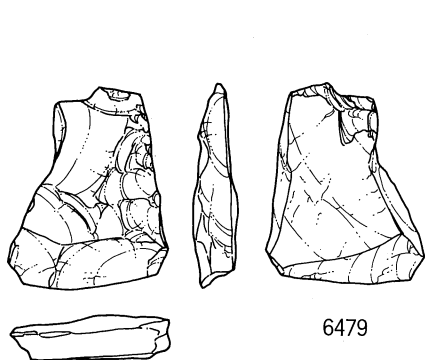

6479

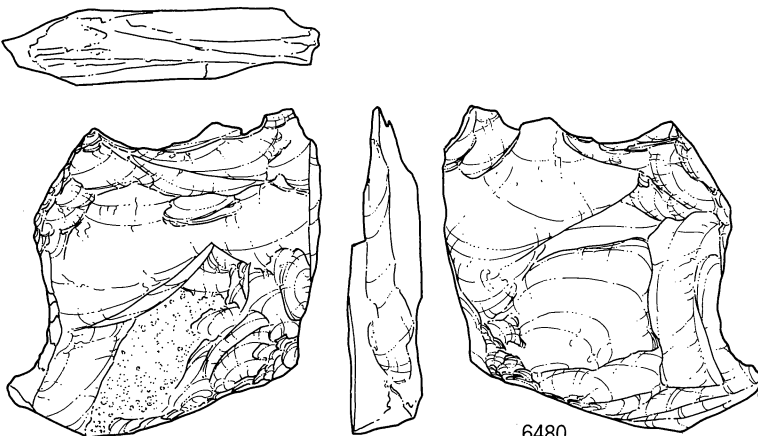

6480



竖穴住居 SH46023 (6473) SH46024 (6474 · 6475) SH46025 (6478)
SH46034 (6476 · 6477)
包含層 (6479 · 6480)

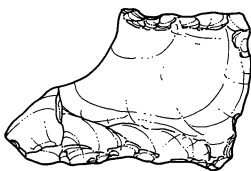

6481



6482

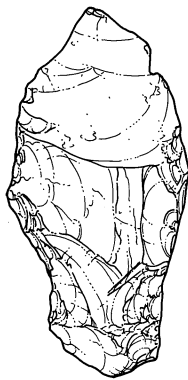
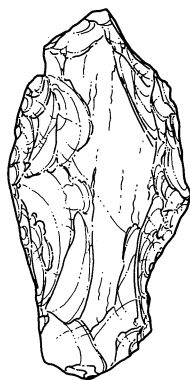
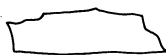

6483

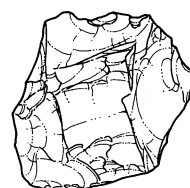

6484

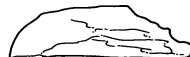

6485

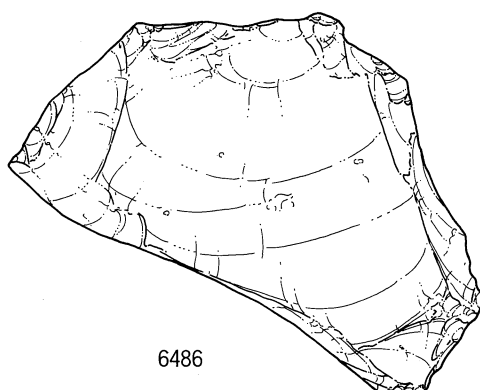
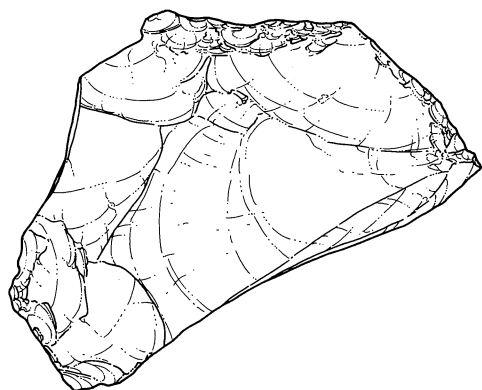

6486

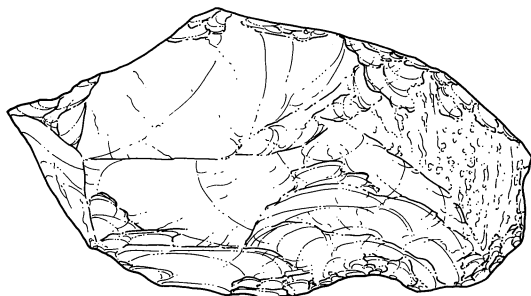

6487

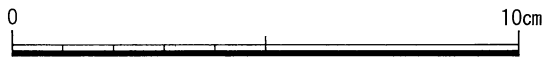

竖穴住居 SH46024 (6481)
土坑 SK46092 (6486)
包含层 (6482~6485·6487)

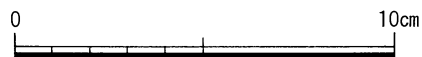
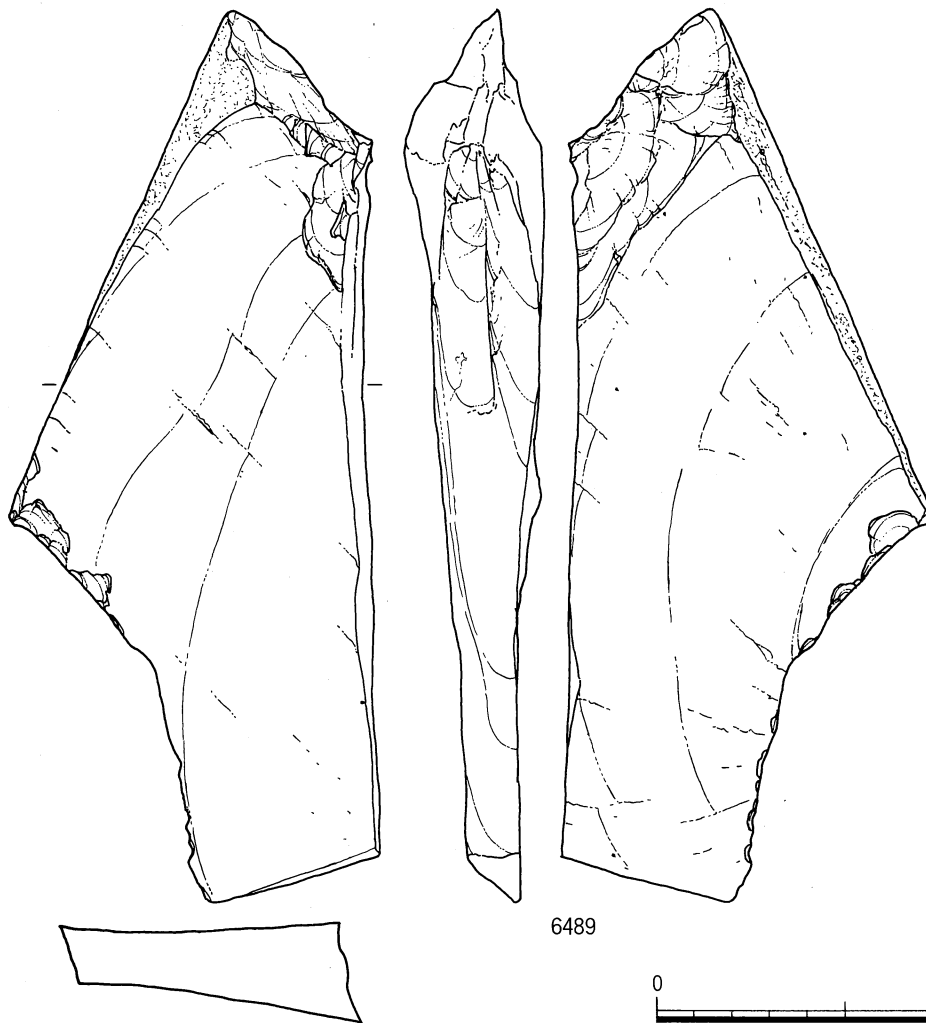
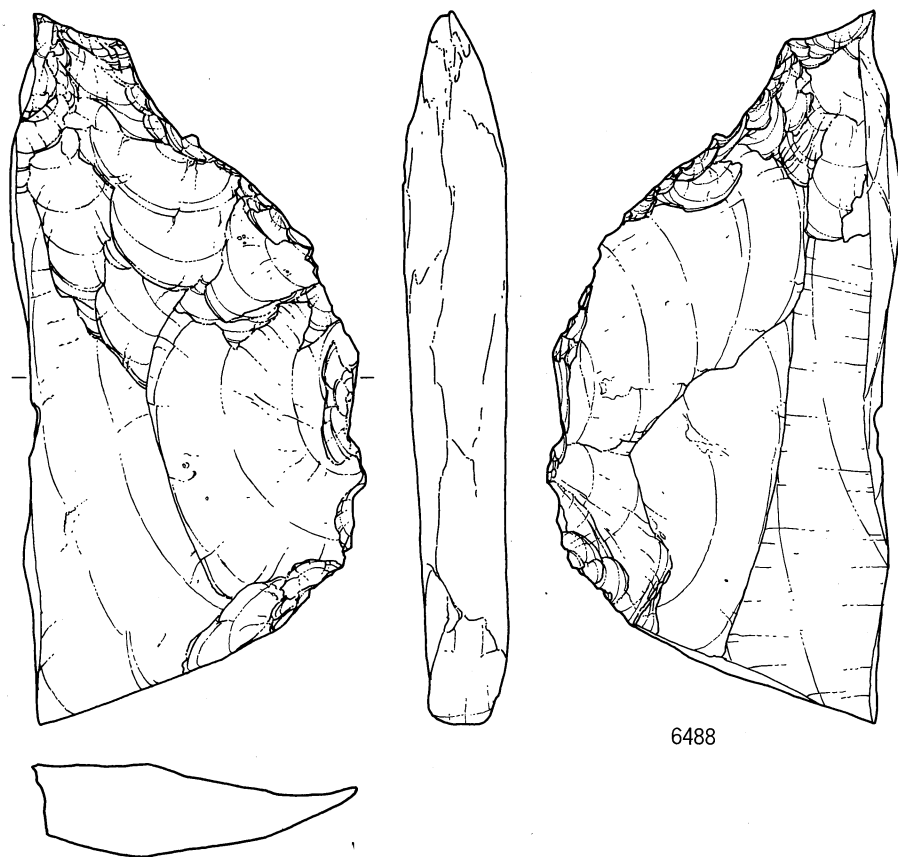

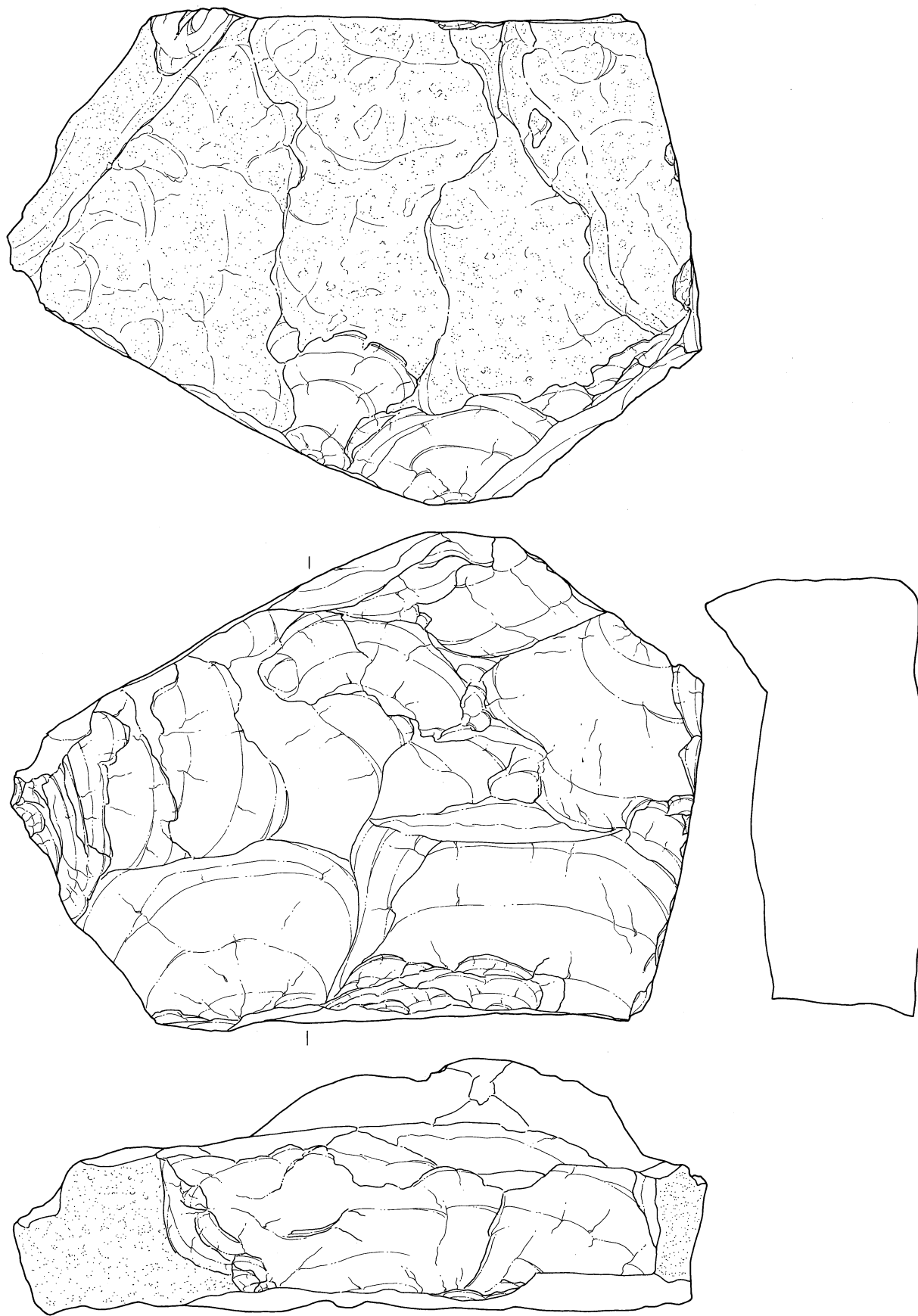

6490

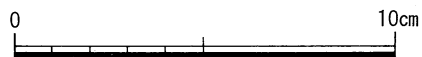

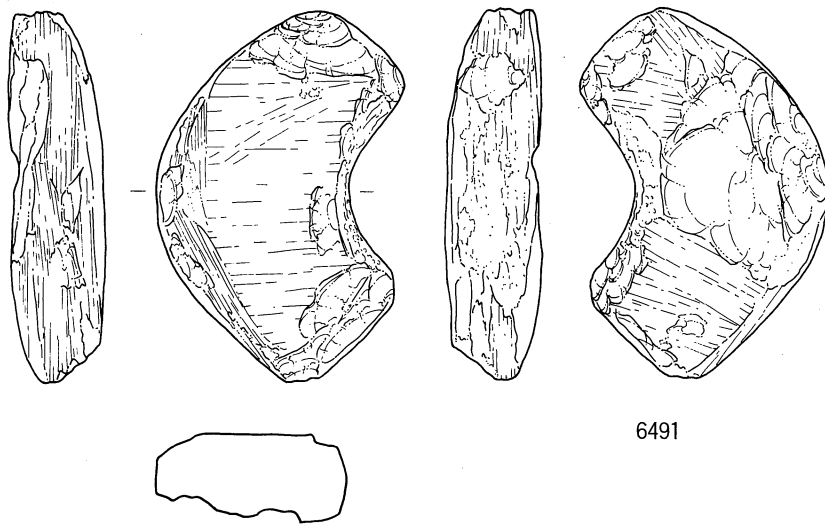

6491

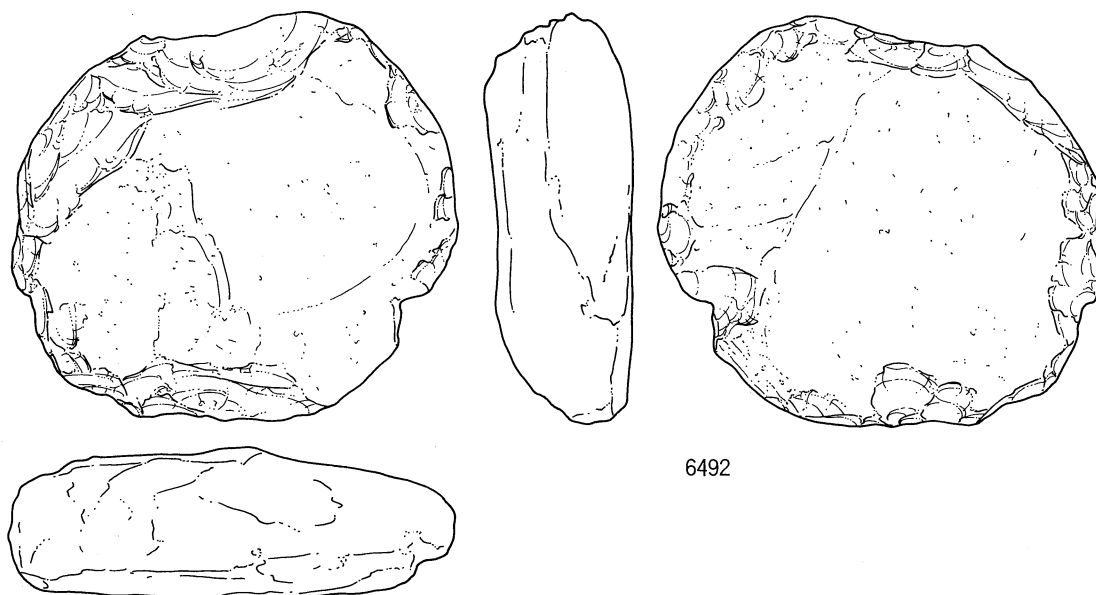

6492



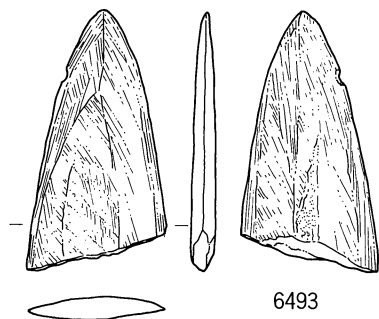

6493

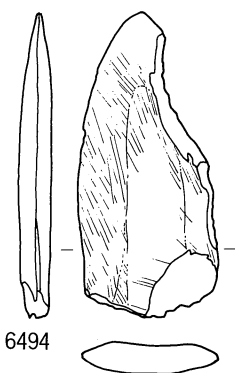

6494

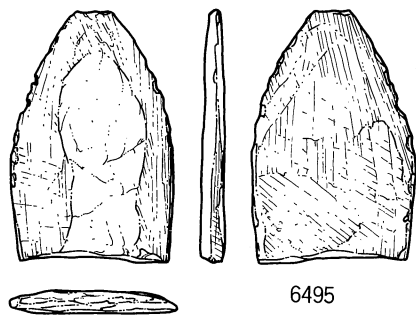

6495

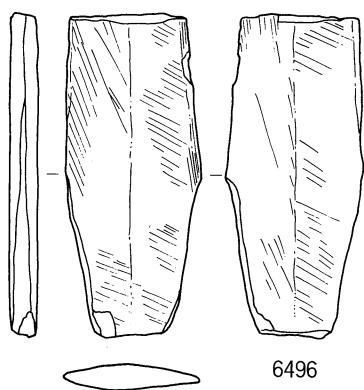

6496

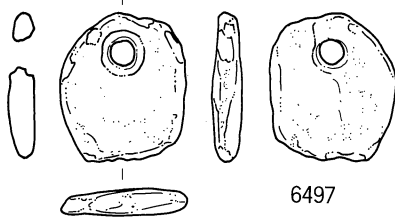

6497

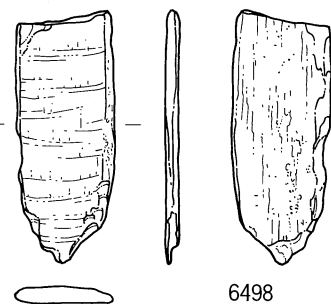

6498

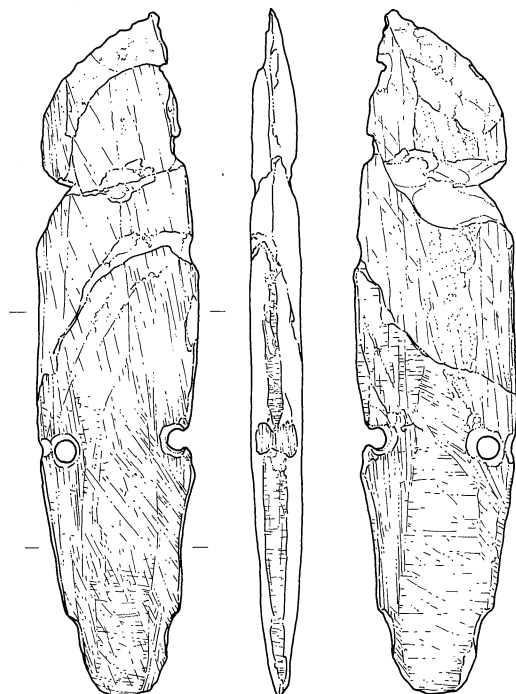

6499

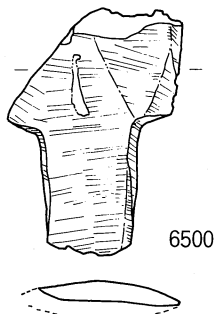

6500



竖穴住居 SH46009 (6497) SH46024 (6496)
 土坑 SK46031 (6500) SK46049 (6493)
 包含层 (6494 · 6495 · 6498 · 6499)

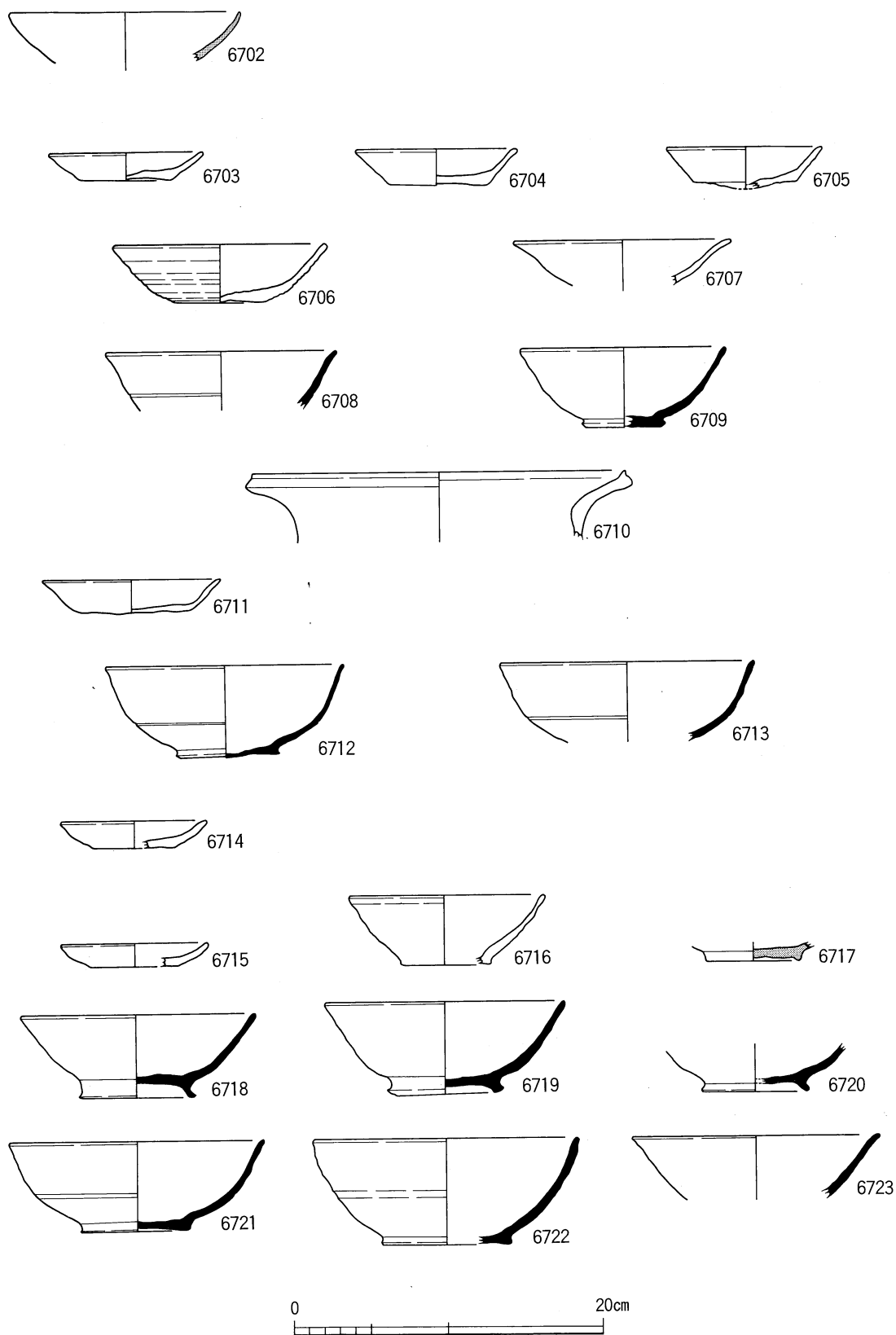

掘立柱建物 SB86001 (6702) SB86002 (6703~6710)
土坑 SK86001 (6711) SK86002 (6712・6713)
柱穴 P86001 (6714)
包含層 (6715~6723)

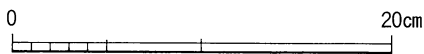
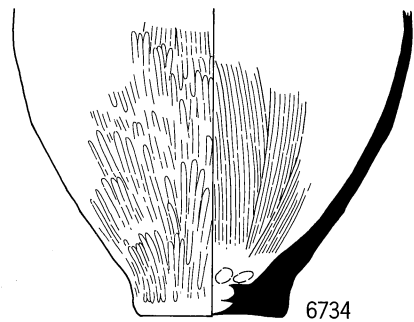
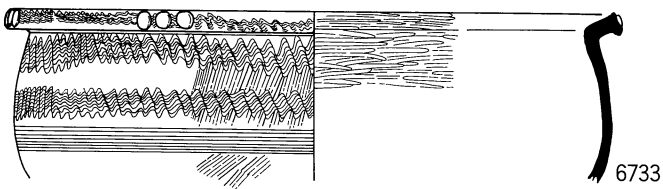
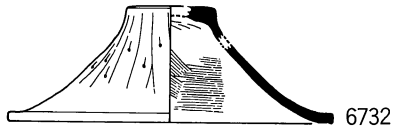
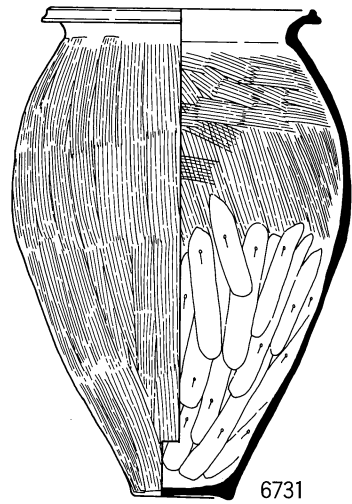
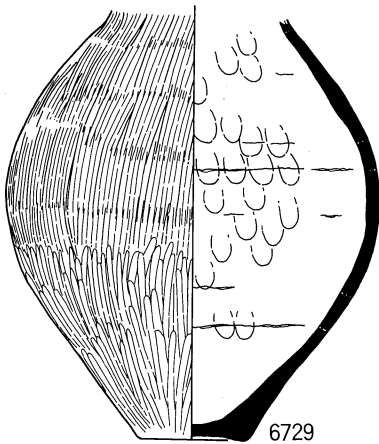
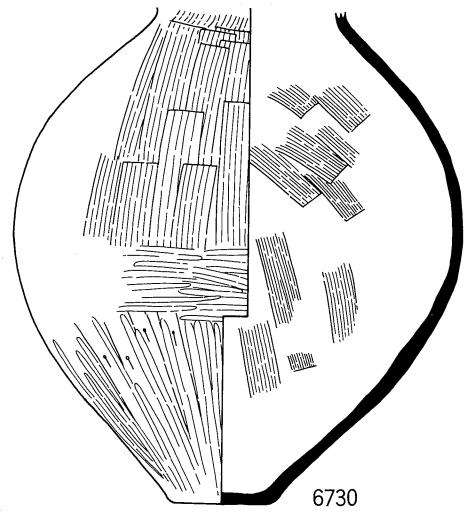
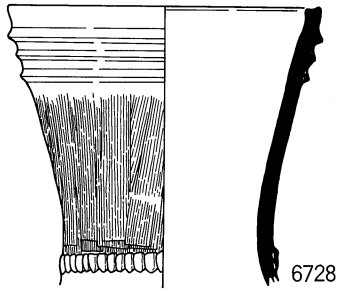
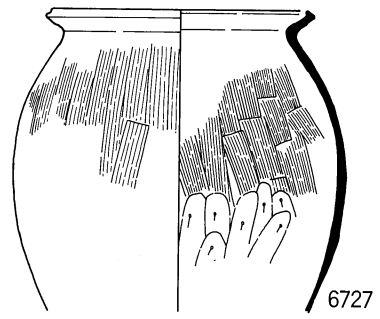
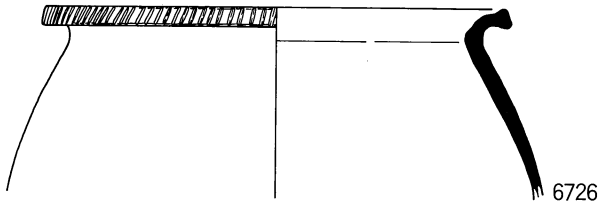

竖穴住居 SH46041 (6726 · 6727) SH46043 (6728~6731)
SH46044 (6732 · 6733) SH46045 (6734)

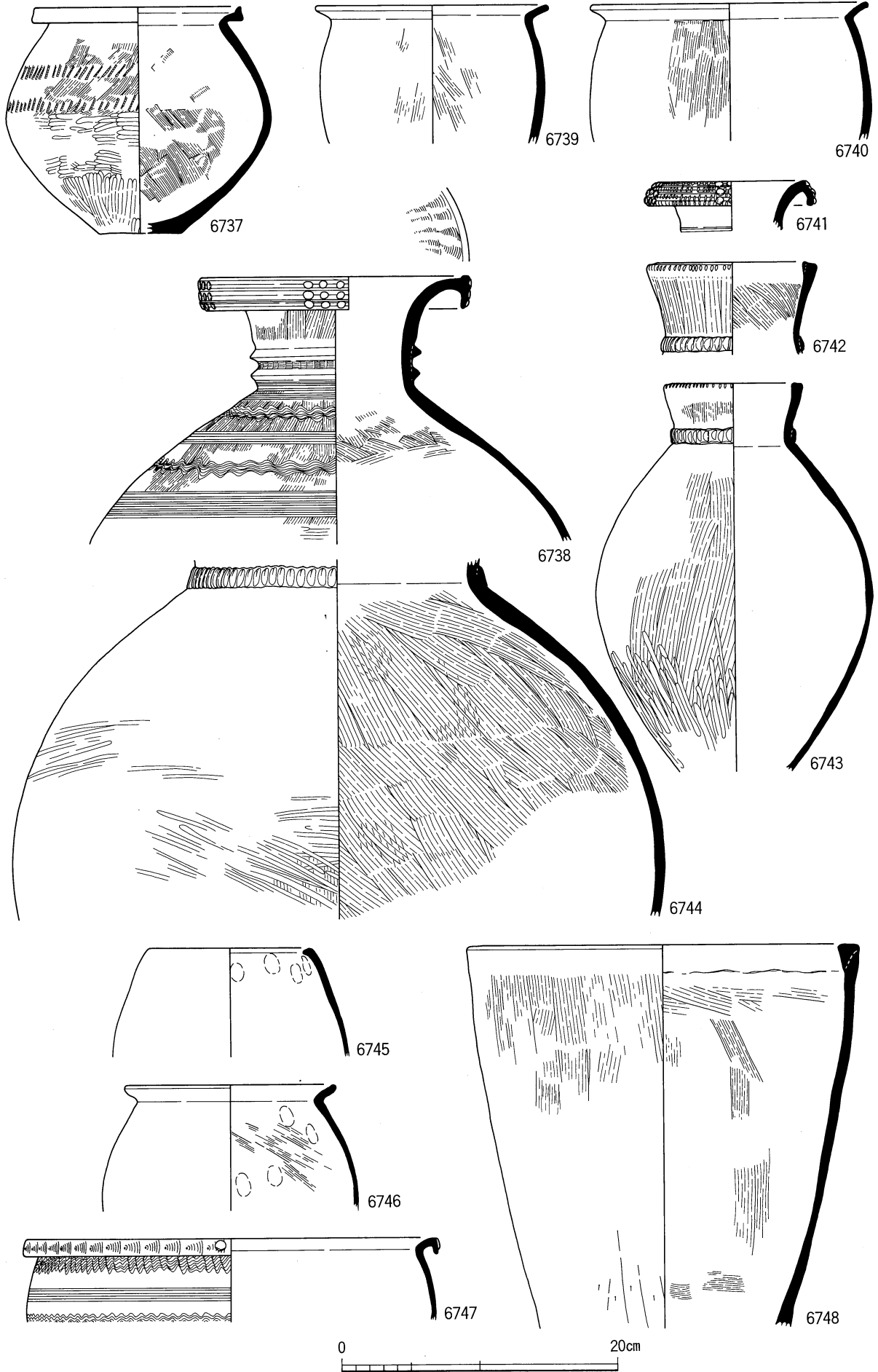

土坑 SK46135 (6737) SK46136 (6738~6740) SK46138 (6741~6748)

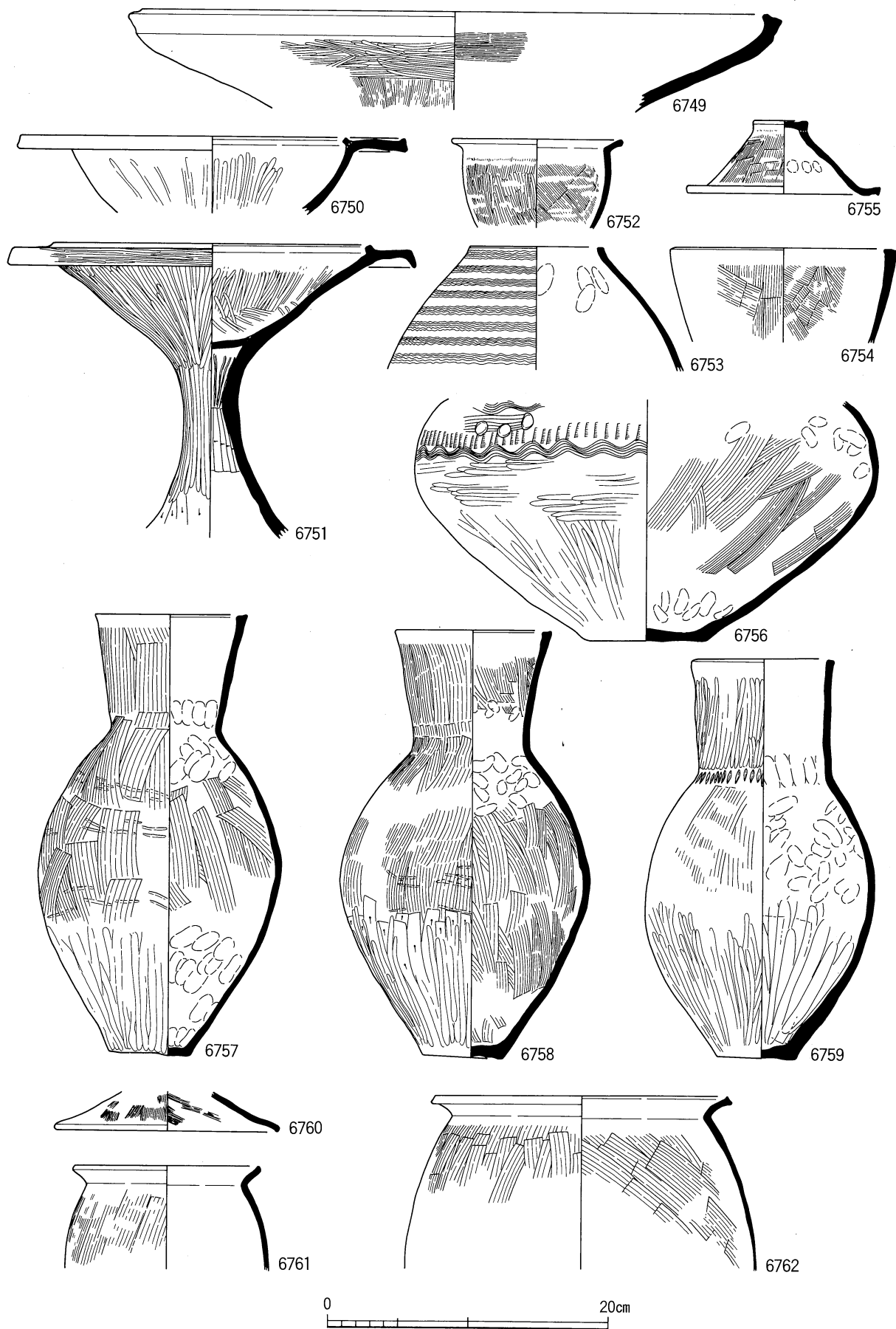

土坑 SK46138 (6749~6751) SK46139 (6752) SK46140 (6753·6754)
 SK46141 (6755) SK46143 (6756~6762)

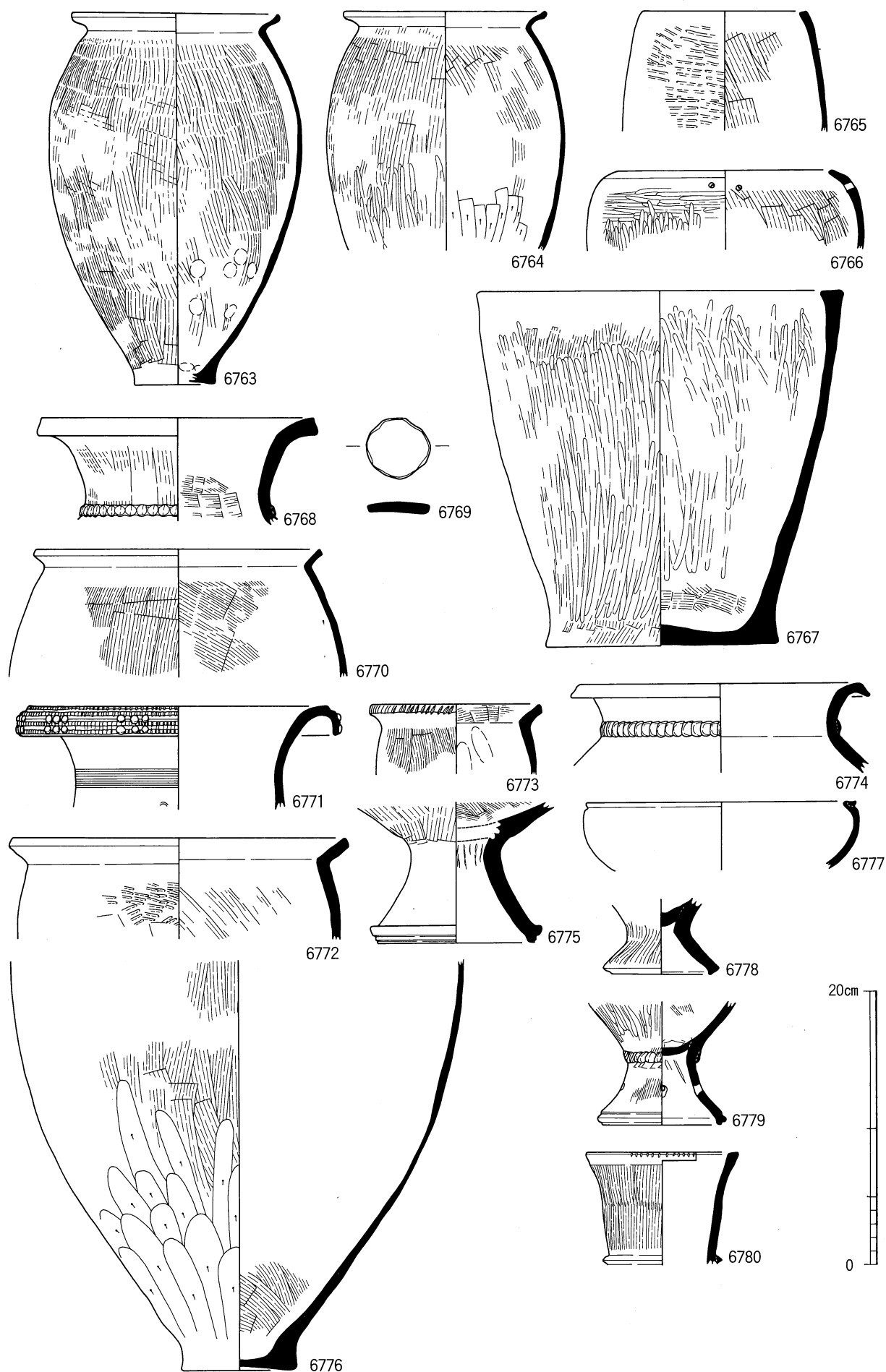

土坑 SK46143 (6763~6767) SK46145 (6768~6770) SK46146 (6771·6772)
 SK46147 (6773) SK46148 (6774) SK46149 (6775)
 SK46150 (6776~6779) SK46151 (6780)

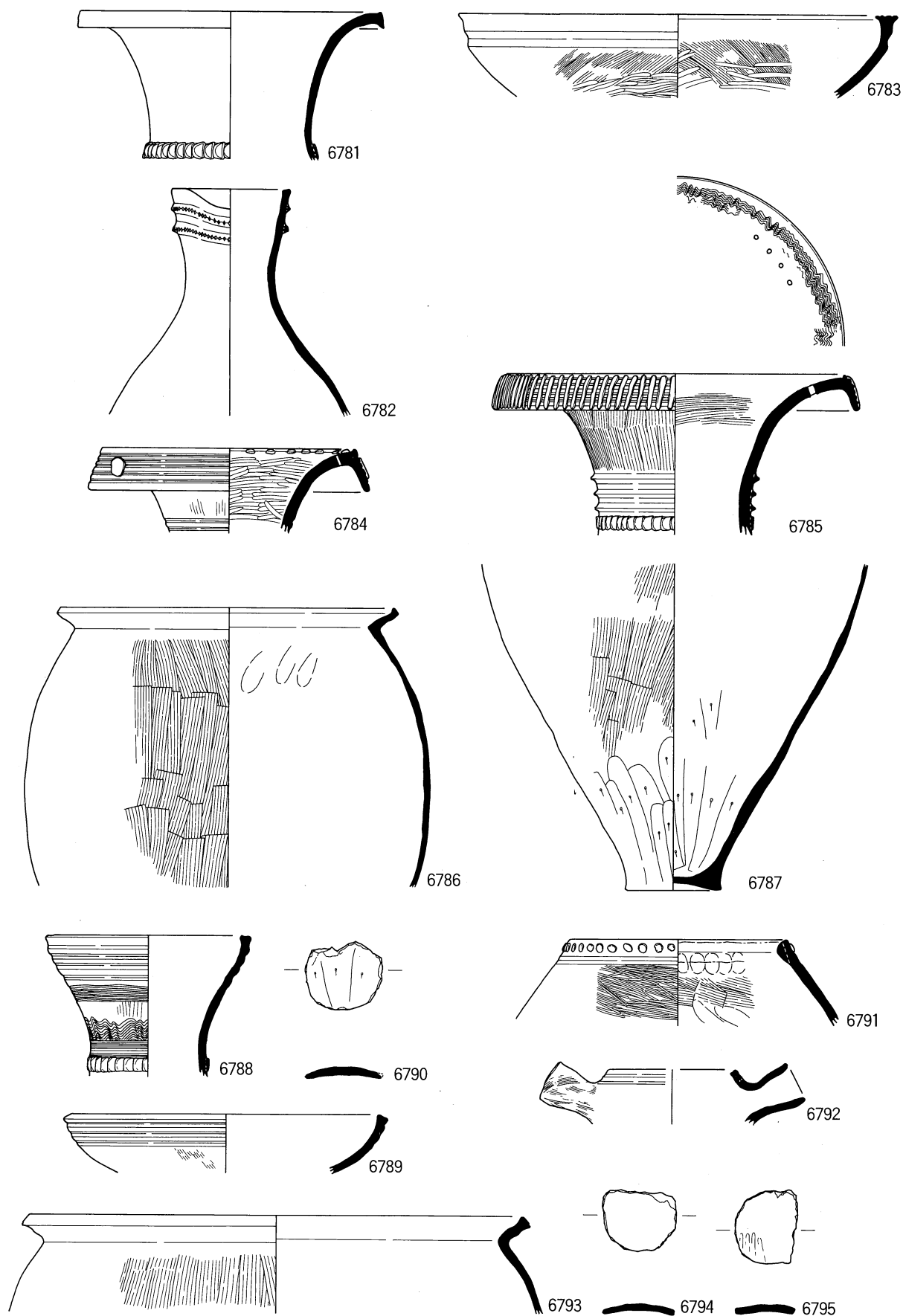

土坑 SK46152 (6781·6782) SK46153 (6783) SK46154 (6784·6785)
 SK46155 (6786·6787) SK46158 (6788~6790)
 SK46159 (6791·6792) SK46162 (6793~6795)

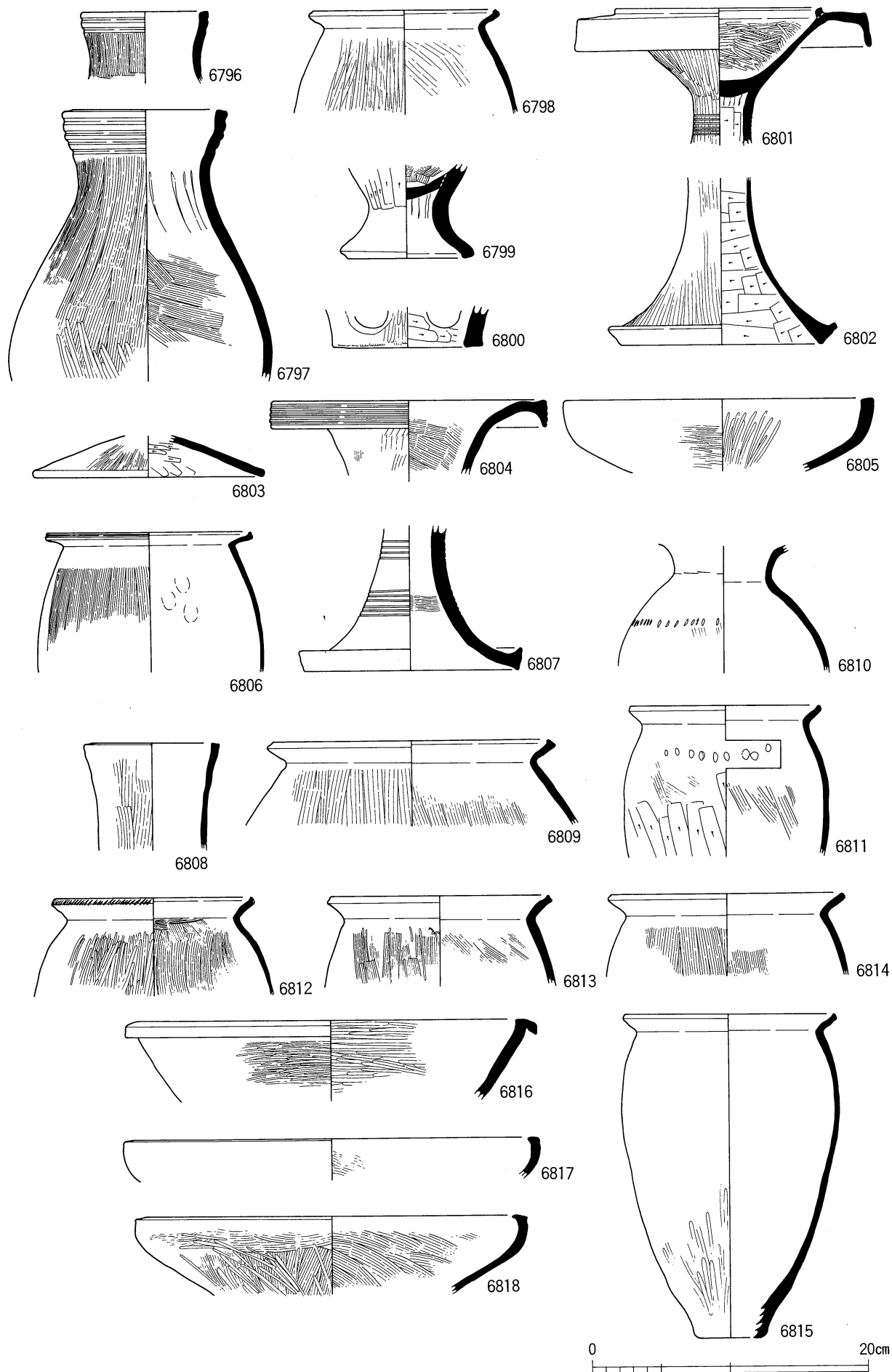

土坑 SK46165 (6796~6802) SK46166 (6803) SK46167 (6804·6805)
 SK46168 (6806) SK46169 (6807) SK46172 (6808·6809)
 SK46174 (6810~6818)

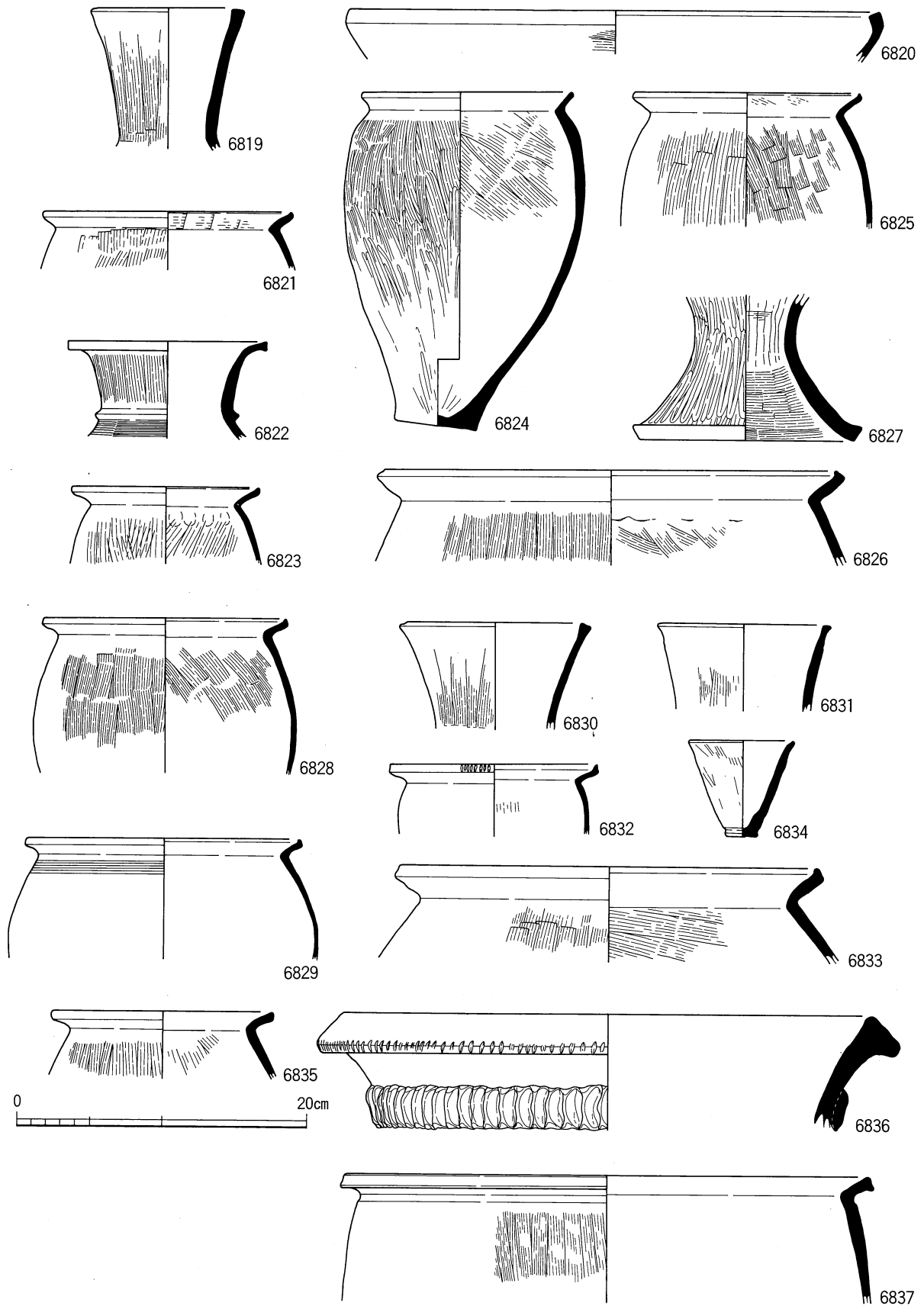

土坑 SK46175 (6819・6820) SK46177 (6821) SK46178 (6822~6827)
 SK46179 (6828・6829) SK46180 (6830~6834) SK46181 (6835)
 SK46182 (6836) SK46183 (6837)

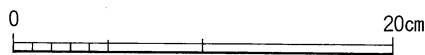
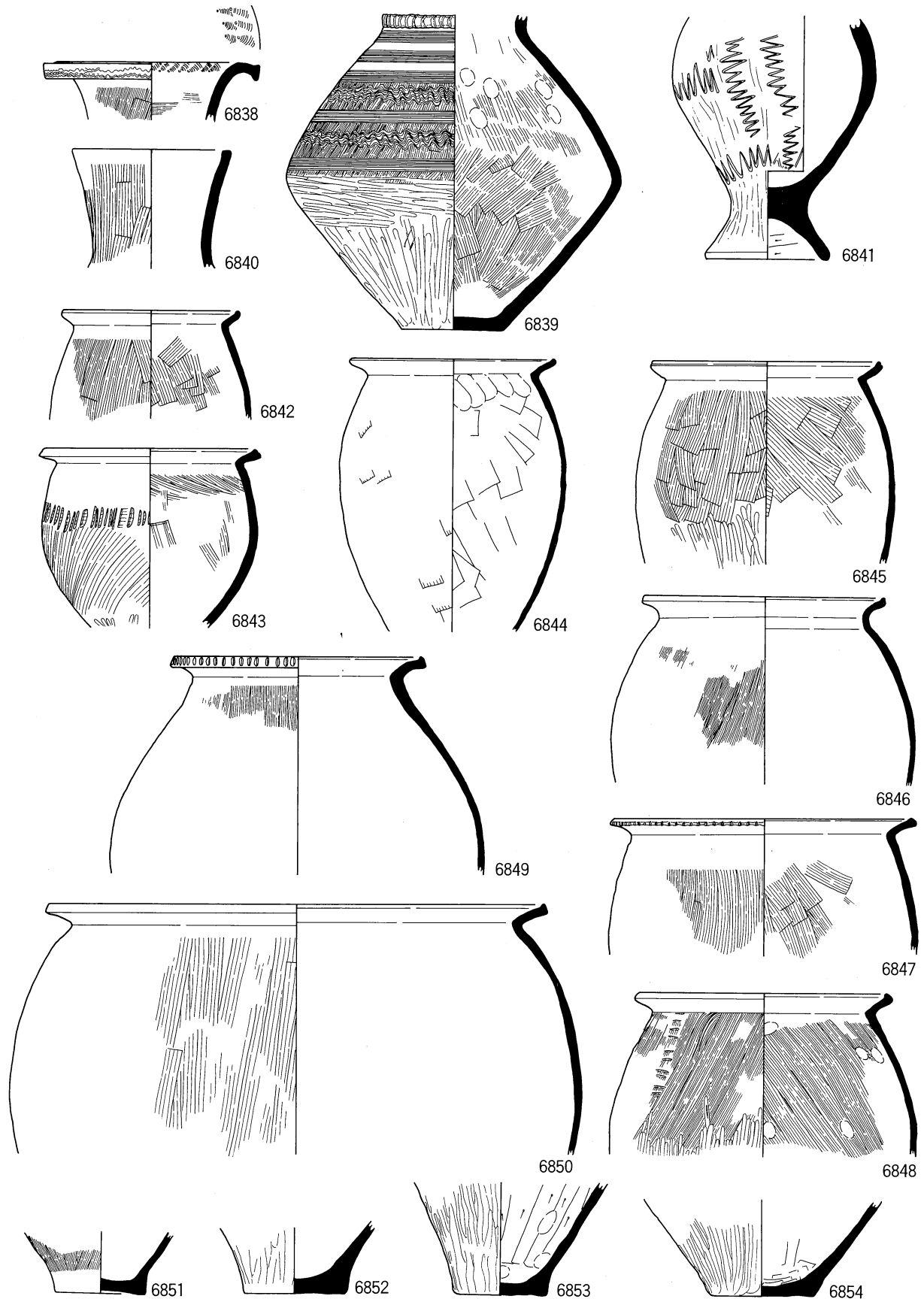

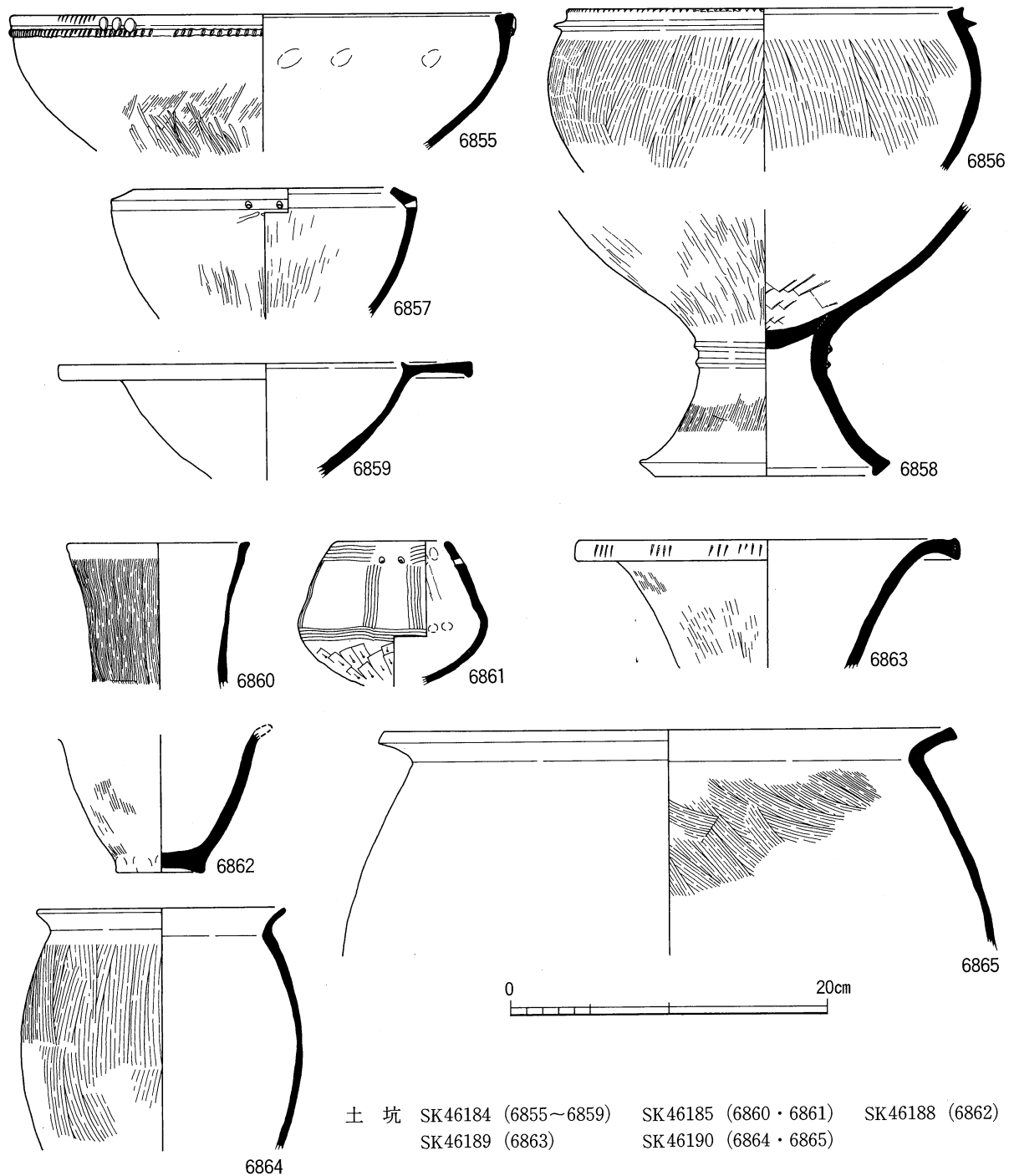

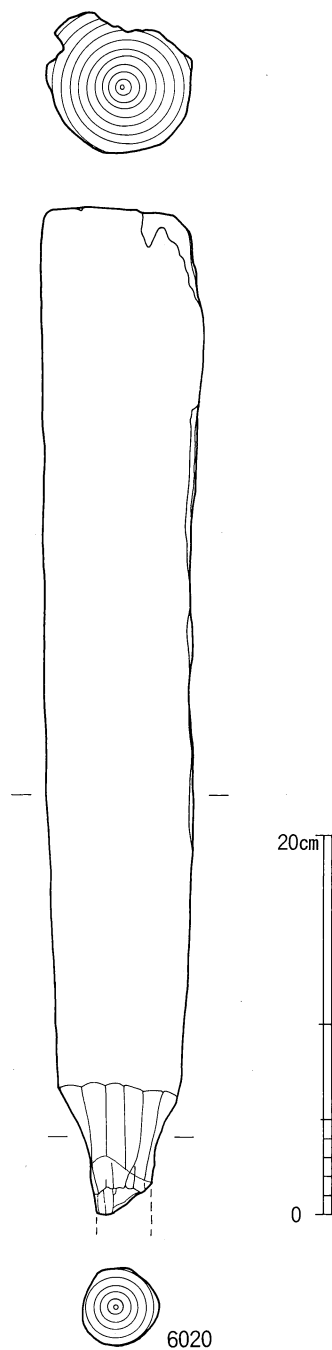
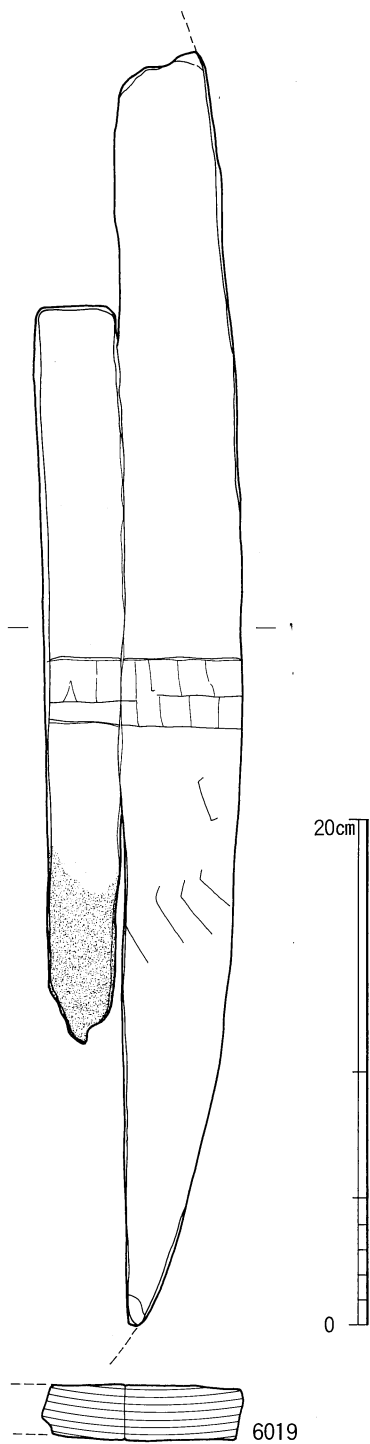

土坑 SK46138 (6019) SK46164 (6020)

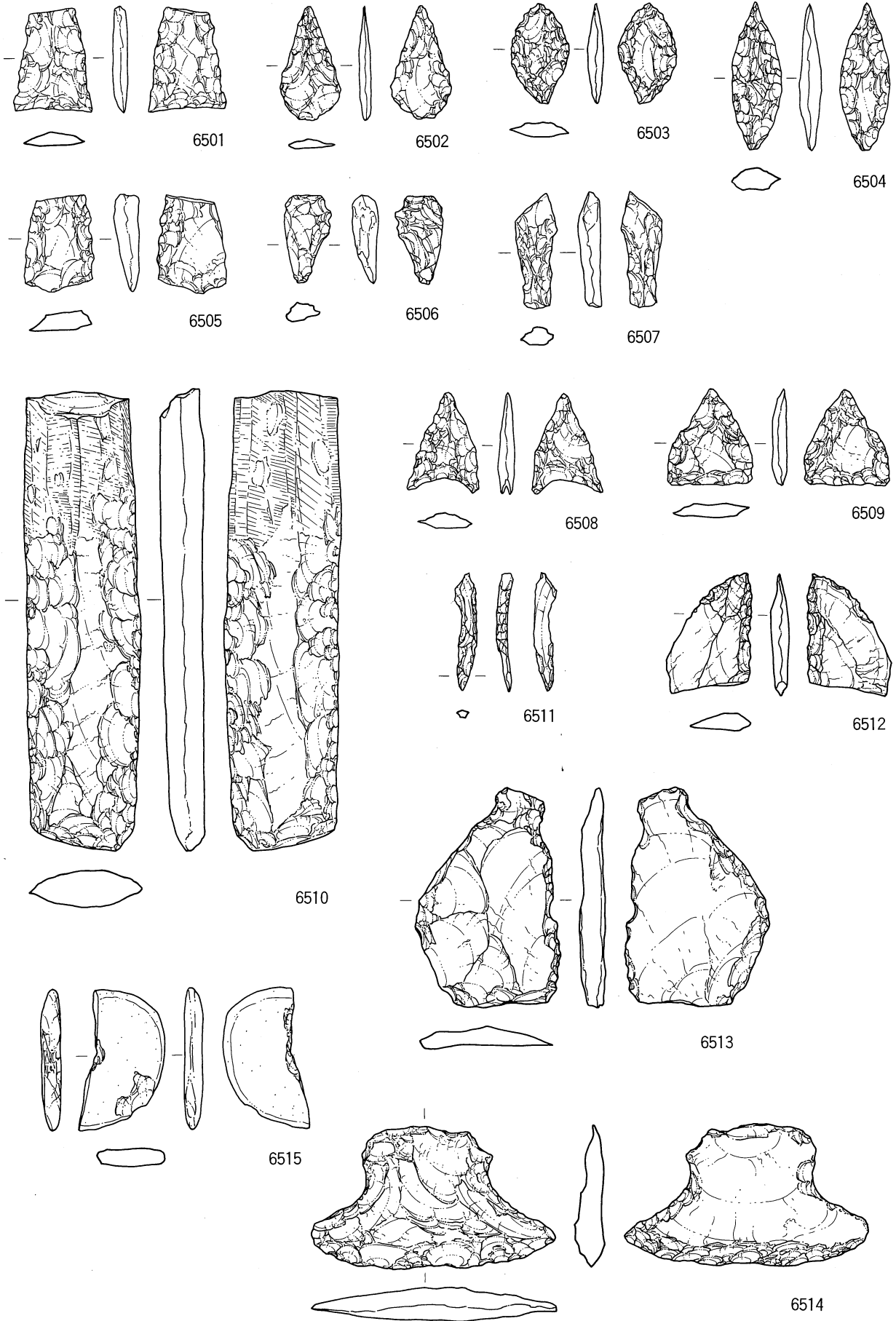

土坑 SK46138 (6502) SK46144 (6506) SK46151 (6501)

SK46188 (6503 · 6505 · 6507)

木棺墓 ST46005 (6504)

上層水田 (6510) 包含層 (6508 · 6509 · 6511~6515)

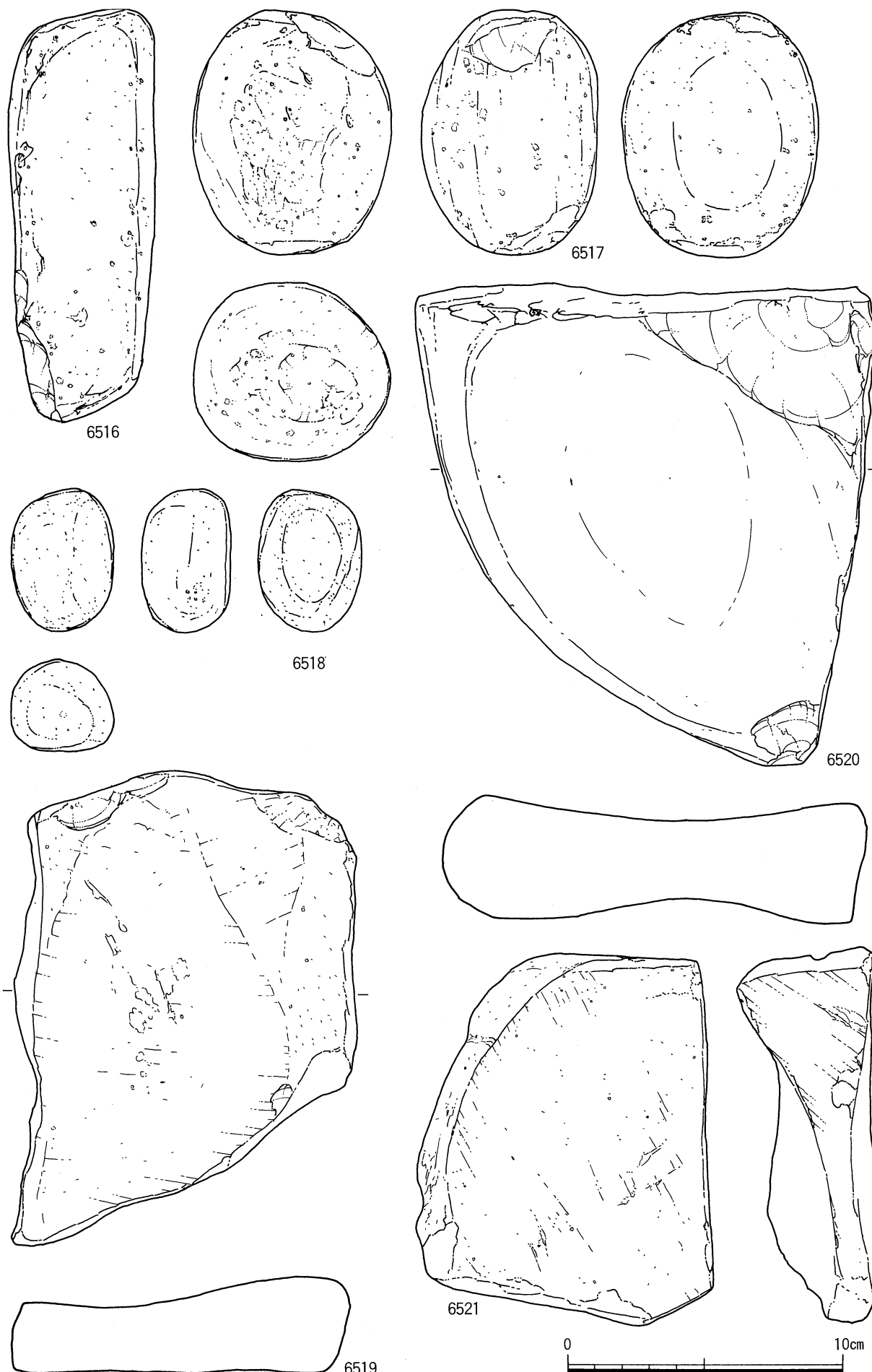

竖穴住居 SH46041 (6520)
 土坑 SK46137 (6521) SK46156 (6518) SK46180 (6517)
 木棺墓 ST46005 (6519)
 包含层 (6516)

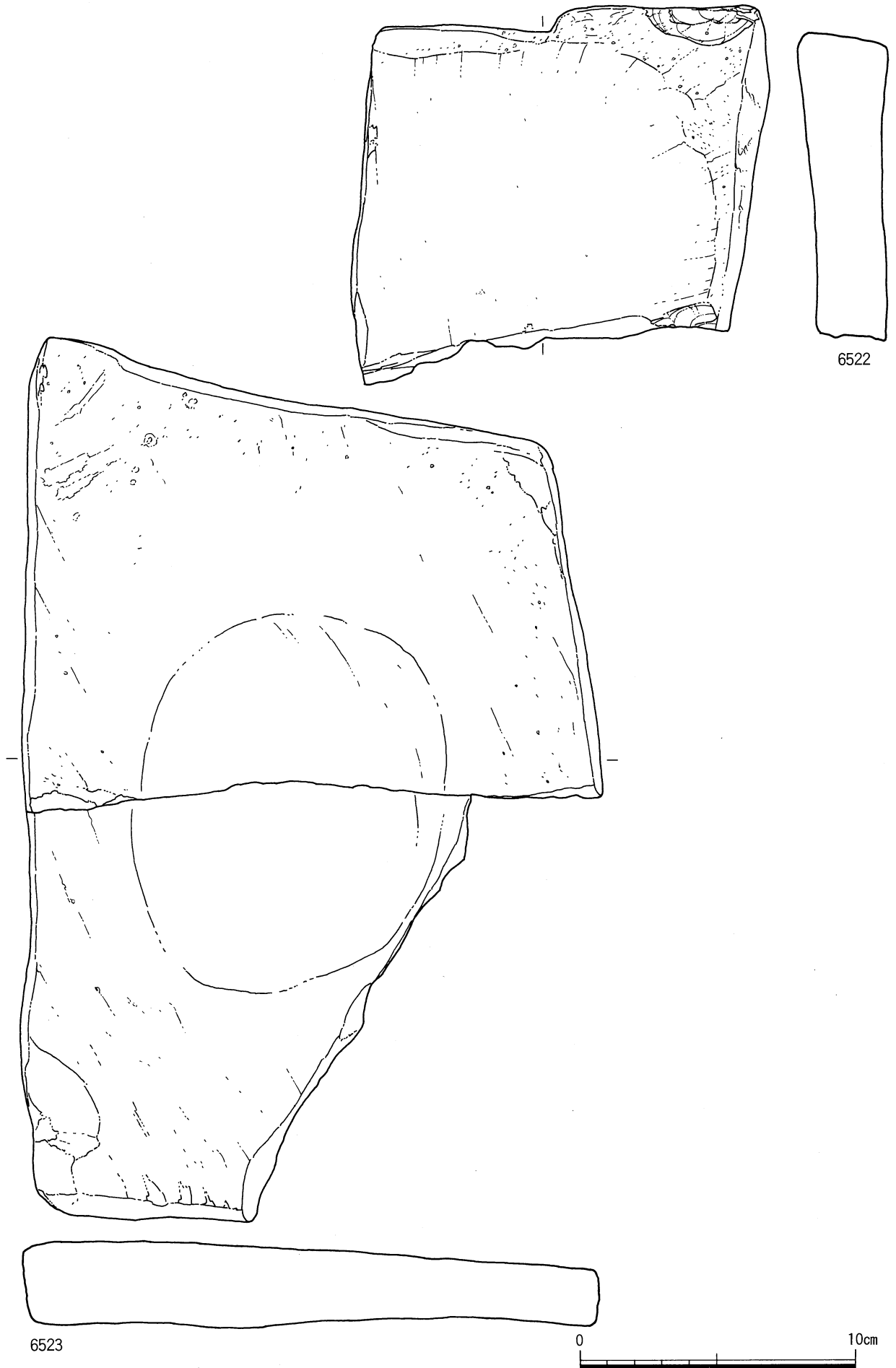

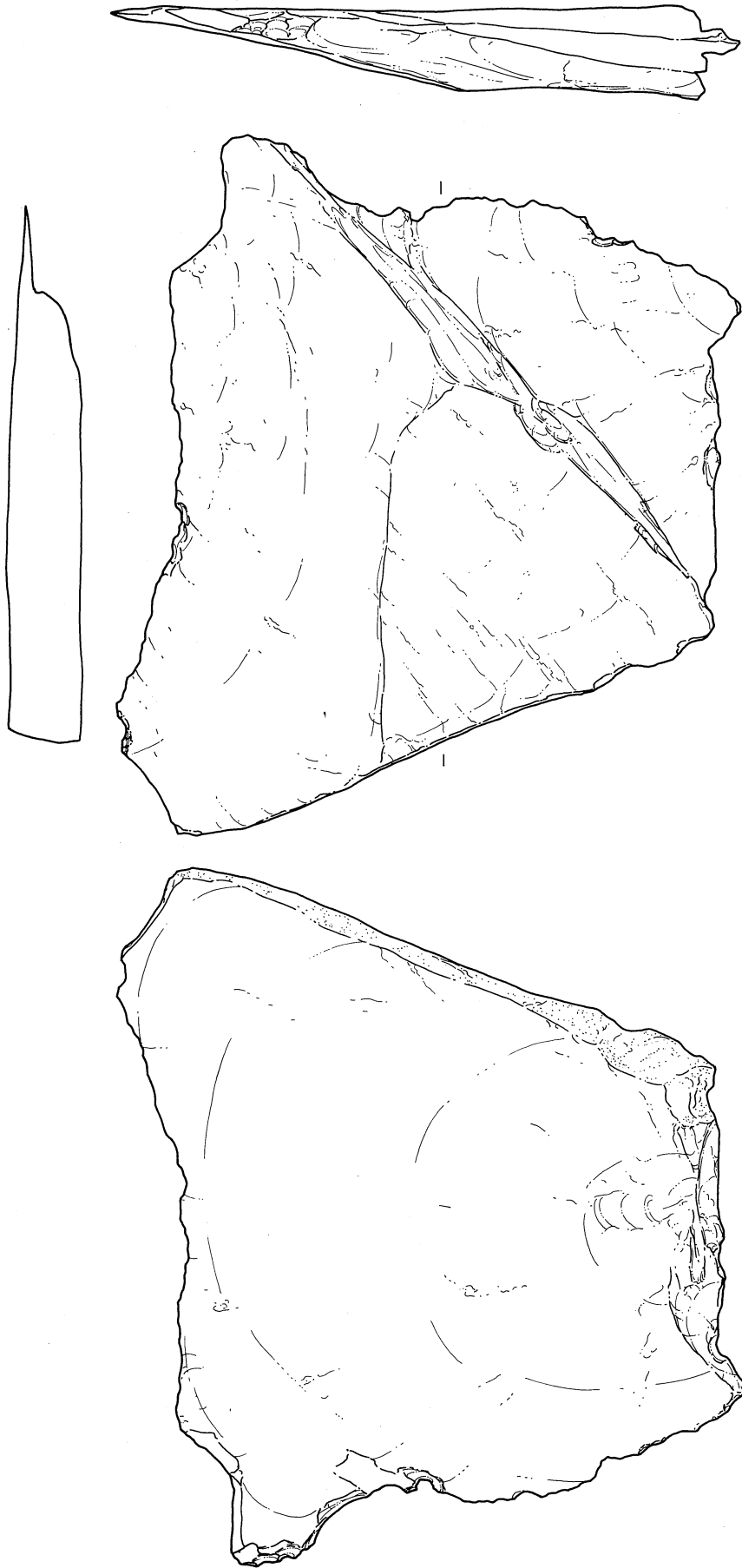

6524



弥生中期上層 出土石器 4 (包含層)

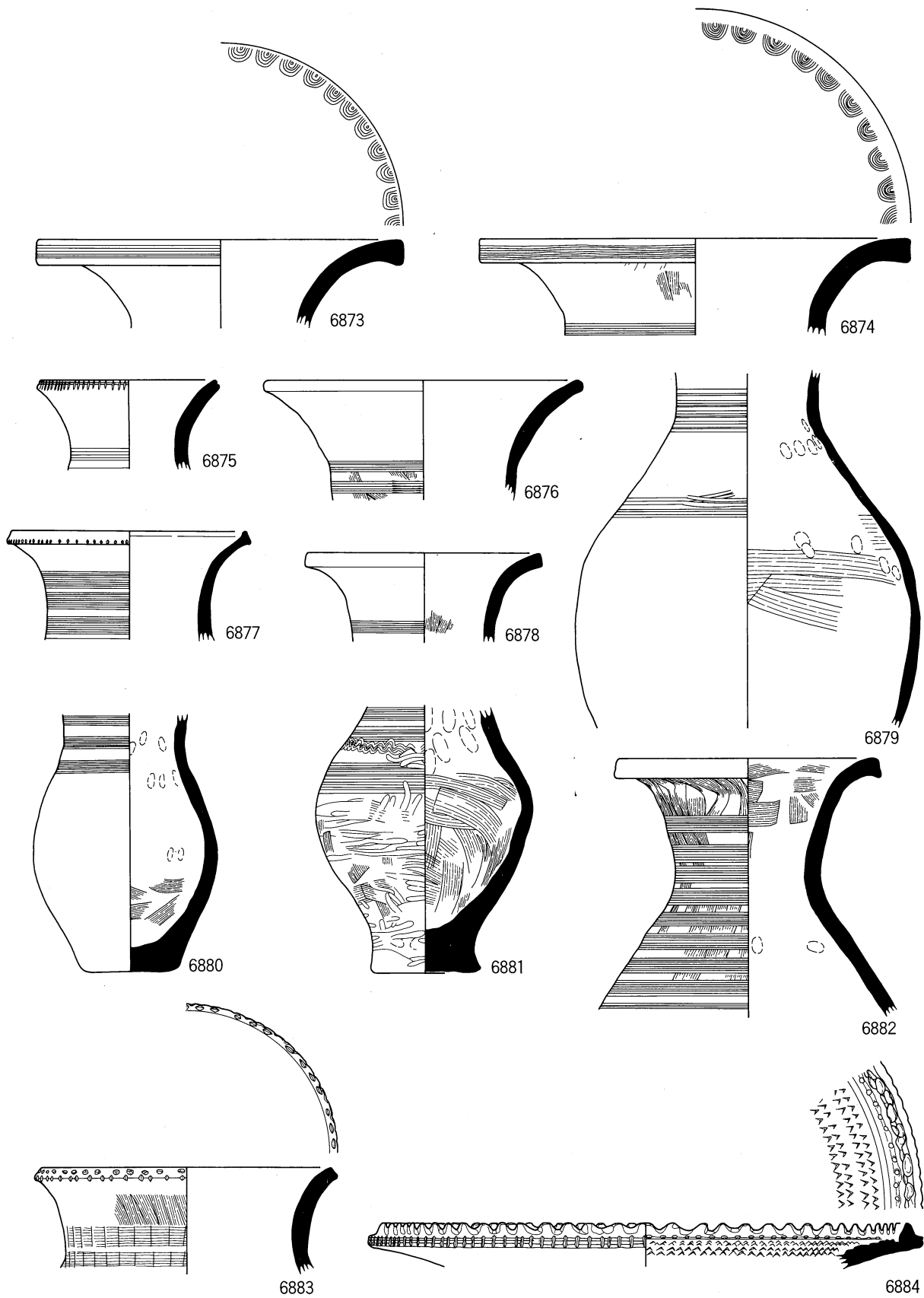

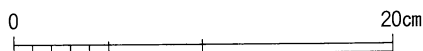
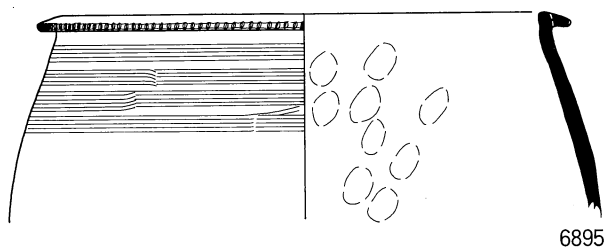
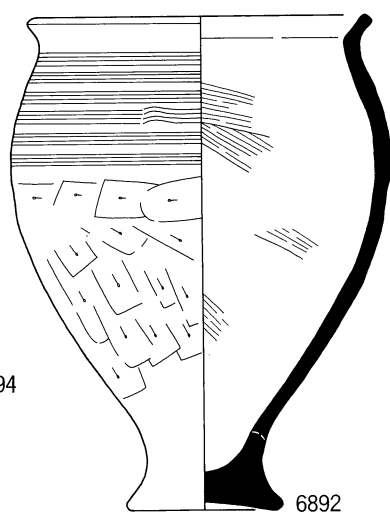
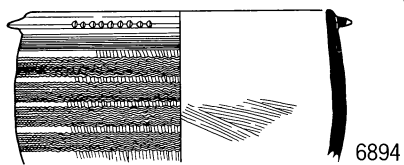
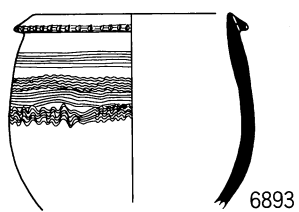
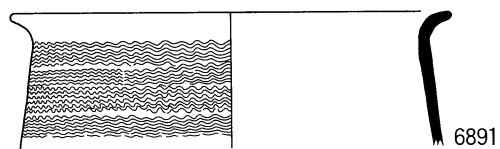
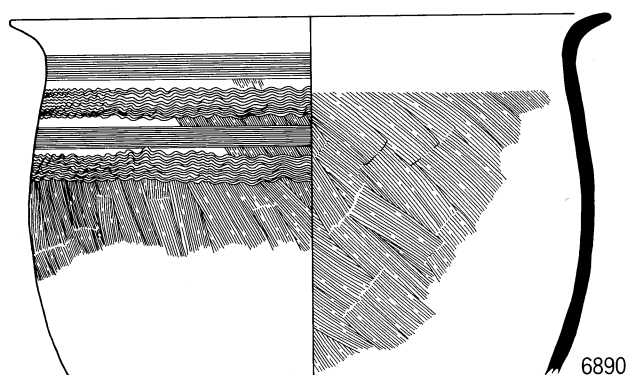
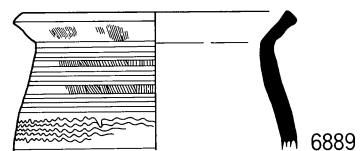
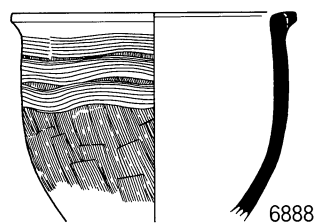
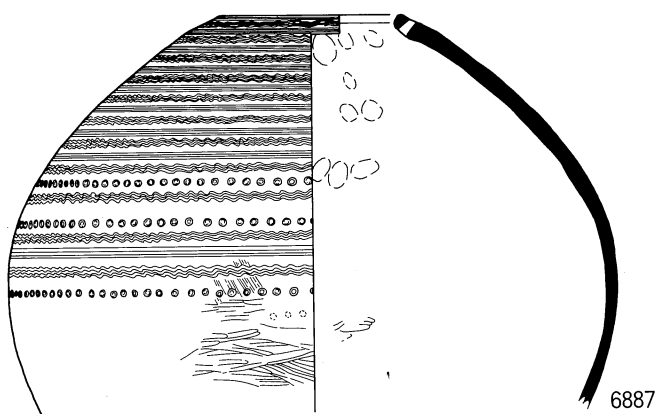
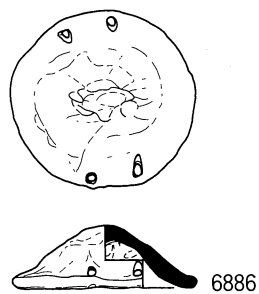
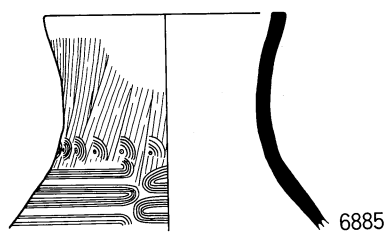

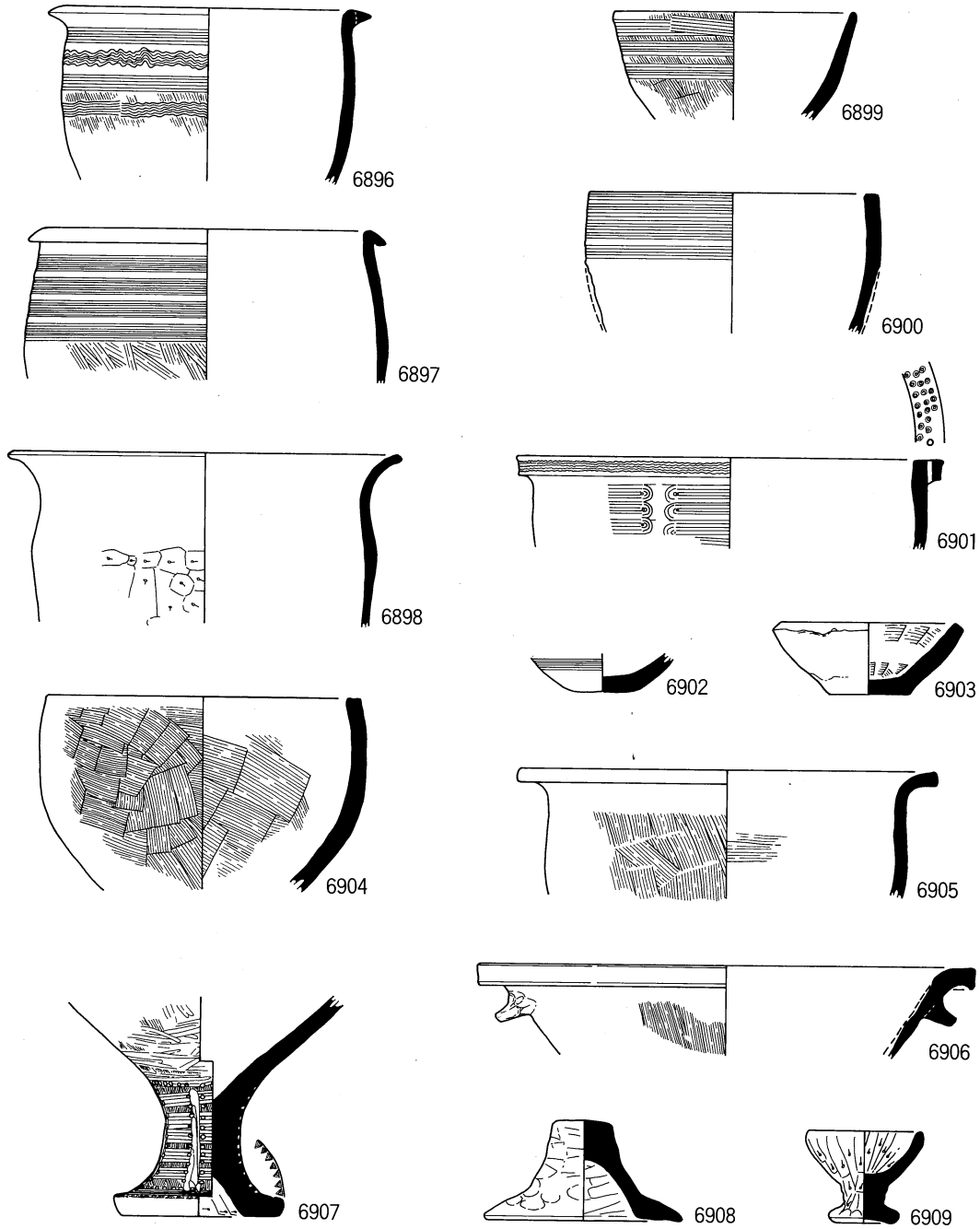

0 20cm

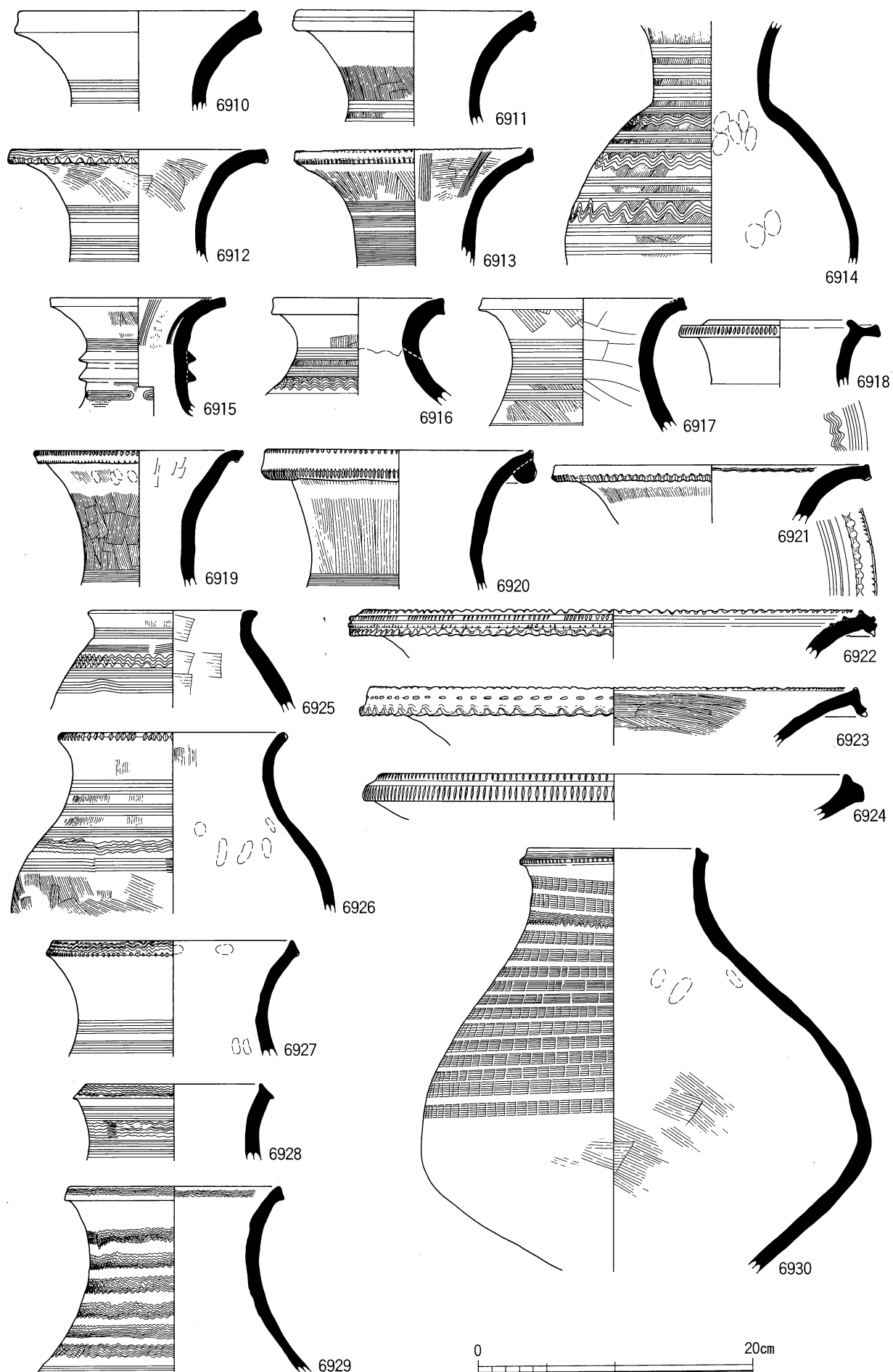

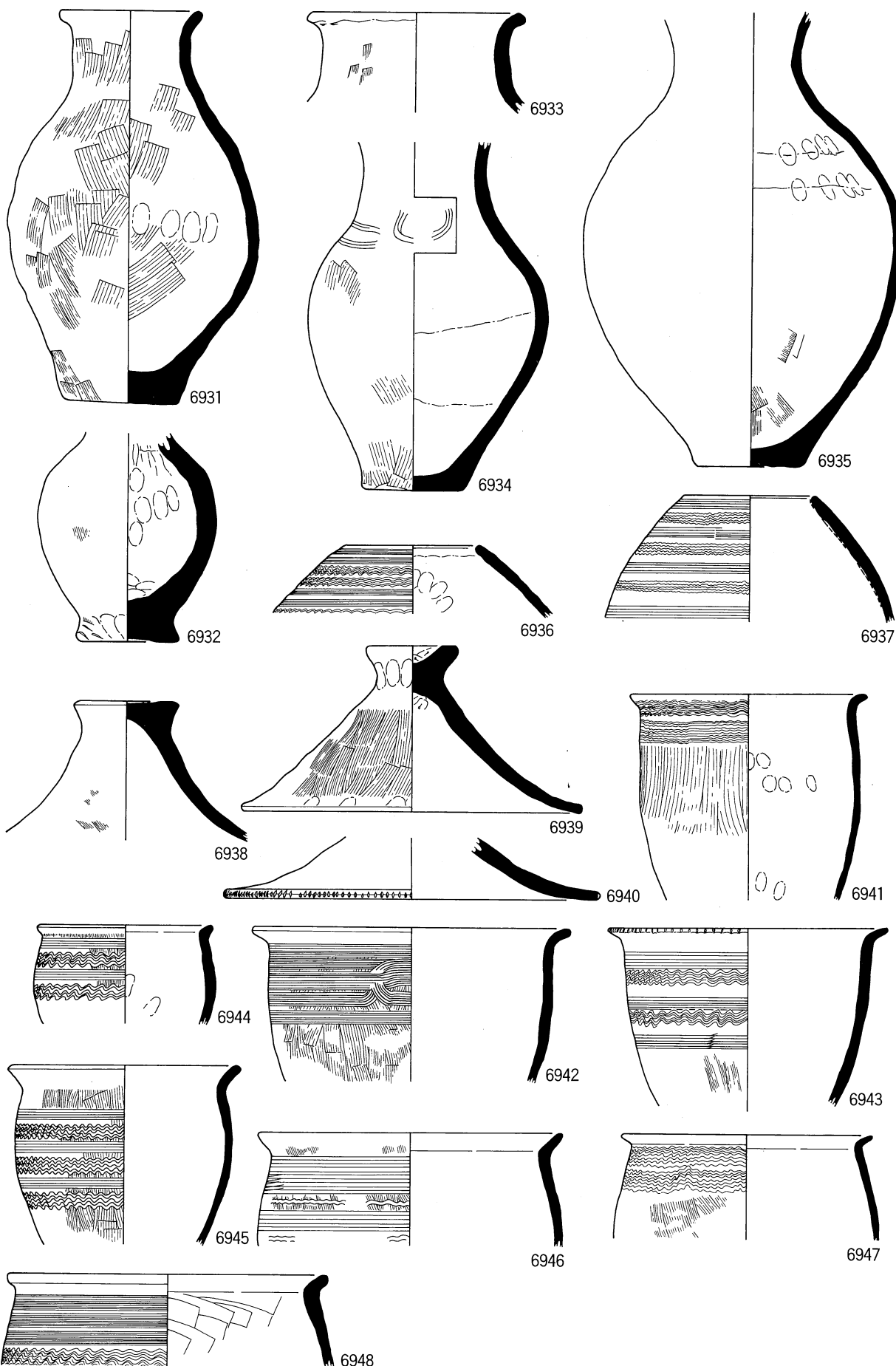

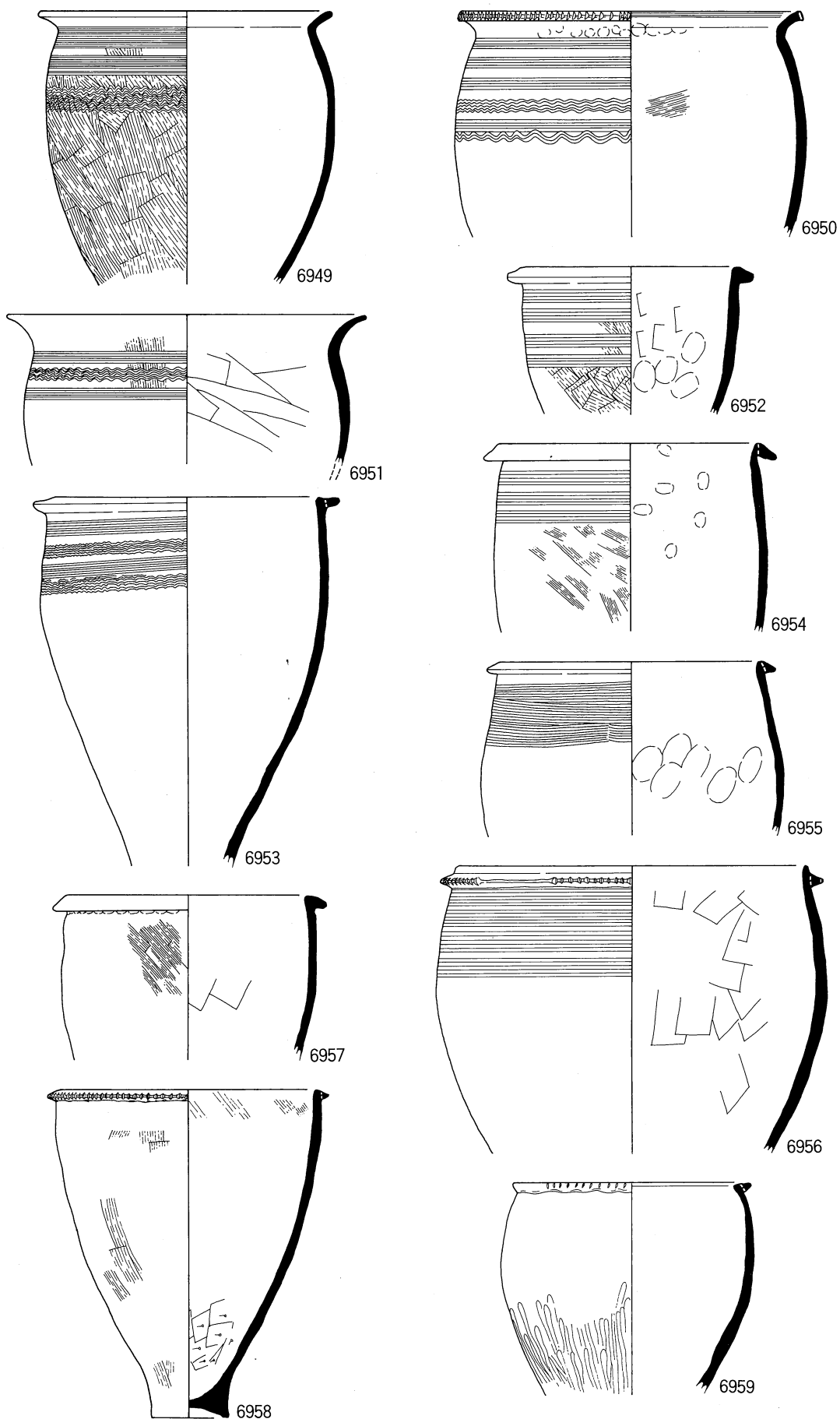

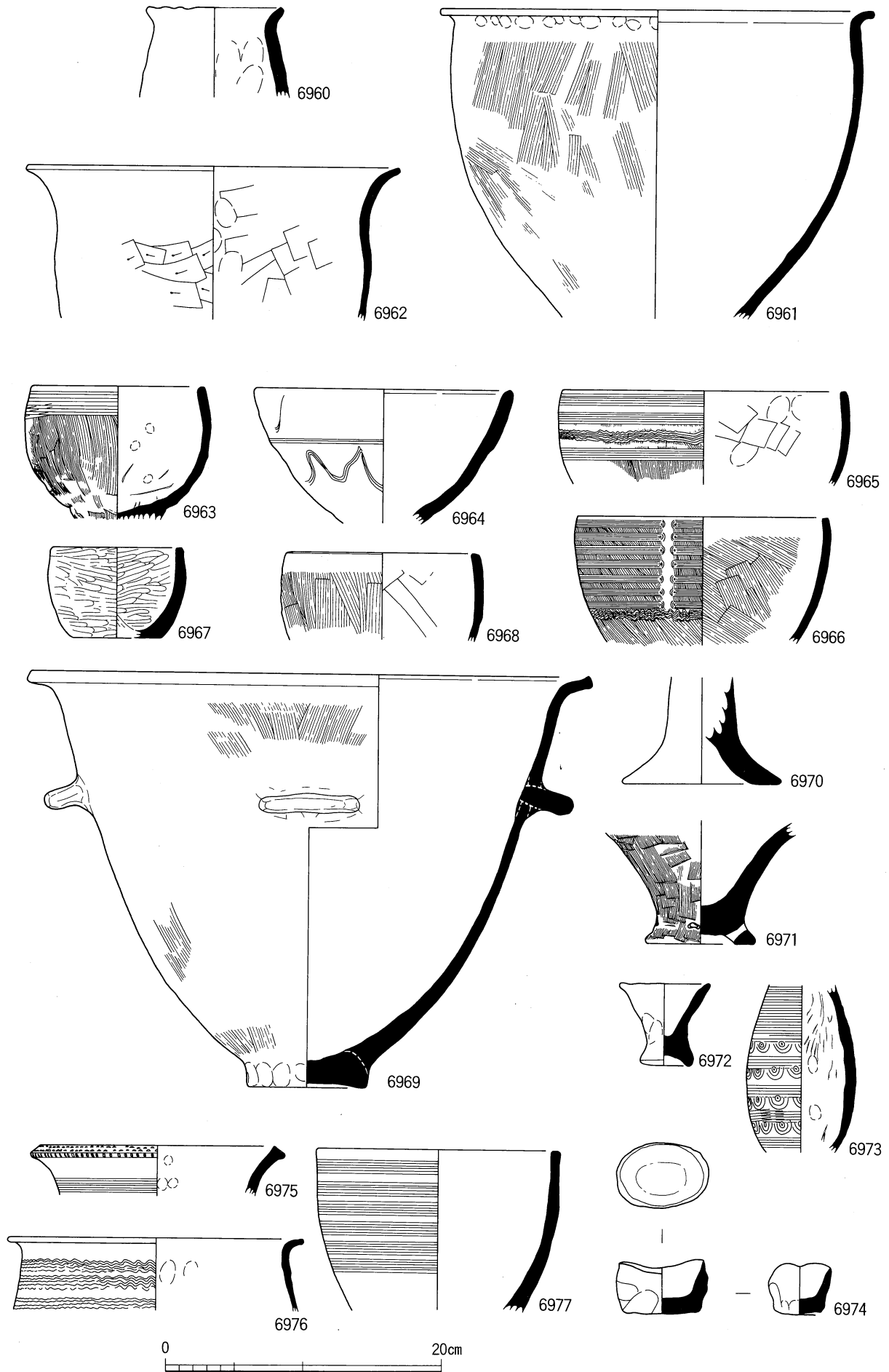

溝 SD36001 (6960~6974) SD36002 (6975~6977)

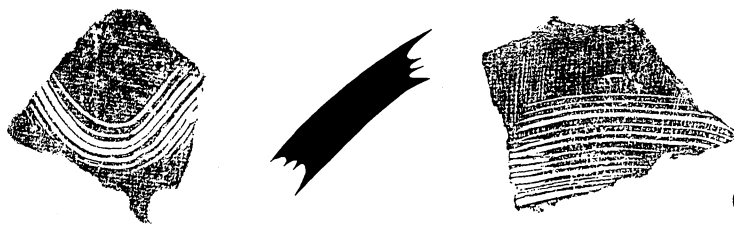

6978



6979

6980

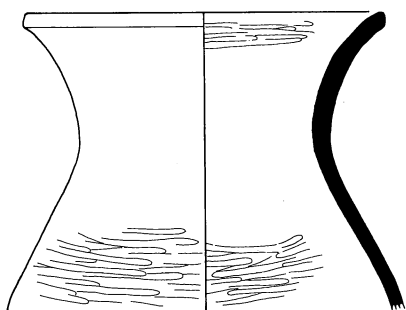

6981

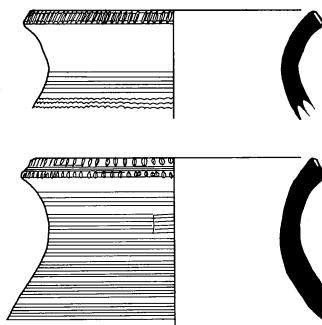

6983

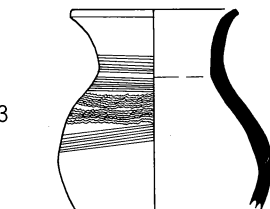

6986

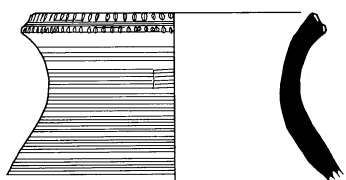

6984

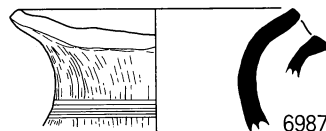

6987

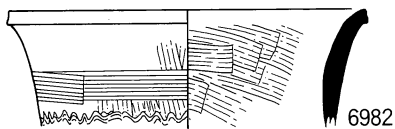

6982

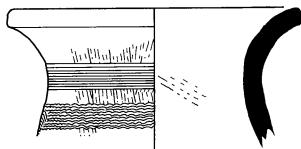

6985

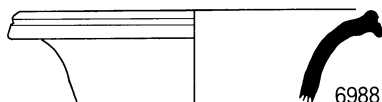

6988

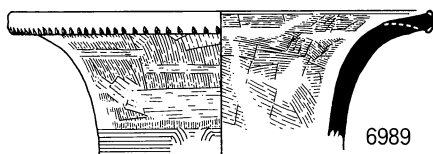

6989

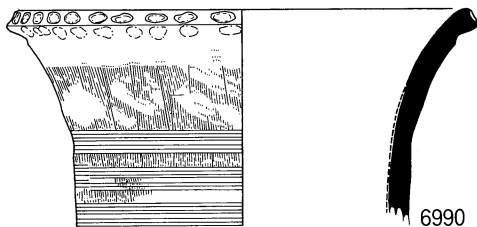

6990

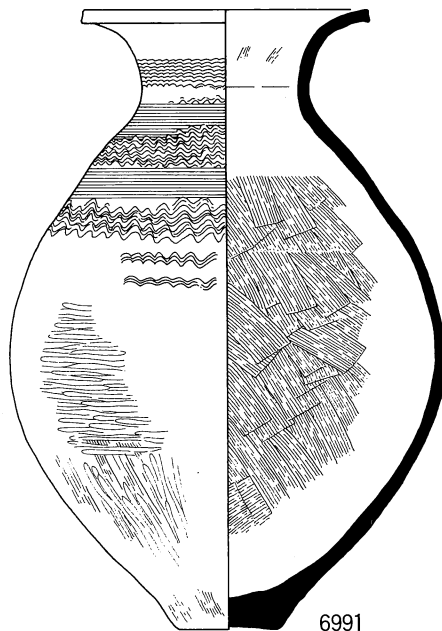

6991



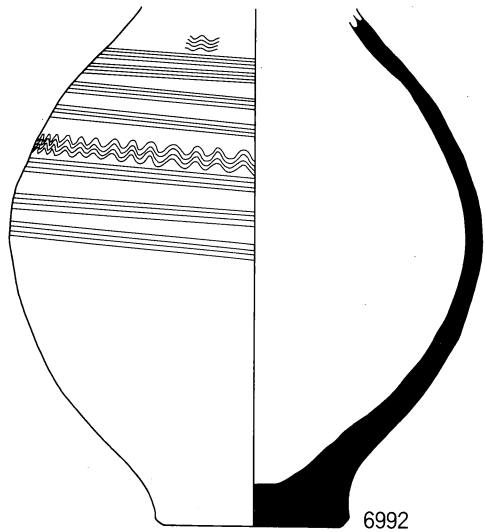

6992

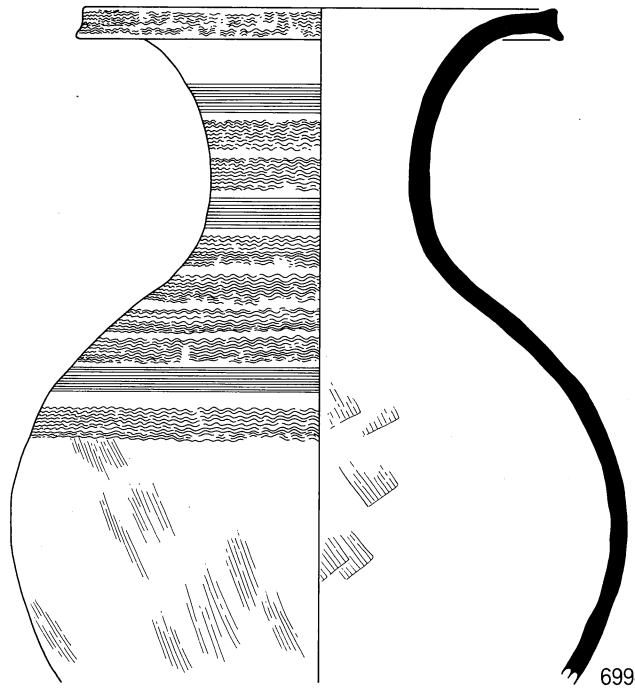

6994

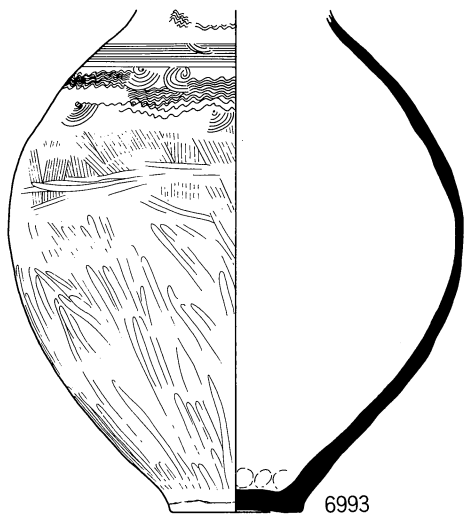

6993

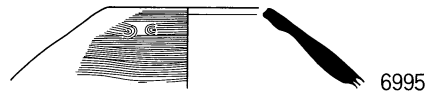

6995

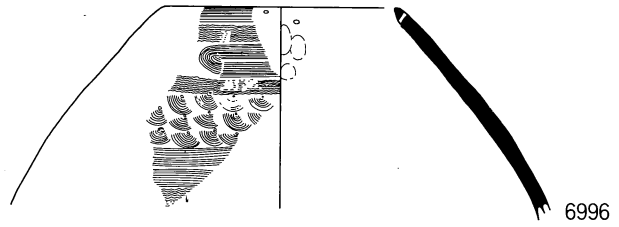

6996

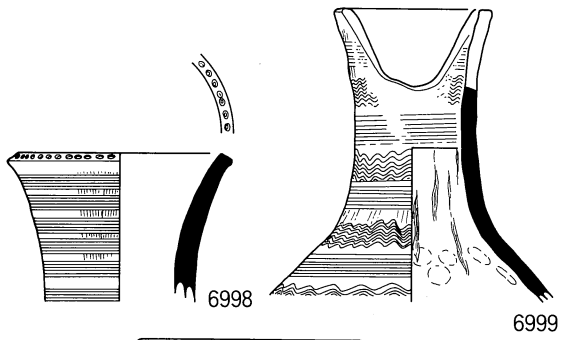

6998

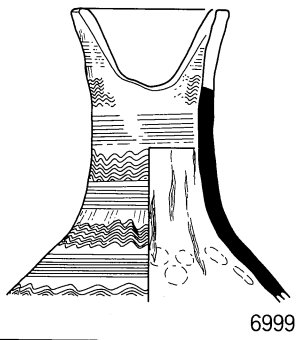

6999

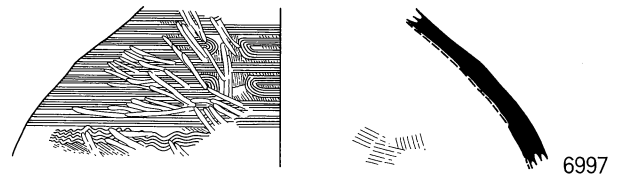

6997

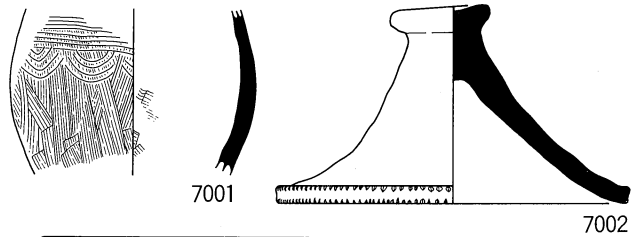

7001

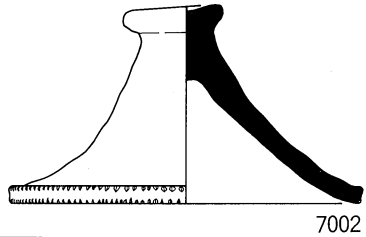

7002

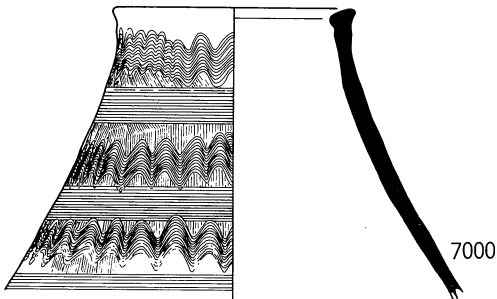

7000

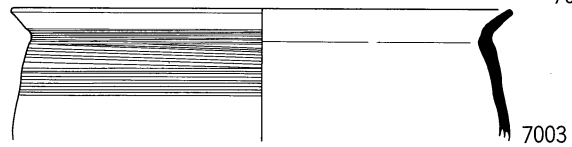

7003

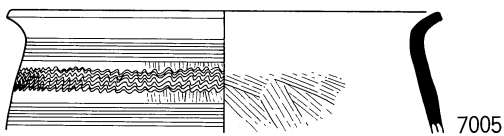

7005

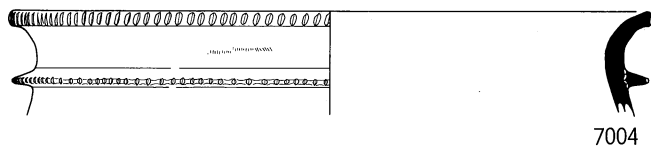

7004



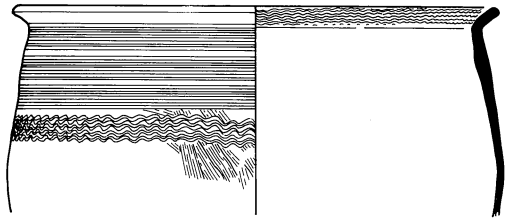

7006

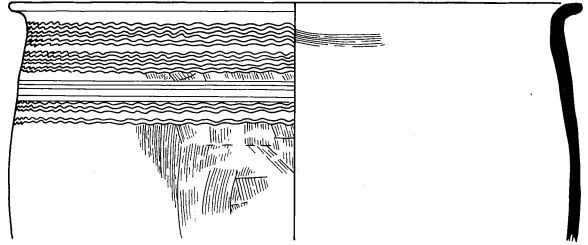

7007

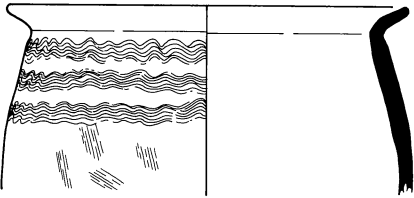

7008

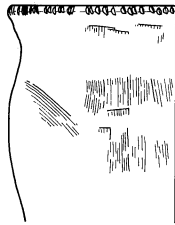

7011

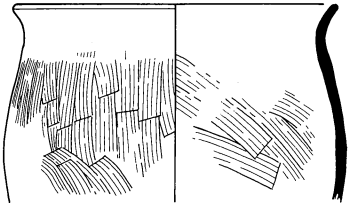

7012

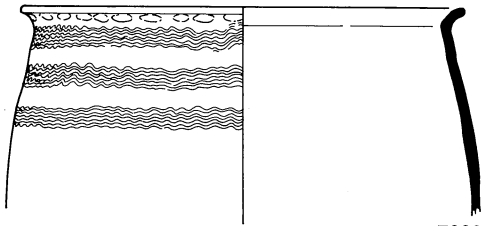

7009

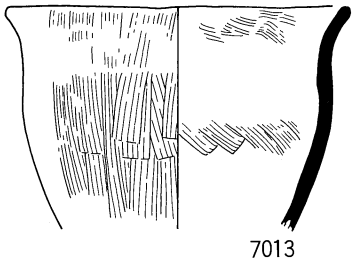

7013

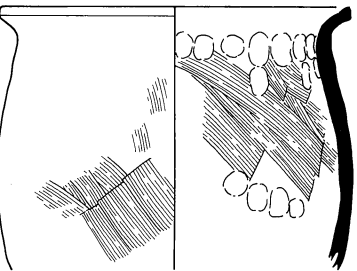

7014



7010

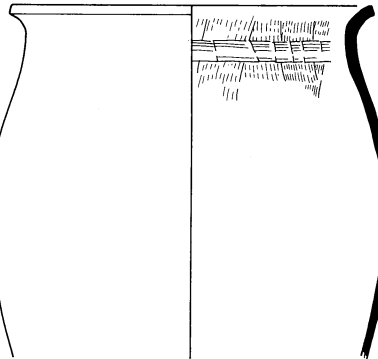

7015

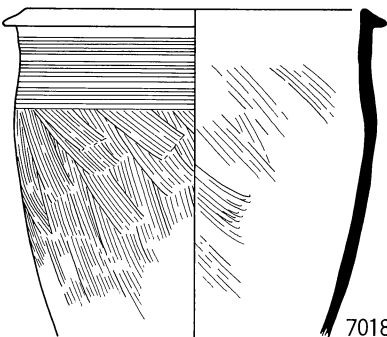

7018

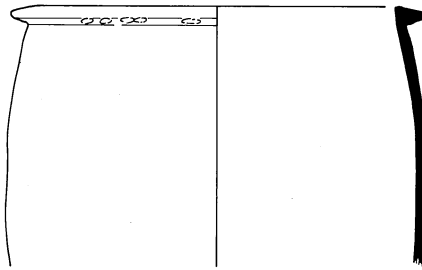

7016

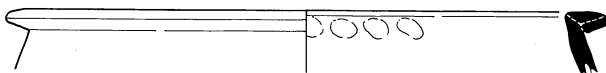

7017

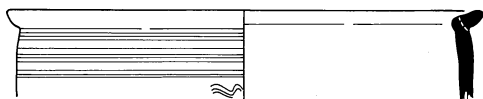

7019

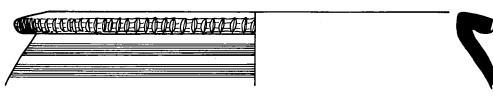

7020

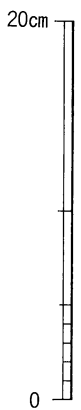

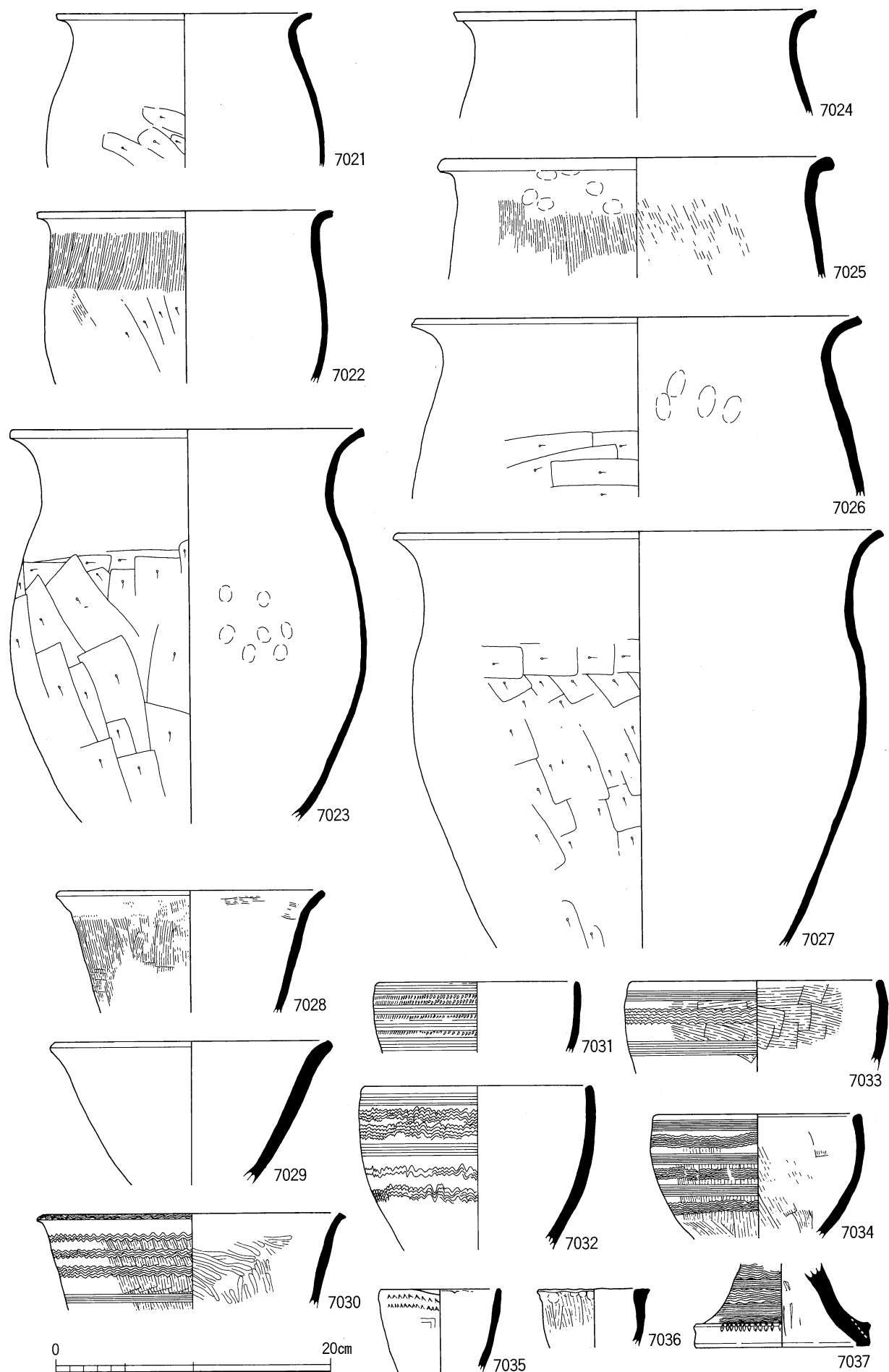

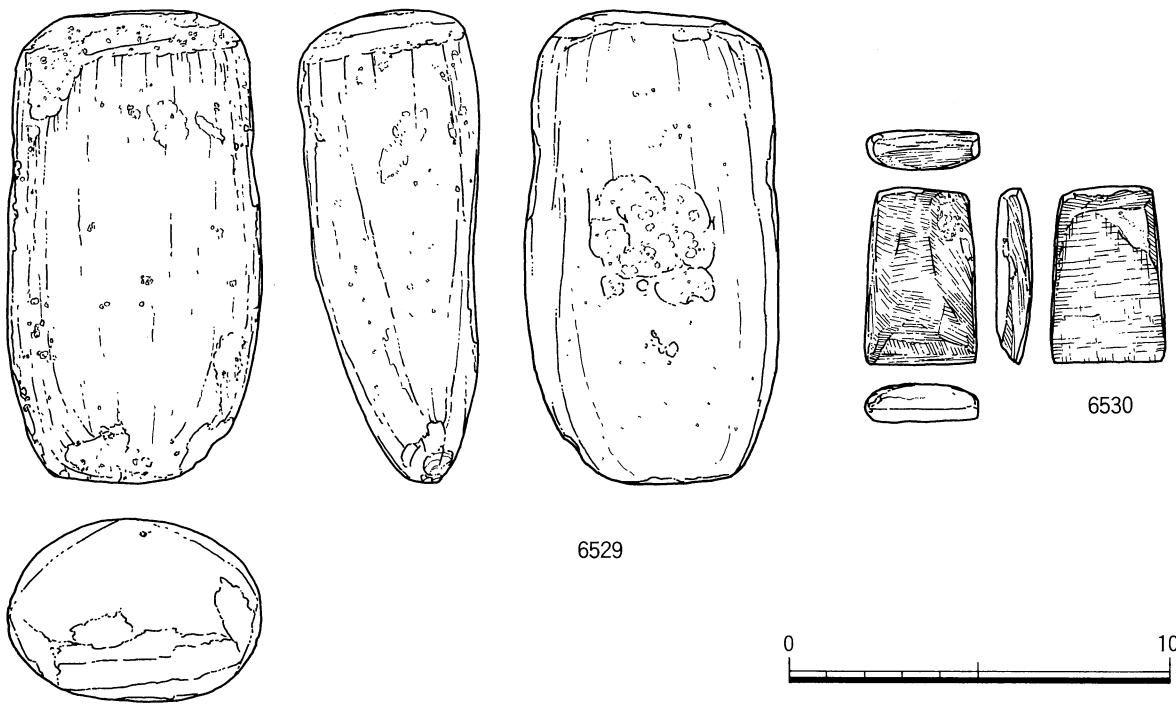
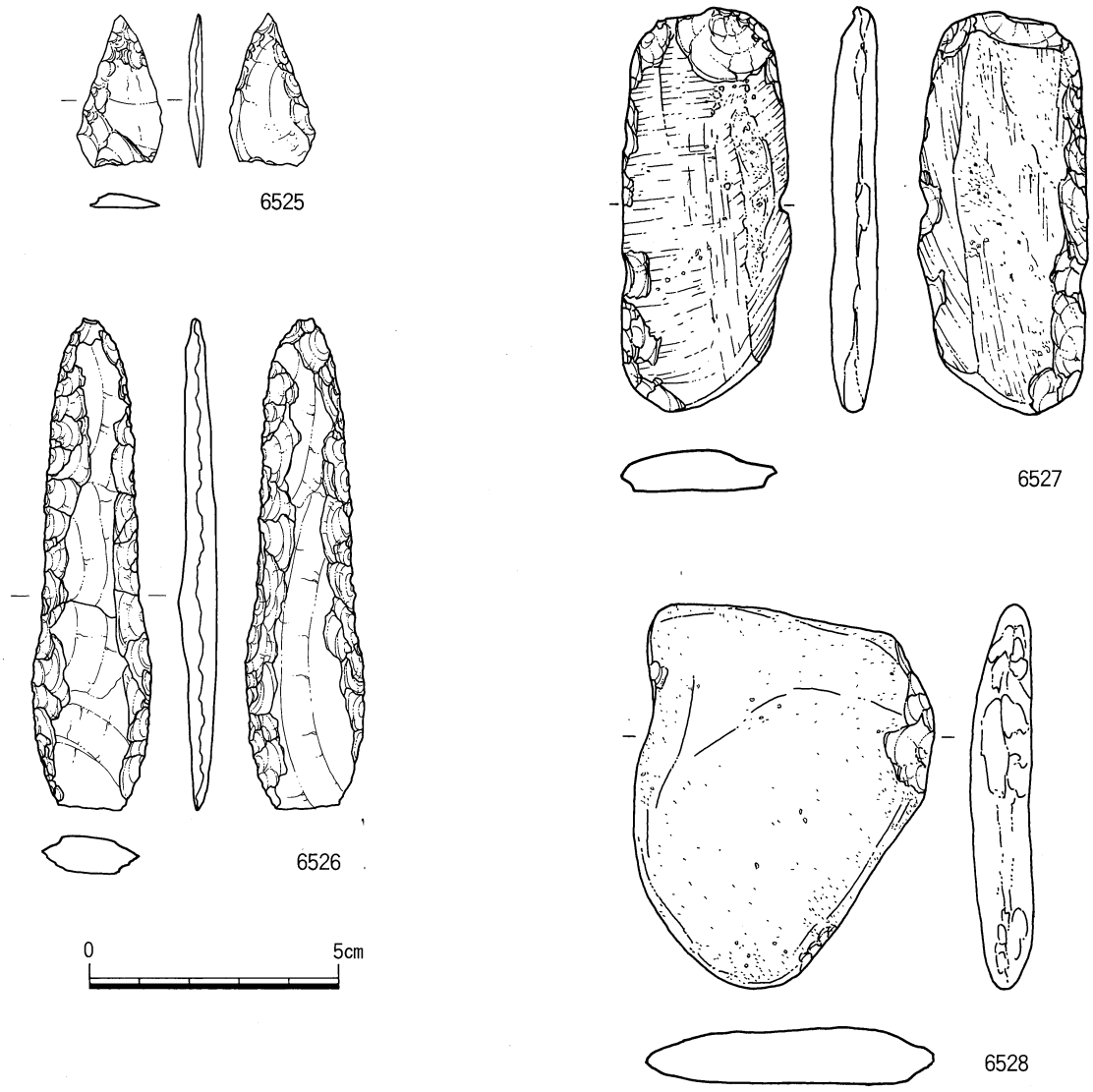

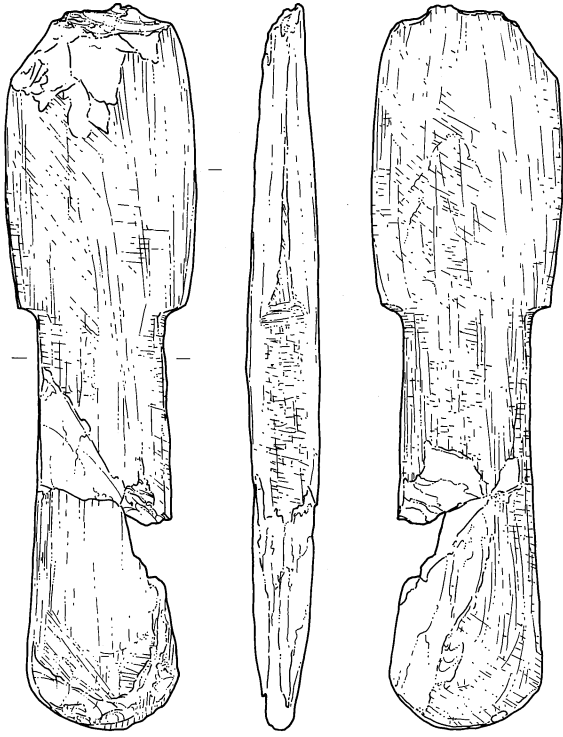

6531

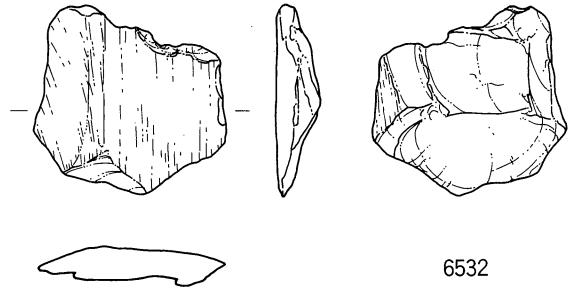
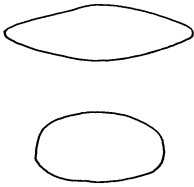

6532

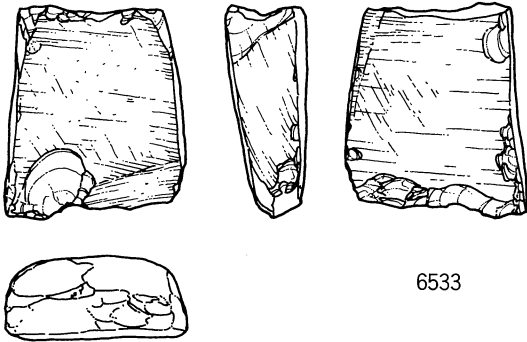

6533

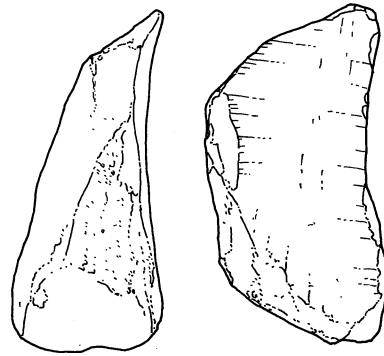

6534

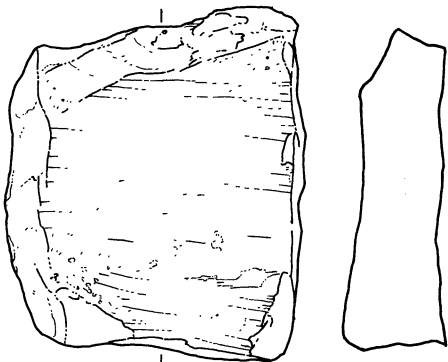

6535



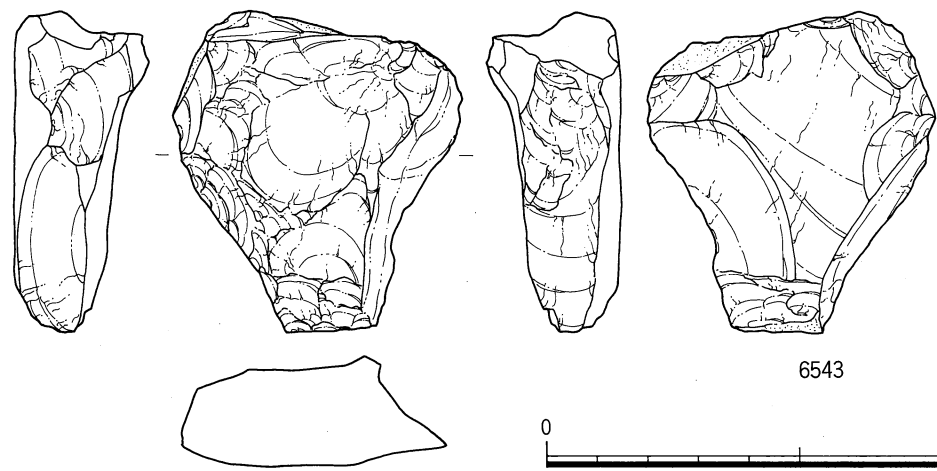
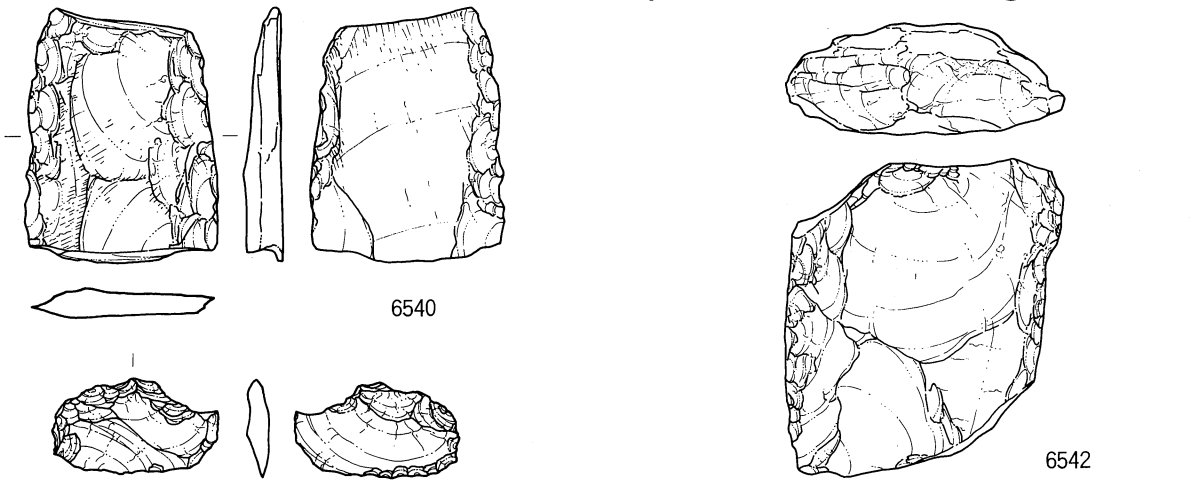
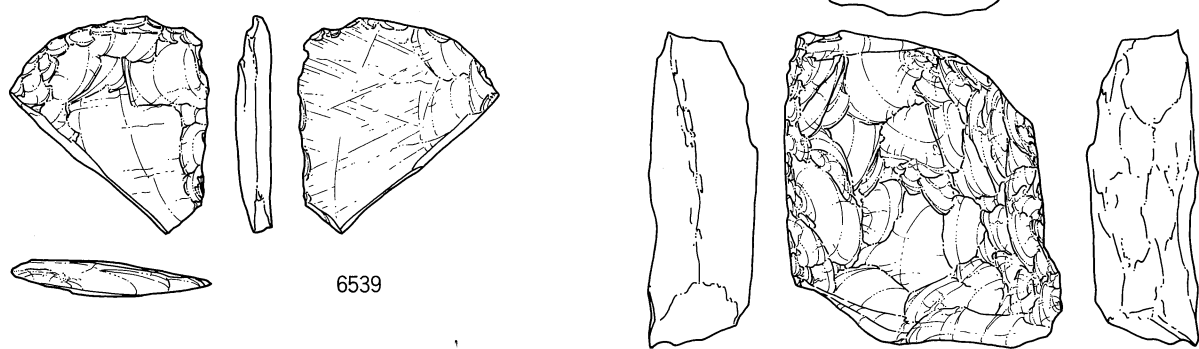
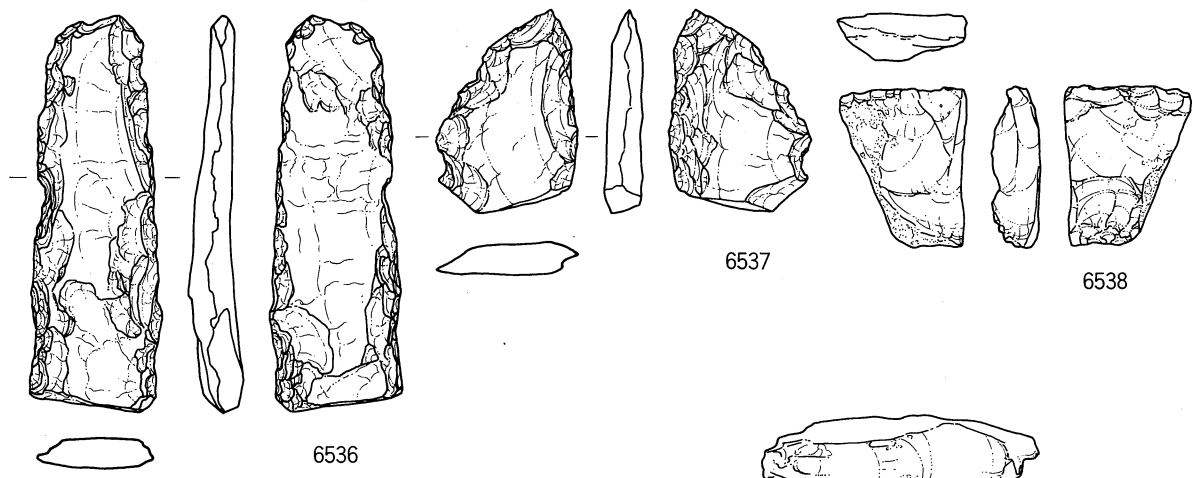

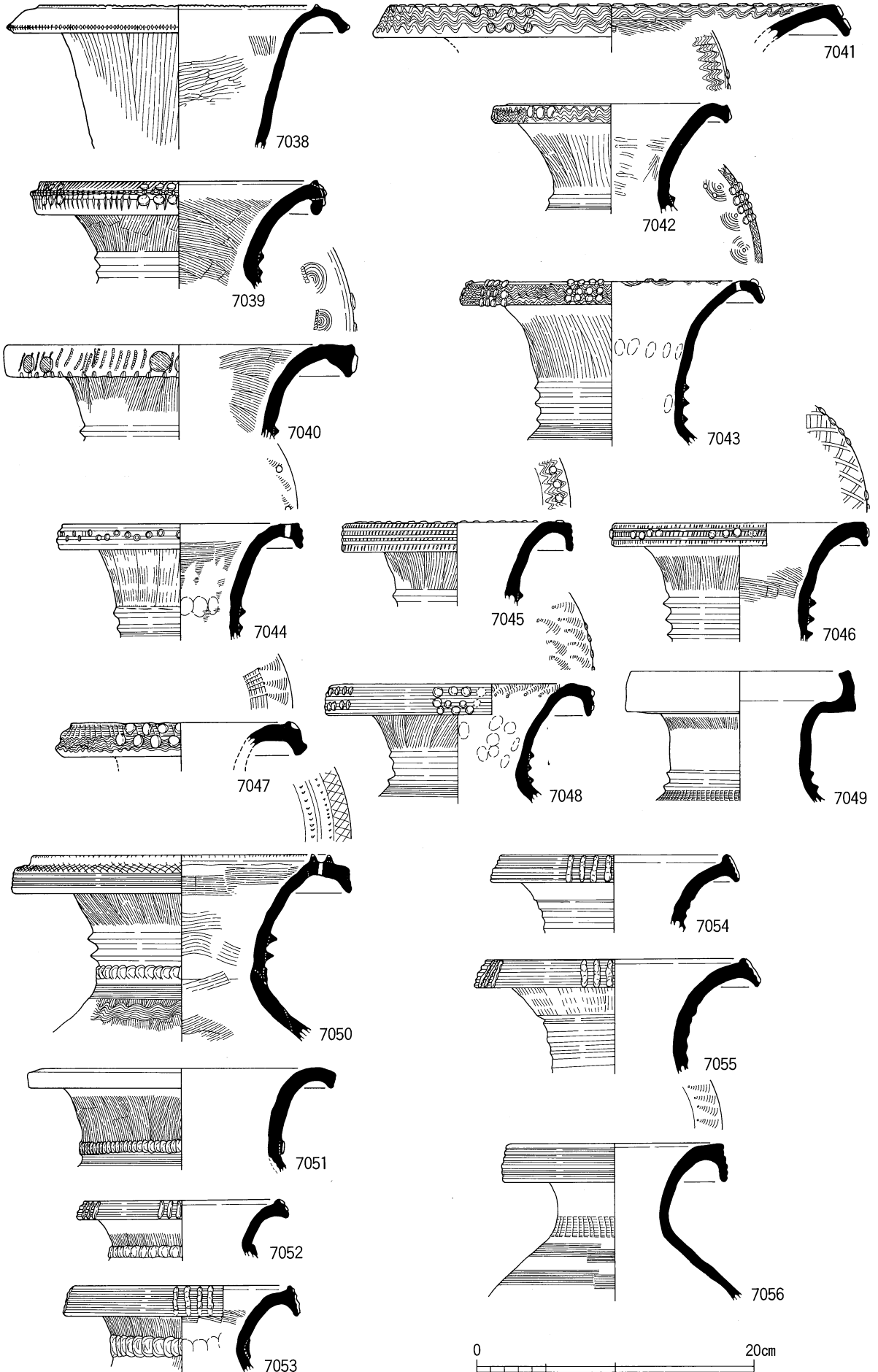

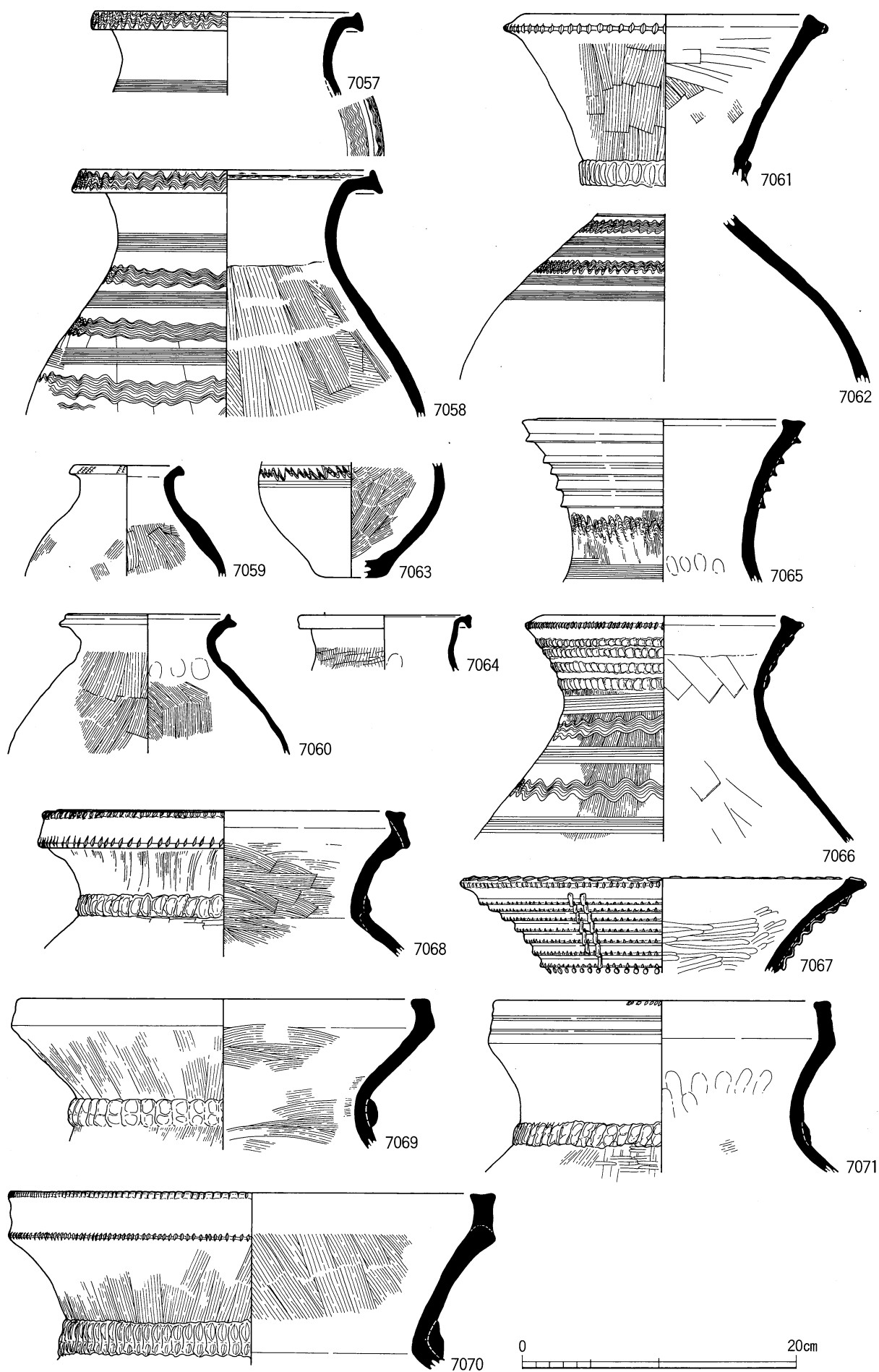

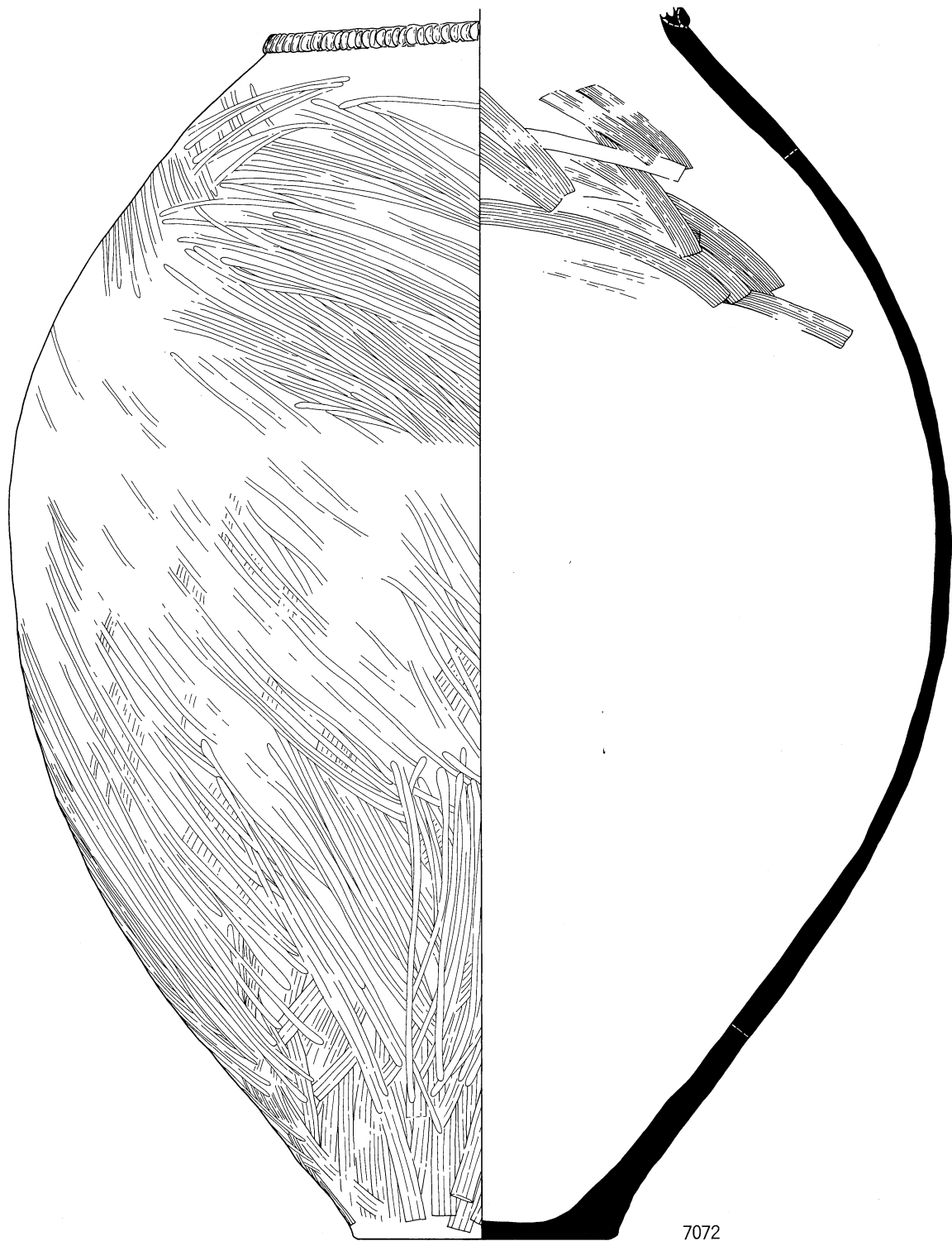

0 20cm

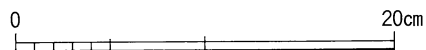
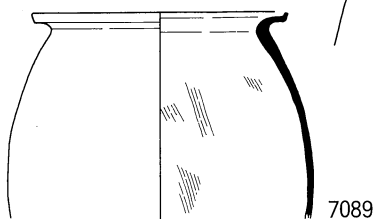
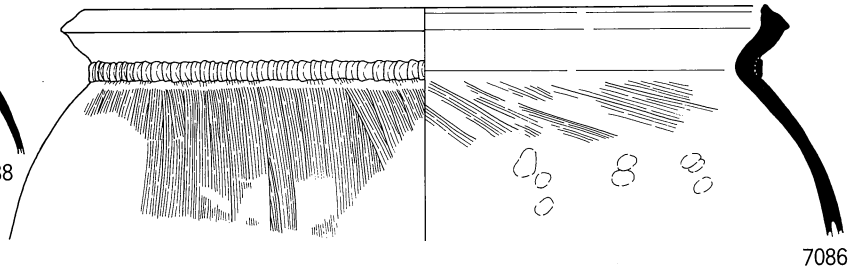
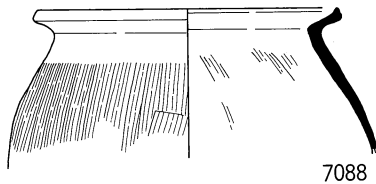
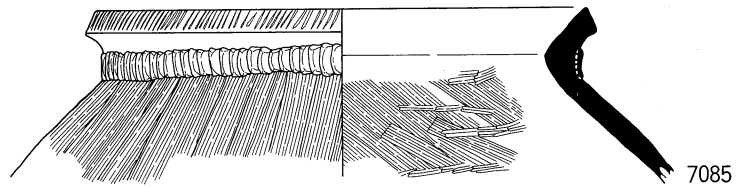
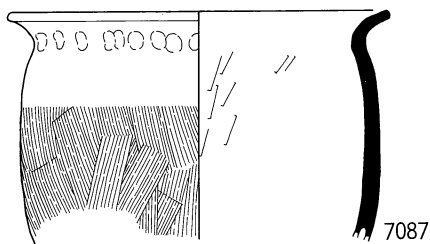
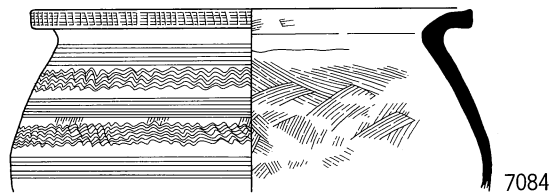
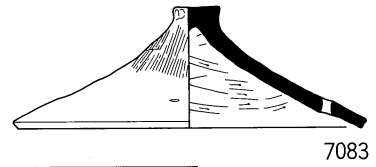
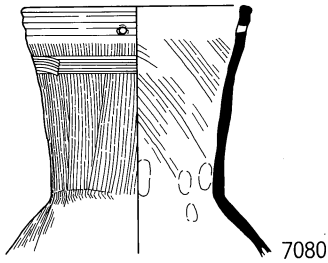
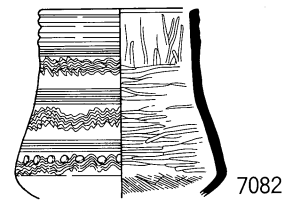
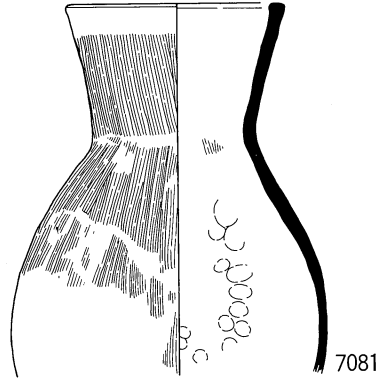
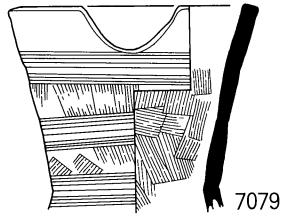
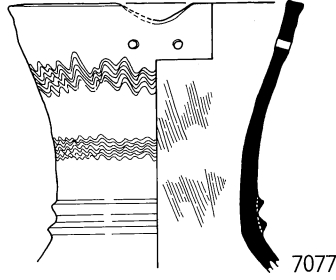
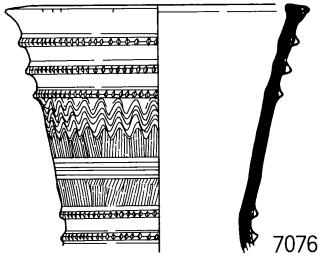
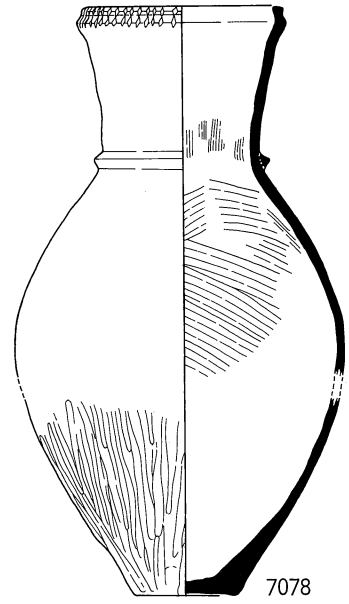
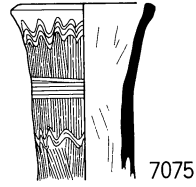
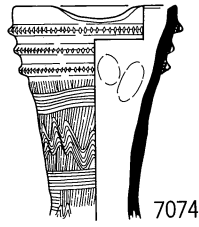
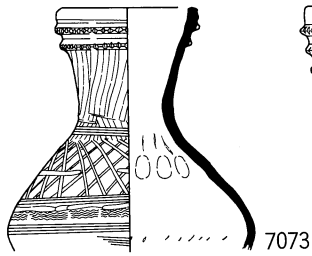

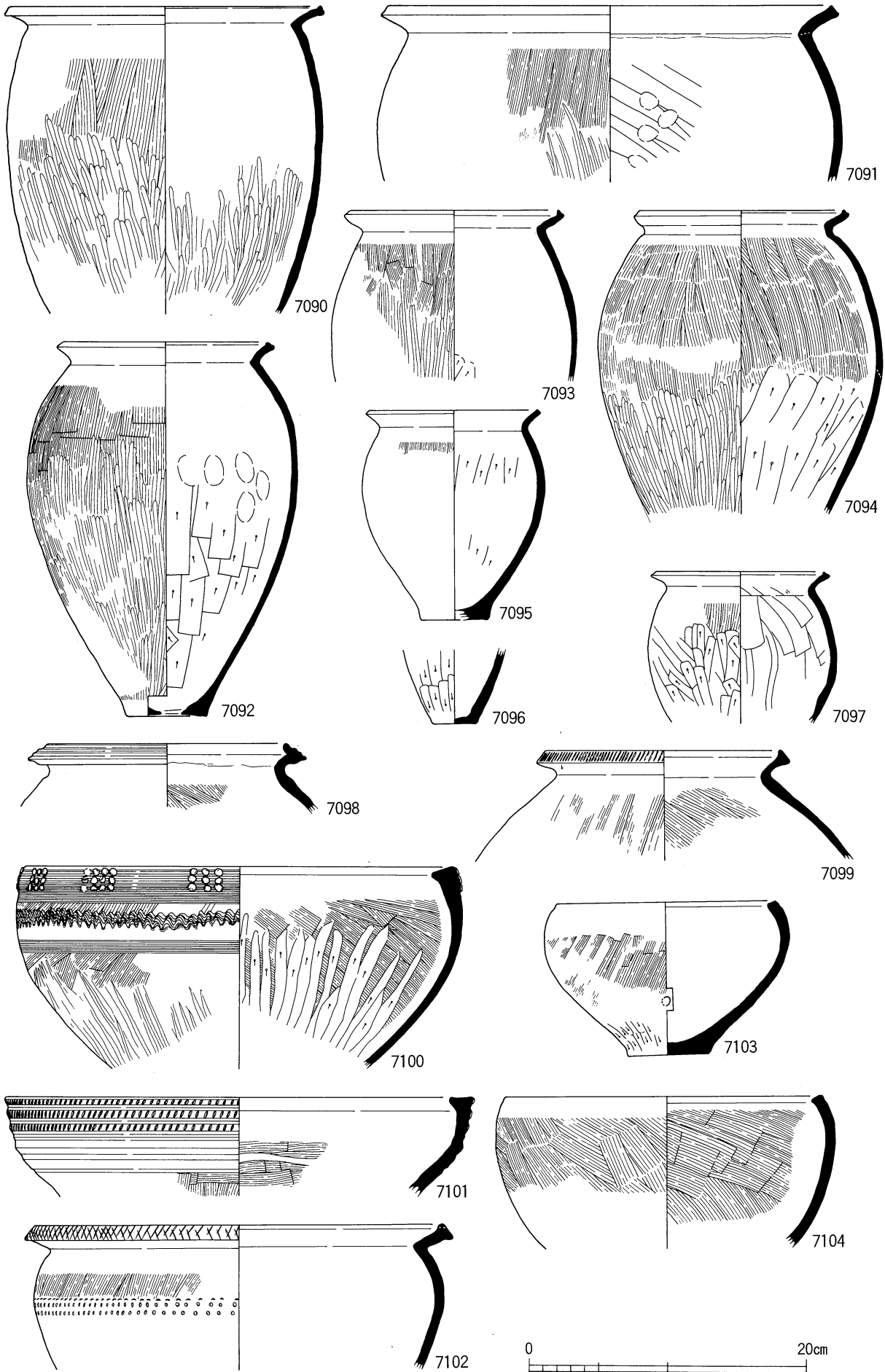

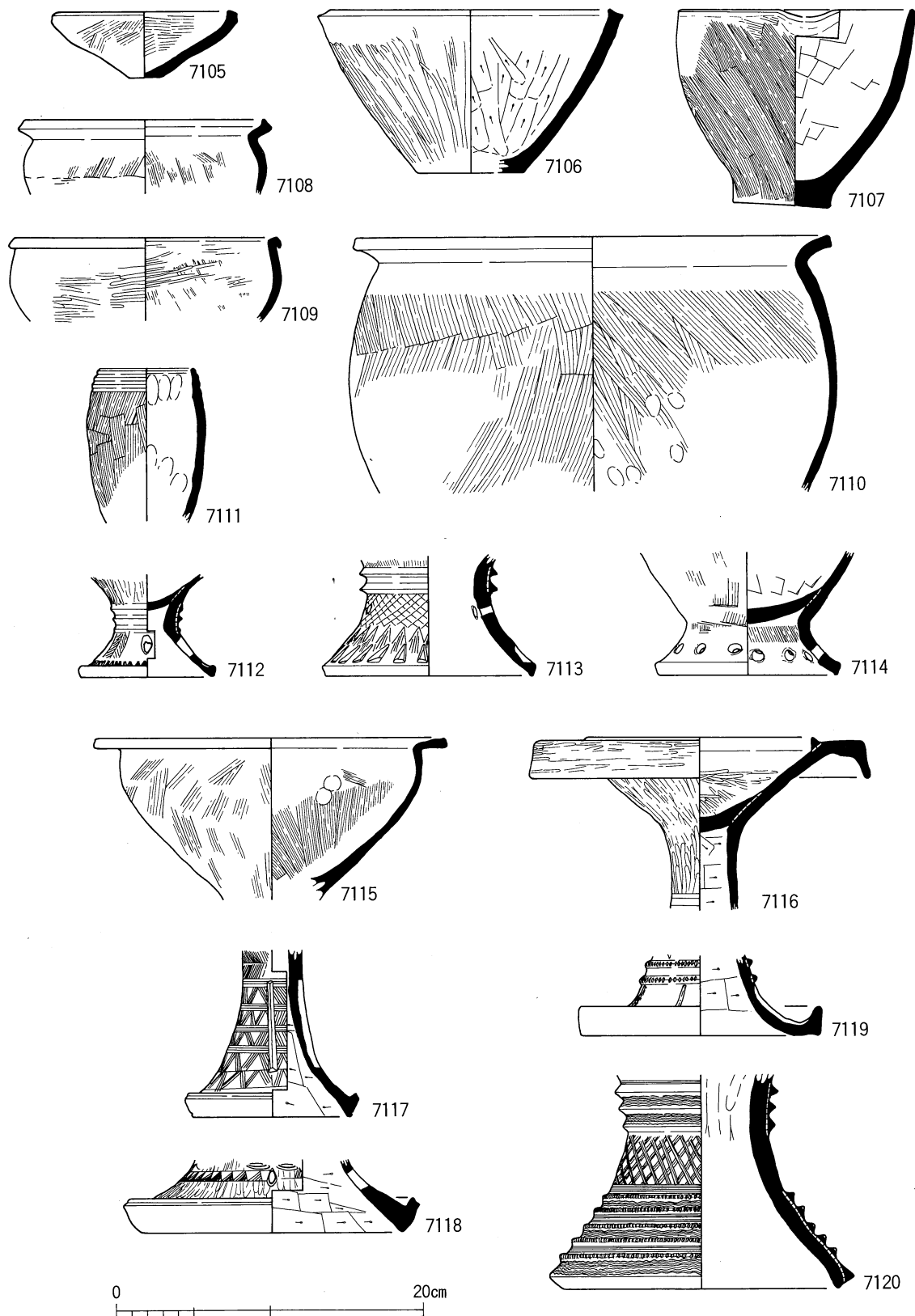

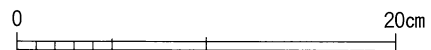
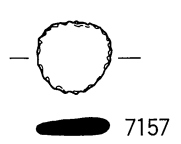
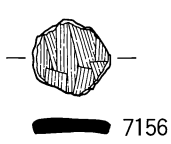
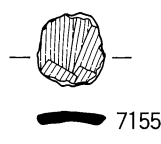
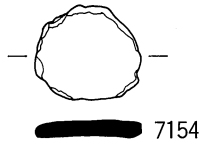
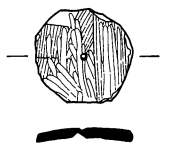
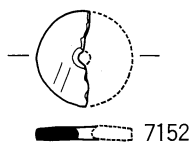
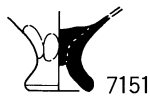
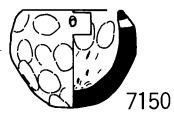
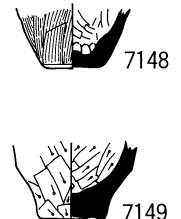
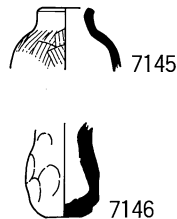
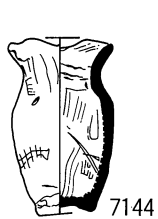
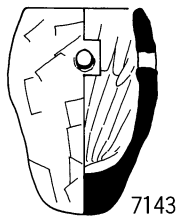
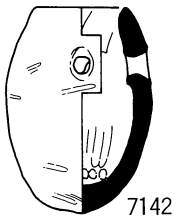
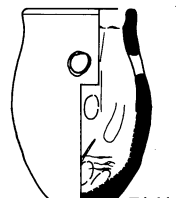
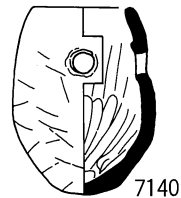
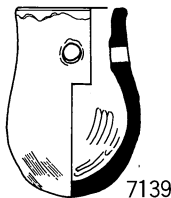
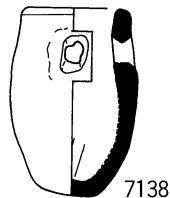
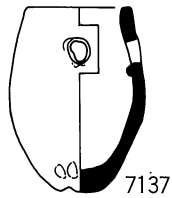
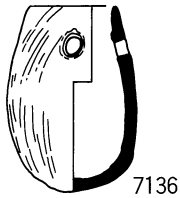
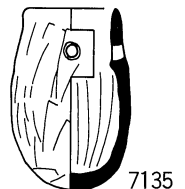
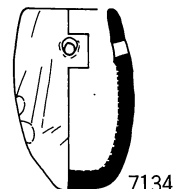
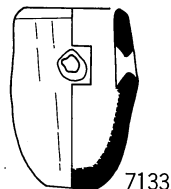
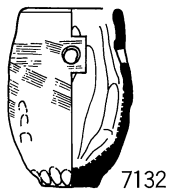
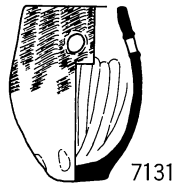
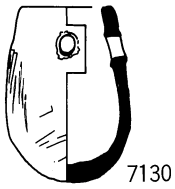
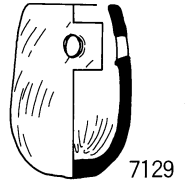
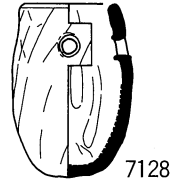
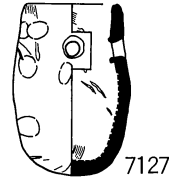
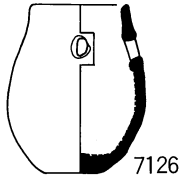
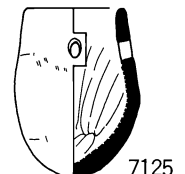
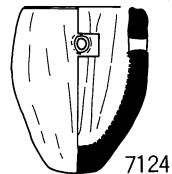
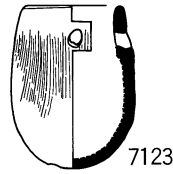
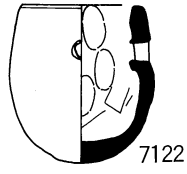
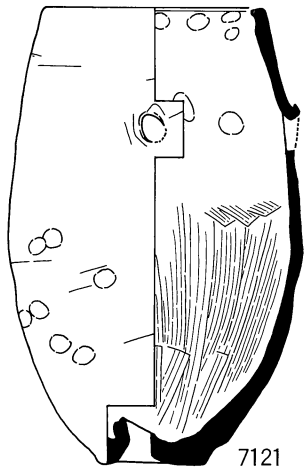

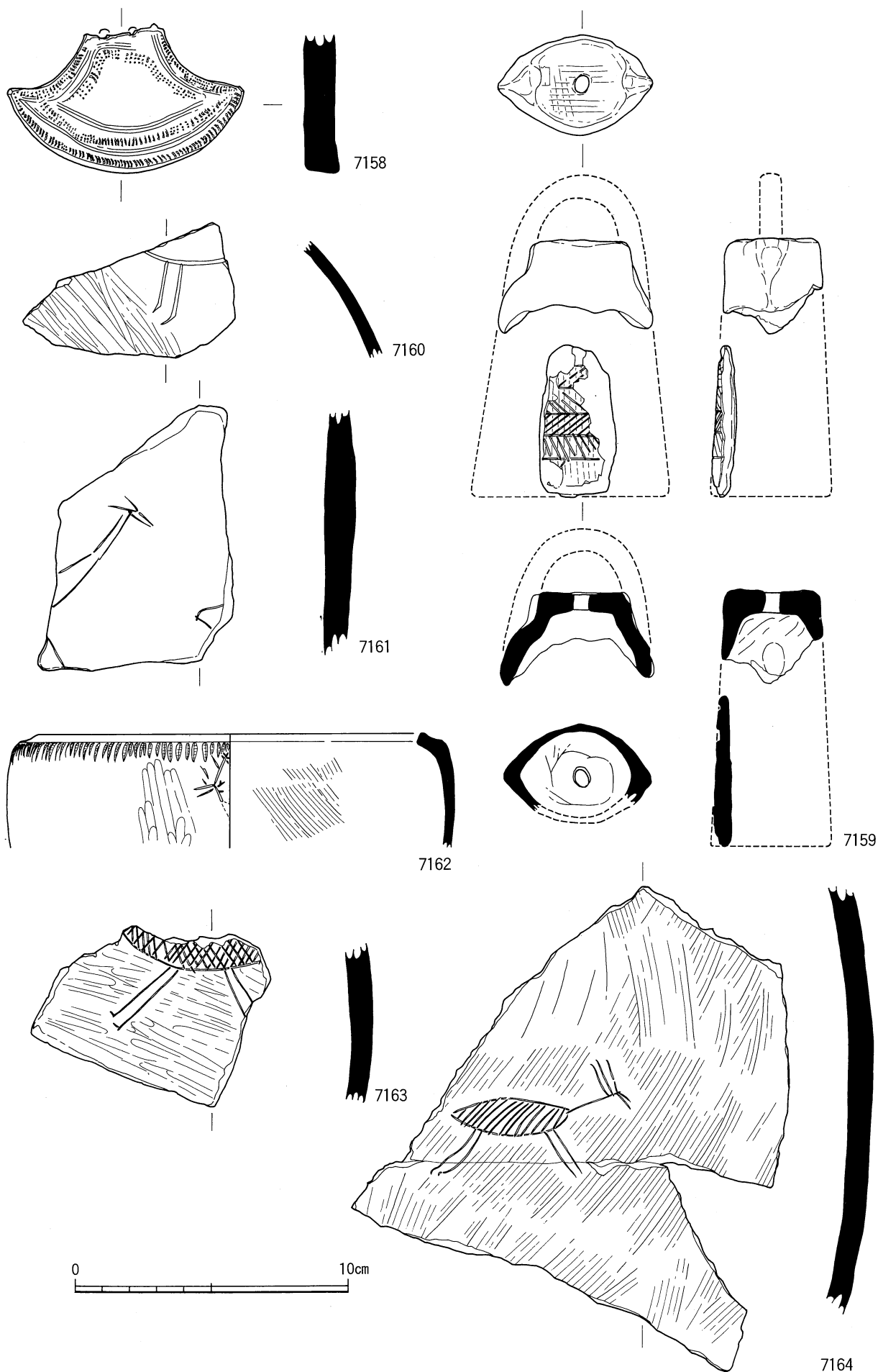

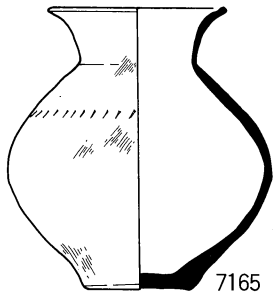

7165

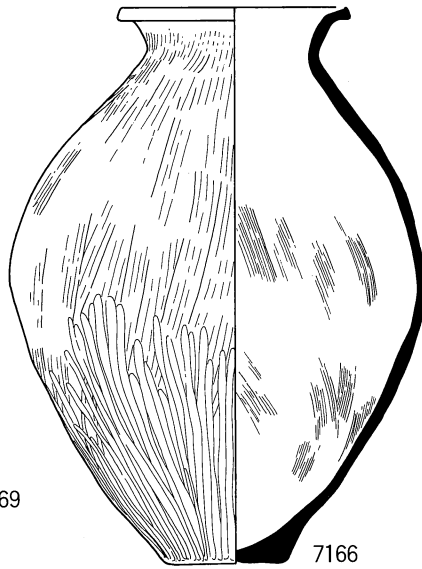

7166

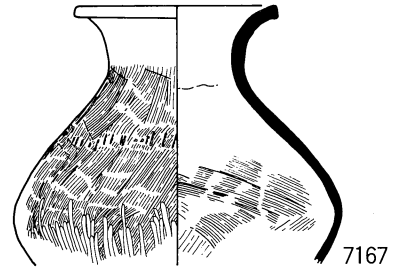

7167

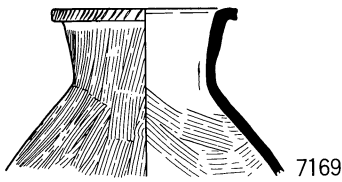

7169

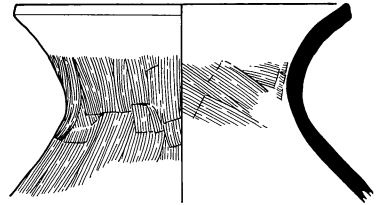

7168

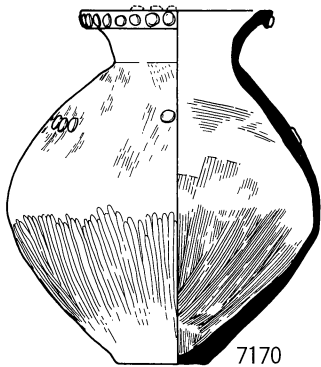

7170

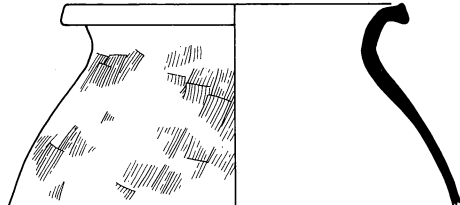

7171

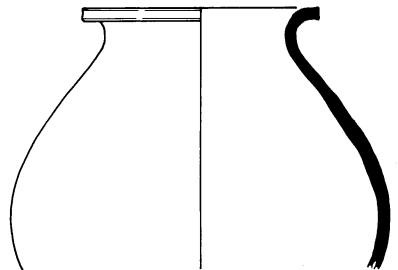

7172

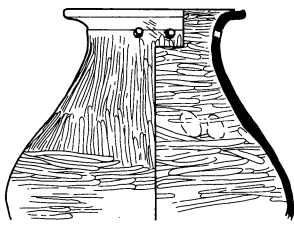

7173

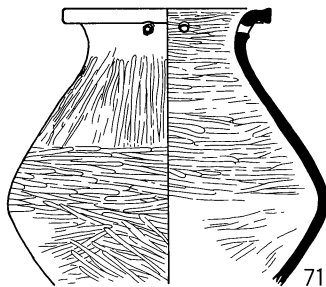

7174

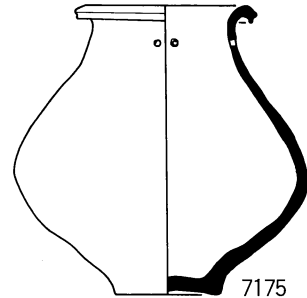

7175

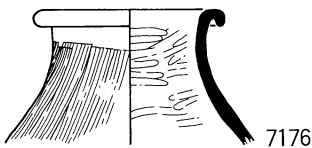

7176

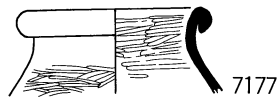

7177

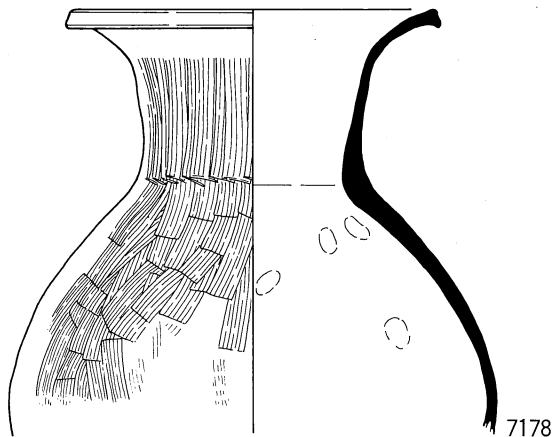

7178

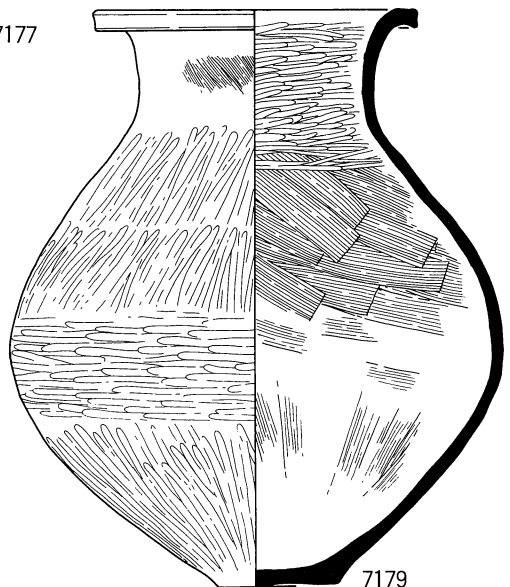

7179



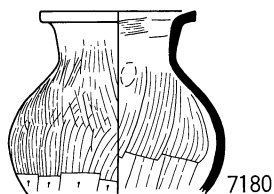

7180

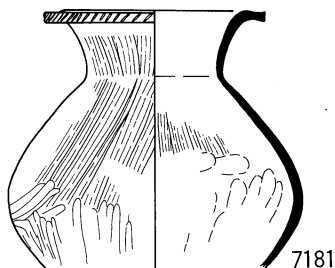

7181

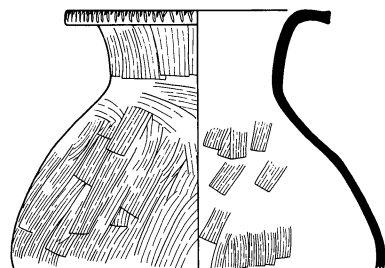

7182

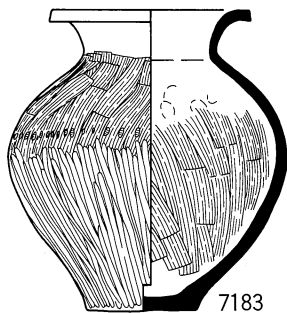

7183

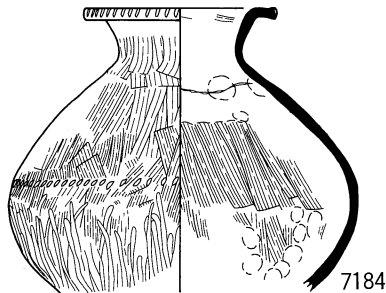

7184

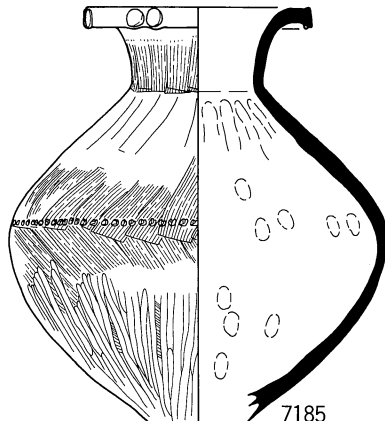

7185

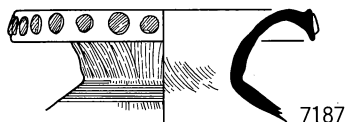

7187



7188



7189

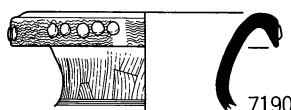

7190

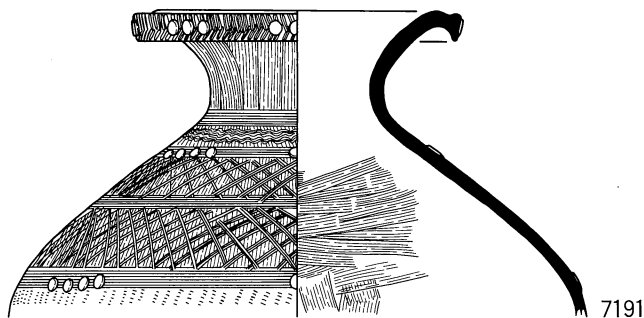

7191

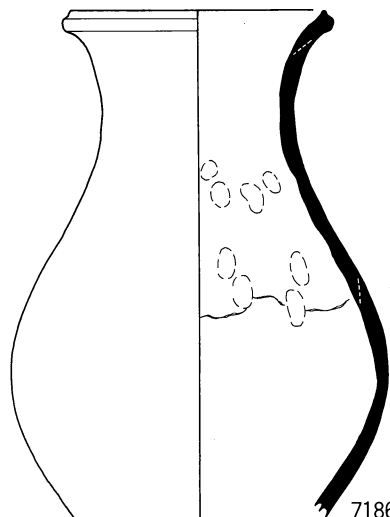

7186

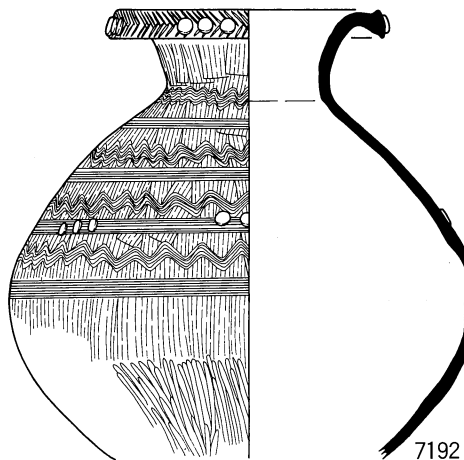

7192

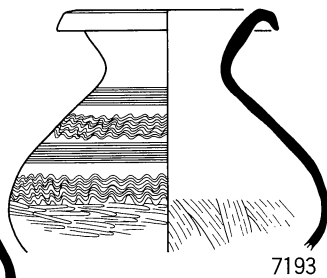

7193

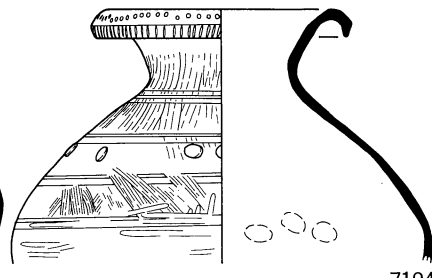

7194



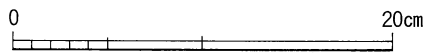
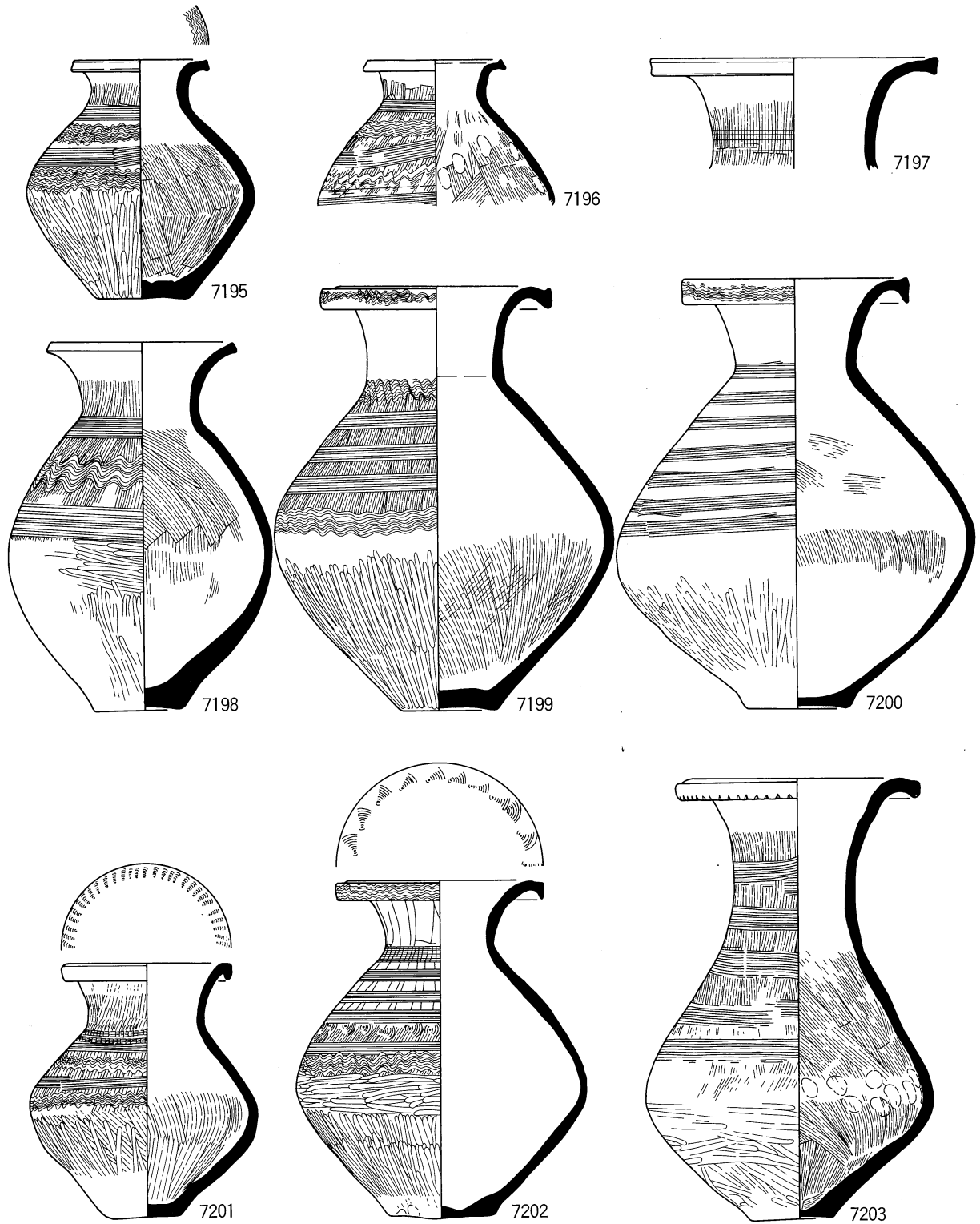

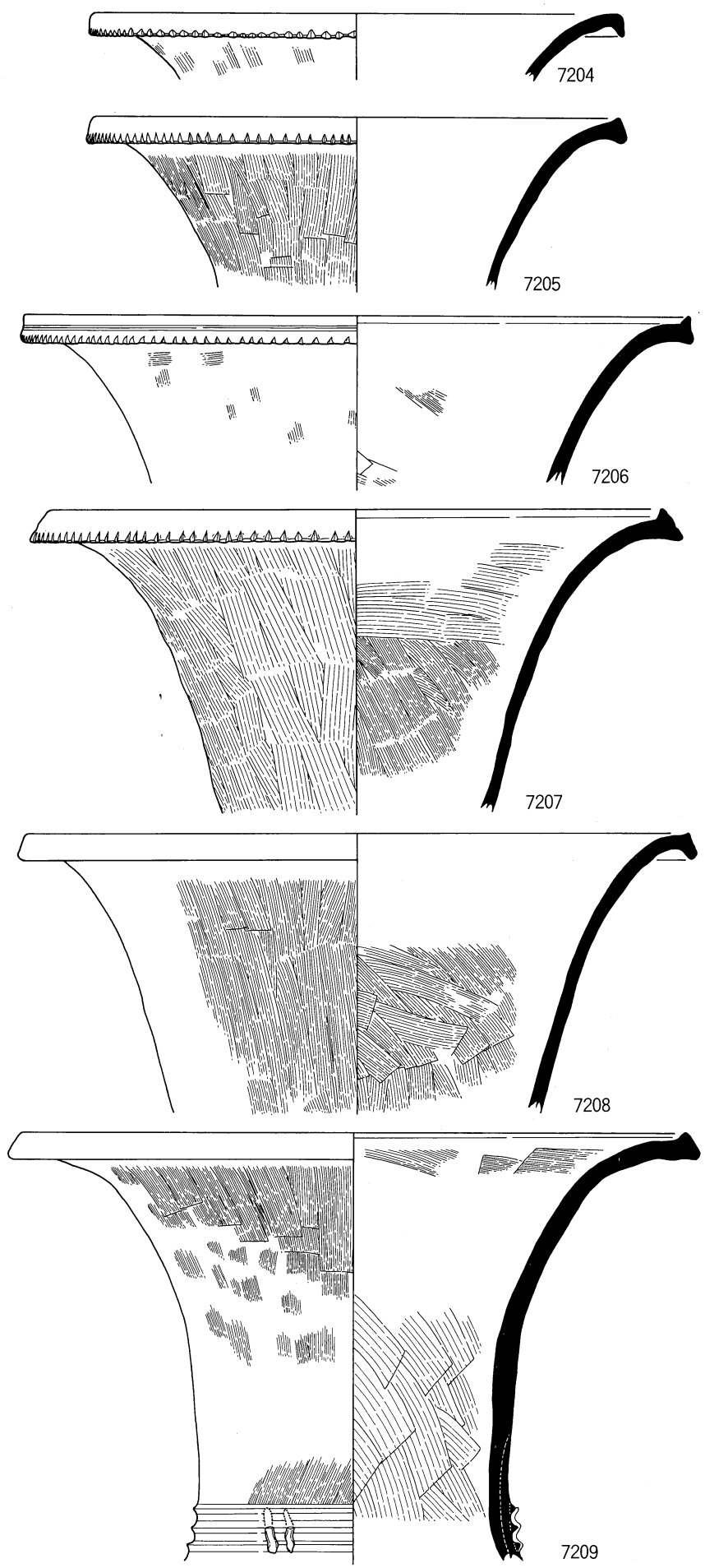

弥生中期上層 旧河道出土土器12 (SR46002)

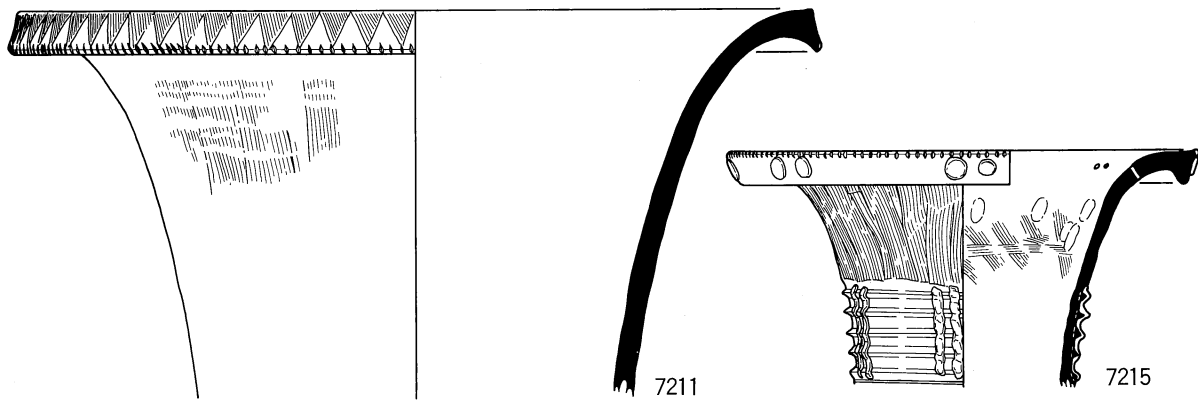
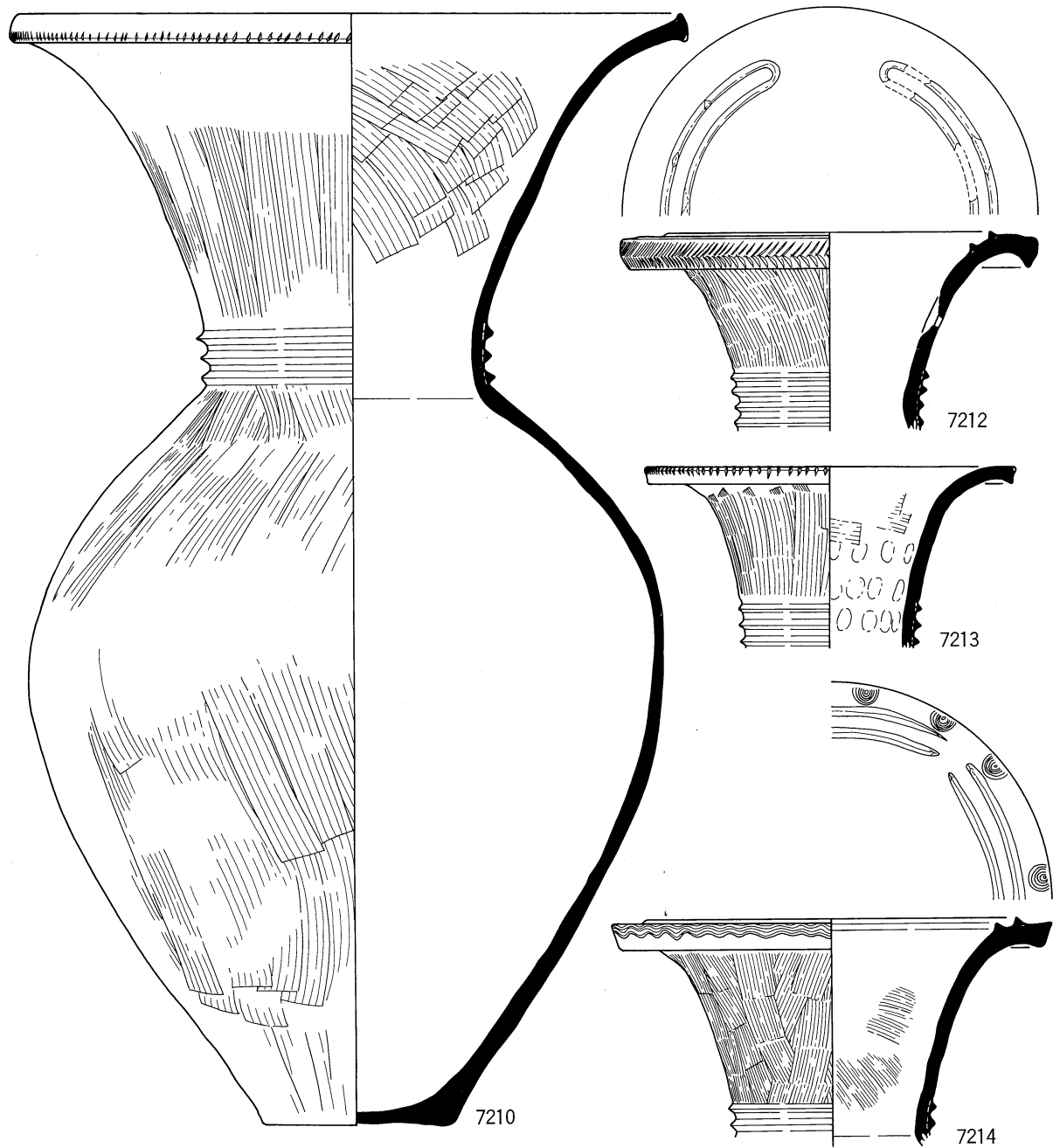

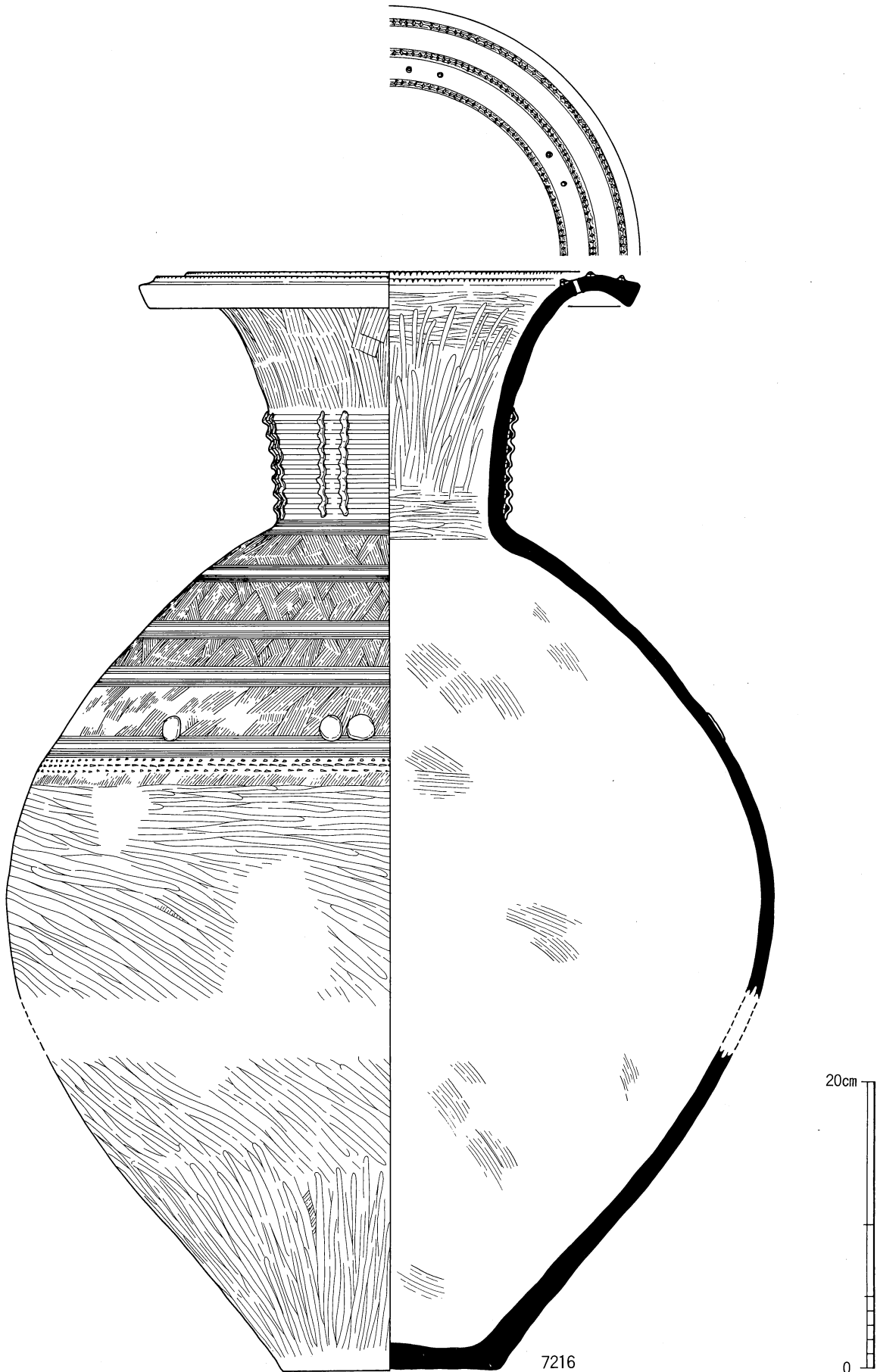

弥生中期上層 旧河道出土土器14 (SR46002)

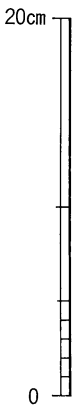
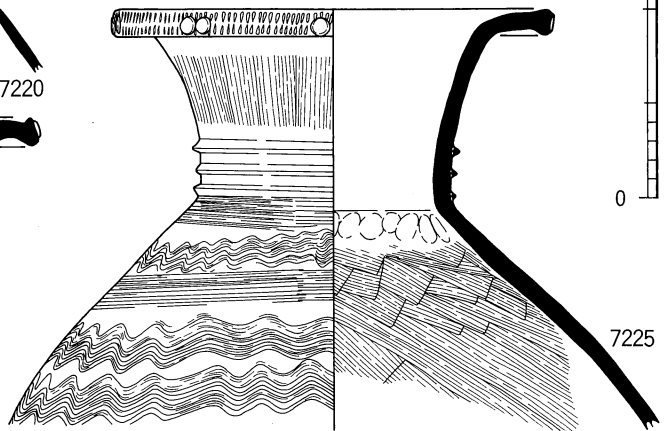
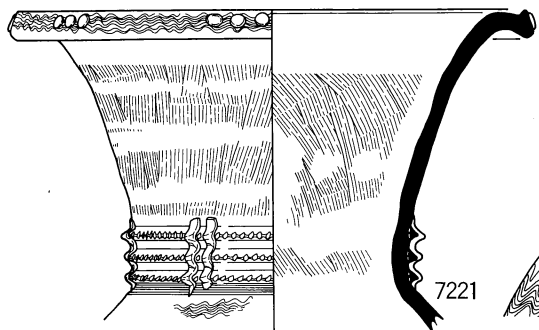
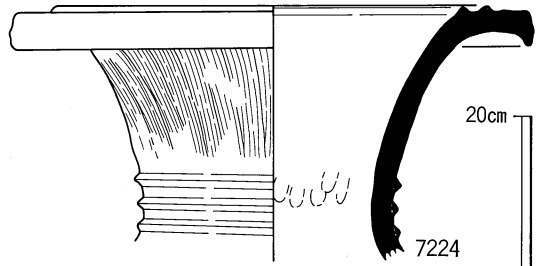
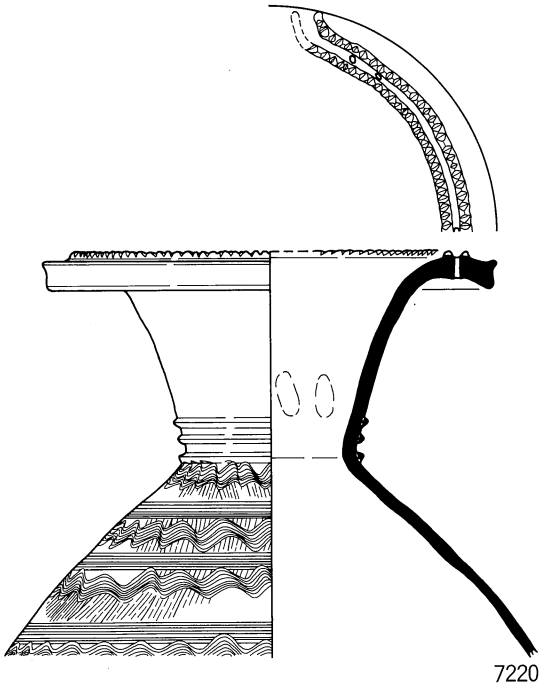
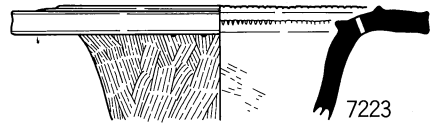
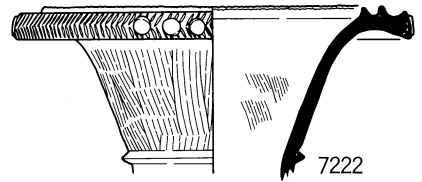
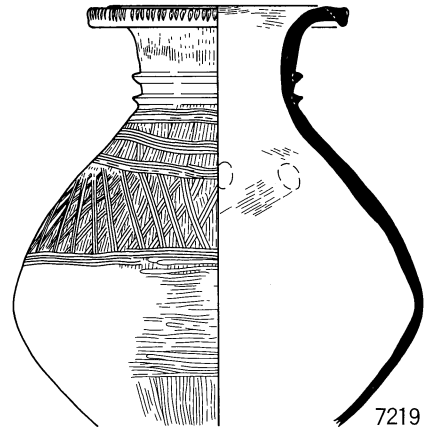
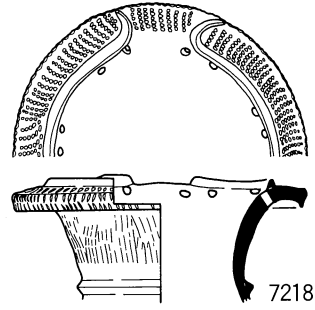
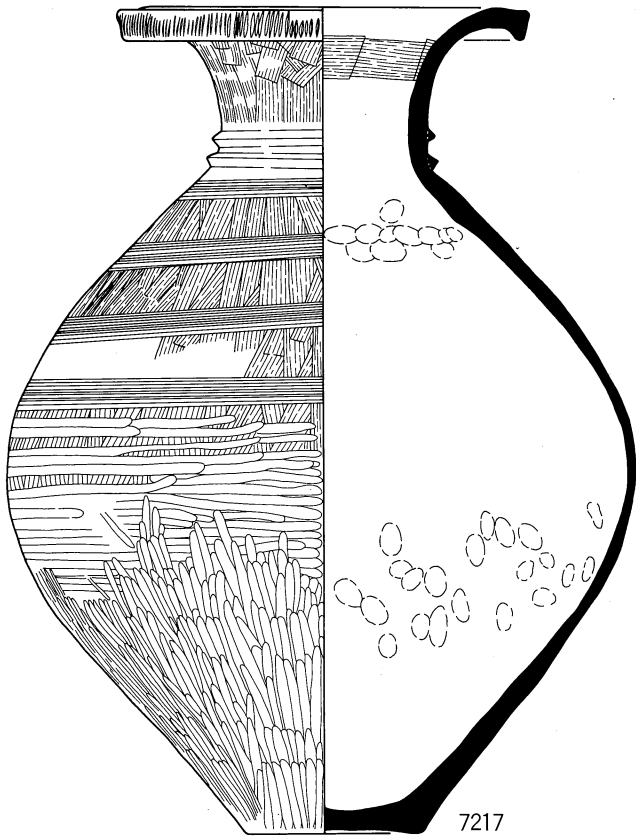

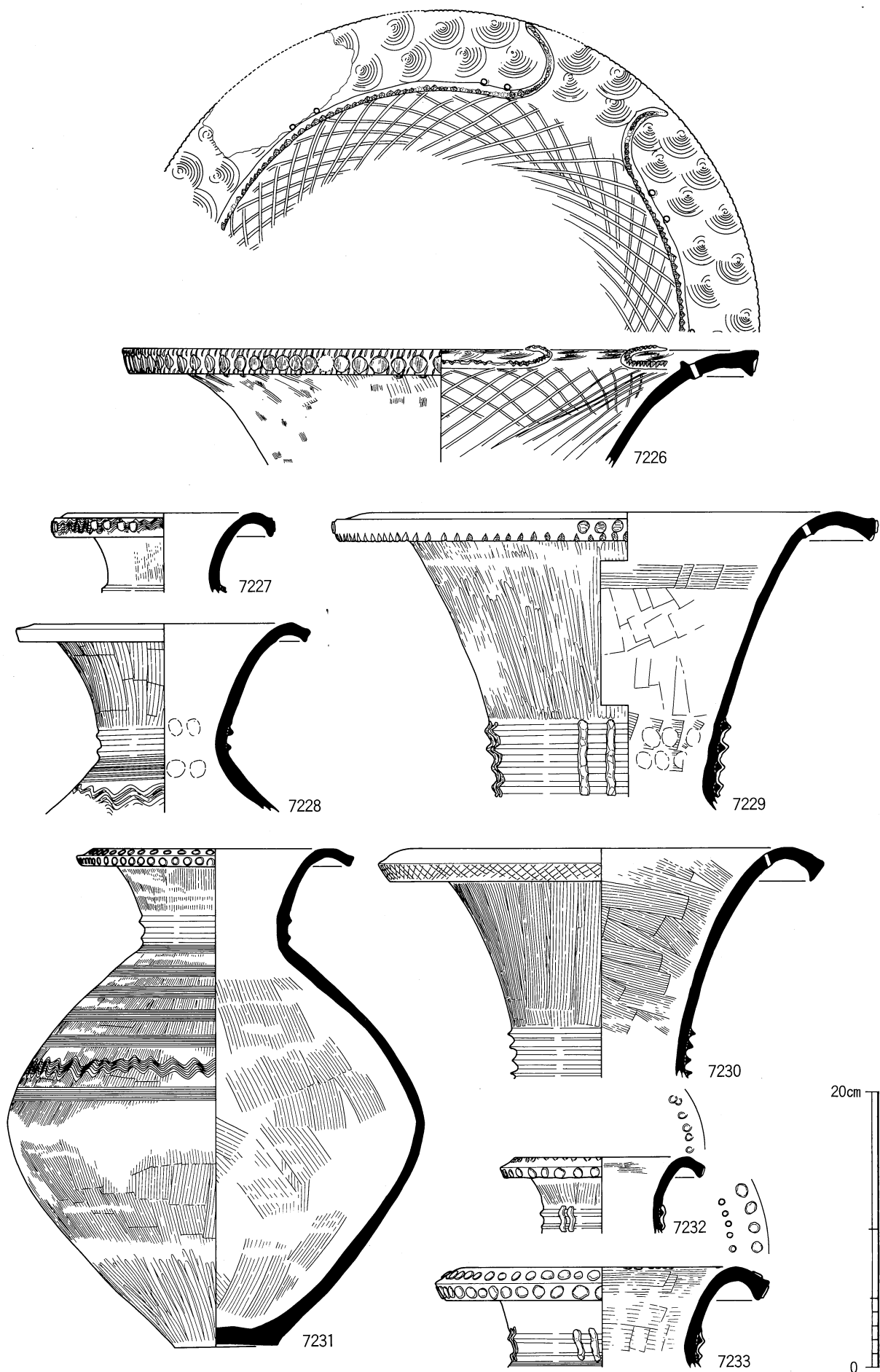

弥生中期上層 旧河道出土土器16 (SR46002)

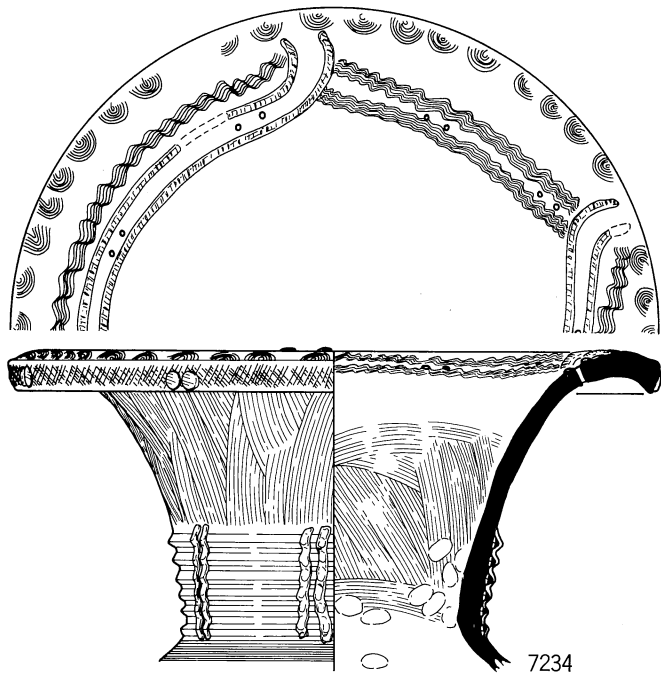

7234

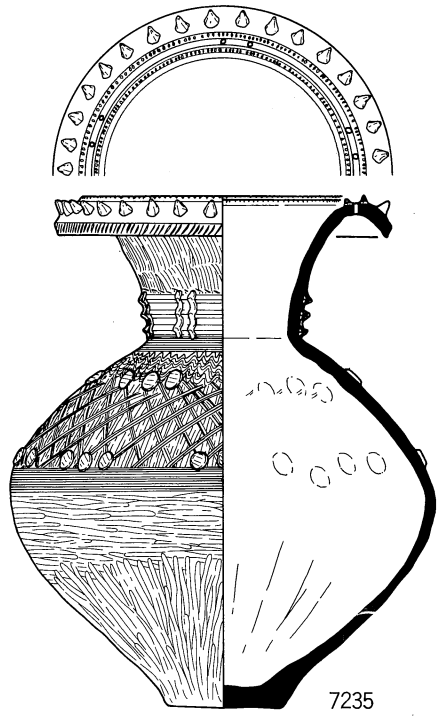

7235

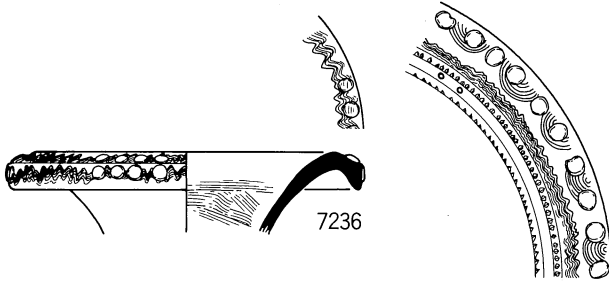

7236

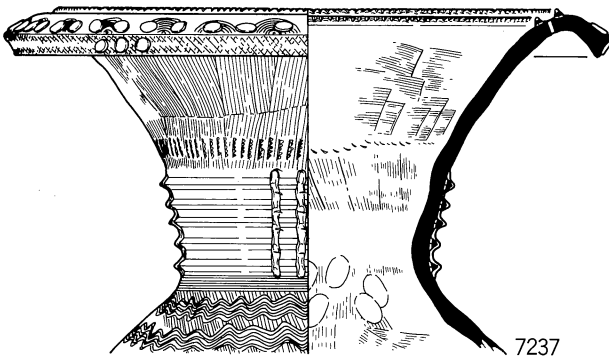

7237

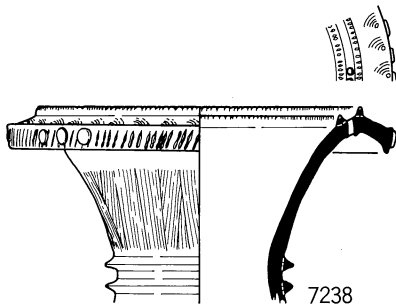

7238

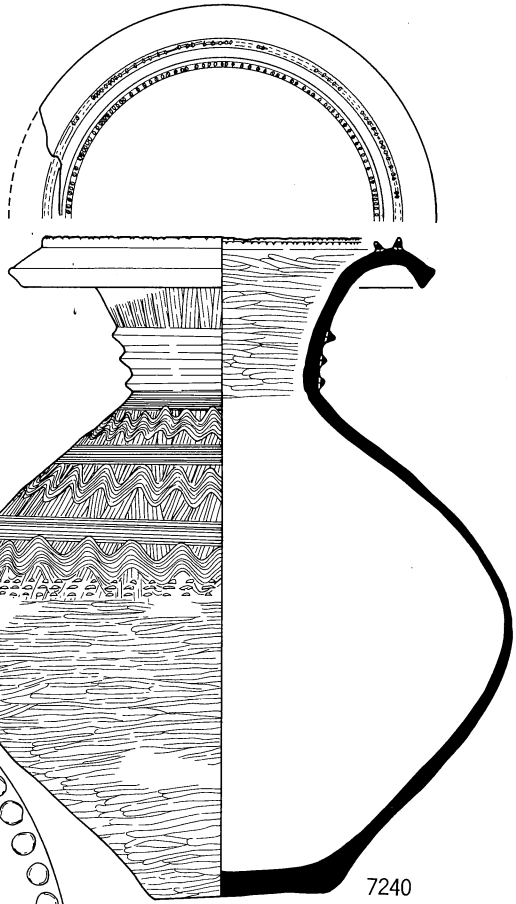

7240

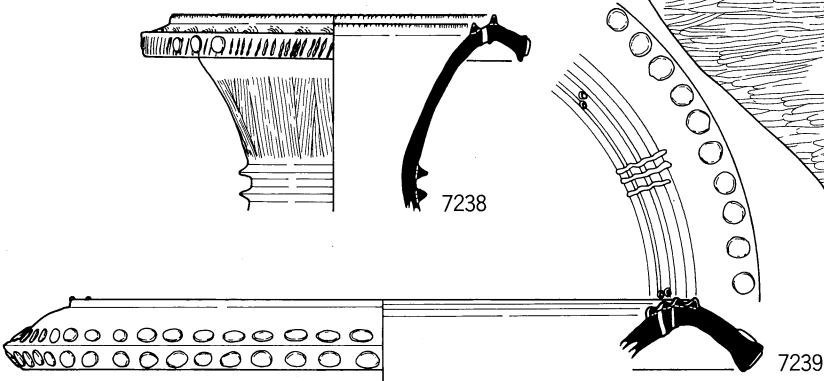

7239



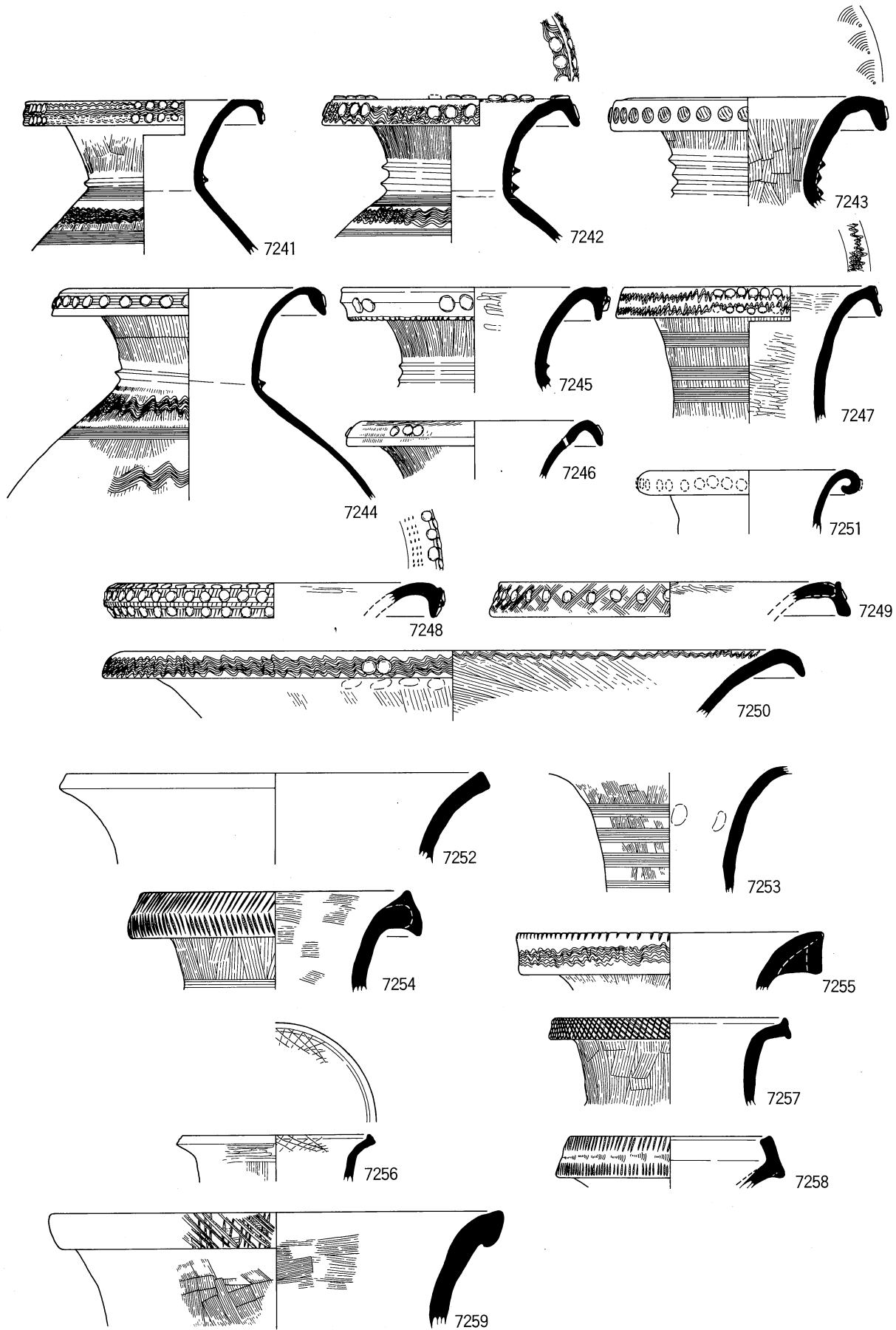

0 20cm

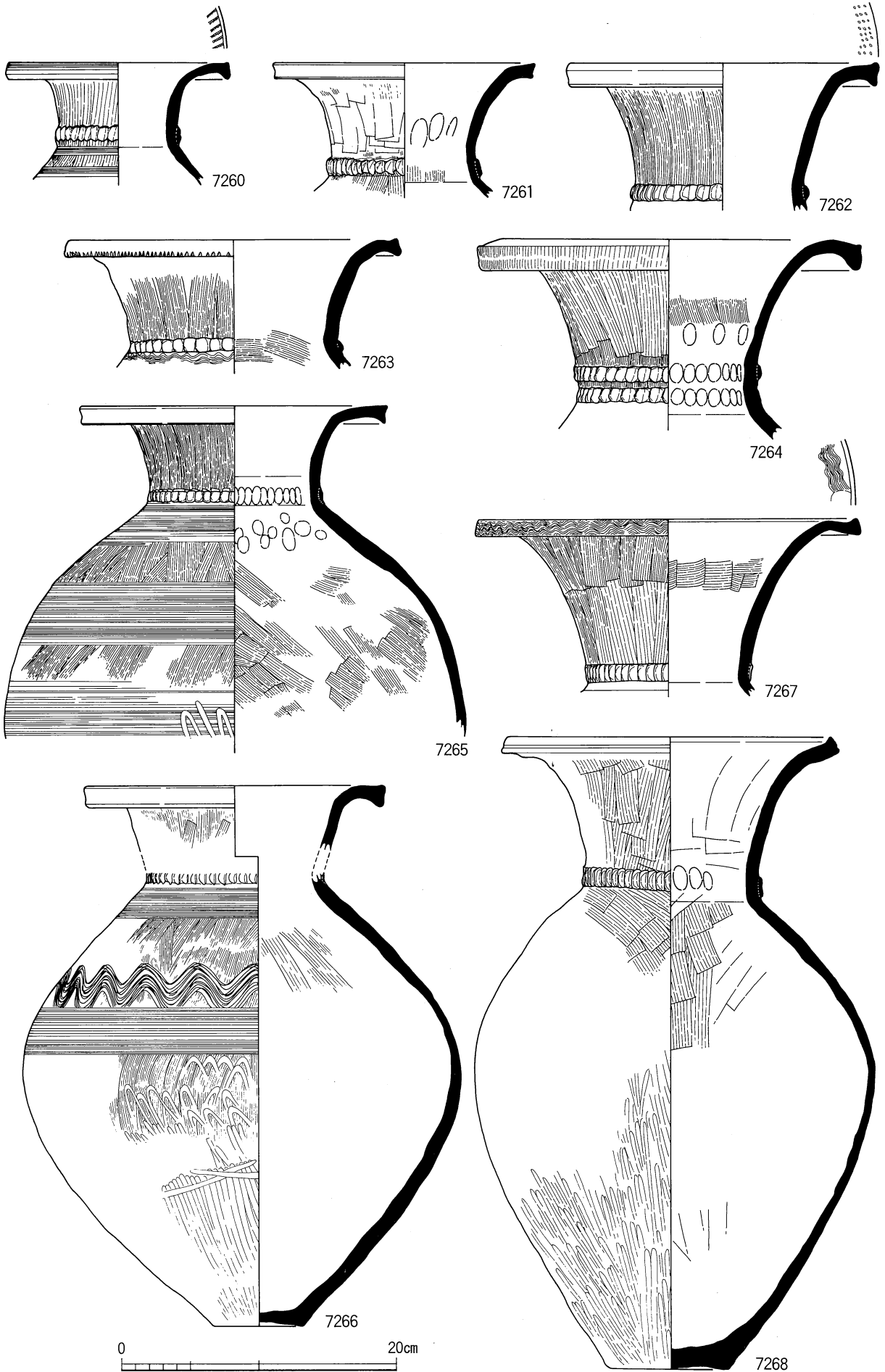

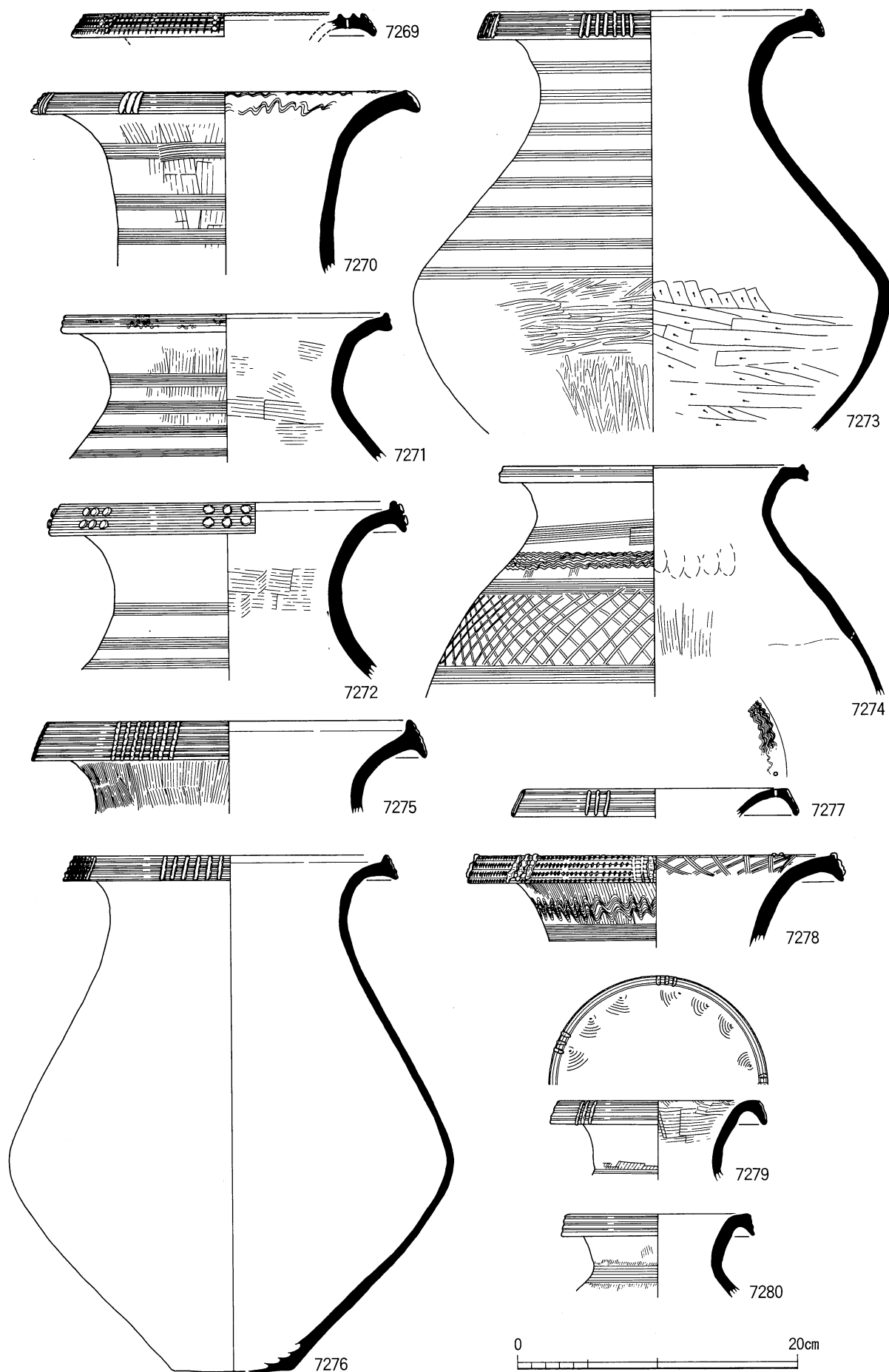

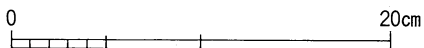
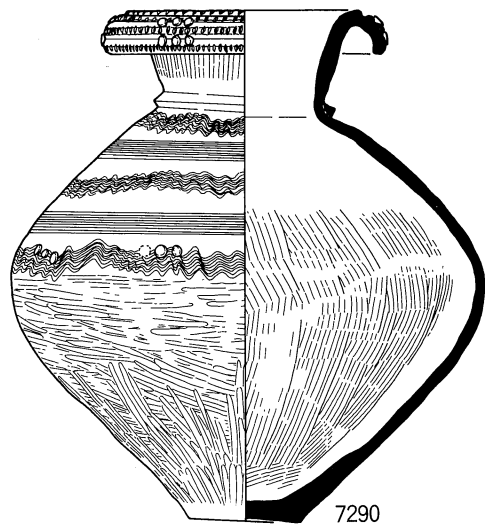
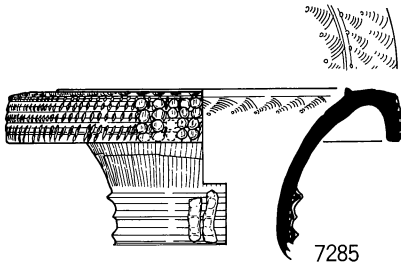
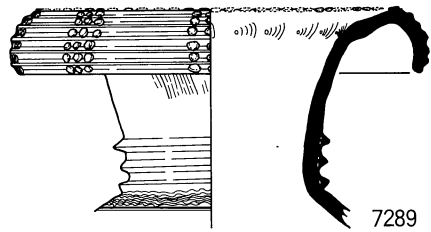
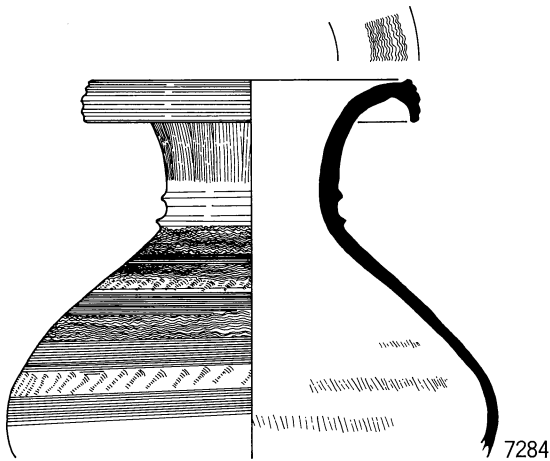
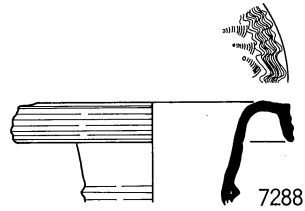
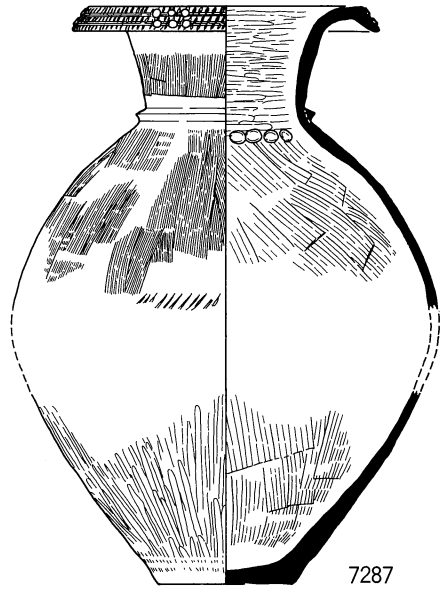
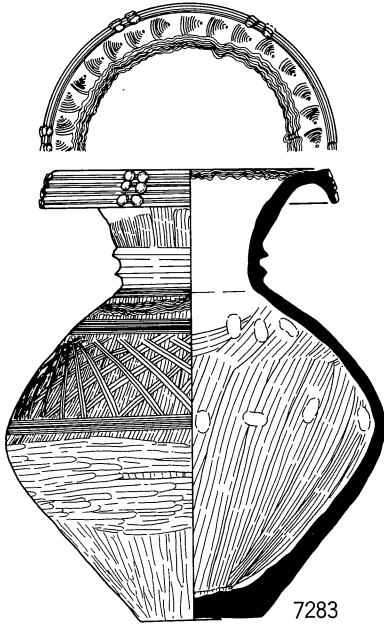
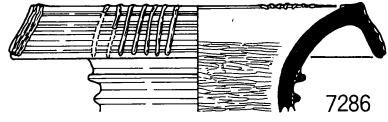
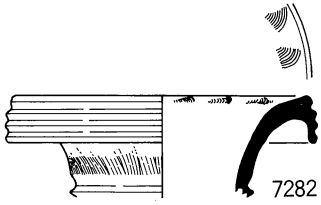
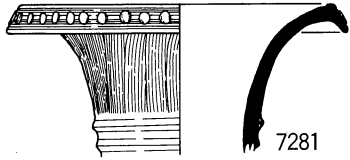

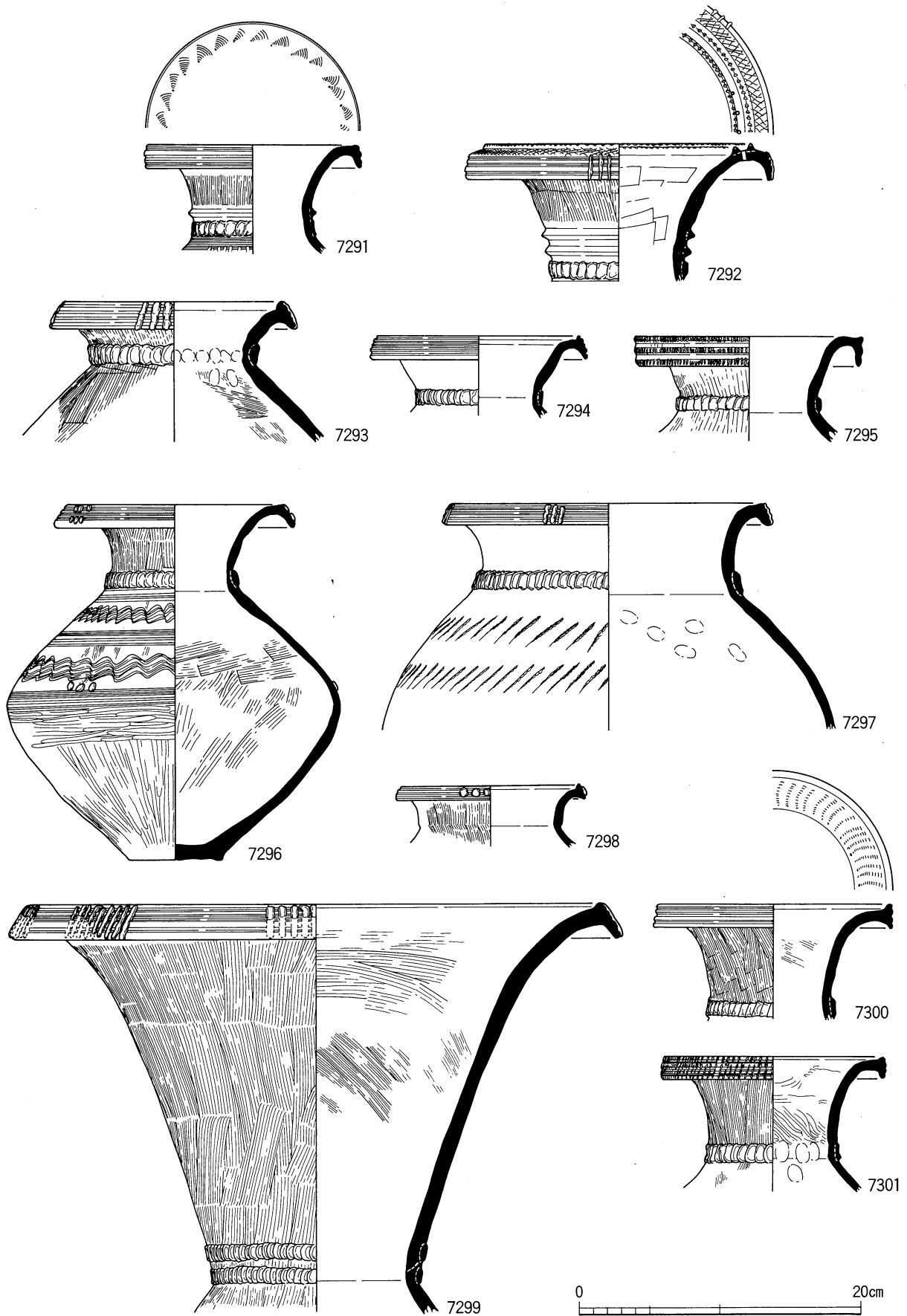

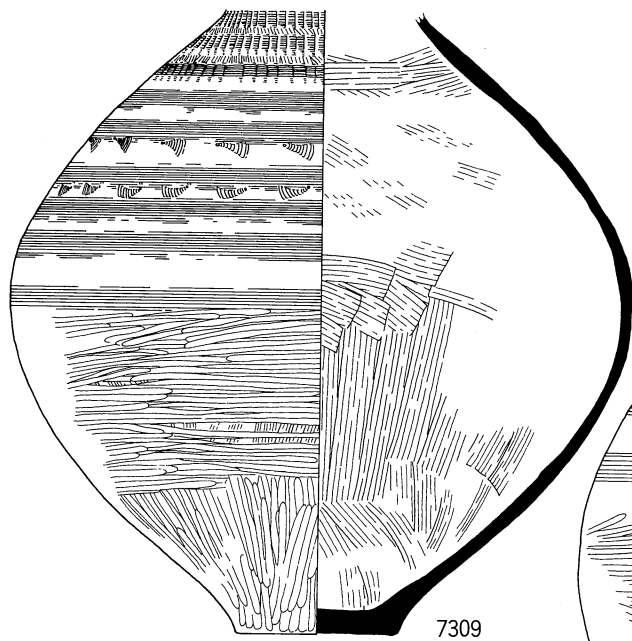
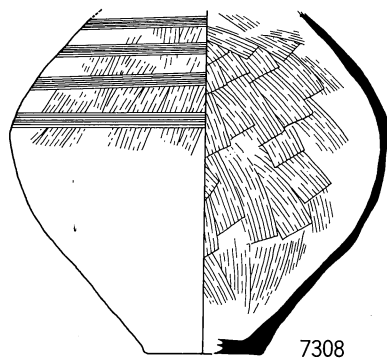
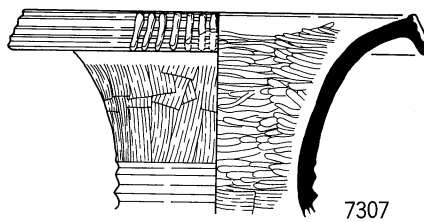
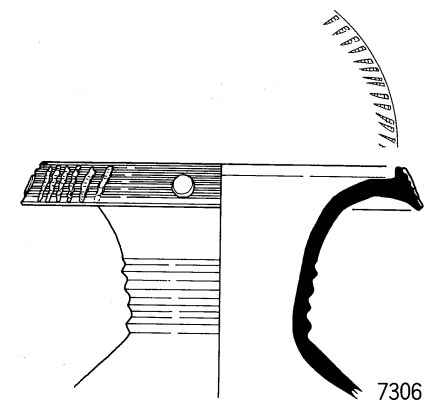
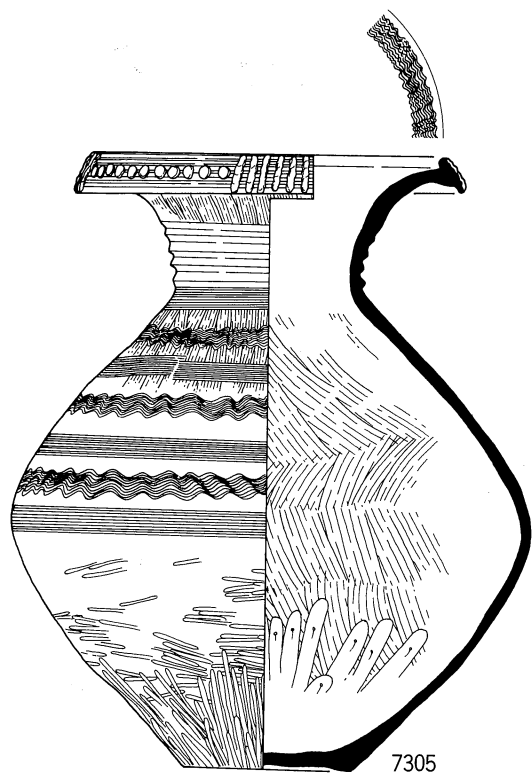
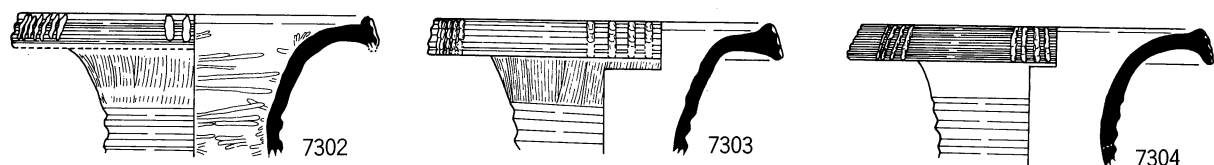

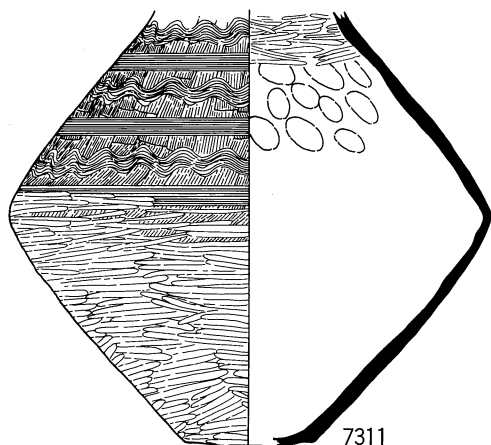

7311

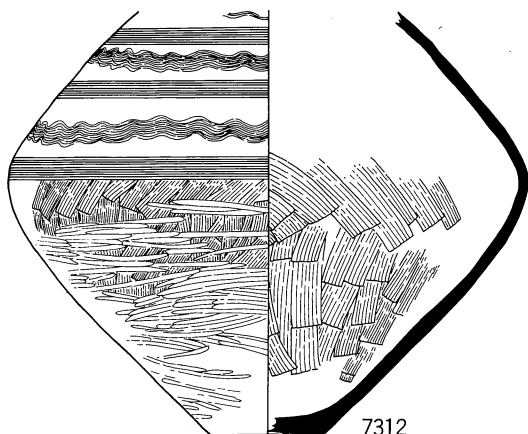

7312

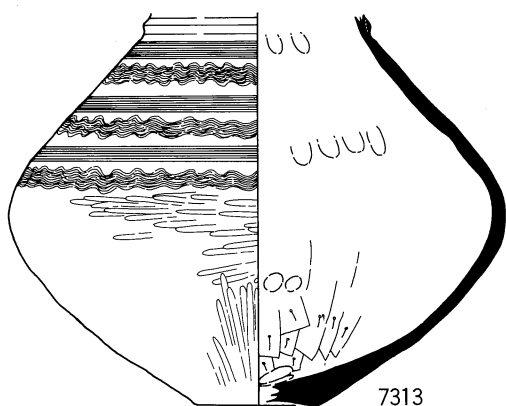

7313

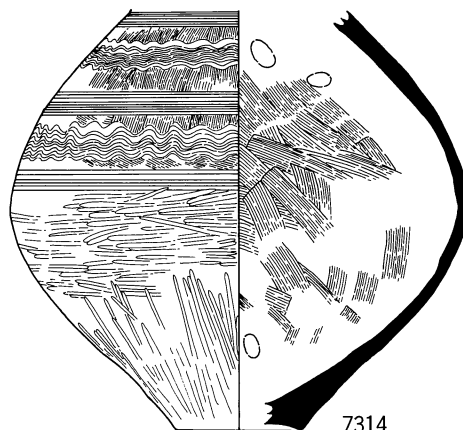

7314

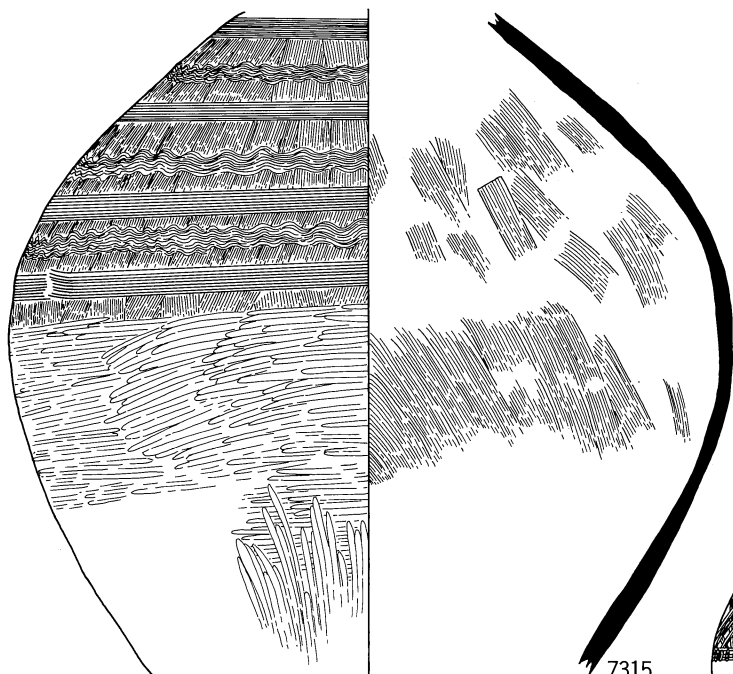

7315

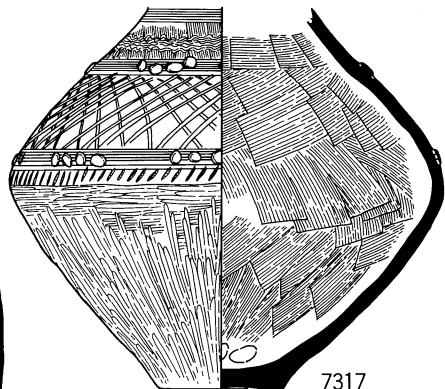

7317

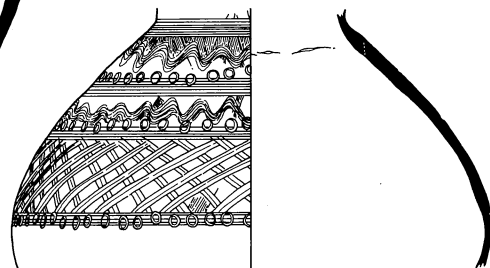

7318

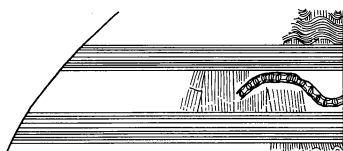

7316



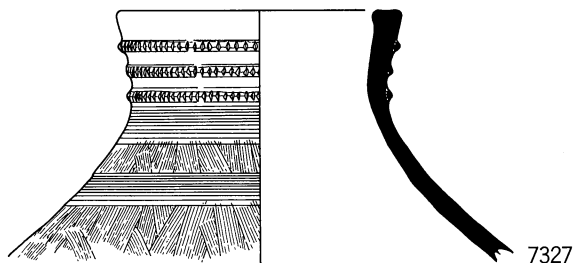
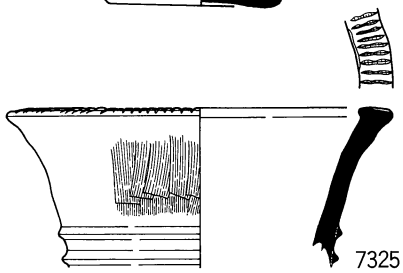
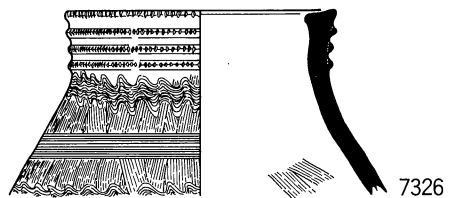
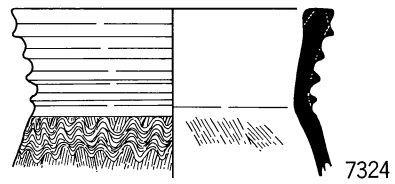
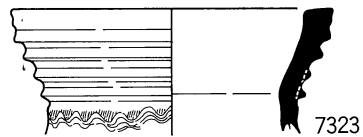
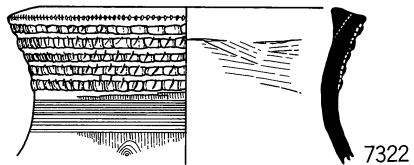
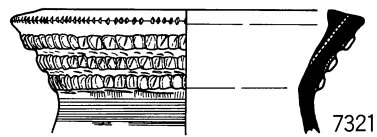
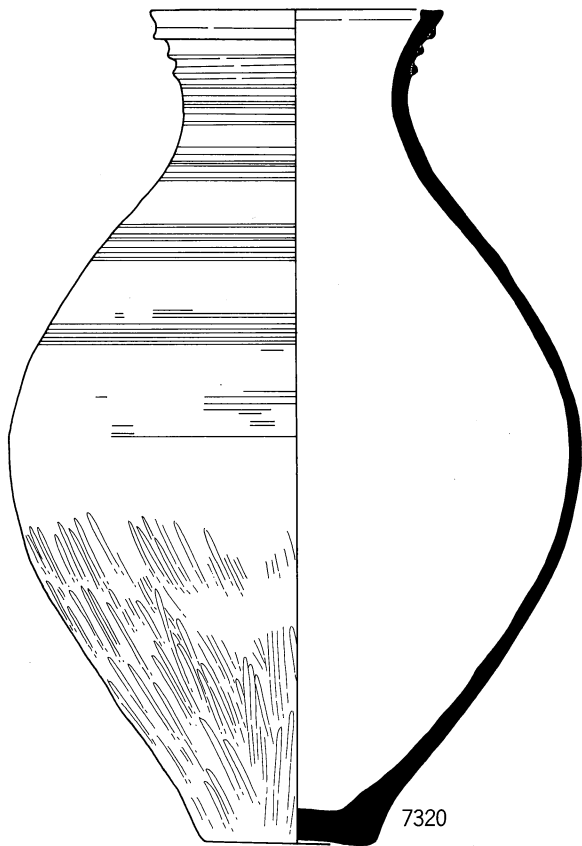
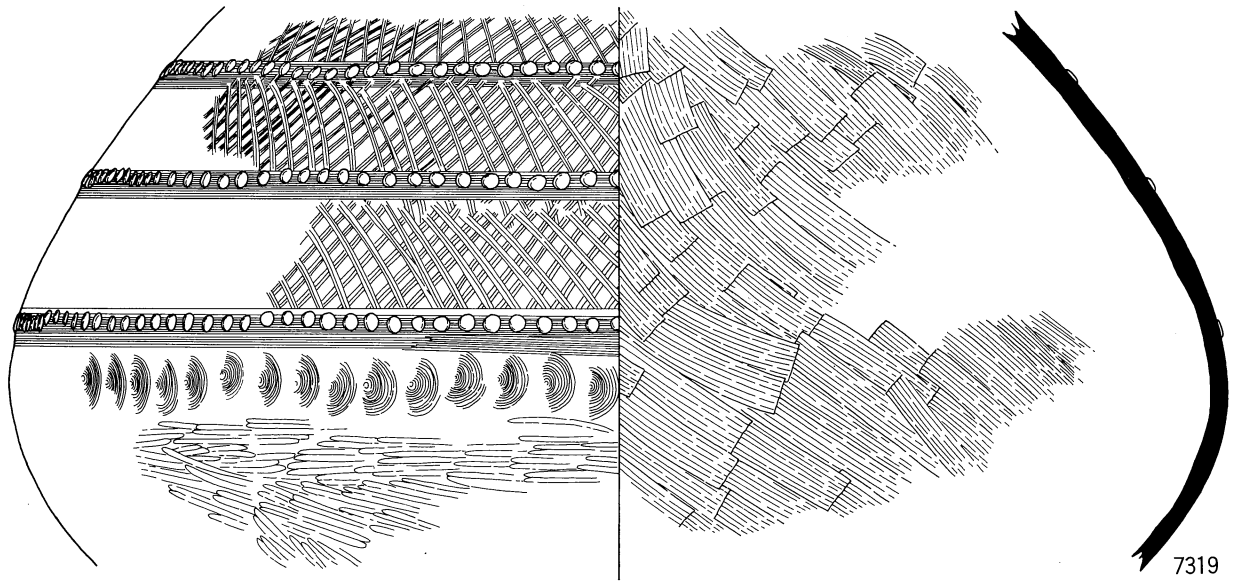

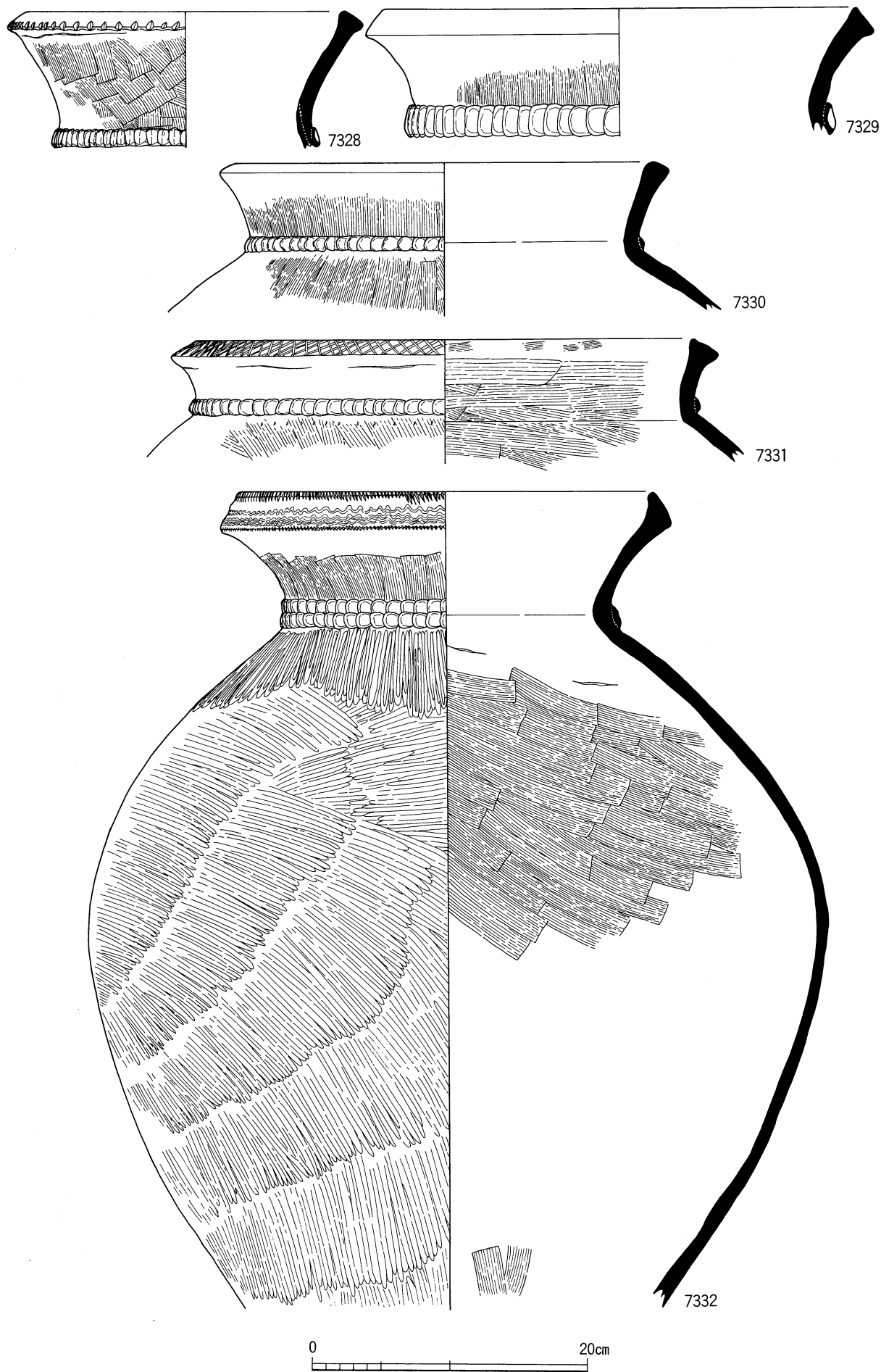

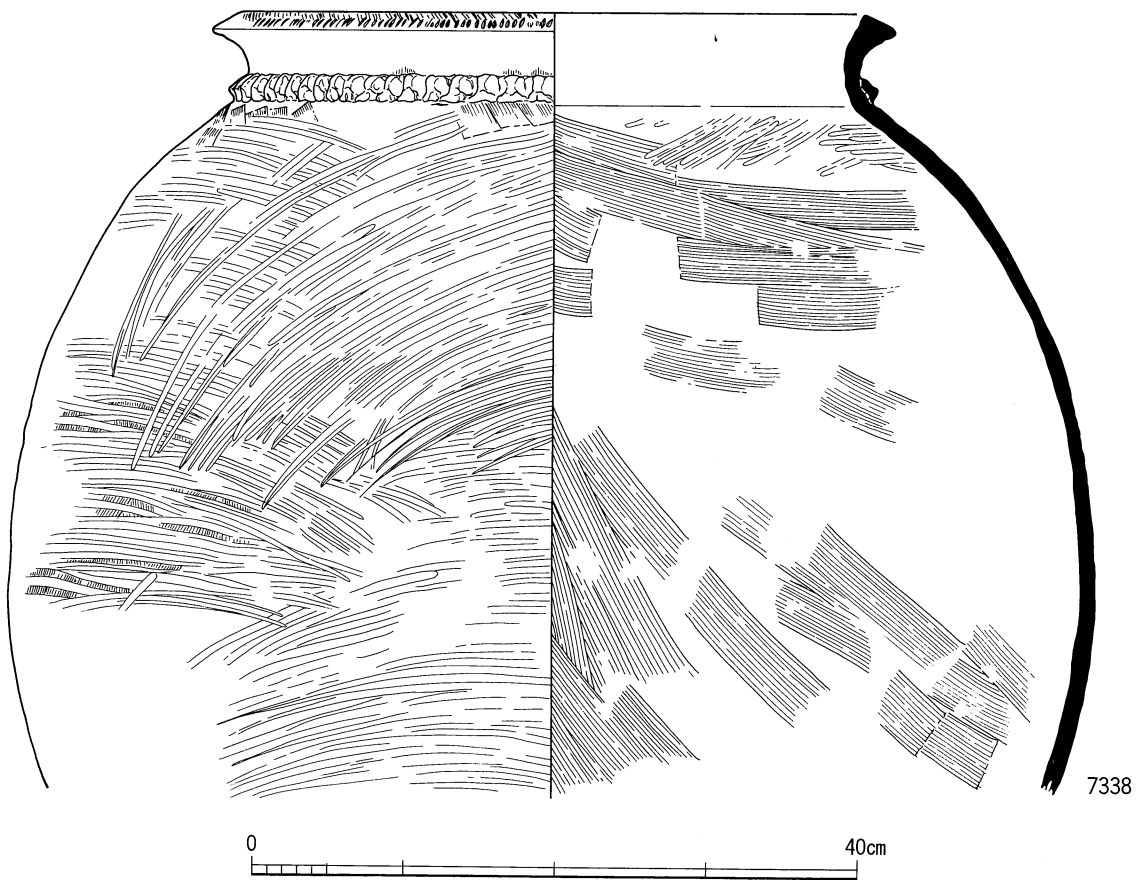
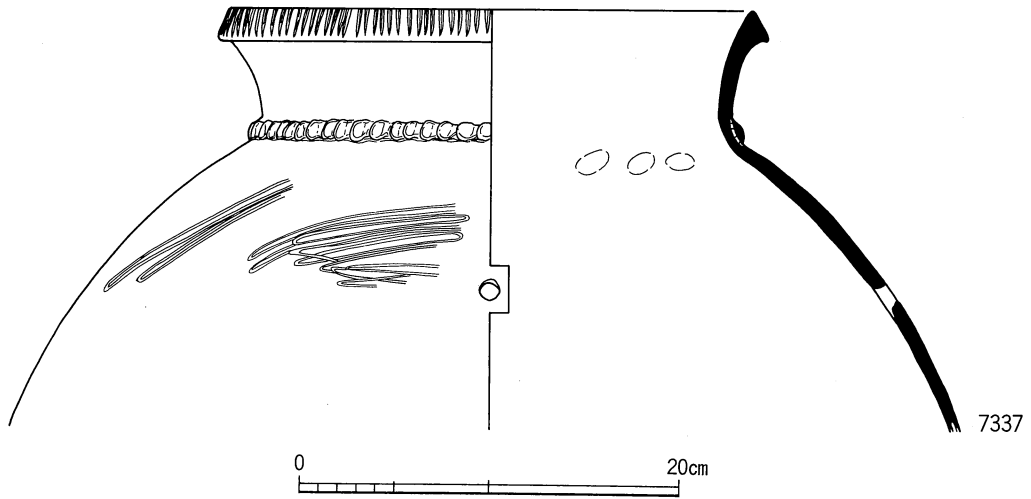
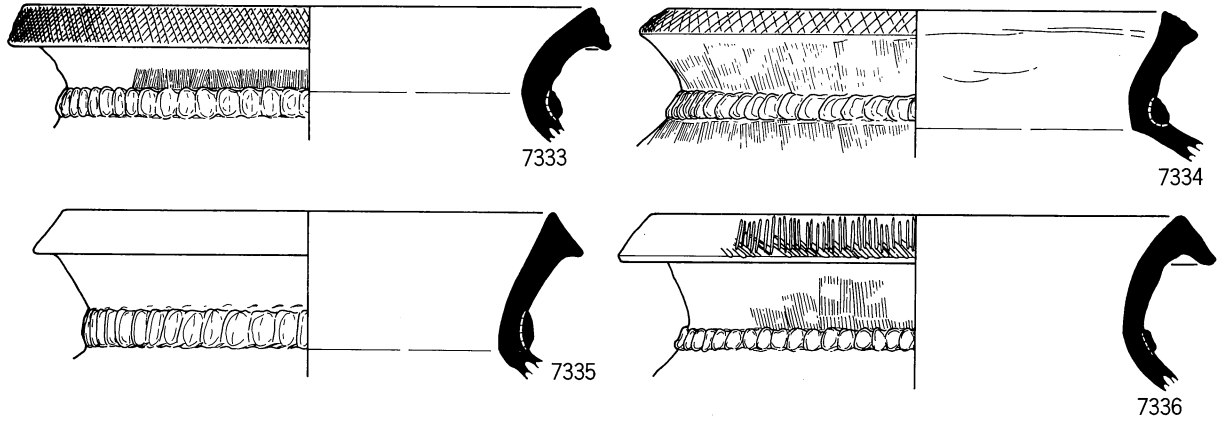

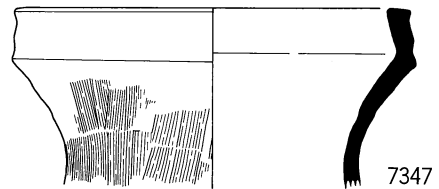
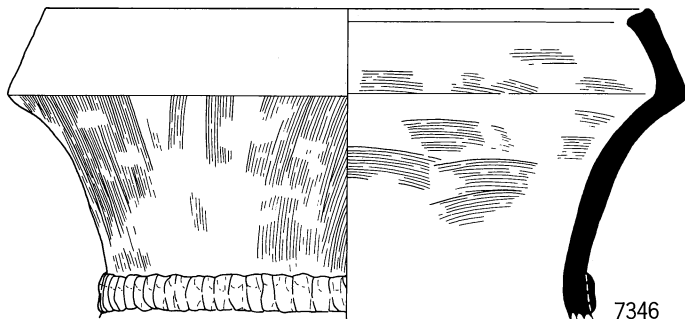
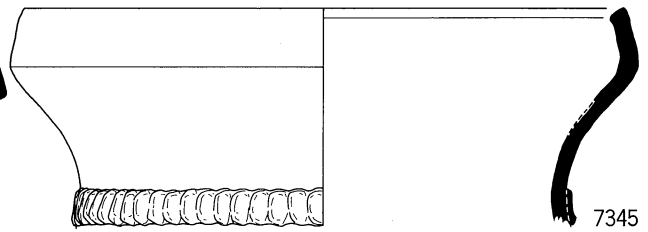
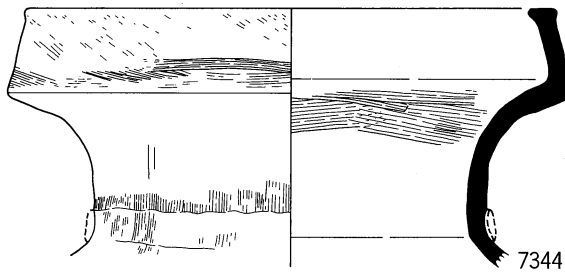
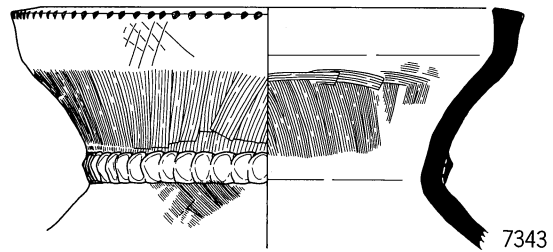
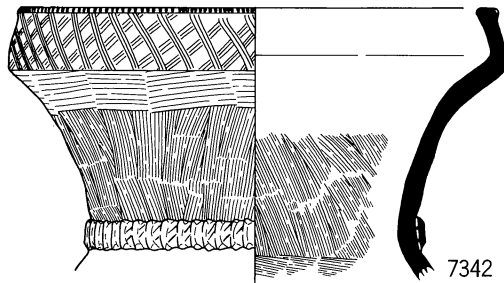
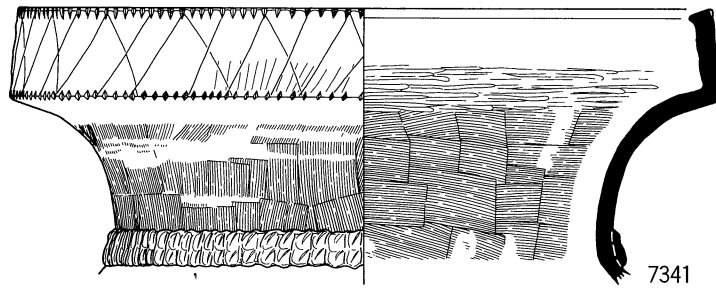
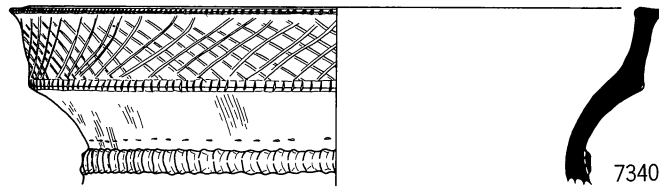
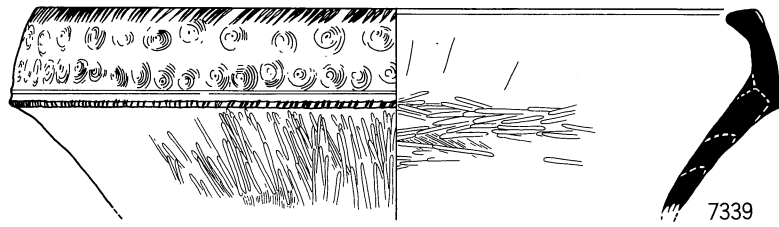

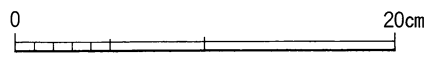
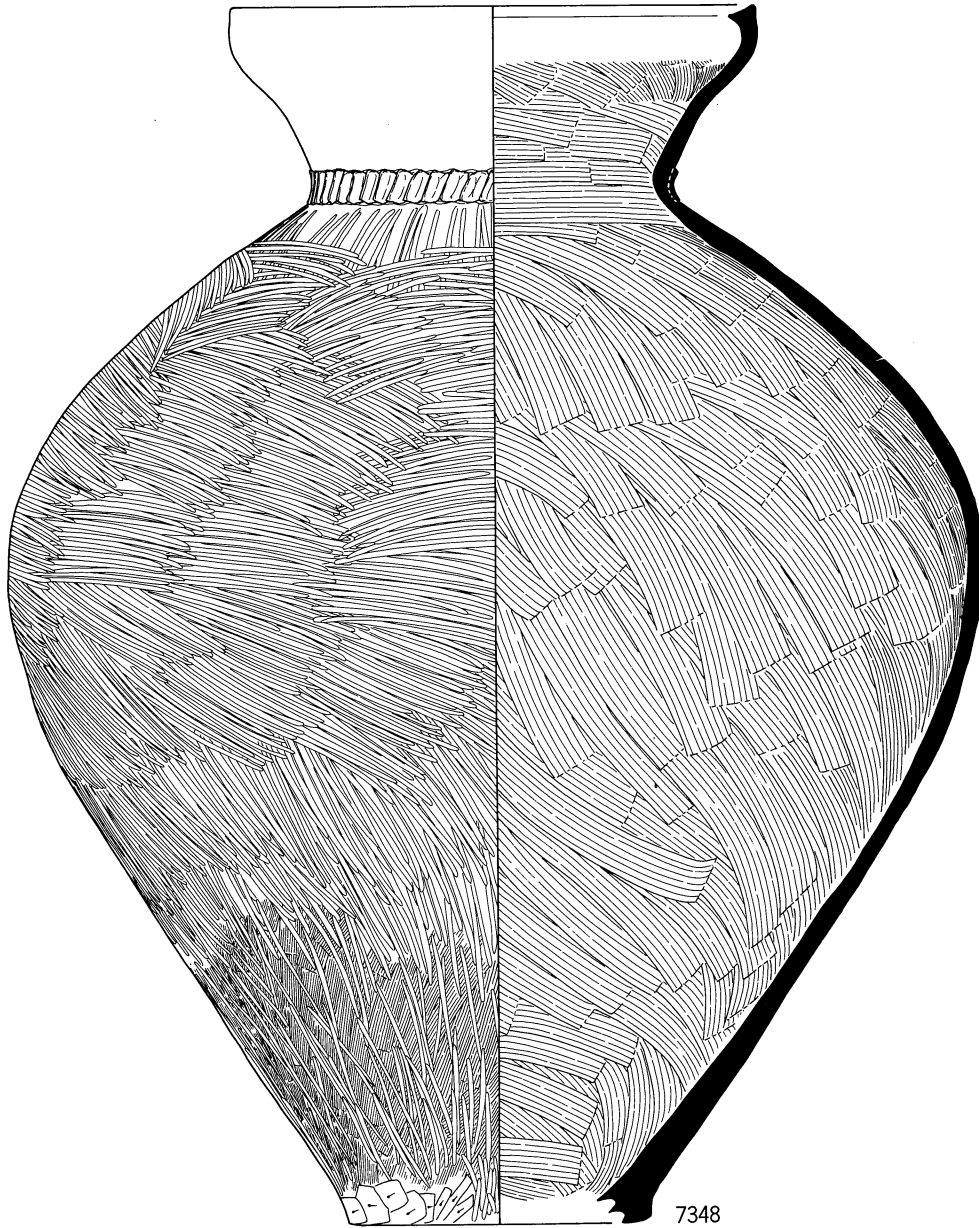

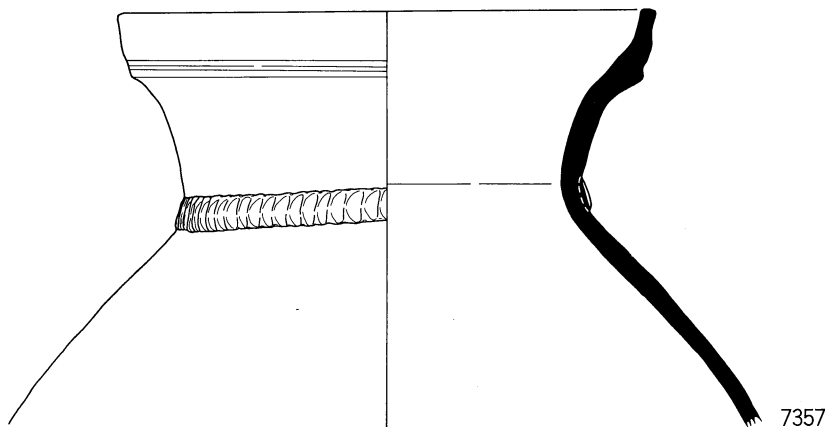
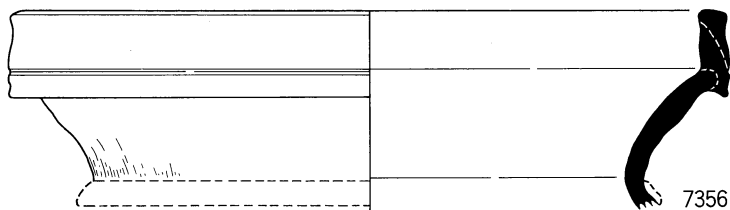
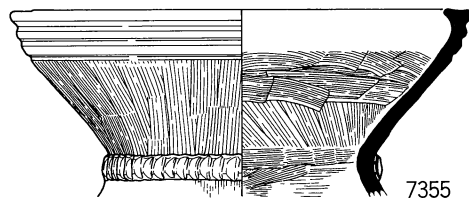
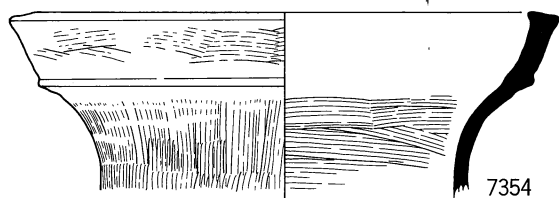
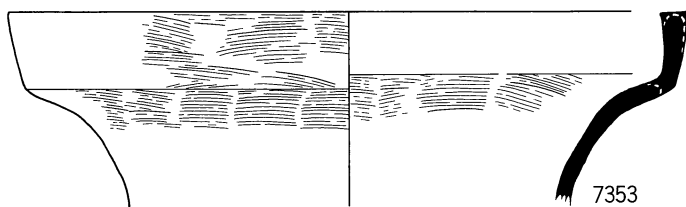
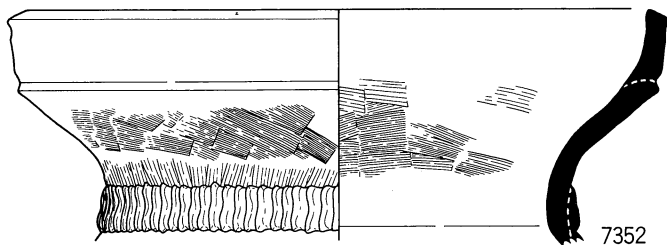
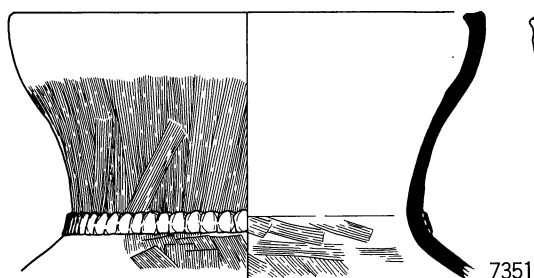
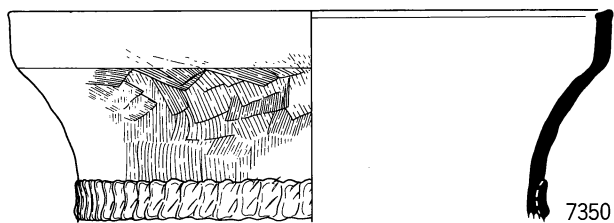
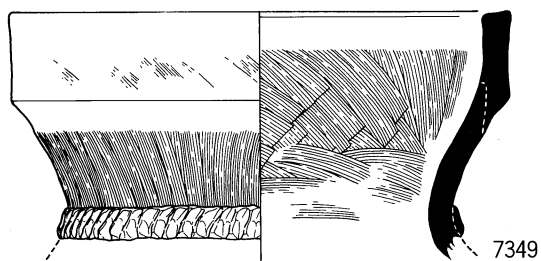

0 20cm

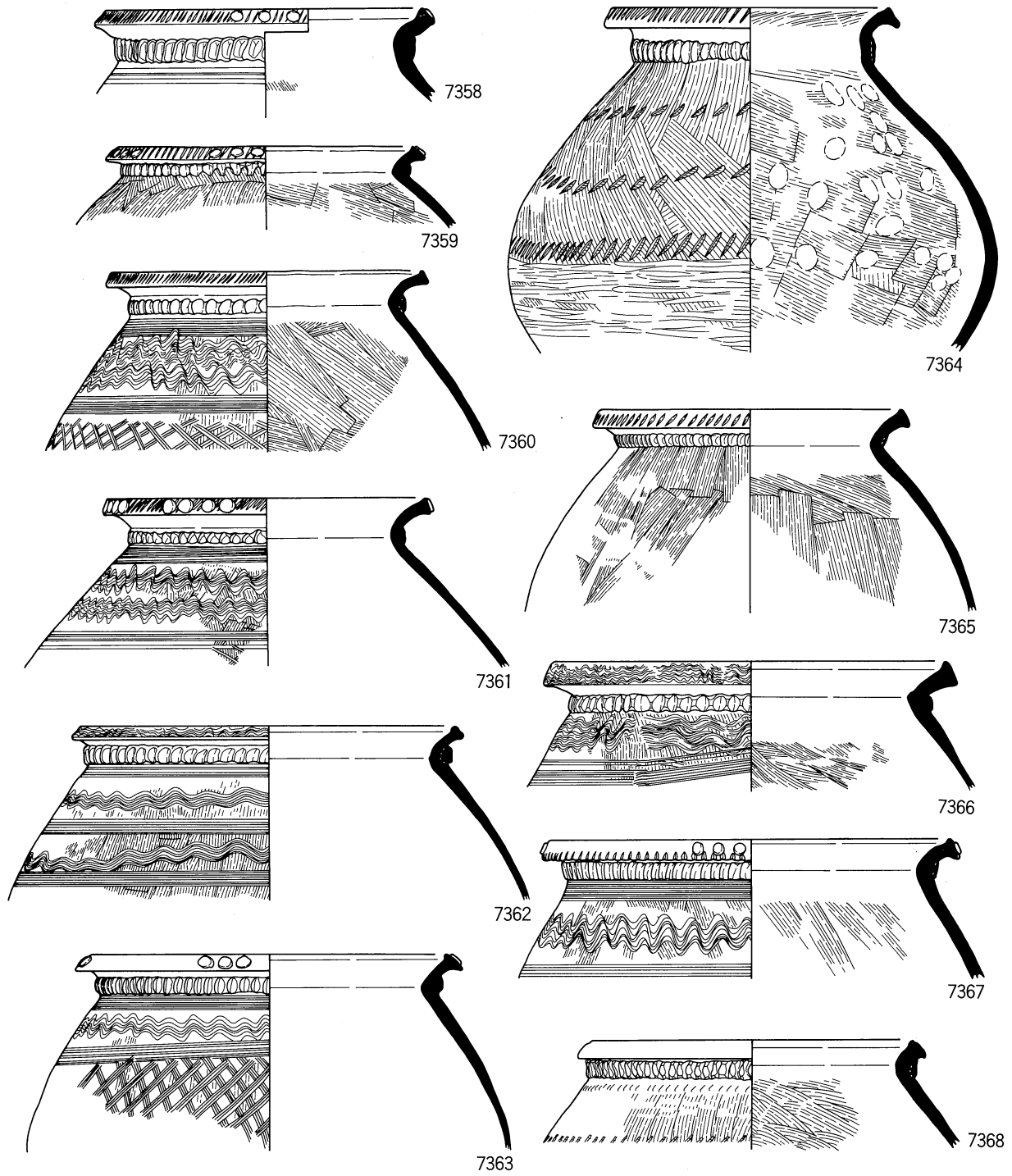

0 20cm

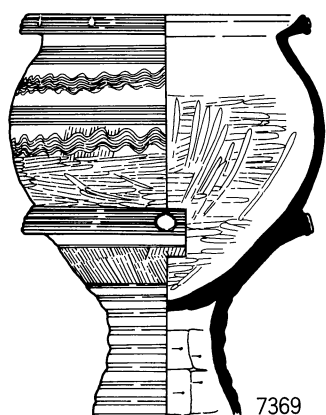

7369

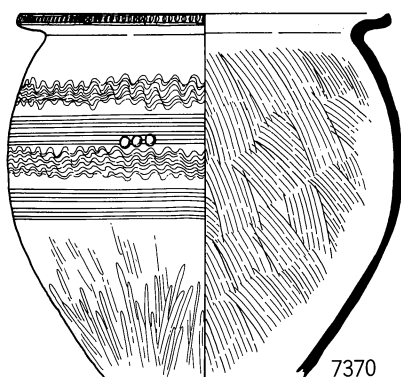

7370

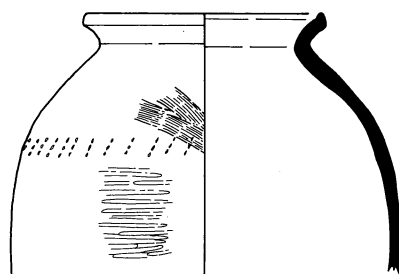

7374

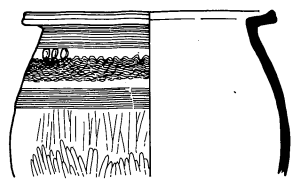

7371

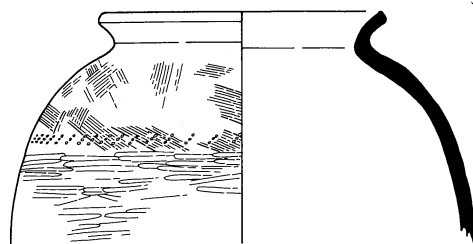

7375



7372

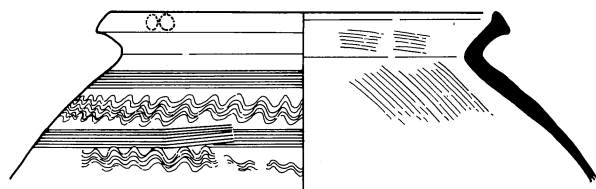

7373

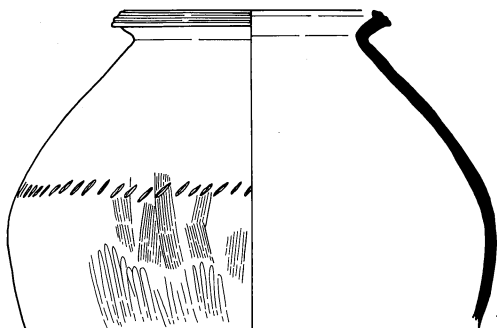

7376

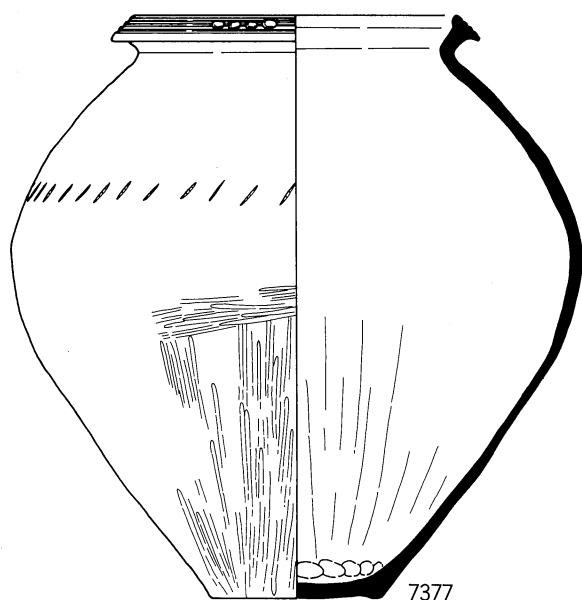

7377

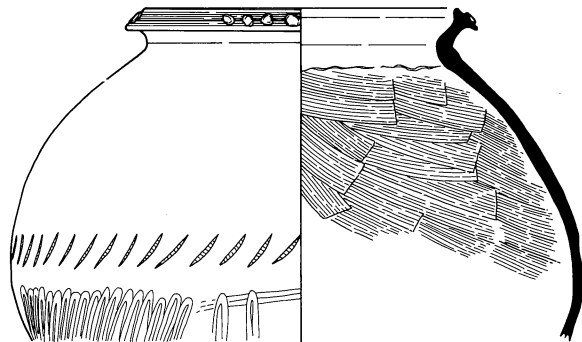

7378

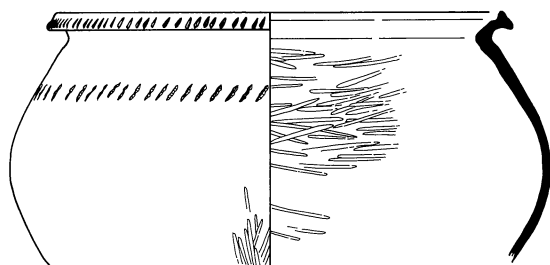

7379



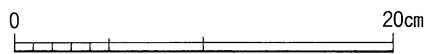
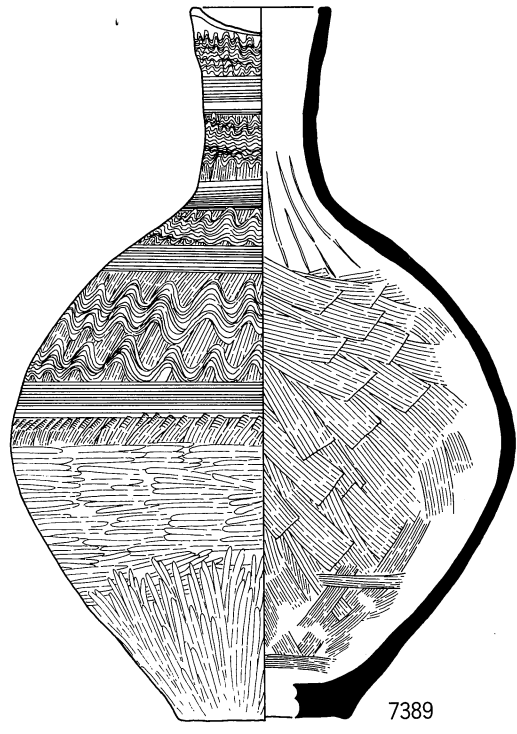
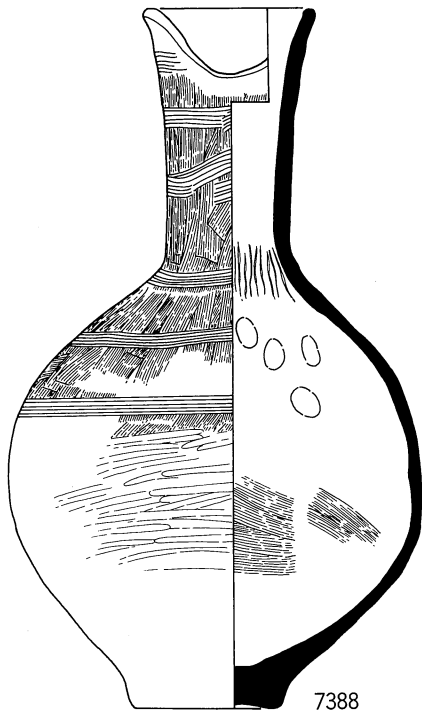
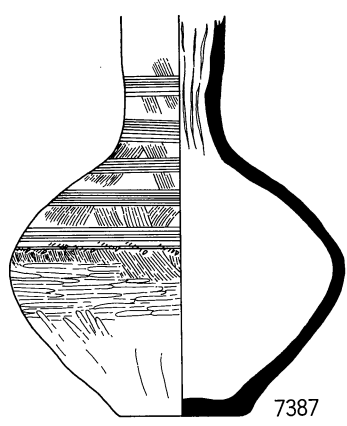
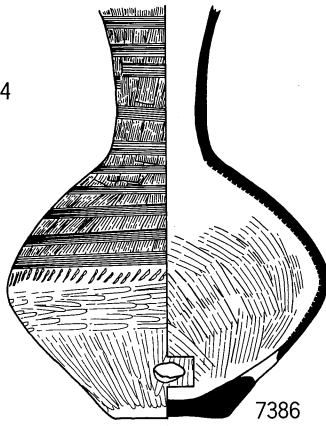
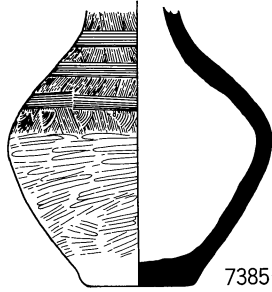
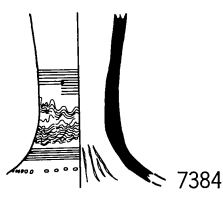
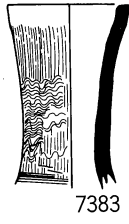
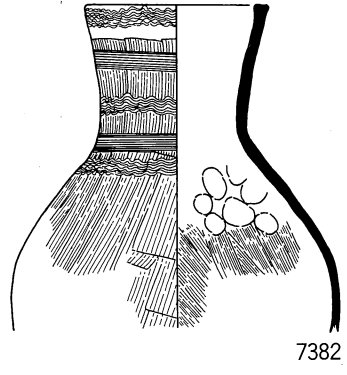
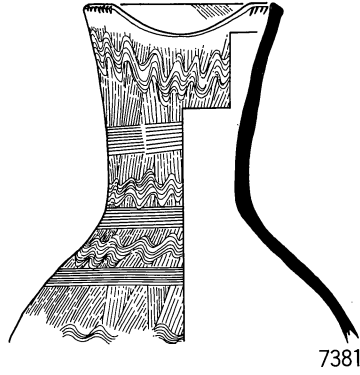
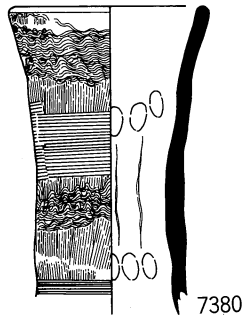

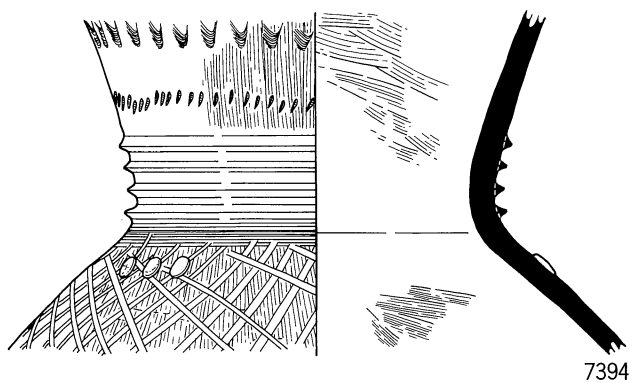
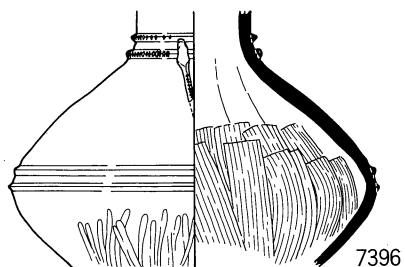
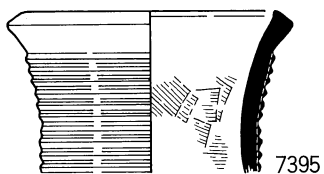
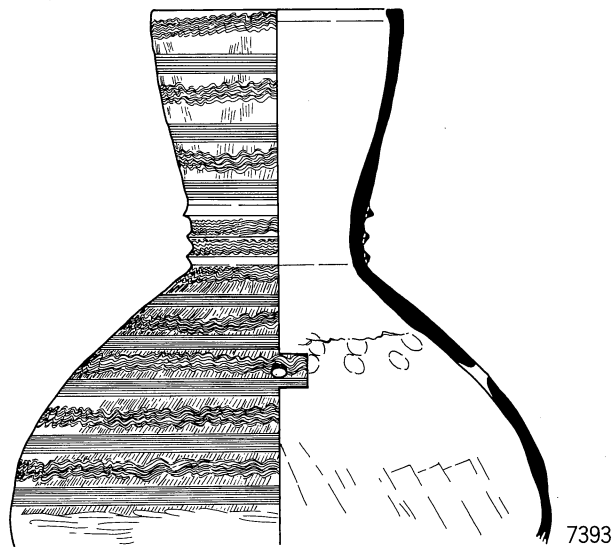
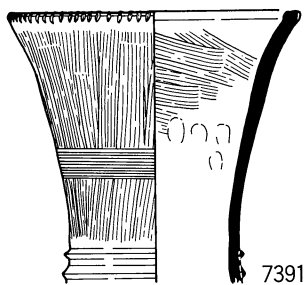
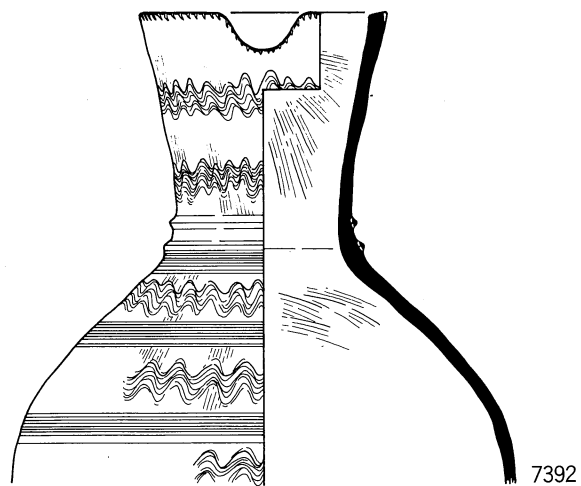
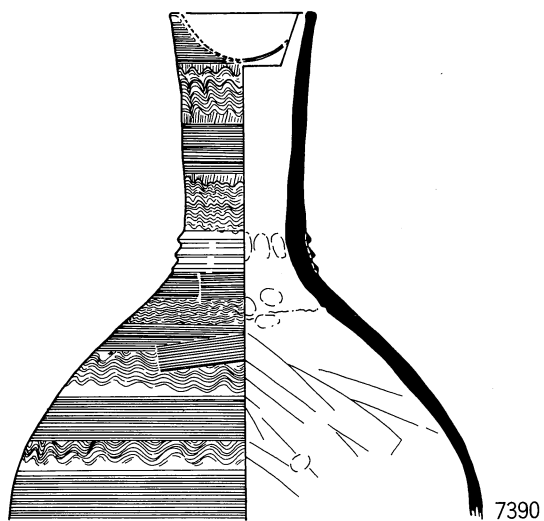



7397

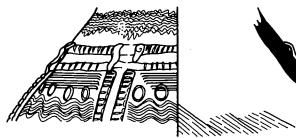

7398

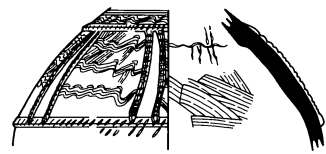

7399

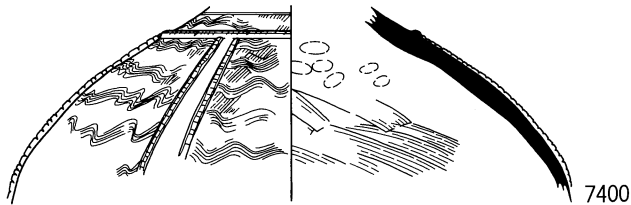

7400

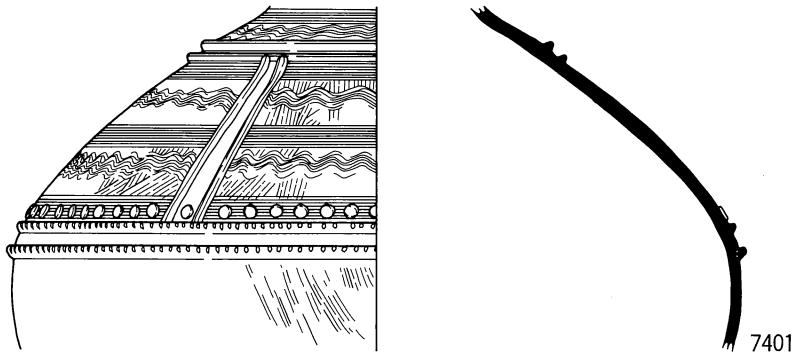

7401

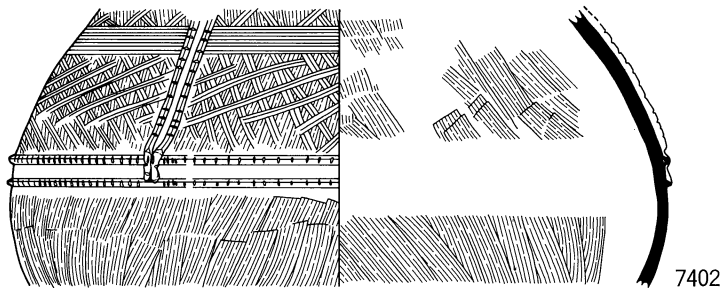

7402

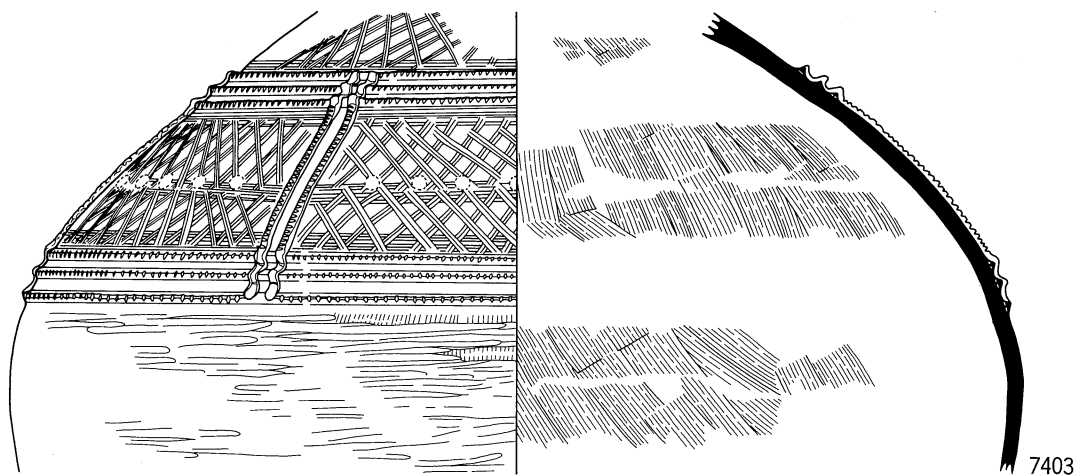

7403

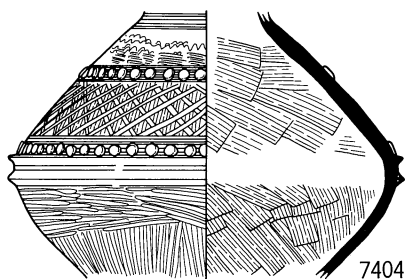

7404

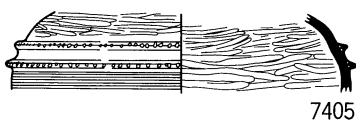

7405

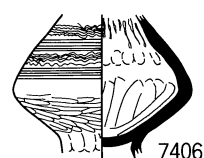

7406

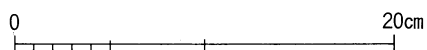

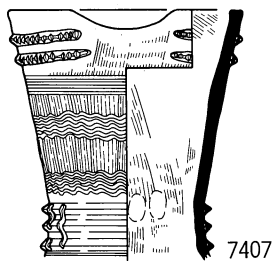

7407

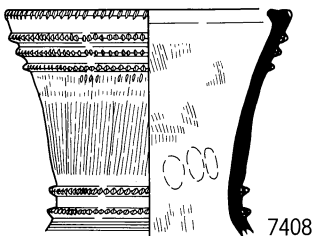

7408

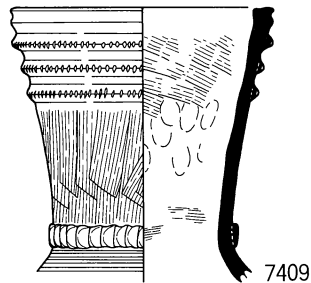

7409

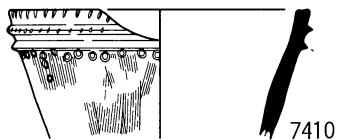

7410

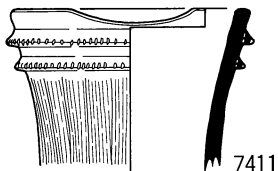

7411

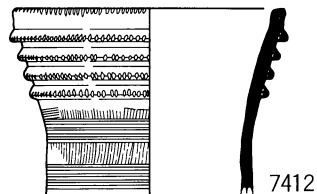

7412

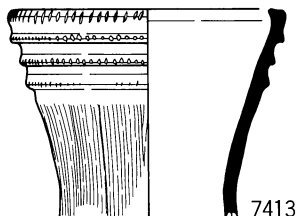

7413

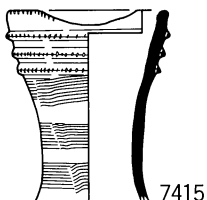

7415

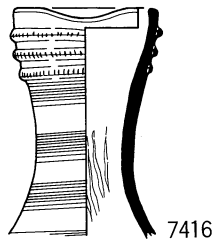

7416

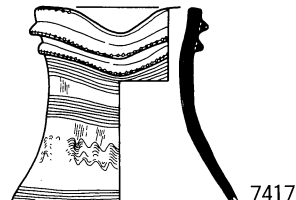

7417

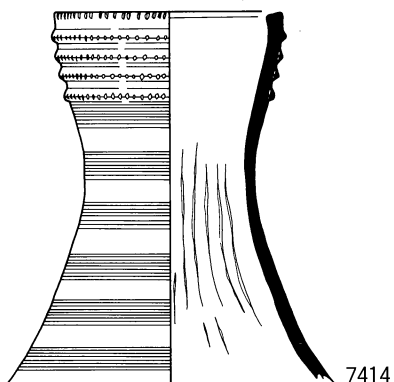

7414

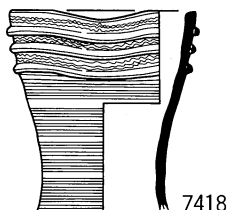

7418

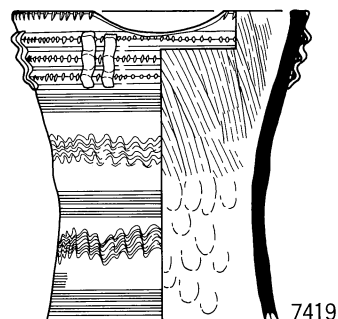

7419

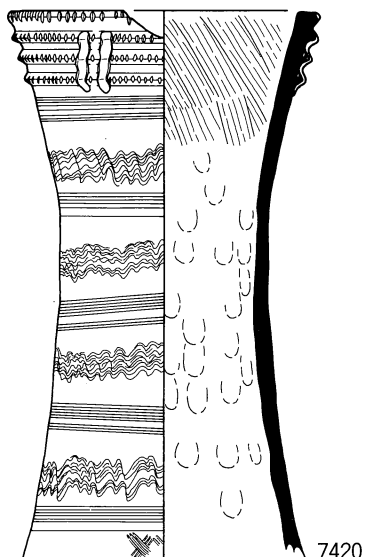

7420



7421

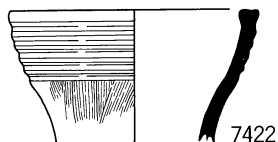

7422

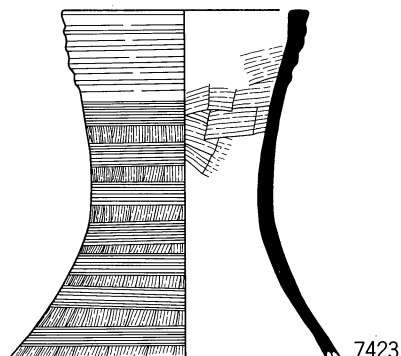

7423



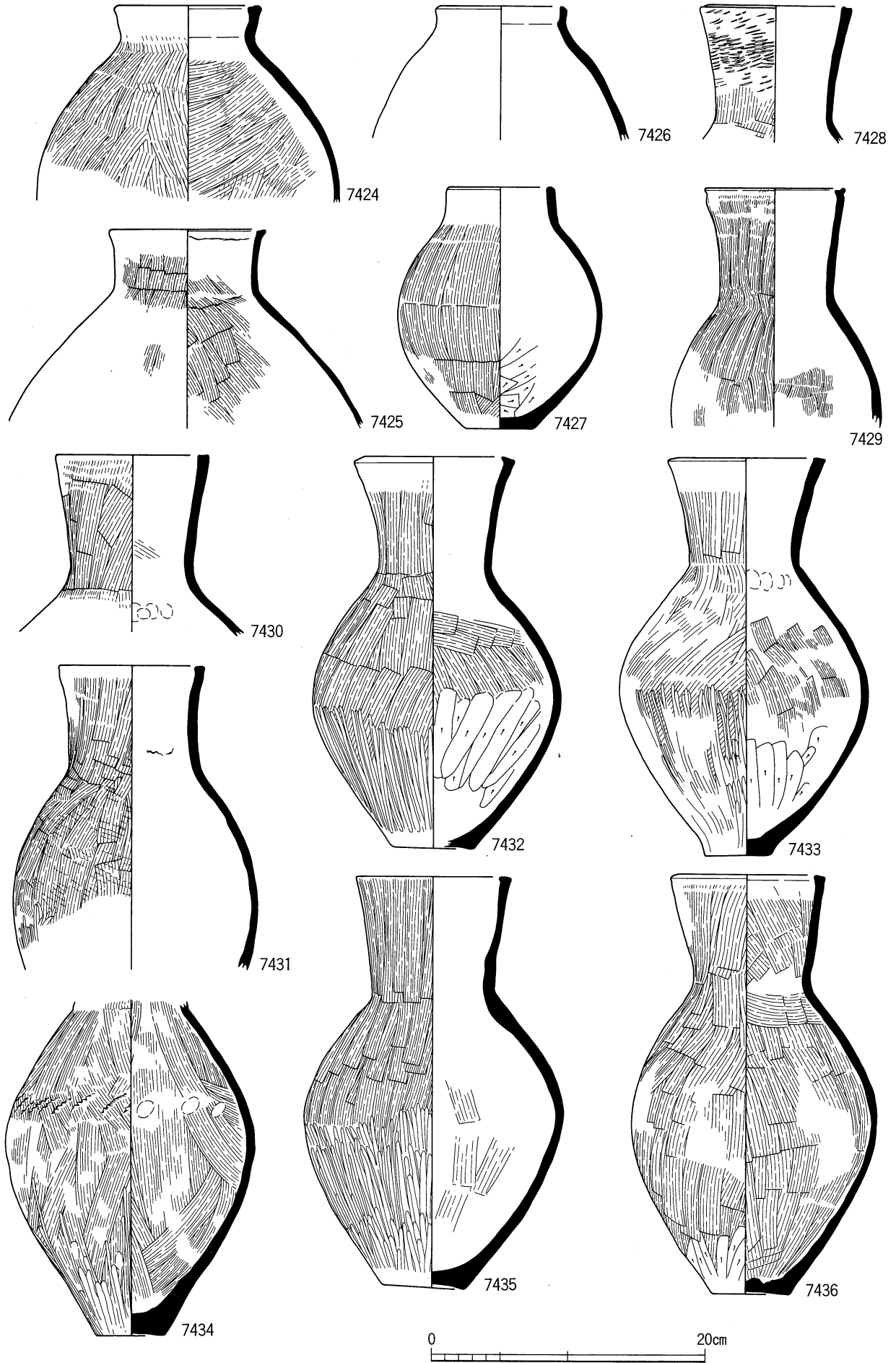

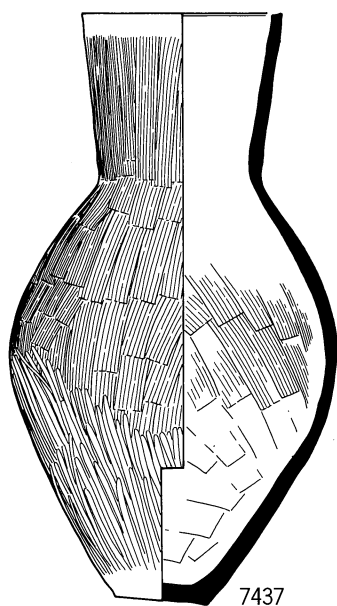

7437

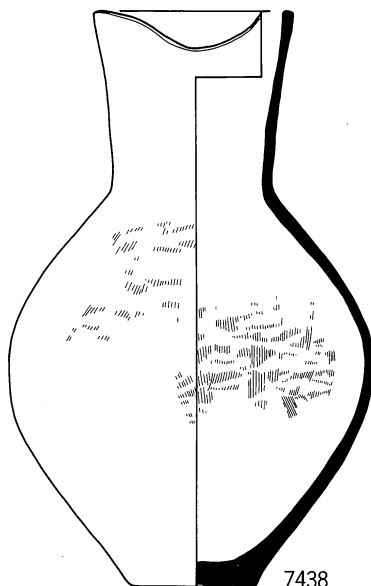

7438

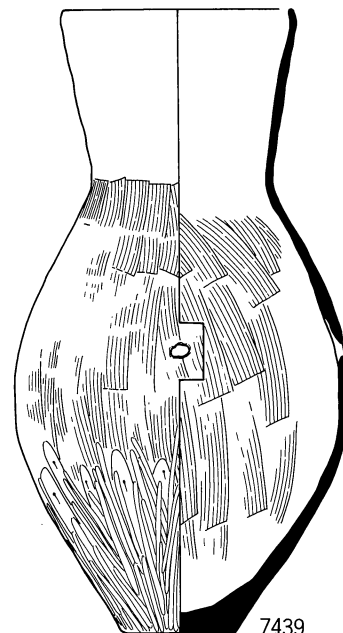

7439

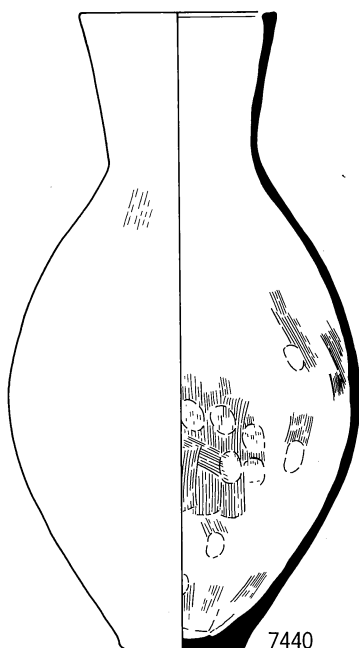

7440

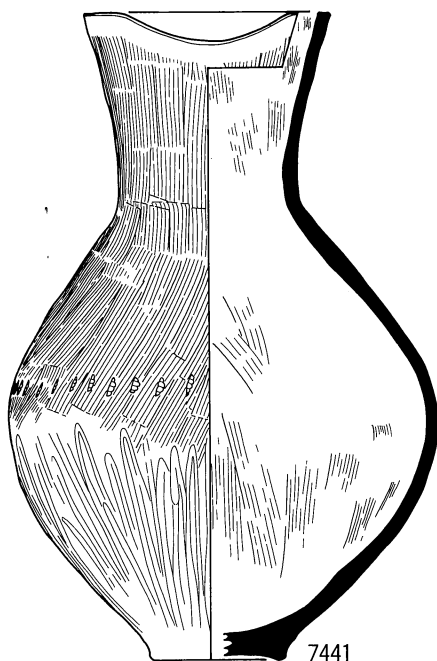

7441

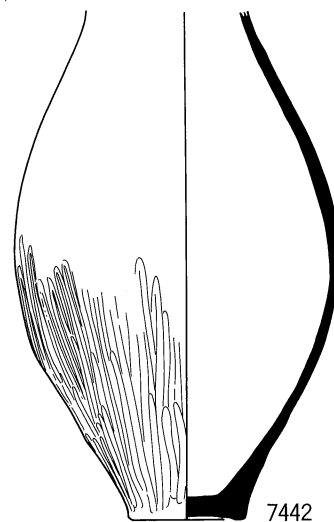

7442

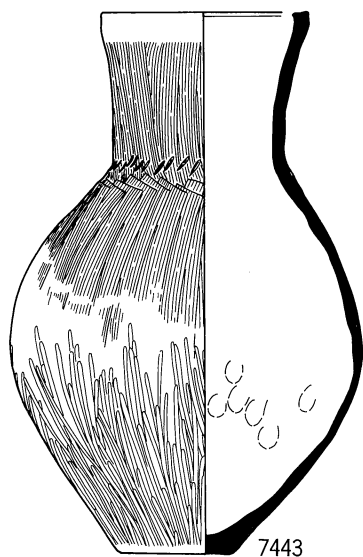

7443

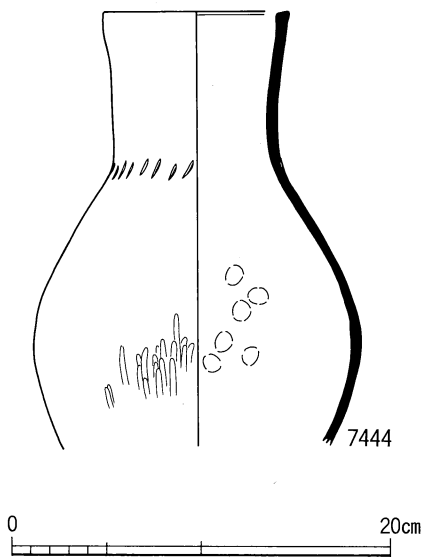

7444

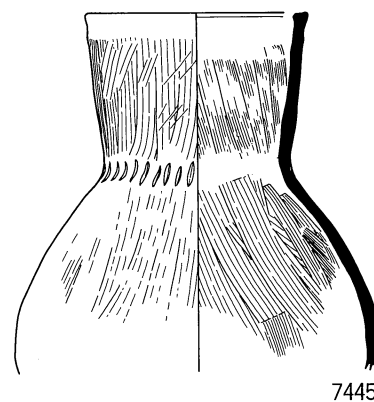

7445



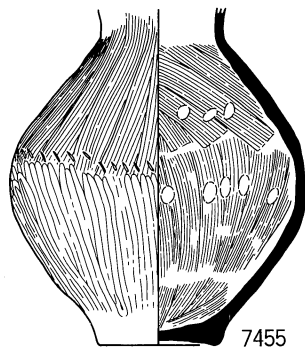
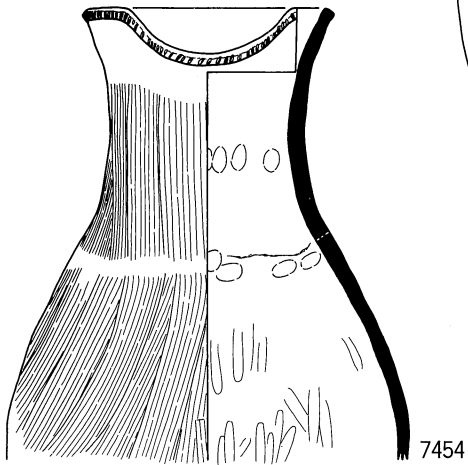
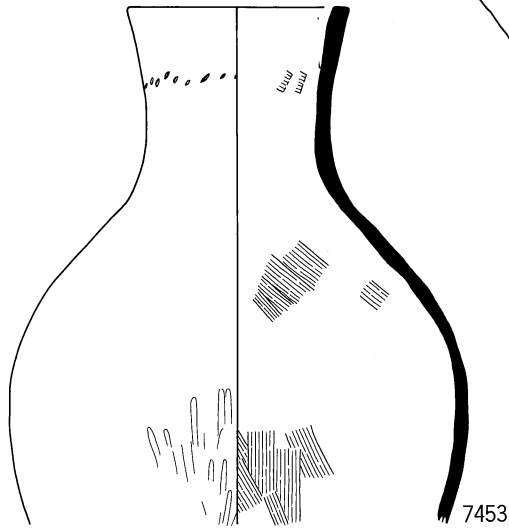
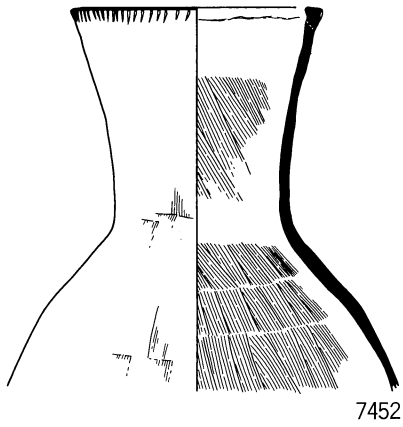
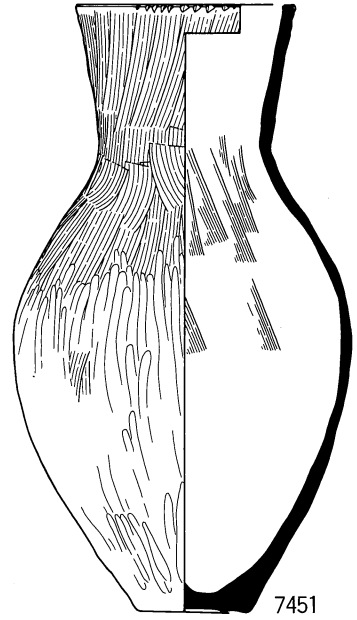
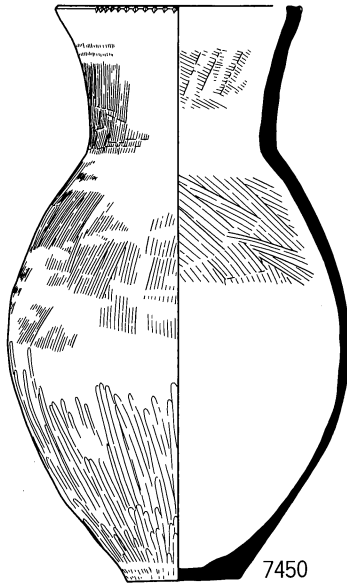
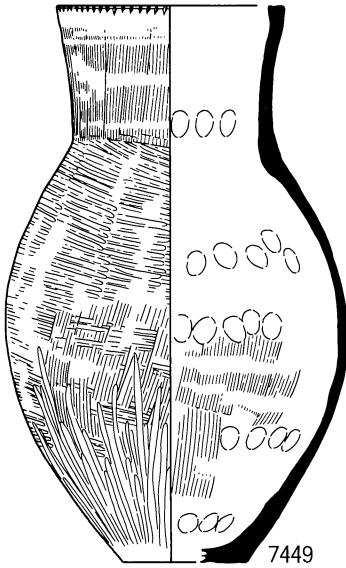
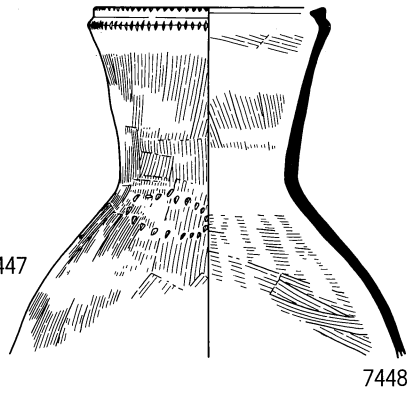
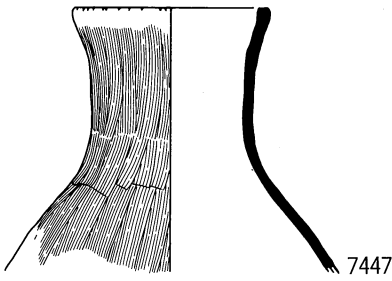
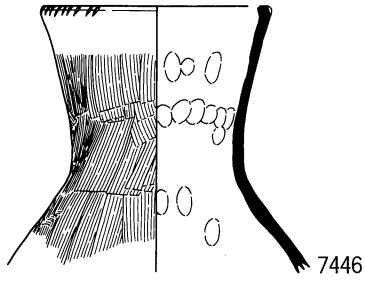

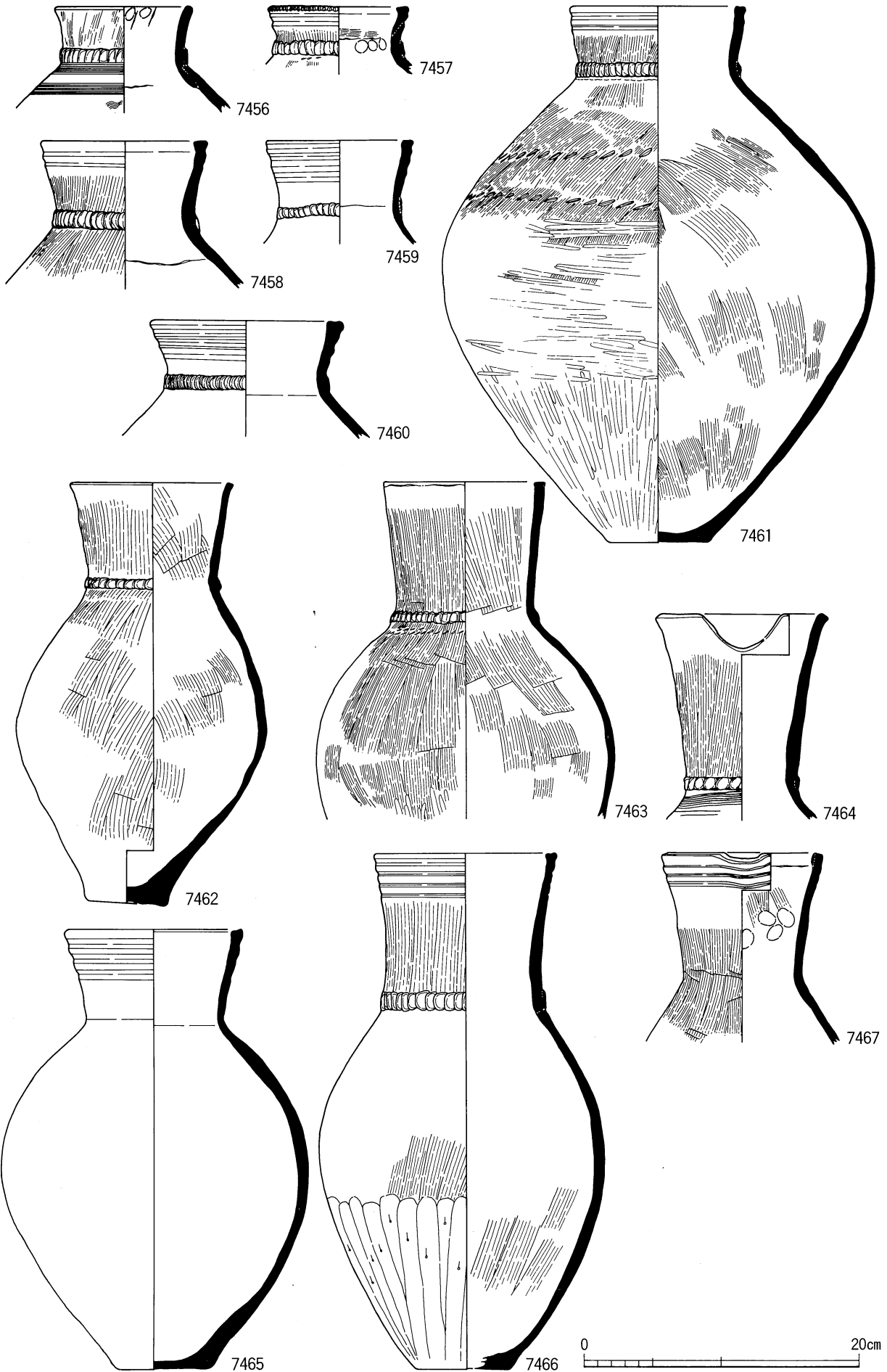

弥生中期上層 旧河道出土土器40 (SR46002)

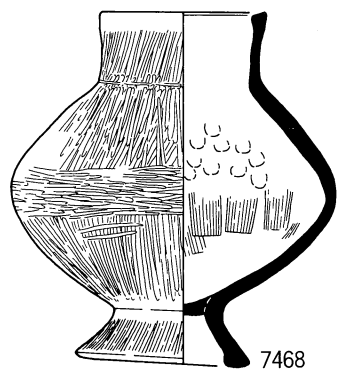

7468

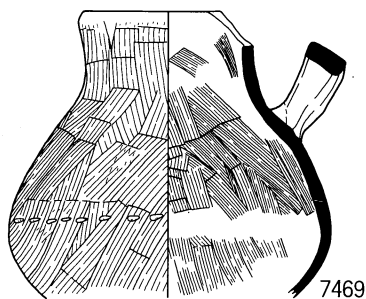

7469

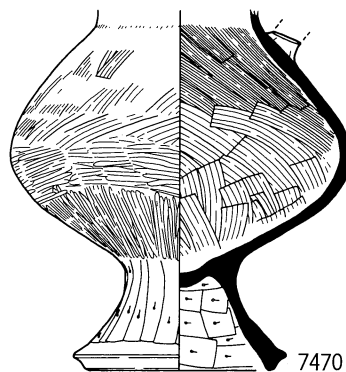

7470

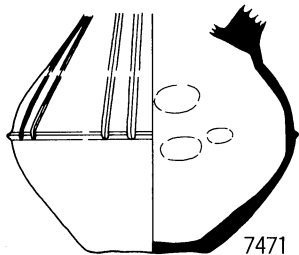

7471

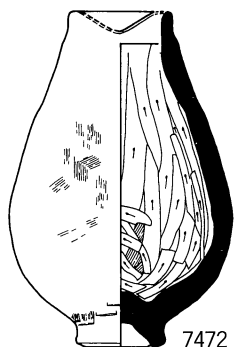

7472



7473

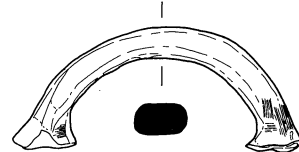

7474

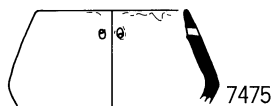

7475

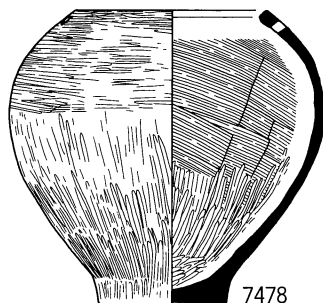

7478

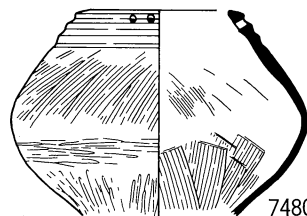

7480

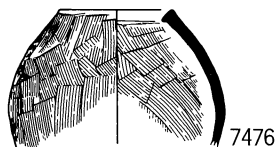

7476

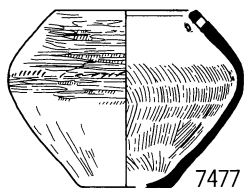

7477

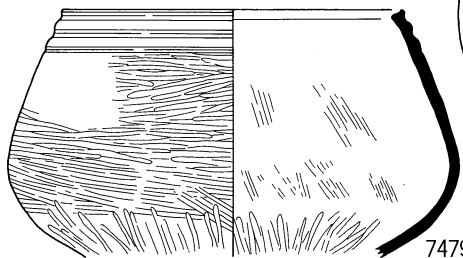

7479

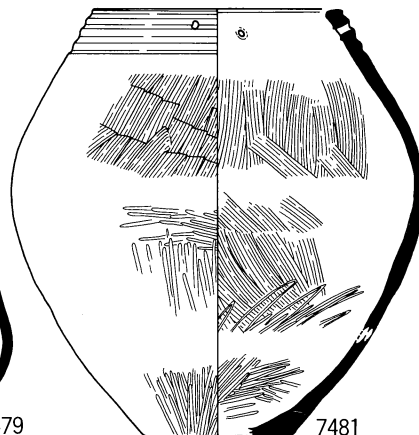

7481

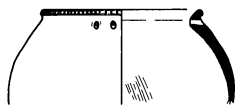

7482

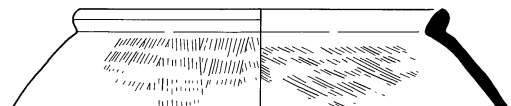

7483

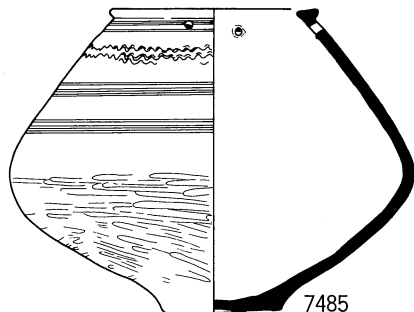

7485

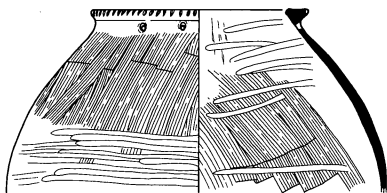

7486

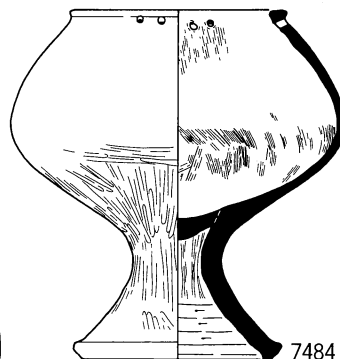

7484



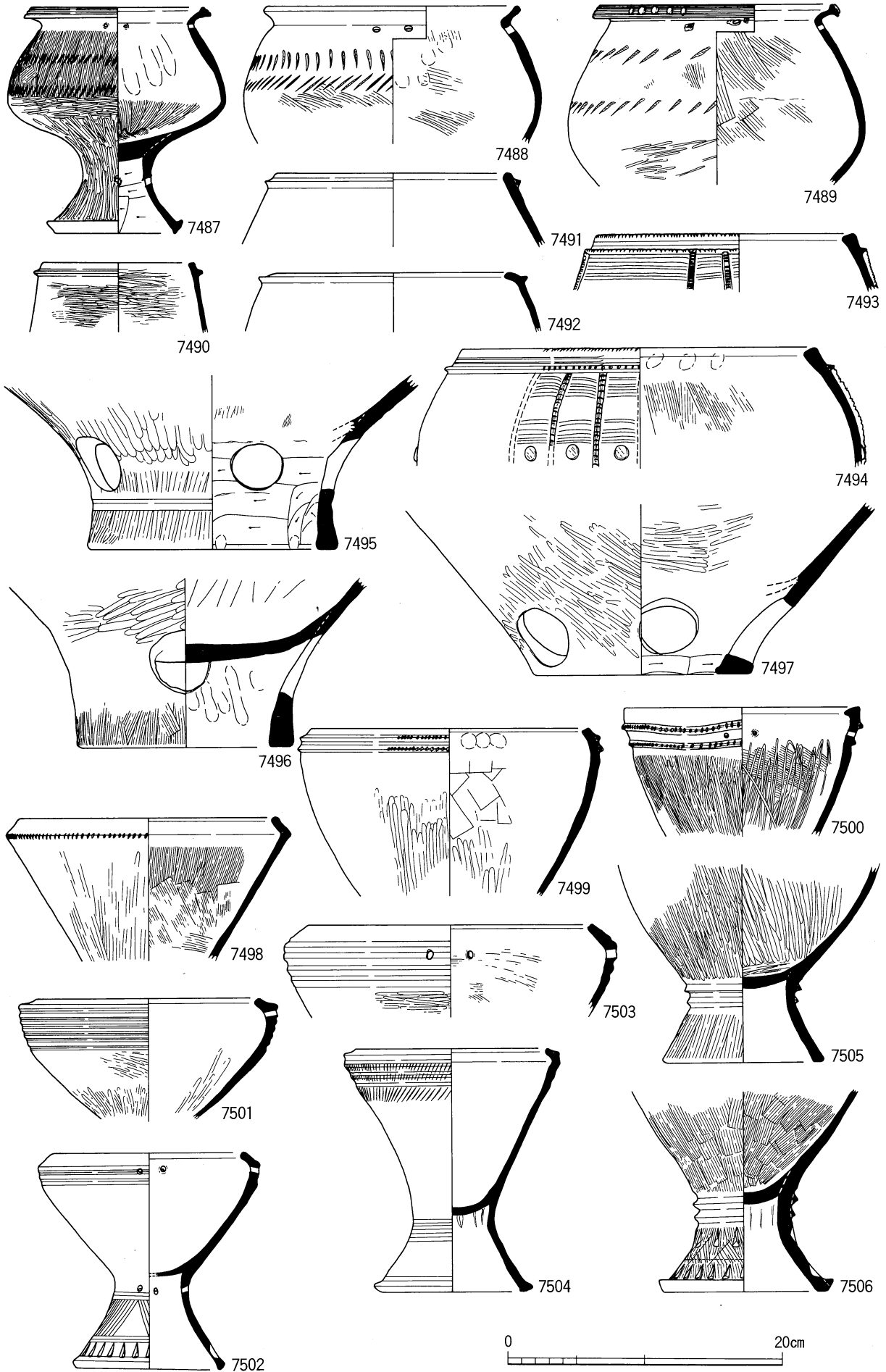

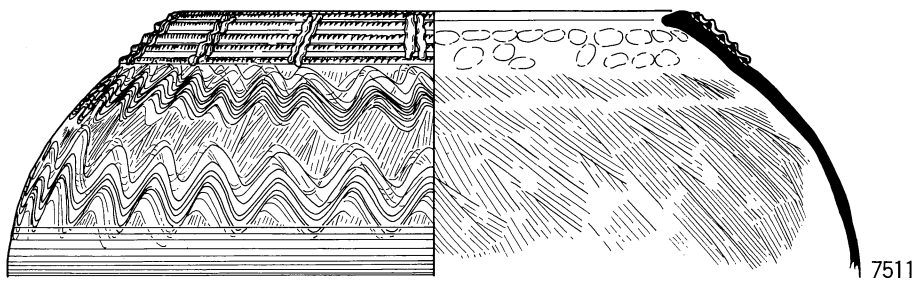
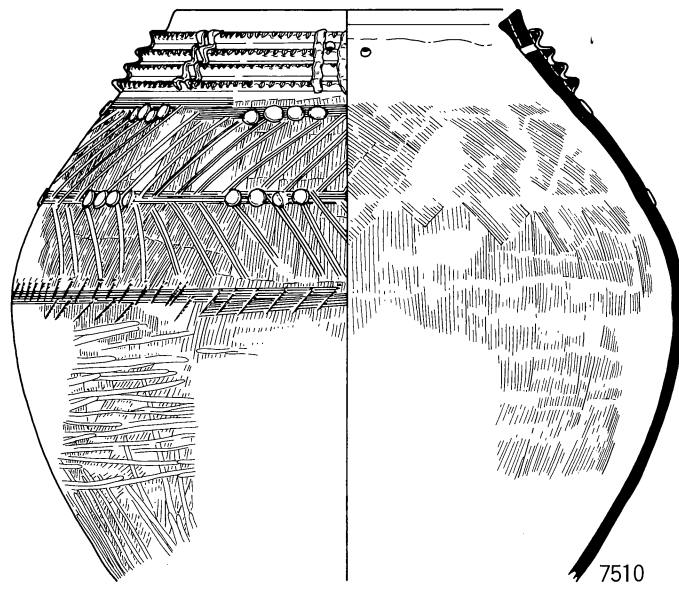
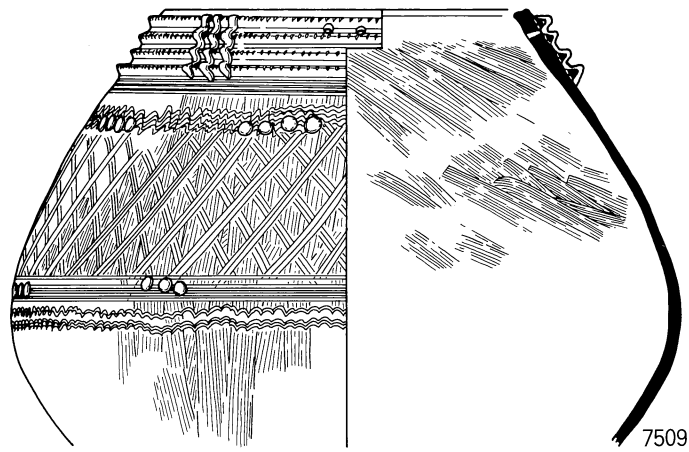
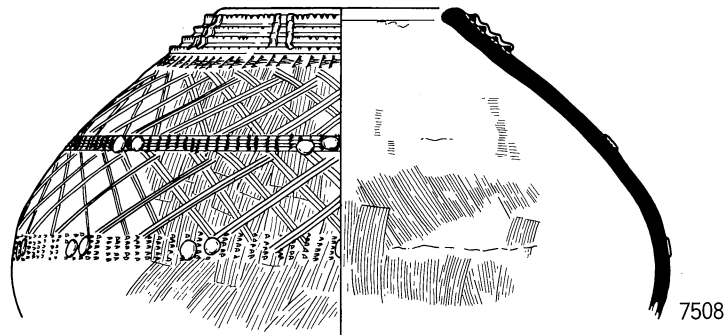
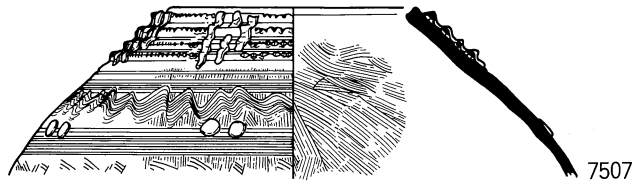

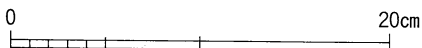
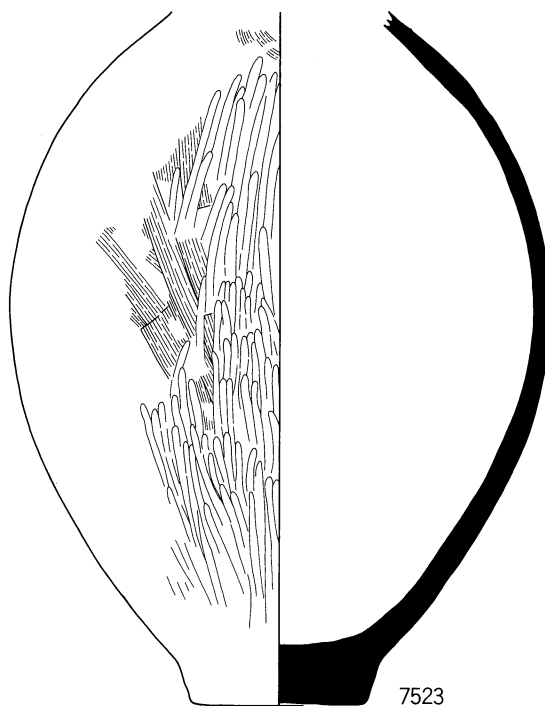
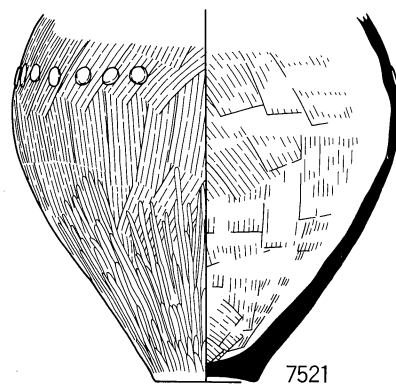
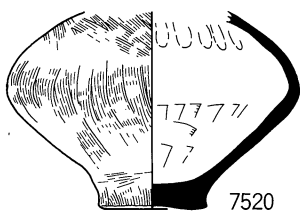
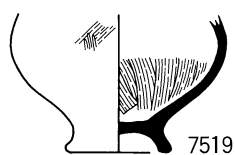
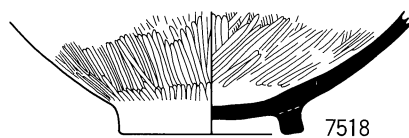
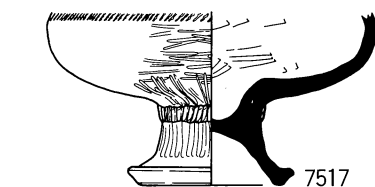
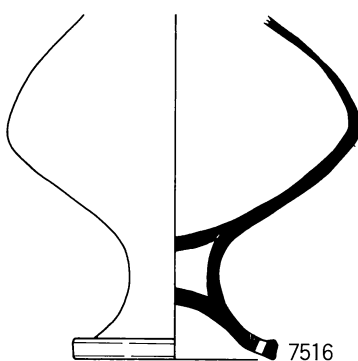
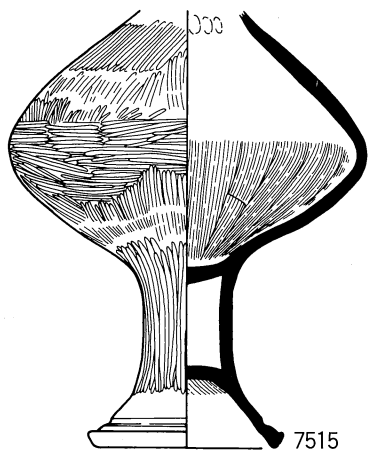
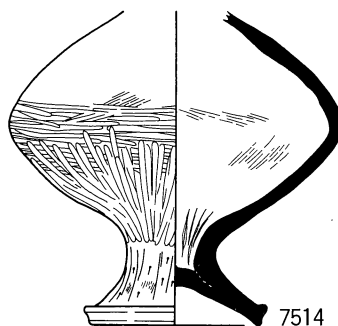
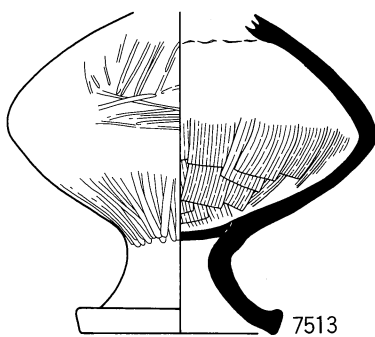
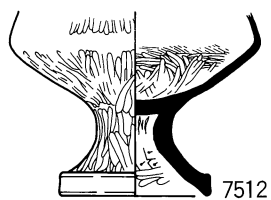

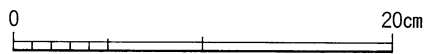
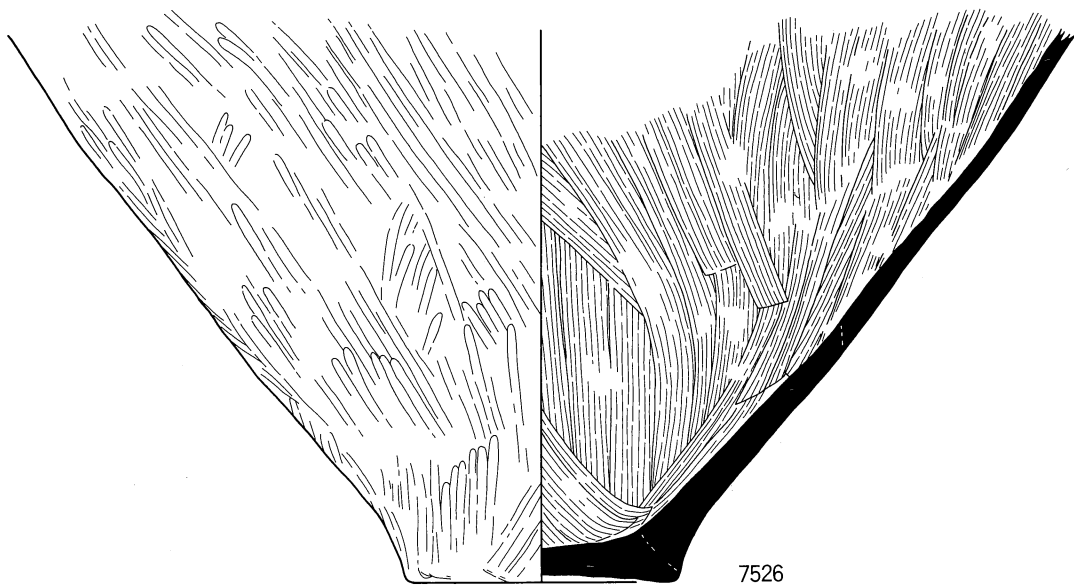
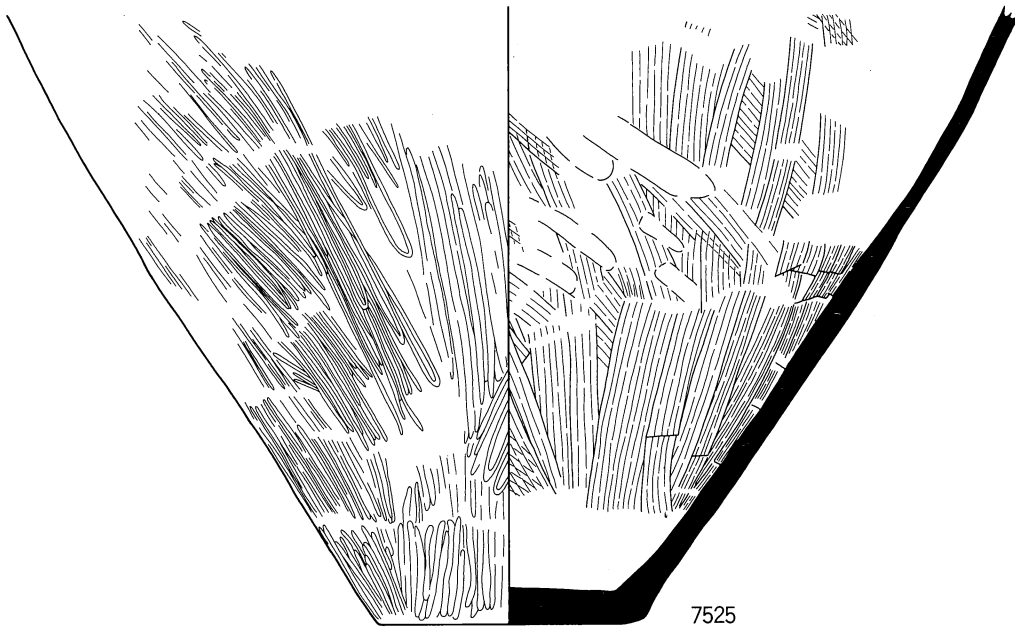
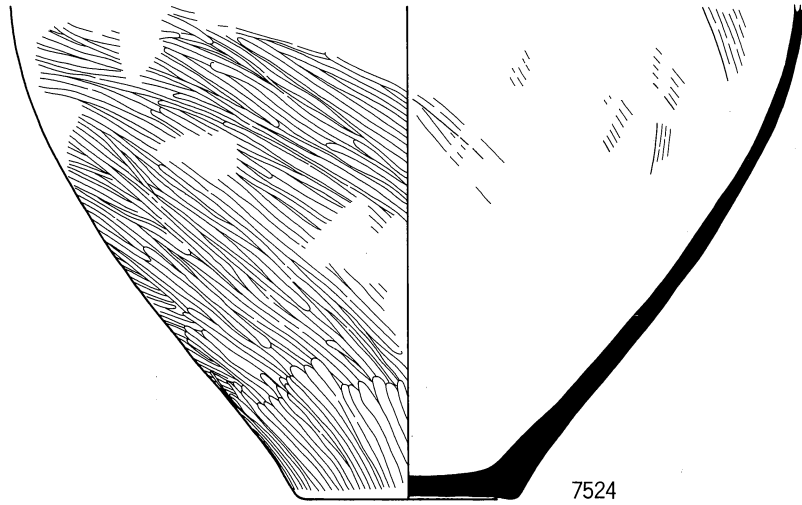

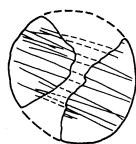
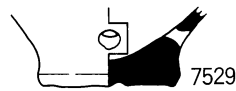

7527

7528

7529

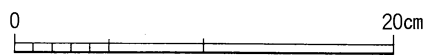

7530



7531

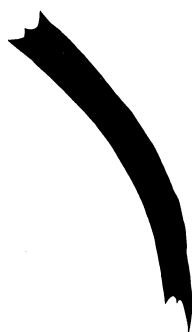

7532

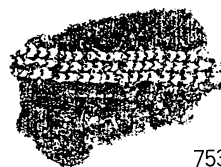

7533

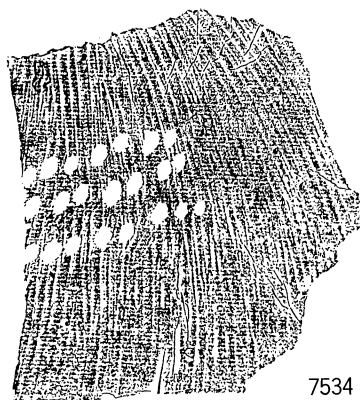
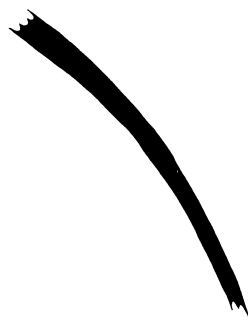

7534

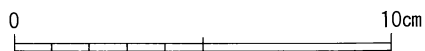

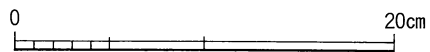
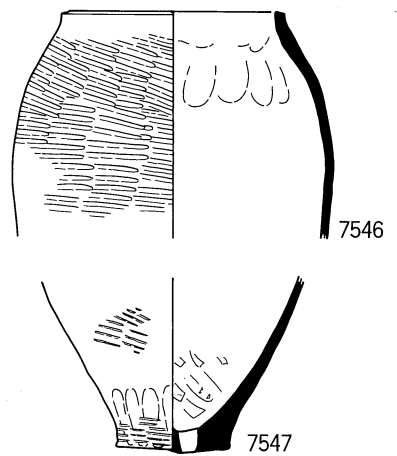
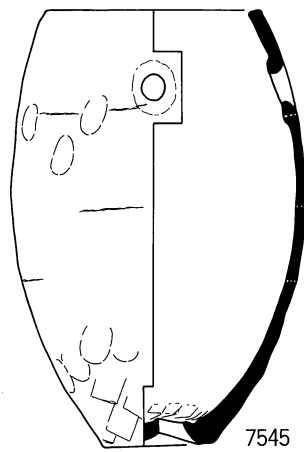
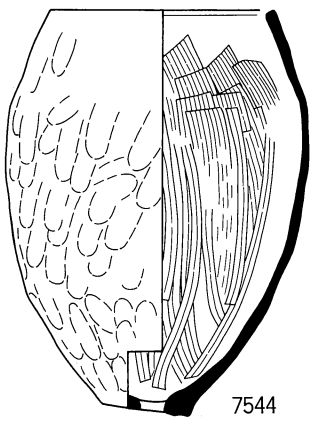
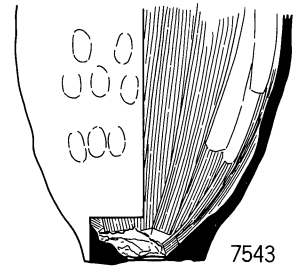
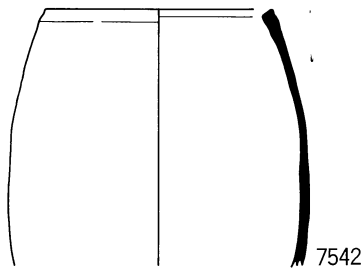
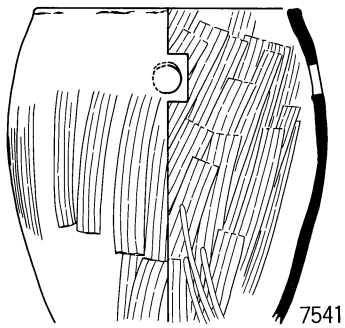
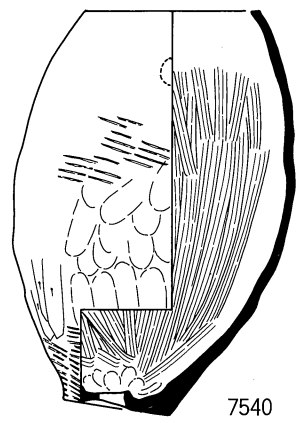
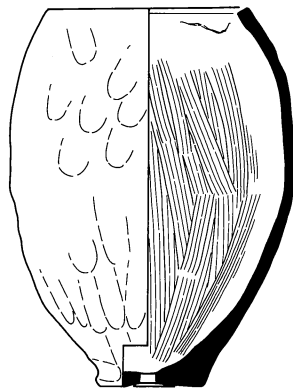
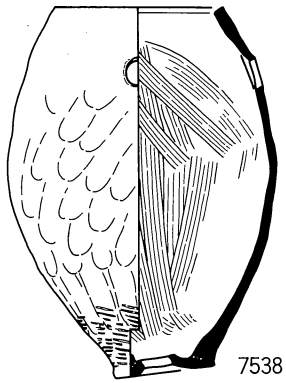
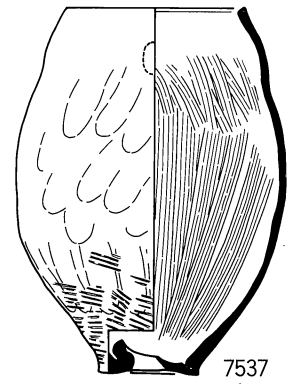
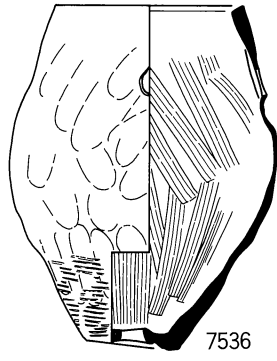
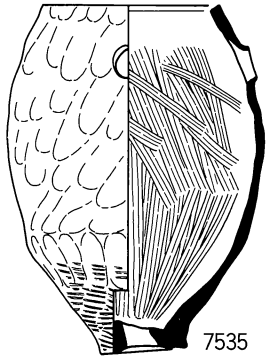

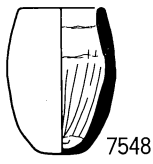

7548

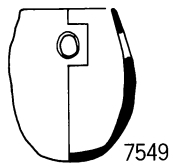

7549

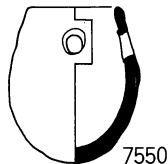

7550



7551

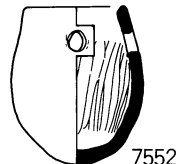

7552

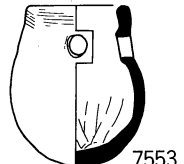

7553

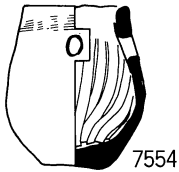

7554



7555



7556

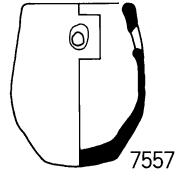

7557



7558



7559

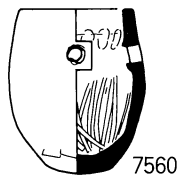

7560

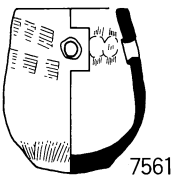

7561

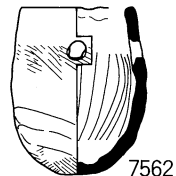

7562

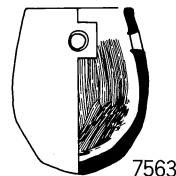

7563

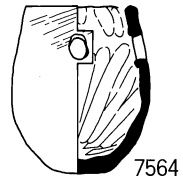

7564

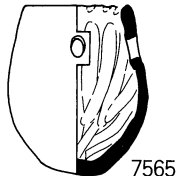

7565

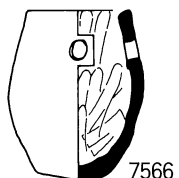

7566

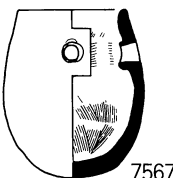

7567

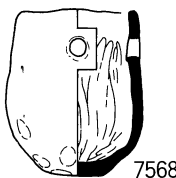

7568

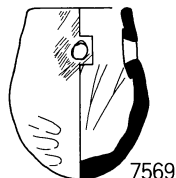

7569

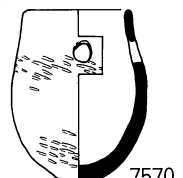

7570

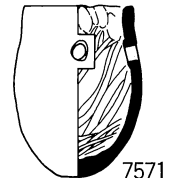

7571



7572

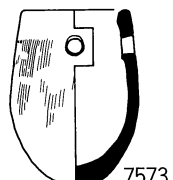

7573

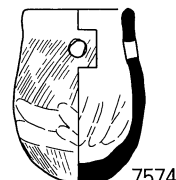

7574

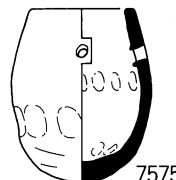

7575

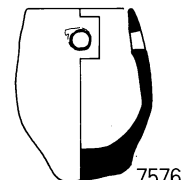

7576

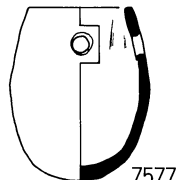

7577

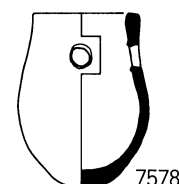

7578

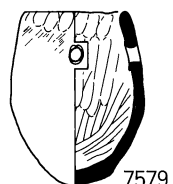

7579

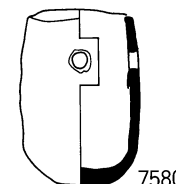

7580

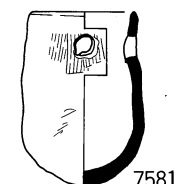

7581

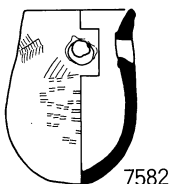

7582



7583

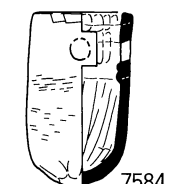

7584

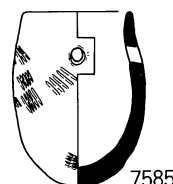

7585

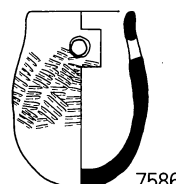

7586

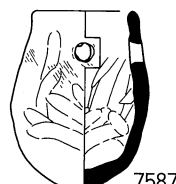

7587

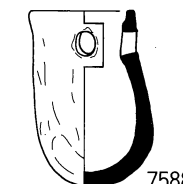

7588

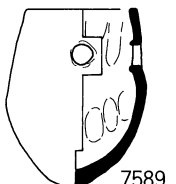

7589



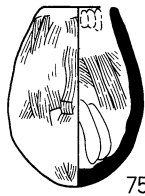

7590

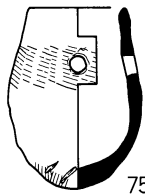

7591

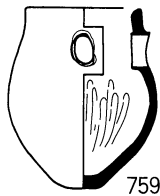

7592

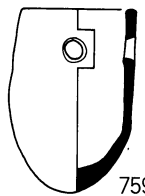

7593

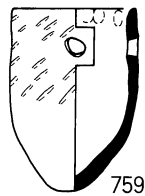

7594

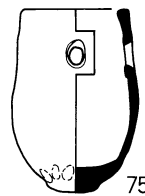

7595

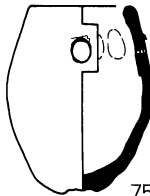

7596

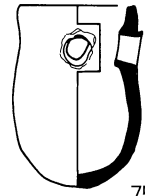

7597

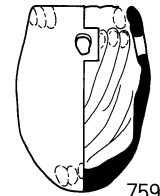

7598

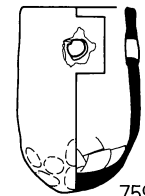

7599

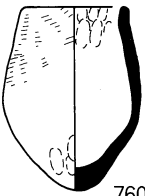

7600

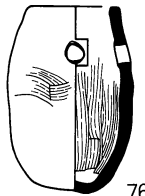

7601



7602



7603

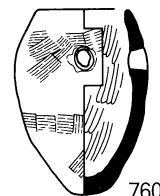

7604

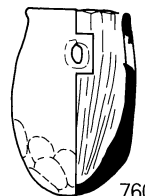

7605

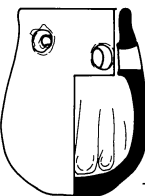

7606

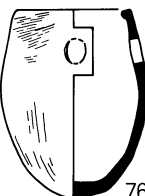

7607

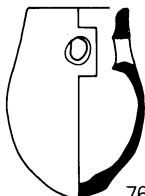

7608

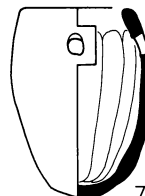

7609

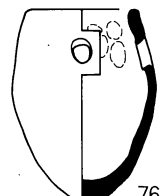

7610

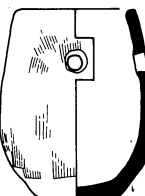

7611

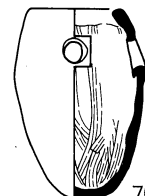

7612

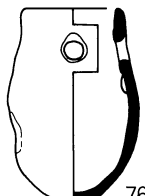

7613

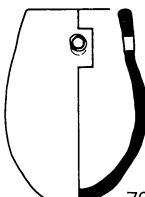

7614

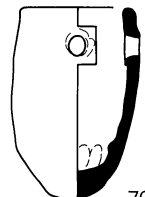

7615

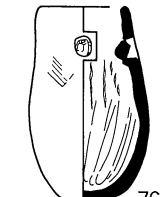

7616

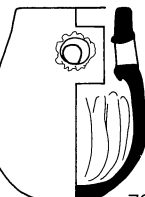

7617

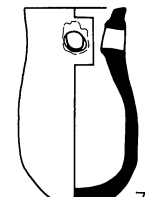

7618

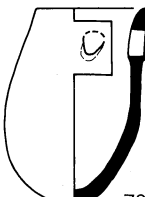

7619

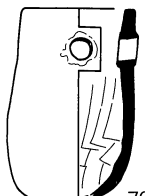

7620

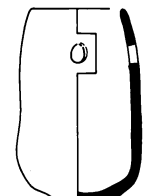

7621

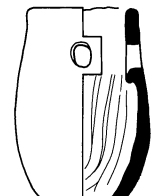

7622

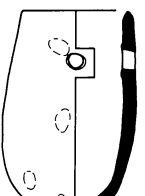

7623

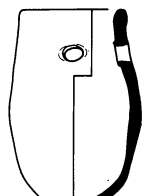

7624

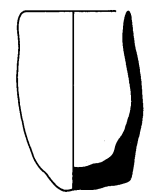

7625



7626

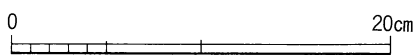

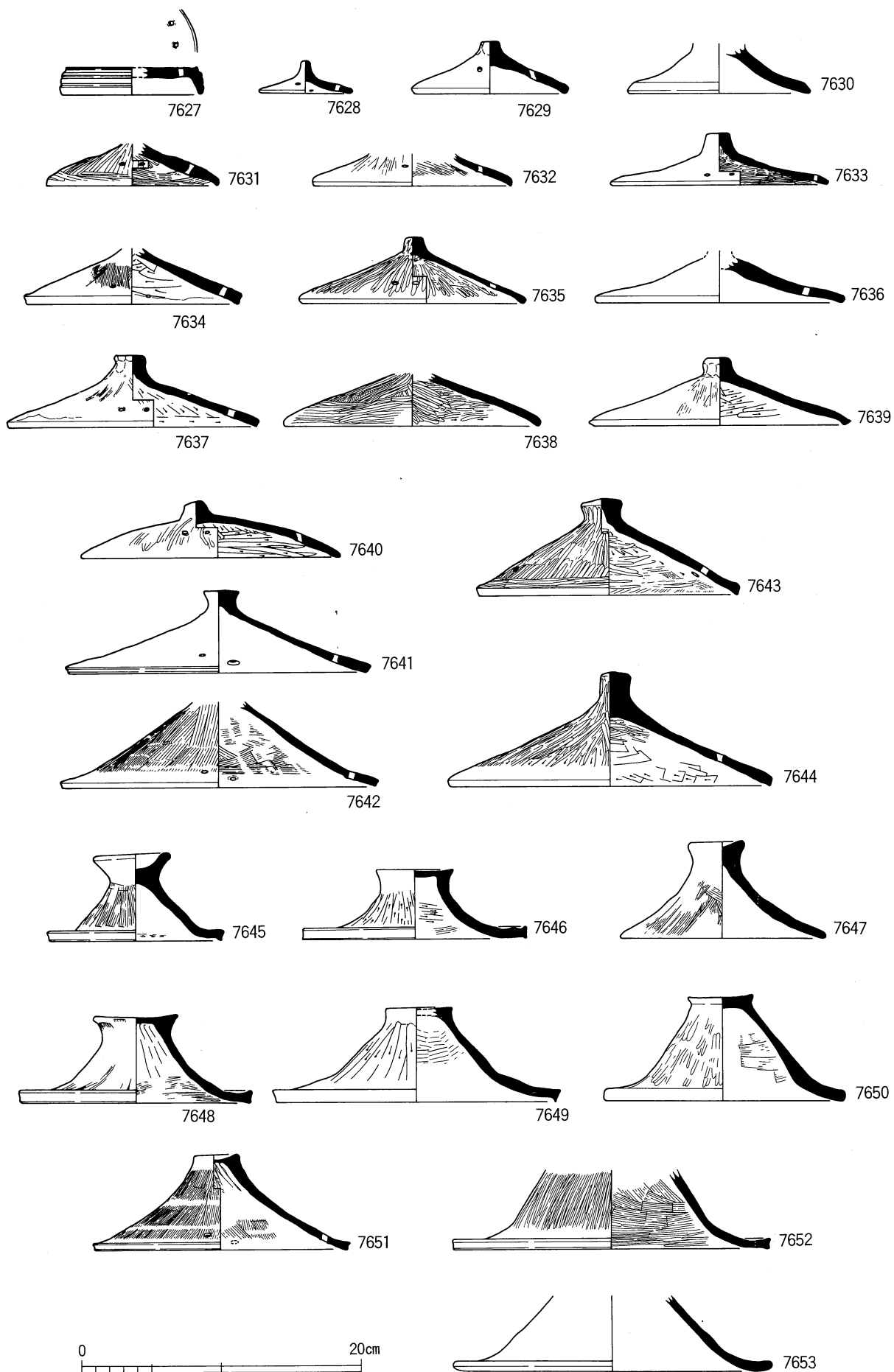

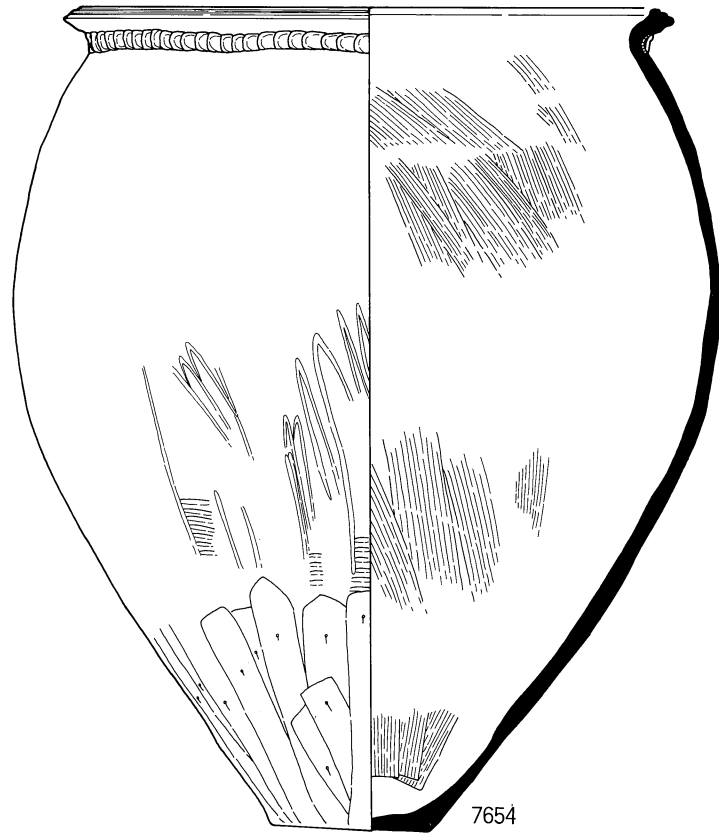

7654

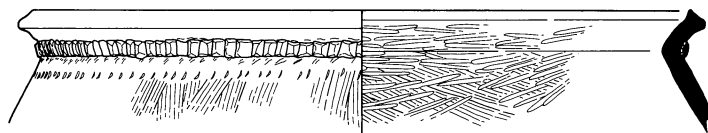

7655

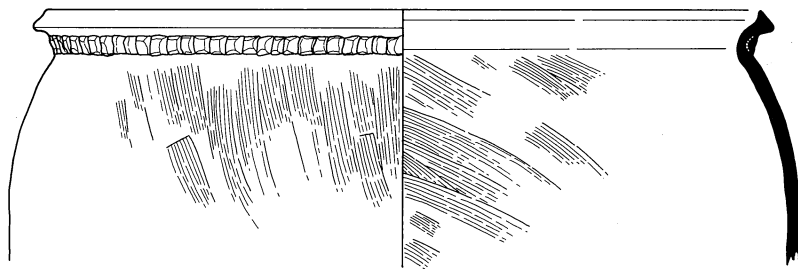

7656



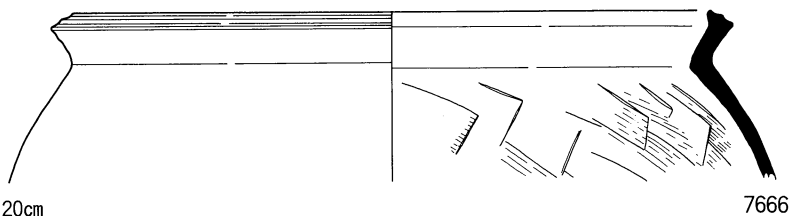
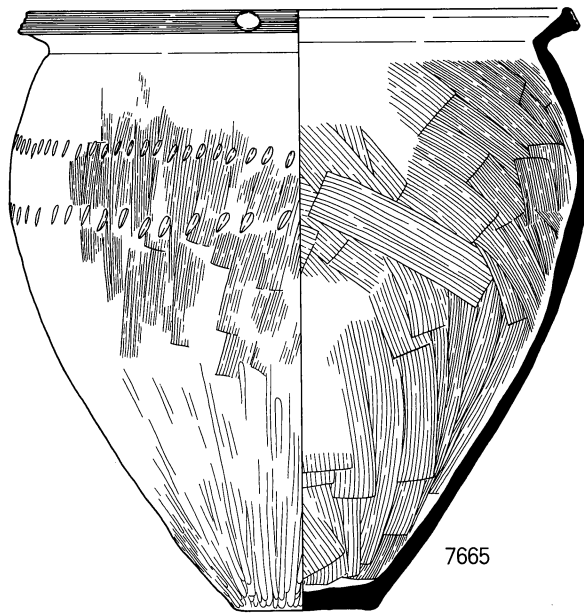
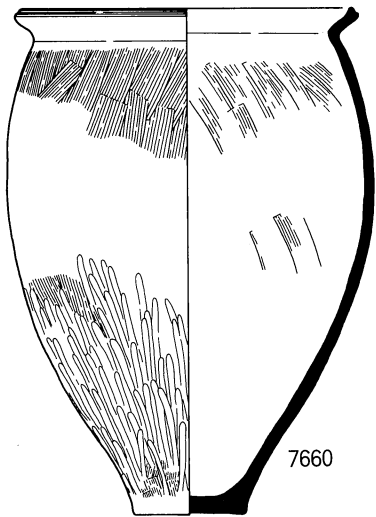
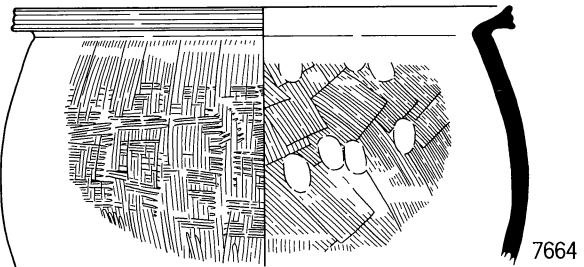
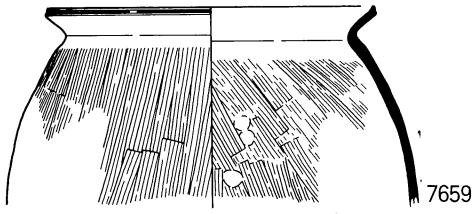
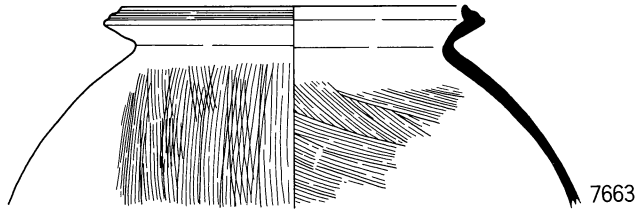
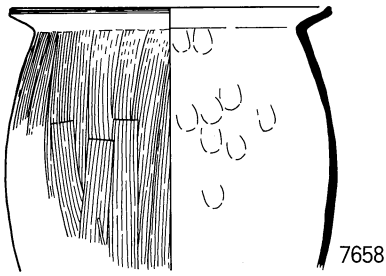
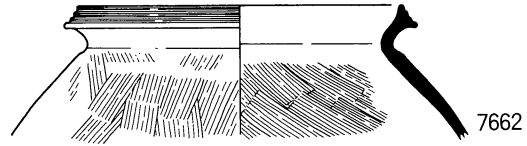
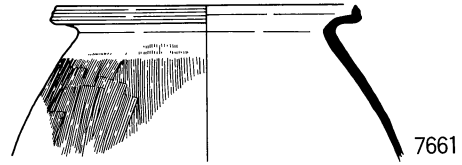
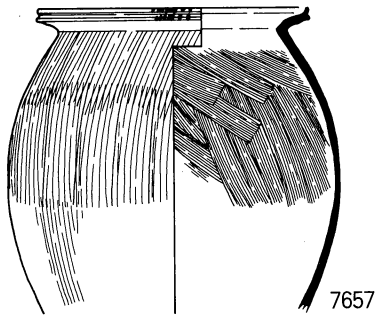

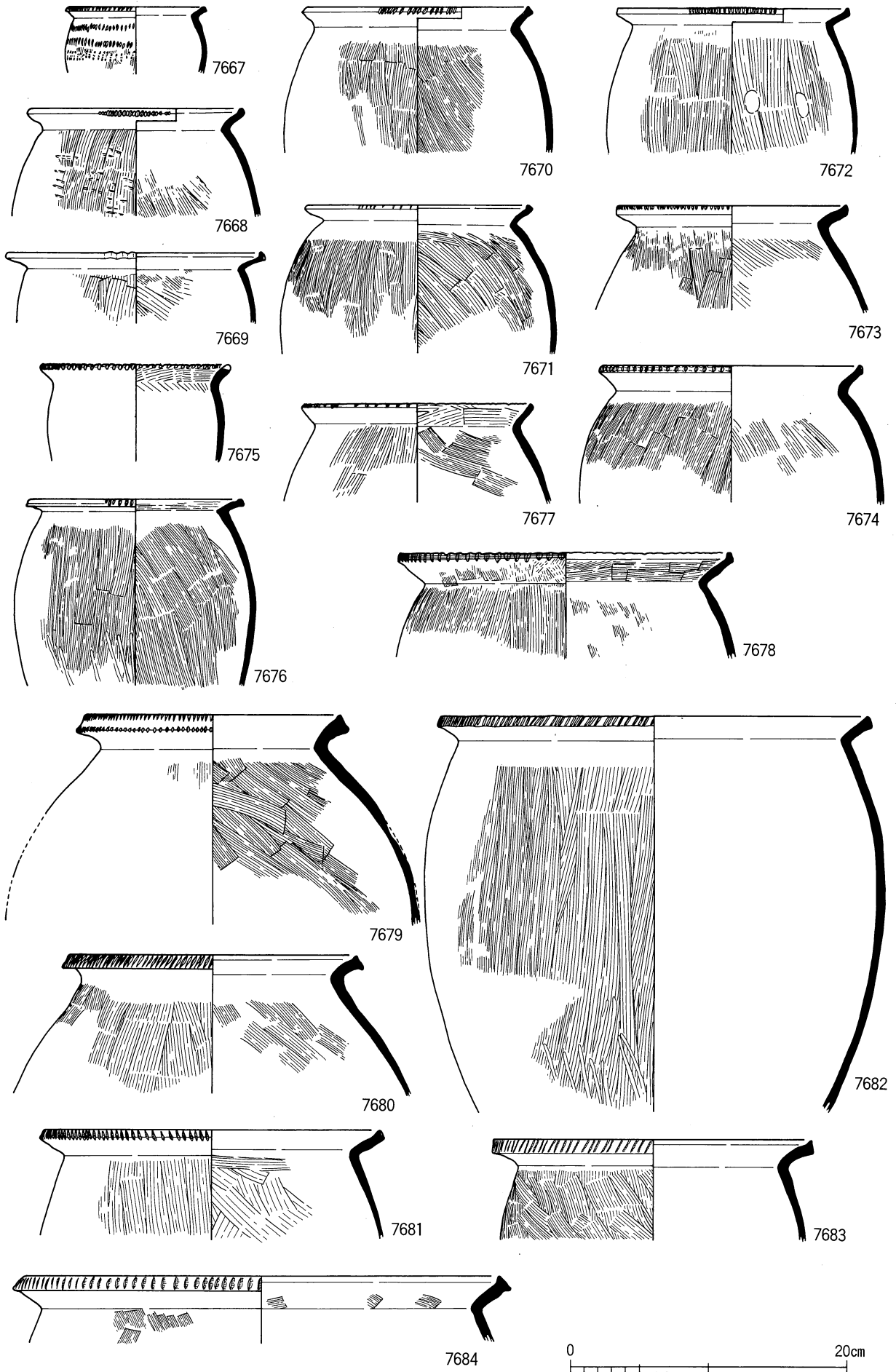

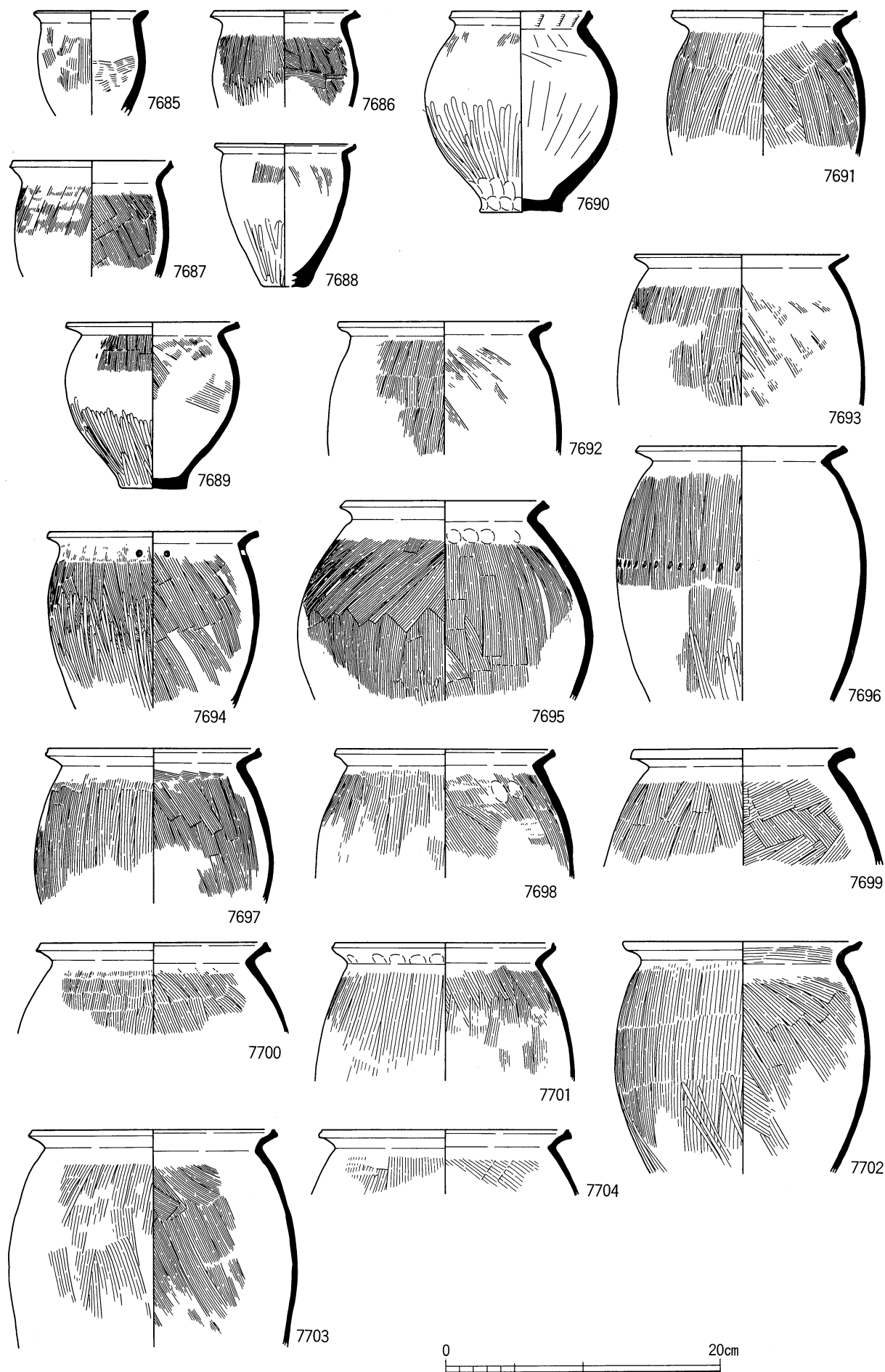

弥生中期上層 旧河道出土土器54 (SR46002)

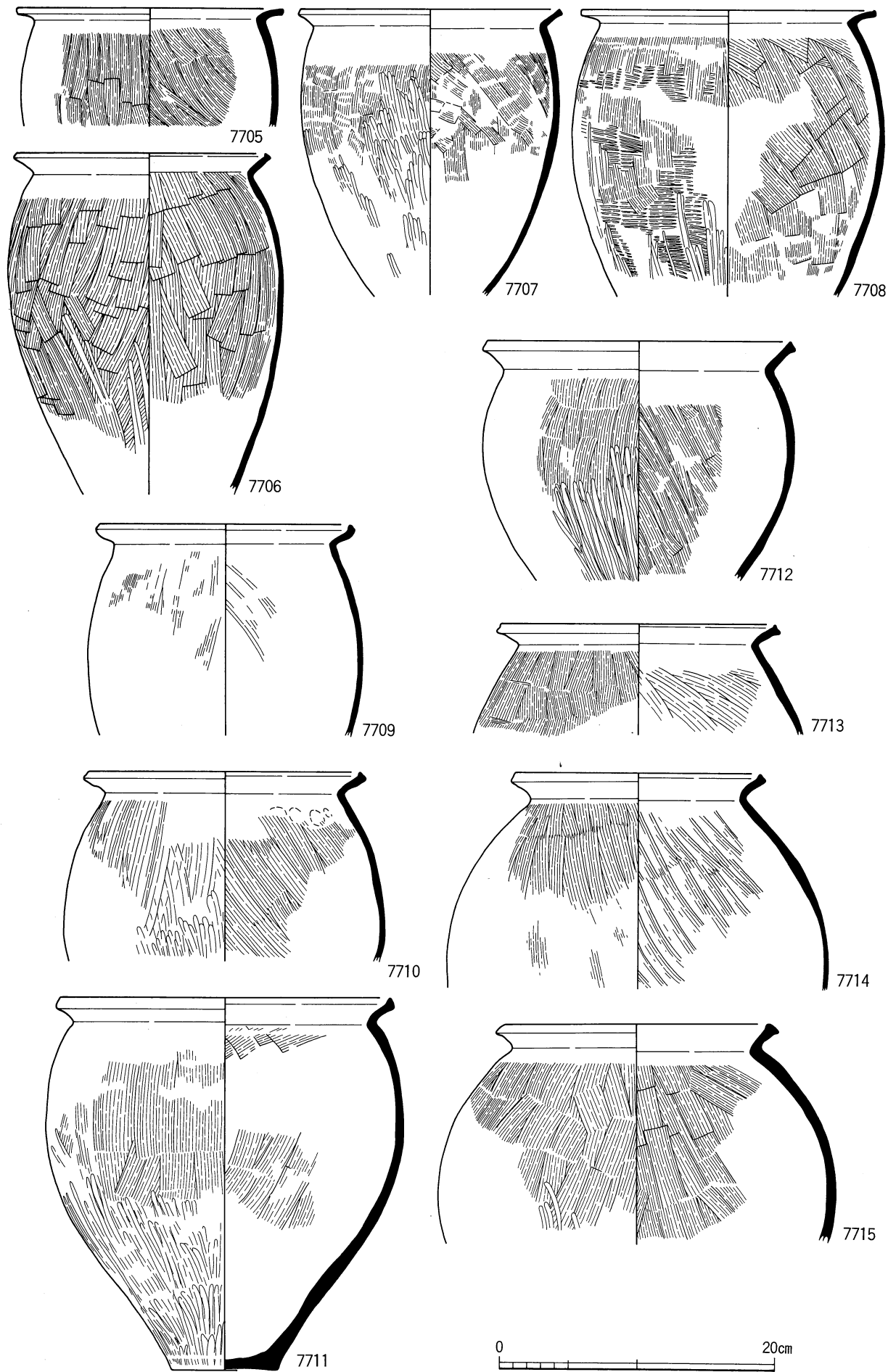

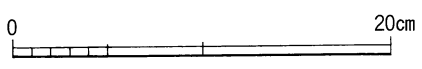
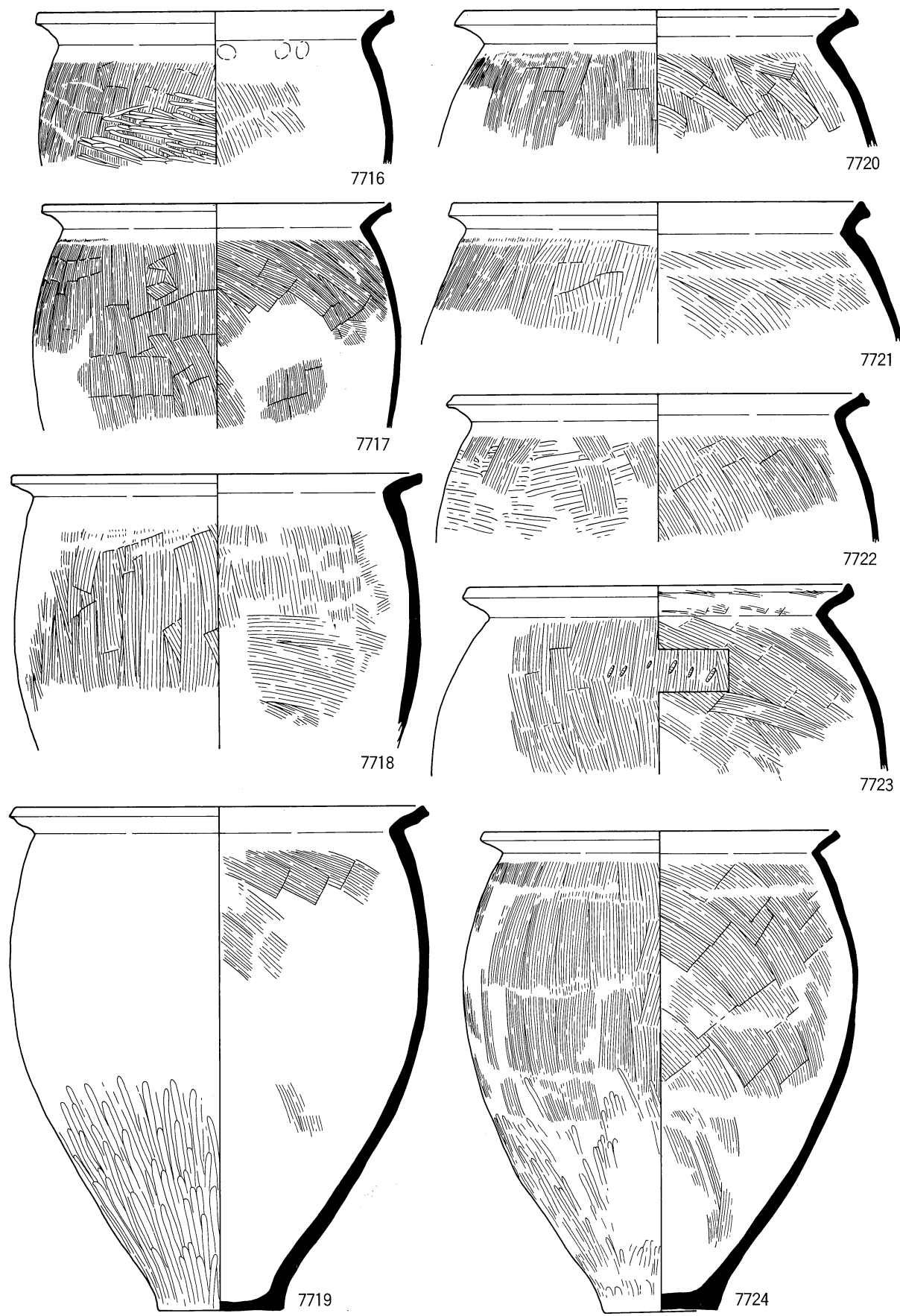

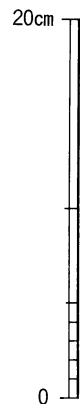
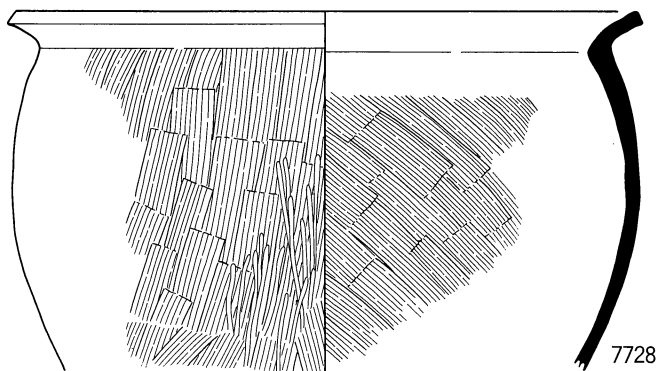
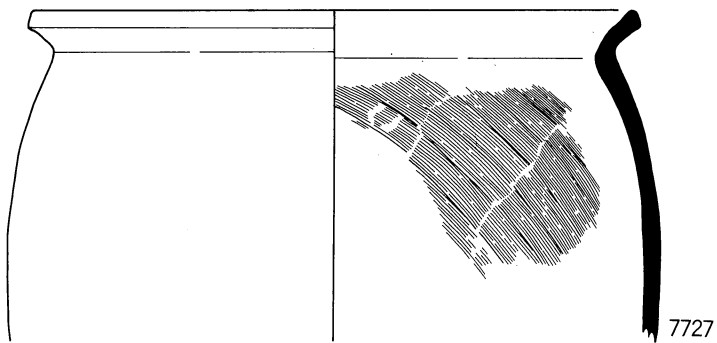
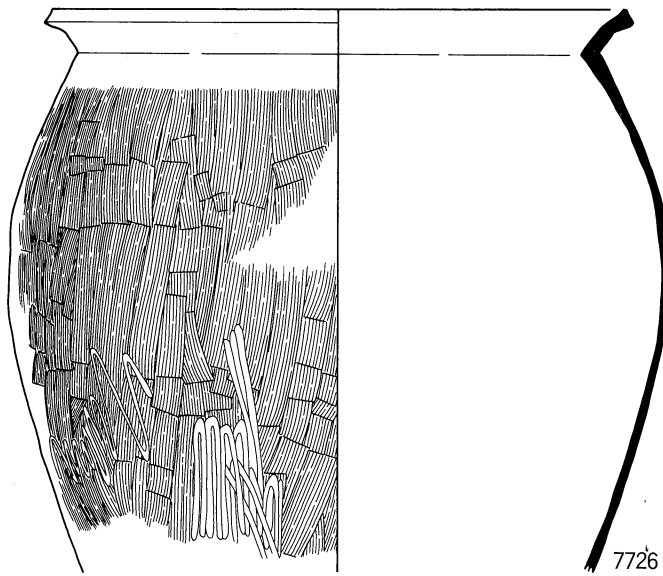
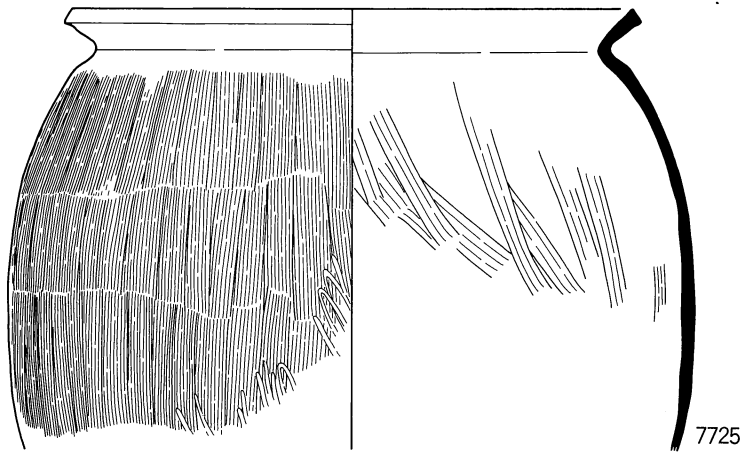

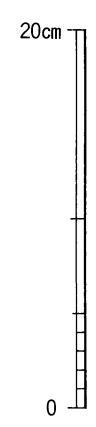
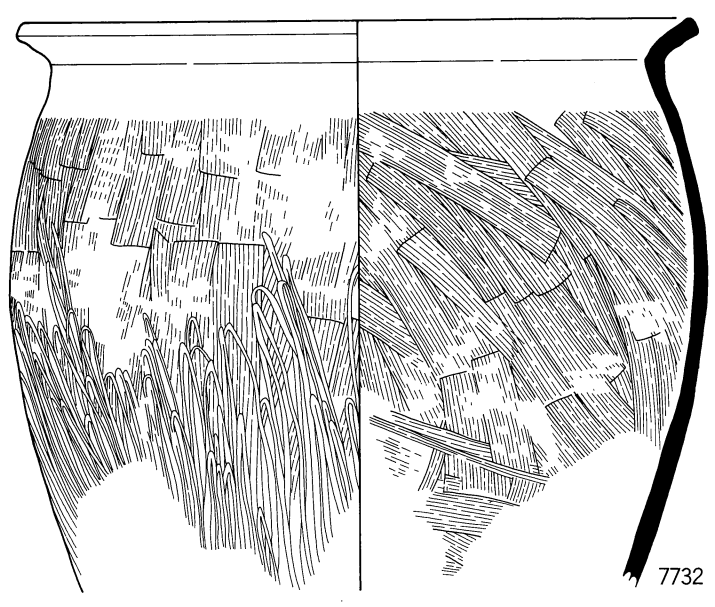
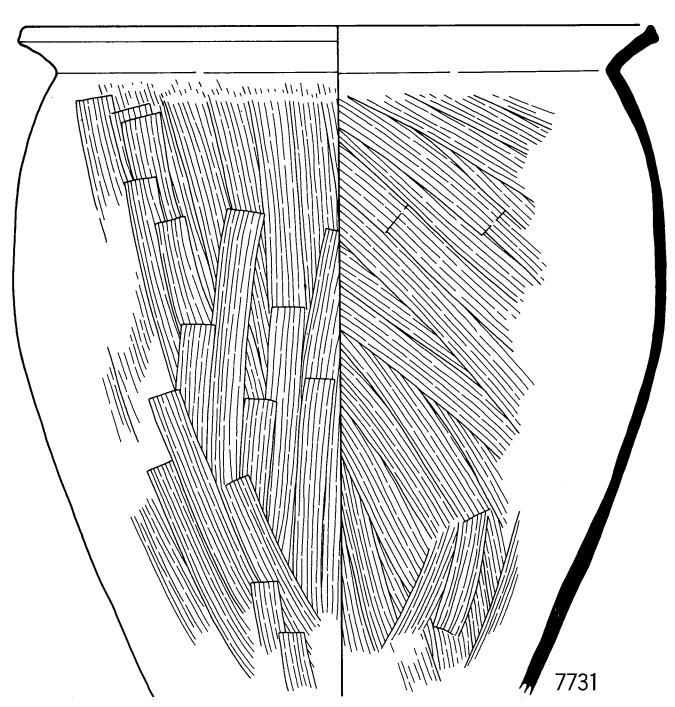
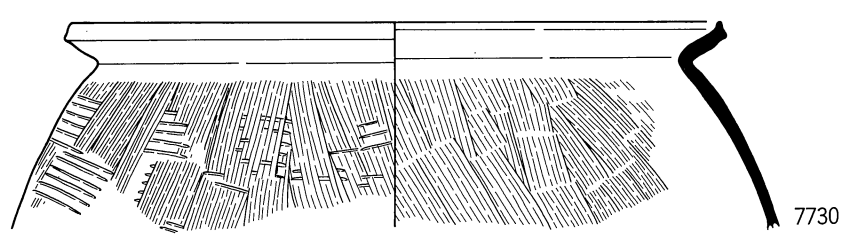
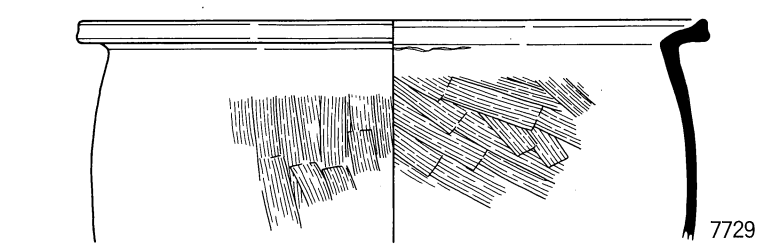

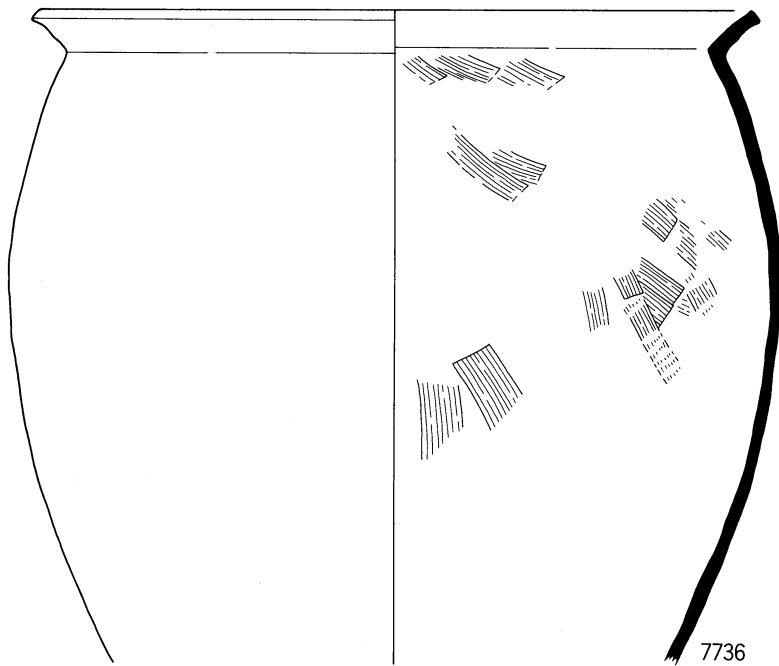
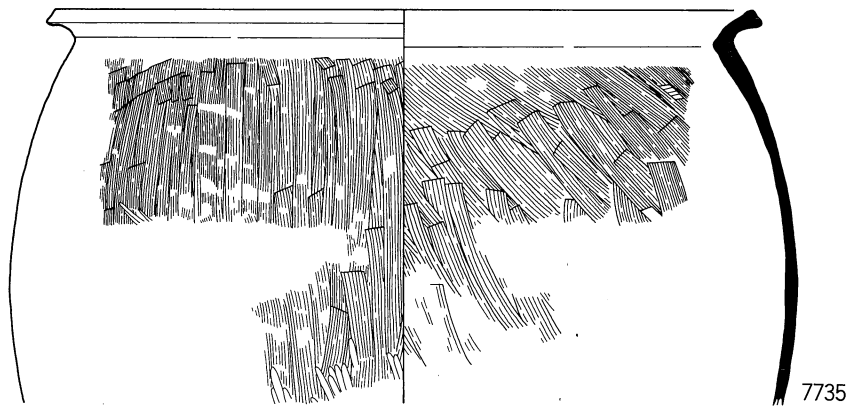
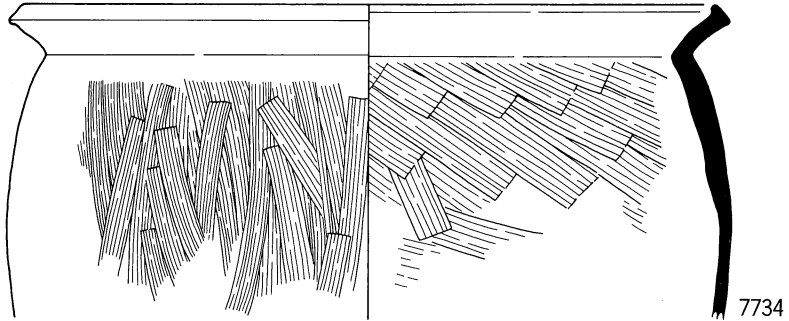
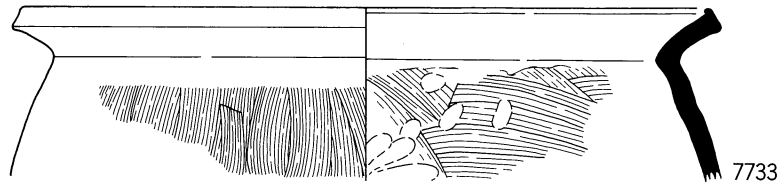

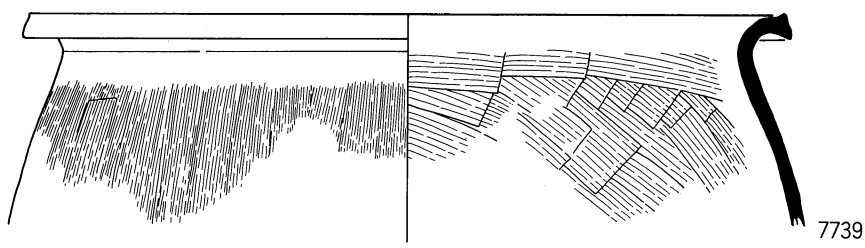
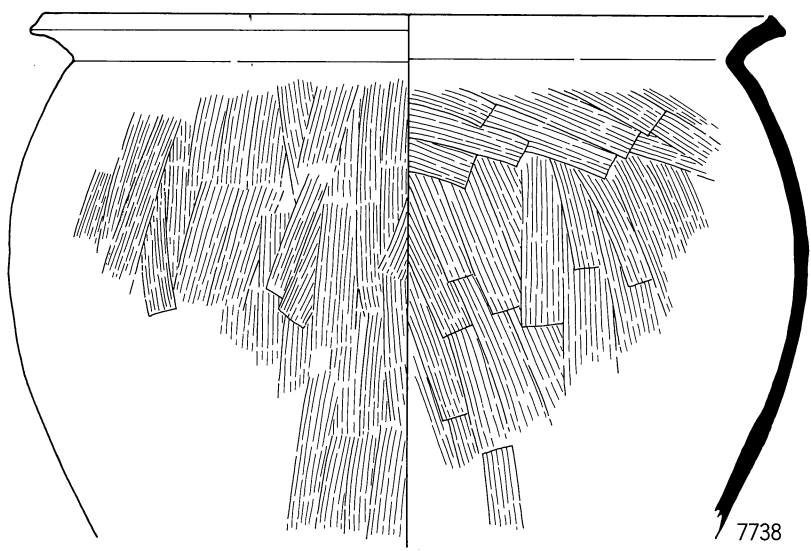
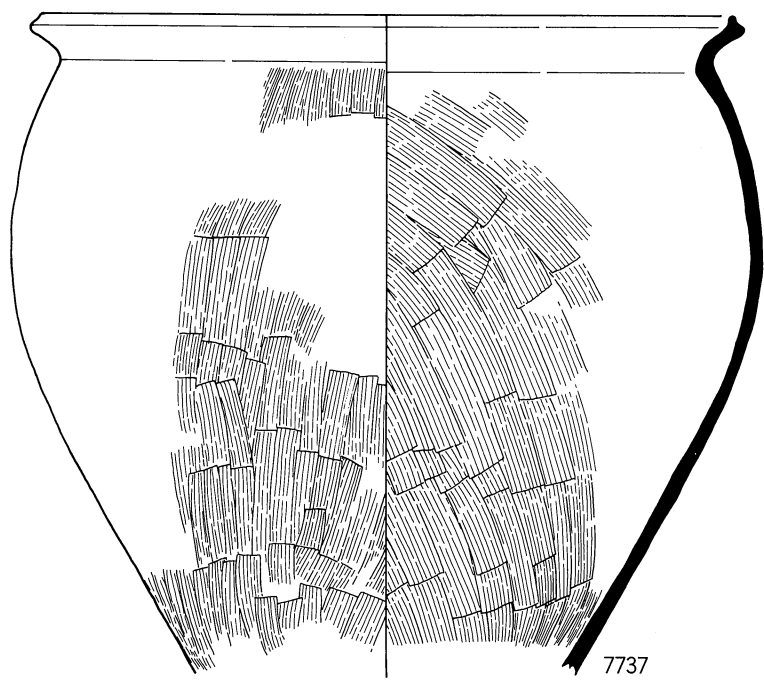

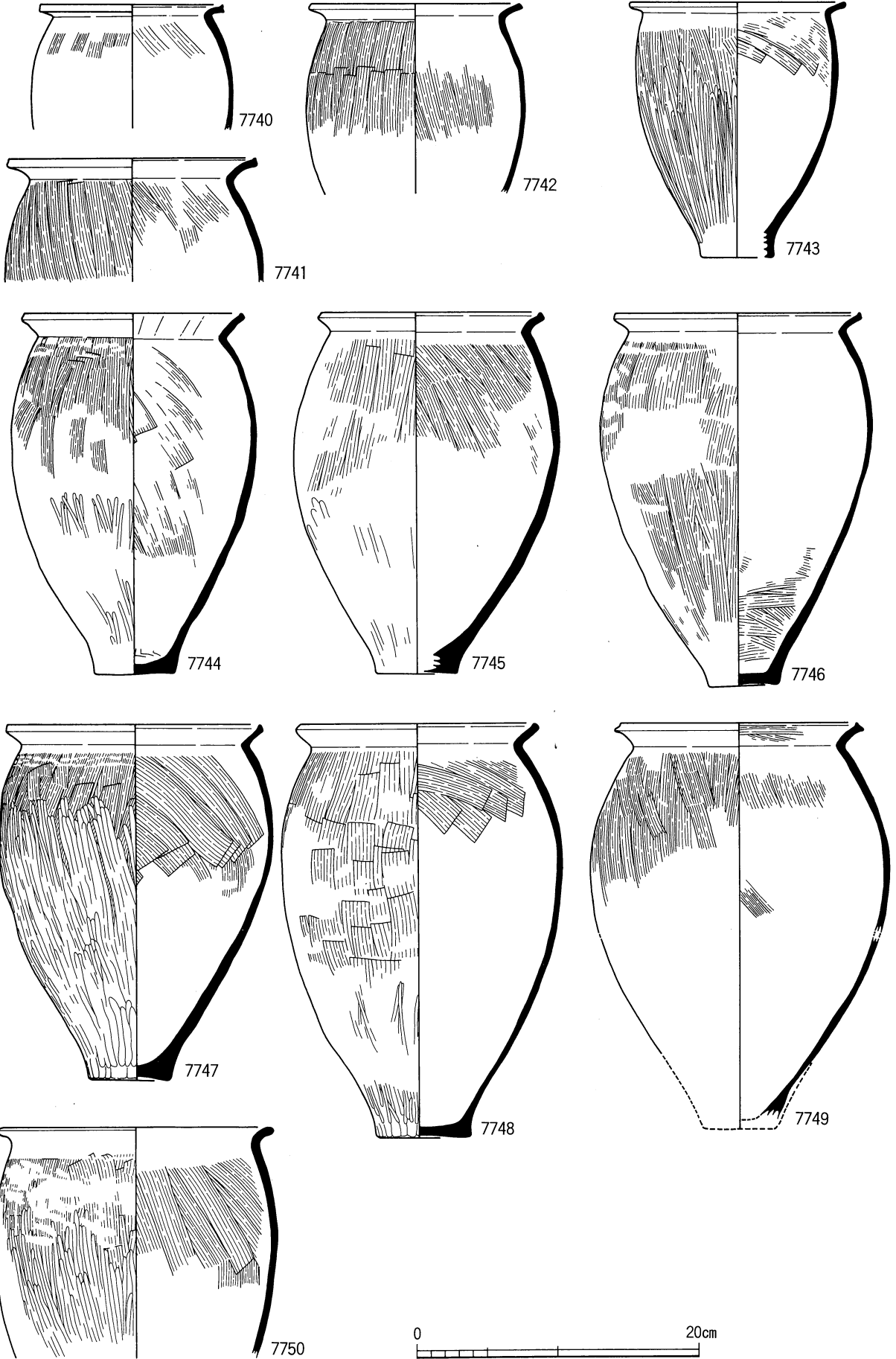

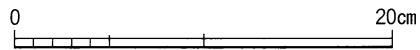
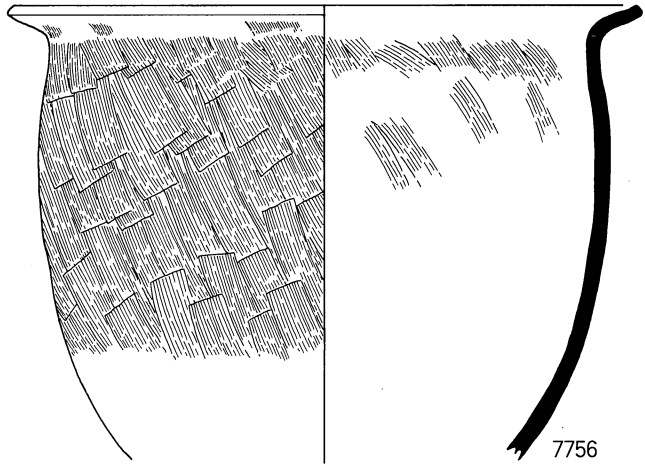
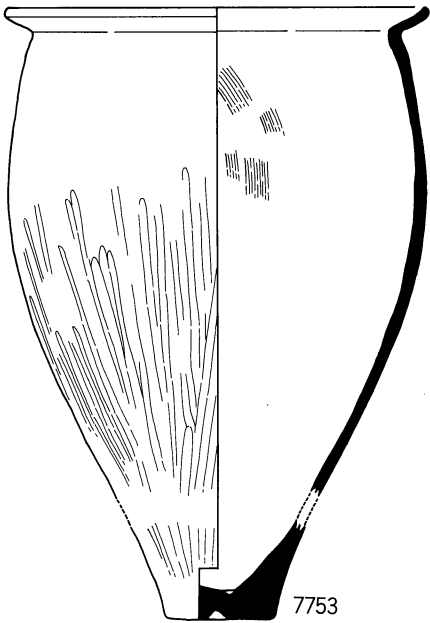
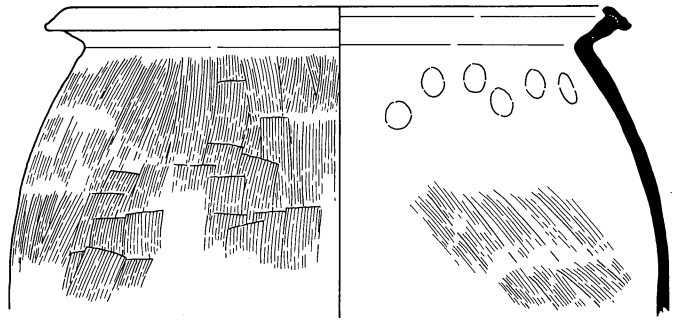
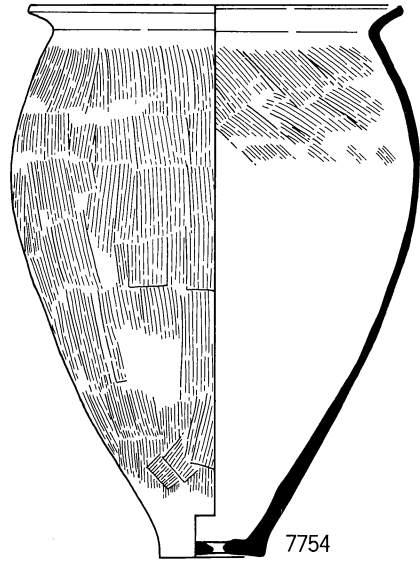
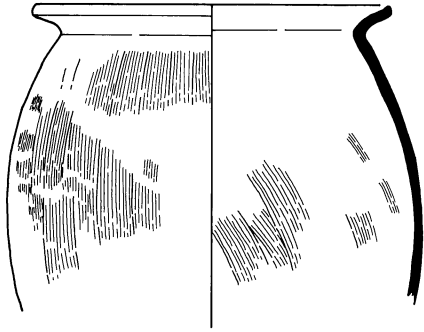

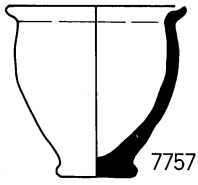

7757

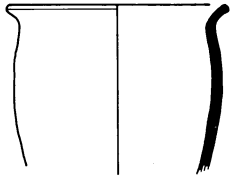

7758

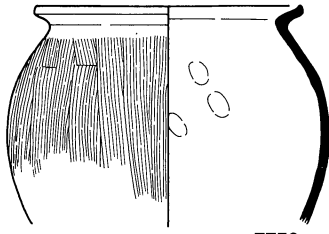

7759

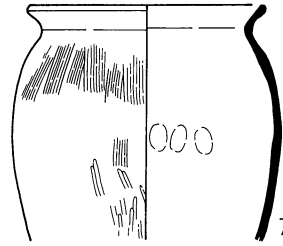

7760

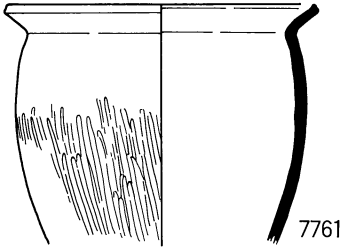

7761

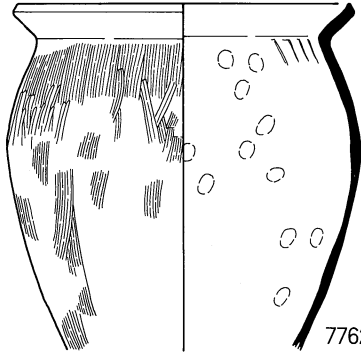

7762

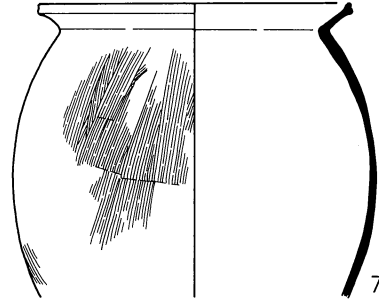

7763

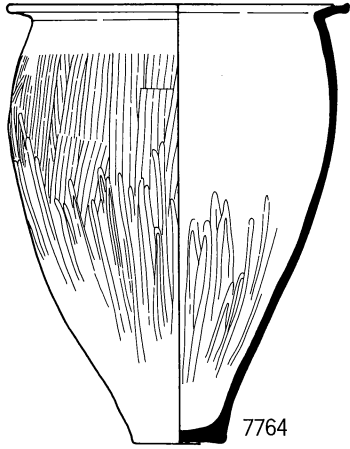

7764

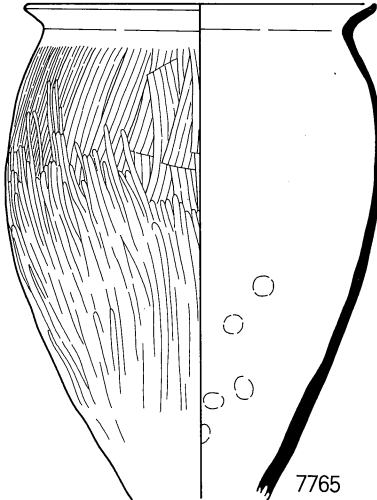

7765

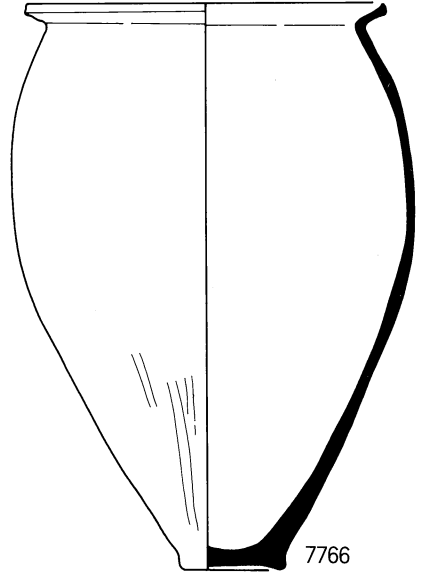

7766

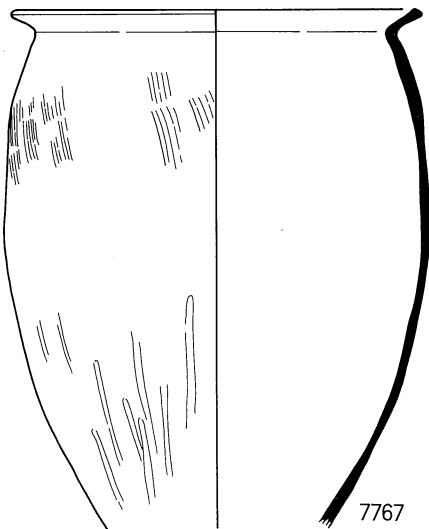

7767

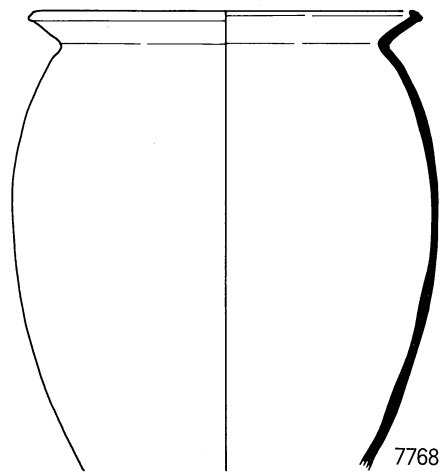

7768

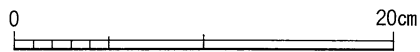

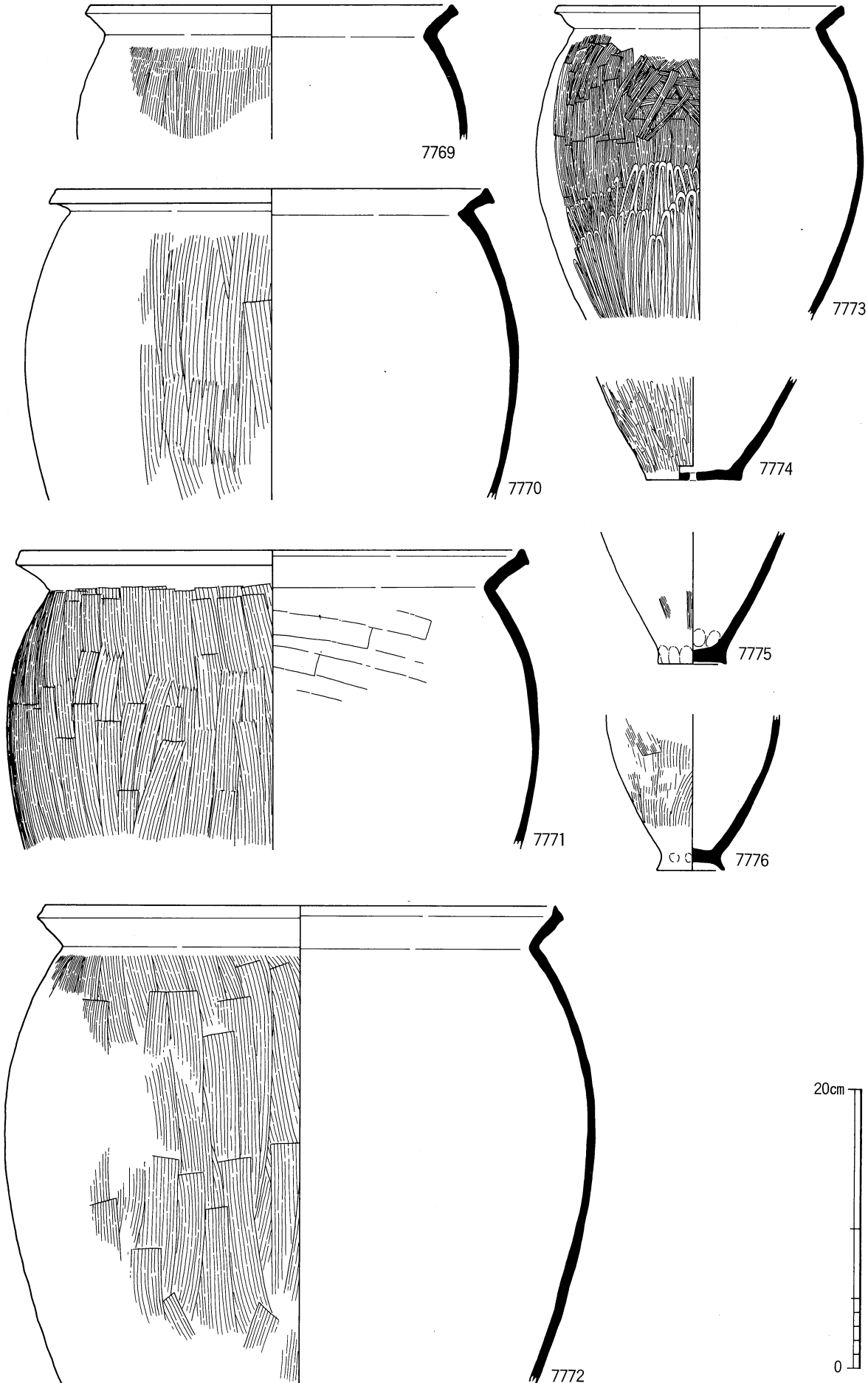

弥生中期上層 旧河道出土土器64 (SR46002)

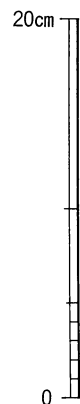
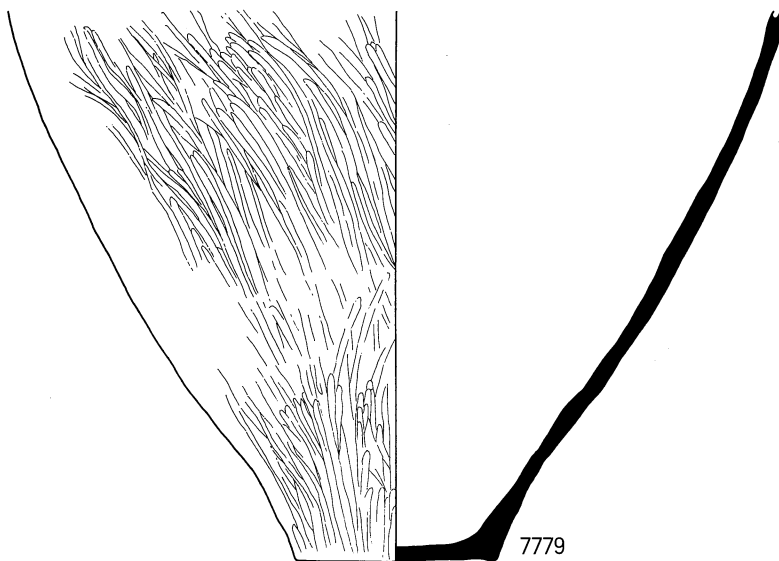
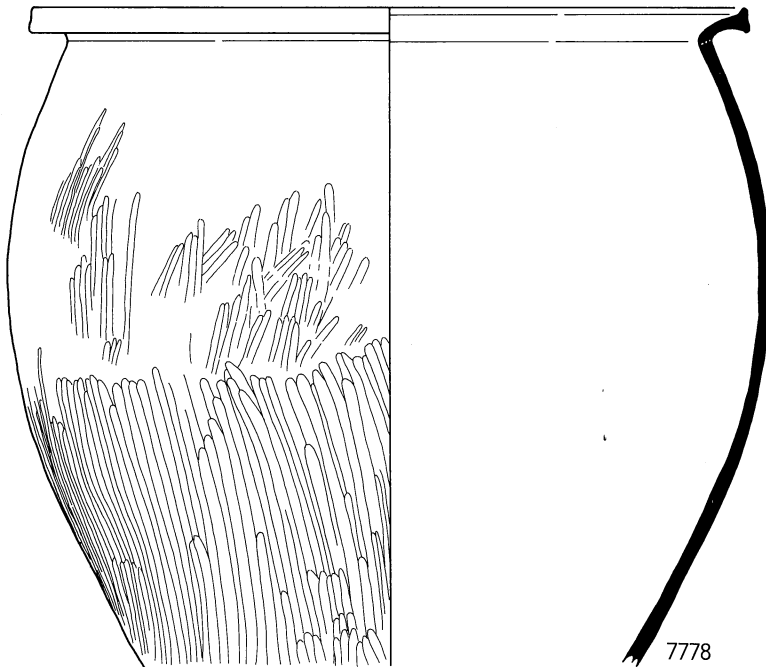
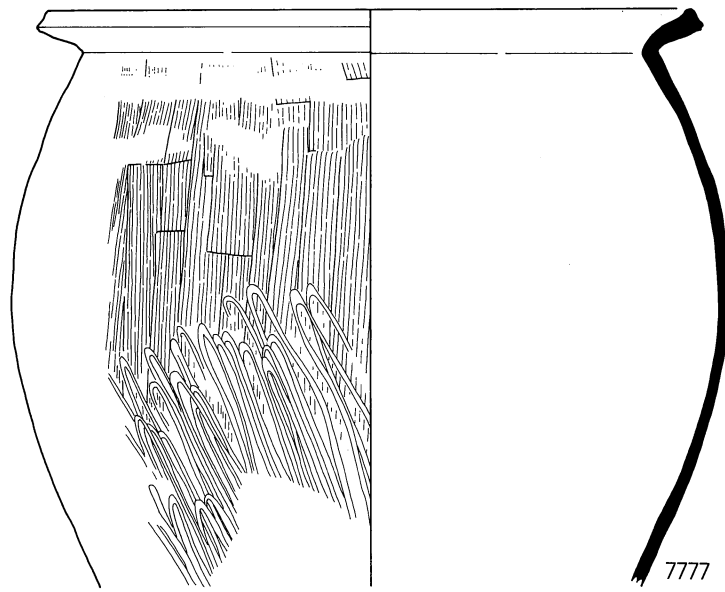

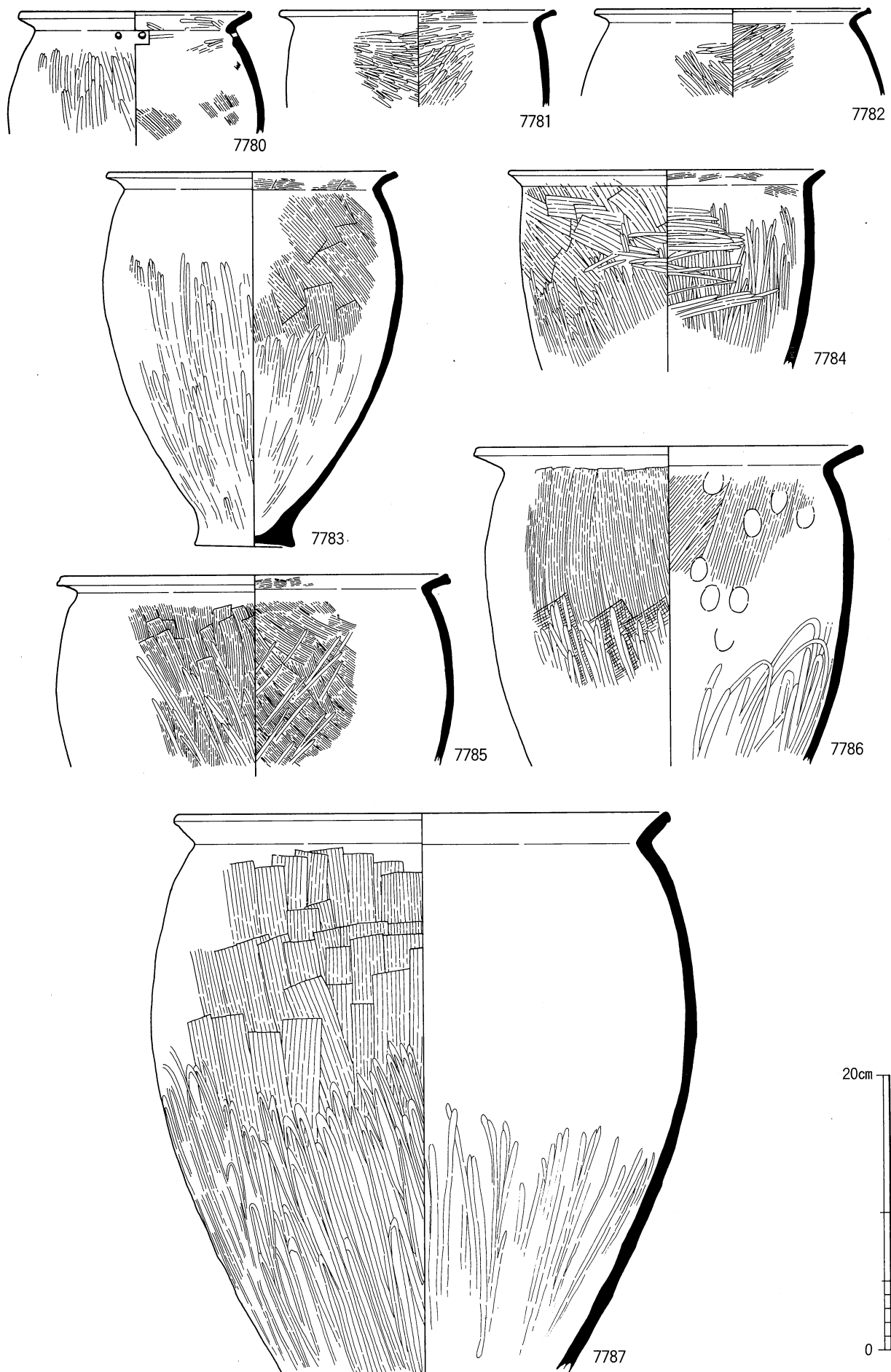

弥生中期上層 旧河道出土土器66 (SR46002)

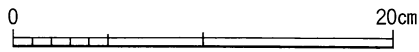
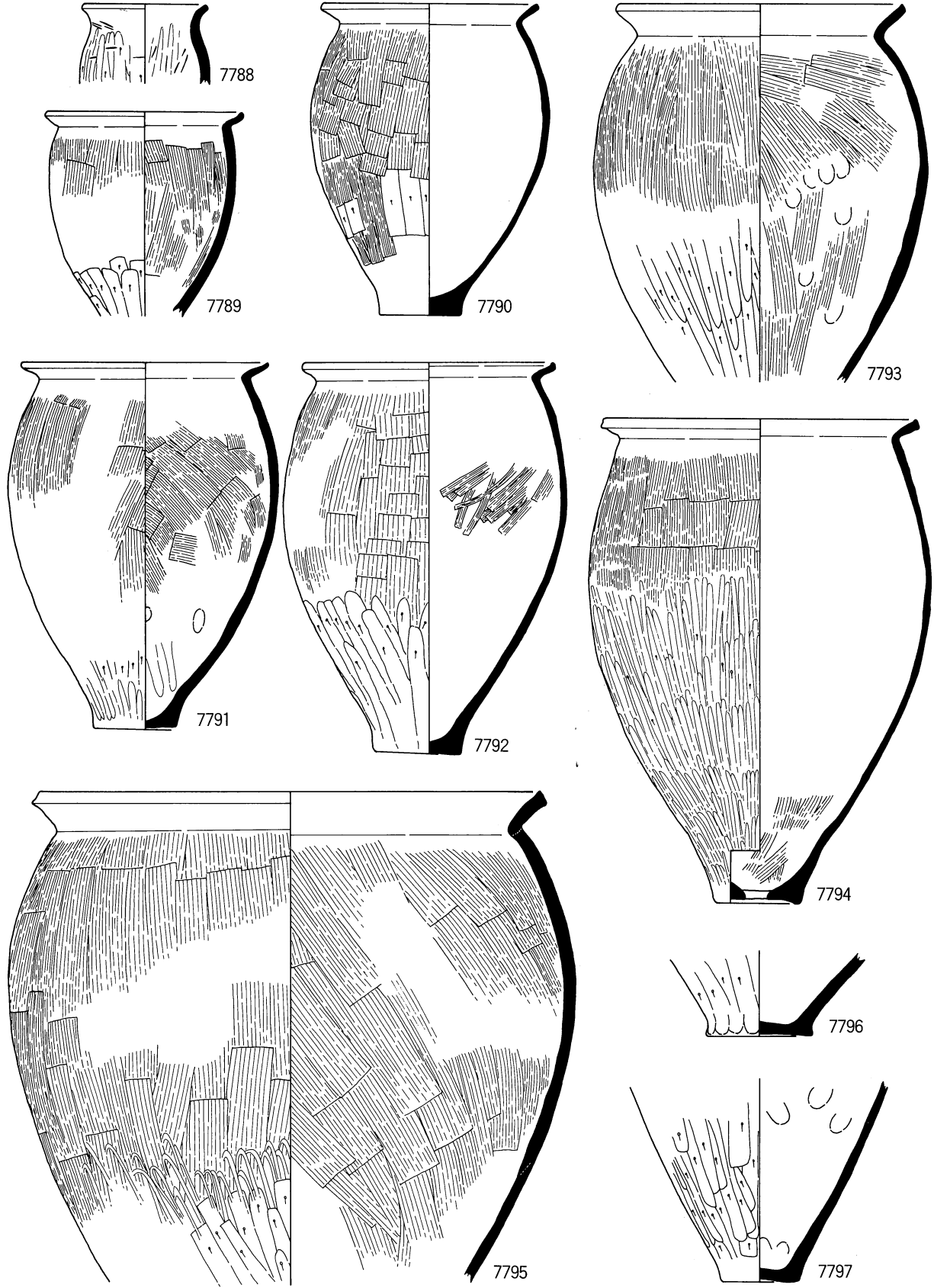

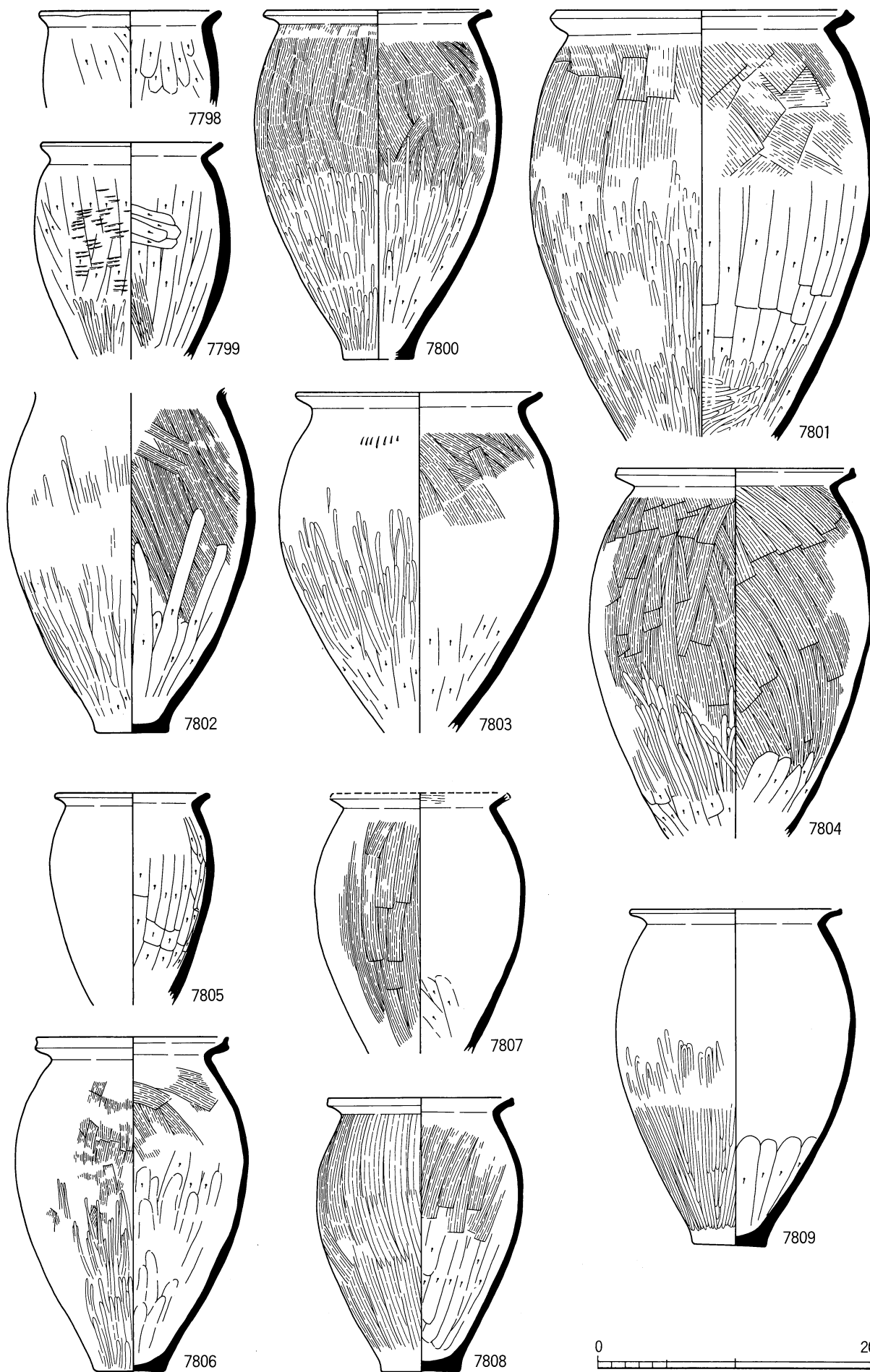

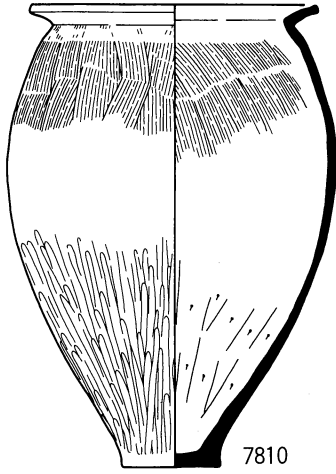

7810

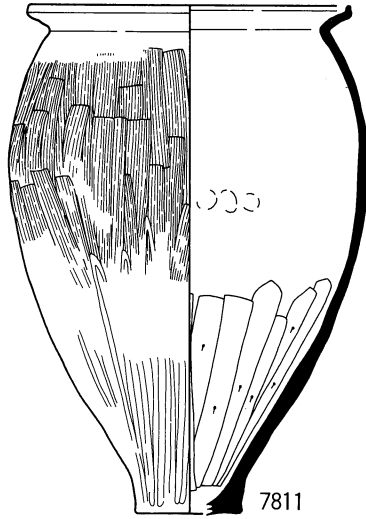

7811

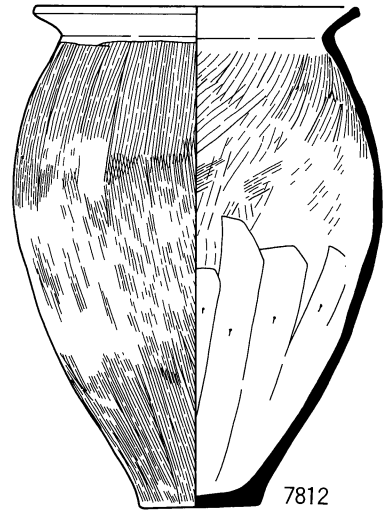

7812

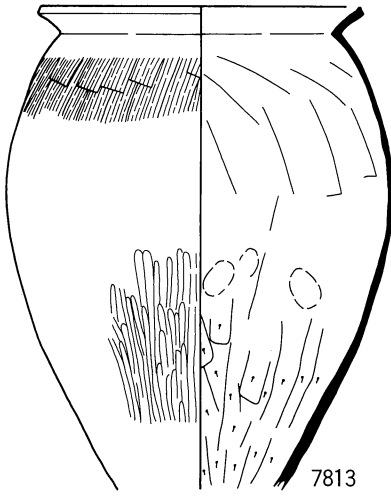

7813

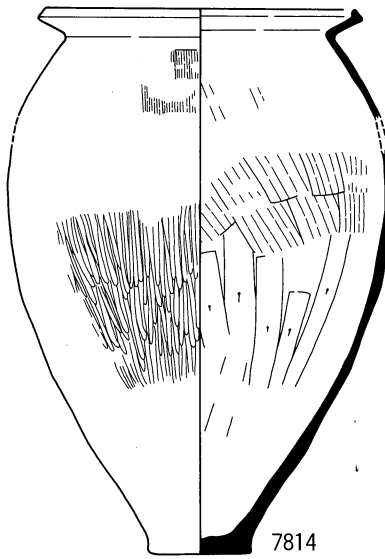

7814

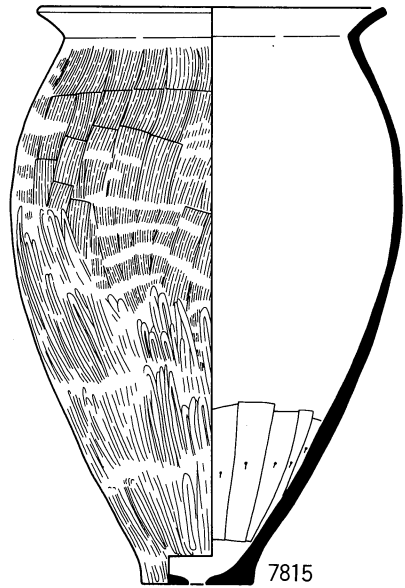

7815

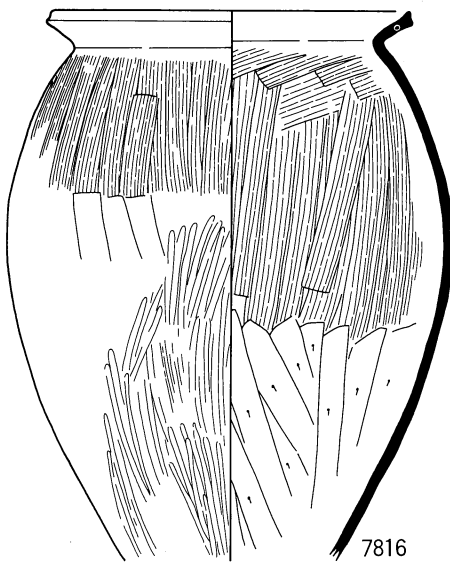

7816

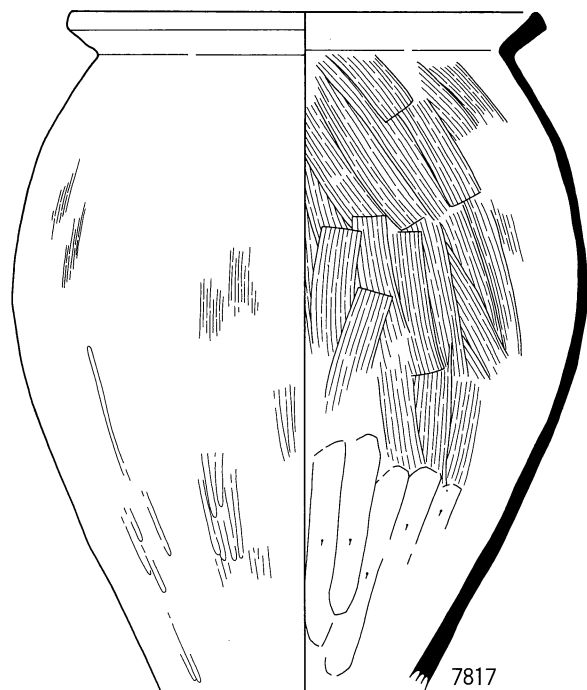

7817

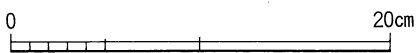



7818

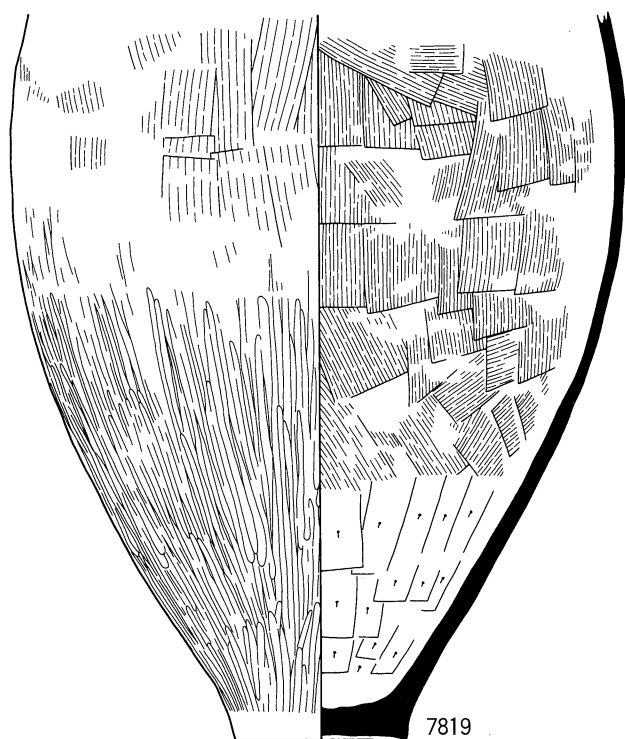

7819

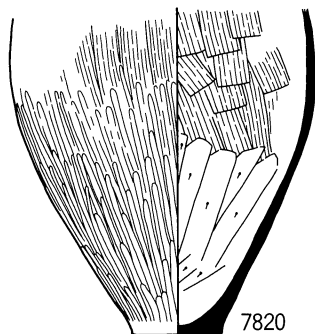

7820



7821



7822

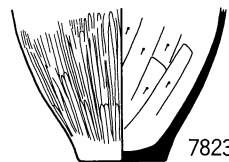

7823

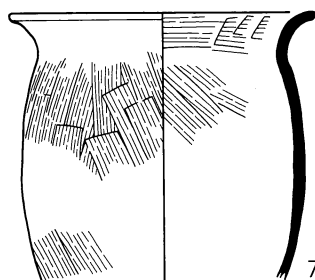

7824

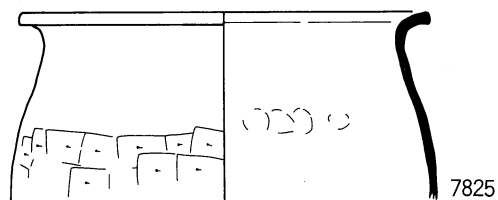

7825

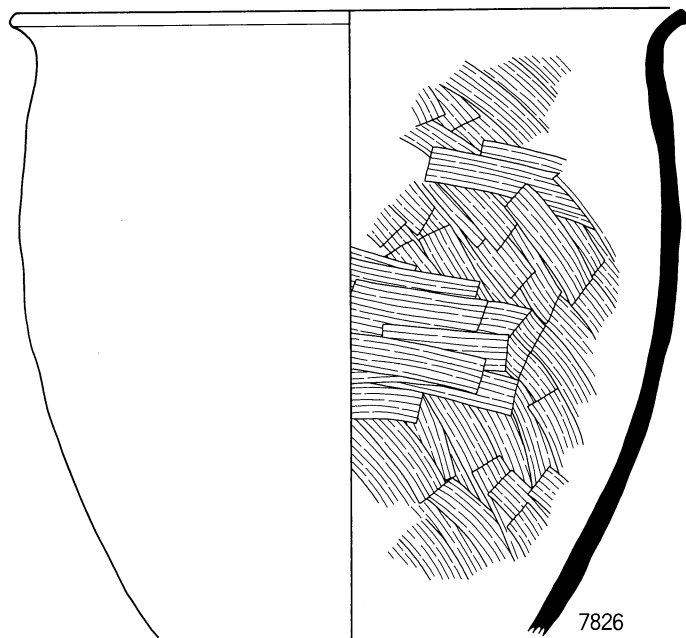

7826

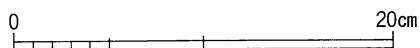

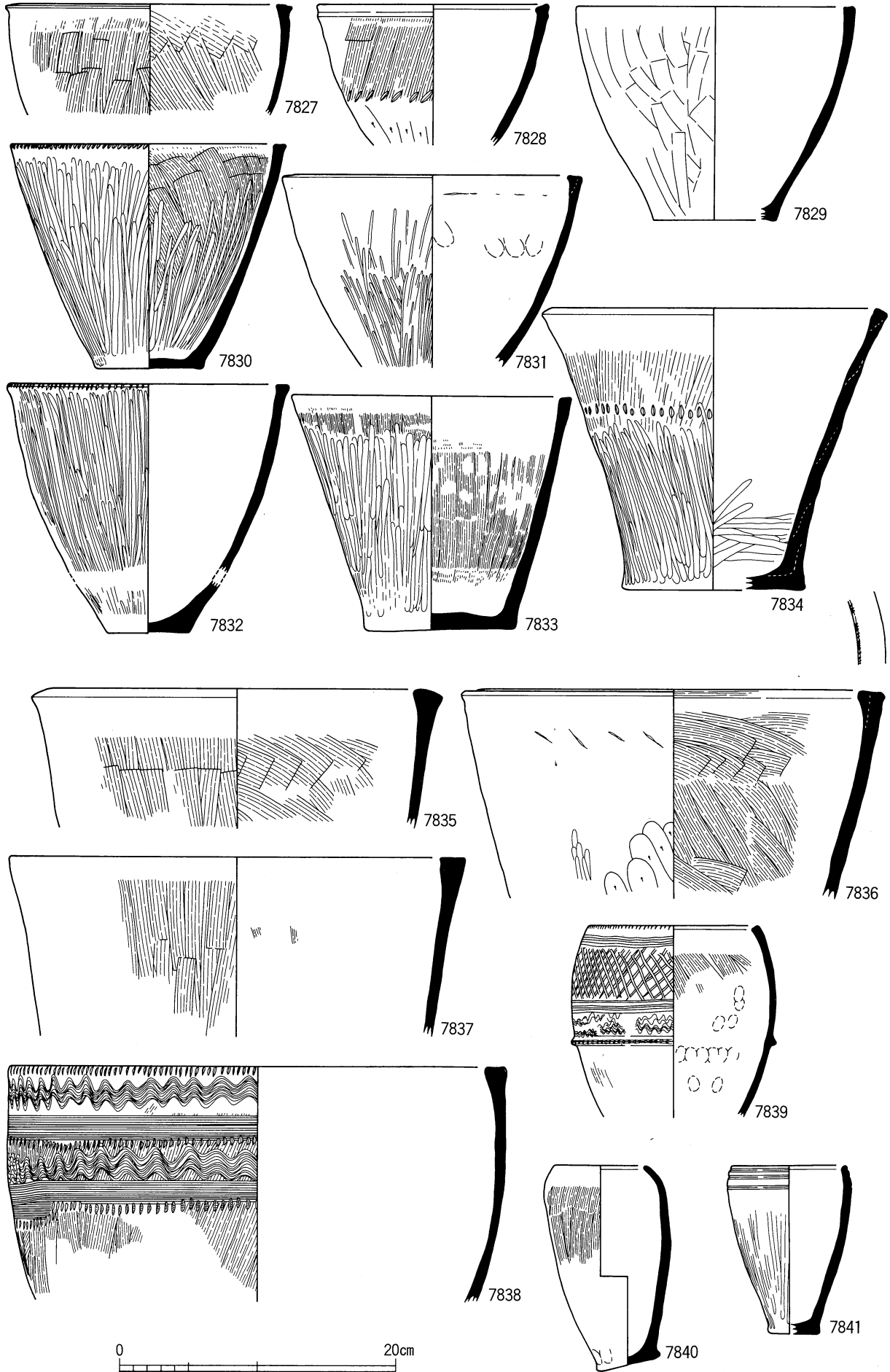

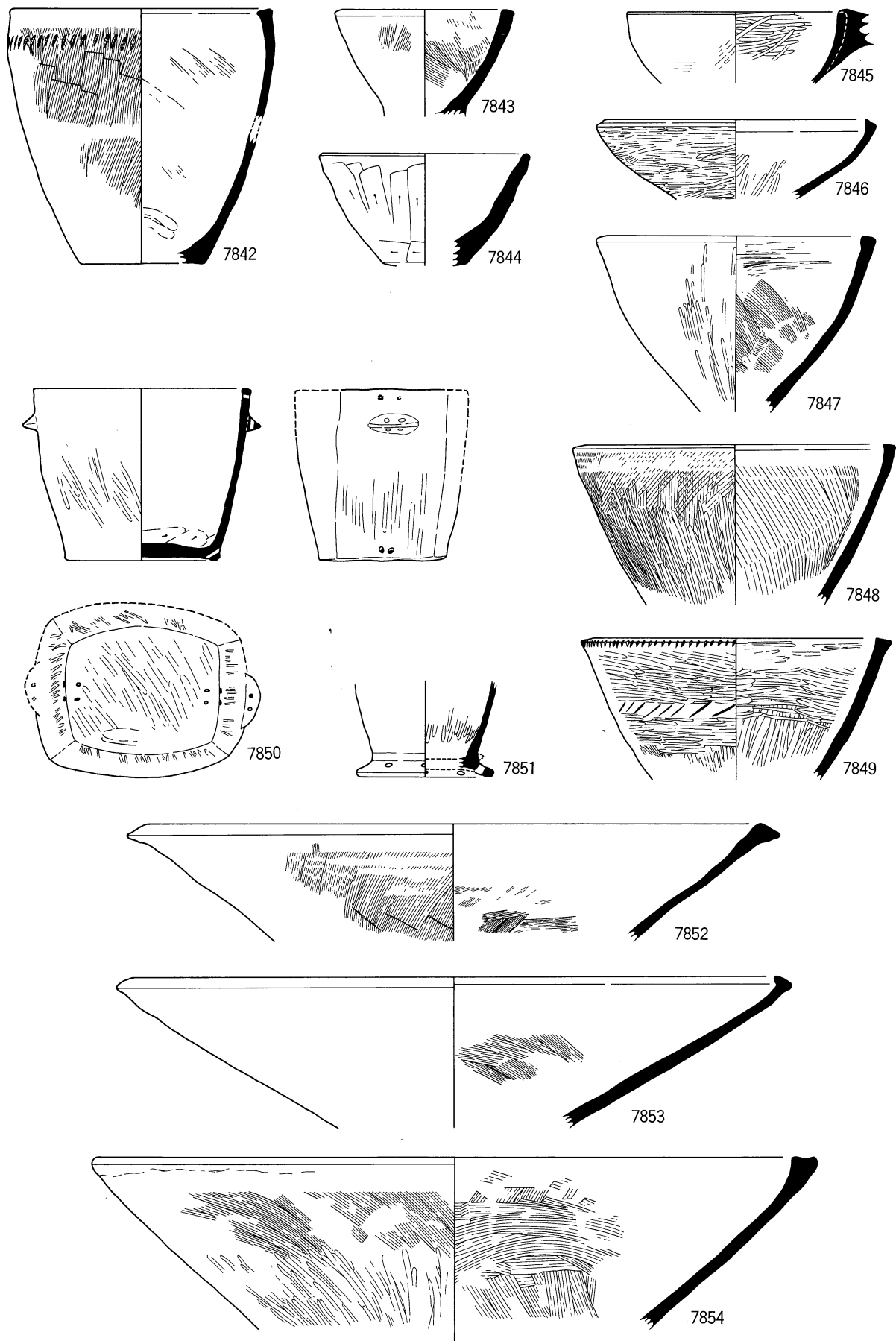

0 20cm

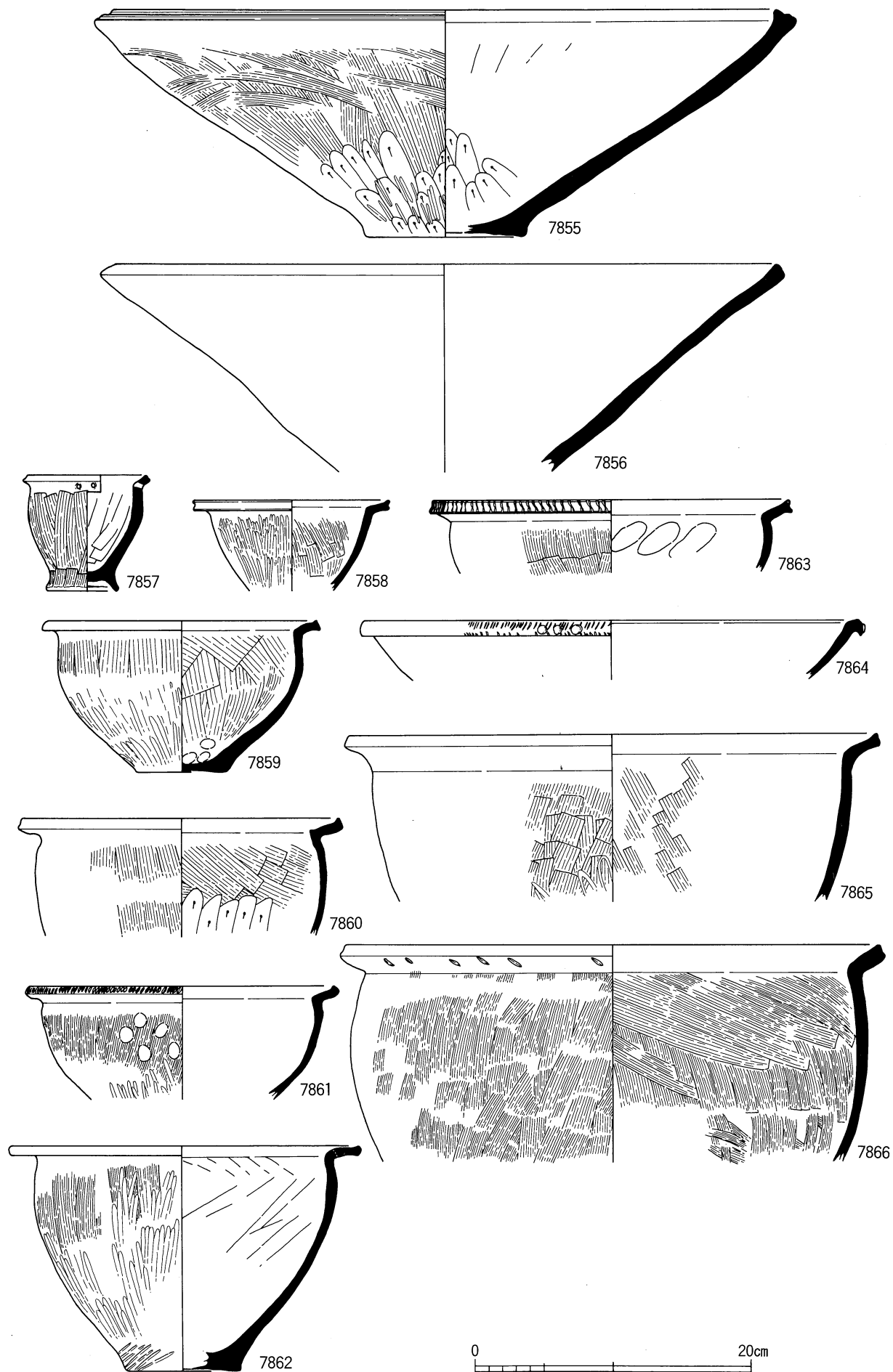



7867

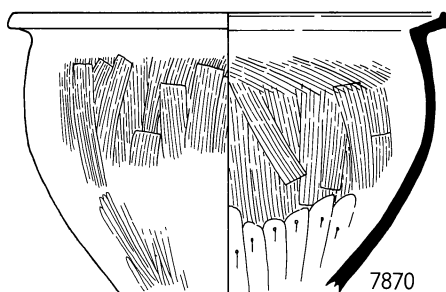

7870

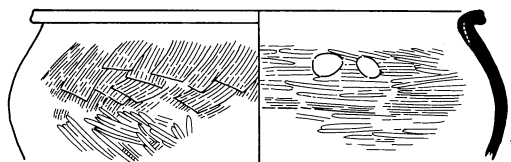

7868

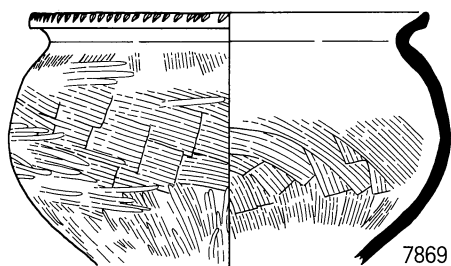

7869

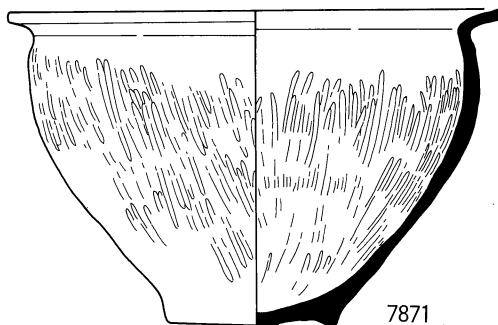

7871

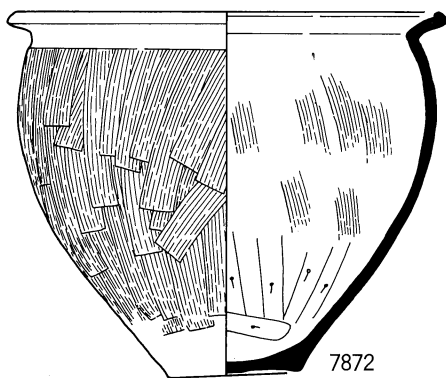

7872

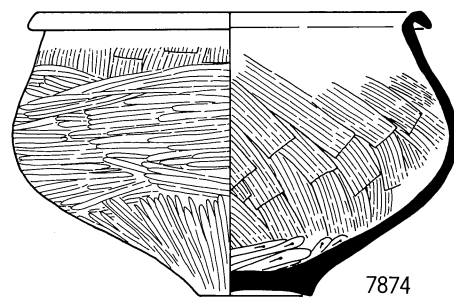

7874

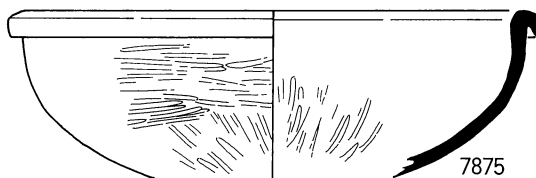

7875

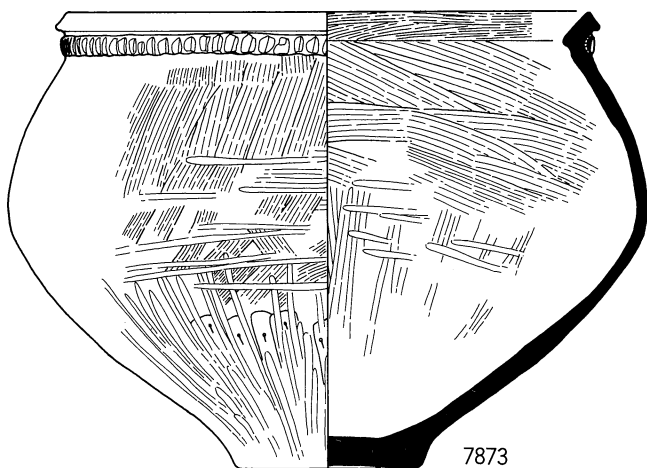

7873

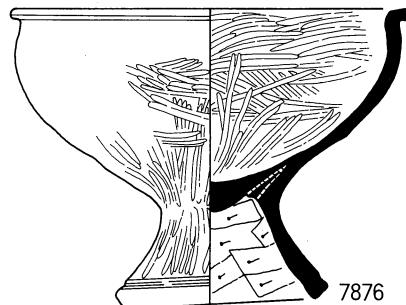

7876

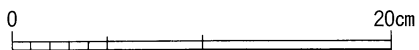

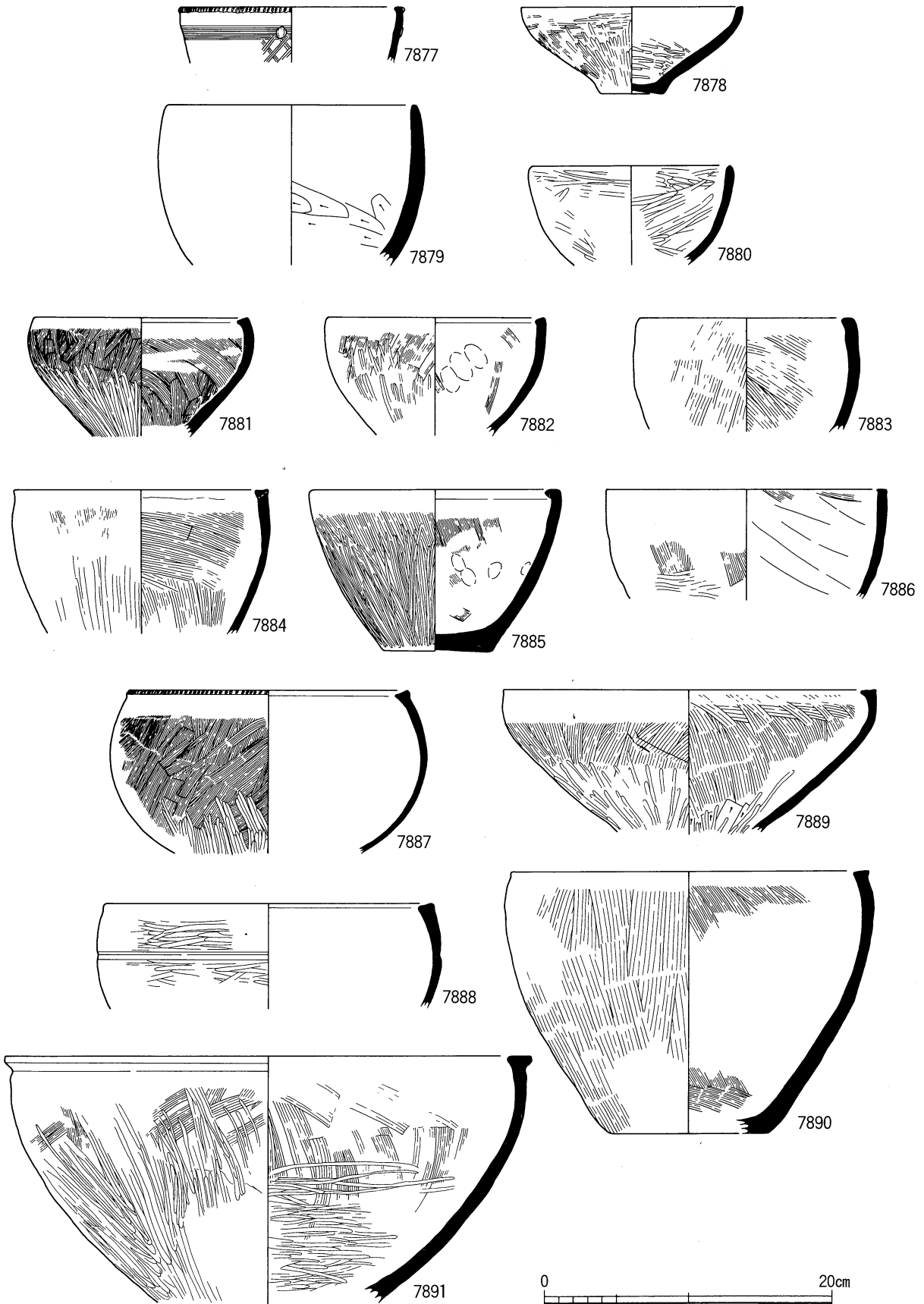

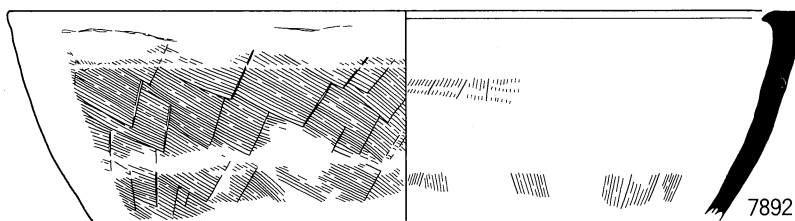

7892

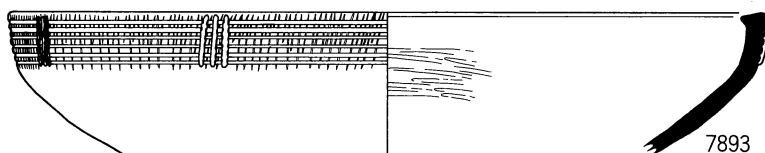

7893

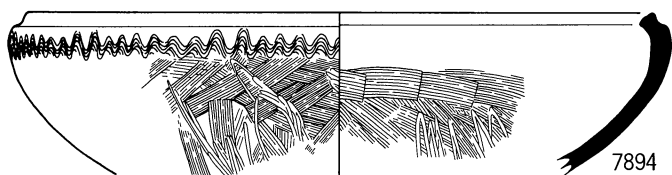

7894

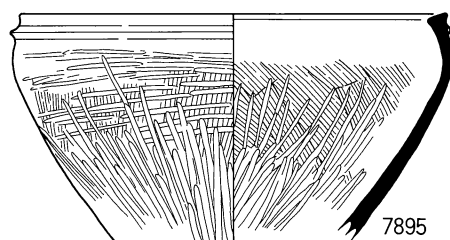

7895

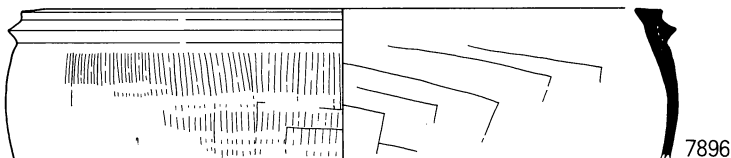

7896

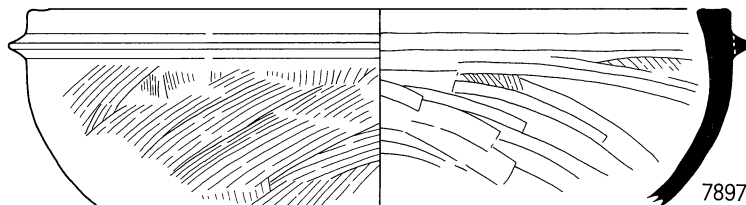

7897

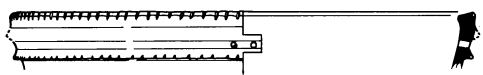

7898

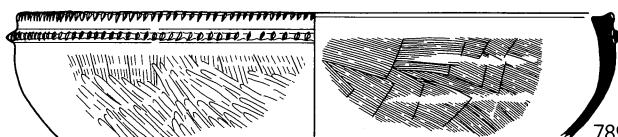

7899

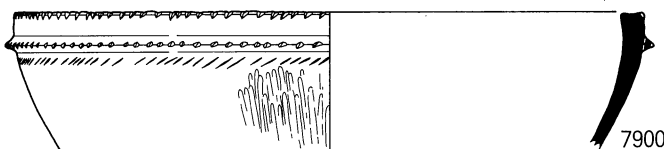

7900

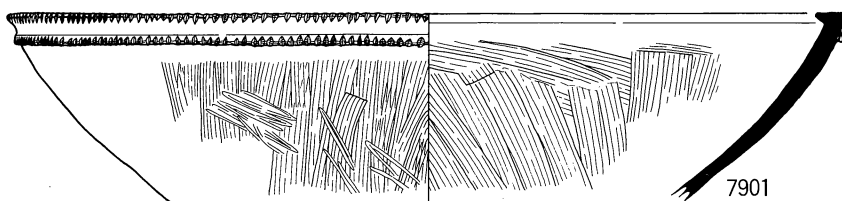

7901

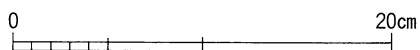

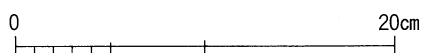
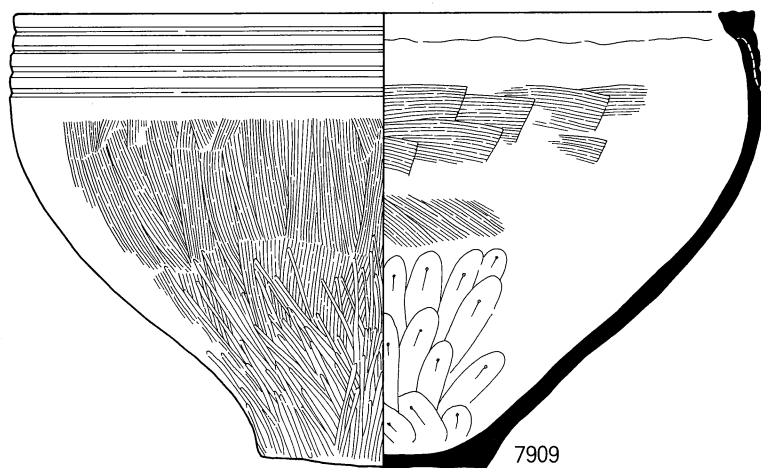
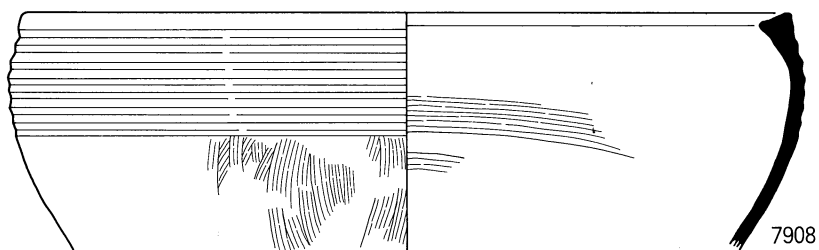
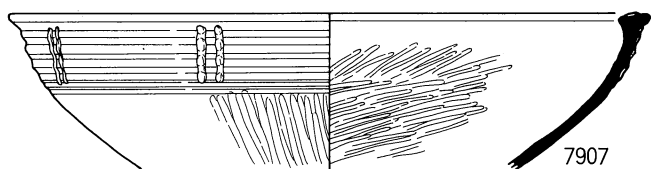
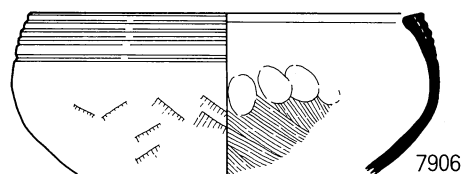
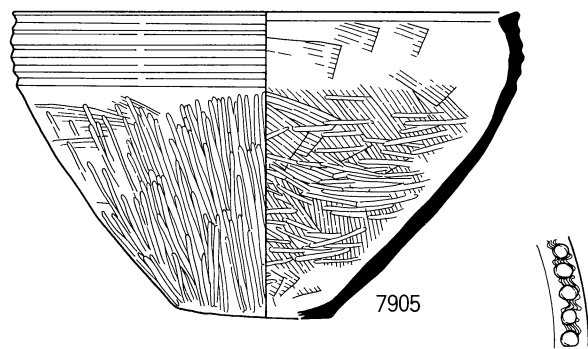
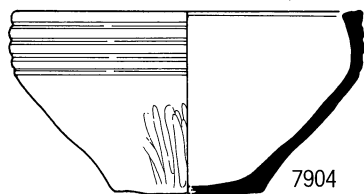
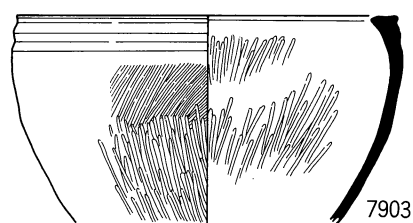
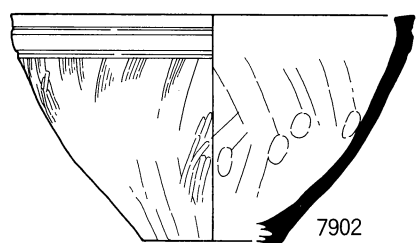

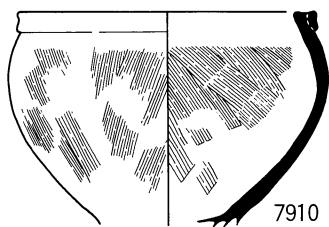

7910

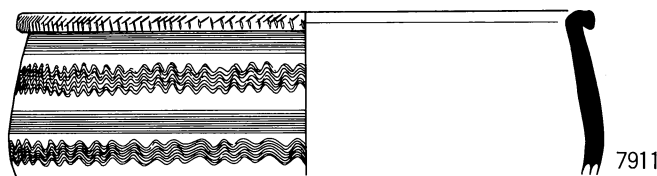

7911

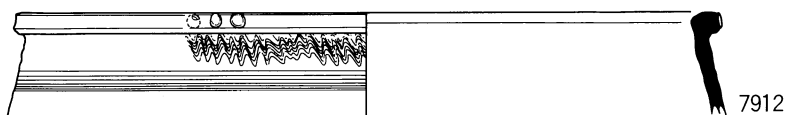

7912

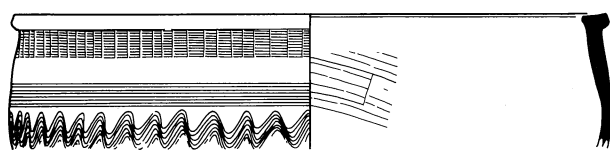

7913

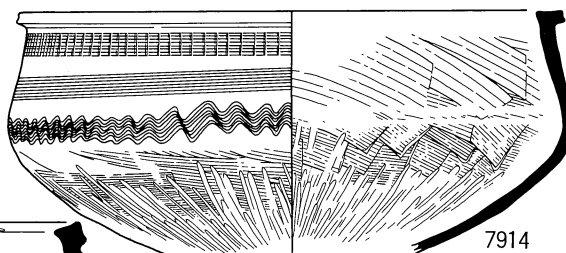

7914

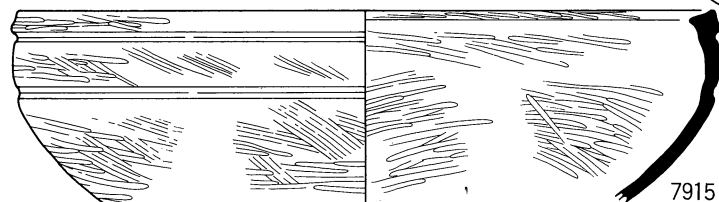

7915

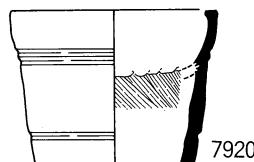

7920

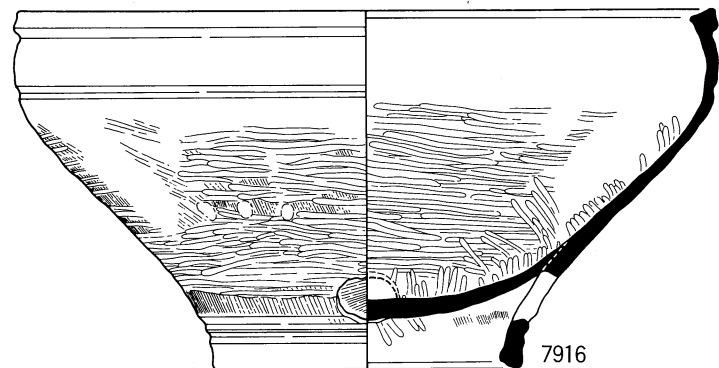

7916

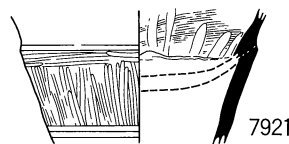

7921

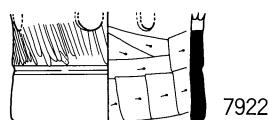

7922

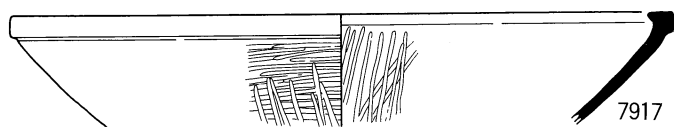

7917

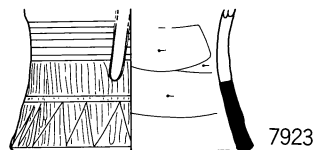

7923

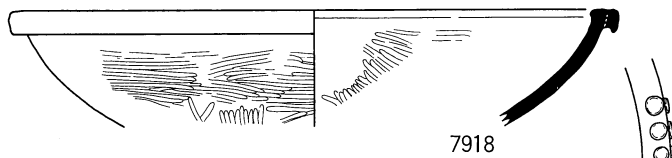

7918

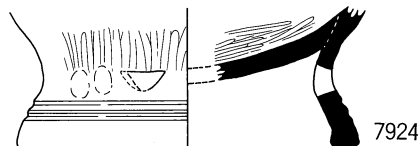

7924

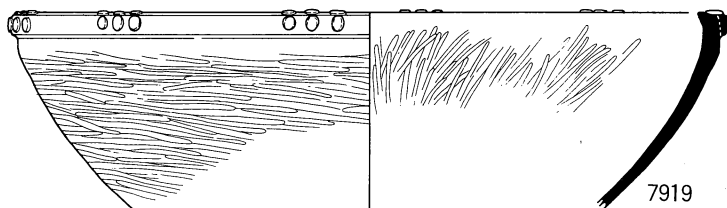

7919



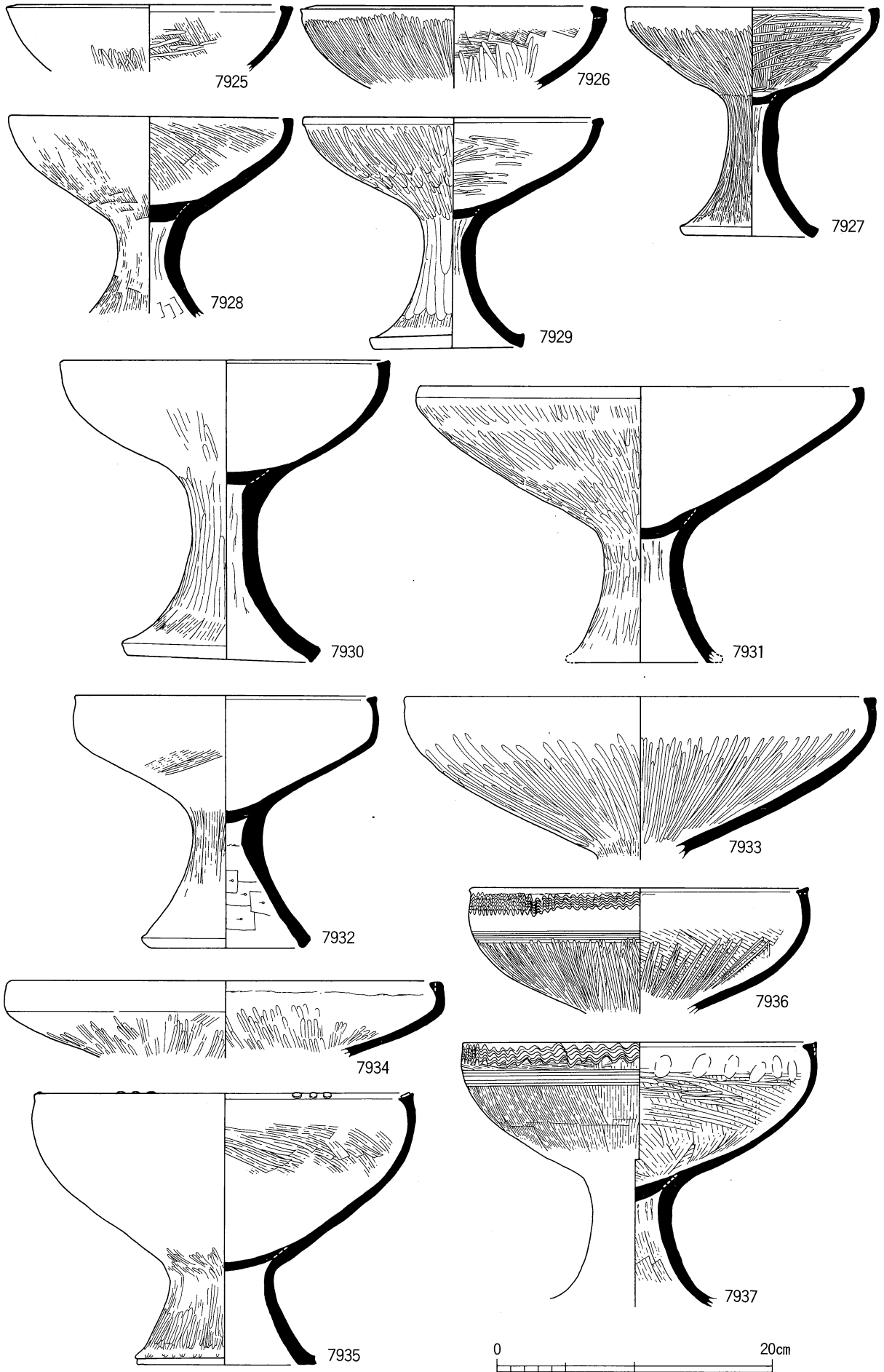

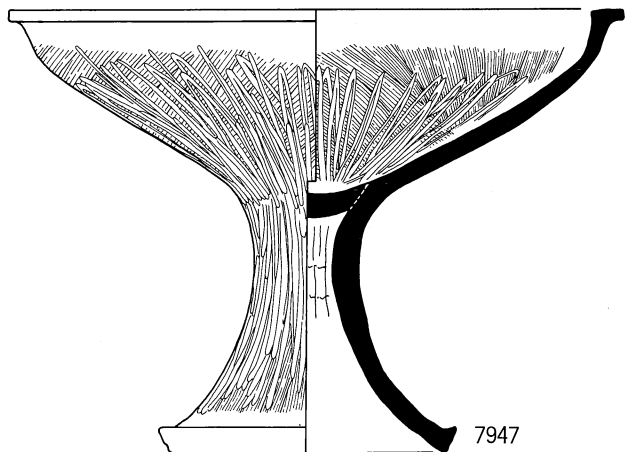
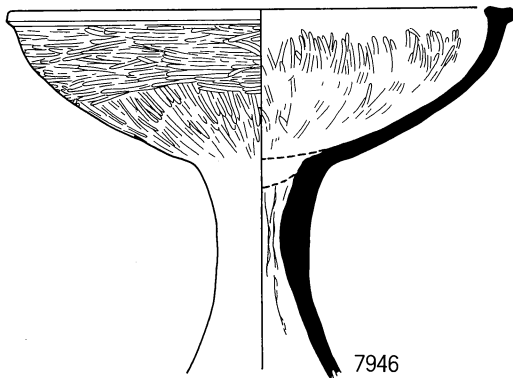
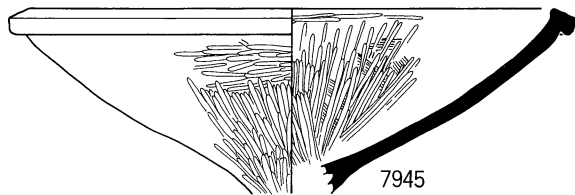
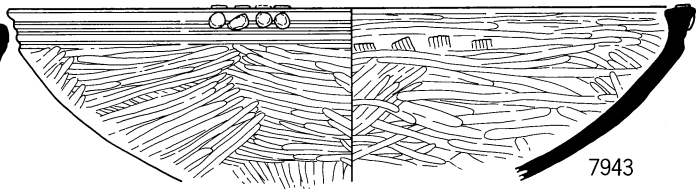
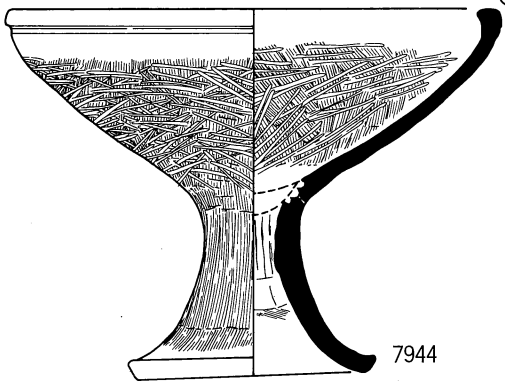
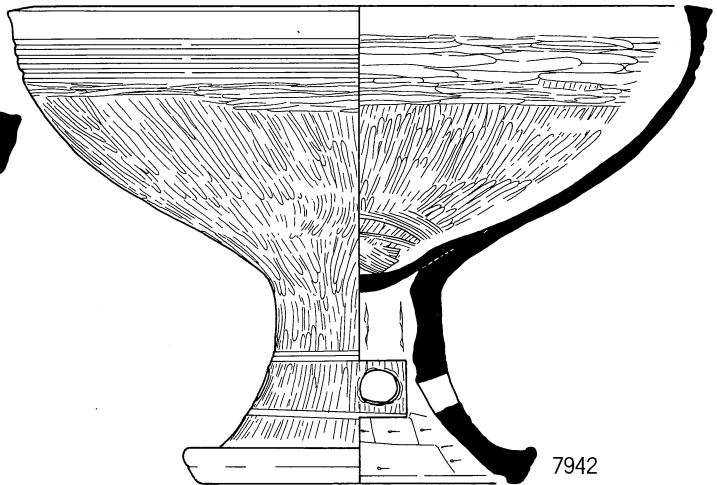
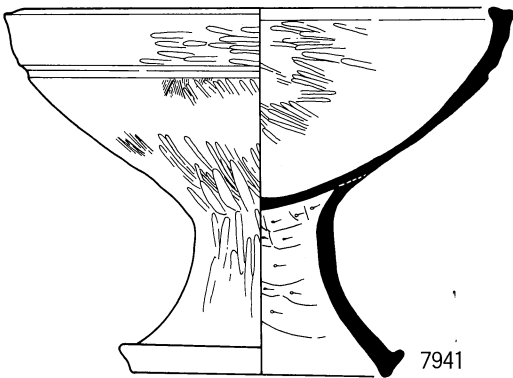
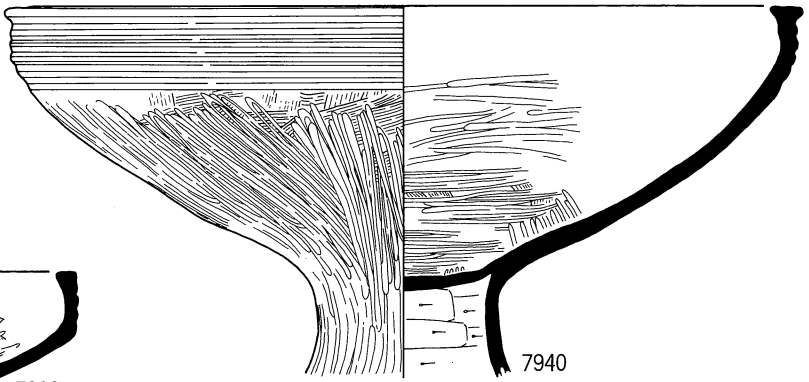
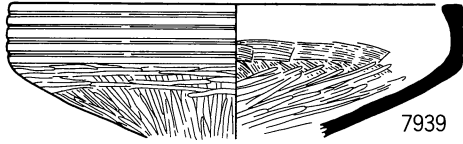
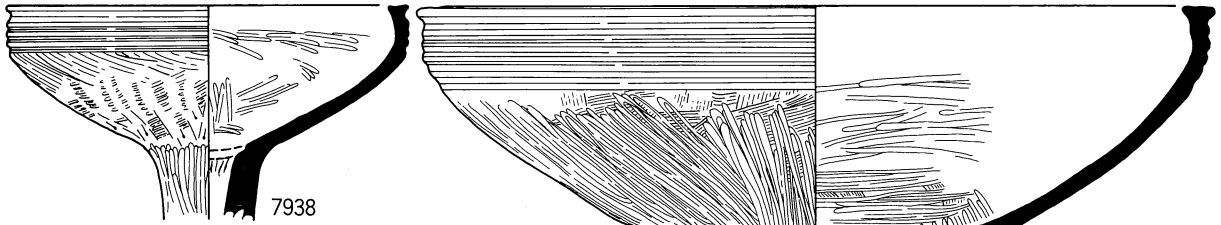

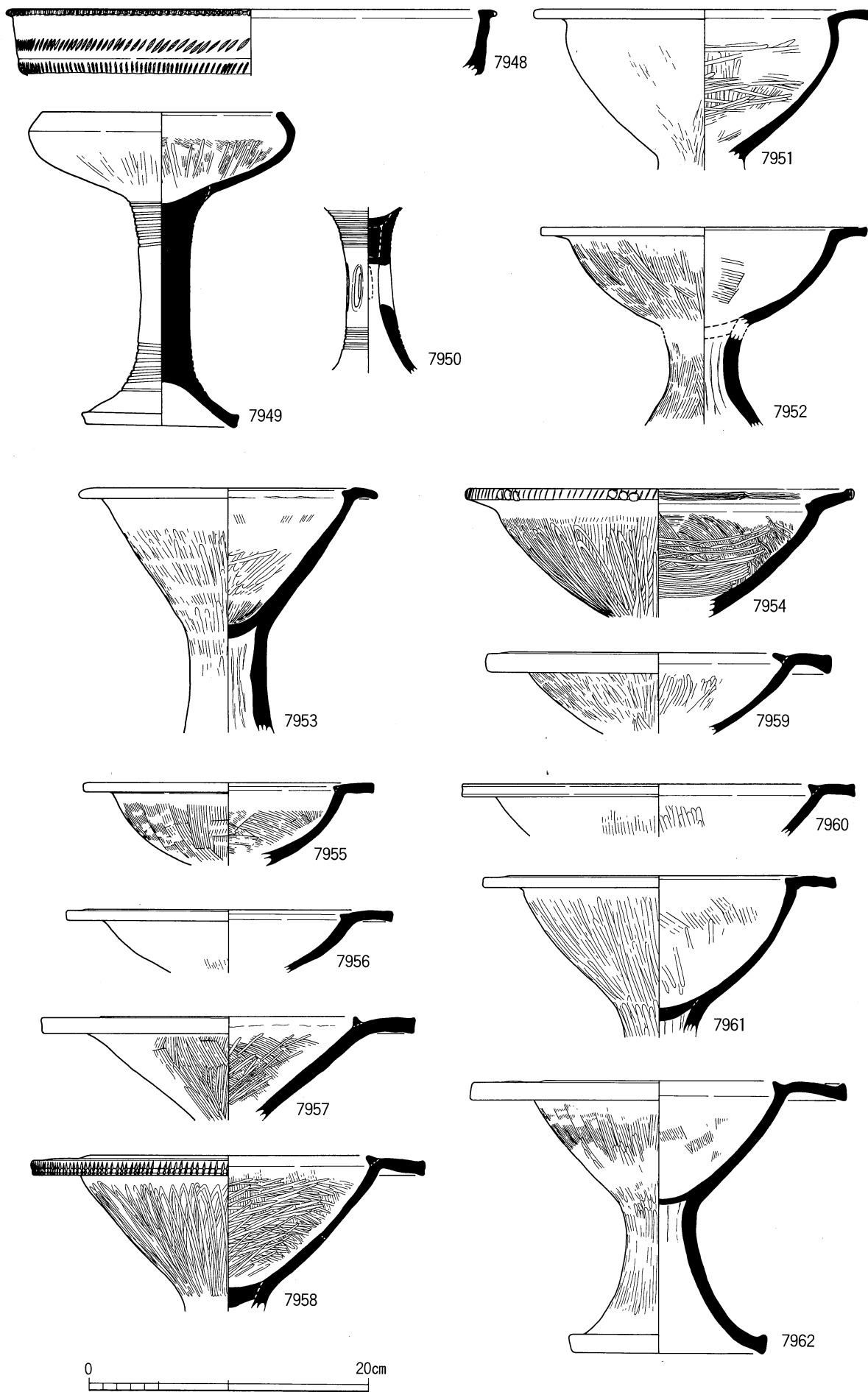

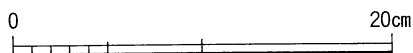
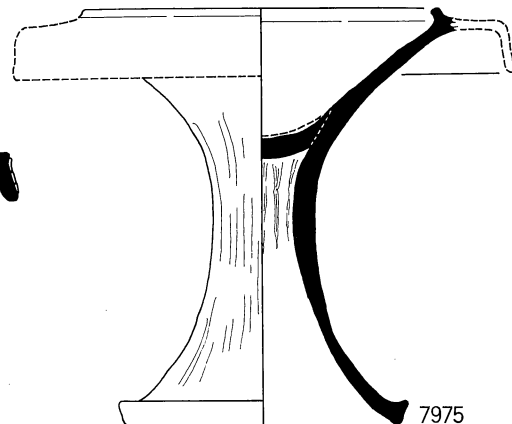
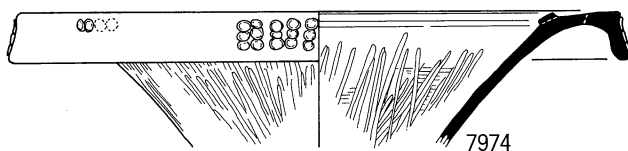
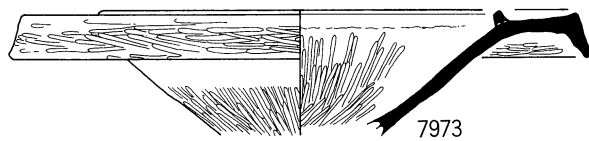
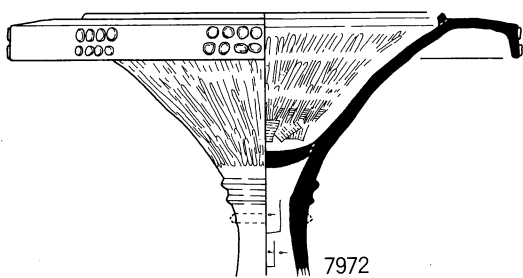
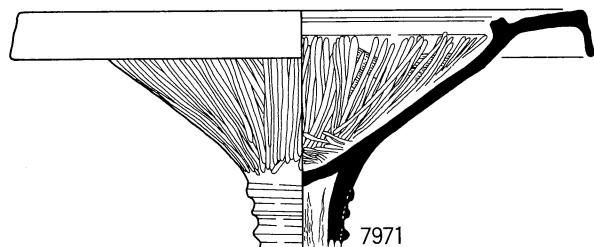
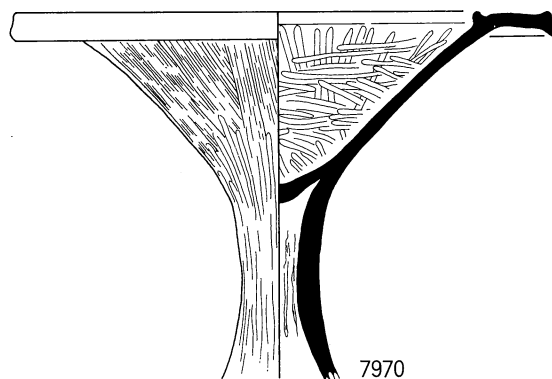
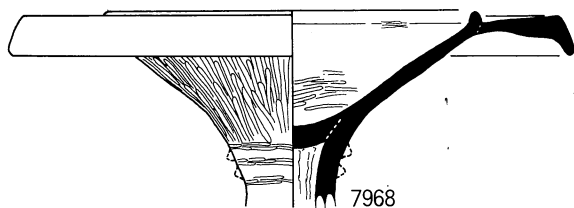
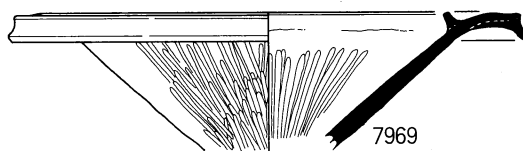
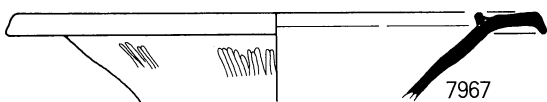
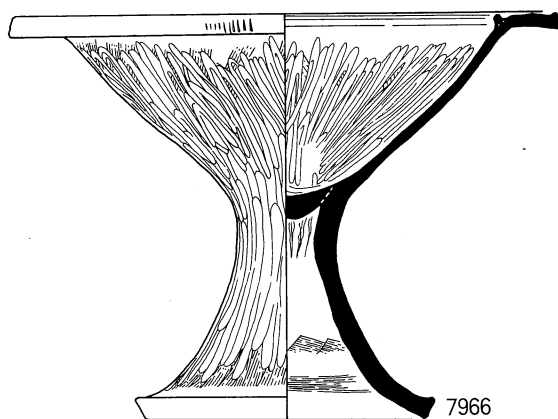
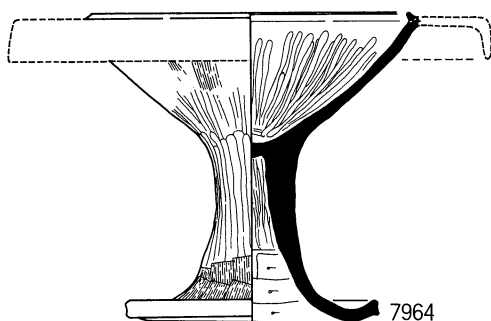
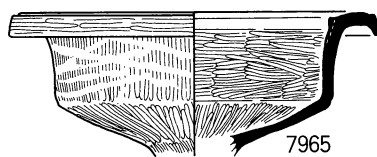
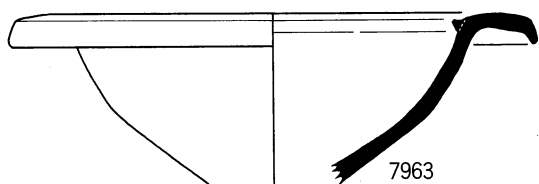

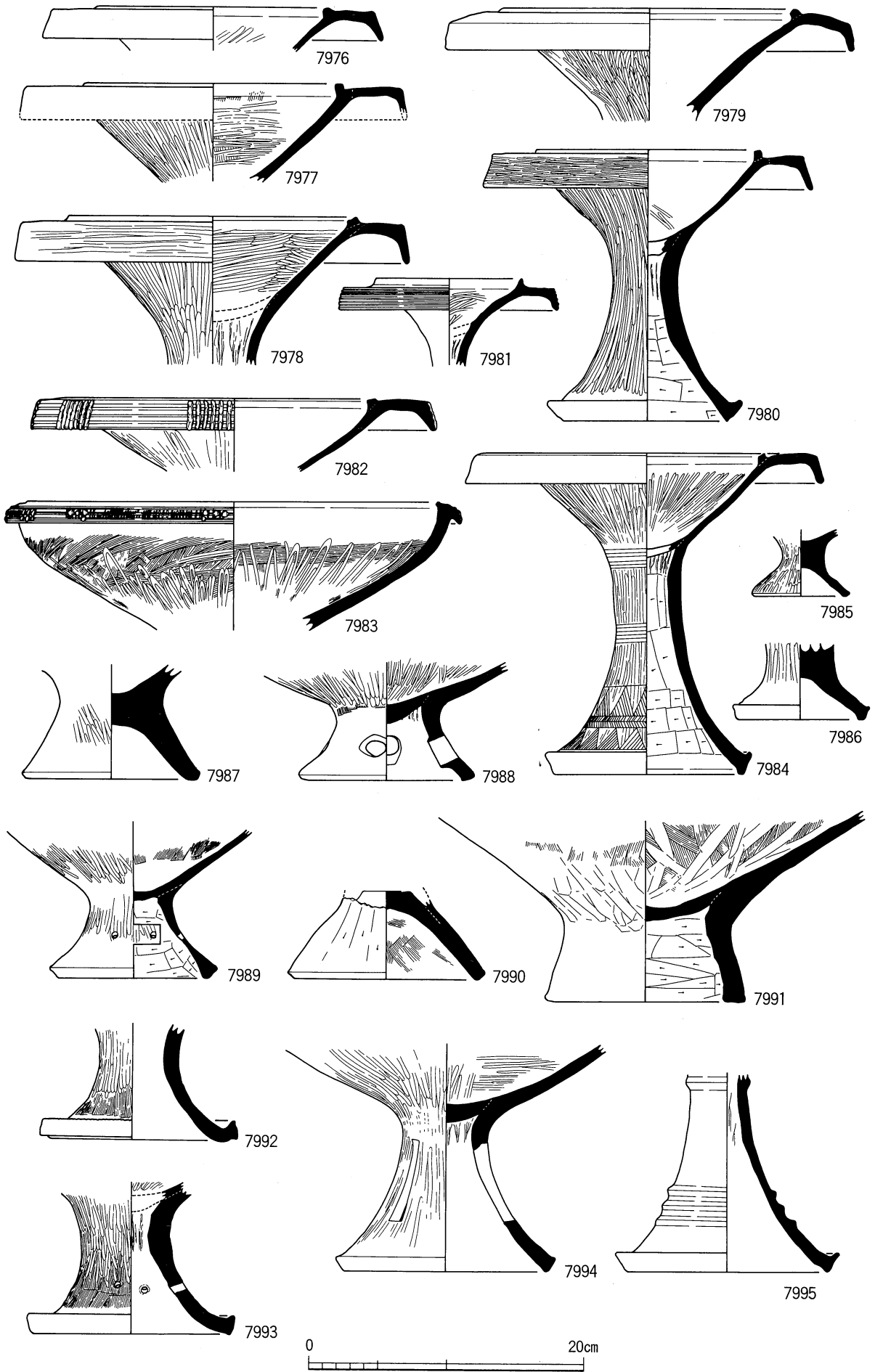

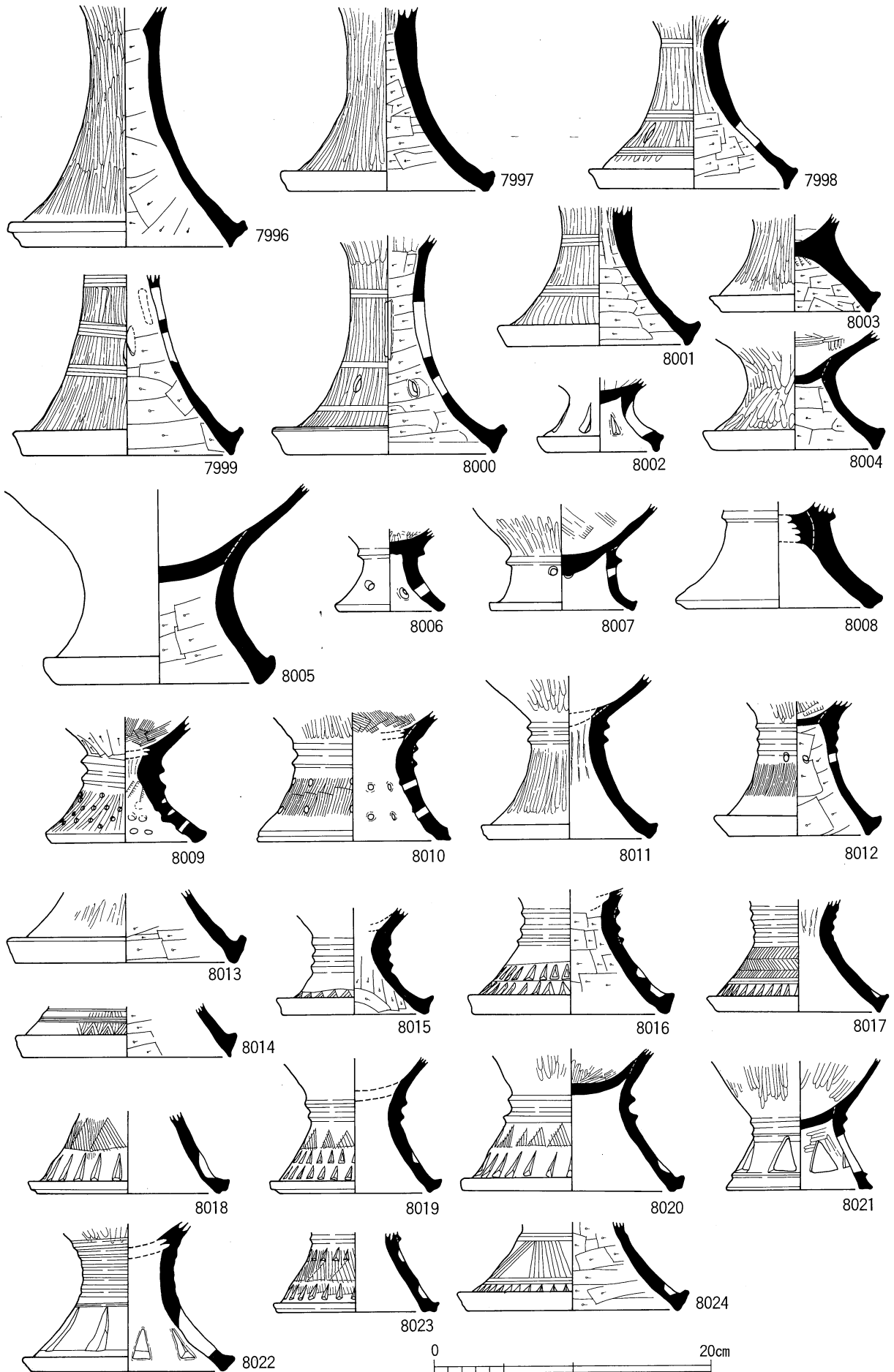

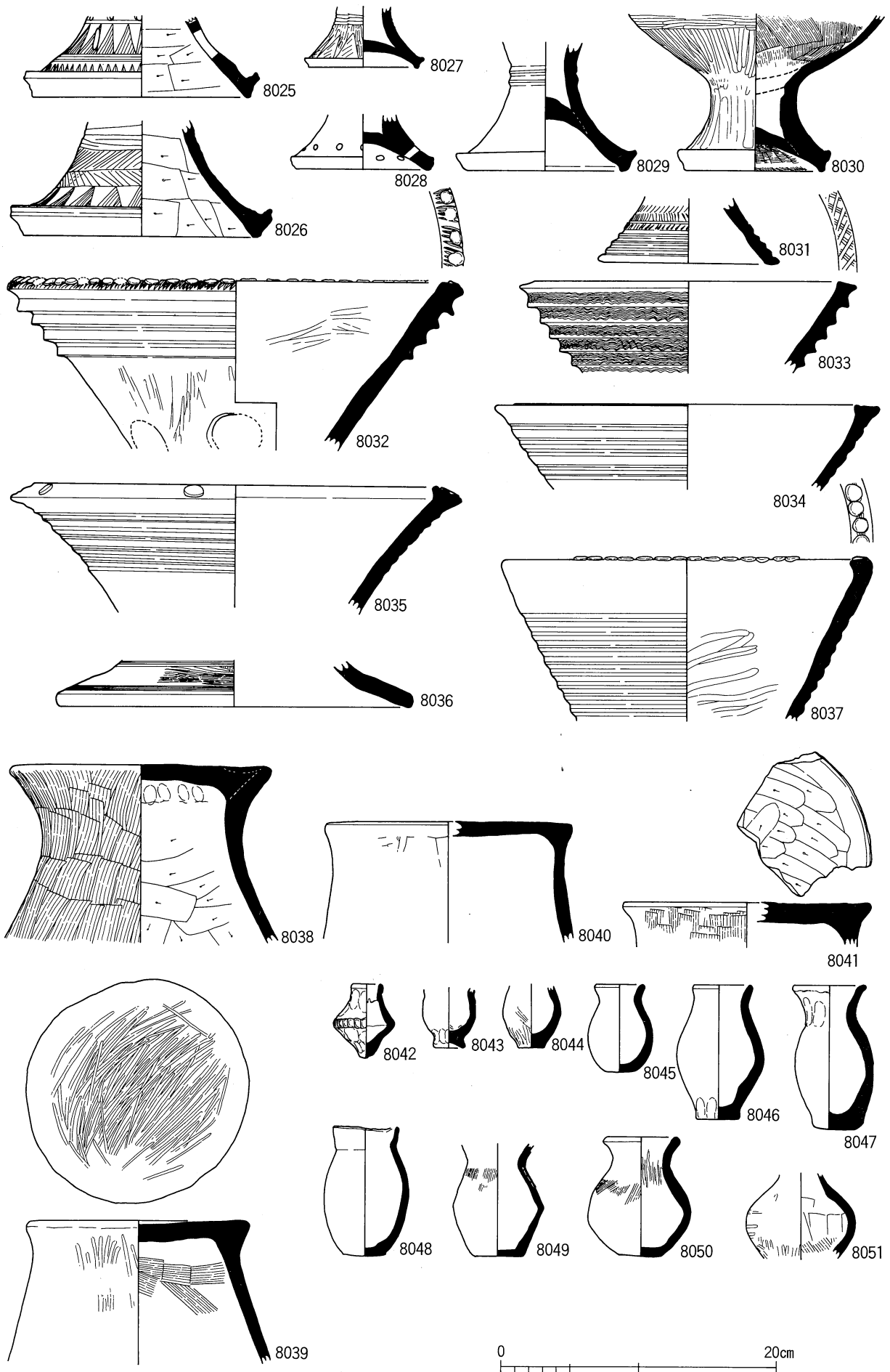

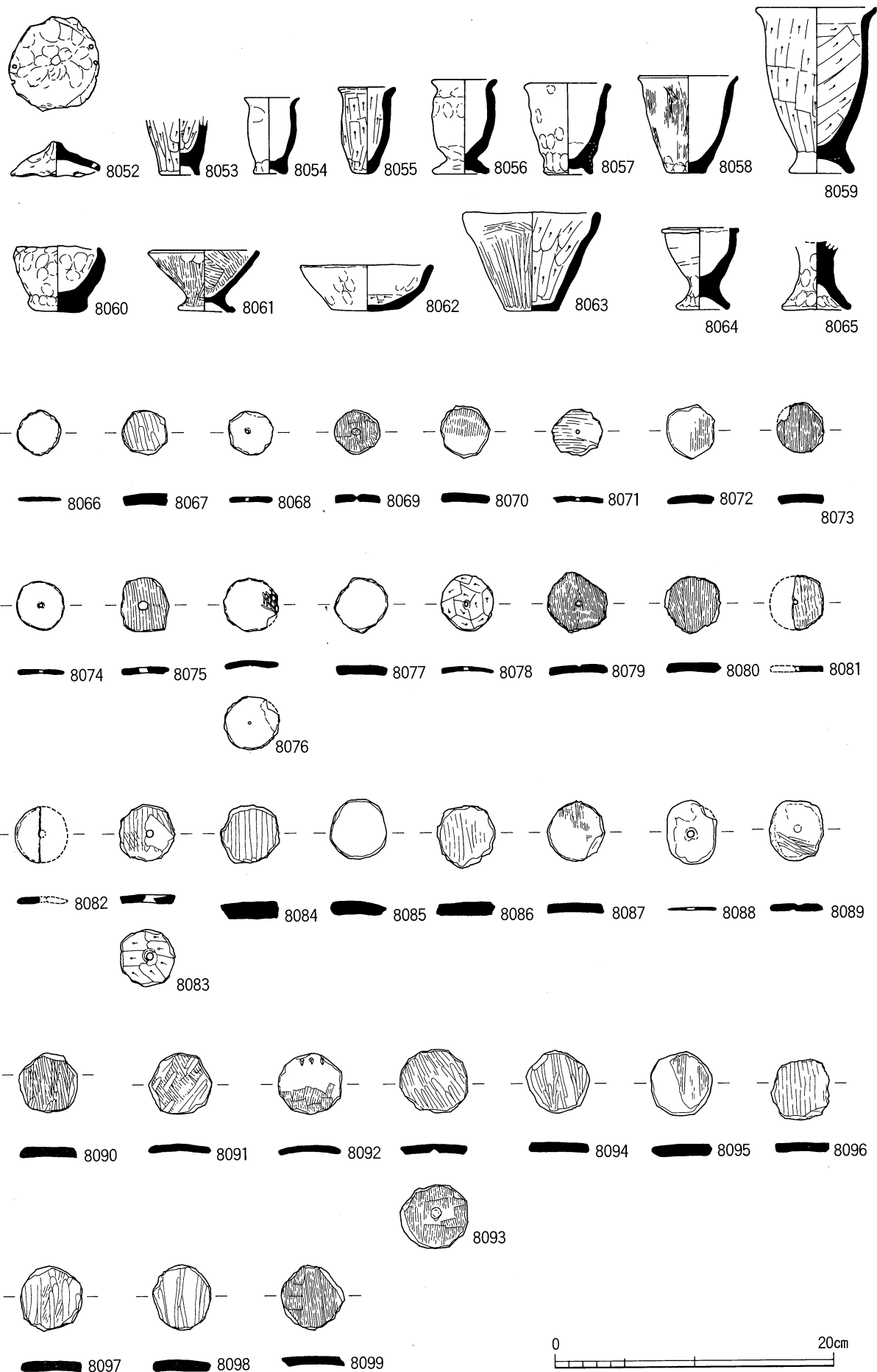

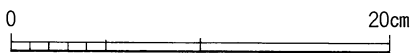
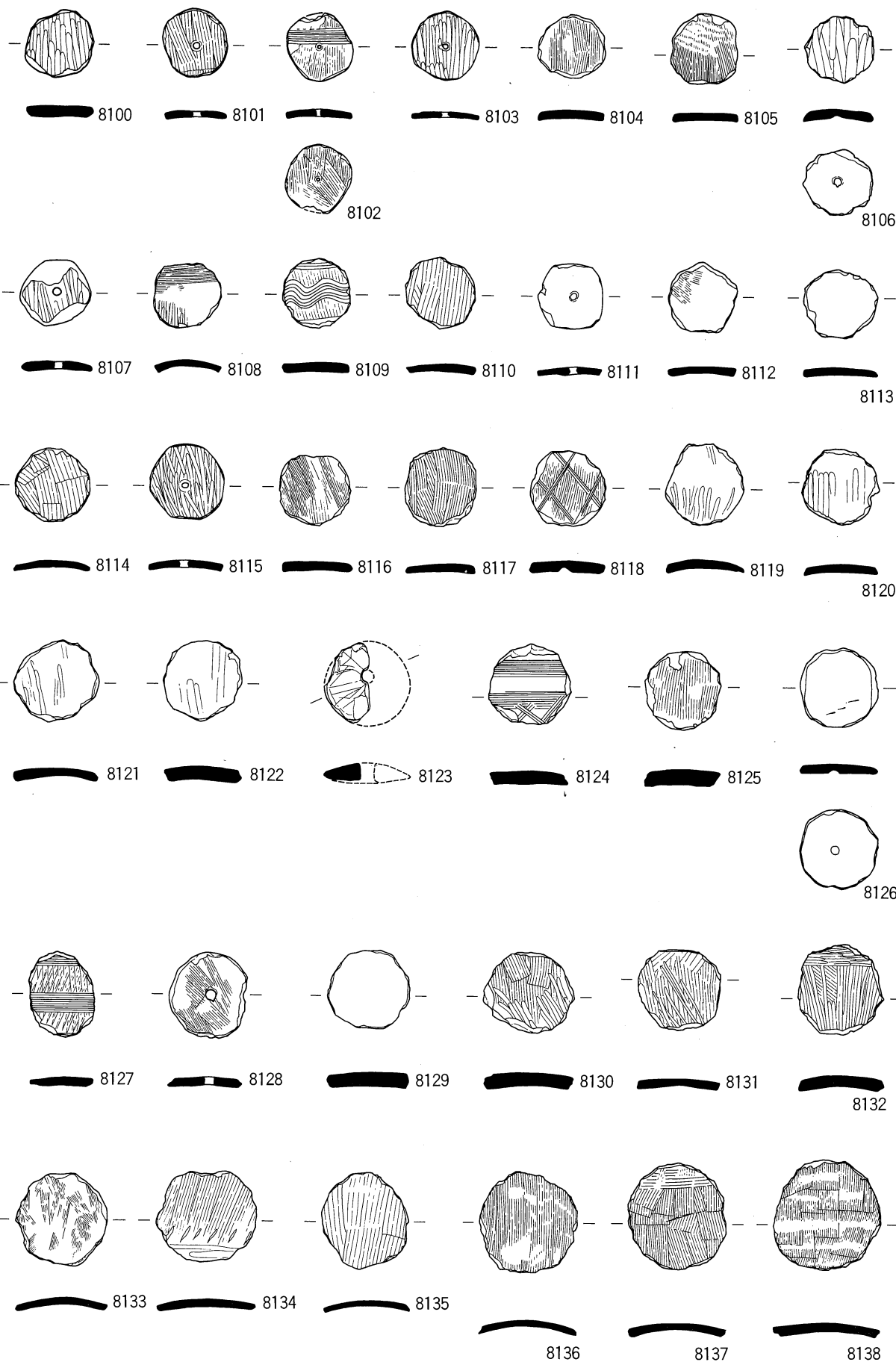

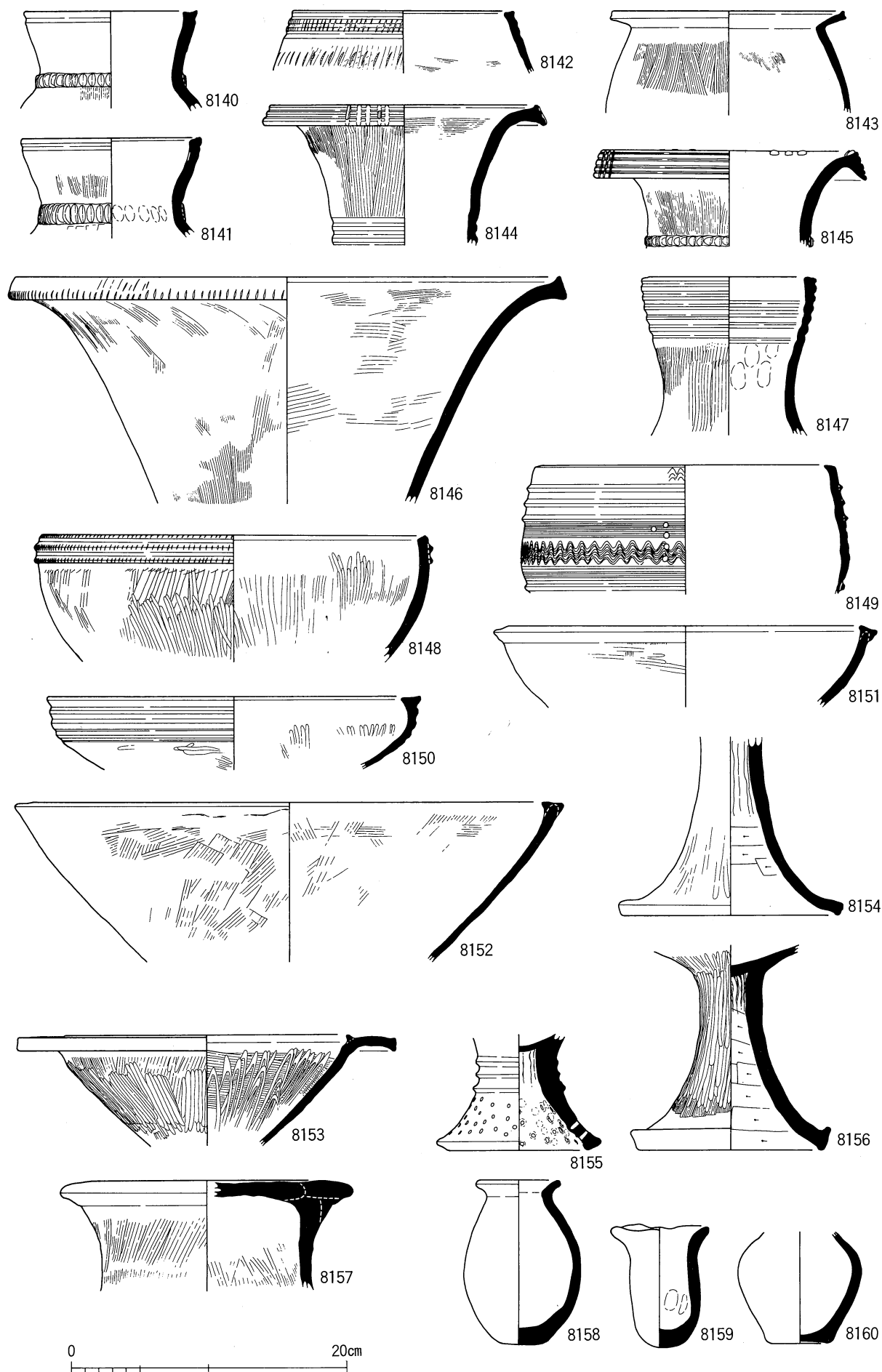

溝 SD46001 (8140~8143) SD46002 (8144~8160)

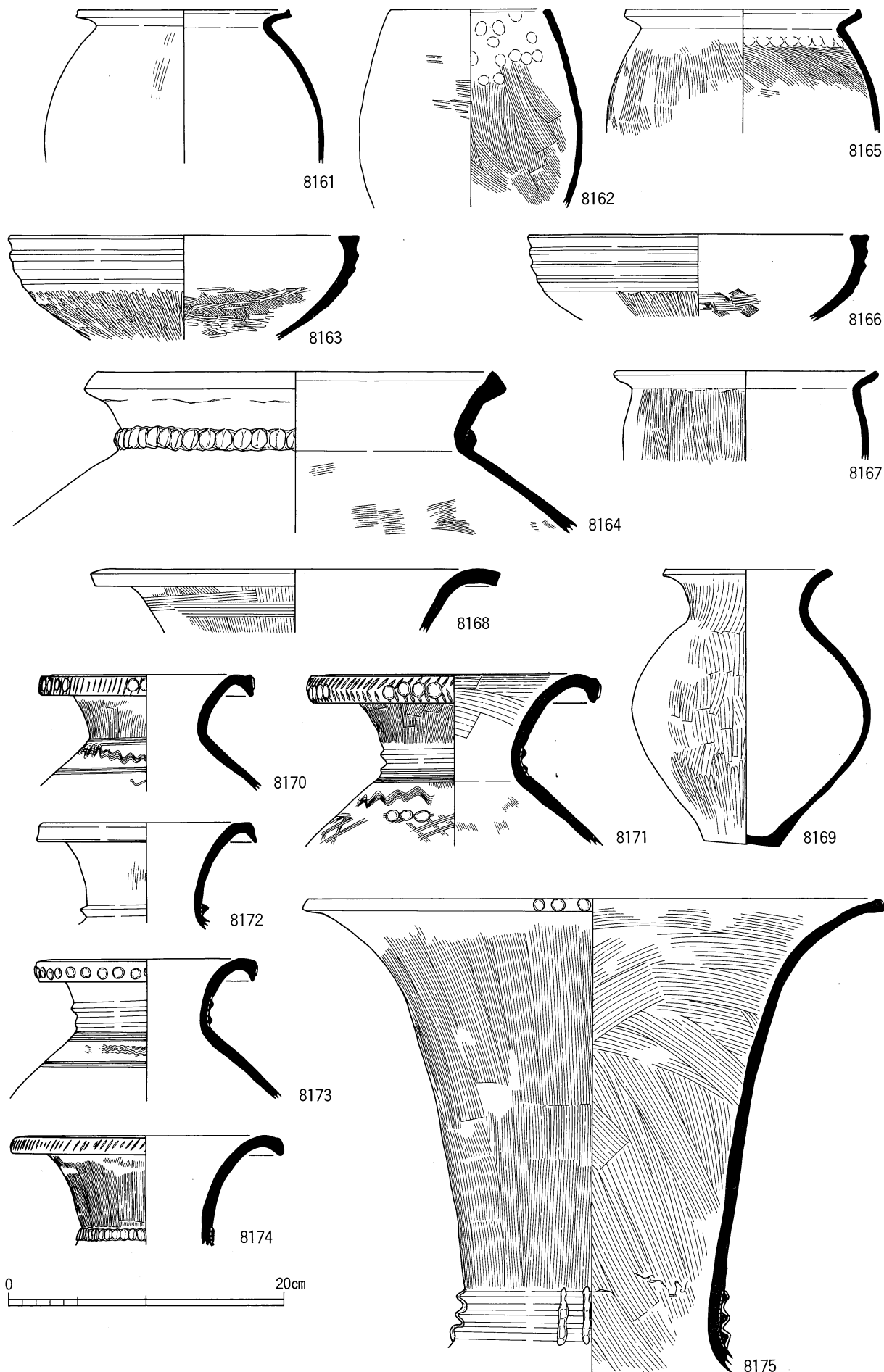

沟 SD46003 (8161~8163) SD46004 (8164~8166) SD46005 (8167)
 SD46007 (8168) SD46008 (8169~8175)

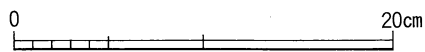
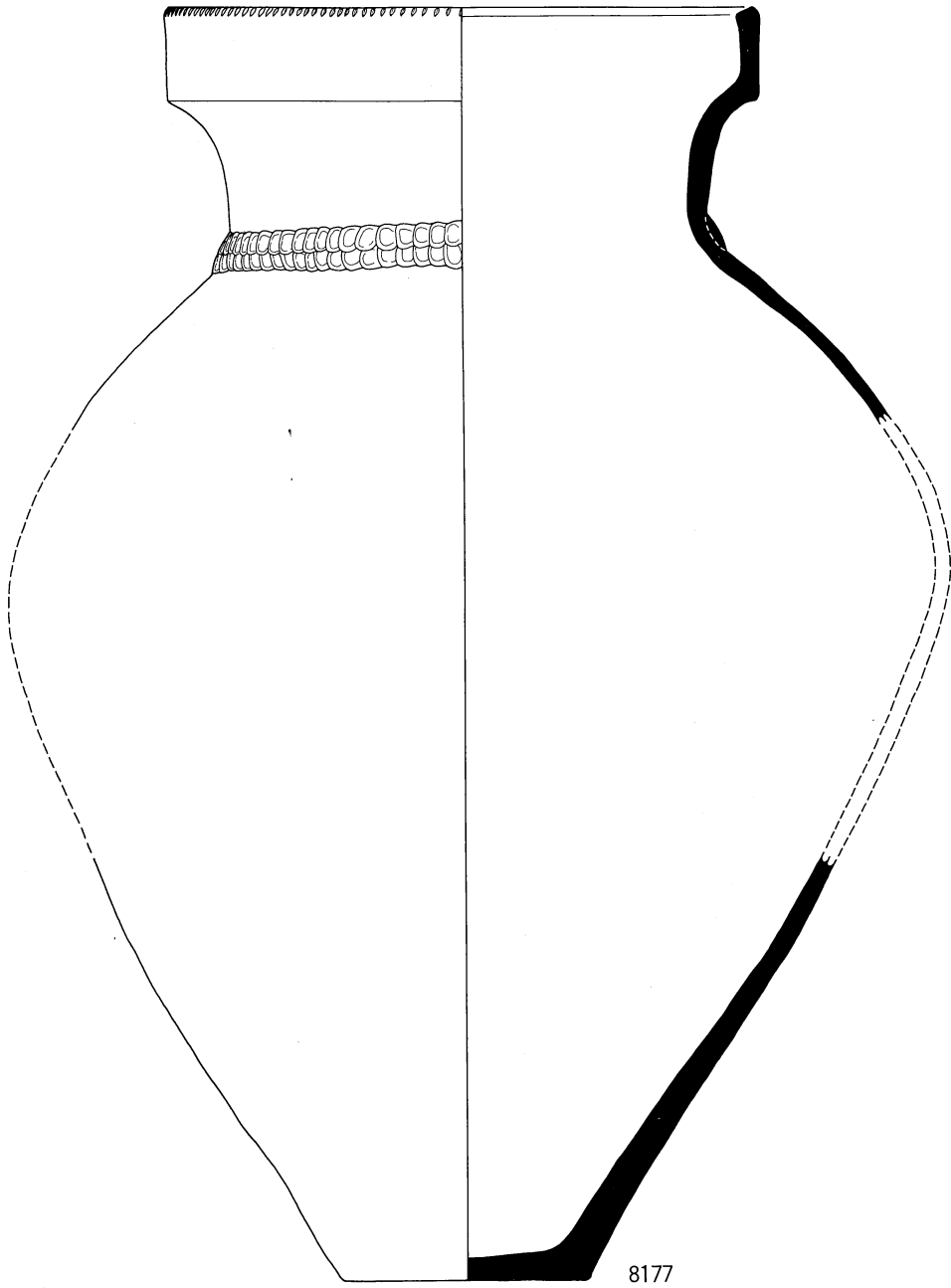
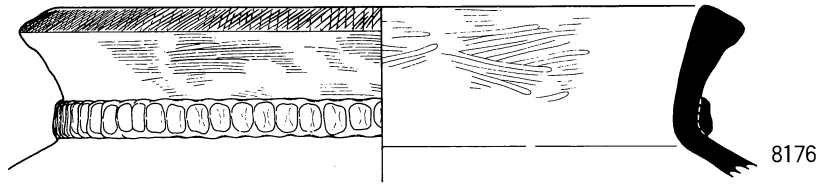

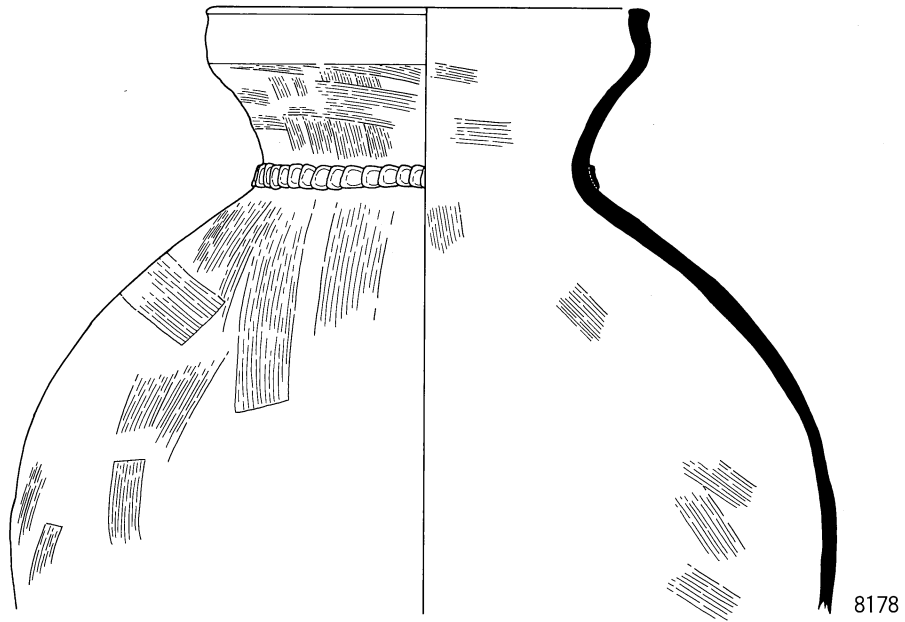

8178

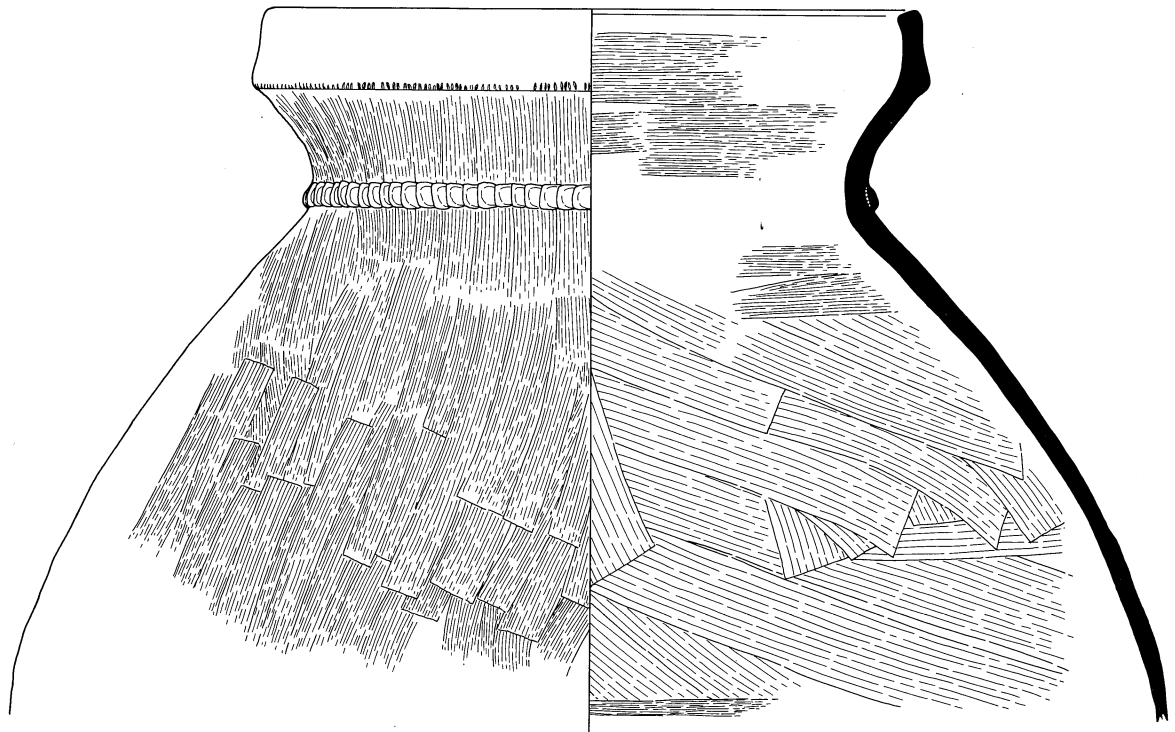

8179

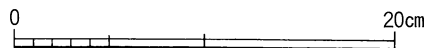

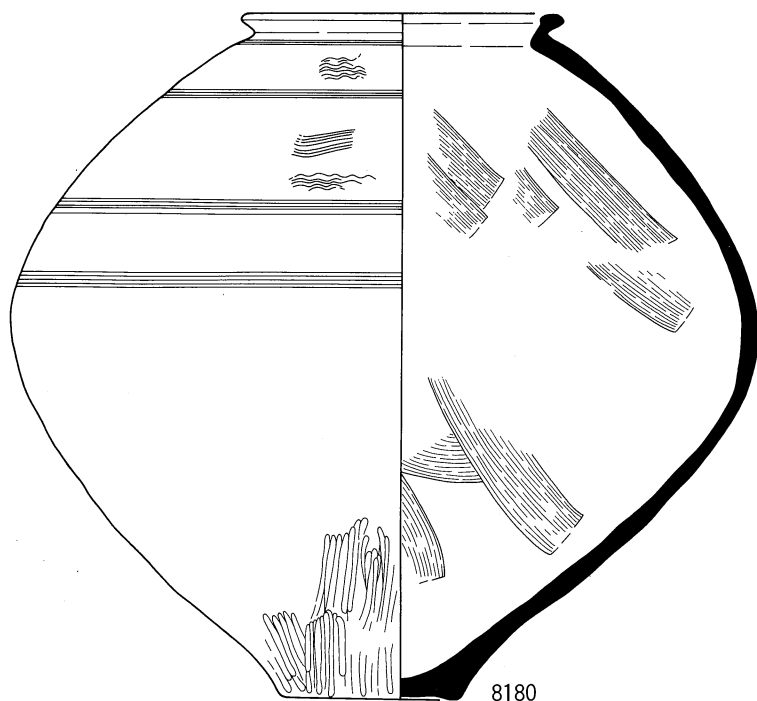

8180

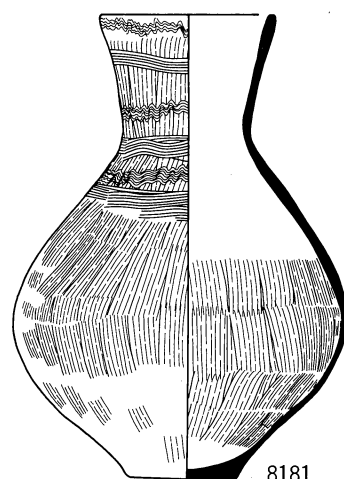

8181

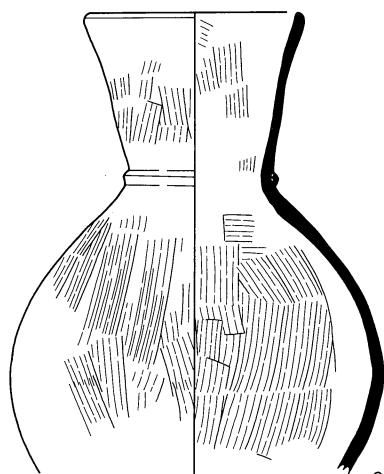

8183

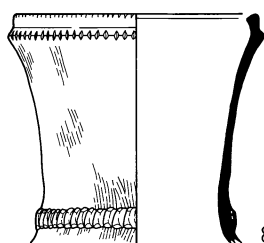

8184

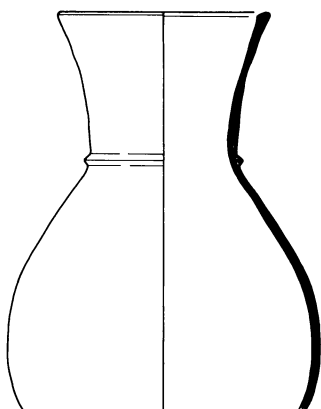

8182

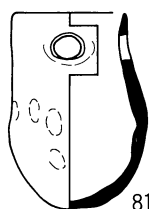

8186

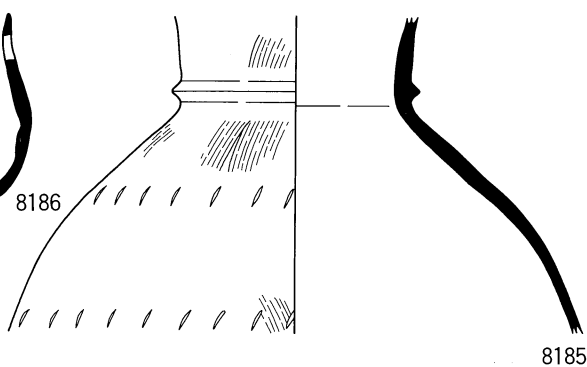

8185

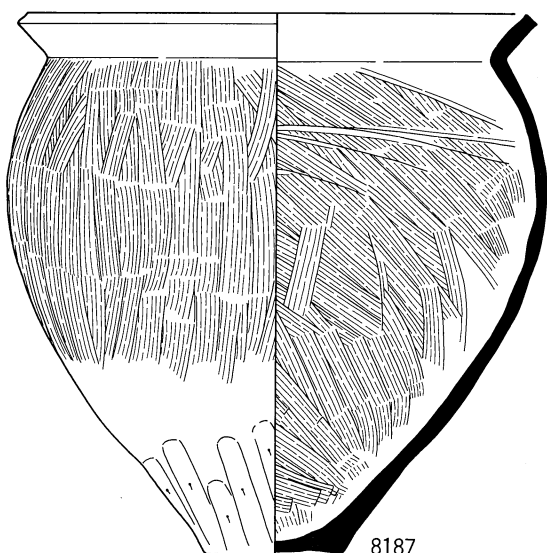

8187

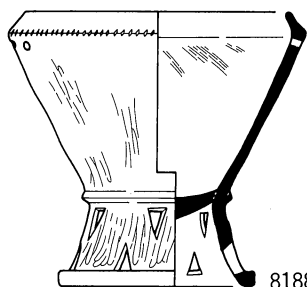

8188

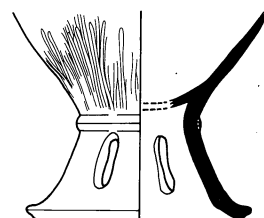

8189

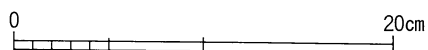

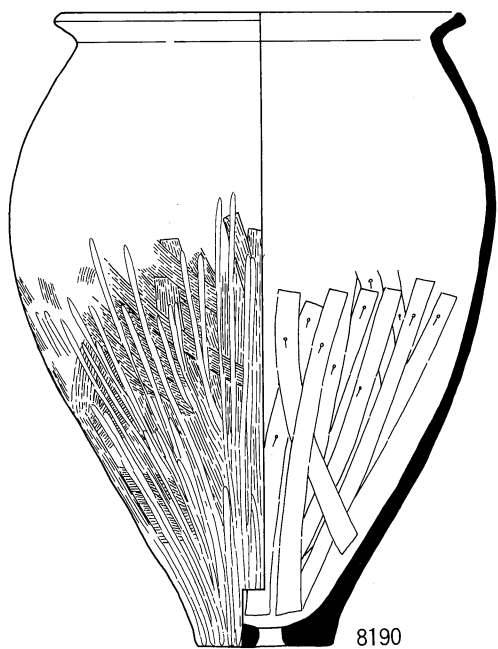

8190

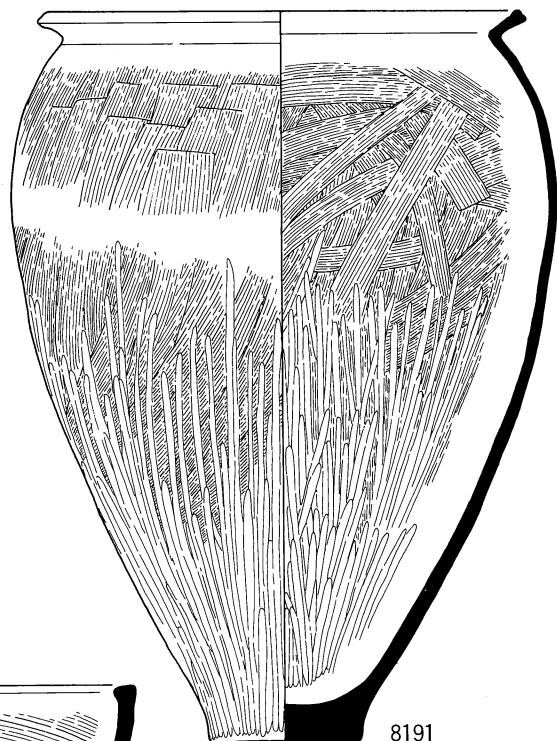

8191

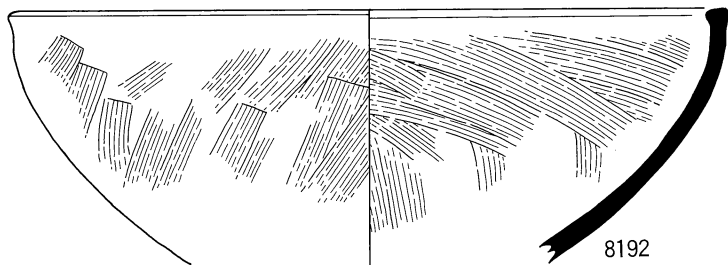

8192



8195

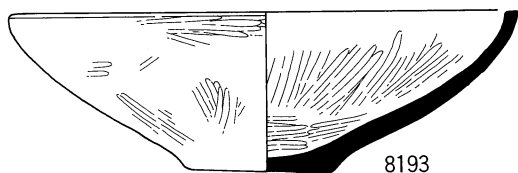

8193

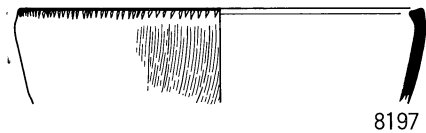

8197

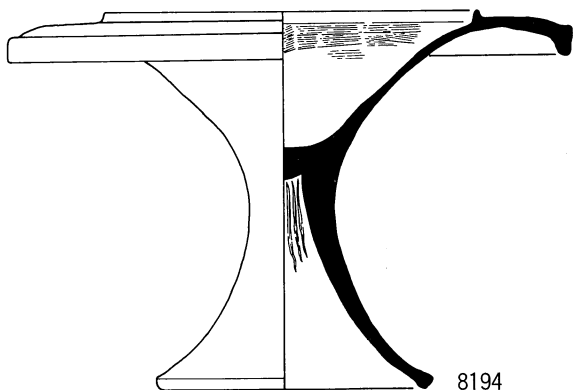

8194

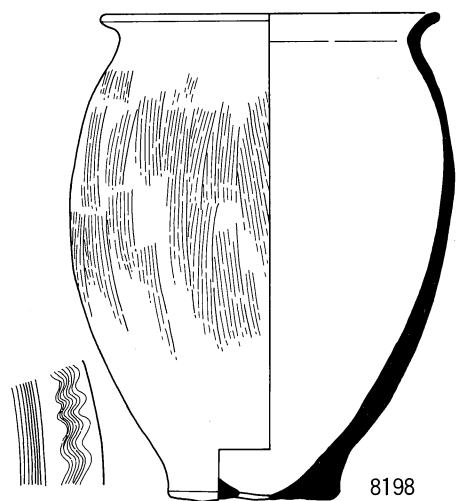

8198

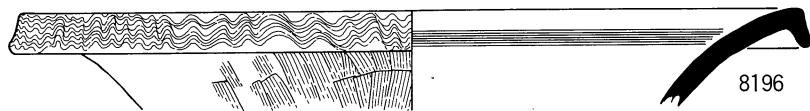

8196

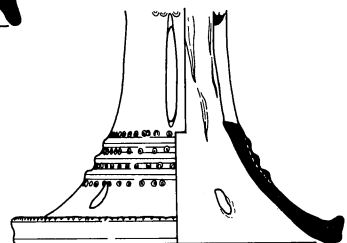
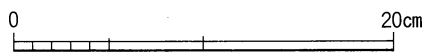

8199

溝 SD46008 (8190~8195)
SD46011 (8198)

SD46009 (8196)
SD56002 (8199)

SD46010 (8197)

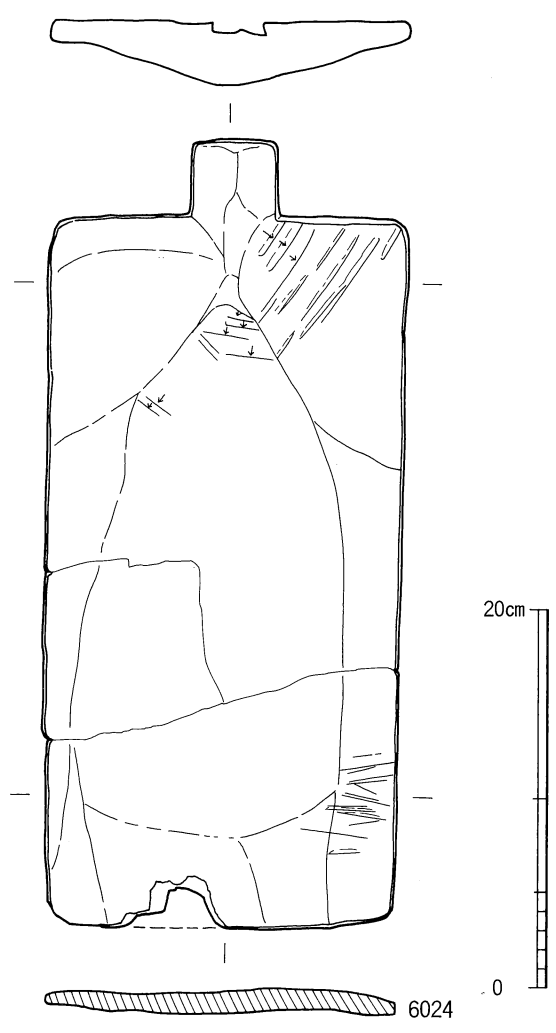
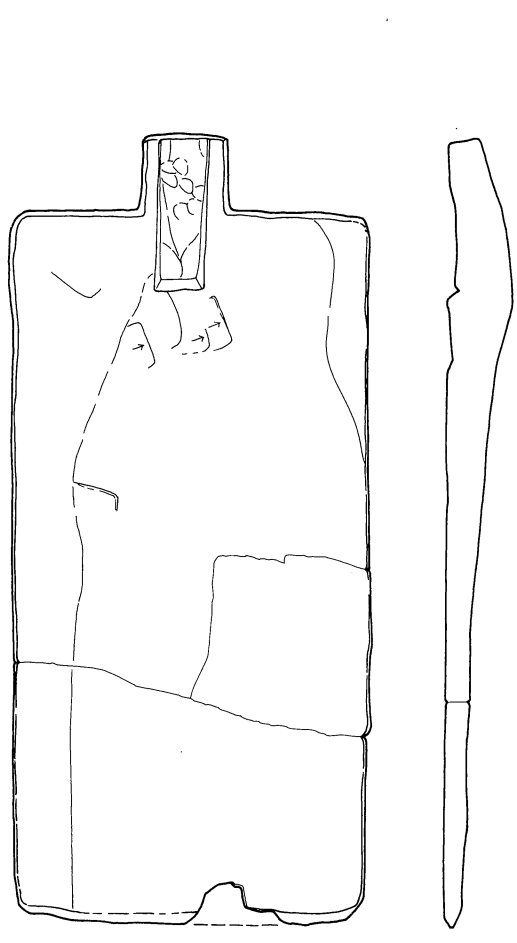
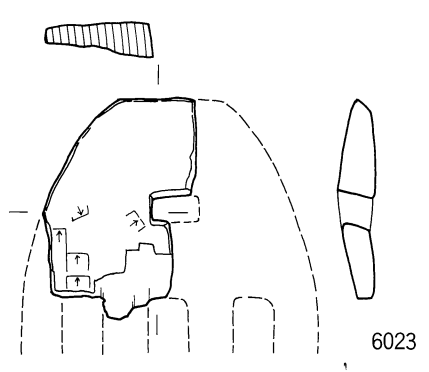
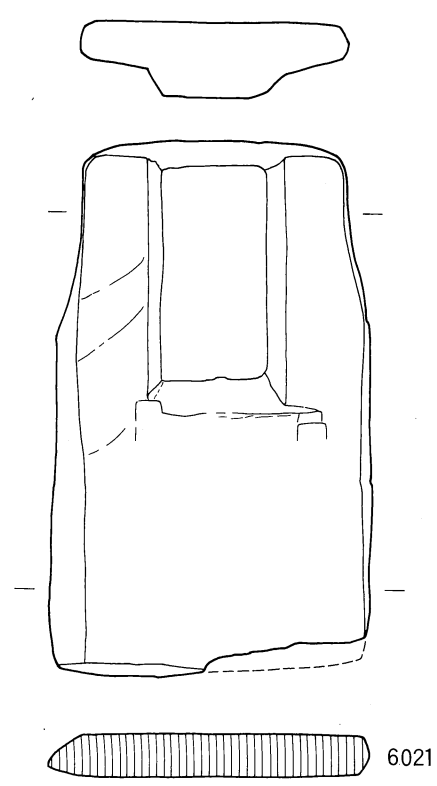
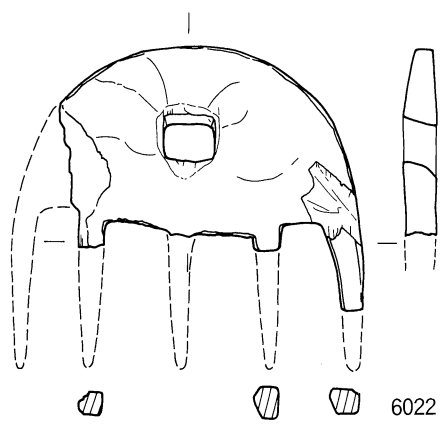

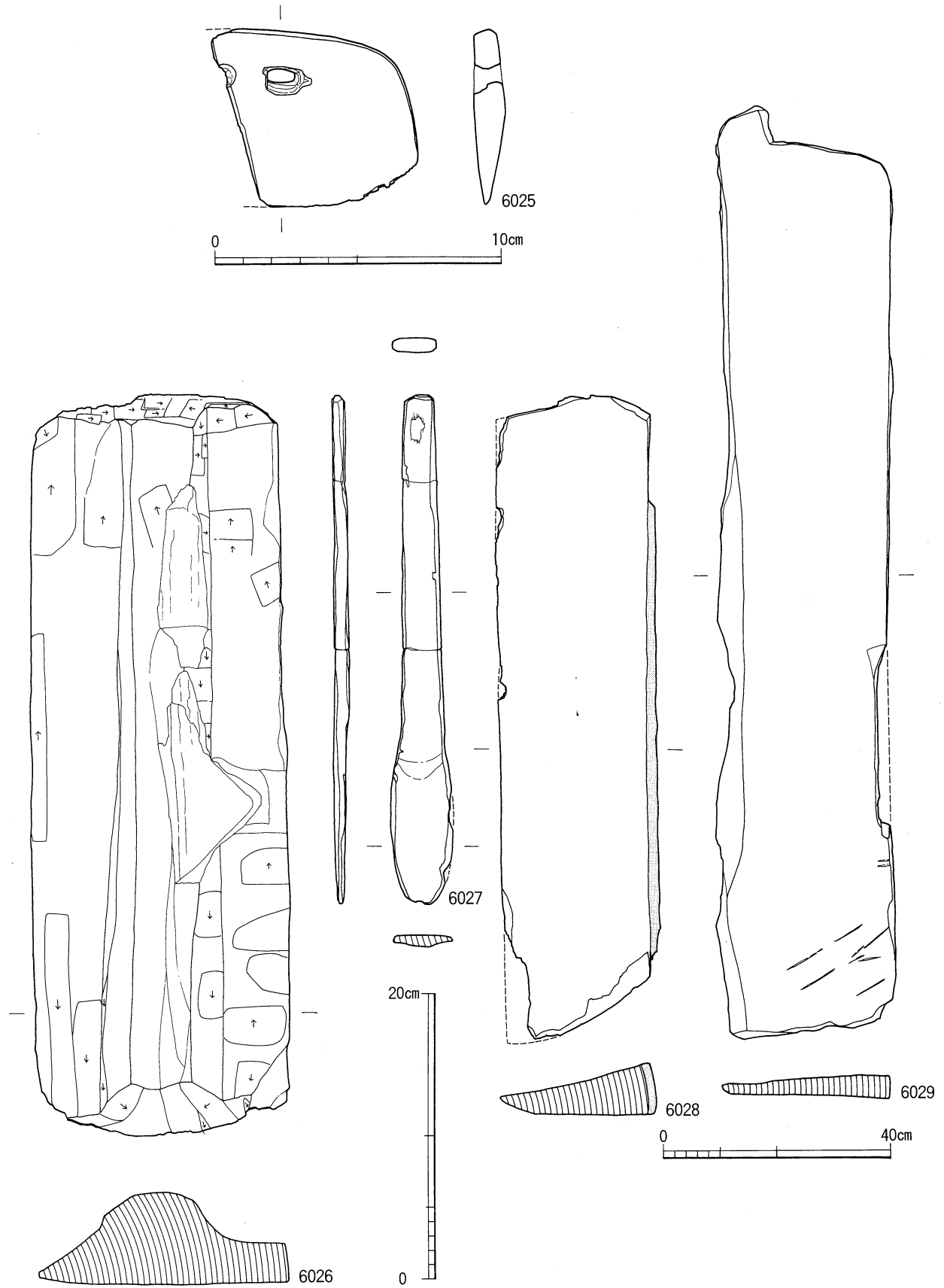

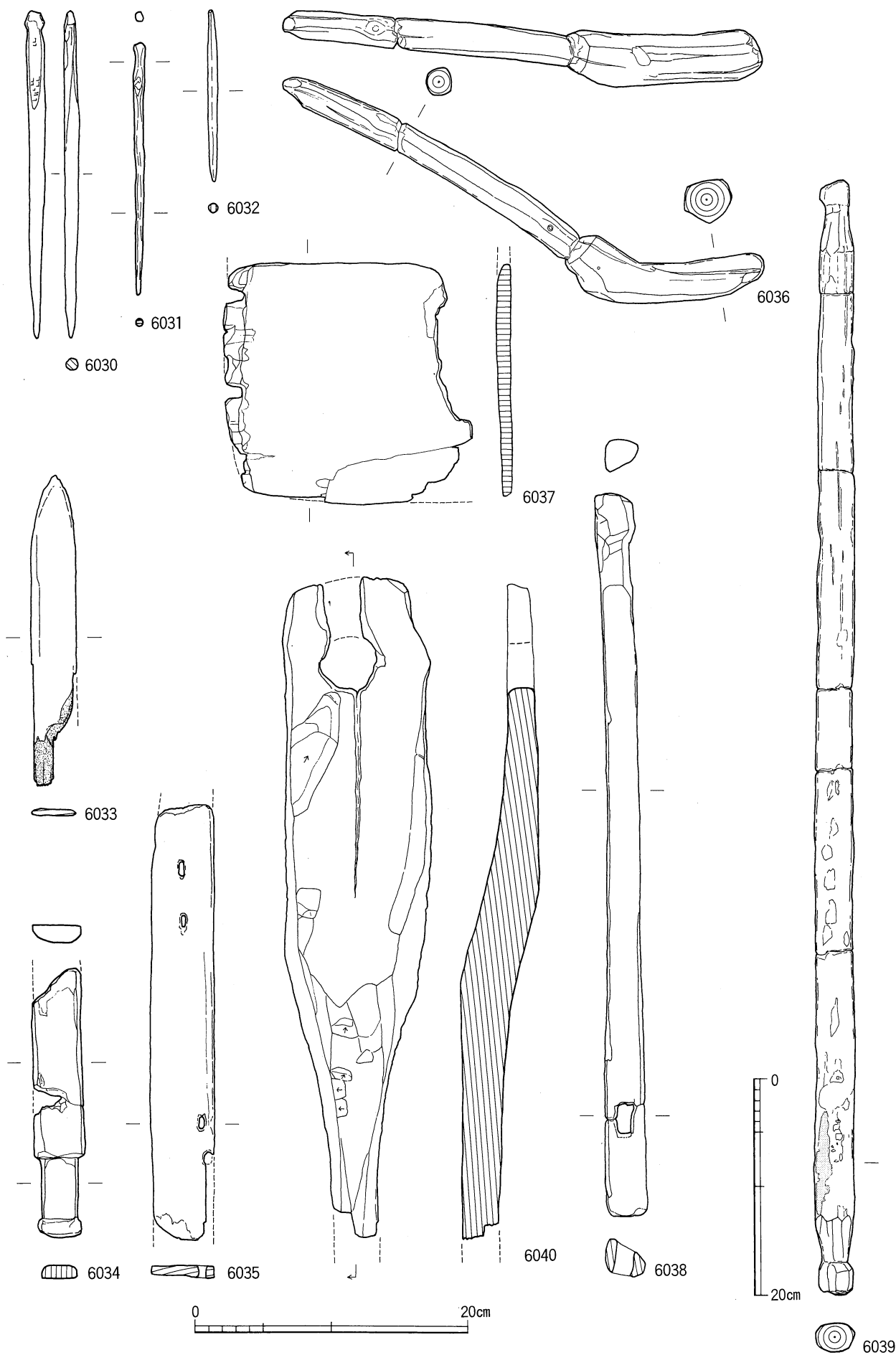

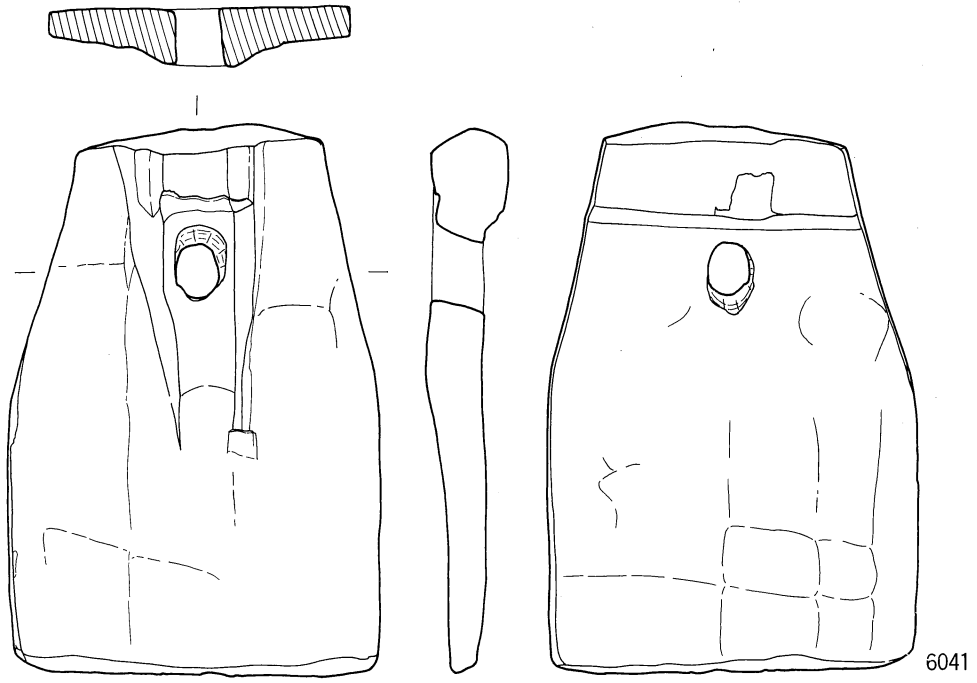

6041

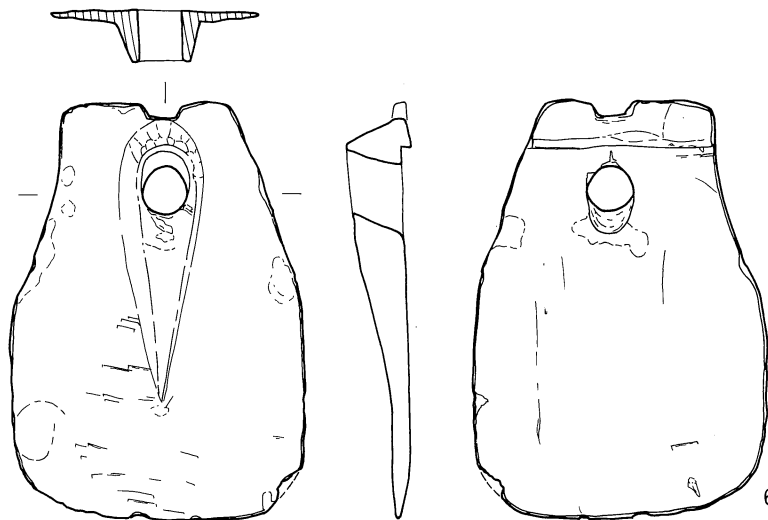

6042

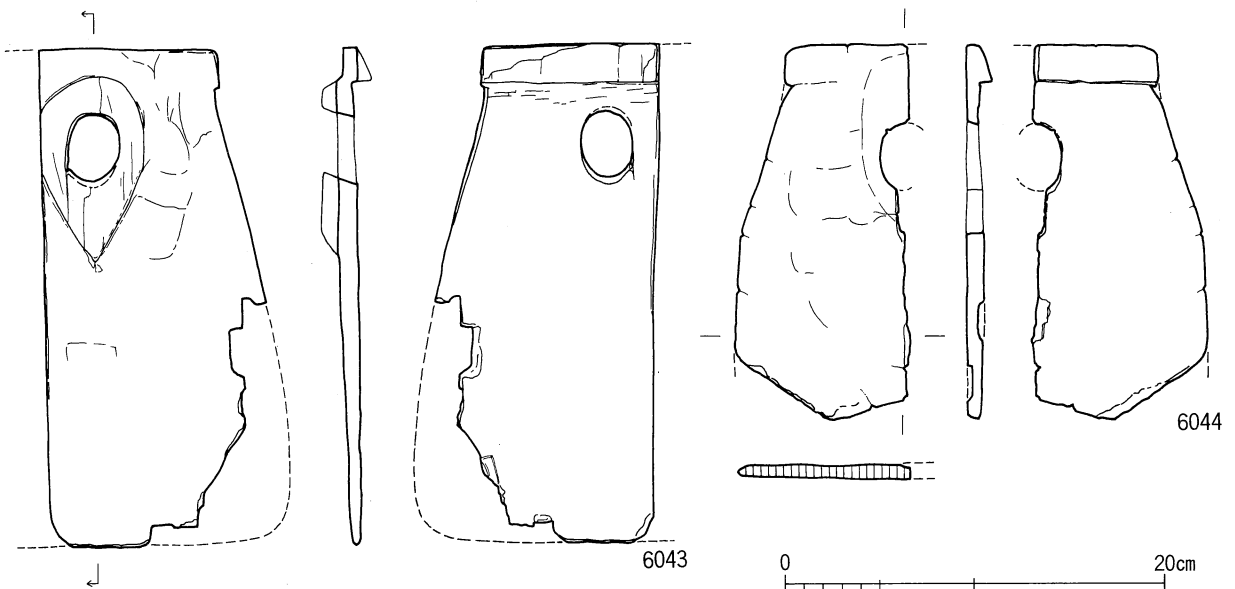

6043

6044

0 20cm

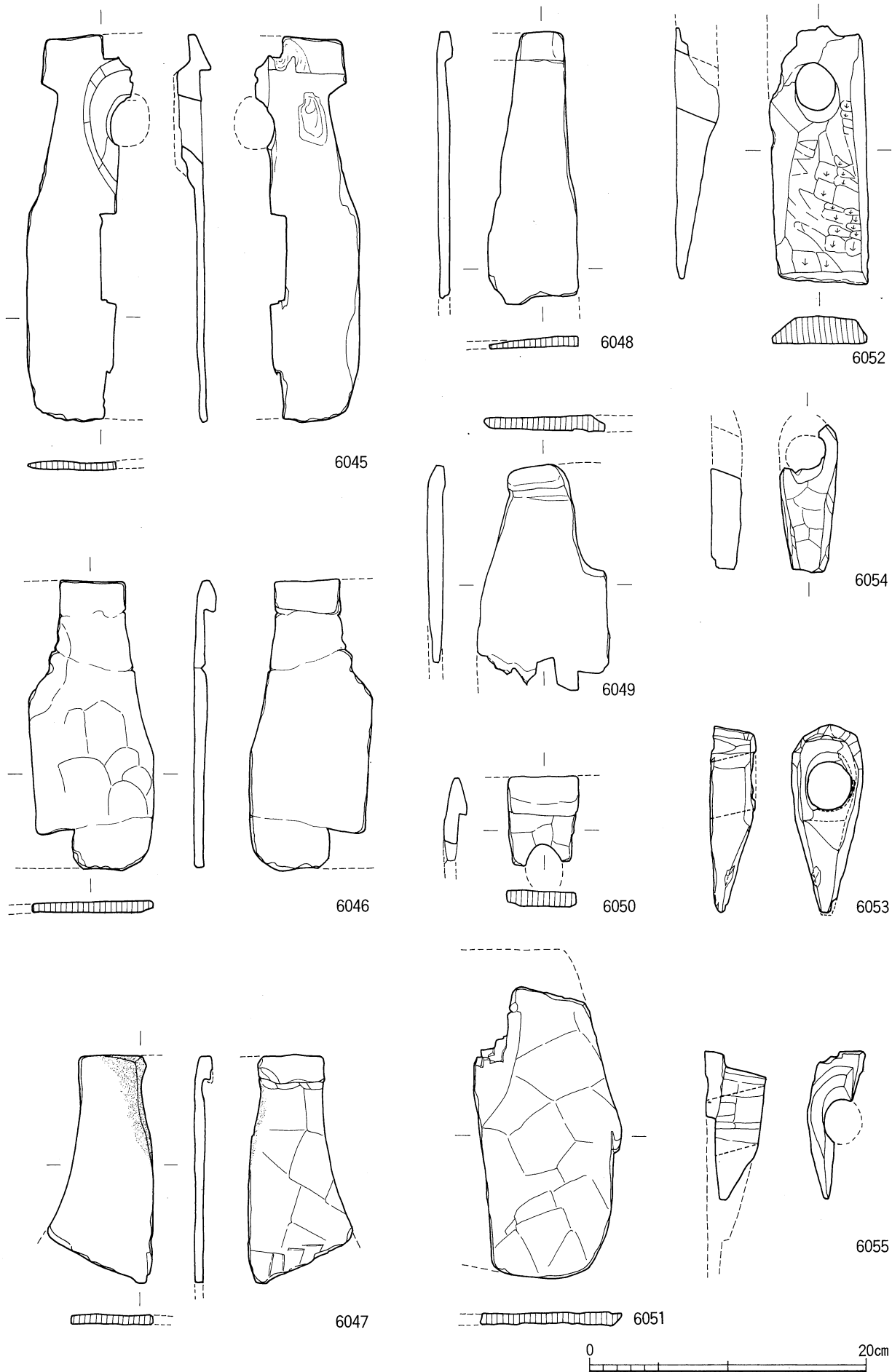

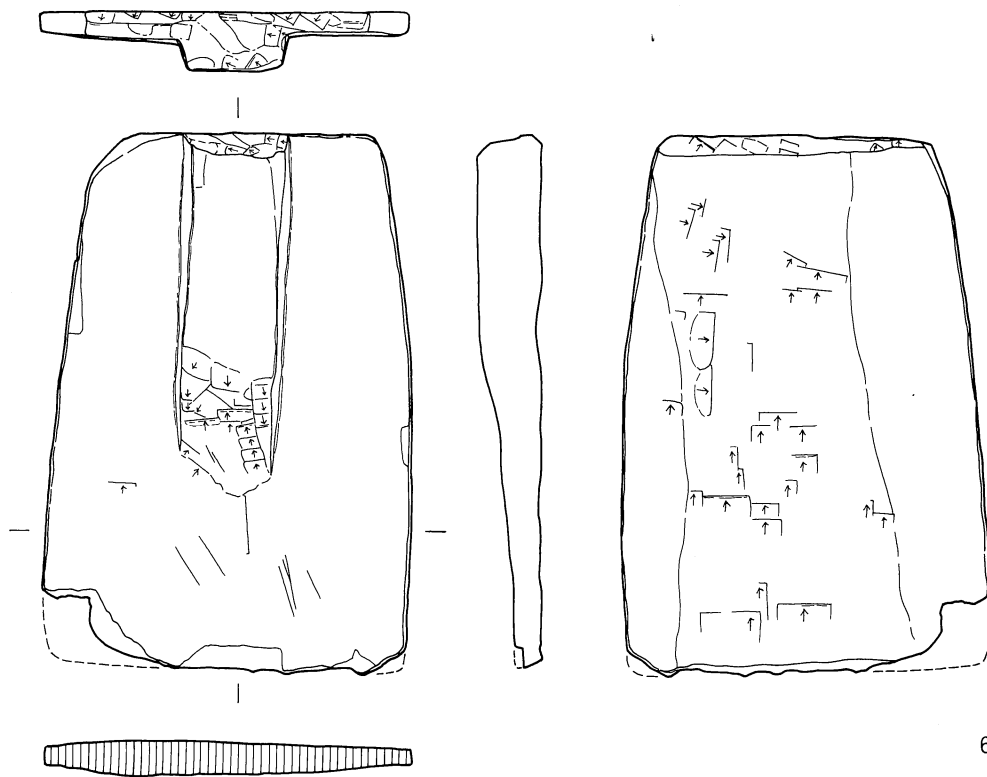
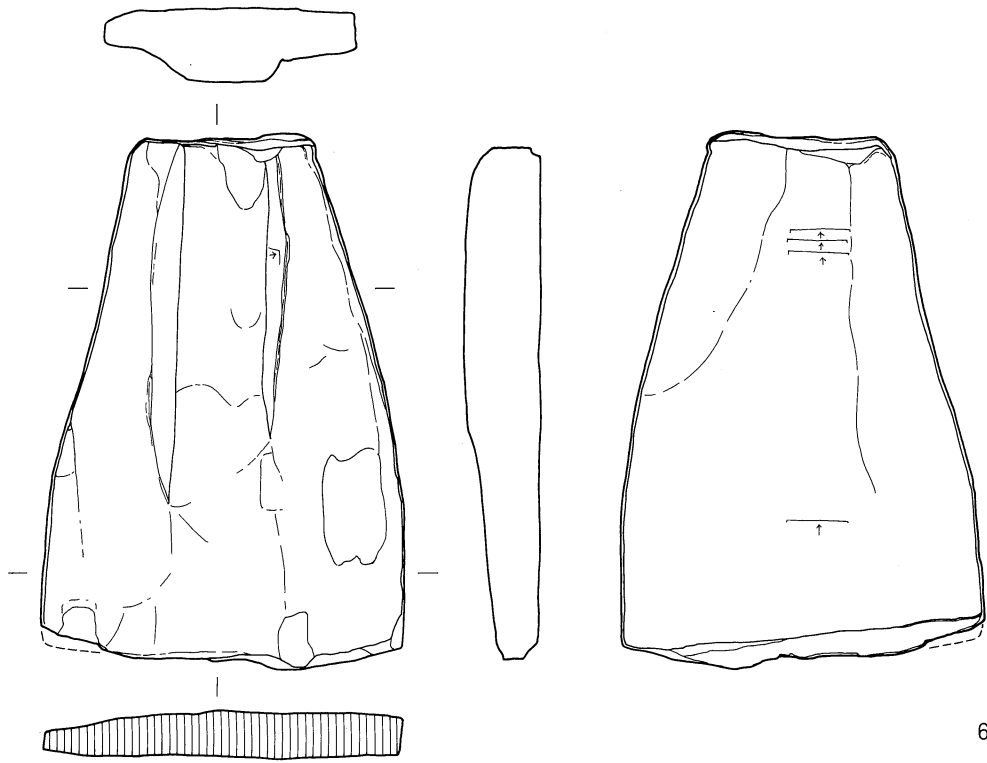

0 20cm

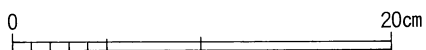
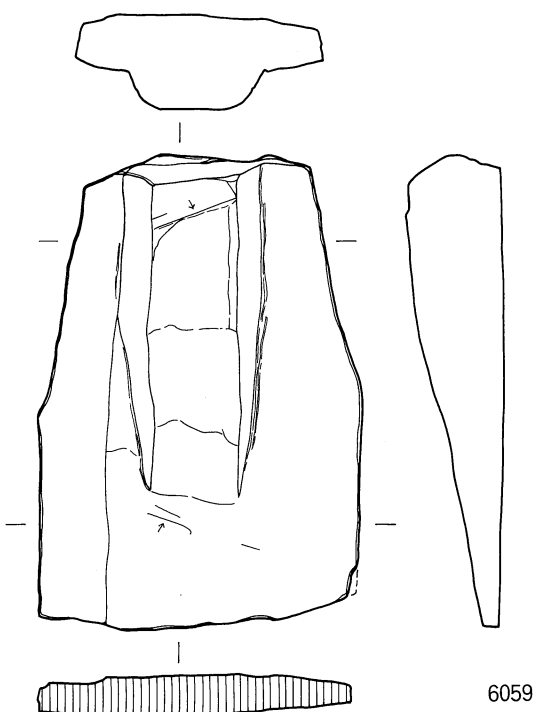
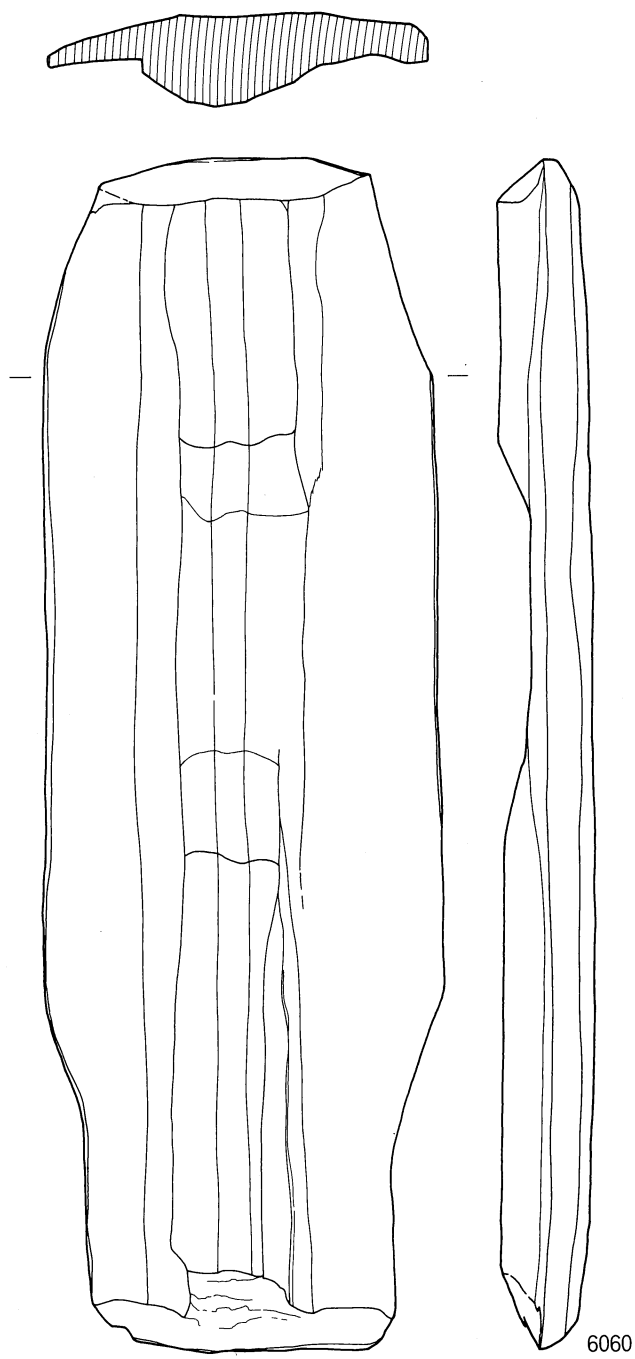
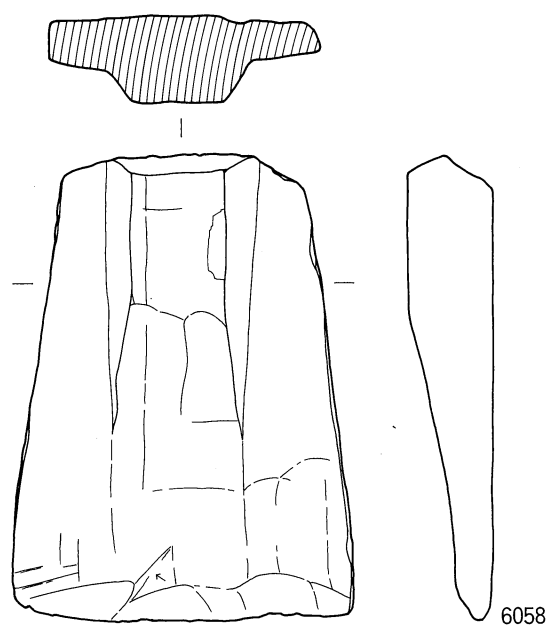

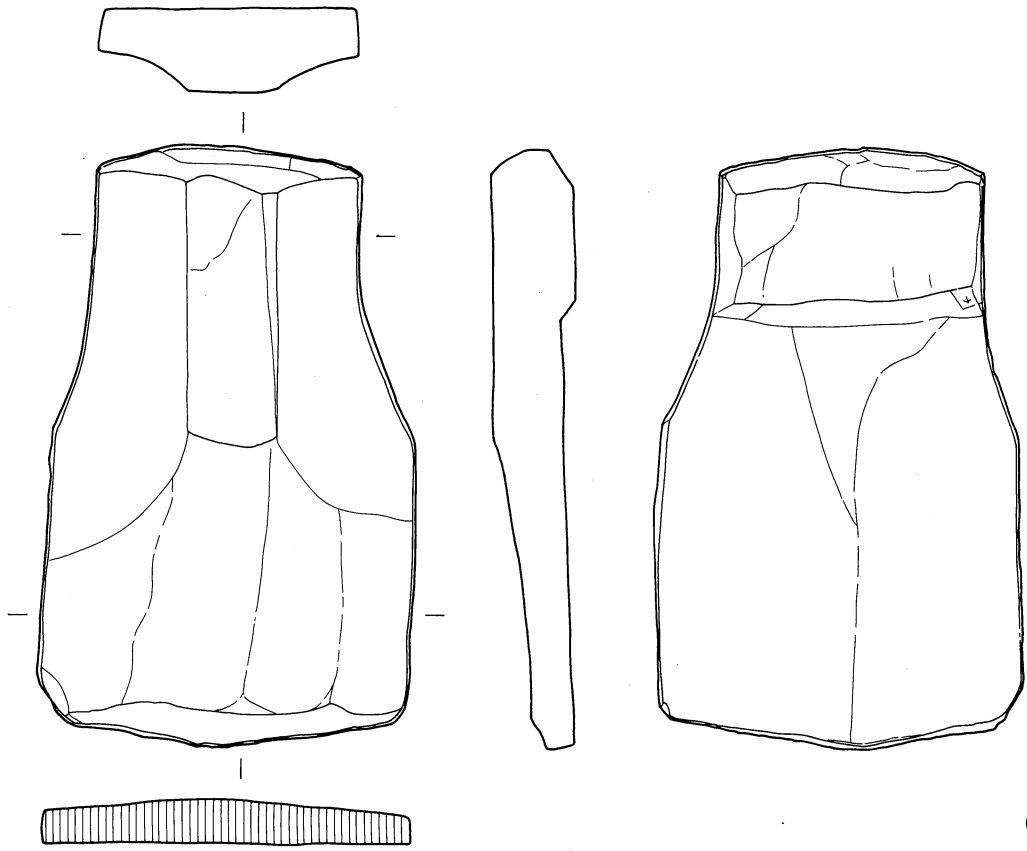

6061

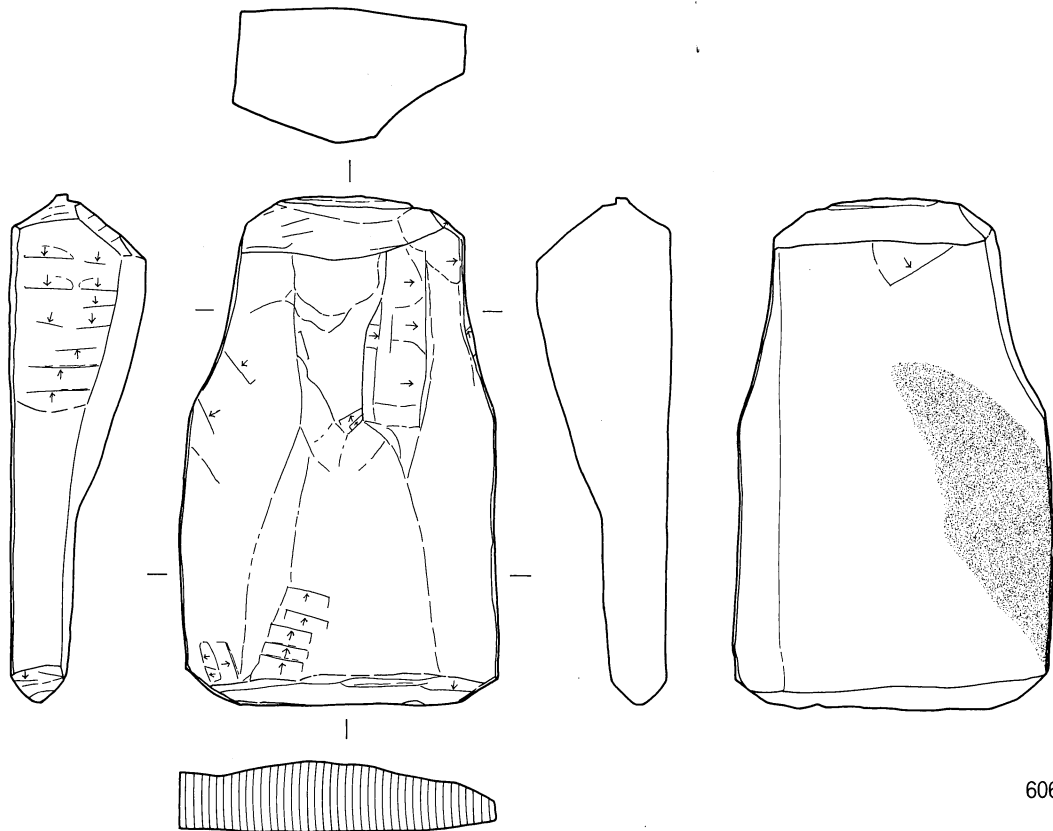

6062



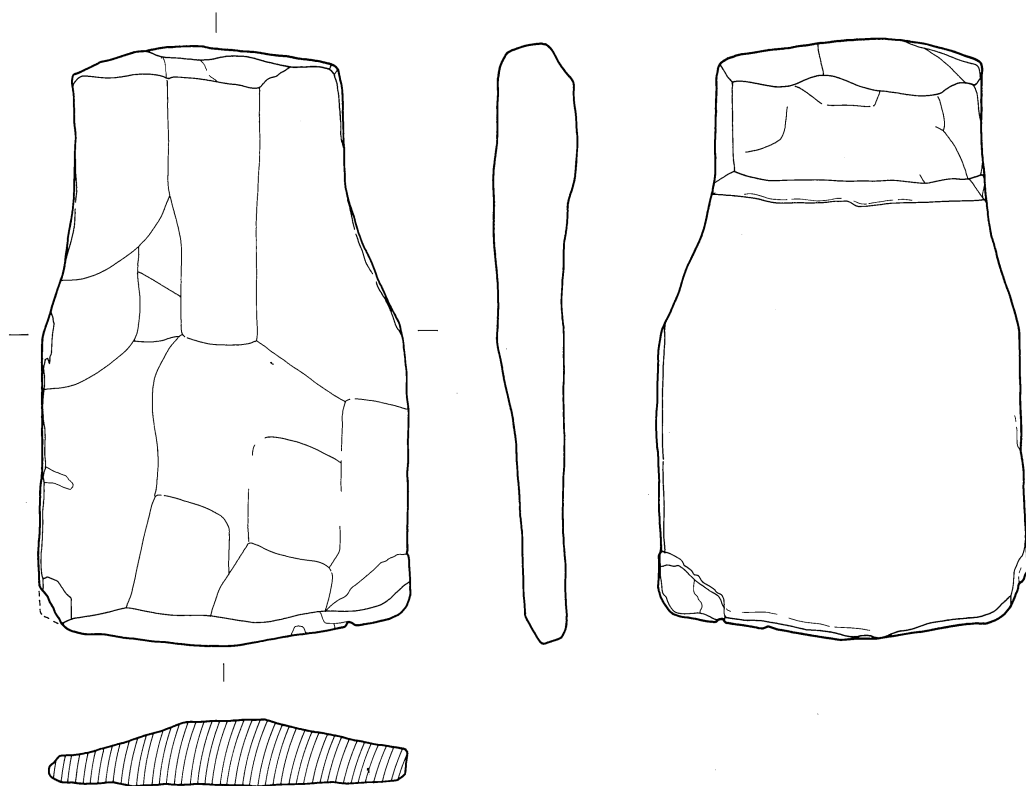

6063

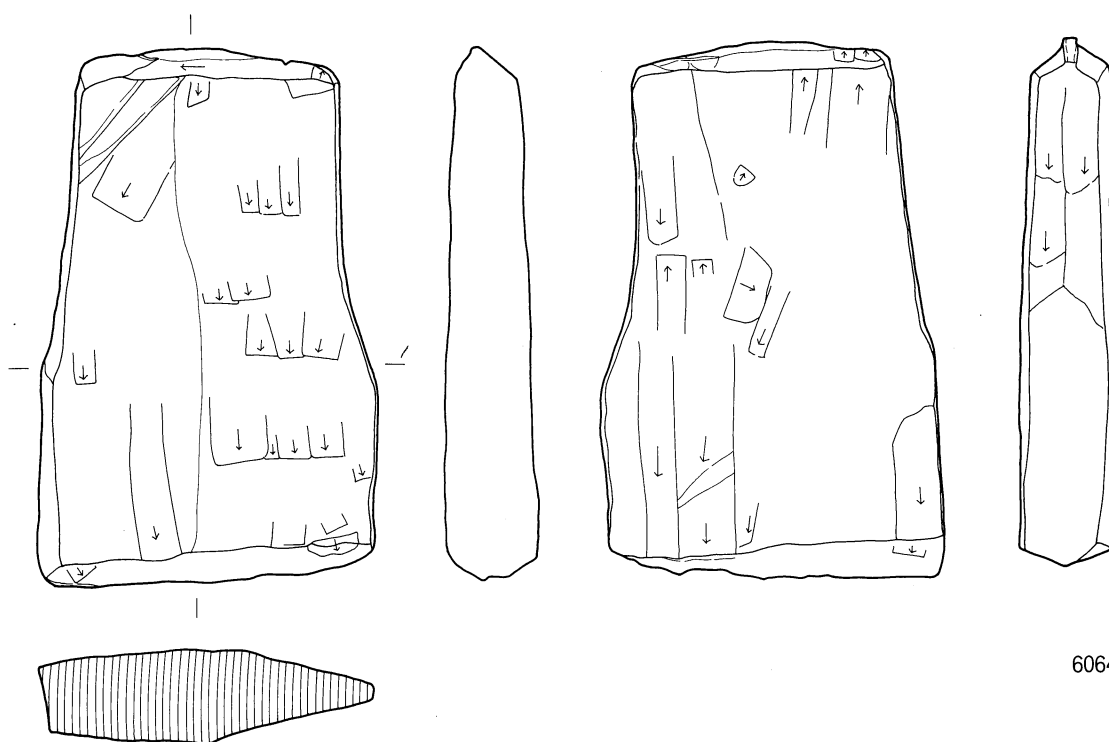

6064



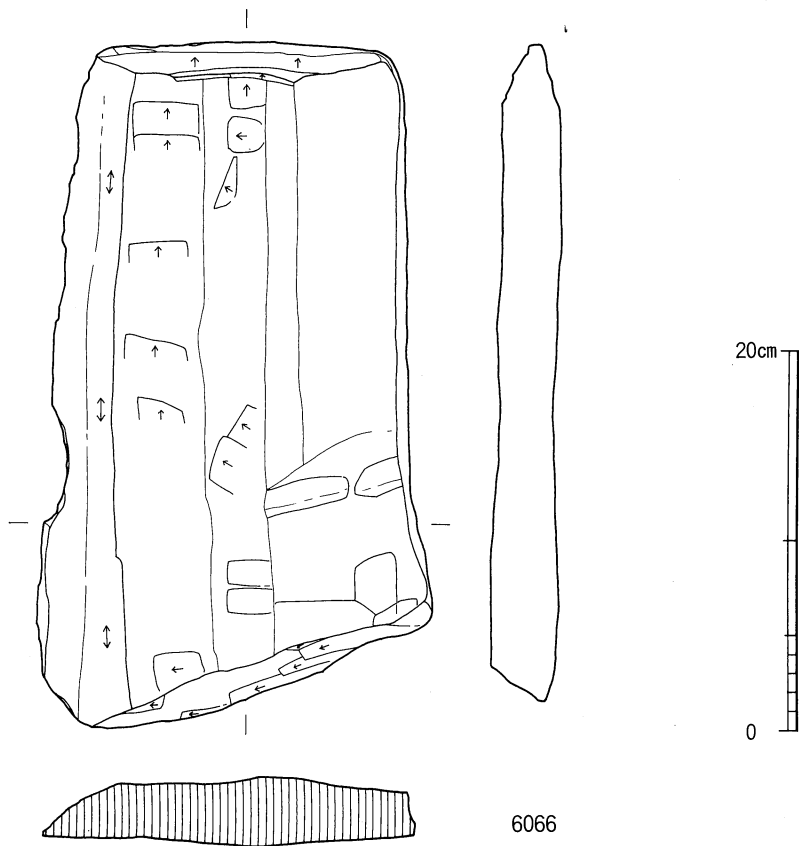
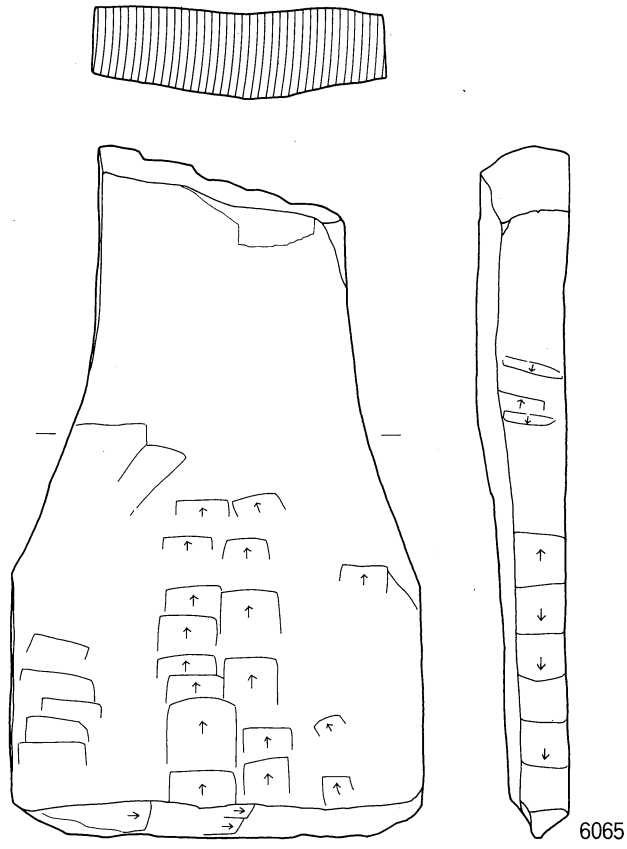

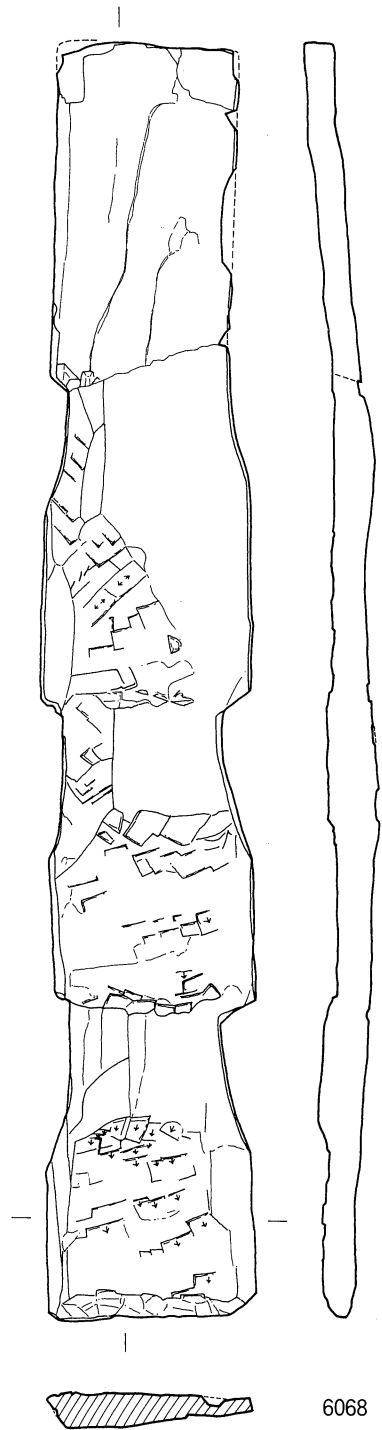
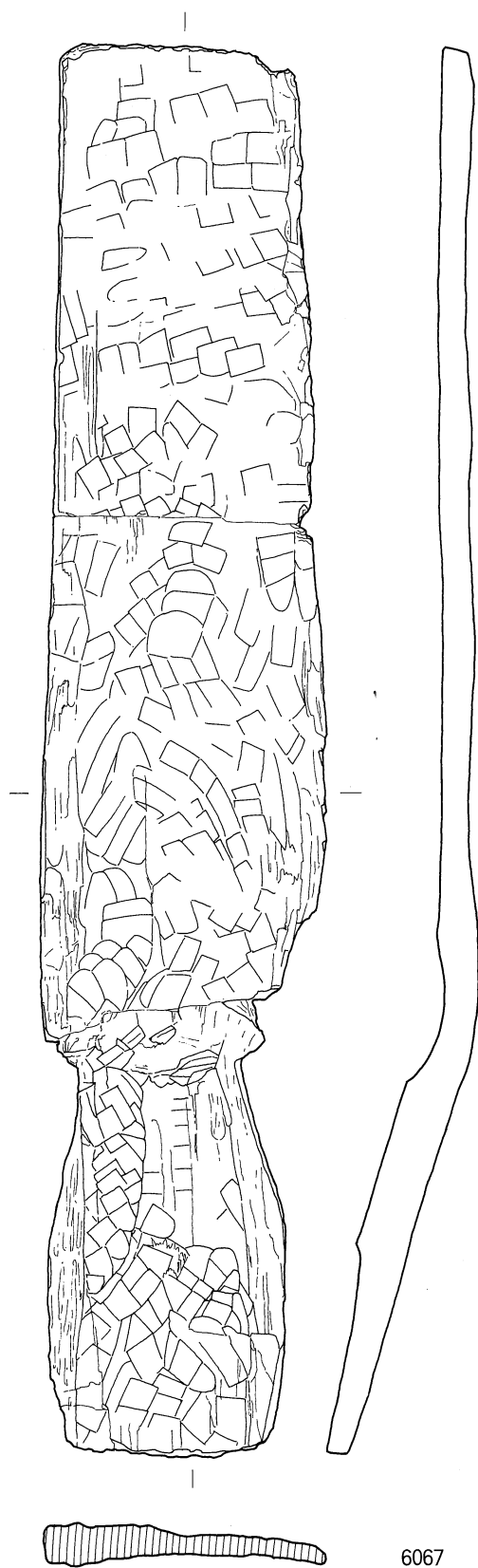

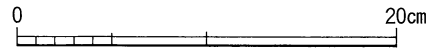
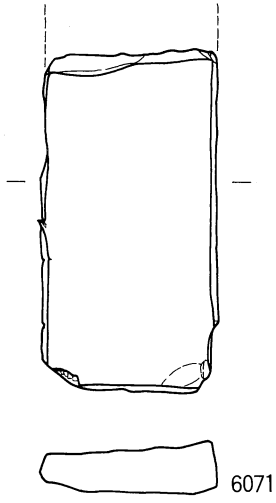
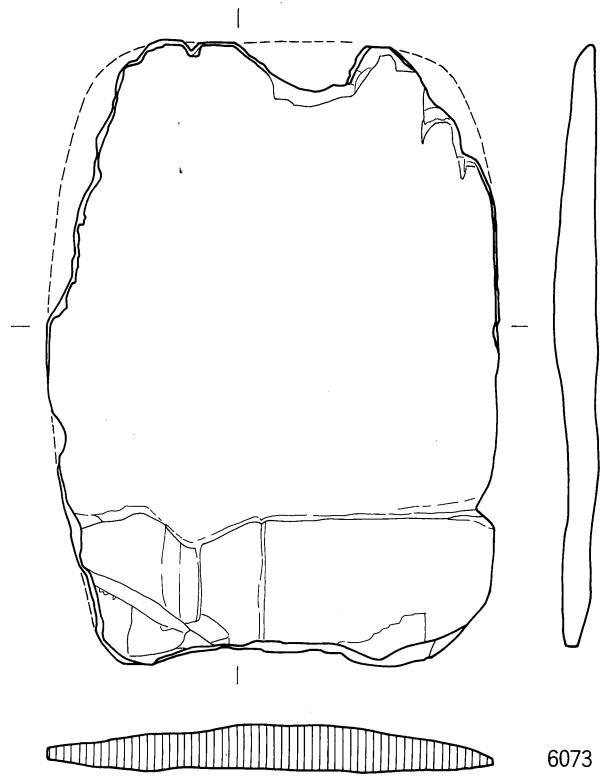
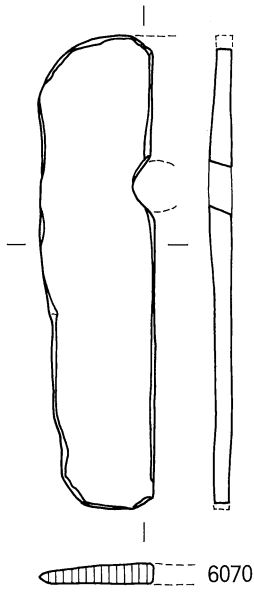
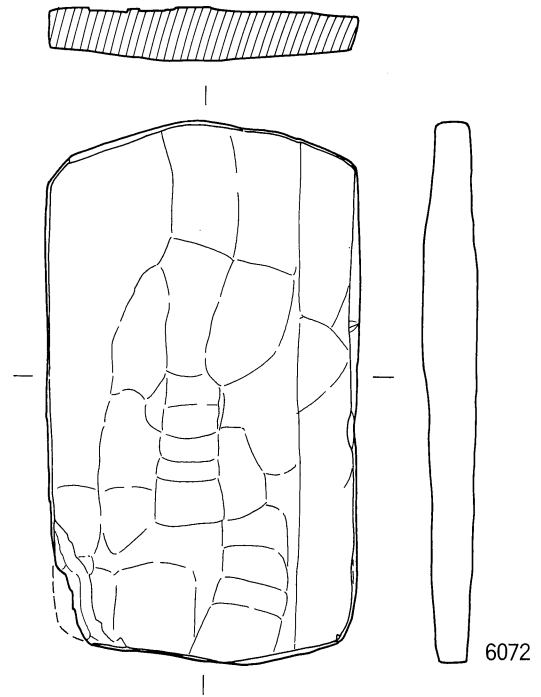
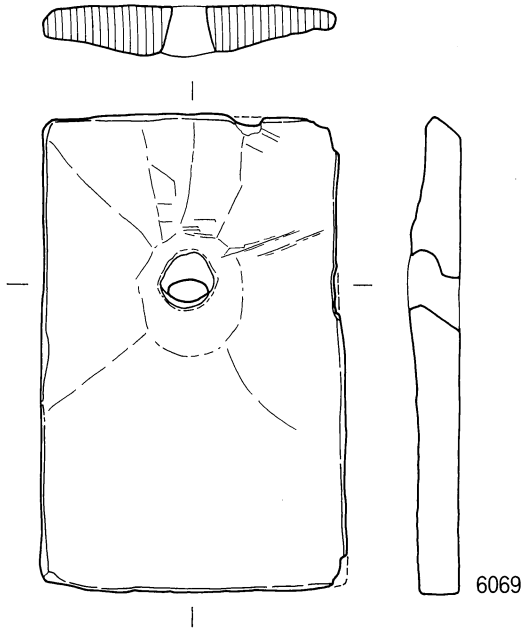

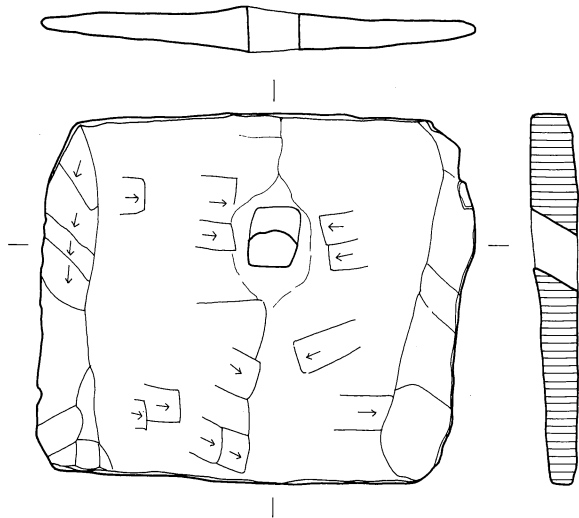

6074

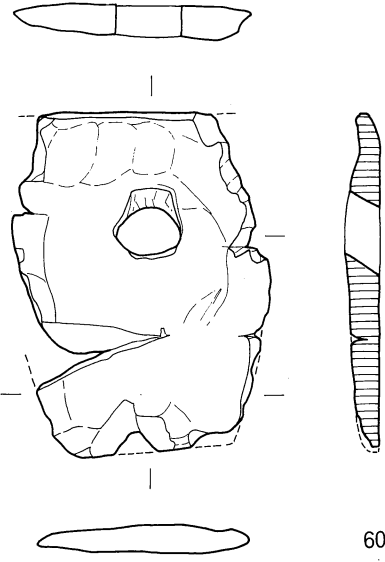

6075

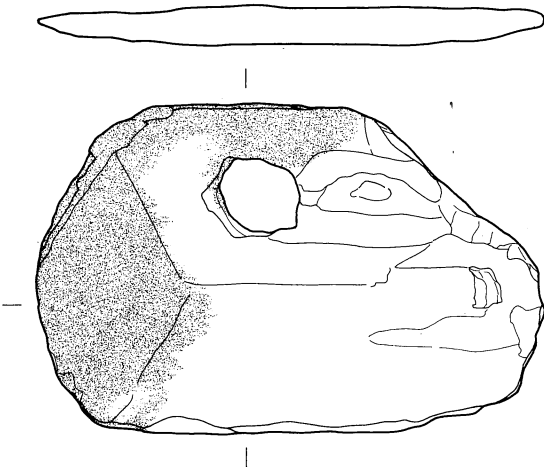

6076

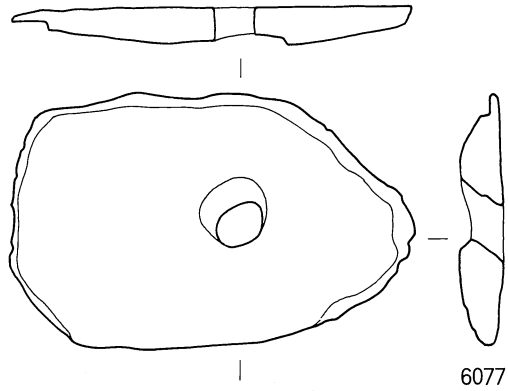

6077

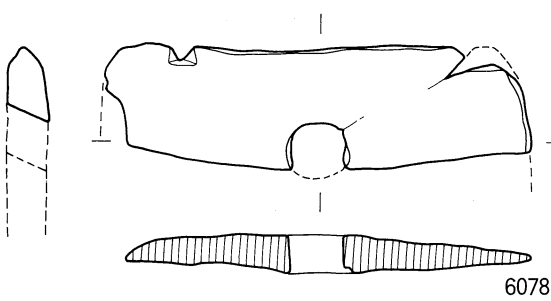

6078

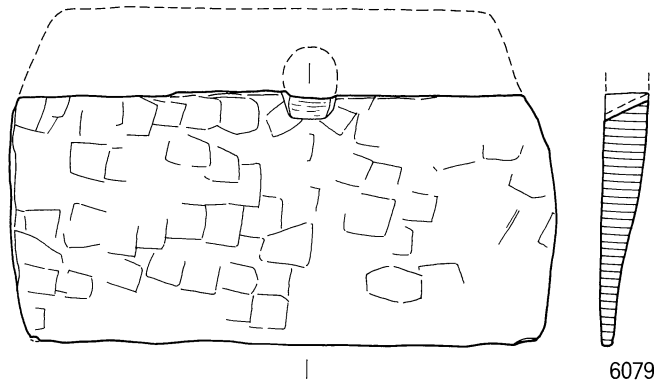

6079



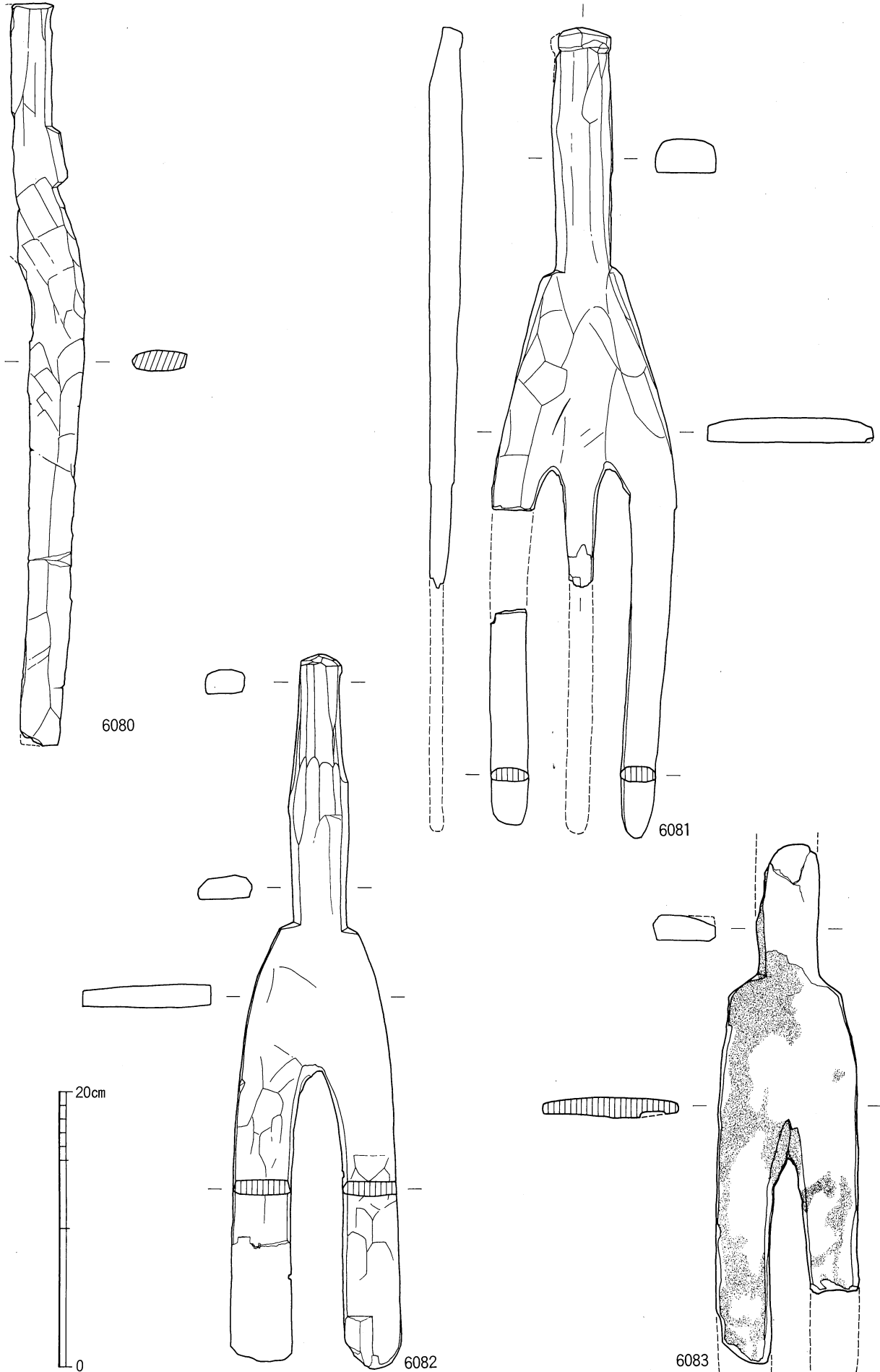

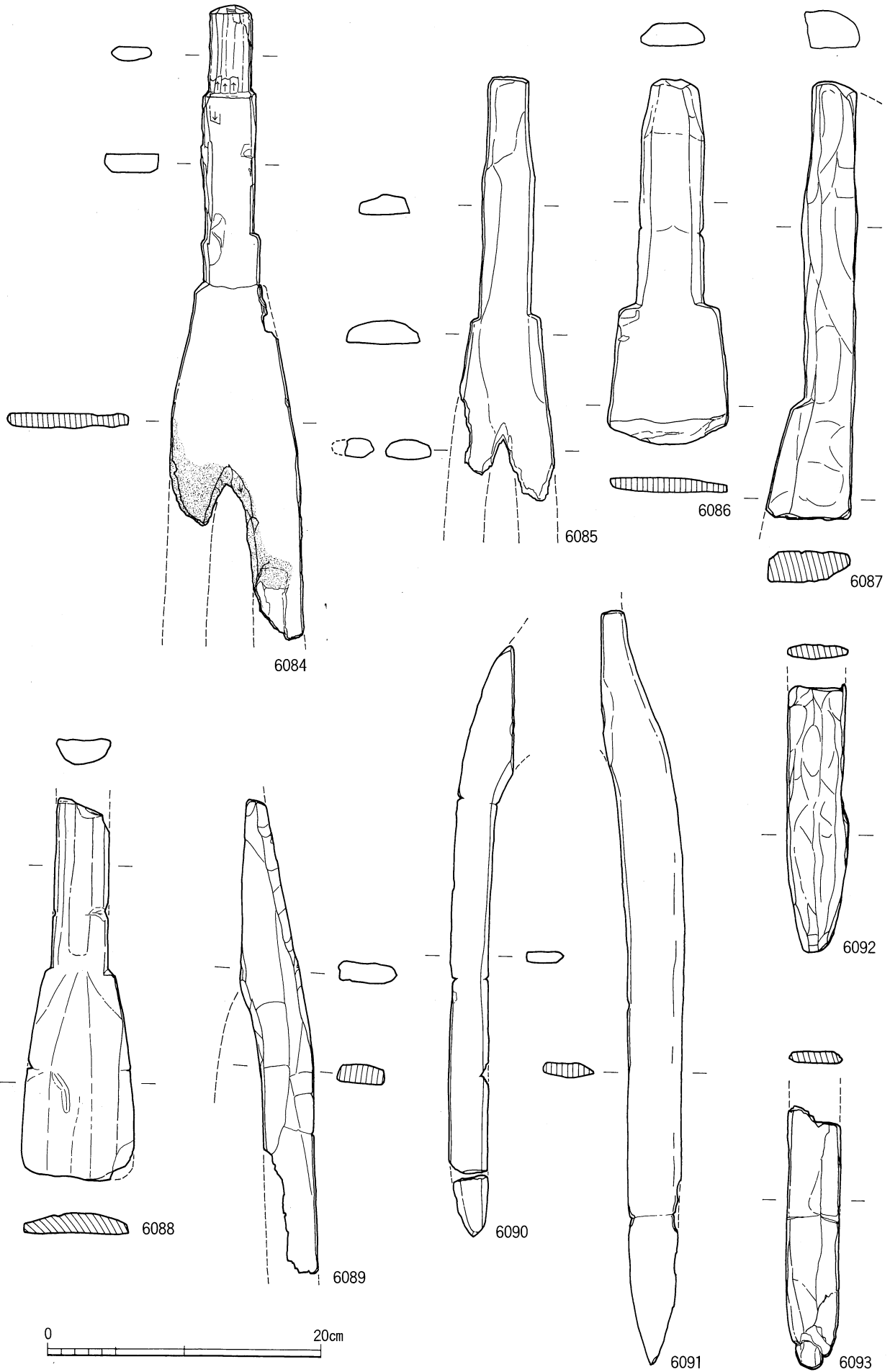

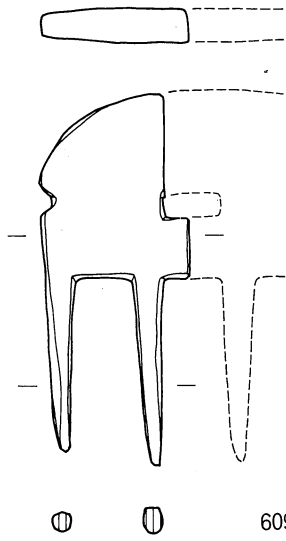

6094

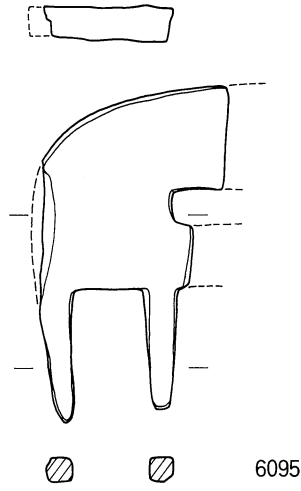

6095

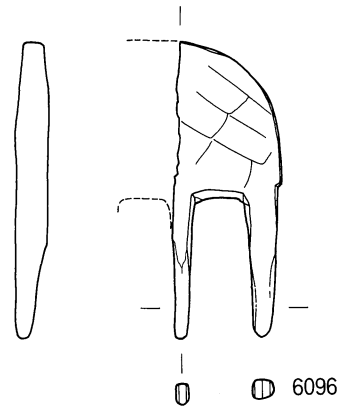

6096

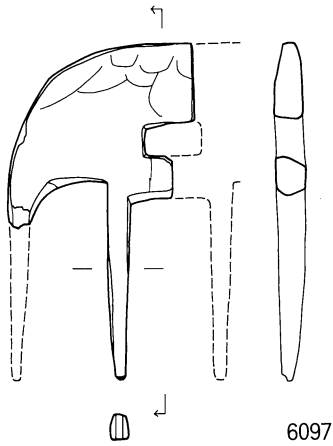

6097

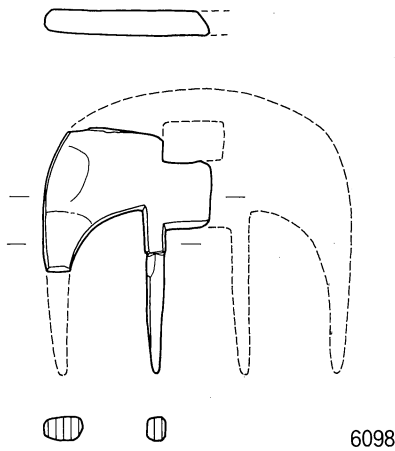

6098

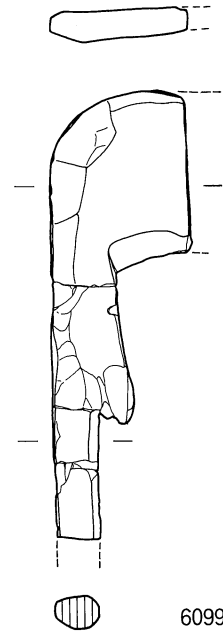

6099

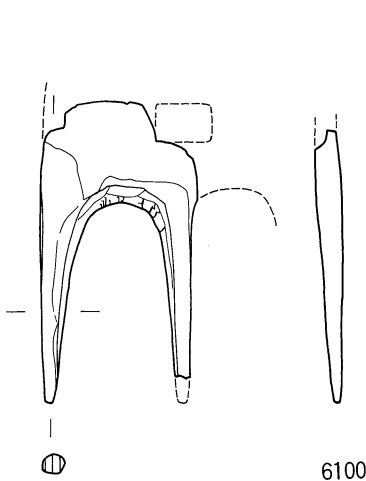

6100

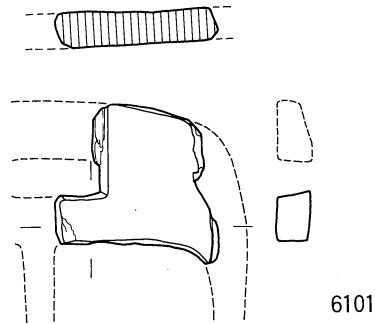

6101

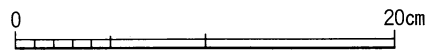

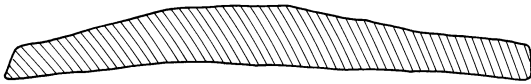
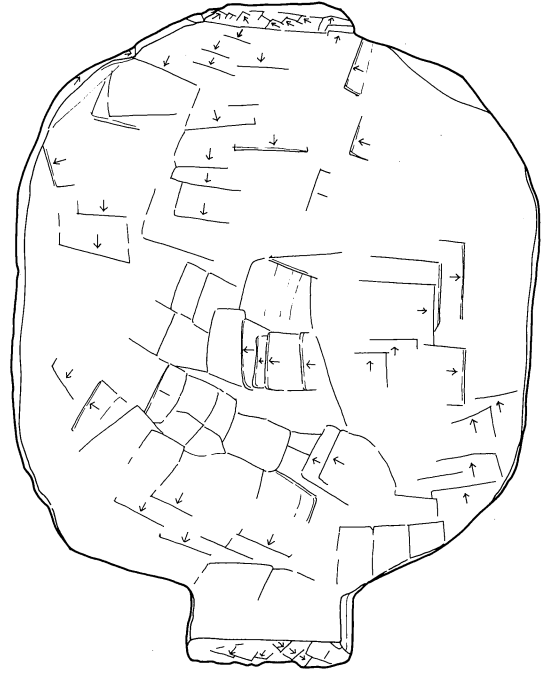
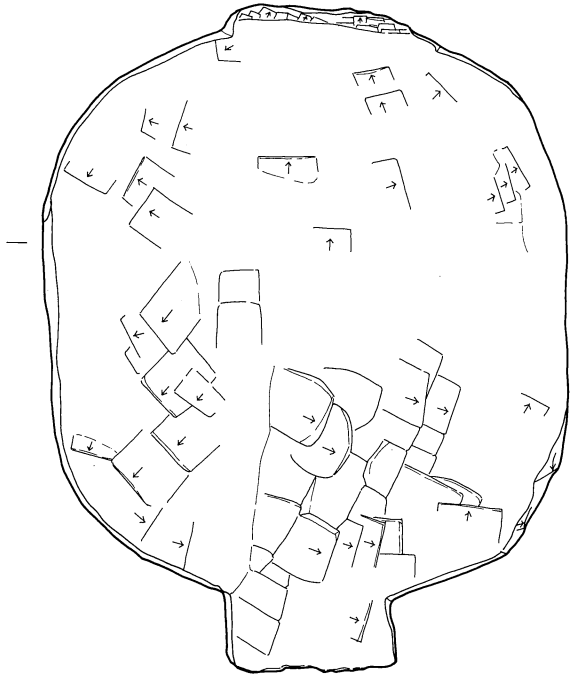

6102

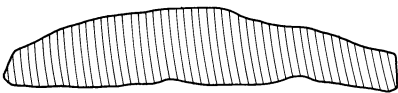
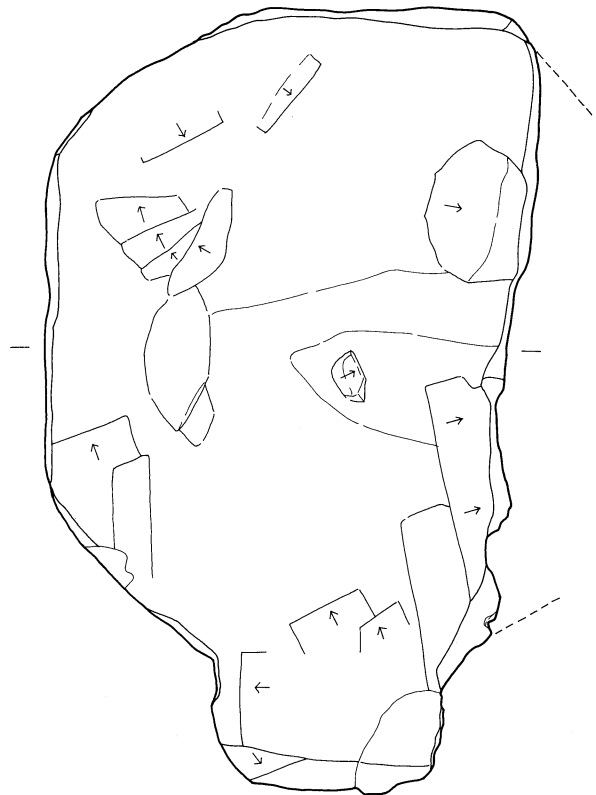
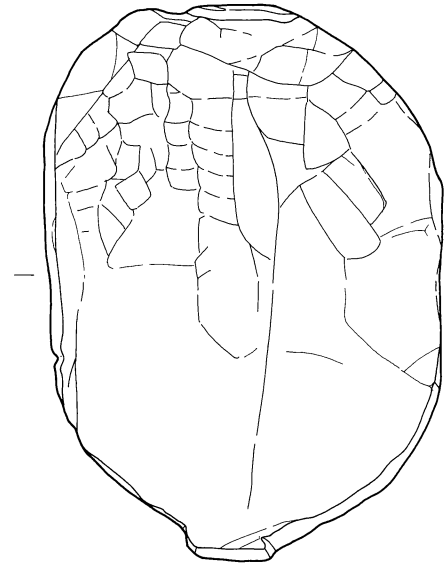

6103

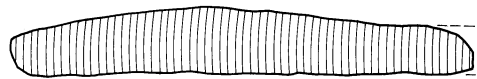

6104



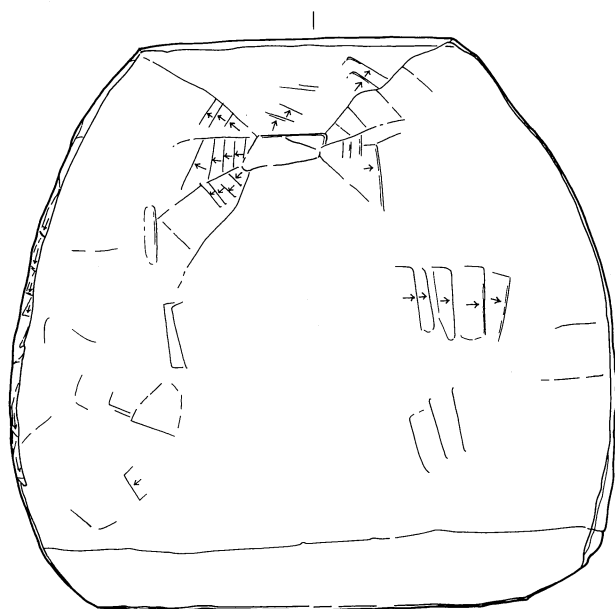

6105

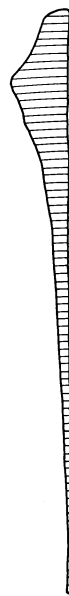
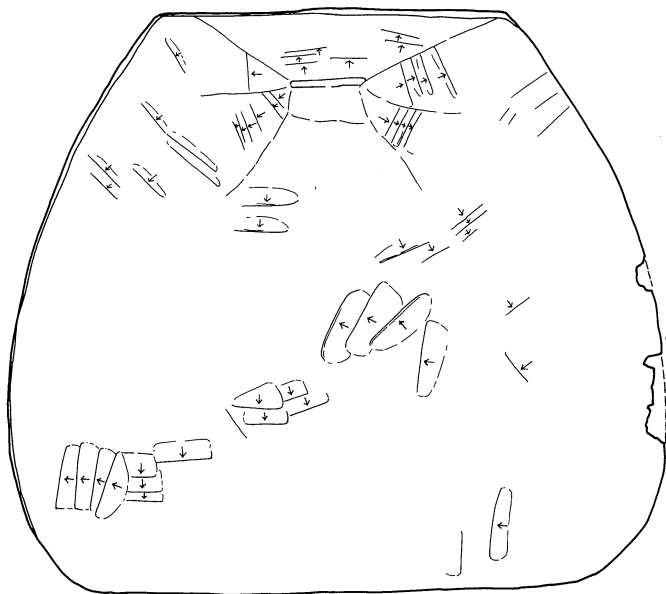

6106

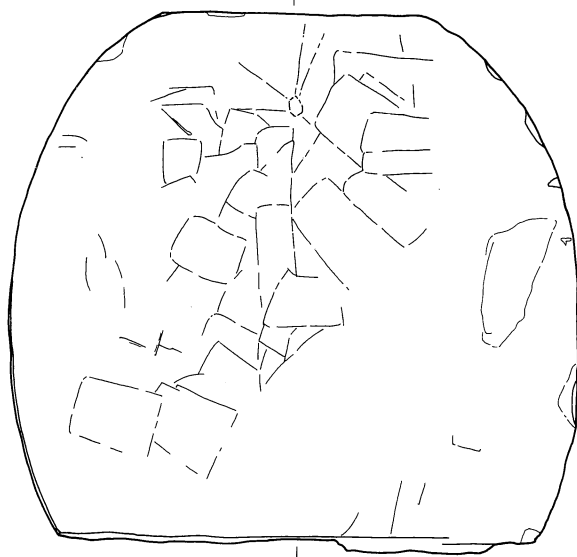

6107



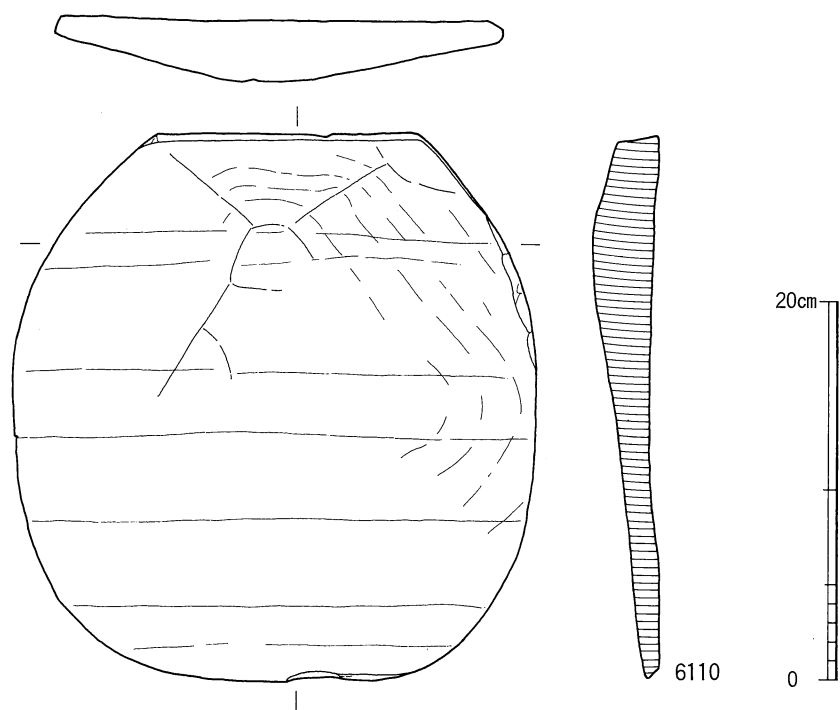
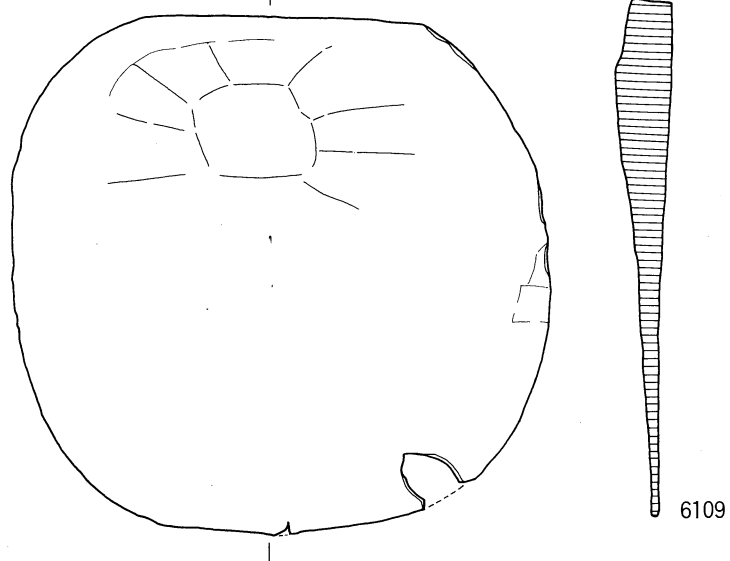
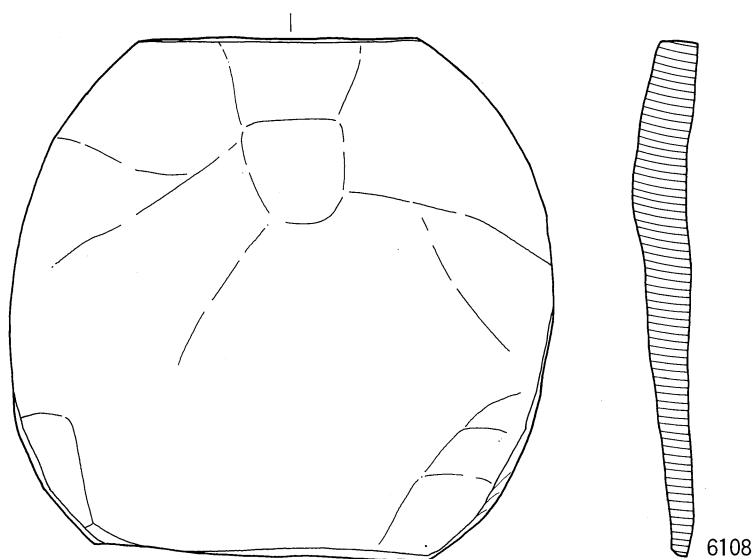

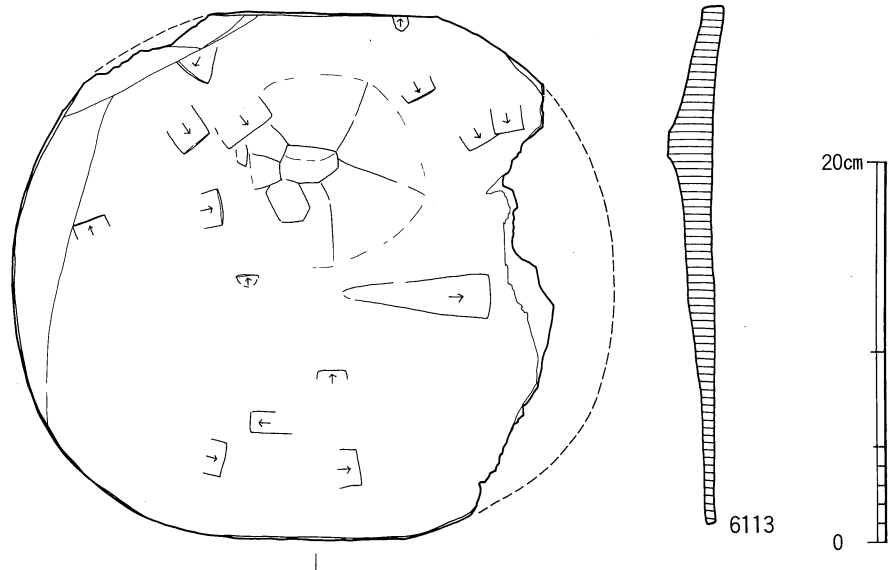
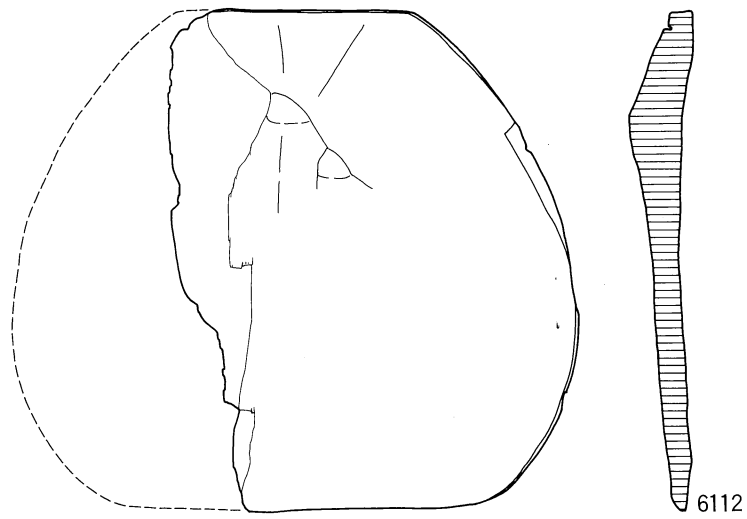
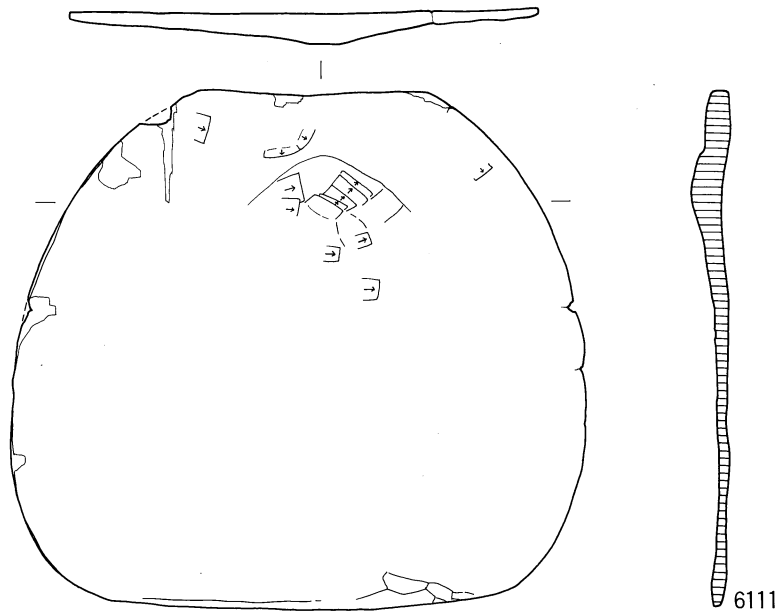

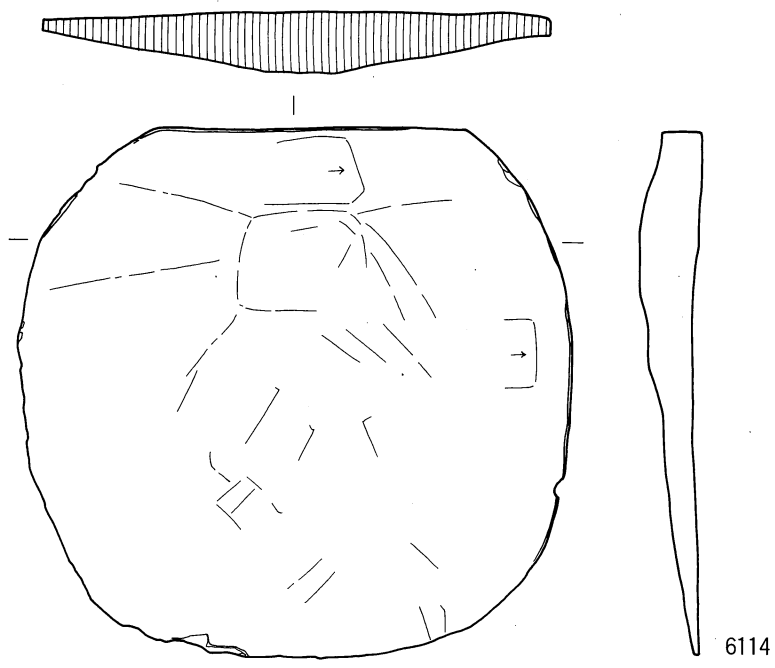

6114

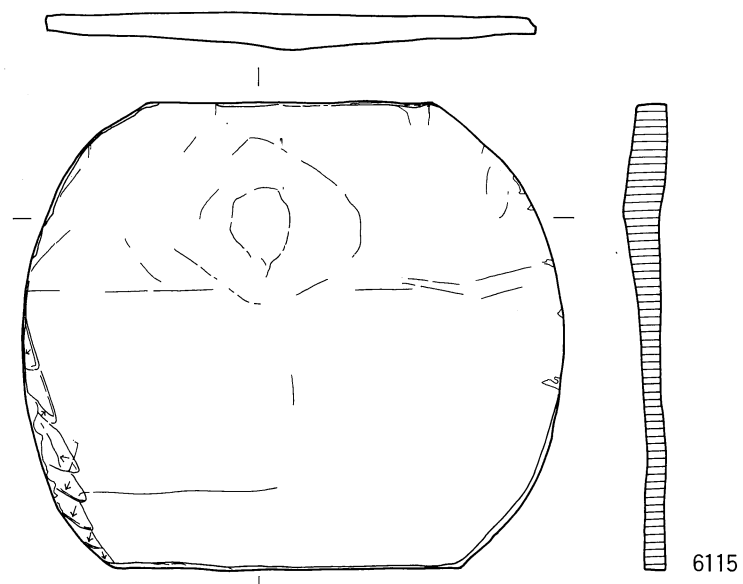

6115

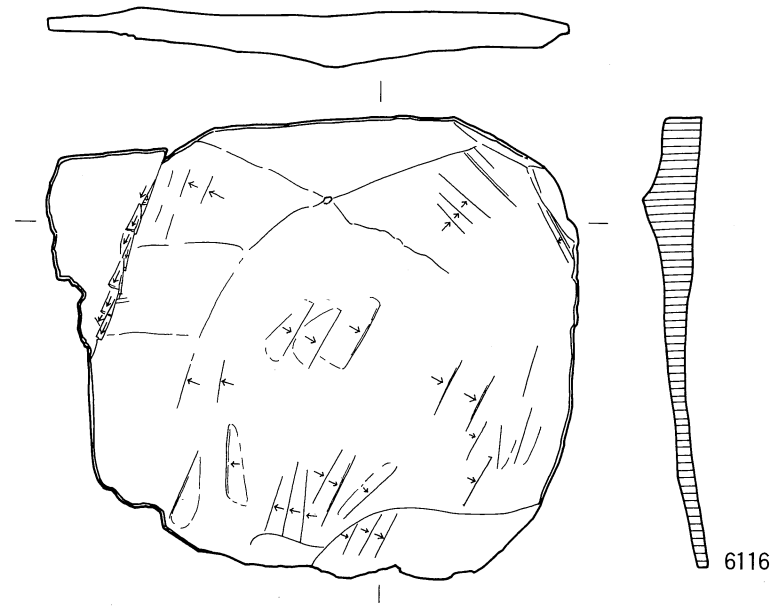

6116



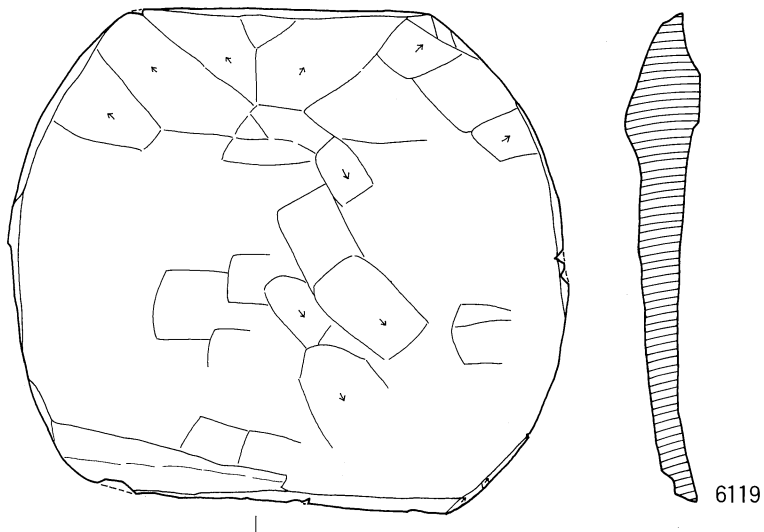
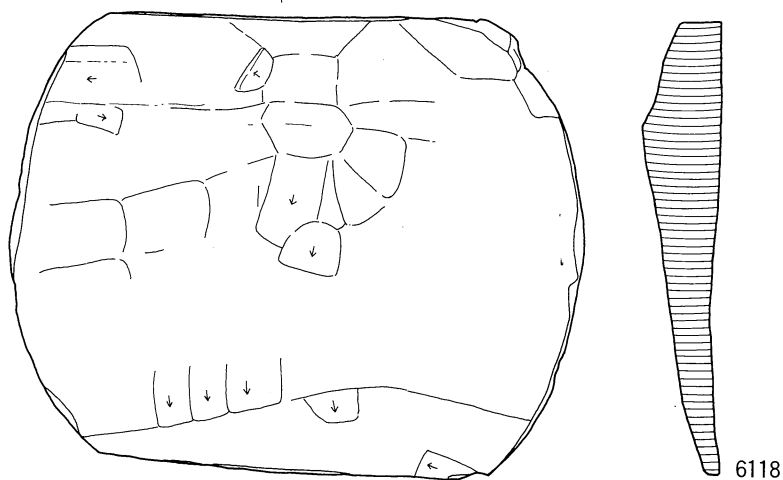
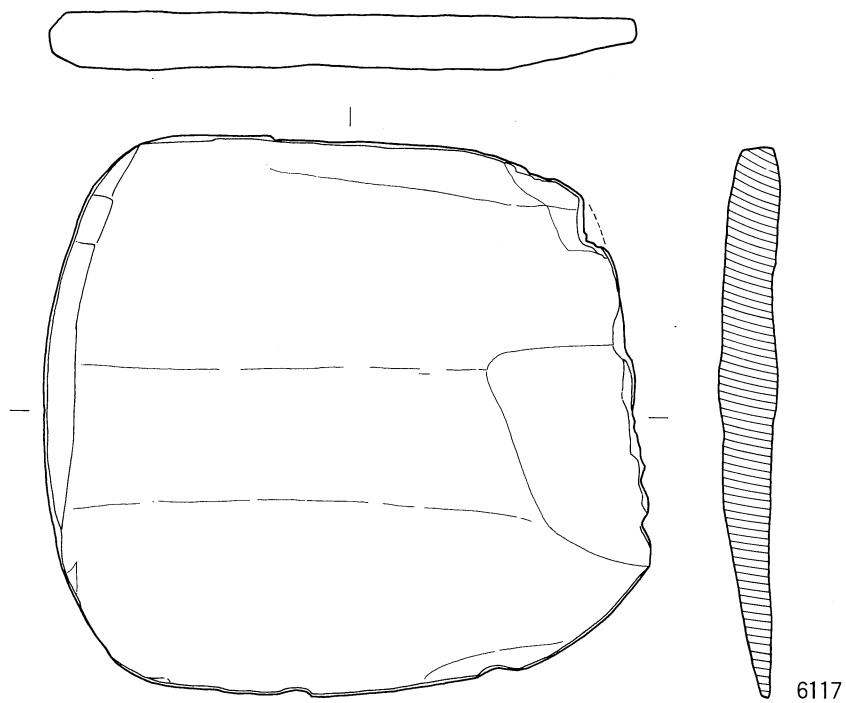

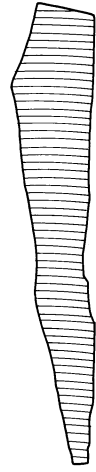
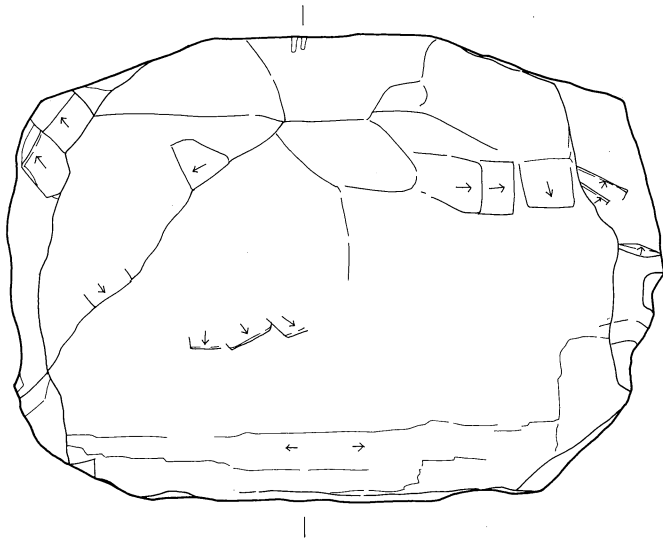

6120

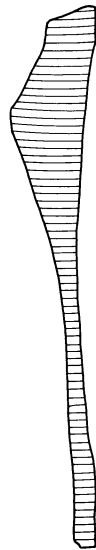
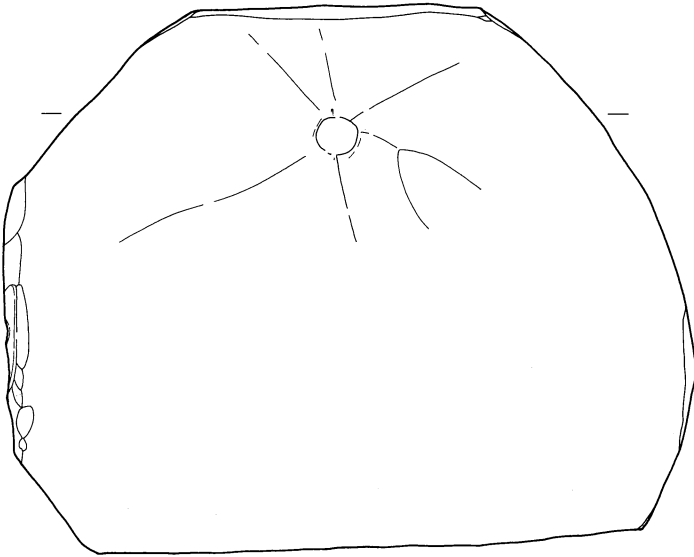

6121

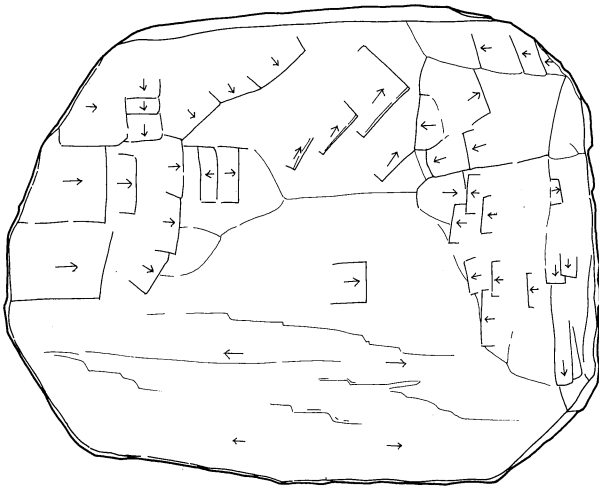

6122



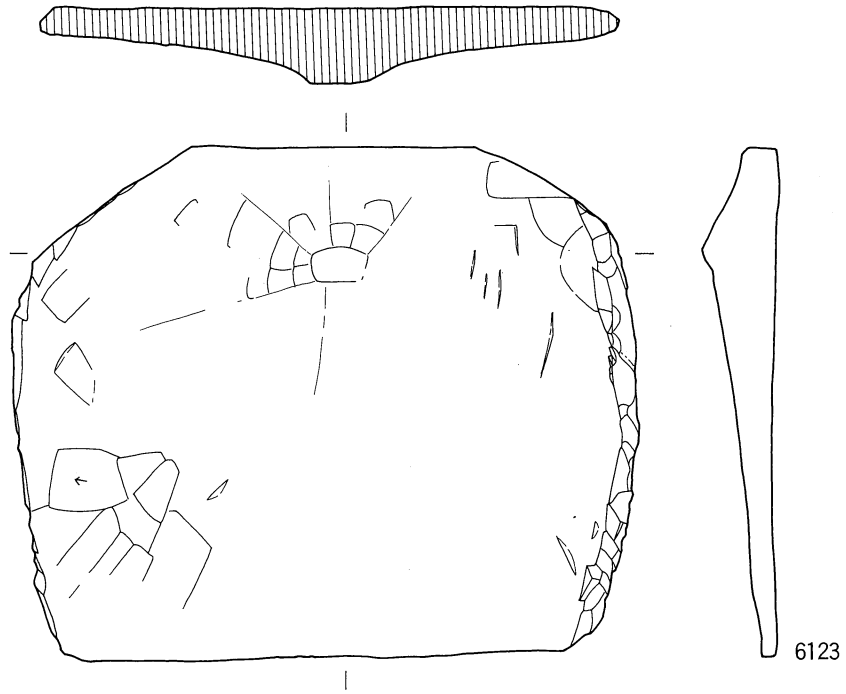

6123

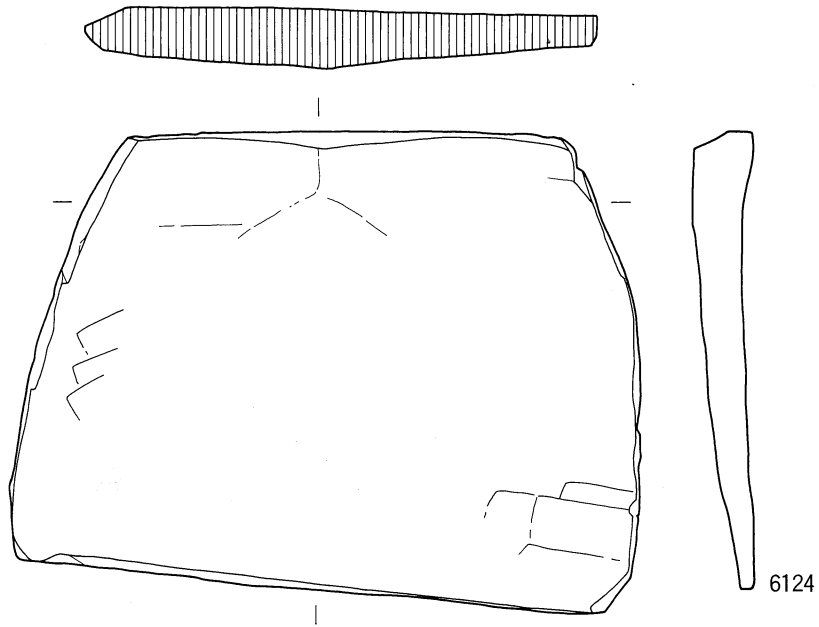

6124



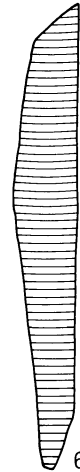
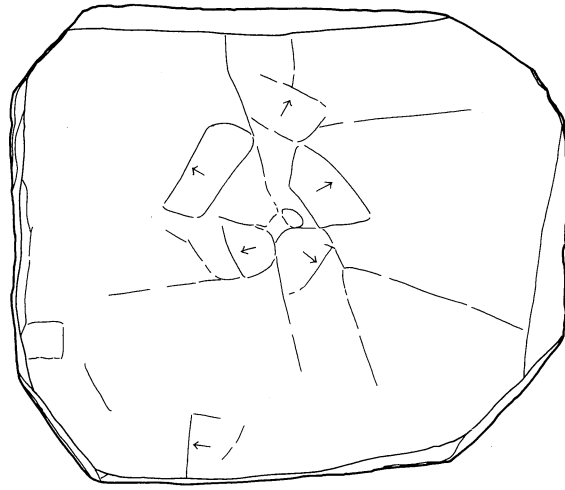

6125

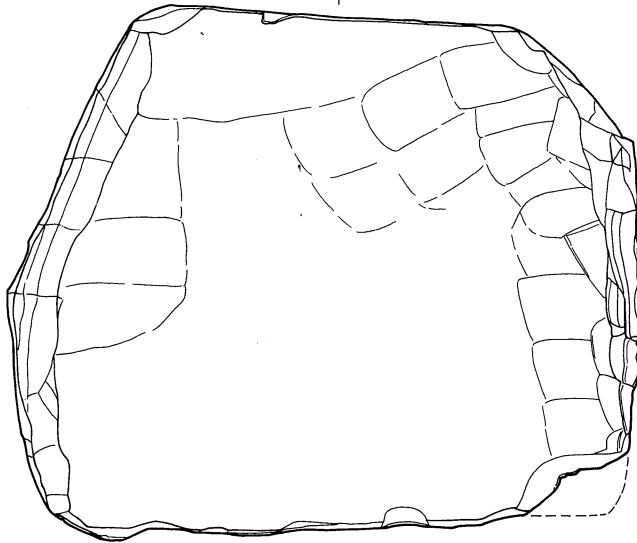
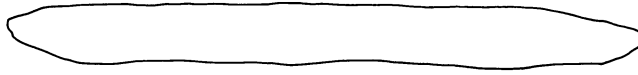

6126

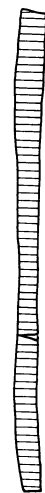
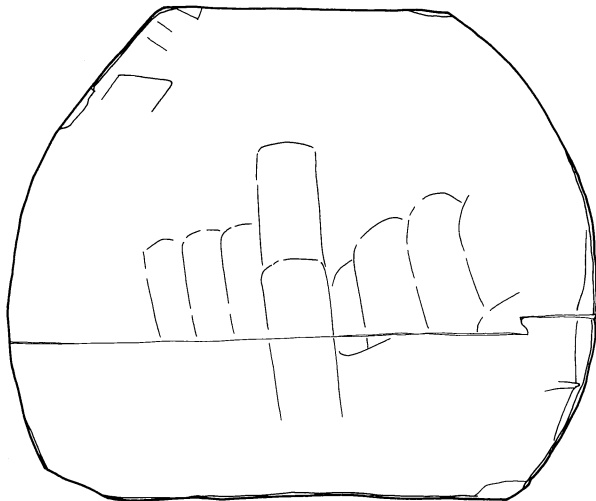
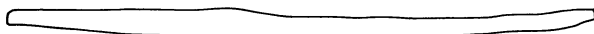

6127



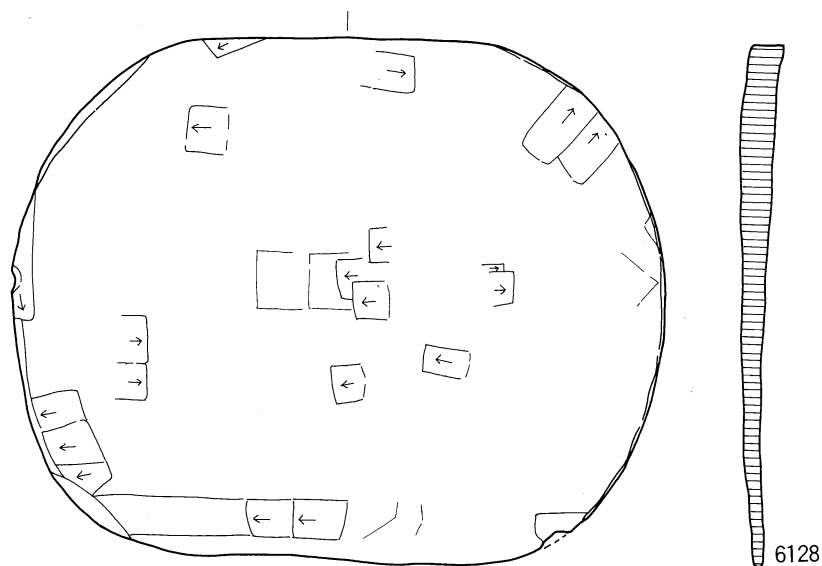

6128

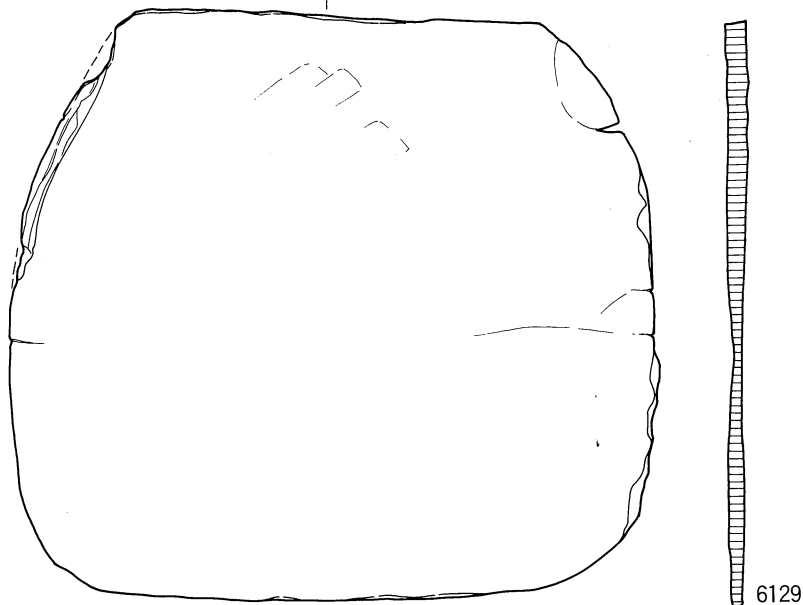

6129

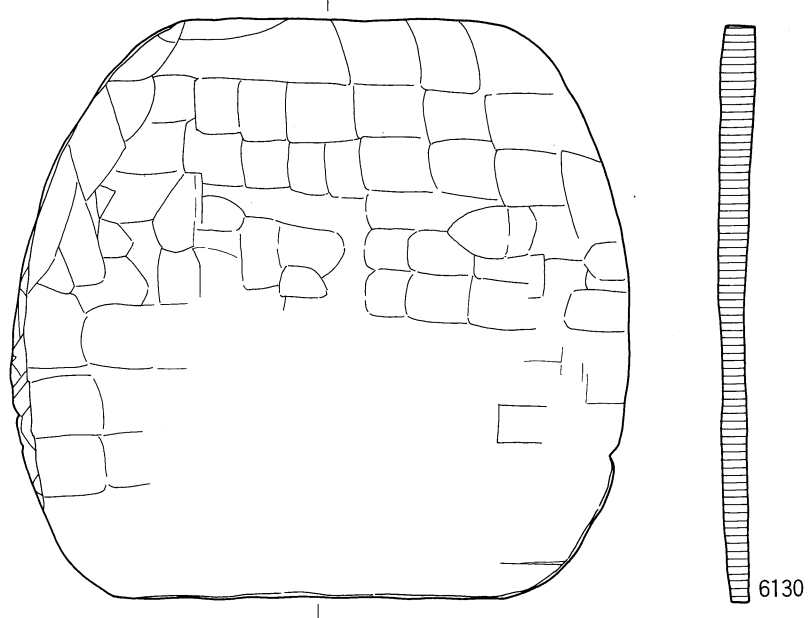

6130

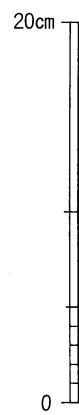

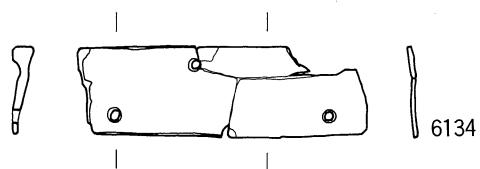
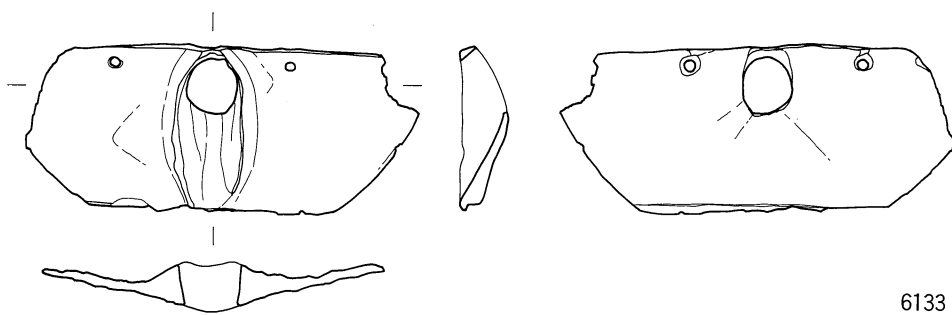
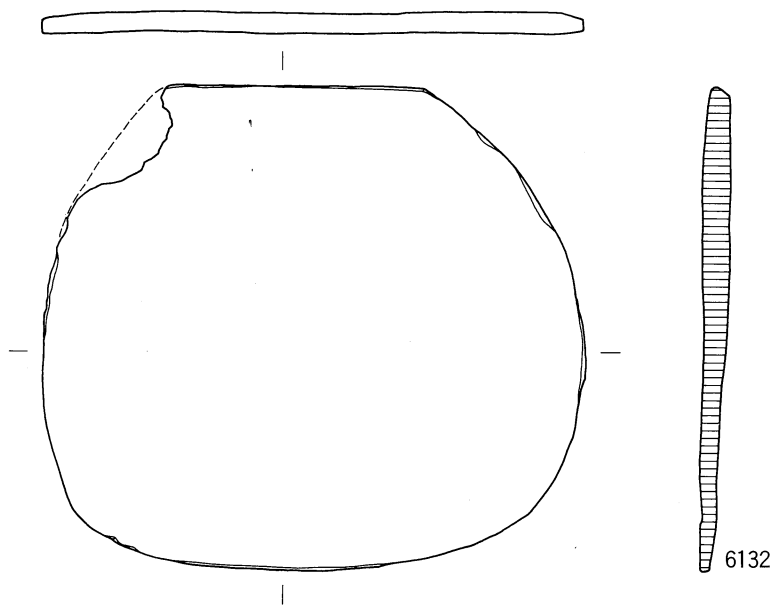
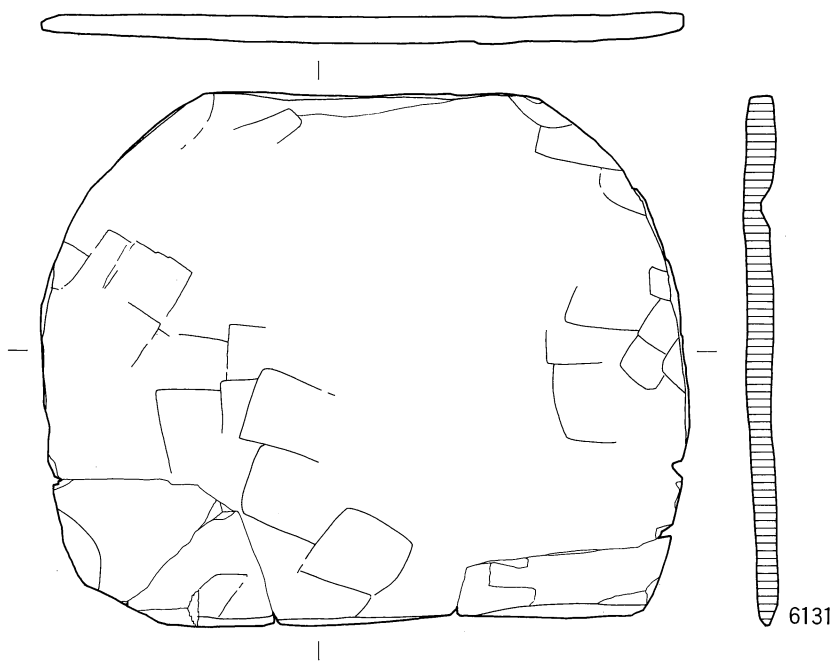



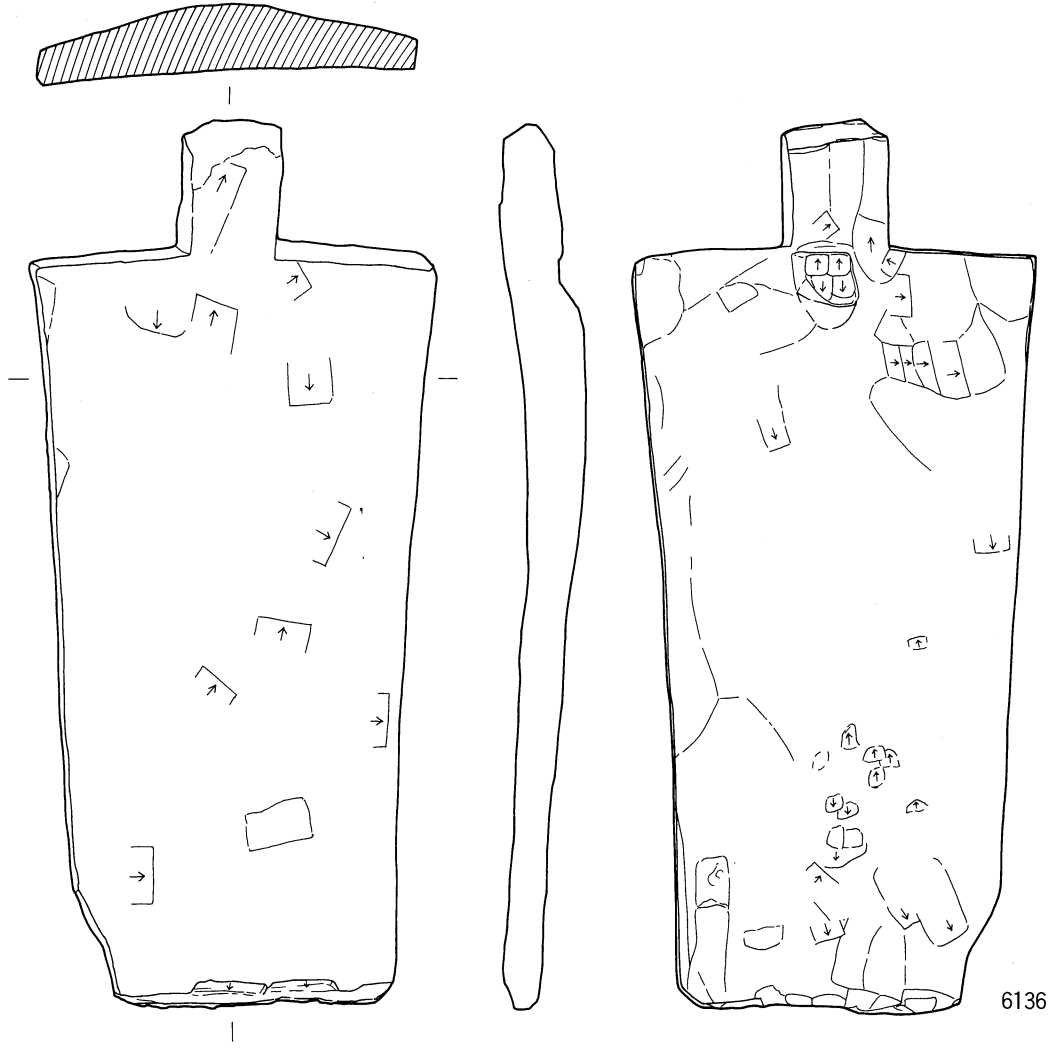

6136

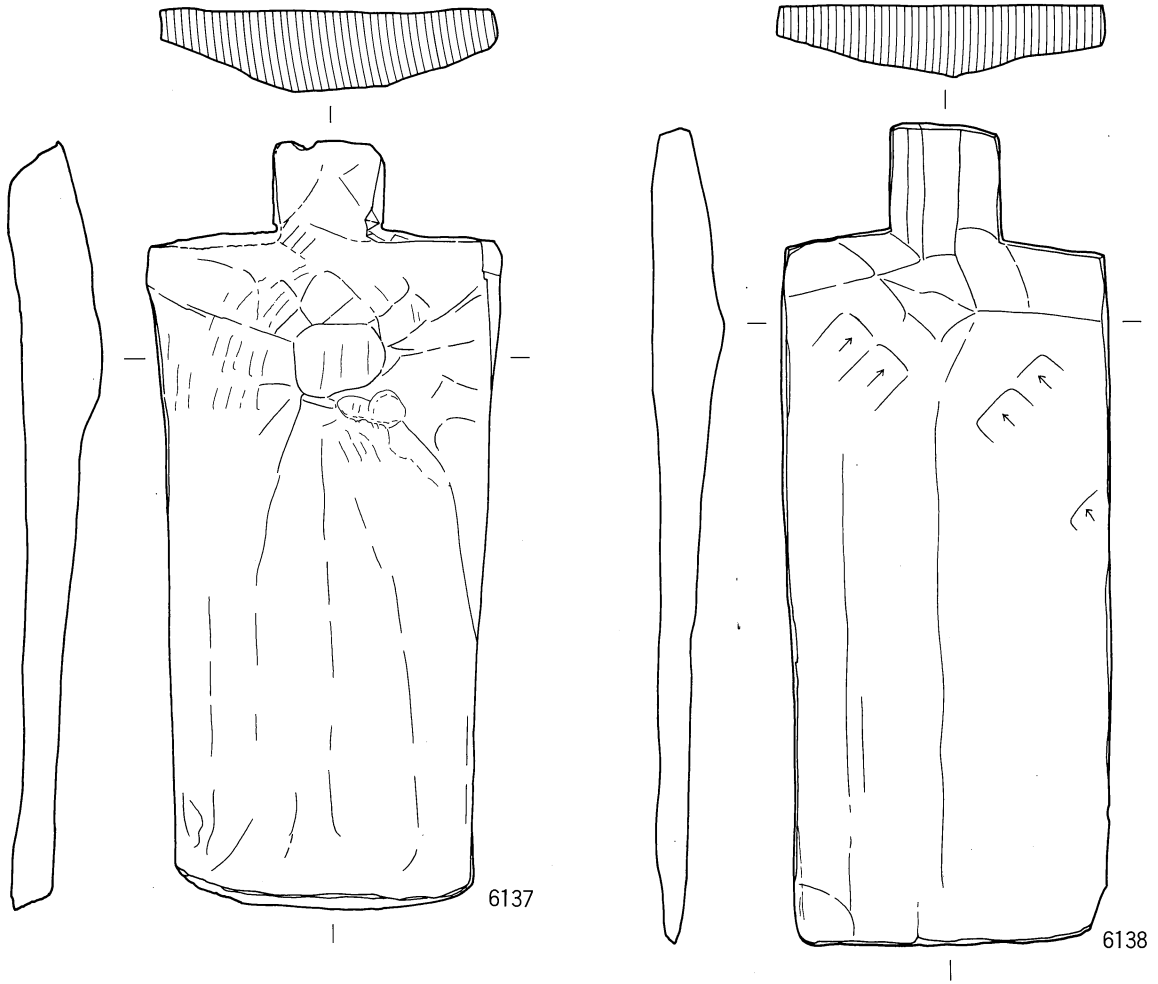

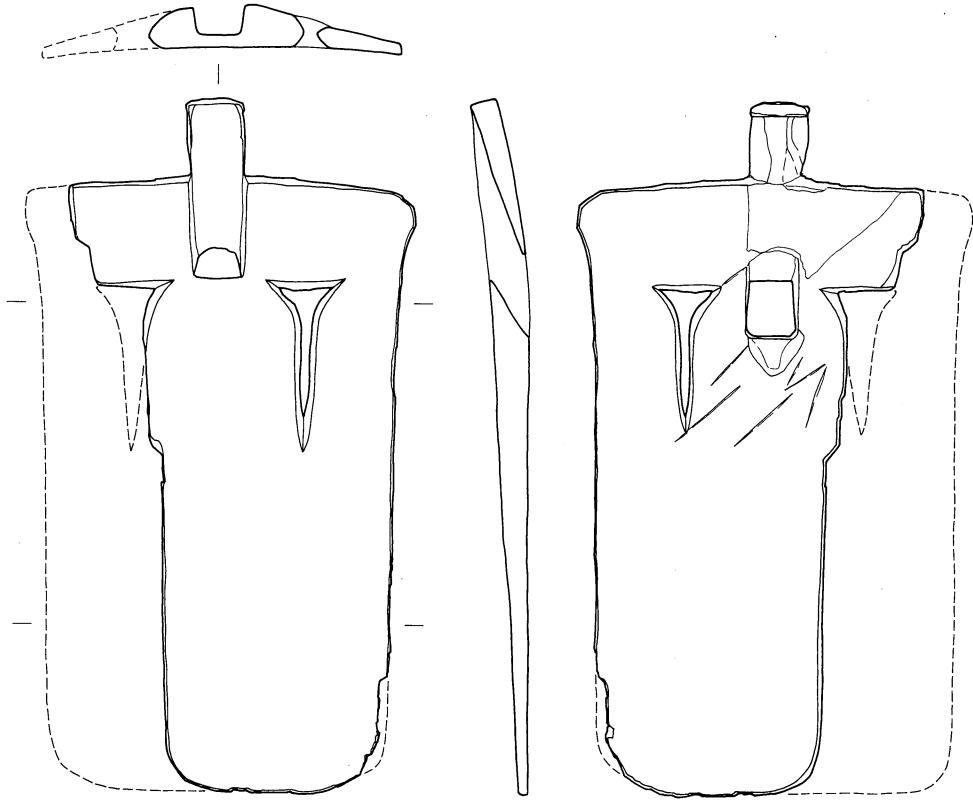

6139

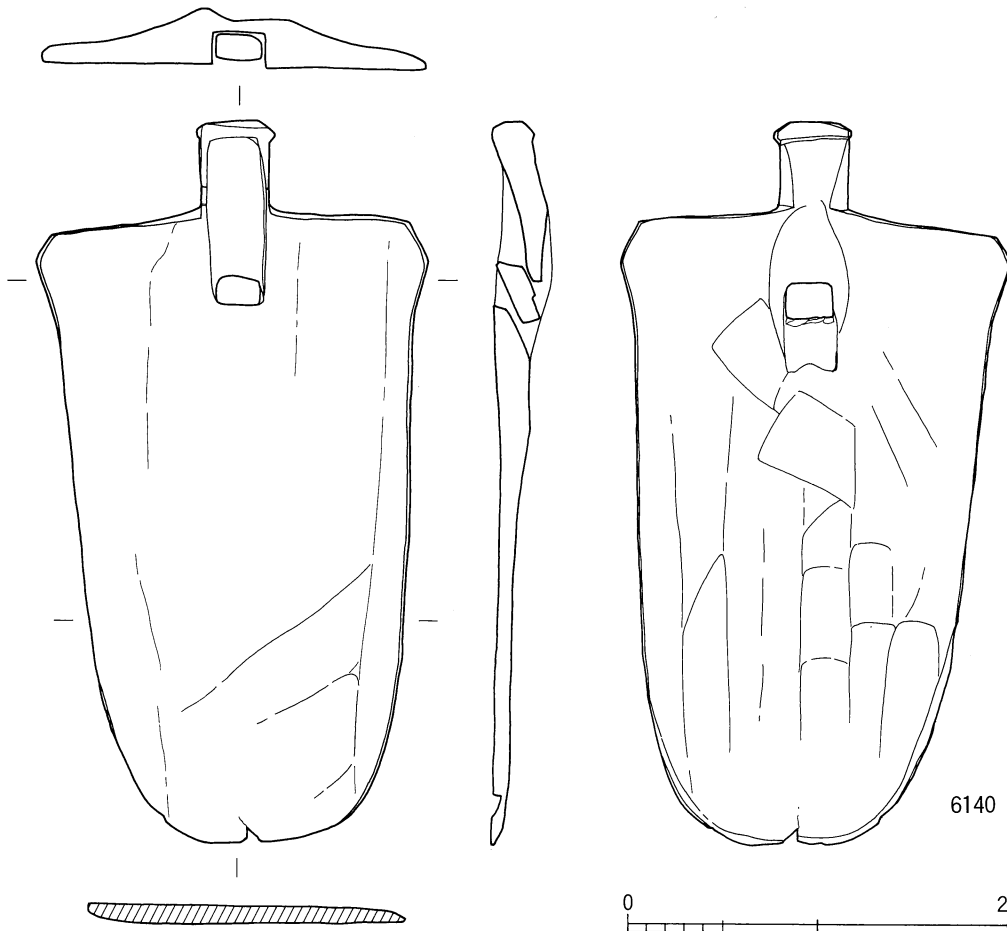

6140

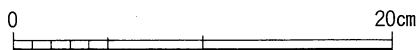
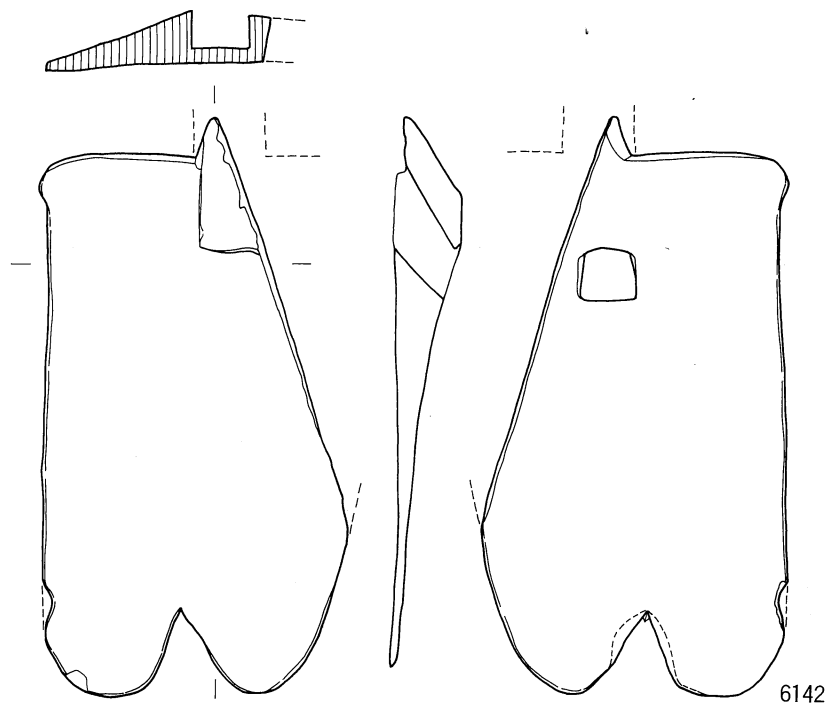
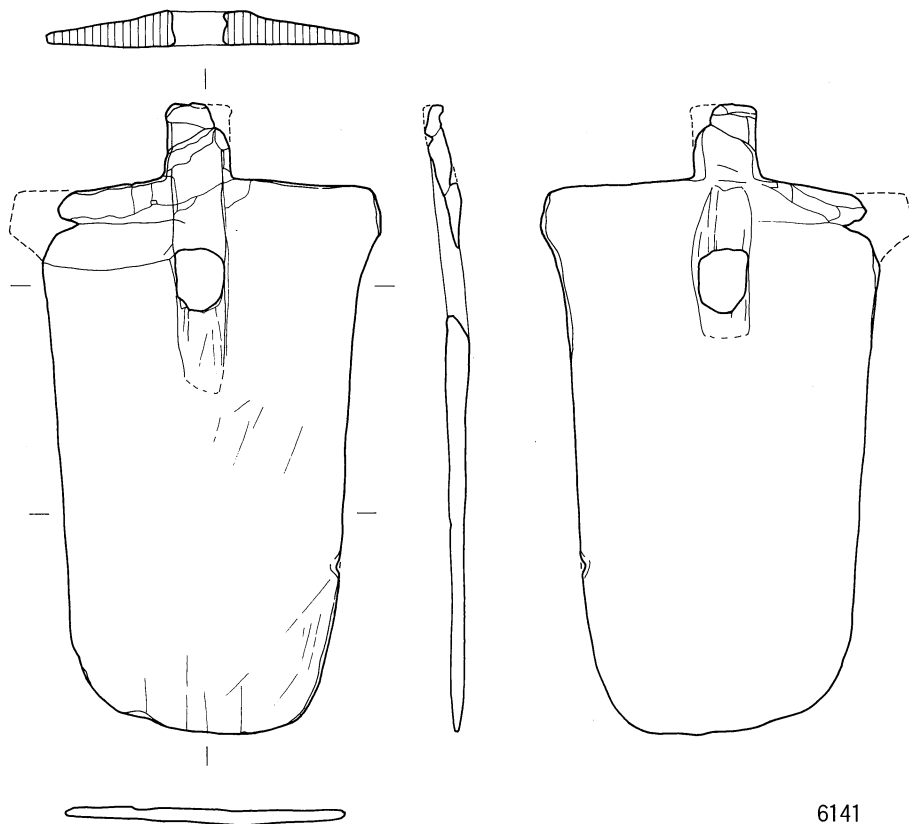

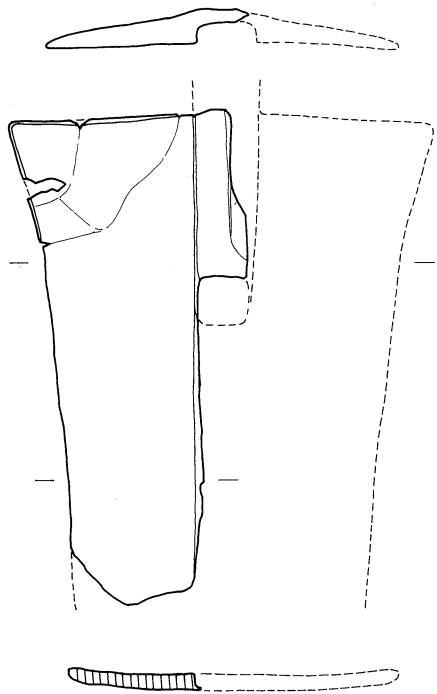

6143

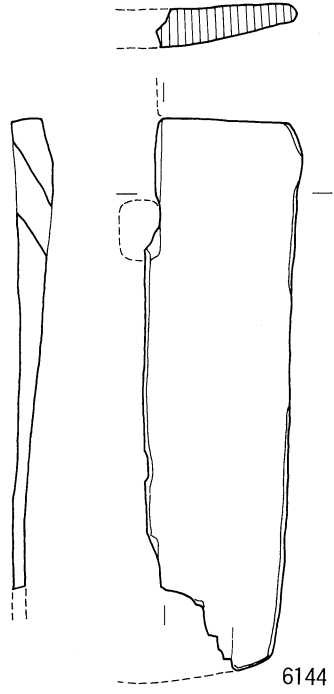

6144

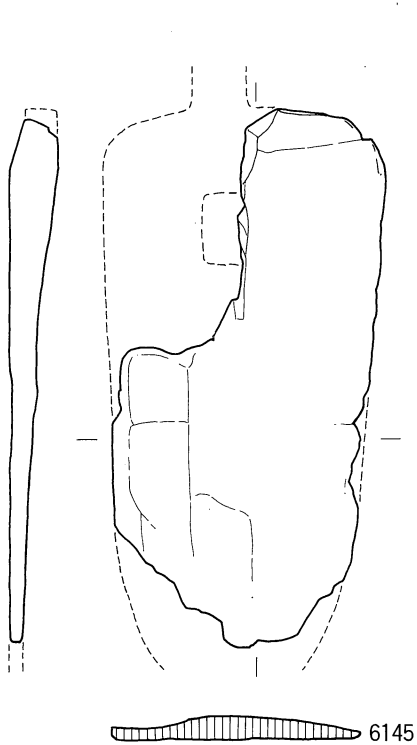

6145

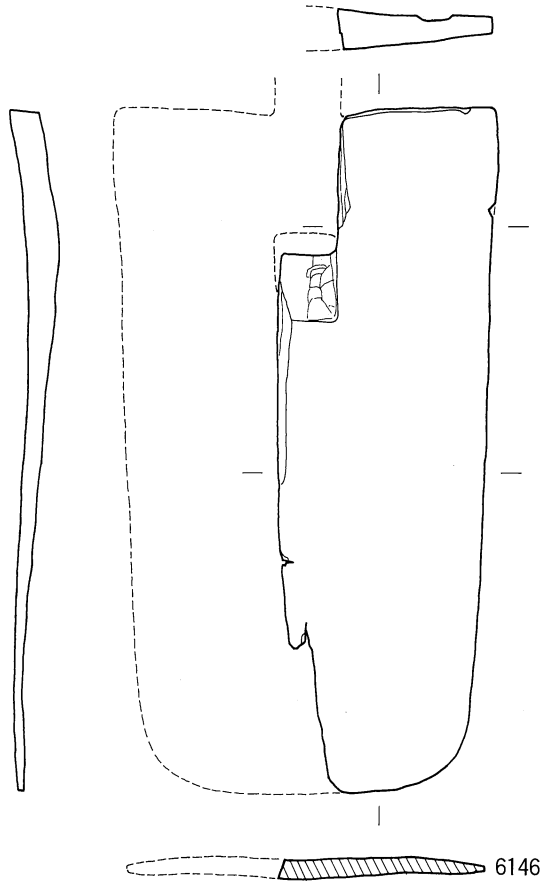

6146

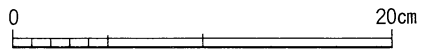

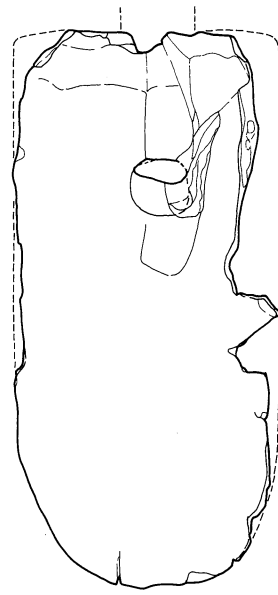
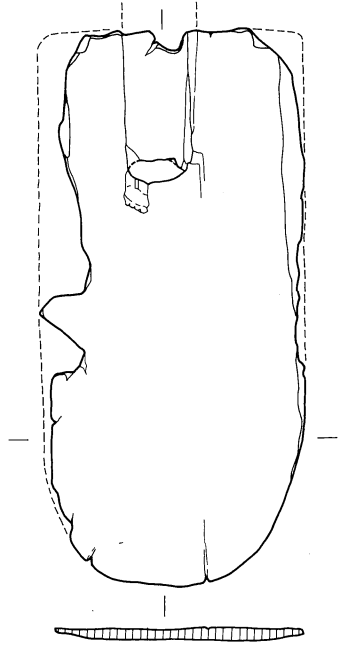

6147

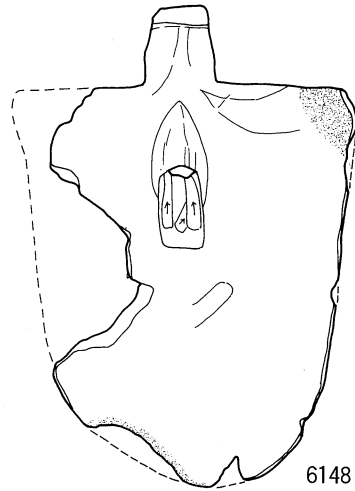
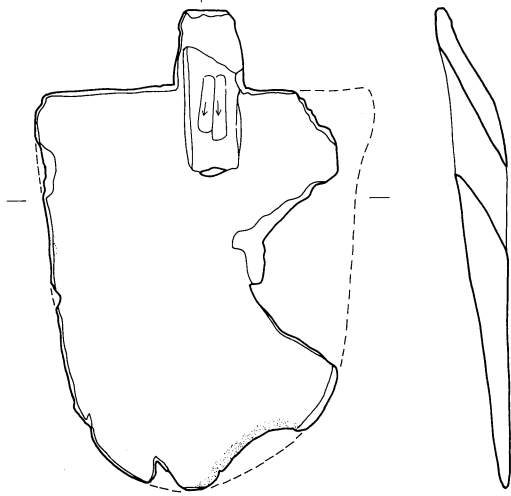

6148

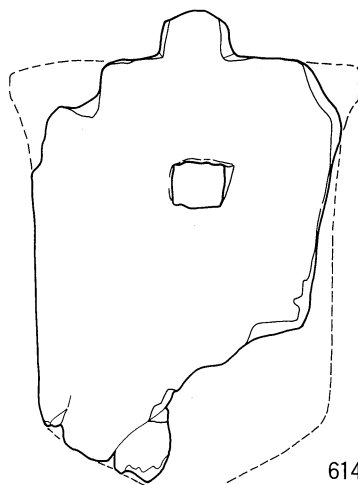
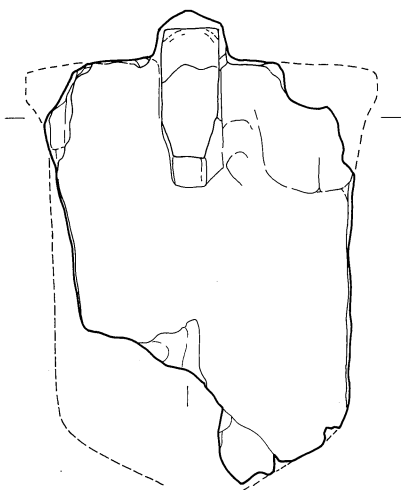

6149

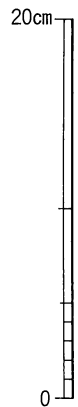

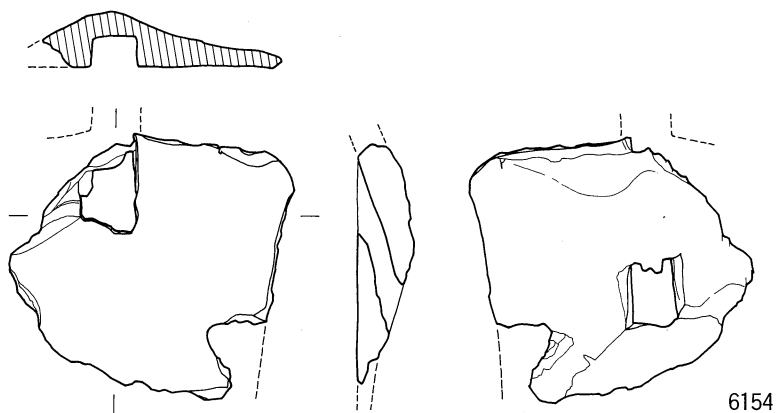
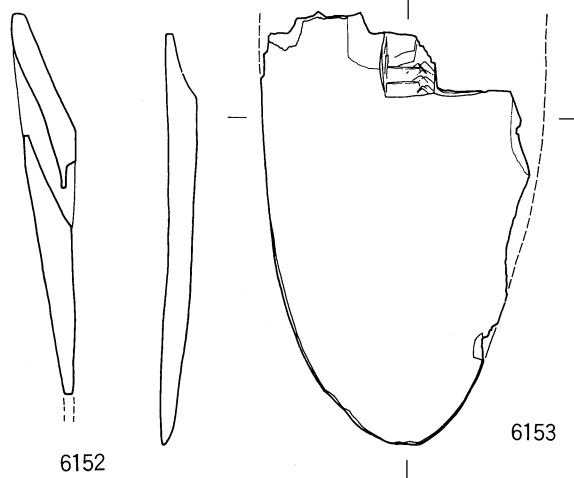
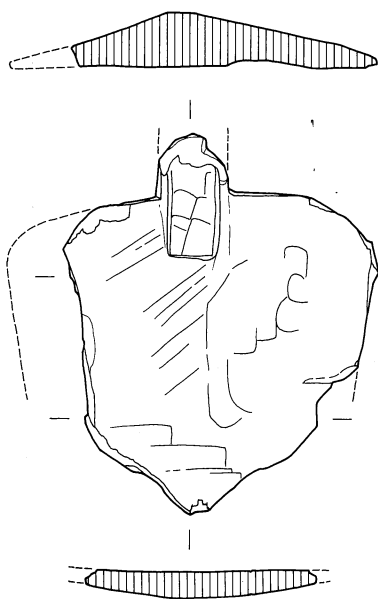
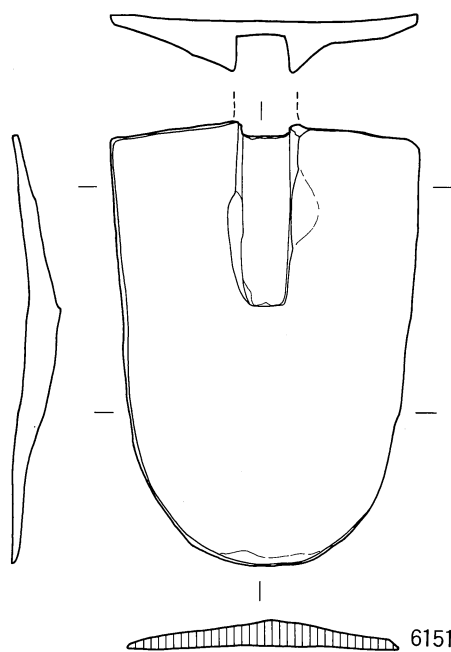
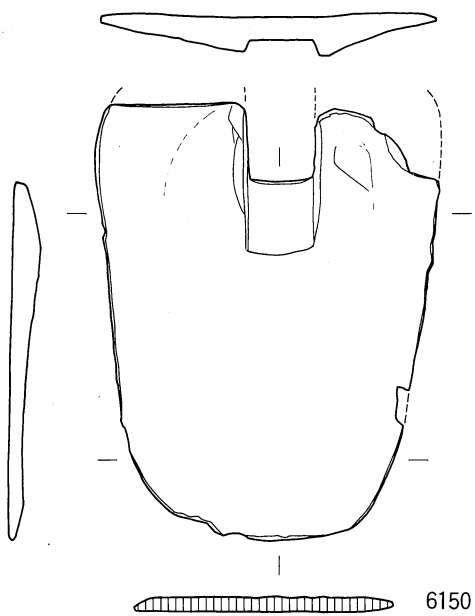

0 20cm

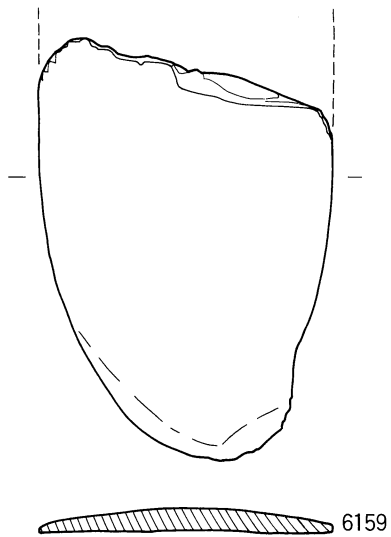
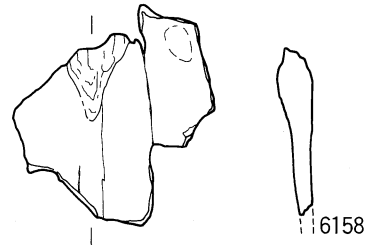
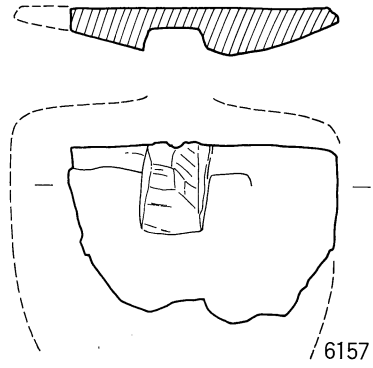
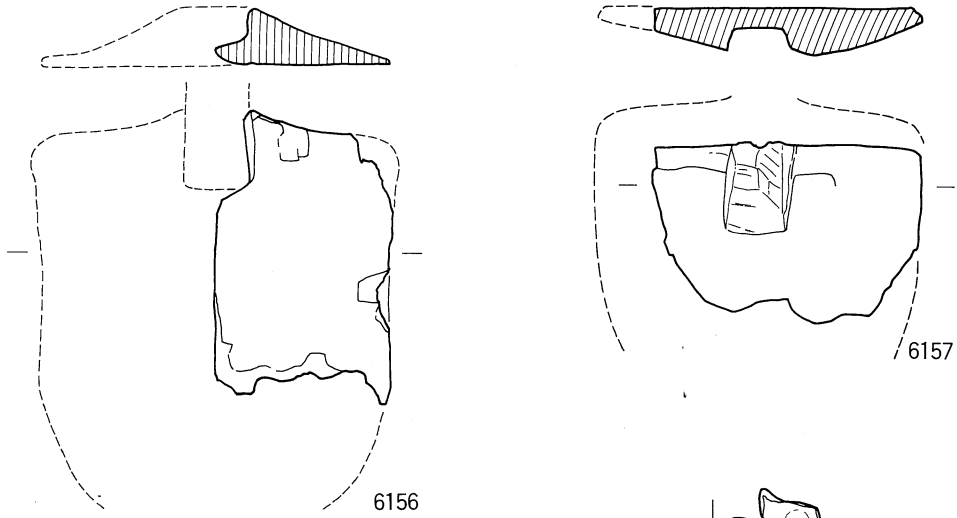
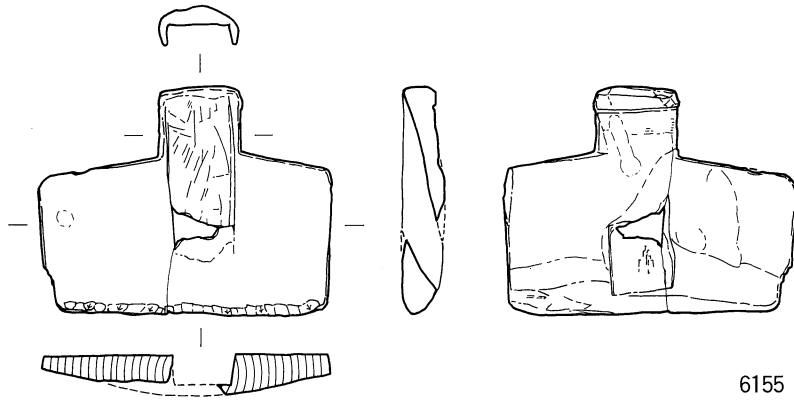

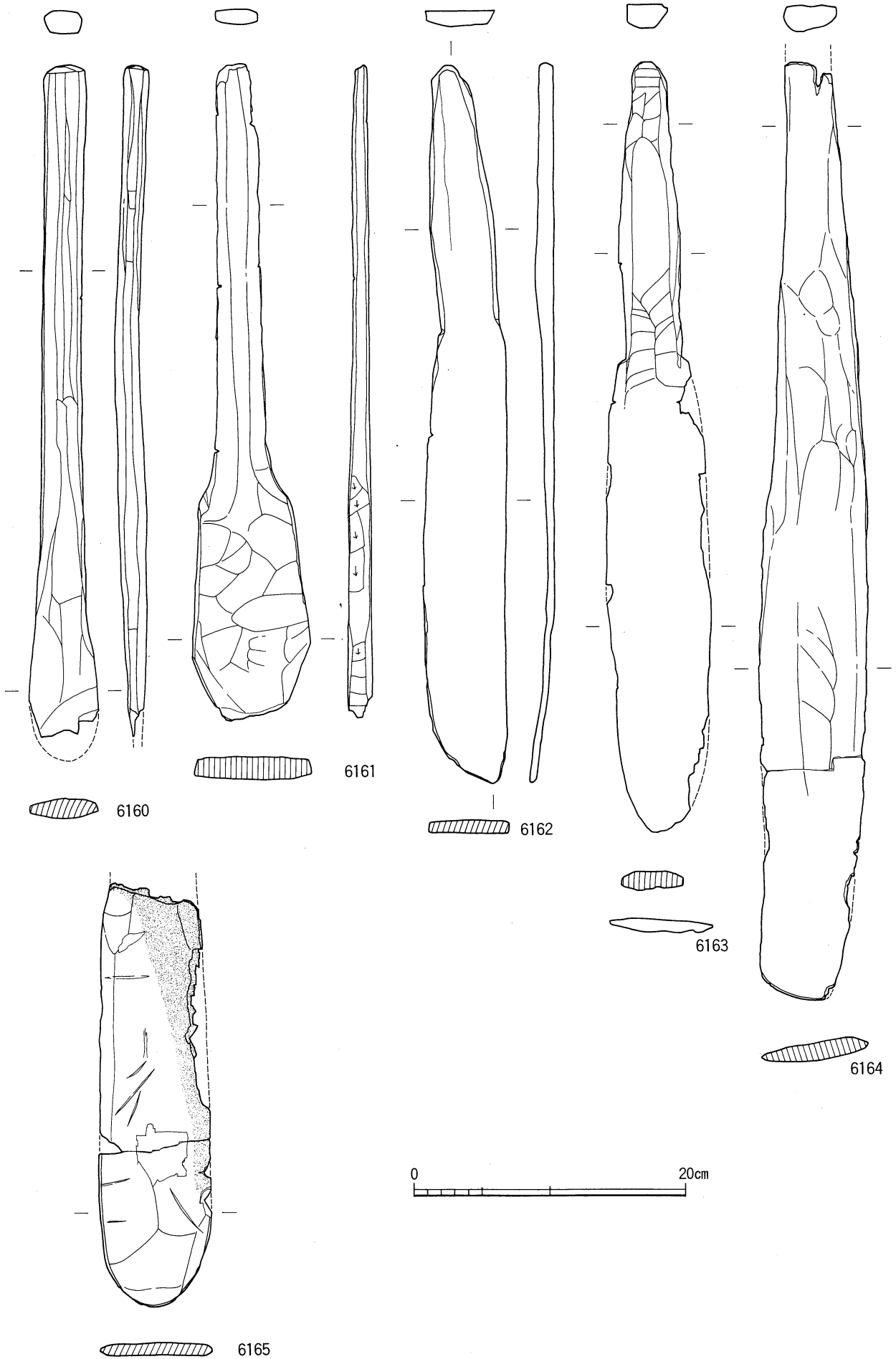

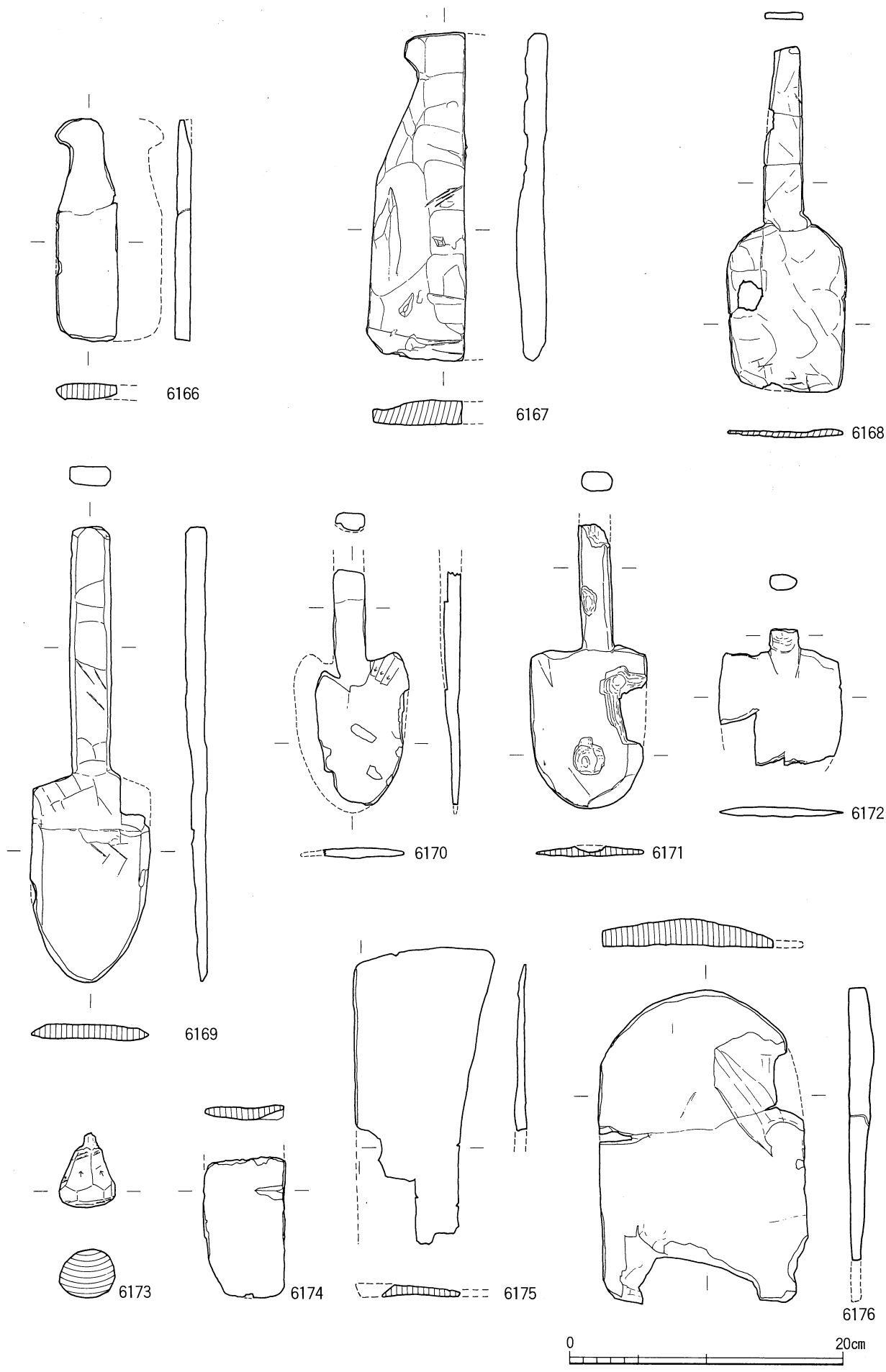

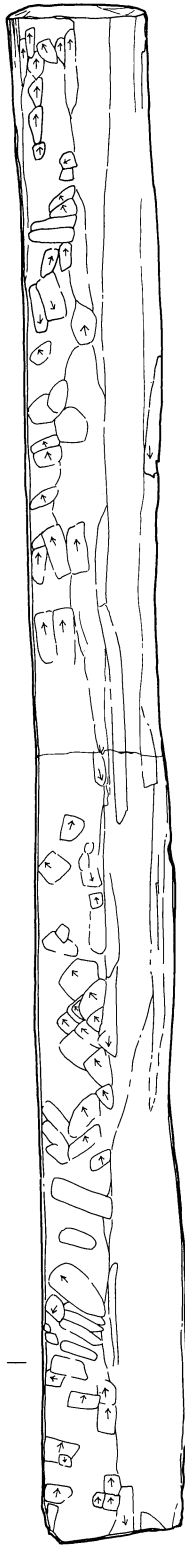

6177



6178

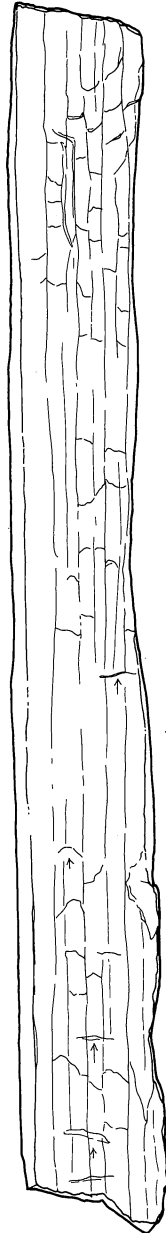

6179

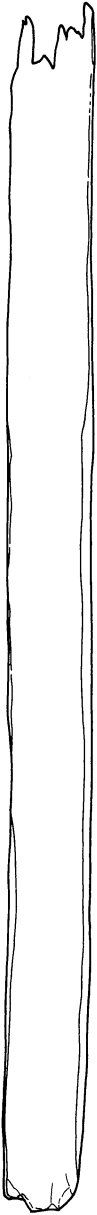

6180

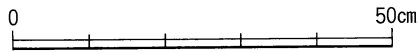

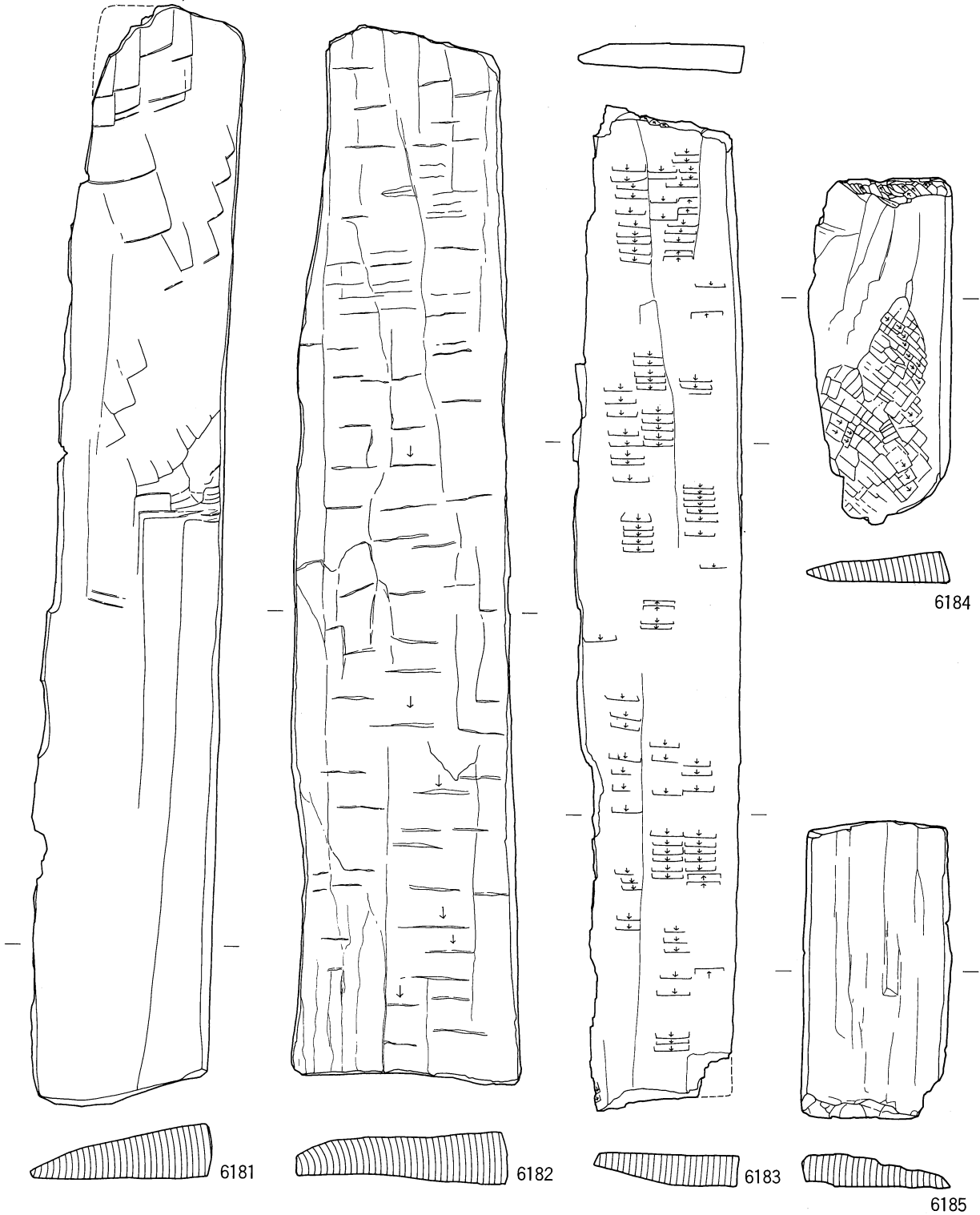

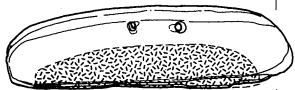
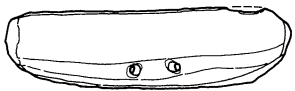

6186

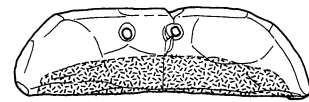

6187

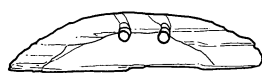

6188

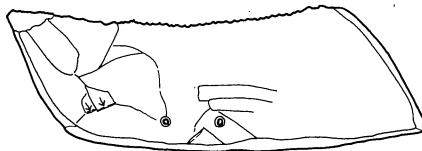
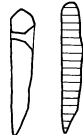
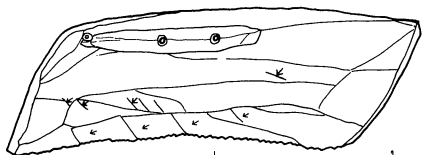

6189

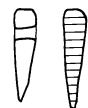

6190

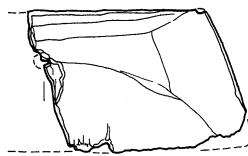
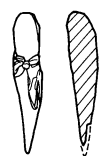
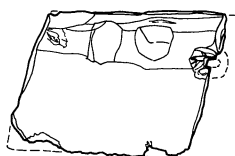

6191

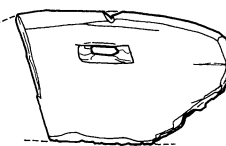

6192

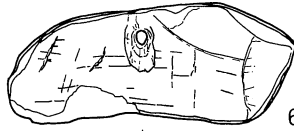
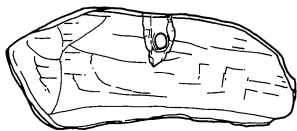

6193

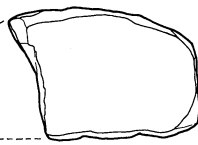
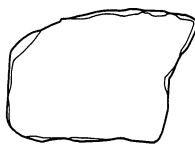

6195

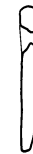
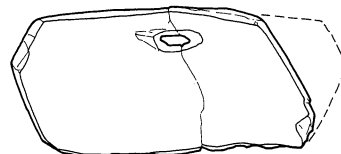

6194

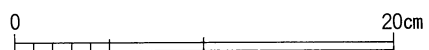



弥生中期上層 旧河道出土木器42 (SR46002)

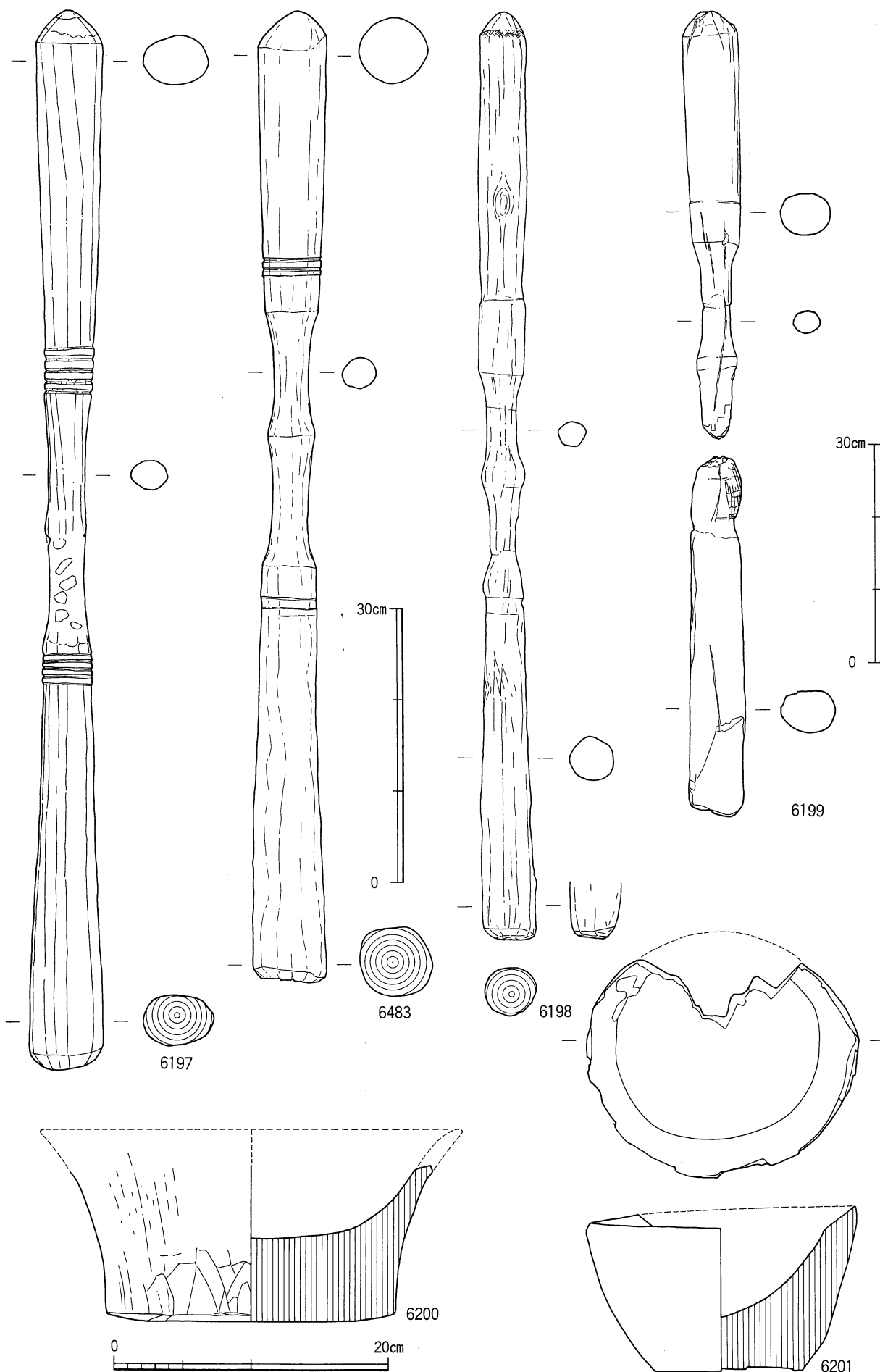

弥生中期上層 旧河道出土木器43 (SR46002)

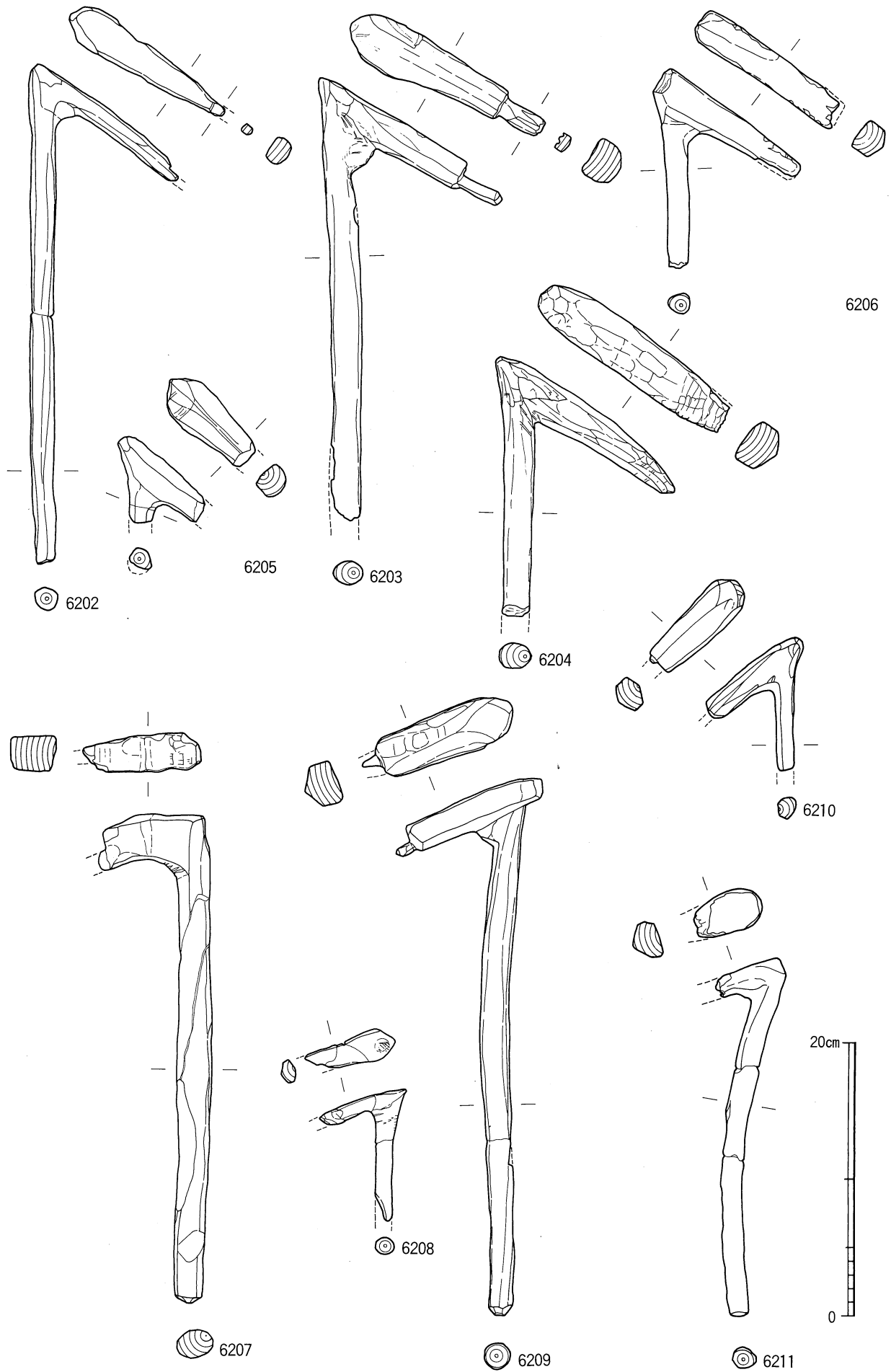

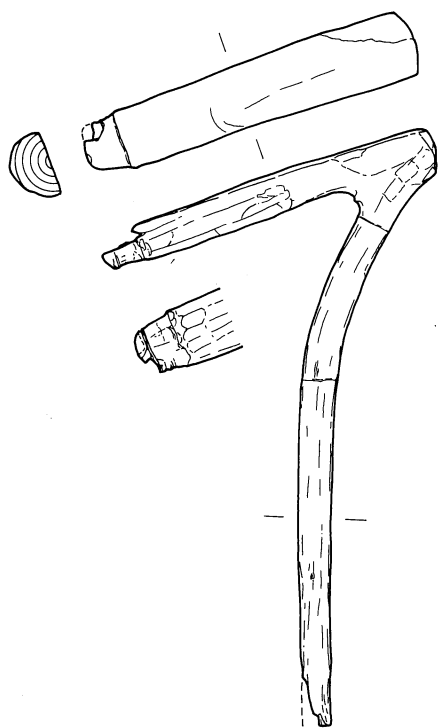

6212

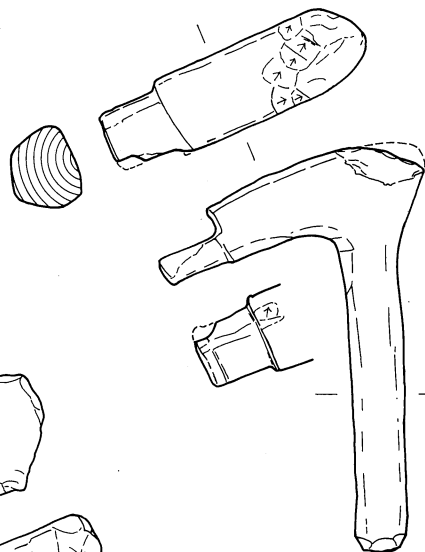

6214

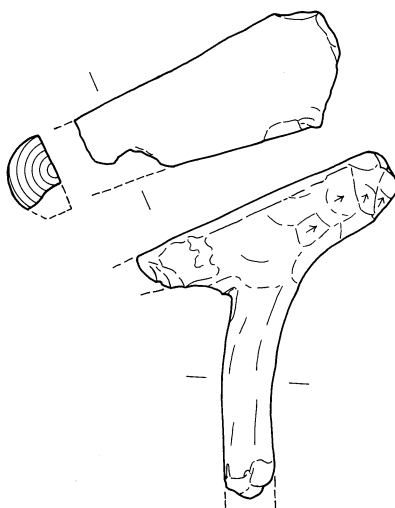

6213

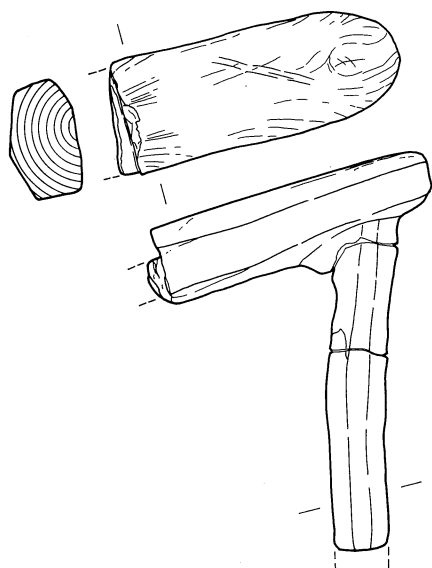

6215

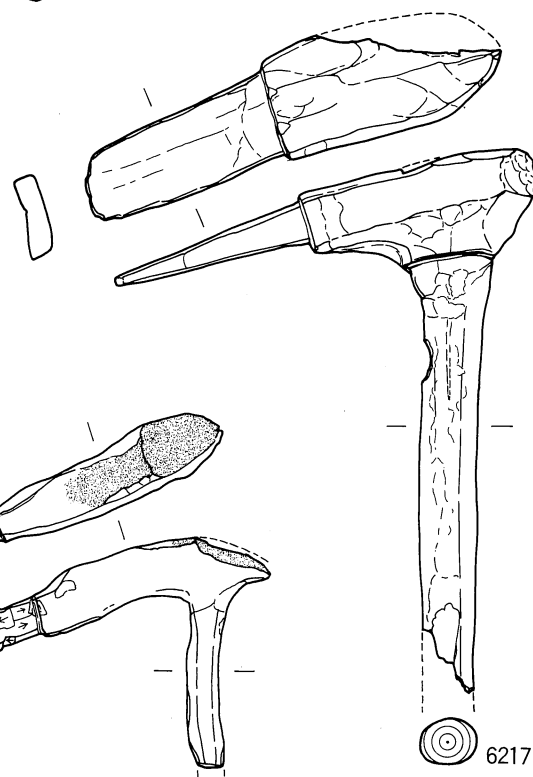

6217

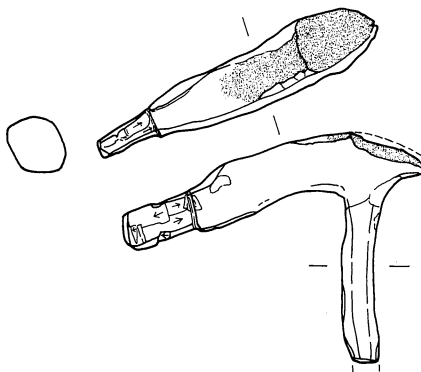

6216

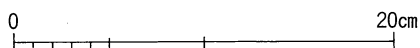

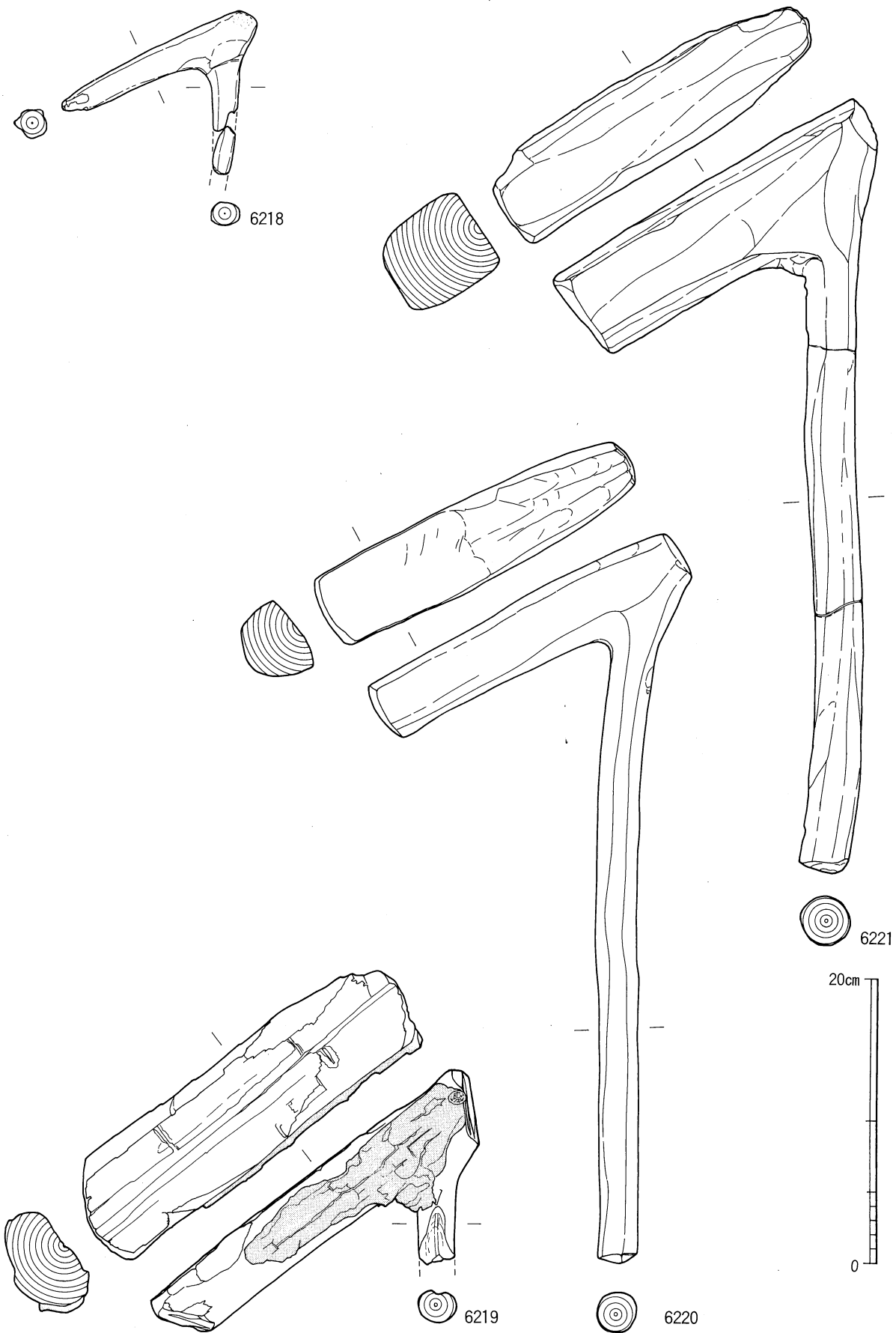

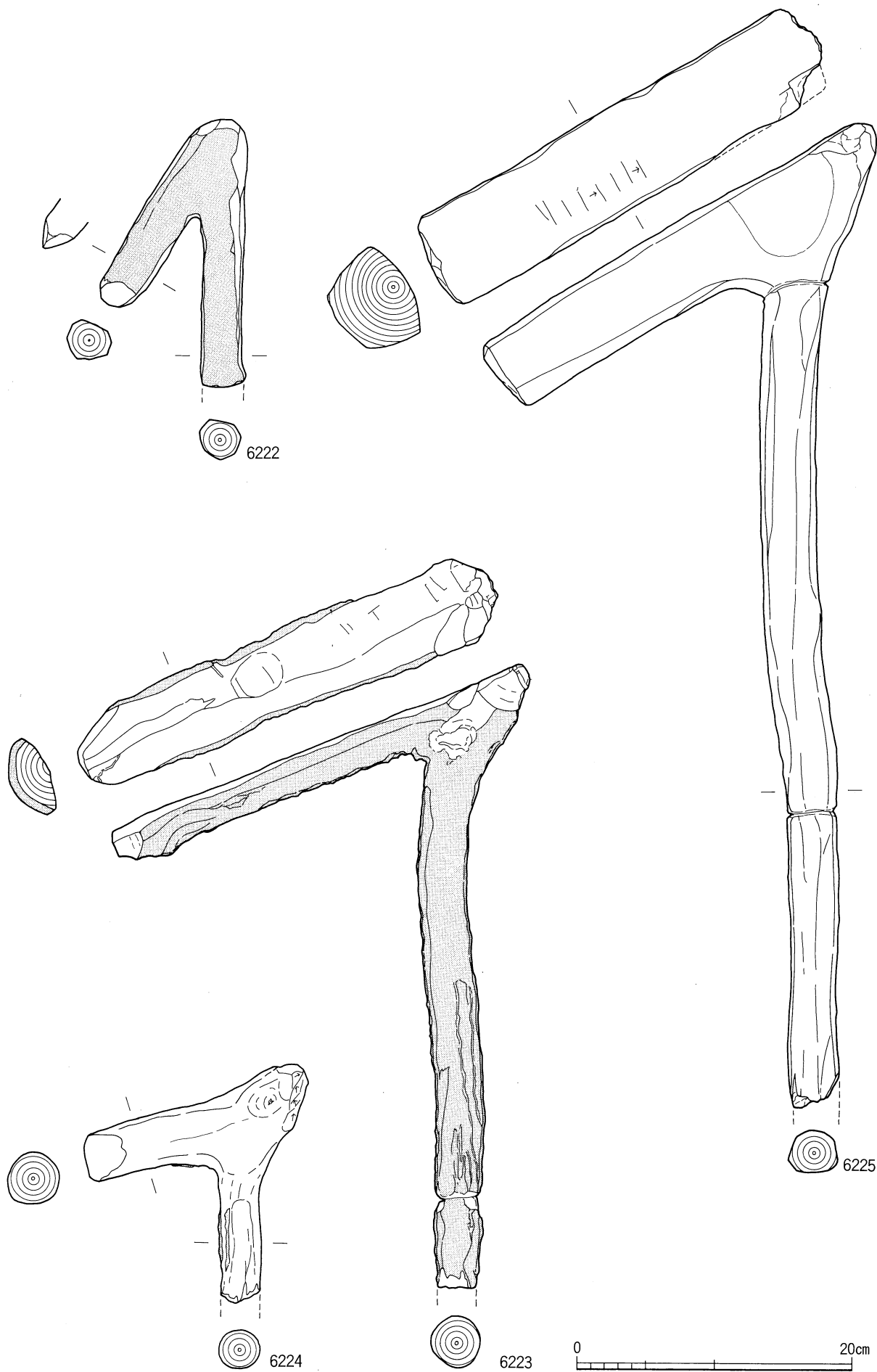

弥生中期上層 旧河道出土木器47 (SR46002)

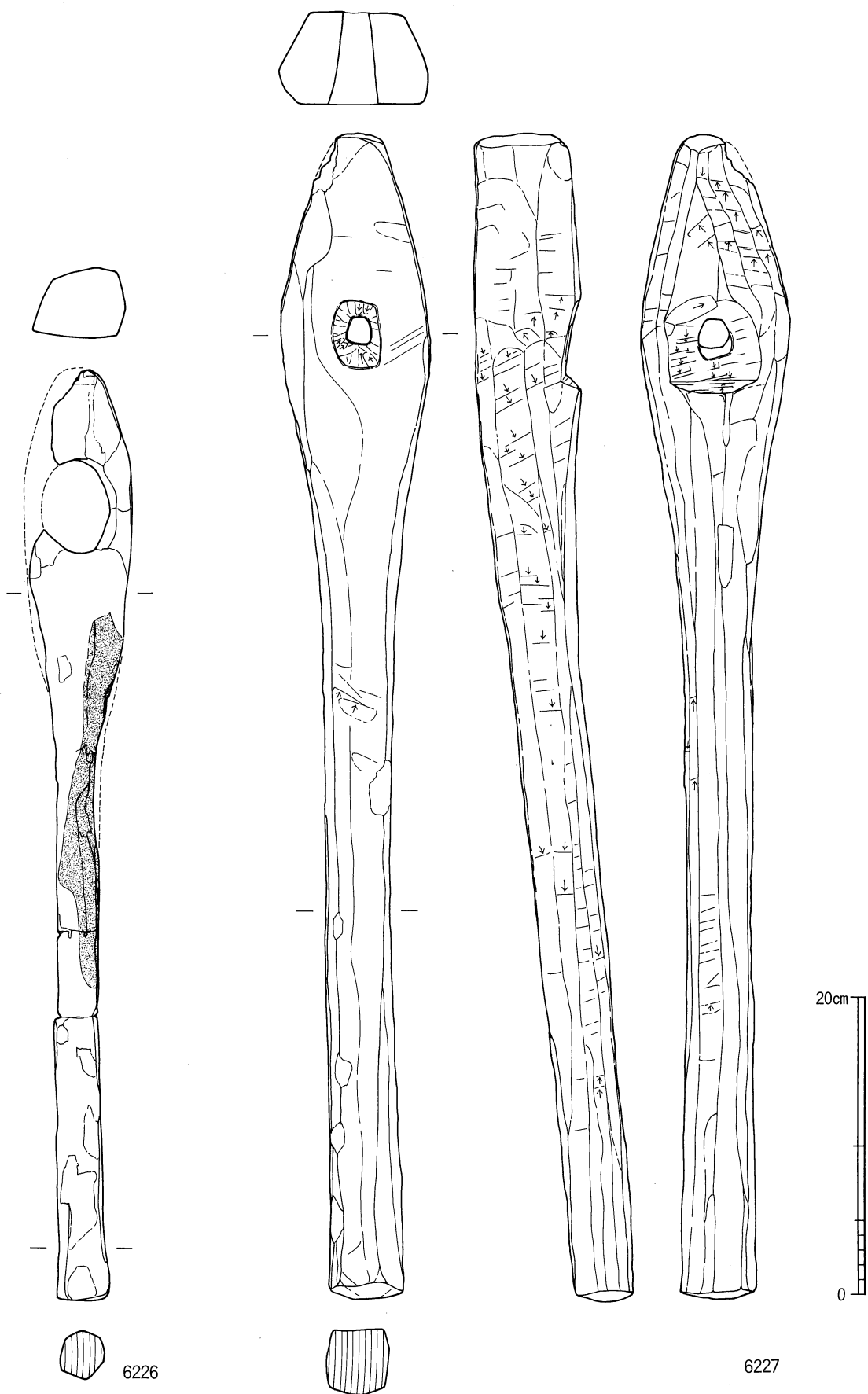

6226

6227

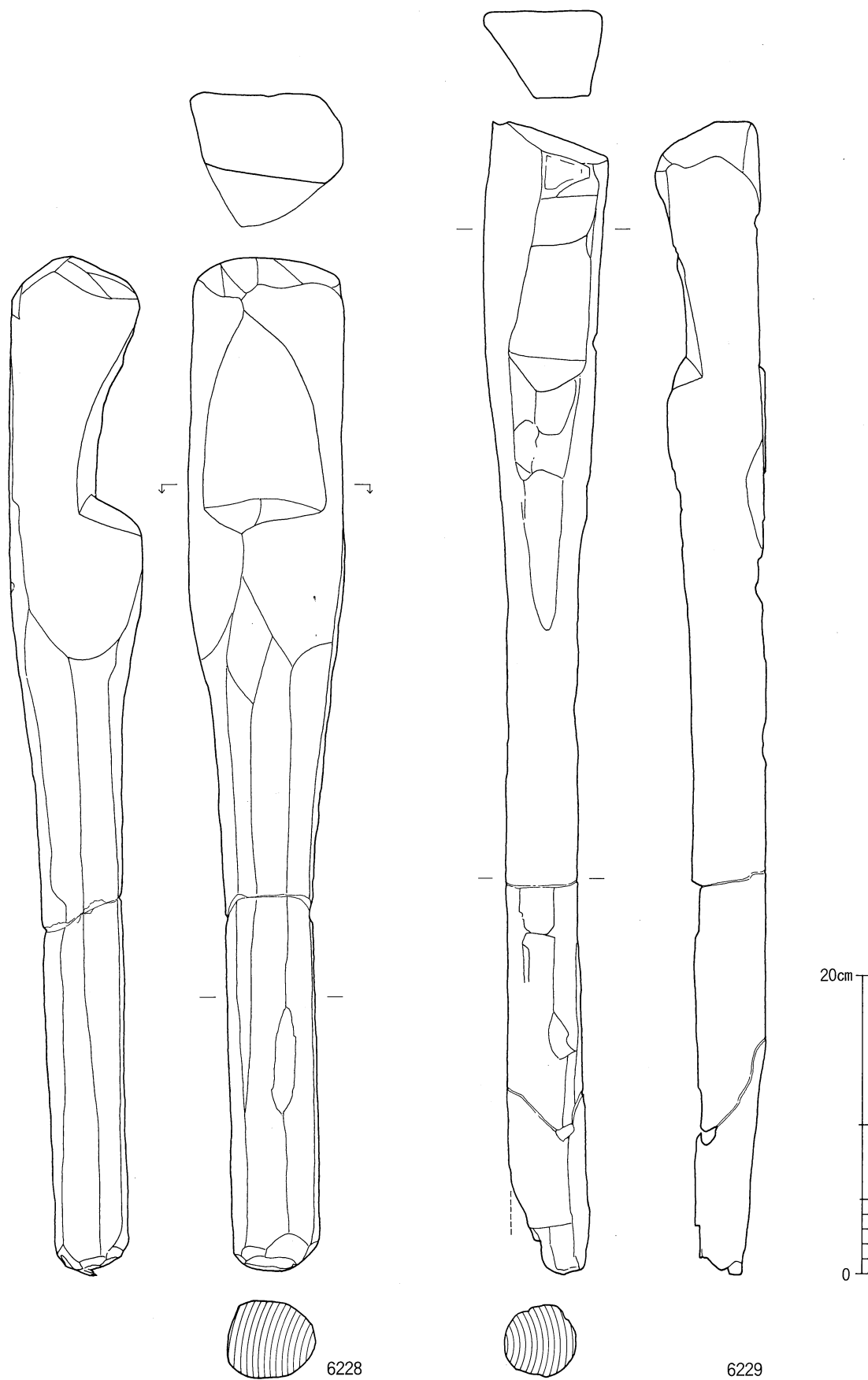

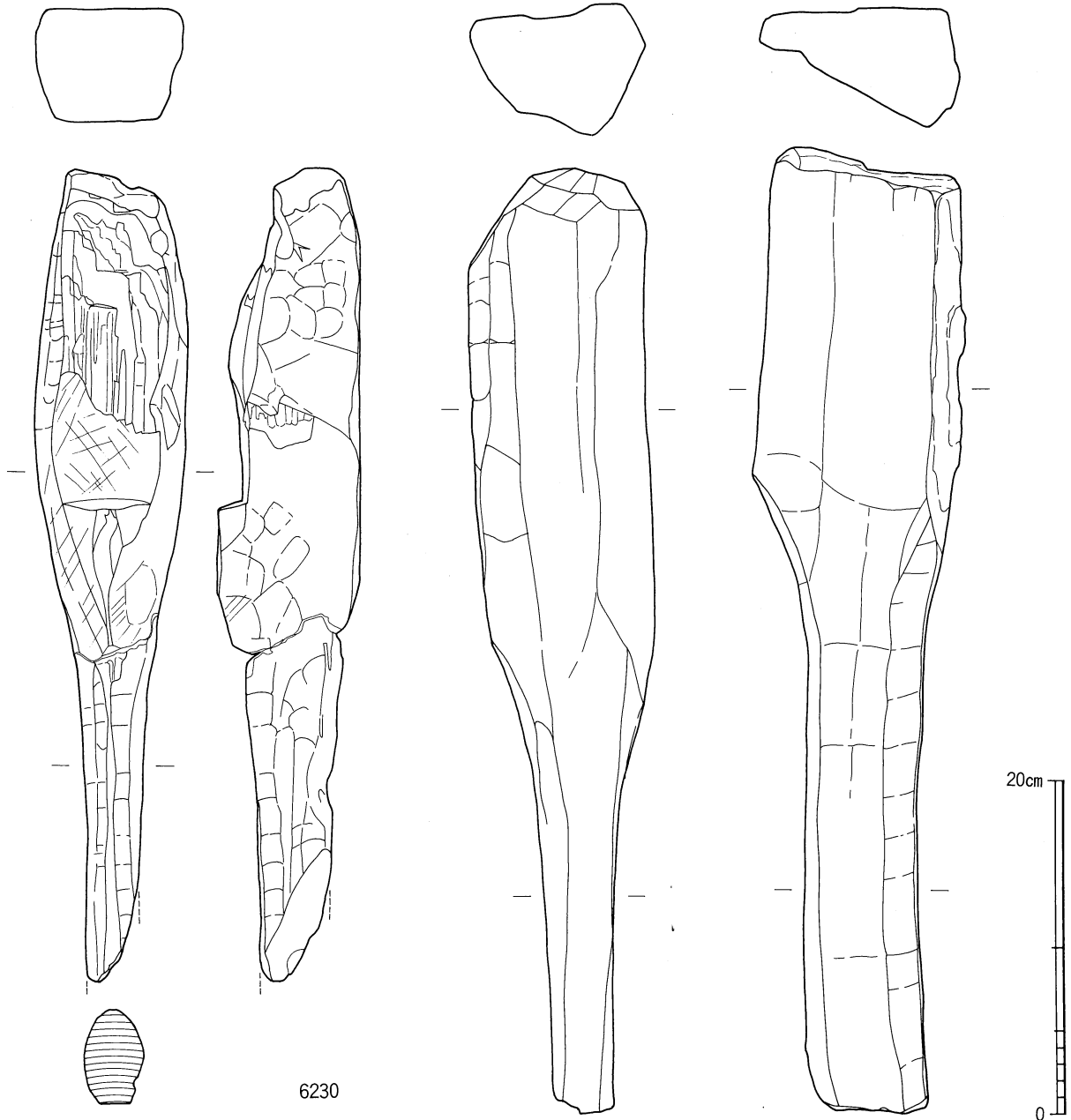

6230

6231

6232

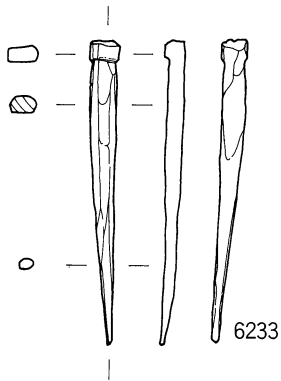
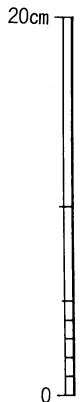

6233

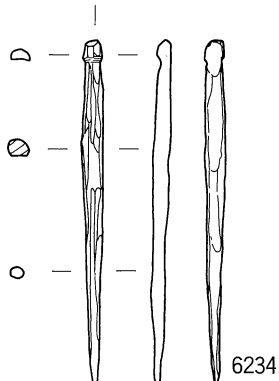

6234

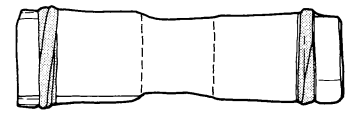
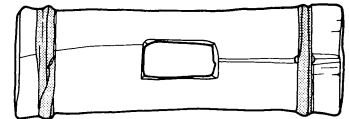

6235

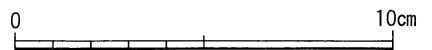

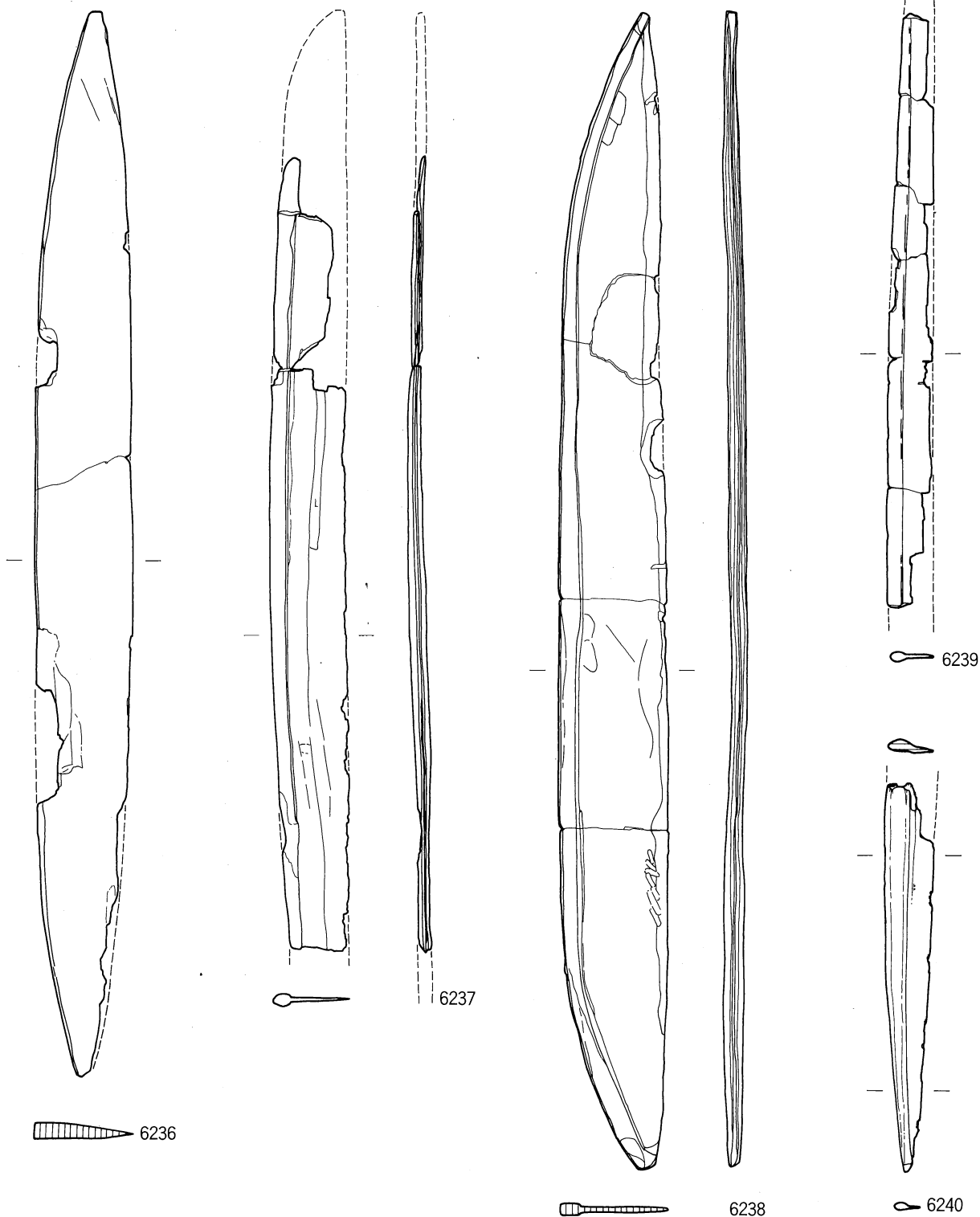

0 20cm

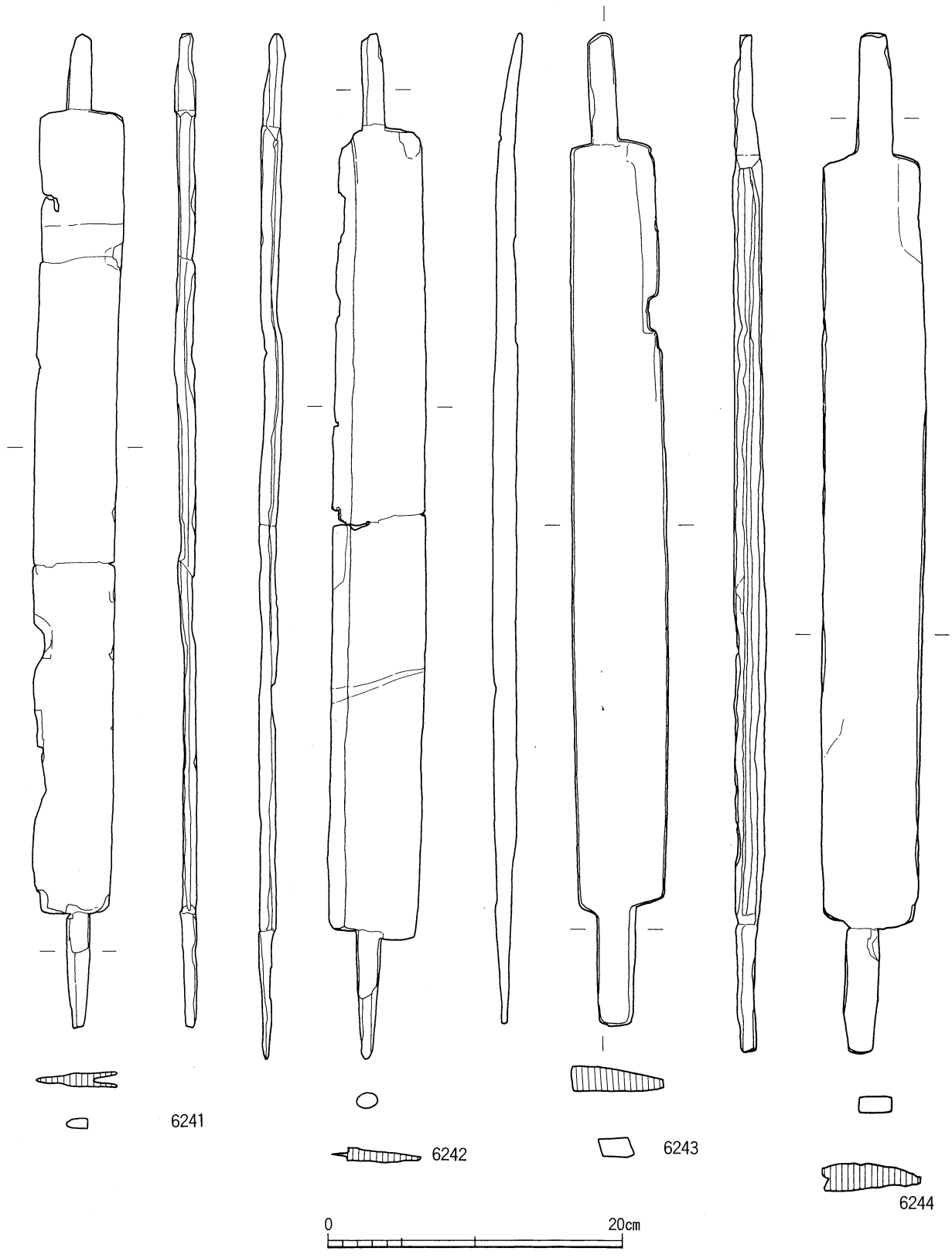

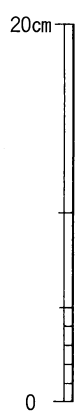
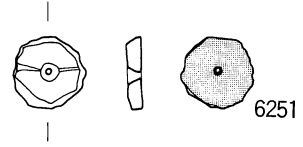
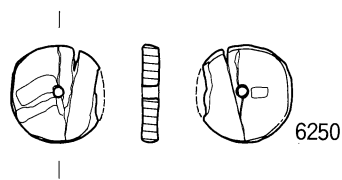
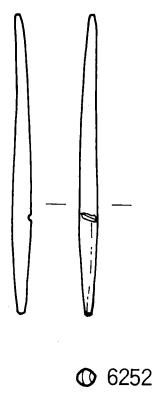
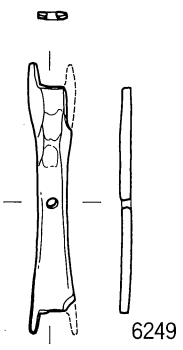
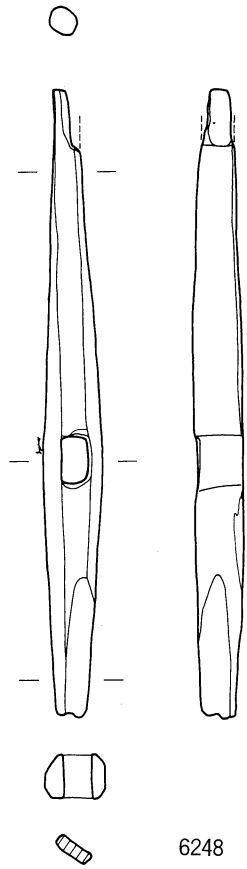
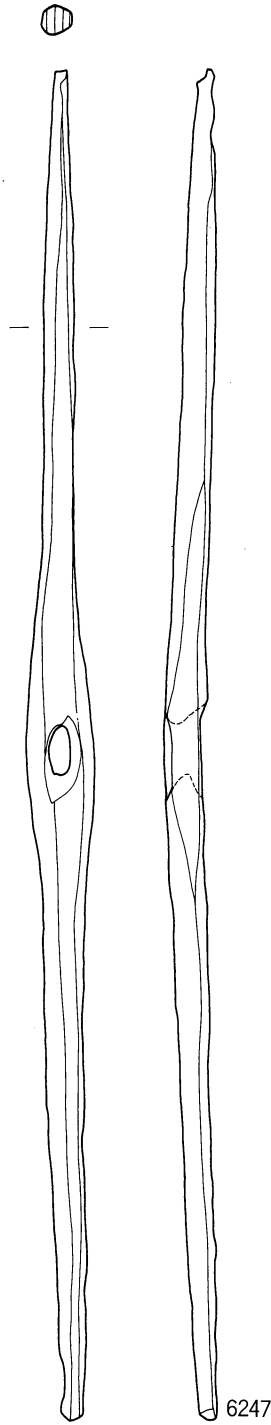
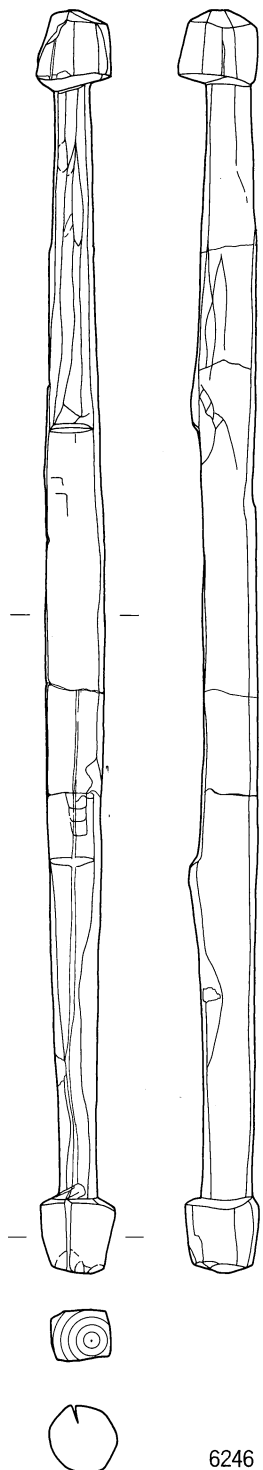

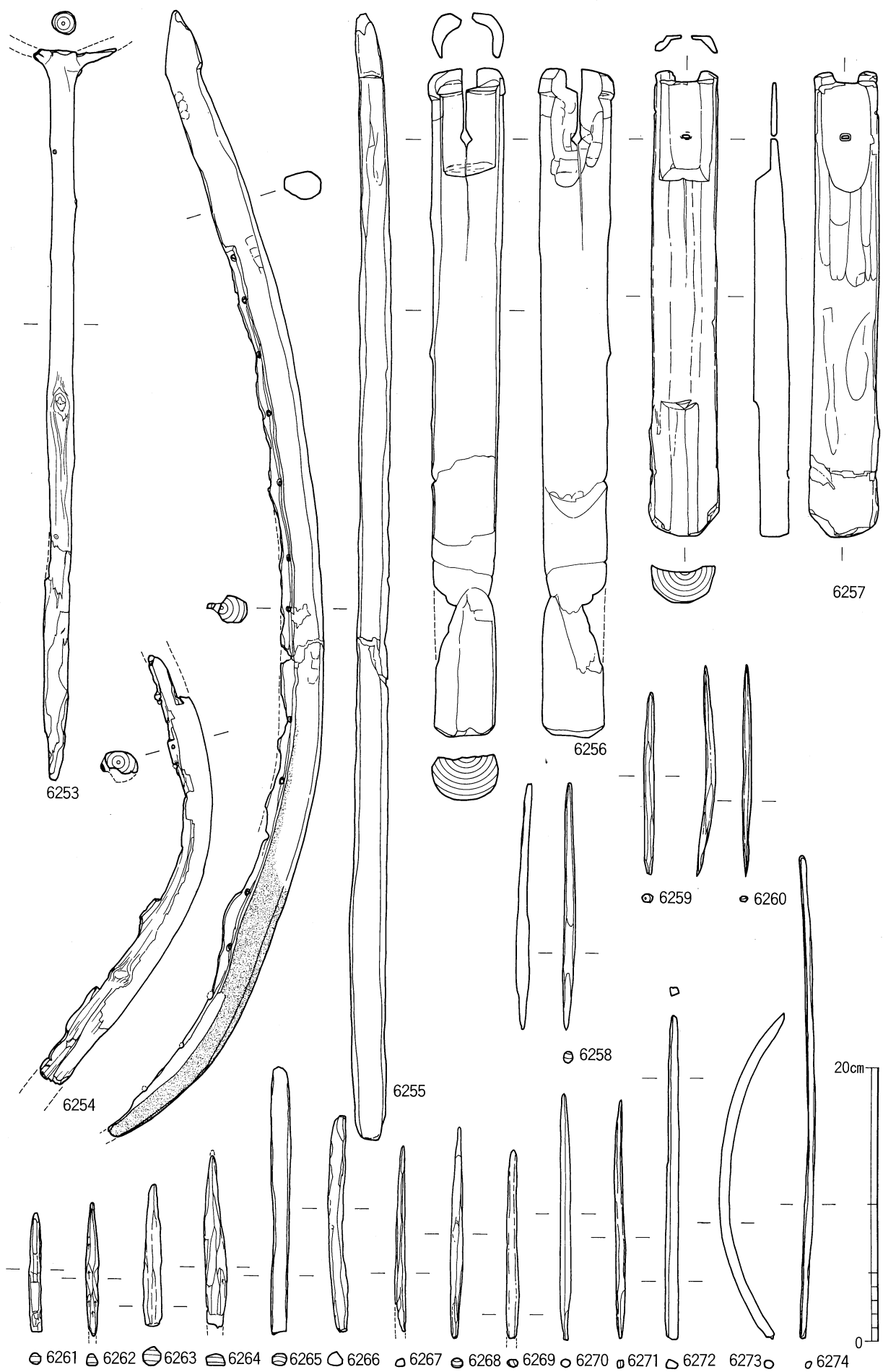

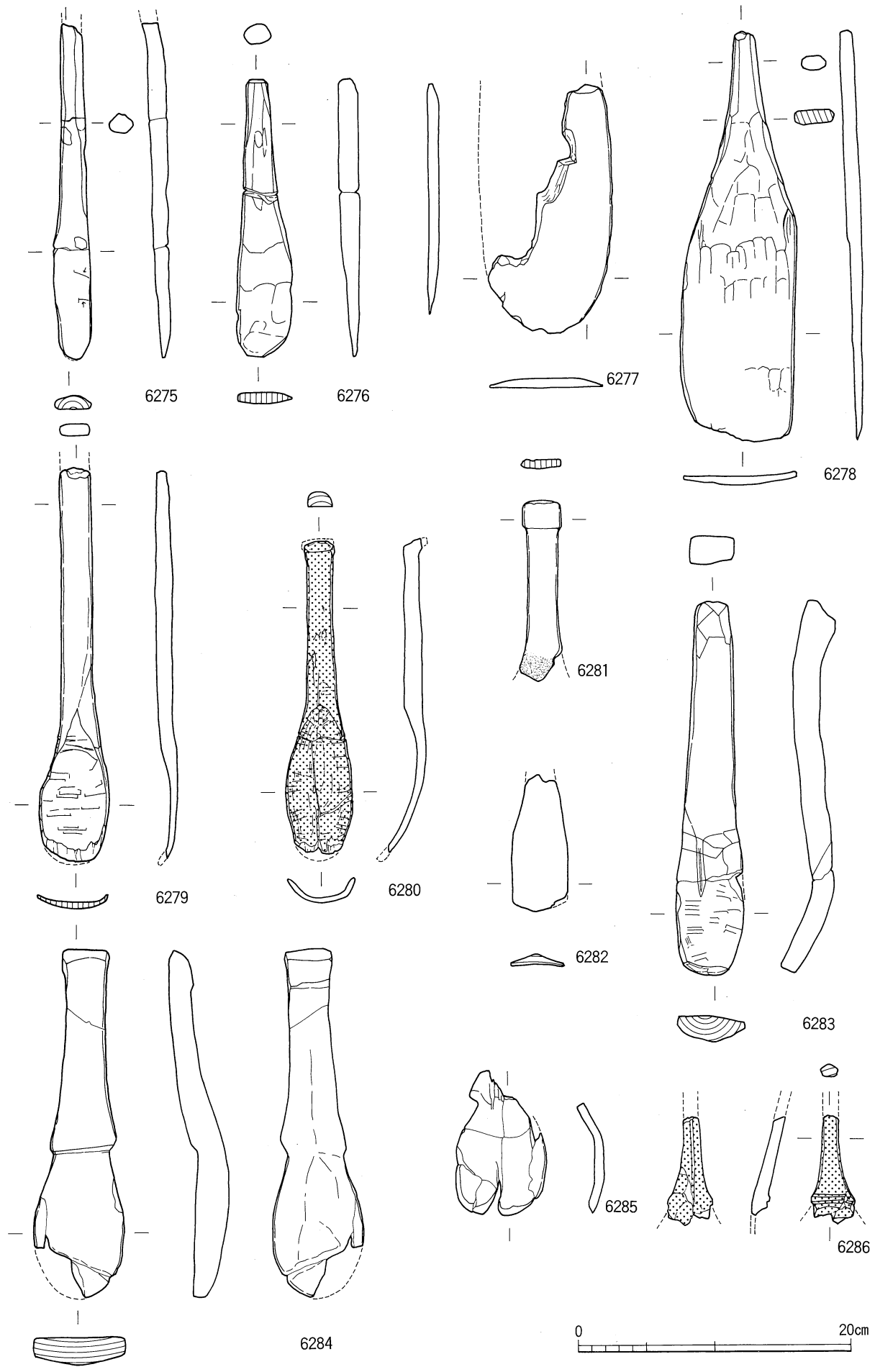

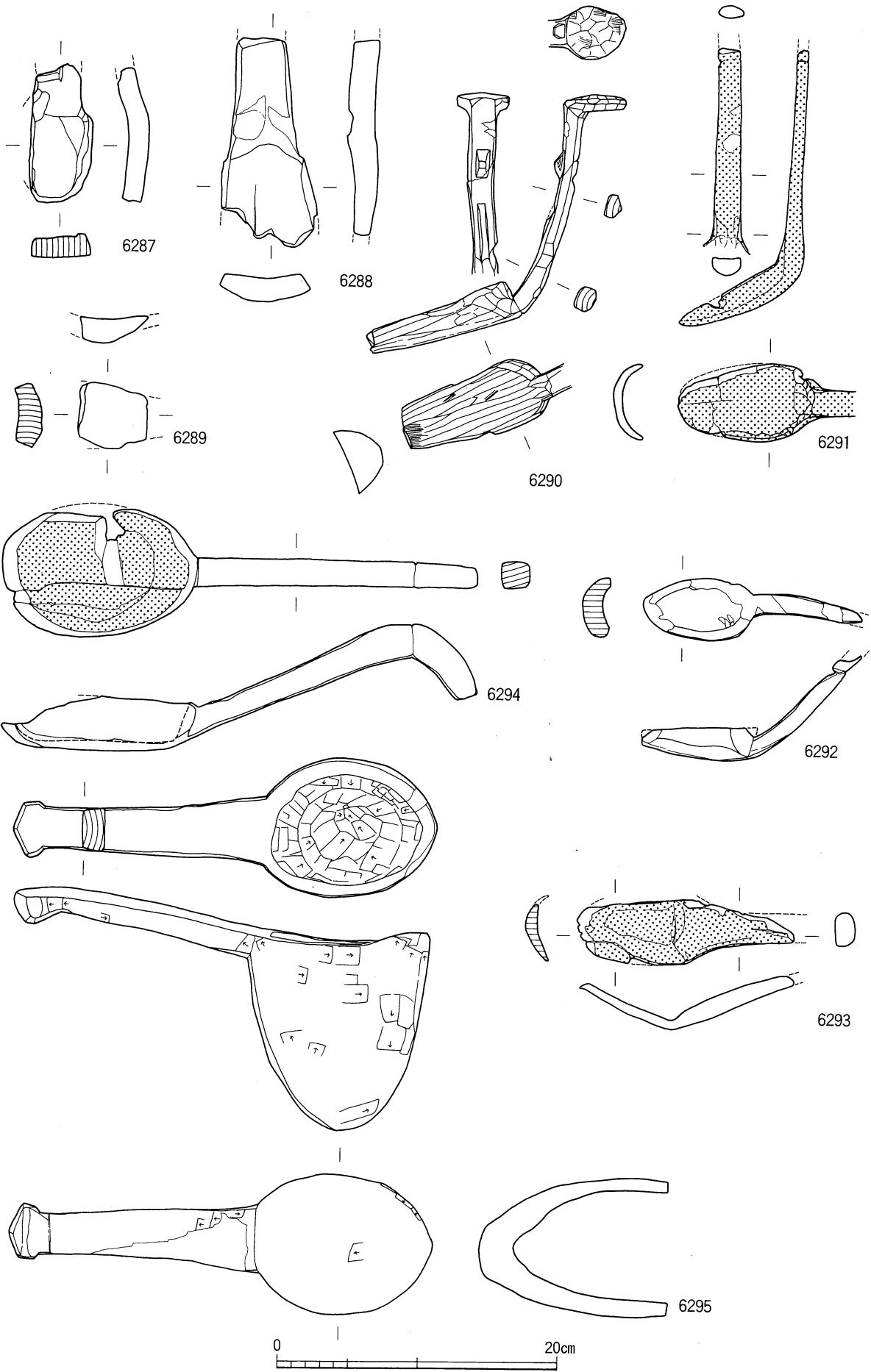

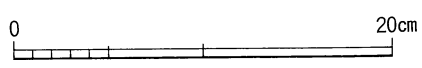
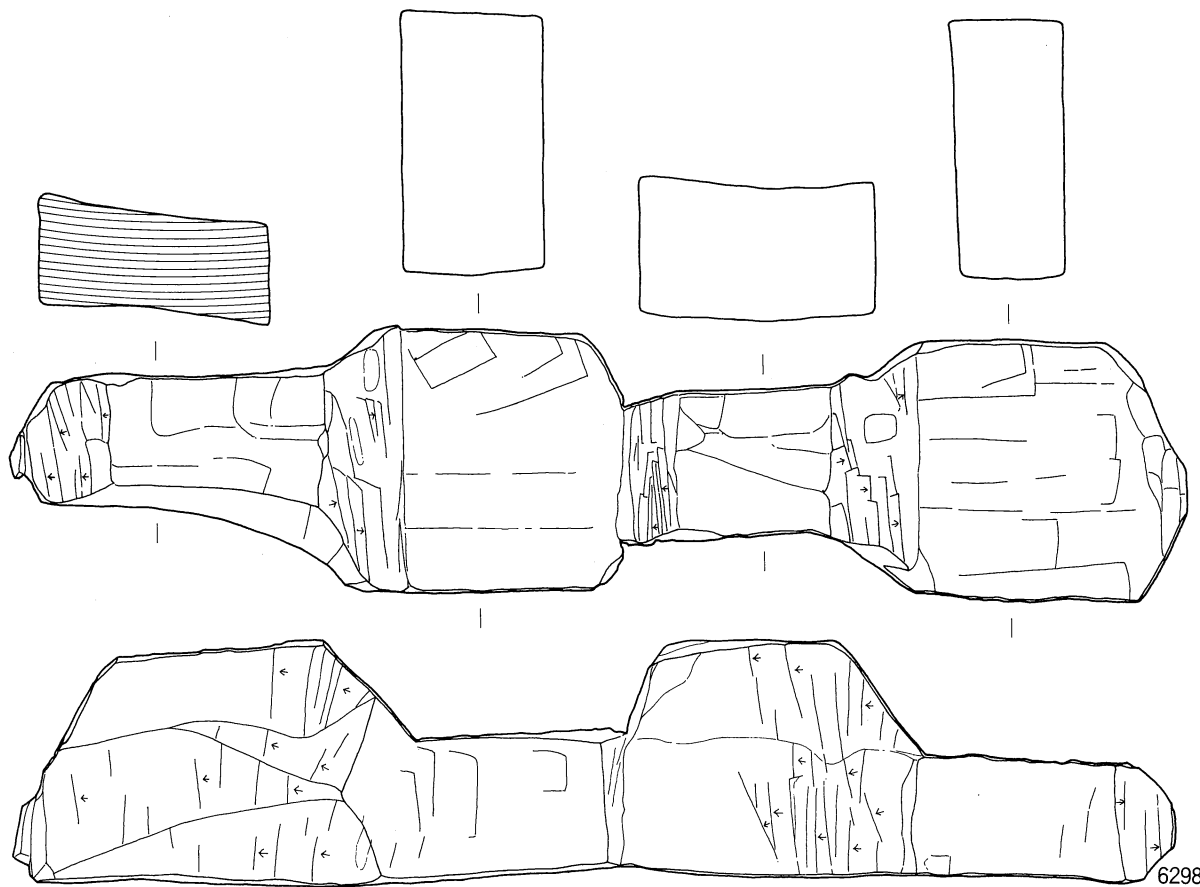
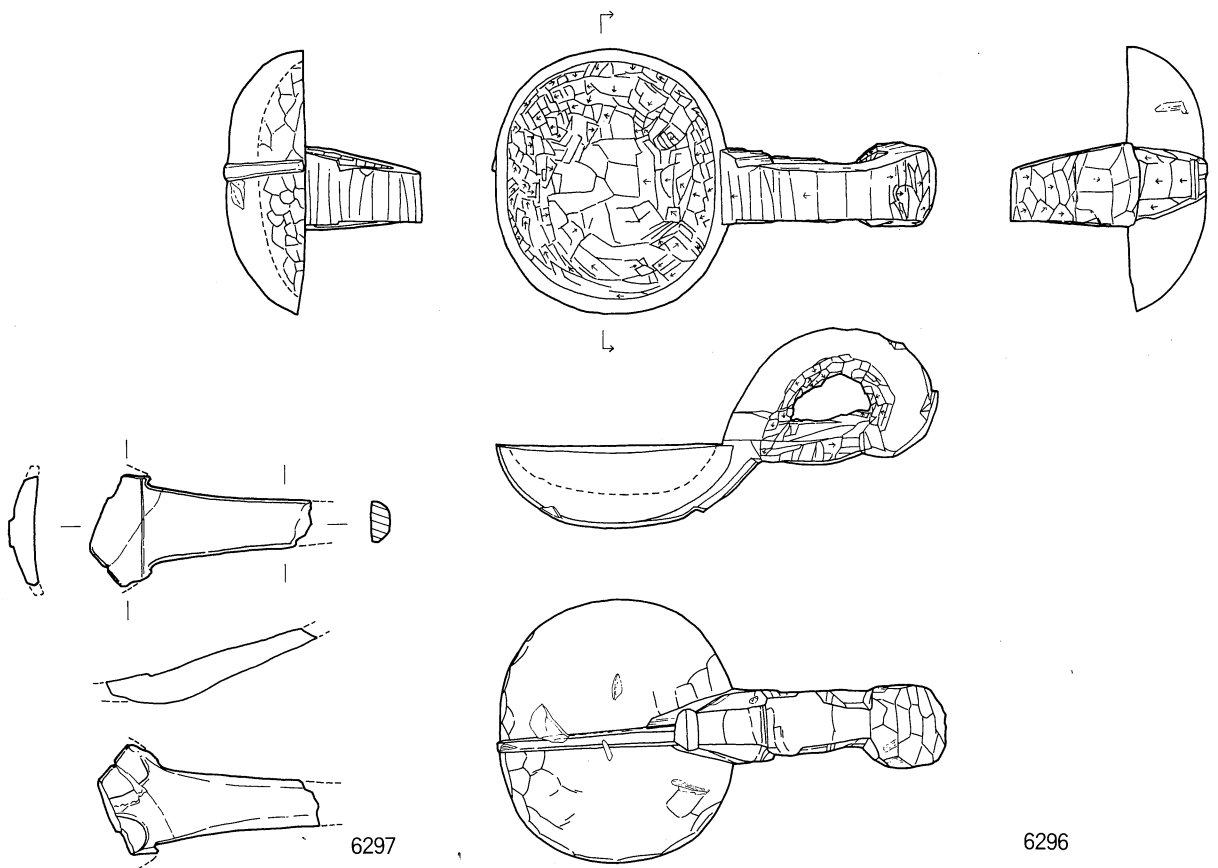

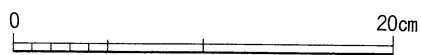
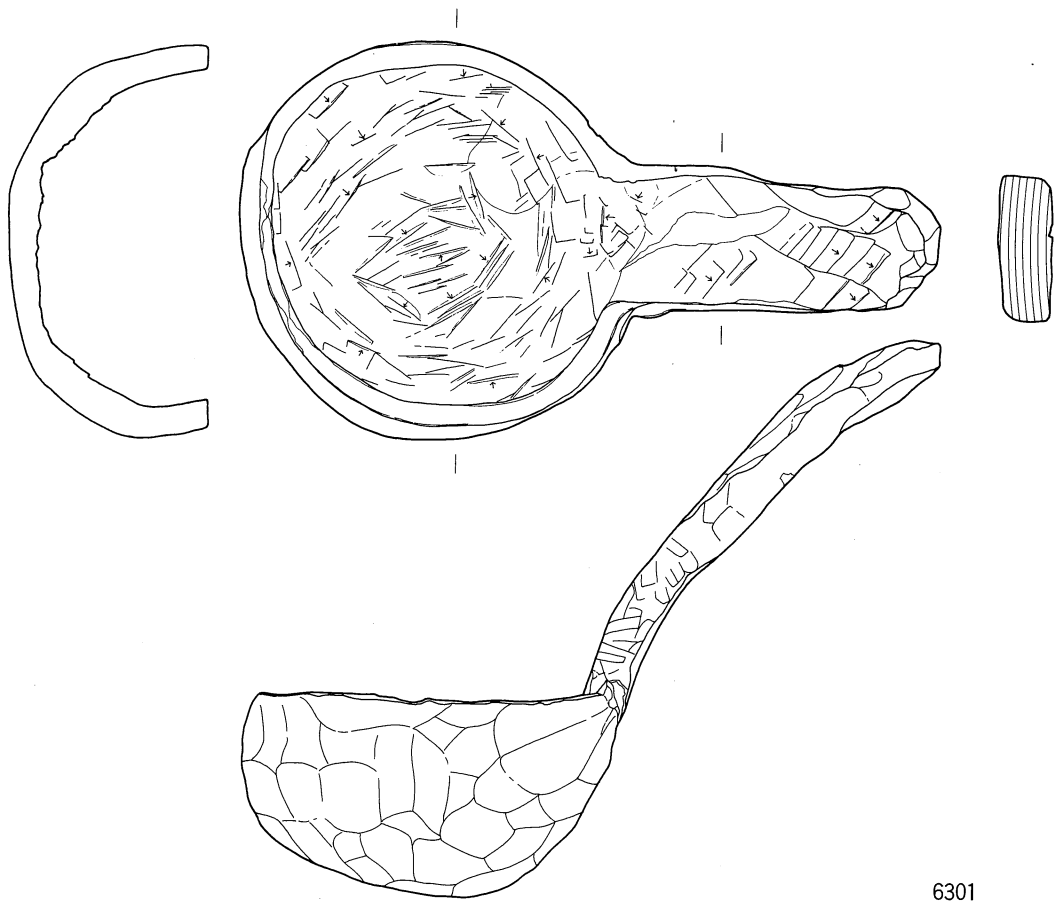
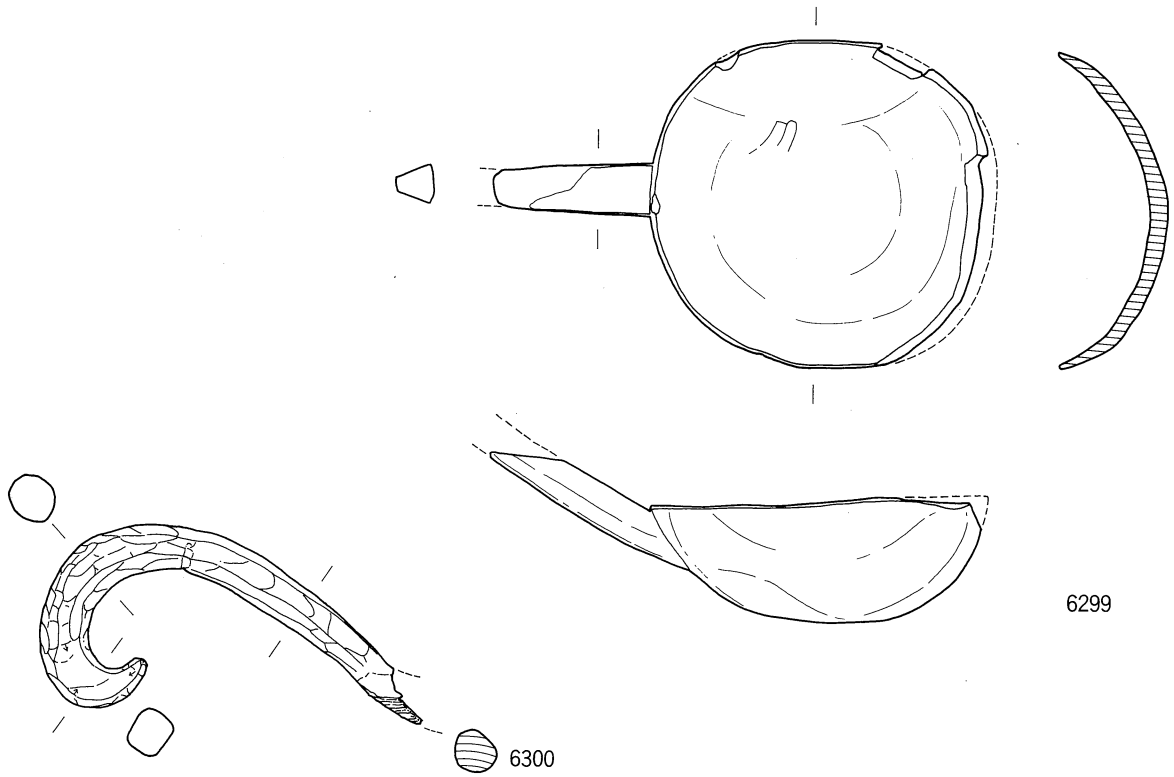

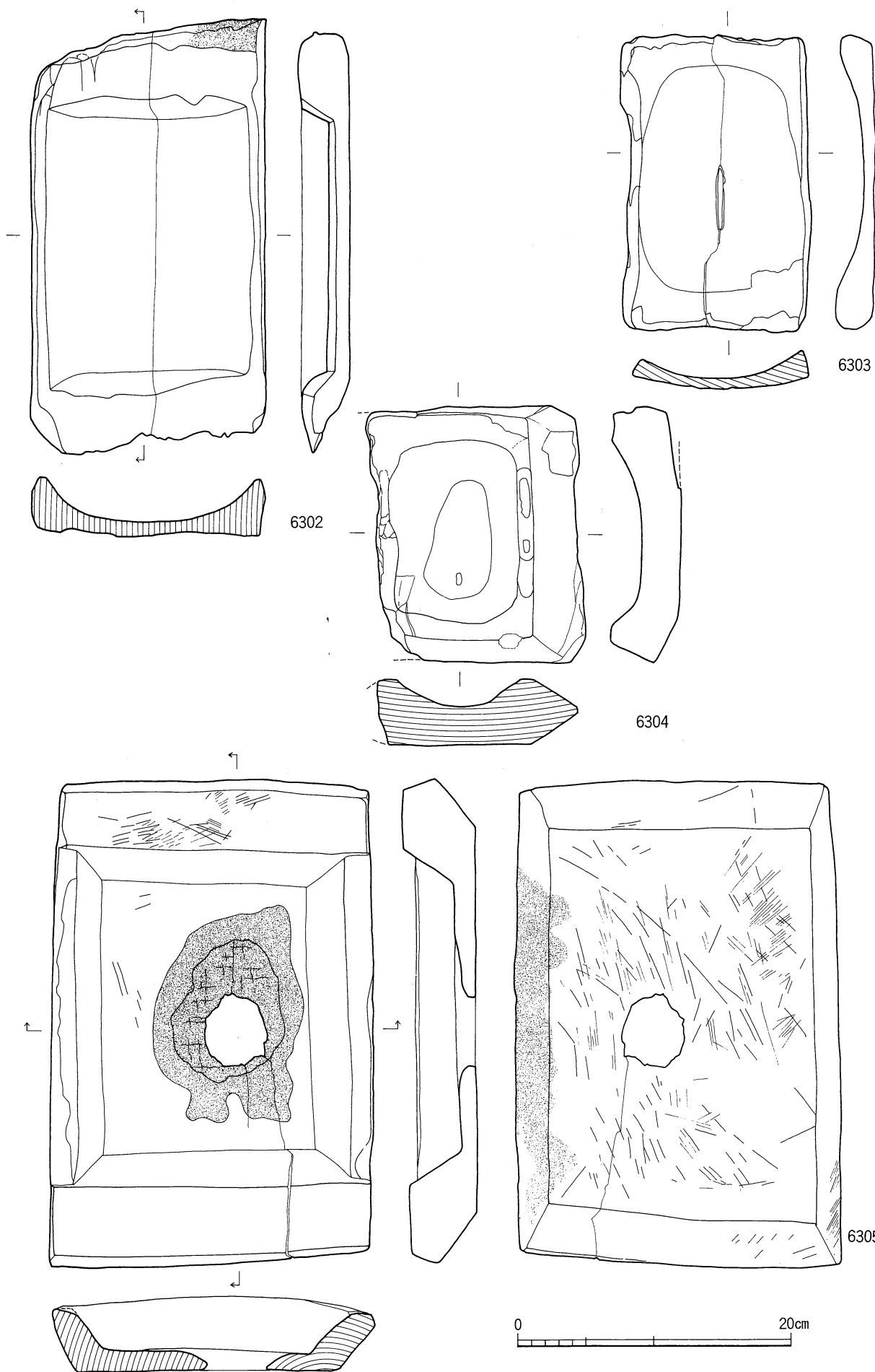

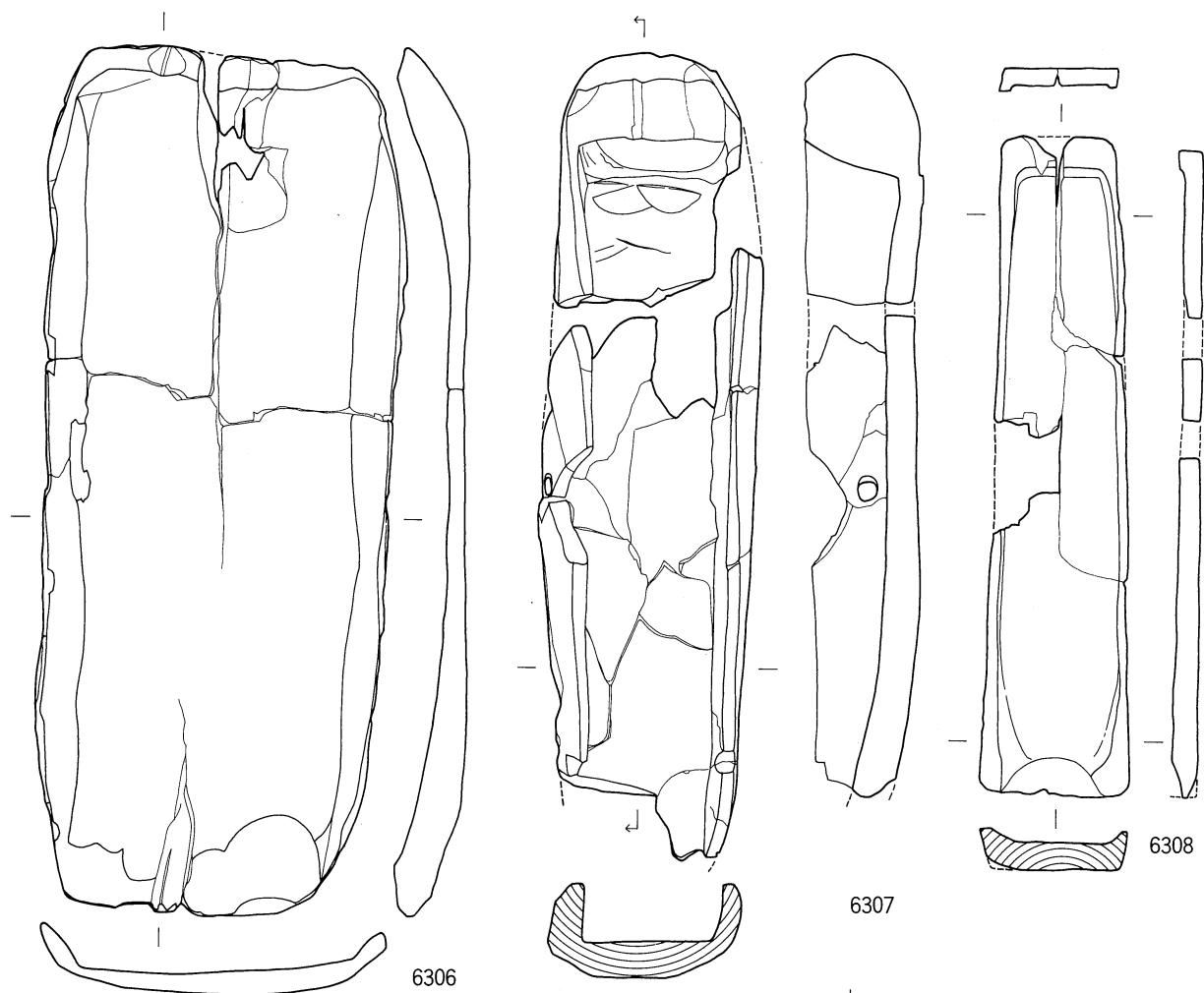

6307

6308

6306



6309

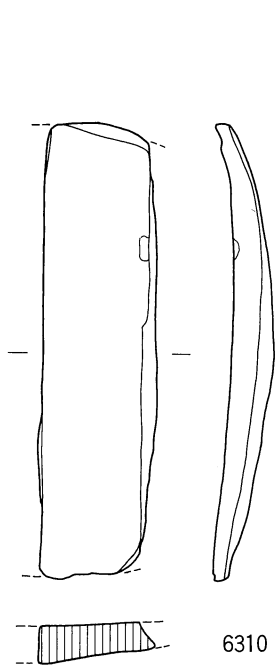

6310

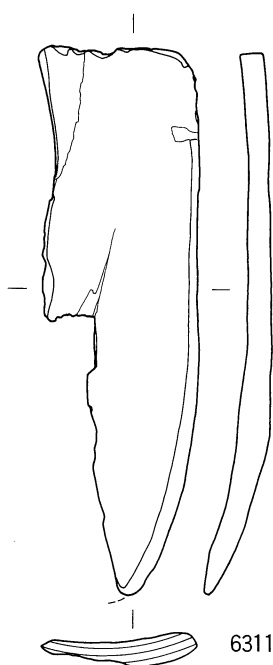

6311

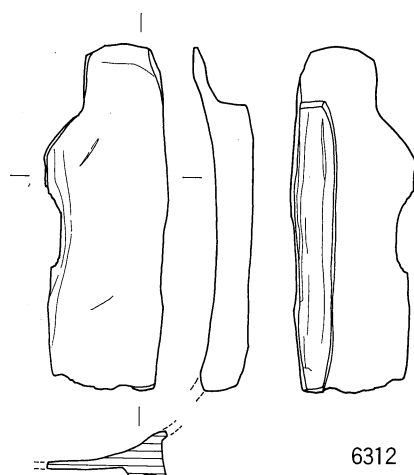

6312

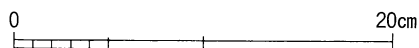

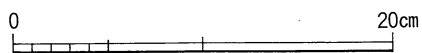
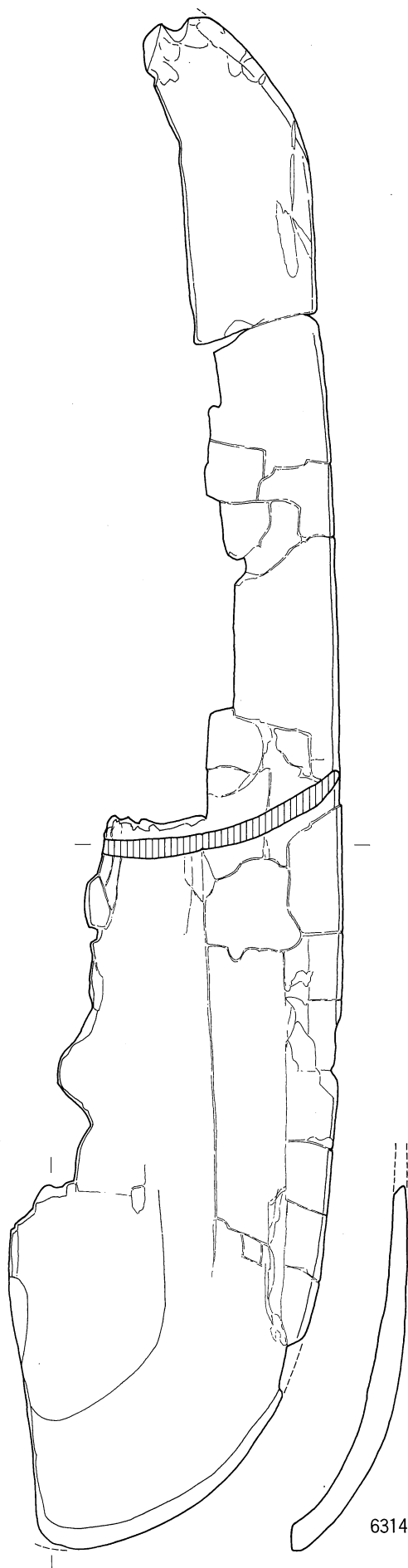
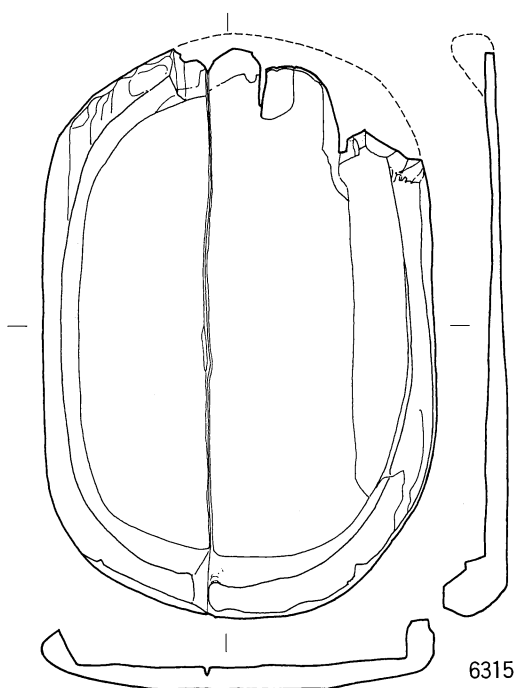

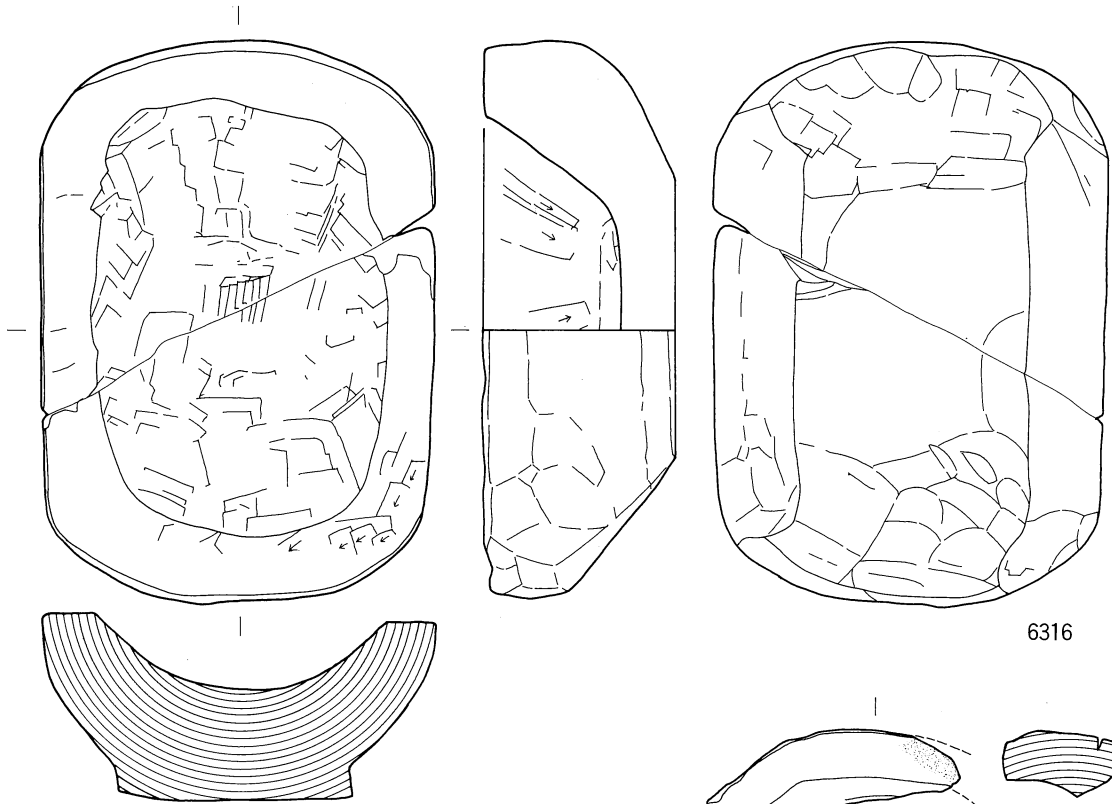

6316

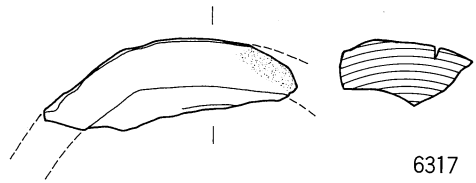

6317

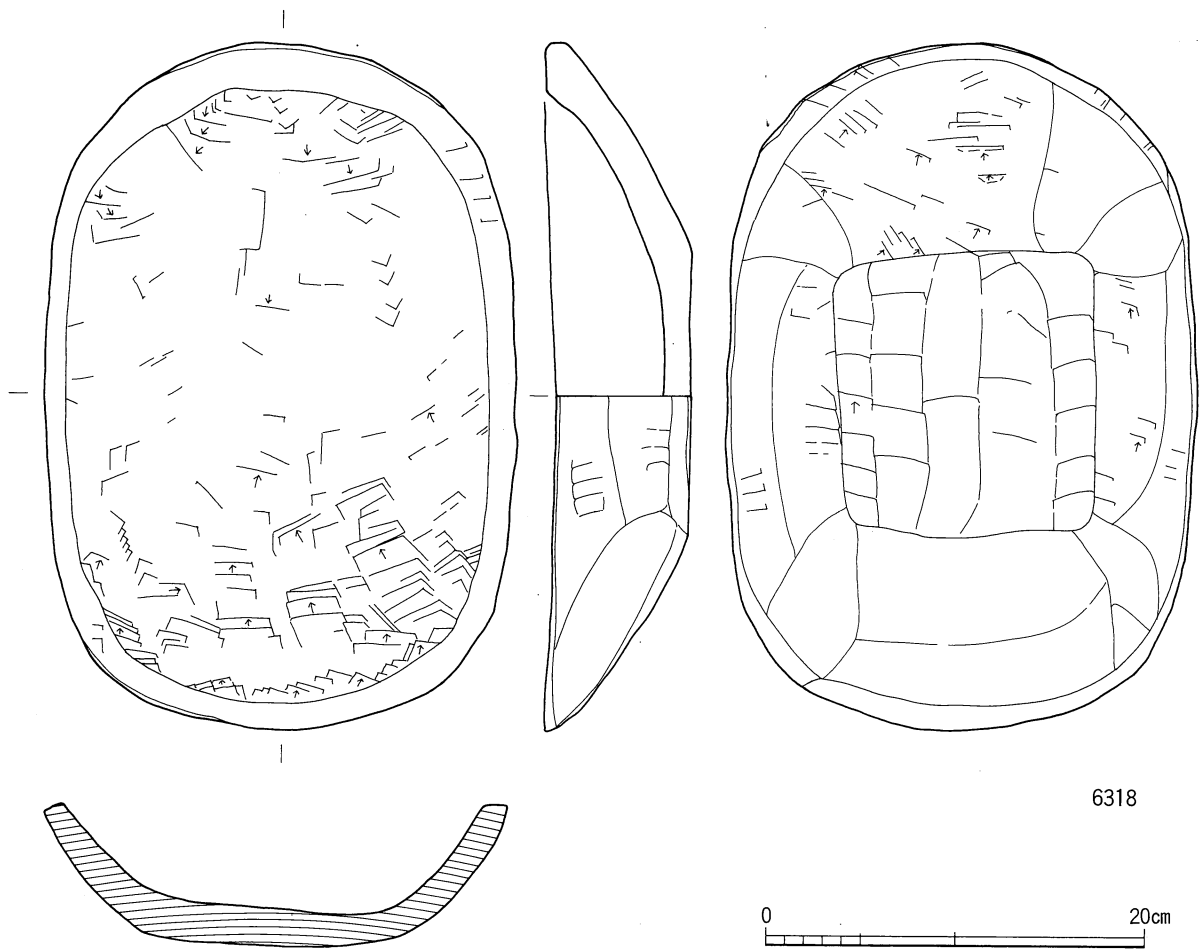

6318



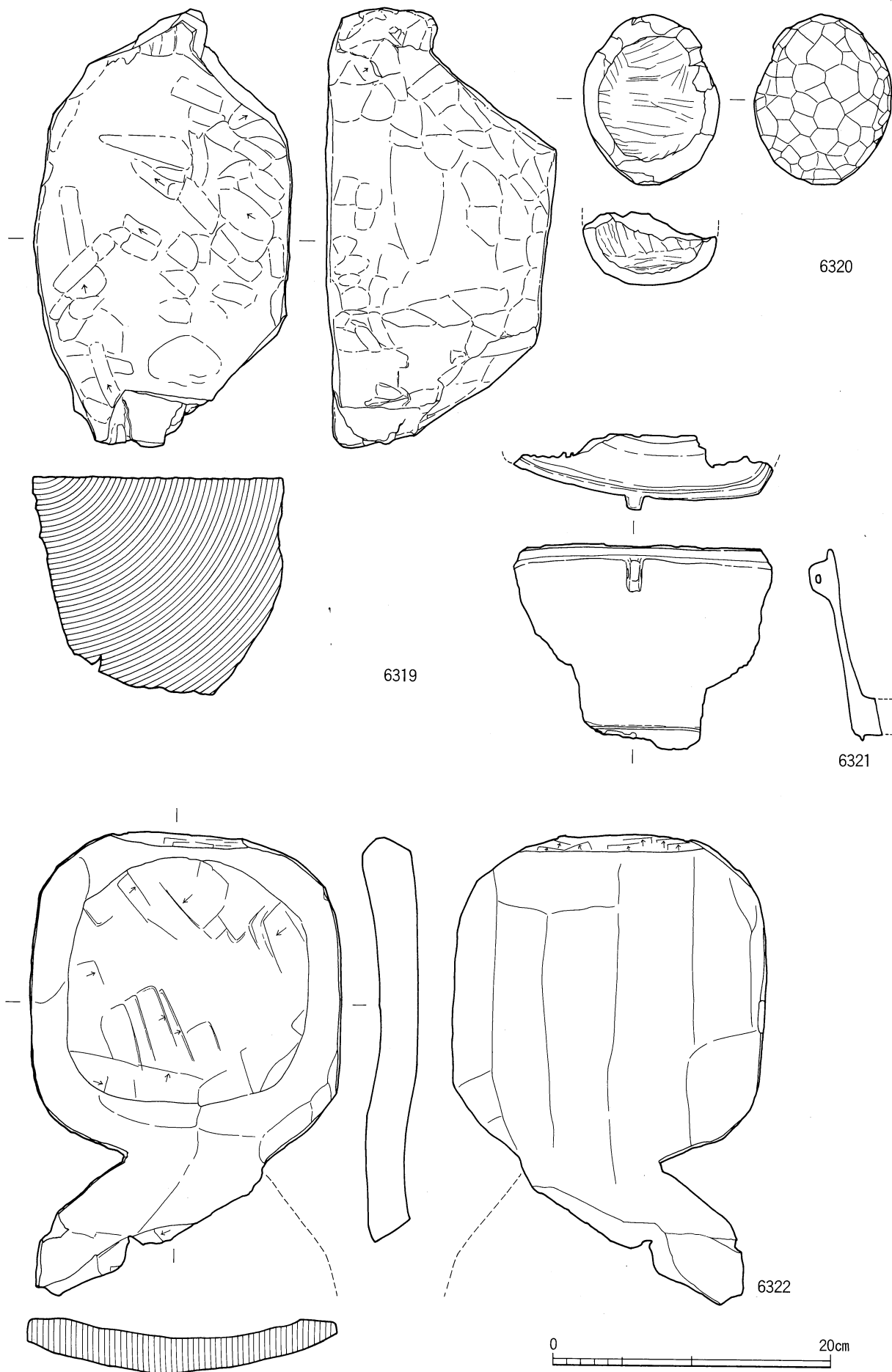

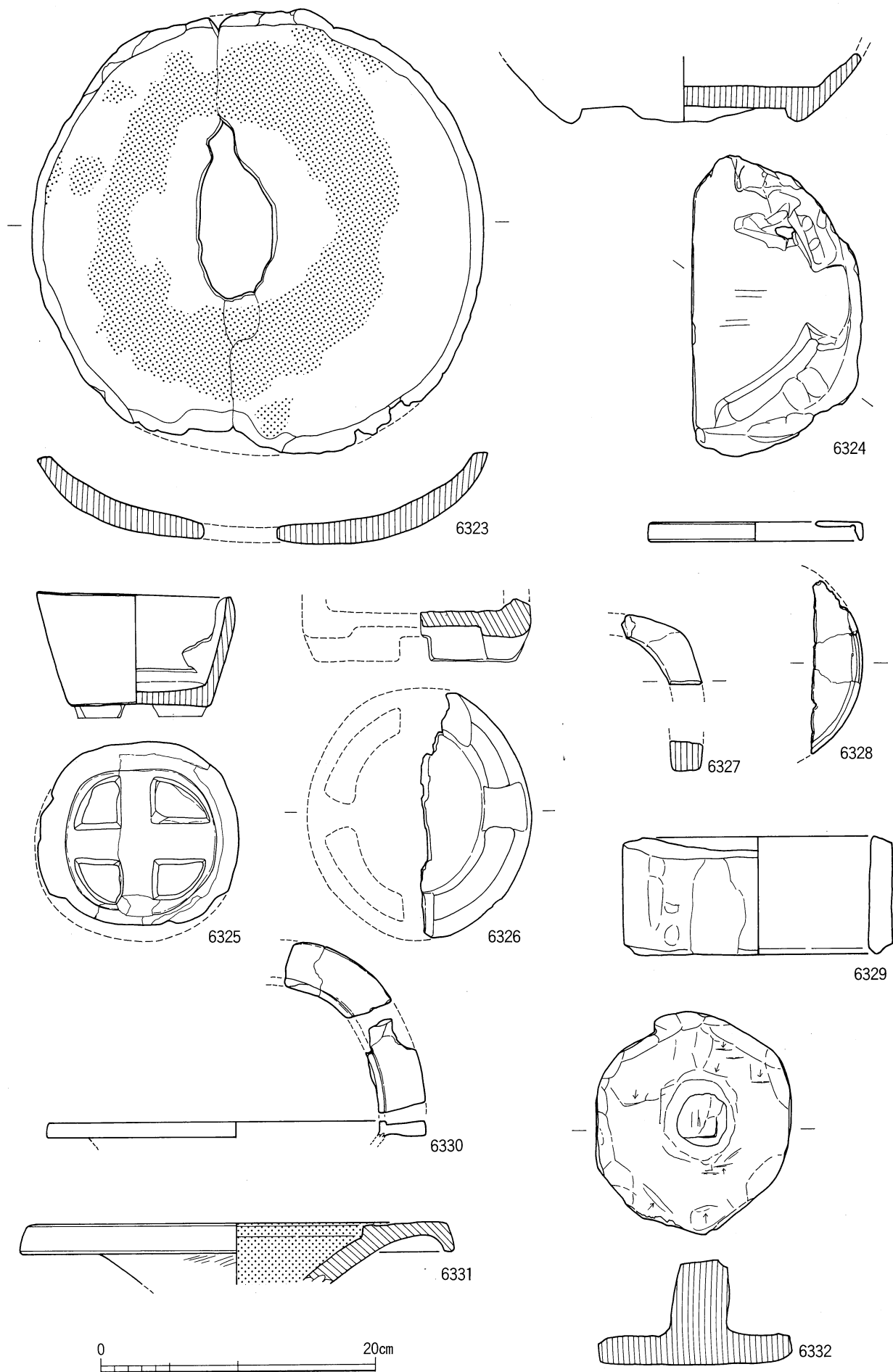

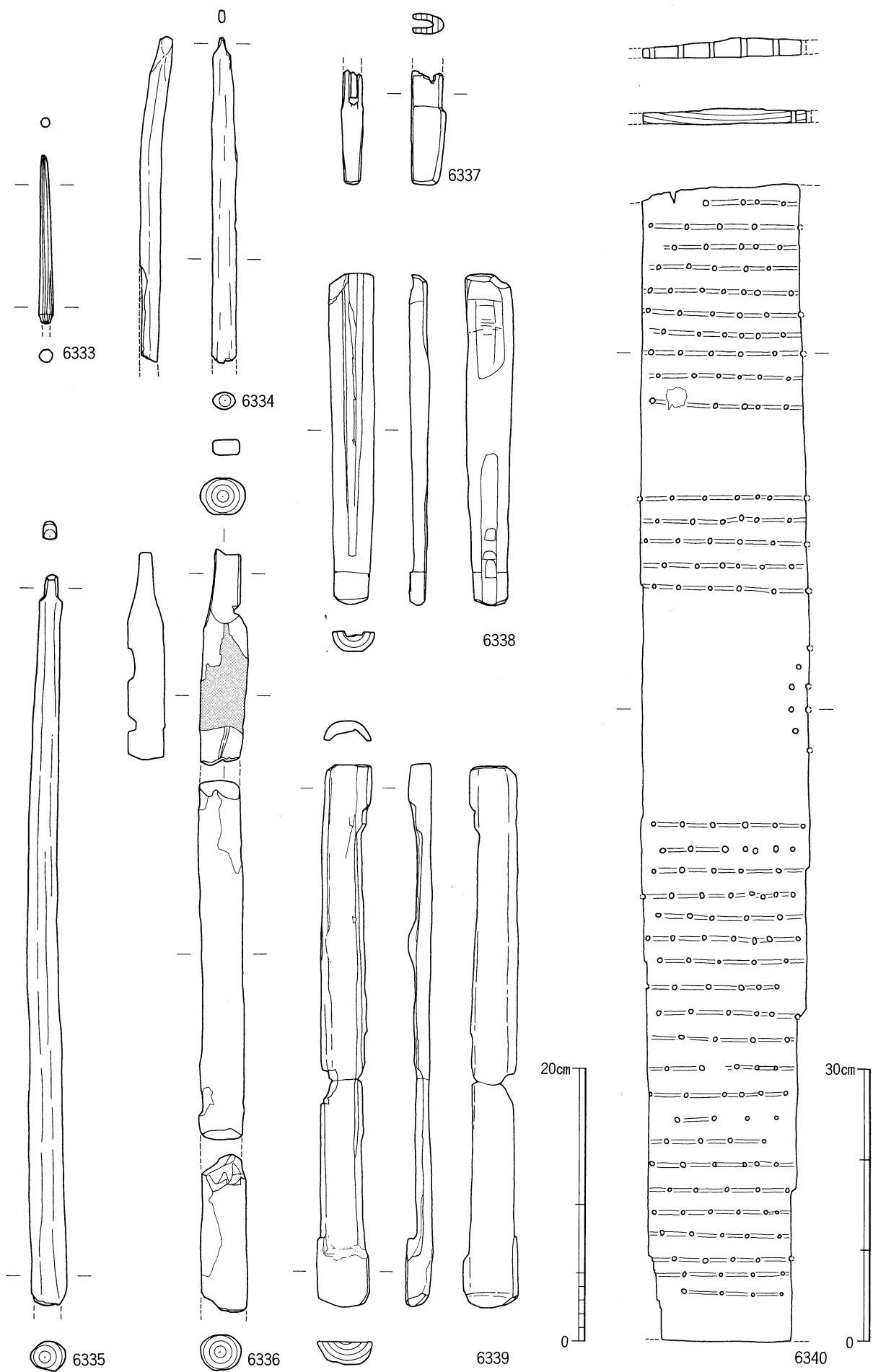

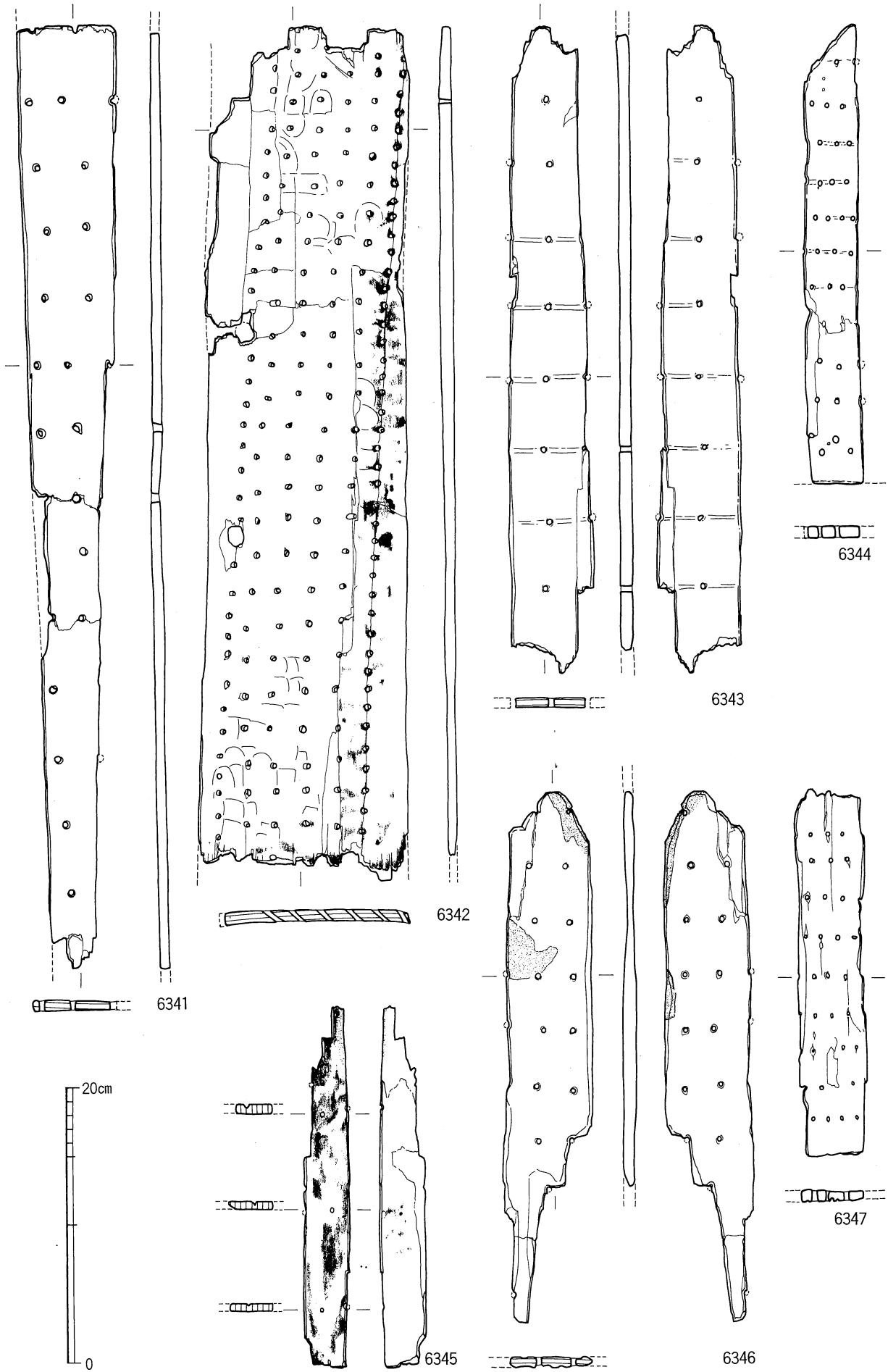

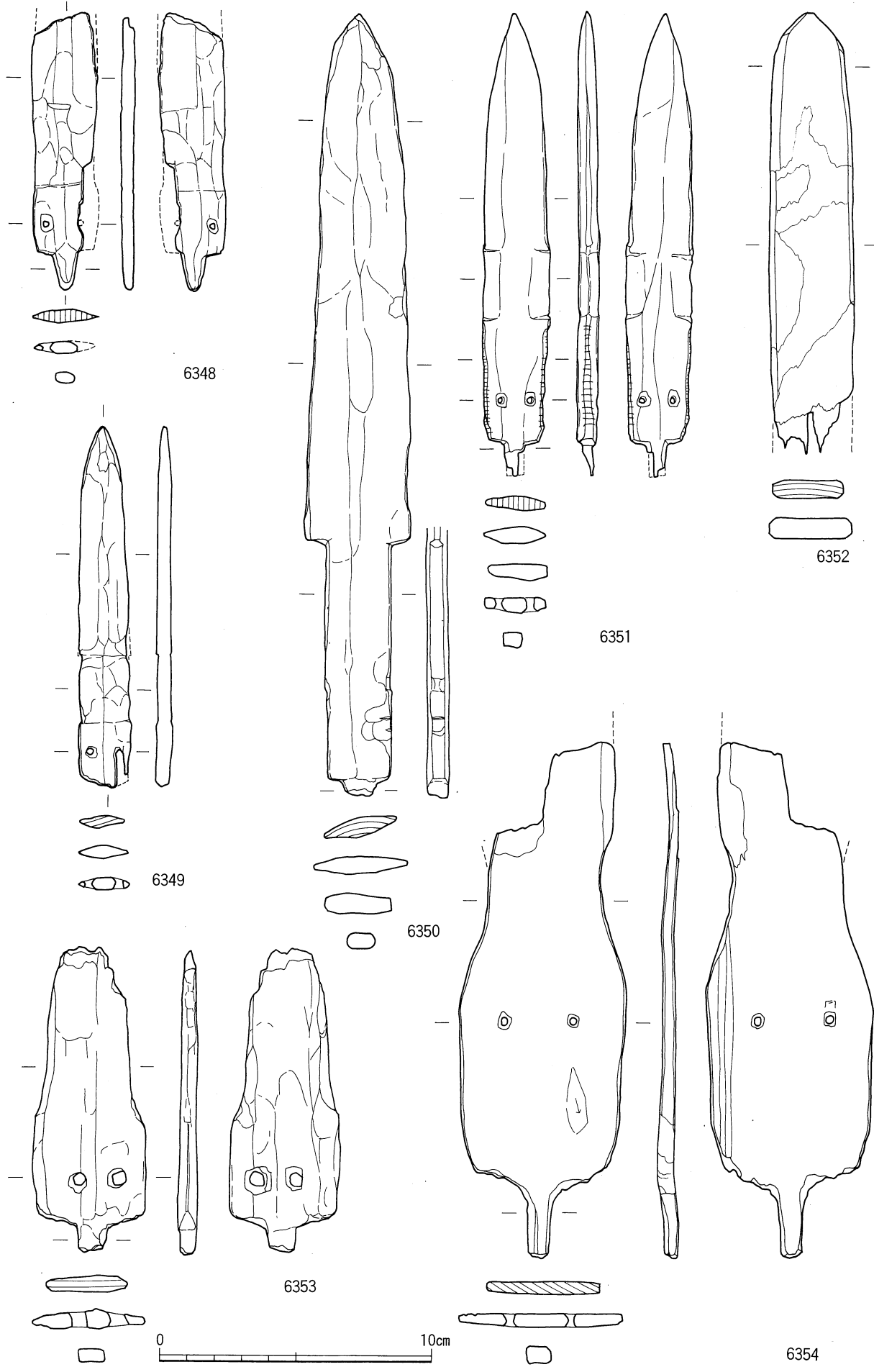

弥生中期上層 旧河道出土木器67 (SR46002)

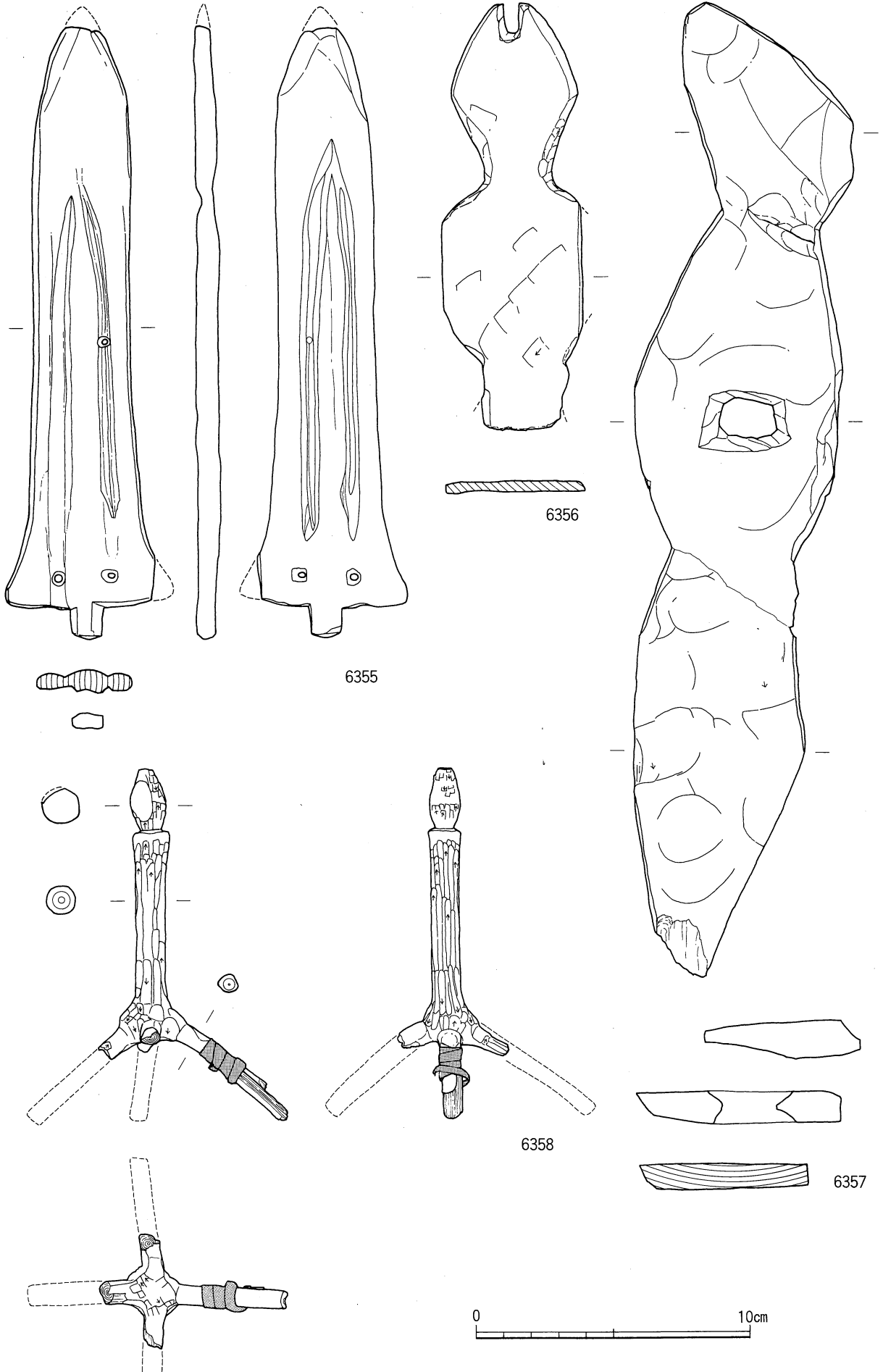

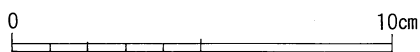
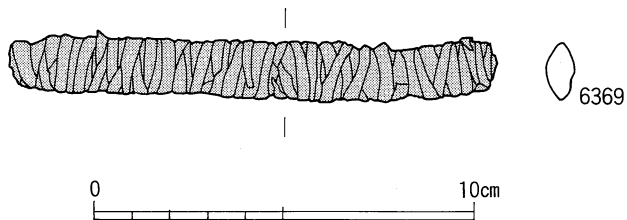
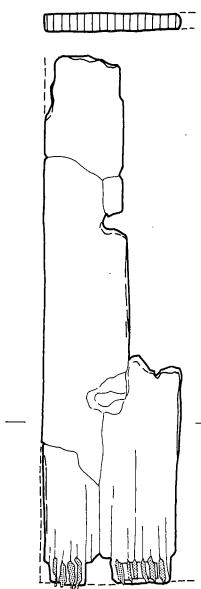
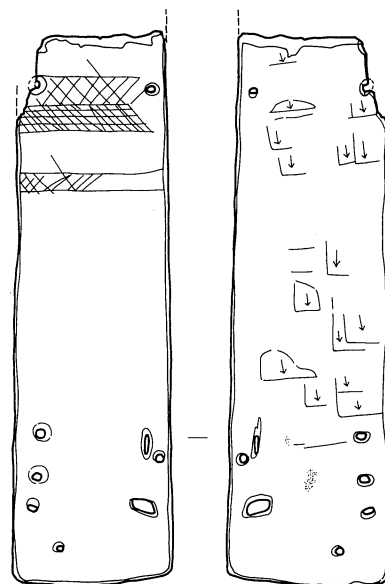
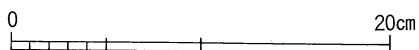
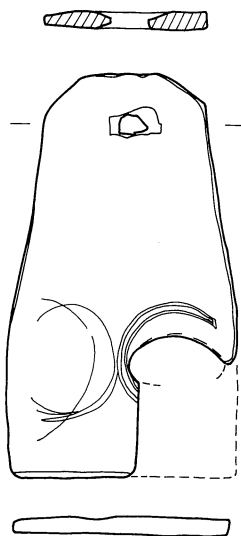
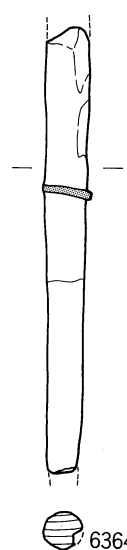
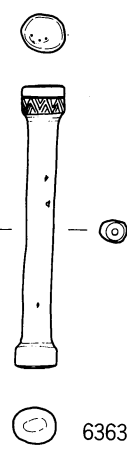
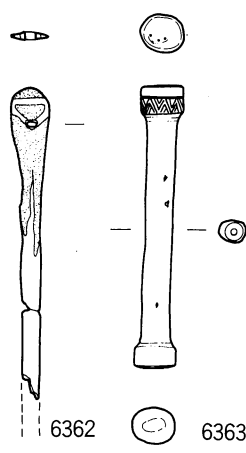
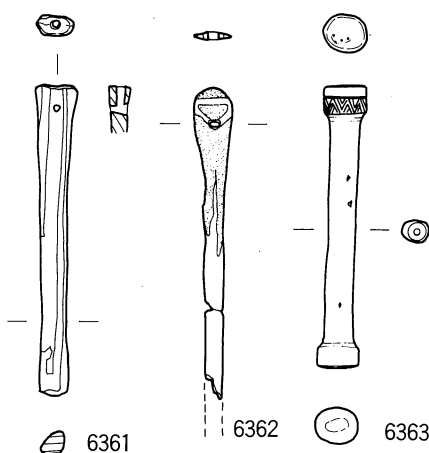
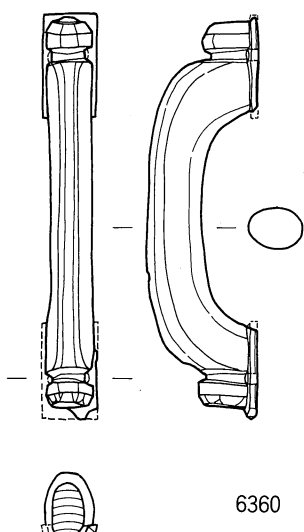
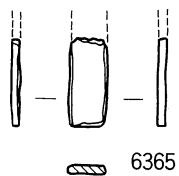
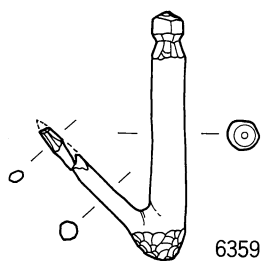

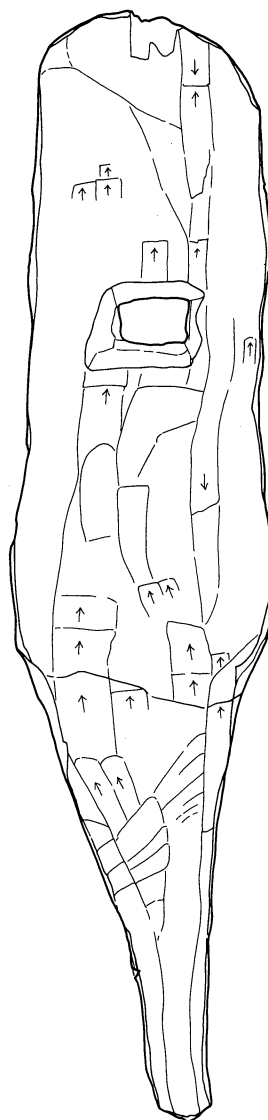
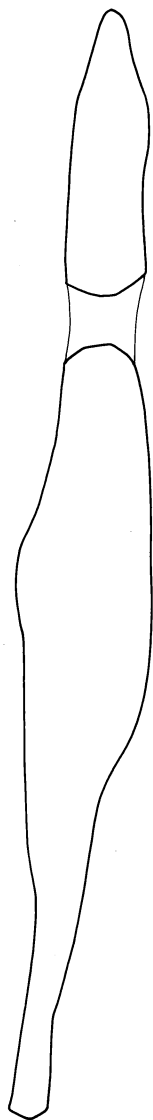
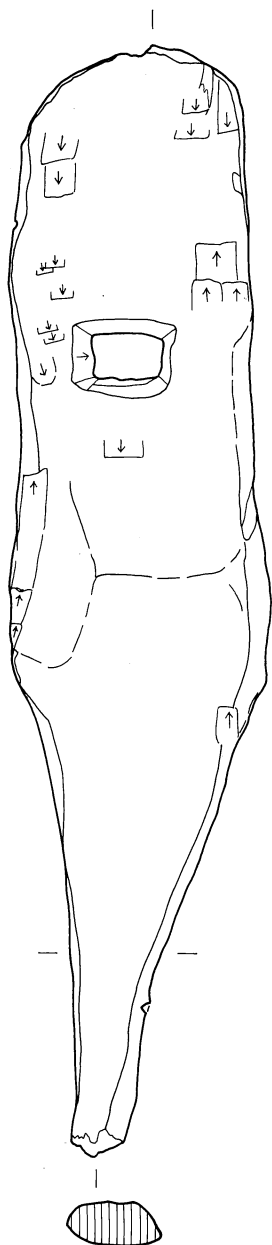

6370

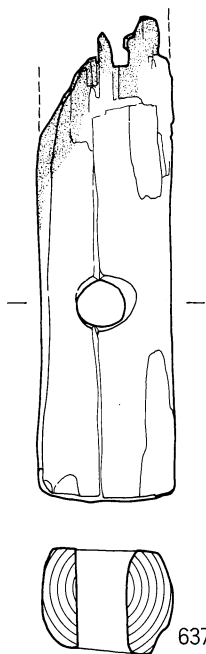

6371

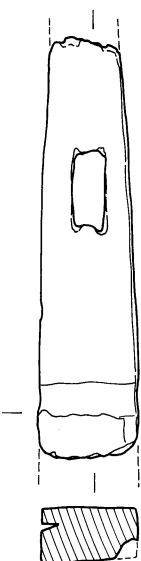

6372

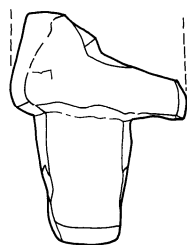
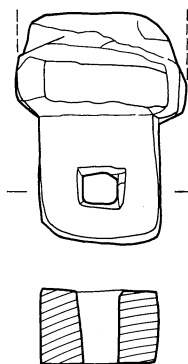
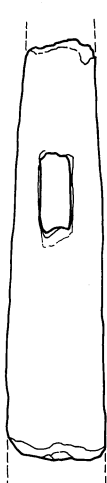

6373

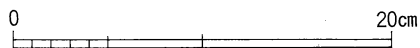

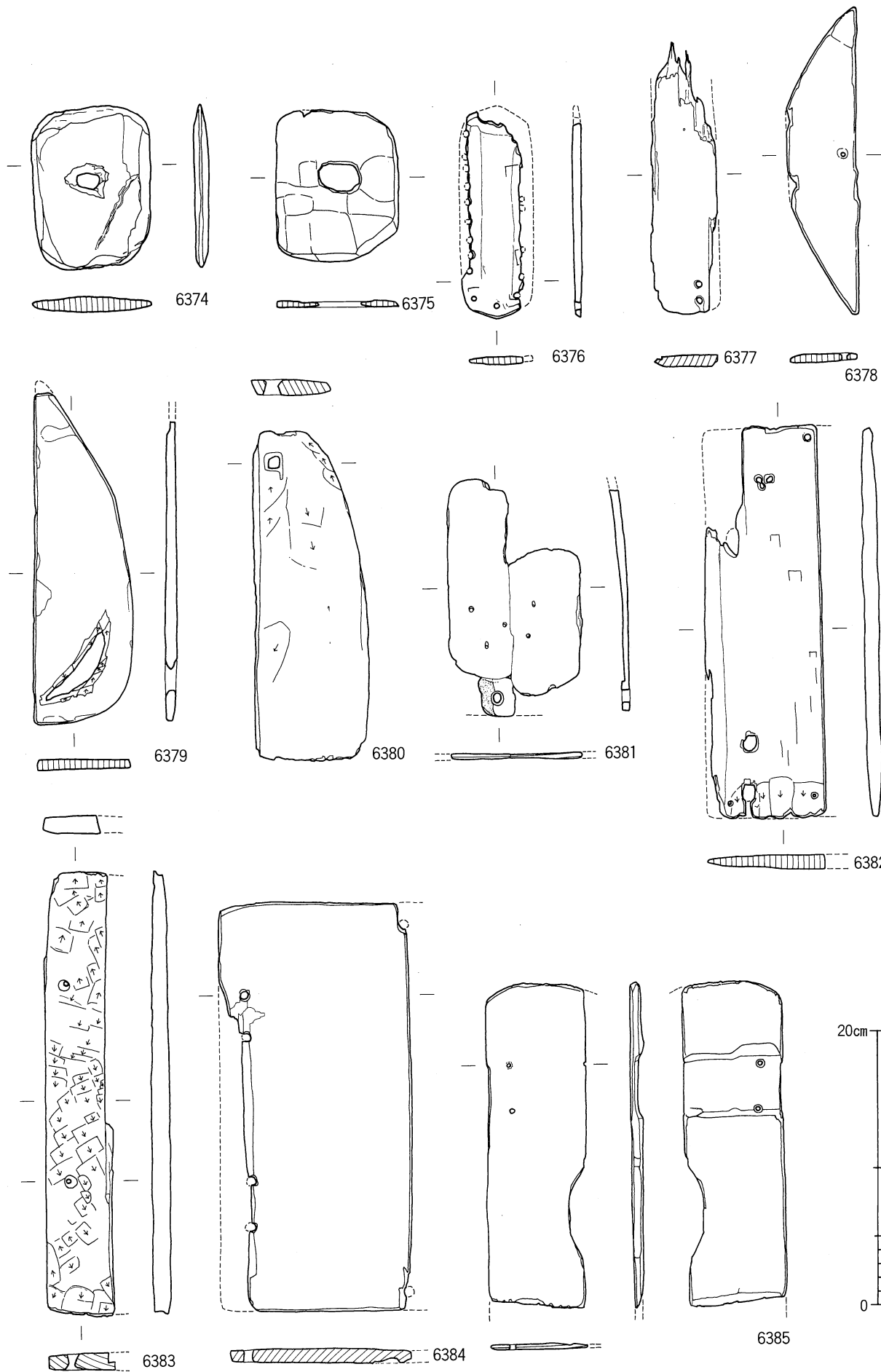

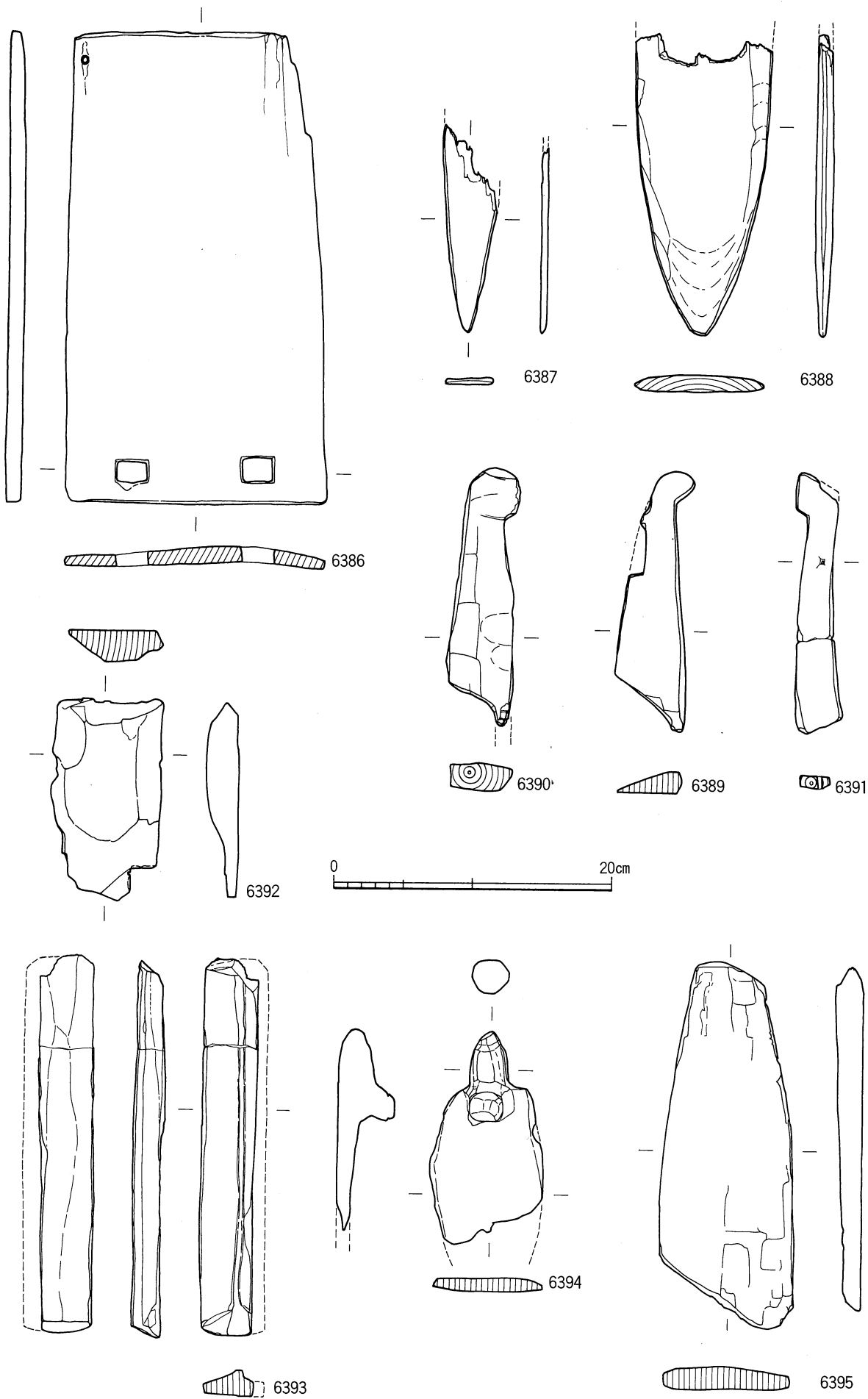



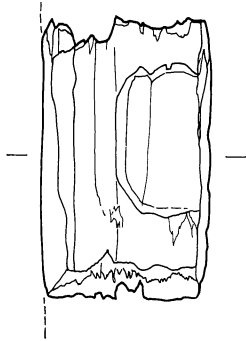

6406

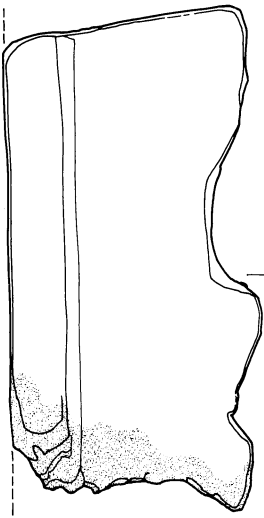
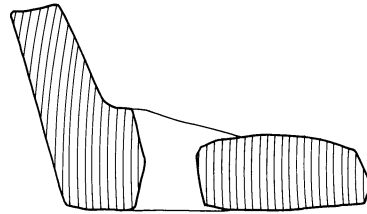
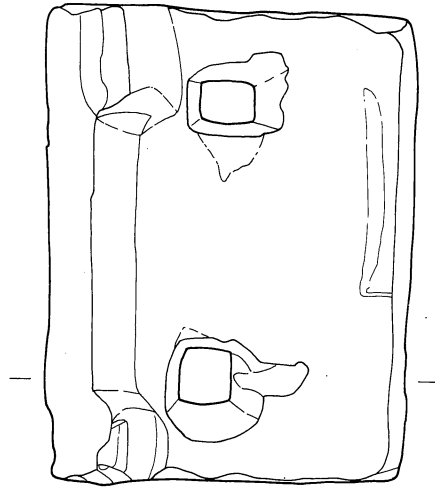

6407

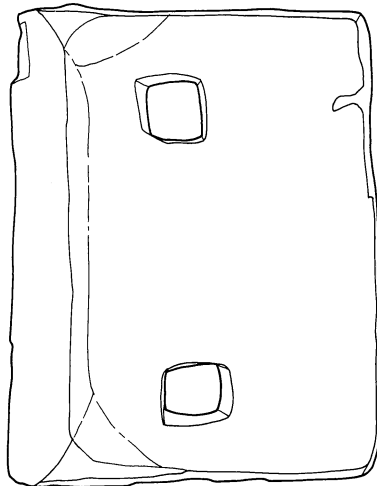

6408

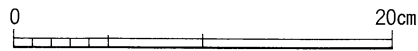

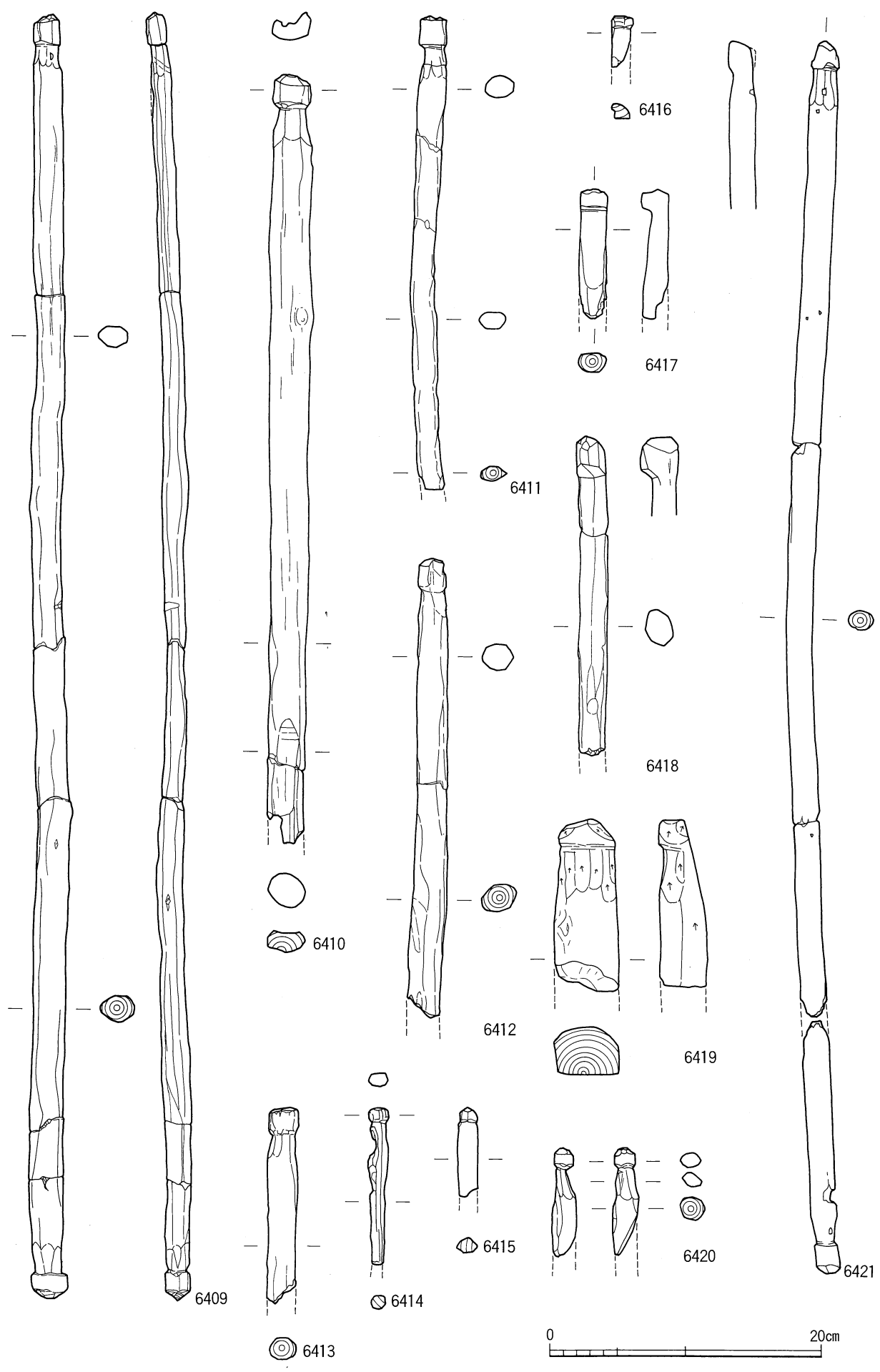

弥生中期上層 旧河道出土木器75 (SR46002)

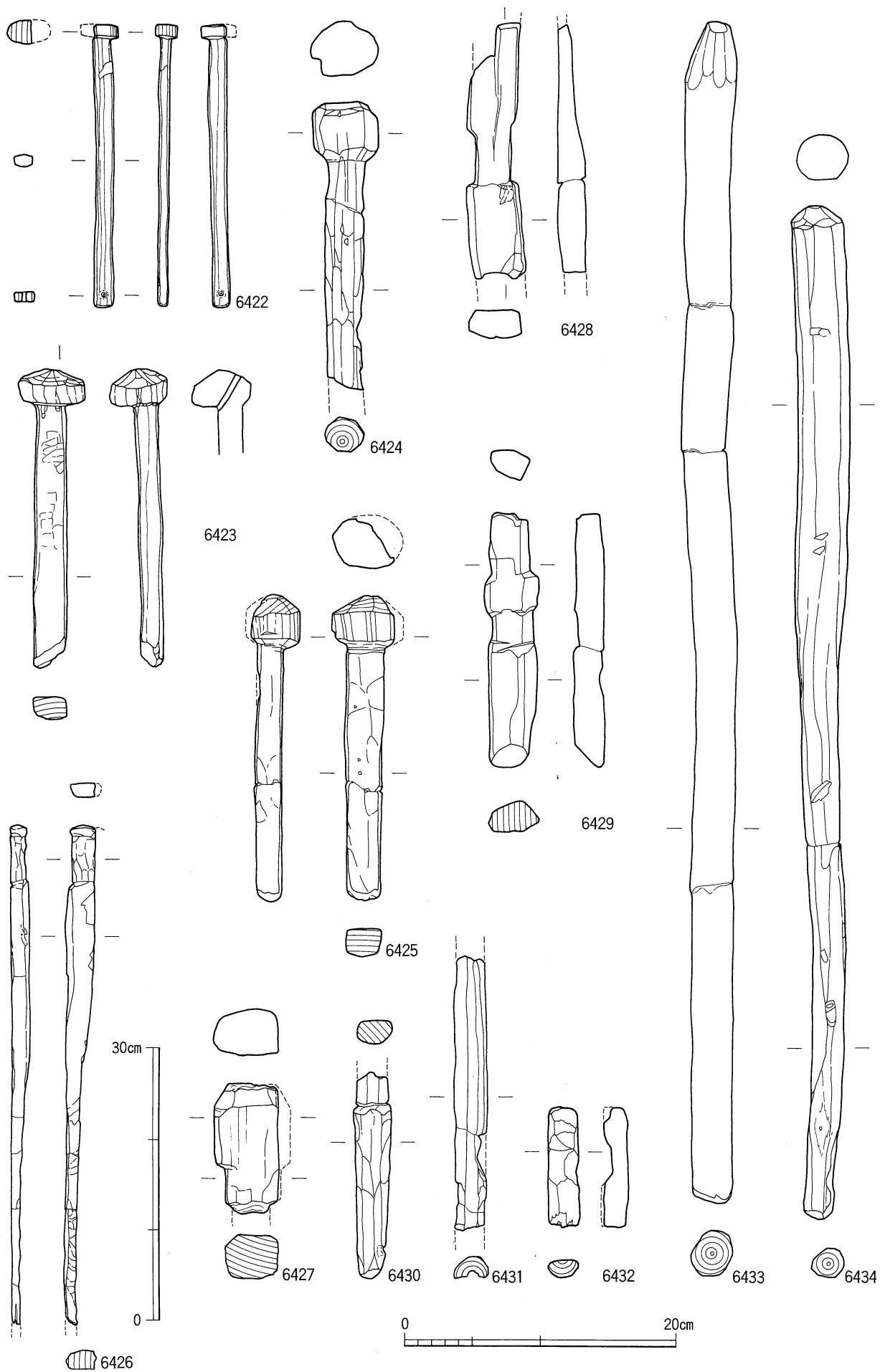

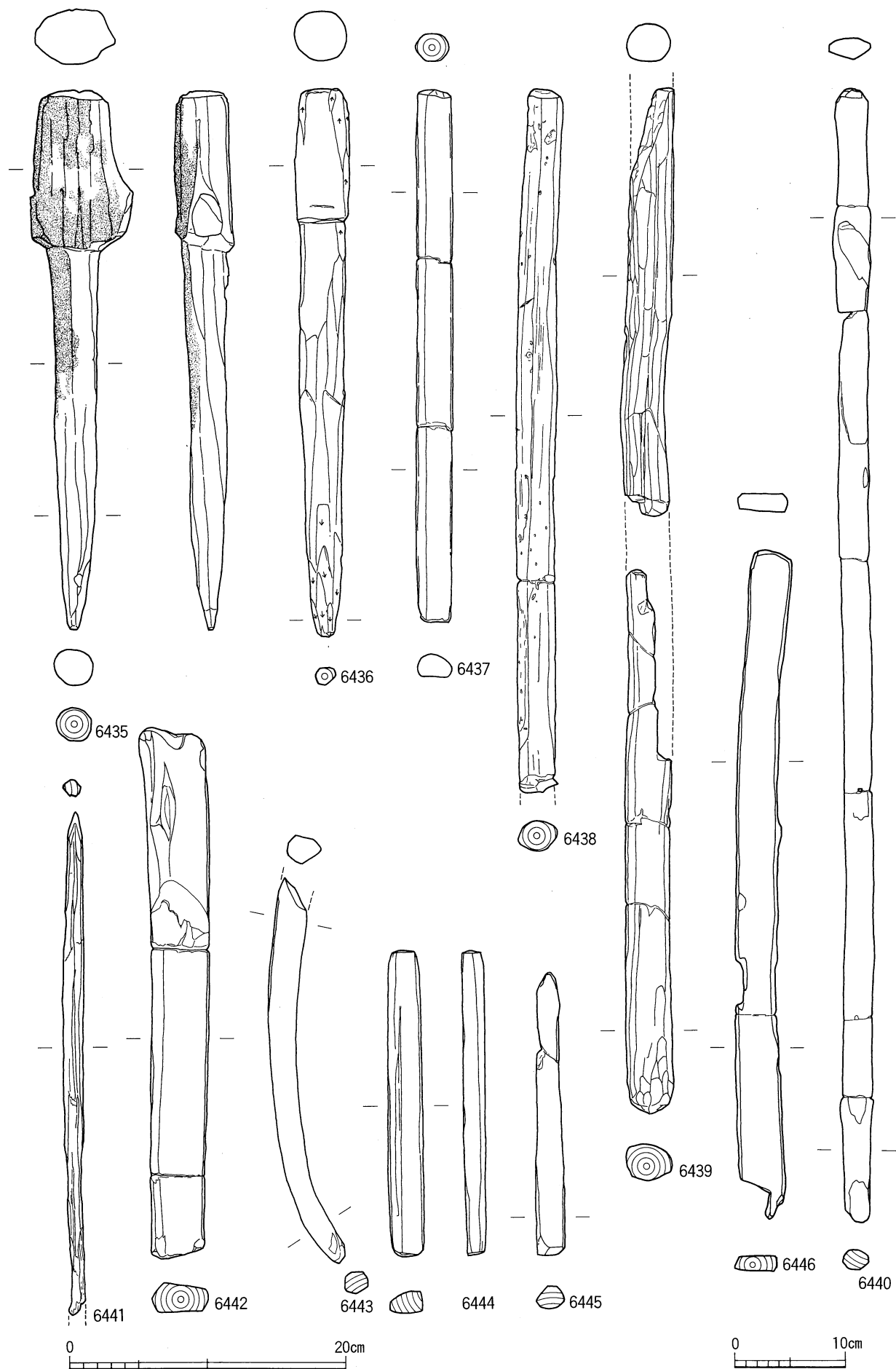

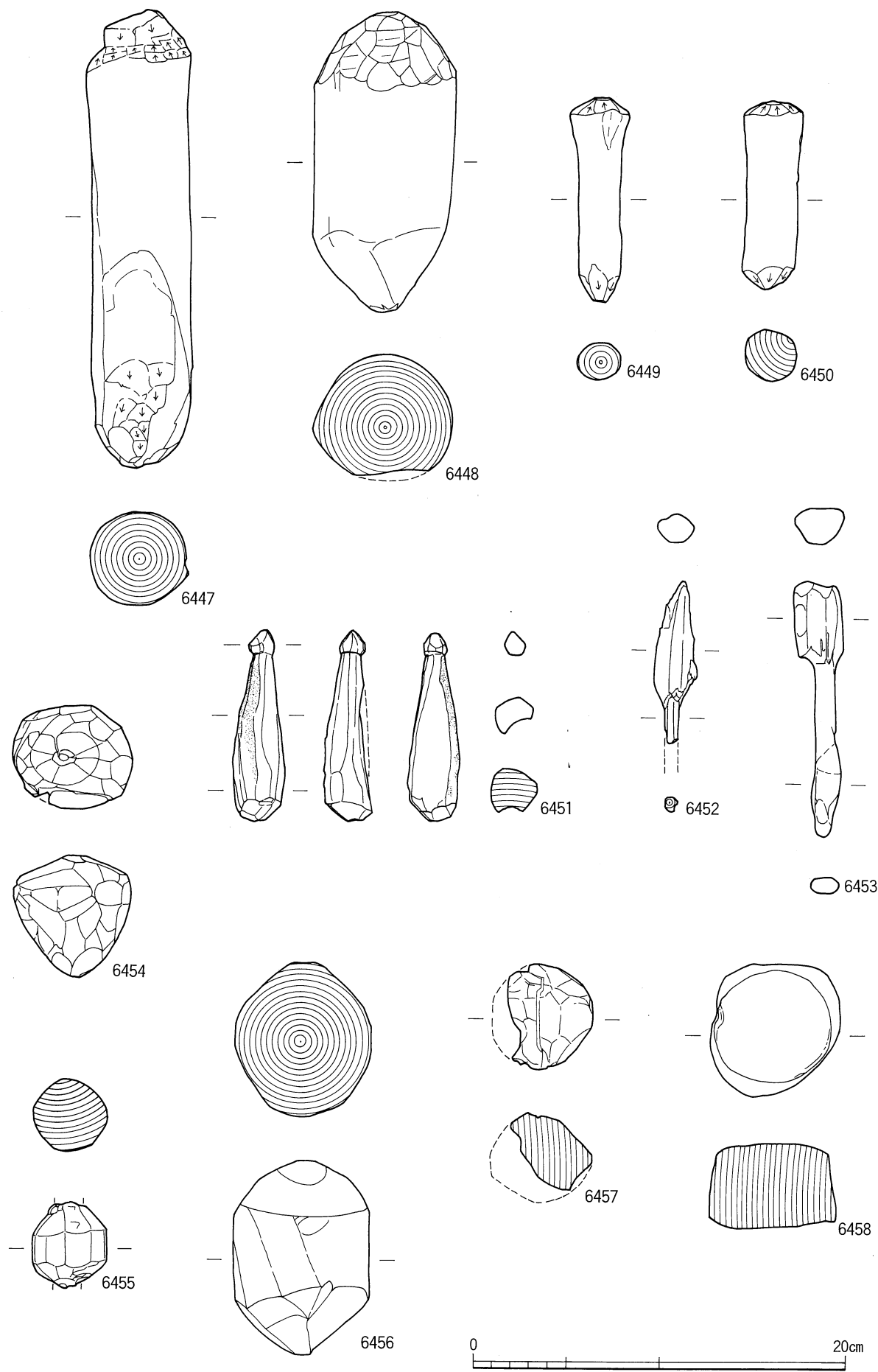

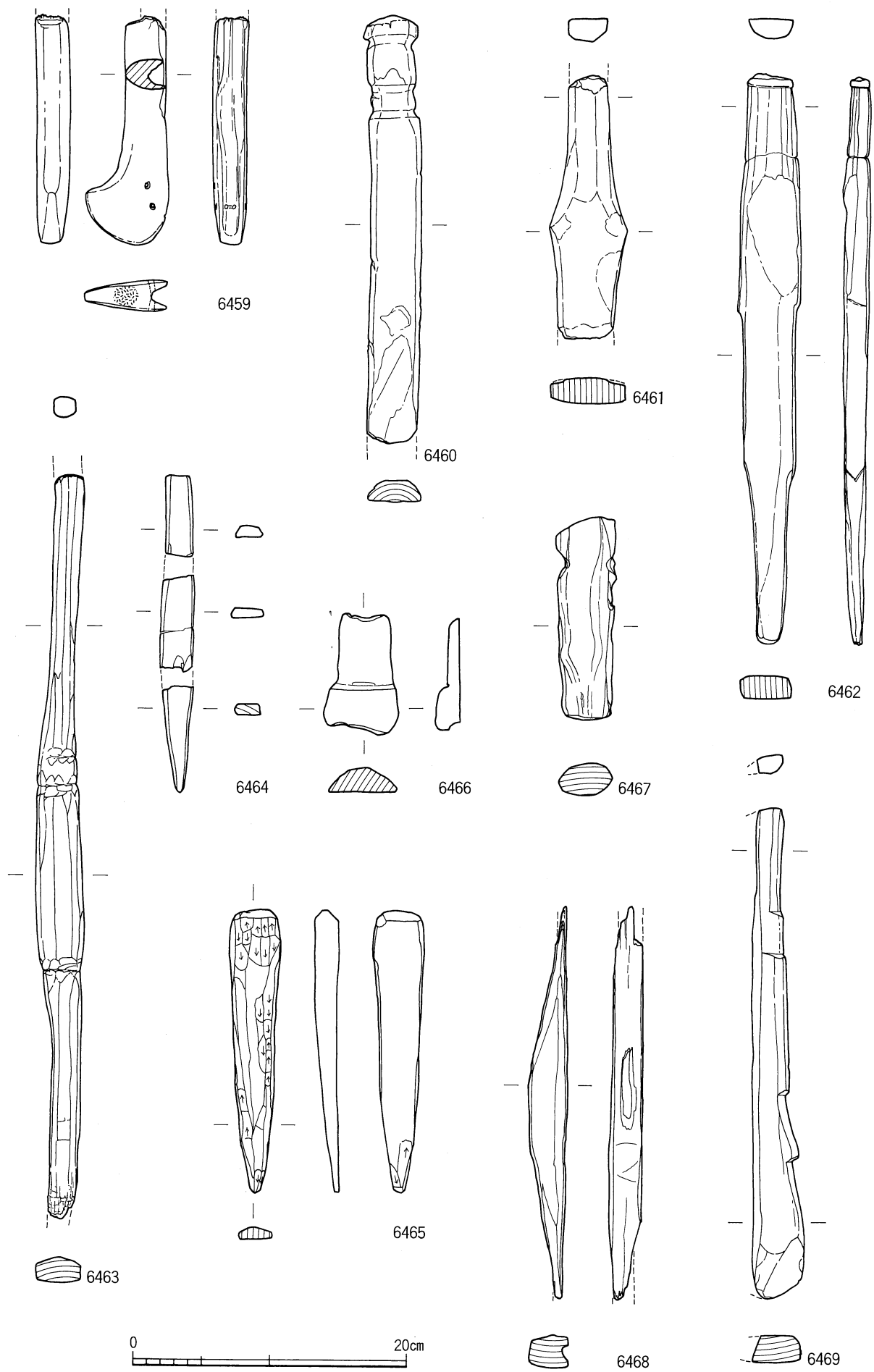

弥生中期上層 旧河道出土木器79 (SR46002)

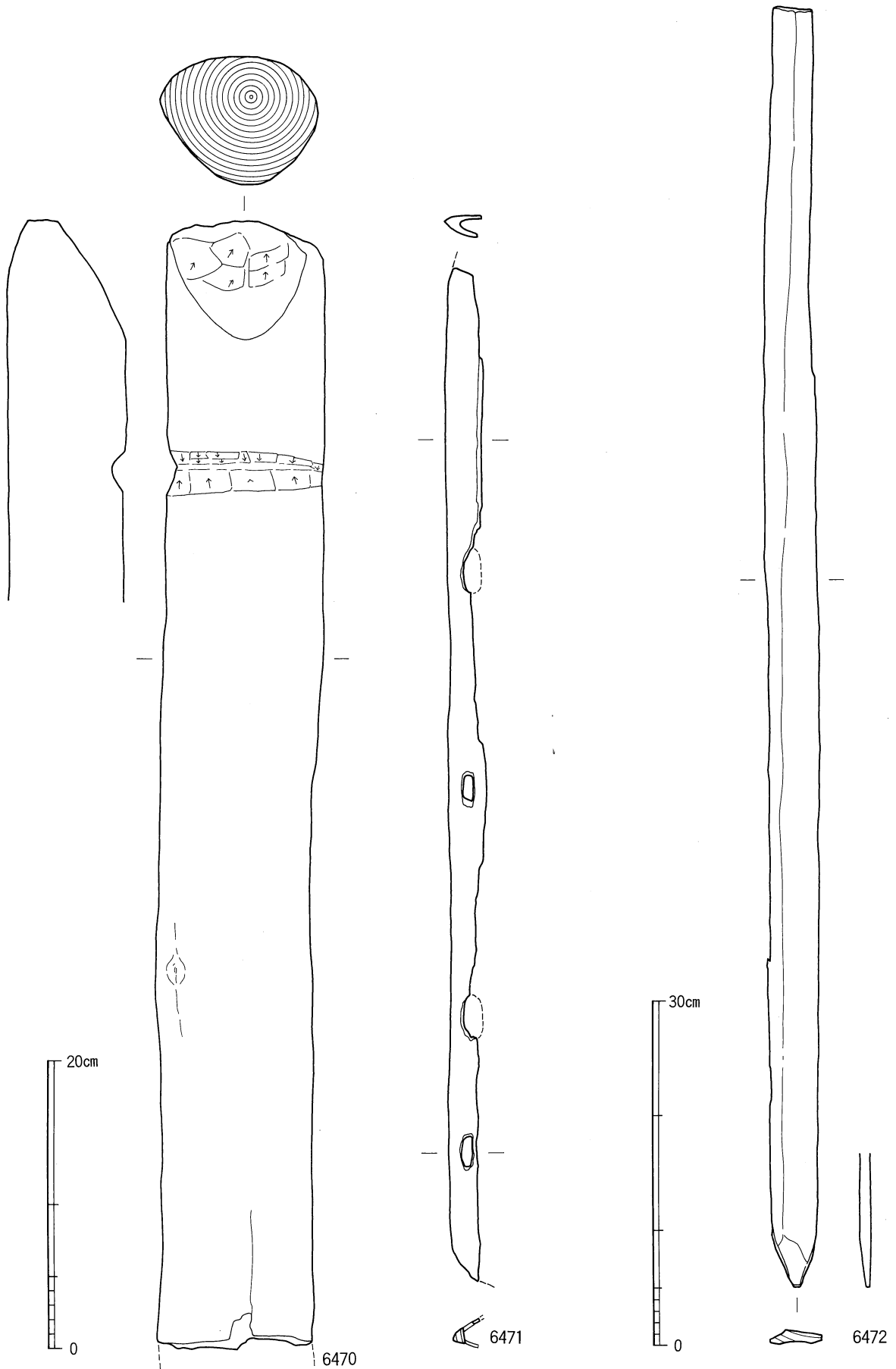

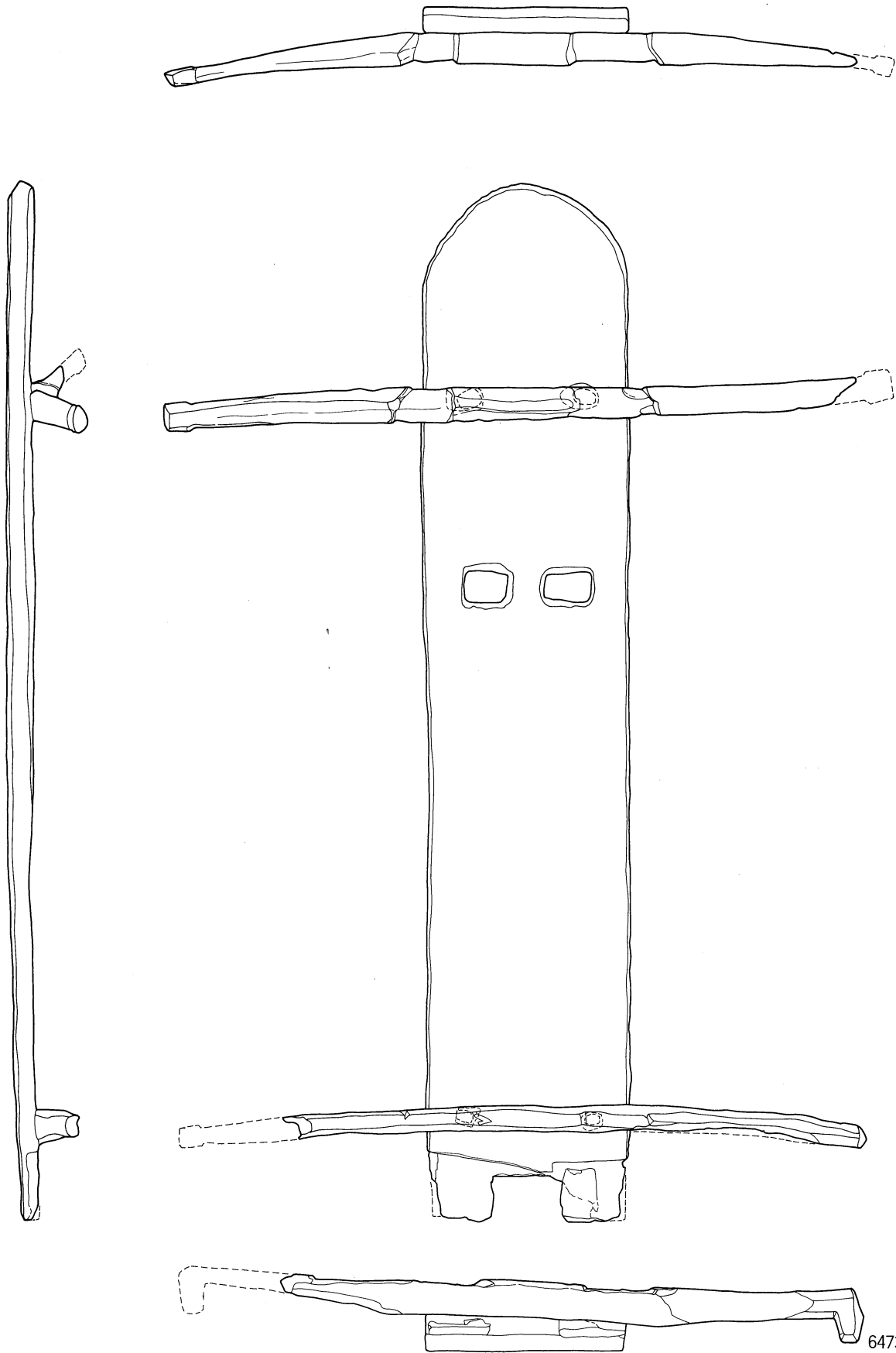

6473

0 30cm

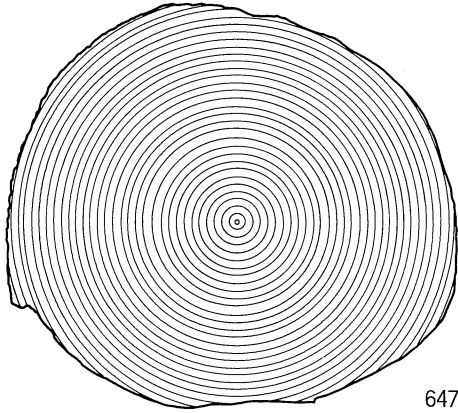

6474

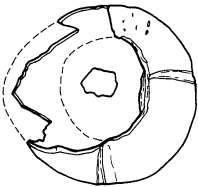
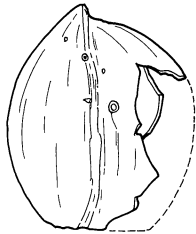
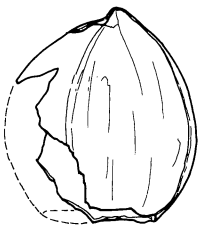
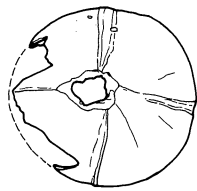

6475

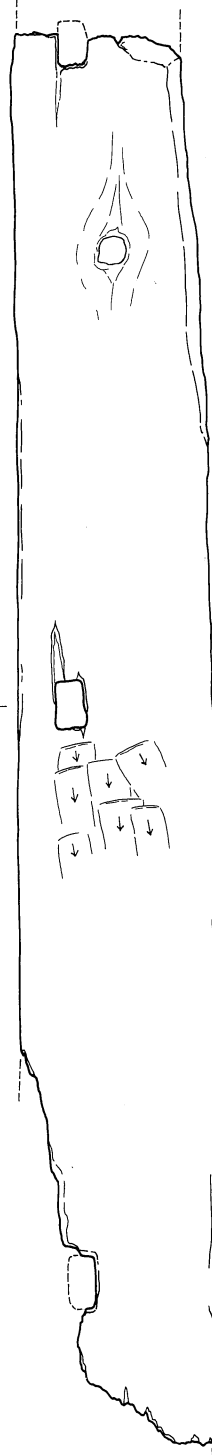

6476

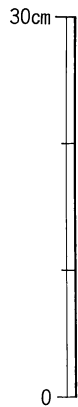

旧河道 SR46002 (6474 · 6475)
 溝 SD56002 (6476)

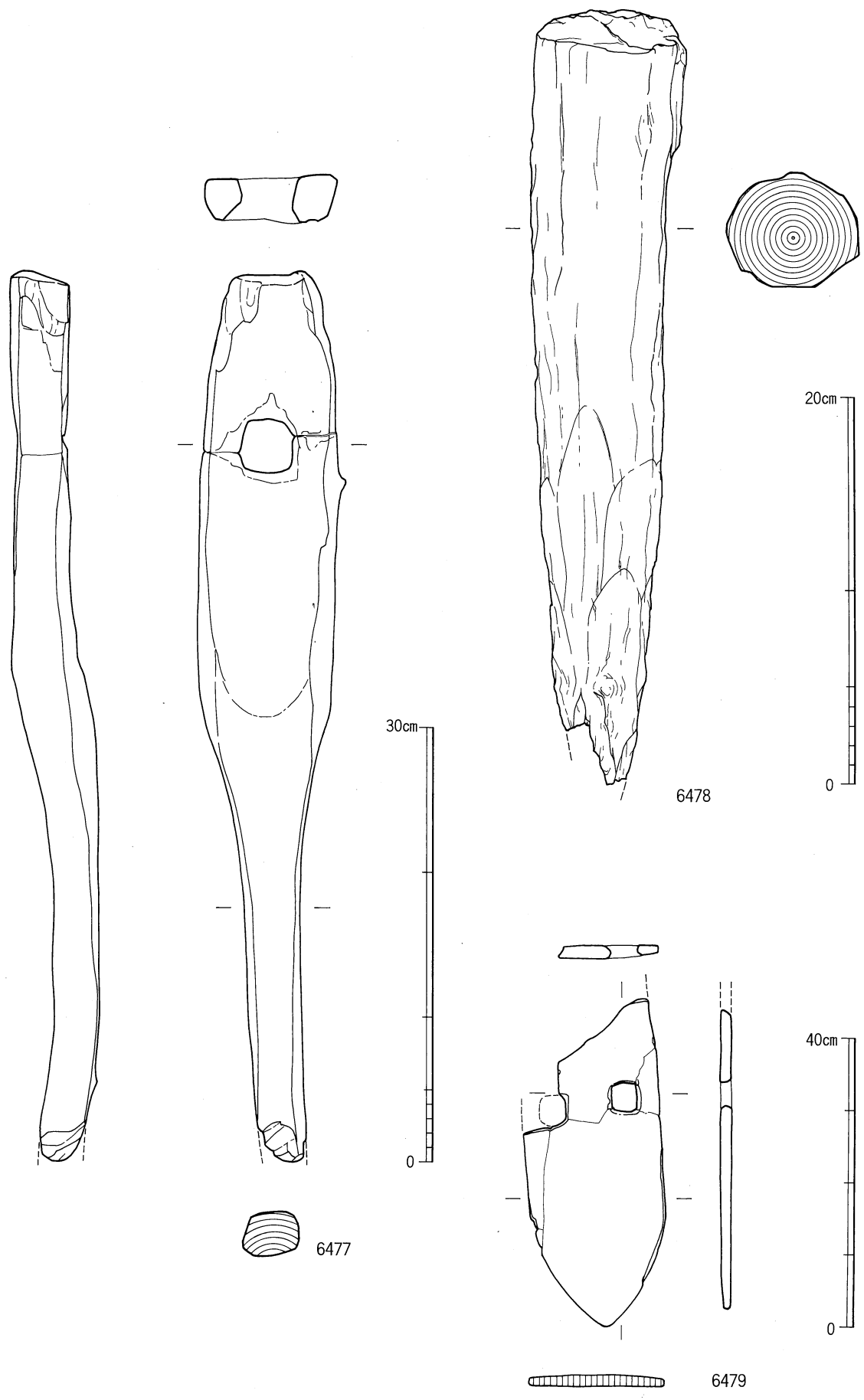

弥生中期上層 旧河道出土木器83 (SR46003)

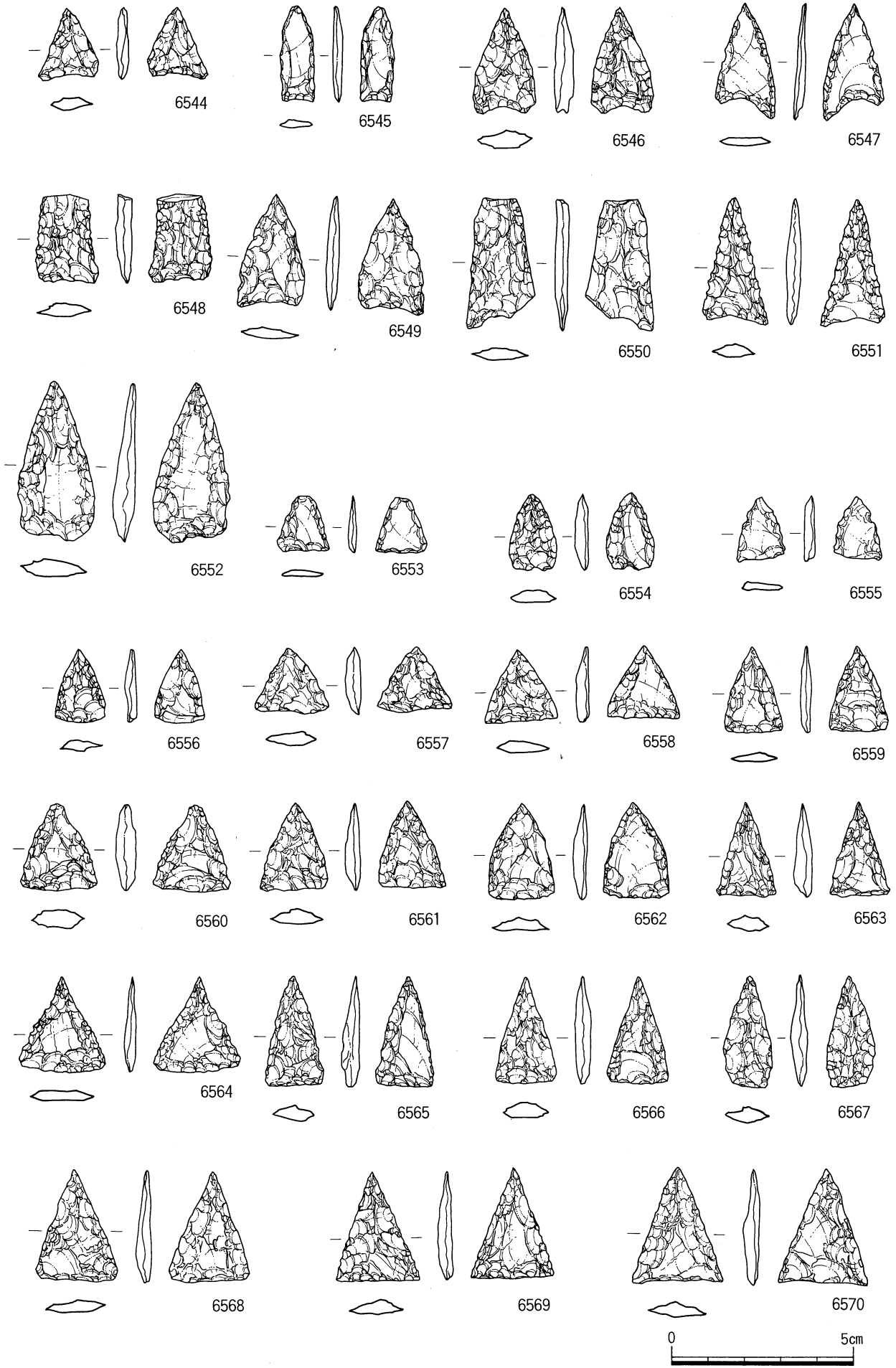

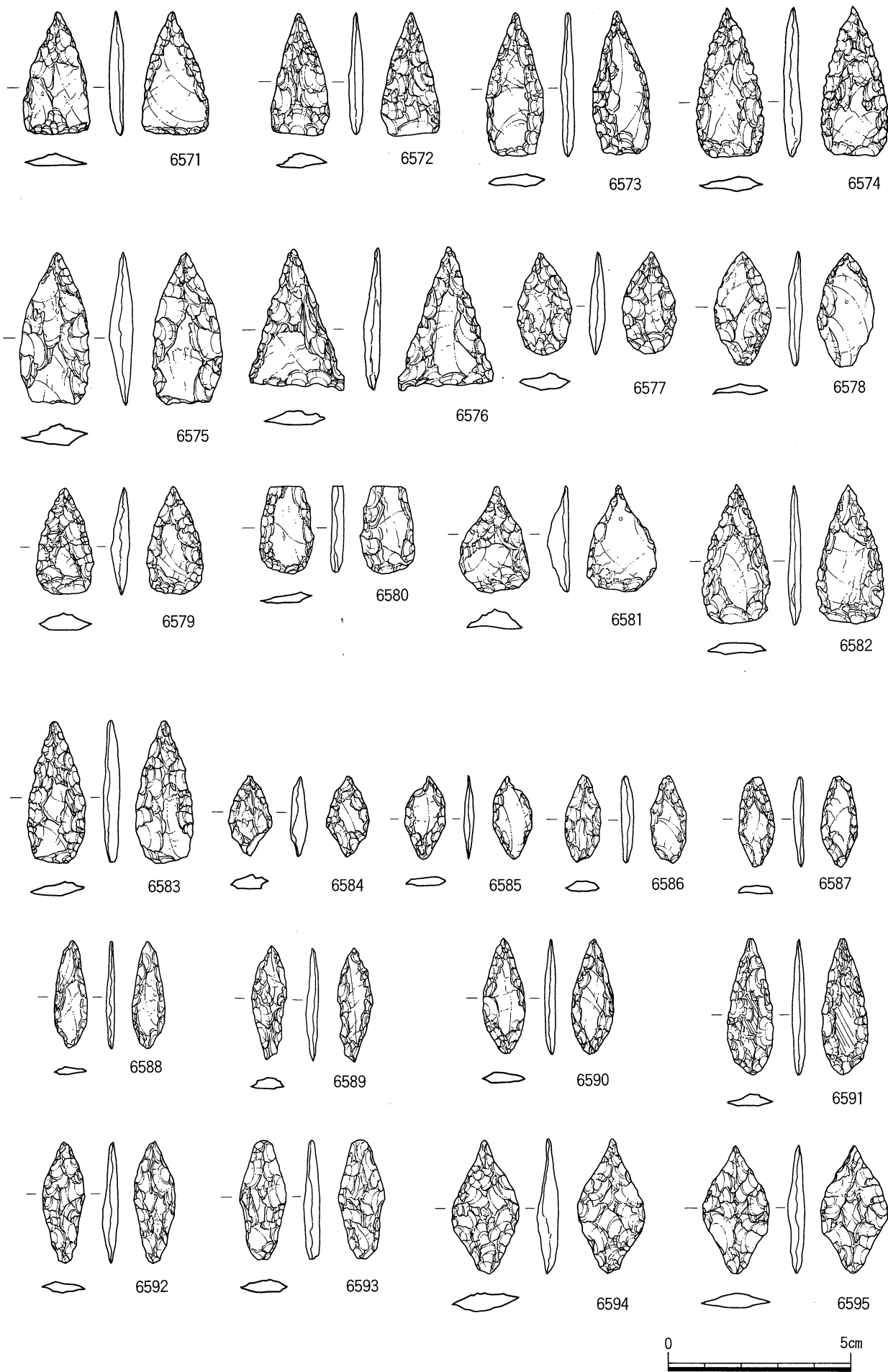

旧河道 SR46002 (6571~6576 · 6578)
 溝 SD56002 (6577 · 6579~6595)

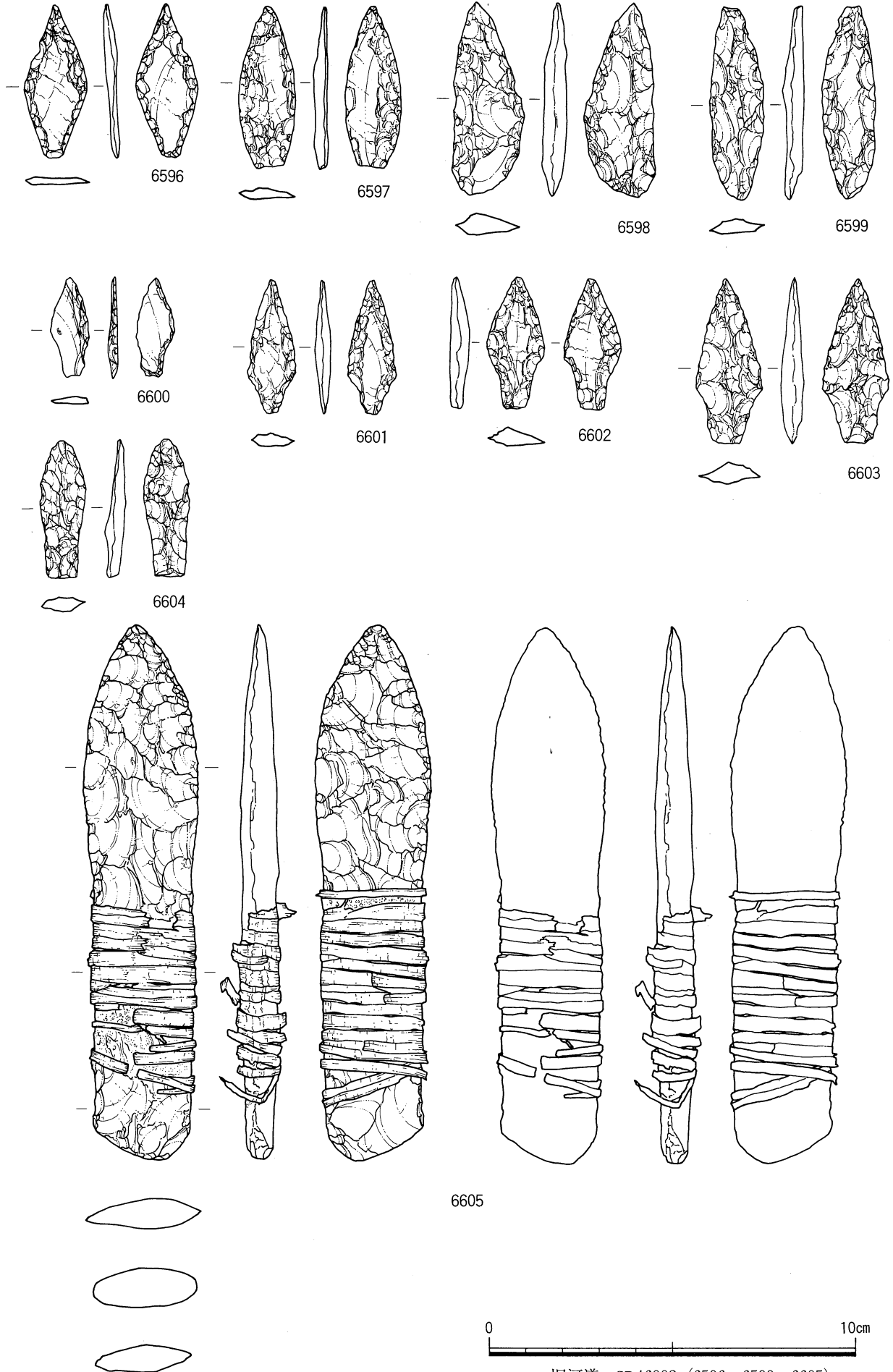

旧河道 SR46002 (6596·6599~6605)
 溝 SD56002 (6598) SD56005 (6597)

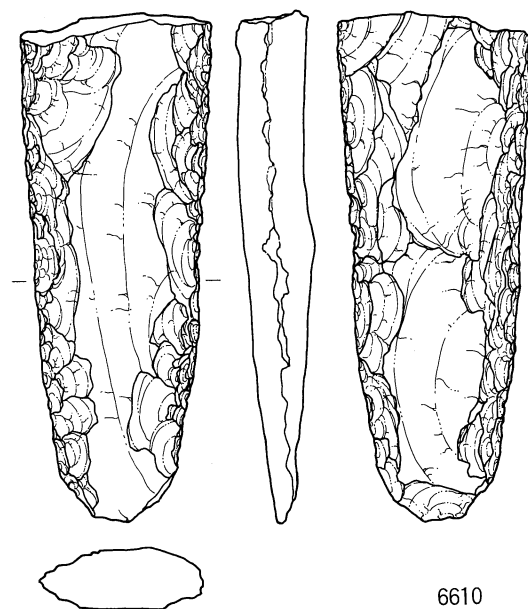
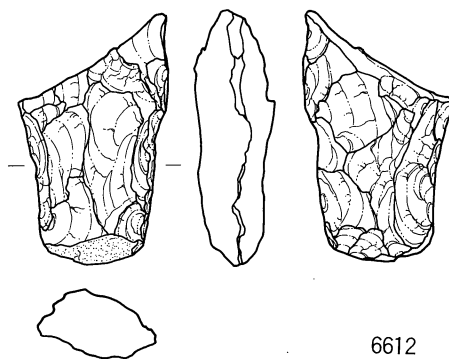
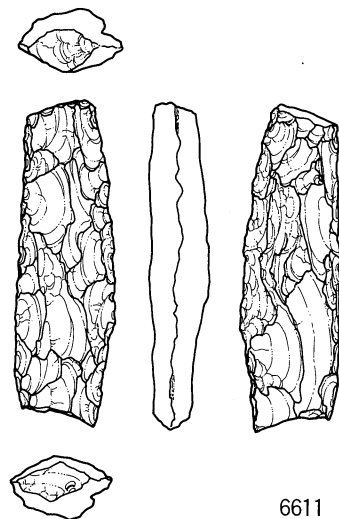
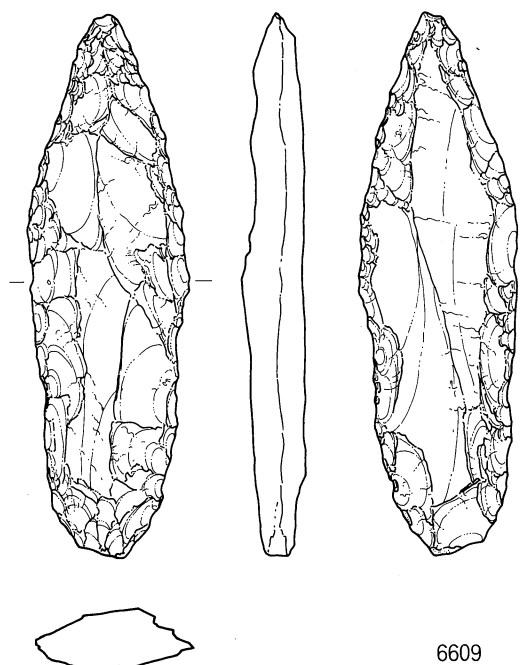
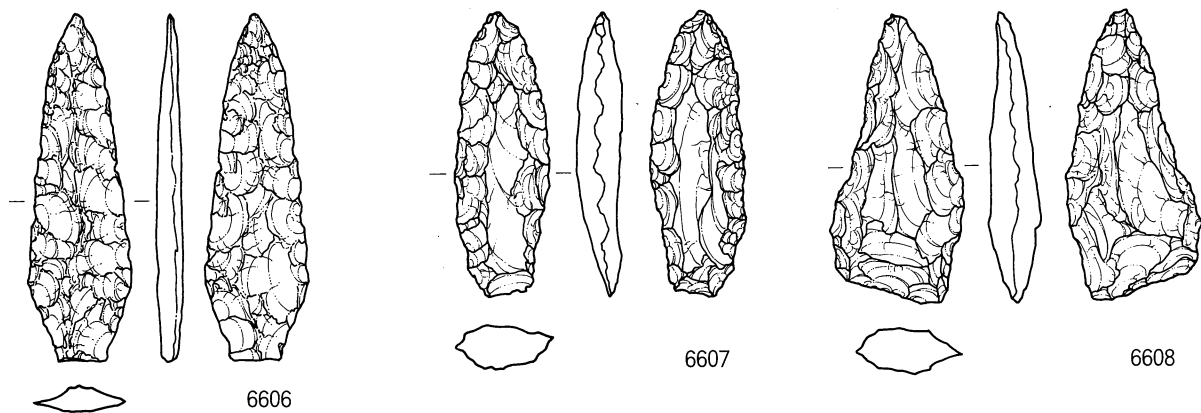

旧河道 SR46002 (6606 · 6607 · 6609~6613)
 溝 SD46008 (6608)

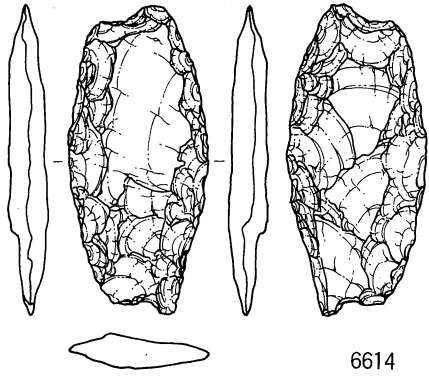

6614

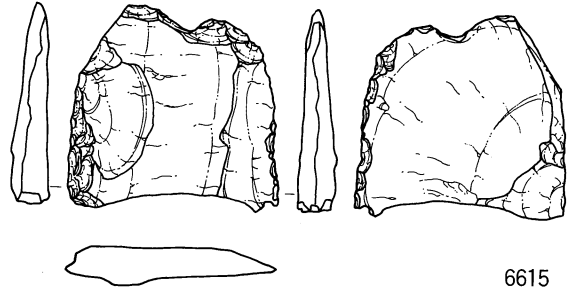

6615

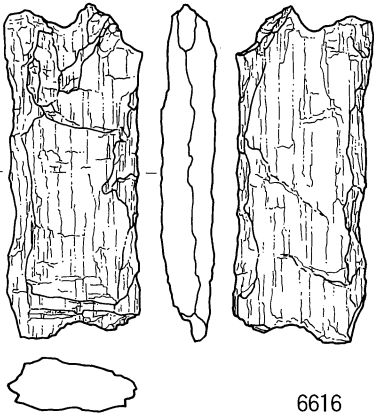

6616

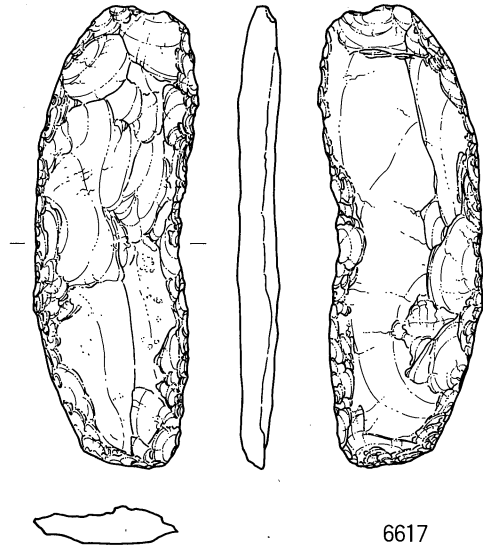

6617

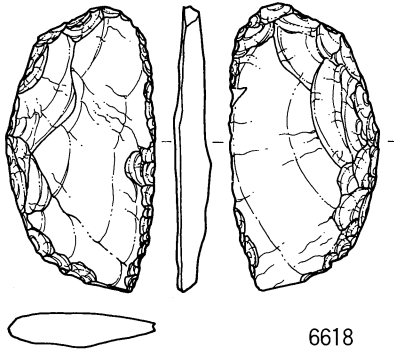

6618

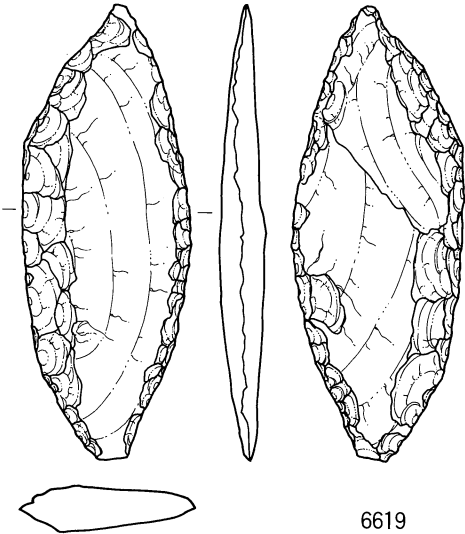

6619

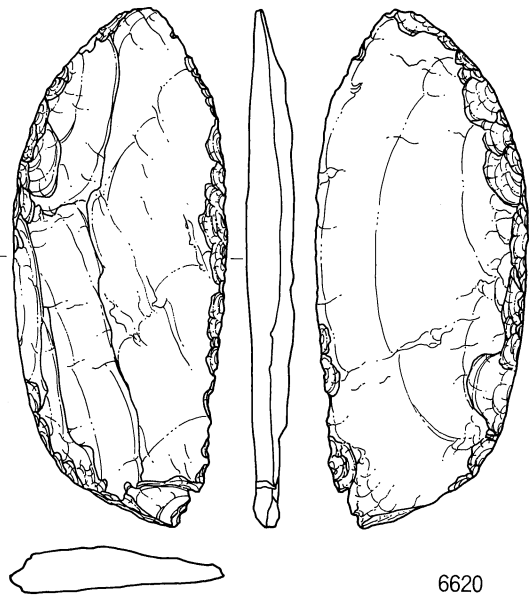

6620



旧河道 SR46001 (6618) SR46002 (6614~6617·6620)
 沟 SD46006 (6619)

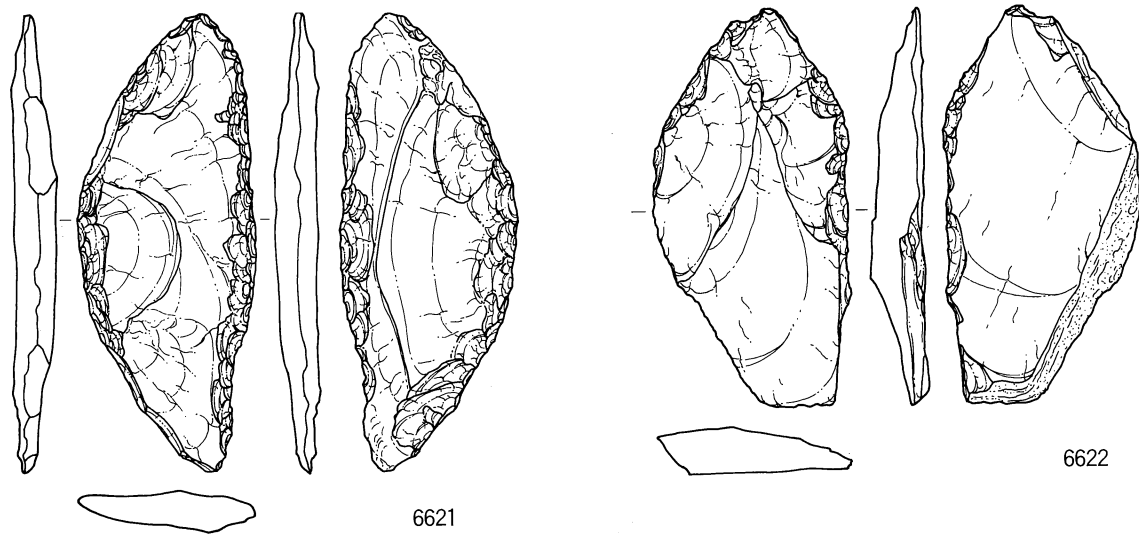

6621

6622

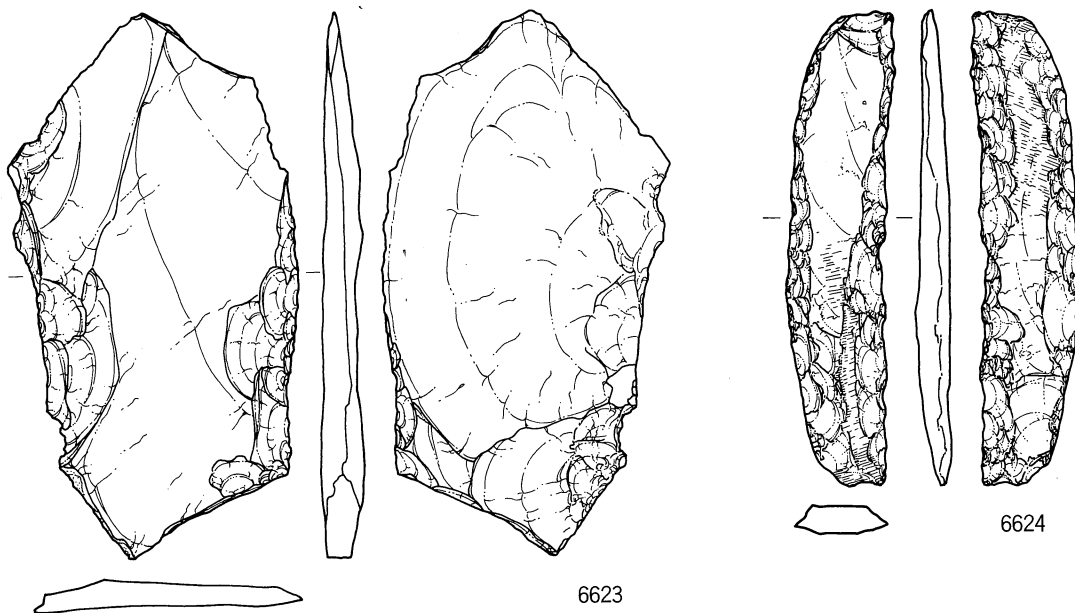

6623

6624

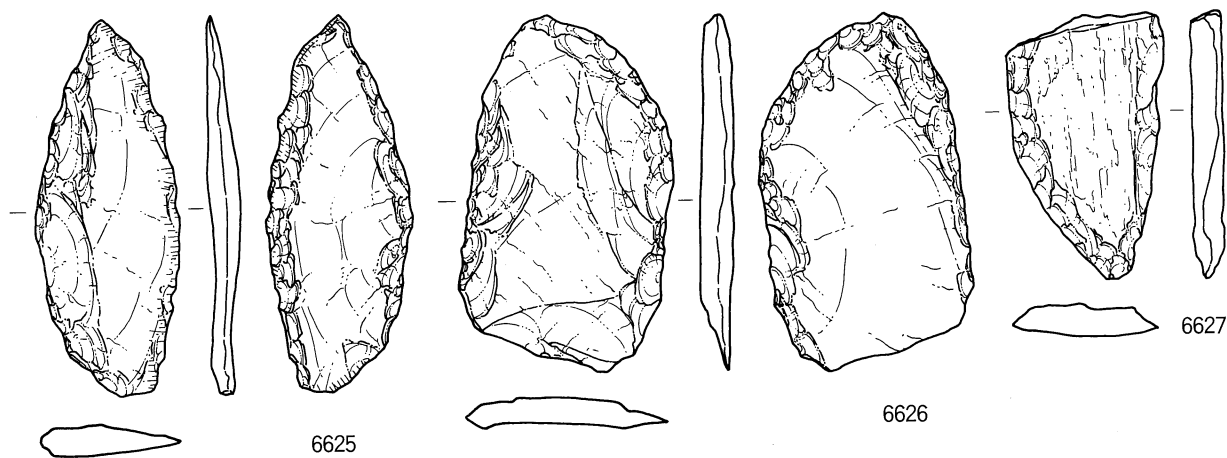

6625

6626

6627



旧河道 SR46001 (6622) SR46002 (6621 · 6623~6627)

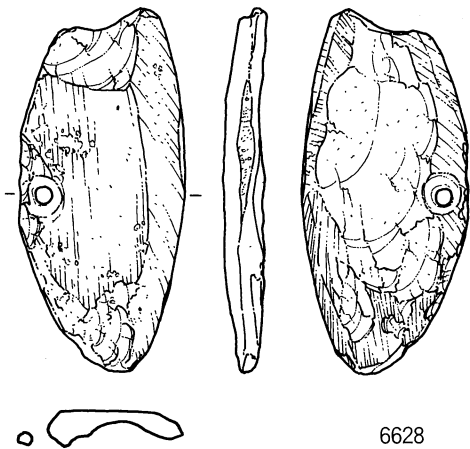

6628

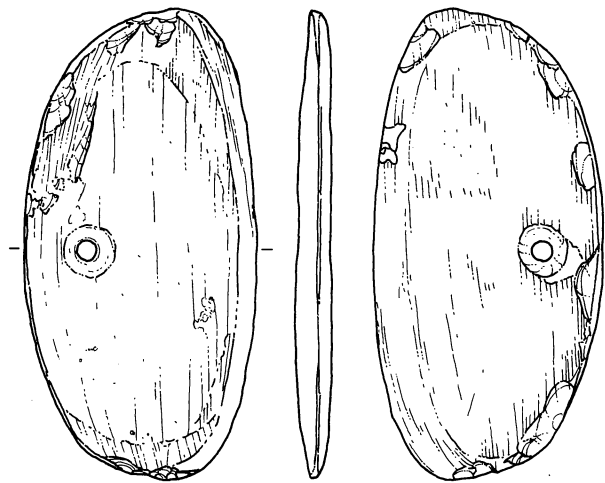

6629

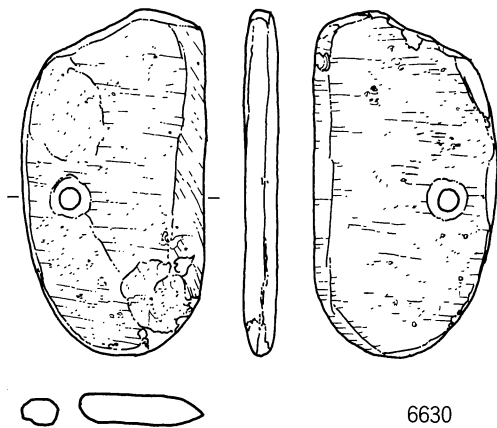

6630

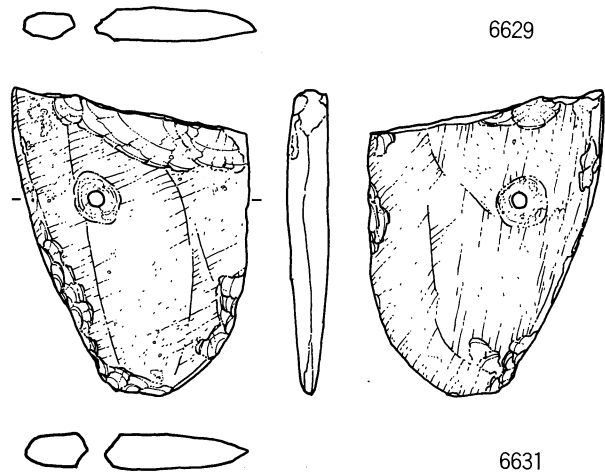

6631

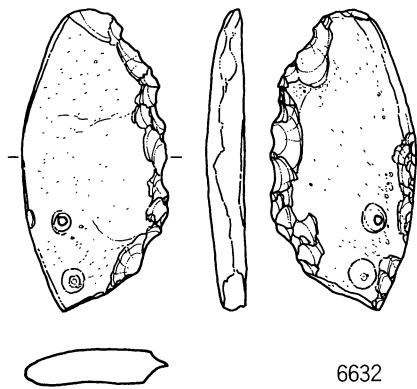

6632

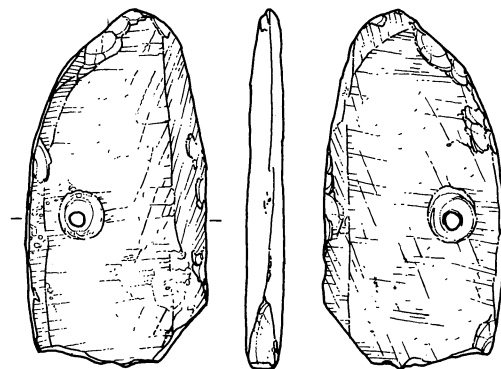

6633

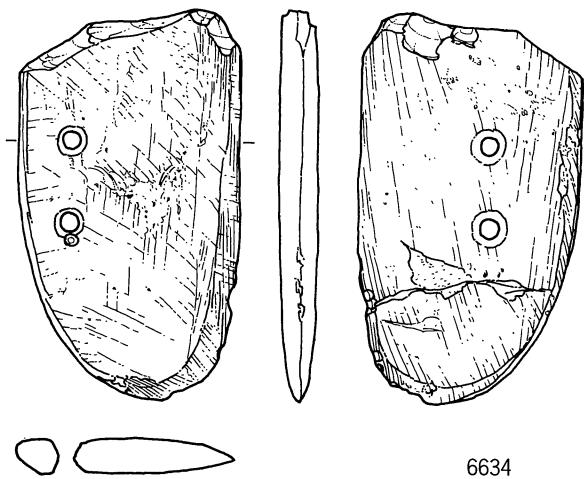

6634

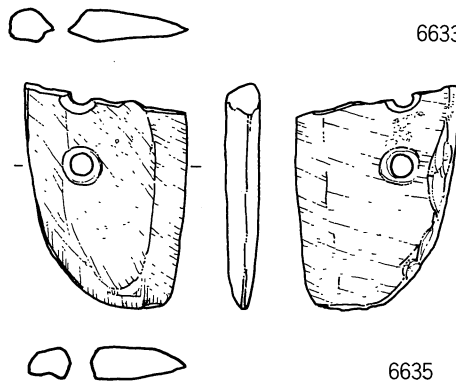

6635



旧河道 SR46001 (6630 · 6634)
 SR46002 (6628 · 6629 · 6631~6633 · 6635)

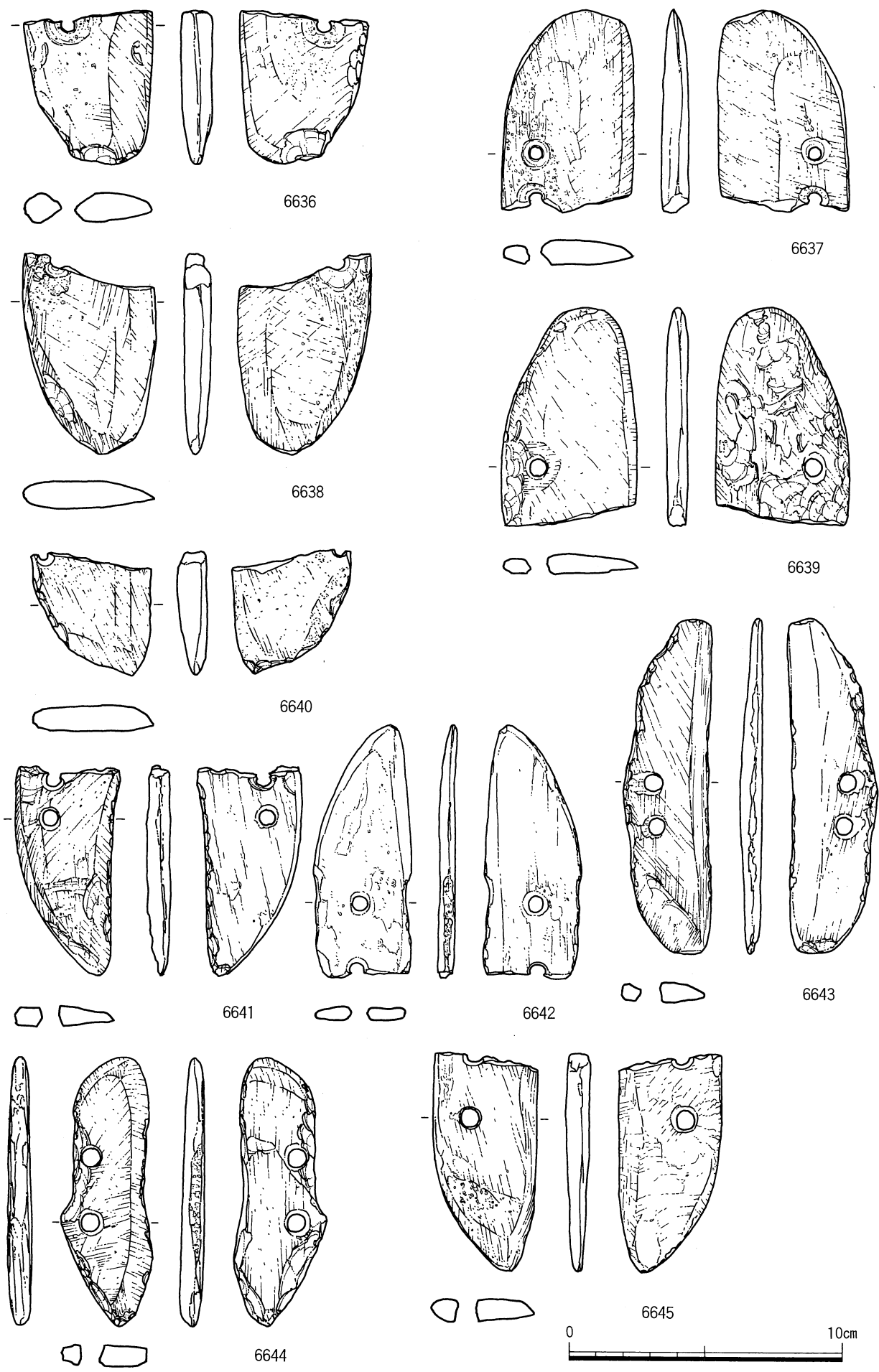

旧河道 SR46001 (6645) SR46002 (6636~6644)

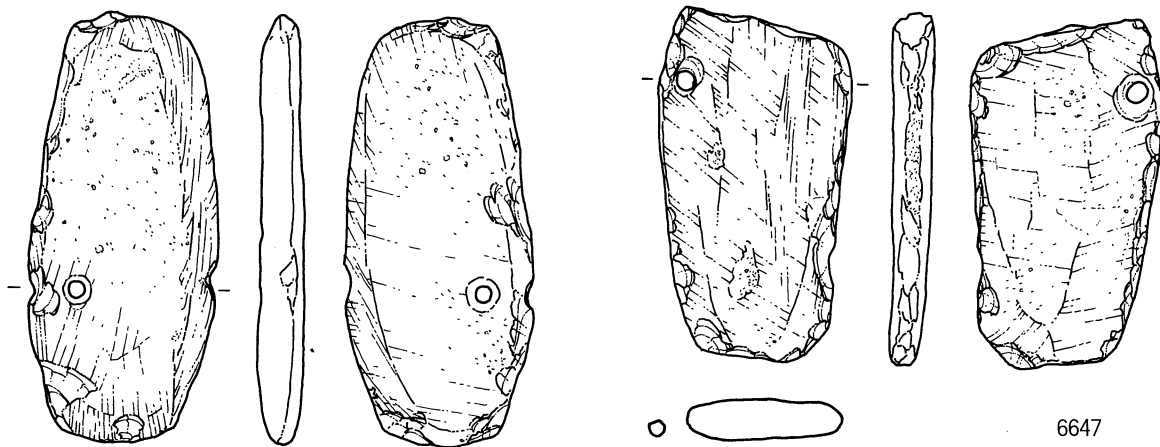

6646

6647

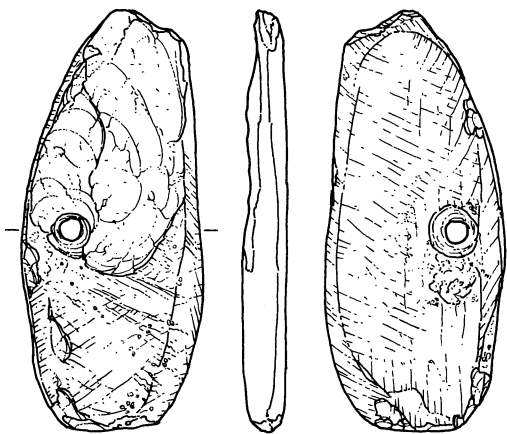
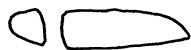

6648

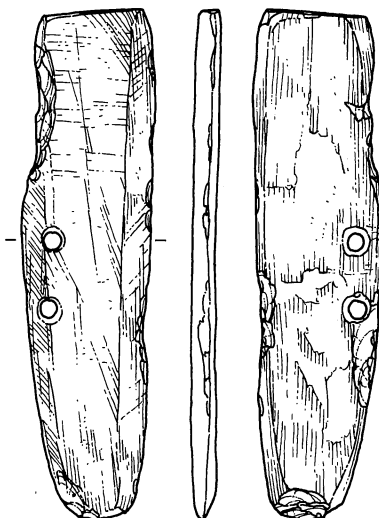

6649

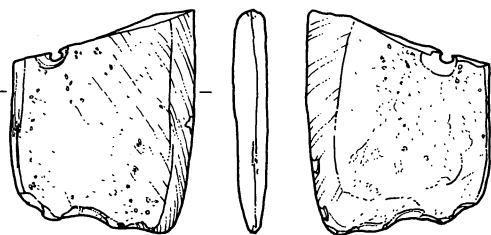

6650

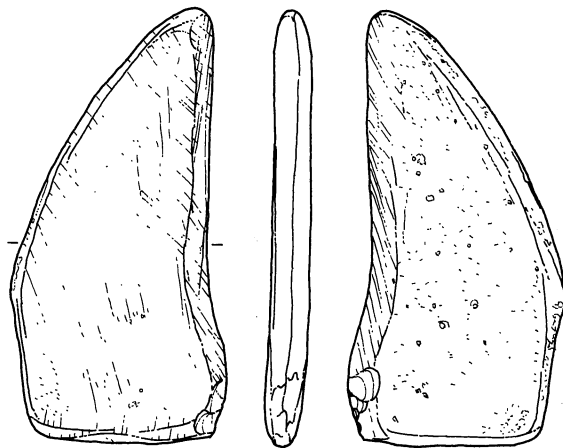

6652

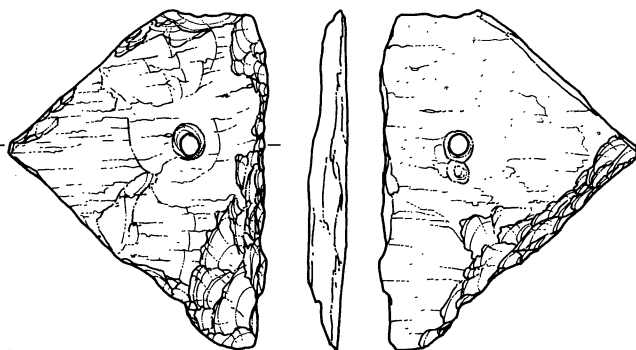

6651

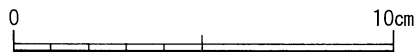

旧河道 SR46001 (6649 · 6650) SR46002 (6646 · 6647 · 6651 · 6652)
 溝 SD56002 (6648)

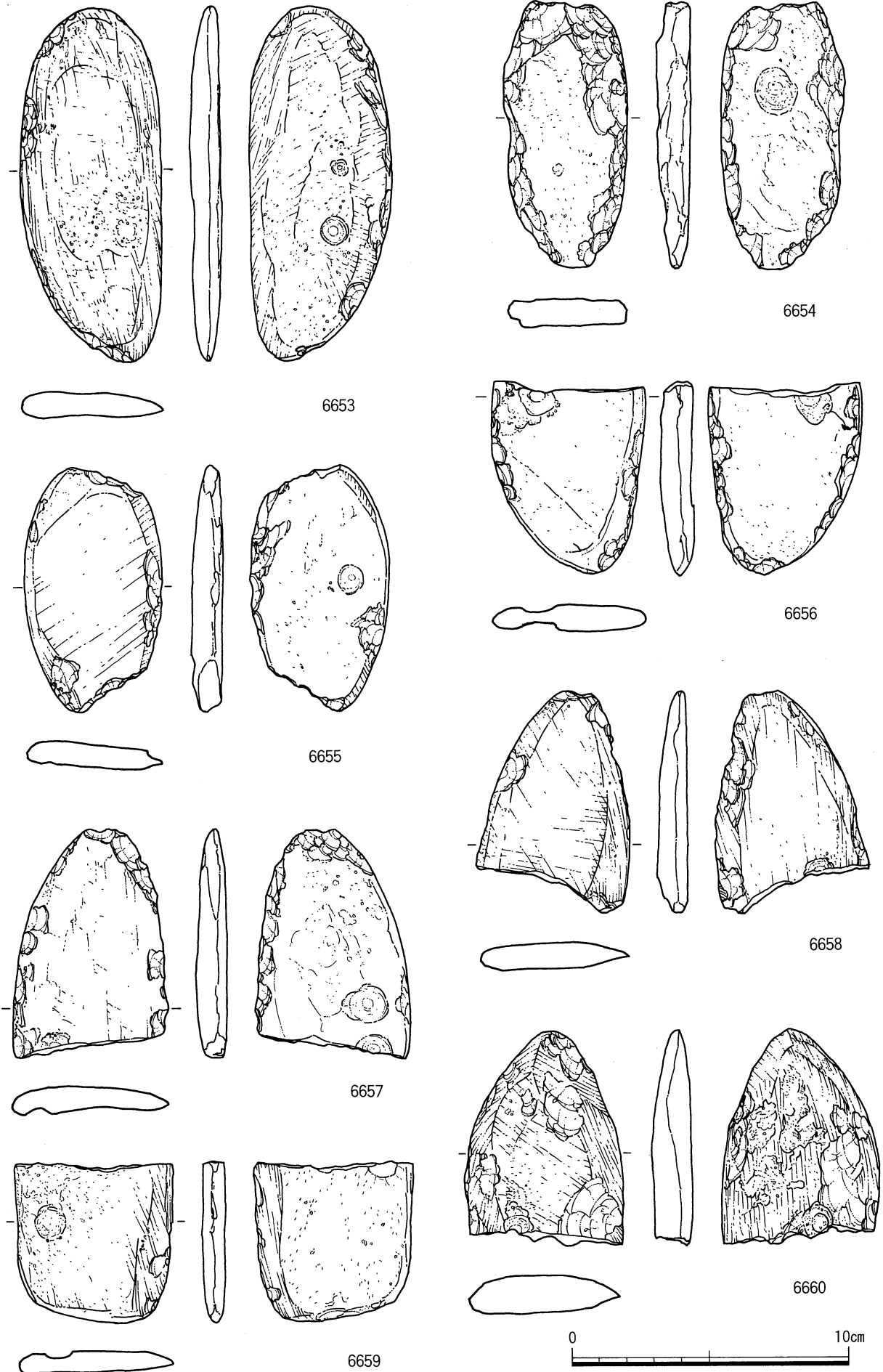

旧河道 SR46001 (6653 · 6656)
 SR46002 (6654 · 6655 · 6657 · 6658 · 6660)
 溝 SD66002 (6659)

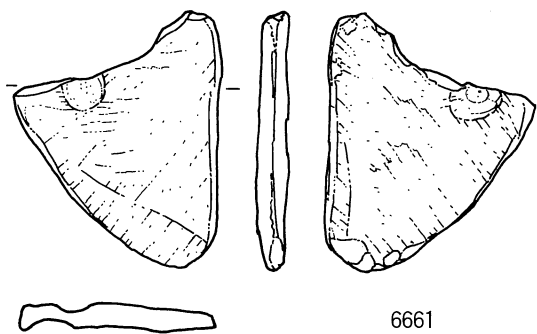

6661

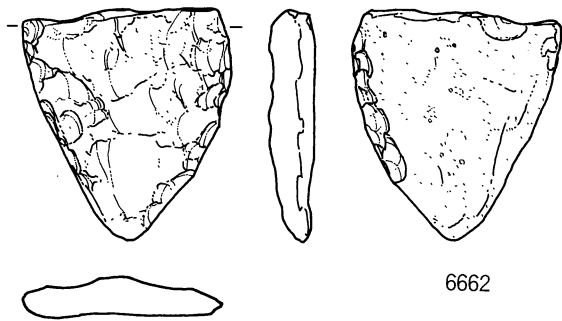

6662

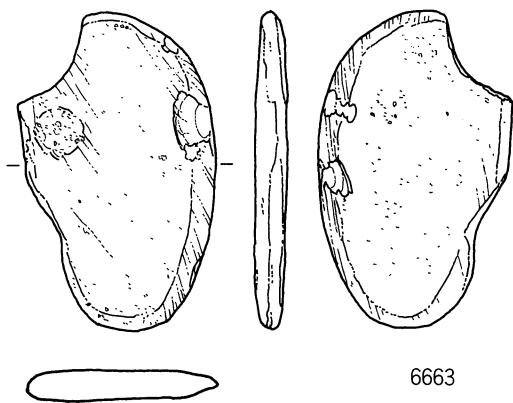

6663

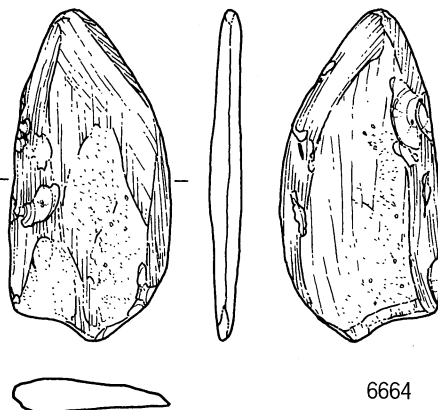

6664

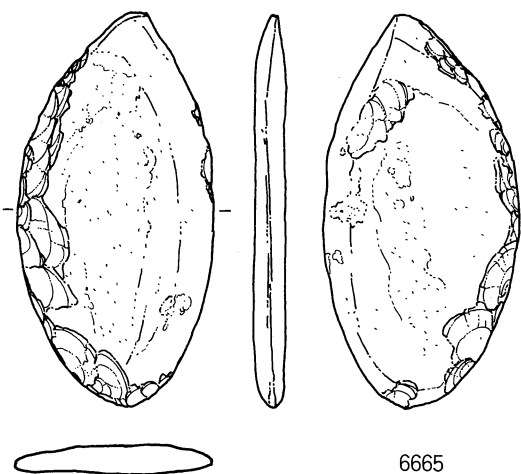

6665

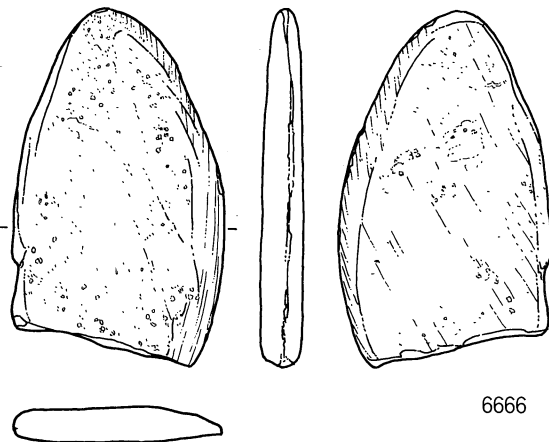

6666

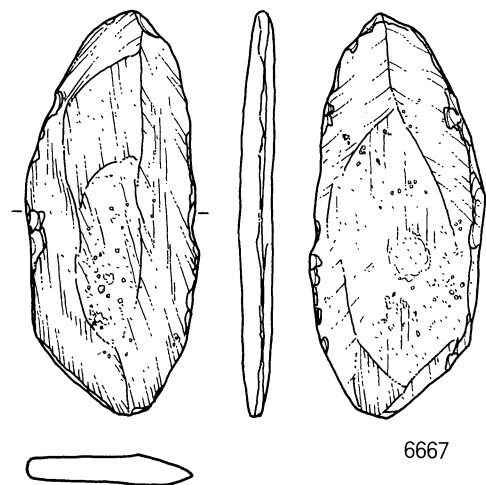

6667

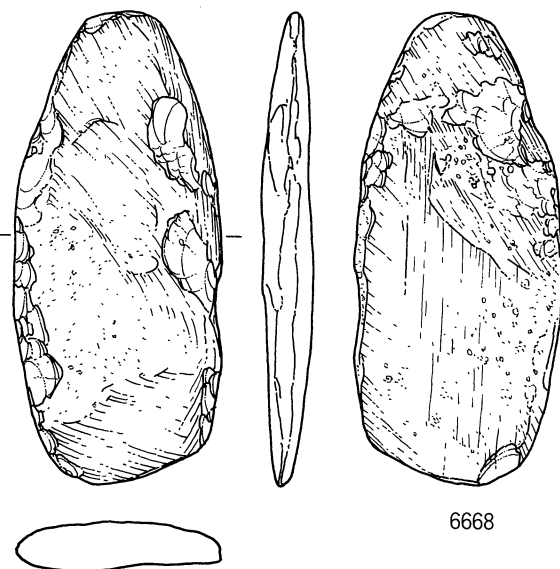

6668

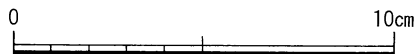

旧河道 SR46001 (6667) SR46002 (6663~6666·6668)
 溝 SD46002 (6662) SD46008 (6661)

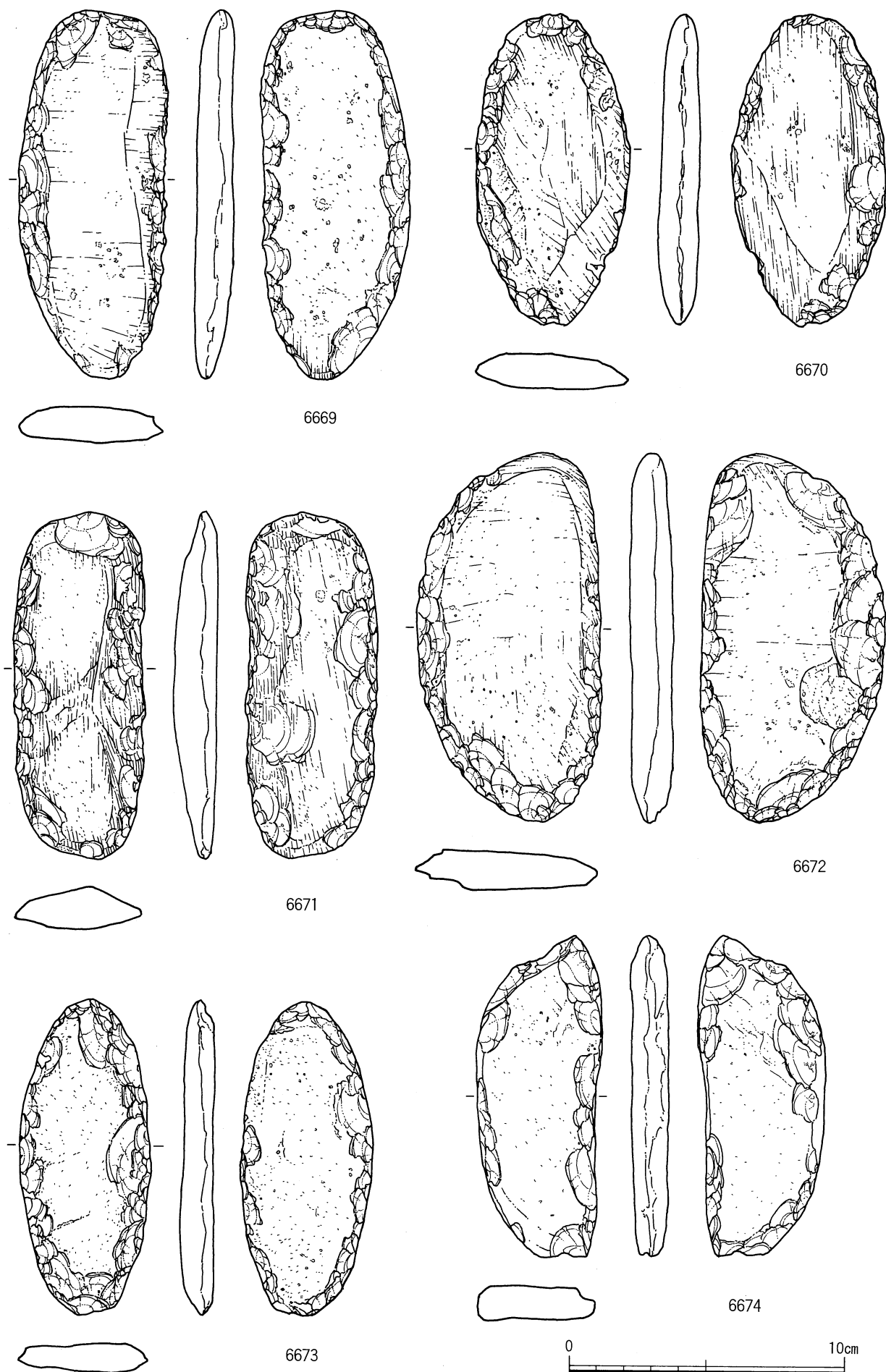

旧河道 SR46002 (6669)
沟 SD46008 (6670~6674)

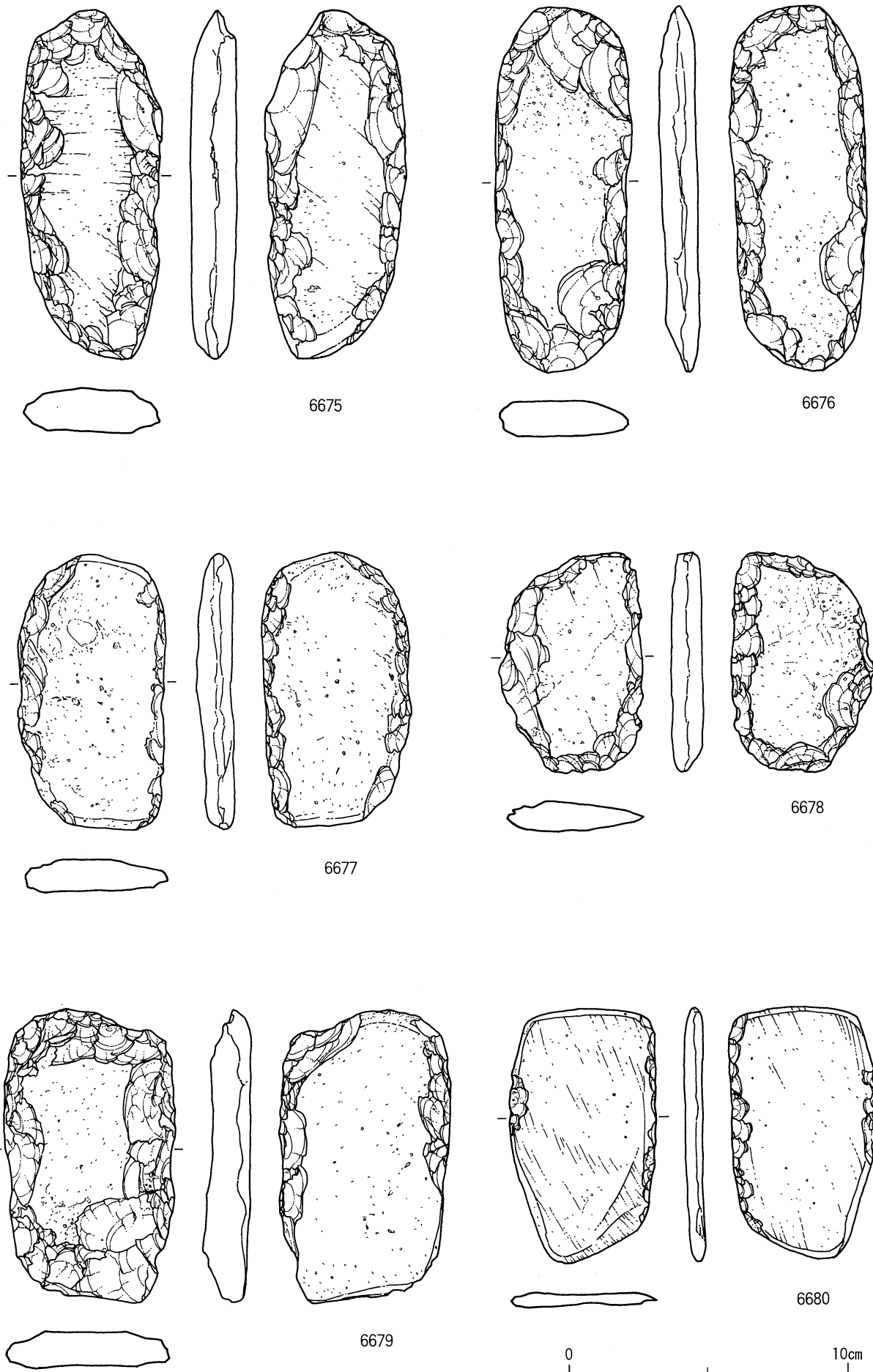

6675

6676

6677

6678

6679

6680



旧河道 SR46001 (6675 · 6677 · 6679 · 6680) SR46002 (6676)
 溝 SD56002 (6678)

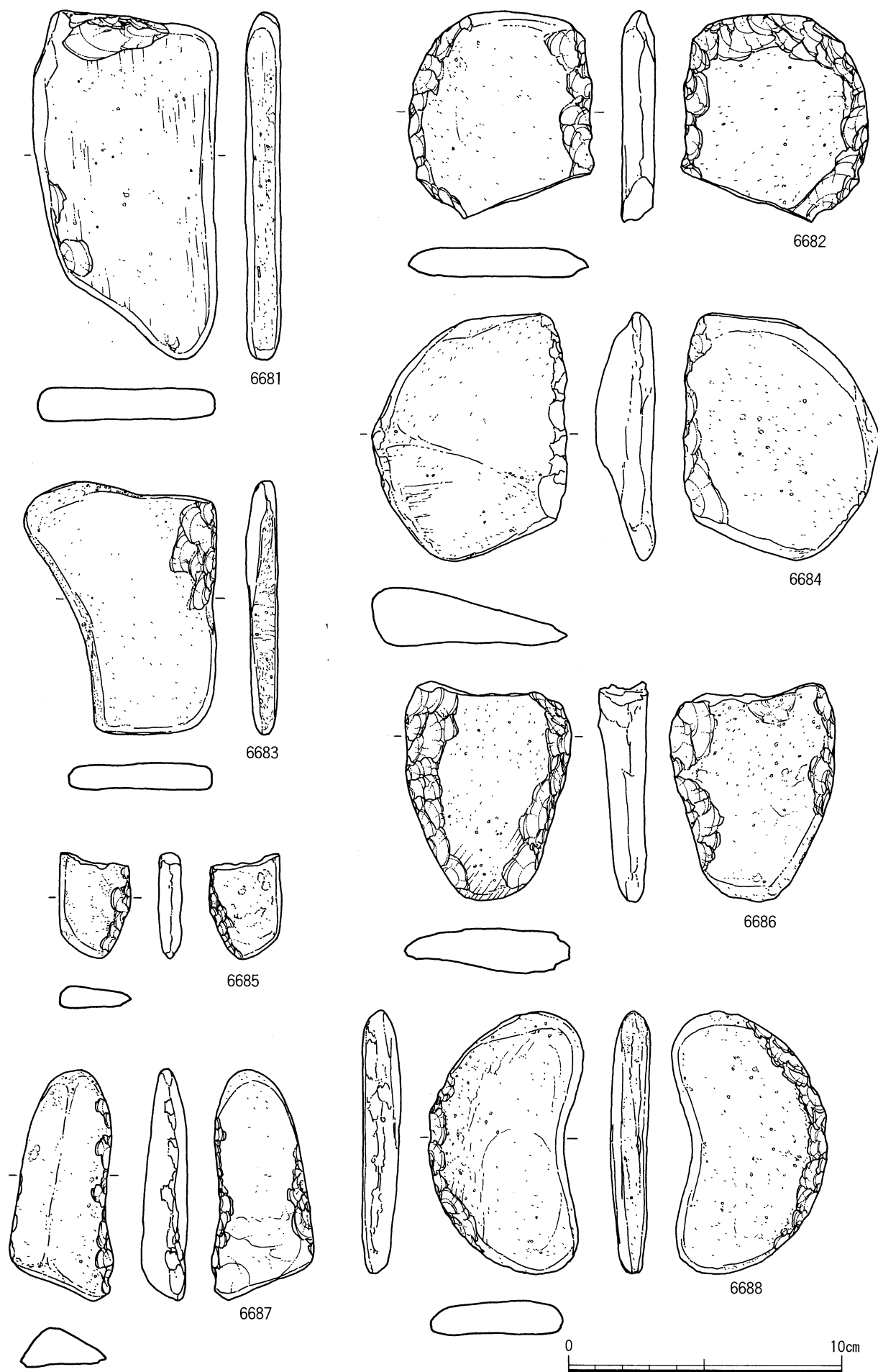

旧河道 SR46001 (6684) SR46002 (6681~6683 · 6685 · 6686 · 6688)
 溝 SD46008 (6687)

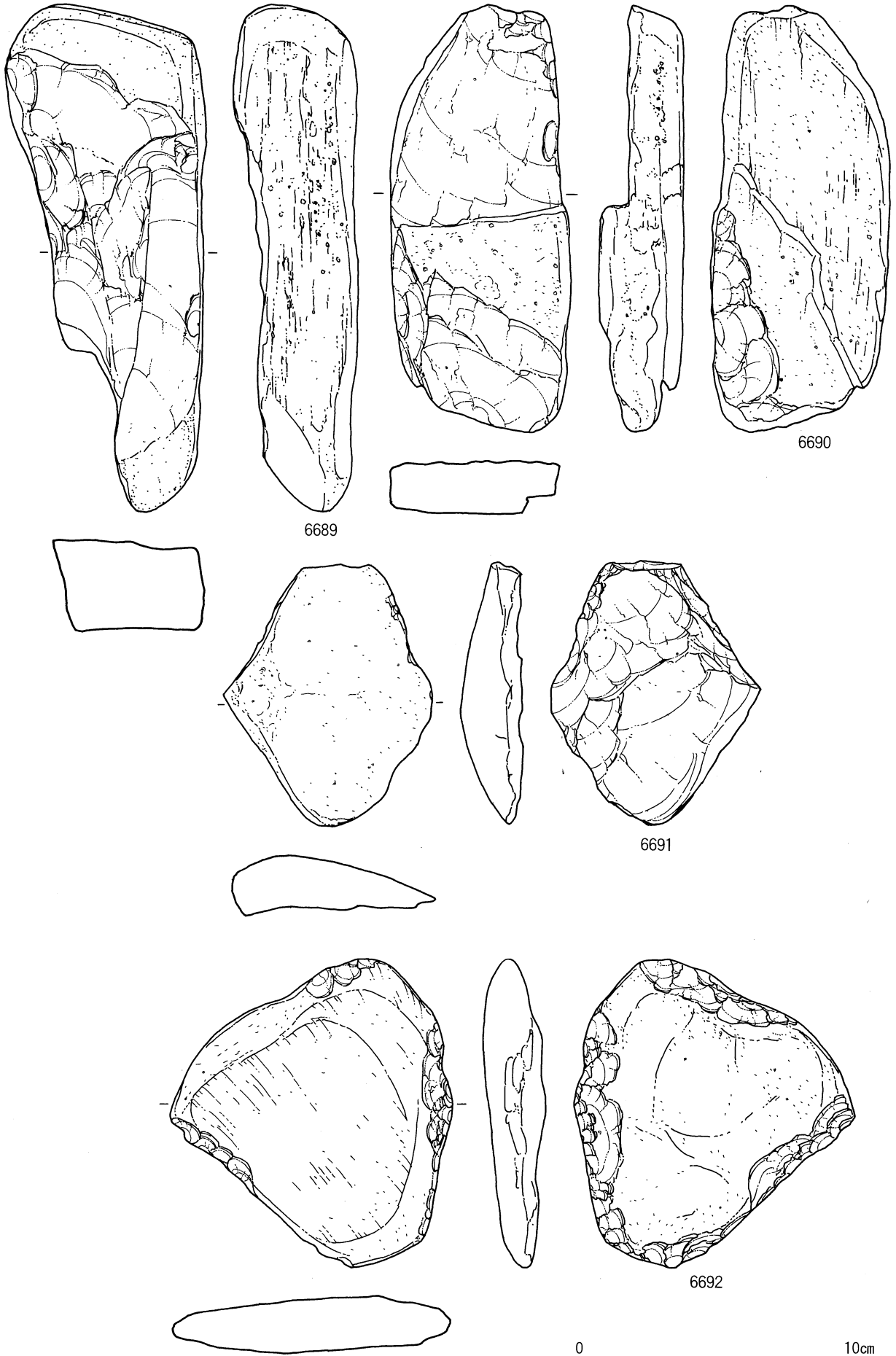

旧河道 SR46001 (6691) SR46002 (6689 · 6690 · 6692)

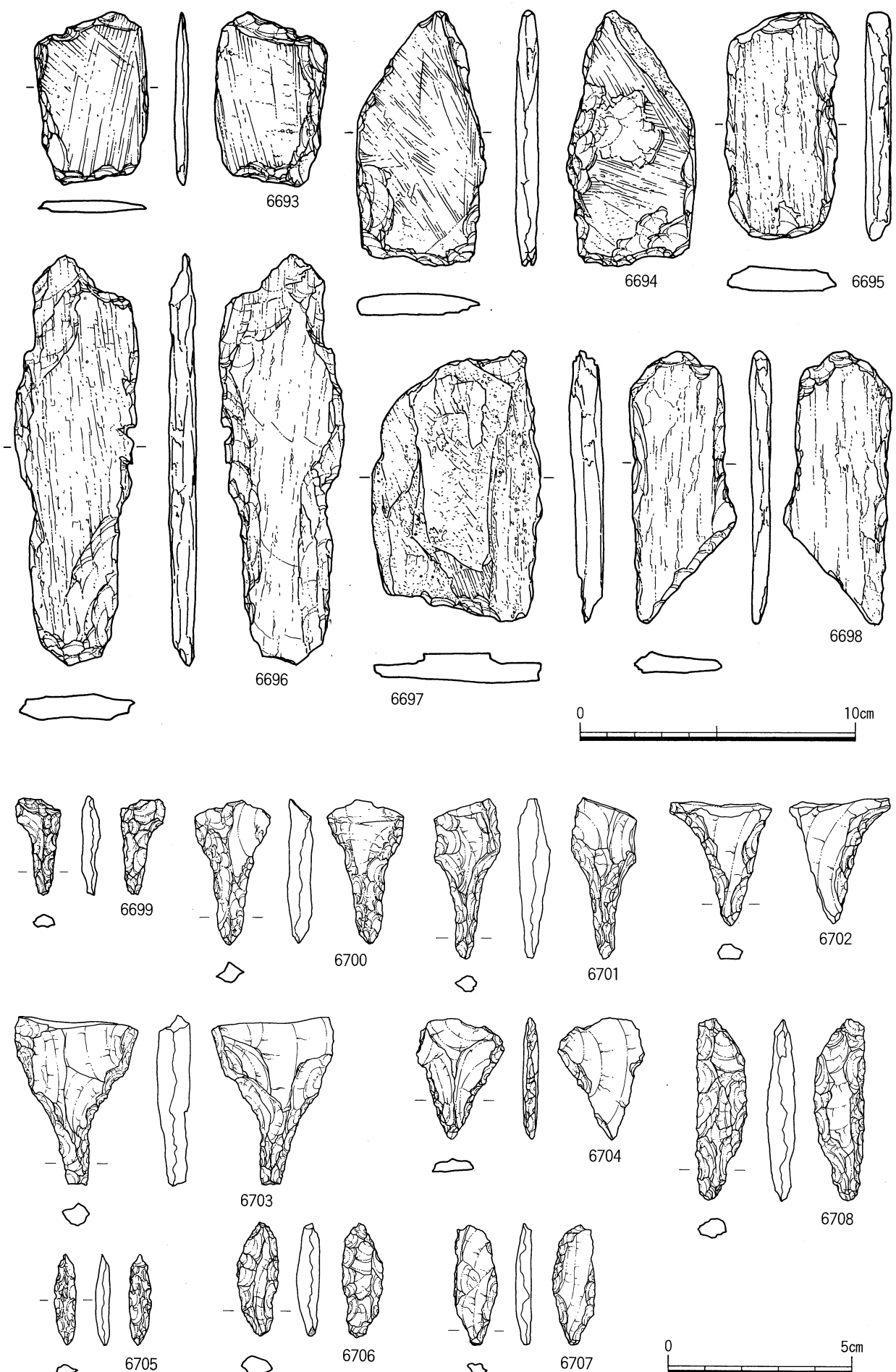

旧河道 SR46001 (6693 · 6707)

SR46002 (6694 · 6695 · 6697~6704 · 6706 · 6708)

溝 SD46008 (6705) SD56005 (6696)

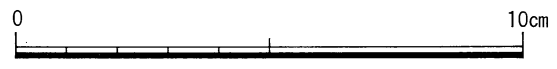
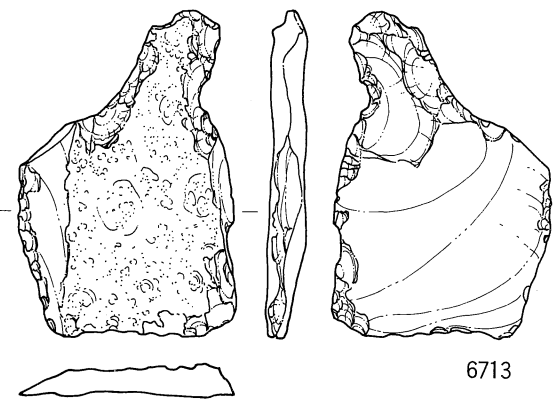
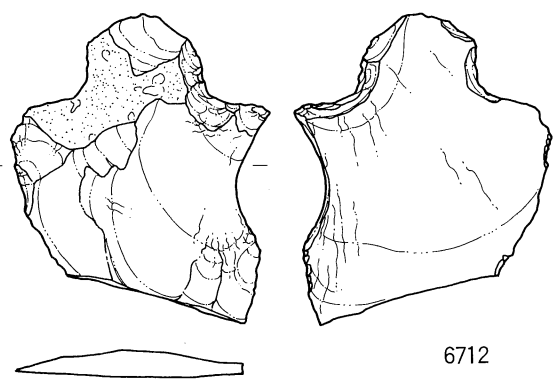
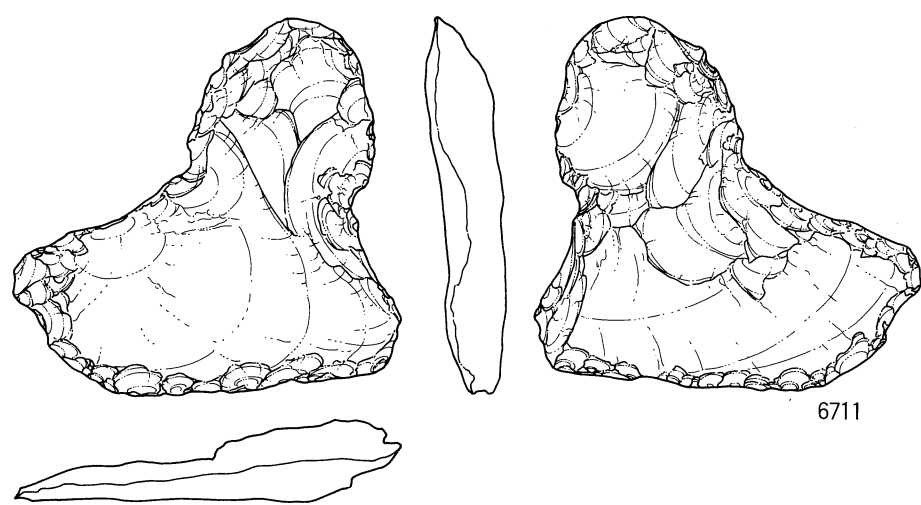
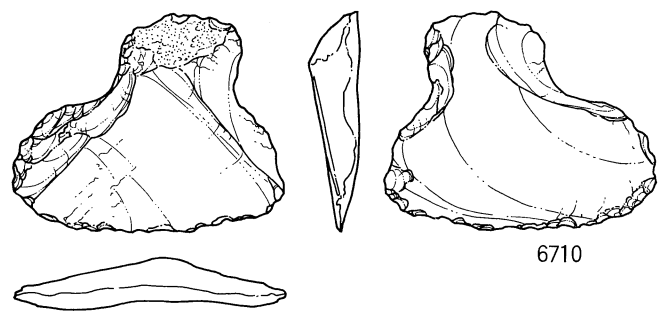
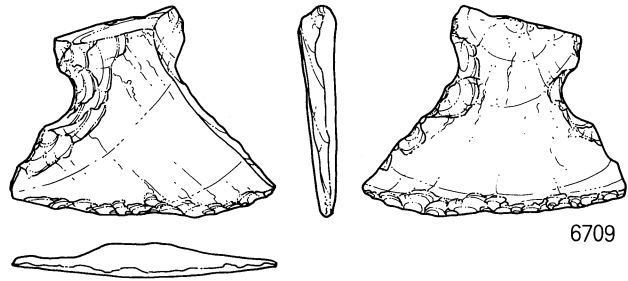

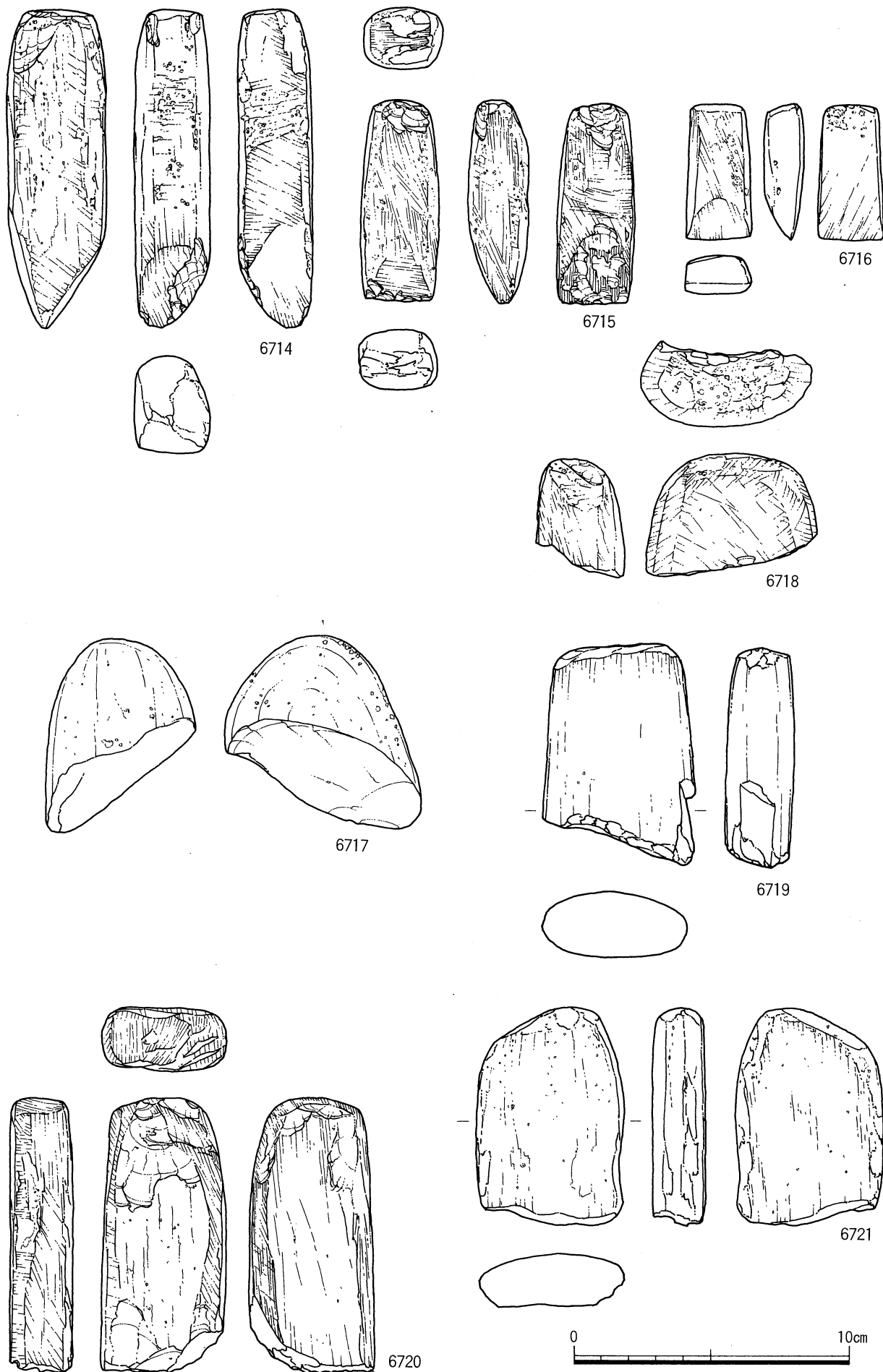

旧河道 SR46001 (6716) SR46002 (6714 · 6715 · 6717~6721)

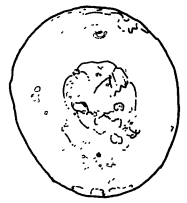
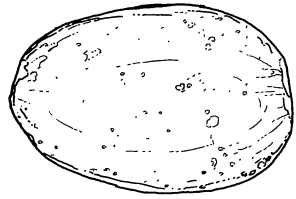
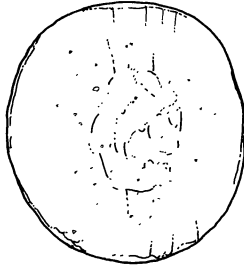
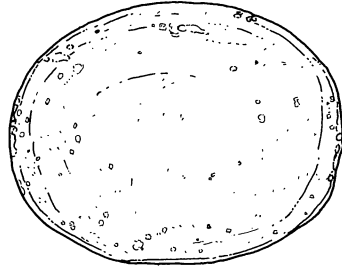
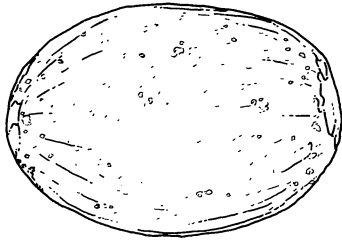
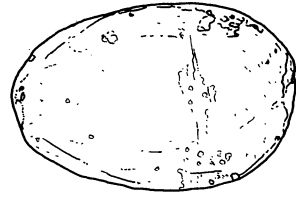
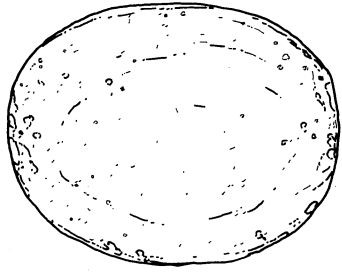

6723

6722

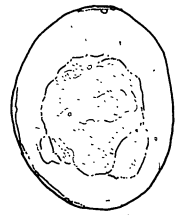
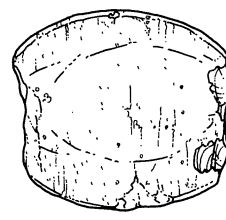
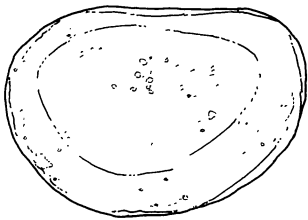
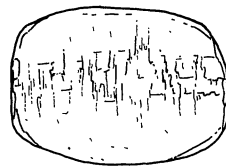
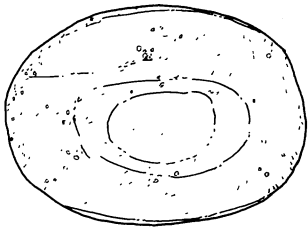
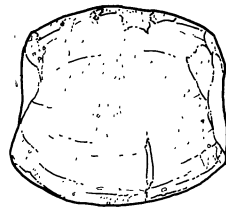

6725

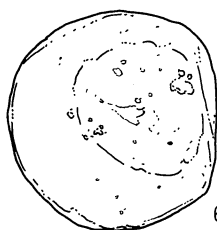
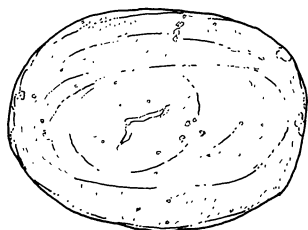

6724



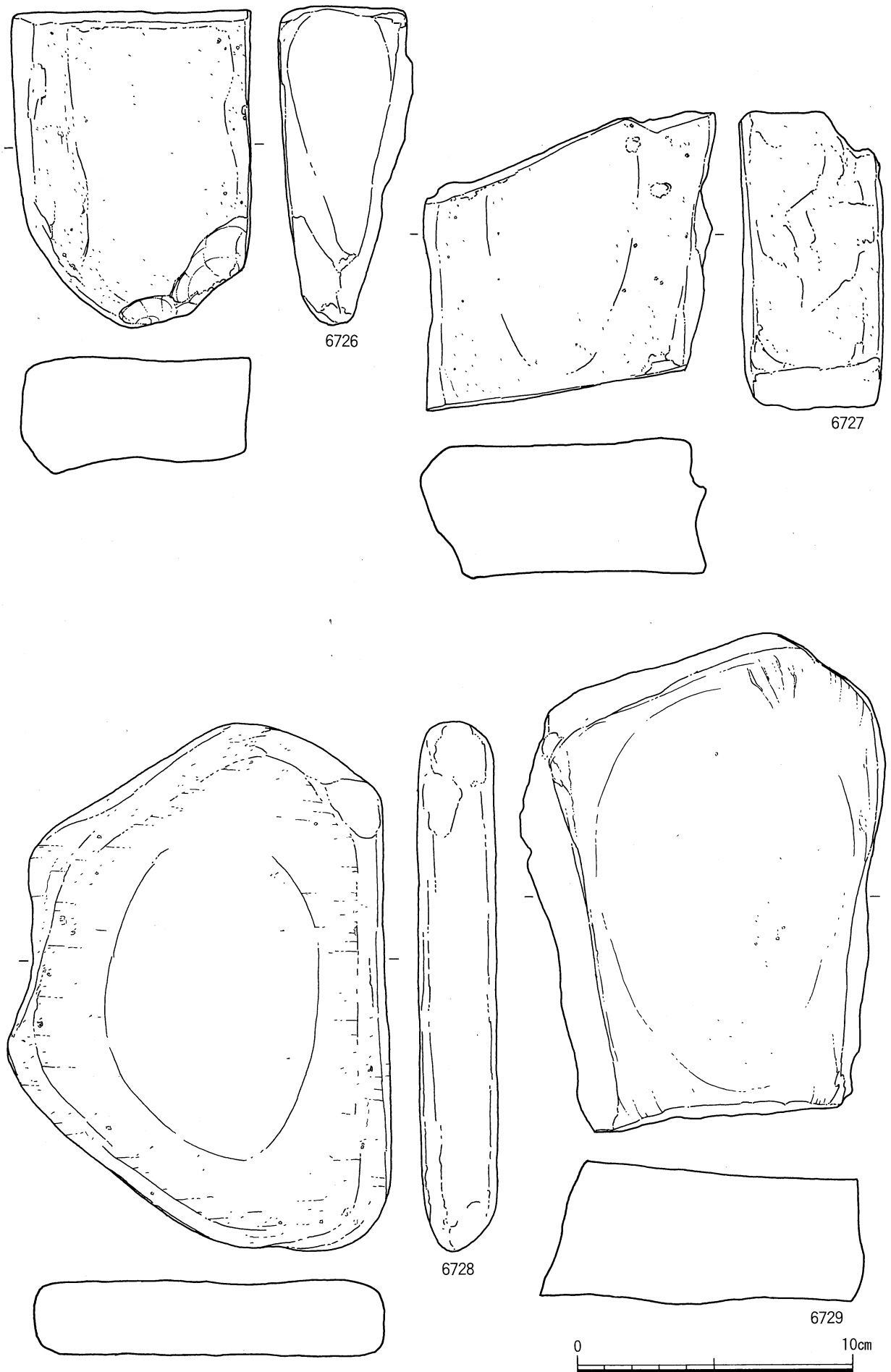

旧河道 SR46001 (6728) SR46002 (6726 · 6727 · 6729)

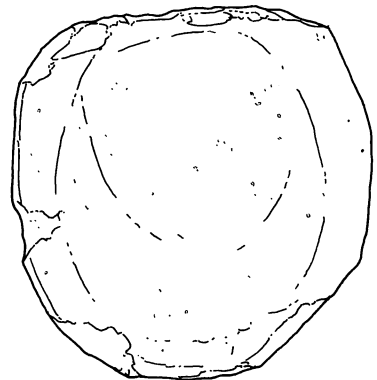
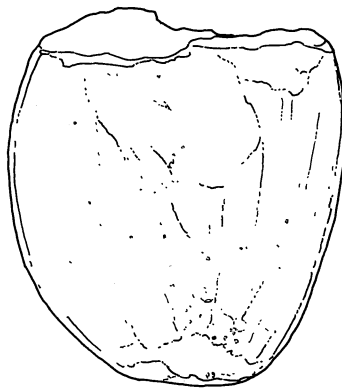
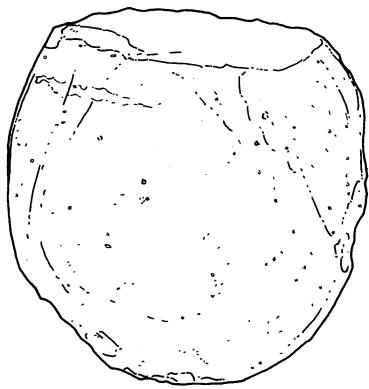

6730

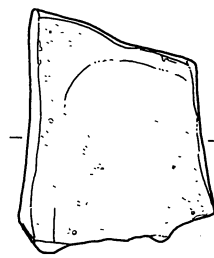
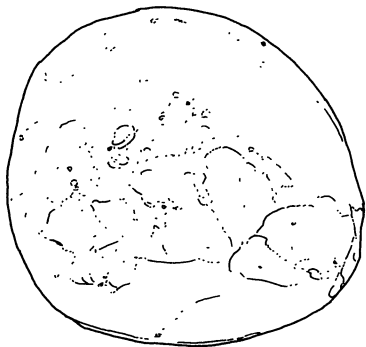

6731

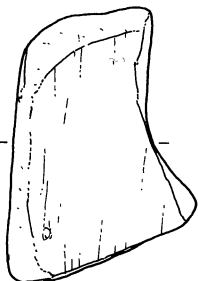

6732

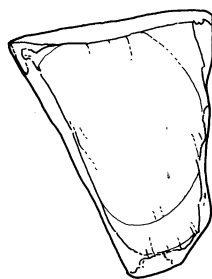
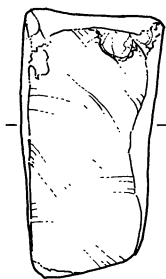

6733

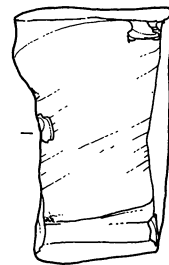

6734

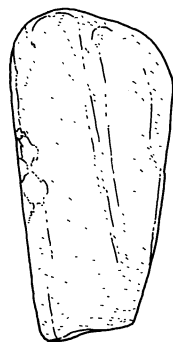
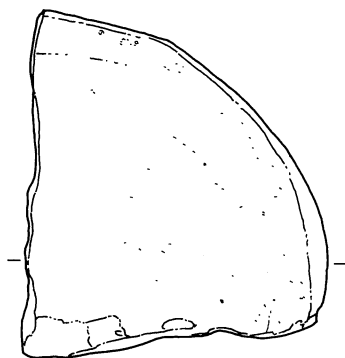
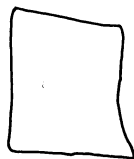

6736

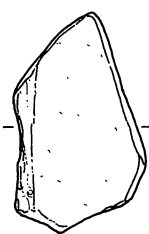

6737



6735



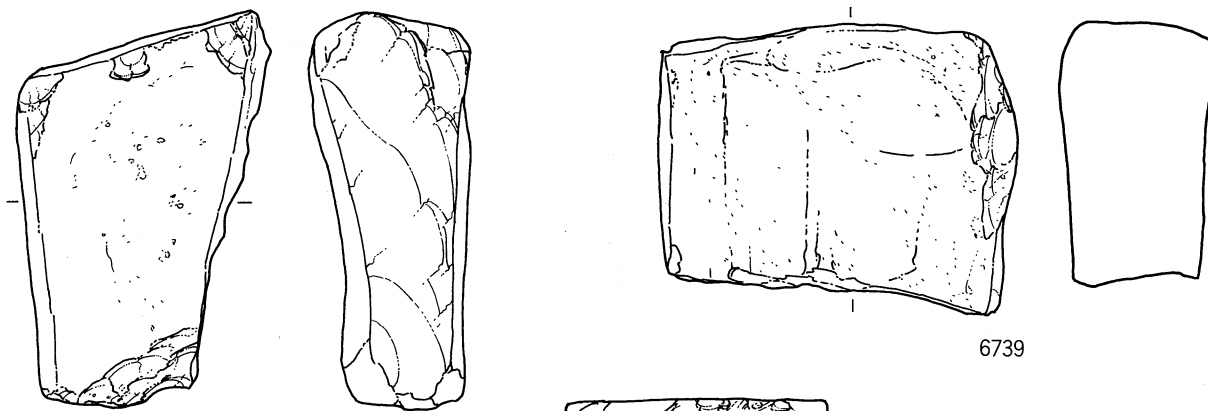

6738

6739

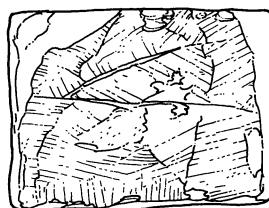

6740

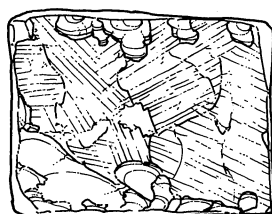

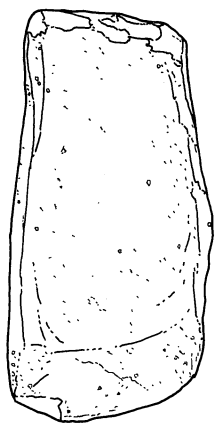
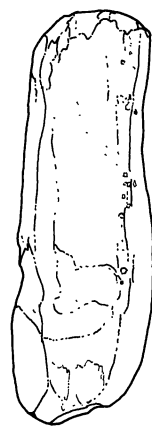
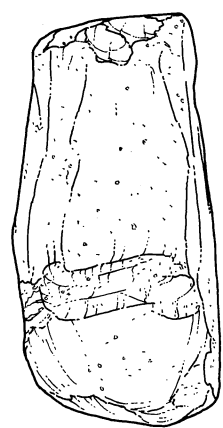
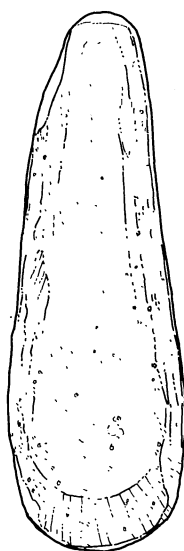
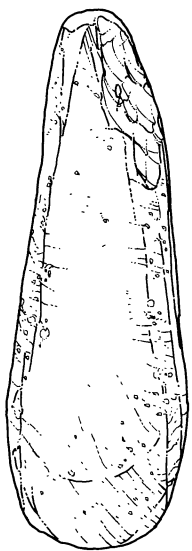
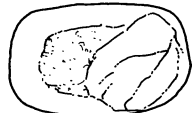

6741

6742

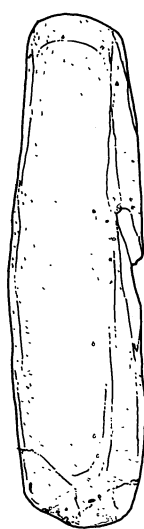
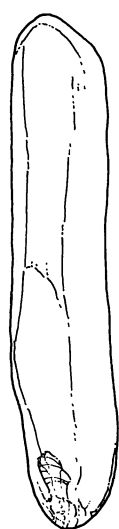

6743

6744

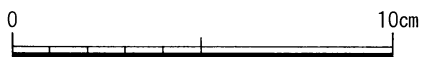

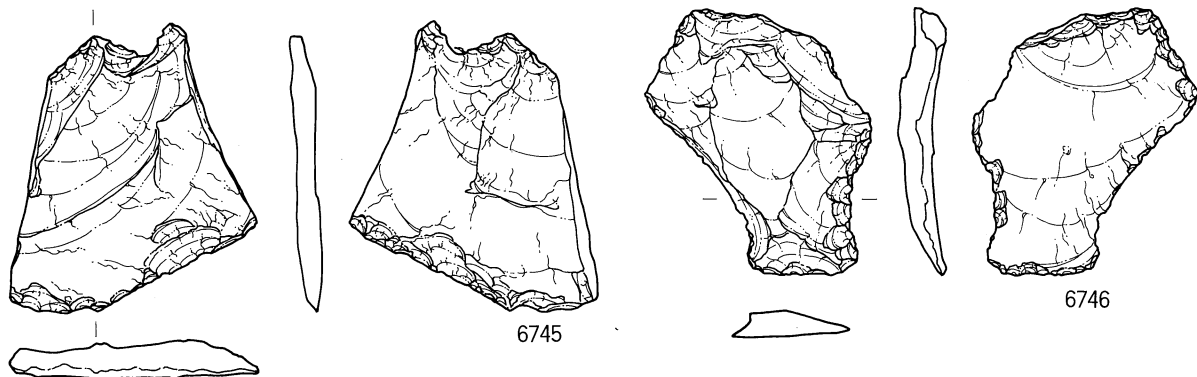

6745

6746

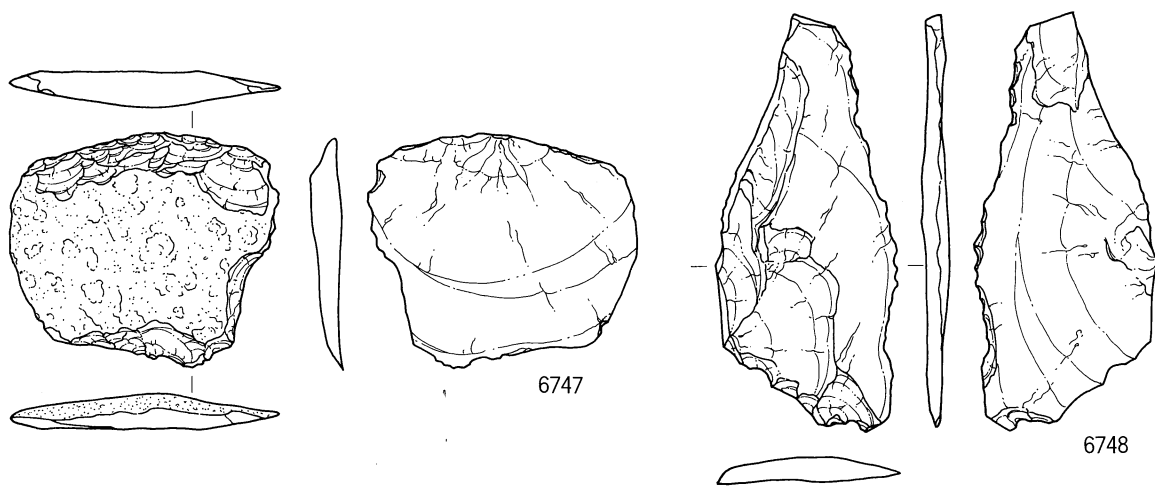

6747

6748

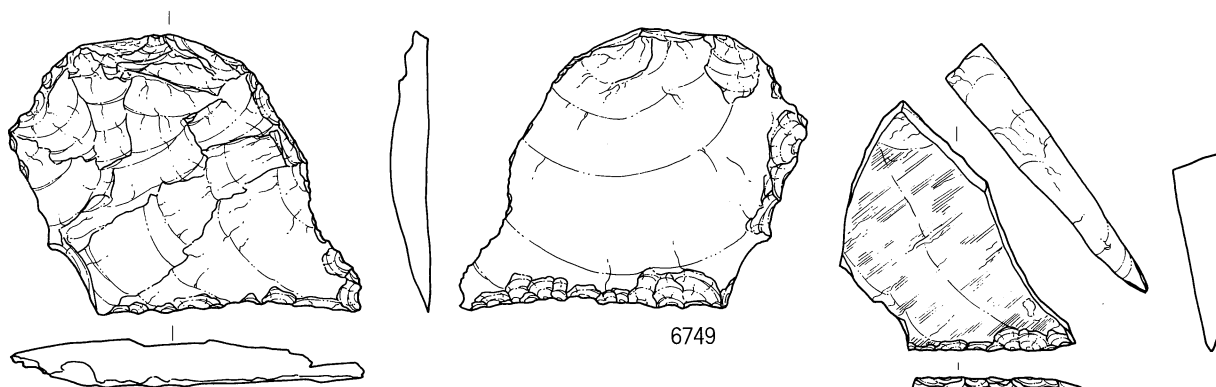

6749

6751

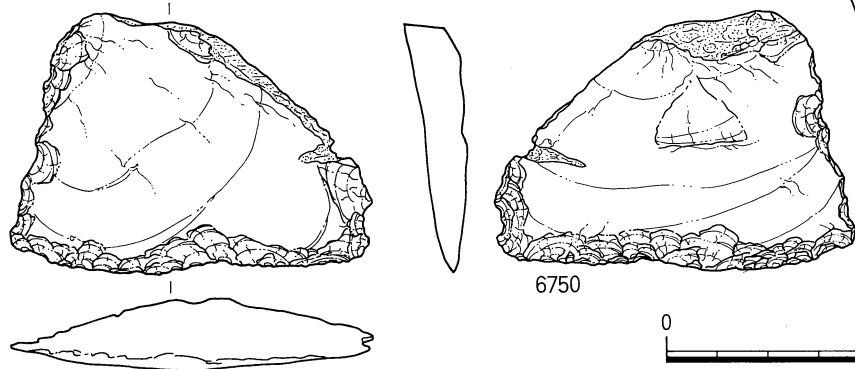

6750



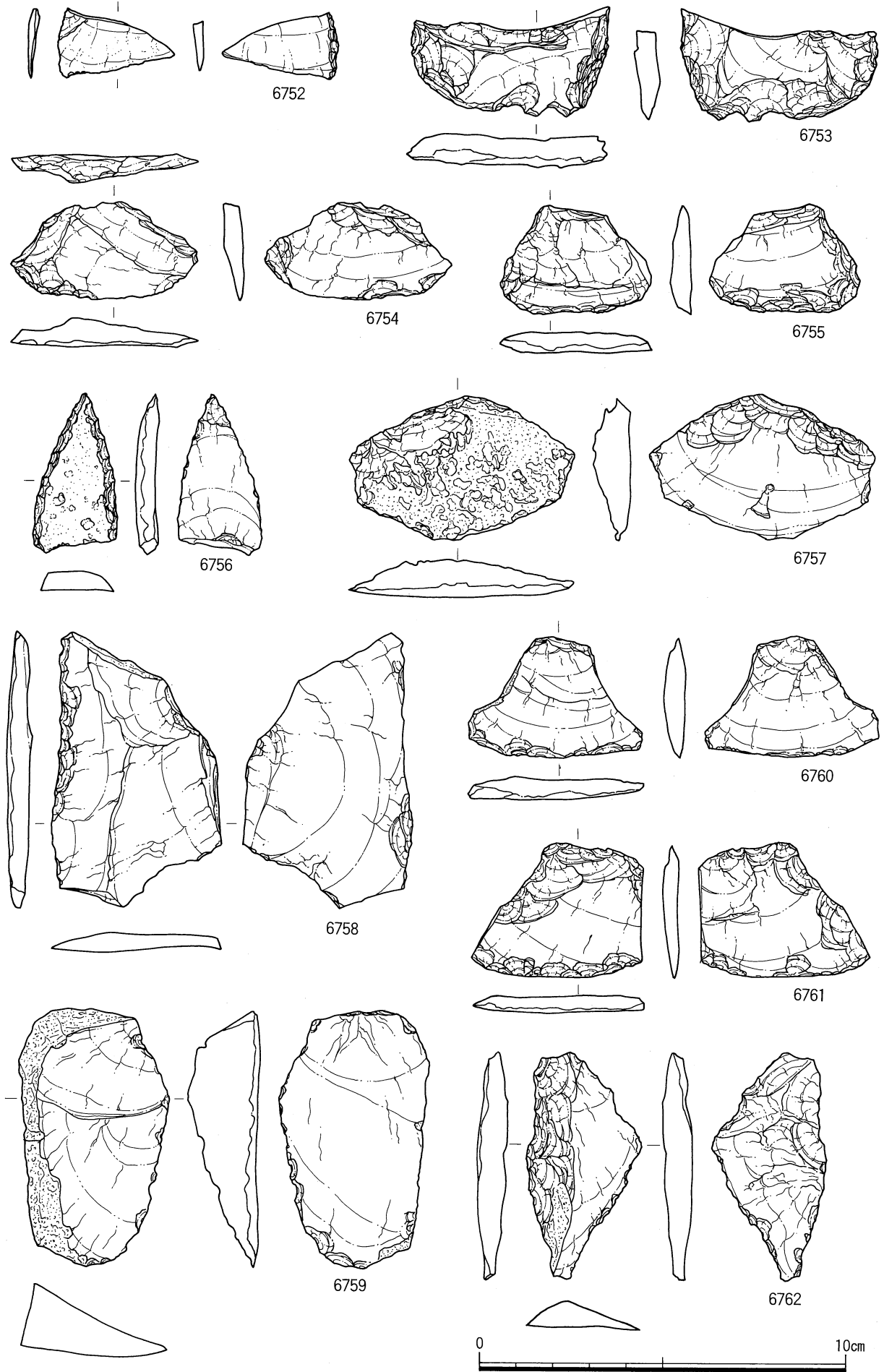

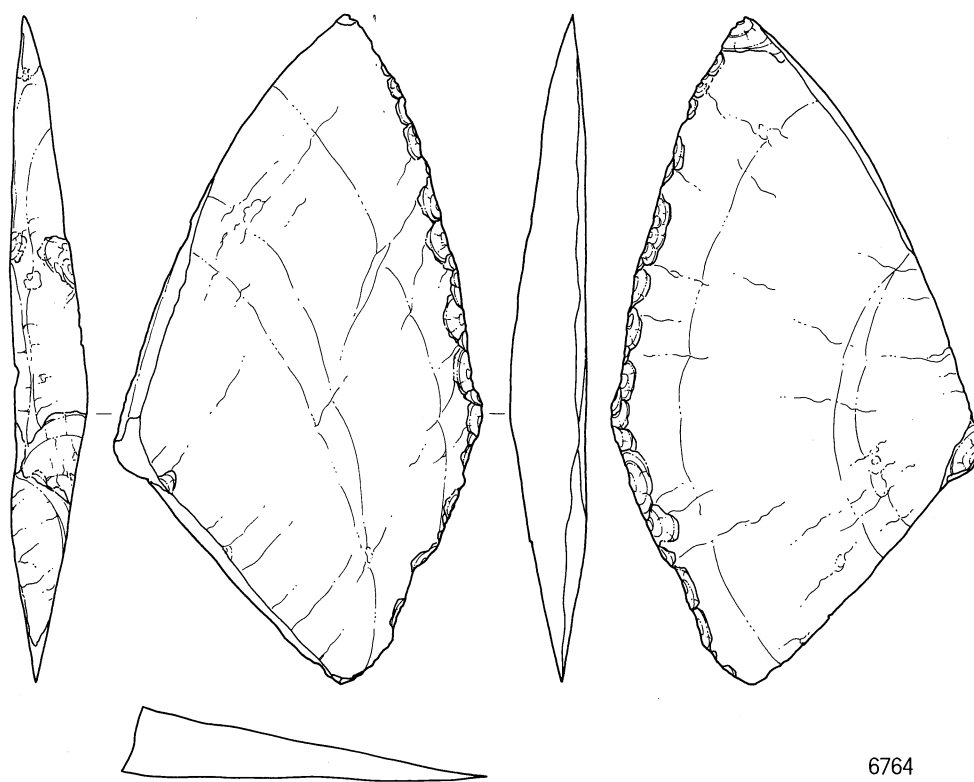
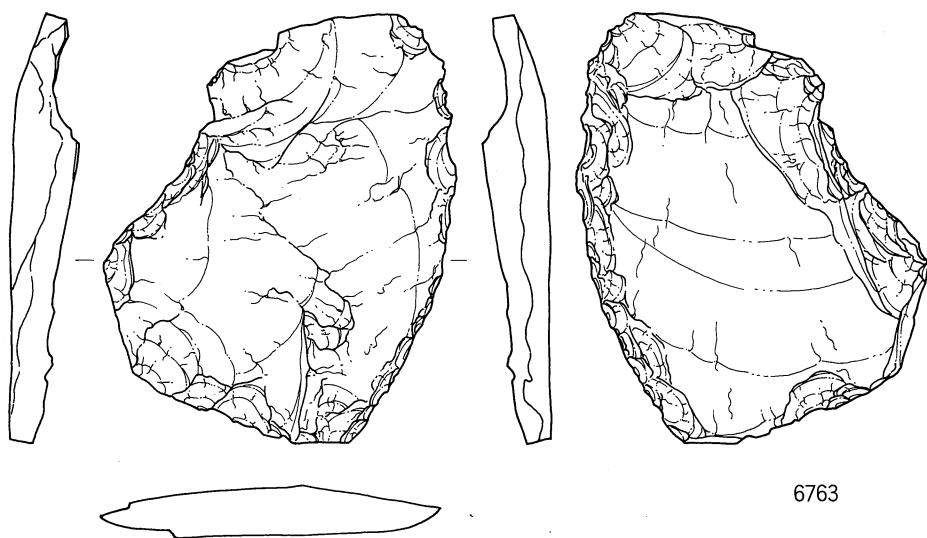

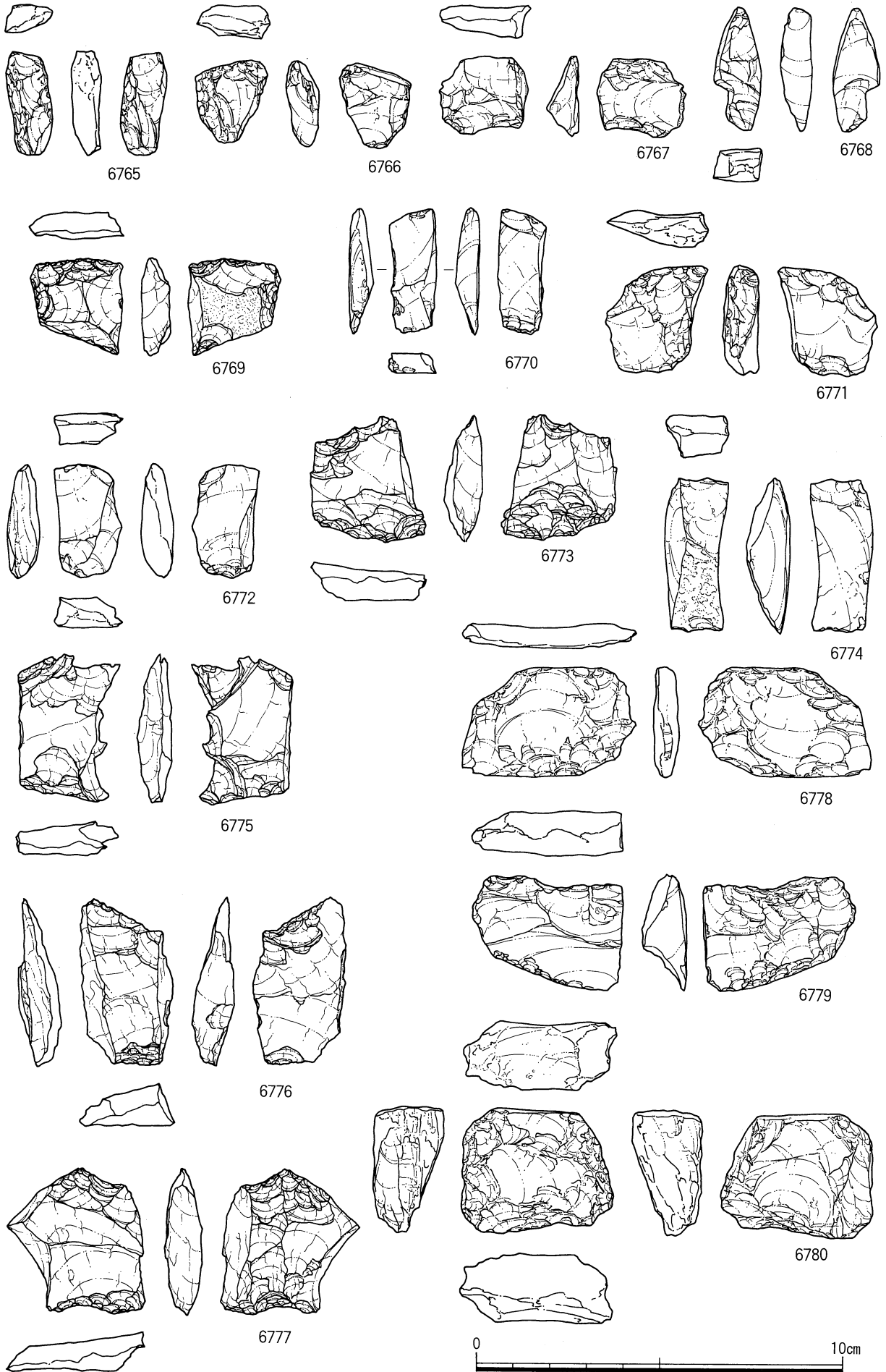

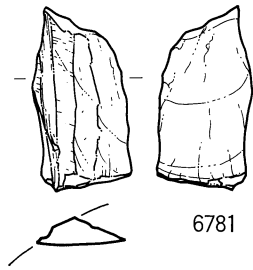

6781

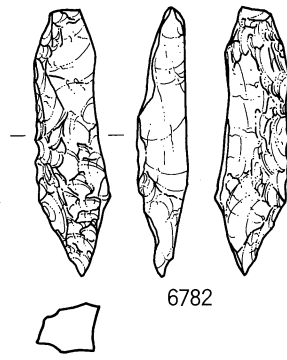

6782



6783

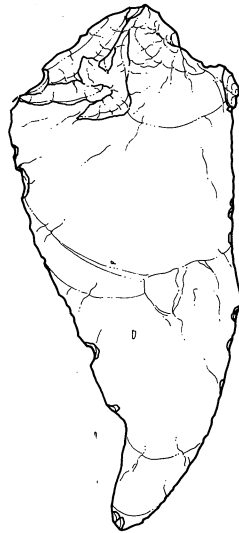

6784

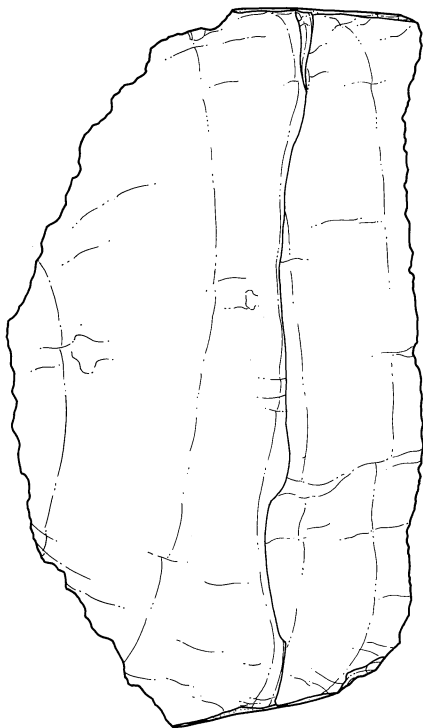

6785



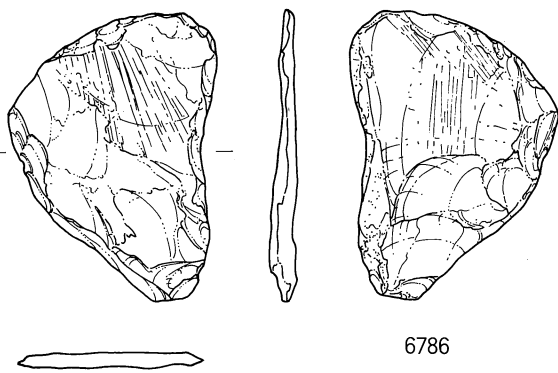

6786

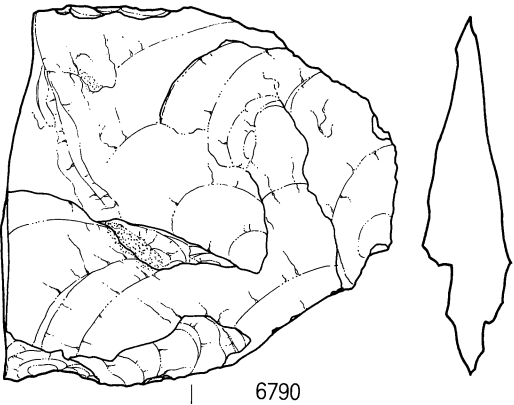
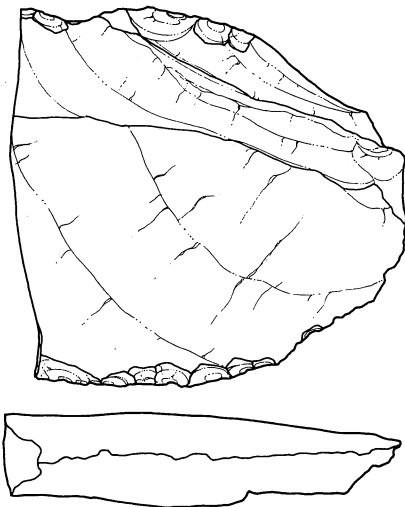

6790



6787

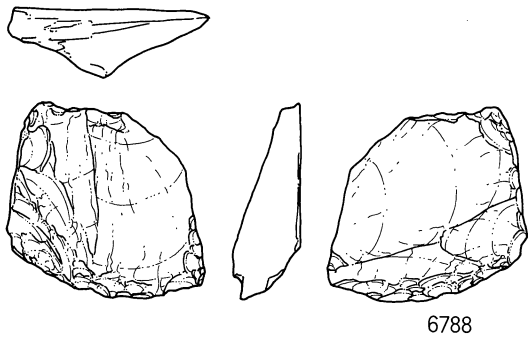

6788

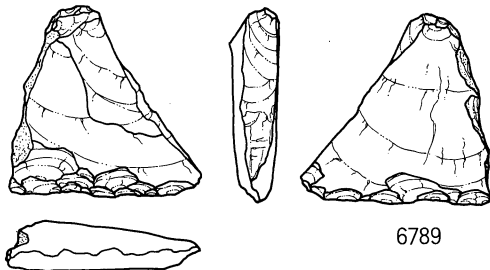

6789



6791



旧河道 SR46002 (6786 · 6791)

沟 SD46008 (6789 · 6790)

SD56002 (6787 · 6788)

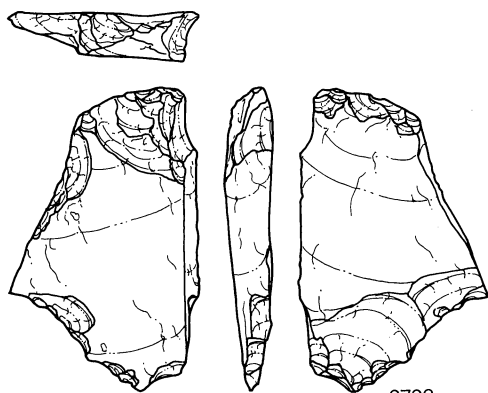

6792

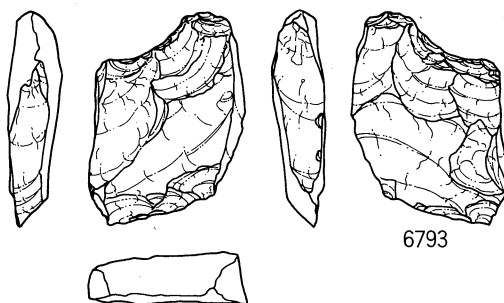

6793

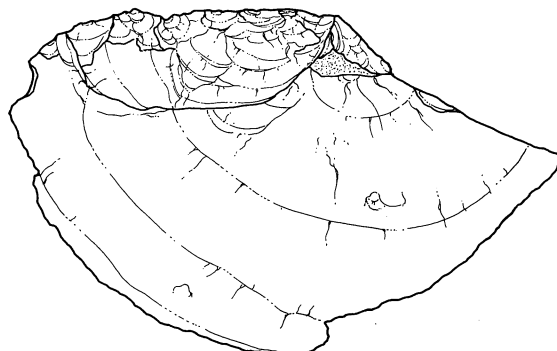
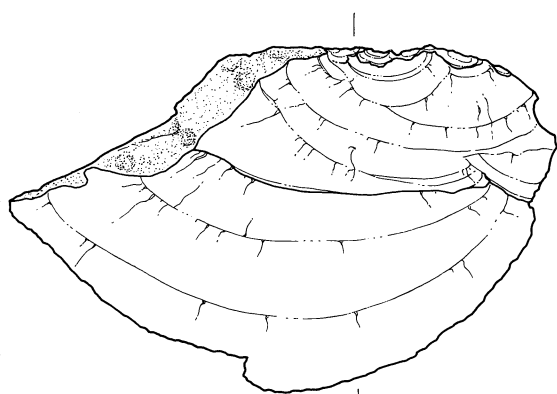

6794

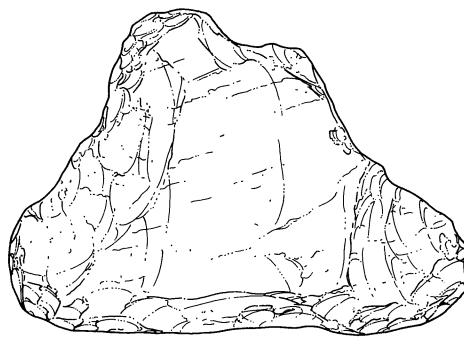

6795

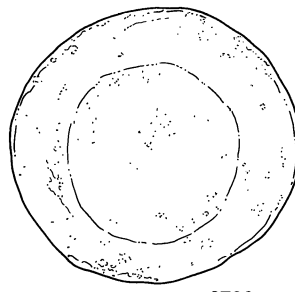
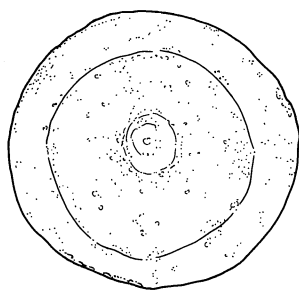
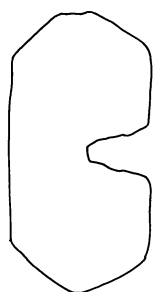
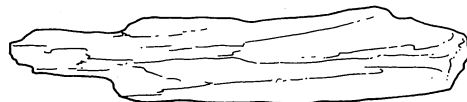

6796



旧河道 SR46001 (6795) SR46002 (6794 · 6796)
 溝 SD46001 (6792) SD46002 (6793)

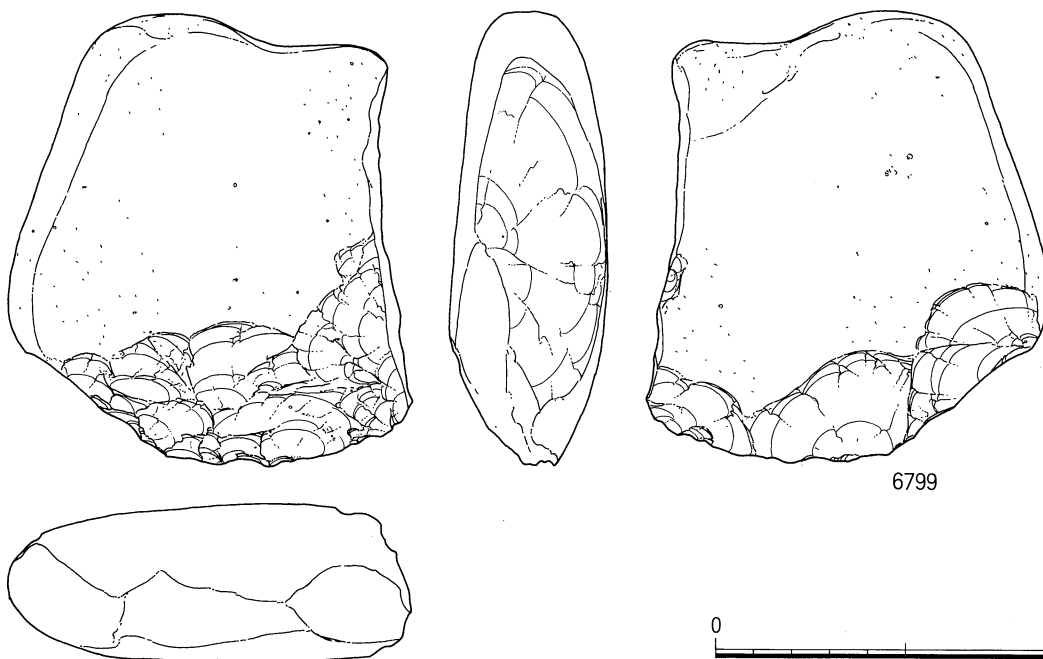
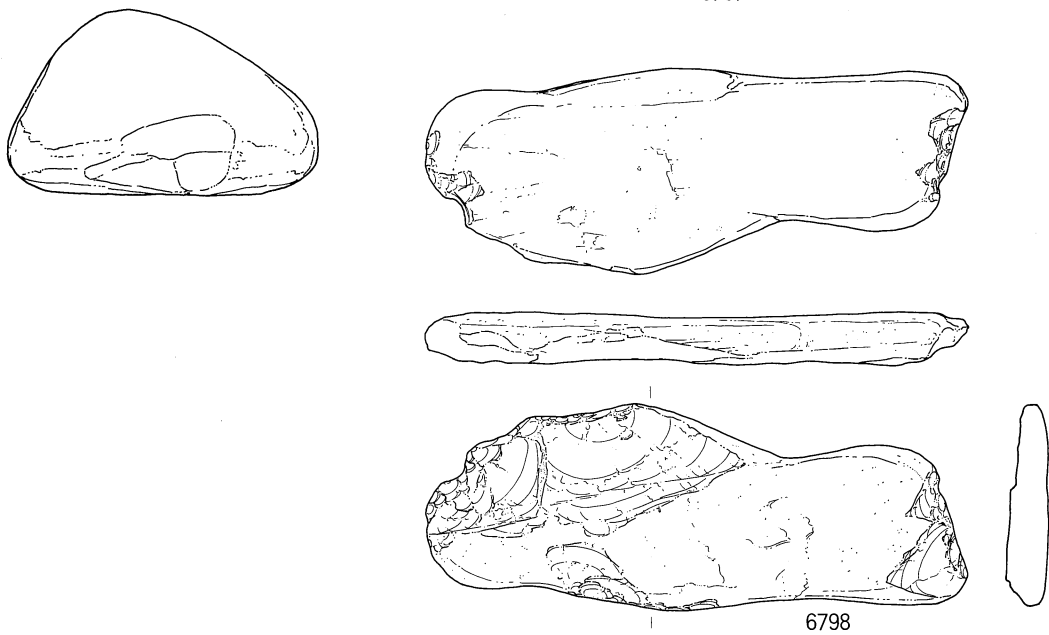
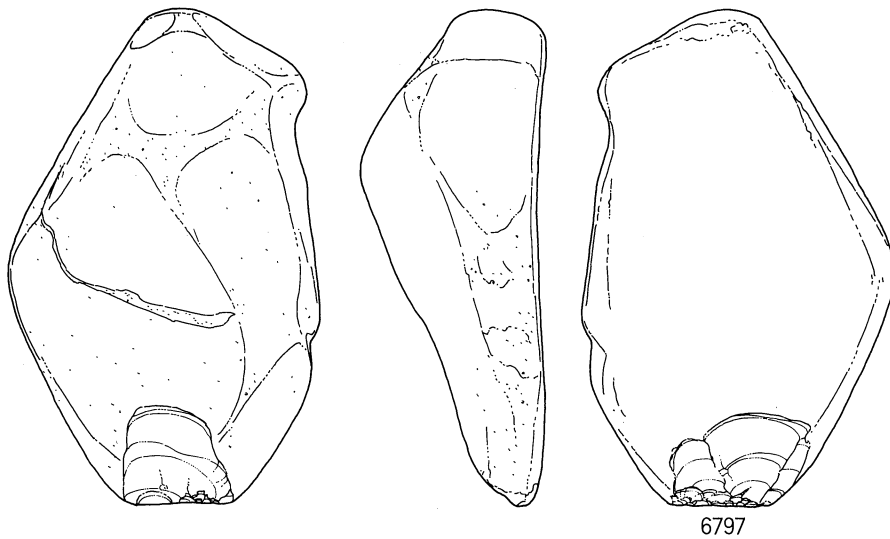

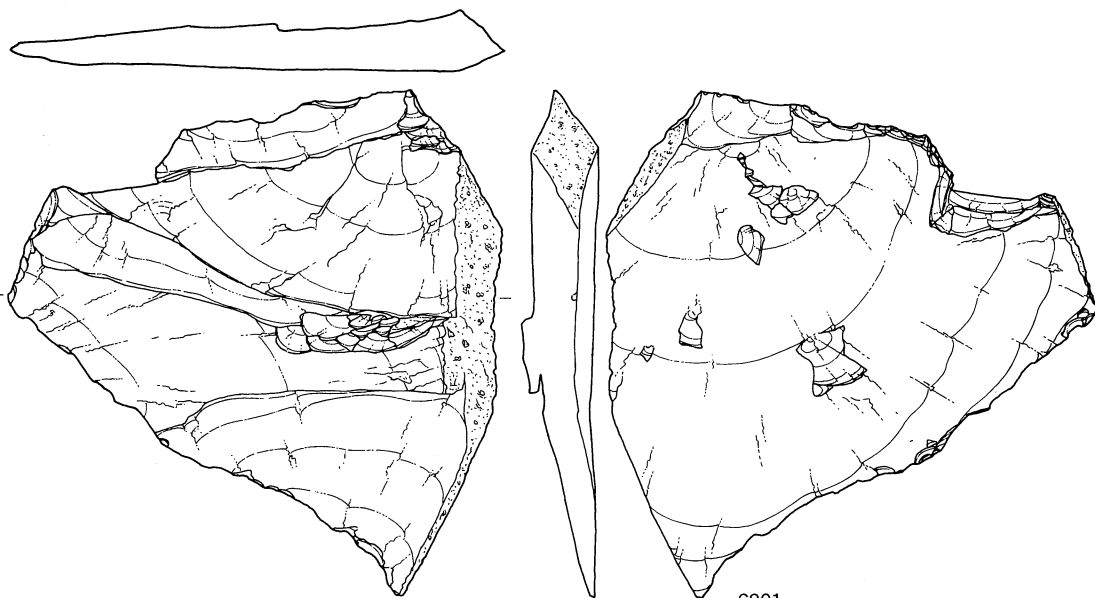
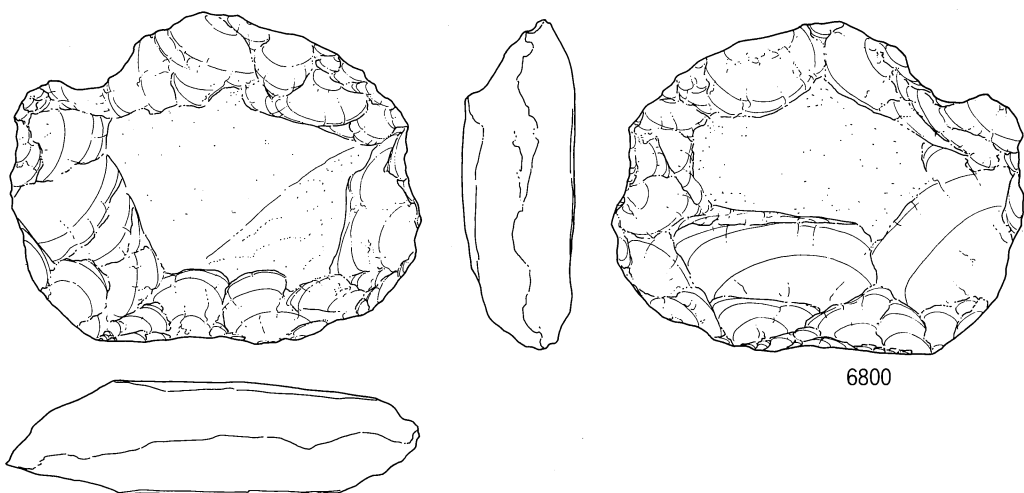

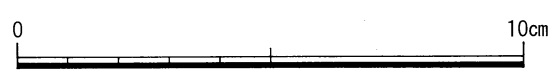
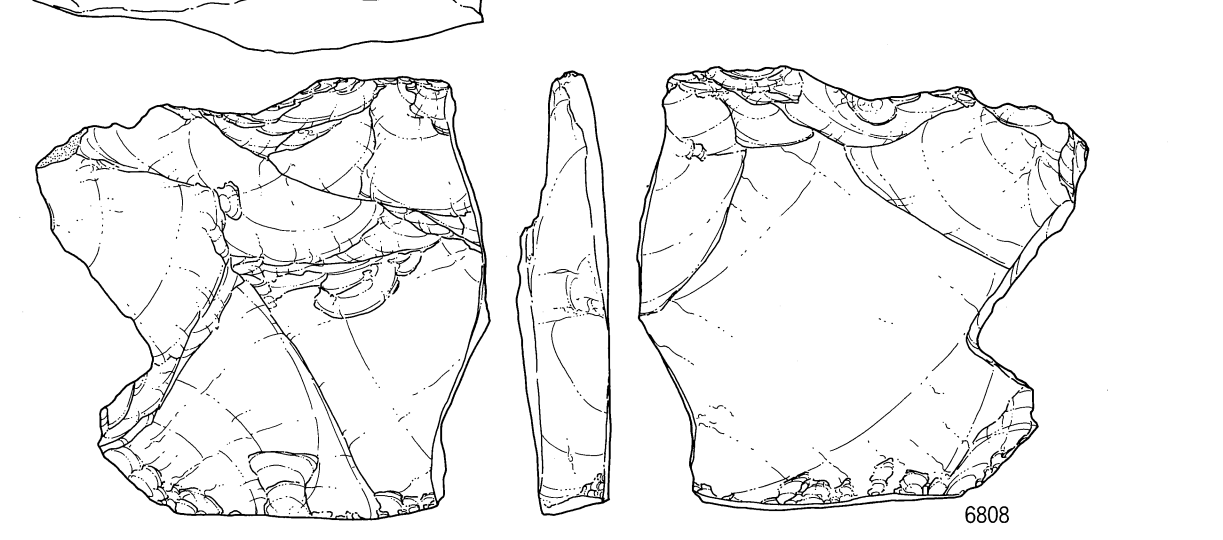
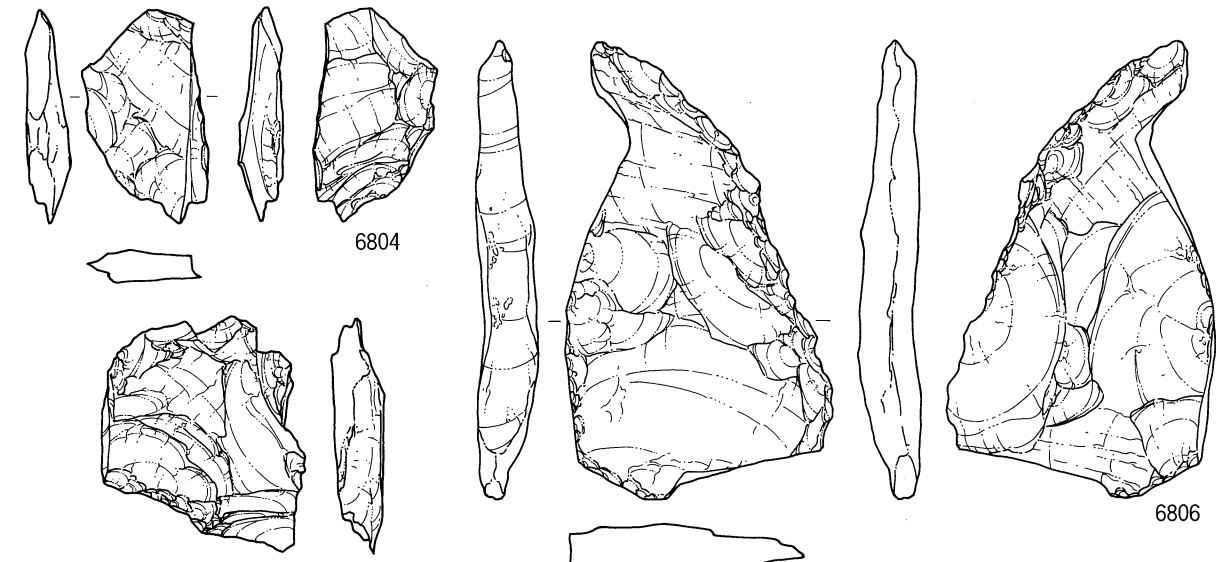
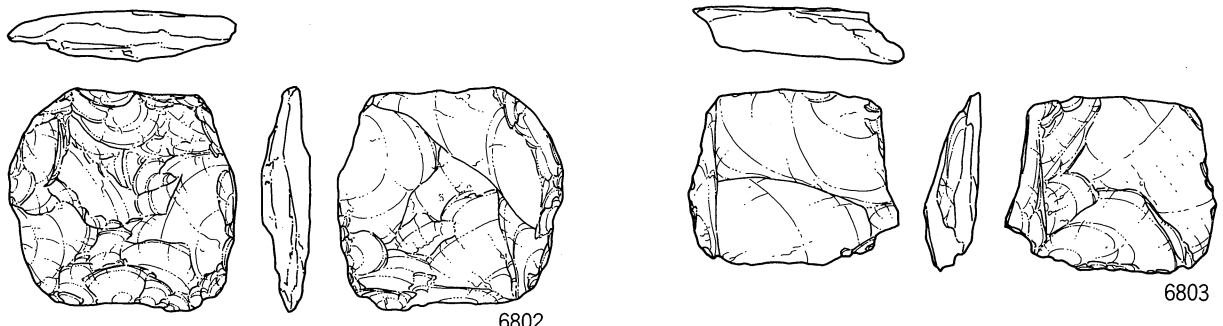

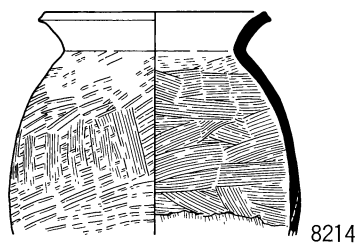
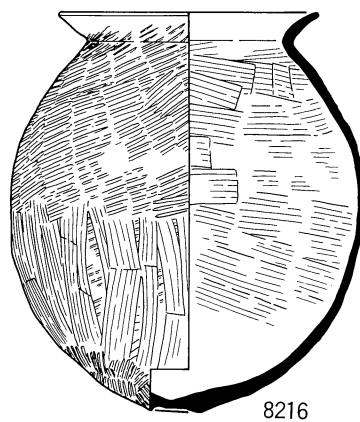
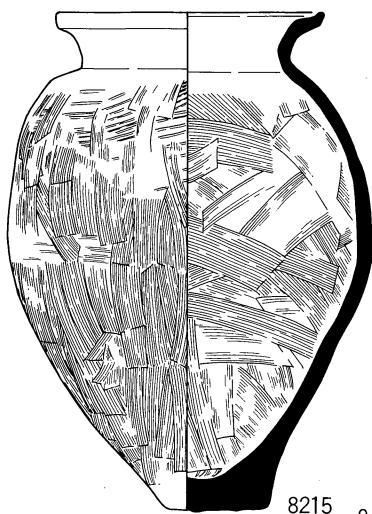
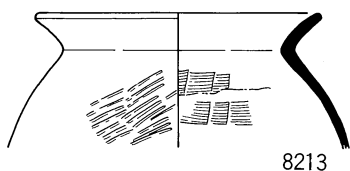
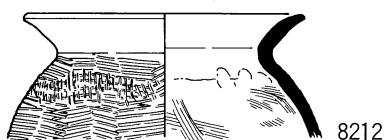
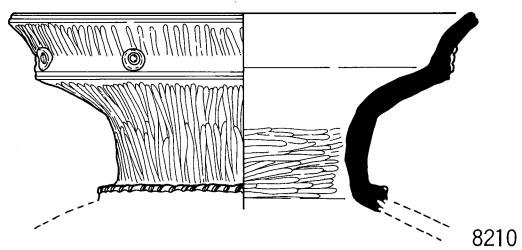
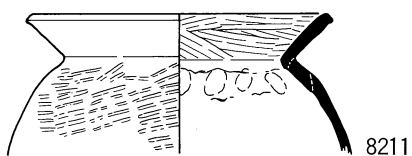
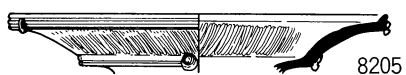
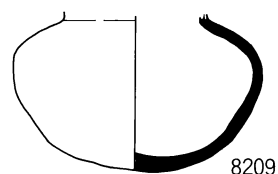
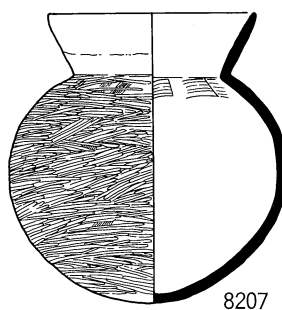
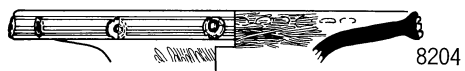
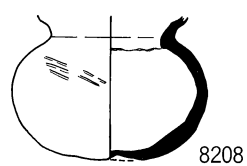
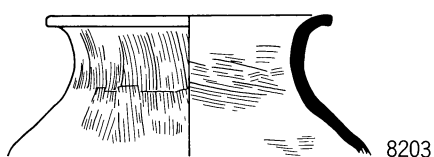
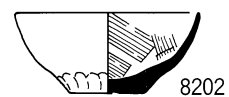
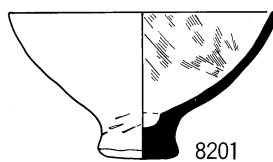
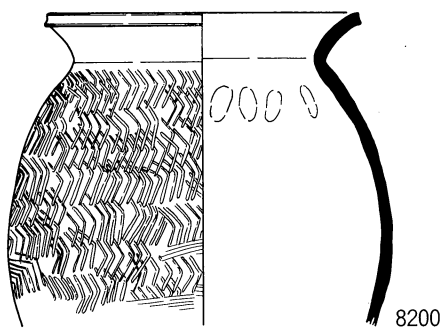

溝 SD56001 (8200~8202) SD56002 (8203~8216)

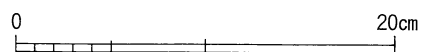
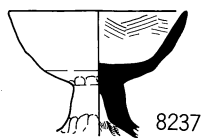
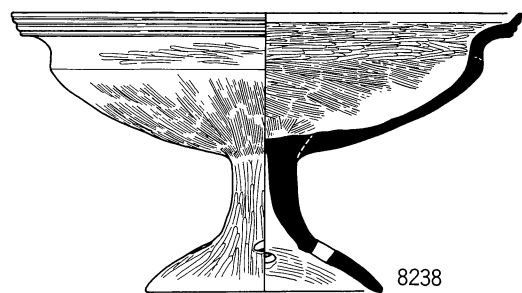
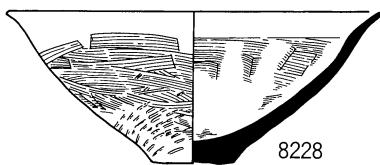
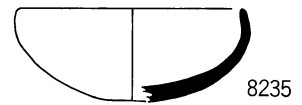
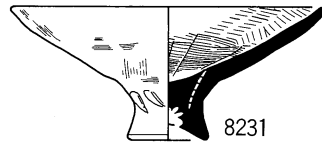
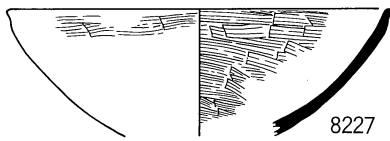
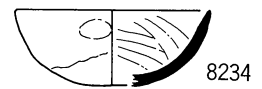
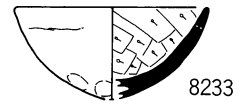
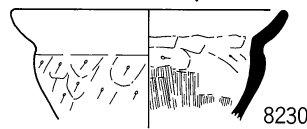
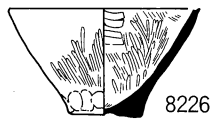
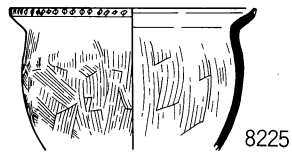
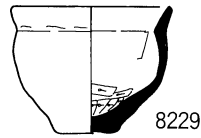
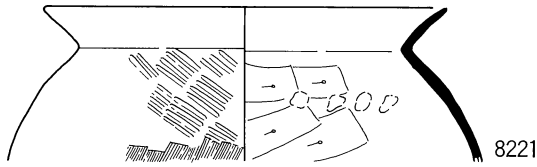
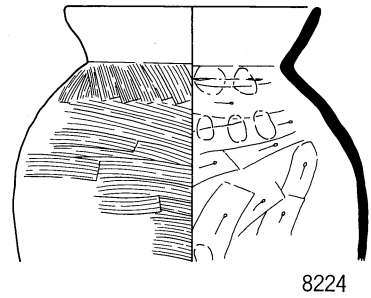
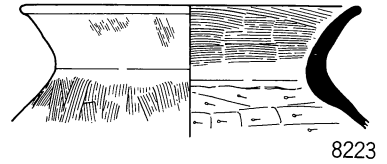
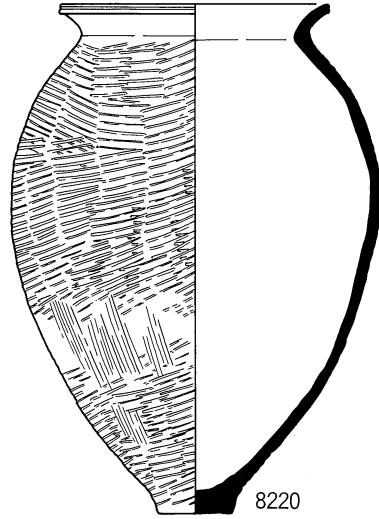
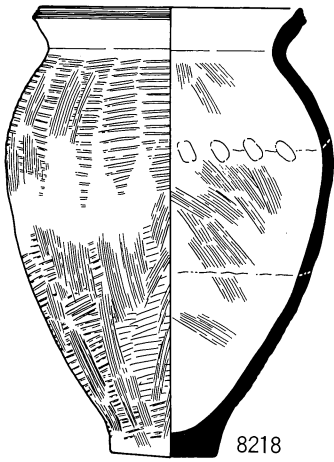
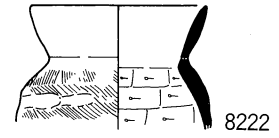
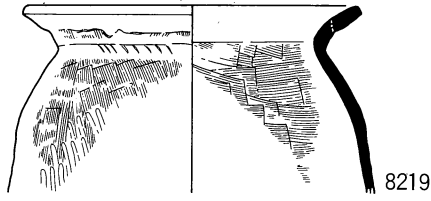
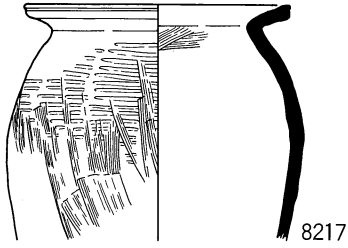

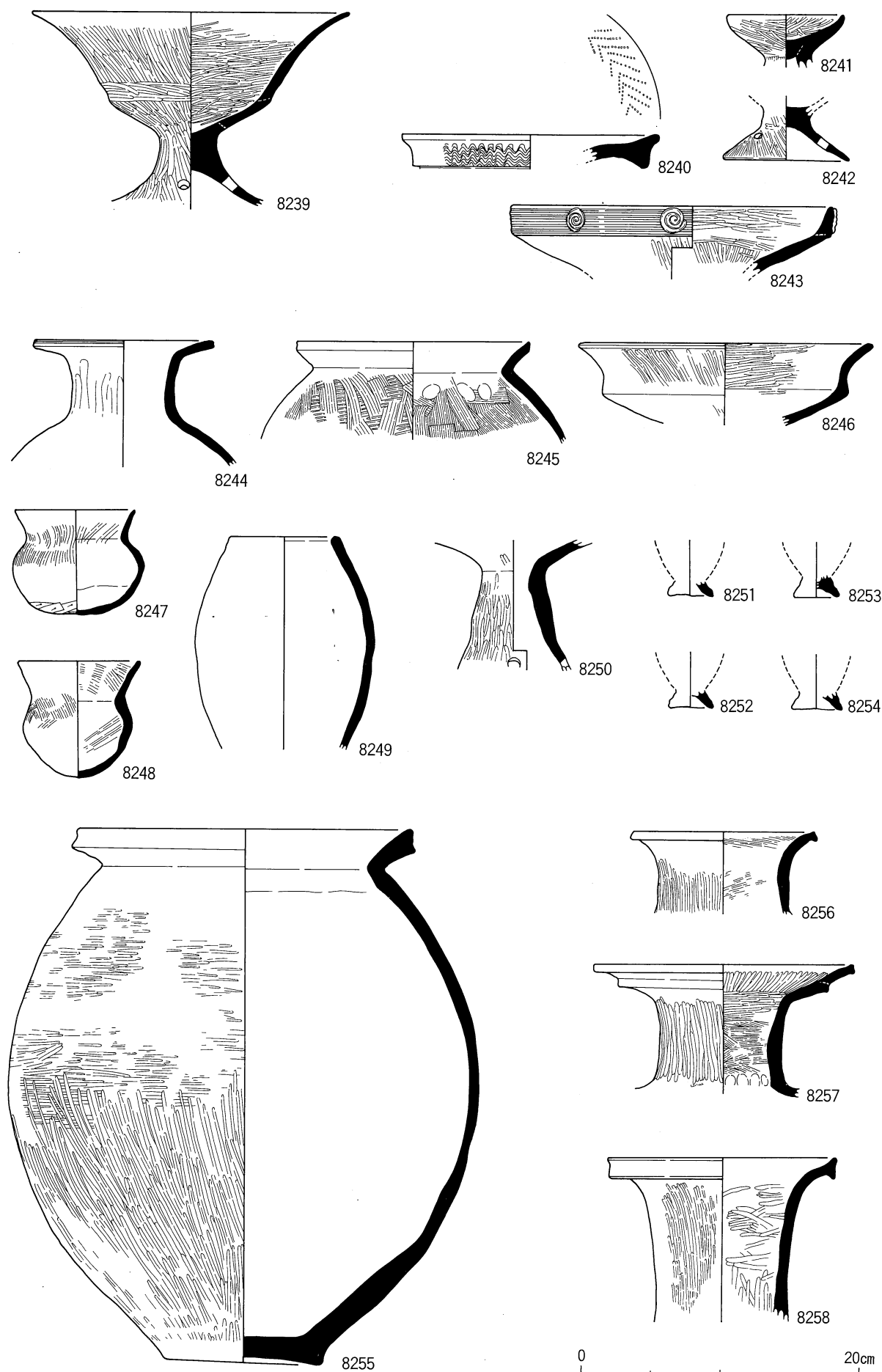

溝	SD56002 (8239~8243)	SD56004 (8244~8247)
	SD56005 (8248・8249)	SD56006 (8250~8254)
旧河道	SR46002 (8255)	SR46003 (8256~8258)

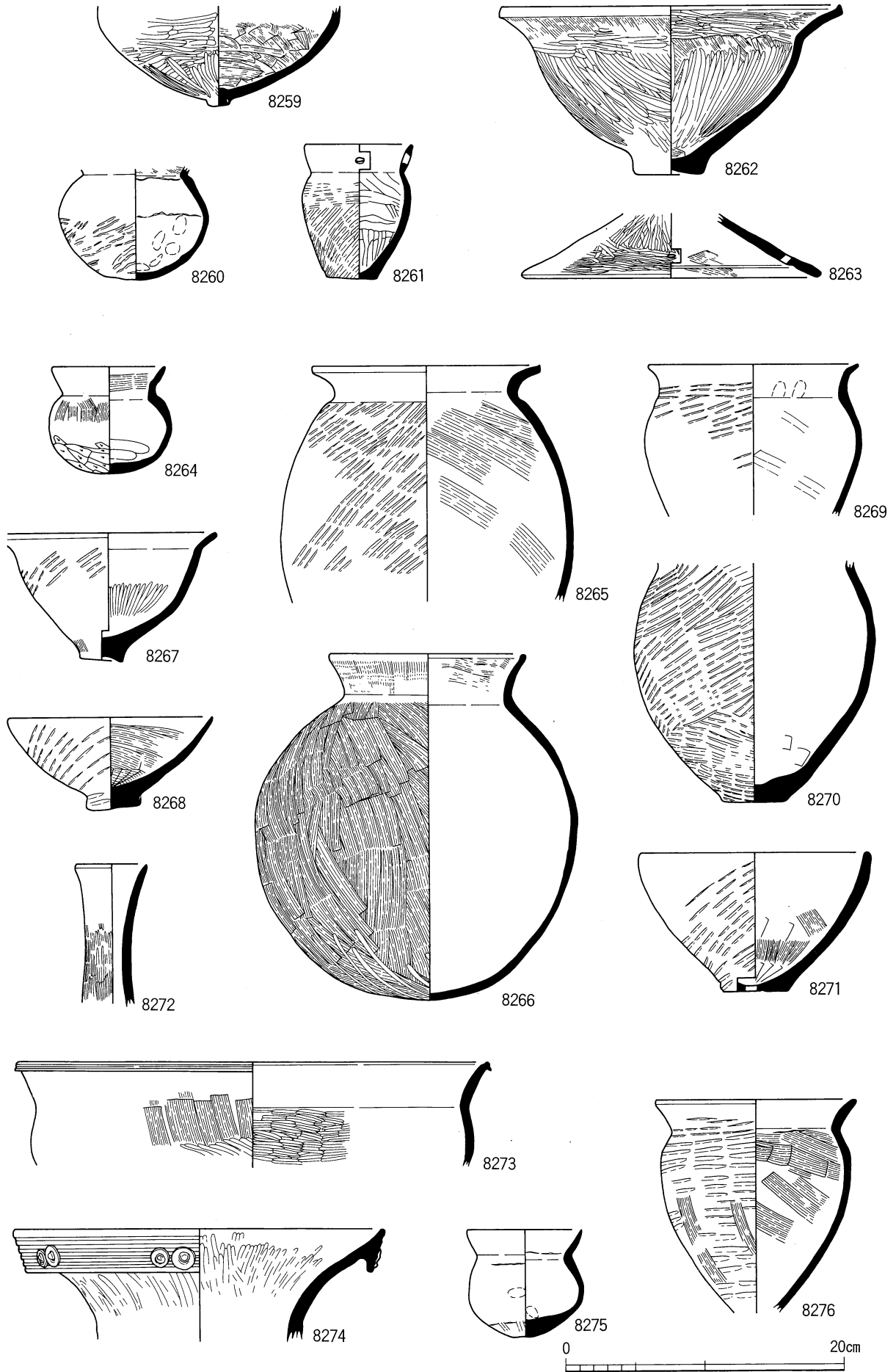

旧河道 SR46003 (8259・8263)

溝 SD66001 (8264~8268) SD66002 (8269~8273)

SD66003 (8274~8276)

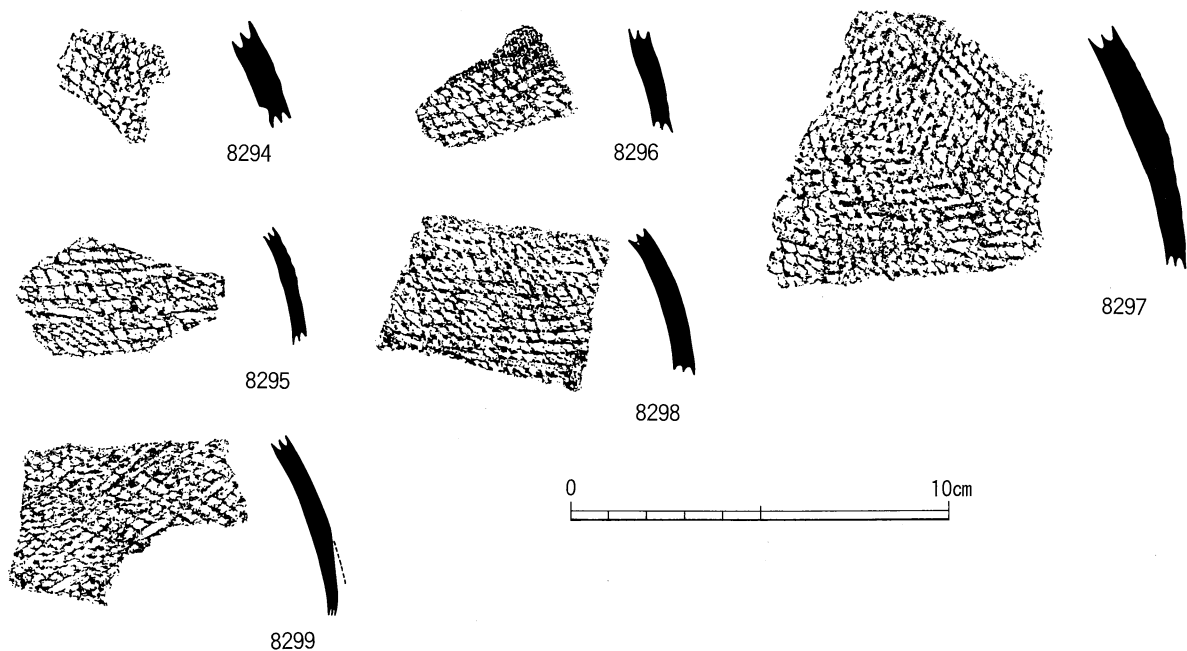
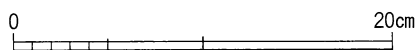
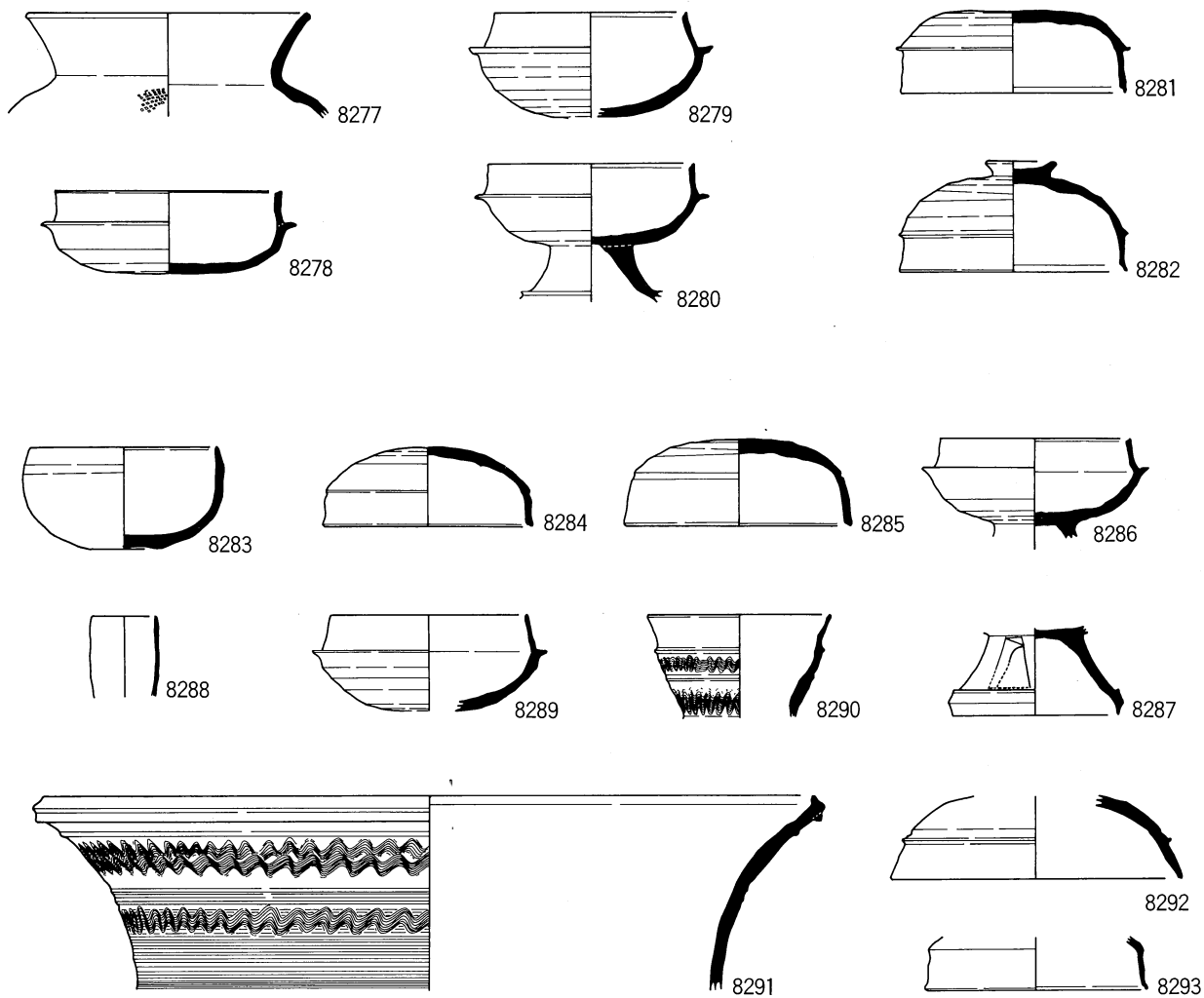

溝 SD66001 (8277・8294~8299) SD66002 (8278~8280)
 SD66003 (8281・8282) SD56002 (8283~8287)
 SD56005 (8288~8291) SD46002 (8292)
 確認調査 (8293)

兵庫県文化財調査報告 第135-5冊

神戸市西区

たま つ た なか い せき
玉 津 田 中 遺 跡

— 第5分冊 [図版編] —

— 田中特定土地地区画整理事業に伴う埋蔵文化財調査報告書 —

平成8年3月29日 発行

編集 兵庫県教育委員会埋蔵文化財調査事務所

〒652 神戸市兵庫区荒田町2丁目1-5

発行 兵庫県教育委員会

〒652 神戸市中央区下山手通5丁目10-1

印刷 水山産業株式会社

〒神戸市長田区二番町3丁目4-1
