

上信越自動車道関係発掘調査報告書 V

和泉^{いずみ}A遺跡

(図版編)

1 9 9 9

新 潟 県 教 育 委 員 会

財団法人 新潟県埋蔵文化財調査事業団

上信越自動車道関係発掘調査報告書 V

和泉^{いずみ} A 遺跡

(図版編)

1 9 9 9





新 潟 県 教 育 委 員 会

財団法人 新潟県埋蔵文化財調査事業団

例 言

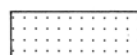
1. 本報告書は、新潟県中頸城郡中郷村大字稻荷山新田字籠峯650番地ほかに所在する和泉A遺跡^{いづみ}の発掘調査報告書である。本書は、2分冊から構成されるうちの図版編である。
2. 発掘調査は上信越自動車道の建設に伴い、新潟県教育委員会が日本道路公団から受託して実施したものである。
3. 発掘調査は、県教委が調査主体となり、財団法人新潟県埋蔵文化財調査事業団に調査を委託し、平成4～7年度に実施した。
4. 整理および報告書作成にかかる作業は、平成8～10年度に実施し、埋文事業団職員がこれにあたった。
5. 出土遺物と調査にかかる資料は、すべて県教委が新潟県埋蔵文化財センターにおいて保管・管理している。ただし、遺物の集合写真・写真实測に用いた写真のネガは、撮影者の小川忠博氏が保管している。
6. 本書に掲載した遺物番号は上層土器・上層石器・下層土器・下層石器それぞれで通し番号を付した。本文・実測図版・写真図版の番号は一致している。また、土製品は土器、石製品は石器の通し番号と連続する番号を付してある。
7. 実測図の理解を補助するために、石器と下層遺構の図版にスクリーントーンを貼付した。石器のスクリーントーンの表示は、本文編・第25図に示したとおりである。下層遺構は、右のとおりである。
8. 石器の実測図には、図版番号とともに出土位置を掲載した。上から、図版番号、出土グリッド、出土遺構・ブロック（括弧で表示）が表されている。

遺構の凡例

	竪穴住居の周堤
	竪穴住居の貼床 黒色硬化面
	掘立柱建物の柱穴 1
	掘立柱建物の柱穴 2
	廃棄ブロック

図版目次

実測図版

- 図版 1 上層 遺構全体図
- 図版 2 上層 遺構実測図 (1) 土坑群
- 図版 3 上層 遺構実測図 (2) S K 001・S K 007・S K 013・S K 402・S K 116
- 図版 4 上層 遺構実測図 (3) S X 124・S S 400・S B 2
- 図版 5 上層 遺構実測図 (4) S B 1・S B 3
- 図版 6 上層 遺構実測図 (5) S B 4・S B 5
- 図版 7 上層 土器実測図 (1) S K 005・S K 006
- 図版 8 上層 土器実測図 (2) S K 007・S X 116・S X 124
- 図版 9 上層 土器実測図 (3) ブロック 1
- 図版 10 上層 土器実測図 (4) ブロック 2
- 図版 11 上層 土器実測図 (5) ブロック 2
- 図版 12 上層 土器実測図 (6) ブロック 3
- 図版 13 上層 土器実測図 (7) ブロック 3
- 図版 14 上層 土器実測図 (8) ブロック 4
- 図版 15 上層 土器実測図 (9) ブロック 5
- 図版 16 上層 土器実測図 (10) ブロック 5
- 図版 17 上層 土器実測図 (11) ブロック 6
- 図版 18 上層 土器実測図 (12) ブロック 7
- 図版 19 上層 土器実測図 (13) ブロック 8
- 図版 20 上層 土器実測図 (14) ブロック 8
- 図版 21 上層 土器実測図 (15) ブロック 8
- 図版 22 上層 土器実測図 (16) ブロック 8
- 図版 23 上層 土器実測図 (17) ブロック 9
- 図版 24 上層 土器実測図 (18) ブロック 9
- 図版 25 上層 土器実測図 (19) ブロック 10
- 図版 26 上層 土器実測図 (20) ブロック 11
- 図版 27 上層 土器実測図 (21) ブロック 12
- 図版 28 上層 土器実測図 (22) ブロック 12
- 図版 29 上層 土器実測図 (23) ブロック 12
- 図版 30 上層 土器実測図 (24) ブロック 12
- 図版 31 上層 土器実測図 (25) ブロック 13

- 図版 32 上層 土器実測図 (26) ブロック 14
- 図版 33 上層 土器実測図 (27) ブロック外
- 図版 34 上層 土器実測図 (28) ブロック外
- 図版 35 上層 土器実測図 (29) ブロック外
- 図版 36 上層 土器実測図 (30) ブロック外
- 図版 37 上層 土器実測図 (31) ブロック外
- 図版 38 上層 土器実測図 (32) ブロック外
- 図版 39 上層 土製品・石製品実測図
- 図版 40 上層 石器実測図 (1) S K 006
- 図版 41 上層 石器実測図 (2) S X 124
- 図版 42 上層 石器実測図 (3) 石鏃
- 図版 43 上層 石器実測図 (4) 石鏃・石鏃未成品
- 図版 44 上層 石器実測図 (5) 石鏃未成品・石錐・楔形石器
- 図版 45 上層 石器実測図 (6) 楔形石器
- 図版 46 上層 石器実測図 (7) 楔形石器
- 図版 47 上層 石器実測図 (8) 打製石斧
- 図版 48 上層 石器実測図 (9) 打製石斧
- 図版 49 上層 石器実測図 (10) 磨製石斧
- 図版 50 上層 石器実測図 (11) 磨製石斧・スクレイパー
- 図版 51 上層 石器実測図 (12) スクレイパー
- 図版 52 上層 石器実測図 (13) スクレイパー・両面調整石器
- 図版 53 上層 石器実測図 (14) 折断調整石器・スクレイパー・両面調整石器
- 図版 54 上層 石器実測図 (15) 微細剥離痕ある剥片・剥片
- 図版 55 上層 石器実測図 (16) 微細剥離痕ある剥片・剥片・石核
- 図版 56 上層 石器実測図 (17) 石核
- 図版 57 上層 石器実測図 (18) 石核
- 図版 58 上層 石器実測図 (19) 石核
- 図版 59 上層 石器実測図 (20) 石核・楔形石器・剥片
- 図版 60 上層 石器実測図 (21) 磨石類
- 図版 61 上層 石器実測図 (22) 磨石類・石皿・石鋸形石器・砥石
- 図版 62 上層 古墳時代以降の遺物
- 図版 63 下層 遺構全体図
- 図版 64 下層 遺構全体図 (1)
- 図版 65 下層 遺構全体図 (2)
- 図版 66 下層 遺構全体図 (3)
- 図版 67 下層 遺構全体図 (4)
- 図版 68 下層 遺構実測図 (1) S I 117

- 図版 69 下層 遺構実測図 (2) S I 117
- 図版 70 下層 遺構実測図 (3) S I 117 磔平面図・遺物出土図
- 図版 71 下層 遺構実測図 (4) S I 120
- 図版 72 下層 遺構実測図 (5) S I 120
- 図版 73 下層 遺構実測図 (6) S I 120
- 図版 74 下層 遺構実測図 (7) S I 120 遺物出土図
- 図版 75 下層 遺構実測図 (8) S I 403
- 図版 76 下層 遺構実測図 (9) S I 403 磔平面図
- 図版 77 下層 遺構実測図 (10) S I 403
- 図版 78 下層 遺構実測図 (11) S I 403
- 図版 79 下層 遺構実測図 (12) S I 403 遺物出土図
- 図版 80 下層 遺構実測図 (13) S B 6
- 図版 81 下層 遺構実測図 (14) S B 7・S B 8・S B 9
- 図版 82 下層 遺構実測図 (15) S B 10・S B 11
- 図版 83 下層 遺構実測図 (16) S B 12・S B 13
- 図版 84 下層 遺構実測図 (17) S B 14・S B 15・S B 16
- 図版 85 下層 遺構実測図 (18) S B 17・S B 18
- 図版 86 下層 遺構実測図 (19) S B 19・S B 20
- 図版 87 下層 遺構実測図 (20) S B 21・S B 22
- 図版 88 下層 遺構実測図 (21) S B 23
- 図版 89 下層 遺構実測図 (22) S B 24
- 図版 90 下層 遺構実測図 (23) S B 25
- 図版 91 下層 遺構実測図 (24) S B 26・S B 27
- 図版 92 下層 遺構実測図 (25) S B 28
- 図版 93 下層 遺構実測図 (26) S B 29・S B 30
- 図版 94 下層 遺構実測図 (27) S B 31
- 図版 95 下層 遺構実測図 (28) S B 32
- 図版 96 下層 遺構実測図 (29) S B 33
- 図版 97 下層 遺構実測図 (30) S B 34
- 図版 98 下層 遺構実測図 (31) S B 35・S B 36
- 図版 99 下層 遺構実測図 (32) S B 37
- 図版 100 下層 遺構実測図 (33) S B 38・S B 39
- 図版 101 下層 遺構実測図 (34) S B 40
- 図版 102 下層 遺構実測図 (35) S B 41
- 図版 103 下層 遺構実測図 (36) S B 42
- 図版 104 下層 遺構実測図 (37) S B 43
- 図版 105 下層 遺構実測図 (38) S B 44・S B 46

- 図版 106 下層 遺構実測図 (39) S B 45
- 図版 107 下層 遺構実測図 (40) S K 205・S K 269・S K 414・S K 953・S K 962・S K 648・
S K 431・S K 442・S K 474・S K 1288・S K 1282・S K 1343
- 図版 108 下層 遺構実測図 (41) S K 123・S K 838・S K 477・S K 917・S K 952 B・S K 951・
S K 432・P 593
- 図版 109 下層 遺構実測図 (42) S K 460・S K 461・S K 462
- 図版 110 下層 遺構実測図 (43) S K 472・S K 473・S K 994
- 図版 111 下層 遺構実測図 (44) S A 1・S B 29
- 図版 112 下層 遺構実測図 (45) S A 2・S A 3・S B 30
- 図版 113 下層 遺構実測図 (46) S D 404・S D 405
- 図版 114 下層 遺構実測図 (47) 廃棄ブロック 1
- 図版 115 下層 遺構実測図 (48) 廃棄ブロック 2・廃棄ブロック 3
- 図版 116 下層 遺構実測図 (49) 廃棄ブロック 4・廃棄ブロック 5 A・5 B
- 図版 117 下層 遺構実測図 (50) 廃棄ブロック 6
- 図版 118 下層 遺構実測図 (51) 廃棄ブロック 7
- 図版 119 下層 土器実測図 (1) S I 117
- 図版 120 下層 土器実測図 (2) S I 117
- 図版 121 下層 土器実測図 (3) S I 117
- 図版 122 下層 土器実測図 (4) S I 117
- 図版 123 下層 土器実測図 (5) S I 117・S I 120
- 図版 124 下層 土器実測図 (6) S I 403
- 図版 125 下層 土器実測図 (7) S I 403
- 図版 126 下層 土器実測図 (8) S I 403
- 図版 127 下層 土器実測図 (9) S I 403
- 図版 128 下層 土器実測図 (10) S I 403・廃棄ブロック 4
- 図版 129 下層 土器実測図 (11) P i t・S X 122・廃棄ブロック外
- 図版 130 下層 土器実測図 (12) S D 405・S D 404・P i t・廃棄ブロック外・S K 460・S K 462・
S K 432
- 図版 131 下層 土器実測図 (13) 廃棄ブロック 1
- 図版 132 下層 土器実測図 (14) 廃棄ブロック 1
- 図版 133 下層 土器実測図 (15) 廃棄ブロック 1
- 図版 134 下層 土器実測図 (16) 廃棄ブロック 1
- 図版 135 下層 土器実測図 (17) 廃棄ブロック 2
- 図版 136 下層 土器実測図 (18) 廃棄ブロック 2
- 図版 137 下層 土器実測図 (19) 廃棄ブロック 3・廃棄ブロック 5
- 図版 138 下層 土器実測図 (20) 廃棄ブロック 6
- 図版 139 下層 土器実測図 (21) 廃棄ブロック 6

- 図版 140 下層 土器実測図 (22) 廃棄ブロック 6
- 図版 141 下層 土器実測図 (23) 廃棄ブロック 6
- 図版 142 下層 土器実測図 (24) 廃棄ブロック 6
- 図版 143 下層 土器実測図 (25) 廃棄ブロック 6
- 図版 144 下層 土器実測図 (26) 廃棄ブロック 6
- 図版 145 下層 土器実測図 (27) 廃棄ブロック 7
- 図版 146 下層 土器実測図 (28) 廃棄ブロック外
- 図版 147 下層 土器実測図 (29) 廃棄ブロック外
- 図版 148 下層 土器実測図 (30) 廃棄ブロック外
- 図版 149 下層 土製品実測図 (1) 土器片円盤
- 図版 150 下層 土製品実測図 (2) 土偶・環状土製品・焼成粘土塊
- 図版 151 下層 石器実測図 (1) 石鏃・石錐
- 図版 152 下層 石器実測図 (2) 尖頭器・石匙・楔形石器
- 図版 153 下層 石器実測図 (3) 楔形石器
- 図版 154 下層 石器実測図 (4) スクレイパー・楔形石器・石錐 (玉髓製小形石器)
- 図版 155 下層 石器実測図 (5) 打製石斧
- 図版 156 下層 石器実測図 (6) 打製石斧
- 図版 157 下層 石器実測図 (7) 打製石斧
- 図版 158 下層 石器実測図 (8) 打製石斧
- 図版 159 下層 石器実測図 (9) 打製石斧
- 図版 160 下層 石器実測図 (10) 打製石斧
- 図版 161 下層 石器実測図 (11) 打製石斧
- 図版 162 下層 石器実測図 (12) 磨製石斧
- 図版 163 下層 石器実測図 (13) 磨製石斧
- 図版 164 下層 石器実測図 (14) 磨製石斧
- 図版 165 下層 石器実測図 (15) スクレイパー
- 図版 166 下層 石器実測図 (16) スクレイパー
- 図版 167 下層 石器実測図 (17) スクレイパー
- 図版 168 下層 石器実測図 (18) スクレイパー・両面調整石器・微細剥離痕ある剥片
- 図版 169 下層 石器実測図 (19) 両面調整石器
- 図版 170 下層 石器実測図 (20) 両面調整石器
- 図版 171 下層 石器実測図 (21) 両面調整石器
- 図版 172 下層 石器実測図 (22) 両面調整石器・周縁敲打調整石器
- 図版 173 下層 石器実測図 (23) 両面調整石器
- 図版 174 下層 石器実測図 (24) スクレイパー・両面調整石器
- 図版 175 下層 石器実測図 (25) 両面調整石器
- 図版 176 下層 石器実測図 (26) 両面調整石器

- 図版 177 下層 石器実測図 (27) 両面調整石器・折断調整石器・対向調整石器・周縁敲打調整石器
- 図版 178 下層 石器実測図 (28) 礫器・スクレイパー・石核
- 図版 179 下層 石器実測図 (29) 微細剥離痕ある剥片・剥片・石核
- 図版 180 下層 石器実測図 (30) 石核
- 図版 181 下層 石器実測図 (31) 石核
- 図版 182 下層 石器実測図 (32) 石核・原石
- 図版 183 下層 石器実測図 (33) 磨石類
- 図版 184 下層 石器実測図 (34) 磨石類
- 図版 185 下層 石器実測図 (35) 磨石類
- 図版 186 下層 石器実測図 (36) 磨石類・環状石製品・石皿・丸石
- 図版 187 下層 石器実測図 (37) 石皿
- 図版 188 下層 石器実測図 (38) 石皿
- 図版 189 下層 石器実測図 (39) 石皿・砥石
- 図版 190 下層 石器実測図 (40) 砥石
- 図版 191 下層 石製品実測図 石棒・玉類・翡翠原石

写真図版

- 図版 192 和泉 A 遺跡周辺の景観
- 図版 193 上層 遺構 (1) 土坑群・S K 003・S K 004・S K 005
- 図版 194 上層 遺構 (2) S K 005・S K 006・S K 007・S K 010
- 図版 195 上層 遺構 (3) S K 011・S K 012・S K 001・S K 116・S S 400
- 図版 196 上層 遺構 (4) S K 402・S X 124・S B 1・S B 2・S B 3
- 図版 197 上層 遺構 (5) S B 3
- 図版 198 上層 遺構 (6) ブロック 1・ブロック 2・ブロック 3・ブロック 4・ブロック 8・
ブロック 9・ブロック 11
- 図版 199 上層 遺構 (7) ブロック 12・ブロック 14・上層完掘状況・調査風景
- 図版 200 上層 土器 (1) S K 101・S K 006・S K 007・S X 116・S X 124
- 図版 201 上層 土器 (2) ブロック 1・ブロック 2
- 図版 202 上層 土器 (3) ブロック 2・ブロック 3
- 図版 203 上層 土器 (4) ブロック 3
- 図版 204 上層 土器 (5) ブロック 4・ブロック 5
- 図版 205 上層 土器 (6) ブロック 5・ブロック 6
- 図版 206 上層 土器 (7) ブロック 6・ブロック 7
- 図版 207 上層 土器 (8) ブロック 8
- 図版 208 上層 土器 (9) ブロック 8

- 図版 209 上層 土器 (10) ブロック 8・ブロック 9
- 図版 210 上層 土器 (11) ブロック 9・ブロック 10
- 図版 211 上層 土器 (12) ブロック 11・ブロック 12
- 図版 212 上層 土器 (13) ブロック 12
- 図版 213 上層 土器 (14) ブロック 12・ブロック 13
- 図版 214 上層 土器 (15) ブロック 14・ブロック外
- 図版 215 上層 土器 (16) ブロック外
- 図版 216 上層 土器 (17) ブロック外
- 図版 217 上層 土器 (18) ブロック外
- 図版 218 上層 土製品・石製品、古墳時代以降の遺物
- 図版 219 上層 石器 (1) S K 006・S X 124
- 図版 220 上層 石器 (2) 石鏃
- 図版 221 上層 石器 (3) 石錐・楔形石器
- 図版 222 上層 石器 (4) 打製石斧・磨製石斧
- 図版 223 上層 石器 (5) 磨製石斧・スクレイパー
- 図版 224 上層 石器 (6) 両面調整石器・スクレイパー・微細剥離痕ある剥片・剥片
- 図版 225 上層 石器 (7) 剥片・微細剥離痕ある剥片・石核
- 図版 226 上層 石器 (8) 石核
- 図版 227 上層 石器 (9) 石核・楔形石器・磨石類・石皿・石鋸形石器・砥石
- 図版 228 下層 遺構 (1) 下層完掘状況・土層断面
- 図版 229 下層 遺構 (2) S I 117
- 図版 230 下層 遺構 (3) S I 117
- 図版 231 下層 遺構 (4) S I 117
- 図版 232 下層 遺構 (5) S I 120
- 図版 233 下層 遺構 (6) S I 120
- 図版 234 下層 遺構 (7) S I 120
- 図版 235 下層 遺構 (8) S I 403
- 図版 236 下層 遺構 (9) S I 403
- 図版 237 下層 遺構 (10) S I 403
- 図版 238 下層 遺構 (11) S I 403
- 図版 239 下層 遺構 (12) S B 6・S B 7・S B 9
- 図版 240 下層 遺構 (13) S B 9・S B 10・S B 11・S B 12
- 図版 241 下層 遺構 (14) S B 13・S B 14・S B 15・S B 16・S B 17・S B 18
- 図版 242 下層 遺構 (15) S B 19・S B 20・S B 21・S B 22
- 図版 243 下層 遺構 (16) S B 22・S B 23・S B 24
- 図版 244 下層 遺構 (17) S B 23・S B 24
- 図版 245 下層 遺構 (18) S B 25・S B 26・S B 27

- 図版 246 下層 遺構 (19) S B 28・S B 29・S A 1
- 図版 247 下層 遺構 (20) S B 30・S B 31
- 図版 248 下層 遺構 (21) S B 32
- 図版 249 下層 遺構 (22) S B 33
- 図版 250 下層 遺構 (23) S B 34・S B 35・S B 36
- 図版 251 下層 遺構 (24) S B 37・S B 38・S B 39・S B 40
- 図版 252 下層 遺構 (25) S B 41・S B 42・S B 43
- 図版 253 下層 遺構 (26) S B 42・S B 43・S B 44・S B 45・S B 46
- 図版 254 下層 遺構 (27) S K 205・S K 269・S K 414・S K 431・S K 442・S K 648・S K 953・
S K 962
- 図版 255 下層 遺構 (28) S K 123・S K 474・S K 838・S K 1282・S K 1288・S K 1343
- 図版 256 下層 遺構 (29) S K 432・S K 477・S K 917・S K 951・S K 952 B・P 593
- 図版 257 下層 遺構 (30) S K 460・S K 461・S K 462・S K 472・S K 473・S K 994
- 図版 258 下層 遺構 (31) S D 404・S D 405
- 図版 259 下層 遺構 (32) 廃棄ブロック 1・廃棄ブロック 2
- 図版 260 下層 遺構 (33) 廃棄ブロック 1・廃棄ブロック 2
- 図版 261 下層 遺構 (34) 廃棄ブロック 3・廃棄ブロック 4・廃棄ブロック 5
- 図版 262 下層 遺構 (35) 廃棄ブロック 5・廃棄ブロック 6・廃棄ブロック 7
- 図版 263 下層 遺構 (36) 廃棄ブロック 6・廃棄ブロック 7
- 図版 264 下層 土器 (1) S I 117
- 図版 265 下層 土器 (2) S I 117
- 図版 266 下層 土器 (3) S I 117
- 図版 267 下層 土器 (4) S I 117
- 図版 268 下層 土器 (5) S I 117・S I 120・S I 403
- 図版 269 下層 土器 (6) S I 403
- 図版 270 下層 土器 (7) S I 403
- 図版 271 下層 土器 (8) S I 403
- 図版 272 下層 土器 (9) S I 403・廃棄ブロック 4
- 図版 273 下層 土器 (10) P i t・廃棄ブロック外・S D 405・S D 404
- 図版 274 下層 土器 (11) S D 404・P i t・廃棄ブロック外・S K 460・S K 462・S K 432・
廃棄ブロック 1
- 図版 275 下層 土器 (12) 廃棄ブロック 1
- 図版 276 下層 土器 (13) 廃棄ブロック 1
- 図版 277 下層 土器 (14) 廃棄ブロック 1
- 図版 278 下層 土器 (15) 廃棄ブロック 2
- 図版 279 下層 土器 (16) 廃棄ブロック 2・廃棄ブロック 3・廃棄ブロック 5
- 図版 280 下層 土器 (17) 廃棄ブロック 6

- 図版 281 下層 土器 (18) 廃棄ブロック 6
- 図版 282 下層 土器 (19) 廃棄ブロック 6
- 図版 283 下層 土器 (20) 廃棄ブロック 6
- 図版 284 下層 土器 (21) 廃棄ブロック 6
- 図版 285 下層 土器 (22) 廃棄ブロック 6・廃棄ブロック 7
- 図版 286 下層 土器 (23) 廃棄ブロック外
- 図版 287 下層 土器 (24) 廃棄ブロック外
- 図版 288 下層 土製品
- 図版 289 下層 石器 (1) 石鎌・石錐・尖頭器・石匙・楔形石器
- 図版 290 下層 石器 (2) 楔形石器・打製石斧
- 図版 291 下層 石器 (3) 打製石斧
- 図版 292 下層 石器 (4) 打製石斧
- 図版 293 下層 石器 (5) 打製石斧・磨製石斧
- 図版 294 下層 石器 (6) 磨製石斧・スクレイパー
- 図版 295 下層 石器 (7) スクレイパー・微細剥離痕ある剥片・両面調整石器
- 図版 296 下層 石器 (8) 両面調整石器
- 図版 297 下層 石器 (9) 両面調整石器・周縁敲打調整石器
- 図版 298 下層 石器 (10) 両面調整石器・スクレイパー
- 図版 299 下層 石器 (11) 両面調整石器・折断調整石器・対向調整石器・周縁敲打調整石器・
微細剥離痕ある剥片・剥片
- 図版 300 下層 石器 (12) 礫器・スクレイパー・石核
- 図版 301 下層 石器 (13) 石核・磨石類
- 図版 302 下層 石器 (14) 磨石類
- 図版 303 下層 石器 (15) 磨石類・丸石・環状石製品・石皿
- 図版 304 下層 石器 (16) 石皿
- 図版 305 下層 石器 (17) 石製品・石皿・砥石
下層 石製品 石棒・玉類・翡翠原石
- 図版 306 下層 土器 展開写真 (1)
- 図版 307 下層 土器 展開写真 (2)
- 図版 308 下層 土器 展開写真 (3)
- 図版 309 下層 石器 玉髓製小形石錐 顕微鏡写真

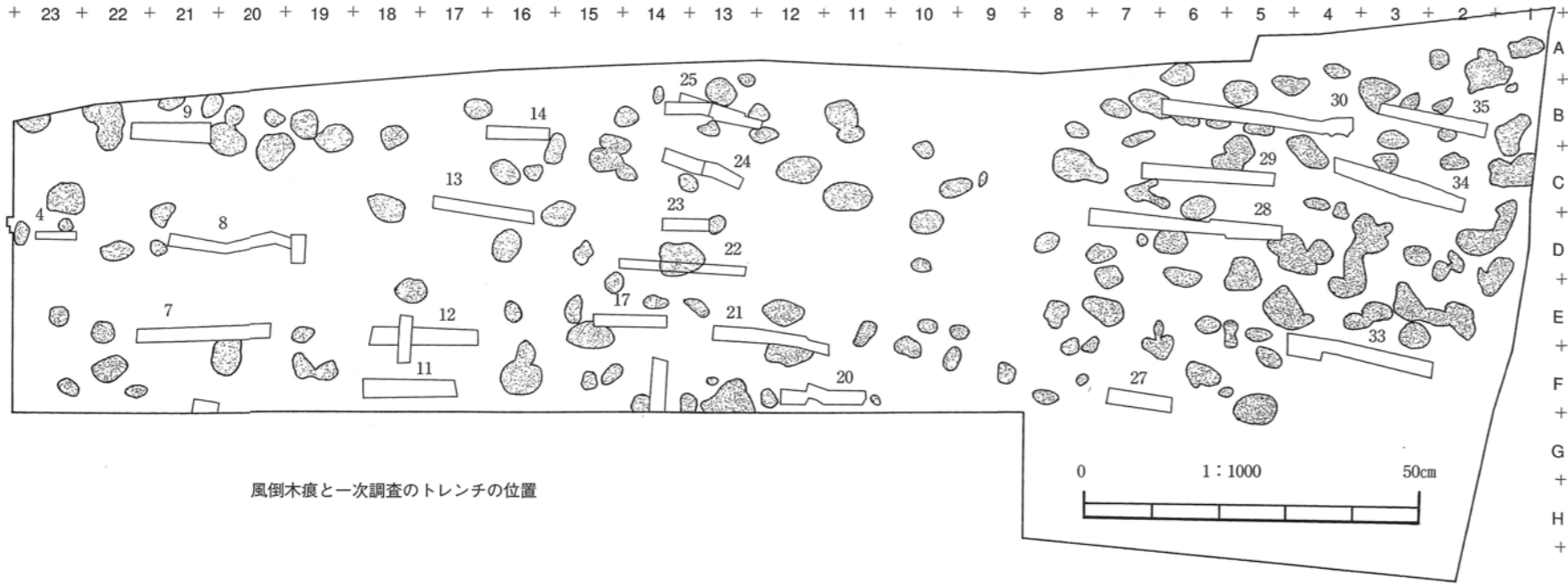
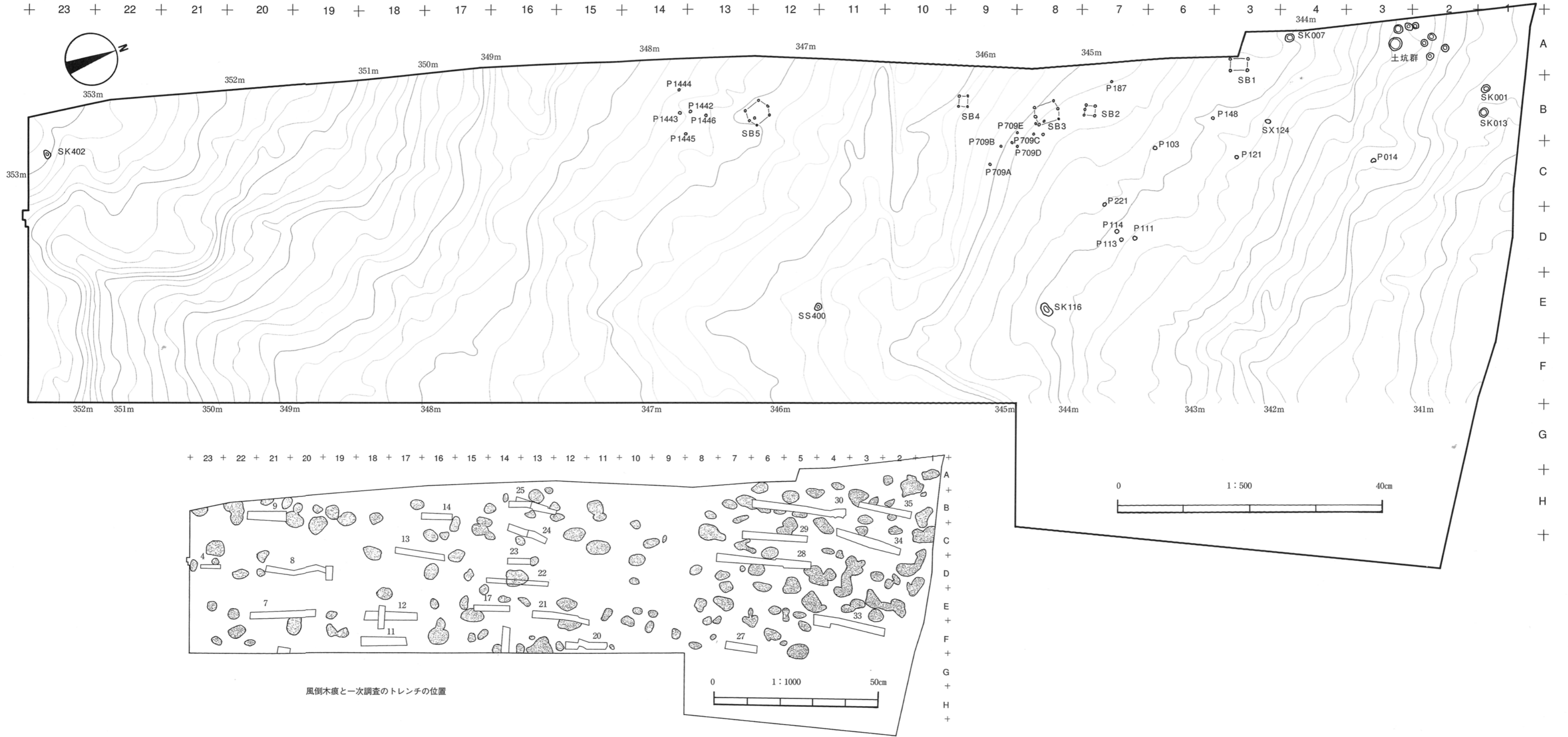

風倒木痕と一次調査のトレンチの位置

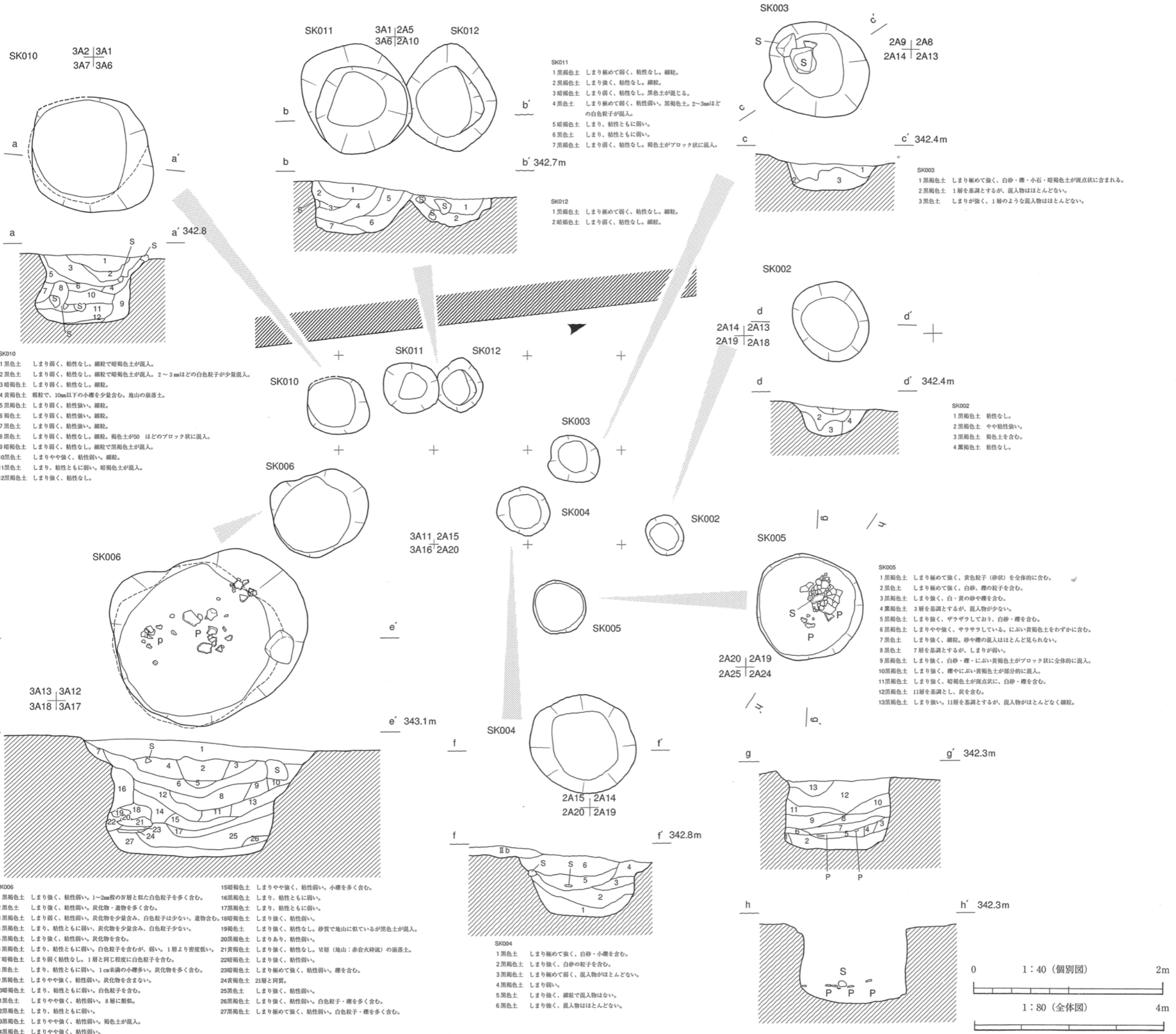

SK001

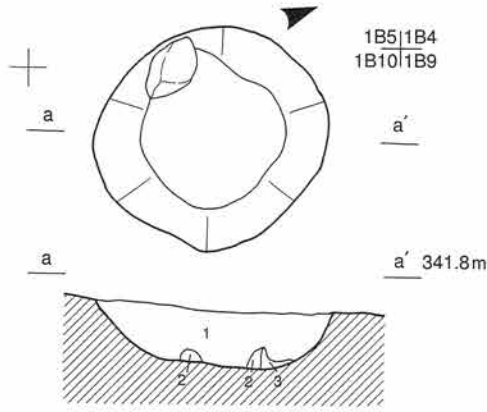

SK001

- 1 黒褐色土 粘性弱く、しまり強い。細粒で、V層のような白色粒子を多量に含む。
- 2 黒褐色土 粘性弱く、しまり弱い。1層とVI層が混じり合い、粗粒。
- 3 黄褐色土 VI層(赤倉火砕流)のブロック状堆積。

SK007

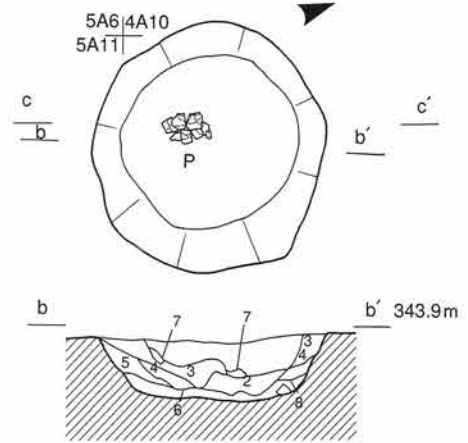

SK007

- 1 黒褐色土 白色粒子を少量含む。
- 2 暗褐色土 しまり粘性ともに弱い。
- 3 暗褐色土 しまり強く、粘性弱い。白色粒子を少量含む。
- 4 暗褐色土 しまり弱く、粘性やや強い。
- 5 黒褐色土 しまり極めて弱く、粘性弱い。
- 7 褐色土 しまり強く、白色粒子を多量に含む。

SK013

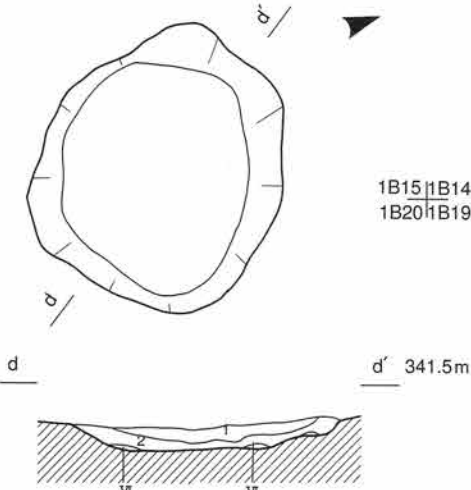

SK013

- 1 黒褐色土 しまり、粘性ともにやや強い。白色粒子を多く含む。
- 2 暗褐色土 しまりやや強く、粘性やや弱い。白色粒子を多く含む。
- VI層(赤倉火砕流)が混入。

SK116

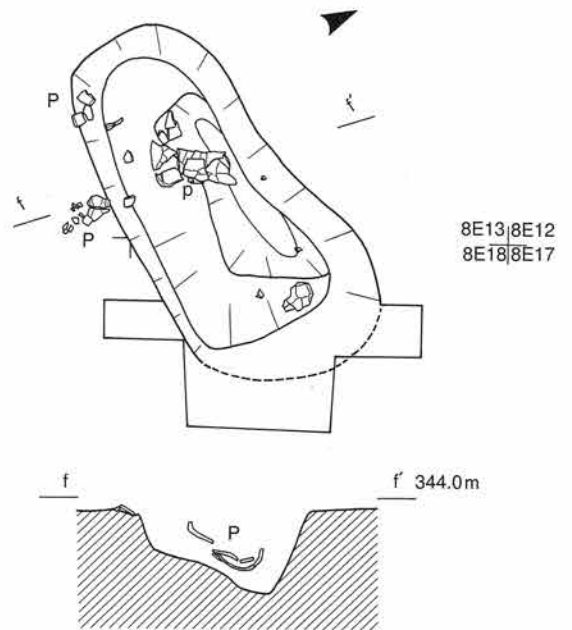

SK402

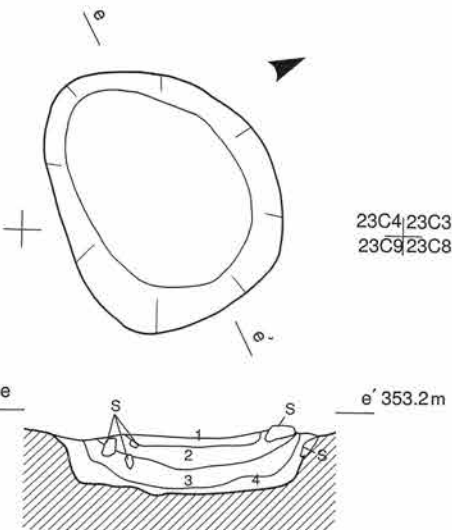

SK402

- 1 黒色土 しまり、粘性ともにやや弱い。細粒で、礫が混入。
- 2 黒褐色土 しまり弱く、粘性やや強い。細粒で、礫が混入。
- 3 黒褐色土 しまり弱く、粘性やや弱い。粗粒で、所々ブロック状になる。礫・4層が少々混入。
- 4 黒褐色土 しまりやや強く、粘性弱い。粗粒で、礫・VI層土(赤倉火砕流)が混入。

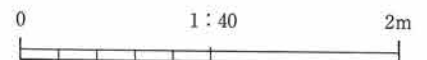

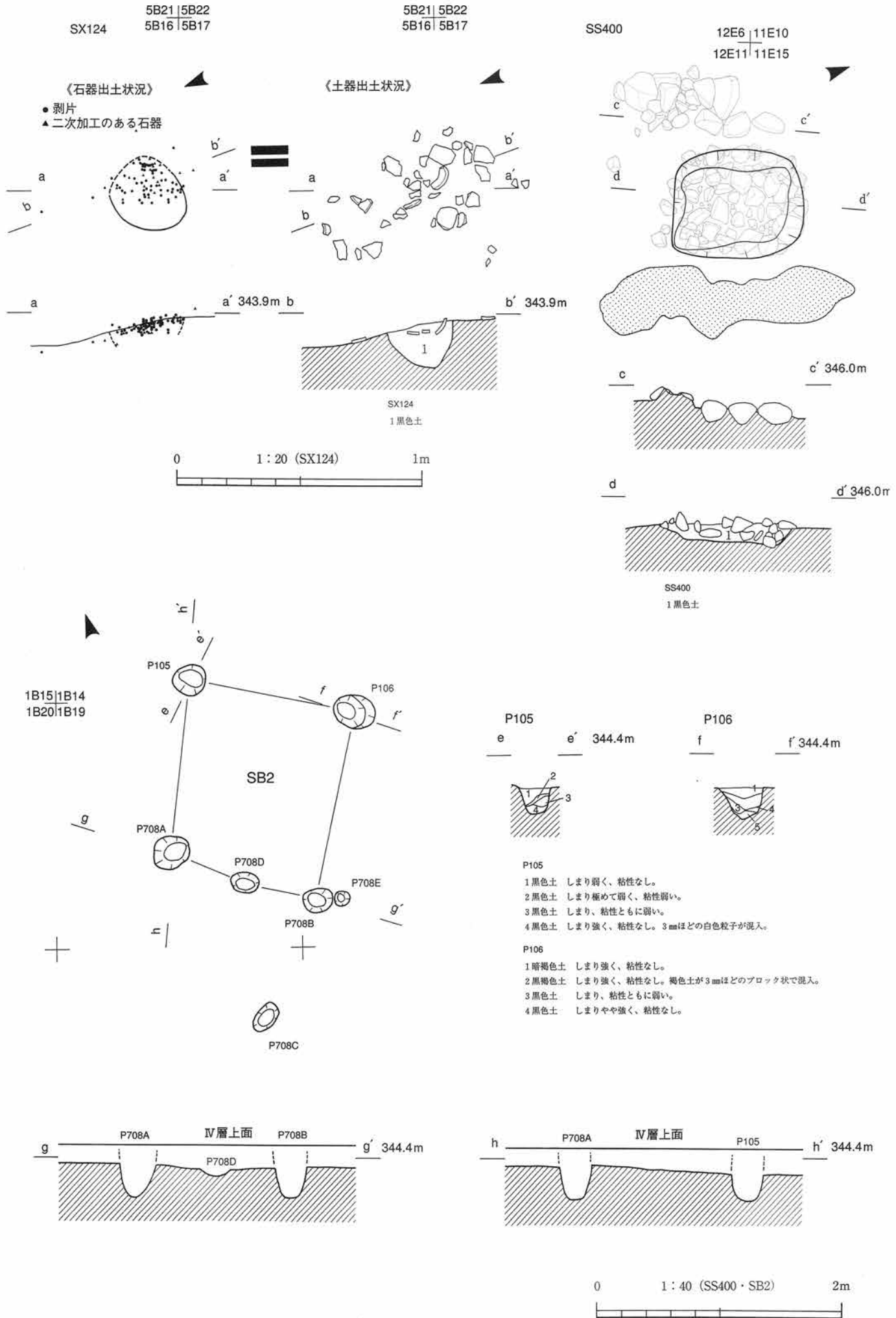

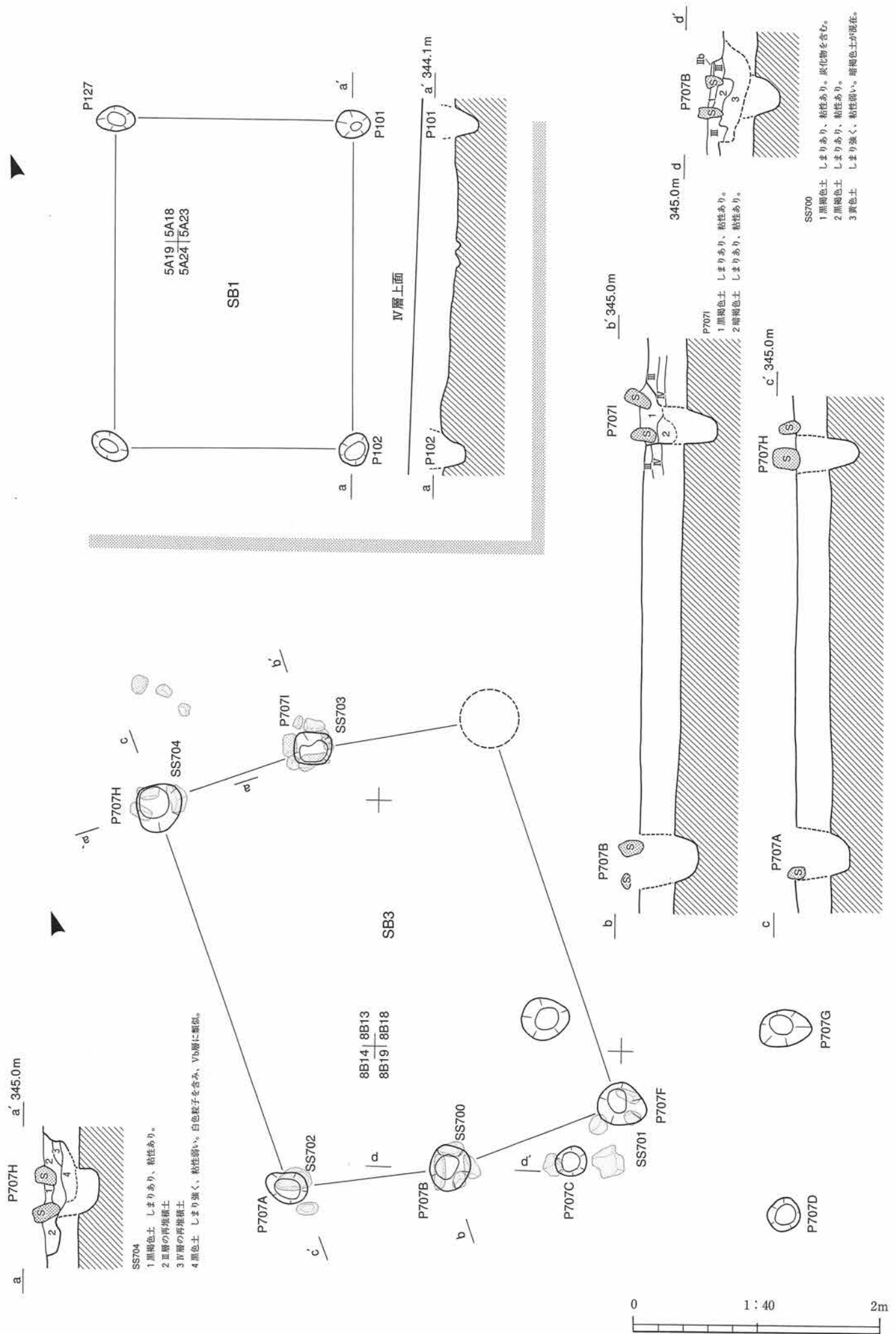

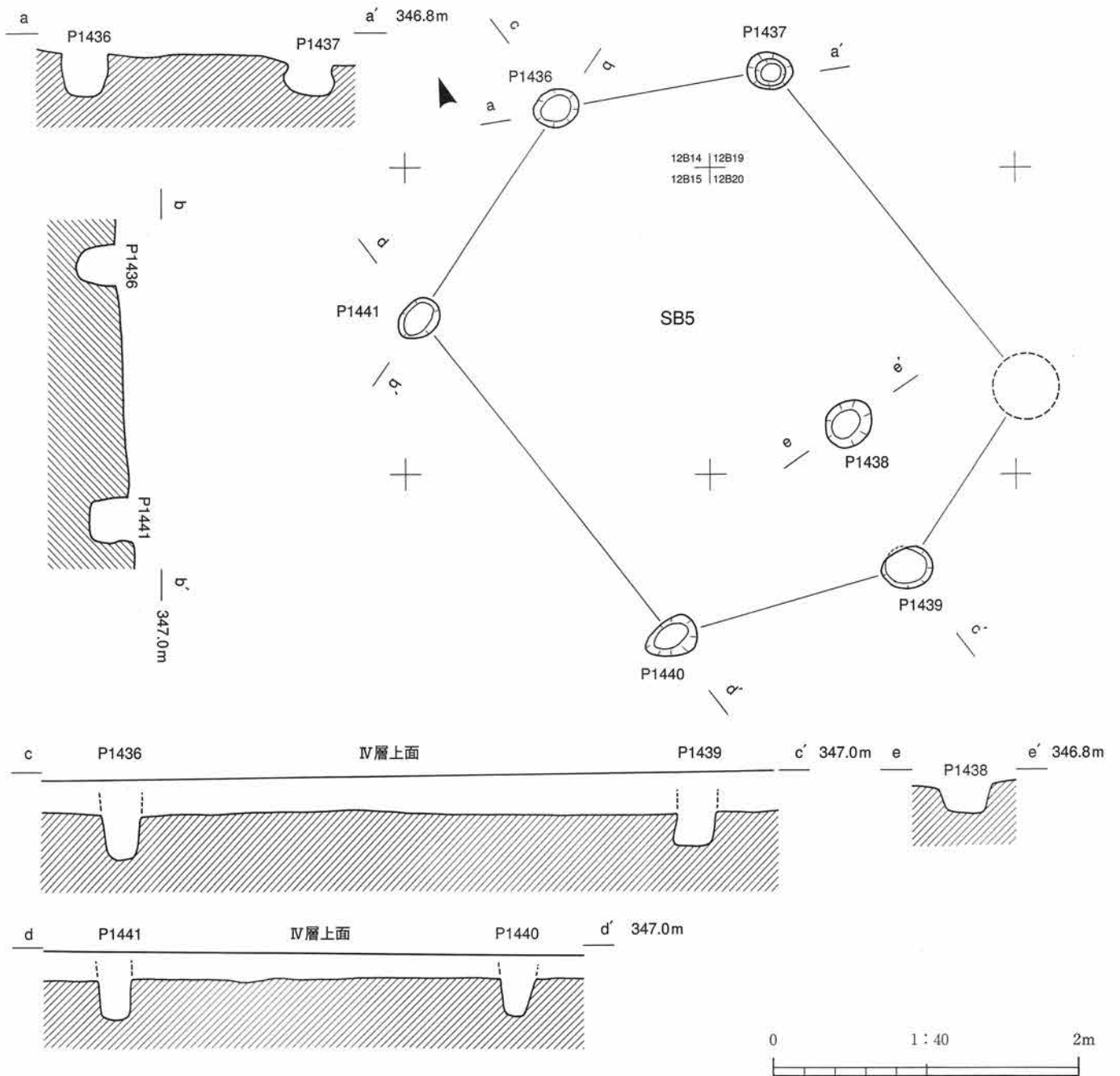
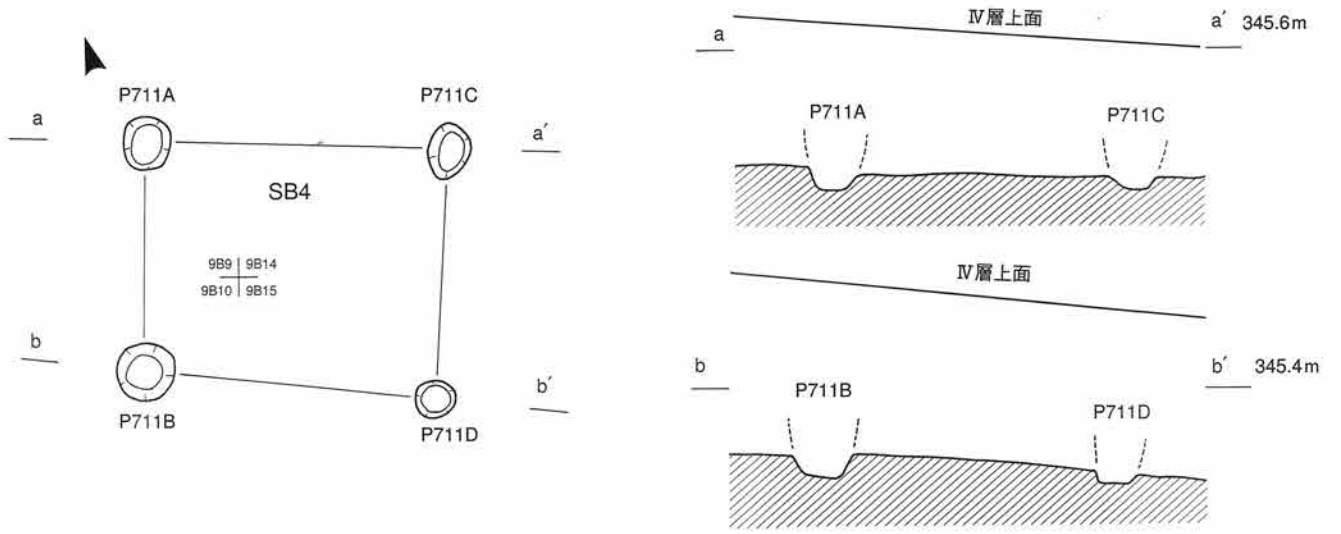

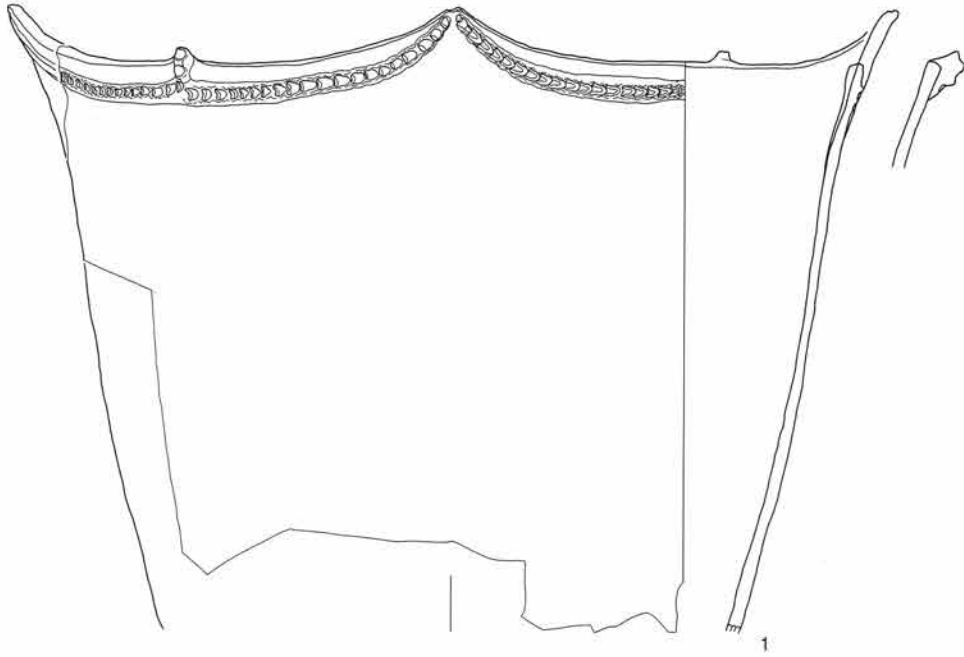

1

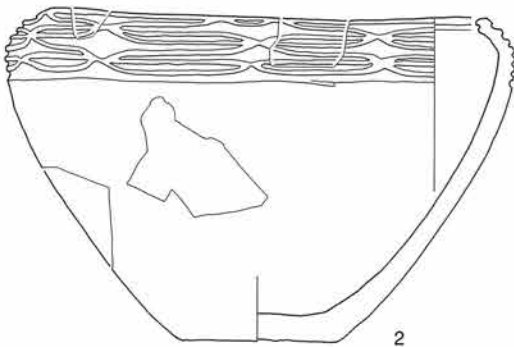

2

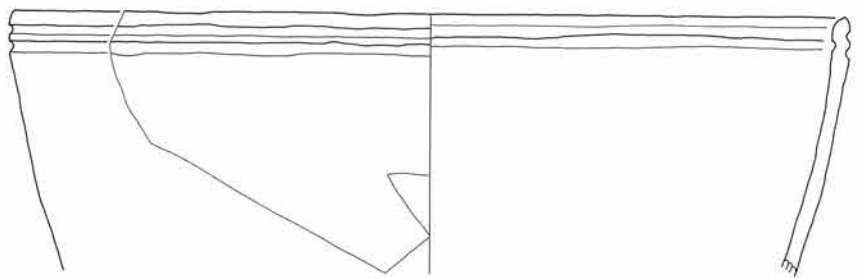
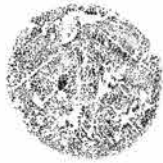

3

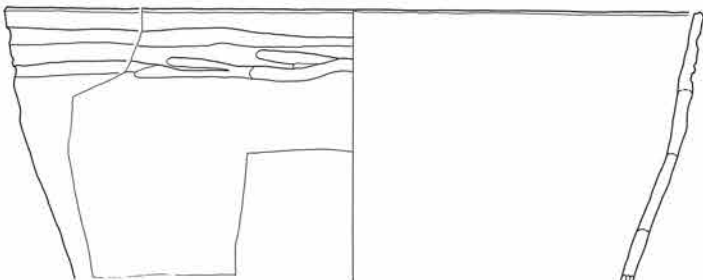

4



5

SK005 : 1
SK006 : 2~5

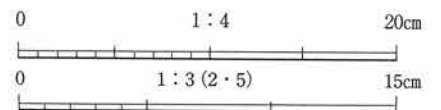

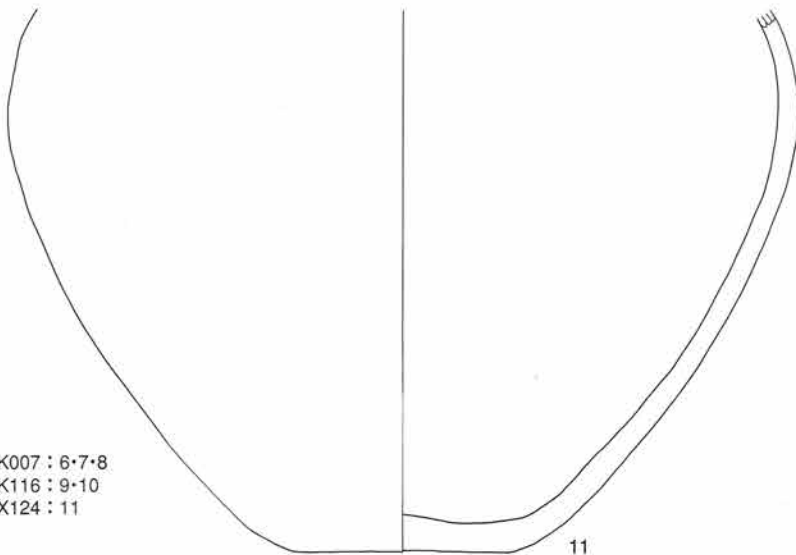
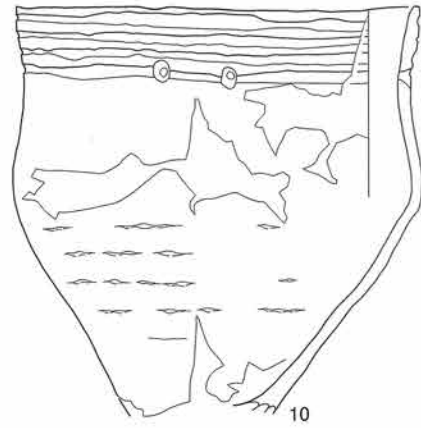
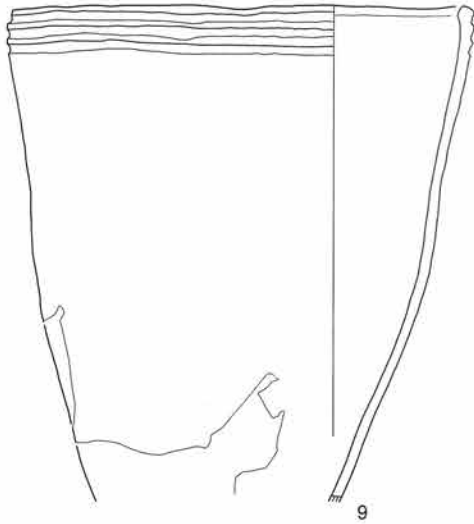
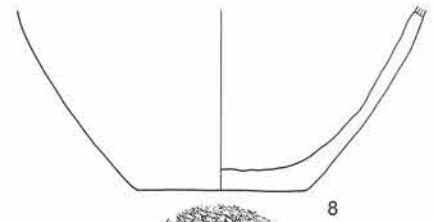
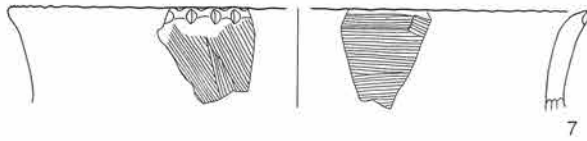
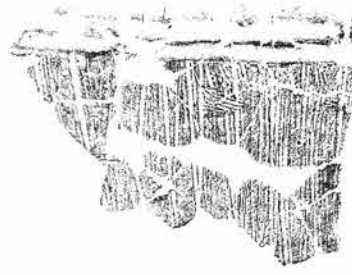
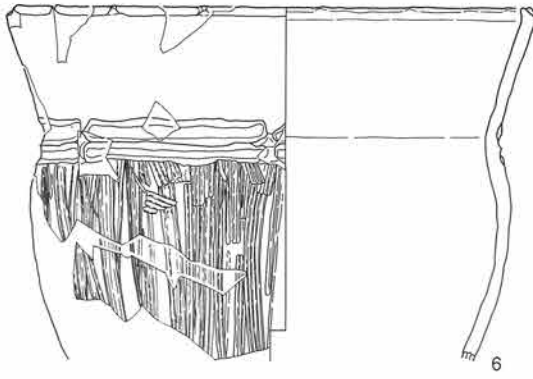

SK007 : 6・7・8
 SK116 : 9・10
 SX124 : 11

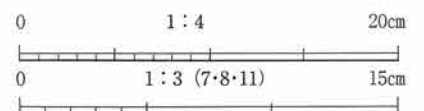

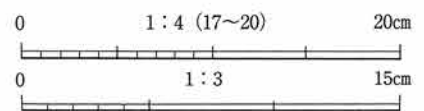
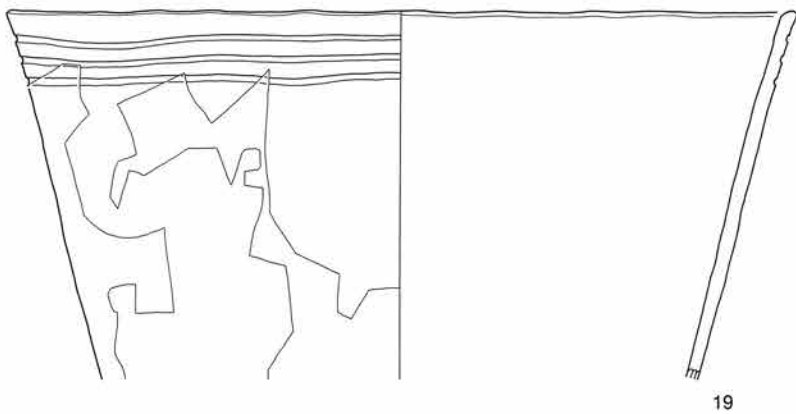
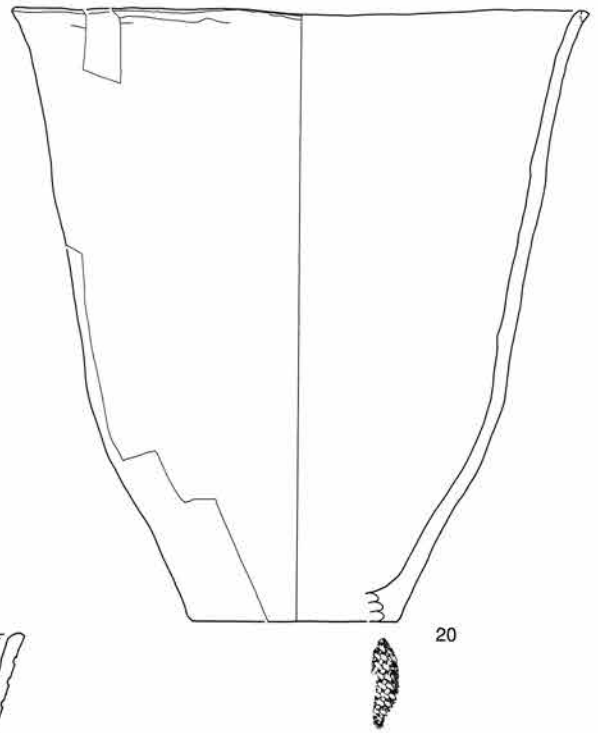
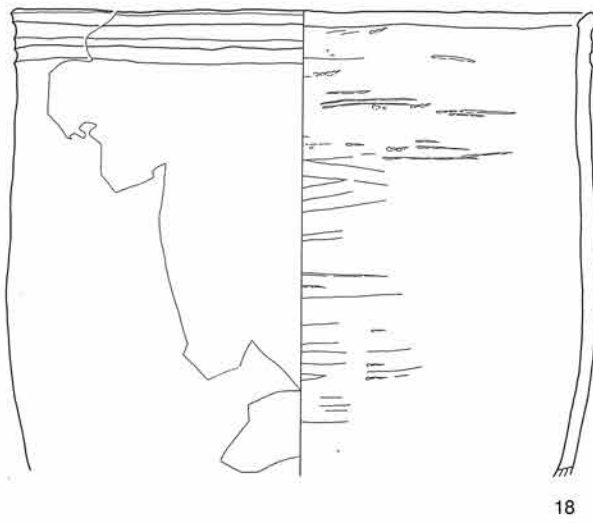
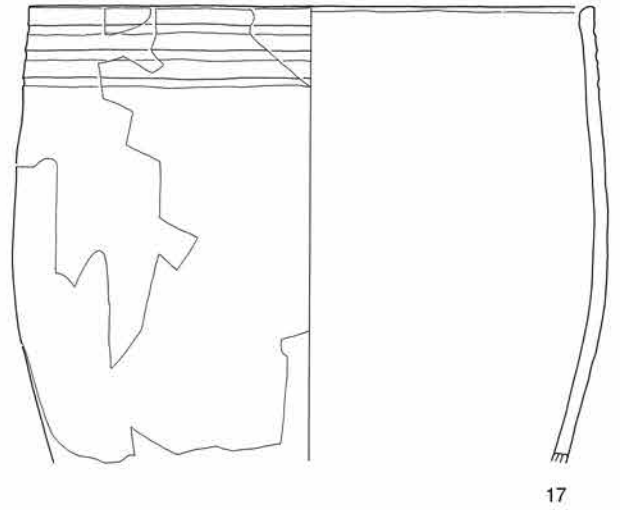
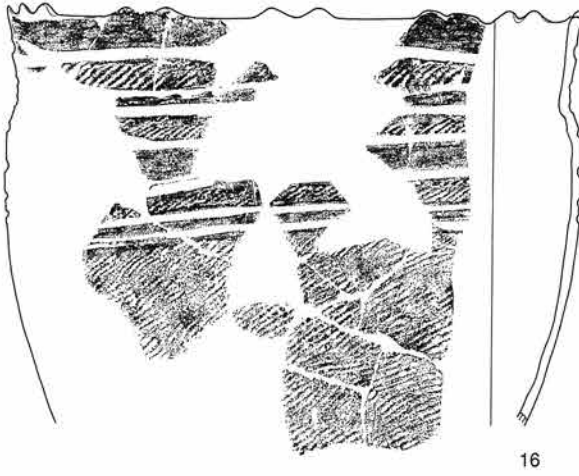
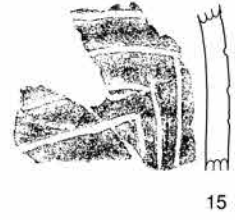
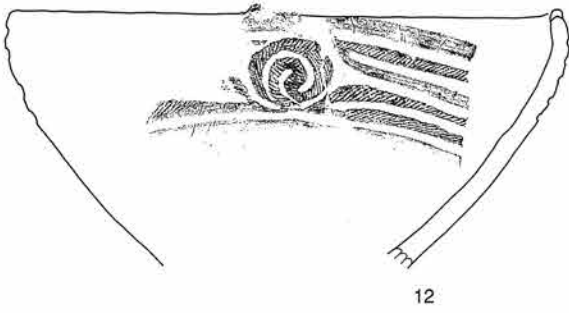

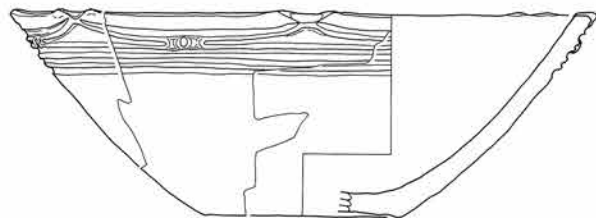

21



22

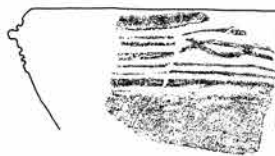

23



24



25



26

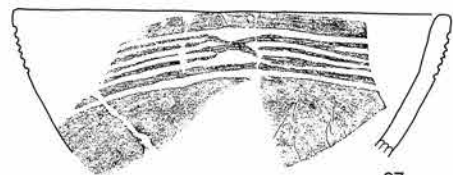

27



28

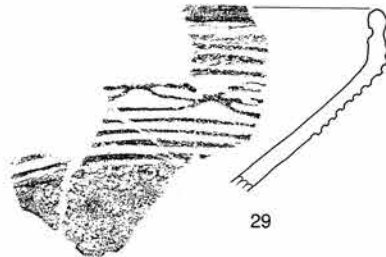

29



30



31



32



33



34



35



36



37

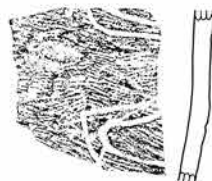

38

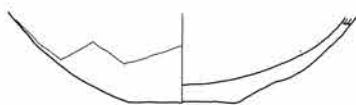

39



40



41

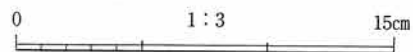

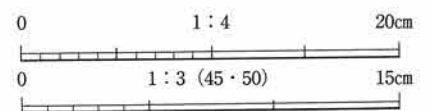
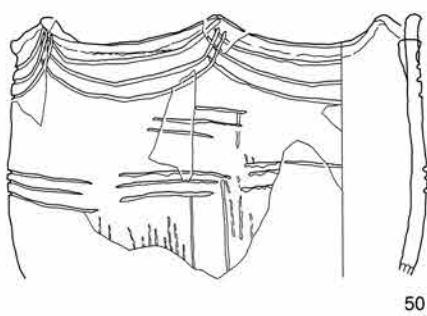
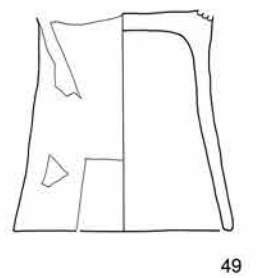
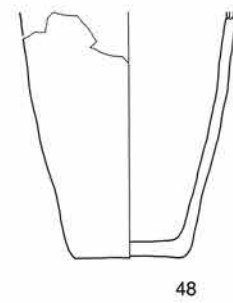
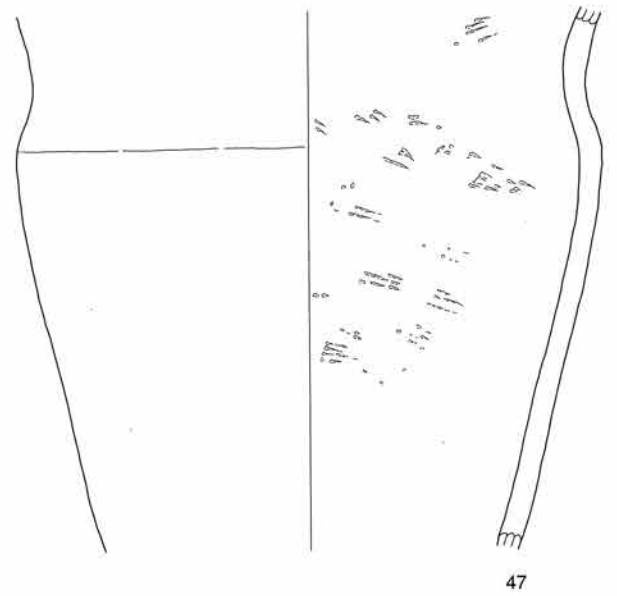
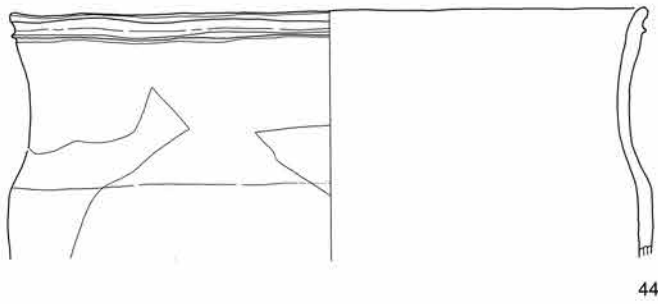
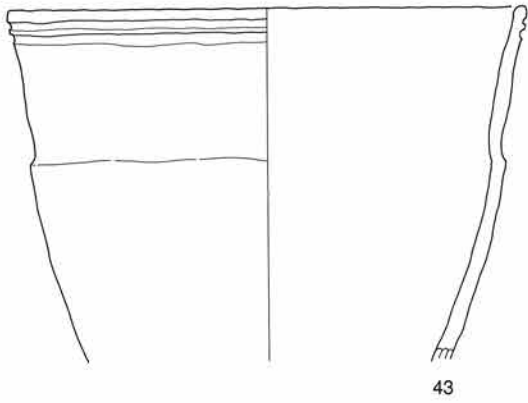
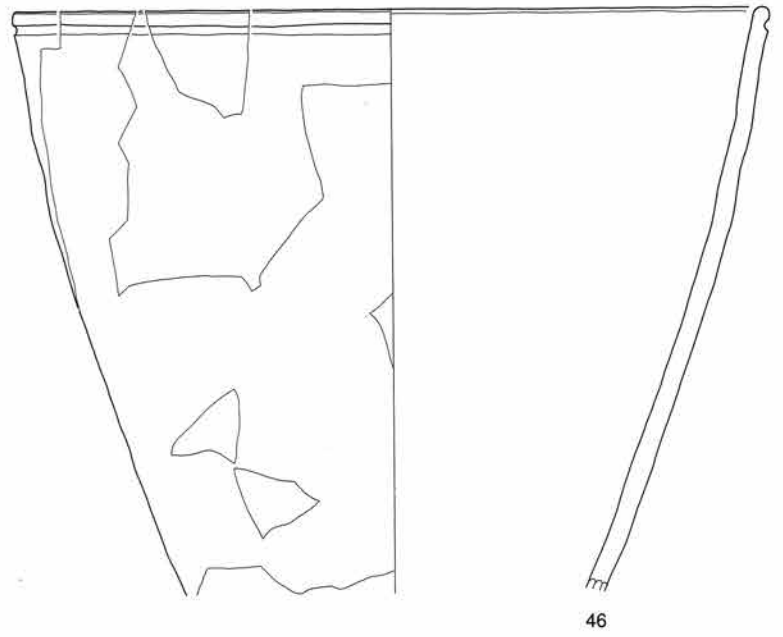
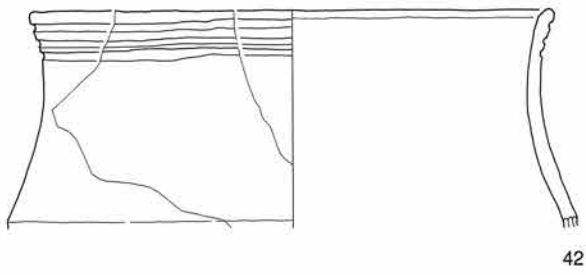

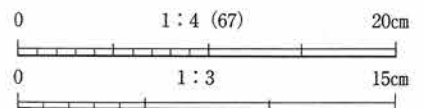
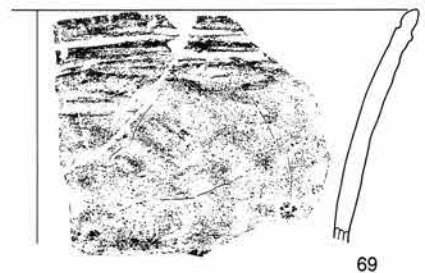
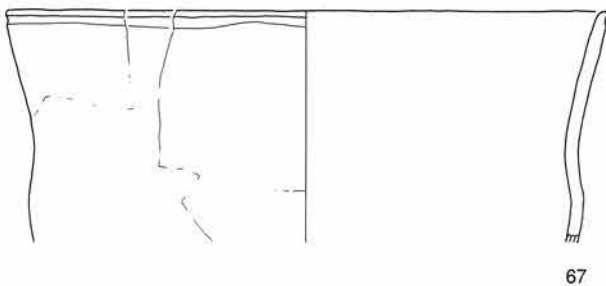
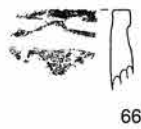
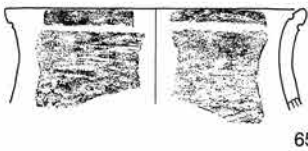
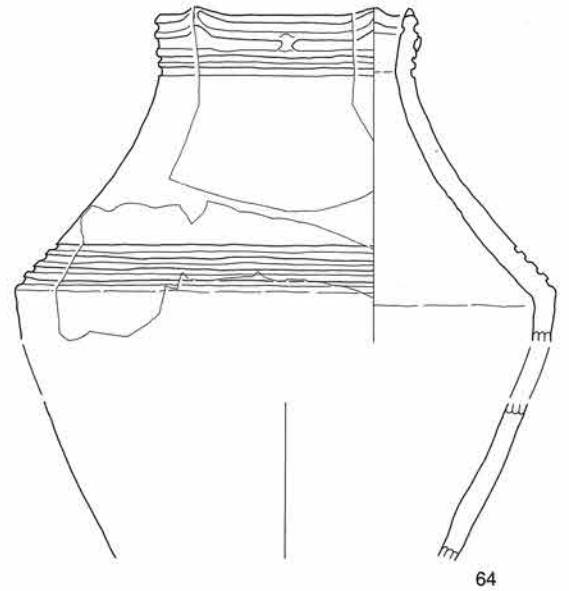
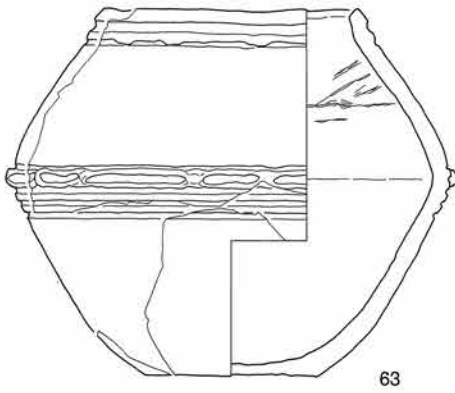
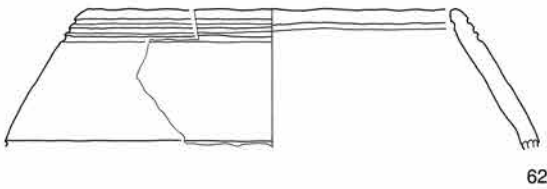
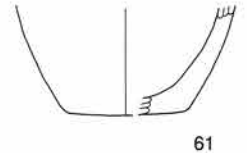
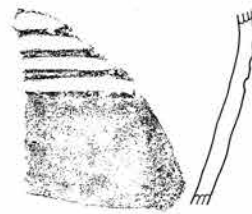
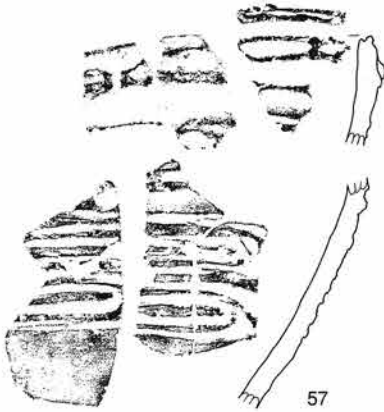
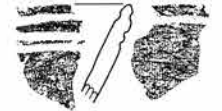
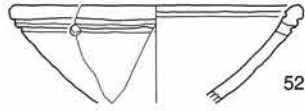



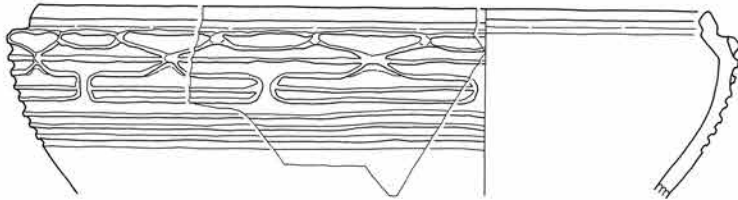

98

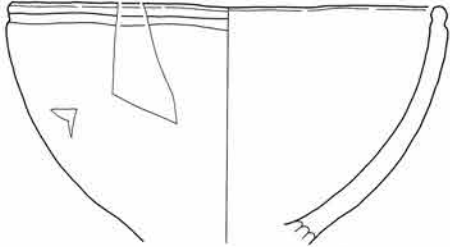
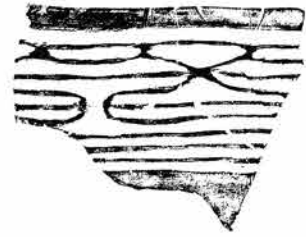

99

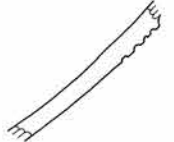

100



101



102

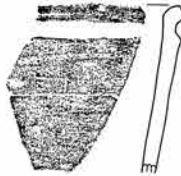

103

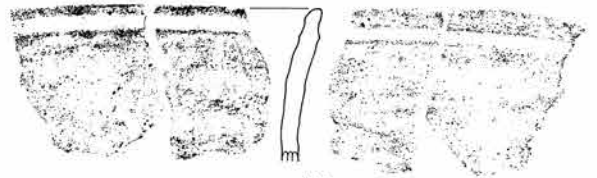

107



104



108

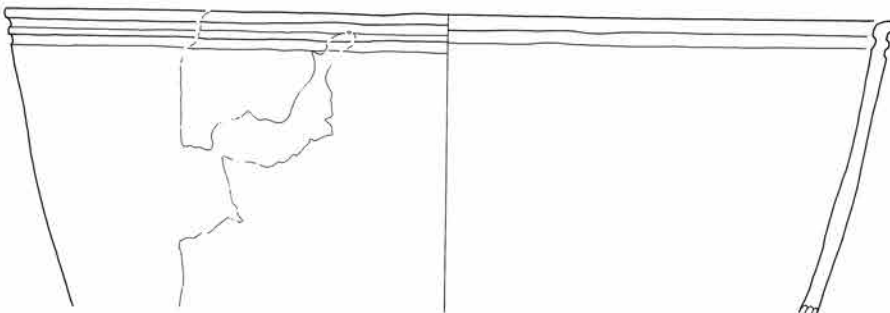

105



109



106



110

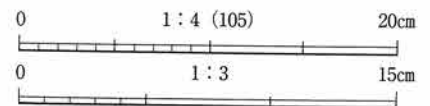

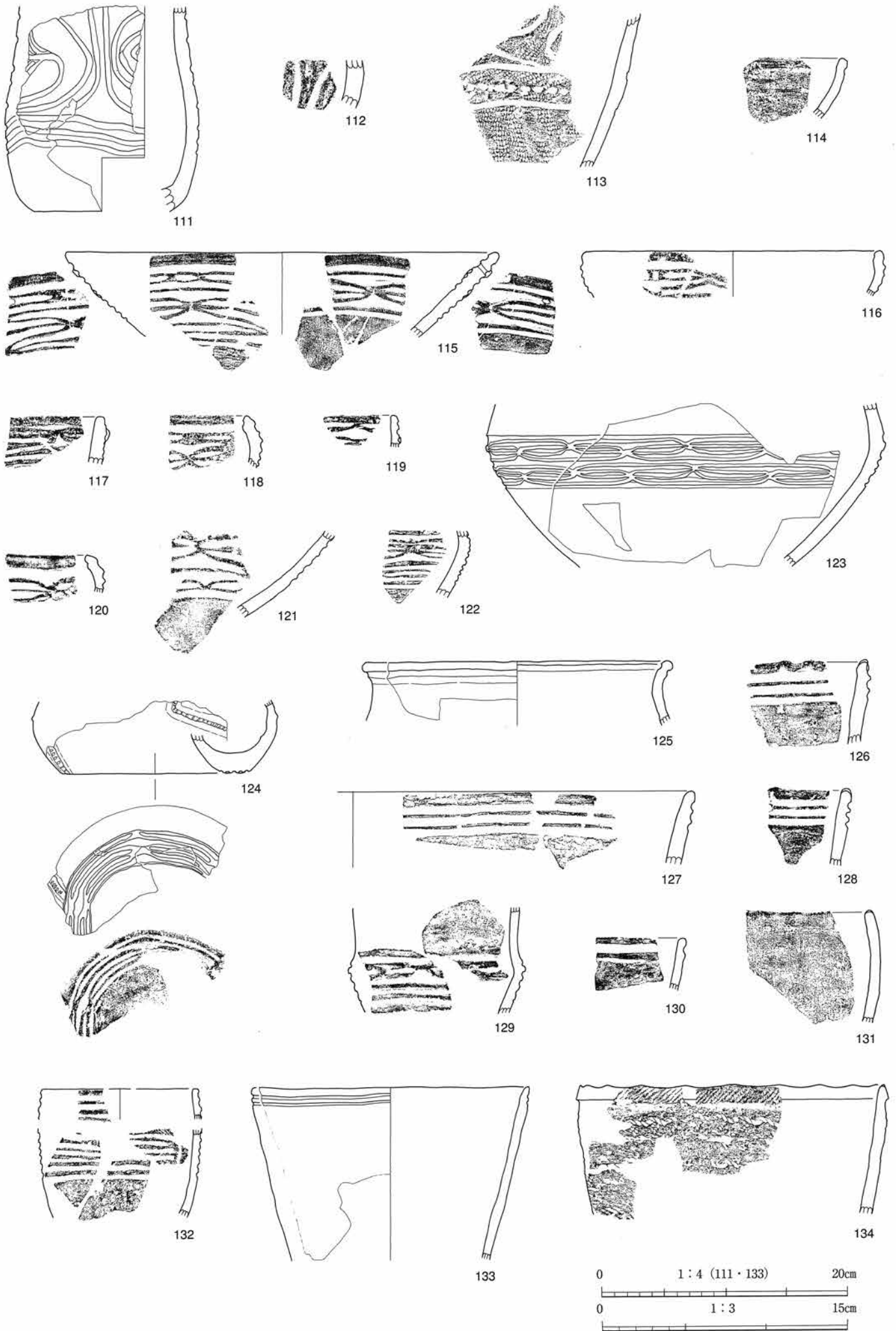

0 1 : 4 (111・133) 20cm
 0 1 : 3 15cm

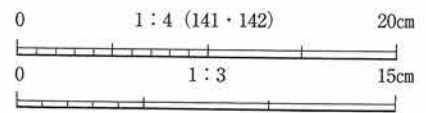
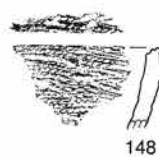
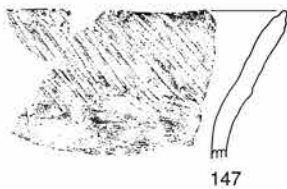
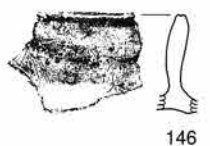
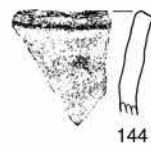
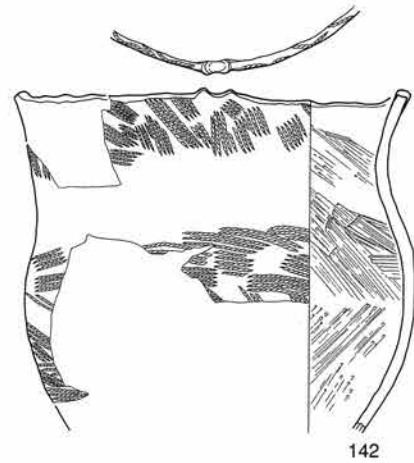
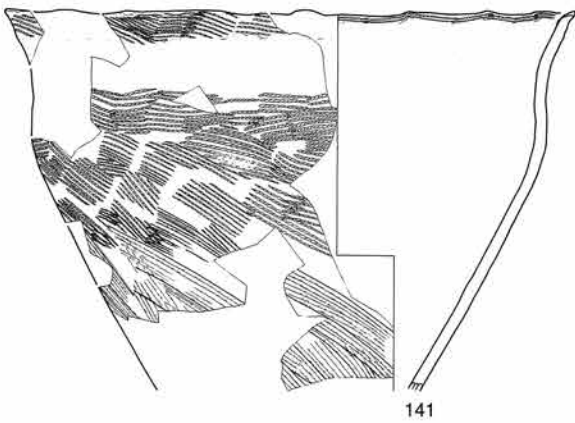
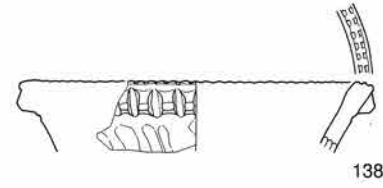
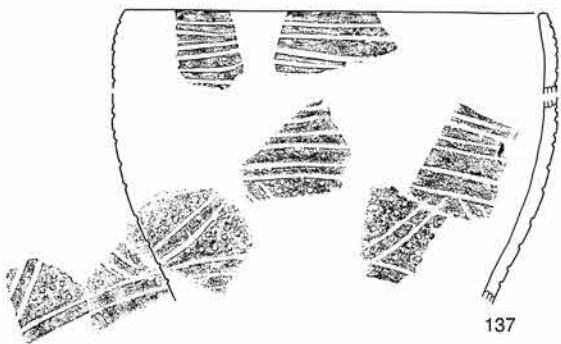
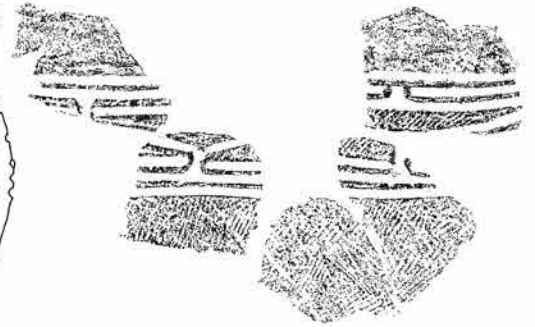
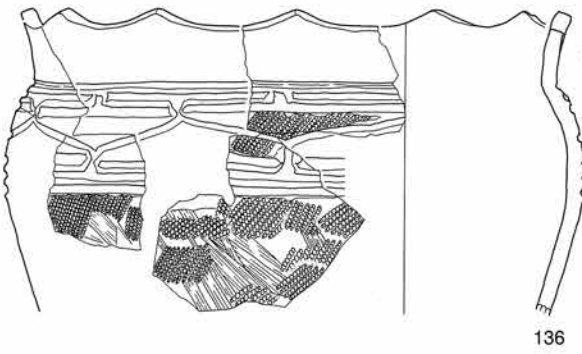
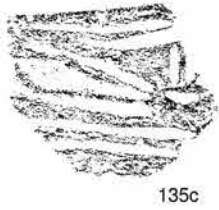
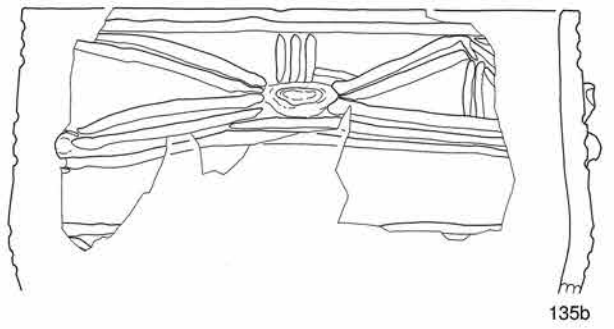
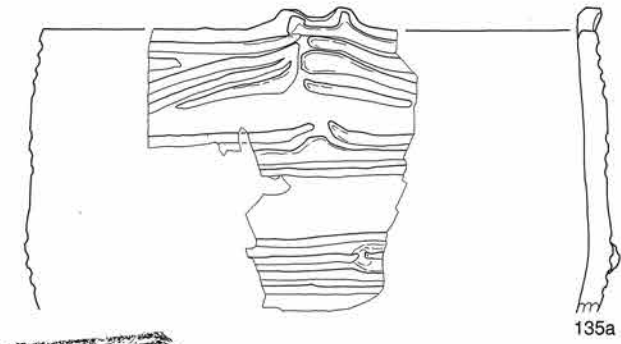



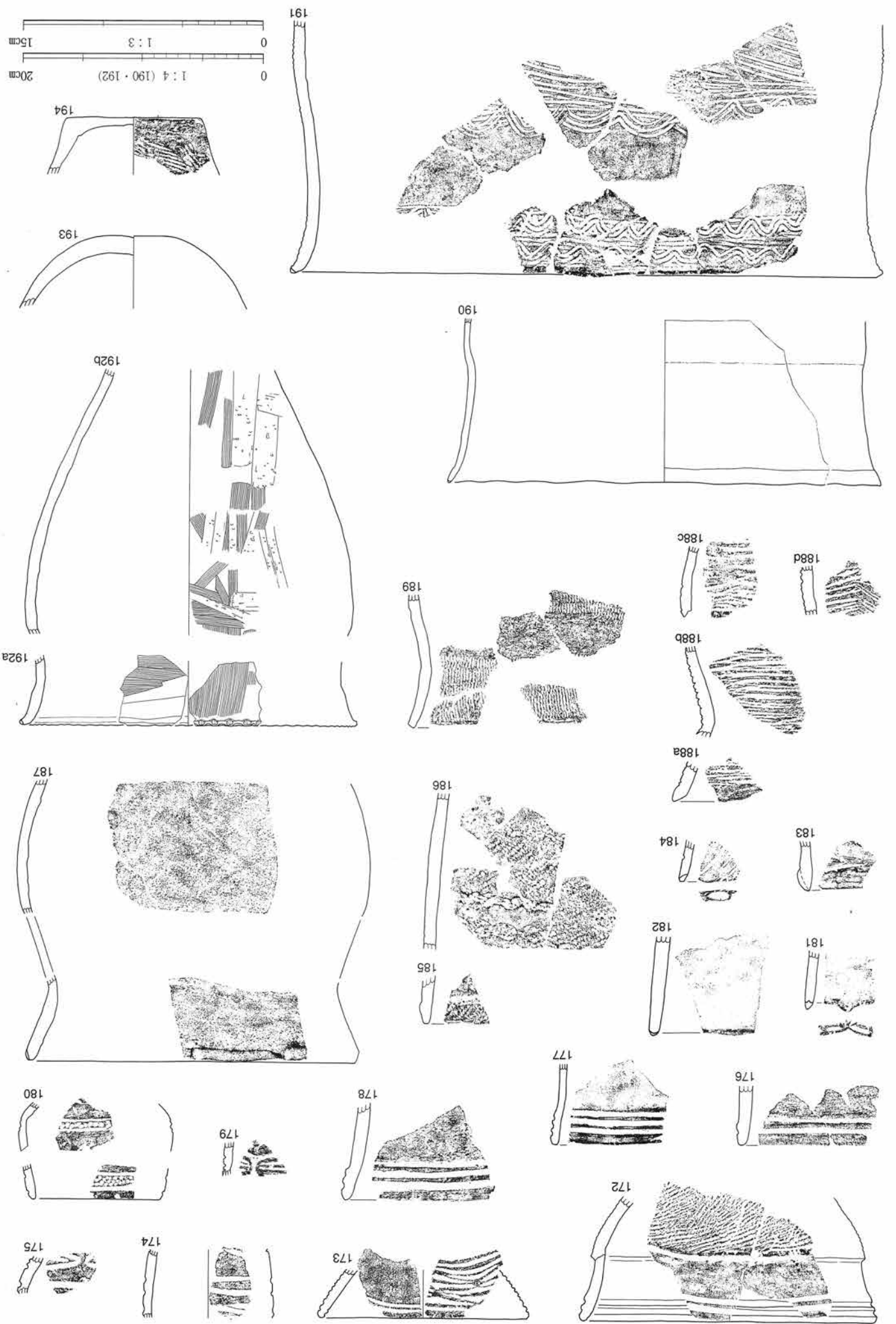

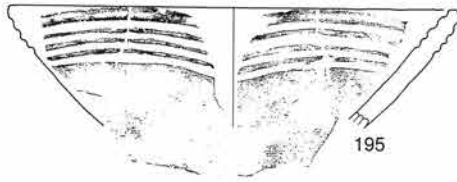

195



196

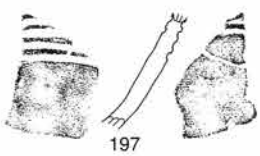

197

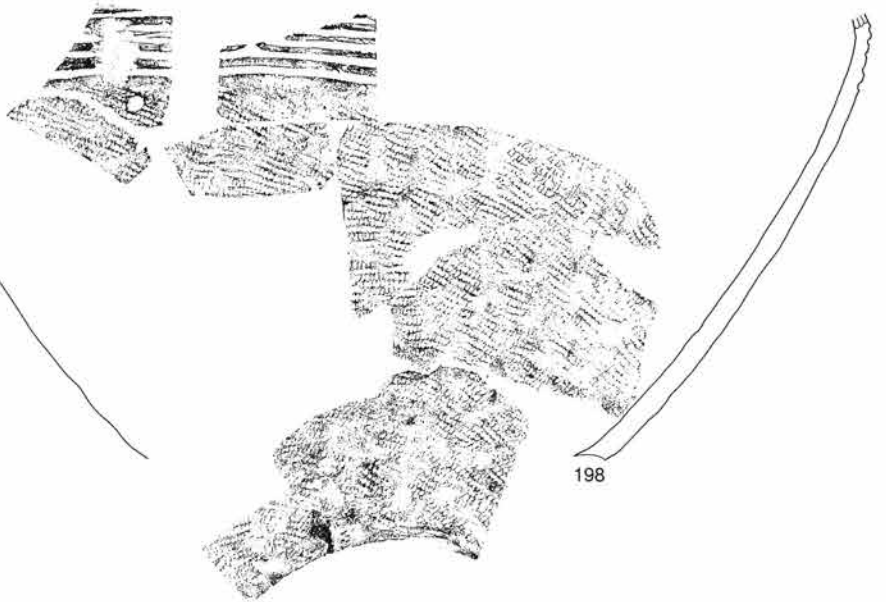

198

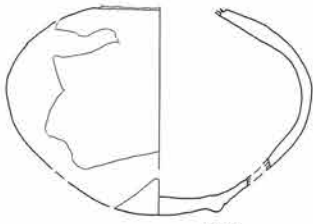

199

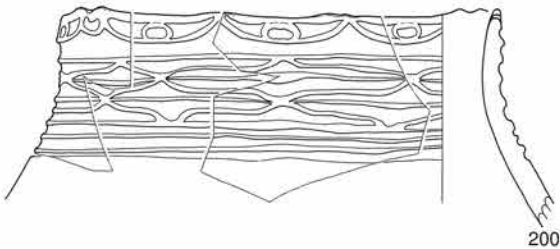

200



201

202



203

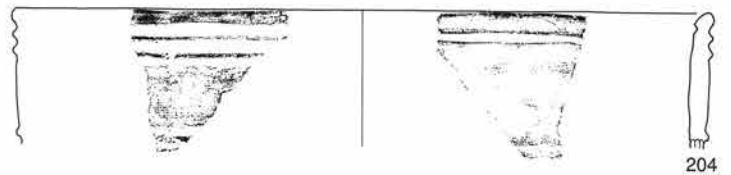

204

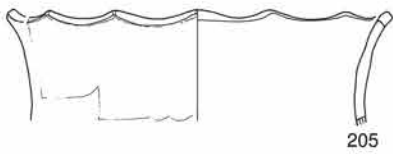

205

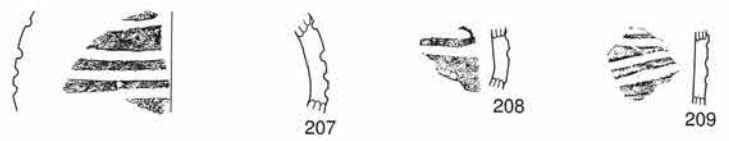

207

208

209

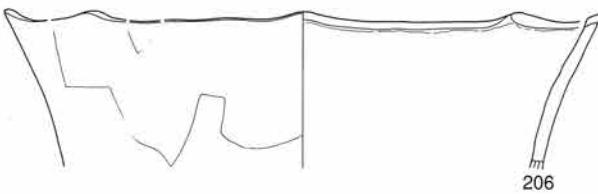

206

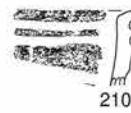

210



211

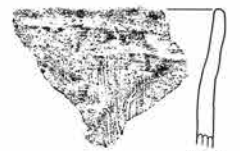

214



212



213

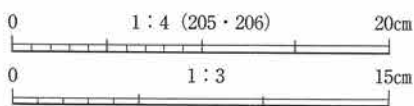

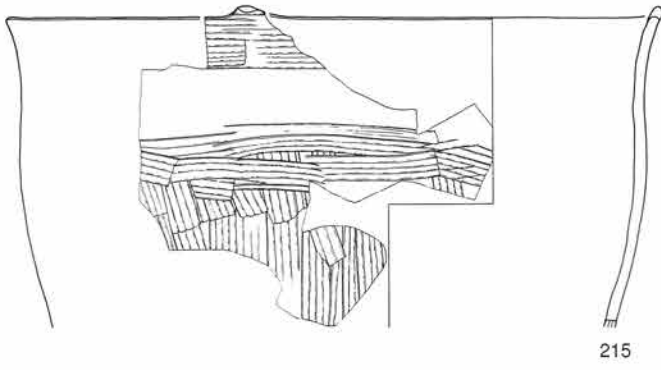

215

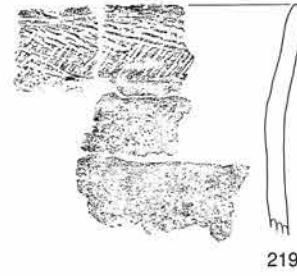

219



220



216

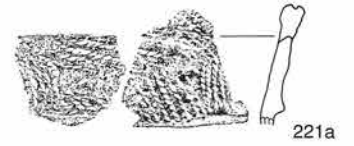

221a



221b

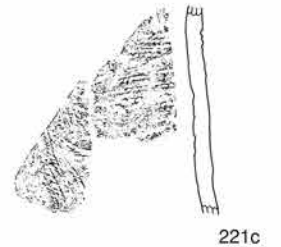

221c



217

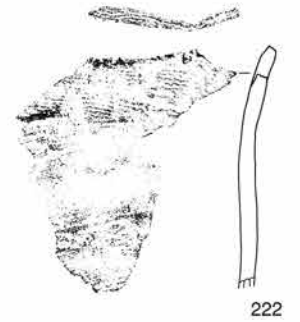

222

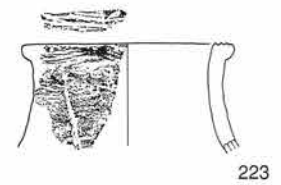

223

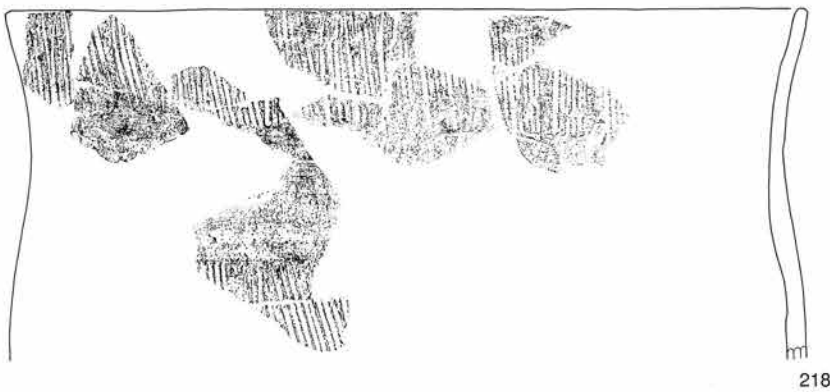

218

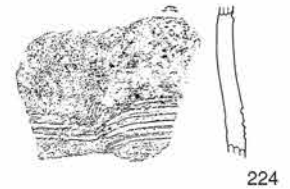

224



225

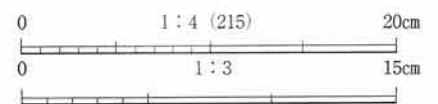

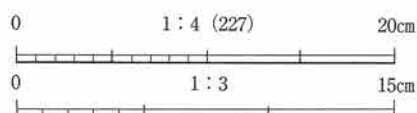
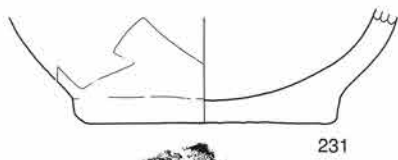
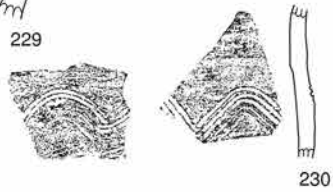
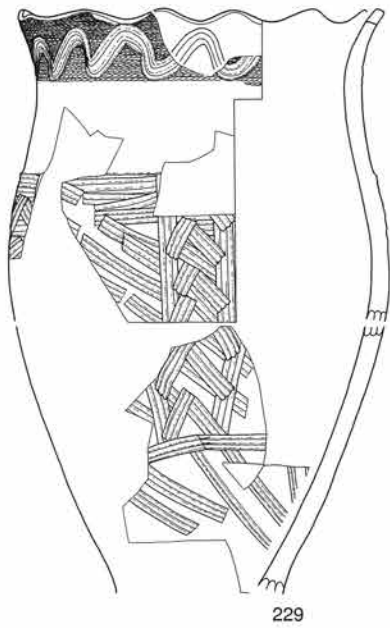
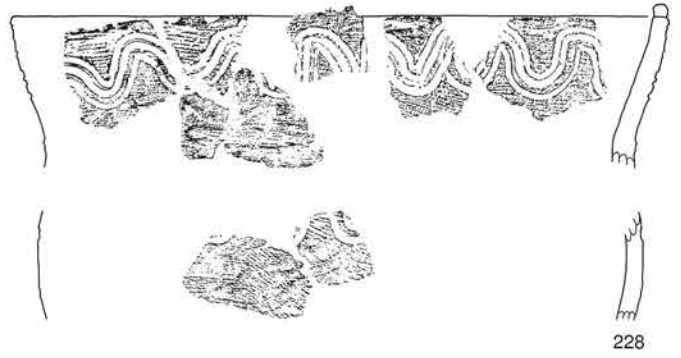
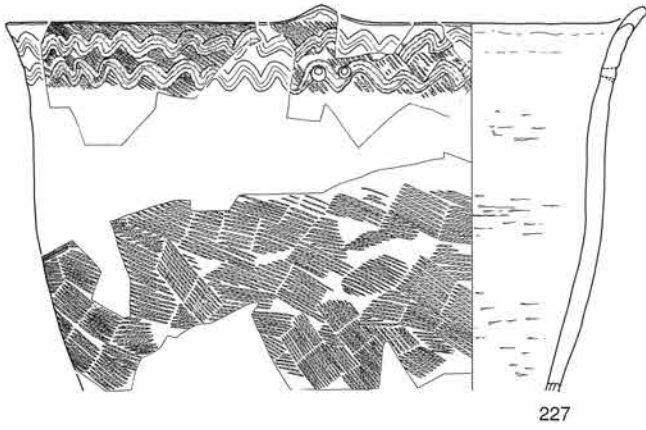
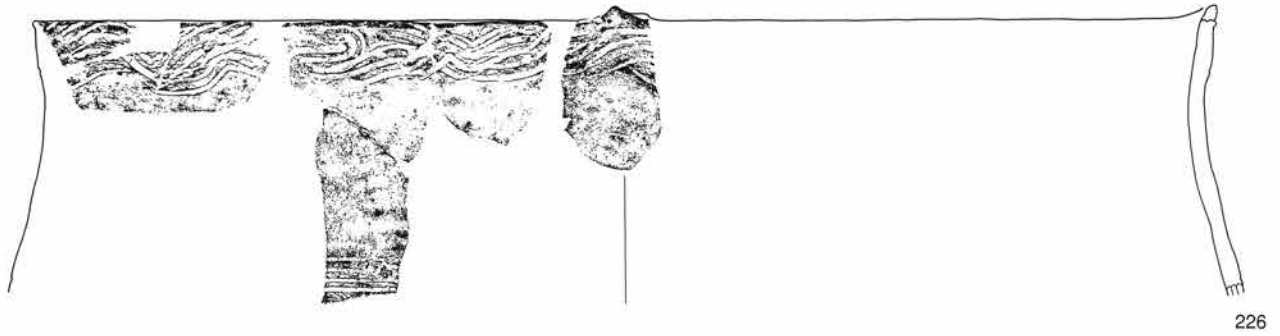





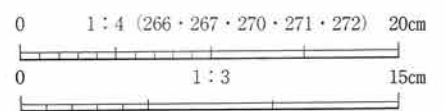
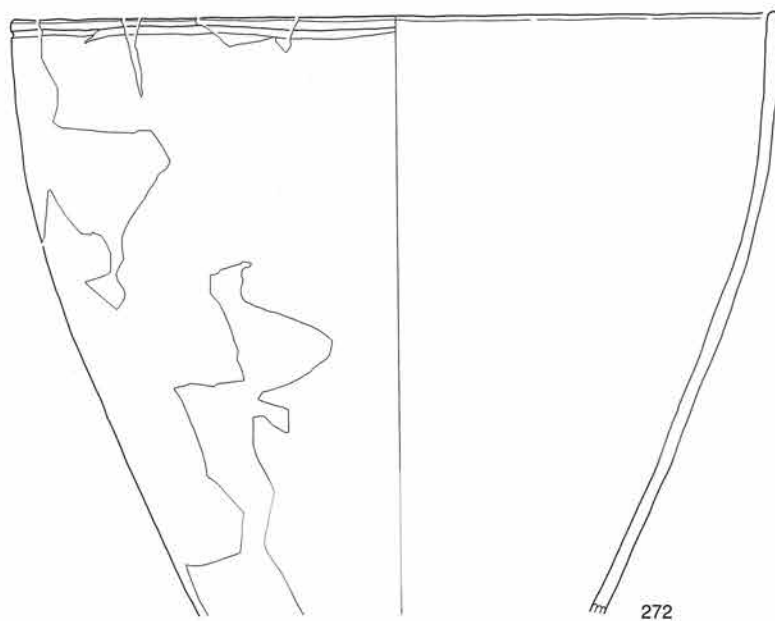
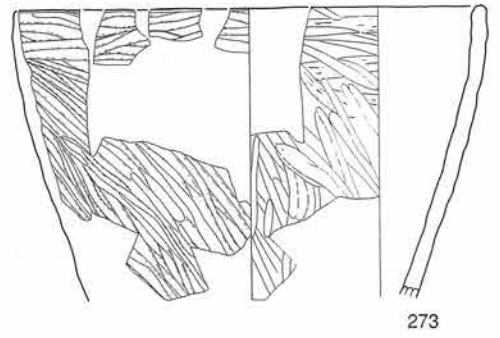
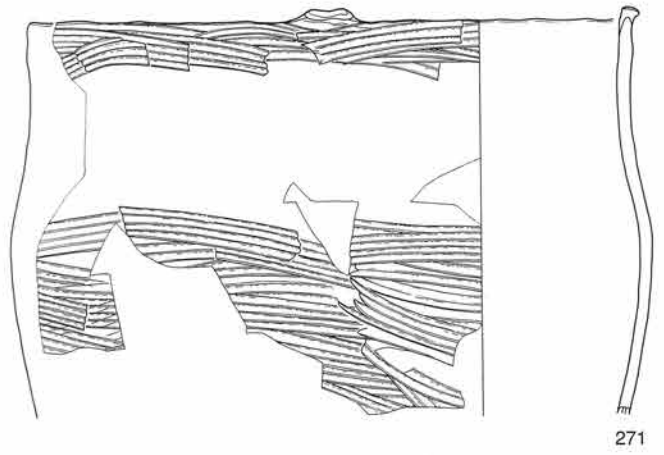
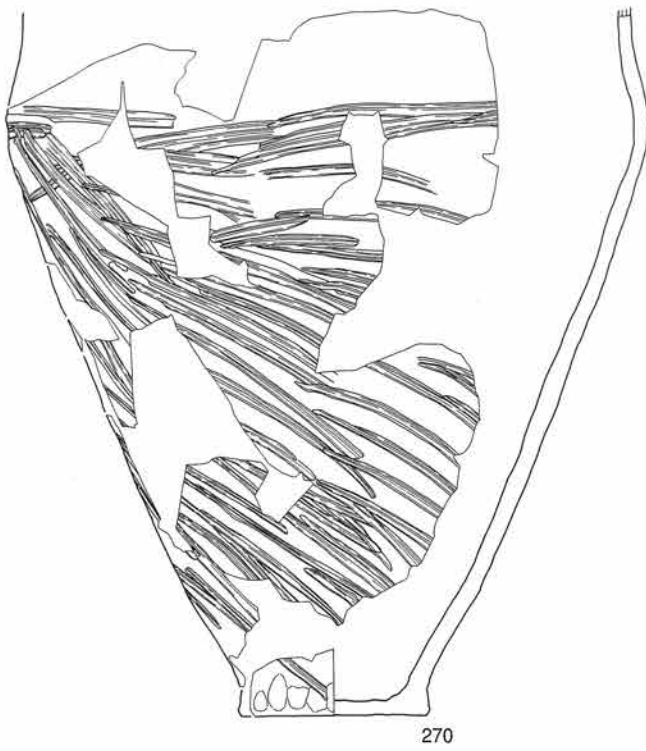
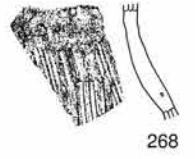
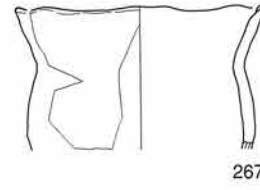
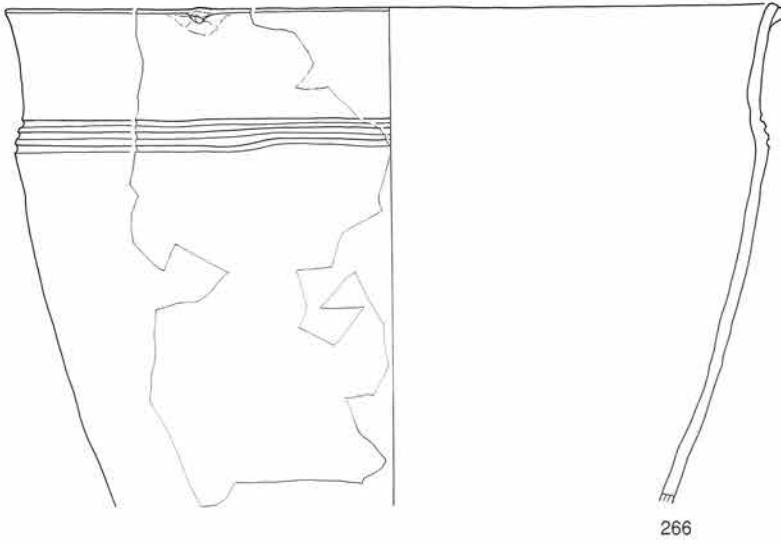

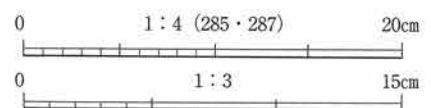
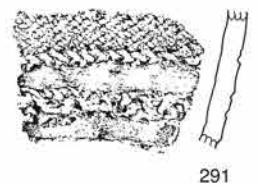
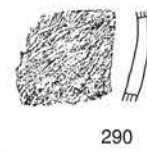
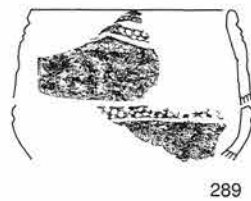
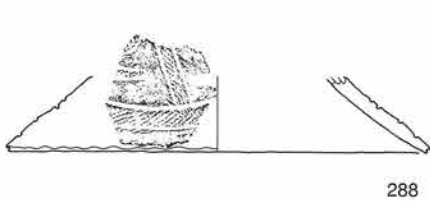
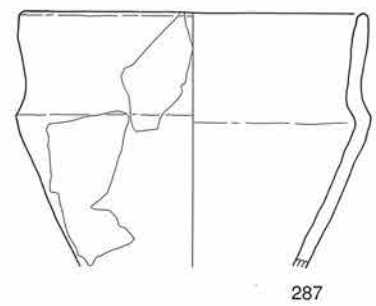
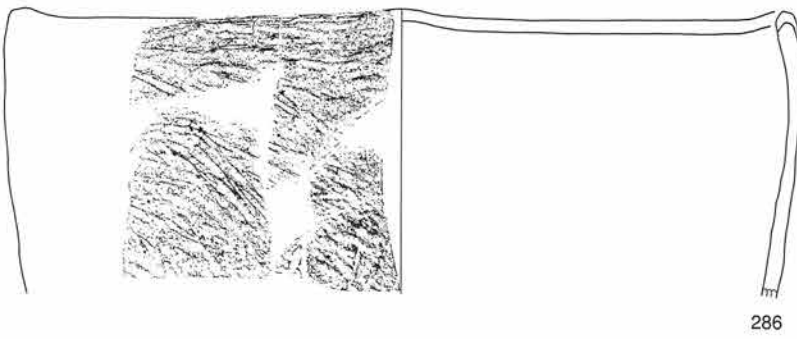
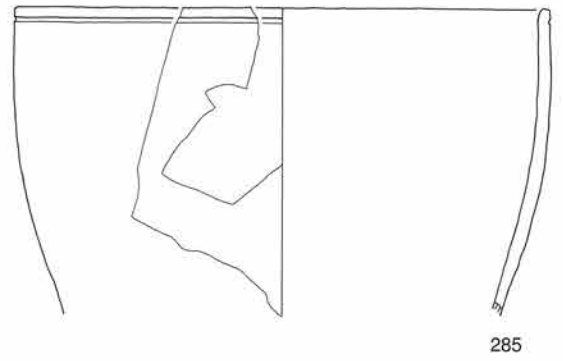
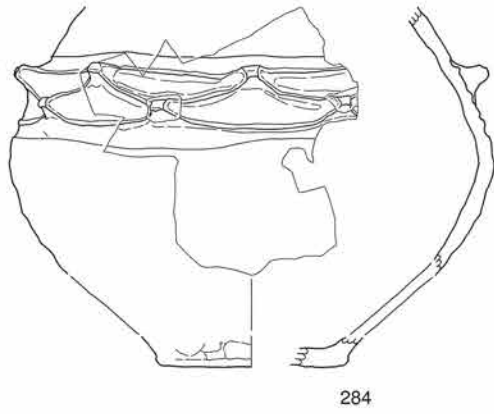
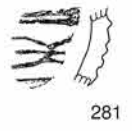
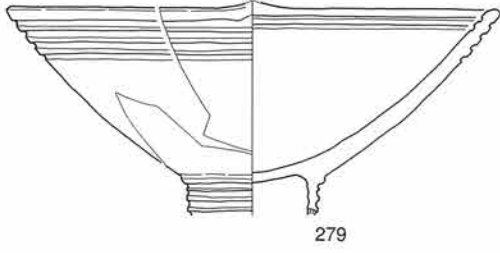
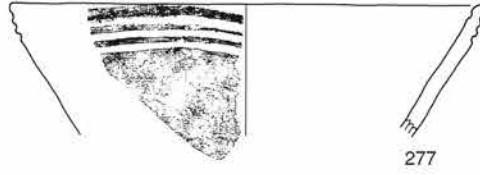
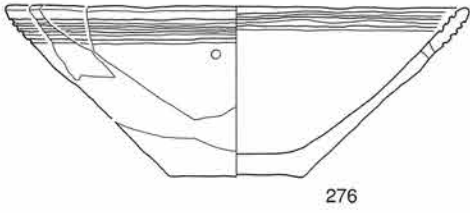

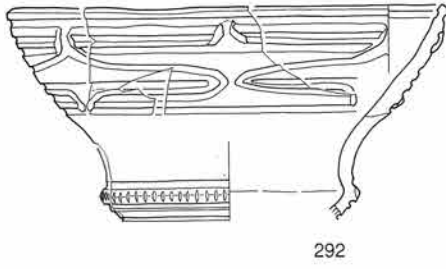

292

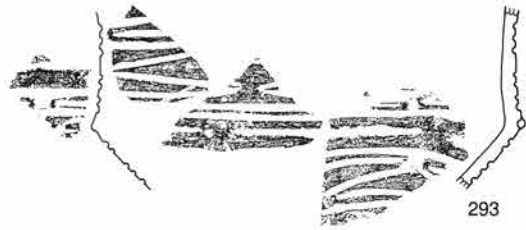

293

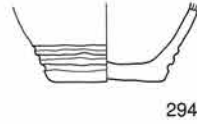

294

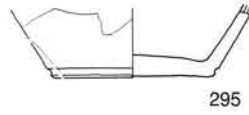

295



296

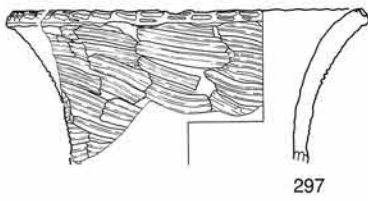

297



298



299

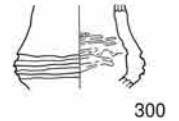

300



301

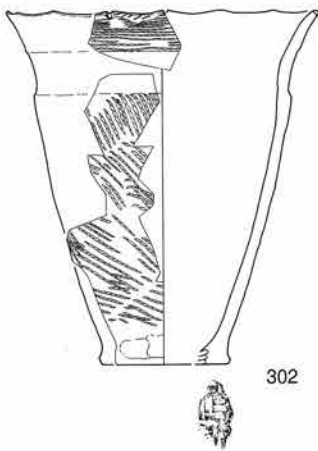

302

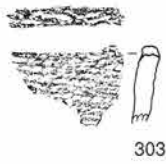

303



304

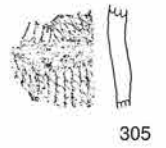

305

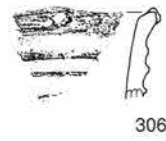

306

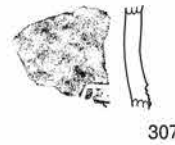

307

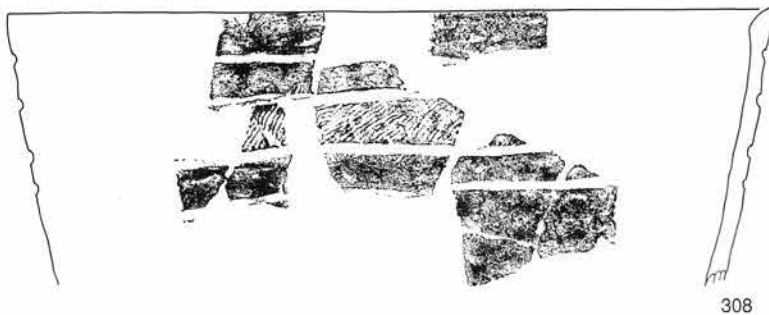

308

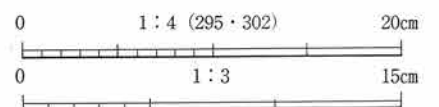

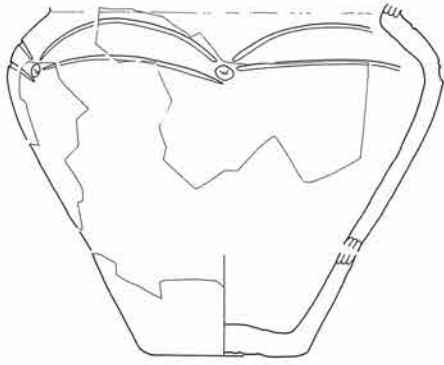

309

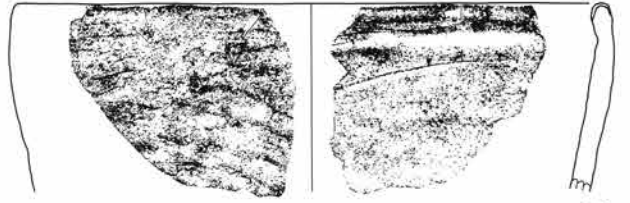
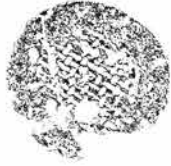

310

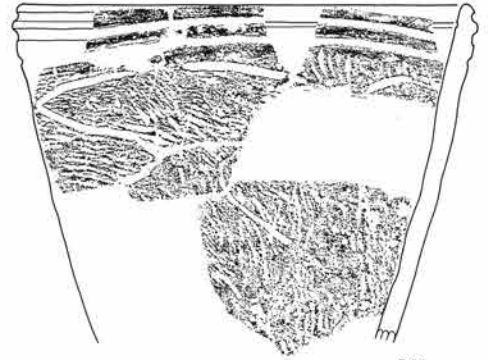

311



312



313



314



315



316

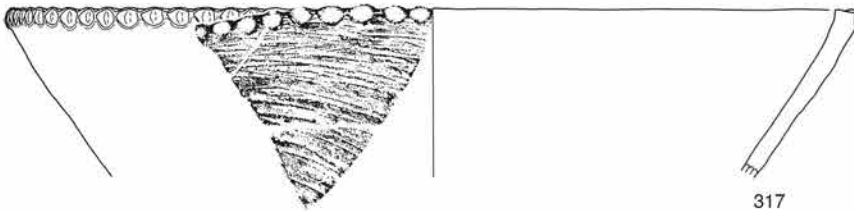
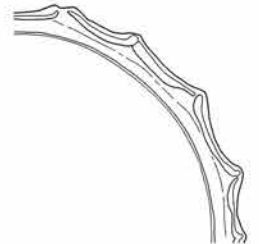

317

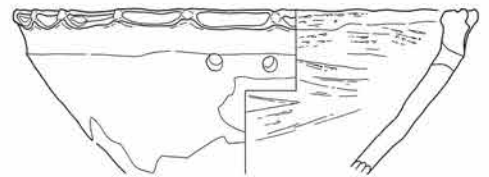

318

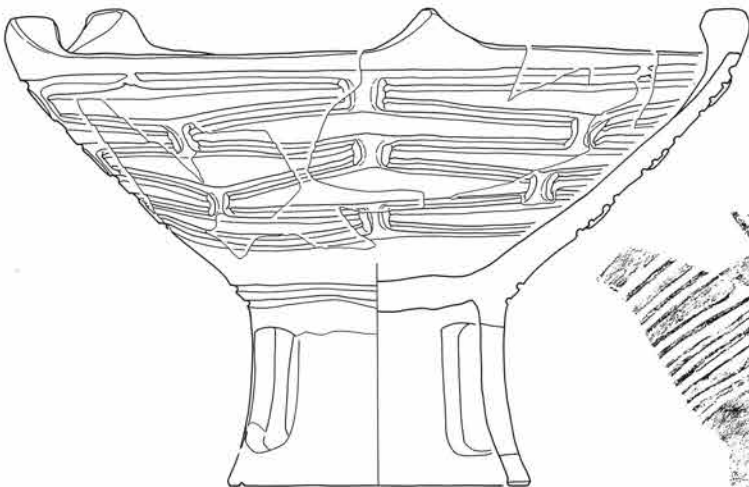

319

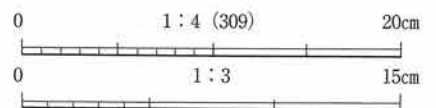
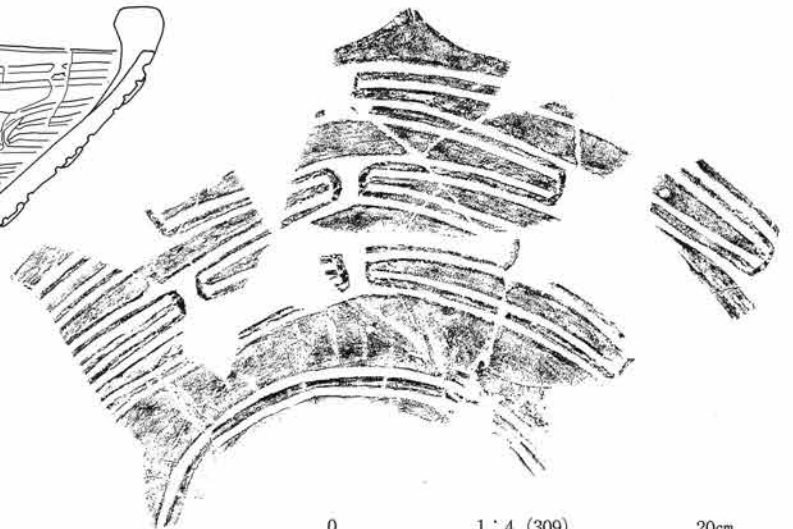

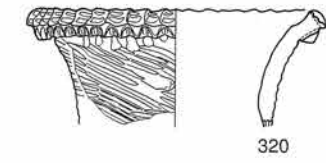

320

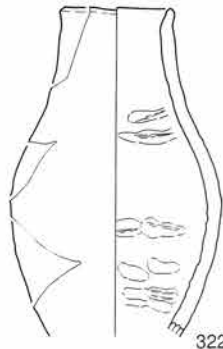

322

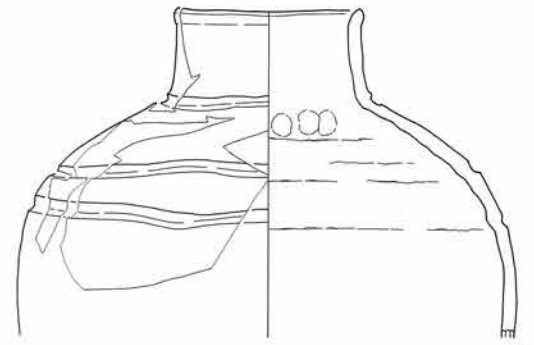

323

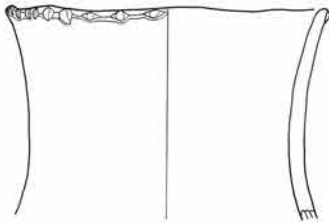

321

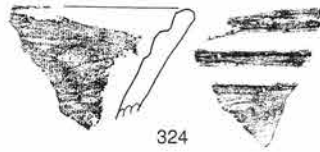

324



325



326

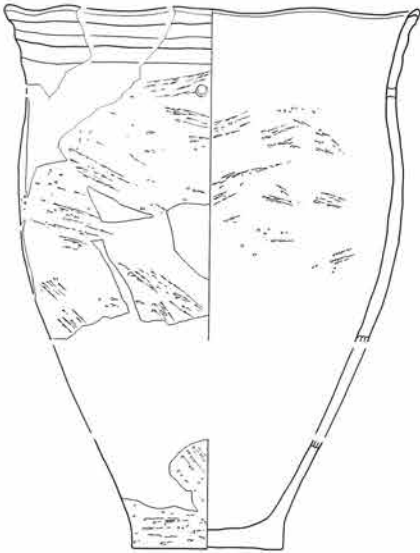

327



328



330



329



331

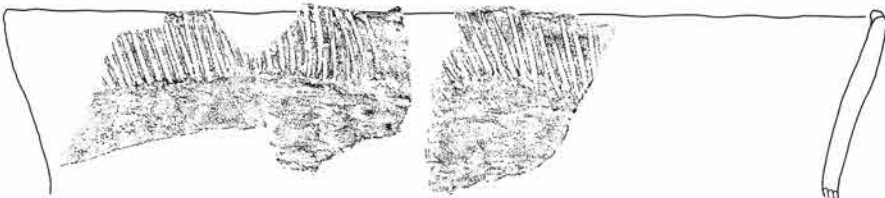

332

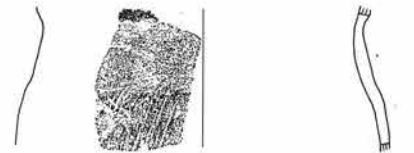

334

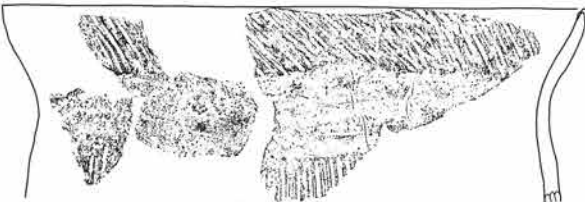

333a

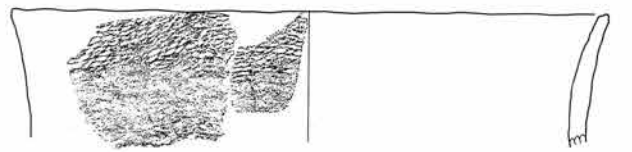

335



333b



336



337

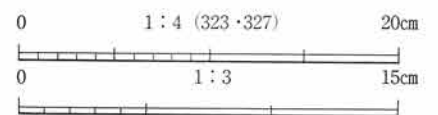

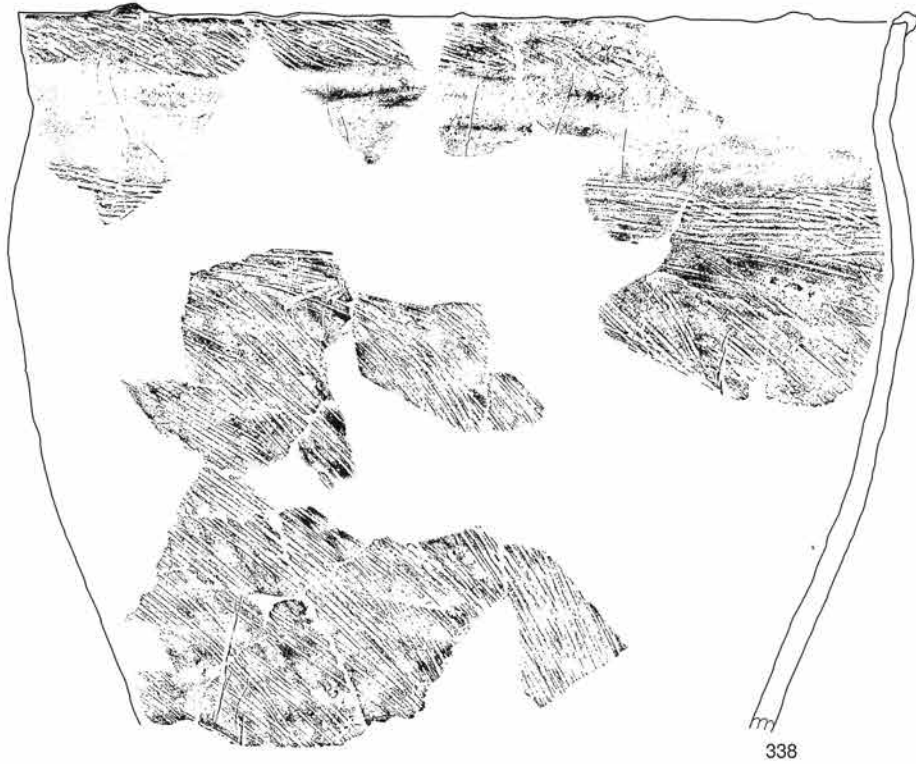

338

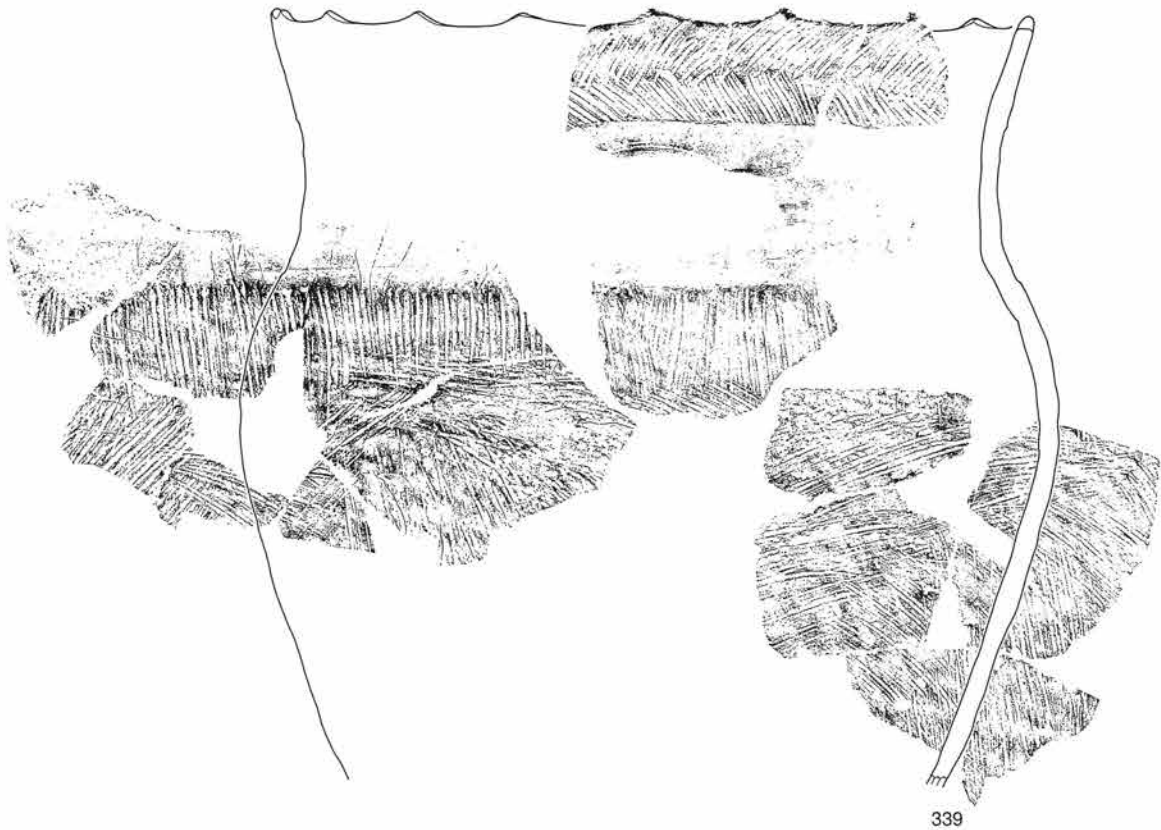

339

0 1:3 15cm

A horizontal scale bar with a vertical tick at the left end (0) and a vertical tick at the right end (15cm). The number '1:3' is positioned between the two ends.

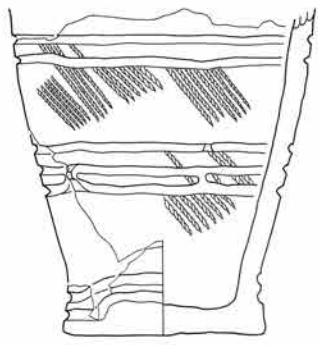

340

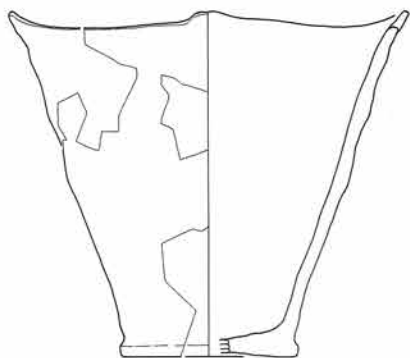

341

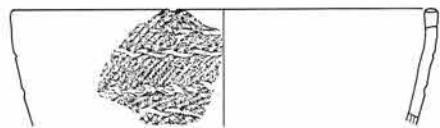

342a



342b

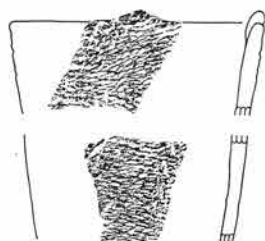

343



344a

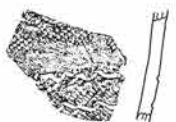

344b



345

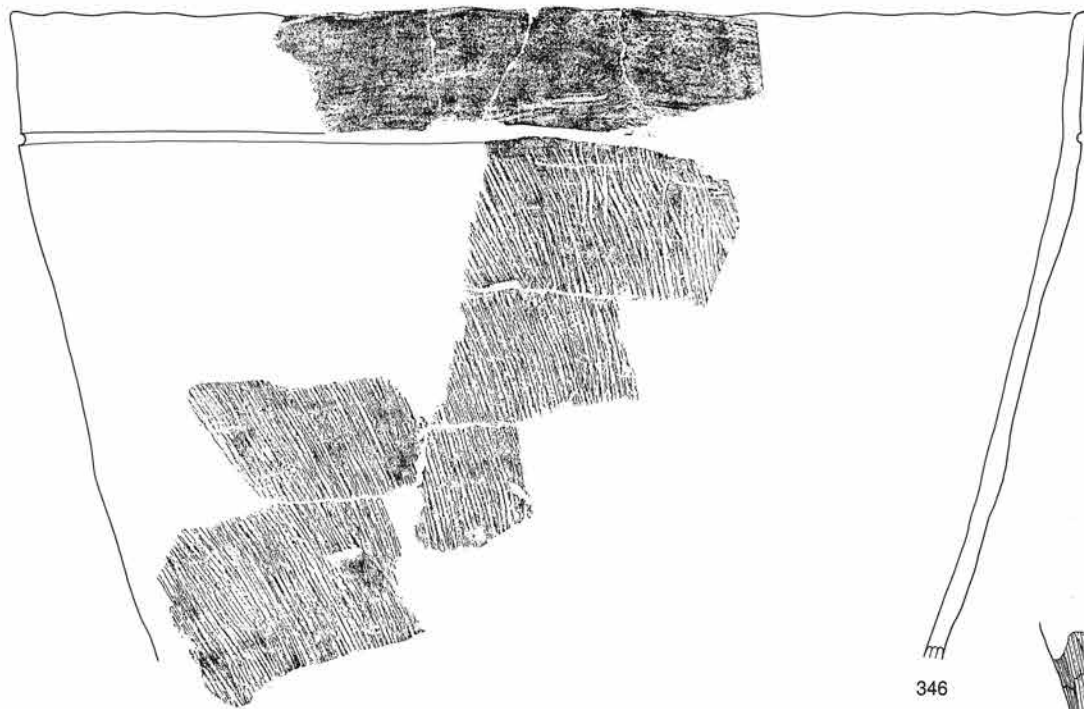

346



347

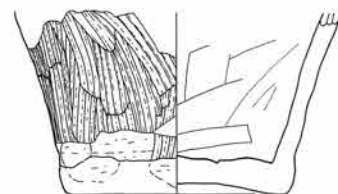

348

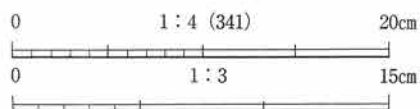

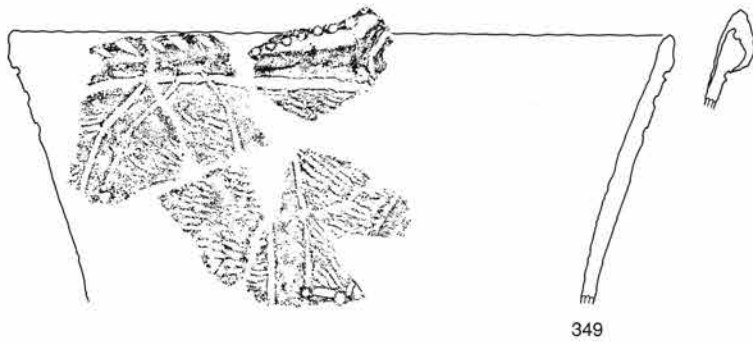

349

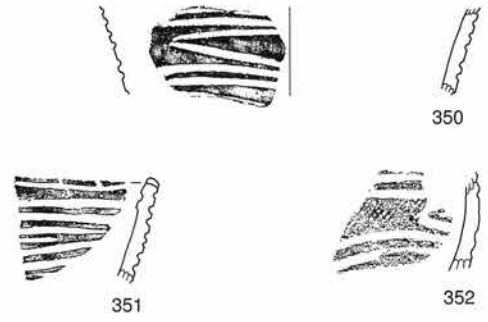

350

351

352

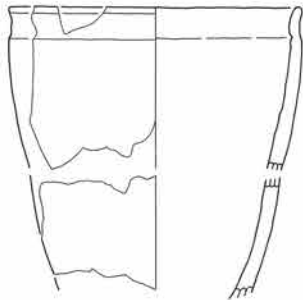

353



354a

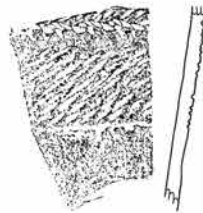

354b



355



356

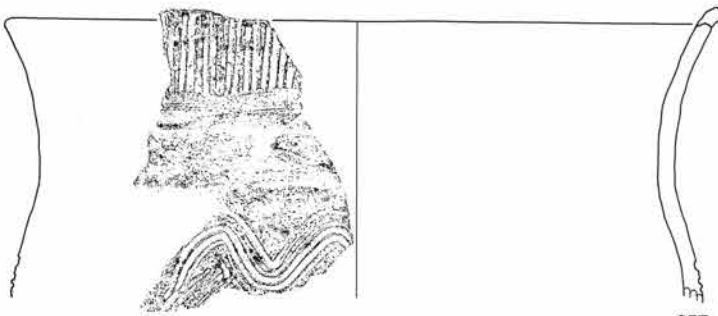

357

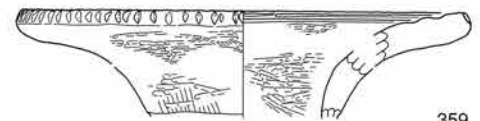

359

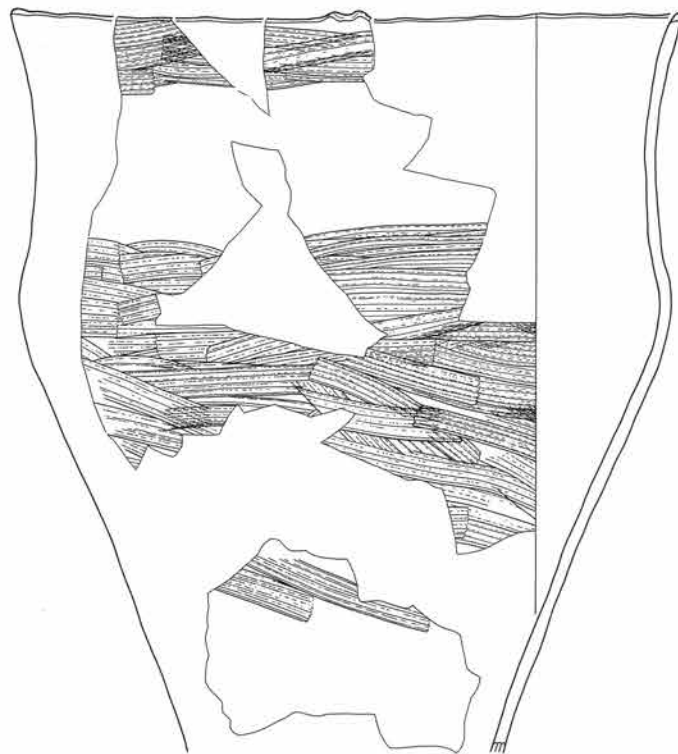

358



360



361

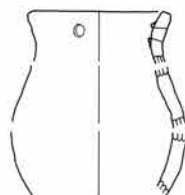

362

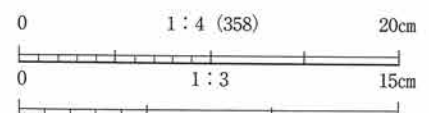

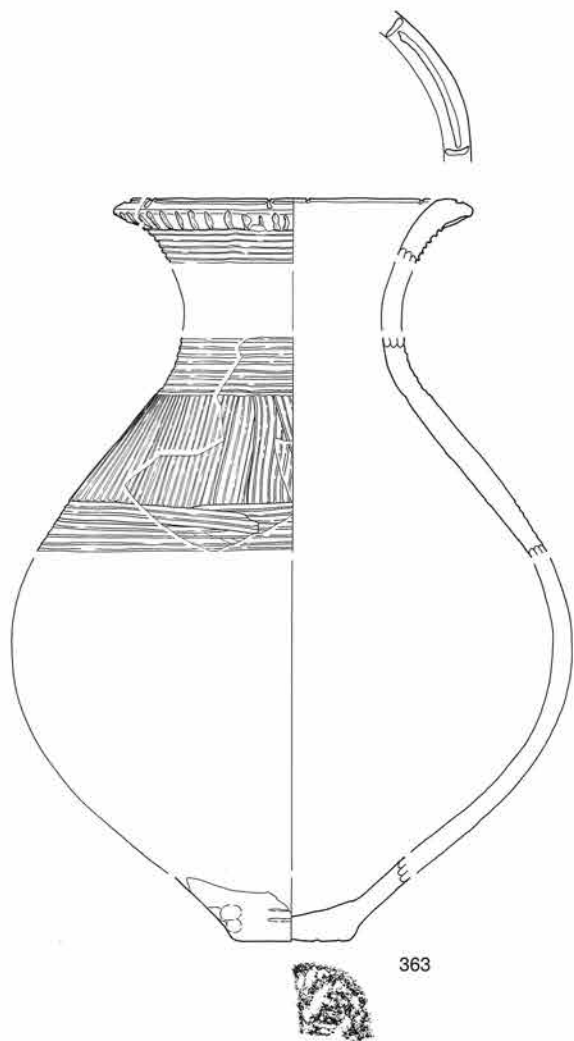

363

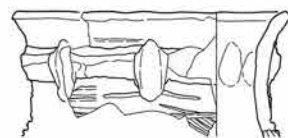

364a



364b



364c

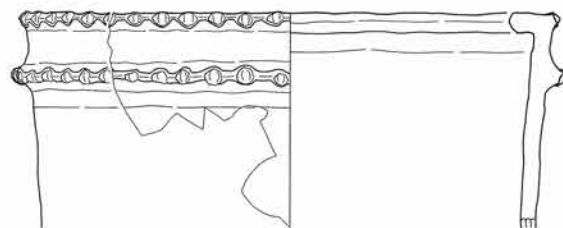

365



366a



366b



366c

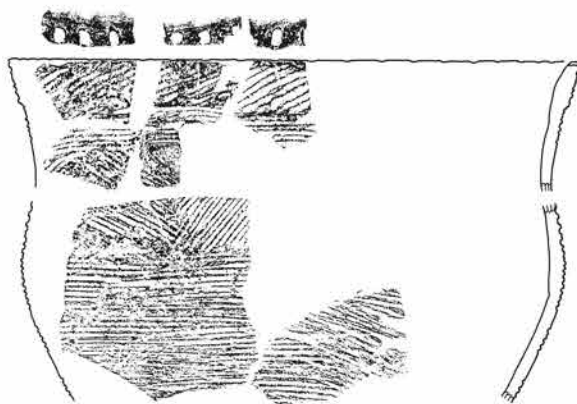

367

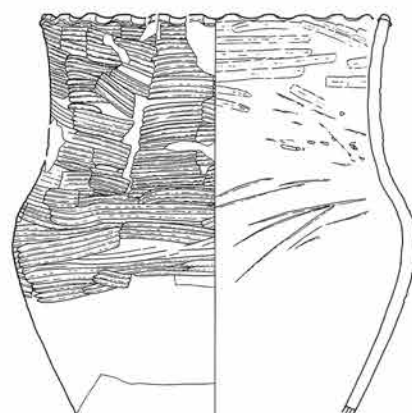

368



369



370



371a



371b



372

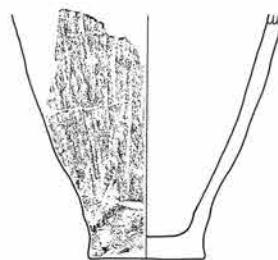

373

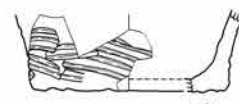

374

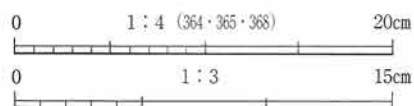

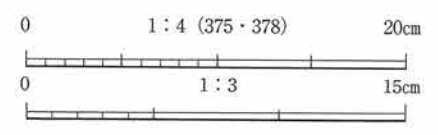
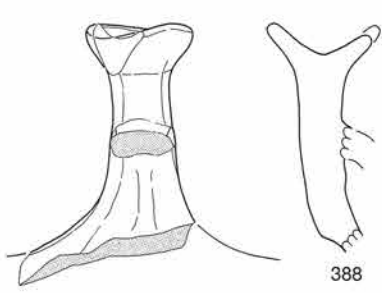
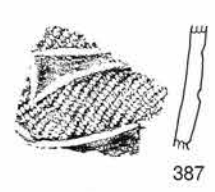
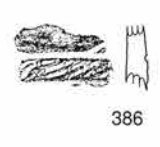
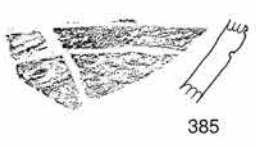
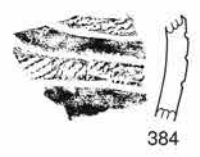
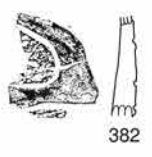
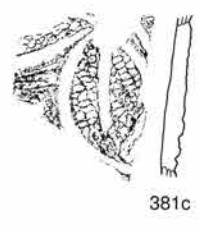
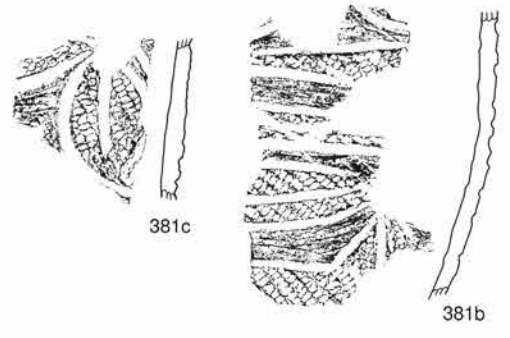
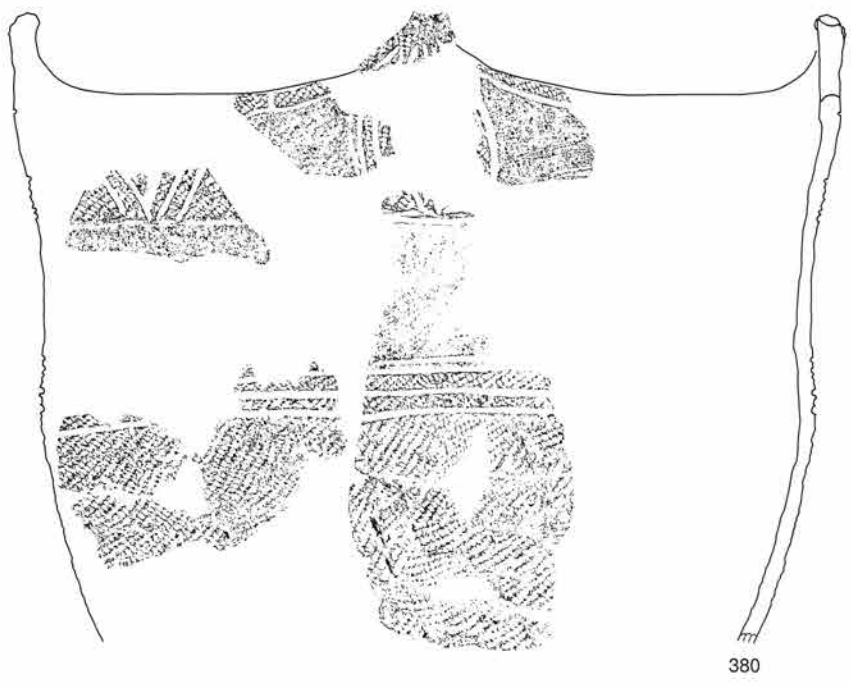
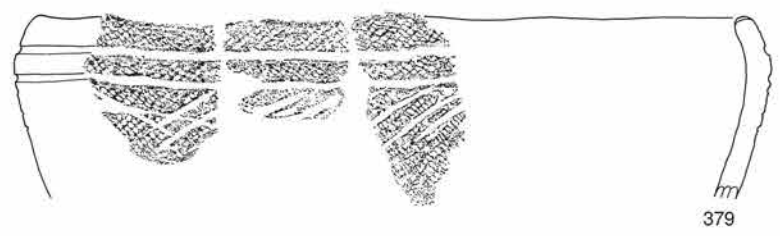
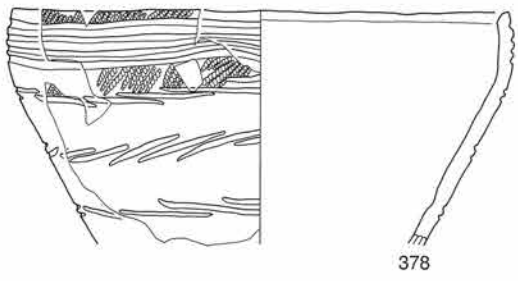
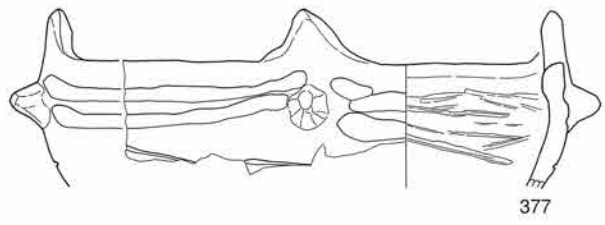
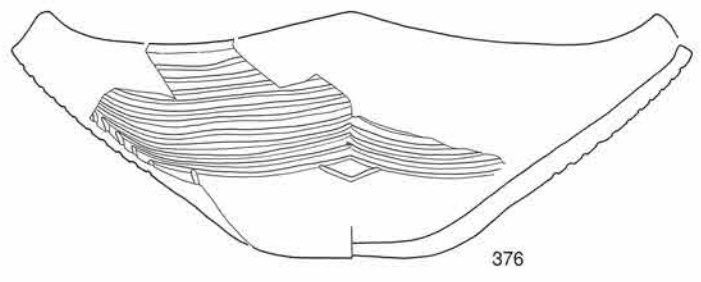
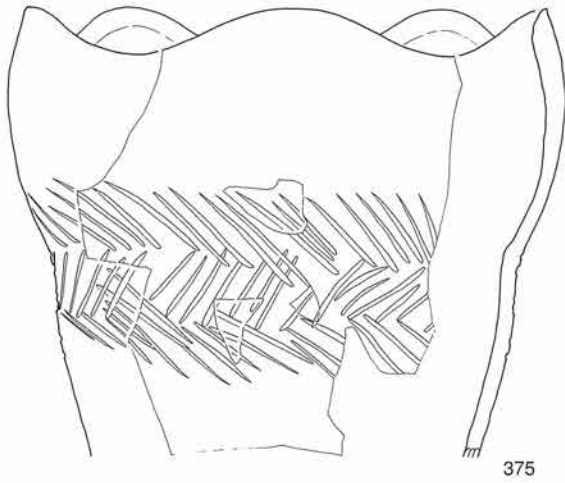

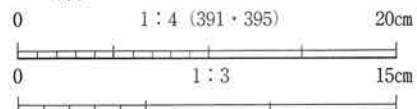
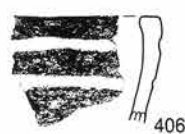
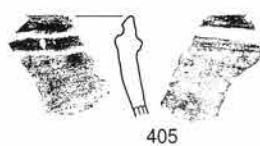
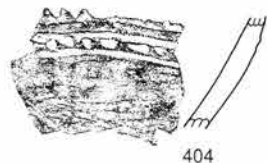
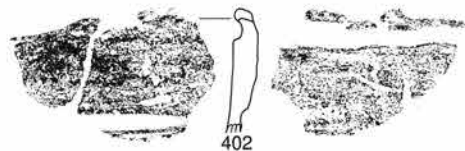
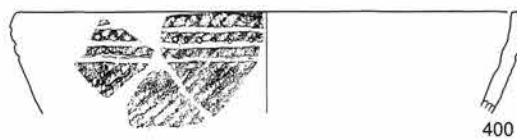
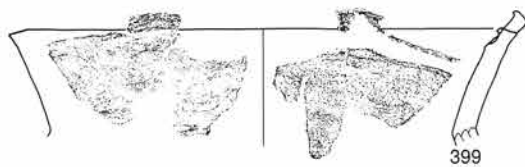
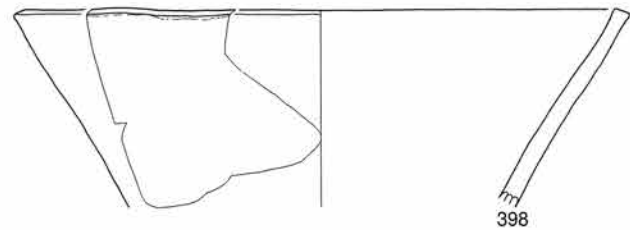
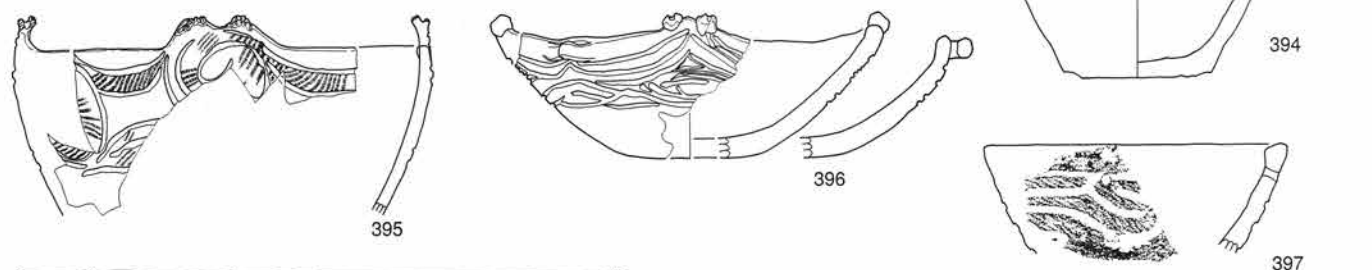
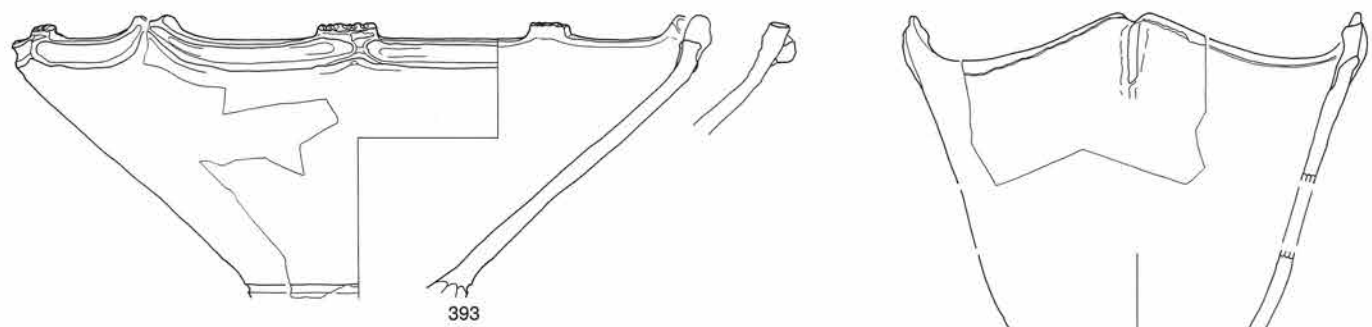
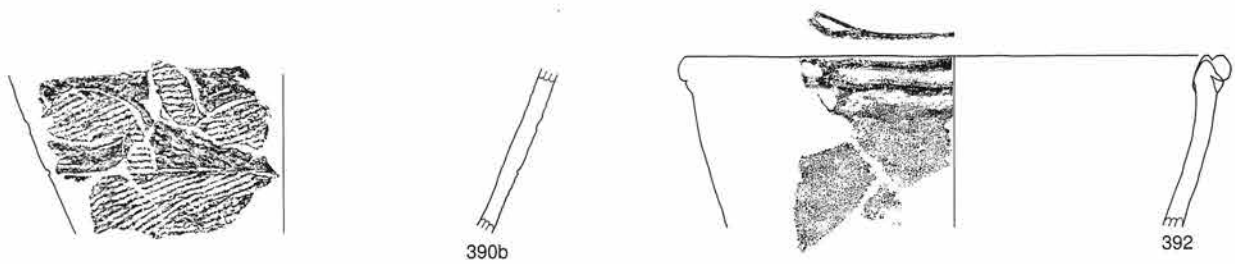
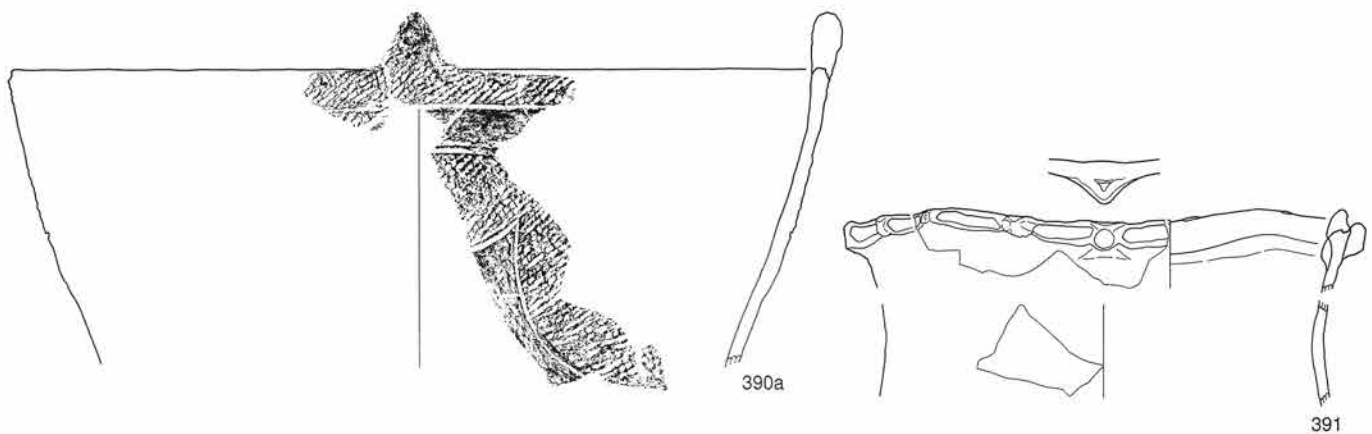

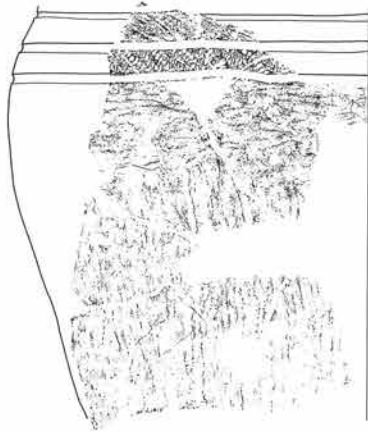

409



410



411

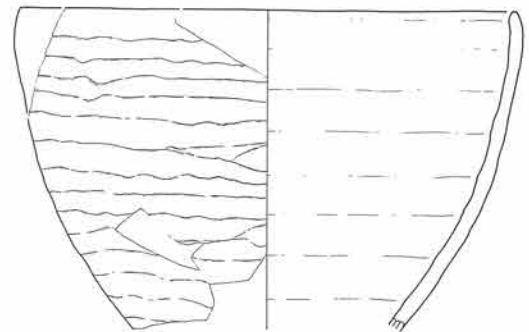

412



413



414

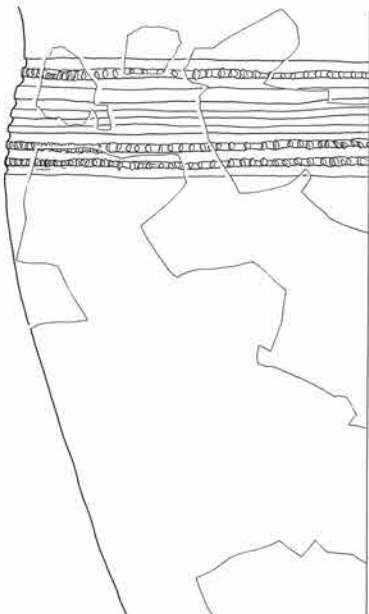

415

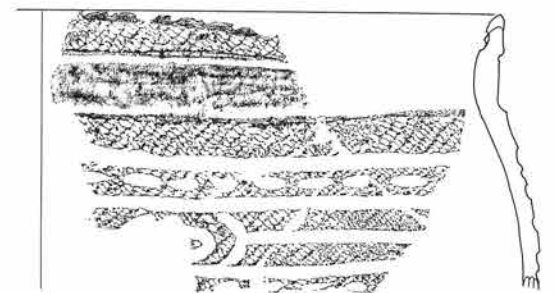

416

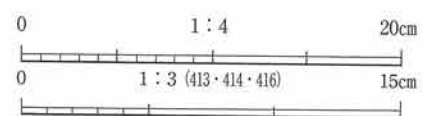

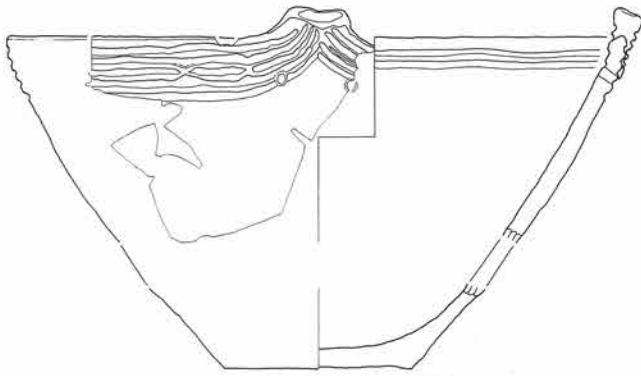

417



418



419

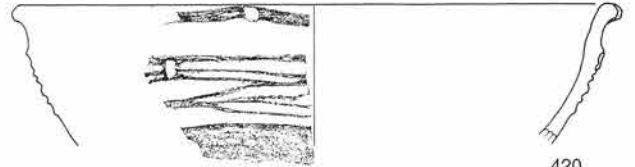

420

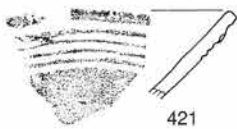

421



422



423



424



425

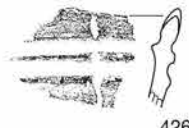

426



427



428



429



430

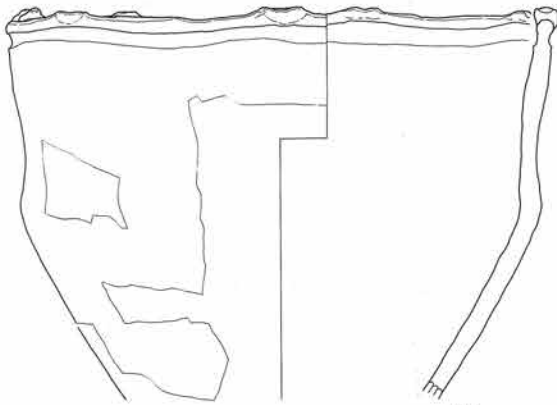

431

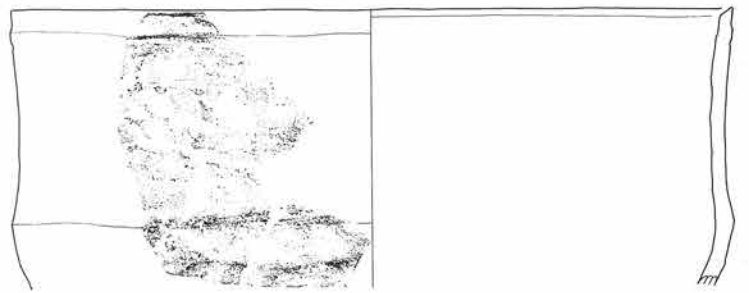

432

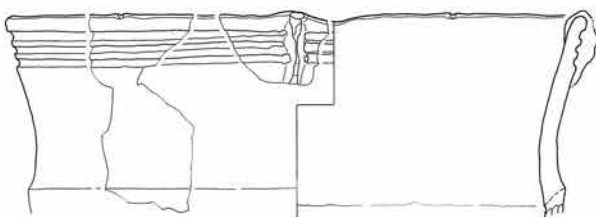

433

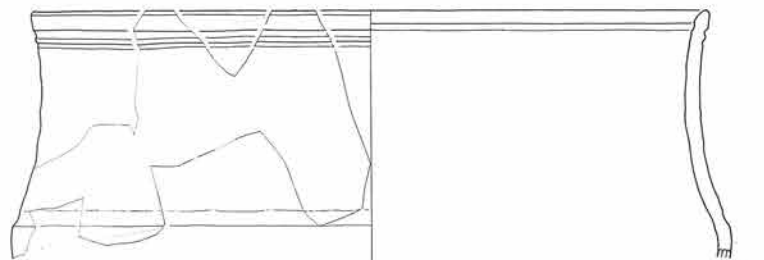

434

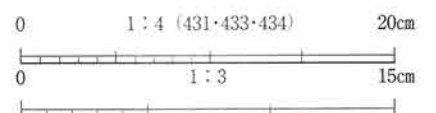

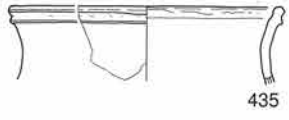

435



436

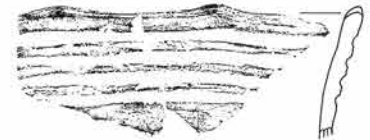

437

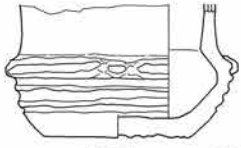

438

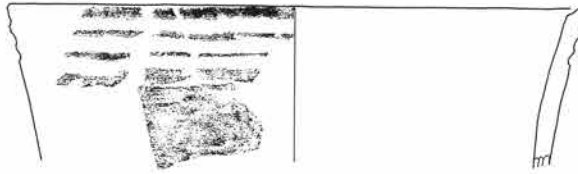

439

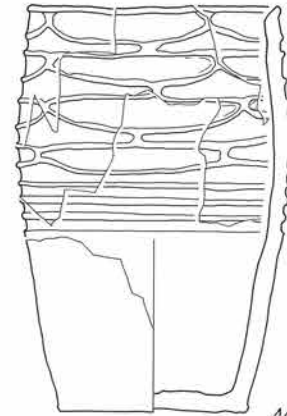

443

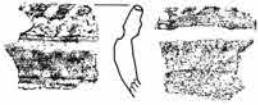

440



441

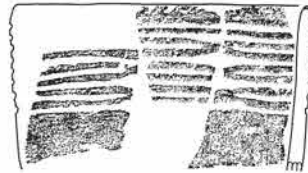

442



444



445



446



447



448



449

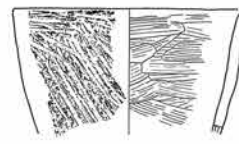

450



451

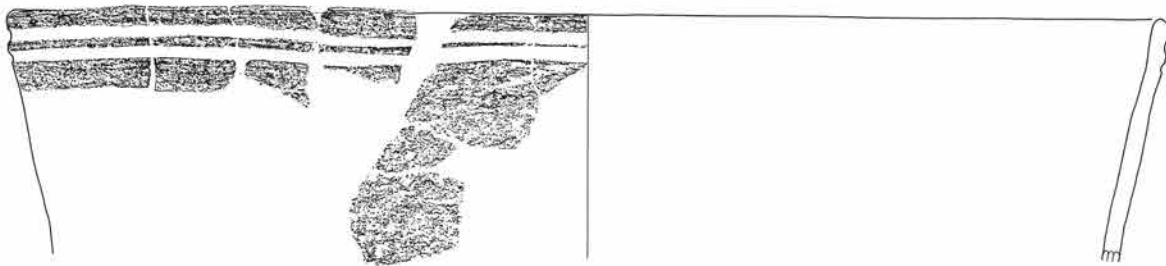

452



453



454

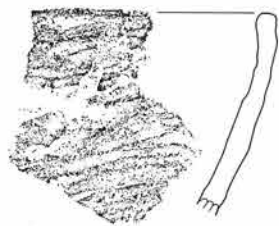

455



456



457



458

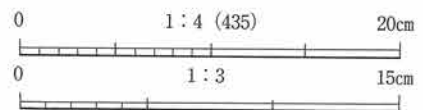

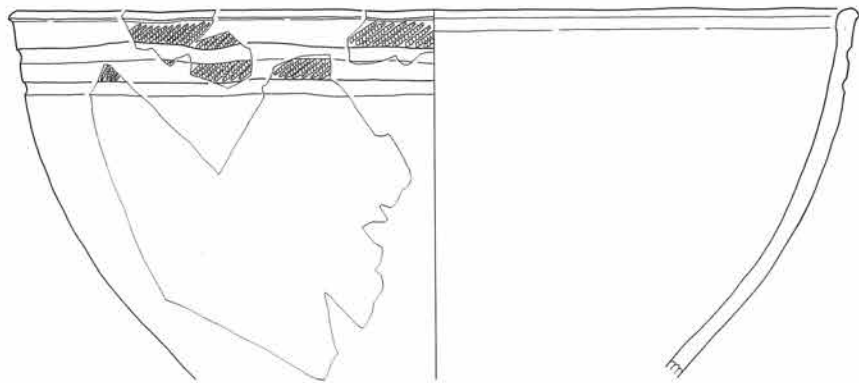

459

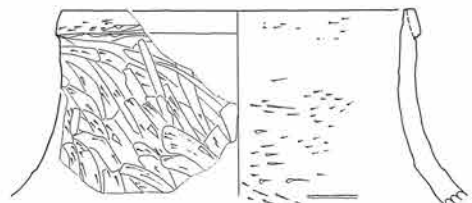

460

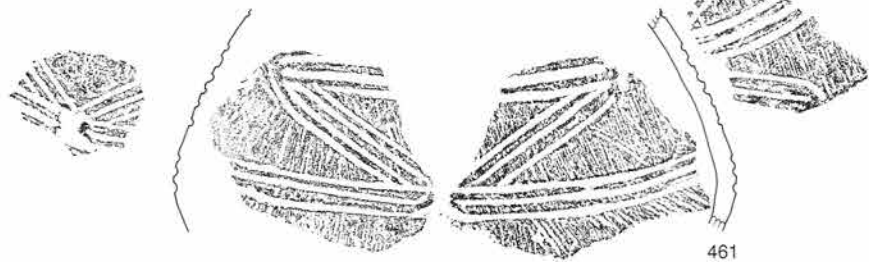

461

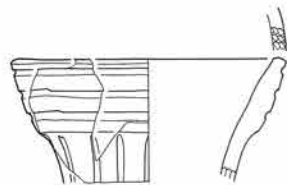

462



463



464



465



466

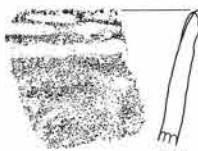

467



468



469



470



476a

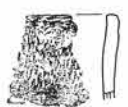

471

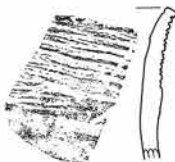

472



473



474



475



476b



477a

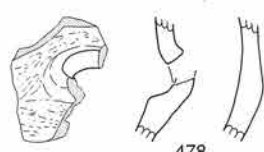

478



480

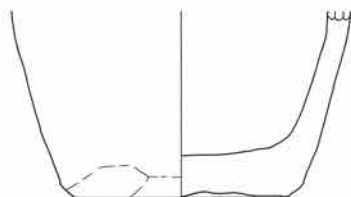

482



477b



479



477c



481

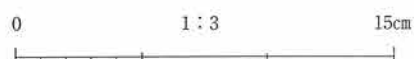
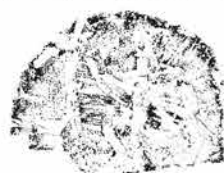

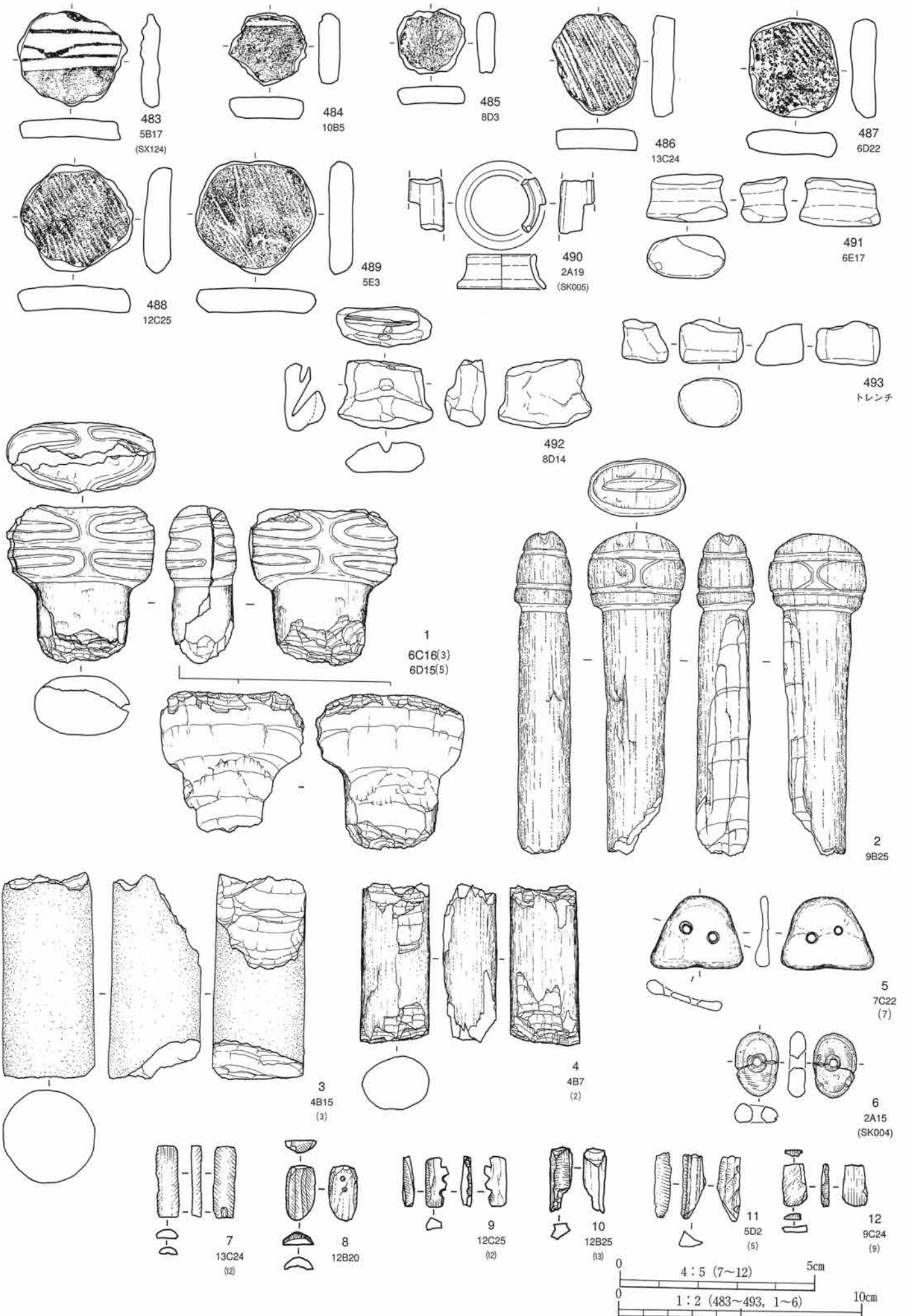



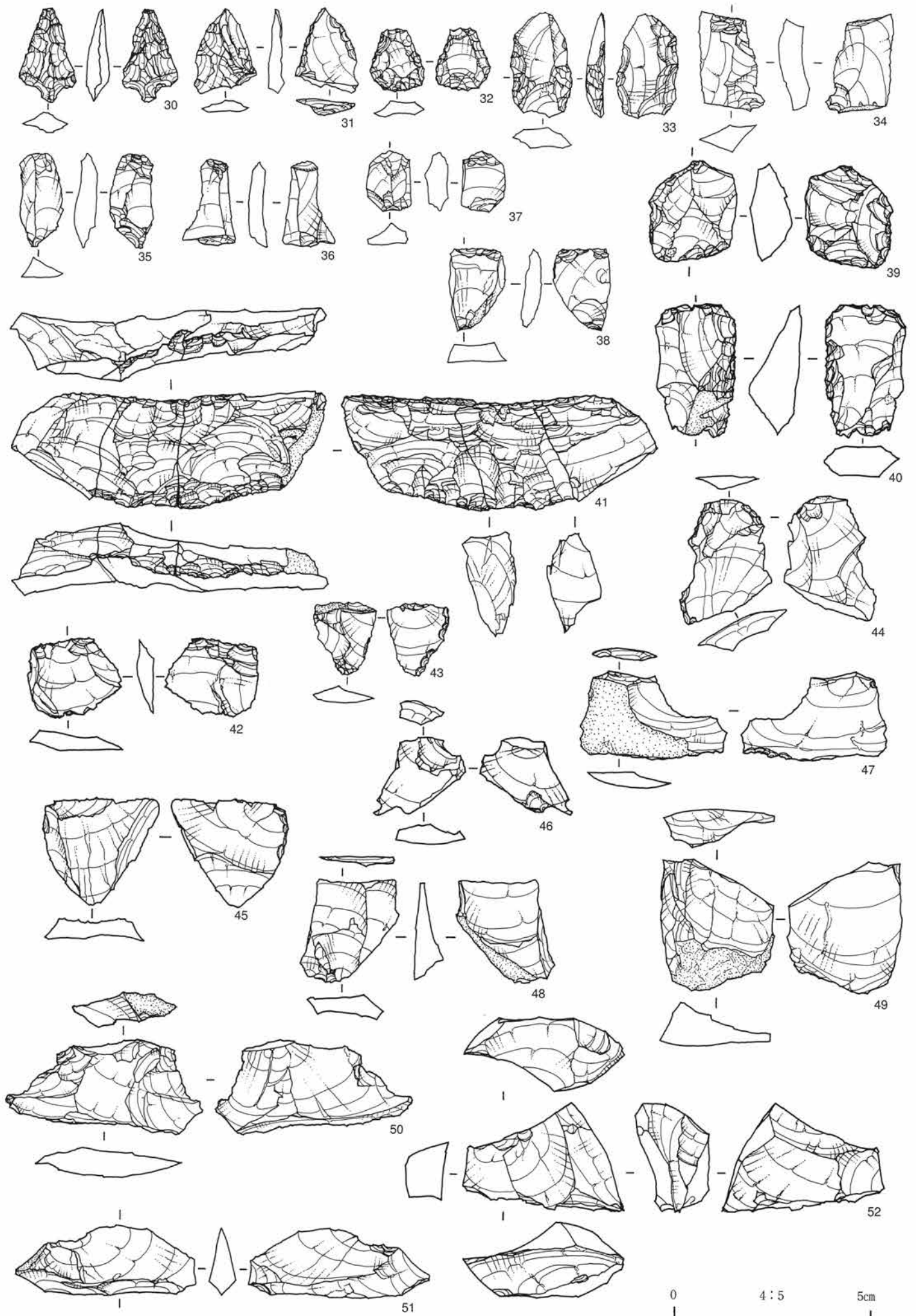

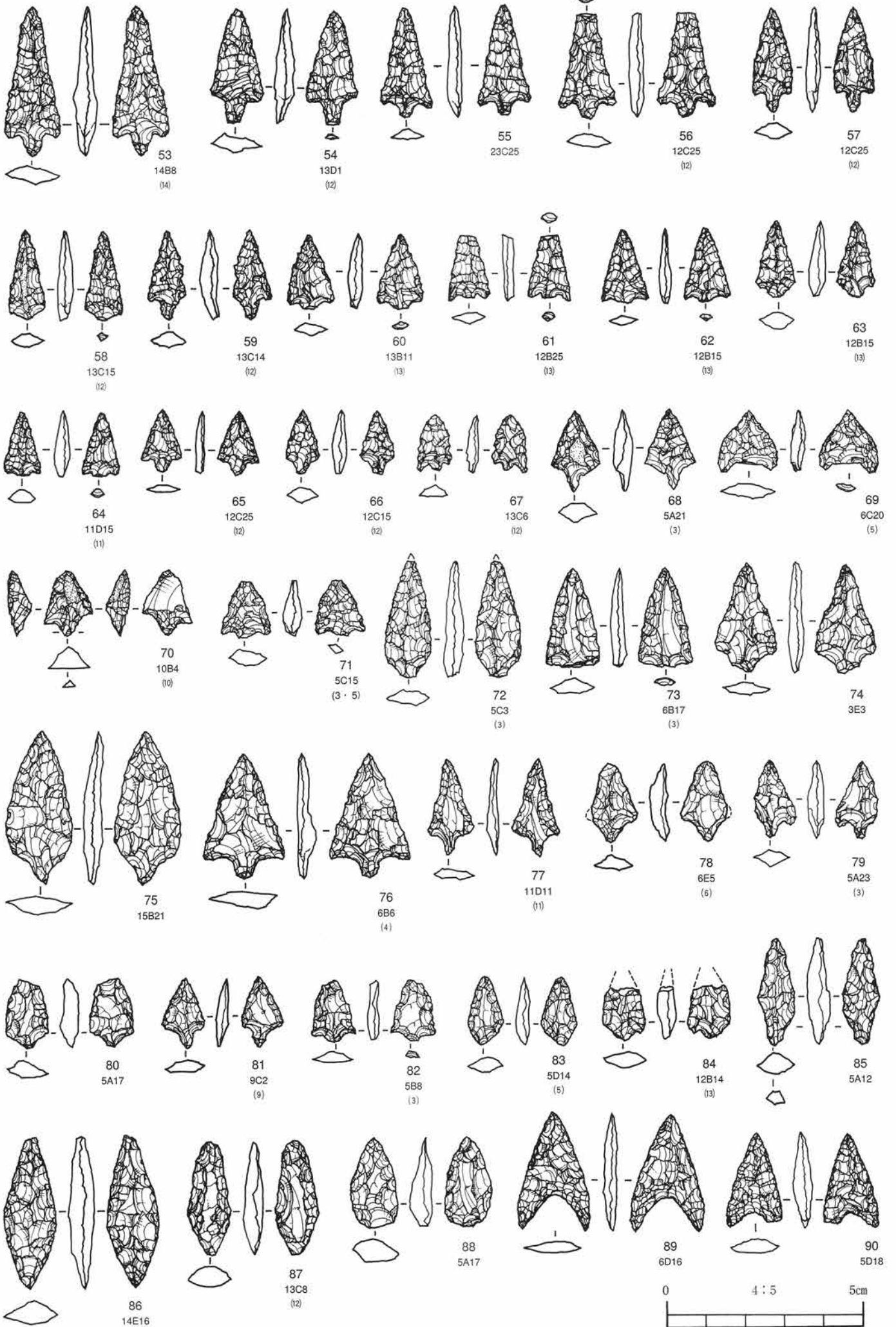

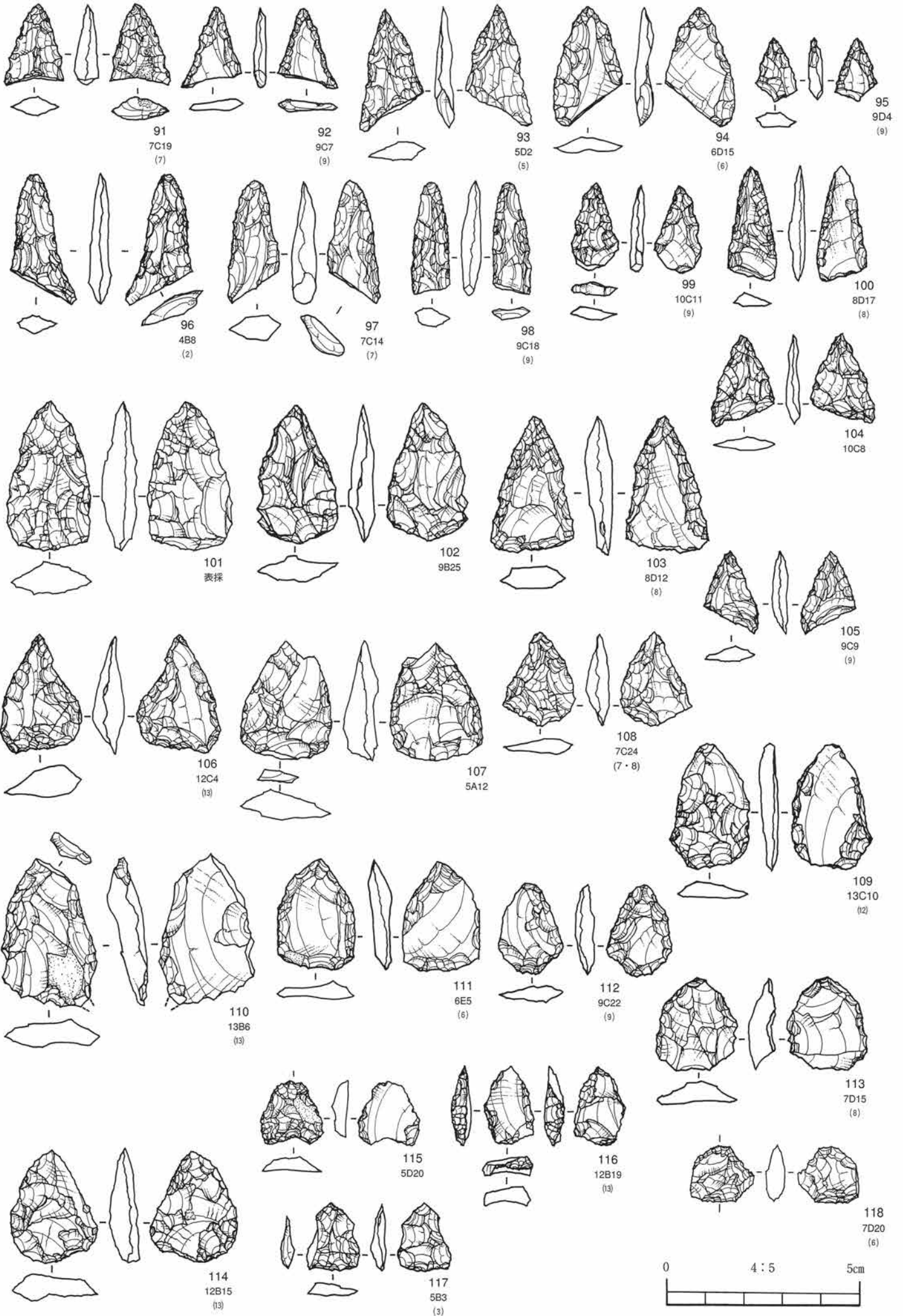

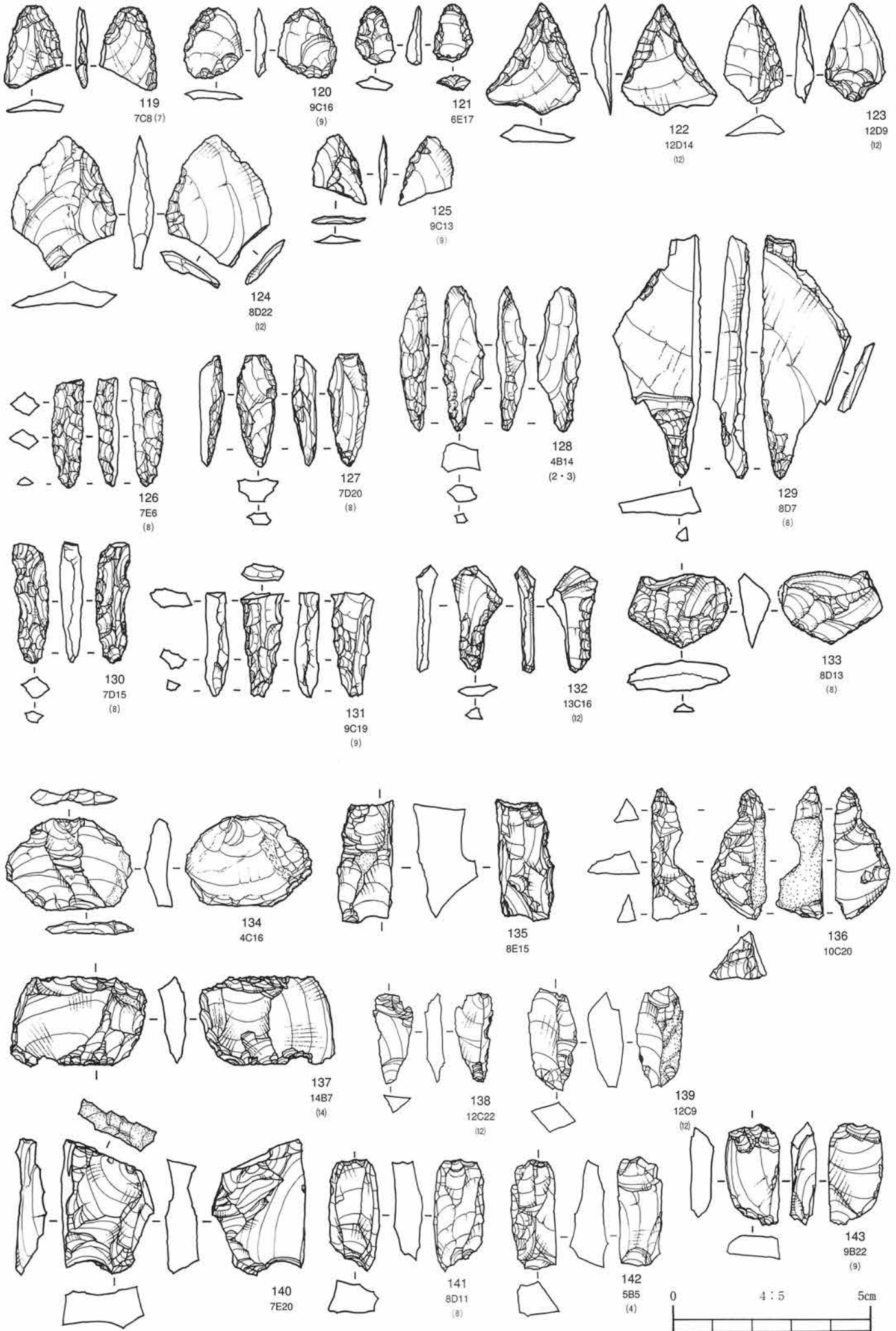

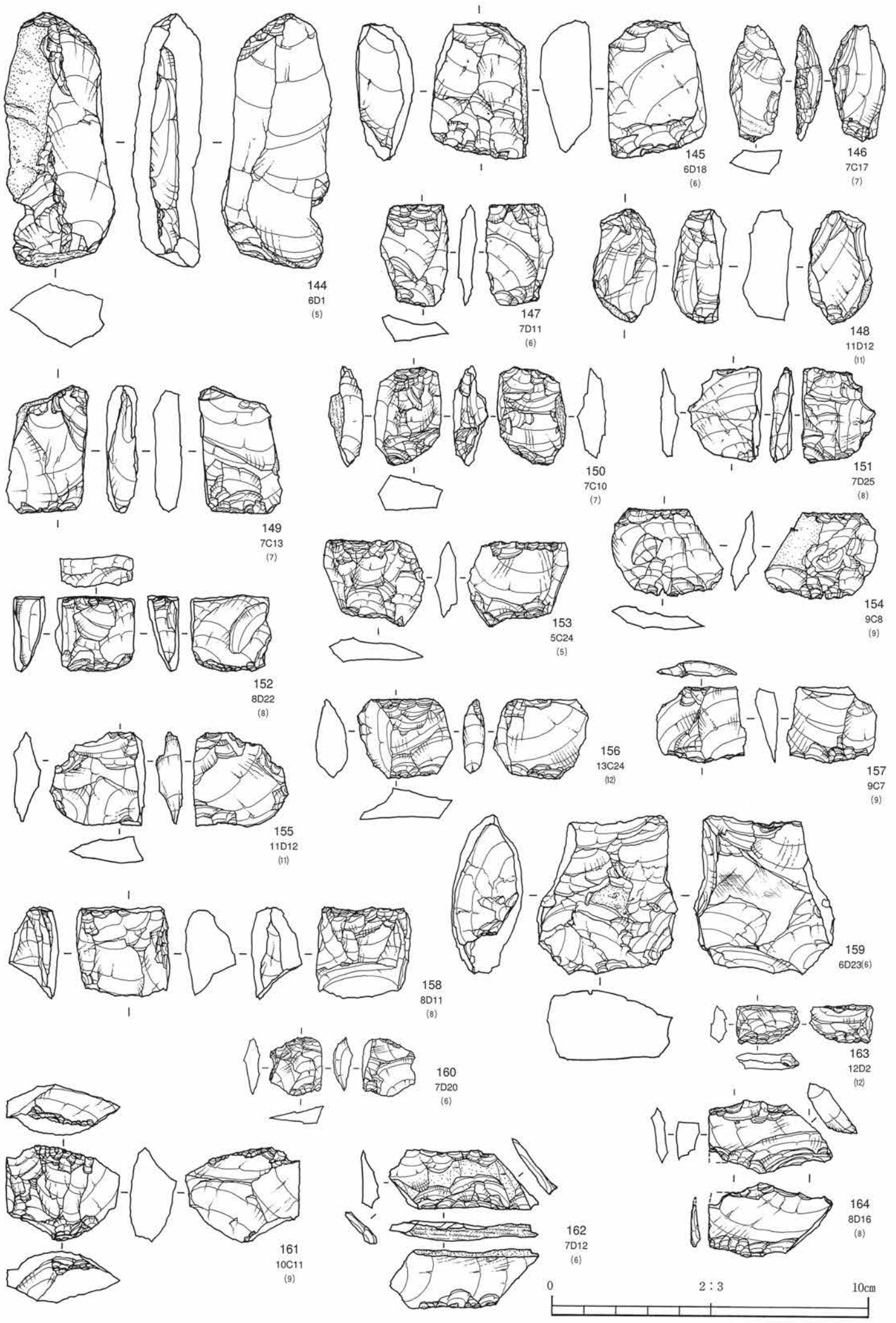

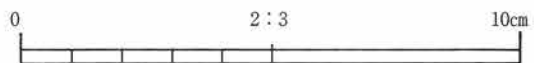
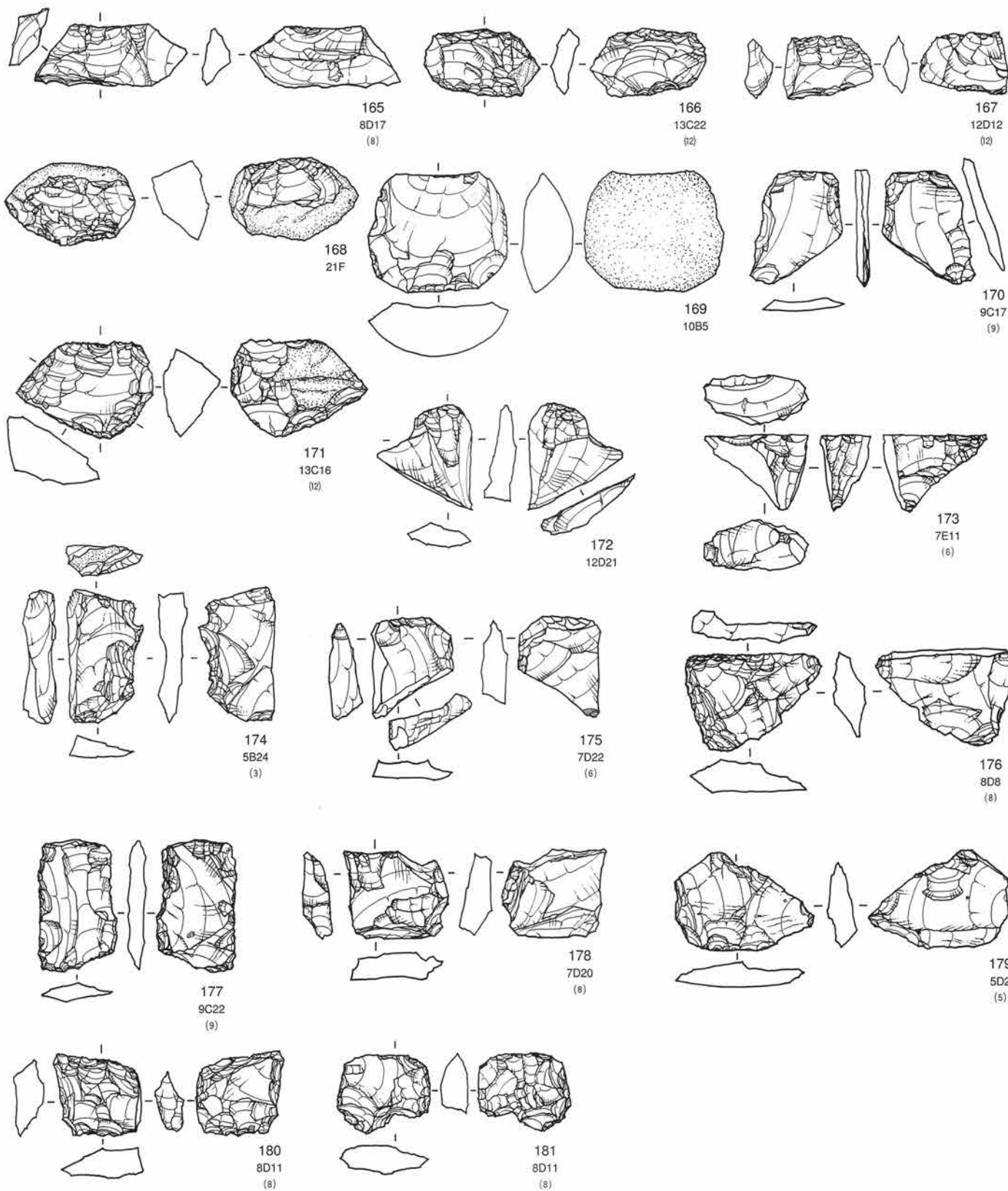

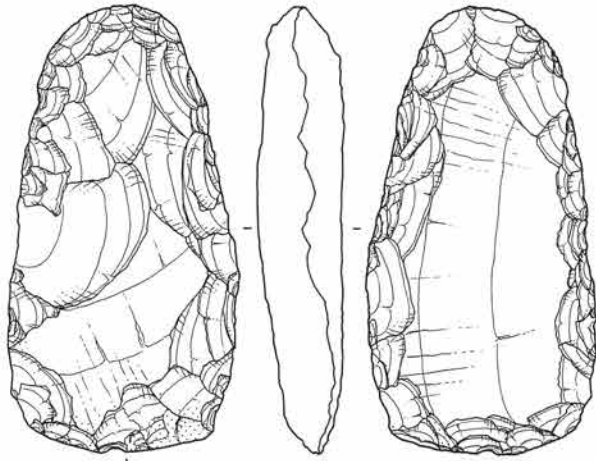

182
7C25
(7・8)

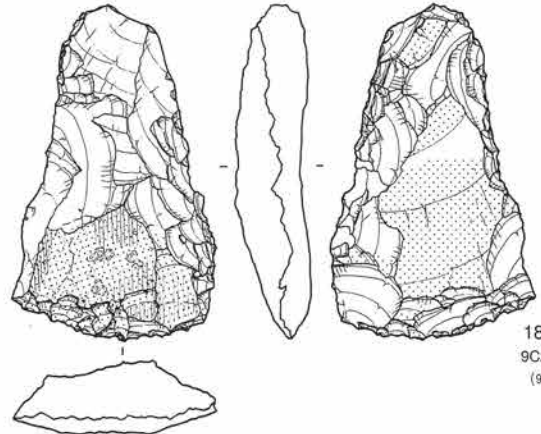

183
9C25
(9)

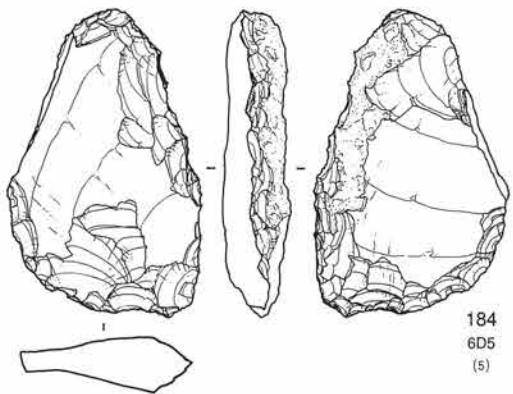

184
6D5
(5)

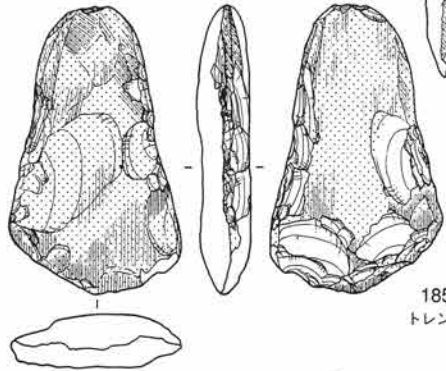

185
トレンチ

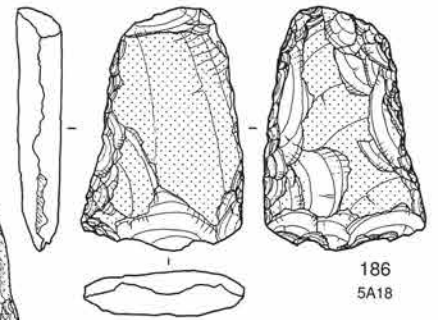

186
5A18

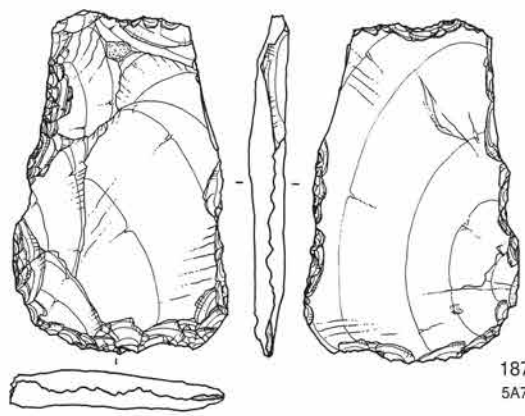

187
5A7

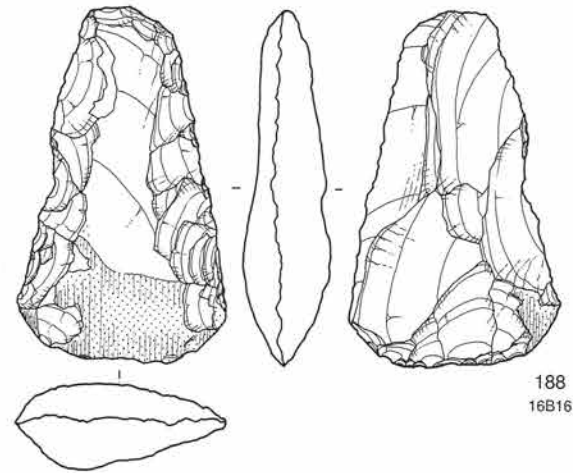

188
16B16

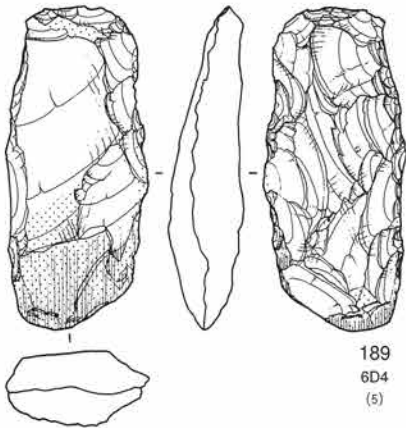

189
6D4
(5)

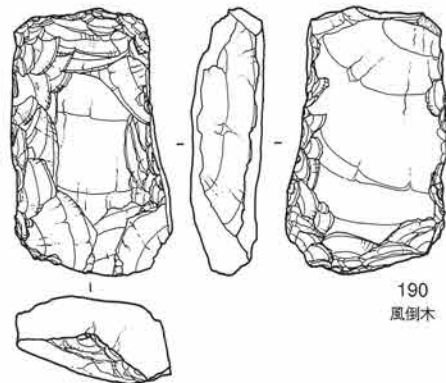

190
風倒木

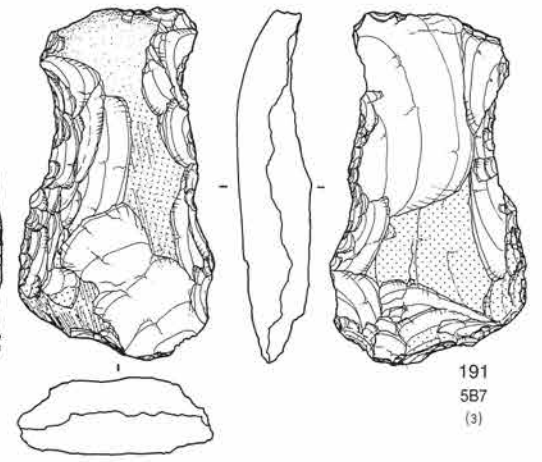

191
5B7
(3)

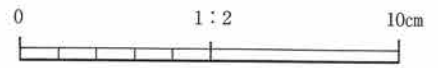

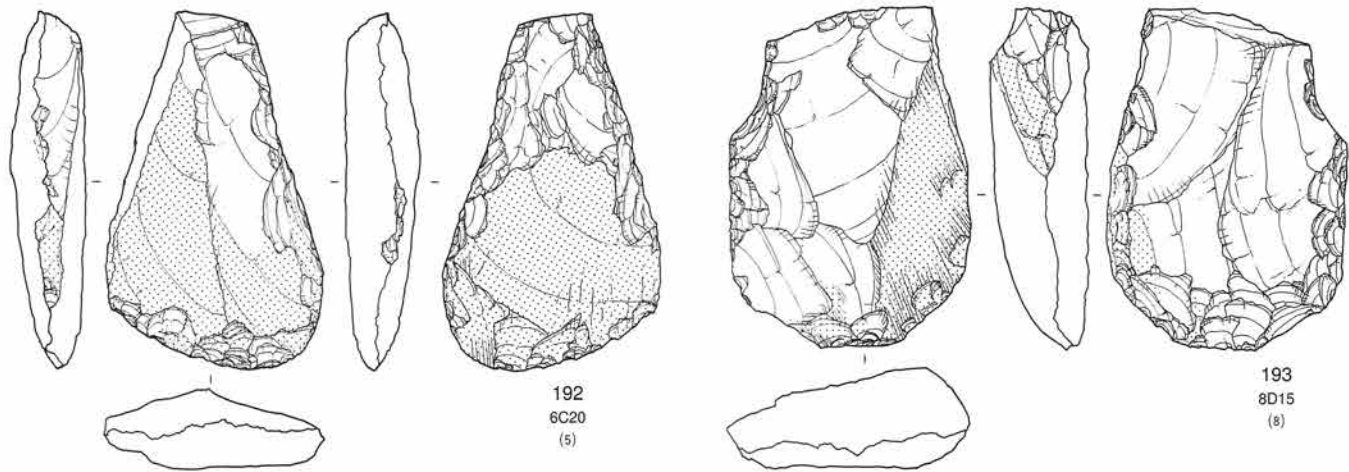

192
6C20
(5)

193
8D15
(8)

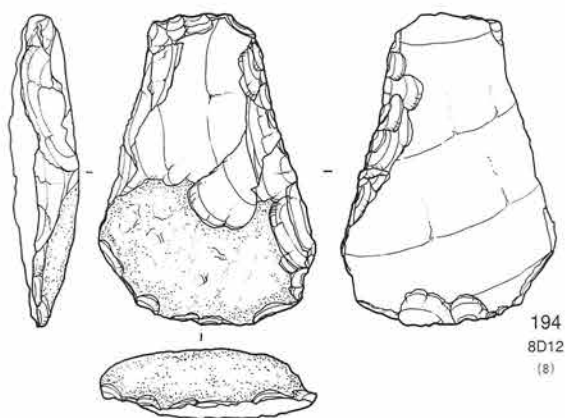

194
8D12
(8)

195
8D13
(8)

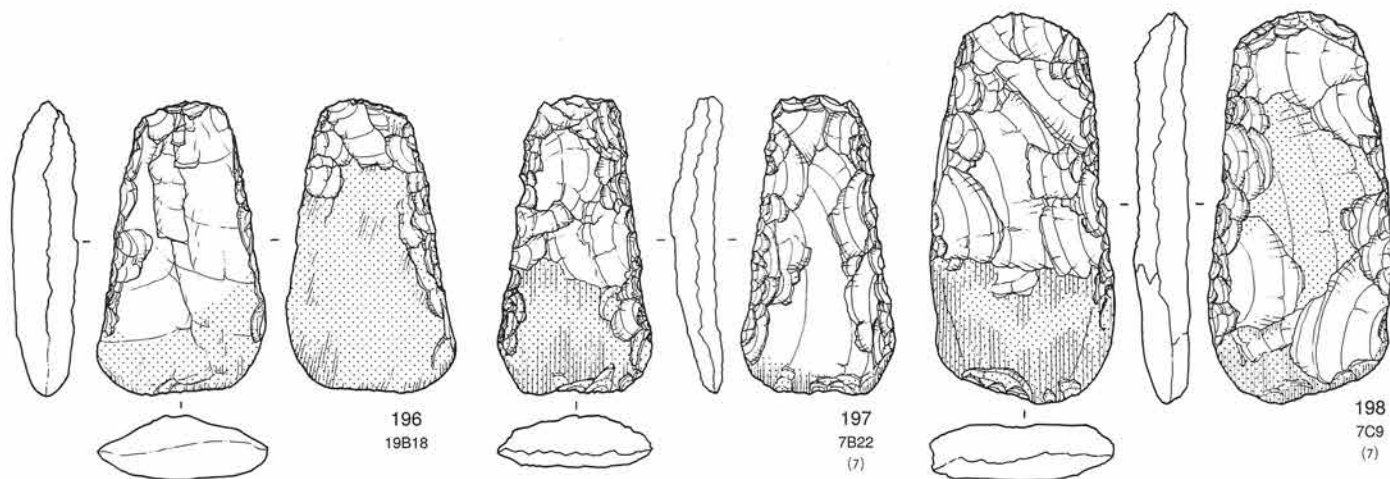

196
19B18

197
7B22
(7)

198
7C9
(7)

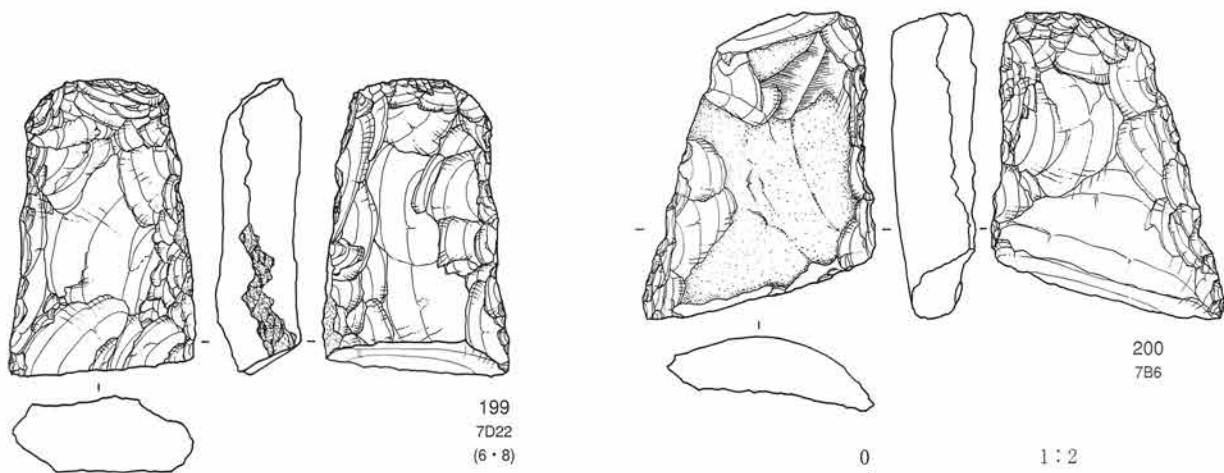

199
7D22
(6·8)

200
7B6

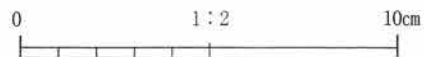

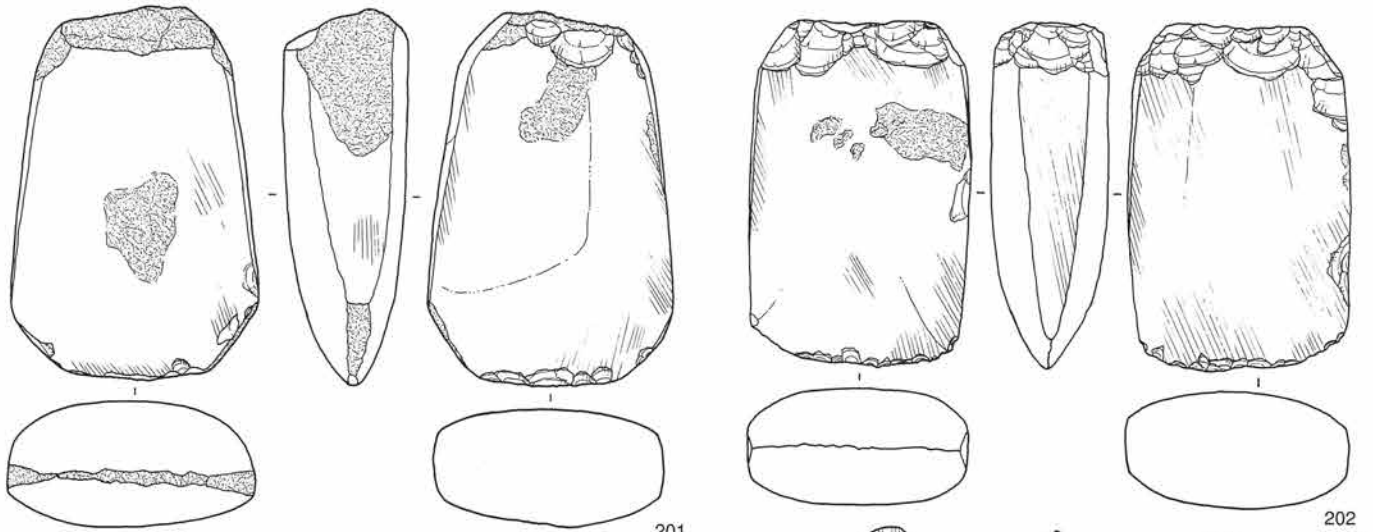

201
11C13

202
12D17

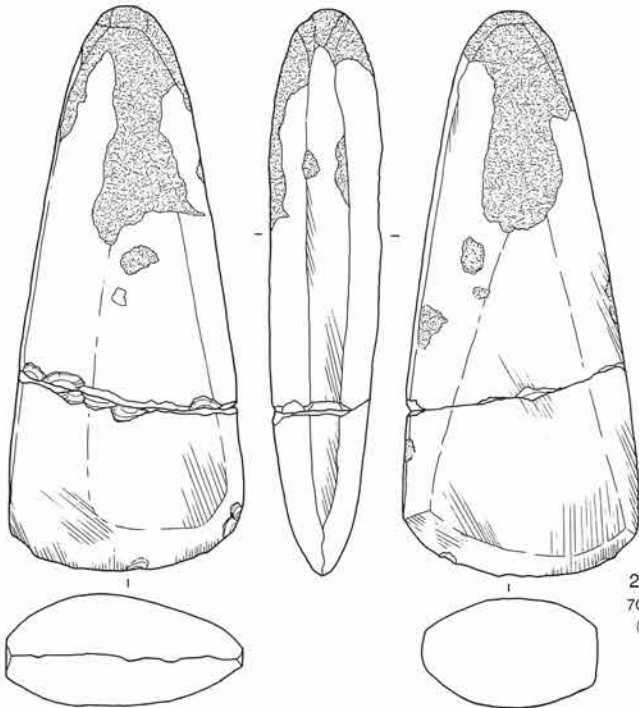

203
7C23
(7)

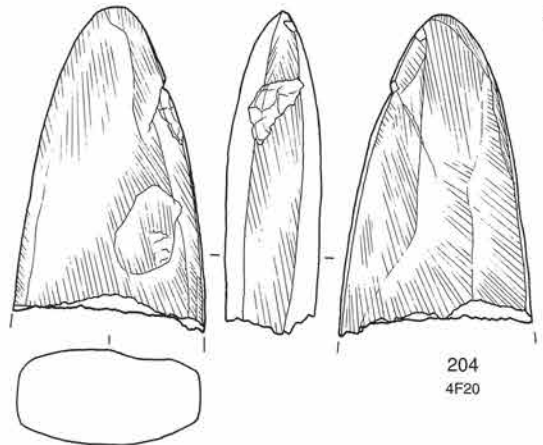

204
4F20

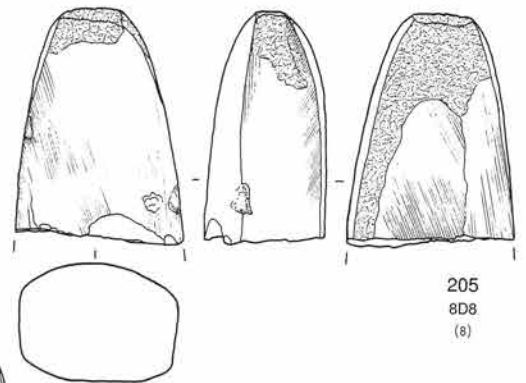

205
8D8
(8)

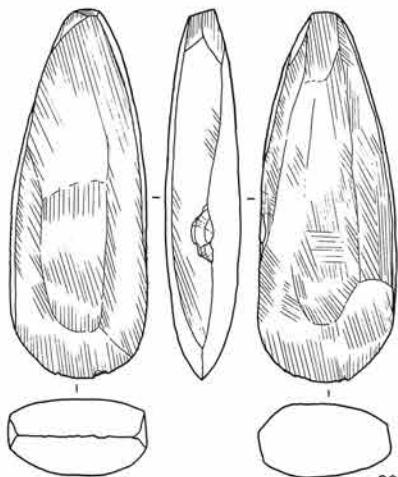

206
13B25
(14)

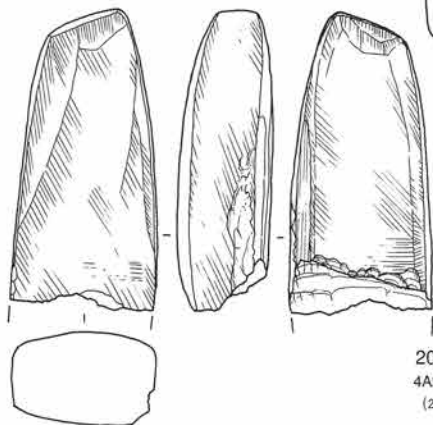

207
4A21
(2)

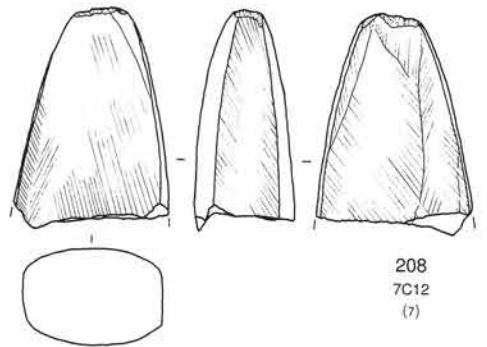

208
7C12
(7)

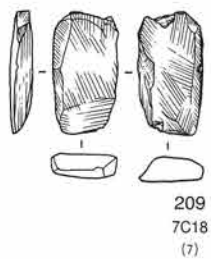

209
7C18
(7)

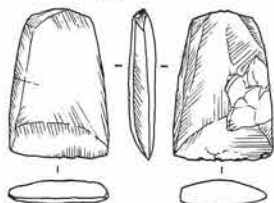

210
7D6
(6)

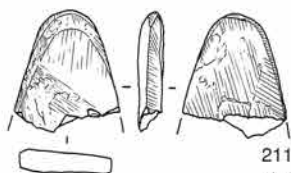

211
7C10
(7)

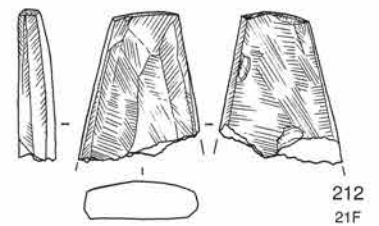

212
21F

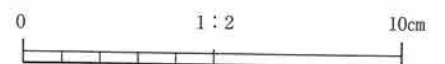

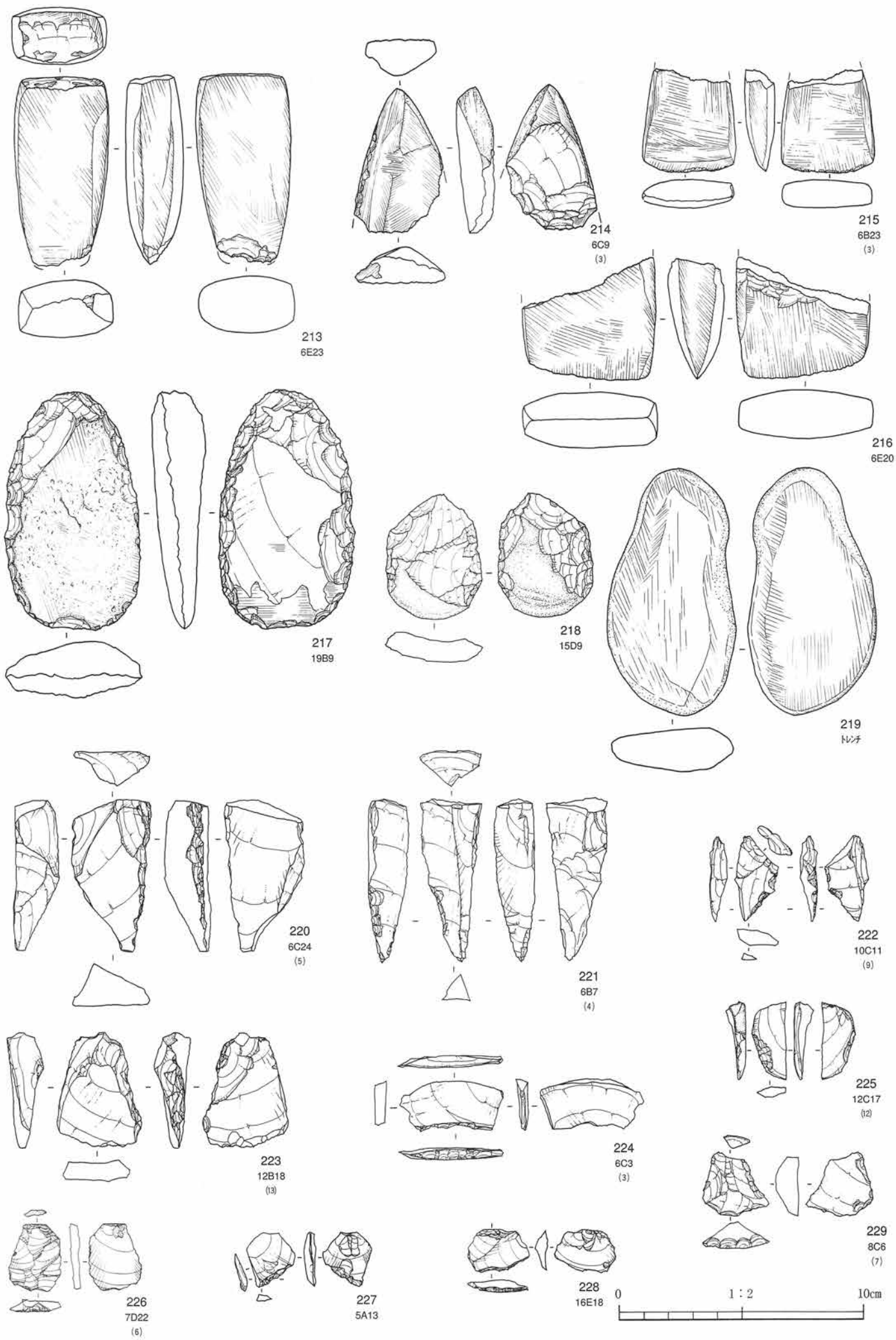

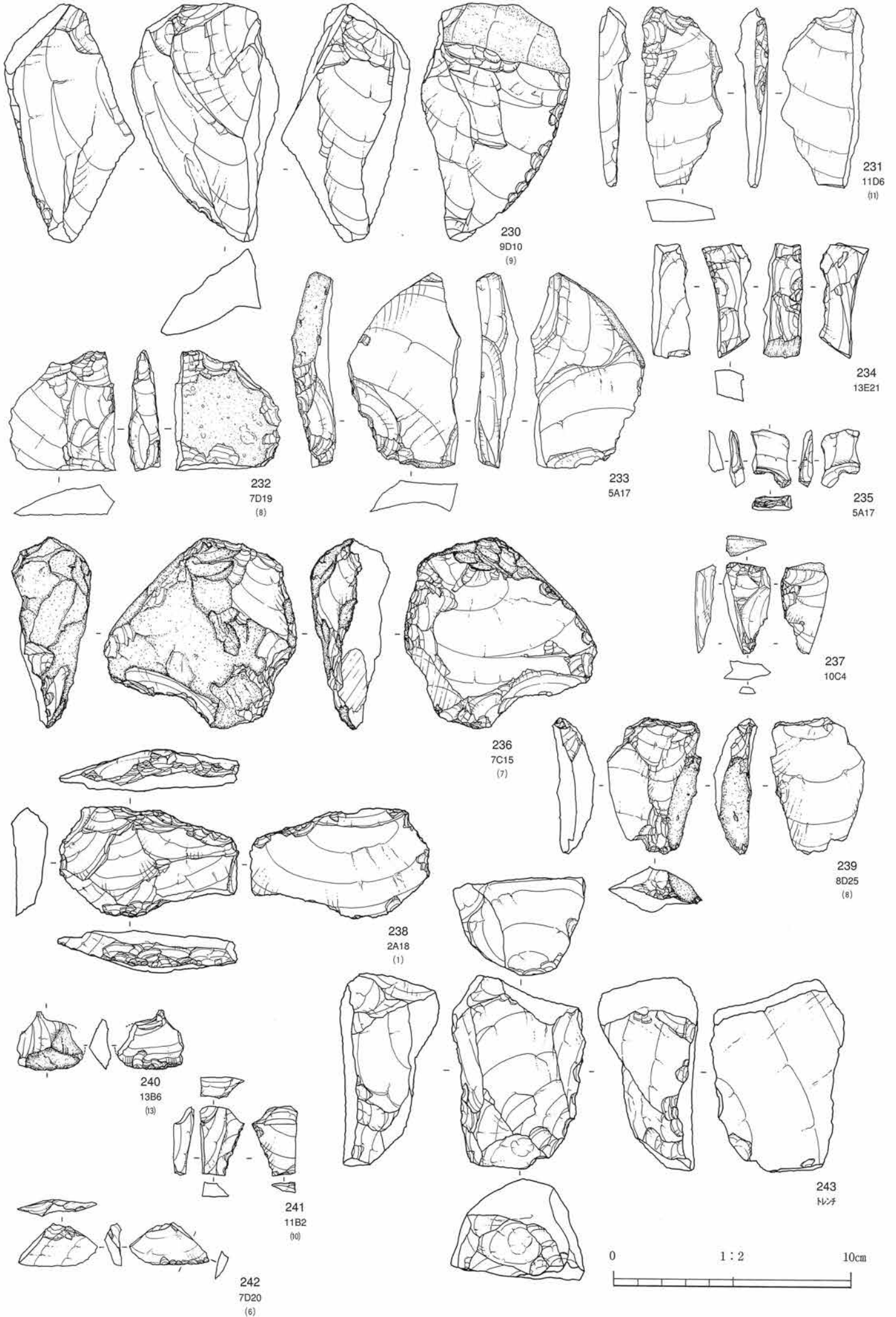

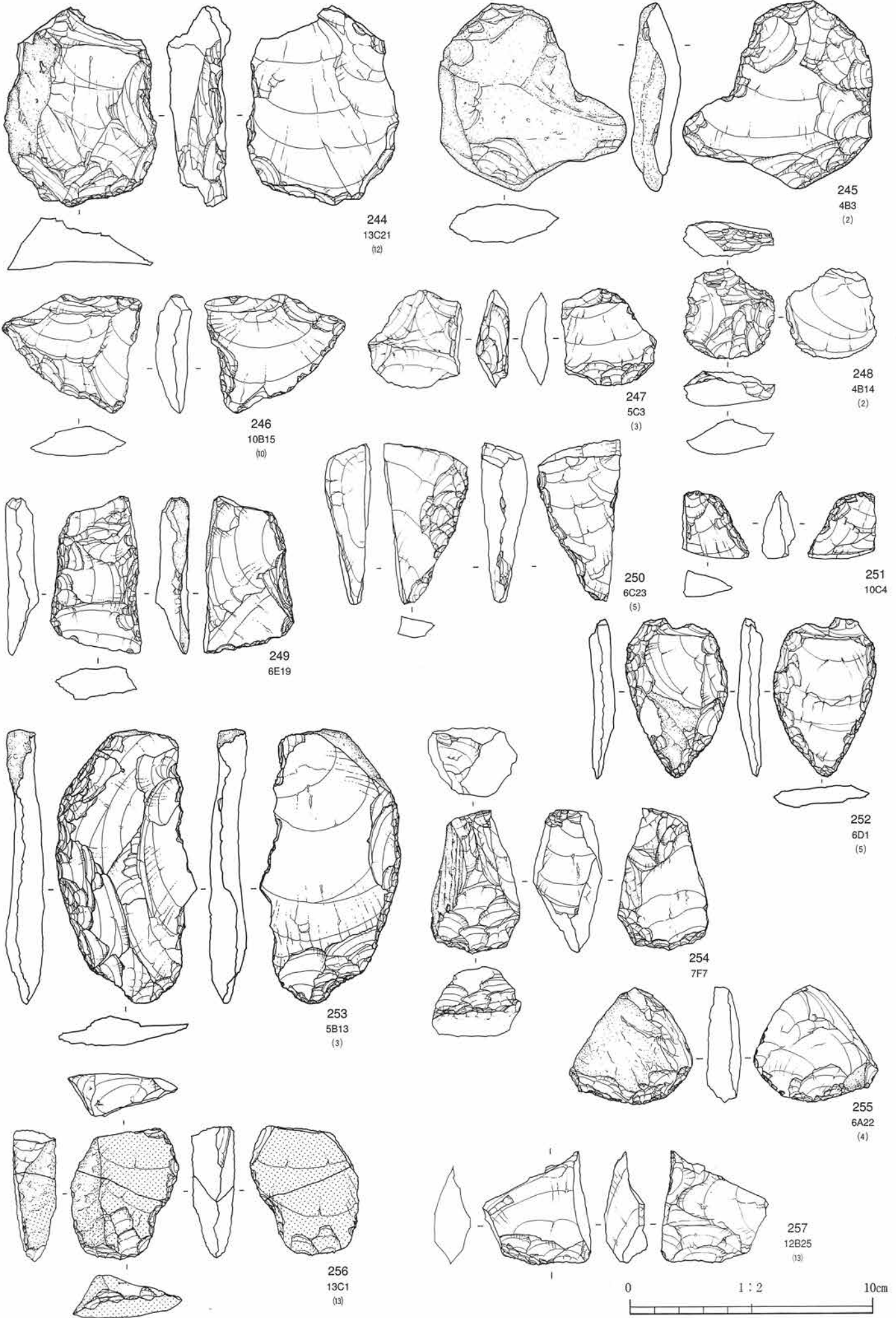

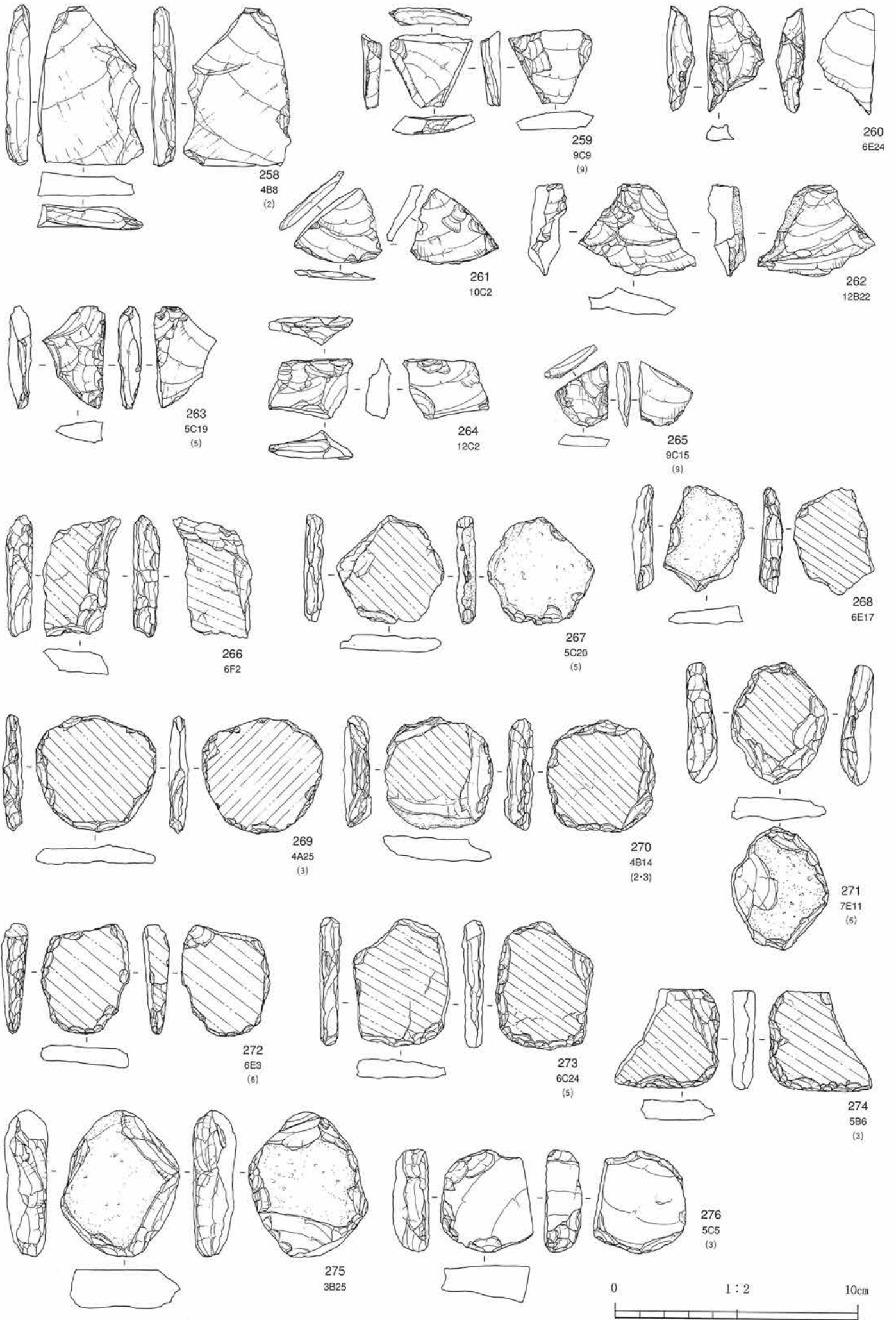

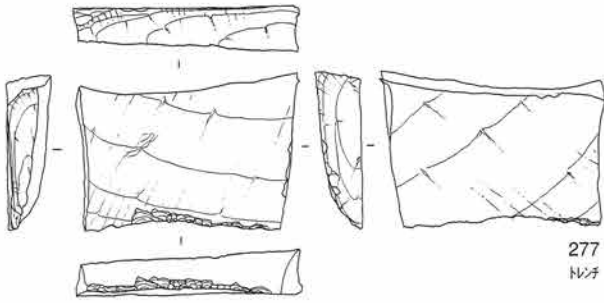

277
N77

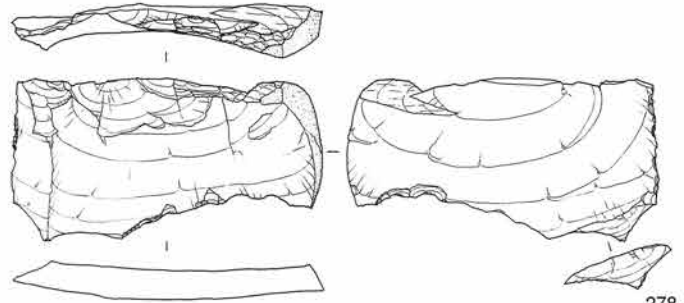

278
14B8
(4)

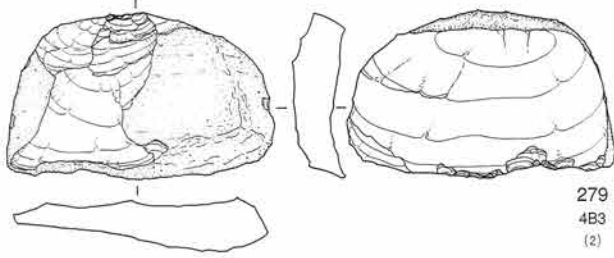

279
4B3
(2)

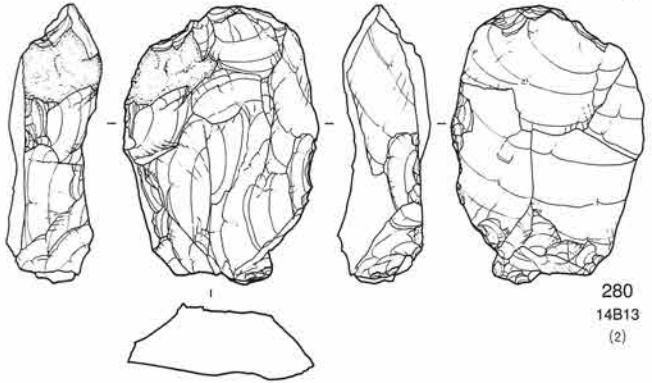

280
14B13
(2)

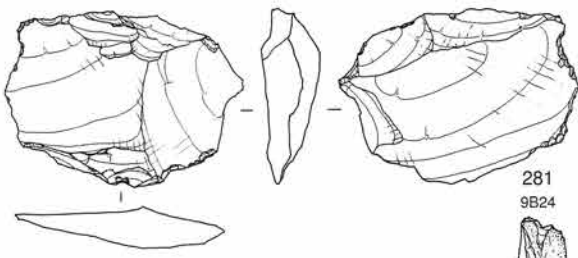

281
9B24

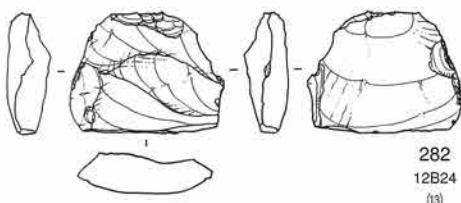

282
12B24
(13)

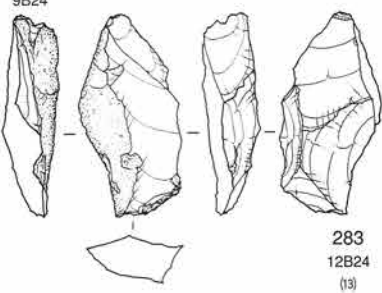

283
12B24
(13)

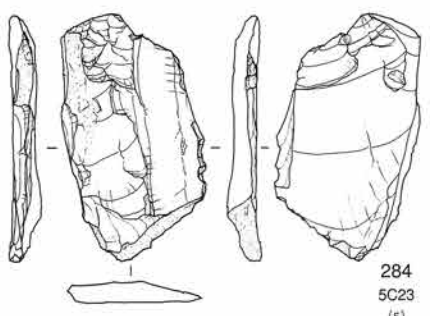

284
5C23
(5)

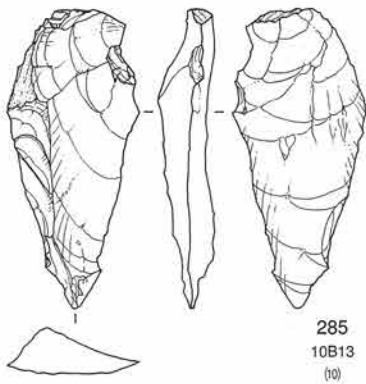

285
10B13
(10)

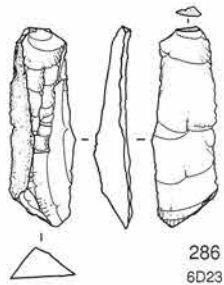

286
6D23

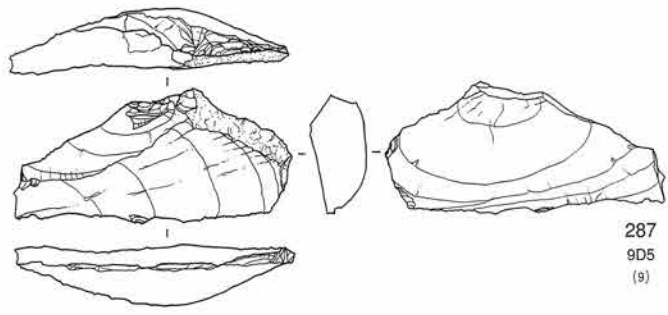

287
9D5
(9)

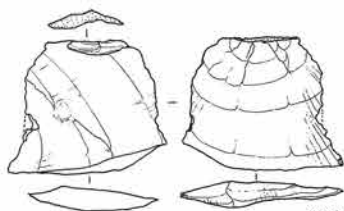

288
5A17

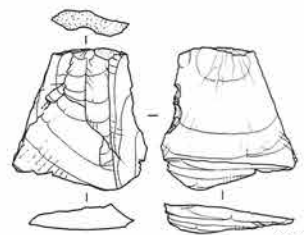

289
13C23
(12)

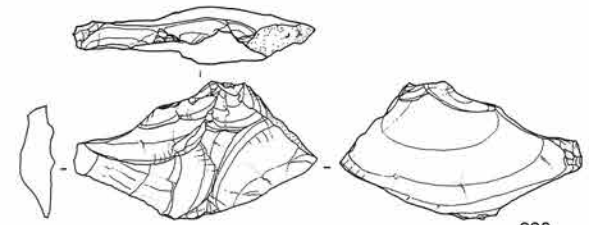

290
12B24
(13)

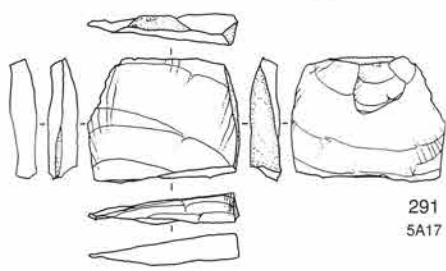

291
5A17

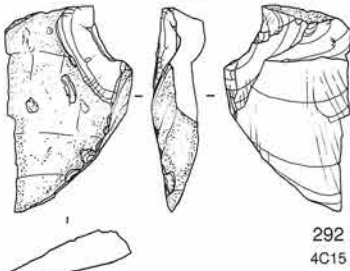

292
4C15

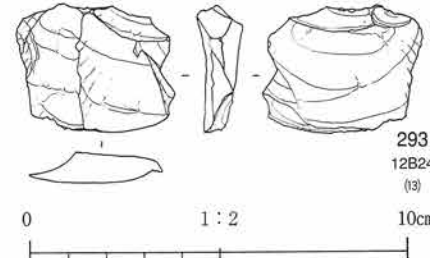

293
12B24
(13)

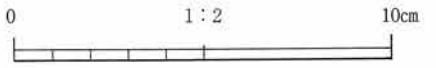

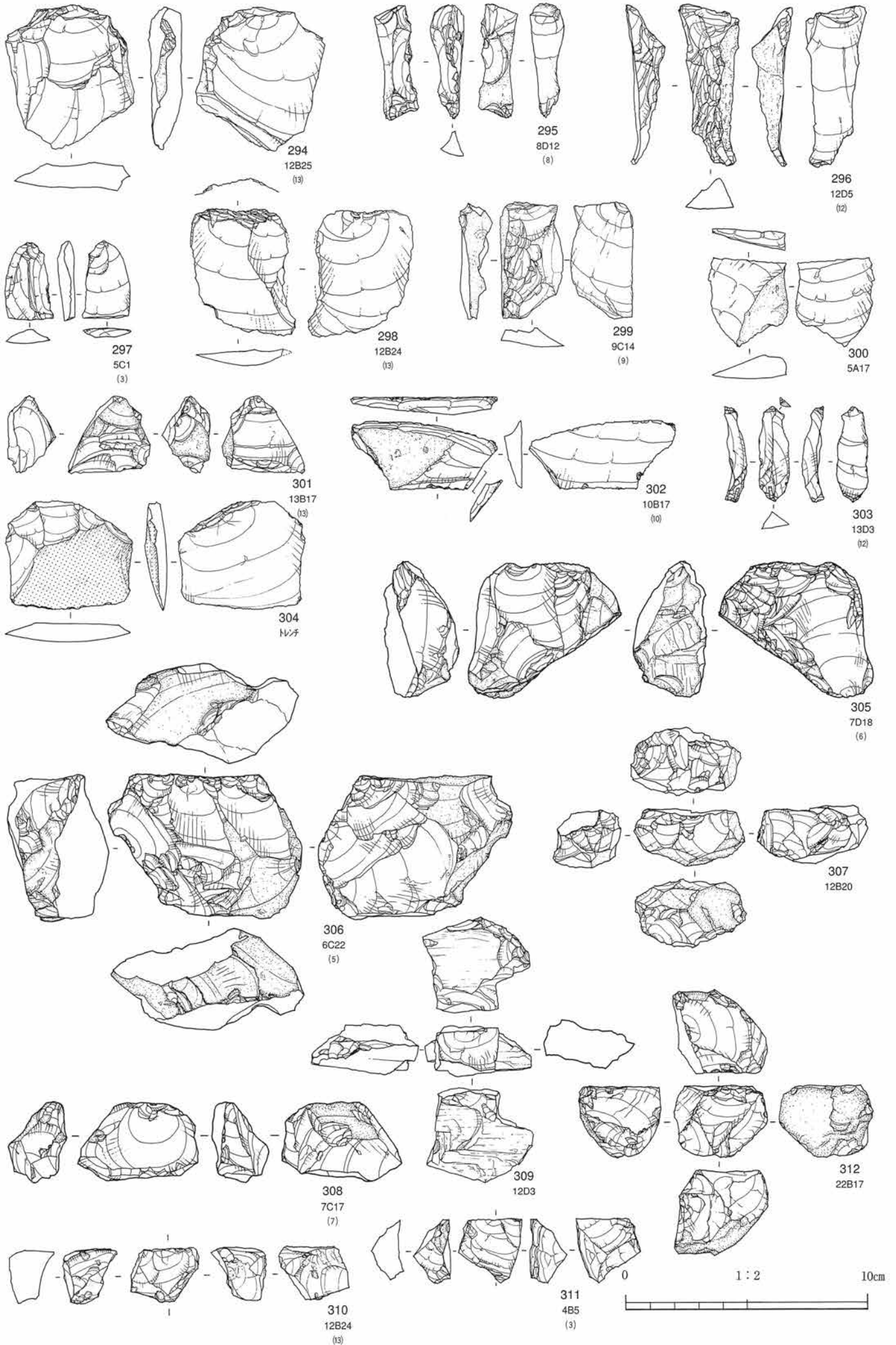

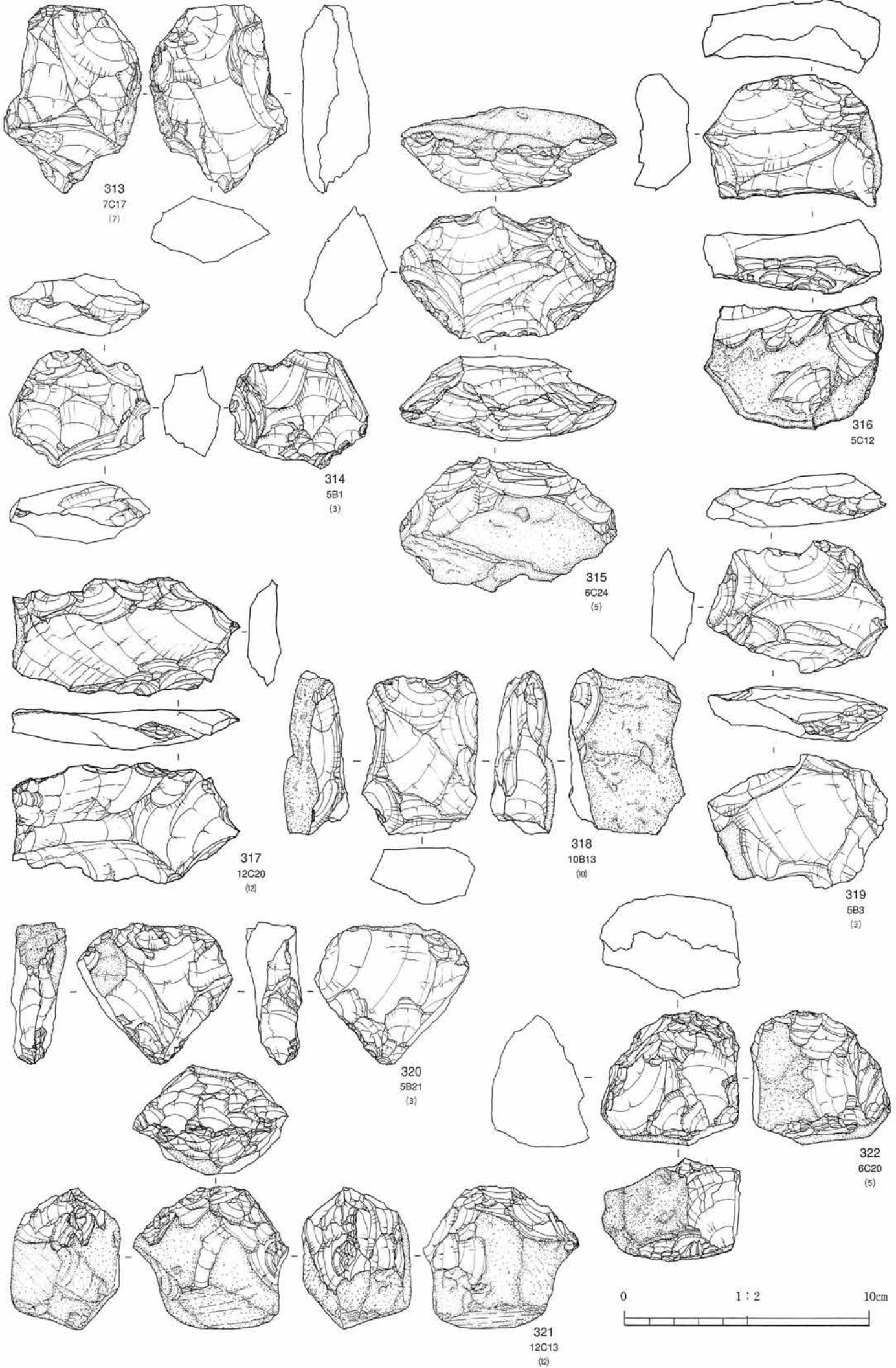

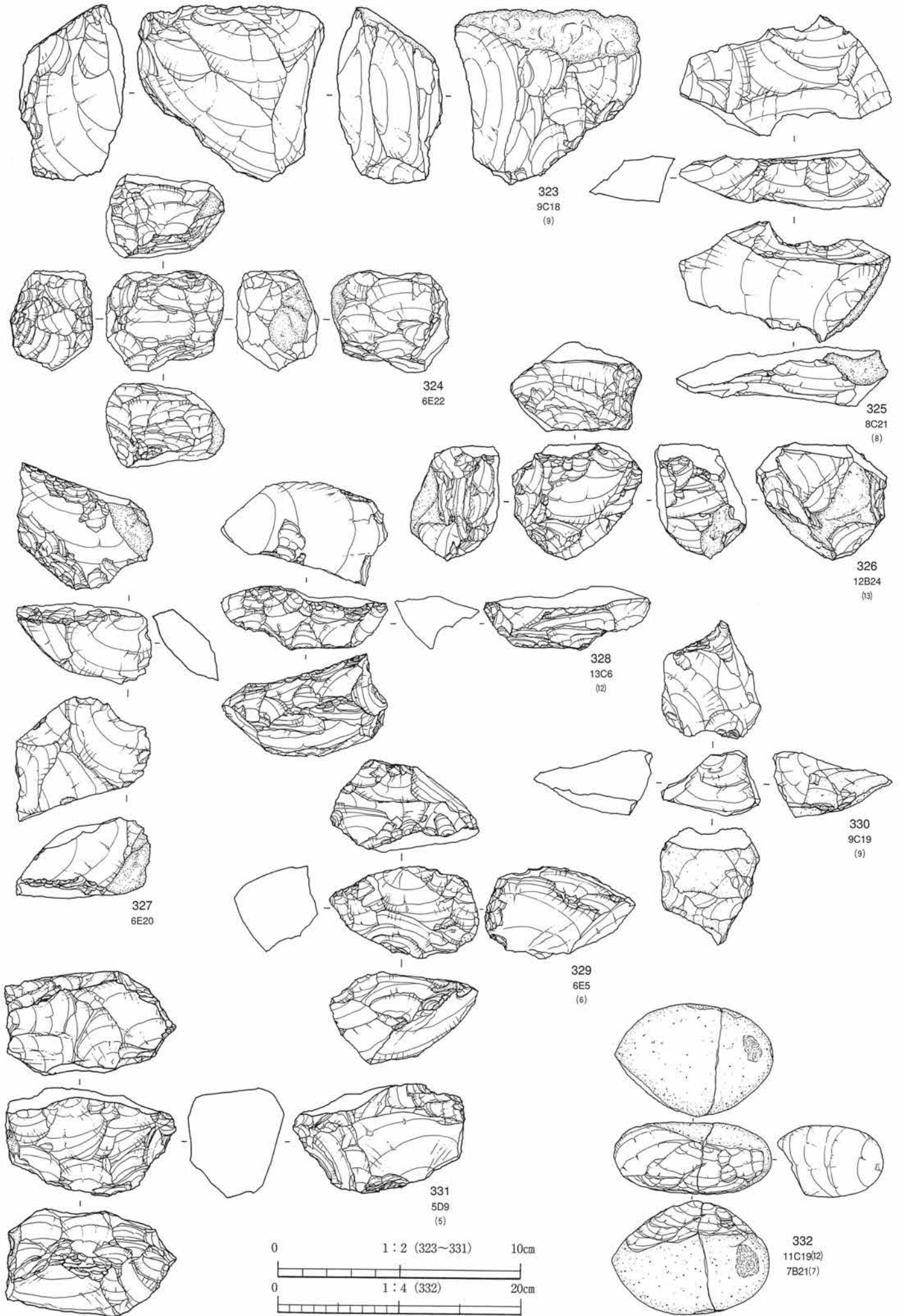

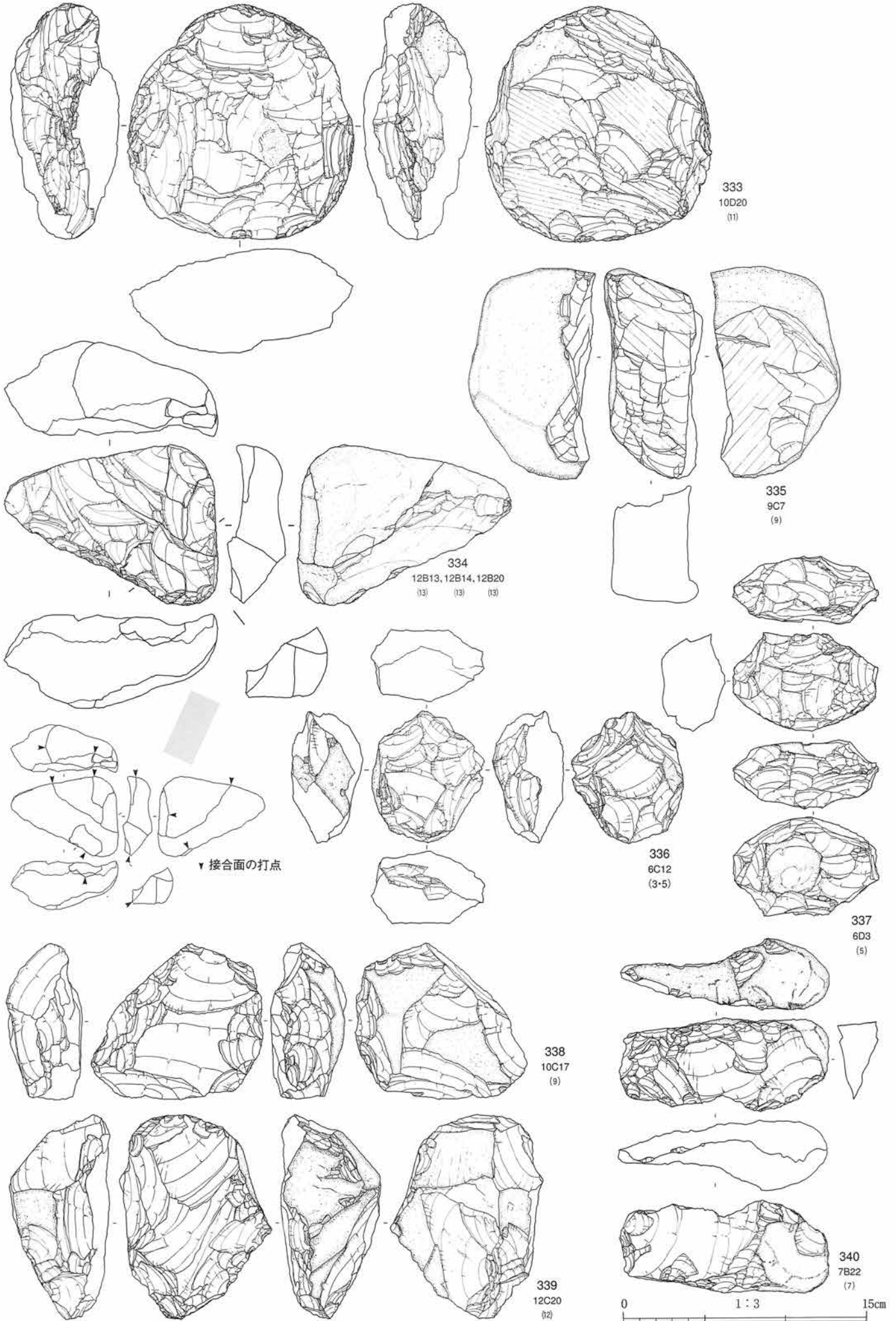

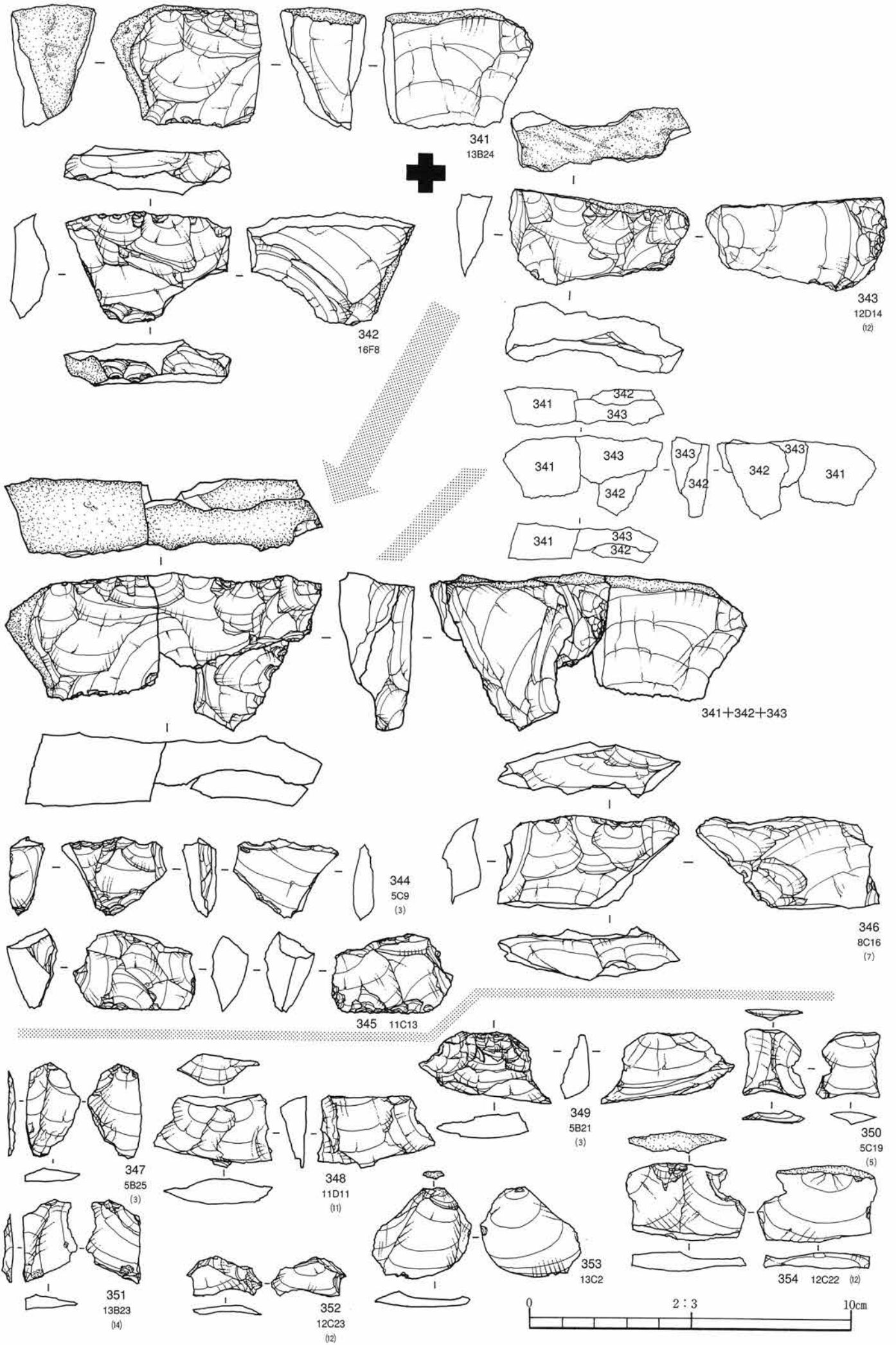

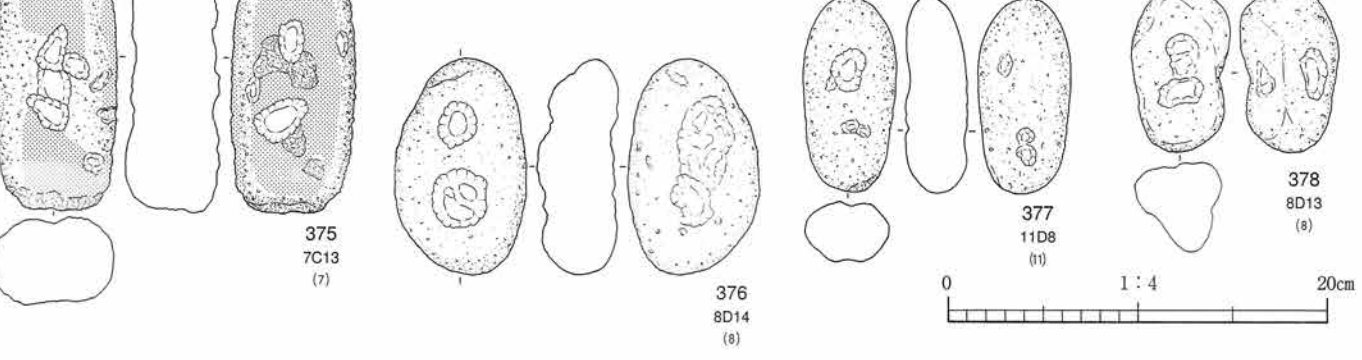
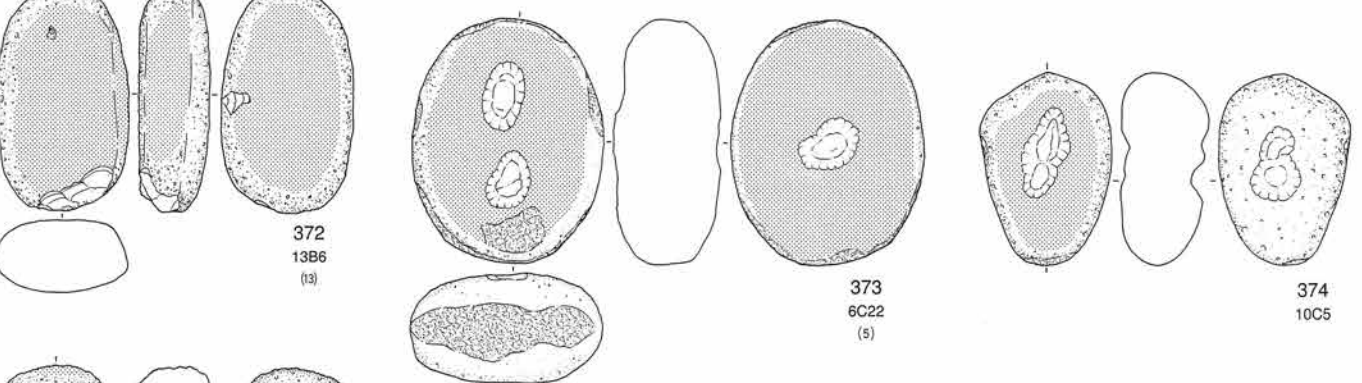
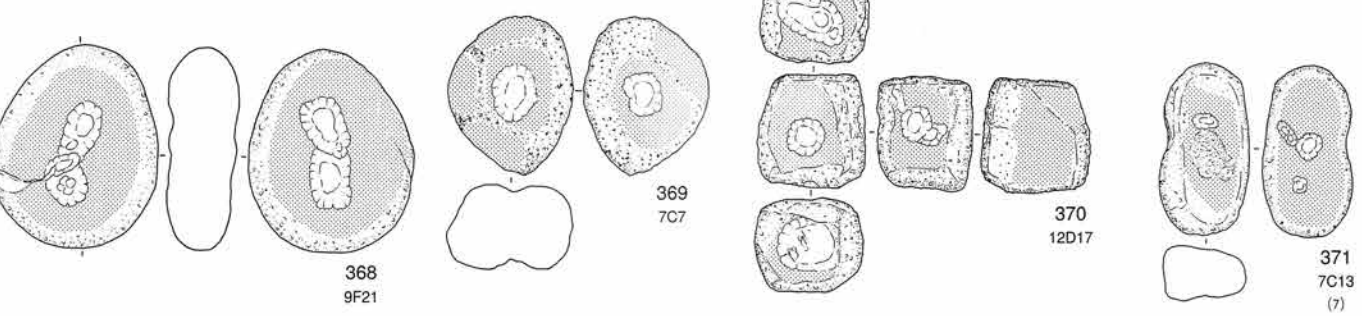
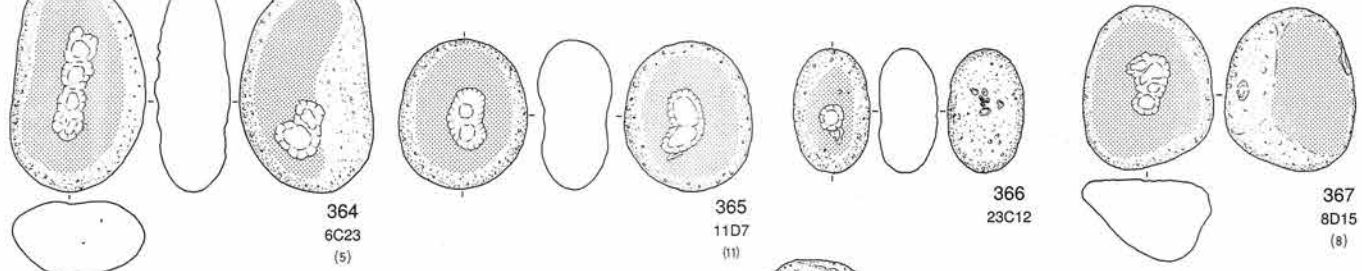
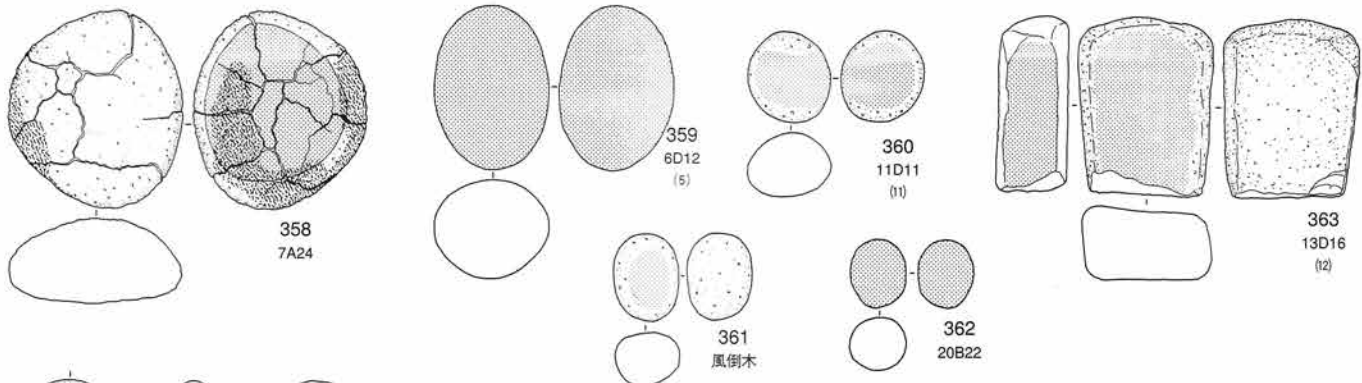
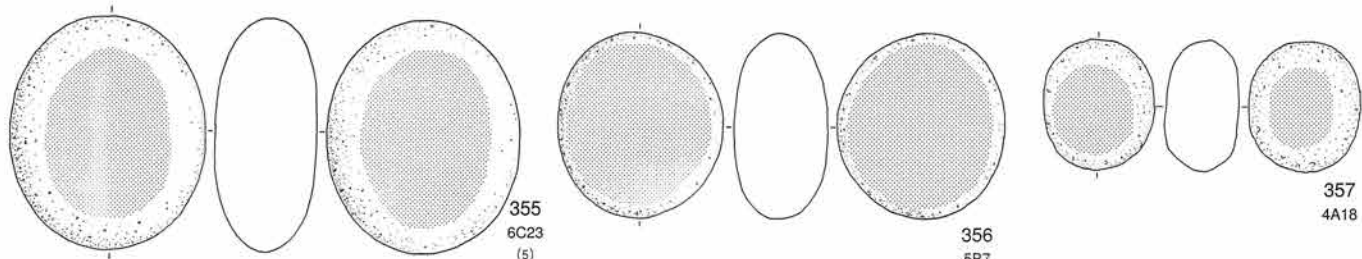

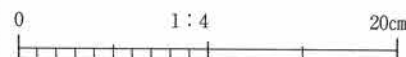
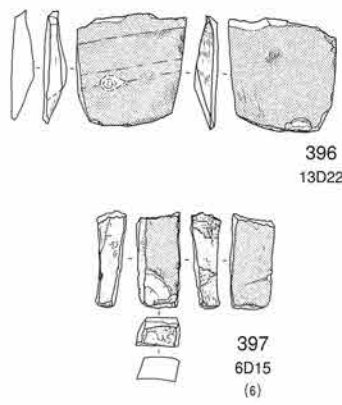
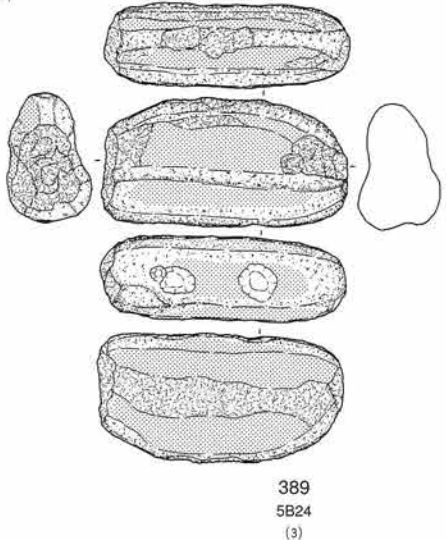
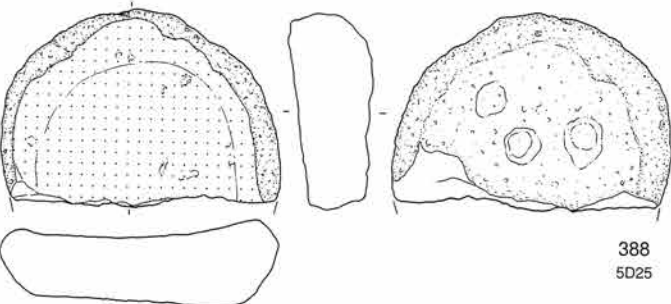
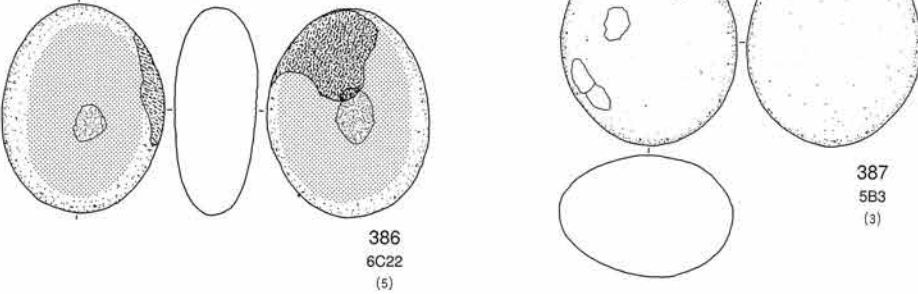
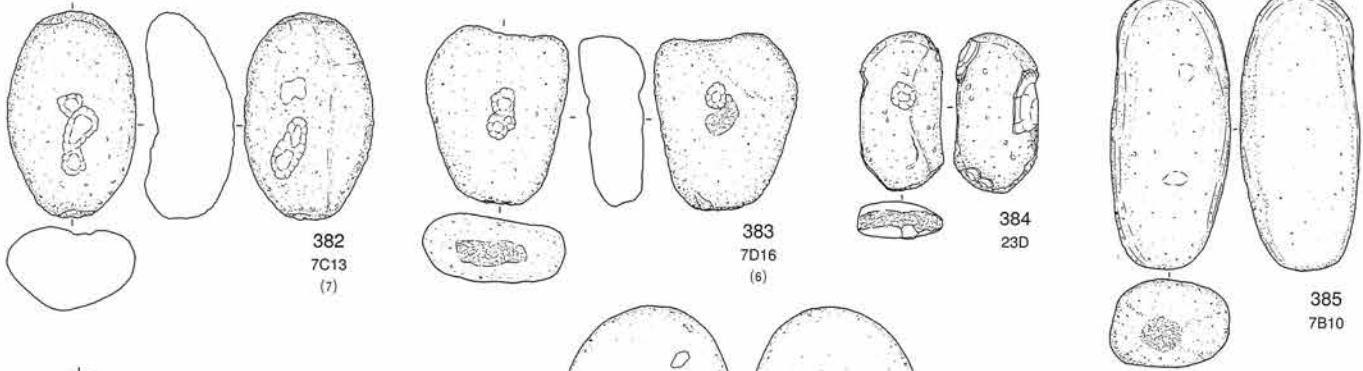
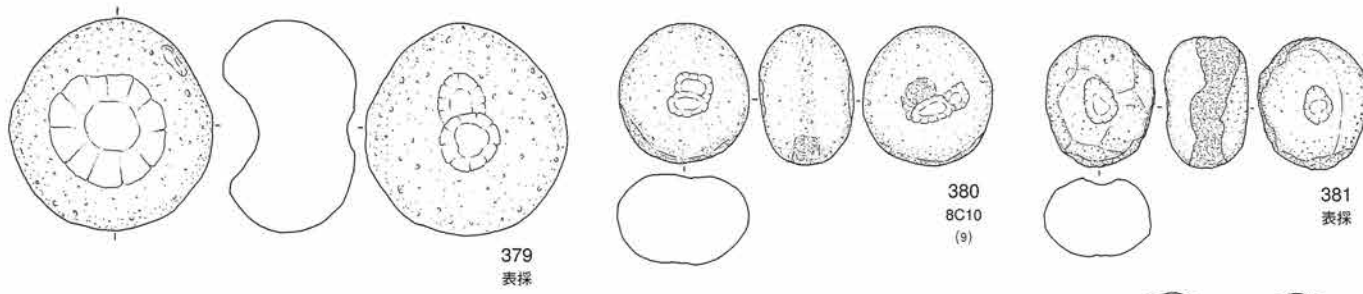

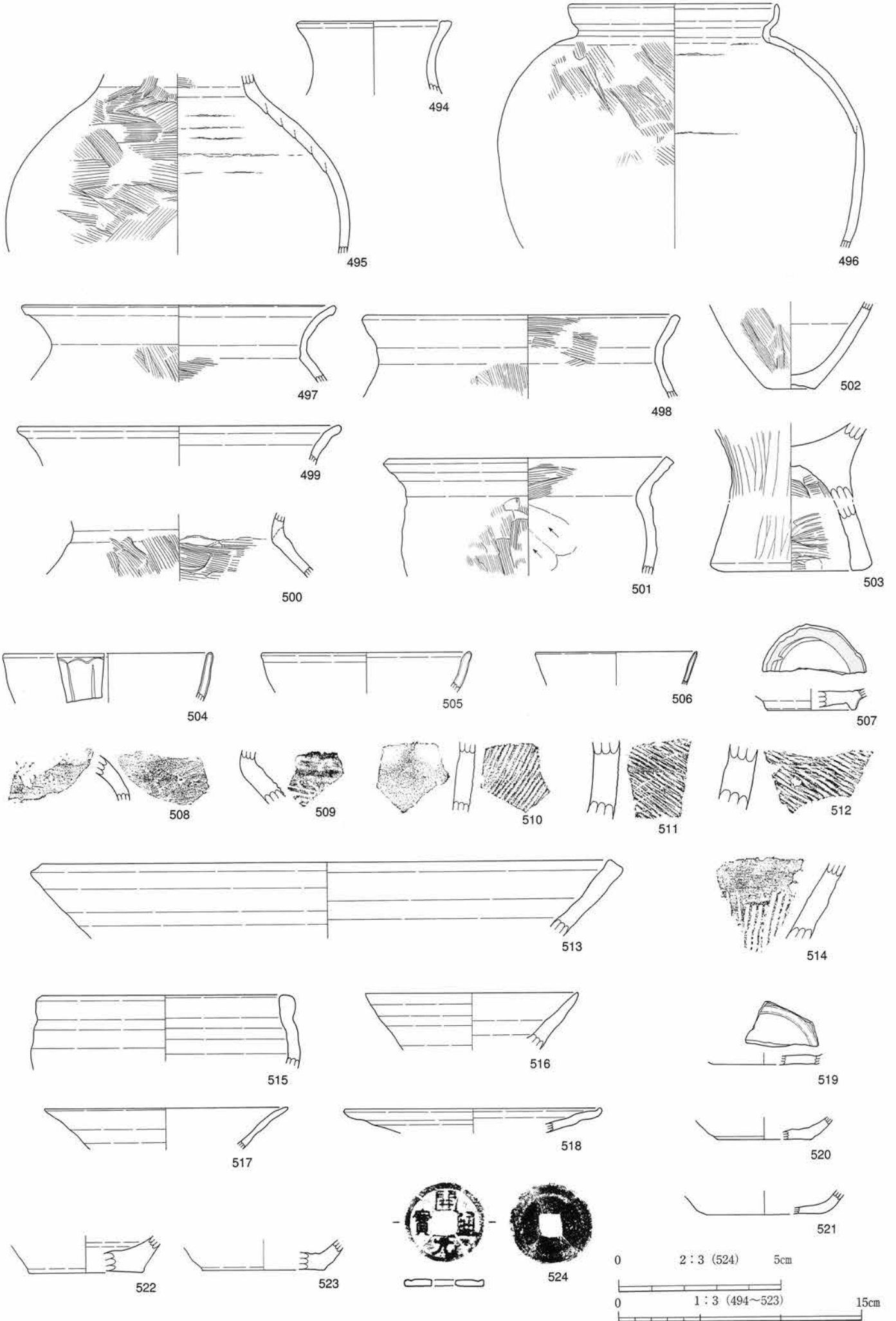

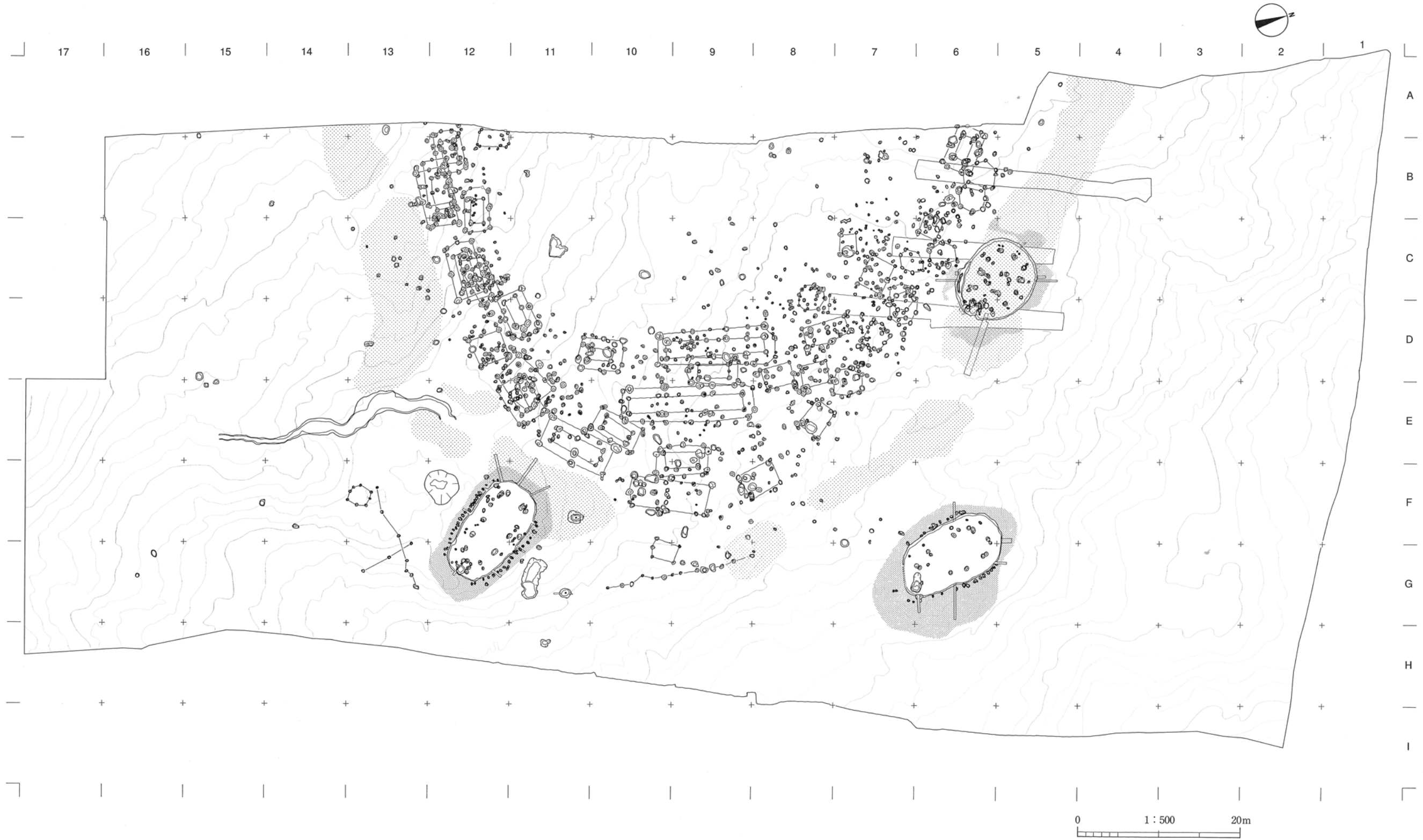



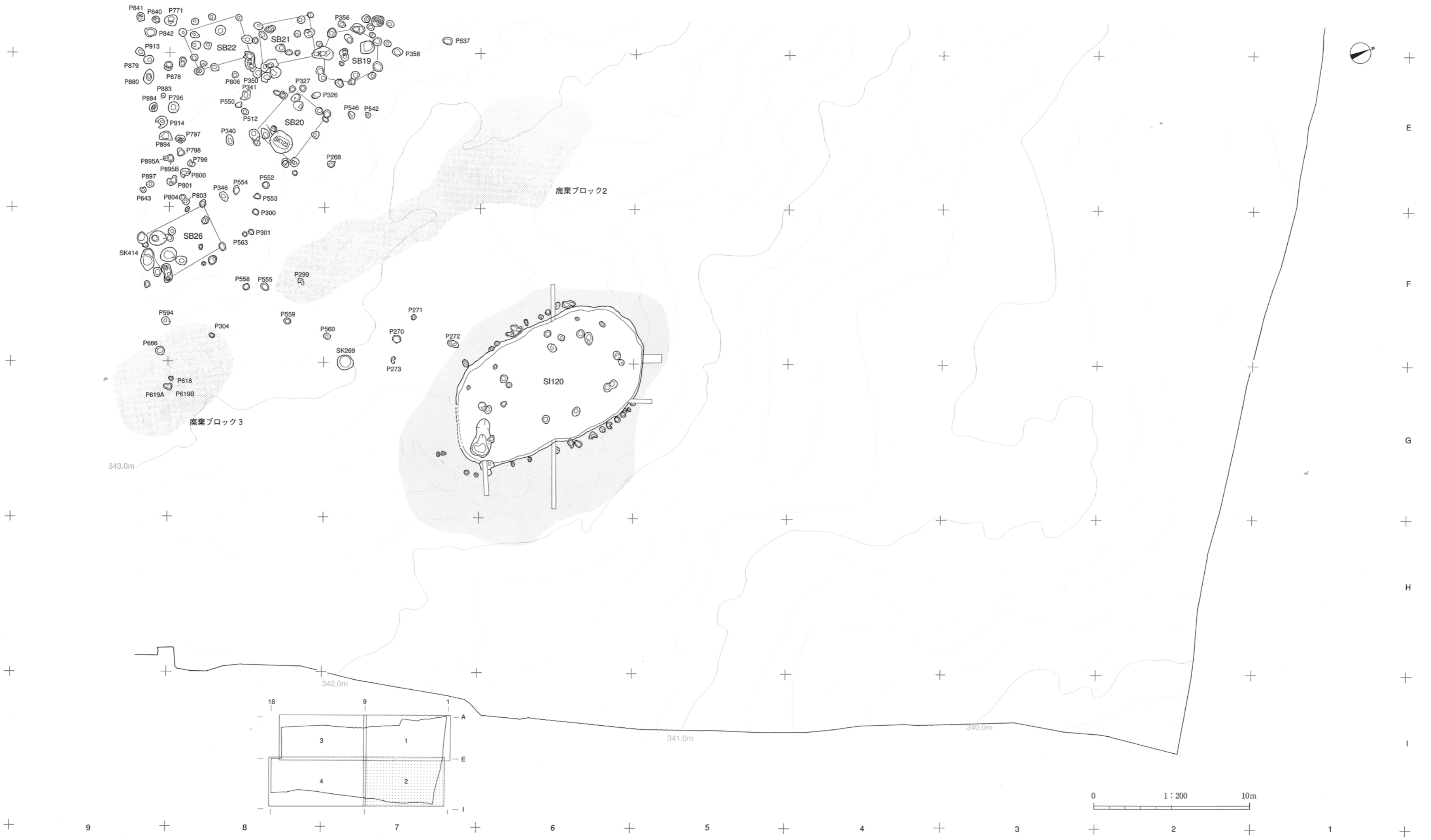

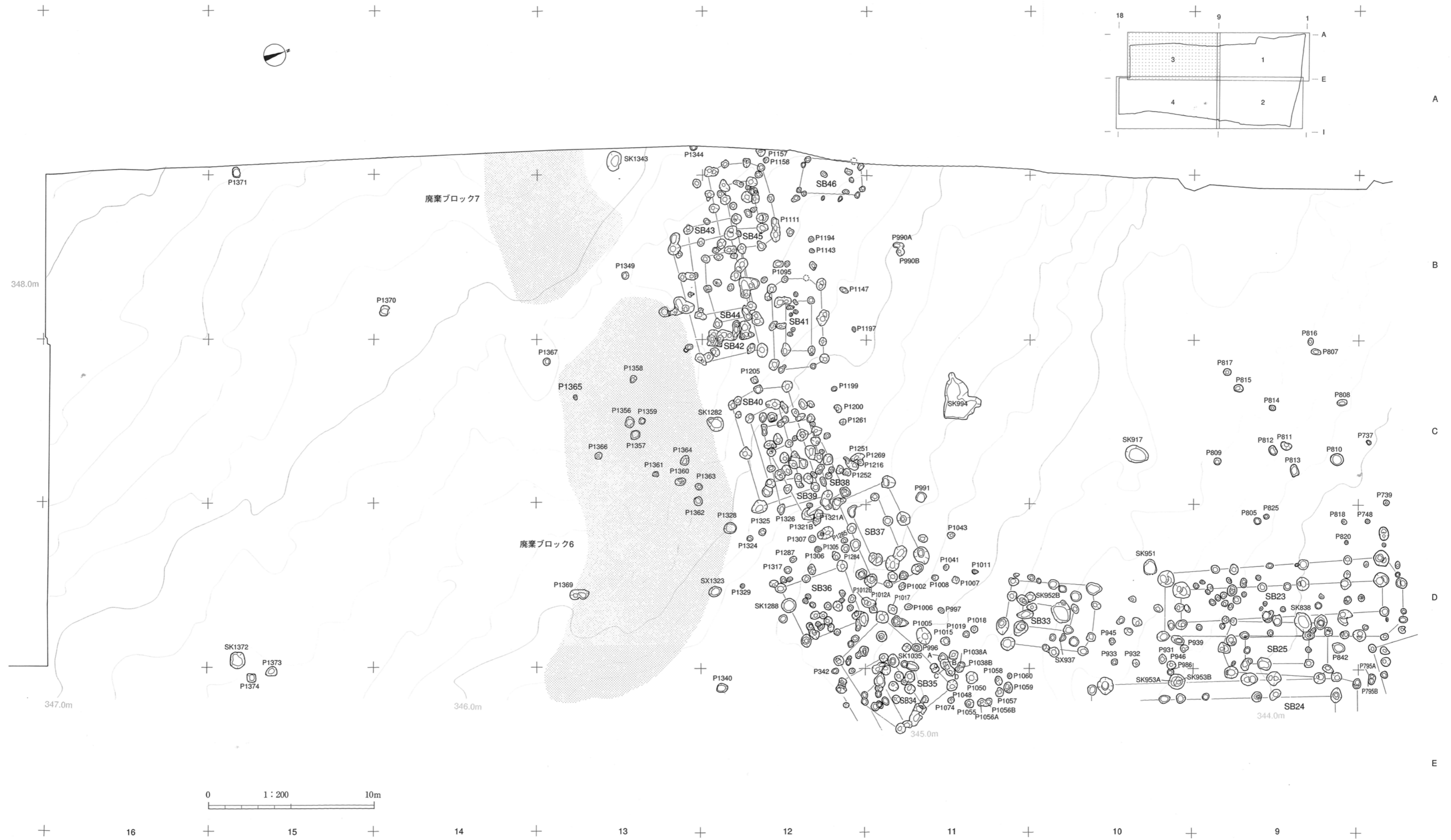

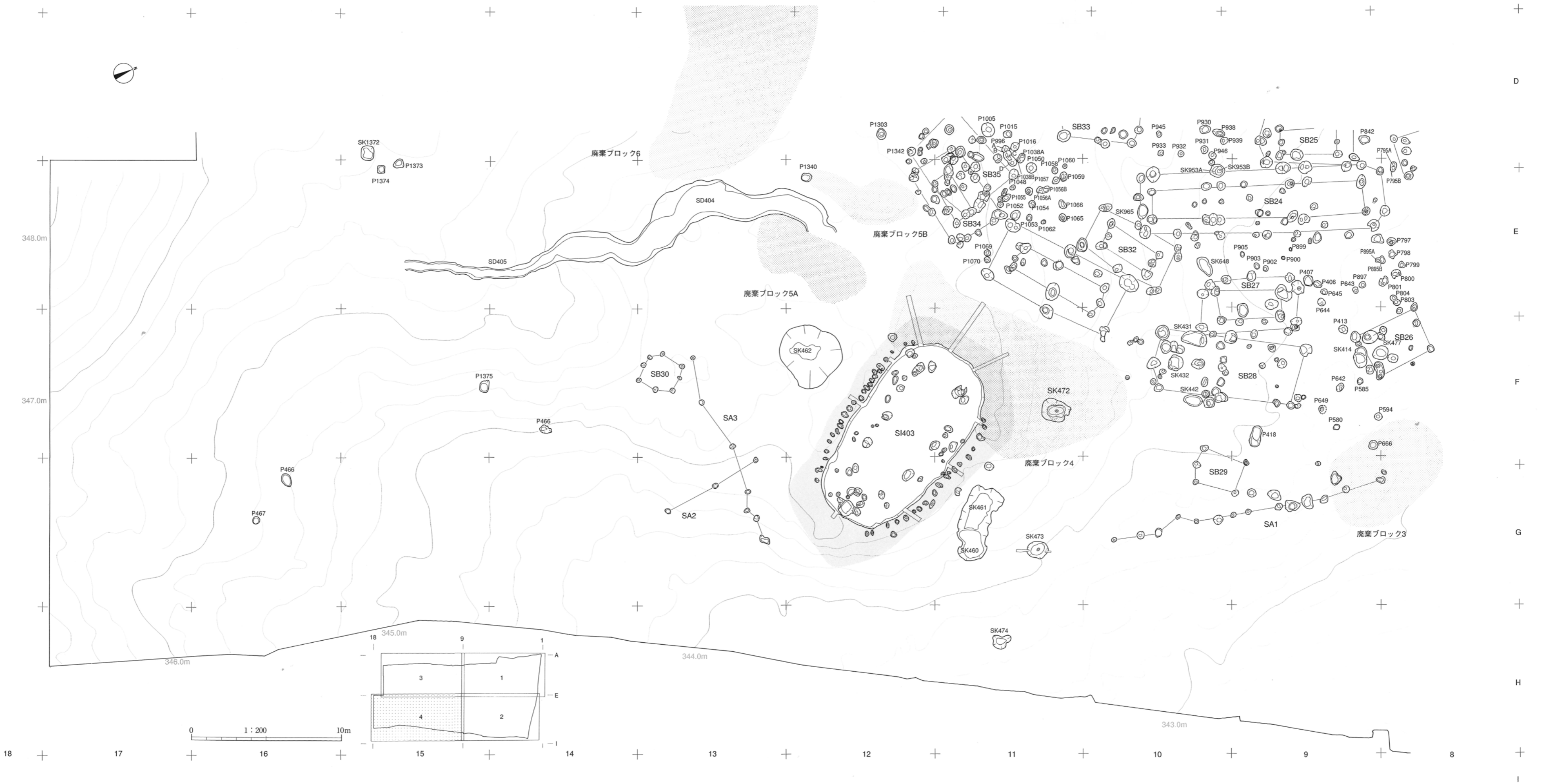

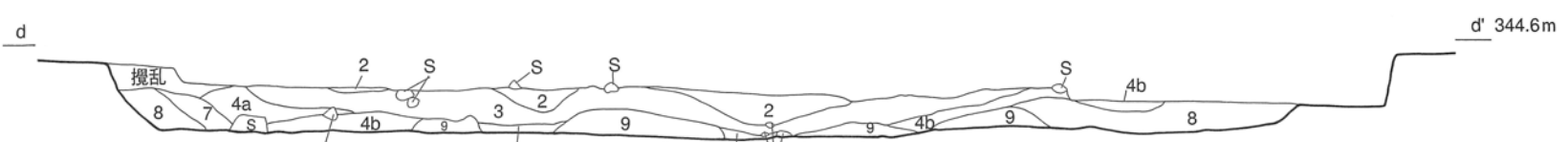
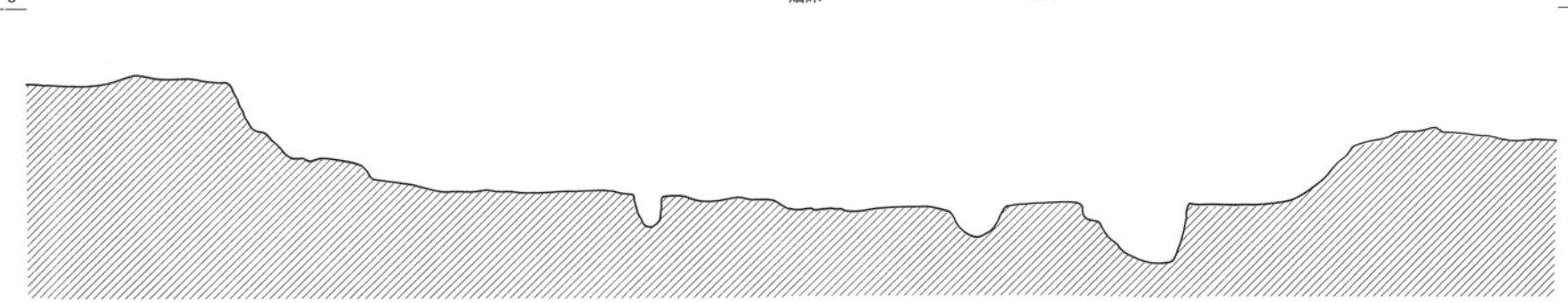
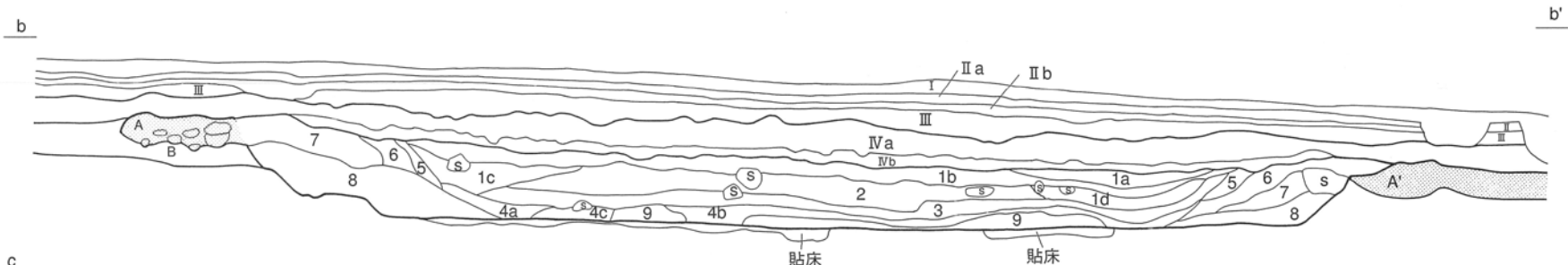

- A 10YR4/3に多い黄褐色土 しまりあり 粘性なし 地山ブロック多量 大礫・白色粒子多量 周壁を構成する人為堆積層 7層と連続するため 5層の上位部分をA層とする
 - A' 10YR4/3に多い黄褐色土 A層と同一だが、木の根により若干漸風を受けていたため、旧表土面及び周壁範囲を明確に確認できなかった
 - B 10YR3/2黒褐色土 しまりあり 粘性弱 白色粒子少量 旧表土層
 - 1 自然堆積層遺物少量P11の直上に位置する部分では窪地状を呈し1層が厚く堆積する
 - 1a 10YR1.7/1黒色土 しまり・粘性弱 白色粒子なし
 - 1b 10YR2/1黒褐色土 しまりあり 粘性弱 炭化物・白色粒子含
 - 1c 10YR2/1黒褐色土 しまり・粘性弱 白色粒子なし
 - 1d 10YR3/1黒褐色土 しまり・粘性弱 白色粒子なし
 - 2 10YR3/2黒褐色土 しまり強 粘性なし 大礫・遺物・炭化物・白色粒子を多量 周壁ブロック1と連続する人為堆積層と推定される
 - 3 10YR2/1黒褐色土 しまり弱 粘性あり 白色粒子・遺物少量 自然堆積層によるものと推定される
 - 4a 10YR3/1黒褐色土 しまり強 粘性弱 小礫・白色粒子多量 遺物少量 周壁層下の自然堆積層と推定される
 - 4b 10YR1.7/1黒色土 しまり強 粘性弱 小礫・白色多量 遺物少量 周壁層下に伴う人為堆積層と推定される
 - 4c 10YR3/3暗褐色土 しまり強 粘性なし 砂質土・礫の割合が多い、周壁層下に伴う人為堆積層と推定される
 - 5 10YR2/2黒褐色土 しまり強 粘性なし 白色粒子・礫含 周壁層下に伴う人為堆積層と推定されるが、黒色土を若干含み1c層へ漸移する
 - 6 10YR2/2黒褐色土 しまり強 粘性なし 地山ブロック・白色粒子多量 周壁層下に伴う人為堆積層
 - 7 10YR4/3に多い黄褐色土 しまり強 粘性なし 地山ブロック多量 礫・白色粒子多量 A層と連続することから、8層の上位部分を7層とする
 - 8 10YR3/3暗褐色土 しまり強 粘性なし 砂質土・地山に起因する土が大半を占める 7層に比べ地山ブロックは小さく均質である 礫・白色粒子多量 周壁層下に伴う人為堆積層
 - 9 10YR6/4Cに多い黄褐色土 しまり弱 粘性なし 砂質土・白色粒子多量 地山土と区別がつかないほど近似する 人為堆積土と推定される
- 貼床 10YR3/3暗褐色土 凹凸のある張り方の上に床面を構築するために土を貼ったもの Ⅴ層土や黒色土などがブロック状混入 上面には部分的に厚さ数mmの硬化した黒色の貼り床が作られている

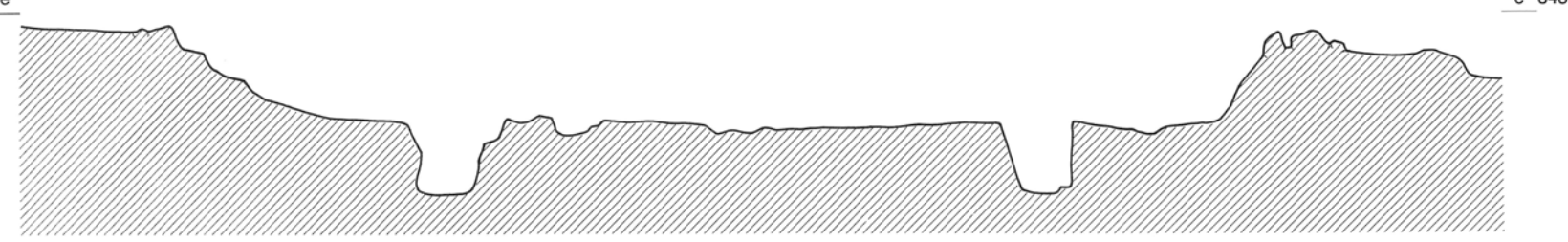

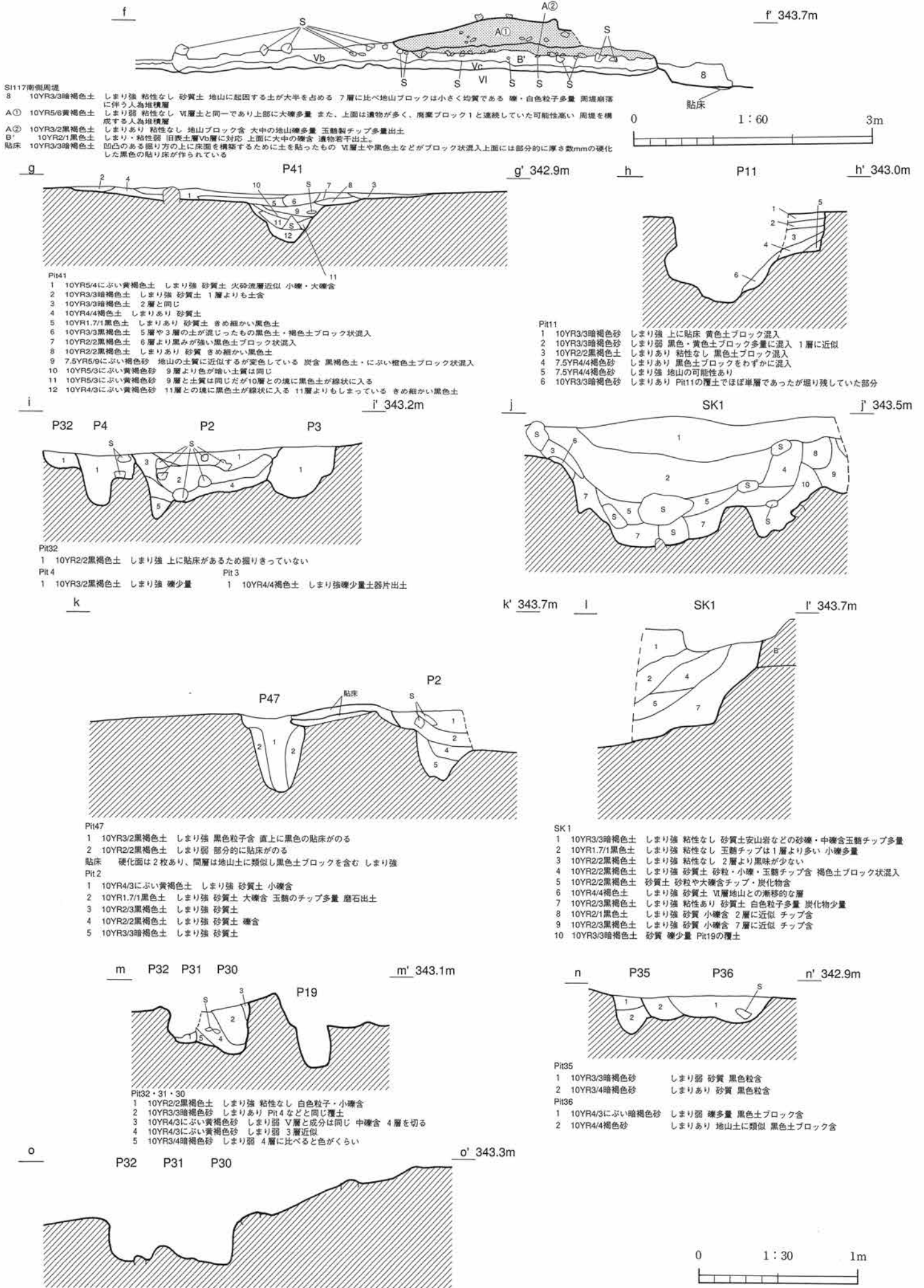

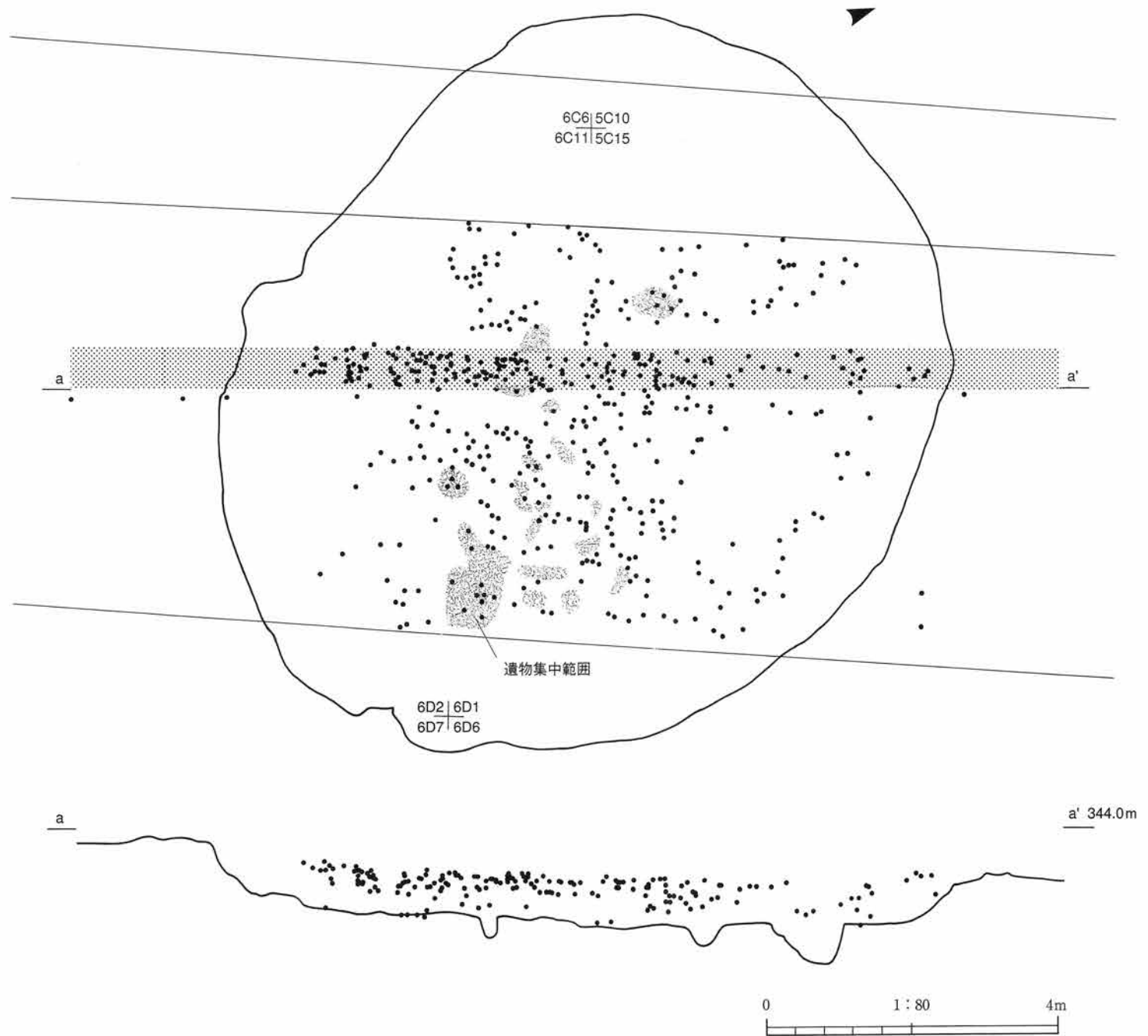
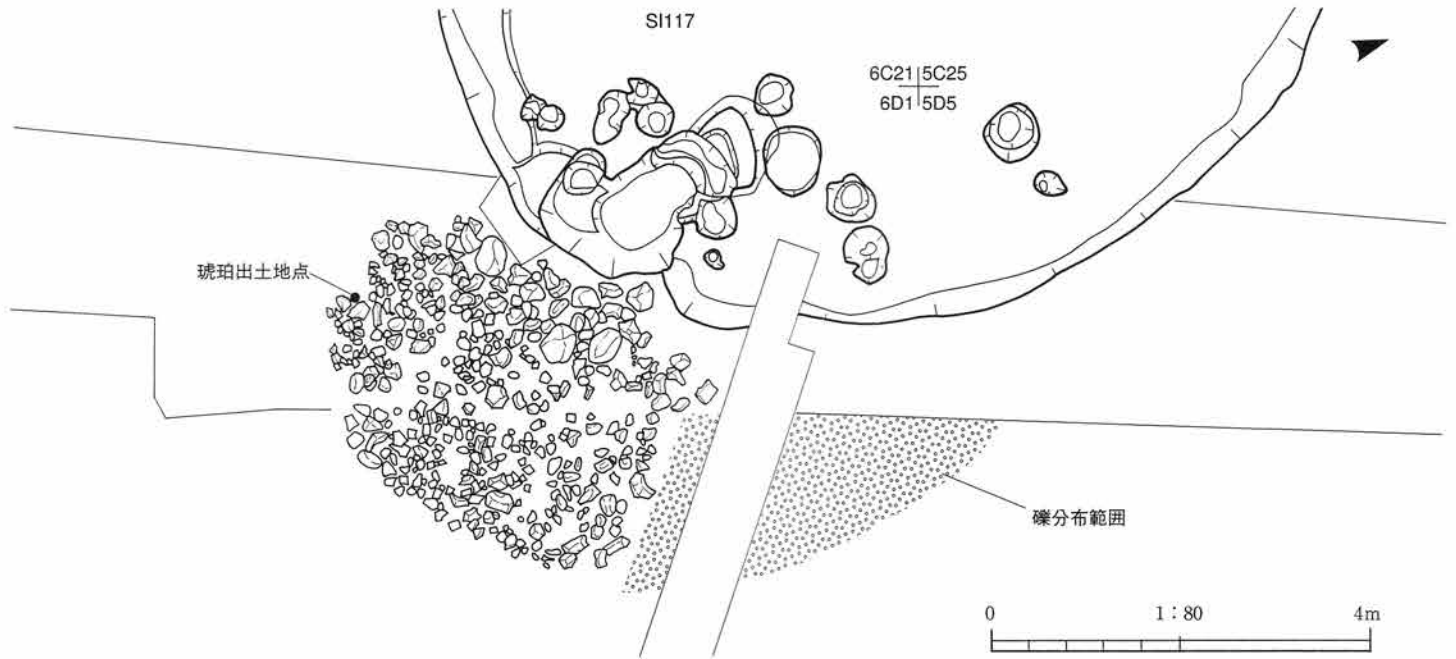

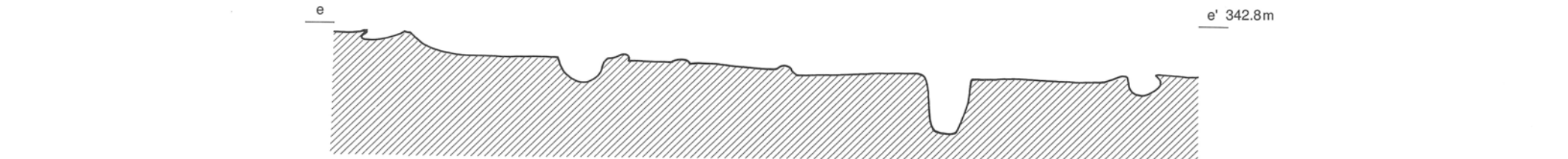
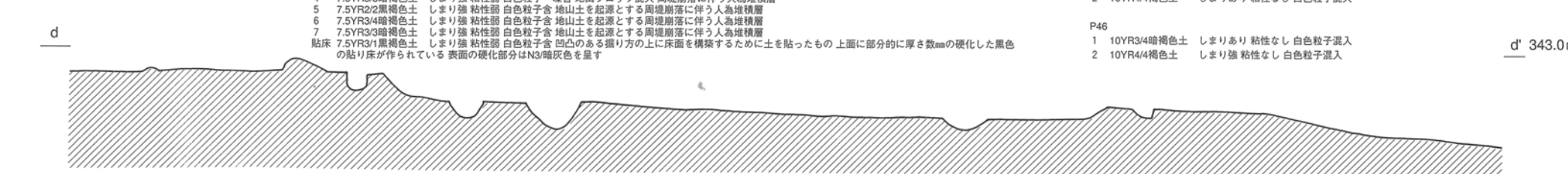
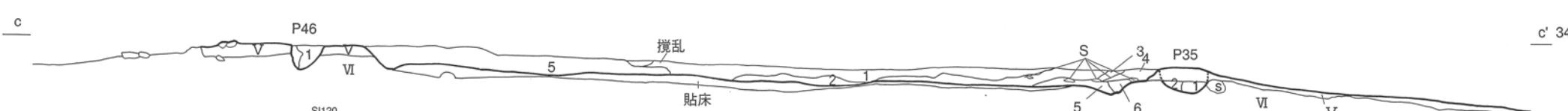
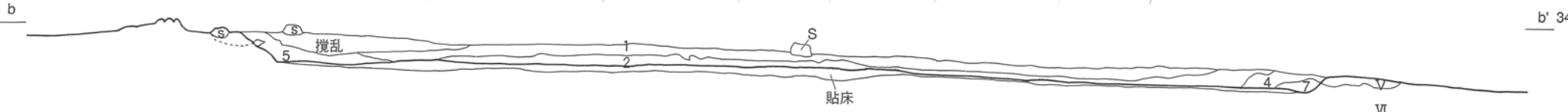
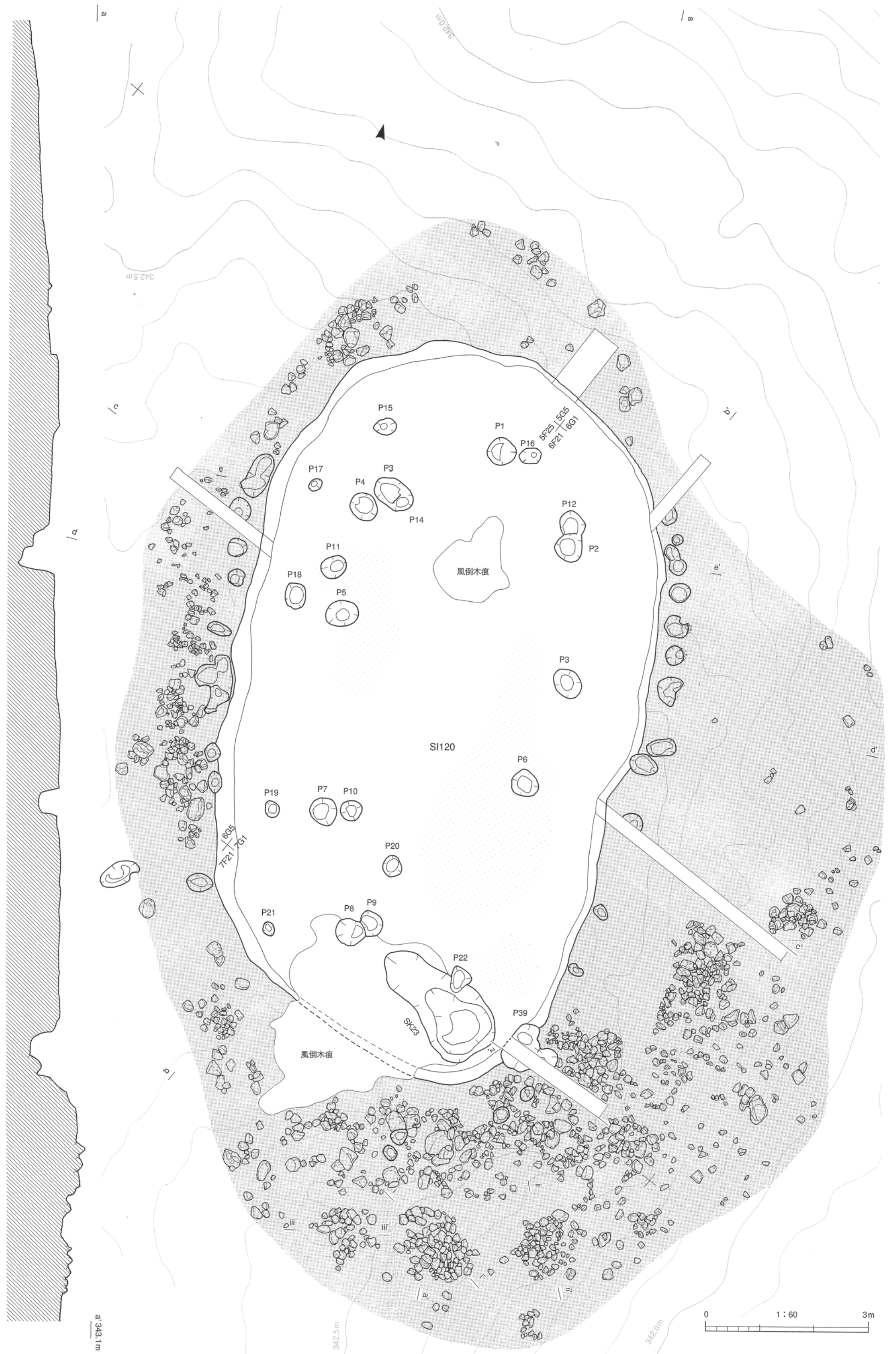

- SI120
- 1 7.5YR3/1黒褐色土 しまり弱 粘性強 白色粒子少量 Vb層類似する周堤崩落後の自然堆積層
 - 2 7.5YR3/2黒褐色土 しまり・粘性弱 白色粒子少量 粒子あらい 地山土を起源とする周堤崩落に伴う人為堆積層
 - 3 7.5YR3/1黒褐色土 しまり強 粘性弱 白色粒子多 地山土に類似する周堤崩落に伴う人為堆積層
 - 4 7.5YR3/3暗褐色土 しまり強 粘性弱 白色粒子・礫含 地山ブロック混入 周堤崩落に伴う人為堆積層
 - 5 7.5YR2/2黒褐色土 しまり強 粘性弱 白色粒子含 地山土を起源とする周堤崩落に伴う人為堆積層
 - 6 7.5YR3/4暗褐色土 しまり強 粘性弱 白色粒子含 地山土を起源とする周堤崩落に伴う人為堆積層
 - 7 7.5YR3/3暗褐色土 しまり強 粘性弱 白色粒子含 地山土を起源とする周堤崩落に伴う人為堆積層
 - 貼床 7.5YR3/1黒褐色土 しまり強 粘性弱 白色粒子含 凹凸のある張り方の上に床面を構築するために土を貼ったもの 上面に部分的に厚さ数mmの硬化した黒色の貼り床が作られている 表面の硬化部分はN3暗灰色を呈す
- P35
- 1 10YR3/4暗褐色土 しまりあり 粘性ややあり 白色粒子混入
 - 2 10YR4/4褐色土 しまりあり 粘性なし 白色粒子混入
- P46
- 1 10YR3/4暗褐色土 しまりあり 粘性なし 白色粒子混入
 - 2 10YR4/4褐色土 しまり強 粘性なし 白色粒子混入

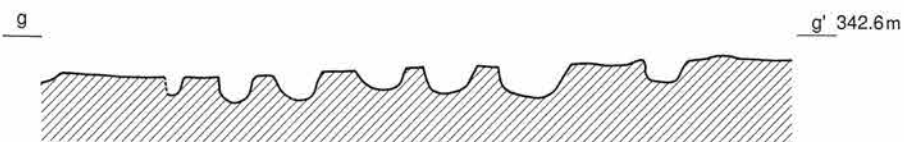
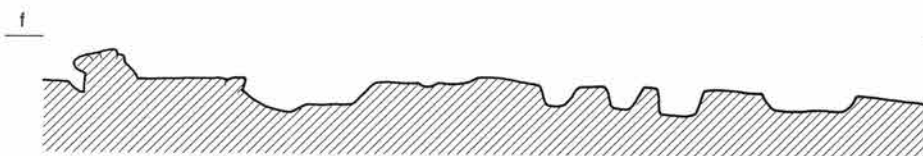
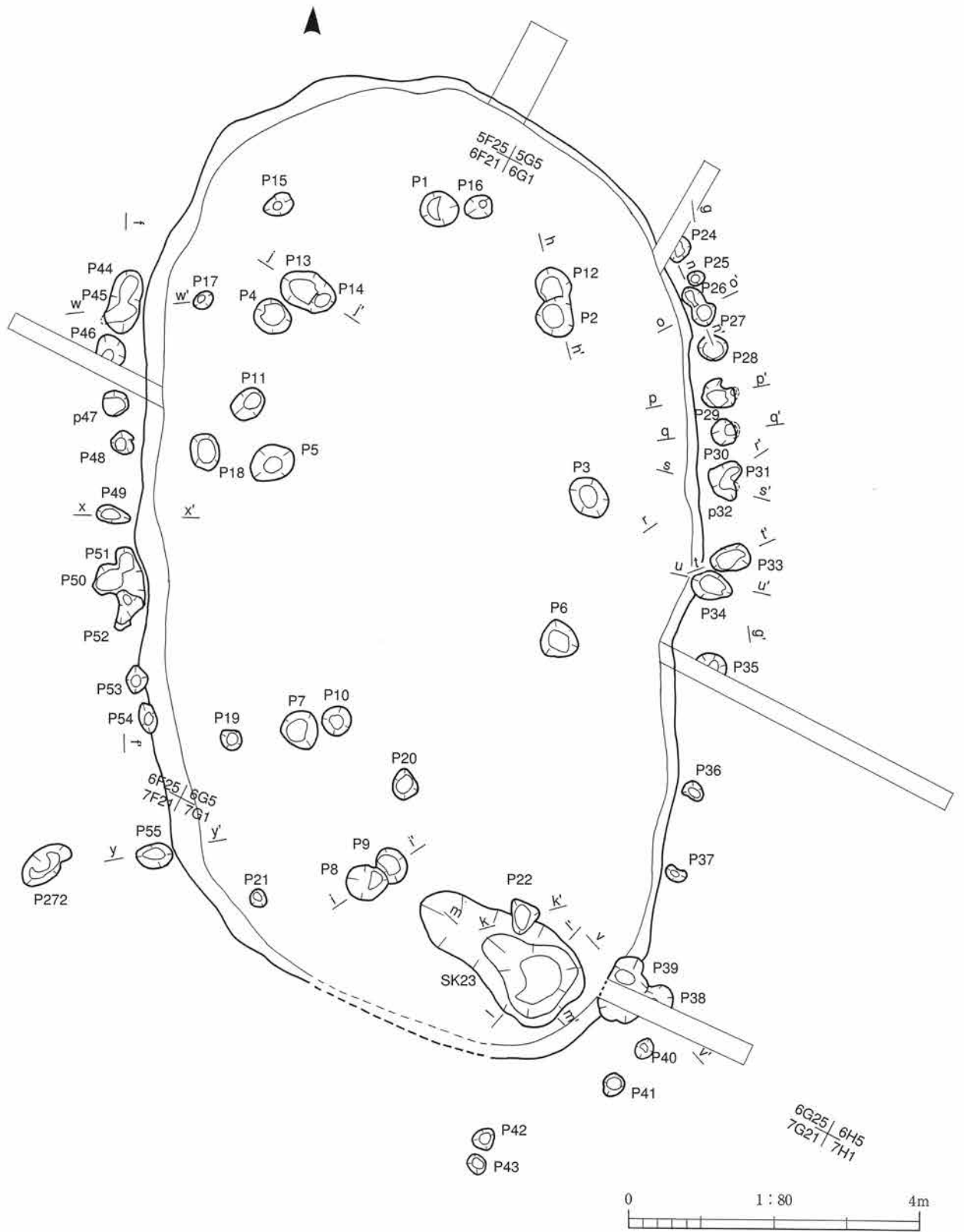

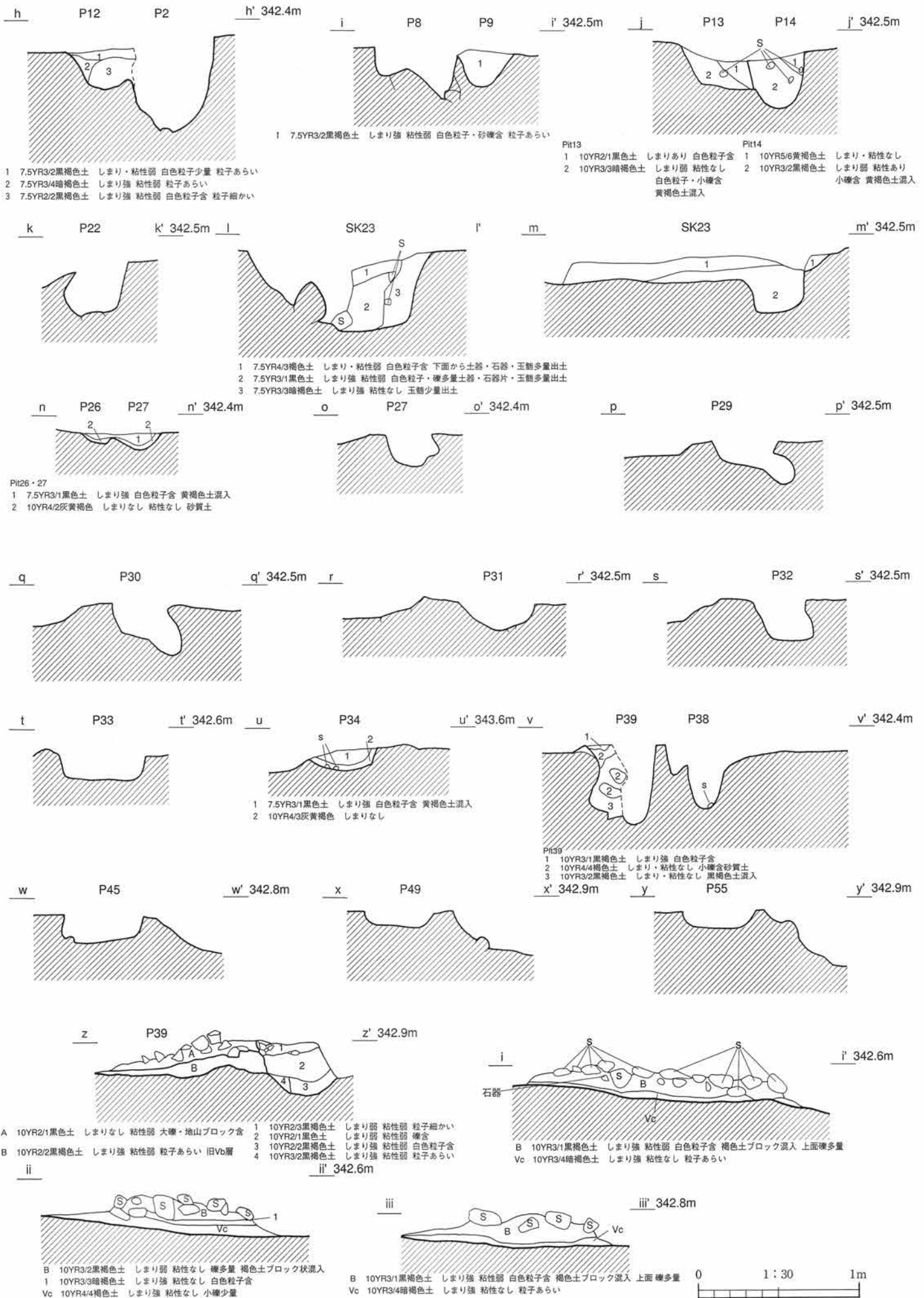

SI120

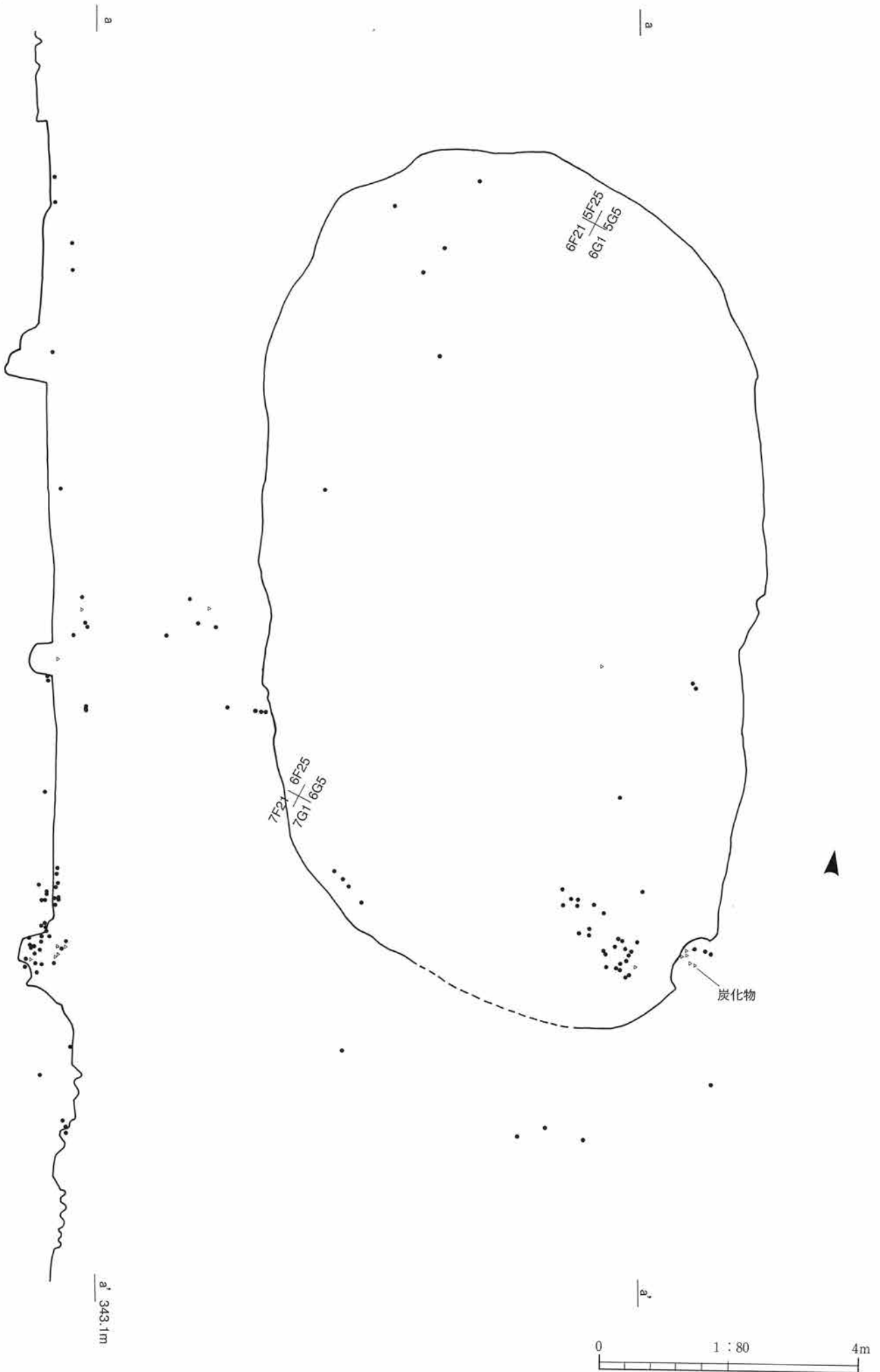



A層
 A① 10YR3/4暗褐色土
 A② 10YR2/2黒褐色土
 A③ 10YR2/2黒褐色土
 A④ 10YR2/4暗褐色土
 A⑤ 10YR2/3黒褐色土
 A⑥ 5YR2/4暗赤褐色土
 B 10YR3/1黒褐色土
 B① 10YR2/1黒褐色土
 2 10YR2/3黒褐色土
 2a 10YR2/2黒褐色土
 2b 10YR2/1黒褐色土
 3 10YR1.7/1黒褐色土
 3a 10YR1.7/1黒褐色土
 3b 10YR2/2黒褐色土

4 10YR3/4暗褐色土
 4a 10YR3/4暗褐色土
 4b 10YR3/3暗褐色土
 4c 10YR4/3暗褐色土
 5 10YR2/2黒褐色土
 5a 10YR2/2黒褐色土
 5b 10YR3/4暗褐色土
 5c 10YR3/4暗褐色土
 5d 10YR2/2黒褐色土
 5e 10YR2/2黒褐色土
 5f 10YR4/4暗褐色土
 5g 10YR2/3黒褐色土
 5h 10YR2/3黒褐色土
 5i 10YR3/4暗褐色土
 5j 10YR2/3黒褐色土
 5k 10YR2/3黒褐色土
 5l 10YR2/3黒褐色土
 5m 10YR2/3黒褐色土
 5n 10YR2/3黒褐色土
 5o 10YR2/3黒褐色土
 5p 10YR2/3黒褐色土
 5q 10YR2/3黒褐色土
 5r 10YR2/3黒褐色土
 5s 10YR2/3黒褐色土
 5t 10YR2/3黒褐色土
 5u 10YR2/3黒褐色土
 5v 10YR2/3黒褐色土
 5w 10YR2/3黒褐色土
 5x 10YR2/3黒褐色土
 5y 10YR2/3黒褐色土
 5z 10YR2/3黒褐色土

自然堆積層 洪水などの要因で短時間に堆積した層と考えられる
 しまり強 粘性なし 均質な土で他の混入物が少ない 地山土より色が暗く砂質である 礫混入は少量白色粒子・礫少量 遺物なし
 しまり強 粘性なし 4a層と5c層が混じったもの
 しまり強 粘性なし 4a層と土質は同じ 4aに比べやや色が暗い

周埋土の崩壊に起因する人為堆積層
 しまり強 粘性あり 白色粒子・褐色土ブロック・炭化物含 周埋土A層と黒色土が混じり合った層
 しまり強 粘性なし 白色粒子・細かい炭化物・小中礫含 砂質の褐色土ブロック混入遺物出土
 A層に近接する層 地山ブロック多数混入がリラインは認めにくく、A層と混同して堆積しているようである
 しまり強 粘性あり A①層と同じくシルト質の地山ブロックと周埋土ブロック4に起因する遺物・炭化物含
 しまり強 粘性なし A①層と同じだがA①層にも近い
 しまり強 粘性なし 地山ブロック多数 A①層と同じ
 しまり強 粘性なし A①層と同じ SK10層土1層
 5c③層と同じ土層だが、鉄分沈着あり SK10層土2層

しまり強 粘性なし 5c層に比べ地山ブロック混入少量で細かいが、土質は均質で地山土を基調とする 色調暗い 小中礫含 遺物少量
 しまり強 粘性あり 5c層と同じくこの付近の地山土である黄褐色シルトブロック含 遺物出土
 しまり強 小礫含 土質は5c層とあまり変わらない
 しまり強 白色粒子を地山に近い層
 凹凸のある層の上方に床面を構築するために土を貼ったもの IV層や黒色土などをブロック状含 上面には部分的に厚さ数mmの硬化した黒色の貼
 り圧が作られている
 しまり強 粘性なし この付近の地山土に近い黄褐色土と黒褐色土が混在 上面から炭化物出土
 貼床 10YR2/3黒褐色土
 P80 10YR2/2黒褐色土
 1 10YR2/2黒褐色土

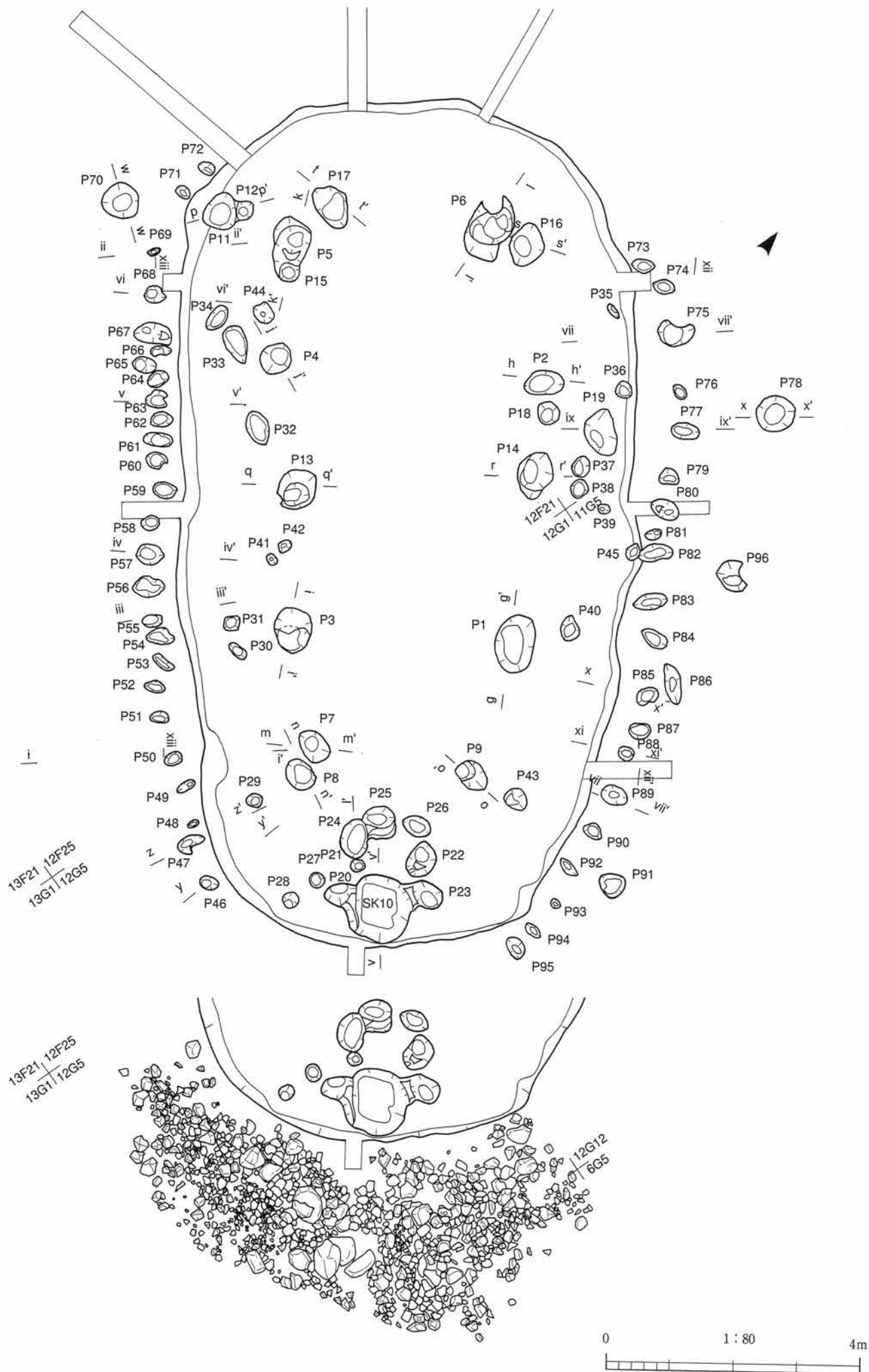

g P1 g' 344.8m h P2 h' 344.8m i P3 i' 344.8m

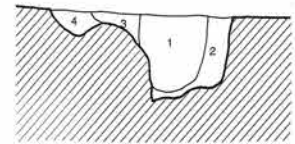
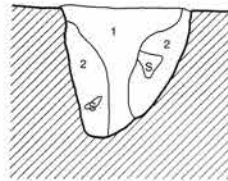
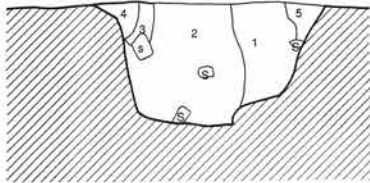

- 1 10YR2/2黒褐色土 しまり強 粘性なし 白色粒子含 柱痕?
- 2 10YR2/3黒褐色土 しまり1層より強 粘性なし 白色粒子・小中礫含 版築?
- 3 10YR3/2黒褐色土 しまり強 粘性なし 白色粒子含
- 4 10YR3/3黒褐色土 しまり弱 粘性なし 砂質 白色粒子少量
- 5 10YR3/3黒褐色土 しまり弱 粘性なし 褐色土ブロック・小礫含 5層に近似

- 1 10YR2/2黒褐色土 しまり強 粘性なし 白色粒子・炭化物含 柱痕
- 2 10YR2/3黒褐色土 しまり強 粘性なし 小礫含 褐色系の土多量 白色粒子少量 版築

- 1 10YR2/1黒色土 しまり強 粘性なし 白色粒子・炭化物含
- 2 10YR3/3暗褐色土 しまり強 粘性なし 礫含
- 3 10YR2/3黒褐色土 しまり強 粘性なし 白色粒子・褐色粒子・小礫含
- 4 10YR3/4暗褐色土 しまり弱 粘性なし 褐色土ブロック・小礫含

j P4 j' 344.8m k P5 P15 k' 344.8m l P6 l' 344.7m

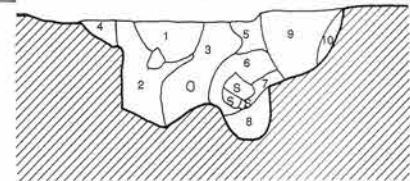
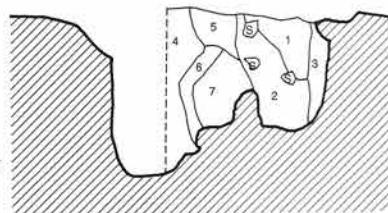
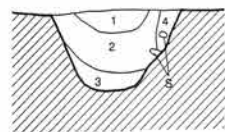

- 1 10YR2/2黒褐色土 しまり強 粘性なし 白色粒子・褐色粒子含 柱痕
- 2 10YR2/3黒褐色土 しまり強 粘性なし 白色粒子・小礫含 柱痕
- 3 10YR2/3黒褐色土 しまり強 粘性なし やや黒みが強い
- 4 10YR3/3暗褐色土 しまり強 粘性なし

Pit 5・15

- 1 10YR2/2黒褐色土 しまり強 粘性なし 白色粒子・褐色粒子・小礫含 P15柱痕
- 2 10YR2/1黒色土 しまり強 粘性なし 白色粒子・小中礫含 P15柱痕
- 3 10YR2/2黒褐色土 しまり強 粘性なし 小礫・暗褐色土ブロック含 白色粒子少量 P15版築
- 4 10YR2/1黒色土 しまり強 粘性なし 白色粒子・褐色粒子・小礫含 P5柱痕
- 5 10YR2/2黒褐色土 しまり強 粘性なし 白色粒子・褐色粒子多量 P5版築
- 6 10YR2/2黒褐色土 しまり強 粘性なし P5版築
- 7 10YR3/2黒褐色土 しまり強 粘性なし 褐色系の土・小礫含 白色粒子少量 P5版築

- 1 10YR2/1黒色土 しまり強 粘性なし 白色粒子・炭化物多量 柱痕
- 2 10YR2/2黒褐色土 しまり強 粘性なし 白色粒子・炭化物・中礫含 柱痕
- 3 10YR3/2暗褐色土 しまり強 粘性なし 白色粒子・褐色粒子・小礫含
- 4 10YR3/3暗褐色土 しまり強 粘性なし 白色粒子少量
- 5 10YR3/3暗褐色土 しまり強 粘性なし 白色粒子・炭化物含
- 6 10YR3/4暗褐色土 しまり強 粘性なし 白色粒子・褐色粒子・大礫含
- 7 10YR4/3に黄褐色土 しまり強 粘性なし 白色粒子少量 地山土含
- 8 10YR3/2暗褐色土 しまり強 粘性なし 白色粒子少量
- 9 10YR3/2暗褐色土 しまり強 粘性なし 白色粒子・褐色粒子含
- 10 10YR4/3に黄褐色土 しまり強 粘性なし 地山土含 礫多量

m P7 m' 344.7m

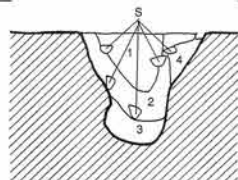

n P8 n' 344.7m

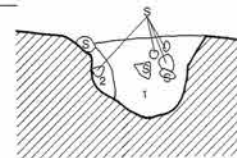

o P9 o' 344.6m

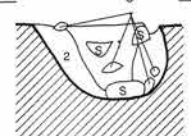

- 1 10YR2/2黒褐色土 しまり強 粘性なし 白色粒子・小礫含
- 2 10YR3/1黒褐色土 しまり強 粘性なし 白色粒子・中礫含
- 3 10YR3/3暗褐色土 しまり強 粘性なし 砂質
- 4 10YR3/4暗褐色土 しまり強 粘性なし 小礫含

- 1 10YR2/2黒褐色土 しまり強 粘性なし 白色粒子・小中礫含
- 2 10YR3/4暗褐色土 しまり強 粘性なし 地山に近い

- 1 10YR2/3黒褐色土 しまりあり 粘性なし 白色粒子・褐色粒子・小中礫・土器
- 2 10YR3/3暗褐色土 しまり強 粘性なし 白色粒子少量

p P11 P12 p' 344.9m

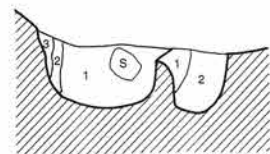

q P13 q' 344.7m

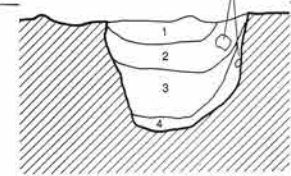

r 貼床 P14 s r' 344.9m

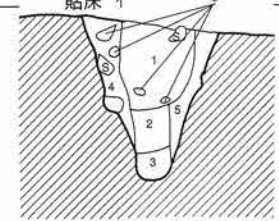

- Pit11
- 1 10YR2/2黒褐色土 しまり強 粘性なし 白色粒子・大礫・土器
 - 2 10YR3/3暗褐色土 しまり強 粘性なし 白色粒子含
 - 3 10YR4/3に黄褐色土 しまり強 粘性なし 褐色土ブロック含
- Pit12
- 1 10YR2/2黒褐色土 しまり強 粘性なし 白色粒子少量 褐色砂含
 - 2 10YR2/2黒褐色土 しまり強 粘性なし 白色粒子含 褐色砂少量

- 1 10YR2/1黒色土 しまりあり 粘性なし 白色粒子・炭化物含
- 2 10YR2/2黒褐色土 しまり強 粘性なし 白色粒子・褐色小ブロック含
- 3 10YR2/2黒褐色土 しまり強 粘性なし 白色粒子・小中礫含
- 4 10YR2/3黒褐色土 しまり強 粘性なし 褐色土ブロック・小礫含

- 1 10YR2/2黒褐色土 しまりあり 粘性なし 白色粒子・小礫・炭化物含 柱痕
- 2 10YR2/3黒褐色土 しまり強 粘性なし 白色粒子少量 柱痕
- 3 10YR3/3暗褐色土 しまり強 粘性なし 砂質 柱痕
- 4 10YR3/3暗褐色土 しまり強 粘性なし 白色粒子・礫含 版築 上面に貼床が施される
- 5 10YR3/2暗褐色土 しまり強 粘性なし 白色粒子・小礫・褐色土含 版築

s P16 s' 344.7m

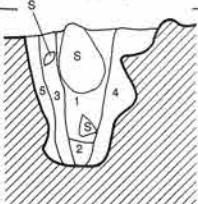

t P17 t' 344.8m

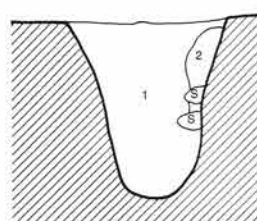

u P24 u' 344.6m



- 1 10YR2/2黒褐色土 しまりあり 粘性なし 大礫・褐色土ブロック含 柱痕
- 2 10YR2/3黒褐色土 しまり強 粘性なし 柱痕
- 3 10YR3/2黒褐色土 しまり強 粘性なし 小礫含 版築
- 4 10YR3/2黒褐色土 しまり強 粘性なし 小礫含 版築
- 5 10YR3/3暗褐色土 しまり強 粘性なし 小礫含 版築

- 1 10YR2/3黒褐色土 しまり強 粘性なし 白色粒子・褐色粒子・炭化物含
- 2 10YR1.7/1黒色土 しまり強 粘性なし 褐色土ブロック含 白色粒子少量

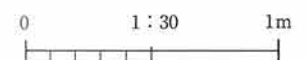

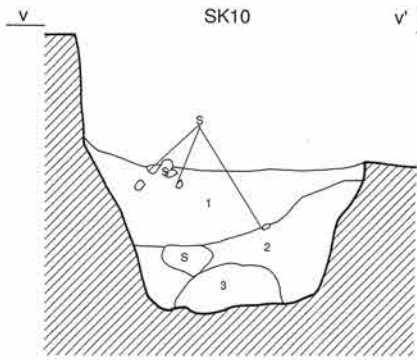

- 1 10YR2/2黒褐色土 しまり強 粘性なし 白色粒子・小中礫含 a-a'セクション5c⑤層
- 2 10YR3/3暗褐色土 しまり強 粘性なし 白色粒子・小~大礫含鉄分の沈着あり a-a'セクション5c⑤層
- 3 10YR3/1黒褐色土 しまり強 粘性なし 炭化物が帯状に底面にのる

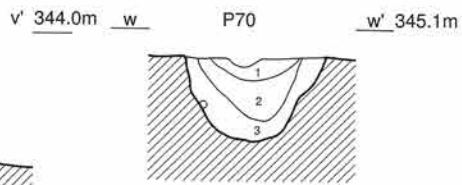

- 1 10YR2/2黒褐色土 しまり強 白色粒子・小礫含
- 2 10YR2/3黒褐色土 しまり強 白色粒子・小礫含
- 3 10YR3/3暗褐色土 しまり強

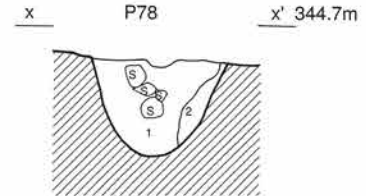

- 1 10YR2/3黒褐色土 しまり強 中礫含
- 2 10YR3/3暗褐色土 しまり強

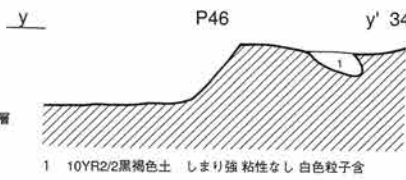

- 1 10YR2/2黒褐色土 しまり強 粘性なし 白色粒子含

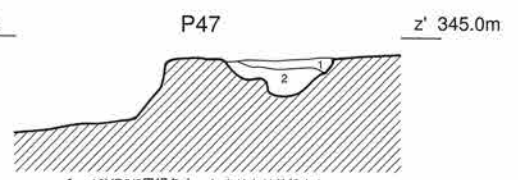

- 1 10YR2/2黒褐色土 しまりあり粘性なし
- 2 10YR2/3黒褐色土 しまり強 粘性なし

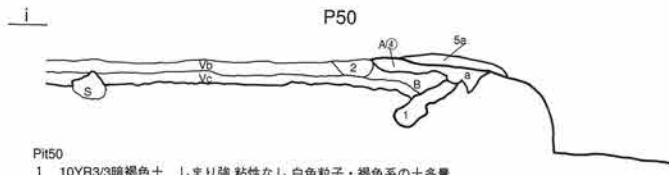

- Pi50
- 1 10YR3/3暗褐色土 しまり強 粘性なし 白色粒子・褐色系の土多量
 - 2 10YR2/3黒褐色土 しまりあり 粘性なし
 - A④ 10YR3/4暗褐色土 しまりあり 粘性なし 地山ブロック多量
 - 5a 10YR3/4暗褐色土 しまりあり 粘性弱 白色粒子・褐色土ブロック・炭化物含 周壁土A層と黒色土が混じり合った層
 - B 10YR3/1黒褐色土 に対応

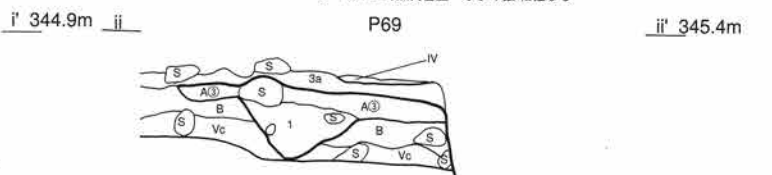

- Pi69
- 3a 10YR1.7/1黒褐色土 しまりあり 粘性弱 白色粒子・小礫含・褐色土ブロック含 遺物出土 2a層に含まれる黄褐色砂若干混入
 - A③ 10YR2/2黒褐色土 しまり強 粘性なし 廃棄ブロック4と関連薄く遺物少量
 - 1 10YR3/2黒褐色土 しまり強 粘性なし 白色粒子・小礫・褐色土ブロック含
 - B 10YR3/1黒褐色土 に対応

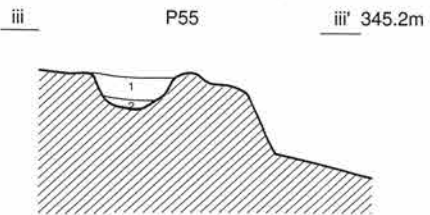

- 1 10YR2/3黒褐色土 しまりあり粘性なし 白色粒子少量・褐色土ブロック含
- 2 10YR2/2黒褐色土 しまり強 粘性なし

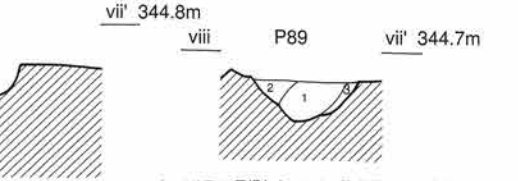
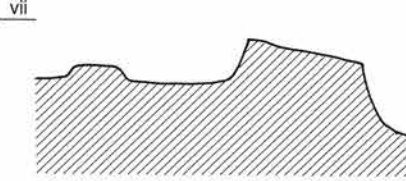
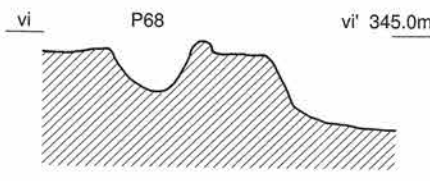
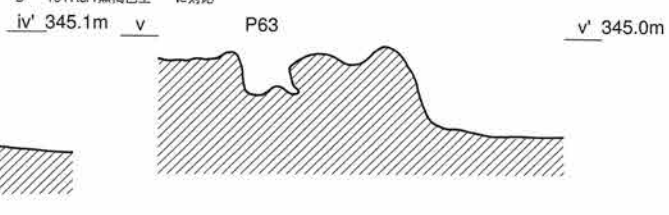
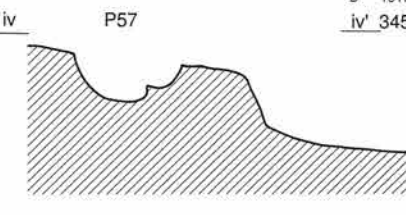

- 1 10YR2/2黒褐色土 しまり強 粘性なし 垂木痕
- 2 10YR3/3暗褐色土 しまり強 粘性なし 白色粒子含
- 3 10YR2/3黒褐色土 しまり強 粘性なし

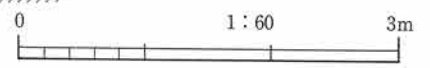
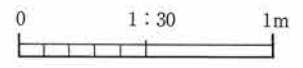
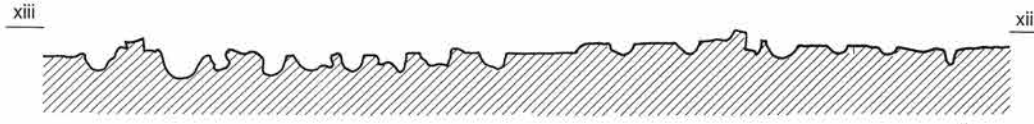
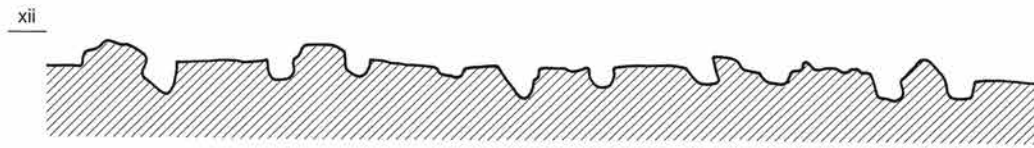
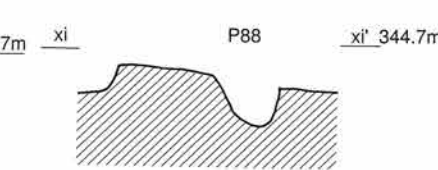
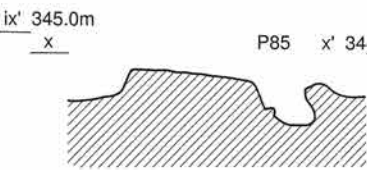
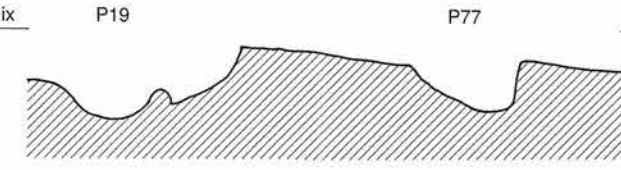



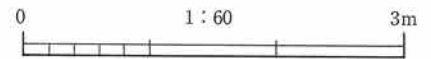
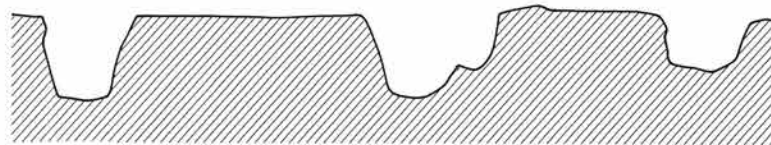
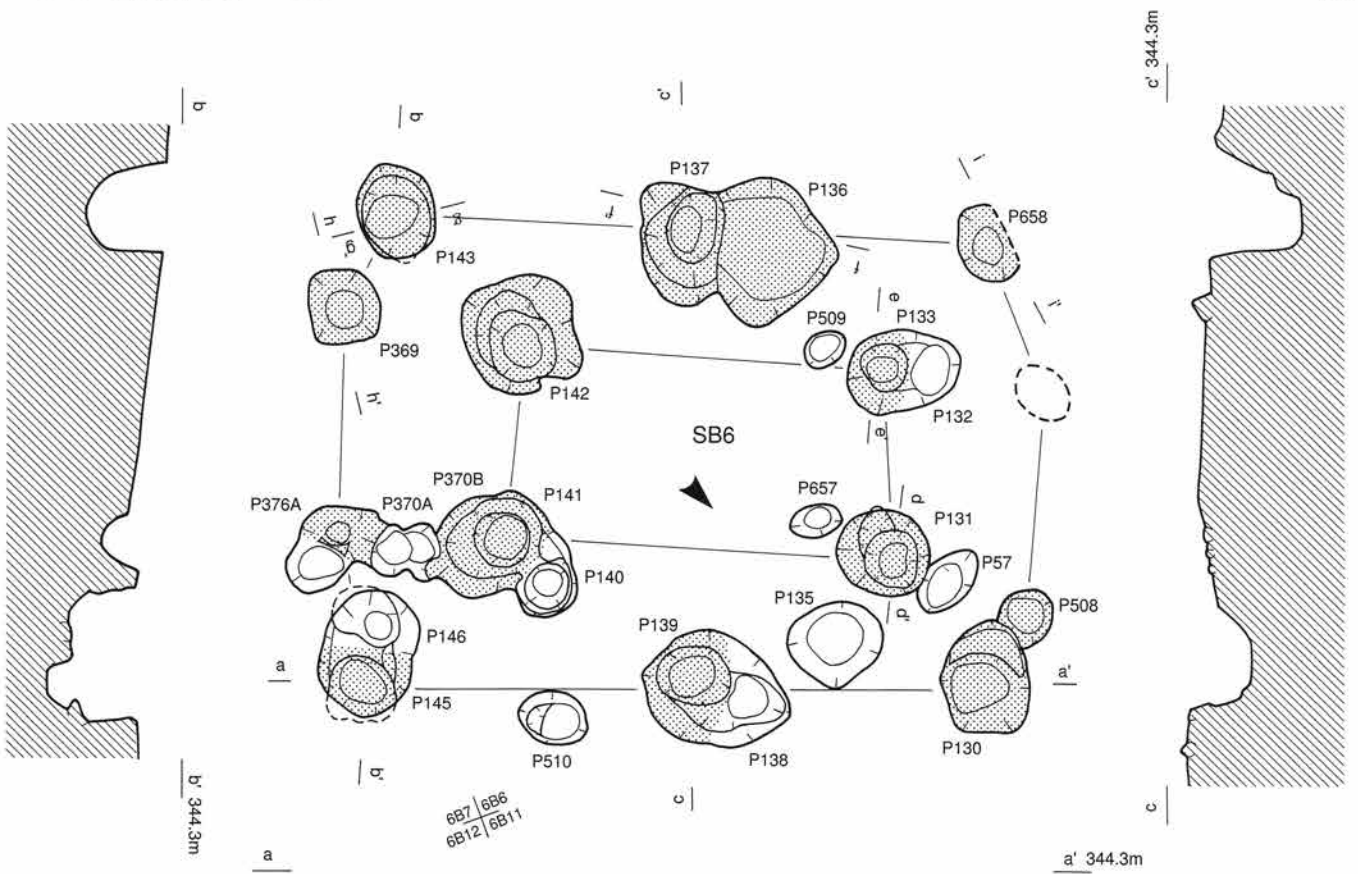

d P131 d' 344.2m

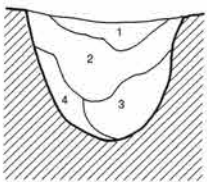

- 1 7.5YR3/3暗褐色土 しまり強 白色粒子・大礫含
- 2 7.5YR3/2黒褐色土 しまり強 白色粒子含
- 3 7.5YR3/2黒褐色土 しまり強
- 4 7.5YR4/3褐色土 しまり強 粘性なし 粒子あらい

e P133 e' 344.3m

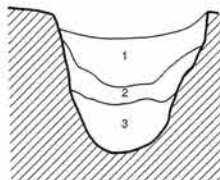

- 1 7.5YR3/1黒褐色土 しまり強 白色粒子多量 中礫含
- 2 7.5YR3/2黒褐色土 白色粒子少量 小礫含
- 3 7.5YR4/3褐色土 しまりなし 粒子あらい

f P136 P137 f' 344.2m

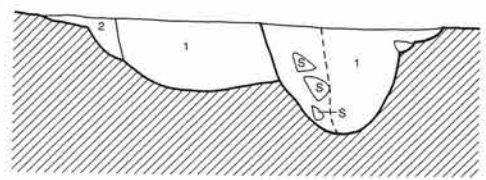

- | | |
|---|--|
| <ul style="list-style-type: none"> P136 1 7.5YR2/2黒褐色土 しまり強 粘性弱 白色粒子 礫含 炭化物少量 粒子細かい 2 7.5YR4/3褐色土 しまり強 粘性弱 白色粒子 小礫含 粒子あらい VI層に近似 | <ul style="list-style-type: none"> P137 1 7.5YR3/1黒褐色土 しまり強 粘性弱 白色粒子・礫 炭化物含 粒子細かい 土器・石器出土 点線左は版築か? |
|---|--|

g P143 g' 344.3m

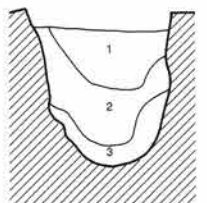

- 1 7.5YR3/4暗褐色土 しまり強 白色粒子多量
- 2 7.5YR3/3暗褐色土 しまり強 1より白色粒子多量
- 3 7.5YR3/3暗褐色土 しまりなし 白色粒子少量

h P369 h' 344.2m

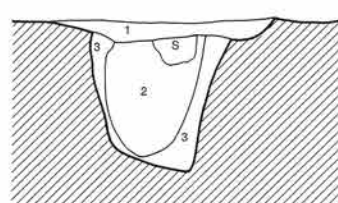

- 1 7.5YR3/1黒褐色土 しまり強 粘性弱 粒子やや細かい 褐色土ブロック含 埋め戻し土
- 2 7.5YR2/1黒色土 しまり強 粘性弱 白色粒子・大礫含 粒子やや細かい 柱痕
- 3 7.5YR3/3暗褐色土 しまり強 粘性なし 礫含 粒子あらい 版築

i P658 i' 344.3m

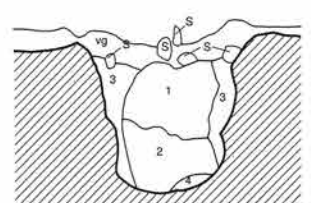

- 1 10YR3/3暗褐色土 しまり強 粘性なし 白色粒子・炭化物多量
- 2 10YR3/3暗褐色土 しまり強 粘性なし 1より白色粒子少量 礫多量
- 3 10YR4/4暗褐色土 しまり強 粘性なし 黄褐色土ブロック含 版築
- 4 10YR3/4暗褐色土 しまり強 粘性なし 褐色土に近い

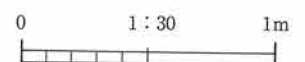

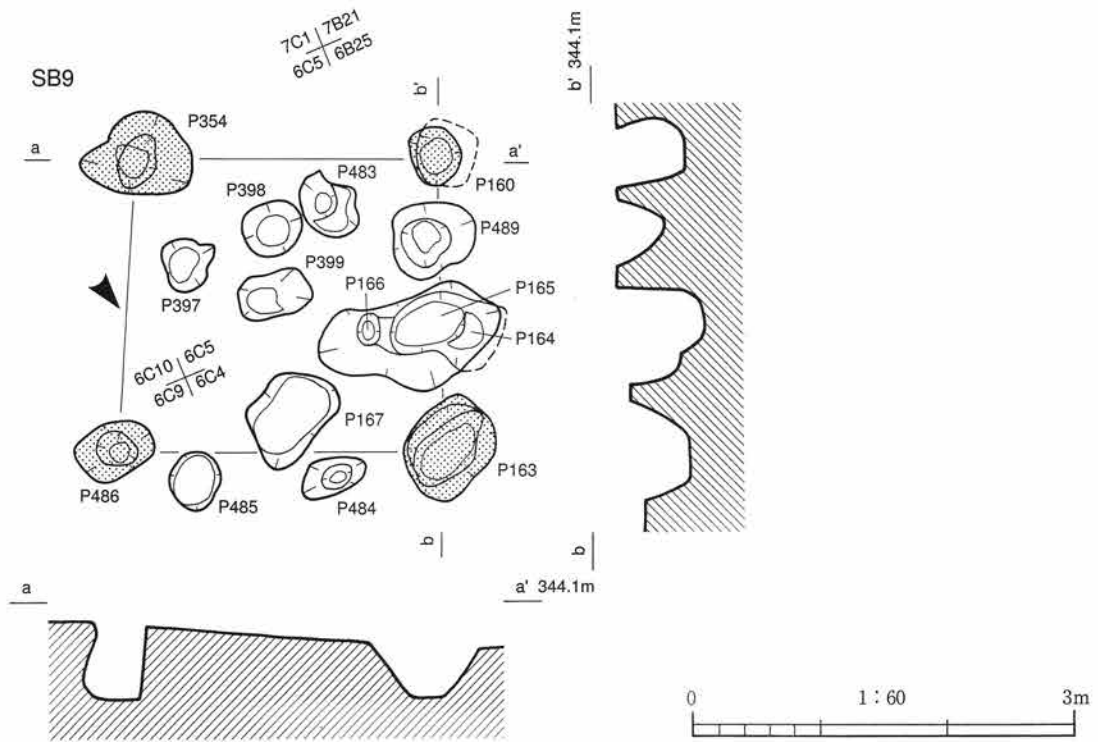
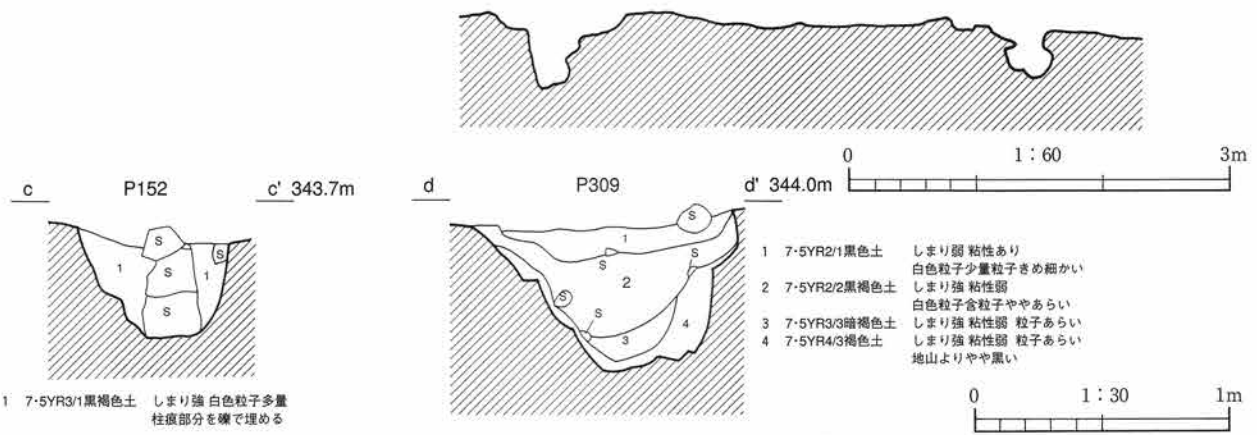
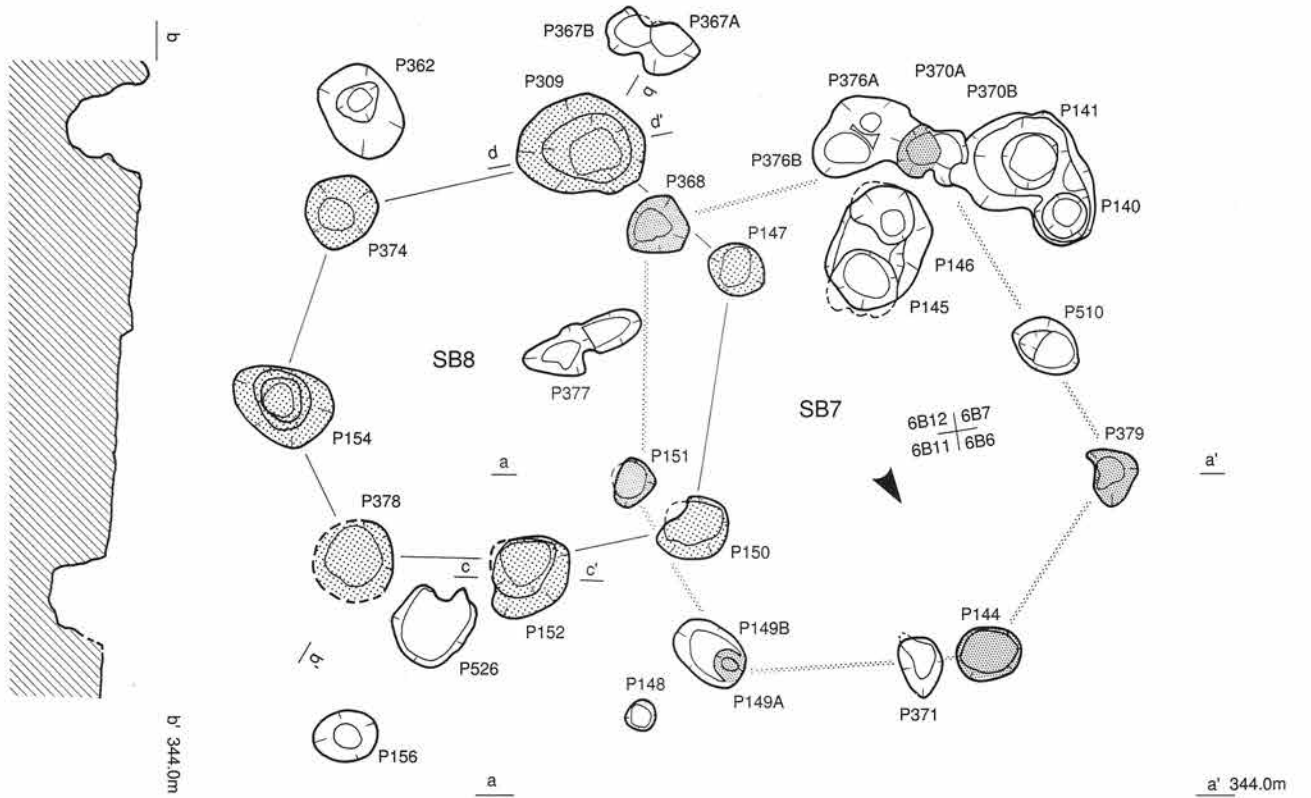

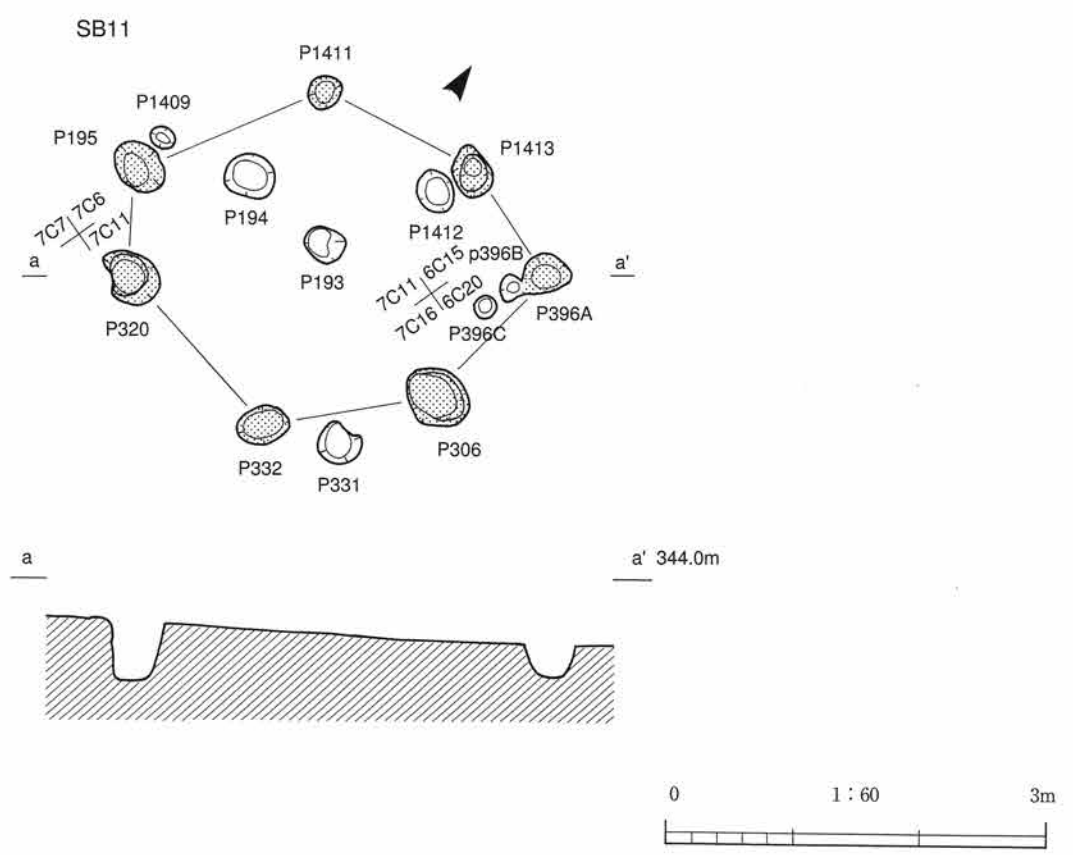
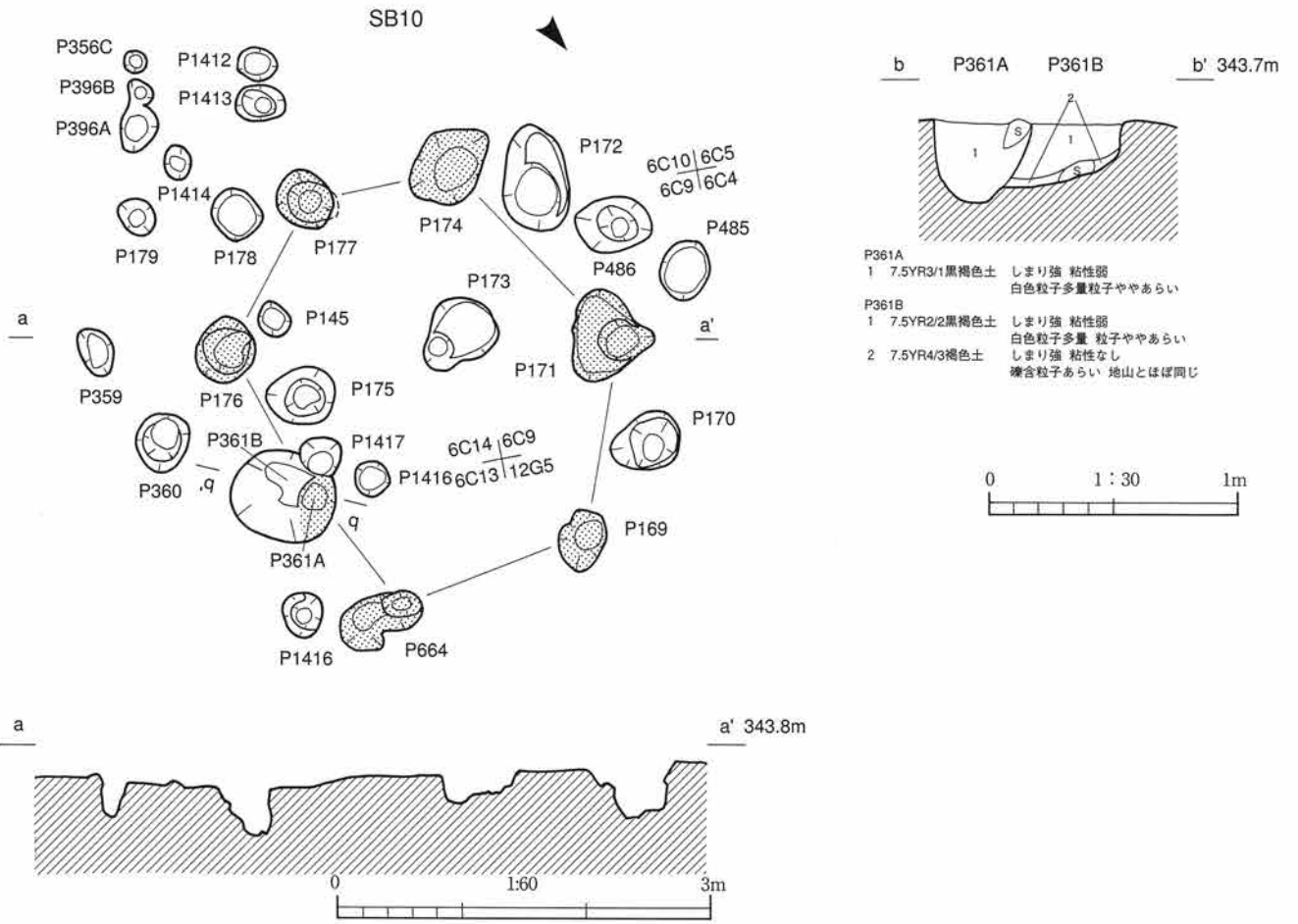

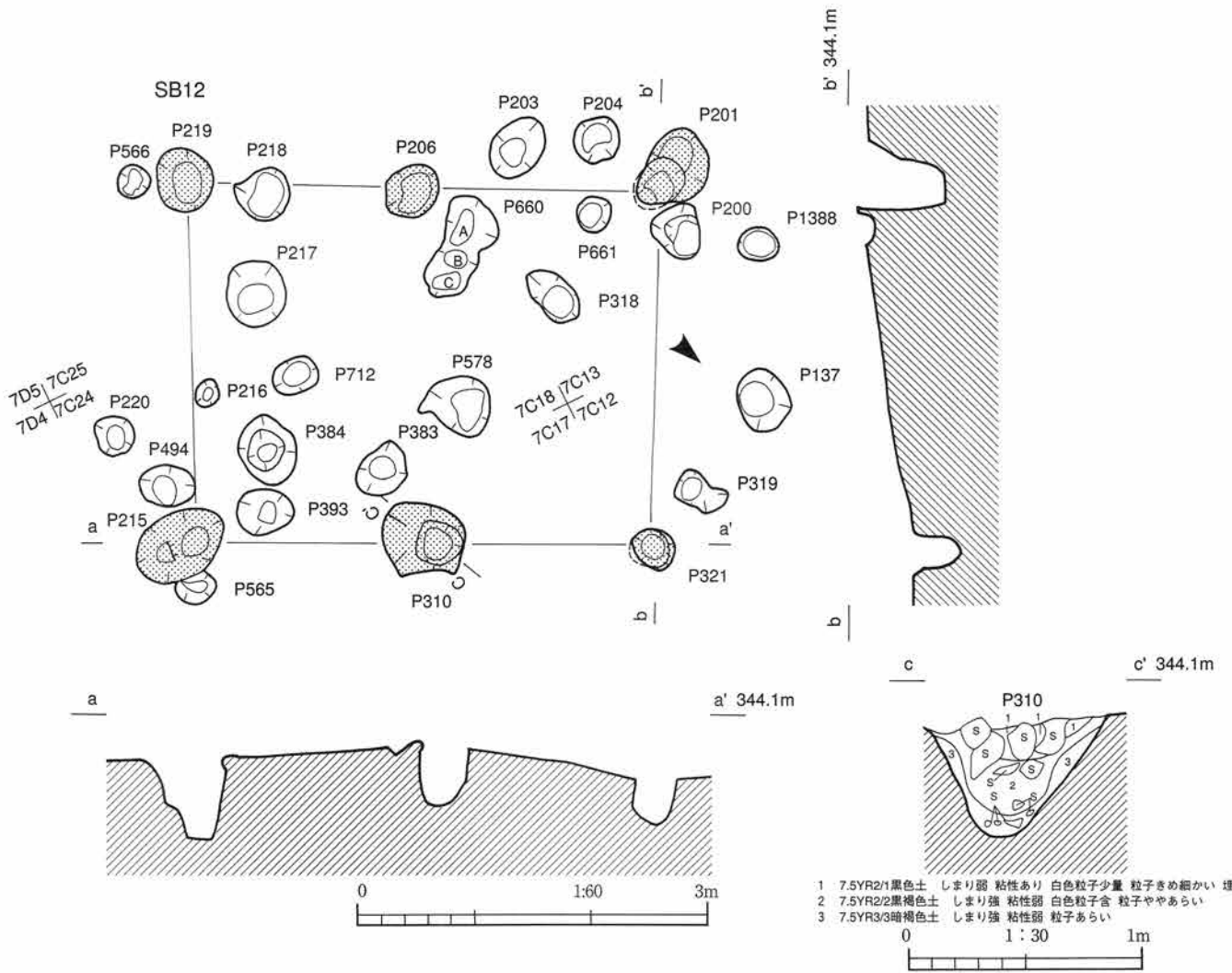

SB13

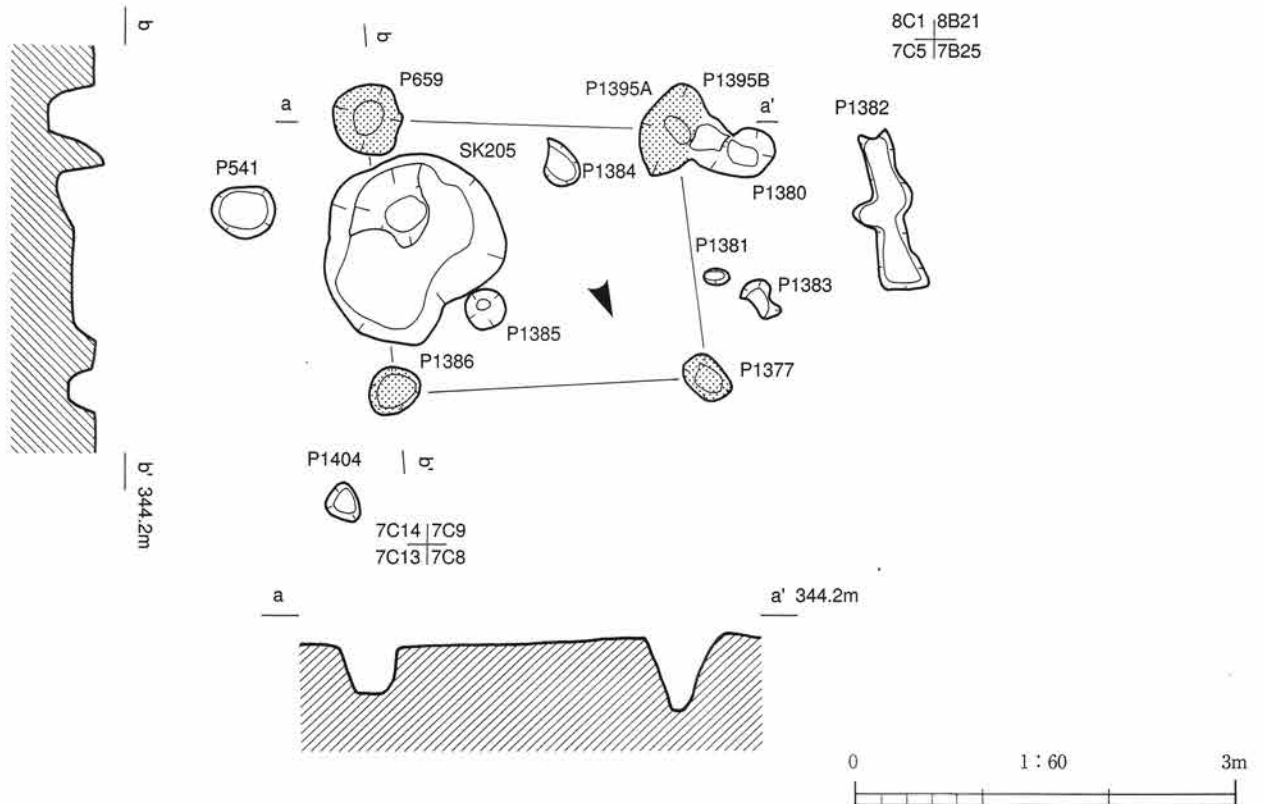

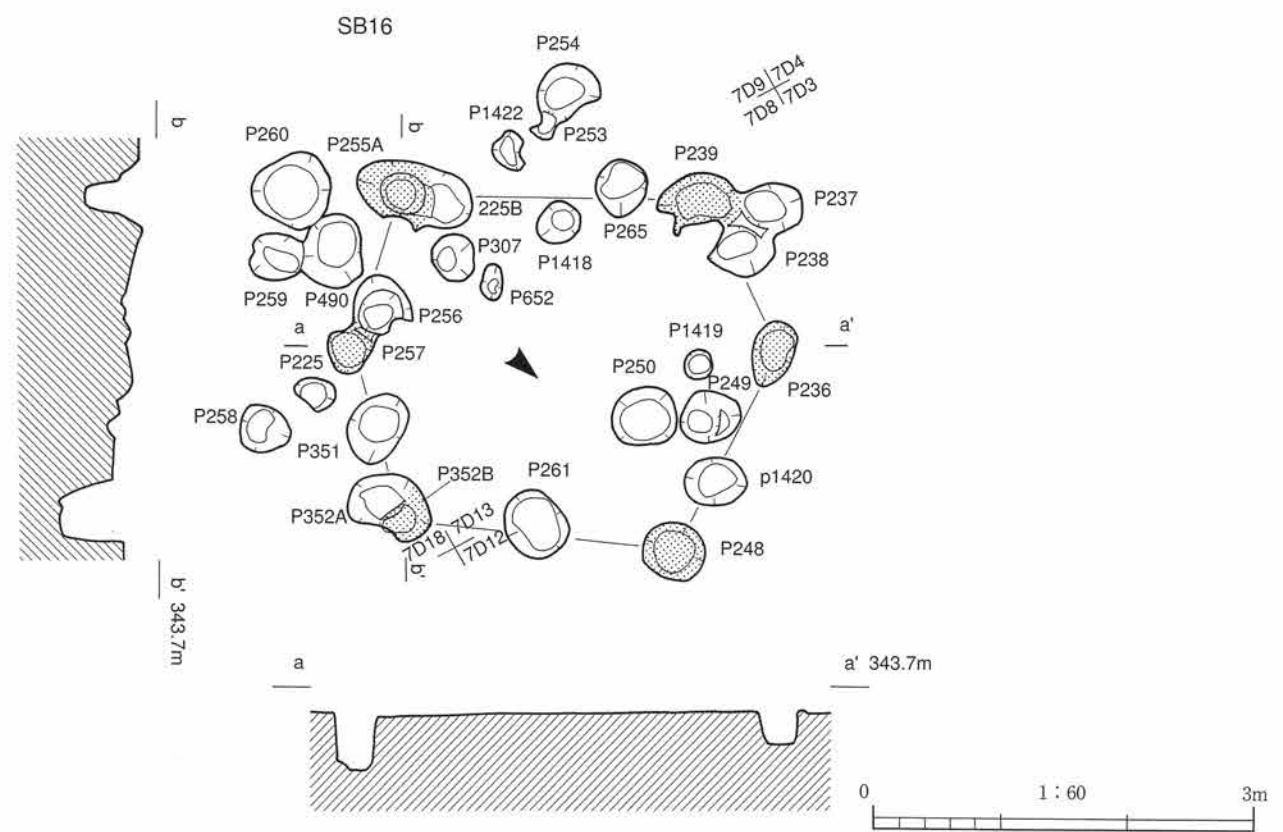
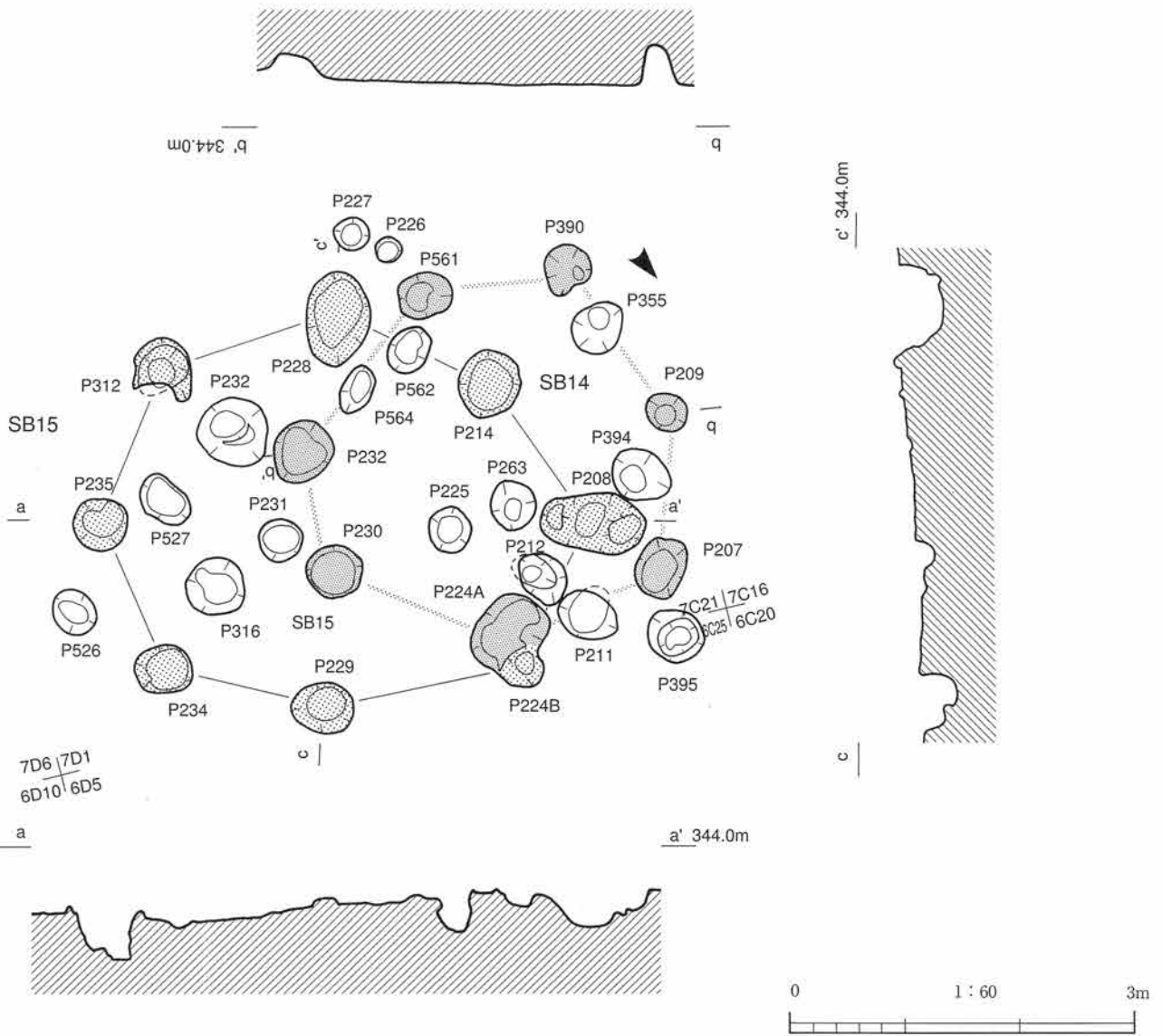

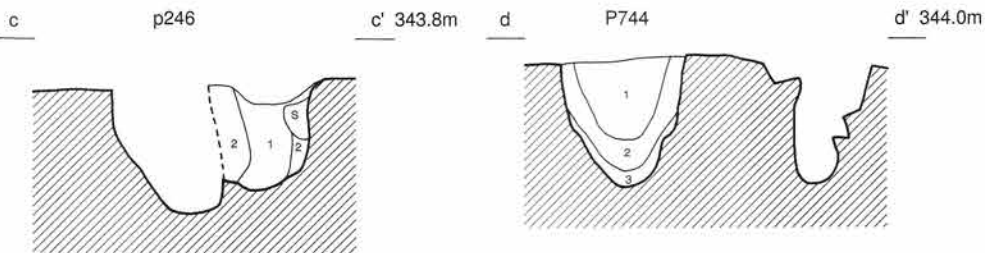
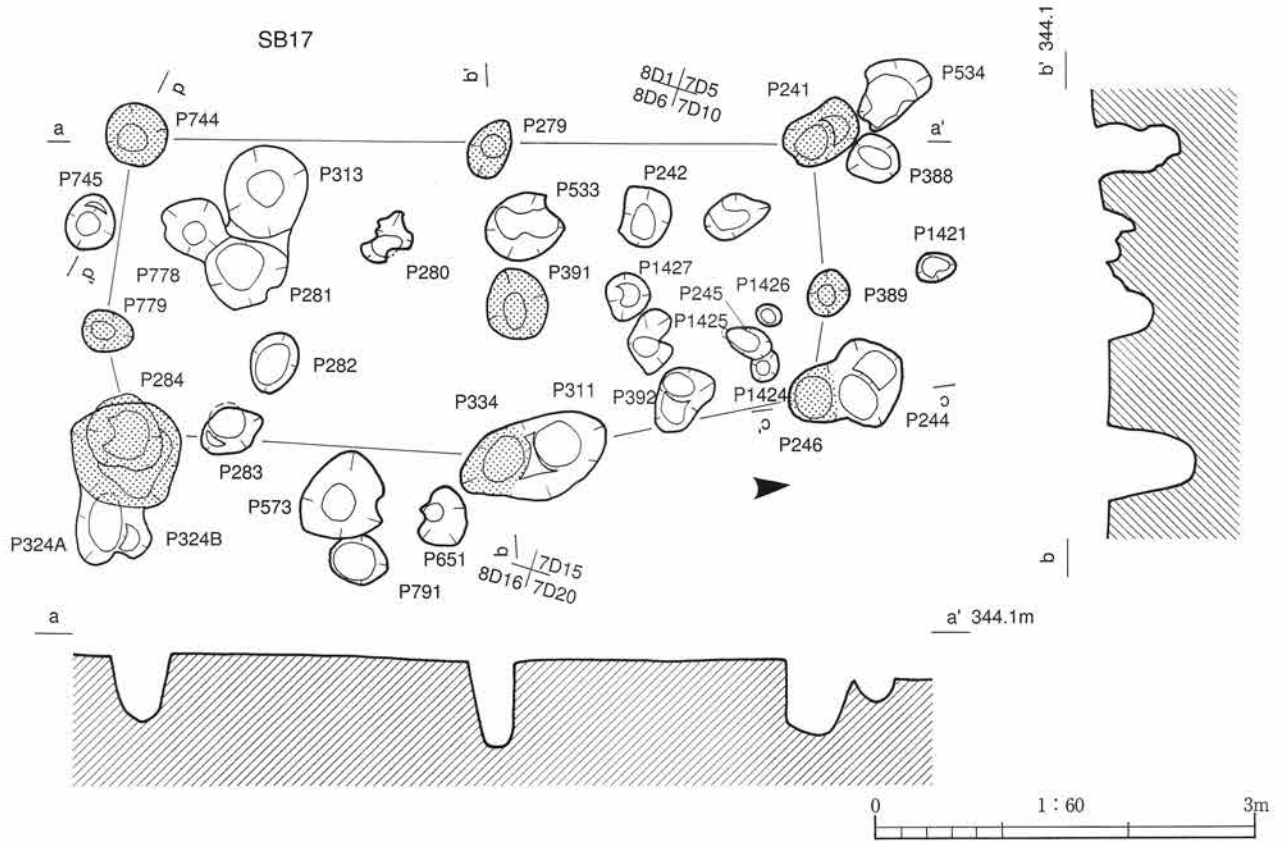

- | | | | | | |
|---|--------------|------|-----|--------|--------------|
| 1 | 7.5YR2/2黒褐色土 | しまり強 | 粘性弱 | 白色粒子含 | 粒子細かい |
| 2 | 7.5YR4/2灰褐色土 | しまり強 | 粘性弱 | 白色粒子含 | 粒子あらい VI層土混入 |
| 1 | 7.5YR3/1黒褐色土 | しまり強 | 粘性弱 | 白色粒子少量 | 中礫含 石器出土 |
| 2 | 7.5YR3/2黒褐色土 | しまり強 | 粘性弱 | 白色粒子少量 | 粒子やや細かい |
| 3 | 7.5YR3/3暗褐色土 | しまり強 | 粘性弱 | 粒子中 | |

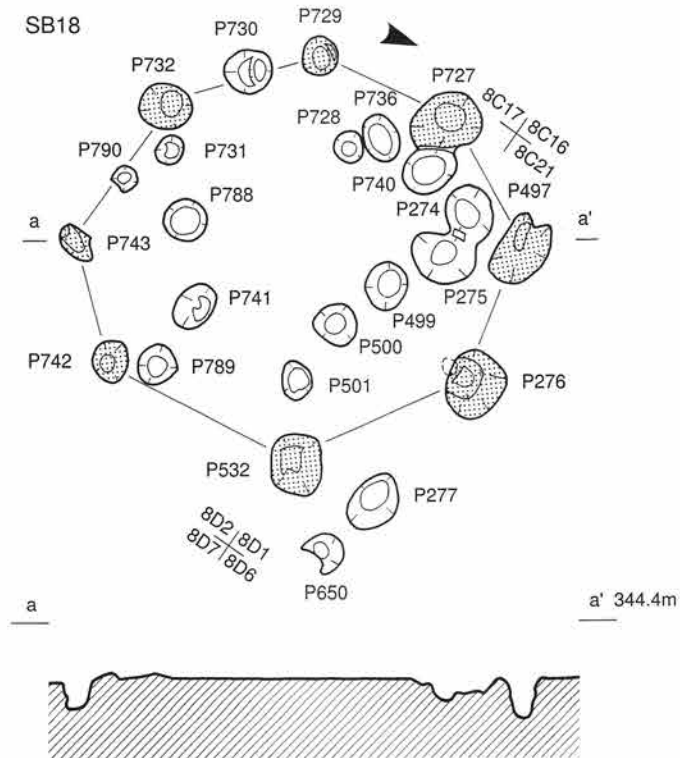
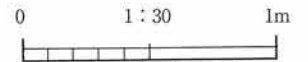

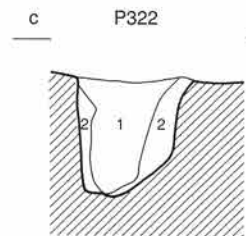
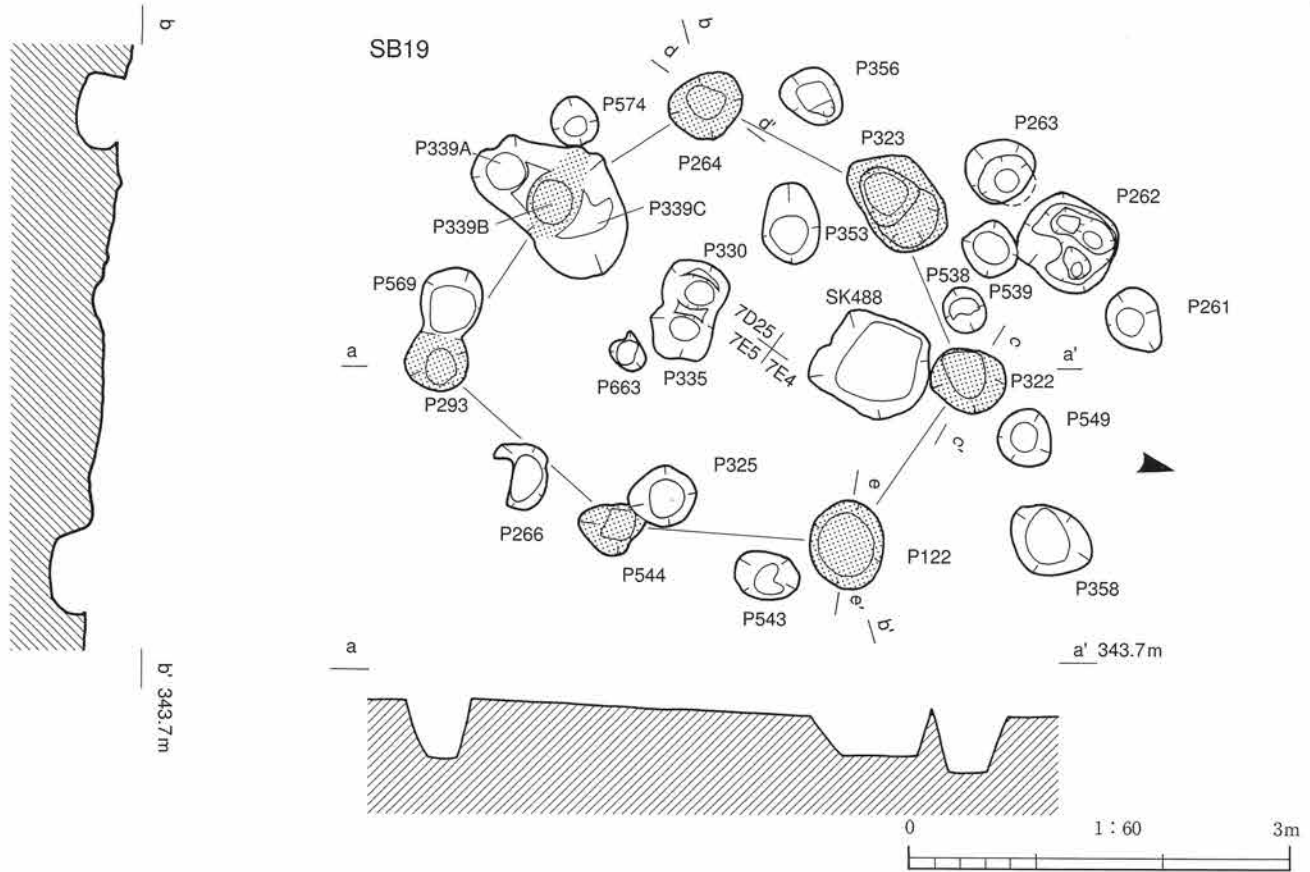

- 1 7.5YR2/2黒褐色土 しまり強 粘性弱 白色粒子含 粒子ややあらい 柱痕
- 2 7.5YR3/3暗褐色土 しまり強 粘性弱 粒子あらい 版築

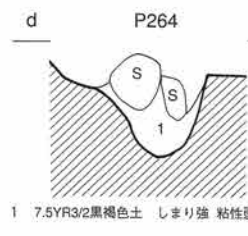

- 1 7.5YR3/2黒褐色土 しまり強 粘性弱 撤入礫出土

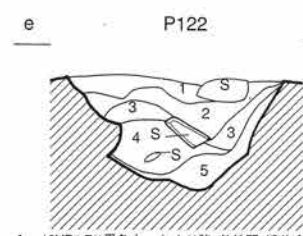

- 1 10YR1.7/1黒色土 しまり強 粘性弱 遺物含
- 2 10YR2/1黒色土 しまり強 粘性なし 白色粒子含
- 3 10YR2/1黒色土 しまり強 粘性なし 礫含 粒子あらい 暗褐色土ブロック含
- 4 10YR2/2黒褐色土 しまり強 粘性なし 白色粒子・礫含
- 5 10YR4/4褐色土 しまり強 粘性なし 白色粒子含 黒褐色土ブロック含

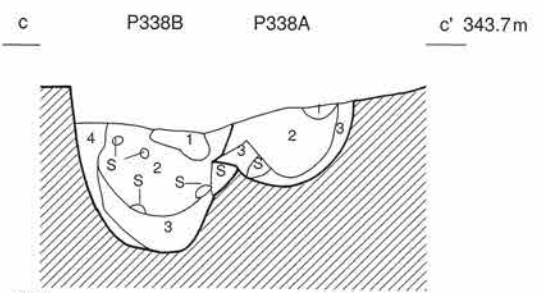
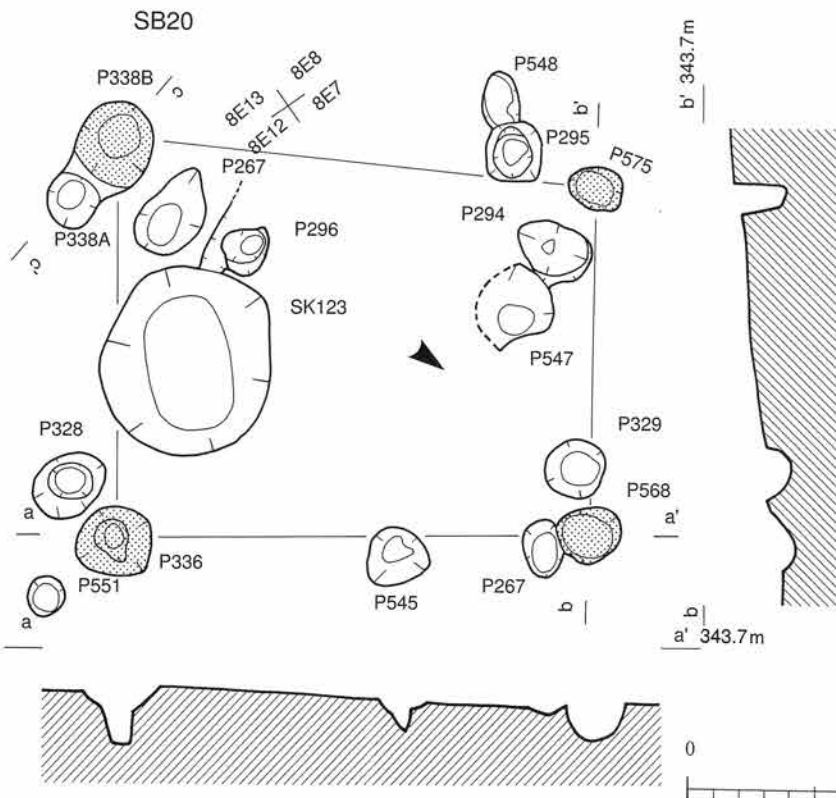
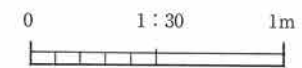

- P338A**
- 1 7.5YR4/3褐色土 しまり強 粘性弱 粒子やや細かい 攪乱あり
- 2 7.5YR2/2黒褐色土 しまり強 粘性弱 白色粒子・礫含 粒子ややあらい 土器出土
- 3 7.5YR4/3褐色土 しまり強 粘性弱 粒子あらい 地山よりやや黒い
- P338B**
- 1 7.5YR2/3極暗褐色土 しまり弱 粘性あり 粒子やや細かい 攪乱あり
- 2 7.5YR2/2黒褐色土 しまり強 粘性弱 白色粒子・礫含 粒子ややあらい
- 3 7.5YR2/3極暗褐色土 しまり強 粘性弱 白色粒子少量 粒子あらい
- 4 7.5YR3/4暗褐色土 しまり強 粘性弱 粒子ややあらい

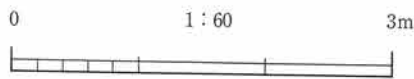
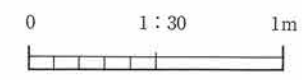

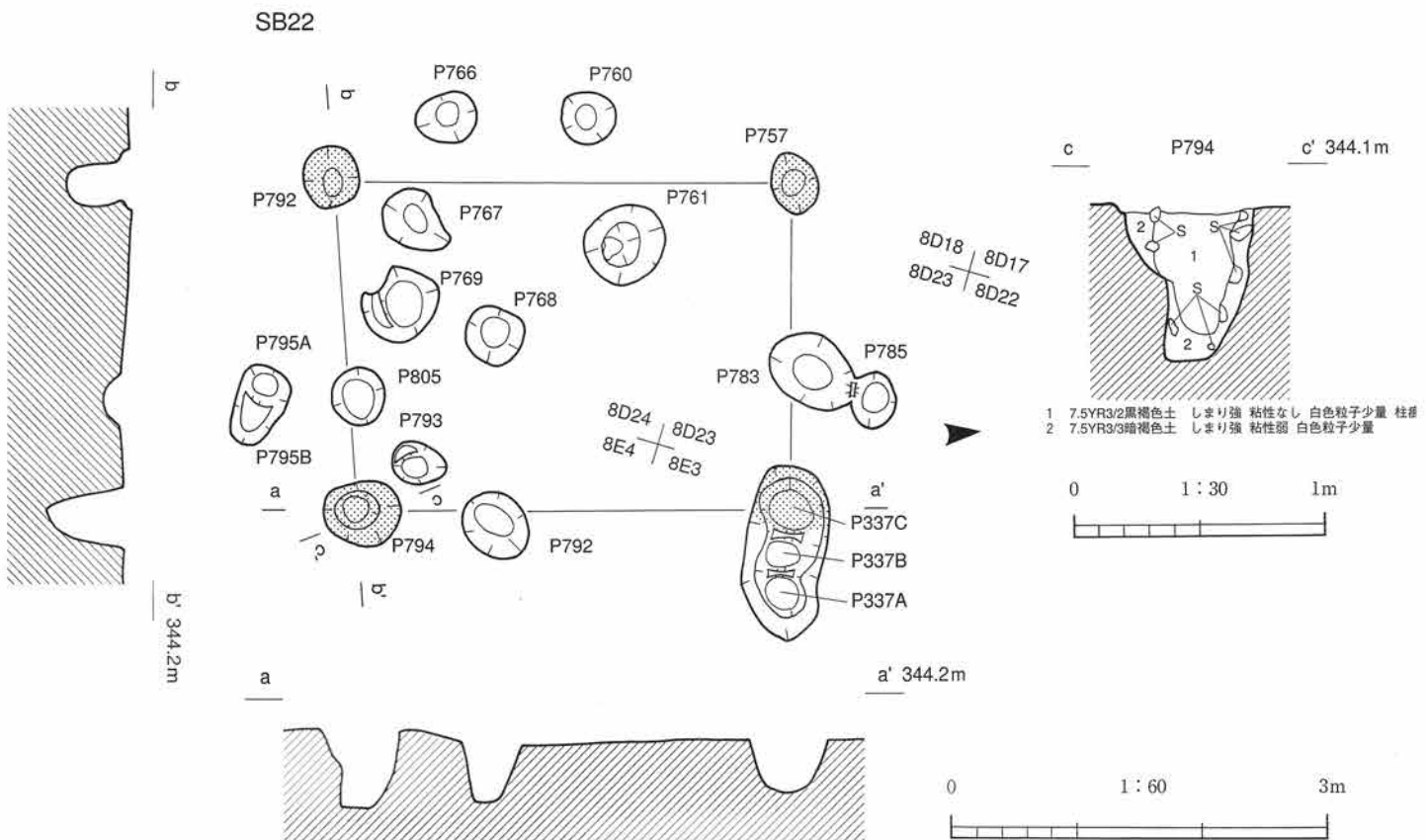
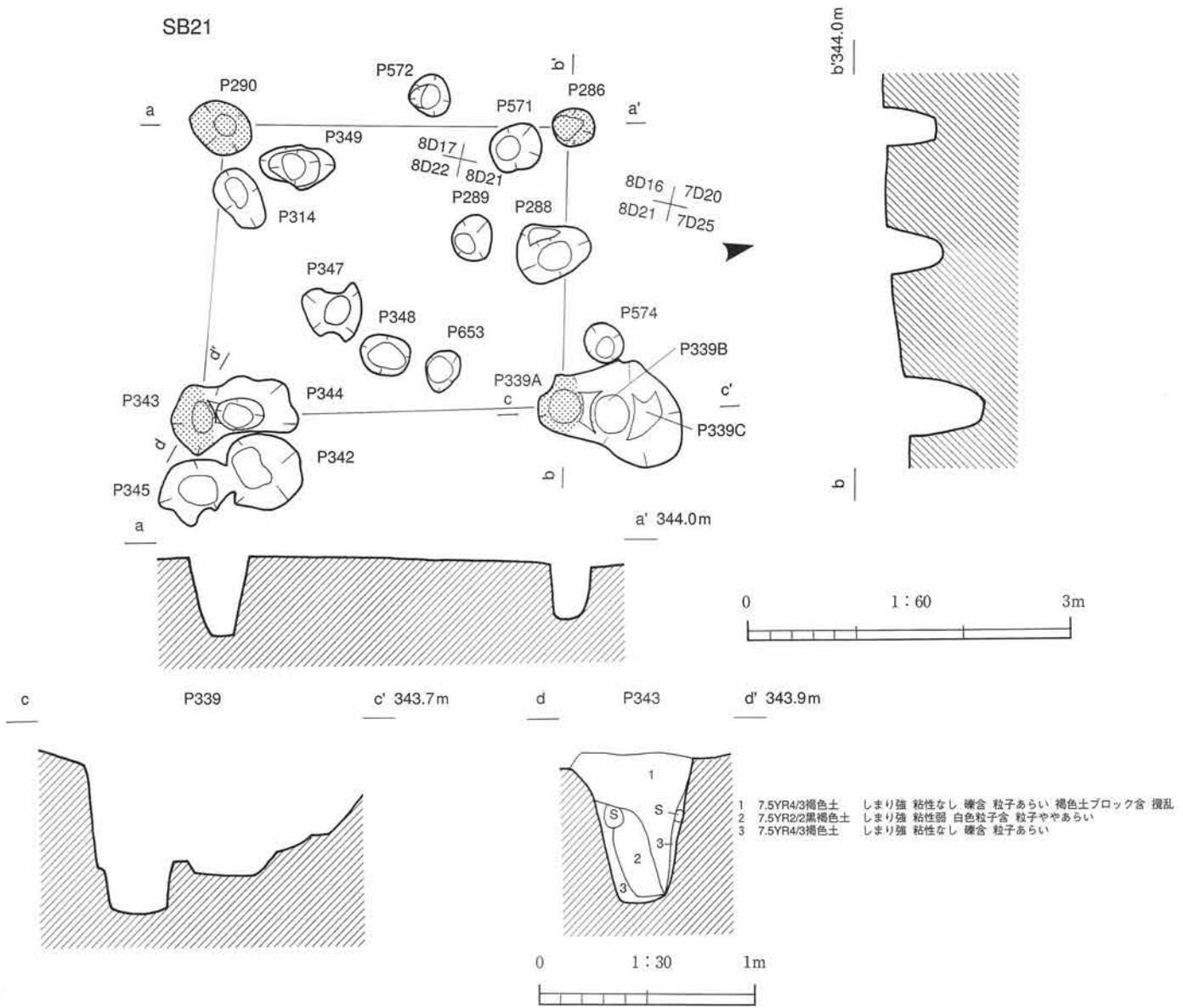

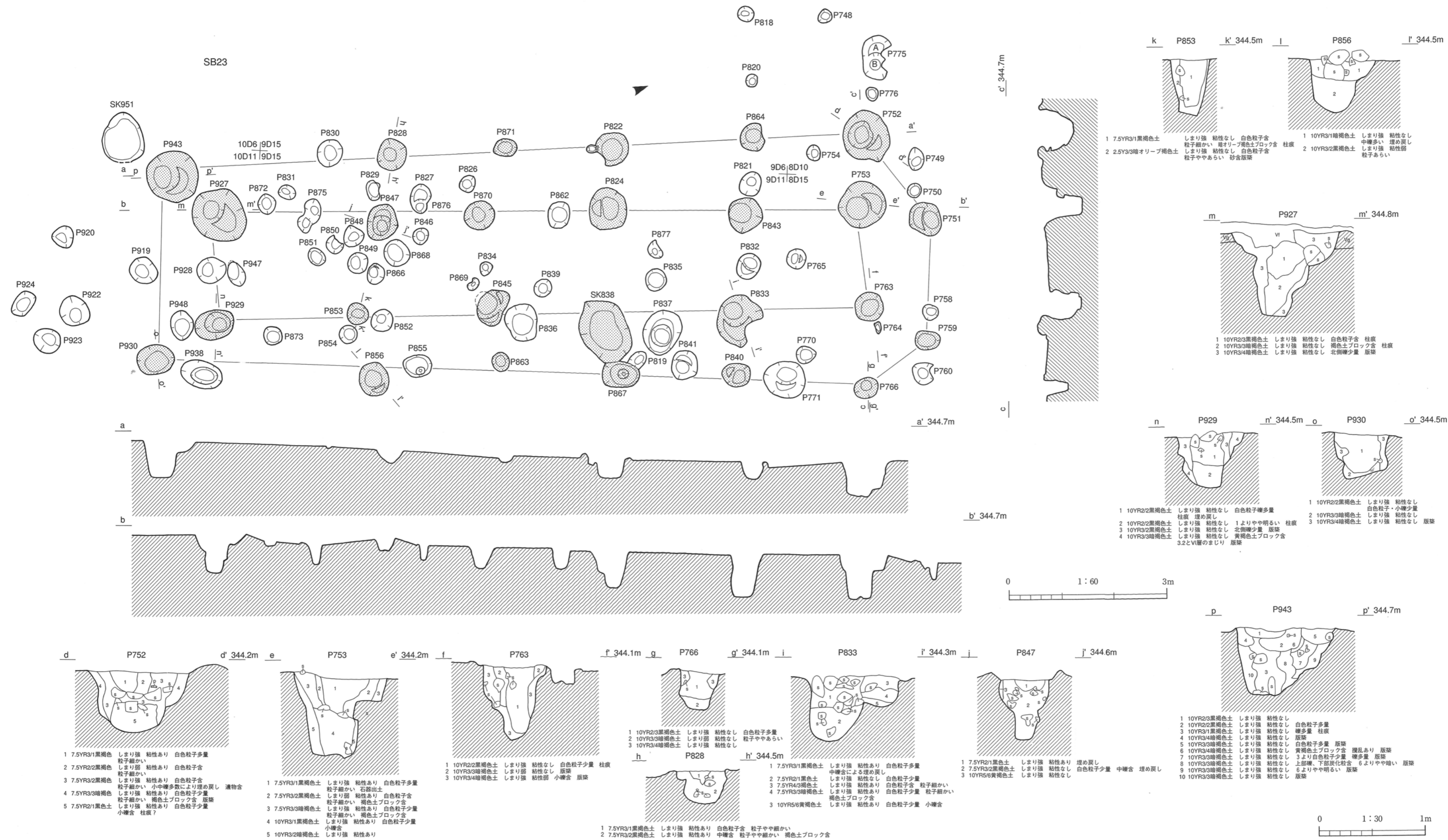

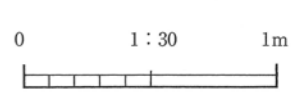
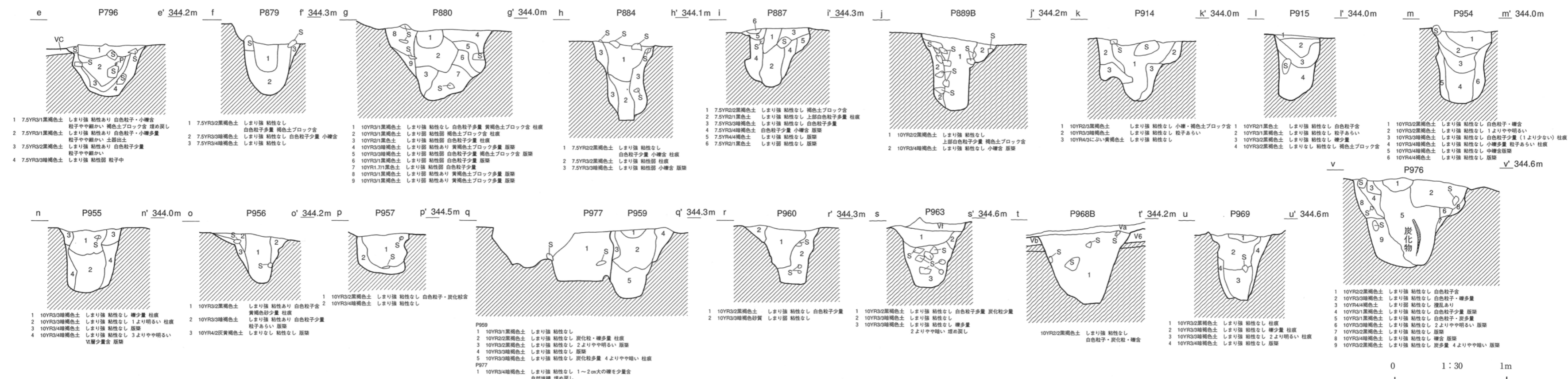
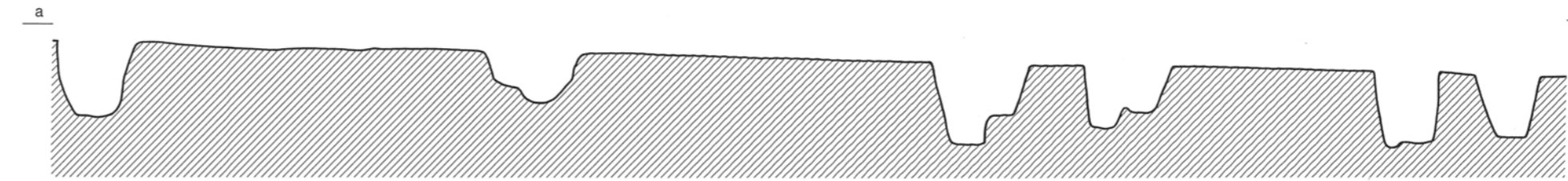
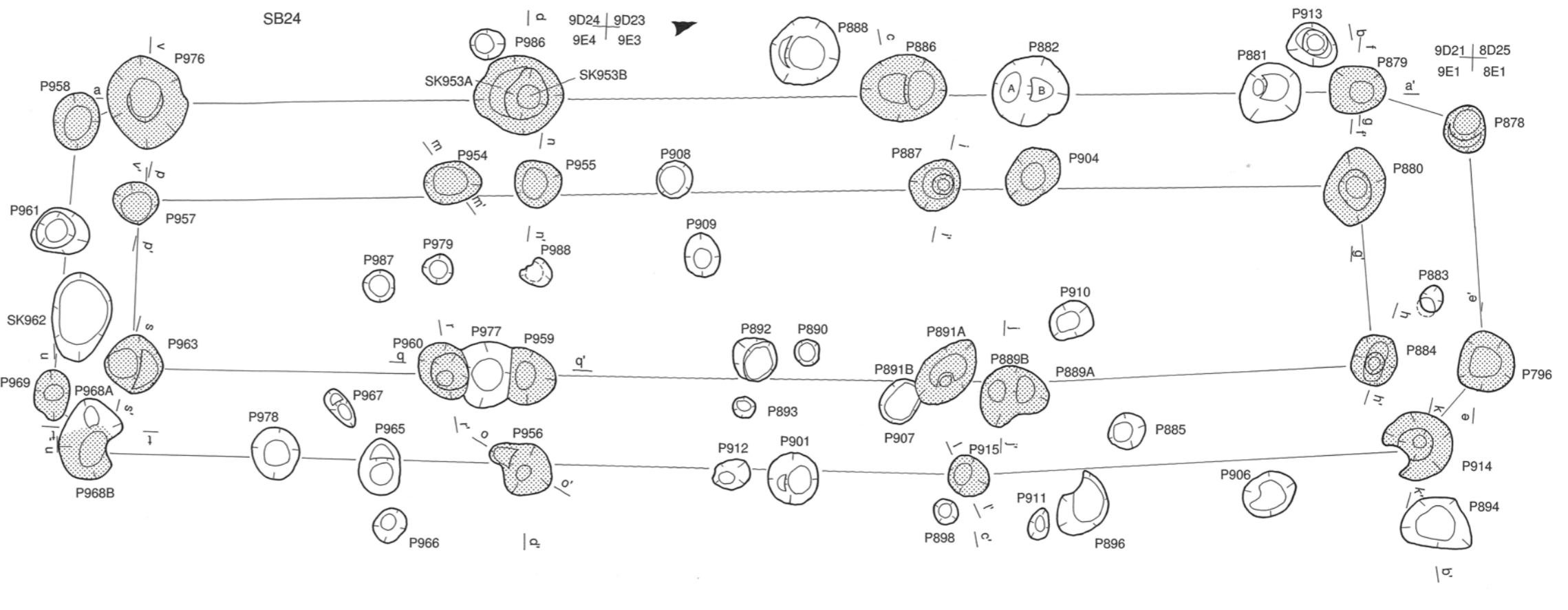
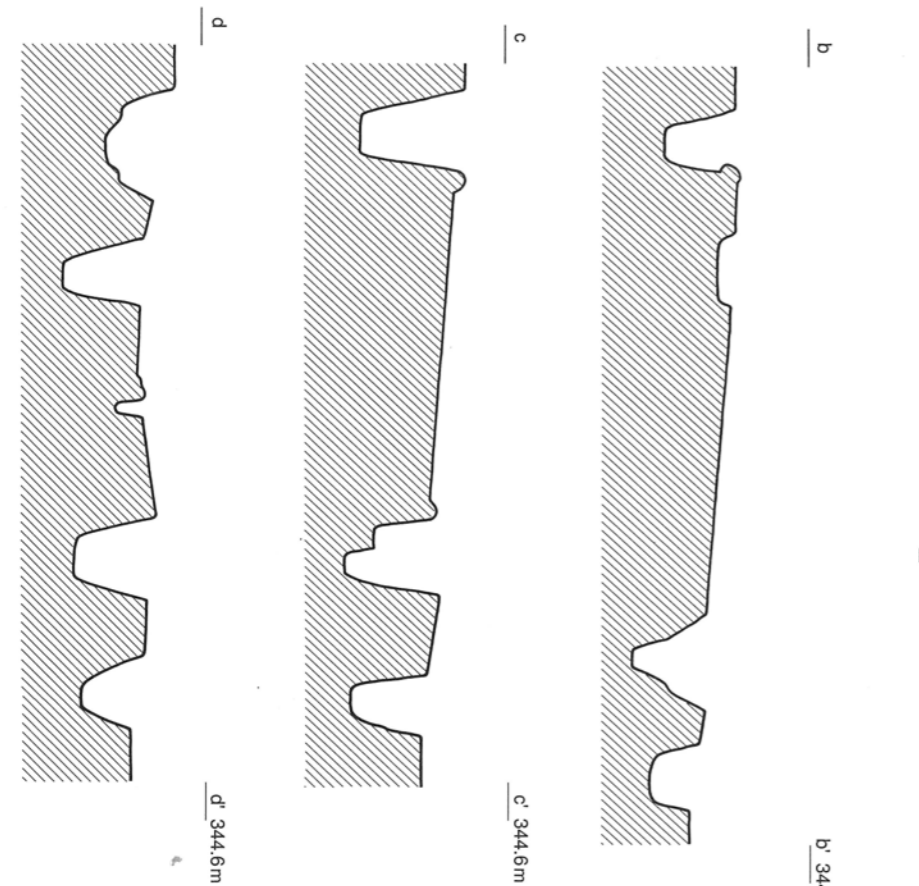

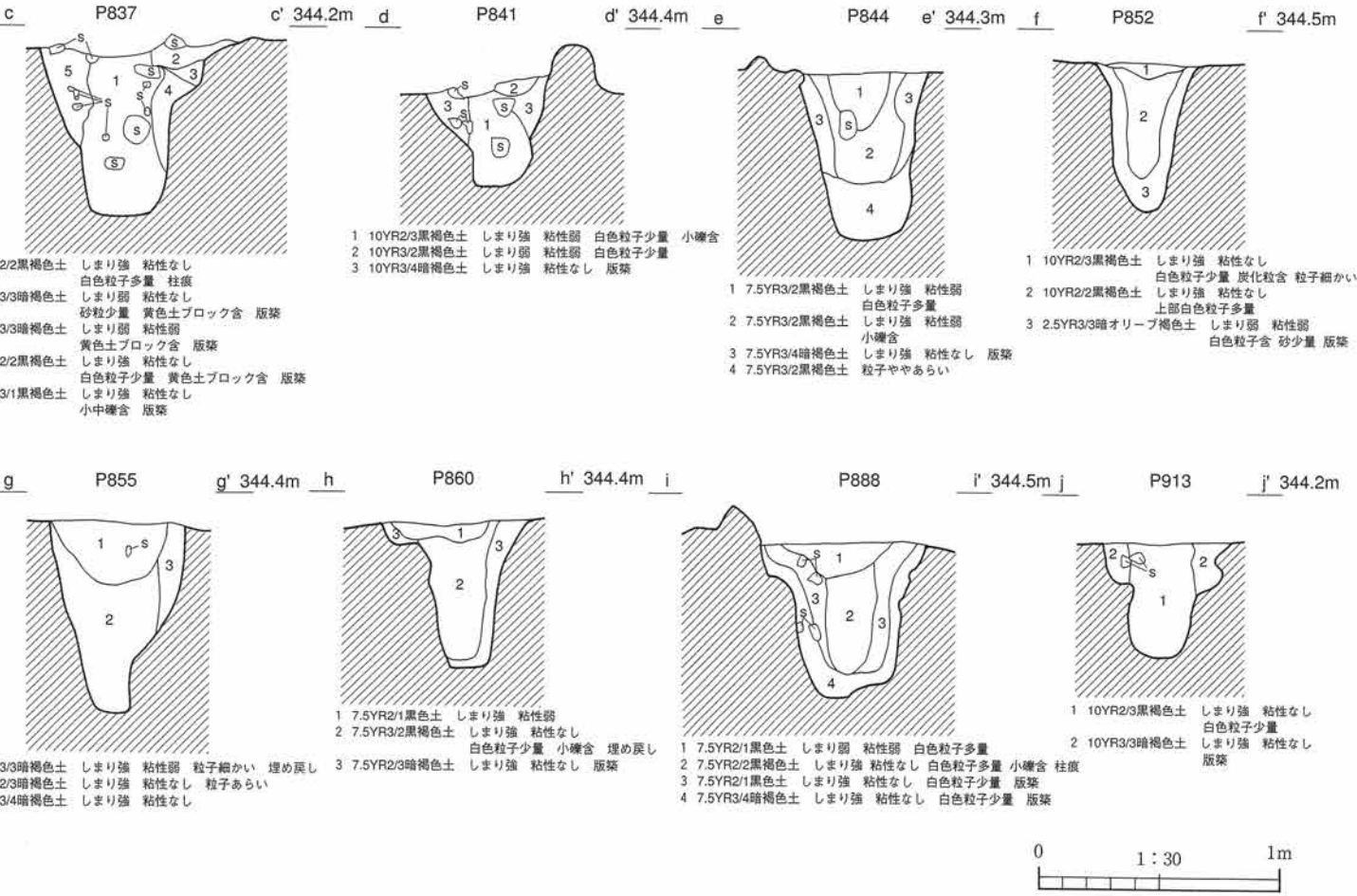
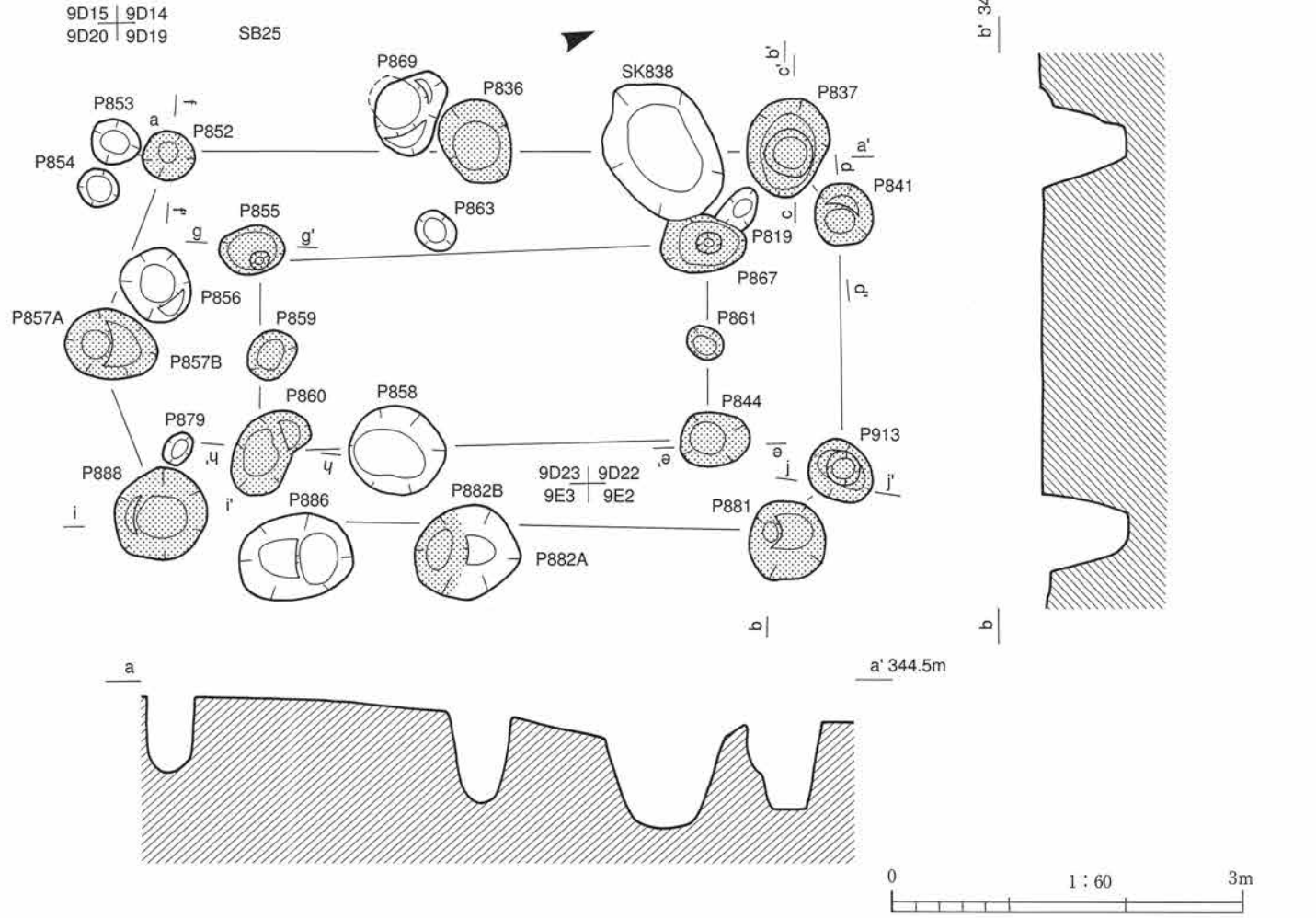

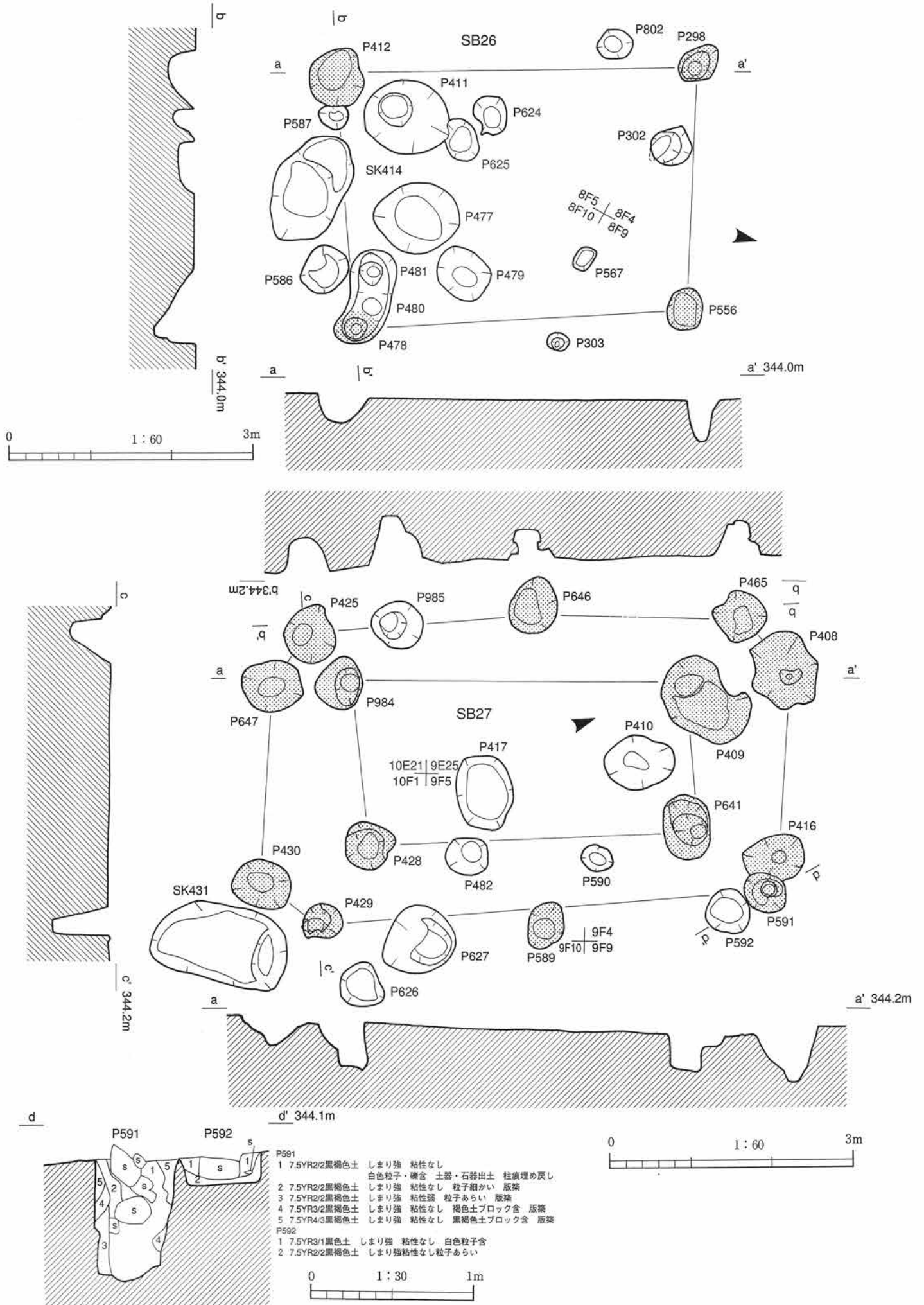

SB29

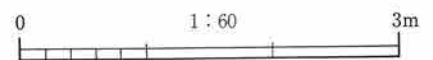
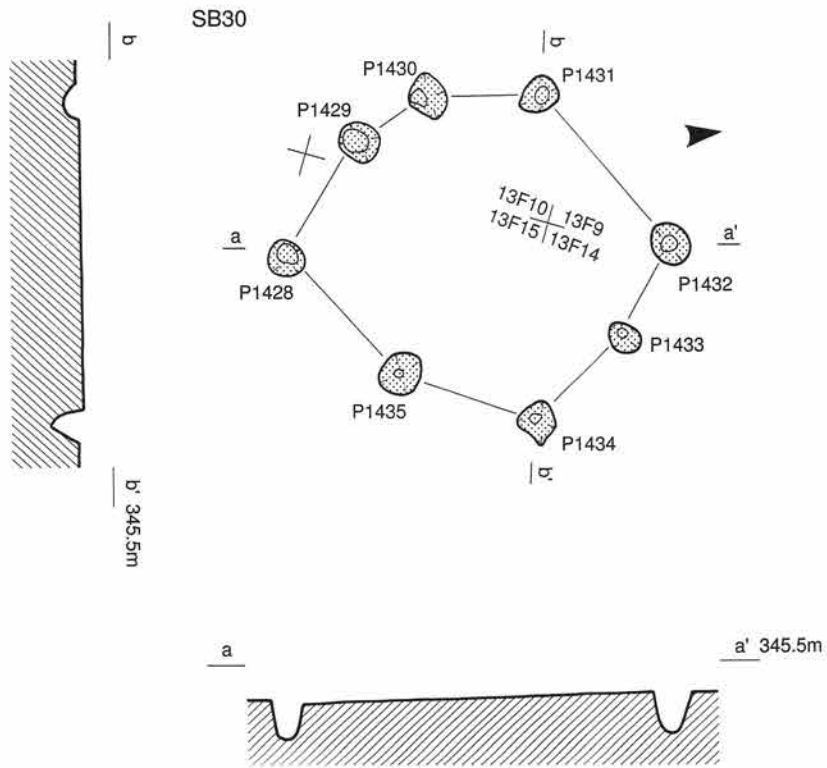
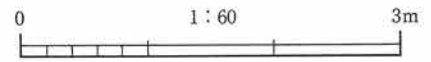
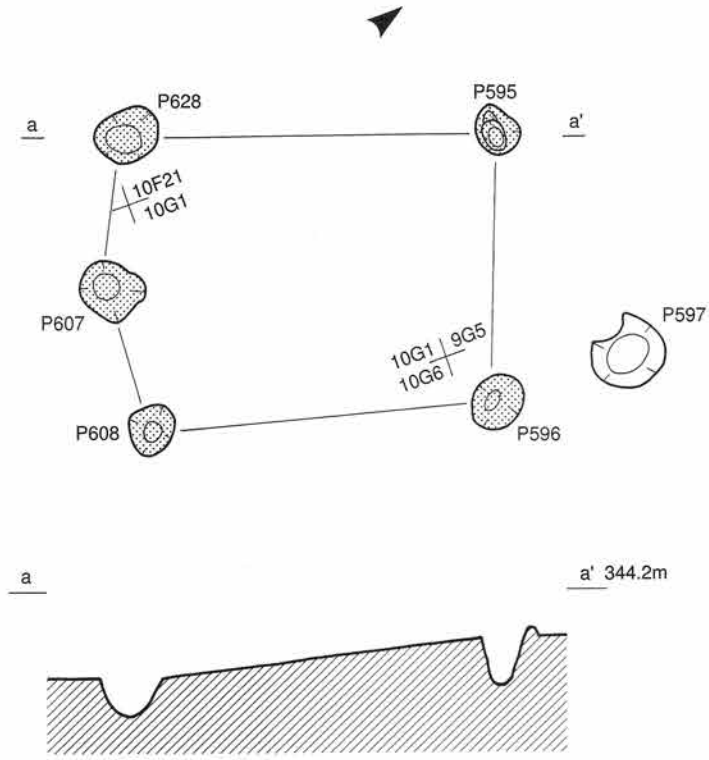

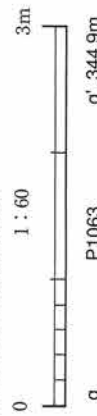
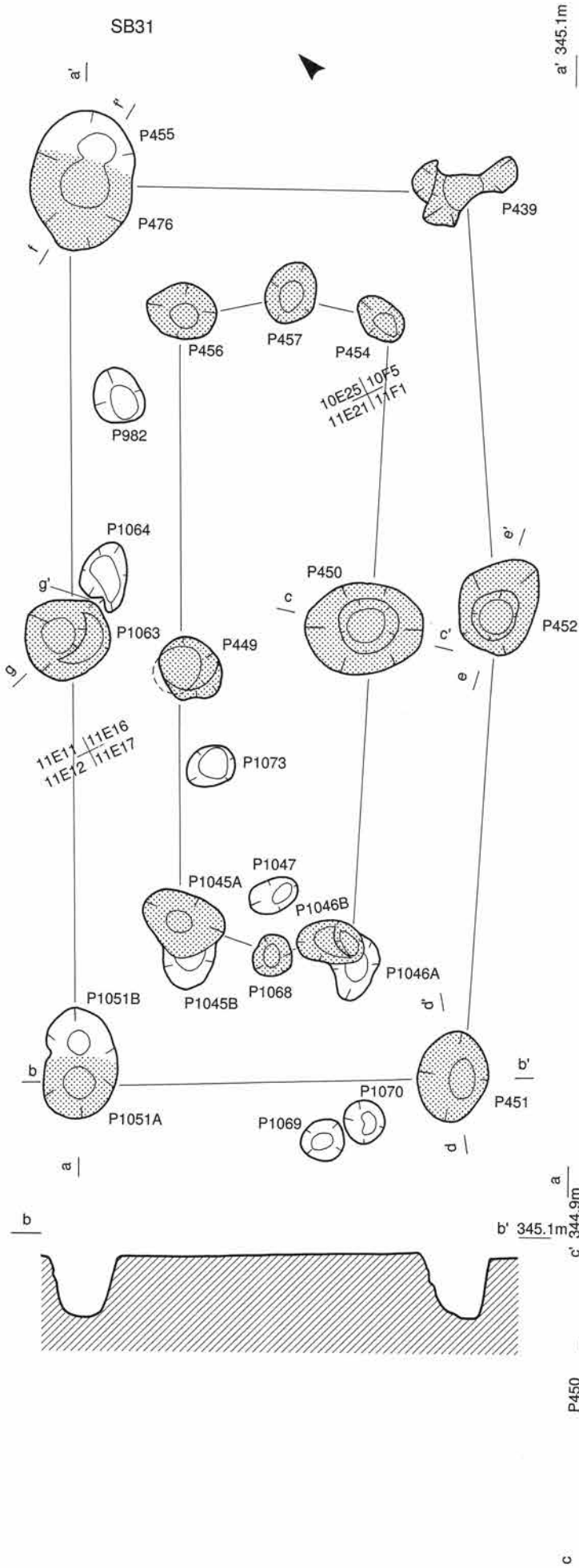

- 1 10FR31黒褐色土 しまり強 粘性なし 白色粘土含 褐色土ブロック含 埋め戻し
2 7-5FR21黒褐色土 しまり強 粘性なし 白色粘土 褐色土 埋め戻し
3 7-5FR54黄褐色土 しまり強 粘性なし 褐色土ブロックと褐色土ブロック含 原塚
4 10FR31黒褐色土 しまり強 粘性なし 砂質土 原塚

- 1 7-5FR22黒褐色土 しまり強 粘性弱 白色粘土
2 7-5FR43褐色土 しまり強 粘性弱
3 7-5FR22黒褐色土 しまり強 粘性弱
4 7-5FR54にさい 褐色 しまり強 粘性弱

- 1 7-5FR21黒褐色土 しまり強 粘性弱 白色粘土
2 7-5FR22黒褐色土 しまり強 粘性弱 埋め戻し
3 7-5FR54にさい 褐色 埋め戻し
4 7-5FR54にさい 褐色 埋め戻し

- 1 7-5FR21黒褐色土 しまり強 粘性弱 白色粘土 柱礎
2 7-5FR31黒褐色土 しまり強 粘性弱 白色粘土 埋め戻し
3 7-5FR21黒褐色土 しまり強 粘性弱 白色粘土 埋め戻し V溝跡入 原塚

- 1 7-5FR21黒褐色土 しまり強 粘性弱 白色粘土 土器・石器出土
2 7-5FR22黒褐色土 しまり強 粘性弱 埋め戻し
3 7-5FR31黒褐色土 しまり強 粘性弱 埋め戻し
4 7-5FR54にさい 褐色 しまり強 粘性弱

- 1 7-5FR21黒褐色土 しまり強 粘性弱 白色粘土
2 7-5FR22黒褐色土 しまり強 粘性弱 埋め戻し

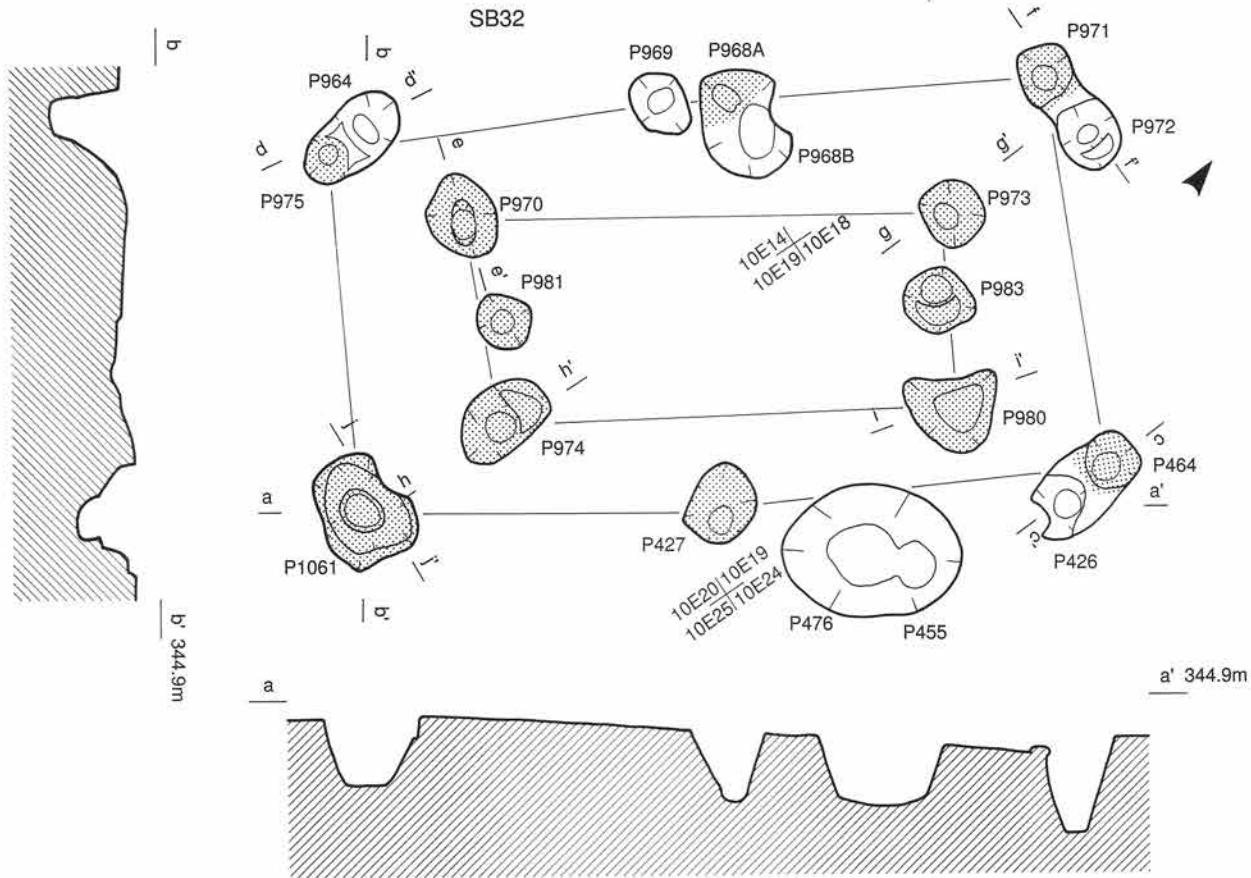

b' 344.9m

a' 344.9m

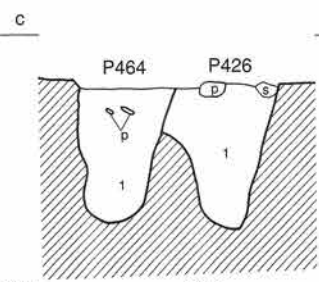
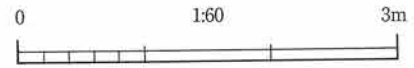

c' 344.6m

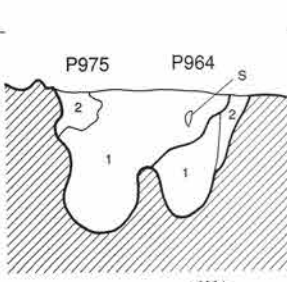

d' 344.7m

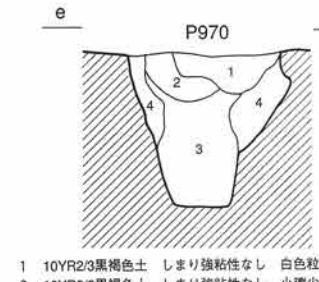

e' 344.7m

P464
1 7.5YR3/1黒褐色土
しまり強 粘性弱
白色粒子・礫・炭化粒含 粒子あ
らい 土器出土

P426
1 7.5YR2/1黒褐色土
しまり強 粘性弱
白色粒子・礫・炭化粒含 粒子あ
らい 土器出土

p0975
1 10YR3/2黒褐色土
しまり強 粘性なし
白色粒子多量
2 10YR3/2黒褐色土
しまり強 粘性なし
1よりやや明るい

p0964
1 10YR3/4暗褐色土
しまり強 粘性なし 柱痕
2 10YR3/3暗褐色土
しまり強 粘性なし 白色
粒子多量 版築

1 10YR2/3黒褐色土 しまり強粘性なし 白色粒子・小礫含
2 10YR3/2黒褐色土 しまり強粘性なし 小礫少量
3 10YR3/3暗褐色土 しまり強粘性なし 炭化粒含 柱痕
4 10YR3/4暗褐色土 しまり強粘性なし 版築

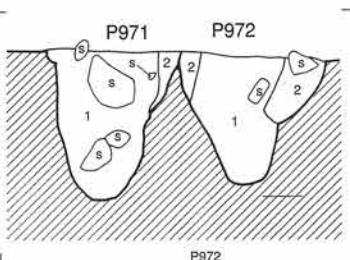

f' 344.4m

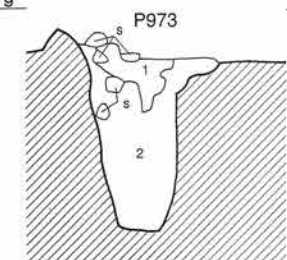

g' 344.6m

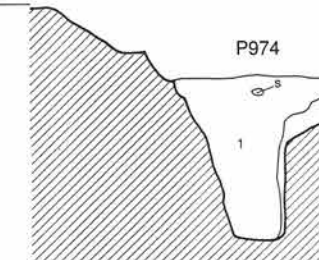

h' 344.9m

P971
1 10YR3/1黒褐色土 しまり強
粘性なし 大小礫多量 埋め戻し
2 10YR3/1黒褐色土 しまり強
粘性なし 黄褐色土ブロック含
1よりやや明るい

P972
1 10YR3/1黒褐色土 しまり強
粘性なし 白色粒子・礫多量
2 10YR3/1黒褐色土 しまり強
粘性なし 黄褐色土ブロック含
版築

1 10YR3/1黒褐色土 しまり強 粘性なし 礫含 埋め戻し
2 10YR3/2黒褐色土 しまり強 粘性なし 小礫多量

1 10YR3/3暗褐色土 しまり強 粘性なし 白色粒子多量・小礫少量
2 10YR3/2黒褐色土 しまり強 粘性なし 黄褐色土ブロック含
1よりやや明るい 版築?

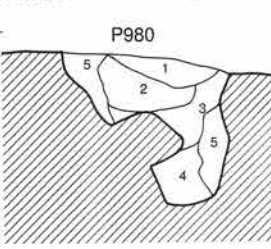

i' 344.5m

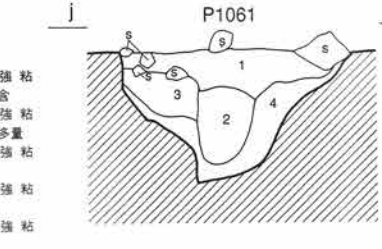

j' 345.0m

1 10YR3/3暗褐色土 しまり強 粘
性なし 白色粒子含
2 10YR2/2黒褐色土 しまり強 粘
性なし 白色粒子多量
3 10YR3/2黒褐色土 しまり強 粘
性なし
4 10YR3/4暗褐色土 しまり強 粘
性なし 柱痕
5 10YR3/4暗褐色土 しまり強 粘
性なし 版築

1 10YR2/1黒色土 しまり弱 粘性弱 礫含
2 10YR3/1黒褐色土 しまり強 粘性なし 白色粒子含
3 10YR3/2黒褐色土 しまり強 粘性なし 褐色土ブロック含 版築
4 10YR4/4暗褐色土 しまり強 粘性なし 黒褐色土ブロック含 版築

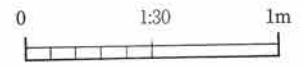

SB33

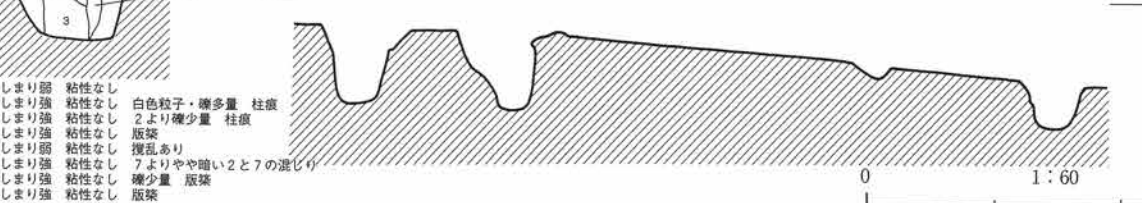
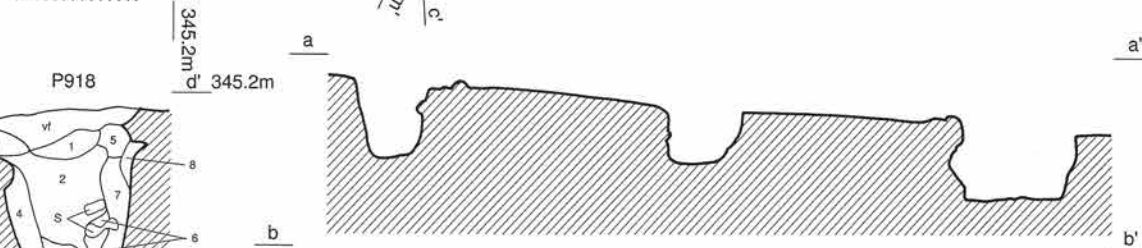
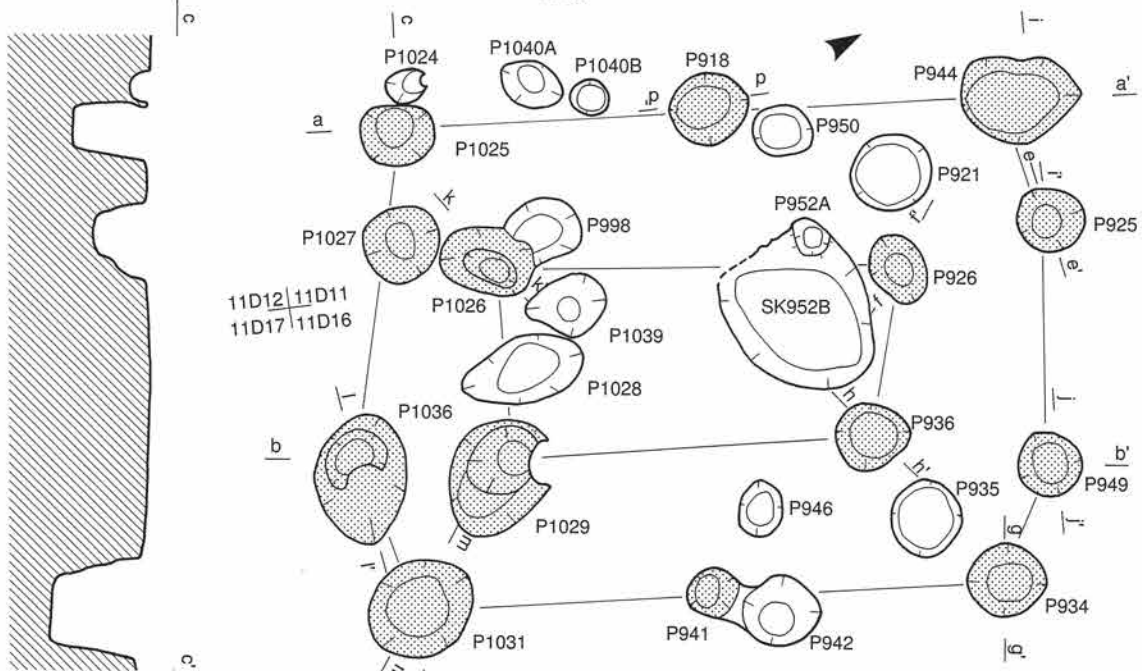

- 1 10YR2/2黒褐色土 しまり弱 粘性なし 白色粒子・礫多量 柱痕
- 2 10YR2/2黒褐色土 しまり強 粘性なし 2より礫少量 柱痕
- 3 10YR3/2黒褐色土 しまり強 粘性なし 版築
- 4 10YR3/3暗褐色土 しまり強 粘性なし 攪乱あり
- 5 10YR3/4暗褐色土 しまり弱 粘性なし 7よりやや暗い2と7の混じり
- 6 10YR3/3暗褐色土 しまり強 粘性なし 礫少量 版築
- 7 10YR3/3暗褐色土 しまり強 粘性なし 版築
- 8 10YR3/4暗褐色土 しまり強 粘性なし 版築

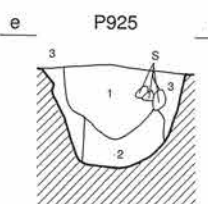
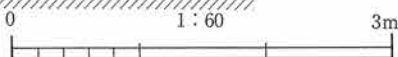

- 1 10YR3/2黒褐色土 しまり強 粘性なし 白色粒子少量 柱痕
- 2 10YR3/3暗褐色土 しまり強 粘性なし 柱痕
- 3 10YR3/4暗褐色土 しまり強 粘性なし 版築

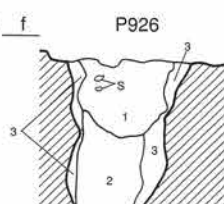

- 1 10YR3/3暗褐色土 しまり強 粘性なし 小礫含 柱痕
- 2 10YR3/4暗褐色土 しまり強 粘性なし 柱痕
- 3 10YR3/4暗褐色土 しまり強 粘性なし 2よりやや明るい 版築

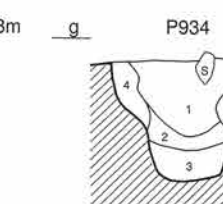

- 1 10YR3/3暗褐色土 しまり強 粘性なし 白色粒子含 柱痕
- 2 10YR3/3暗褐色土 しまり強 粘性なし 1よりやや明るい 柱痕
- 3 10YR3/4暗褐色土 しまり強 粘性なし 柱痕
- 4 10YR3/4暗褐色土 しまり強 粘性なし 3よりやや明るい 版築

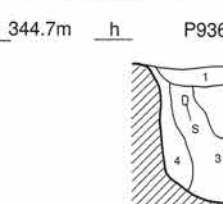

- 1 10YR3/3暗褐色土 しまり強 粘性なし 白色粒子少量
- 2 10YR3/2黒褐色土 しまり強 粘性なし 小礫少量
- 3 10YR3/3暗褐色土 しまり強 粘性なし 1より明るい
- 4 10YR3/4暗褐色土 しまり強 粘性なし 版築

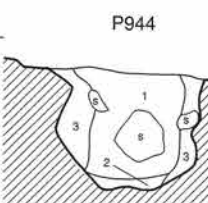

- 1 10YR3/3暗褐色土 しまり強 粘性なし 礫・炭多量
- 2 10YR3/3暗褐色土 しまり強 粘性なし 1よりやや明るい
- 3 10YR3/4暗褐色土 しまり強 粘性なし

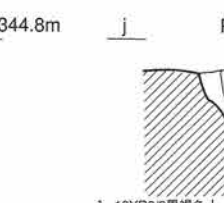

- 1 10YR3/2黒褐色土 しまり強 粘性なし 白色粒子多量
- 2 10YR3/2黒褐色土 しまり強 粘性なし

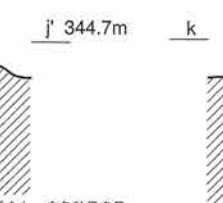

- 1 10YR2/1黒色土 しまり弱 粘性弱 白色粒子少量
- 2 10YR3/1黒褐色土 しまり強 粘性なし 炭化粒少量
- 3 10YR3/2黒褐色土 しまり強 粘性なし 白色粒子少量
- 4 10YR3/2黒褐色土 しまり強 粘性なし 白色粒子少量
- 褐色土ブロック含 版築

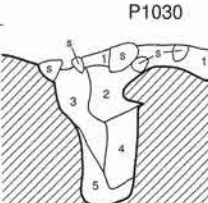

- 1 10YR2/2黒褐色土 しまり強 粘性弱 白色粒子・礫含
- 2 10YR3/1黒褐色土 しまり強 粘性なし 白色粒子多量
- 3 10YR3/2黒褐色土 しまり強 粘性なし 砂含
- 4 10YR4/3黒褐色土 しまりなし 粘性なし 黒褐色土ブロック含
- 5 7.5YR3/2黒褐色土 しまりなし 粘性なし 粒子細かい

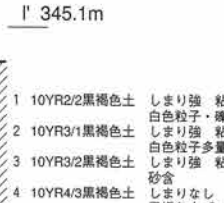

- 1 10YR2/1黒色土 しまり弱 粘性弱 白色粒子含 粒子細かい
- 2 10YR2/2黒褐色土 しまり強 粘性なし 白色粒子少量 版築
- 3 10YR3/1黒褐色土 しまり強 粘性なし 褐色土ブロック含 版築

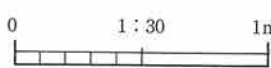

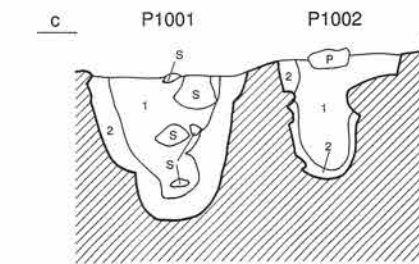
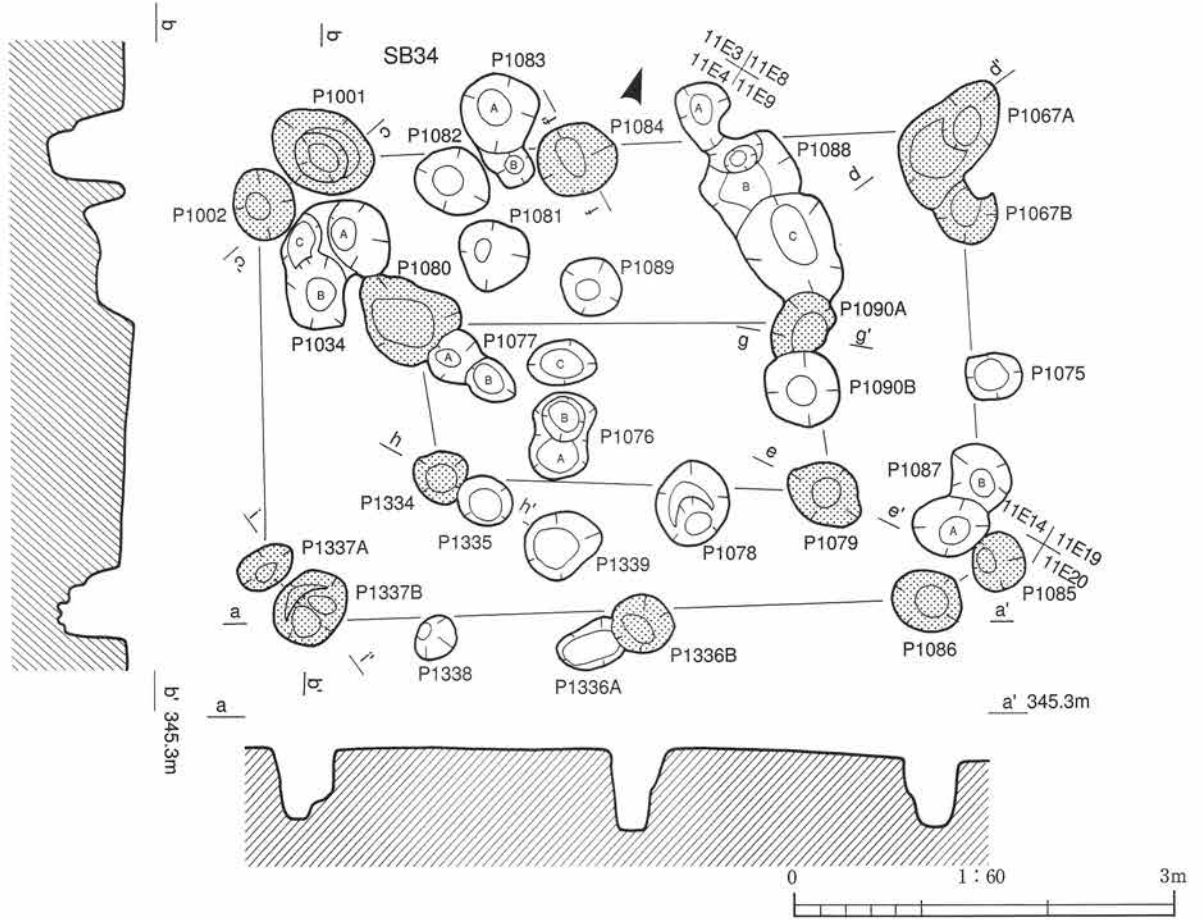

- P1001
 1 10YR3/1黒褐色土 しまり強 粘性なし
 2 10YR3/2黒褐色土 しまり強 粘性なし 褐色土ブロック含
- P1002
 1 10YR3/1黒褐色土 しまり強 粘性なし 炭化物少量
 2 10YR3/2黒褐色土 しまり強 粘性なし 礫含

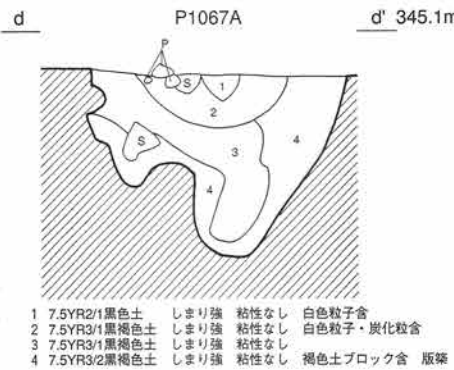

- P1067A
 1 7.5YR2/1黒色土 しまり強 粘性なし 白色粒子含
 2 7.5YR3/1黒褐色土 しまり強 粘性なし 白色粒子・炭化物含
 3 7.5YR3/1黒褐色土 しまり強 粘性なし
 4 7.5YR3/2黒褐色土 しまり強 粘性なし 褐色土ブロック含 版築

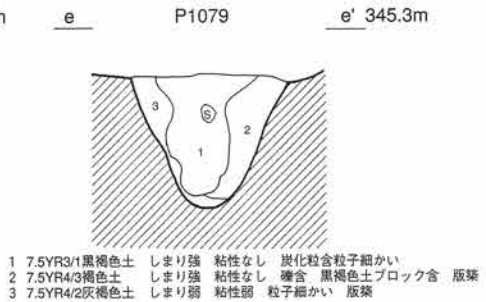

- P1079
 1 7.5YR3/1黒褐色土 しまり強 粘性なし 炭化粒含粒子細かい
 2 7.5YR4/3褐色土 しまり強 粘性なし 礫含 黒褐色土ブロック含 版築
 3 7.5YR4/2灰褐色土 しまり弱 粘性弱 粒子細かい 版築

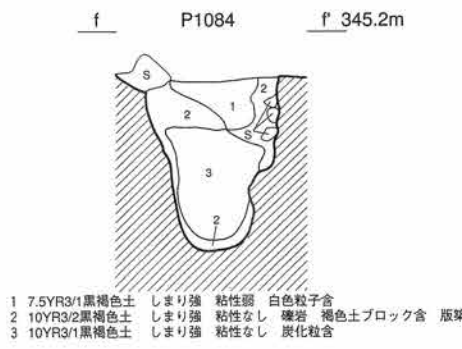

- P1084
 1 7.5YR3/1黒褐色土 しまり強 粘性弱 白色粒子含
 2 10YR3/2黒褐色土 しまり強 粘性なし 礫岩 褐色土ブロック含 版築
 3 10YR3/1黒褐色土 しまり強 粘性なし 炭化粒含

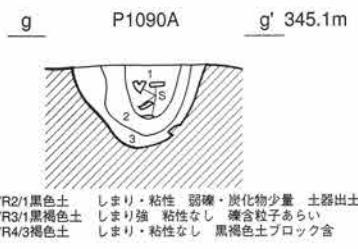

- P1090A
 1 10YR2/1黒色土 しまり・粘性 弱礫・炭化物少量 土器出土
 2 10YR3/1黒褐色土 しまり強 粘性なし 礫含 粒子あらい
 3 10YR4/3褐色土 しまり・粘性なし 黒褐色土ブロック含

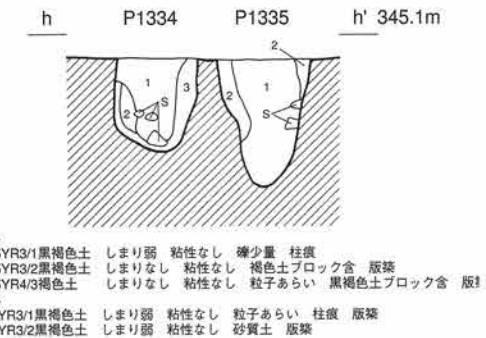

- P1334
 1 7.5YR3/1黒褐色土 しまり弱 粘性なし 礫少量 柱痕
 2 7.5YR3/2黒褐色土 しまりなし 粘性なし 褐色土ブロック含 版築
 3 7.5YR4/3褐色土 しまりなし 粘性なし 粒子あらい 黒褐色土ブロック含 版築
- P1335
 1 10YR3/1黒褐色土 しまり弱 粘性なし 粒子あらい 柱痕 版築
 2 10YR3/2黒褐色土 しまり弱 粘性なし 砂質土 版築

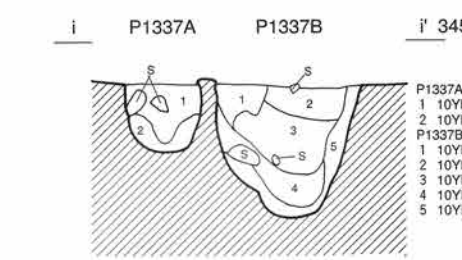

- P1337A
 1 10YR3/1黒褐色土 しまり強 粘性なし 礫少量
 2 10YR3/2黒褐色土 しまり強 粘性なし 褐色土ブロック含
- P1337B
 1 10YR3/1黒褐色土 しまり弱 粘性なし 粒子細かい
 2 10YR3/1黒褐色土 しまり強 粘性なし 白色粒子含
 3 10YR3/2黒褐色土 しまり・粘性なし 粒子あらい
 4 10YR3/2黒褐色土 しまり・粘性なし 褐色土ブロック含
 5 10YR4/3褐色土 しまり・粘性なし 黒褐色土ブロック含 版築

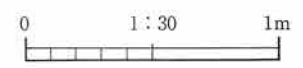

SB35

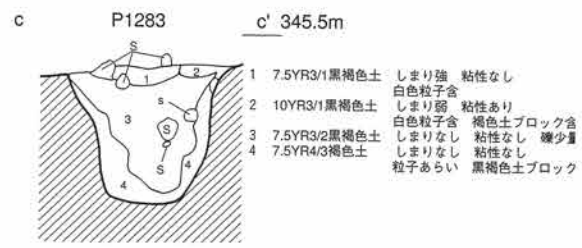
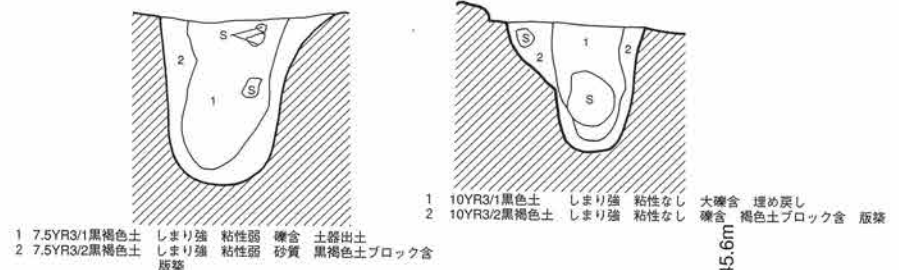
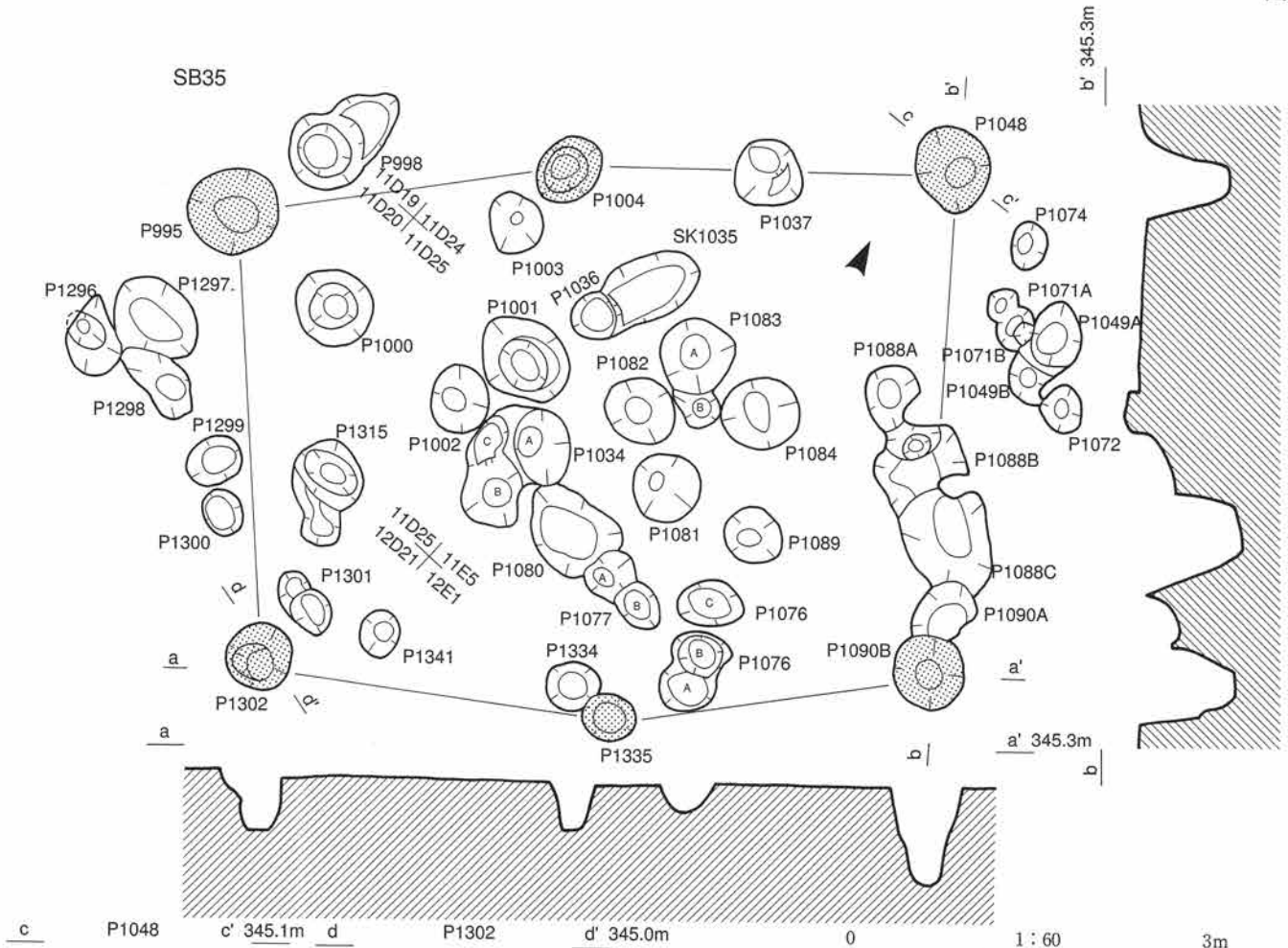

SB36

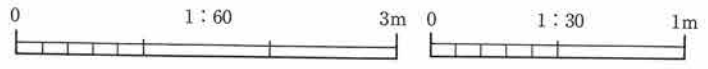
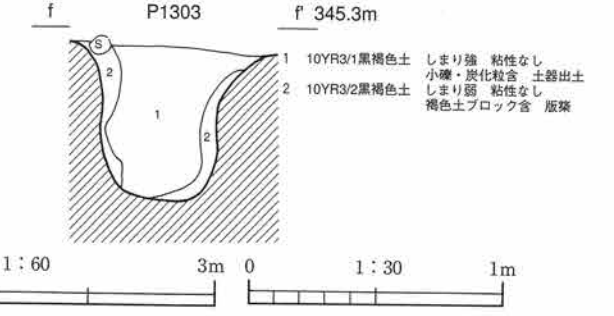
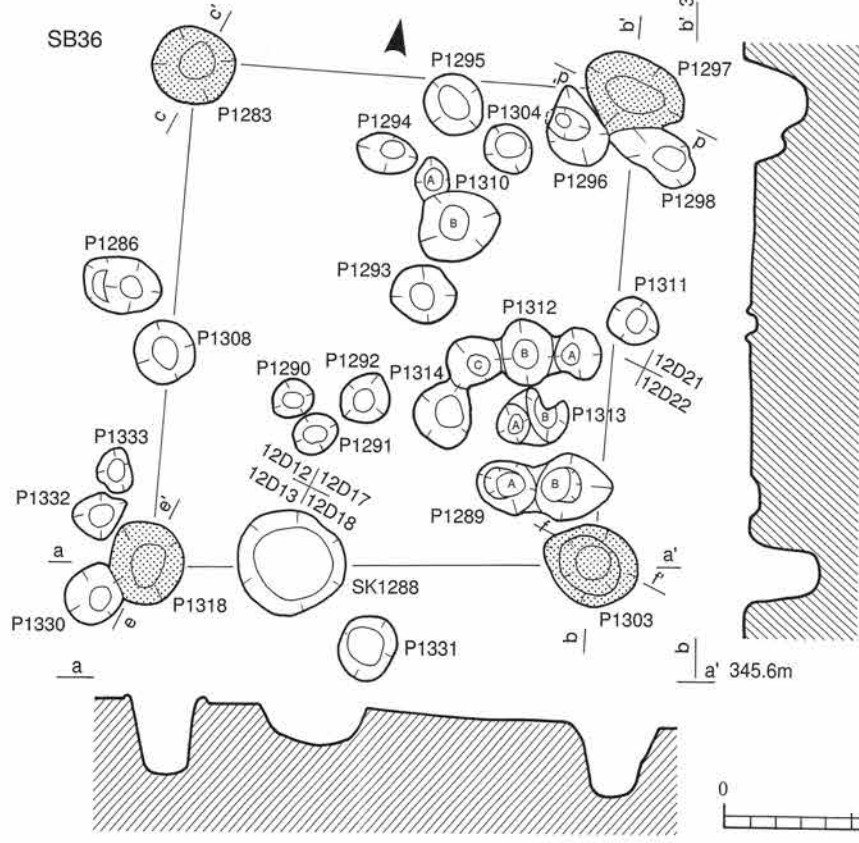

SB37

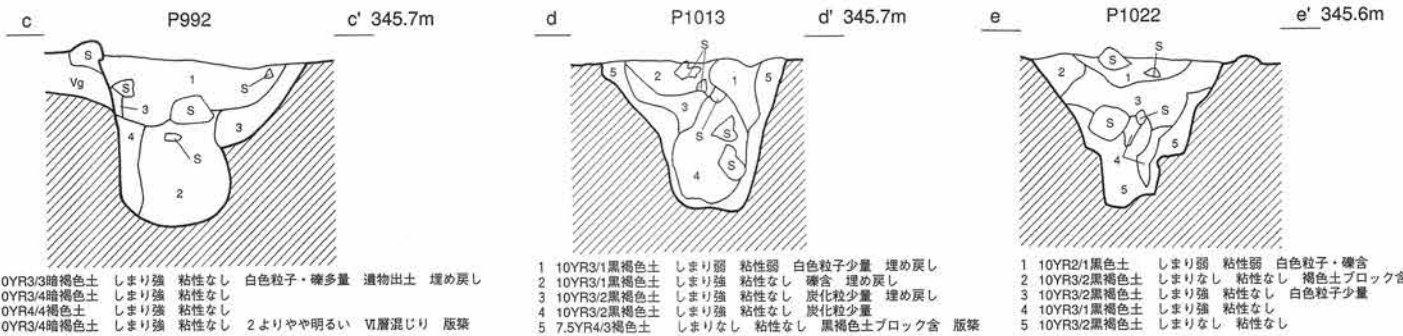
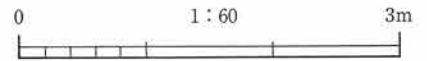
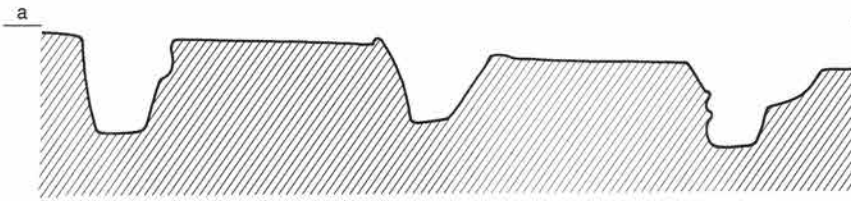
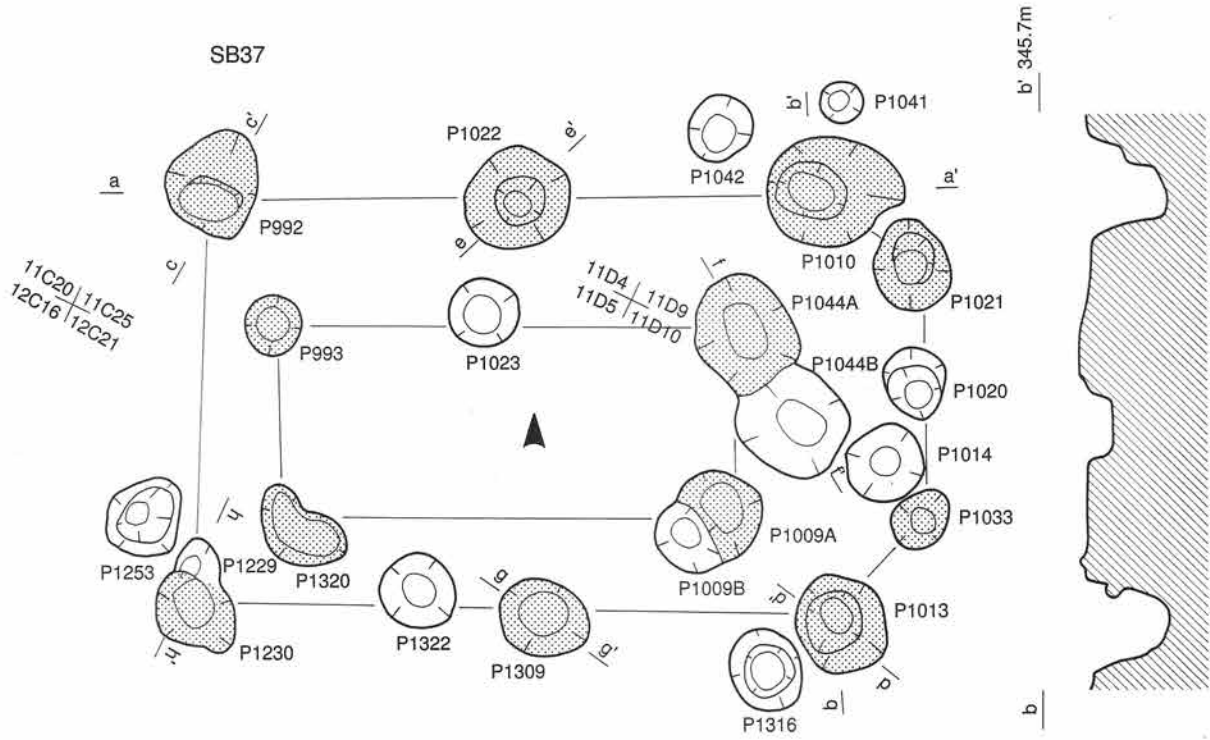

- 1 10YR3/3暗褐色土 しまり強 粘性なし 白色粒子・礫多量 遺物出土 埋め戻し
 2 10YR3/4暗褐色土 しまり強 粘性なし
 3 10YR4/4褐色土 しまり強 粘性なし
 4 10YR3/4暗褐色土 しまり強 粘性なし 2よりやや明るい VI層混じり 版築

- 1 10YR3/1黒褐色土 しまり弱 粘性弱 白色粒子少量 埋め戻し
 2 10YR3/1黒褐色土 しまり強 粘性なし 礫含 埋め戻し
 3 10YR3/2黒褐色土 しまり強 粘性なし 炭化粒少量 埋め戻し
 4 10YR3/2黒褐色土 しまり強 粘性なし 炭化粒少量
 5 7.5YR4/3褐色土 しまりなし 粘性なし 黒褐色土ブロック含 版築

- 1 10YR2/1黒色土 しまり弱 粘性弱 白色粒子・礫含
 2 10YR3/2黒褐色土 しまりなし 粘性なし 褐色土ブロック含
 3 10YR3/2黒褐色土 しまり強 粘性なし 白色粒子少量
 4 10YR3/1黒褐色土 しまり強 粘性なし
 5 10YR3/2黒褐色土 しまりなし 粘性なし

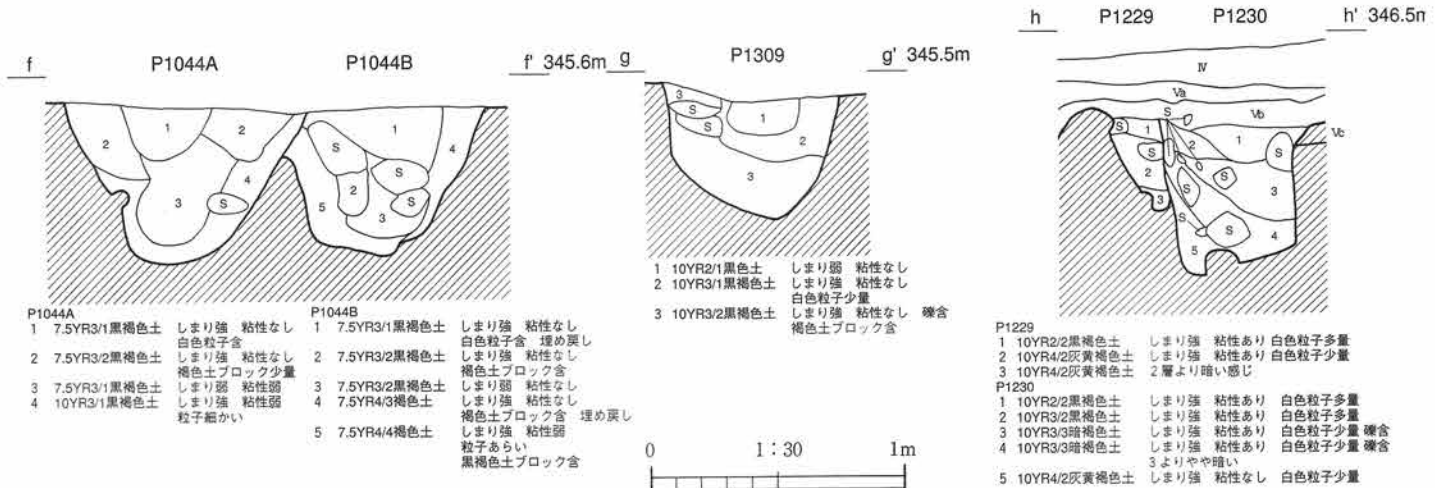

- P1044A
 1 7.5YR3/1黒褐色土 しまり強 粘性なし 白色粒子含
 2 7.5YR3/2黒褐色土 しまり強 粘性なし 褐色土ブロック少量
 3 7.5YR3/1黒褐色土 しまり弱 粘性弱
 4 10YR3/1黒褐色土 しまり強 粘性弱 粒子細かい
- P1044B
 1 7.5YR3/1黒褐色土 しまり強 粘性なし 白色粒子含 埋め戻し
 2 7.5YR3/2黒褐色土 しまり強 粘性なし 褐色土ブロック含
 3 7.5YR3/2黒褐色土 しまり強 粘性なし
 4 7.5YR4/3褐色土 しまり強 粘性弱 褐色土ブロック含 埋め戻し
 5 7.5YR4/4褐色土 しまり強 粘性弱 粒子あらい 黒褐色土ブロック含

- 1 10YR2/1黒色土 しまり弱 粘性なし
 2 10YR3/1黒褐色土 しまり強 粘性なし 白色粒子少量
 3 10YR3/2黒褐色土 しまり強 粘性なし 礫含 褐色土ブロック含

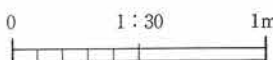

- P1229
 1 10YR2/2黒褐色土 しまり強 粘性あり 白色粒子多量
 2 10YR4/2灰黄褐色土 しまり強 粘性あり 白色粒子少量
 3 10YR4/2灰黄褐色土 2層より暗い感じ
- P1230
 1 10YR2/2黒褐色土 しまり強 粘性あり 白色粒子多量
 2 10YR3/2黒褐色土 しまり強 粘性あり 白色粒子多量
 3 10YR3/3暗褐色土 しまり強 粘性あり 白色粒子少量 礫含
 4 10YR3/3暗褐色土 しまり強 粘性あり 白色粒子少量 礫含
 5 10YR4/2灰黄褐色土 しまり強 粘性なし 白色粒子少量

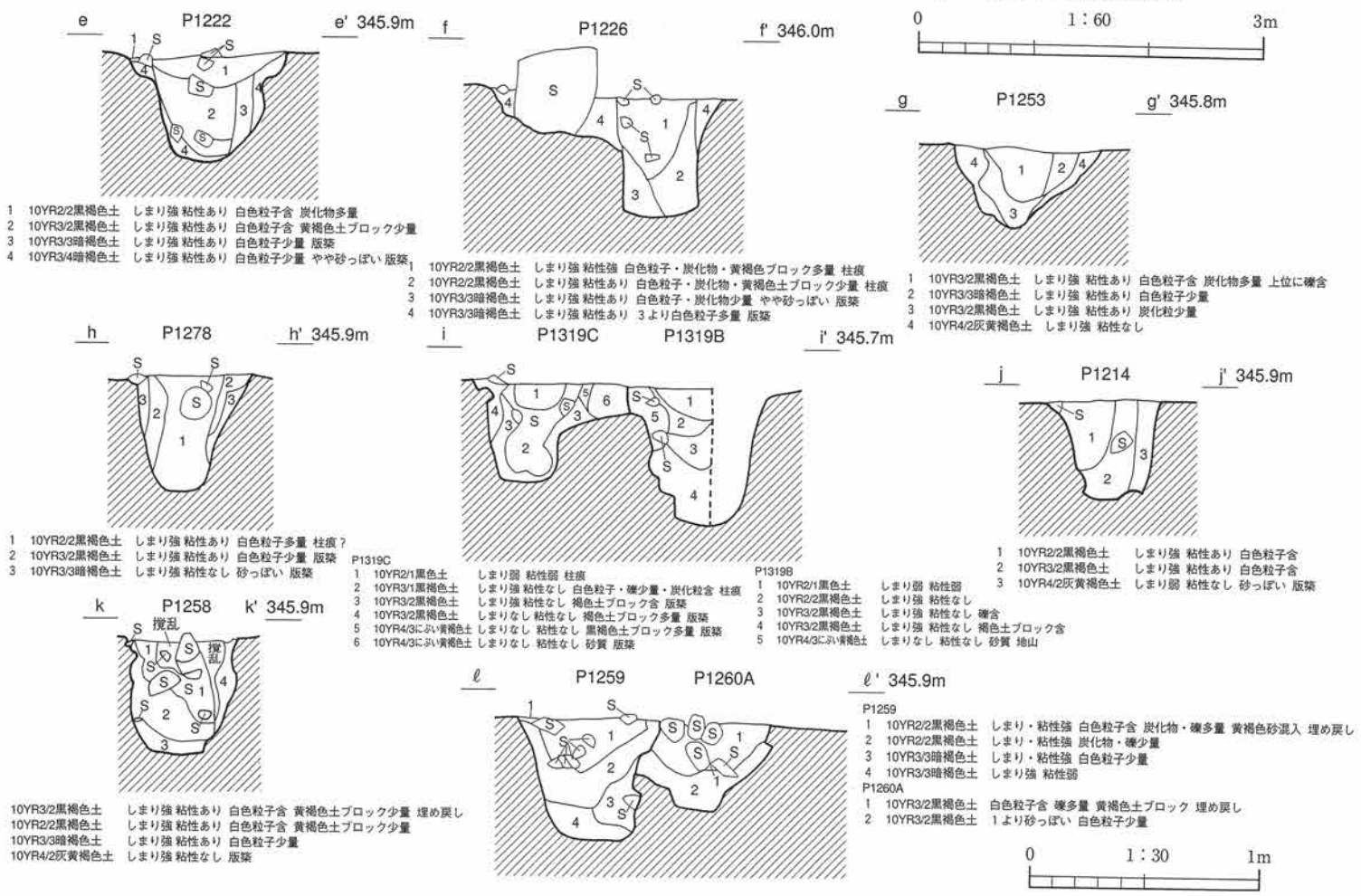
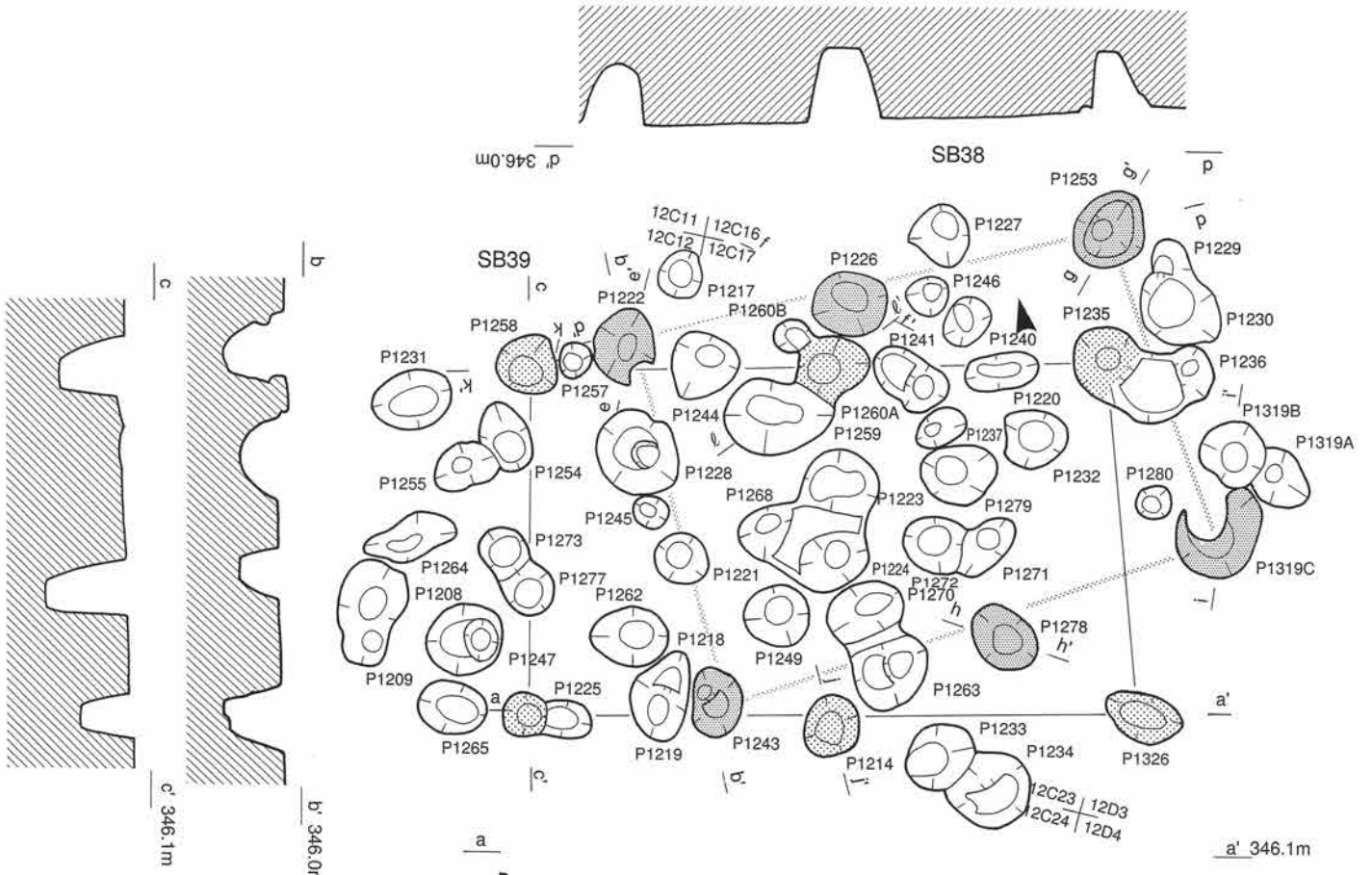

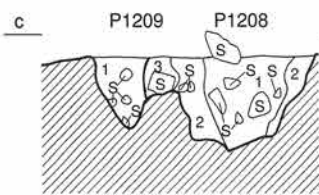
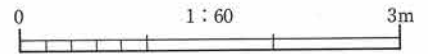
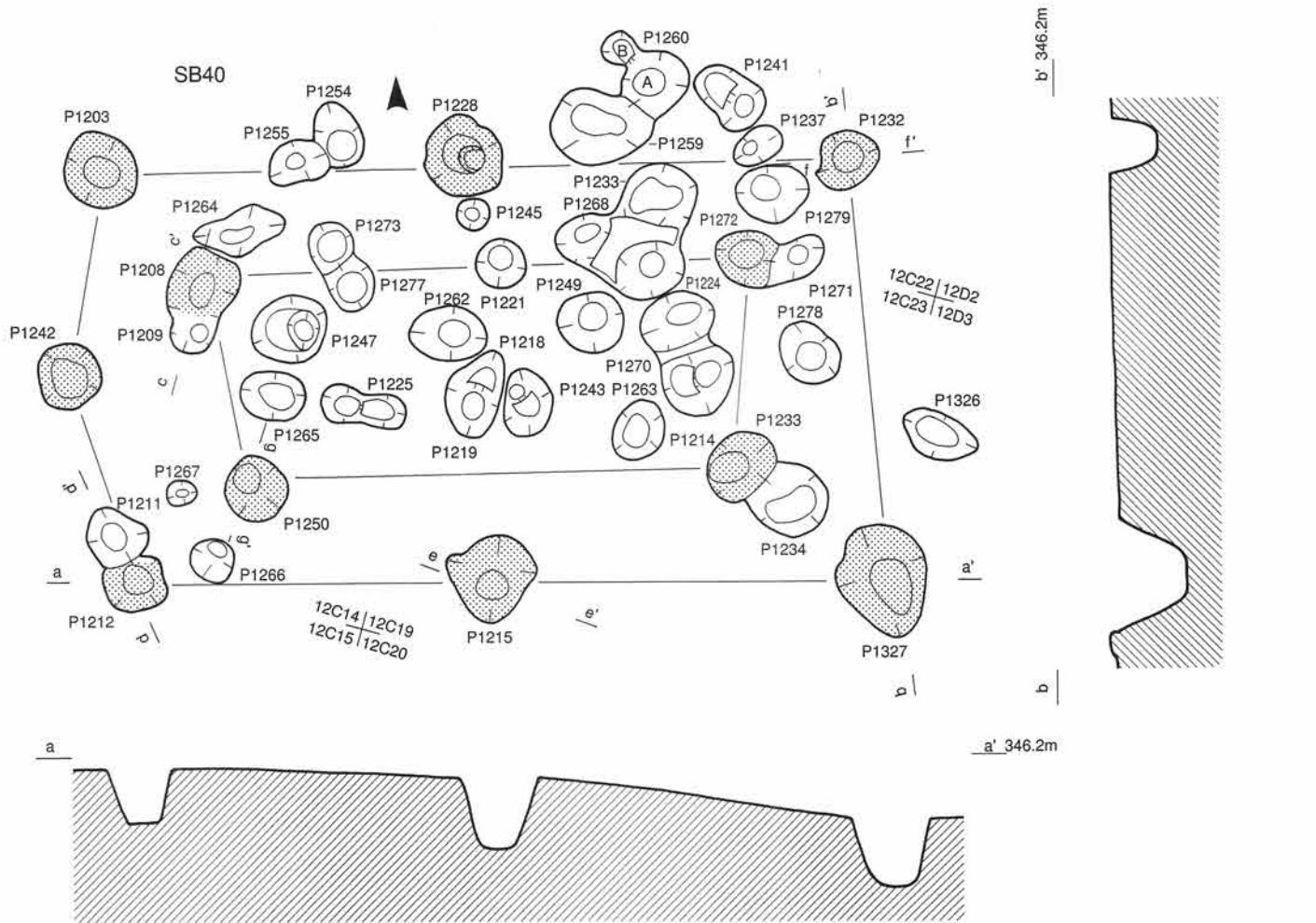

P1209
1 10YR3/3暗褐色土 しまり強 粘性弱 白色粒子少量

P1208
1 10YR3/2黒褐色土 しまり強 粘性弱 白色粒子含 小礫多量 埋め戻し
2 10YR3/3暗褐色土 しまり強 粘性弱 白色粒子少量 版築
3 10YR4/2灰黄褐色土 しまりなし 粘性なし 版築

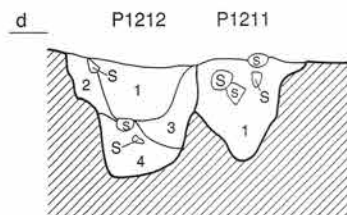

P1212
1 10YR3/2黒褐色土 しまり強 粘性あり 白色粒子多量
2 10YR3/1黒褐色土 しまり強 粘性あり 白色粒子多量 版築
3 10YR2/3暗褐色土 しまり弱 粘性あり
4 10YR2/2黒褐色土 しまり弱 粘性あり 白色粒子少量 小礫多量

P1211
1 10YR3/3暗褐色土 しまり強 粘性あり 白色粒子少量 礫多量

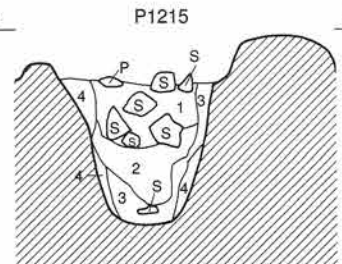

1 10YR2/2黒褐色土 しまり強 粘性あり 白色粒子・小礫多量 炭化粒少量 埋め戻し
2 10YR3/3暗褐色土 しまり強 粘性あり 白色粒子少量
3 10YR3/3暗褐色土 しまりなし 粘性弱 2より砂多量
4 10YR4/2灰黄褐色土 しまり強 粘性なし 砂質土 版築

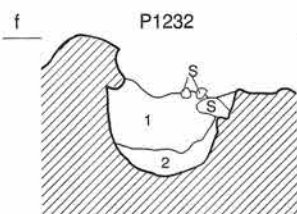

1 10YR2/2黒褐色土 しまり強 粘性あり 白色粒子含 黄褐色土ブロック少量
2 10YR3/3暗褐色土 しまり強 粘性あり 白色粒子少量

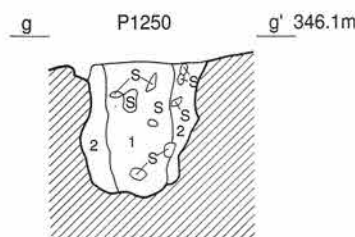

1 10YR3/2黒褐色土 しまり強 粘性あり 白色粒子含 黄褐色土ブロック少量 砂っぽい柱痕
2 10YR3/3暗褐色土 しまり強 粘性弱 白色粒子少量 やや砂っぽい 版築

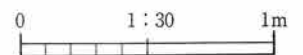

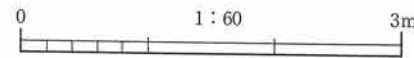
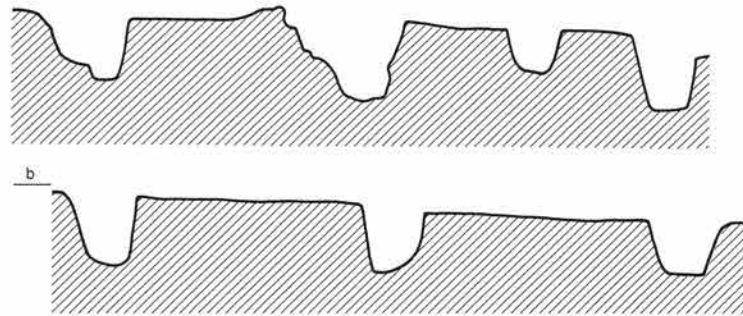
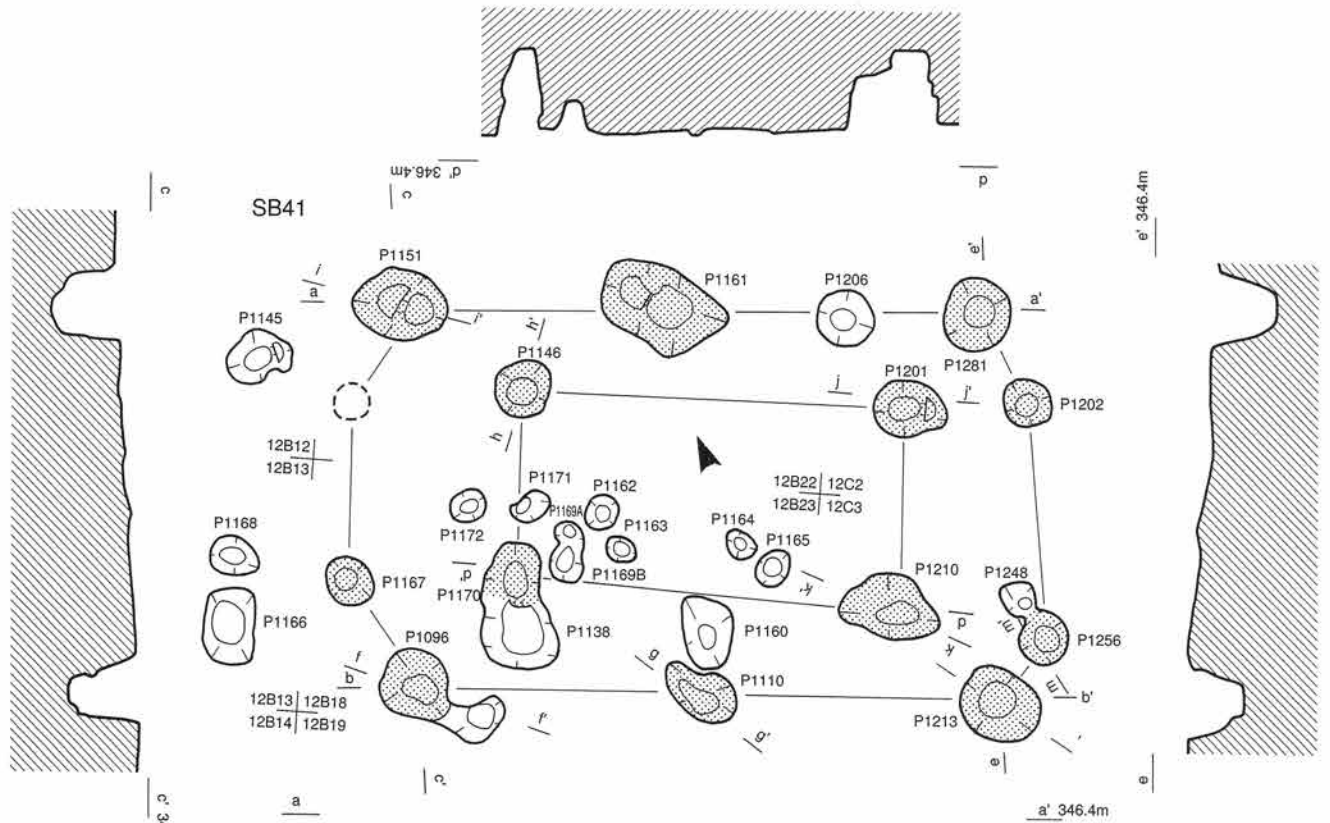

f P1096 f' 346.4m g P1110 g' 346.4m h P1146 h' 346.3m i P1151 i' 346.2m

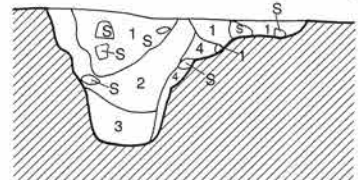

- P1096**
- 1 10YR3/2黒褐色土 しまり強 粘性あり 白色粒子含 黄褐色土ブロック少量
 - 2 10YR3/3暗褐色土 しまり強 粘性弱 白色粒子少量 黄褐色土ブロック少量 砂っぽい
 - 3 10YR3/3暗褐色土 しまりなし 粘性なし
 - 4 10YR4/2灰黄褐色土 しまり弱 粘性なし 版築

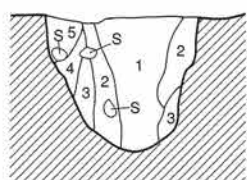

- P1110**
- 1 10YR2/3暗褐色土 しまり強 粘性あり 白色粒子多量 炭化物・黄褐色土ブロック少量 柱痕
 - 2 10YR3/2黒褐色土 しまり強 粘性あり 白色粒子多量 黄褐色土ブロック少量 版築
 - 3 10YR4/2灰黄褐色土 しまり弱 粘性なし 版築
 - 4 10YR4/2灰黄褐色土 しまり弱 粘性あり 3よりやや暗い 版築
 - 5 10YR3/3暗褐色土 しまり強 粘性弱 白色粒子少量 やや砂っぽい

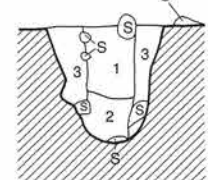

- P1146**
- 1 10YR3/3暗褐色土 しまり強 粘性弱
 - 2 10YR4/2灰黄褐色土 しまり強 粘性なし 砂多量 柱痕
 - 3 10YR3/3暗褐色土 しまり強 粘性弱 1よりやや明るい 版築

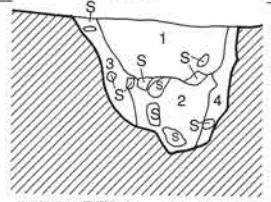

- P1151**
- 1 10YR2/2黒褐色土 しまり強 粘性あり 白色粒子含 炭化物多量 黄褐色土ブロック少量
 - 2 10YR3/3暗褐色土 しまり強 粘性弱 白色粒子少量 砂っぽい 埋め戻し
 - 3 10YR3/2黒褐色土 しまり強 粘性あり 1と近似 版築
 - 4 10YR3/4暗褐色土 しまり強 粘性弱 2より砂っぽい 版築

j P1201 j' 346.2m

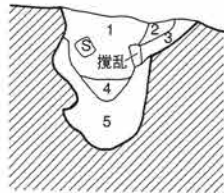

- P1201**
- 1 10YR2/3黒褐色土 しまり強 粘性強 白色粒子含 炭化物少量
 - 2 10YR3/2黒褐色土 しまり強 粘性弱 白色粒子含 炭化物少量
 - 3 10YR4/3にぶい黄褐色土 しまりなし 粘性なし
 - 4 10YR4/3にぶい黄褐色土 しまりなし 粘性なし 3よりやや暗い
 - 5 10YR3/2黒褐色土 しまりなし 粘性なし

k P1210 k' 346.6m

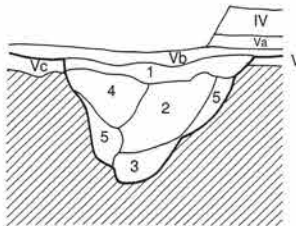

- P1210**
- 1 10YR3/1黒褐色土 しまり強 粘性弱 白色粒子含
 - 2 10YR3/2黒褐色土 しまり強 粘性弱 白色粒子含
 - 3 10YR3/2黒褐色土 しまり強 粘性弱 白色粒子少量
 - 4 10YR2/3黒褐色土 しまり強 粘性弱 白色粒子含 小礫多量 版築
 - 5 10YR4/2灰黄褐色土 しまり強 粘性弱 小礫多量 版築

l P1213 l' 346.3m

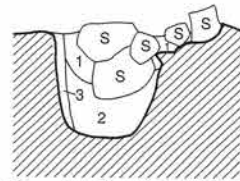

- P1213**
- 1 10YR2/3黒褐色土 しまり強 粘性強 白色粒子含 礫多量 炭化物・黄褐色土ブロック少量 埋め戻し
 - 2 10YR3/2黒褐色土 しまり強 粘性強 白色粒子少量 やや砂っぽい
 - 3 10YR4/2灰黄褐色土 しまり強 粘性弱 砂っぽい 版築

m P1256 m' 346.2m

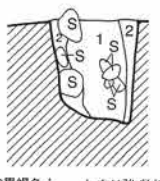

- P1256**
- 1 10YR3/2黒褐色土 しまり強 粘性強 白色粒子含 柱痕
 - 2 10YR3/3暗褐色土 しまり強 粘性弱 白色粒子少量 黄褐色土多量 版築

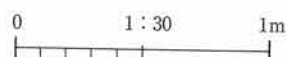

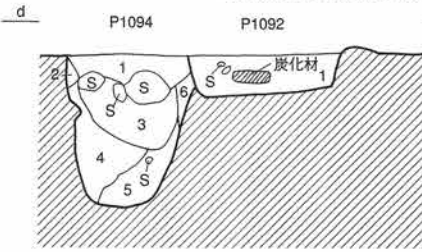
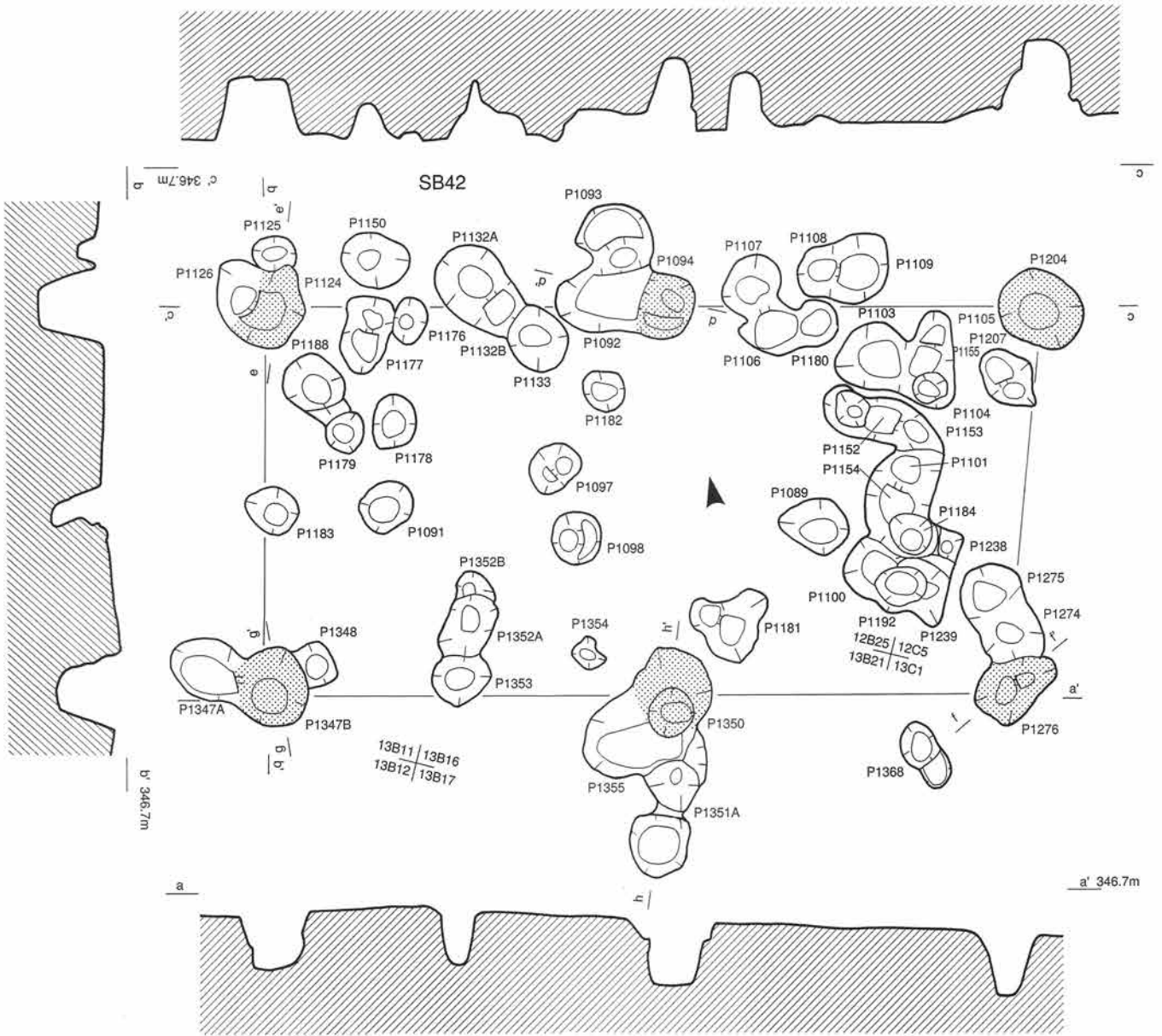

- P1092
 1 10YR2/1黒色土 しまり強 粘性あり 白色粒子含 炭化物多量 黄褐色土ブロック少量 炭化材出土
 P1094
 1 10YR3/2黒褐色土 しまり強 粘性あり 白色粒子含 炭化粒少量
 2 10YR3/3暗褐色土 しまり強 粘性あり 白色粒子少量
 3 10YR2/1黒色土 しまり強 粘性あり 白色粒子含 炭化物多量 粒子ややあらい 上位に礫含
 4 10YR3/2黒褐色土 白色粒子少量 1より明るい粒子あらい
 5 10YR2/1黒色土 しまり強 粘性あり 3より炭化物多量 白色粒子多量 3より粒子ややあらい
 6 10YR3/3暗褐色土 しまり強 粘性弱 2より明るい粒子あらい

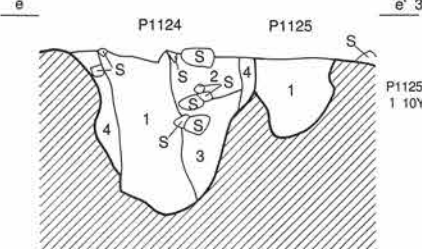
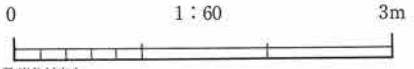

- P1125
 1 10YR3/3暗褐色土 しまり強 粘性あり 白色粒子含

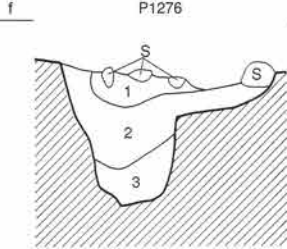

- 1 10YR2/1黒色土 しまり弱 粘性弱 白色粒子少量 小礫含
 2 10YR3/1黒褐色土 しまり強 粘性なし 小礫含
 3 10YR2/3黒褐色土 しまり強 粘性なし 小礫含 粒子あらい

- P1124
 1 10YR2/2黒褐色土 しまり強 粘性あり 白色粒子・炭化物・小礫多量 黄褐色土ブロック少量 柱痕
 2 10YR3/2黒褐色土 しまり強 粘性あり 白色粒子・小礫多量 炭化物少量 版築
 3 10YR3/1黒褐色土 しまり強 粘性あり 白色粒子・小礫多量 炭化物少量 版築
 4 10YR4/2灰黄褐色土 しまり強 粘性弱 白色粒子少量 版築

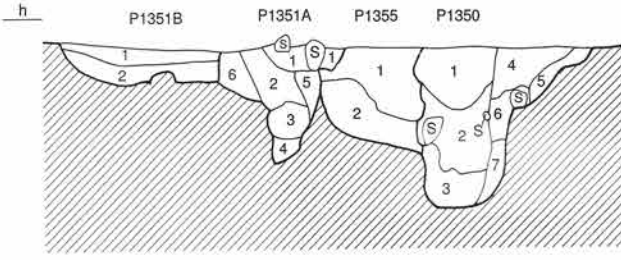

- P1350
 1 10YR2/3黒褐色土 しまり強 粘性なし 白色粒子多量 粒子細かい 柱痕
 2 10YR3/2黒褐色土 しまり強 粘性なし 白色粒子多量 礫少量 1より粒子あらい 柱痕
 3 10YR3/3暗褐色土 しまり強 粘性なし 2より粒子あらく砂っぽい 柱痕
 4 10YR3/3暗褐色土 しまり強 粘性なし 版築
 5 10YR3/3暗褐色土 しまり強 粘性なし 4よりやや明るい 版築
 6 10YR3/3暗褐色土 しまり強 粘性なし 礫多量 版築
 7 10YR3/4暗褐色土 しまり強 粘性なし 砂っぽい 版築
 P1351A
 1 10YR3/2黒褐色土 しまり強 粘性なし 白色粒子多量 粒子細かい
 2 10YR3/3暗褐色土 しまり強 粘性なし 白色粒子多量
 3 10YR2/3黒褐色土 しまり強 粘性なし 礫少量
 4 10YR3/4暗褐色土 しまり弱 粘性なし
 5 10YR3/3暗褐色土 しまり強 粘性なし 2よりやや明るい
 6 10YR3/4暗褐色土 しまり強 粘性なし 礫多量
 P1351B
 1 10YR3/3暗褐色土 しまり強 粘性なし 粒子細かい
 2 10YR3/3暗褐色土 しまり強 粘性なし 白色粒子多量
 P1355
 1 10YR3/2黒褐色土 しまり強 粘性なし 白色粒子多量 1350の版築の可能性あり
 2 10YR3/4暗褐色土 しまり強 粘性なし 白色粒子多量 1350の版築の可能性あり

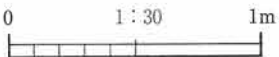

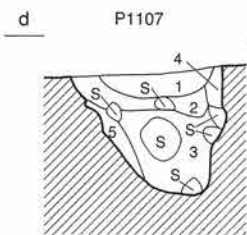
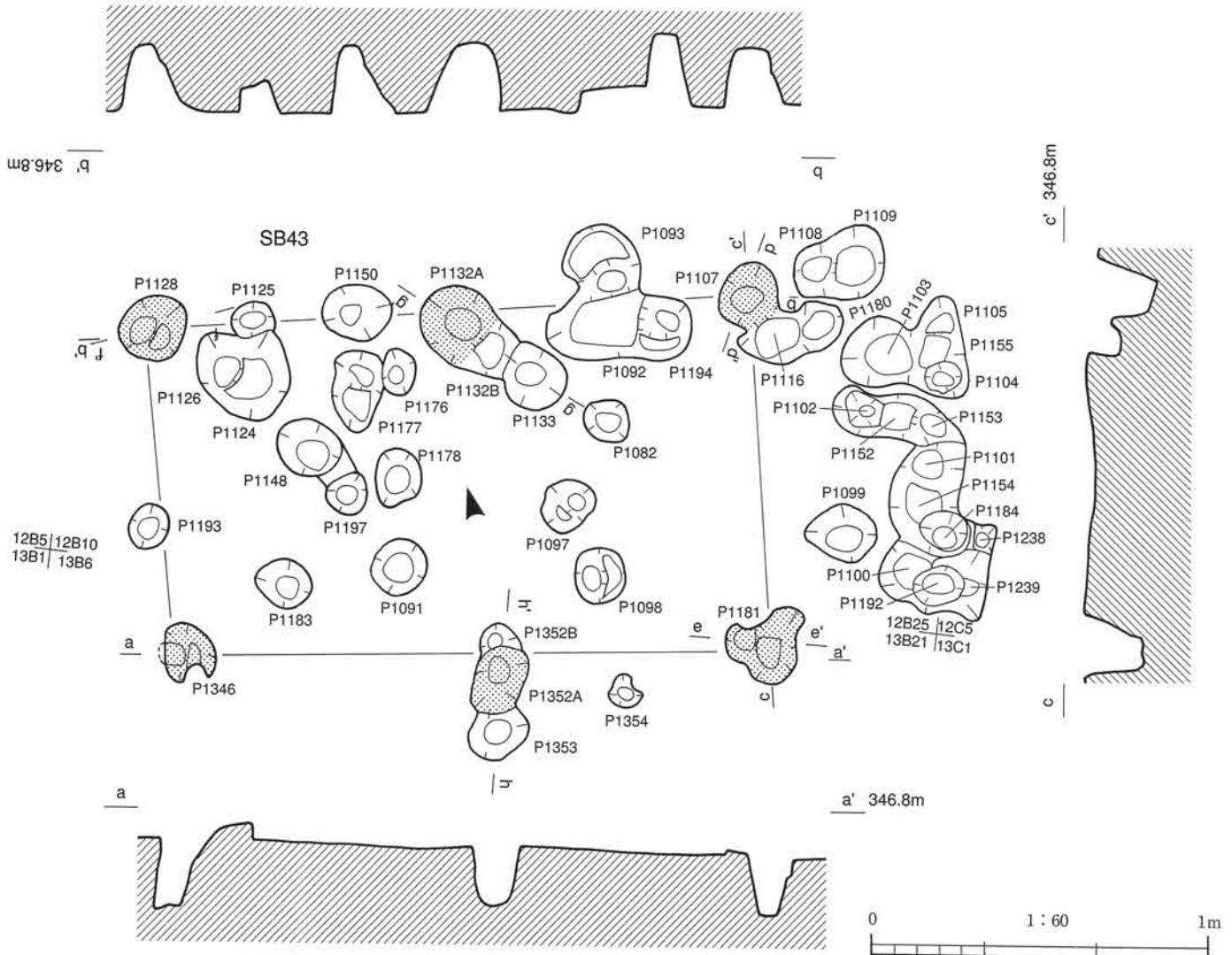

- d** P1107 **d'** 346.5m
- | | | |
|---------------|----------|-----------|
| 1 10YR2/1黒色土 | しまり強粘性あり | 白色粒子含 |
| 2 10YR3/2黒褐色土 | しまり強粘性あり | 白色粒子含 |
| 3 10YR2/2黒褐色土 | しまり強粘性あり | 白色粒子少量 |
| 4 10YR3/3暗褐色土 | しまり強粘性あり | 白色粒子少量 版築 |
| 5 10YR3/1黒褐色土 | しまり強粘性あり | 白色粒子少量 版築 |

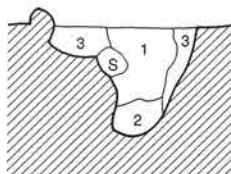

- e** P1181 **e'** 346.6m
- | | | | |
|---------------|----------|-----------------|----|
| 1 10YR3/2黒褐色土 | しまり強粘性あり | 白色粒子含黄褐色土ブロック少量 | 柱痕 |
| 2 10YR3/2黒褐色土 | しまり強粘性あり | 白色粒子少量 | 柱痕 |
| 3 10YR3/3暗褐色土 | しまり強粘性あり | 白色粒子含 | 版築 |

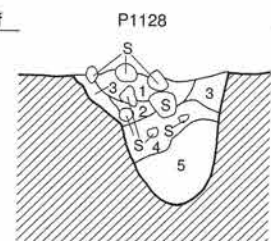

- f** P1128 **f'** 346.6m
- | | | | | | |
|----------------|------|------|------------|-----|------|
| 1 10YR3/2黒褐色土 | しまり強 | 粘性あり | 白色粒子含 | 礫多量 | 埋め戻し |
| 2 10YR3/2黒褐色土 | しまり強 | 粘性あり | 白色粒子少量 | 礫多量 | |
| 3 10YR4/2灰黄褐色土 | しまり強 | 粘性弱 | 白色粒子少量 | | |
| 4 10YR2/2黒褐色土 | しまり強 | 粘性あり | 白色粒子・炭化粒少量 | | |
| 5 10YR2/2黒褐色土 | しまり強 | 粘性あり | 白色粒子・炭化粒少量 | | |

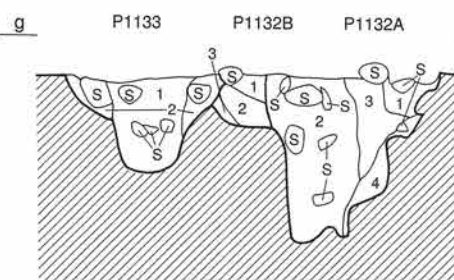

- g** P1133 **g'** 346.6m
- | | | | |
|----------------|------|------|-------|
| 1 10YR3/2黒褐色土 | しまり強 | 粘性あり | 白色粒子含 |
| 2 10YR4/2灰黄褐色土 | しまり強 | 粘性あり | 白色粒子含 |
- h** P1352B P1352A P1353 **h'** 346.7m
- | | | | | | |
|--------|----------------|------|------|-------|---------------------|
| P1132B | 1 10YR3/2黒褐色土 | しまり強 | 粘性あり | 白色粒子含 | 1131Aの版築の可能性あり |
| | 2 10YR3/2黒褐色土 | しまり強 | 粘性あり | 白色粒子含 | 1131Aの版築の可能性あり |
| | 3 10YR4/2灰黄褐色土 | 砂っぽい | | | |
| P1132A | 1 10YR3/2黒褐色土 | しまり強 | 粘性あり | 白色粒子含 | |
| | 2 10YR2/1黒色土 | しまり強 | 粘性あり | 白色粒子含 | 炭化物多量 黄褐色土ブロック 埋め戻し |
| | 3 10YR2/2黒褐色土 | しまり強 | 粘性あり | 礫含 | 炭化物多量 |
| | 4 10YR3/2黒褐色土 | しまり強 | 粘性あり | 砂っぽい | |

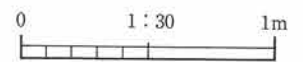

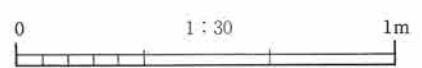
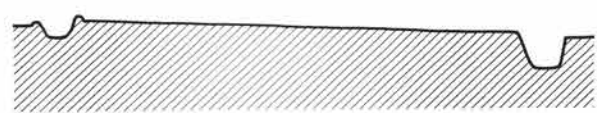
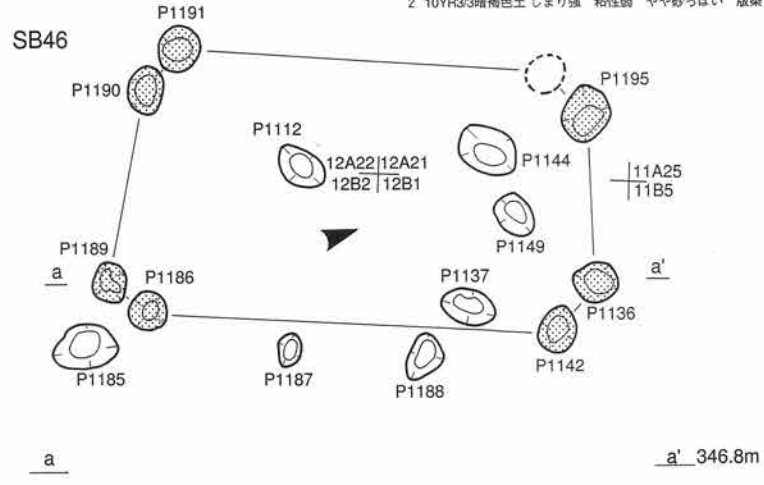
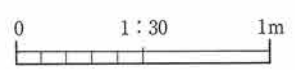
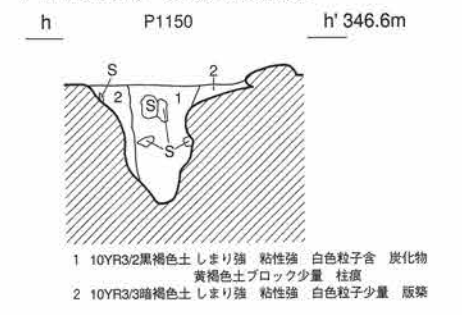
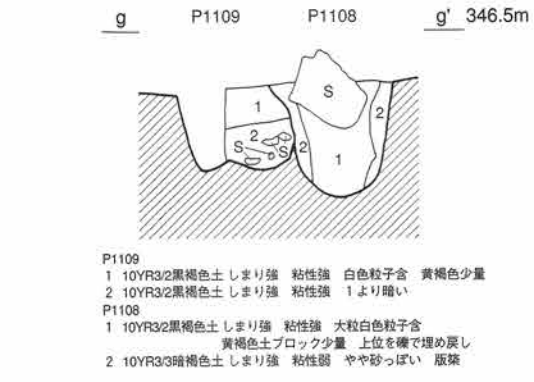
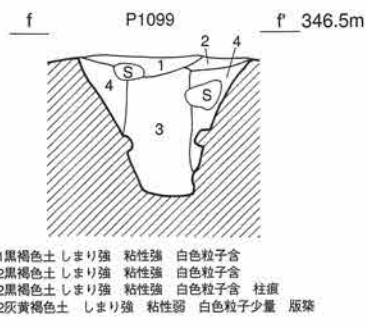
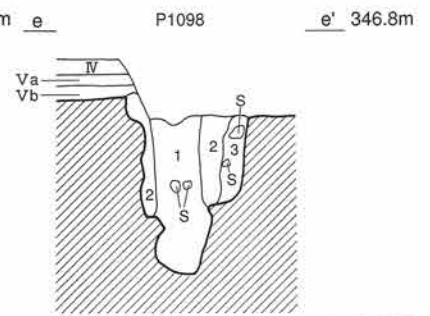
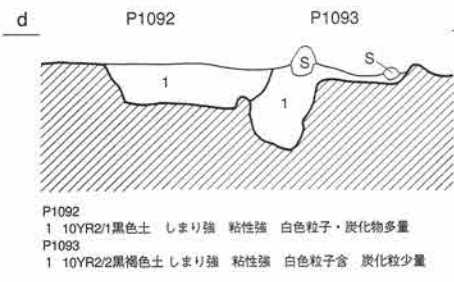
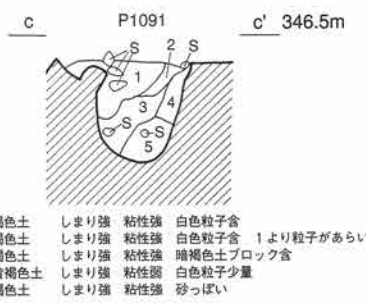
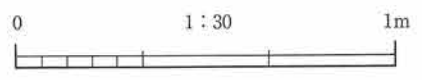
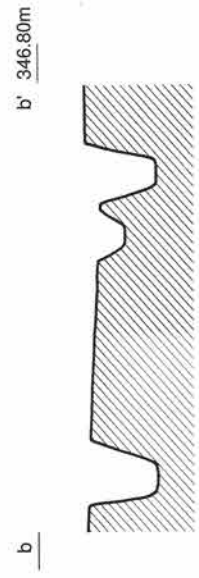
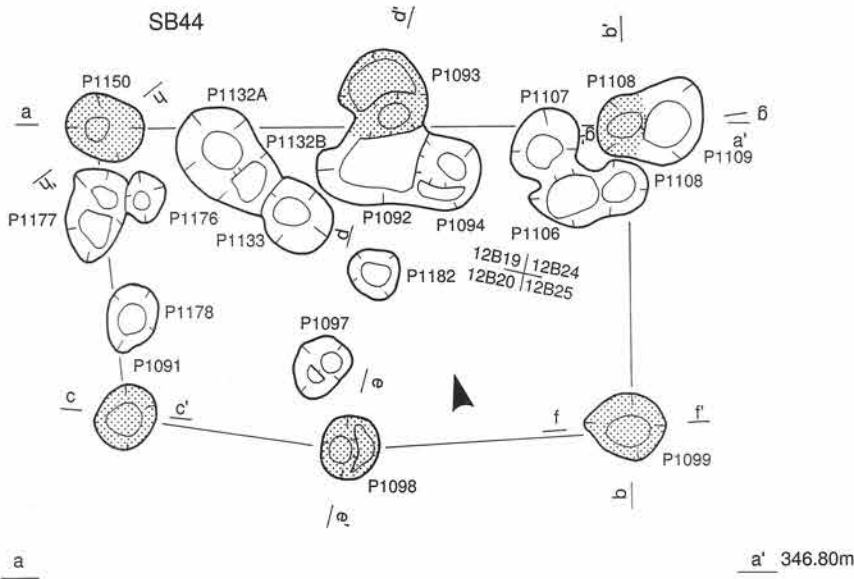

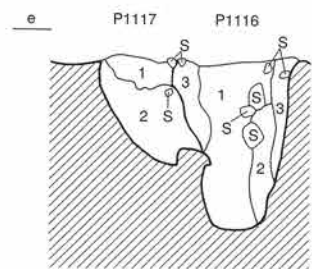
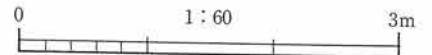
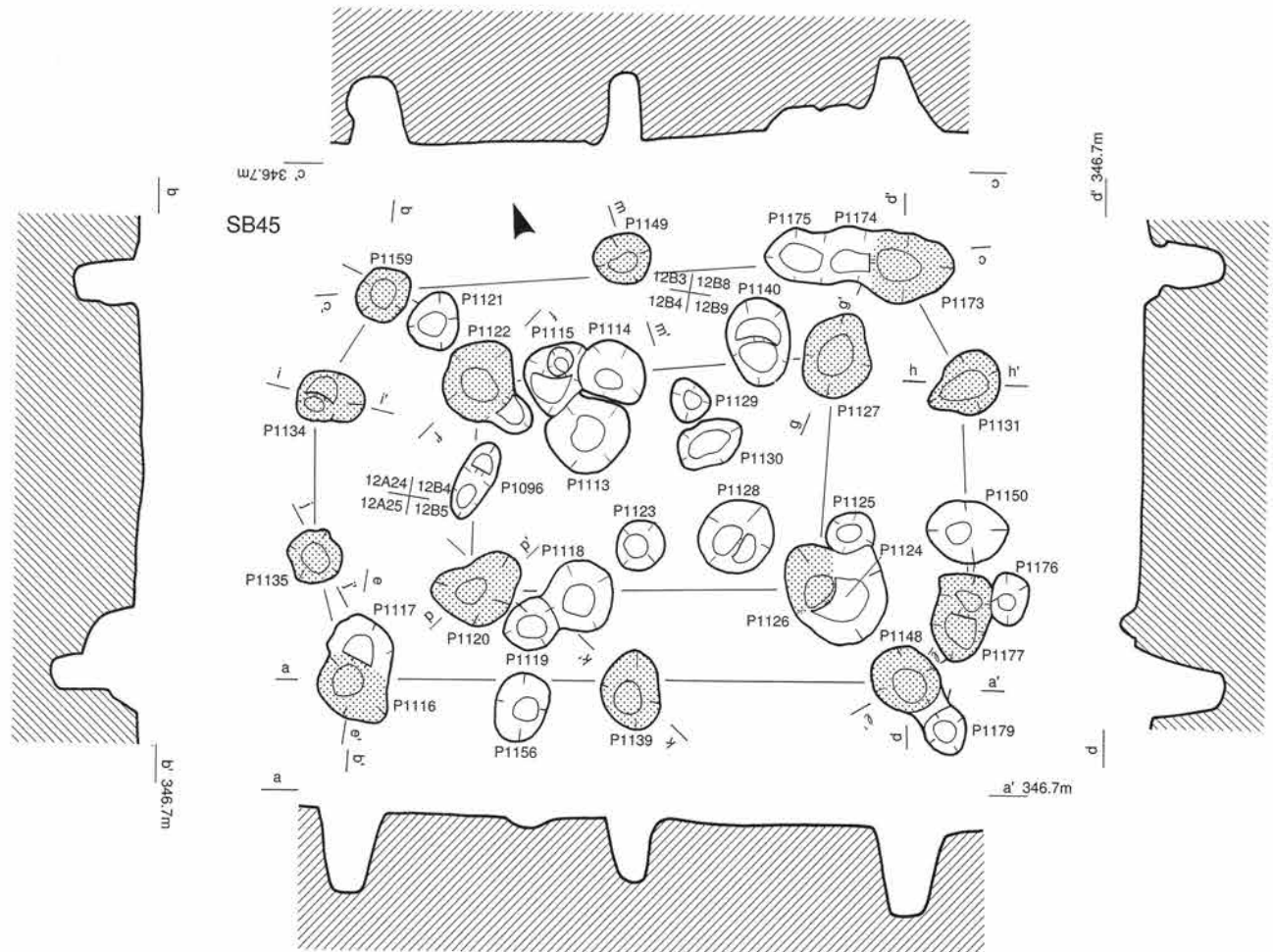

- P1117**
 1 10YR2/2黒褐色土 しまり強 粘性あり 白色粒子含む
 2 10YR2/3暗褐色土 しまり強 粘性あり 白色粒子少量 やや砂っぽい
- P1116**
 1 10YR2/1黒色土 しまり強 粘性あり 白色粒子多量
 炭化粒少量 黄褐色土ブロック少量 柱痕
 2 10YR2/2黒褐色土 しまり強 粘性あり 白色粒子少量 やや砂っぽい 版築
 3 10YR3/2黒褐色土 しまり強 粘性なし 白色粒子少量

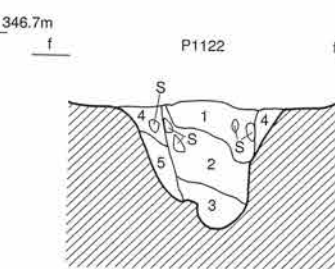

- P1122**
 1 10YR3/2黒褐色土 しまり強 粘性あり 白色粒子含
 2 10YR3/1黒褐色土 しまり強 粘性あり 白色粒子含
 3 10YR3/1黒褐色土 しまり強 粘性弱 白色粒子含
 4 10YR3/3暗褐色土 しまり強 粘性弱 白色粒子少量
 5 10YR4/3にぶい黄褐色土 しまり弱 粘性なし

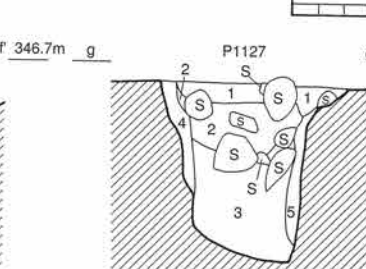

- P1127**
 1 10YR3/2黒褐色土 しまり強 粘性弱 白色粒子含 埋め戻し
 2 10YR2/2黒褐色土 しまり強 粘性弱 白色粒子含 埋め戻し
 3 10YR3/2黒褐色土 しまり強 粘性弱 白色粒子少量
 4 10YR3/3暗褐色土 しまり強 粘性なし 白色粒子含 版築
 5 10YR2/2黒褐色土 しまり強 2より粘性あり 版築

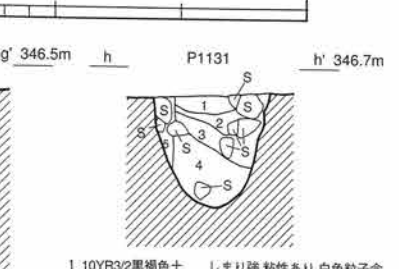

- P1131**
 1 10YR3/2黒褐色土 しまり強 粘性あり 白色粒子含
 2 10YR3/2黒褐色土 しまり強 粘性あり 白色粒子含
 3 10YR3/2黒褐色土 しまり強 粘性あり 白色粒子含
 4 10YR2/2黒褐色土 しまり強 粘性あり 白色粒子・炭化粒少量
 5 10YR4/2灰黄褐色土 しまり強 粘性弱 版築

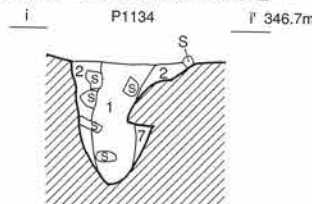

- P1134**
 1 10YR3/2黒褐色土 しまり強 粘性あり 白色粒子含 柱痕
 2 10YR4/2灰黄褐色土 しまり弱 粘性なし 砂っぽい 版築

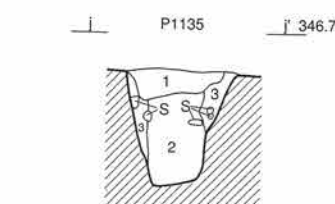

- P1135**
 1 10YR3/3暗褐色土 しまり強 粘性あり 白色粒子少量
 2 10YR3/2黒褐色土 しまり強 粘性あり 白色粒子多量 柱痕
 3 10YR4/2灰黄褐色土 しまり弱 粘性弱 砂多量 版築

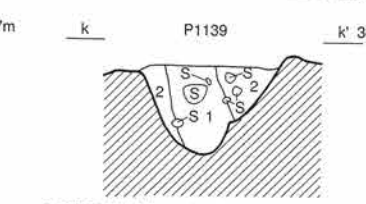

- P1139**
 1 10YR2/2黒褐色土 しまり強 粘性あり 白色粒子含 柱痕
 2 10YR2/2黒褐色土 しまり強 粘性あり 1より砂っぽい 版築

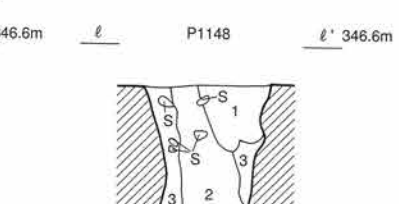

- P1148**
 1 10YR3/2黒褐色土 しまり強 粘性あり 白色粒子多量
 黄褐色土ブロック少量
 2 10YR2/2黒褐色土 しまり強 粘性あり 白色粒子・炭化粒少量 柱痕
 3 10YR2/2黒褐色土 しまり強 粘性弱 砂質土含 版築

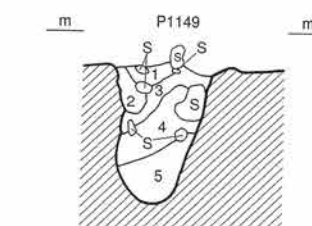

- P1149**
 1 10YR3/2黒褐色土 しまり強 粘性あり 白色粒子含 黄褐色土ブロック少量
 2 10YR3/2黒褐色土 しまり強 粘性あり 白色粒子少量 黄褐色土砂多量
 3 10YR3/2黒褐色土 しまり強 粘性あり 1よりやや暗い
 4 10YR3/3暗褐色土 しまり強 粘性あり 白色粒子少量
 5 10YR3/3暗褐色土 しまり強 粘性なし 砂多量

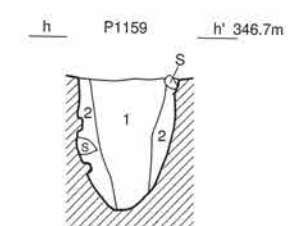

- P1159**
 1 10YR3/2黒褐色土 しまり強 粘性あり 白色粒子含 砂少量 柱痕
 2 10YR3/3暗褐色土 しまり強 粘性弱 白色粒子少量 やや砂っぽい 版築

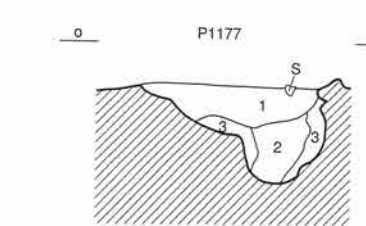

- P1177**
 1 10YR3/2黒褐色土 しまり強 粘性あり 白色粒子含
 2 10YR3/2黒褐色土 しまり強 粘性あり 白色粒子少量
 1より粒子あらい
 3 10YR3/3暗褐色土 しまり強 粘性弱 やや砂っぽい 版築

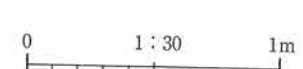

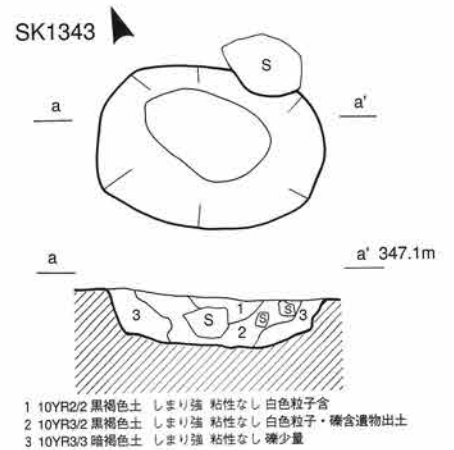
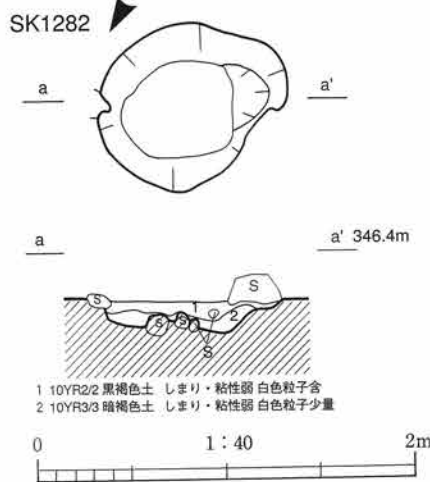
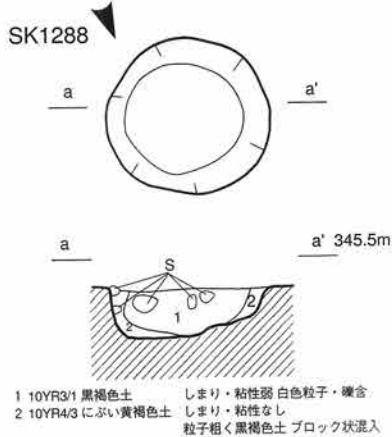
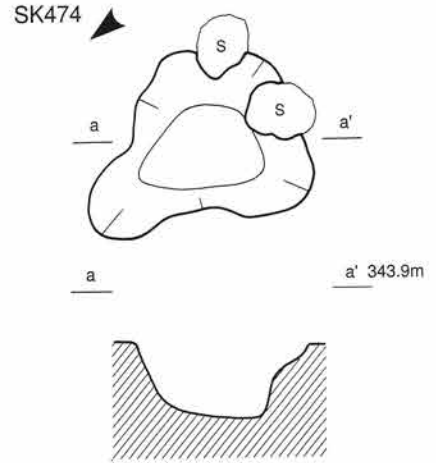
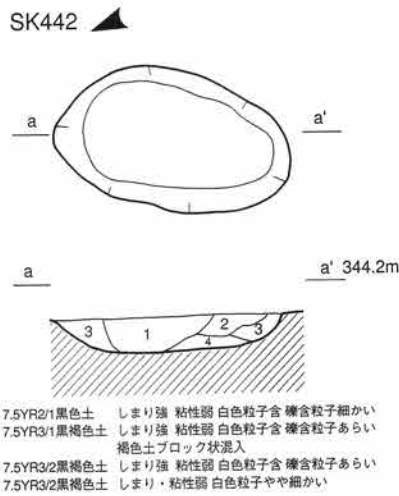
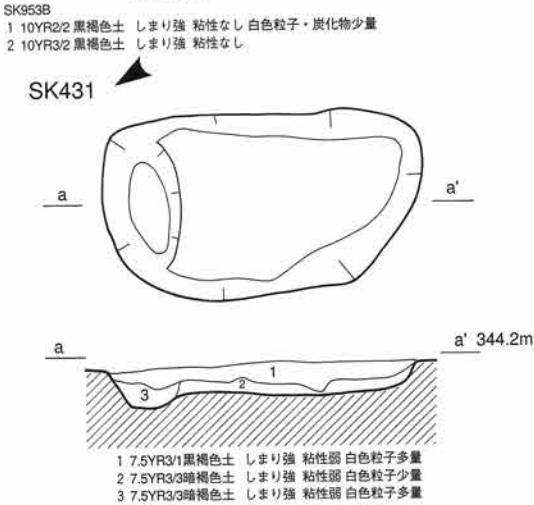
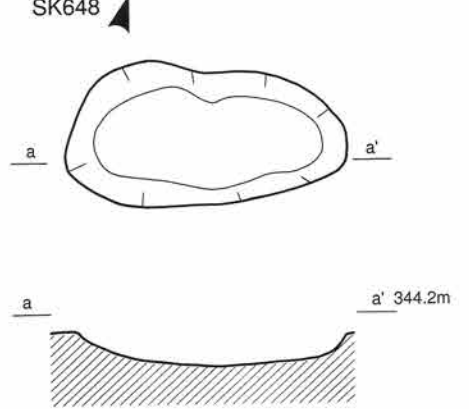
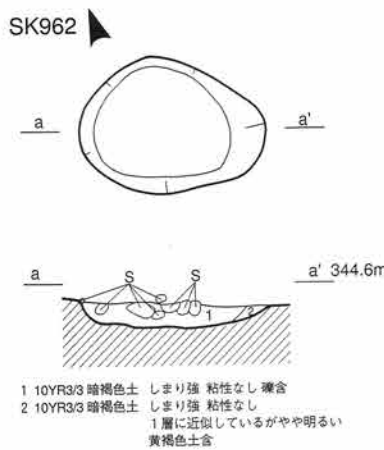
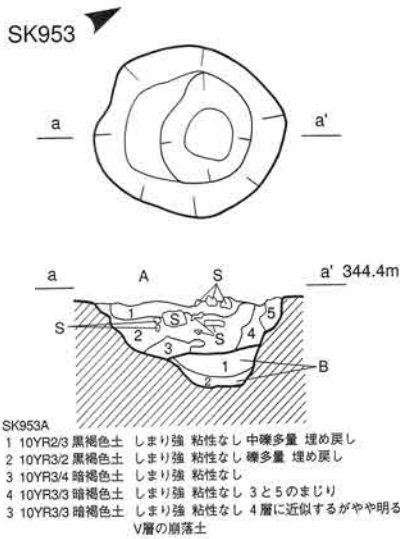
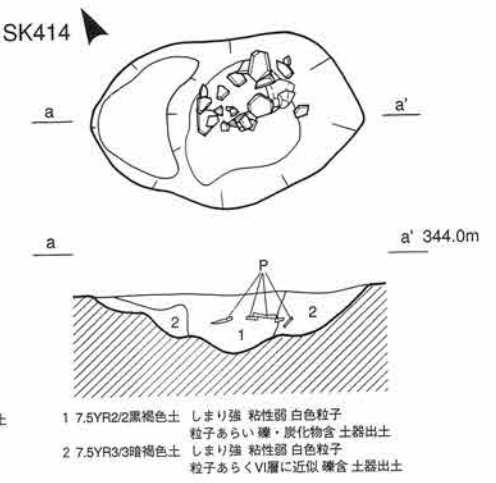
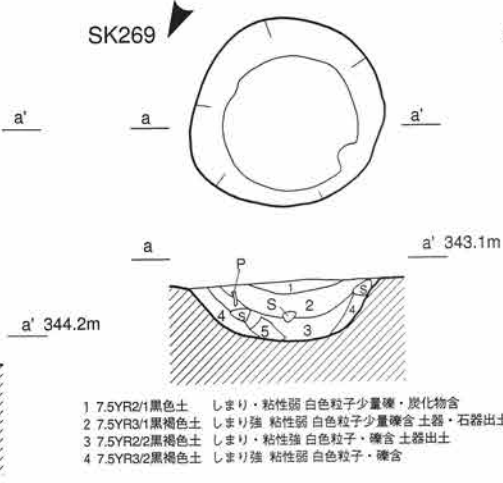
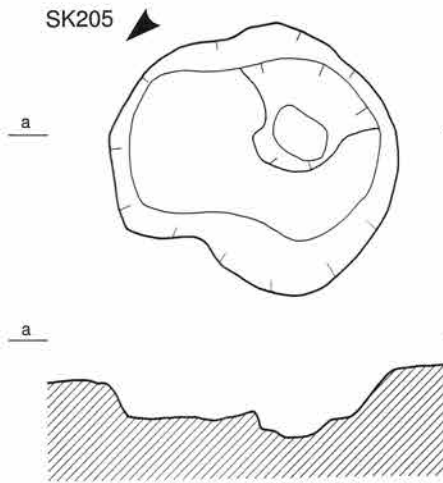

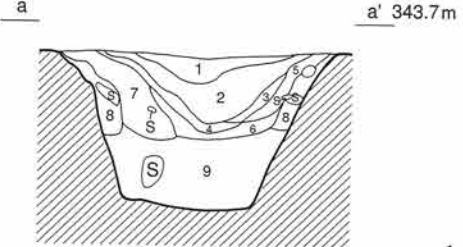
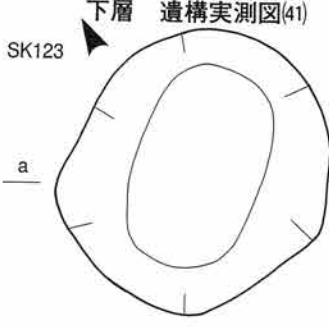

- | | | | |
|---|---------------|-----------|------------|
| 1 | 10YR1.7/1 黒色土 | しまり・粘性弱 | 土器出土 |
| 2 | 10YR1.7/1 黒色土 | しまり強 粘性弱 | 白色粒子含 土器出土 |
| 3 | 10YR2/1 黒色土 | しまり・粘性強 | 白色粒子含 |
| 4 | 10YR2/1 黒色土 | しまり・粘性強 | 黒色の度合い強い |
| 5 | 10YR2/2 黒褐色土 | しまり強 粘性弱 | 白色粒子少量 |
| 6 | 10YR2/1 黒色土 | しまり強 粘性弱 | 礫・白色粒子多量 |
| 7 | 10YR2/2 黒褐色土 | しまり強 粘性なし | 白色粒子含 |
| 8 | 10YR3/3 暗褐色土 | しまり強 粘性なし | 地山の礫含 |
| 9 | 10YR2/2 黒褐色土 | しまり強 粘性なし | 礫・白色粒子含 |

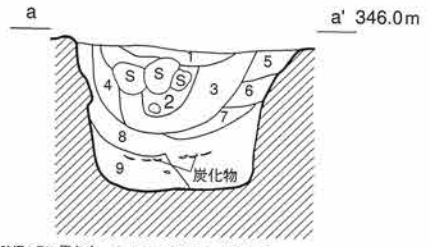
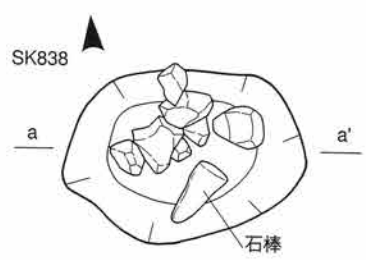

- | | | | |
|---|----------------|----------|------------------------|
| 1 | 10YR1.7/1 黒色土 | しまり・粘性弱 | 木の根含 |
| 2 | 10YR3/1 黒褐色土 | しまり強 粘性弱 | 大礫・白色粒子・土器出土 |
| 3 | 10YR3/1 黒褐色土 | しまり強 粘性弱 | 大礫・白色粒子含 褐色土ブロック混入土器出土 |
| 4 | 10YR2/2 黒褐色土 | しまり強 粘性弱 | 白色粒子含褐色ブロック混入 |
| 5 | 10YR3/3 暗褐色土 | しまり強 粘性弱 | 小礫・白色粒子含 |
| 6 | 10YR3/3 暗褐色土 | しまり強 粘性弱 | 炭化物含5層に比べ褐色土ブロック多量に混入 |
| 7 | 10YR3/4 暗褐色土 | しまり強 粘性弱 | 炭化物少量含 |
| 8 | 10YR4/3 ぶい黄褐色土 | しまり強 | 白色粒子少量炭化物含 |
| 9 | 10YR3/3 暗褐色土 | しまり強 | 白色粒子少量炭化物筋状に混入 |

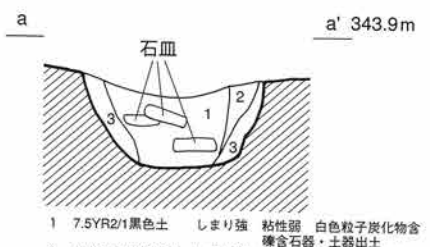
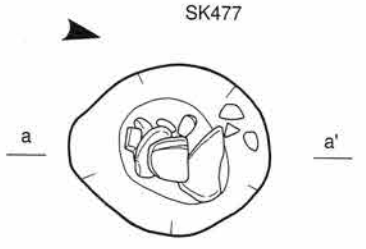

- | | | | |
|---|---------------|----------|--------------------|
| 1 | 7.5YR2/1 黒色土 | しまり強 粘性弱 | 白色粒子炭化物含 礫含石器・土器出土 |
| 2 | 7.5YR3/1 黒褐色土 | しまり強 粘性弱 | 白色粒子・礫含 |
| 3 | 7.5YR3/2 黒褐色土 | しまり強 粘性弱 | 白色粒子・礫含 |

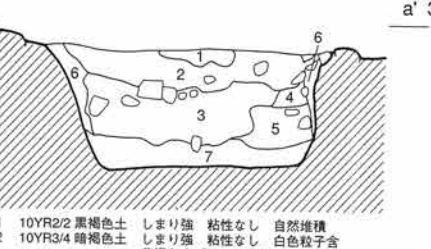
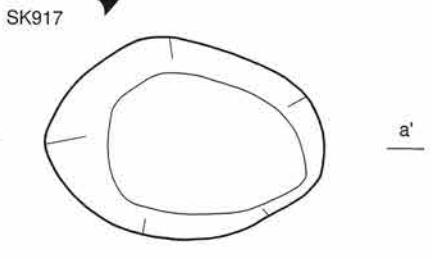

- | | | | |
|---|----------------|-----------|------------------------|
| 1 | 10YR2/2 黒褐色土 | しまり強 粘性なし | 自然堆積 |
| 2 | 10YR3/4 暗褐色土 | しまり強 粘性なし | 白色粒子含 |
| 3 | 10YR3/3 暗褐色土 | しまり強 粘性なし | 黄褐色土ブロック状混入付近におけるVgに近似 |
| 4 | 10YR3/4 暗褐色土 | しまり強 粘性なし | 白色粒子少量・土器・石器・礫含 |
| 5 | 10YR3/3 暗褐色土 | しまり強 粘性なし | 2層と似ているが黄褐色土は含まない |
| 6 | 10YR4/4 褐色土 | しまり強 粘性なし | 壁面崩落の土 |
| 7 | 10YR3/4 暗褐色土砂質 | しまり強 粘性なし | 覆土(3,4,5)と地山の土が混じった土 |

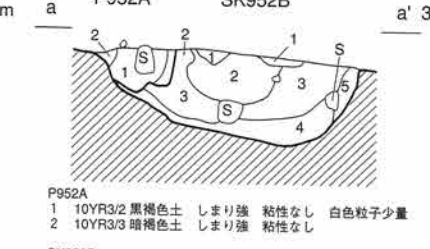
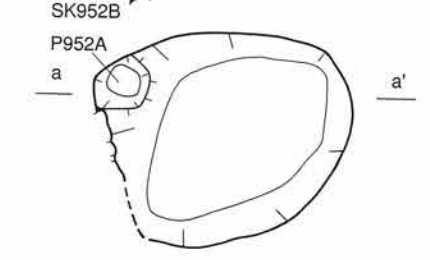

- | | | | |
|--------|--------------|-----------|-----------------|
| P952A | | | |
| 1 | 10YR3/2 黒褐色土 | しまり強 粘性なし | 白色粒子少量 |
| 2 | 10YR3/3 暗褐色土 | しまり強 粘性なし | |
| SK952B | | | |
| 1 | 10YR3/2 黒褐色土 | しまり強 粘性なし | 白色粒子少量 |
| 2 | 10YR3/1 黒褐色土 | しまり強 粘性なし | 白色粒子・小礫少量 |
| 3 | 10YR3/2 黒褐色土 | しまり強 粘性なし | 白色粒子少量 |
| 4 | 10YR3/3 暗褐色土 | しまり強 粘性なし | |
| 5 | 10YR3/3 暗褐色土 | しまり強 粘性なし | 4層に近似しているがやや明るい |

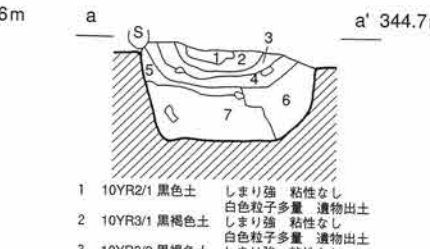
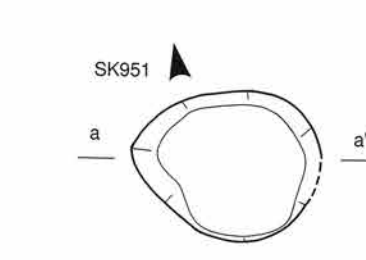

- | | | | |
|---|--------------|-----------|----------------------|
| 1 | 10YR2/1 黒色土 | しまり強 粘性なし | 白色粒子多量 遺物出土 |
| 2 | 10YR3/1 黒褐色土 | しまり強 粘性なし | 白色粒子多量 遺物出土 |
| 3 | 10YR3/2 黒褐色土 | しまり強 粘性なし | 白色粒子多量 遺物出土 |
| 4 | 10YR3/3 暗褐色土 | しまり強 粘性なし | 遺物出土 |
| 5 | 10YR3/3 暗褐色土 | しまり強 粘性なし | 4層に近似しているがやや明るい 遺物出土 |
| 6 | 10YR3/4 暗褐色土 | しまり強 粘性なし | 粒子あらい |
| 7 | 10YR3/4 暗褐色土 | しまり強 粘性なし | |

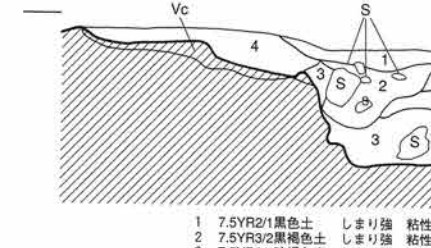
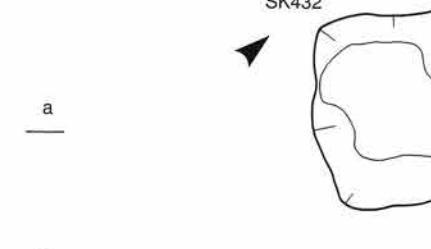

- | | | | |
|---|---------------|----------|--------------------------|
| 1 | 7.5YR2/1 黒色土 | しまり強 粘性弱 | 白色粒子多量 遺物含 炭化物多量 |
| 2 | 7.5YR3/2 黒褐色土 | しまり強 粘性弱 | 白色粒子多量 中礫含 遺物含 大礫多量 埋め戻し |
| 3 | 7.5YR3/4 暗褐色土 | しまり強 粘性弱 | 粘性弱粒状ややあらくどらついている |
| 4 | 7.5YR3/3 暗褐色土 | しまり強 粘性弱 | 白色粒子含 |
| 5 | 7.5YR3/4 暗褐色土 | しまり強 粘性弱 | 白色粒子・小礫含 |

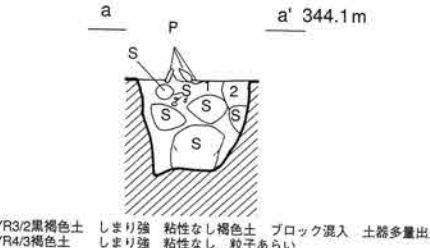
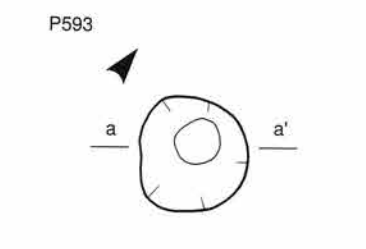

- | | | | |
|---|---------------|-----------|-------------------|
| 1 | 7.5YR3/2 黒褐色土 | しまり強 粘性なし | 褐色土 ブロック混入 土器多量出土 |
| 2 | 7.5YR4/3 褐色土 | しまり強 粘性なし | 粒子あらい |

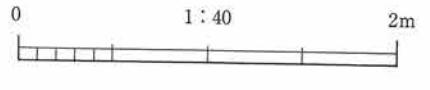

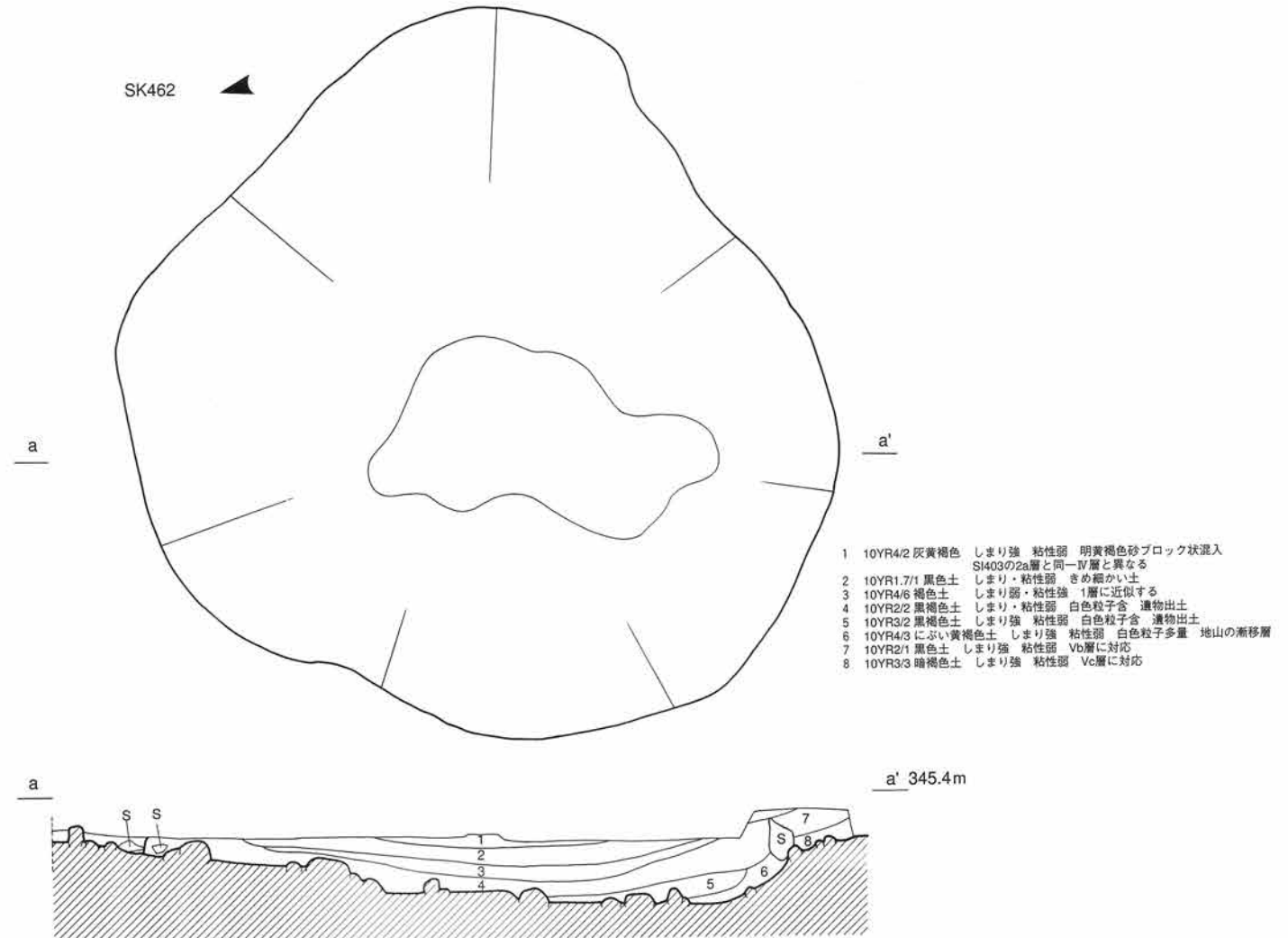
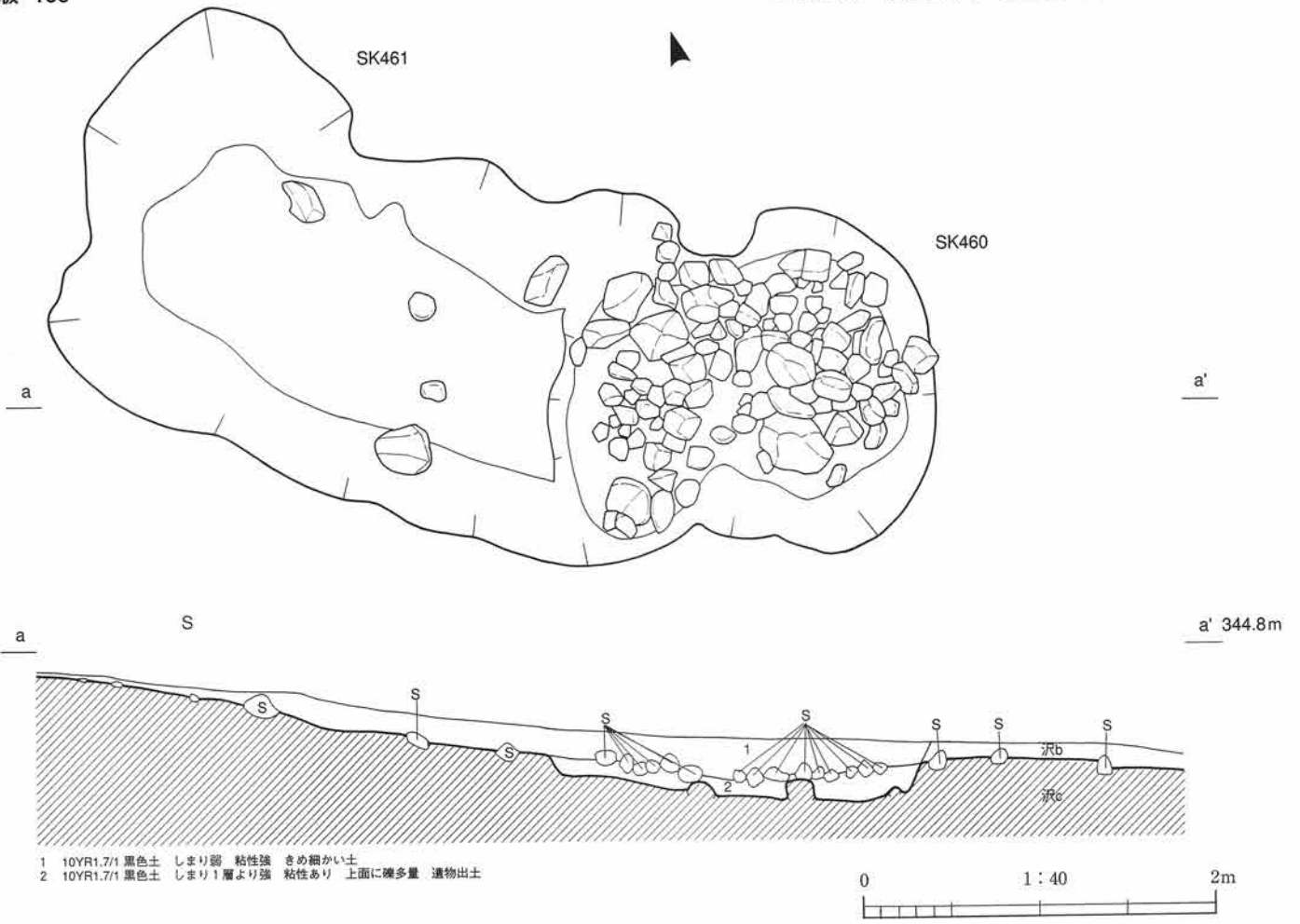

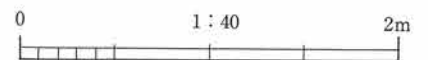
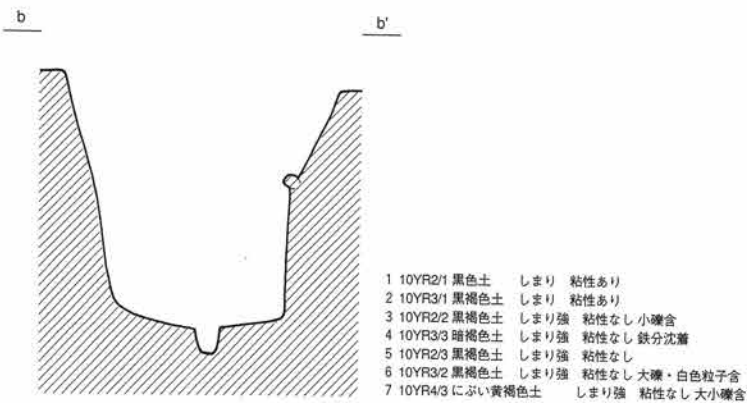
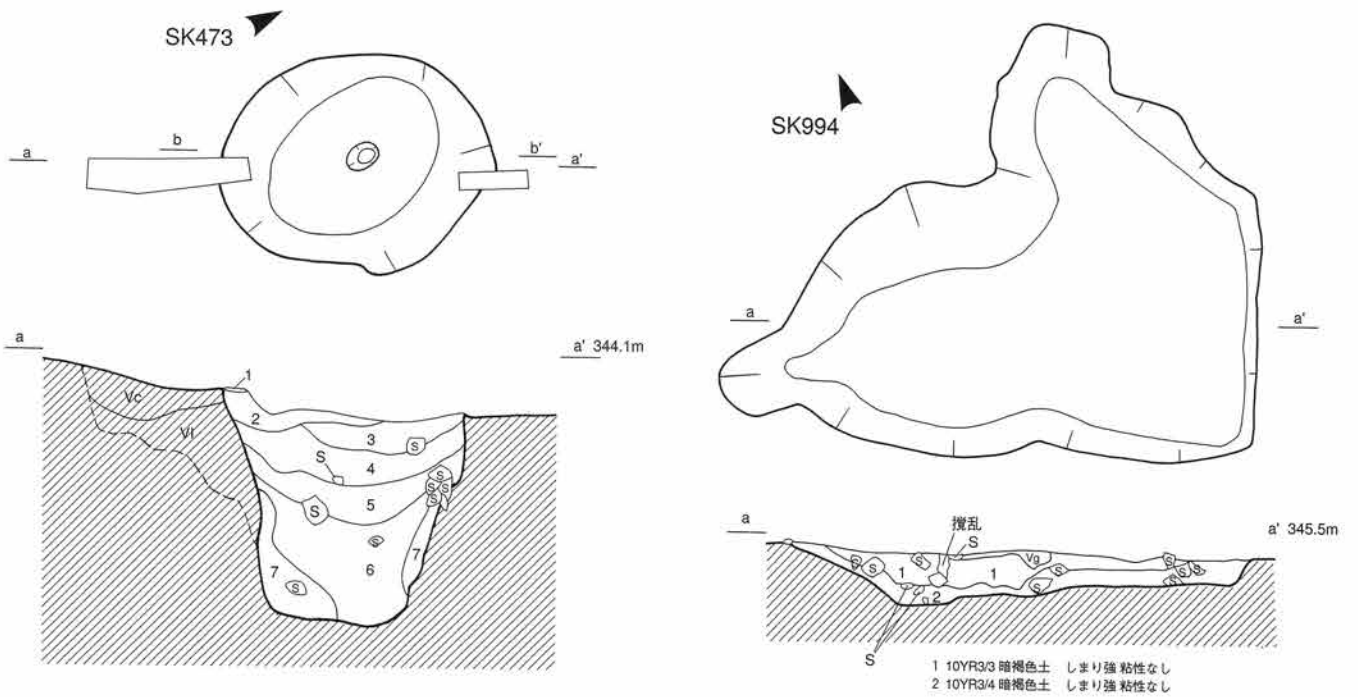
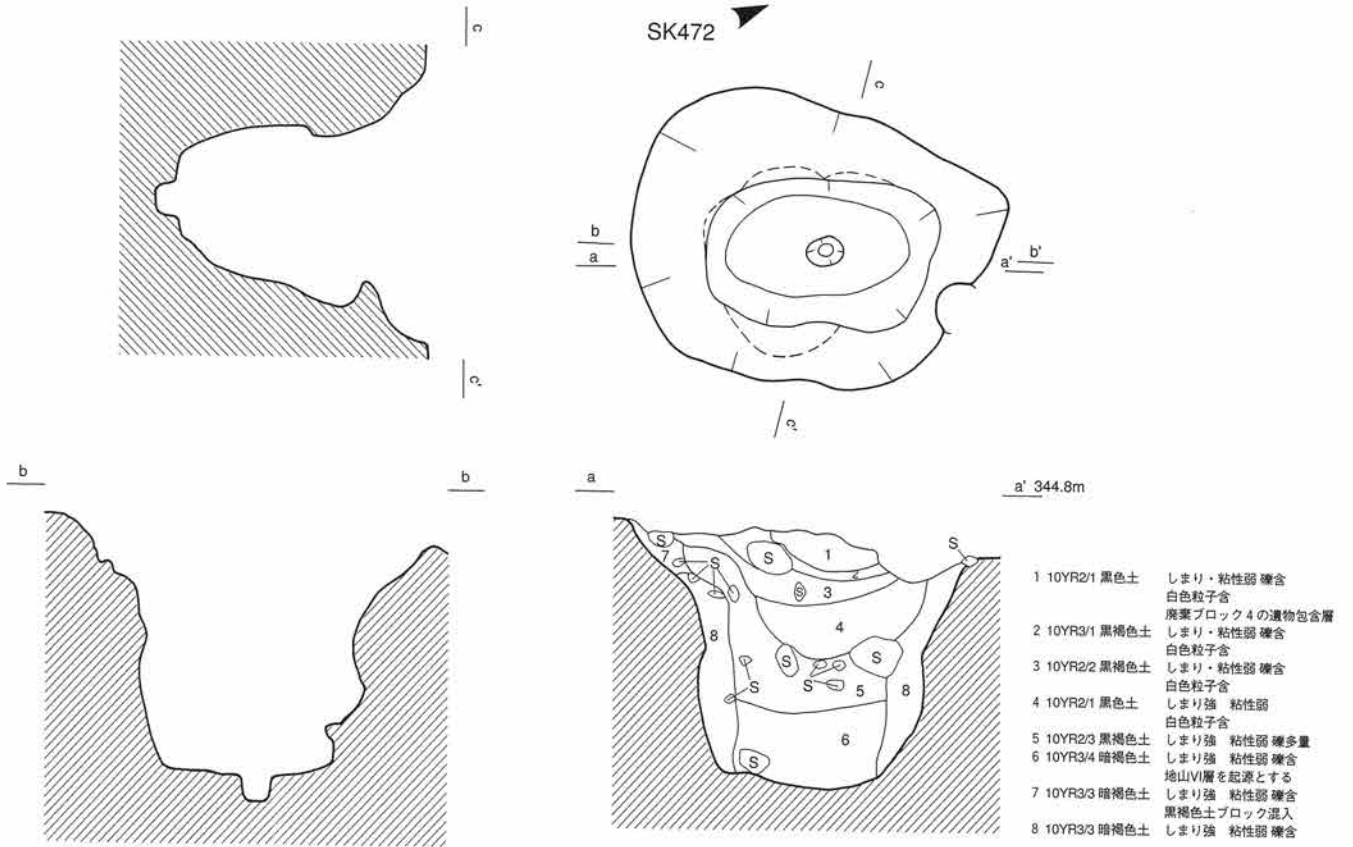

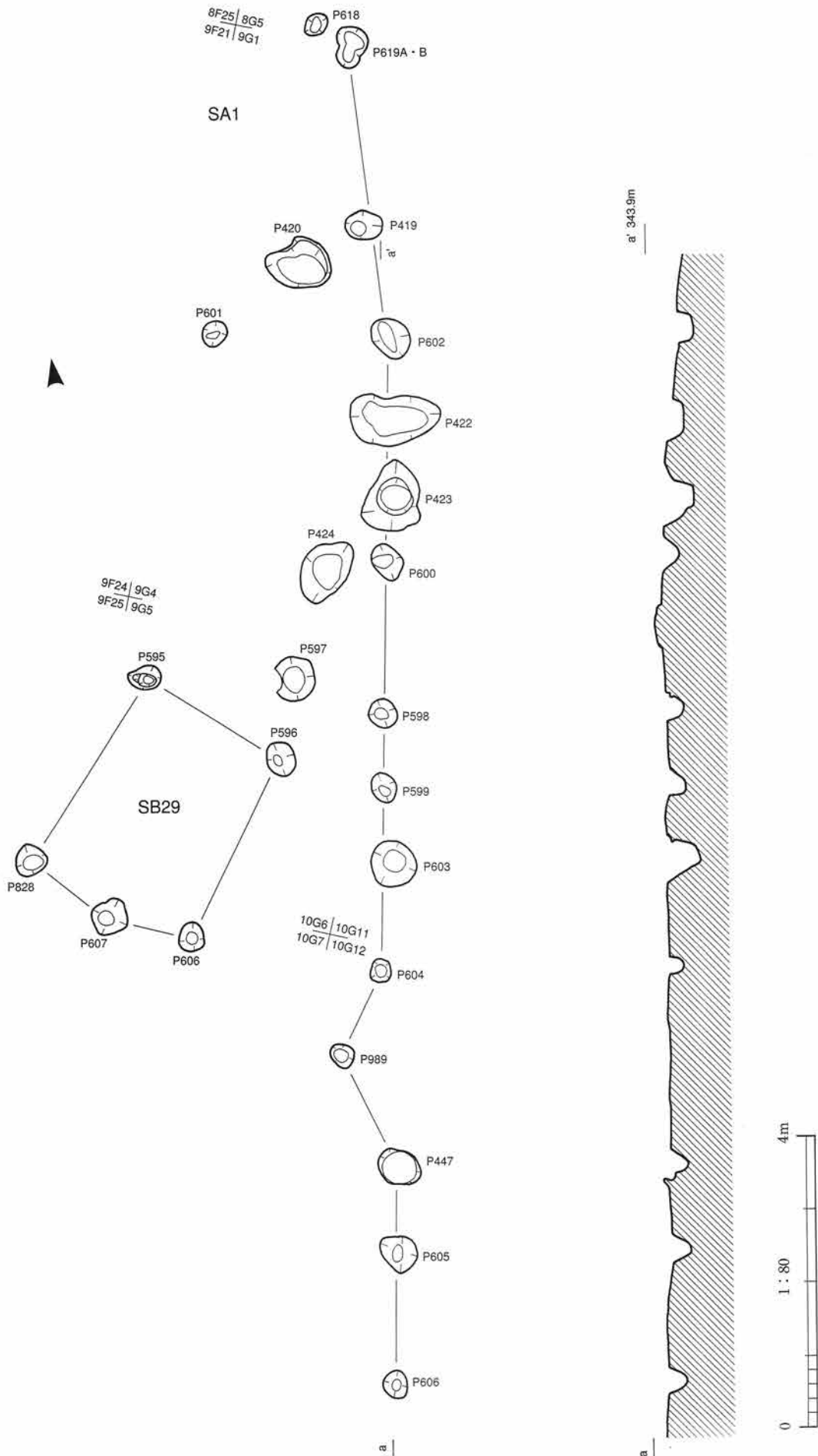

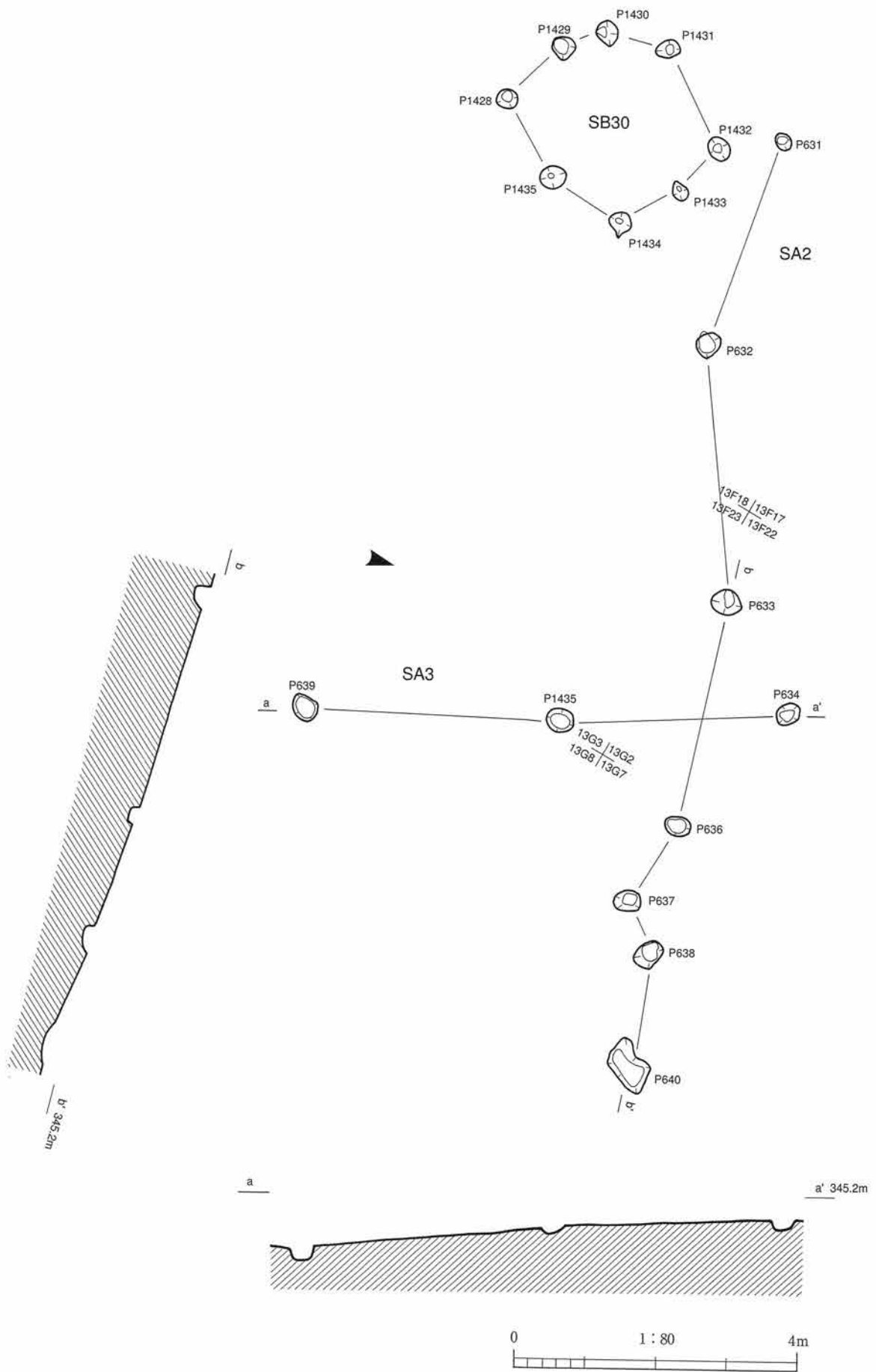

12D25 | 12E5
13D21 | 13E1

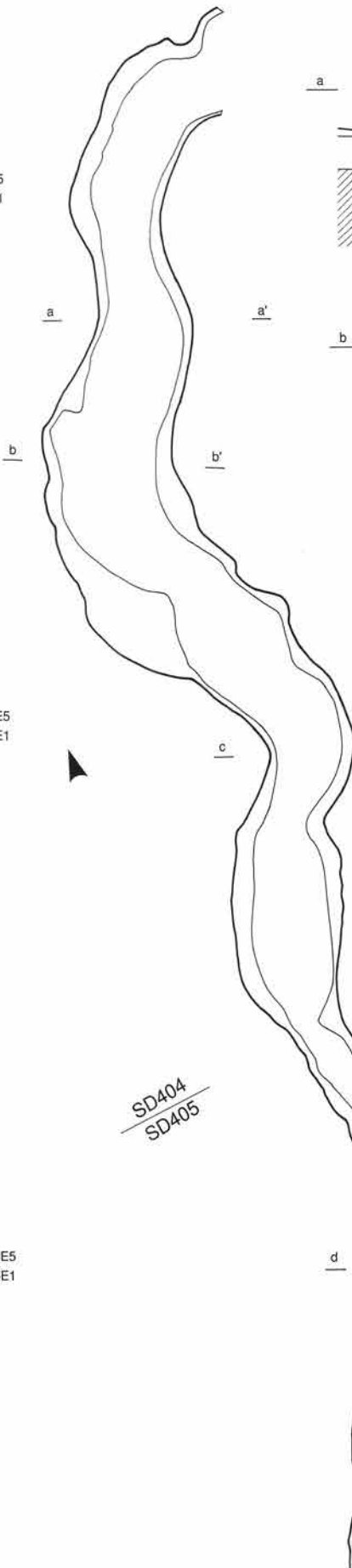

13D25 | 13E5
14D21 | 14E1

14D25 | 14E5
15D21 | 15E1

SD404
SD405

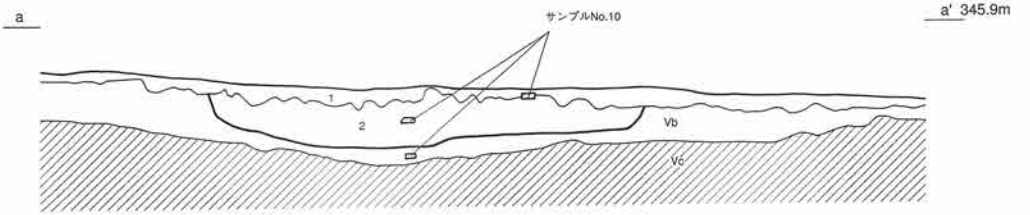

SD404
1 10YR4/3にぶい黄褐色土 しまり・粘性弱 IV層土ブロック状混入
2 7.5YR2/1黒色土 しまり・粘性弱 遺物含

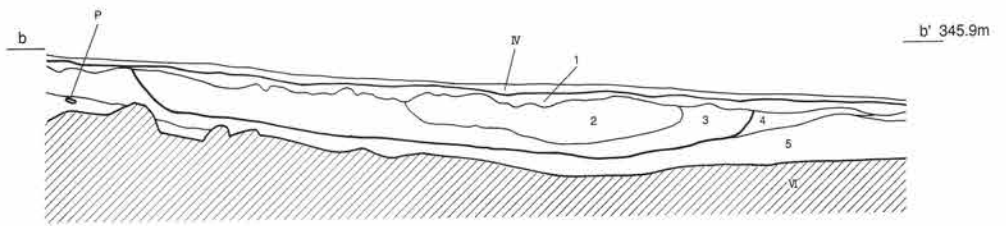

SD404
1 10YR4/3にぶい黄褐色土 しまり・粘性弱 IV層土ブロック状混入 SD404覆土
2 7.5YR2/1黒色土 しまり・粘性弱 遺物含 SD404覆土
3 10YR2/2黒褐色土 しまり・粘性弱 遺物含 Vb層近似 SD404覆土
4 10YR2/2黒褐色土 しまり・粘性弱 Va層近似
5 10YR3/2黒褐色土 しまり強 粘性なし 小礫含 砂質
VI 泥地状のためきめの細かい砂質である 礫少ない

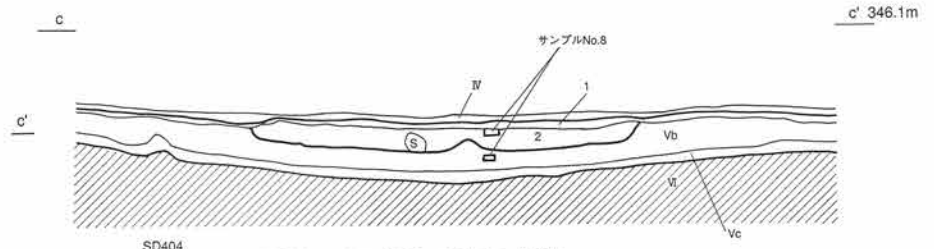

SD404
1 10YR4/3にぶい黄褐色土 しまり・粘性弱 IV層土ブロック状混入
2 7.5YR2/1黒色土 しまり・粘性弱 遺物含

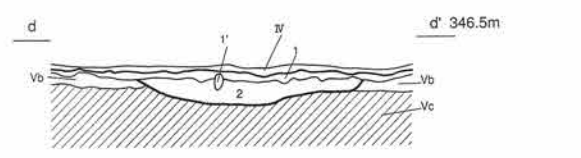

SD405
IV 基本層序IV層の下部
1 10YR4/3にぶい黄褐色土 しまり・粘性弱 IV層土ブロック状混入
1' 7.5YR8/4浅黄褐色土 ブロック状に固まった火砕流
2 7.5YR2/1黒色土 しまり・粘性弱 遺物含

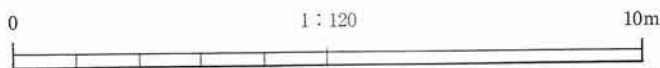
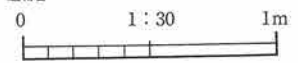

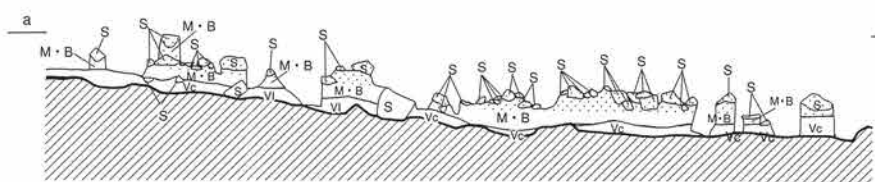
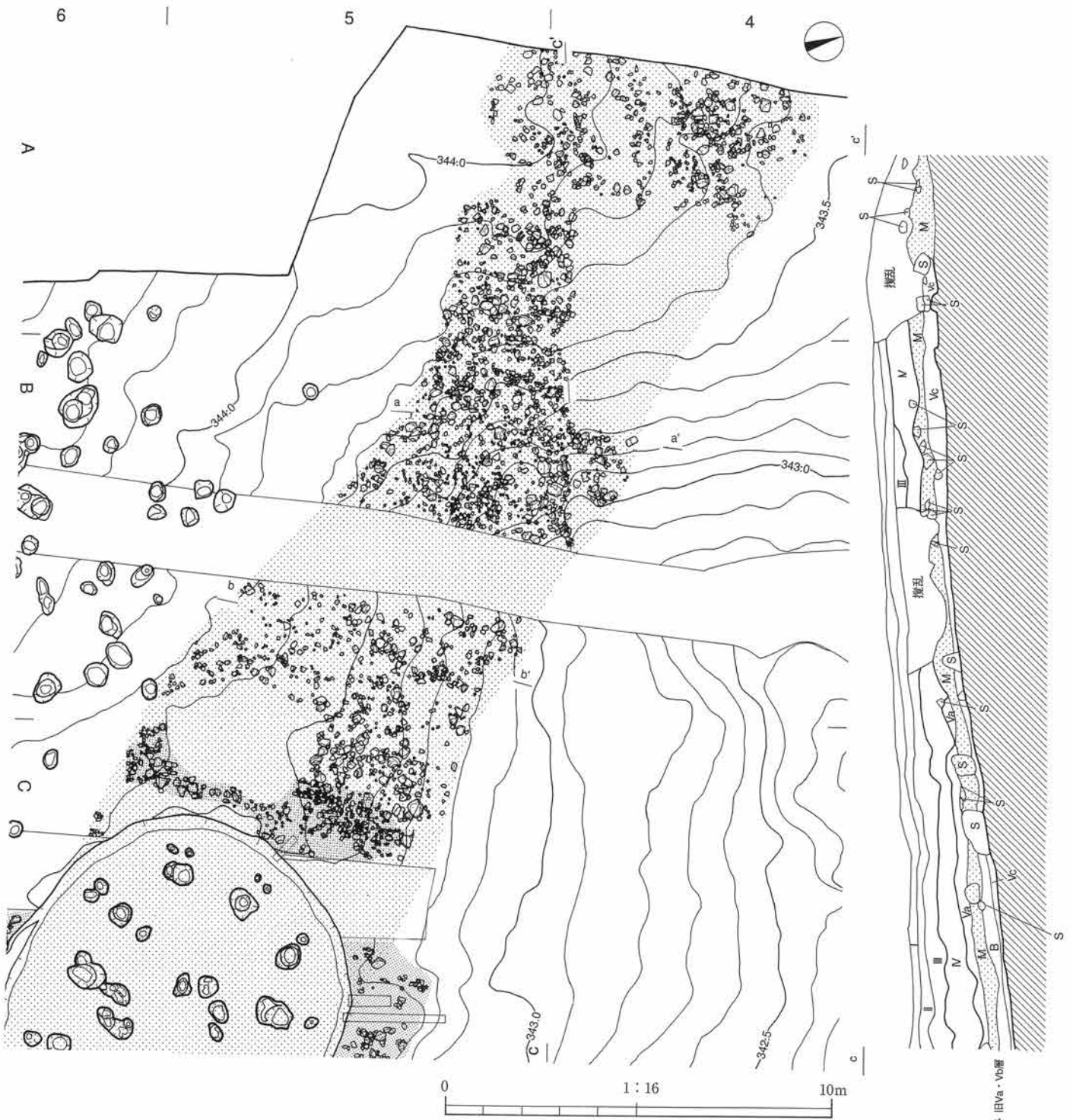

M・B 10YR1.7/1 黒色土 しまり強 粘性弱 白色粒子 (径2~3mm) 含 上面がM, 下がB 旧Vo層
 Vc 10YR1.7/1 黒色土 しまり強 粘性弱 褐色土 (10YR4/4) 混在

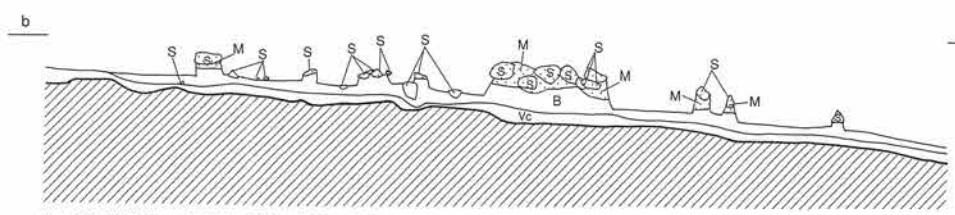

M 10YR1.7/1 黒色土 しまり弱 粘性あり 遺物・礫多量 旧Va・Vb層
 B 10YR1.7/1 黒色土 しまり強 粘性なし 白色粒子含 旧Vo層
 Vc 10YR2/1 黒色土 しまり強 粘性なし 褐色土 (10YR4/4) 混在

- I 7.5YR3/2 黒褐色土 しまり・粘性弱
- II 7.5YR3/1 黒褐色土 しまり・粘性弱
- III 7.5YR2/1 黒色土 しまり弱 粘性強
- IV 10YR5/6 黄褐色土 しまり強 粘性弱
- Va 7.5YR2/1 黒色土 しまり・粘性あり 白色粒子少量
- M 7.5YR2/1 黒色土 しまりあり 粘性弱 白色粒子少量 遺物・礫多 旧Va・Vb層
- B 7.5YR2/1 黒色土 しまりあり 粘性弱 白色粒子少量 旧Vo層
- Vc 7.5YR3/4 暗褐色土 しまり強 粘性弱 白色粒子多量 粒子あらい

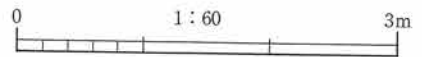

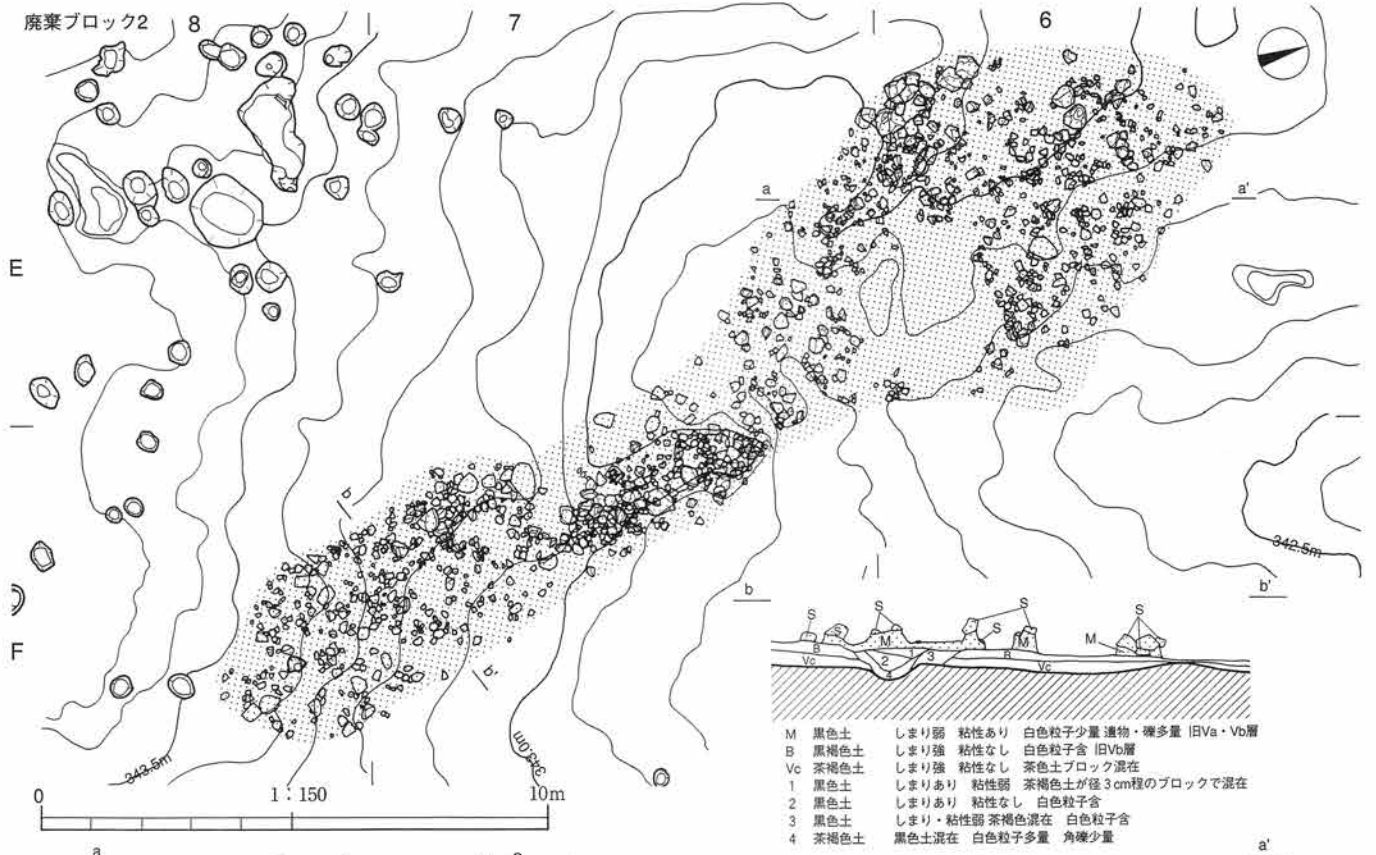

M	黒色土	しまり弱	粘性あり	白色粒子少量	遺物・礫多量	旧Va・Vb層
B	黒褐色土	しまり強	粘性なし	白色粒子含	旧Vb層	
Vc	茶褐色土	しまり強	粘性なし	茶色土ブロック混在		
1	黒色土	しまりあり	粘性弱	茶褐色土が径3cm程のブロックで混在		
2	黒色土	しまりあり	粘性なし	白色粒子含		
3	黒色土	しまり・粘性弱	粘性弱	茶褐色土混在	白色粒子含	
4	茶褐色土	黒色土混在		白色粒子多量	角礫少量	

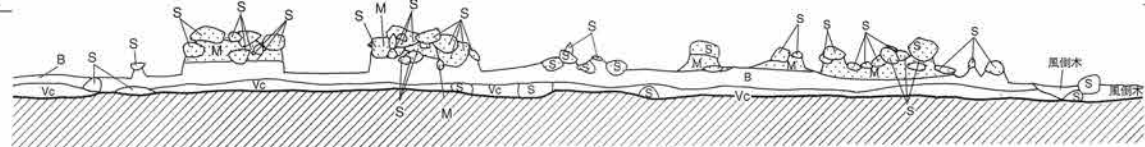

M	7.5YR2/3極暗褐色土	しまり強	粘性弱	白色粒子少量	粒子あらい	地山ブロック含	遺物・礫多量	旧Va・Vb層
B	7.5YR2/1黒色土	しまり強	粘性弱	白色粒子少量	粒子あらい	旧Vb層		
Vc	7.5YR3/3暗褐色土	しまり強	粘性弱	白色粒子多量	粒子細かい			

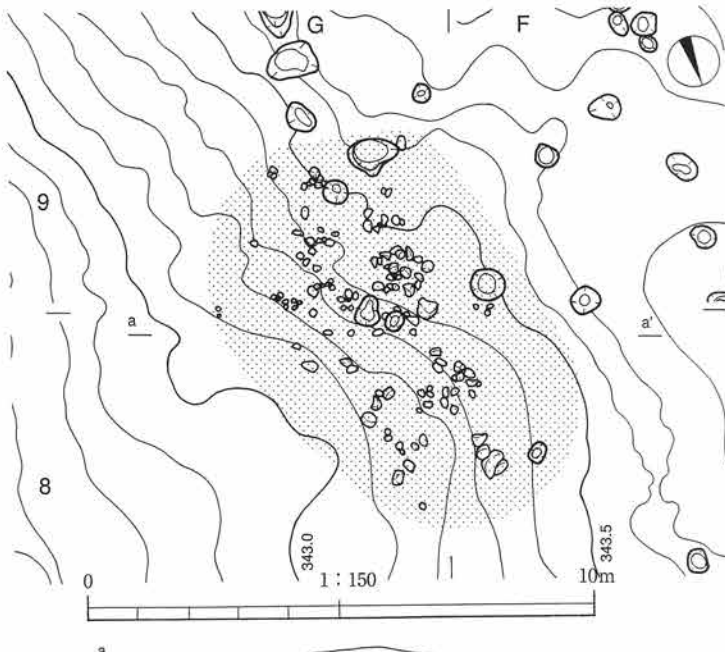
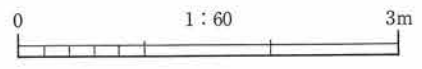

IIa	7.5YR3/1 黒褐色土	しまり・粘性弱				
IIb	7.5YR3/3 暗褐色土	しまり・粘性弱				
III	7.5YR2/1 黒色土	しまり・粘性弱		白色粒子少量		
IVa	10YR5/6 黄褐色土	しまり・粘性弱		暗褐色土混在	粒子あらい	
IVb	10YR5/4 にぶい黄褐色土	しまり・粘性なし		砂状粒子あらい		
IVc	10YR5/3 にぶい黄褐色土	しまり弱	粘性なし	粒子細かい		
IVd	10YR5/4 にぶい黄褐色土	しまり弱	粘性なし	岩石 (大径30cm、小径5cm) 混在		
IVe	7.5YR7/6 橙褐色土	しまり・粘性強		粘土状水分含		
Va	10YR3/3 暗褐色土	しまりあり	粘性弱	白色粒子含		
M	10YR1.7/1 黒色土	しまり強	粘性やや強	地山ブロック・白色粒子混在	遺物・礫含	旧VB層・集石帯黒色土層
Vb・B	10YR2/1 黒色土	しまりあり	粘性なし	白色粒子多量		
Vc	10YR2/2 黒褐色土	しまりあり	粘性なし	白色粒子含		

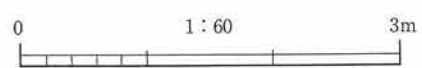
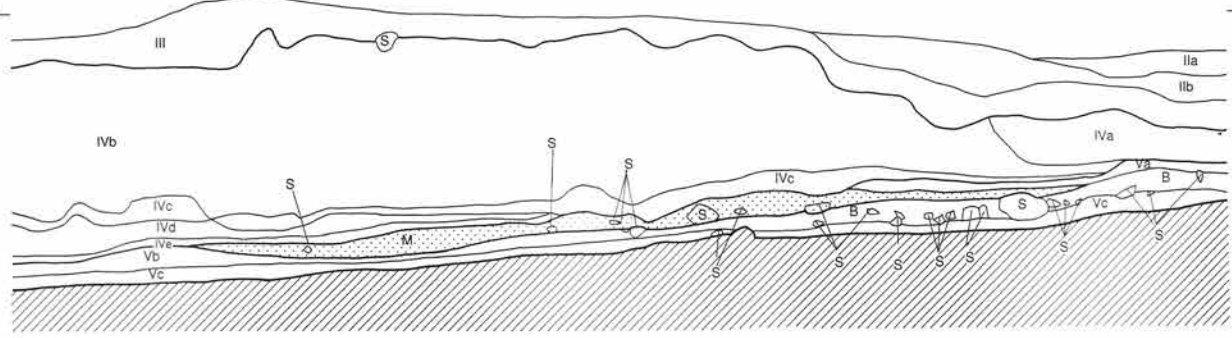

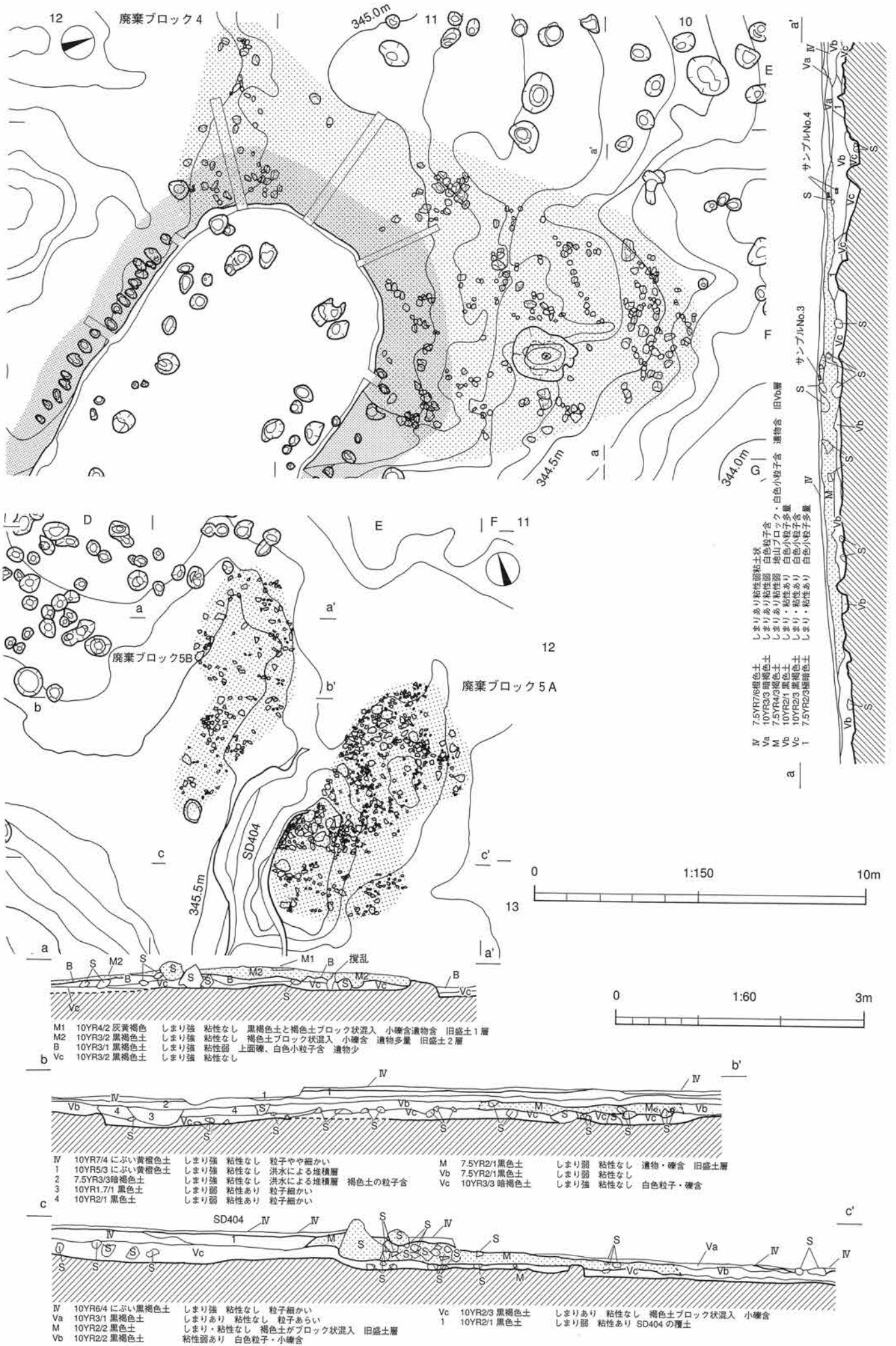

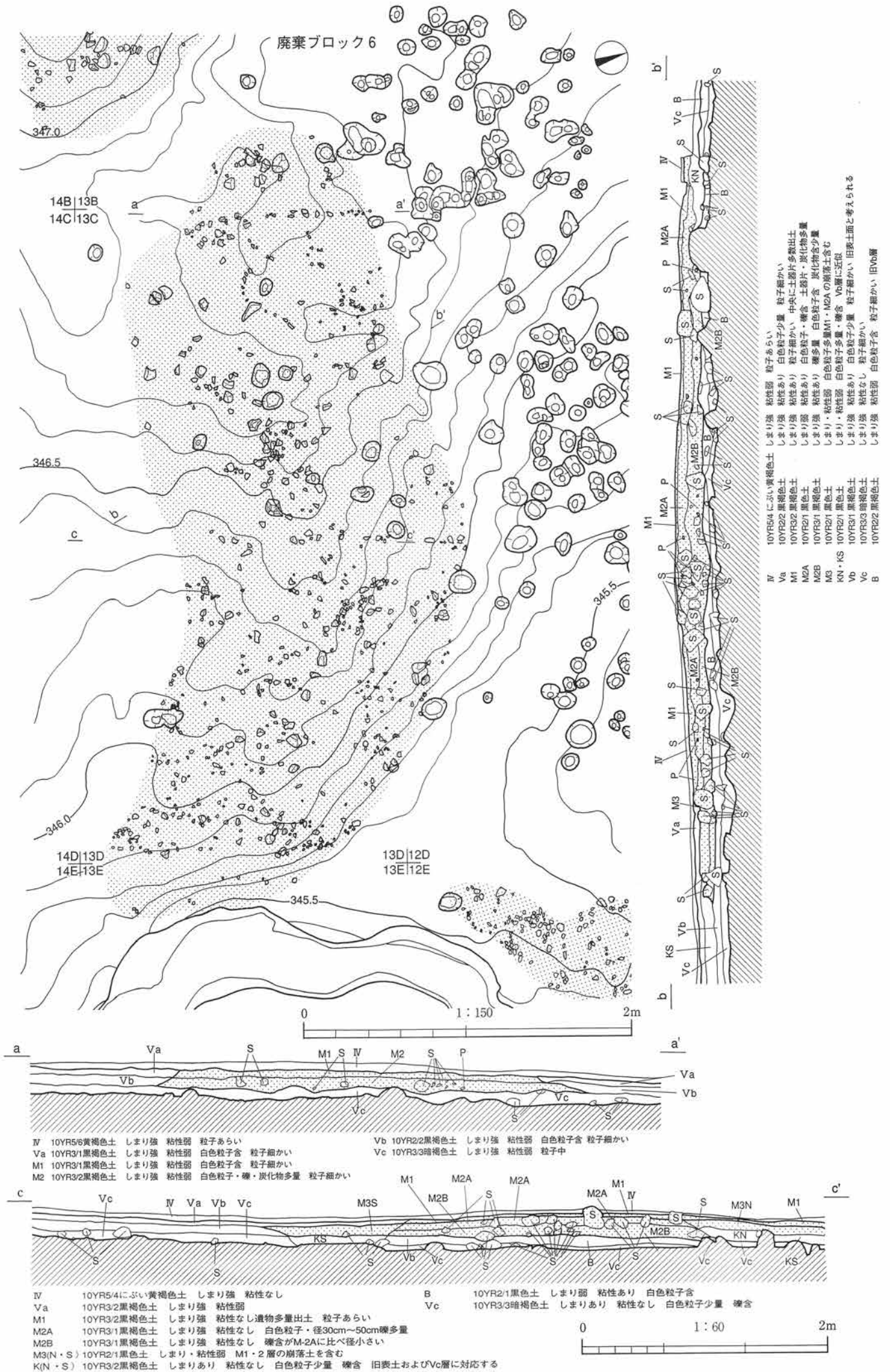

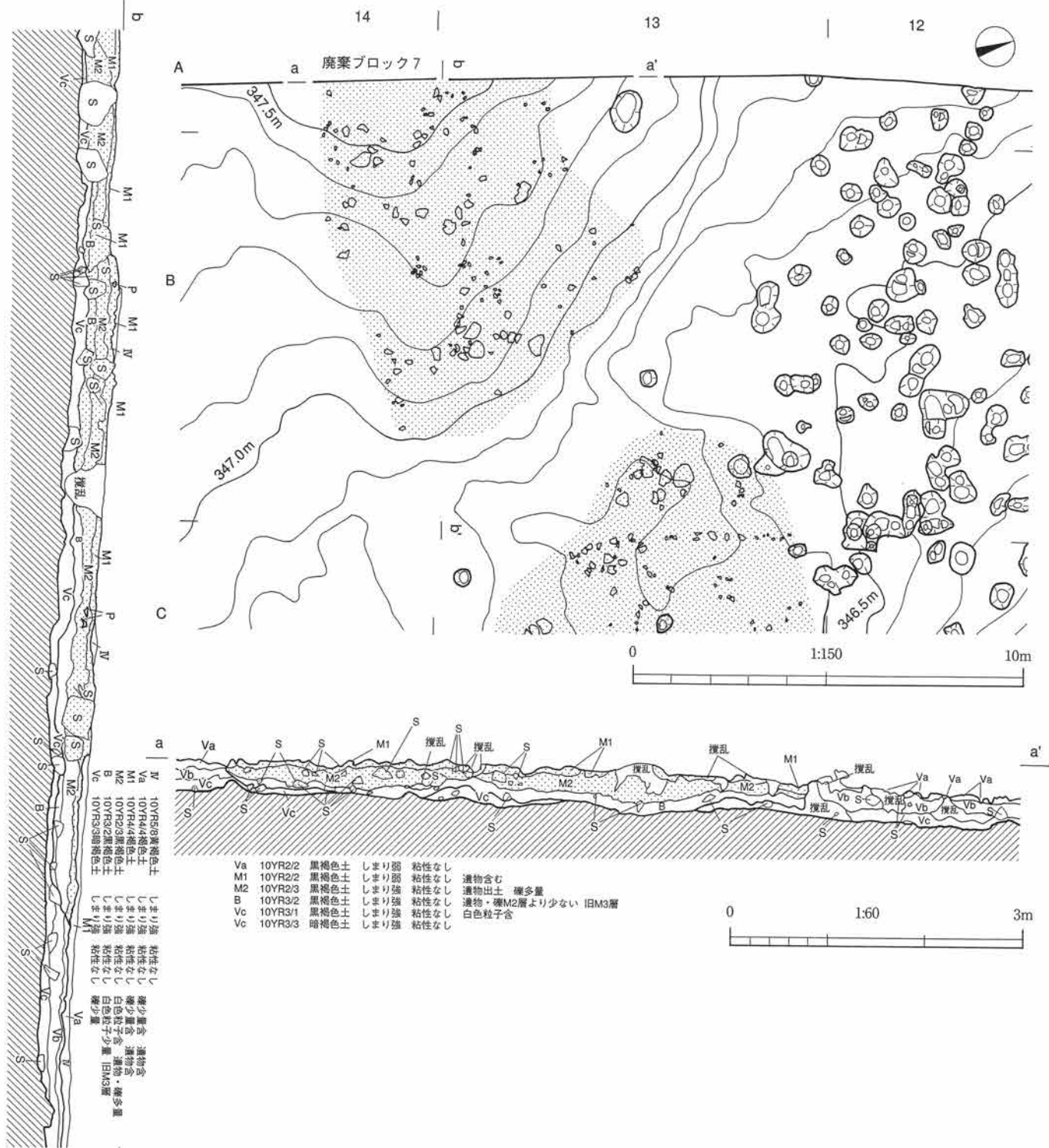

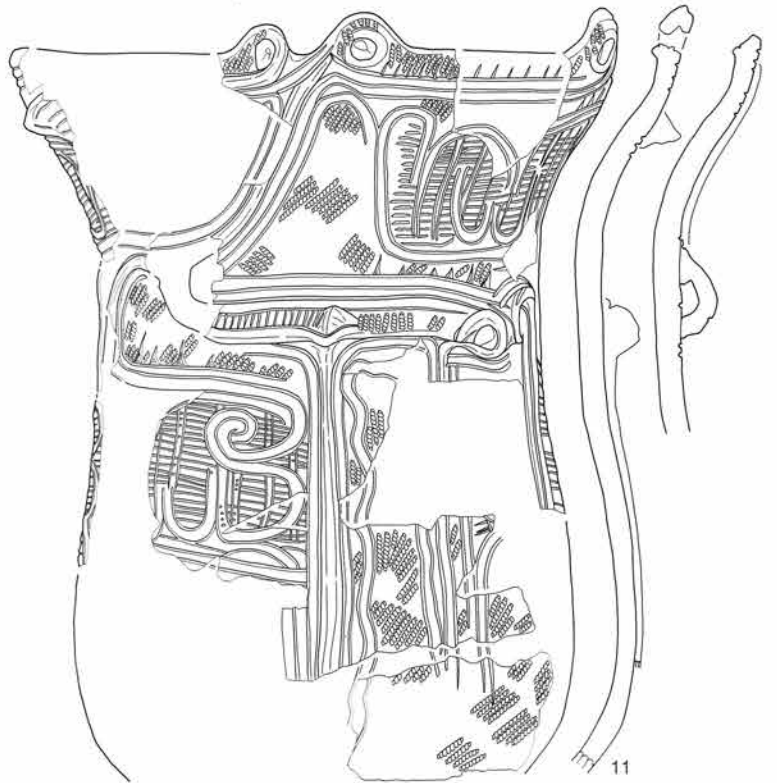
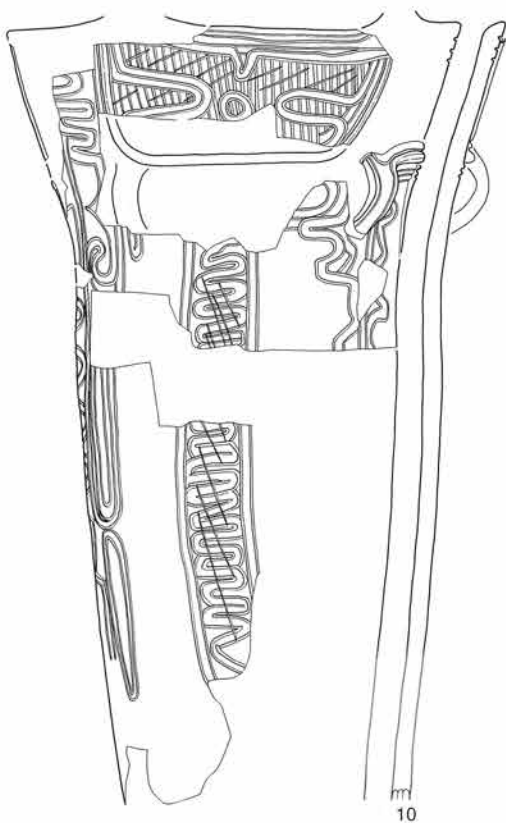
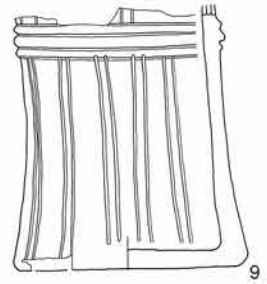
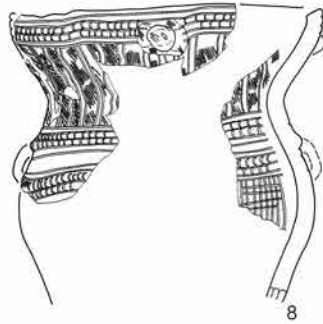
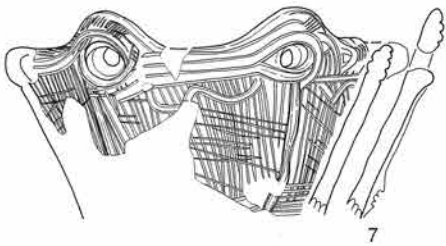
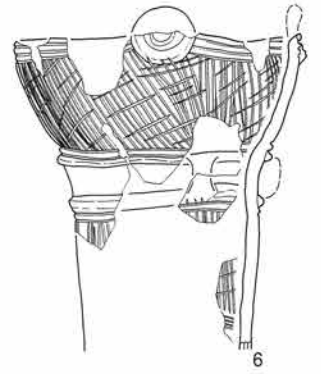
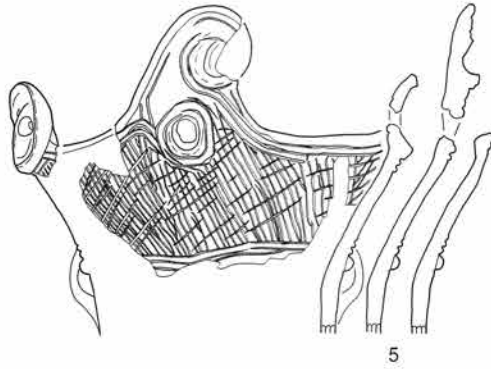
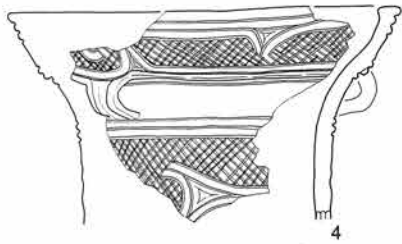
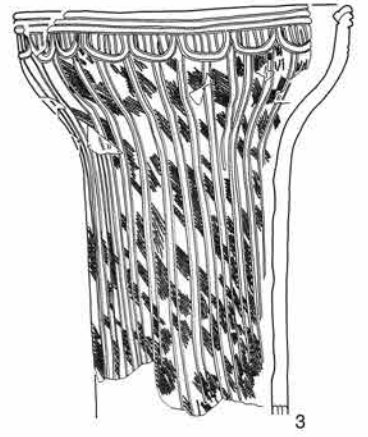
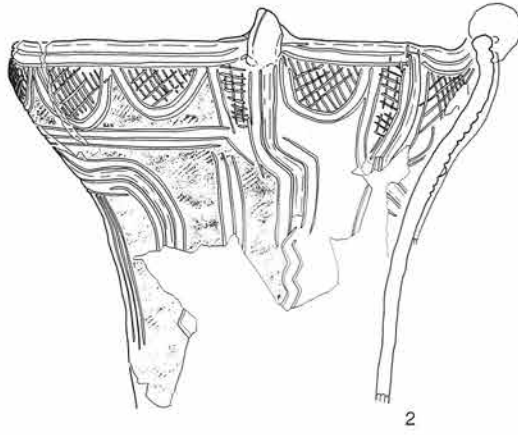
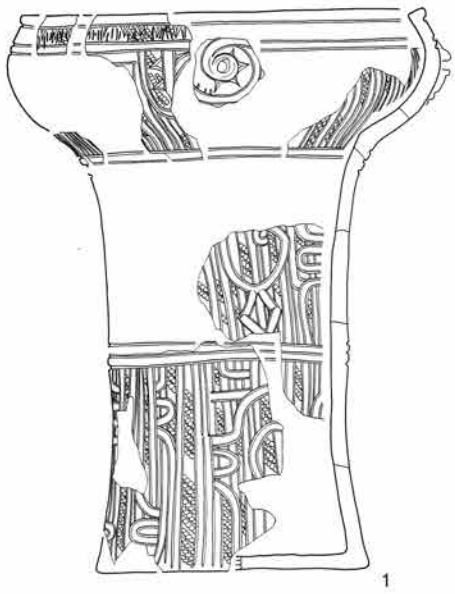

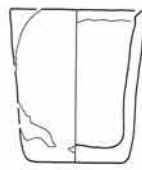
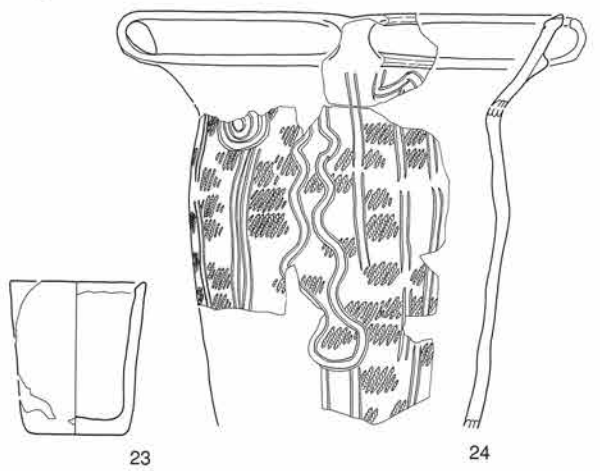
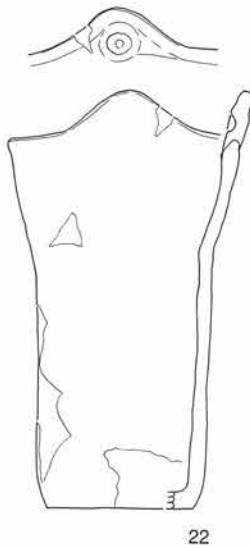
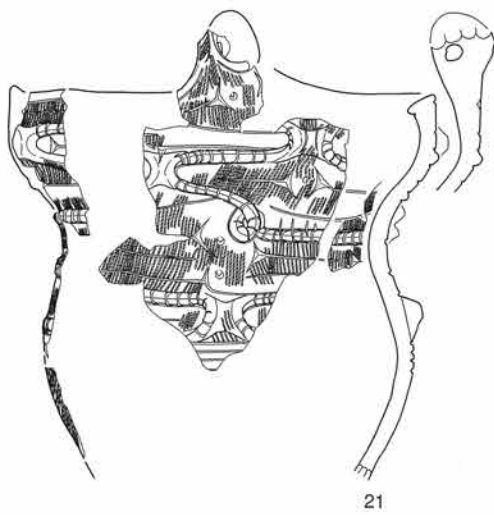
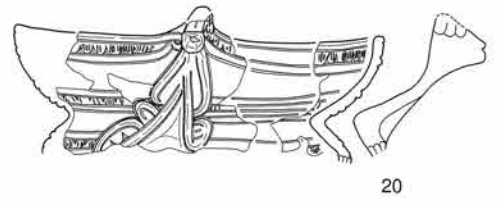
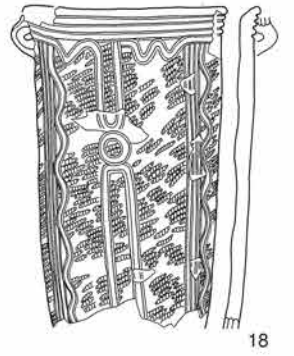
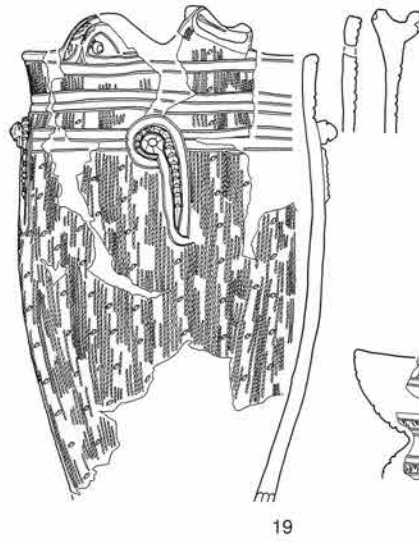
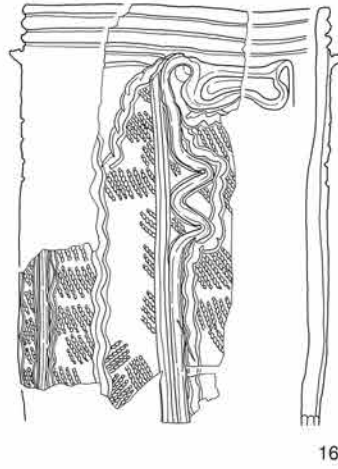
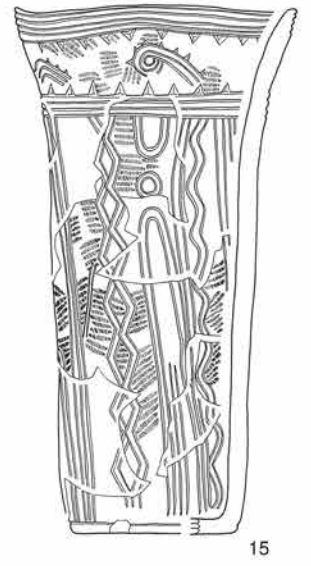
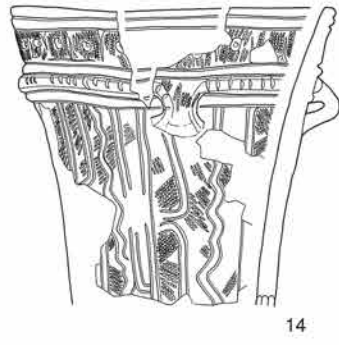

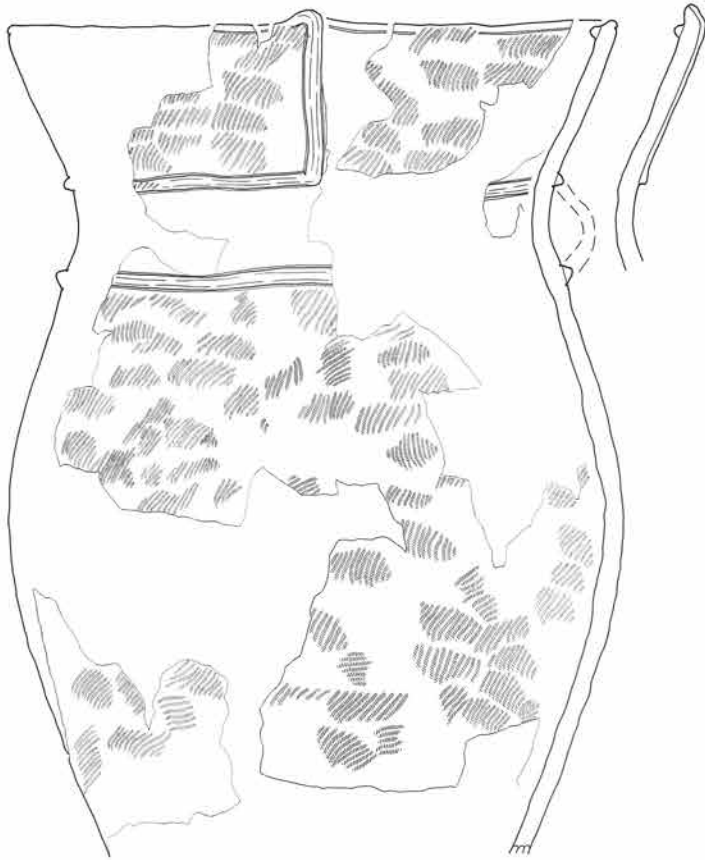

25

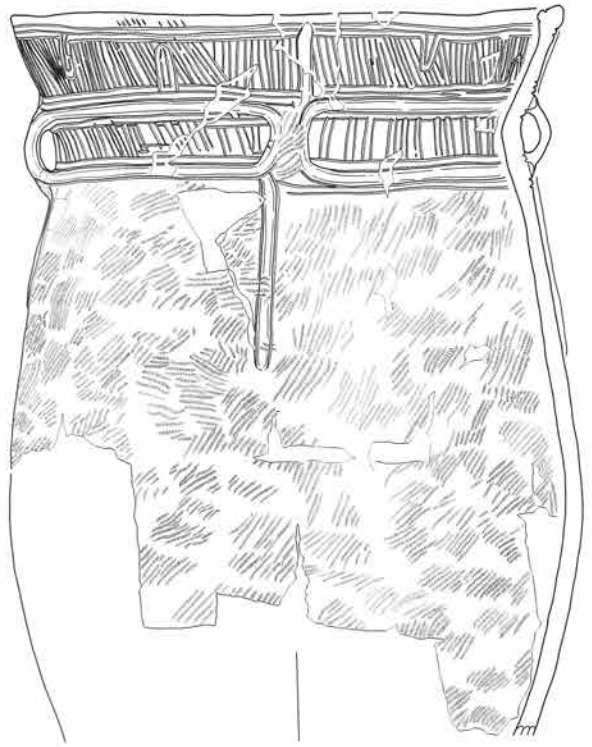

26



27

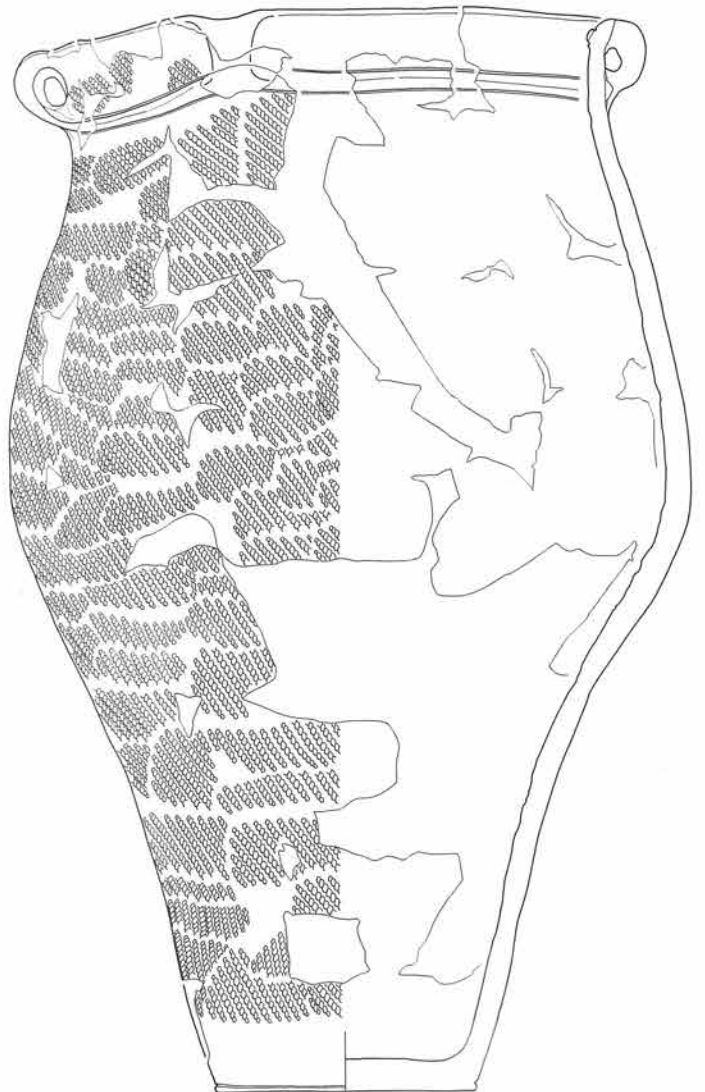

28

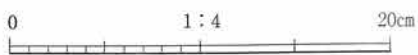

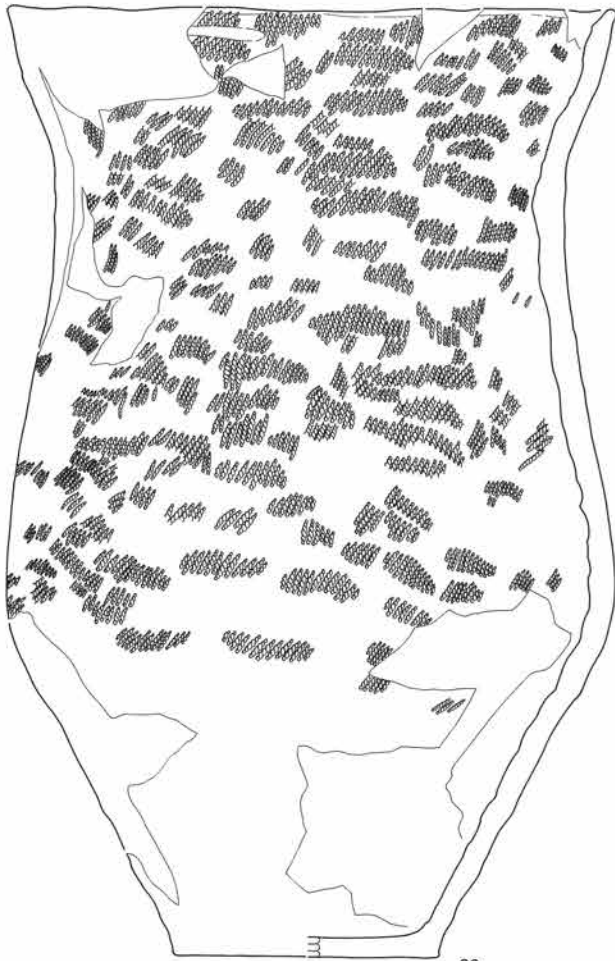

29



30

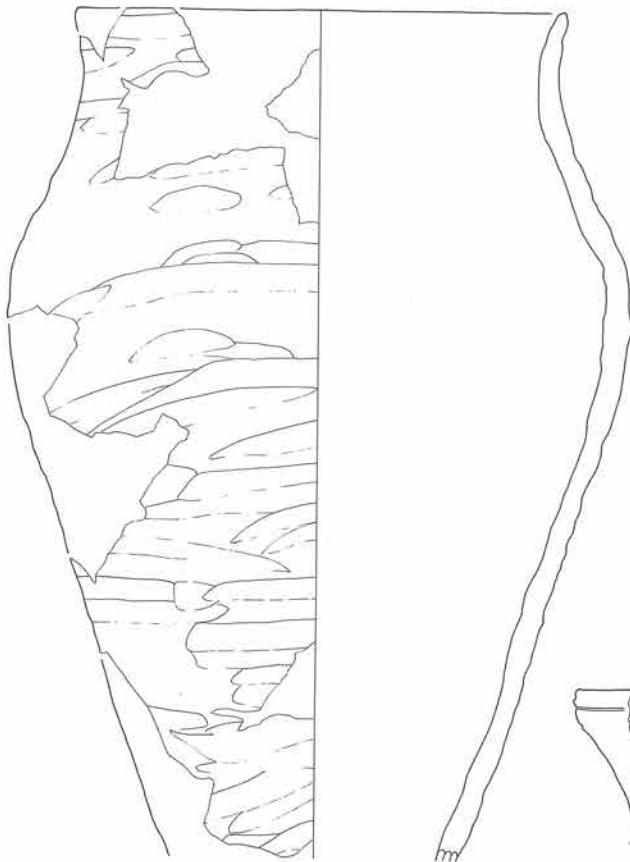

31

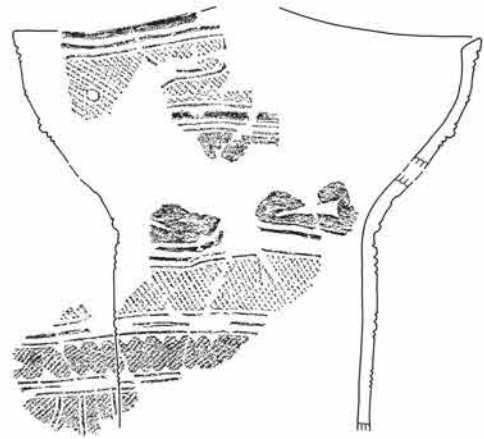

32

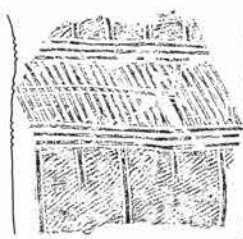

33



34

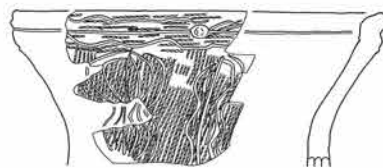

35

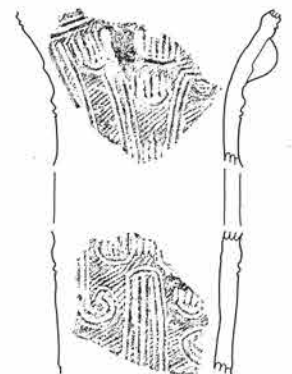

37



36

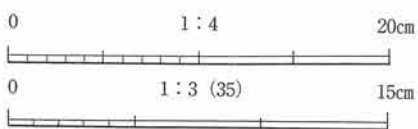

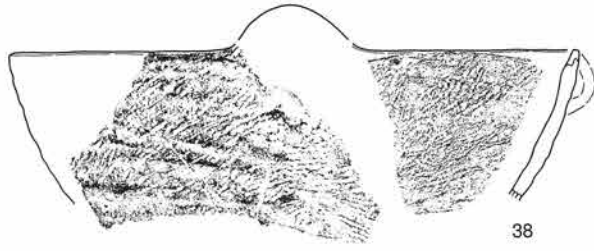

38

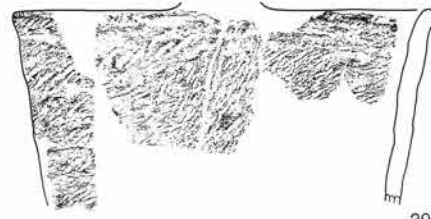

39



40



41

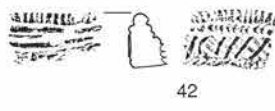

42



43

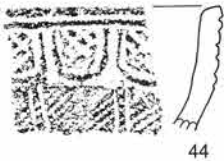

44

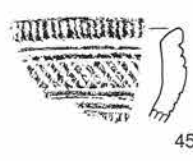

45

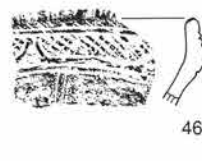

46

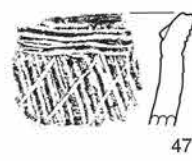

47



48

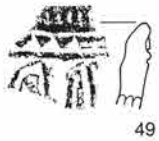

49



50



51



52



53

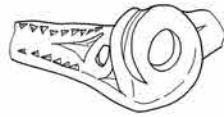

54



55

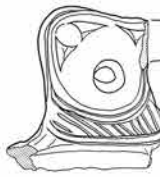
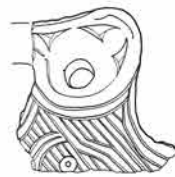

SI117 : 38~55

0 1 : 4 (38·39·51) 20cm

0 1 : 3 (40~50·52~55) 15cm



56



57



58



59

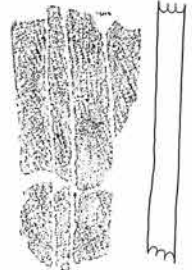

60

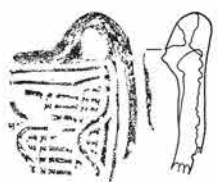

61

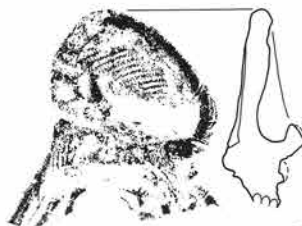

62



63



SI120 : 56~63

0 1 : 4 (56·57) 20cm

0 1 : 3 (58~63) 15cm

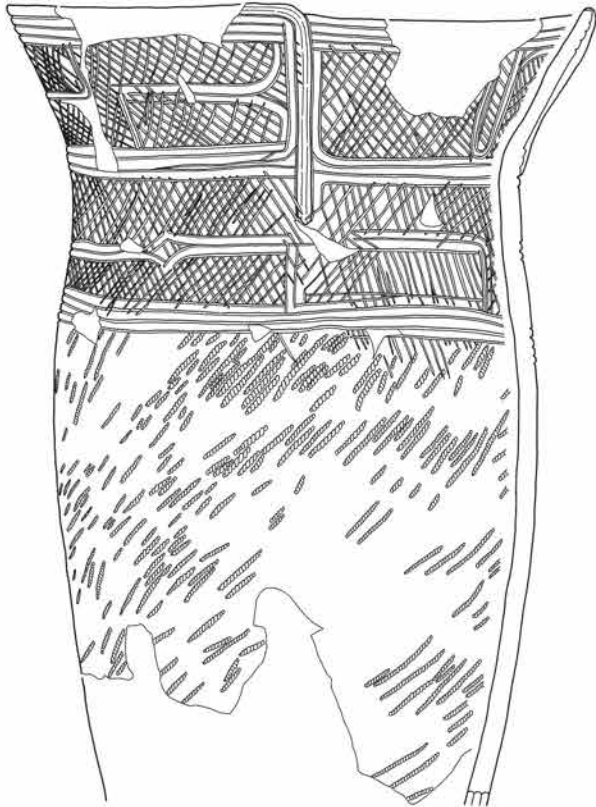
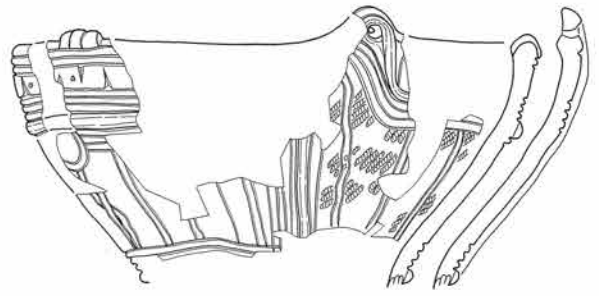
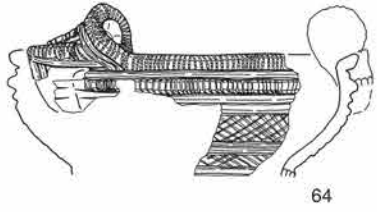

67

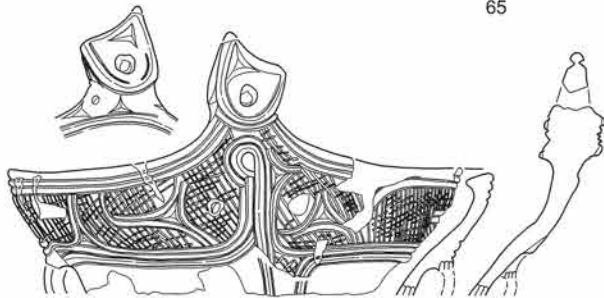

68

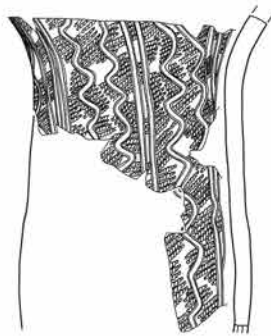
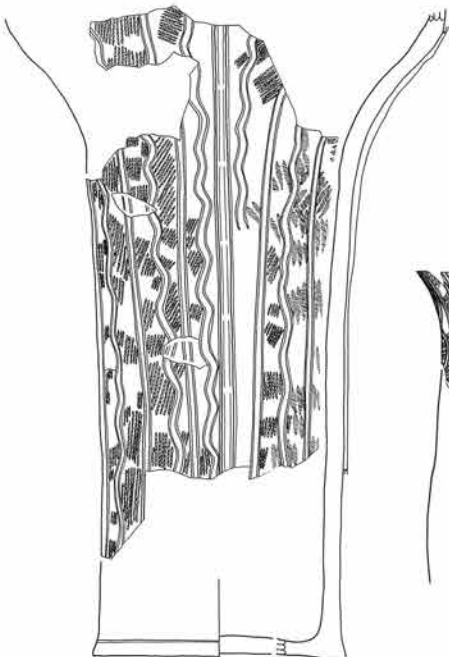

70

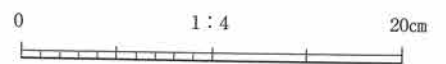

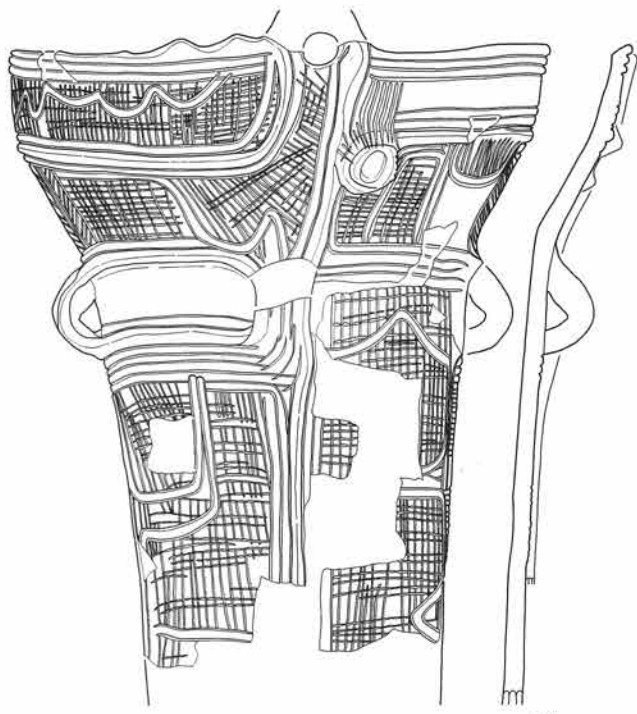

72

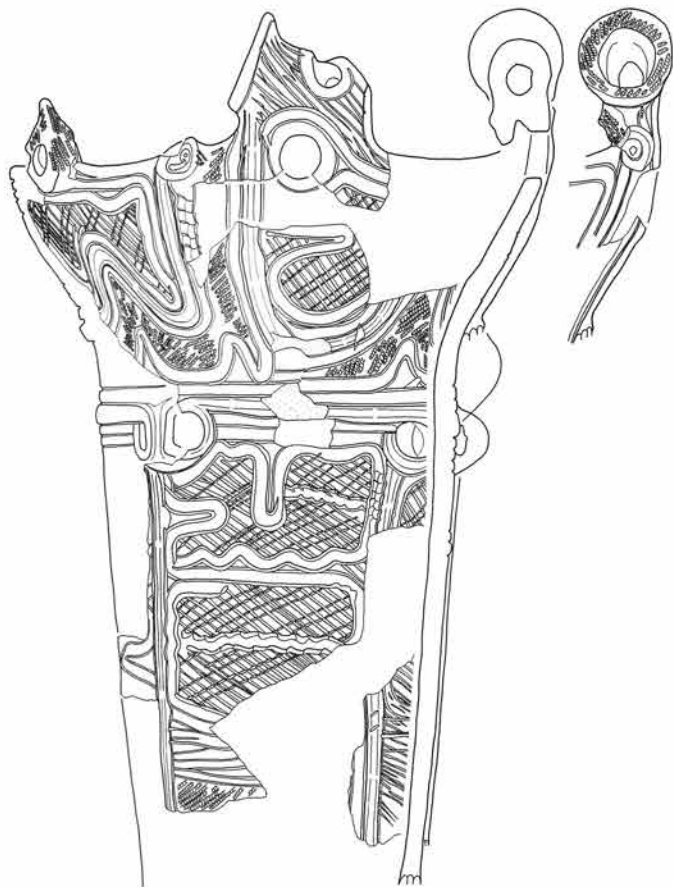

76

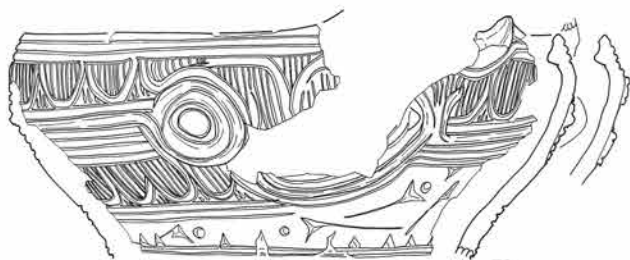

73

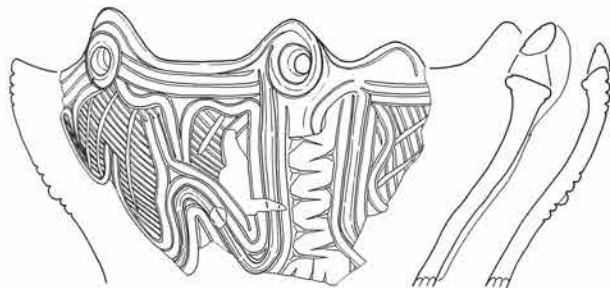

77

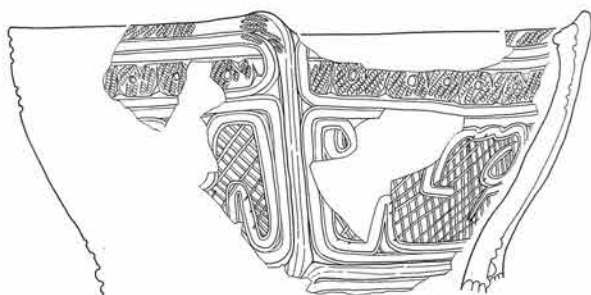

74

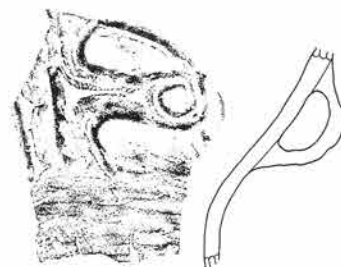

78



75

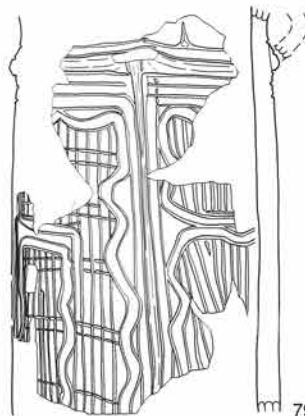

79



80

廃棄ブロック4 : 80

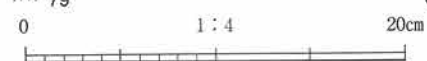



81

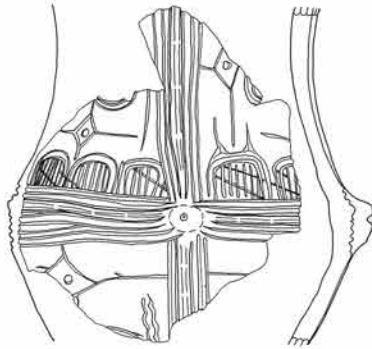

82

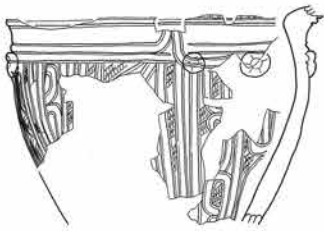

83

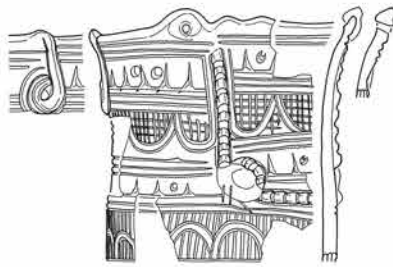

84

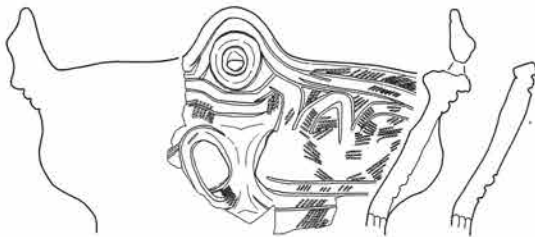

85

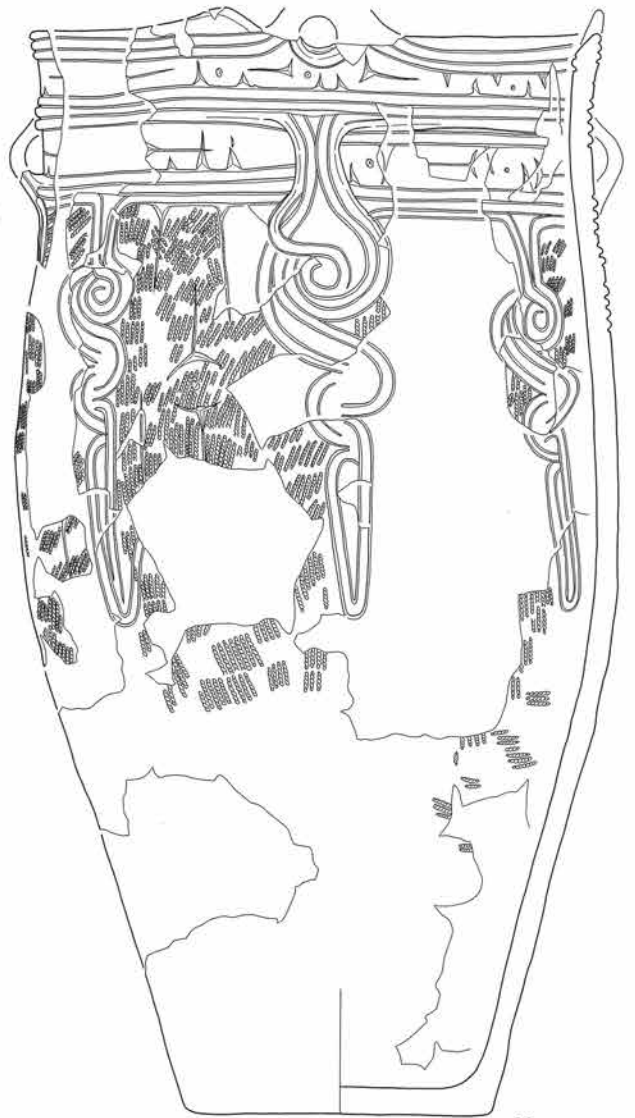

86

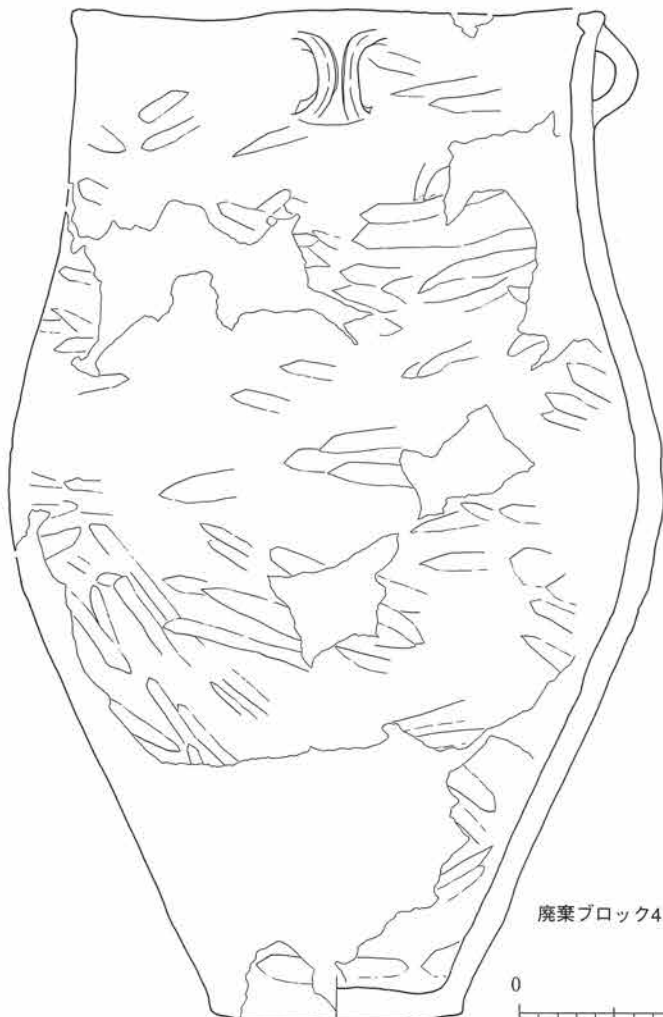

87

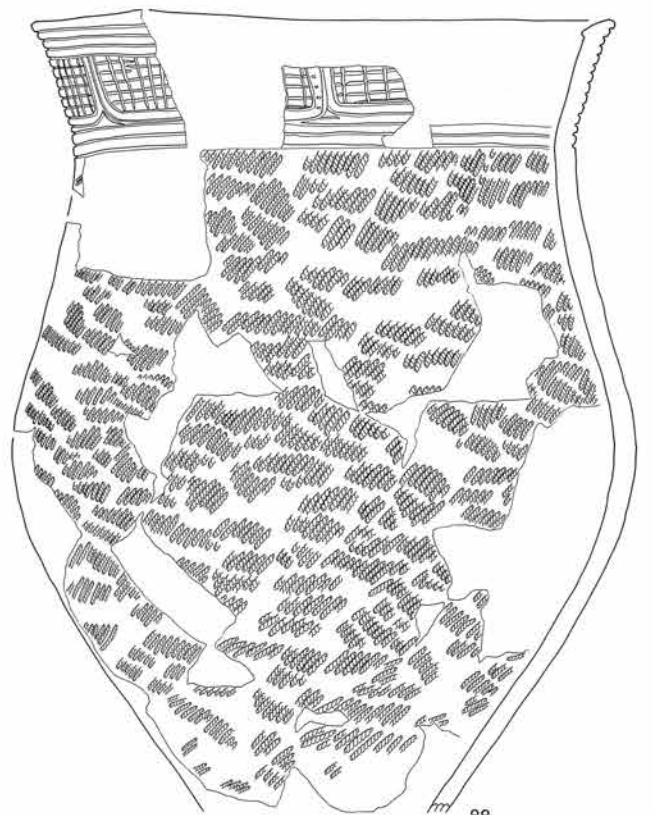

88

廃棄ブロック4:85

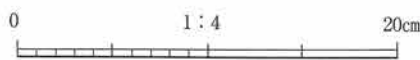

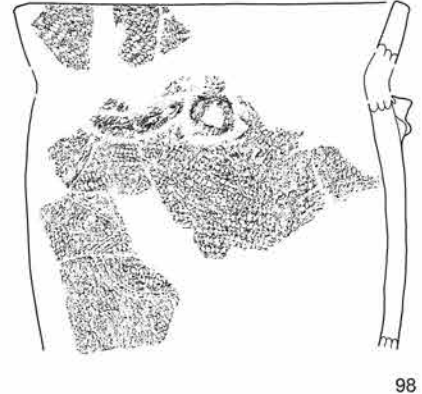
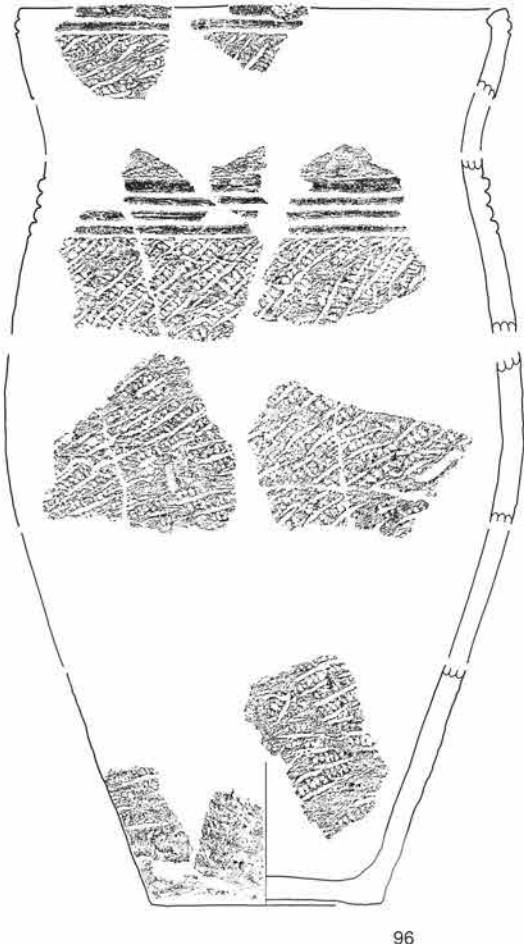
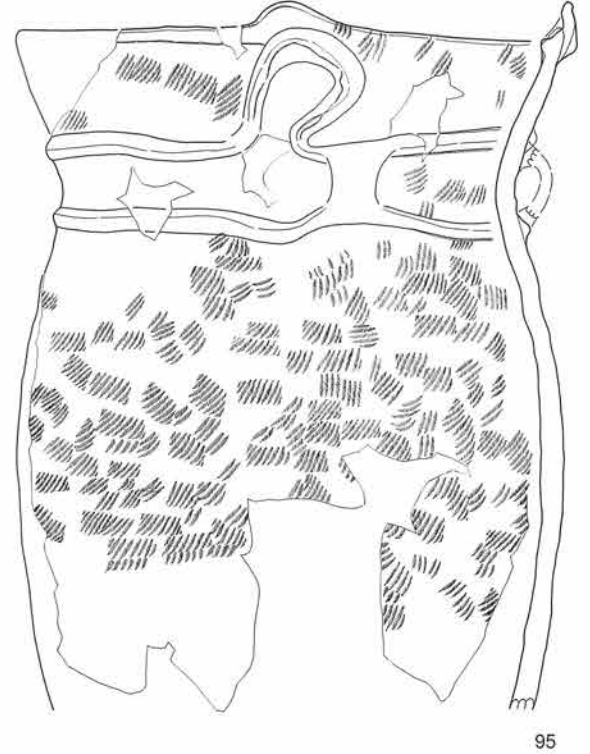
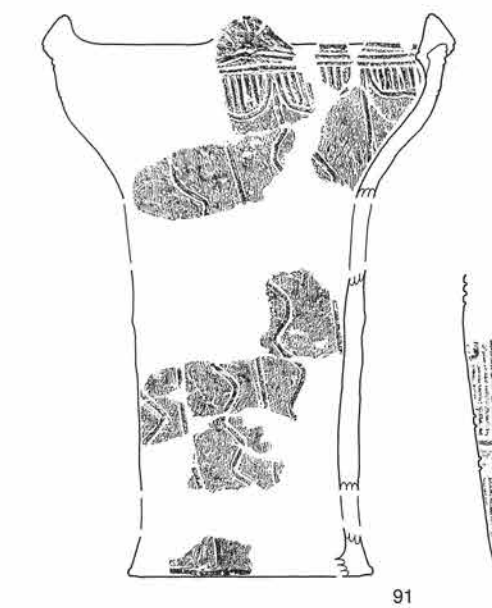
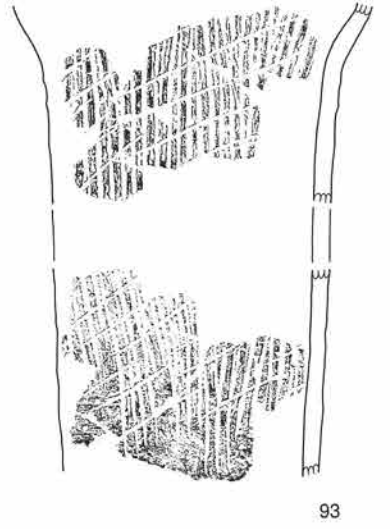
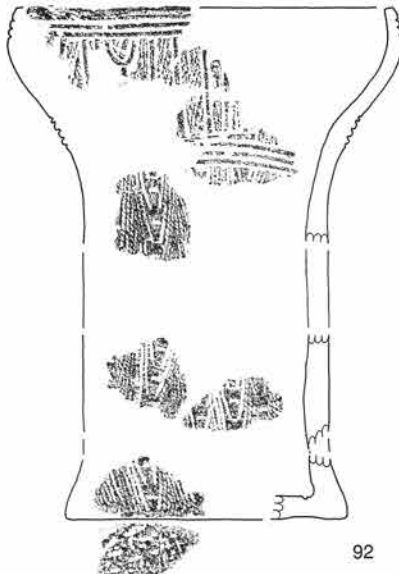
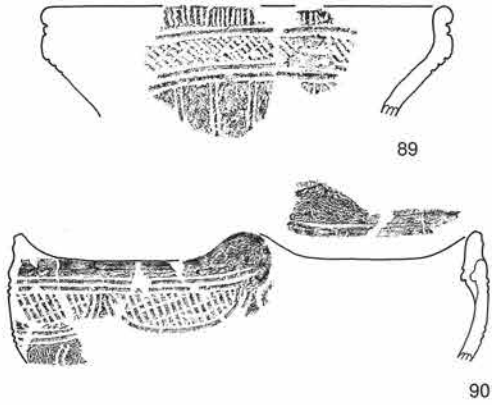

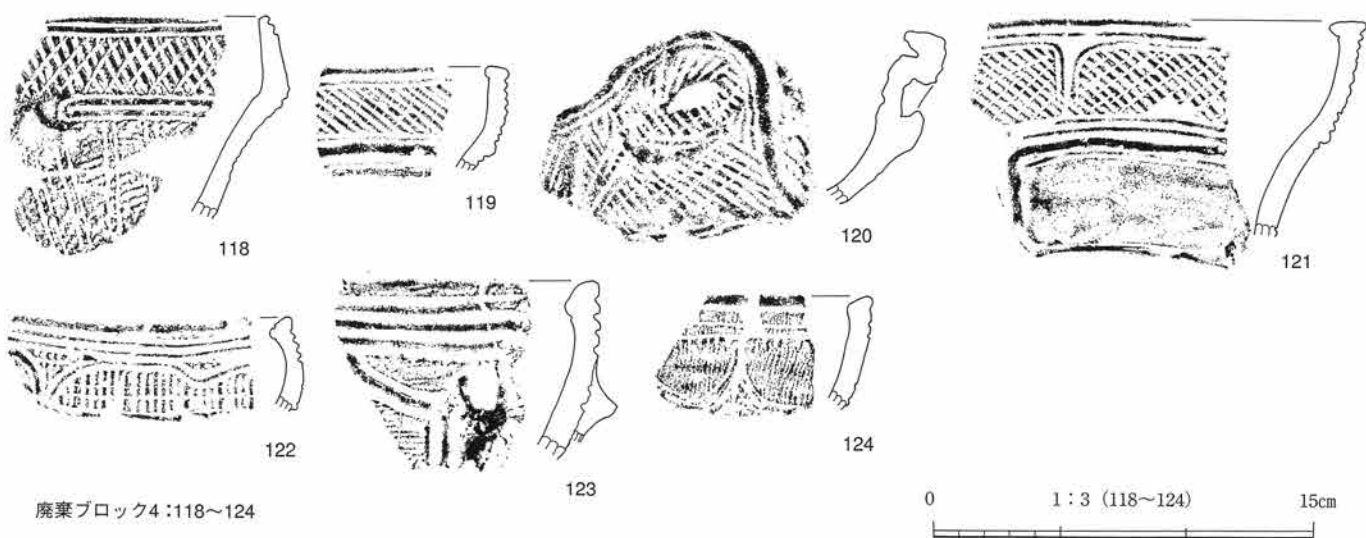
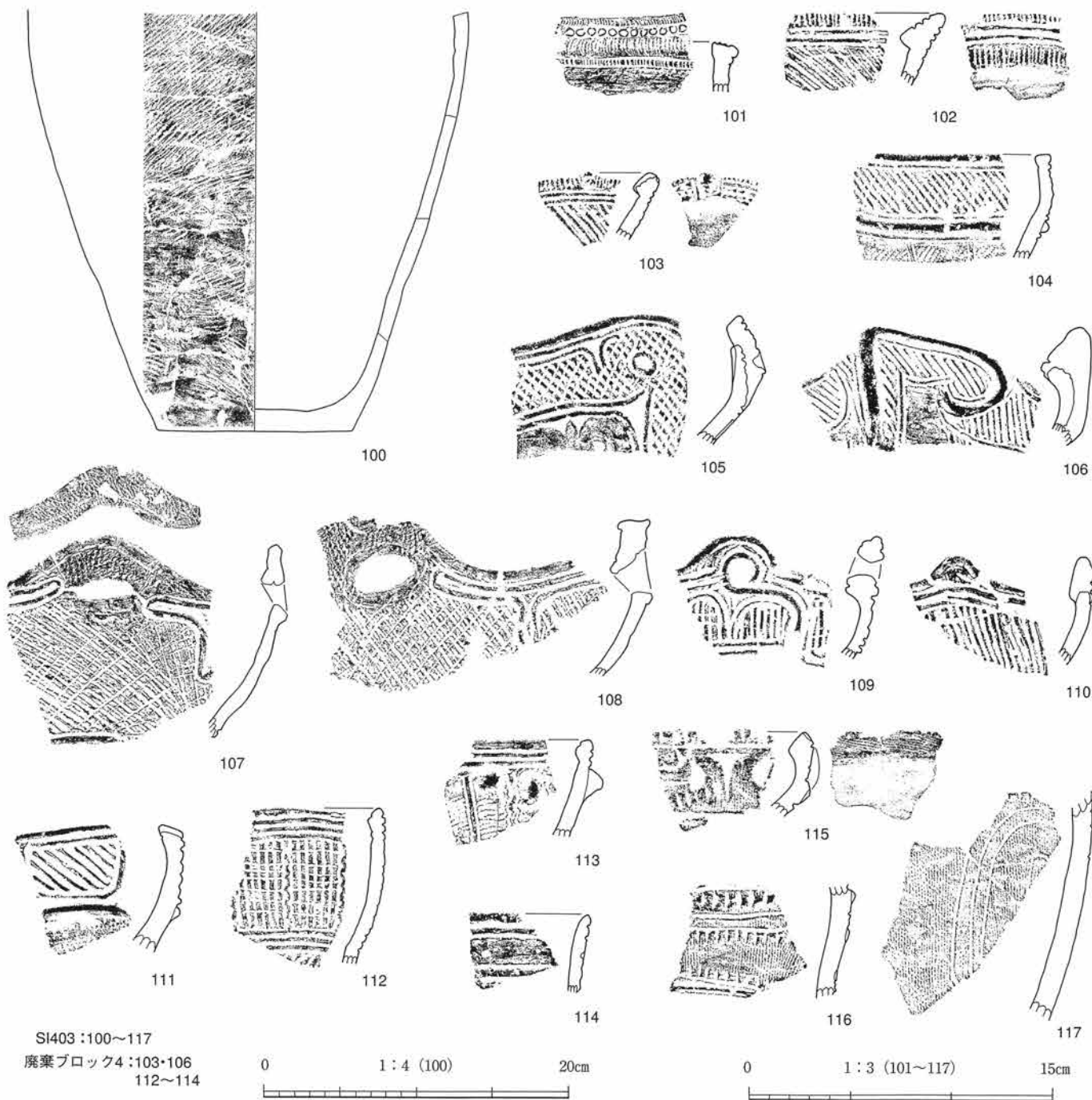

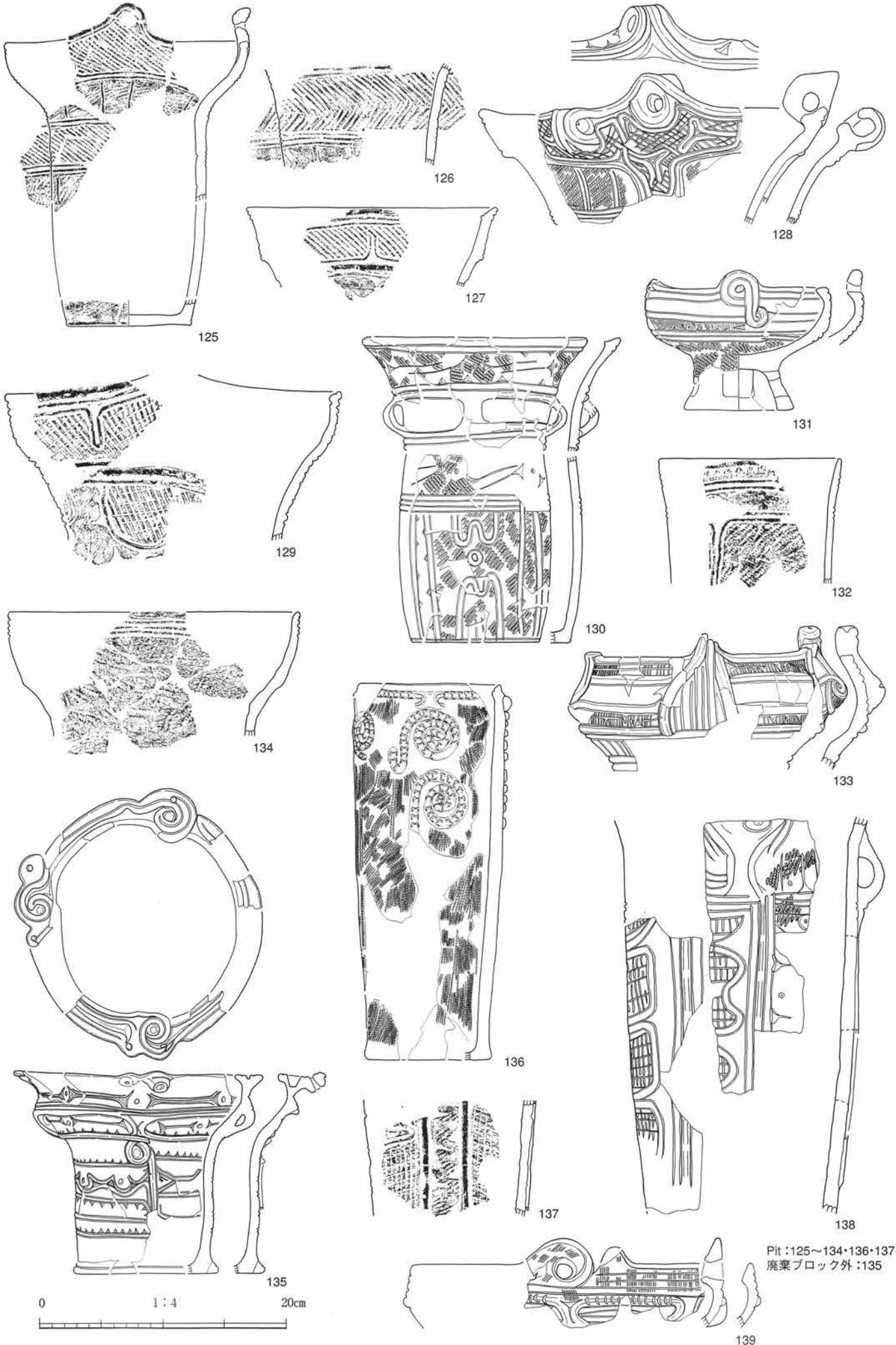

Pit : 125~134・136・137~13
廃棄ブロック外 : 135

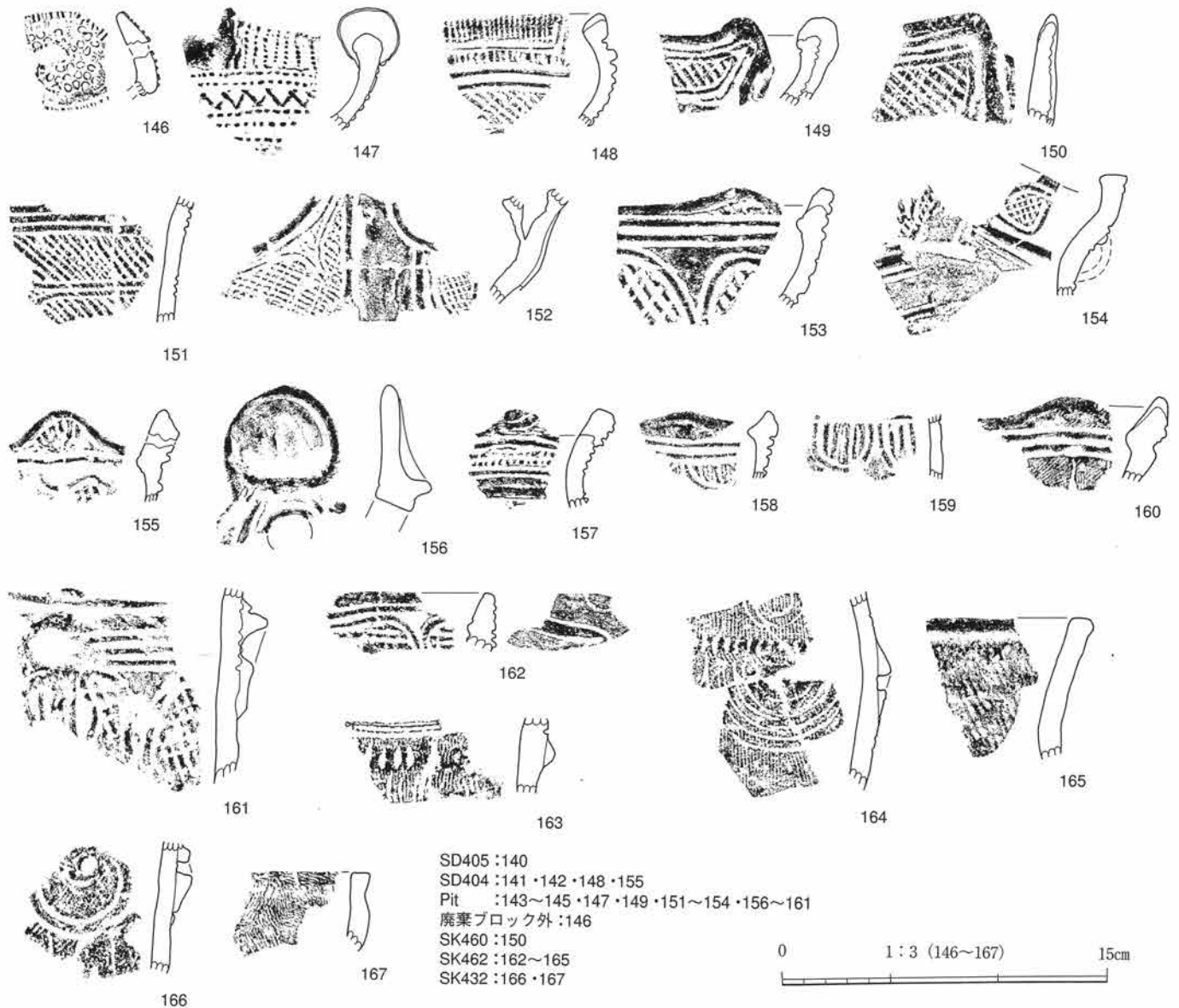
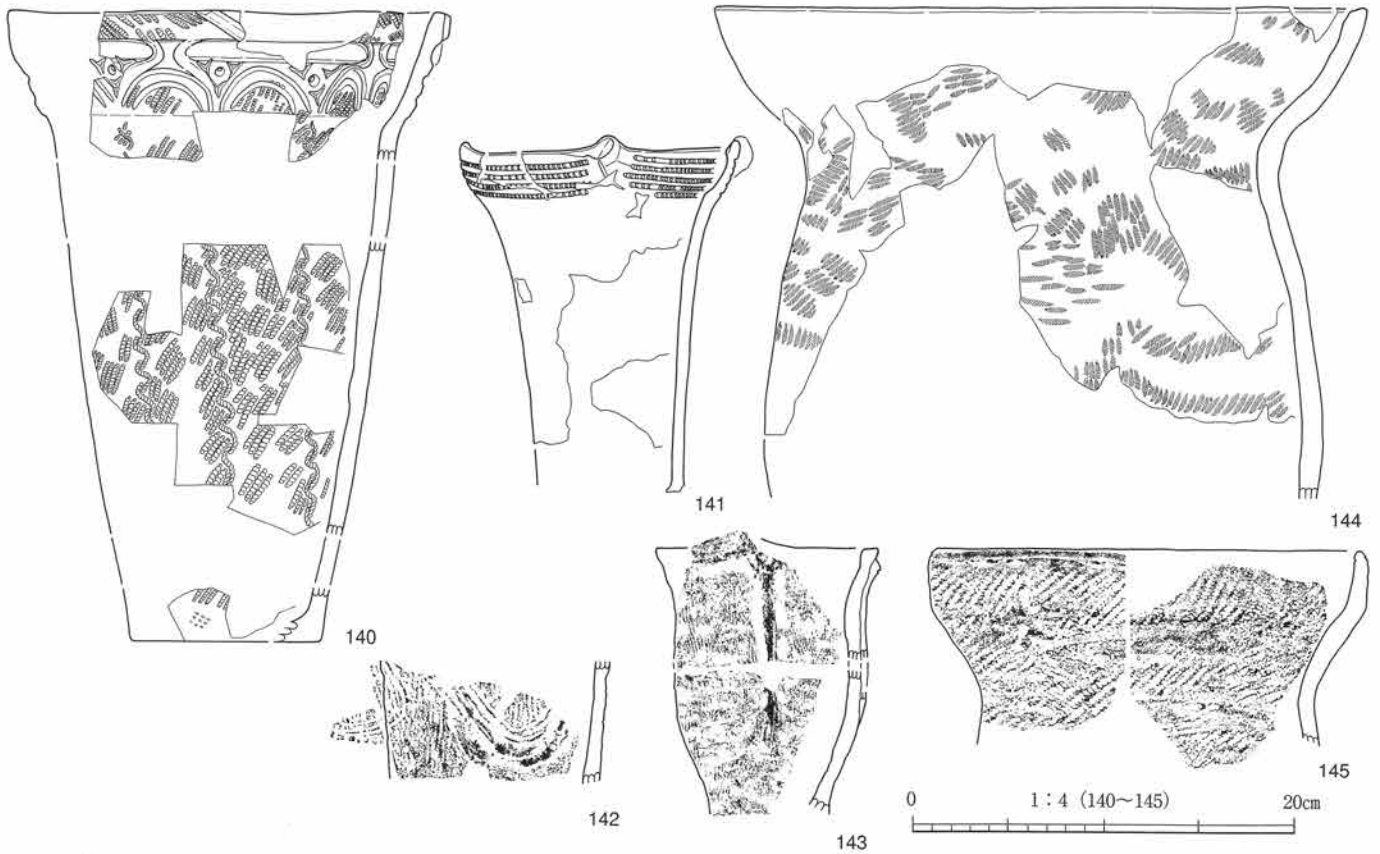

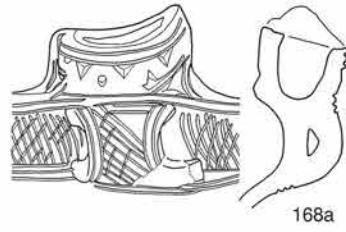

168a



168b

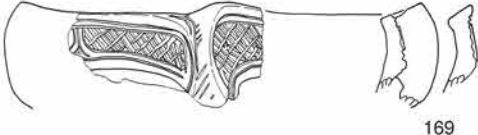

169

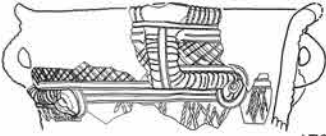

170



171

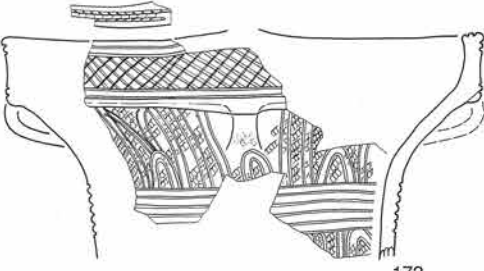

172

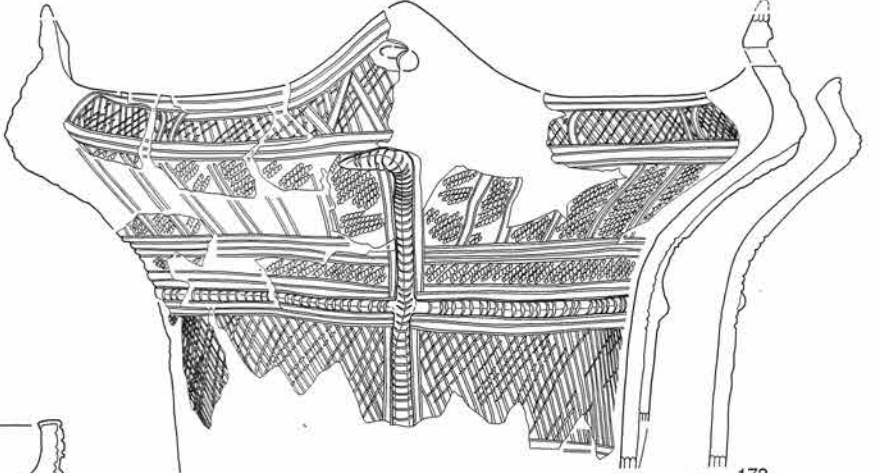

173

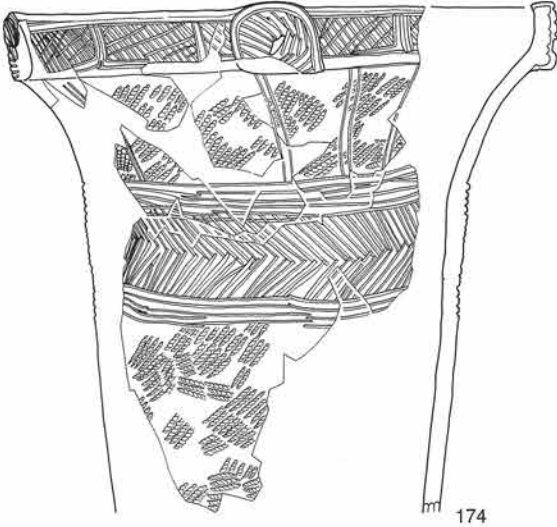

174

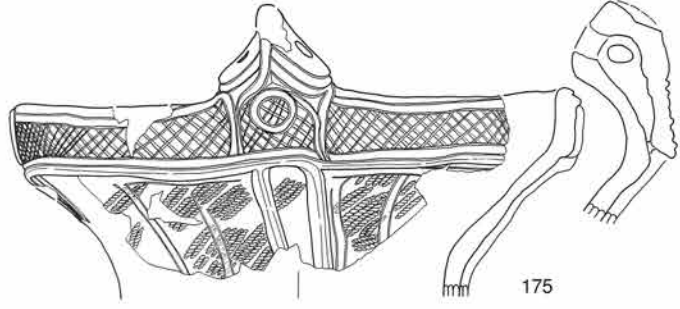

175

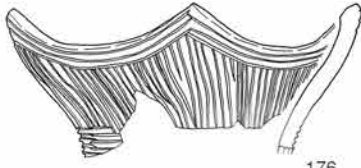

176

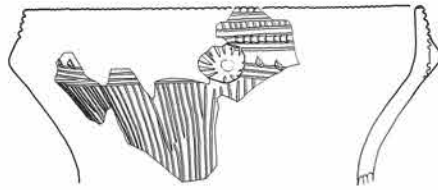

177

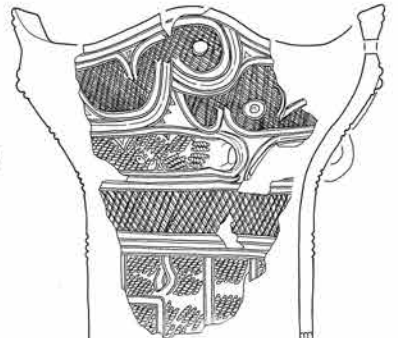

178

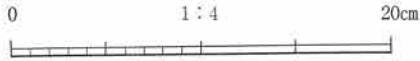

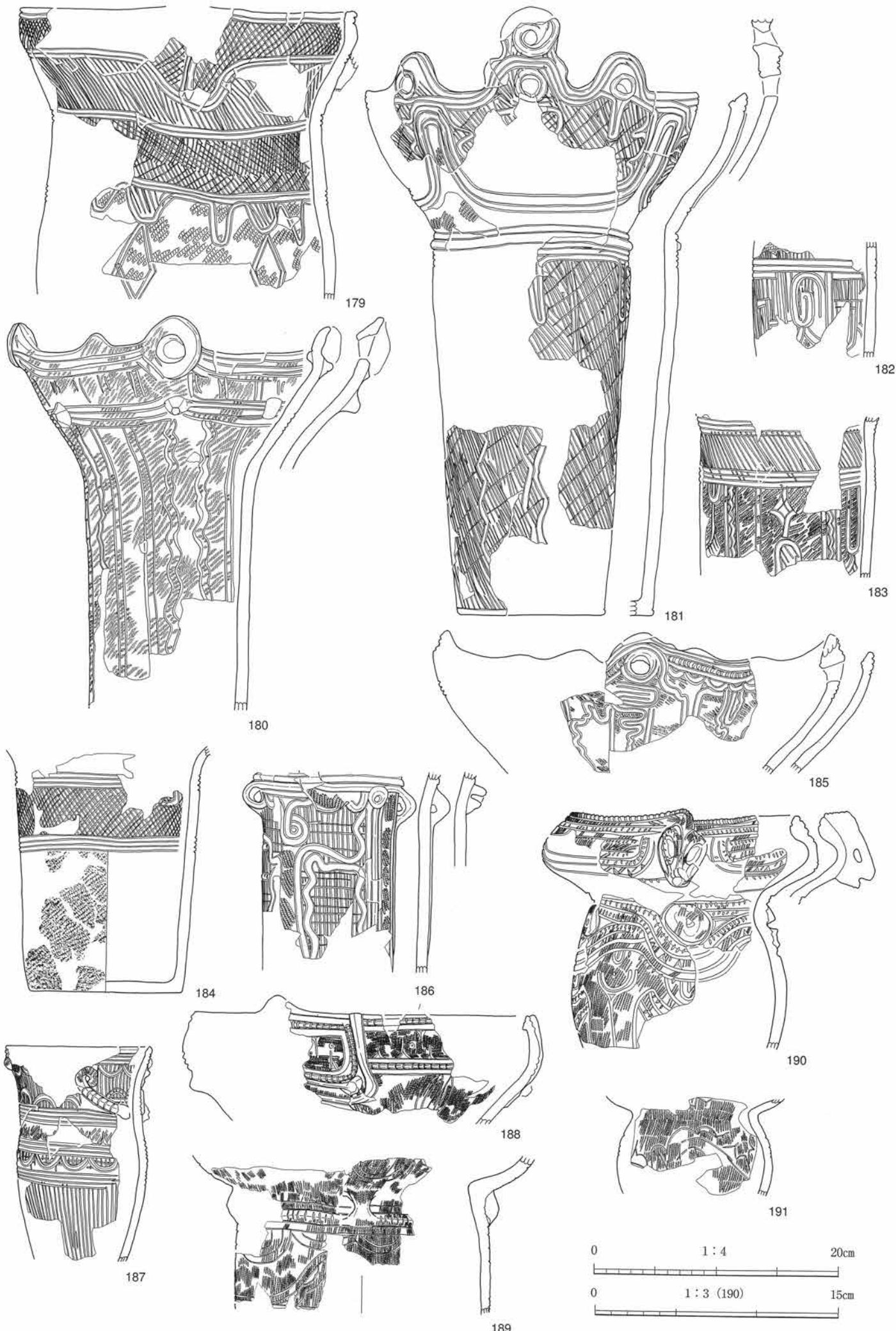

179

182

183

180

181

185

184

186

190

187

188

191

189

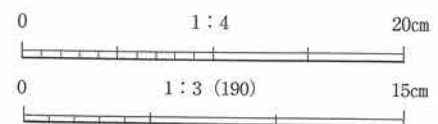

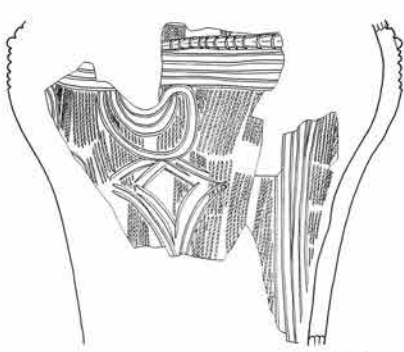

192

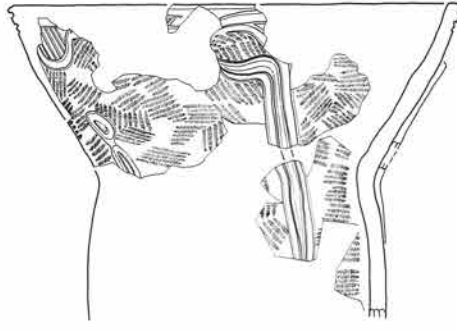

193

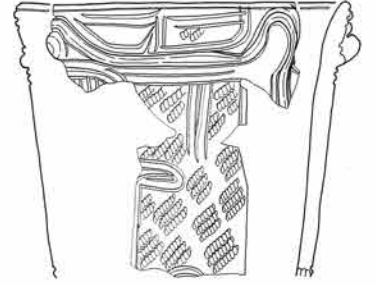

194



195

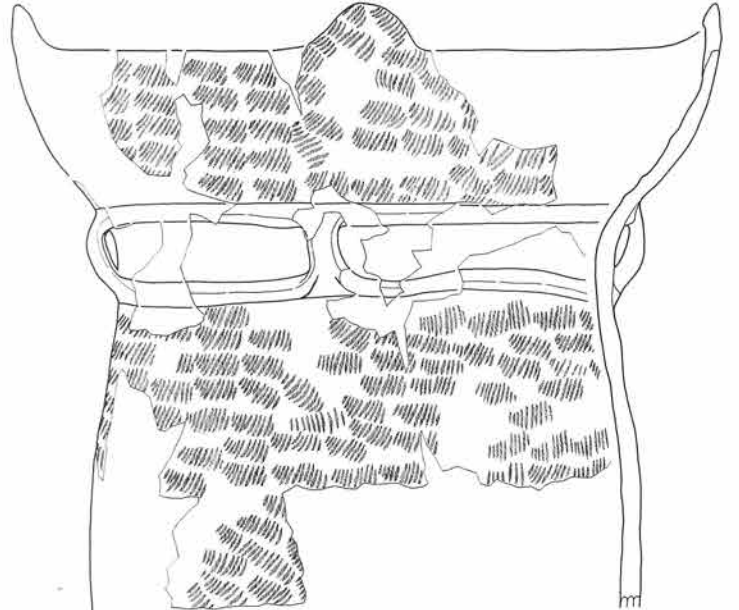

196

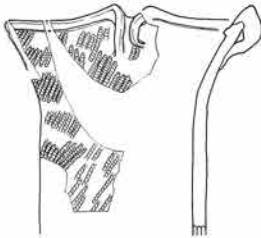

197

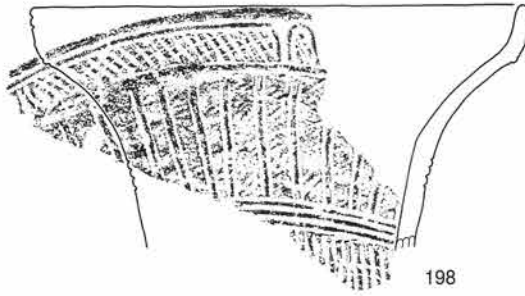

198



199

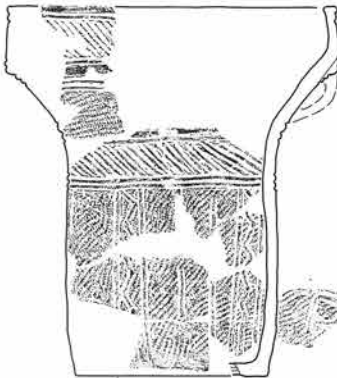

200



202



203



201

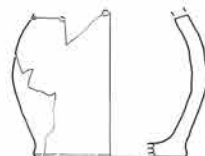

204



205

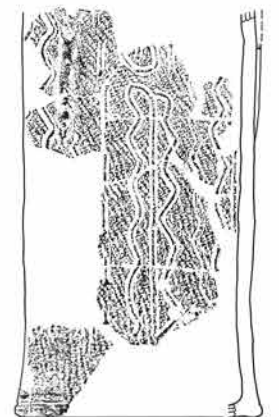

206

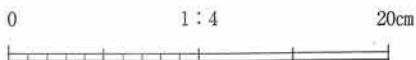

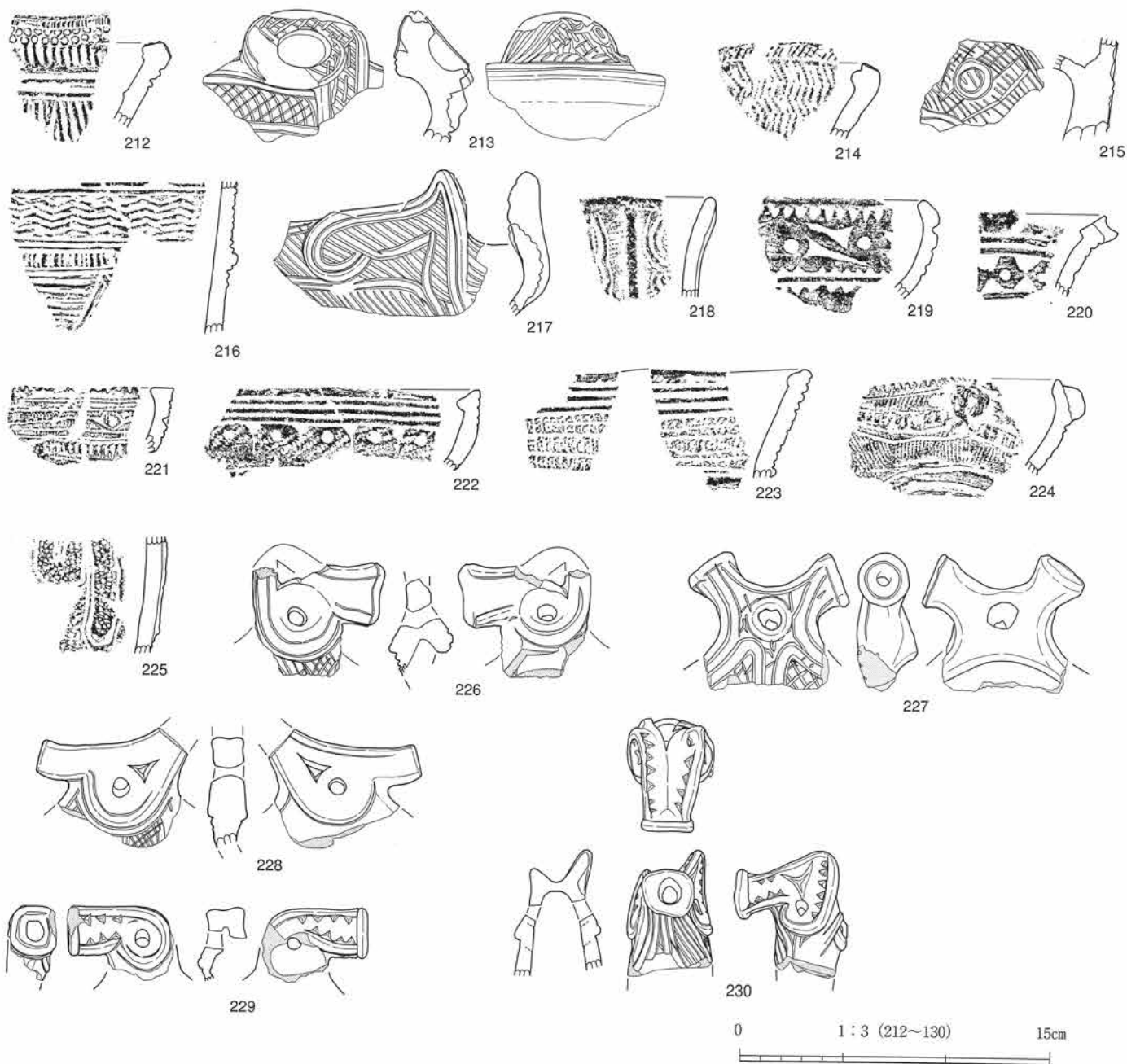
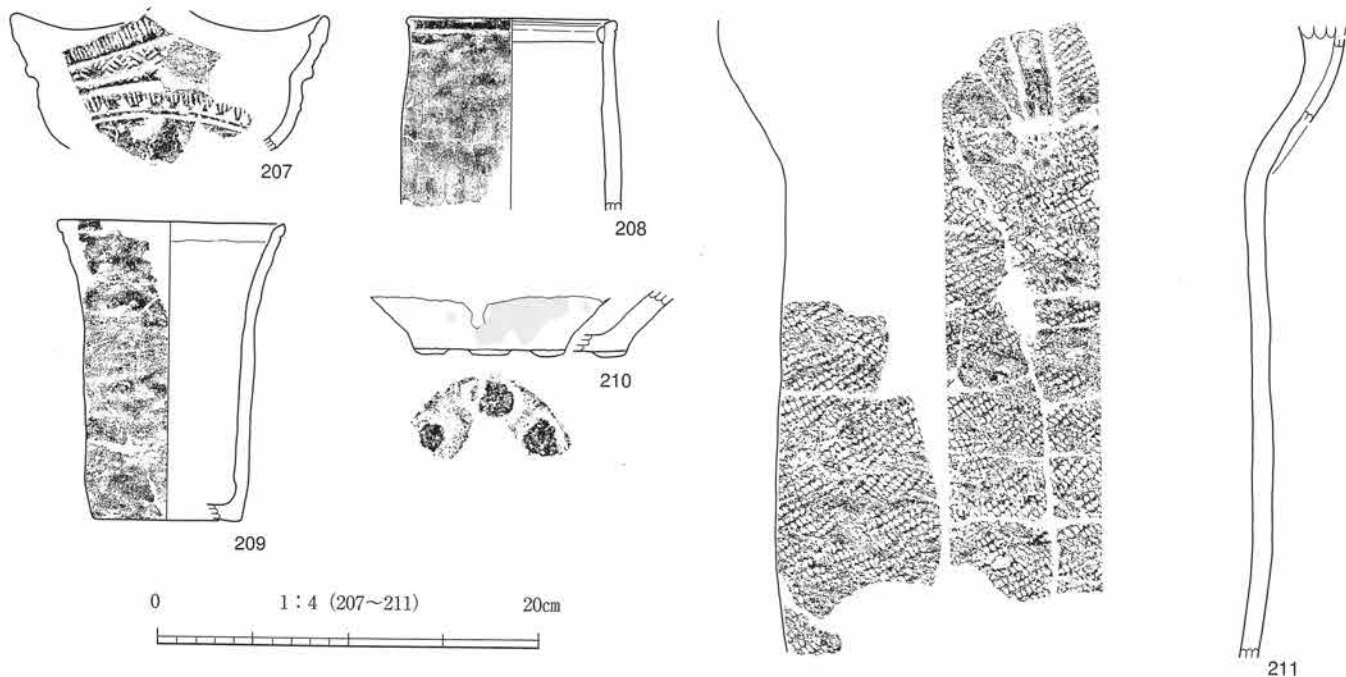

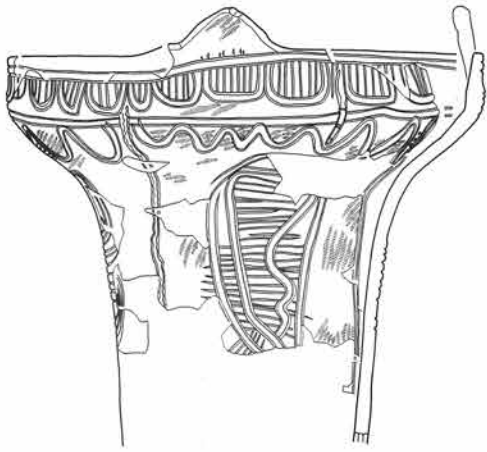

231

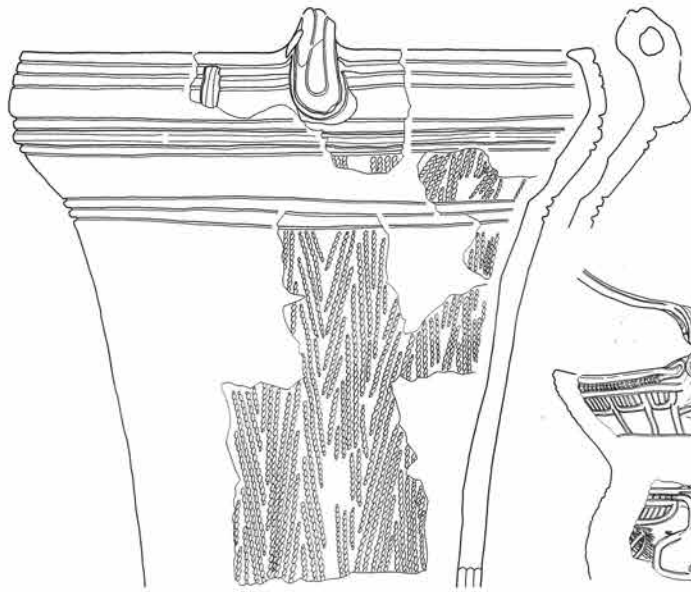

233

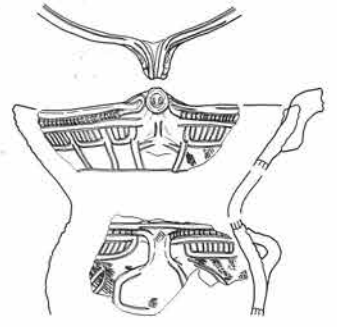

234

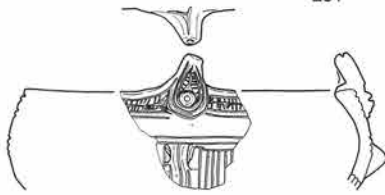

232

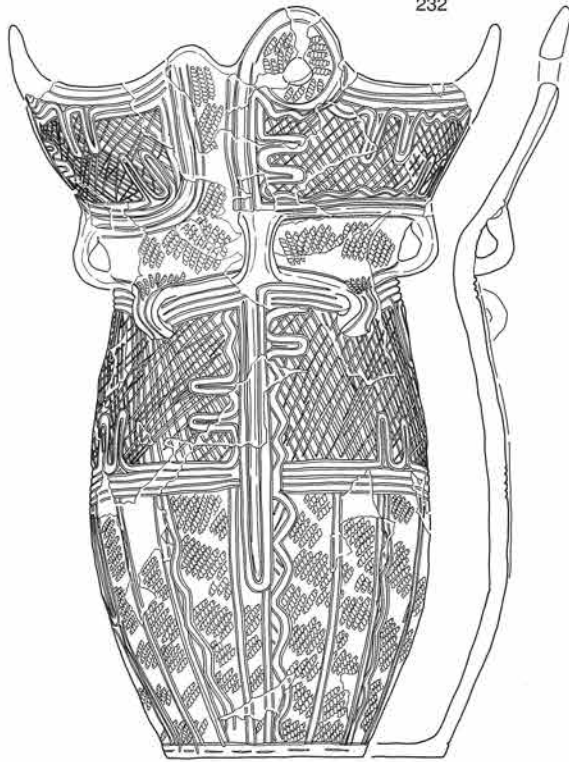

235

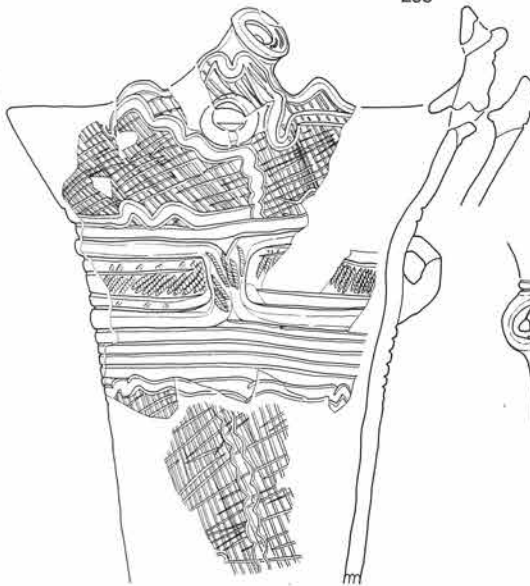

236



237

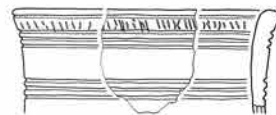

238

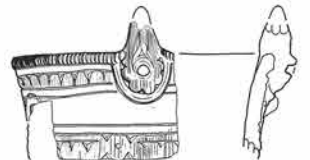

239

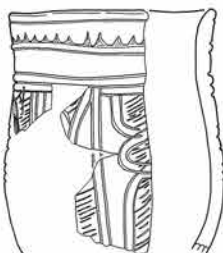

240

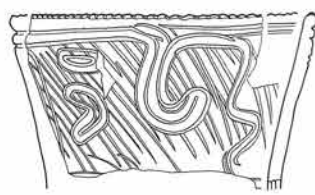

241

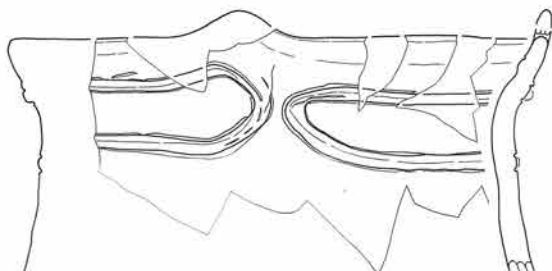

242



243

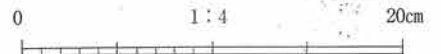

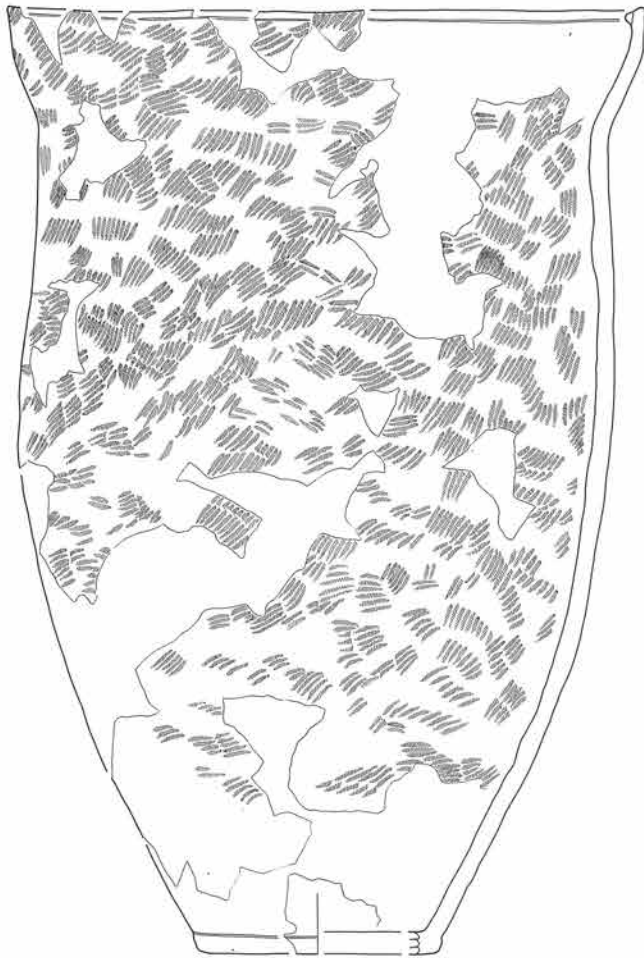

244

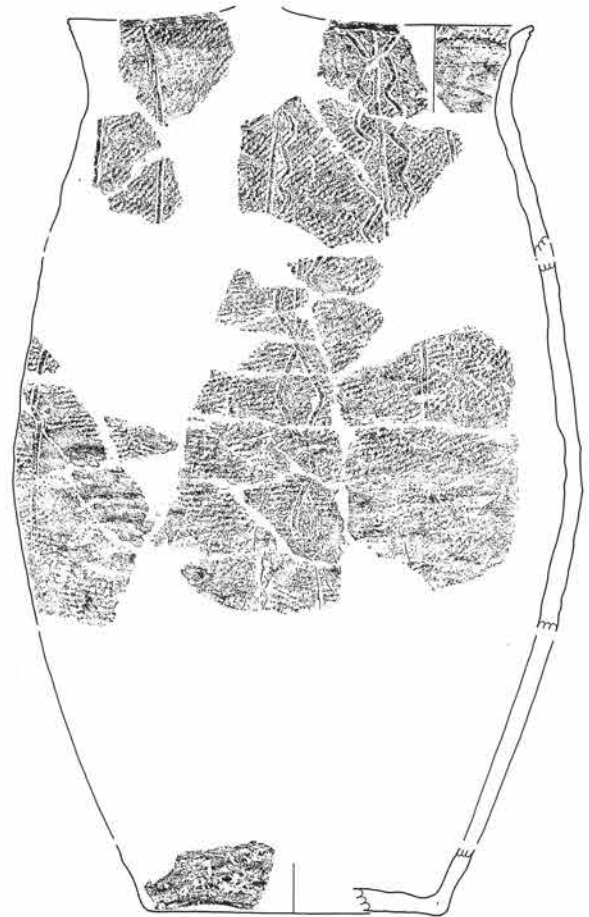

245



246



247



248



249

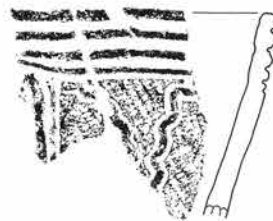

250



251



252



253



254

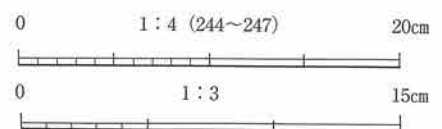

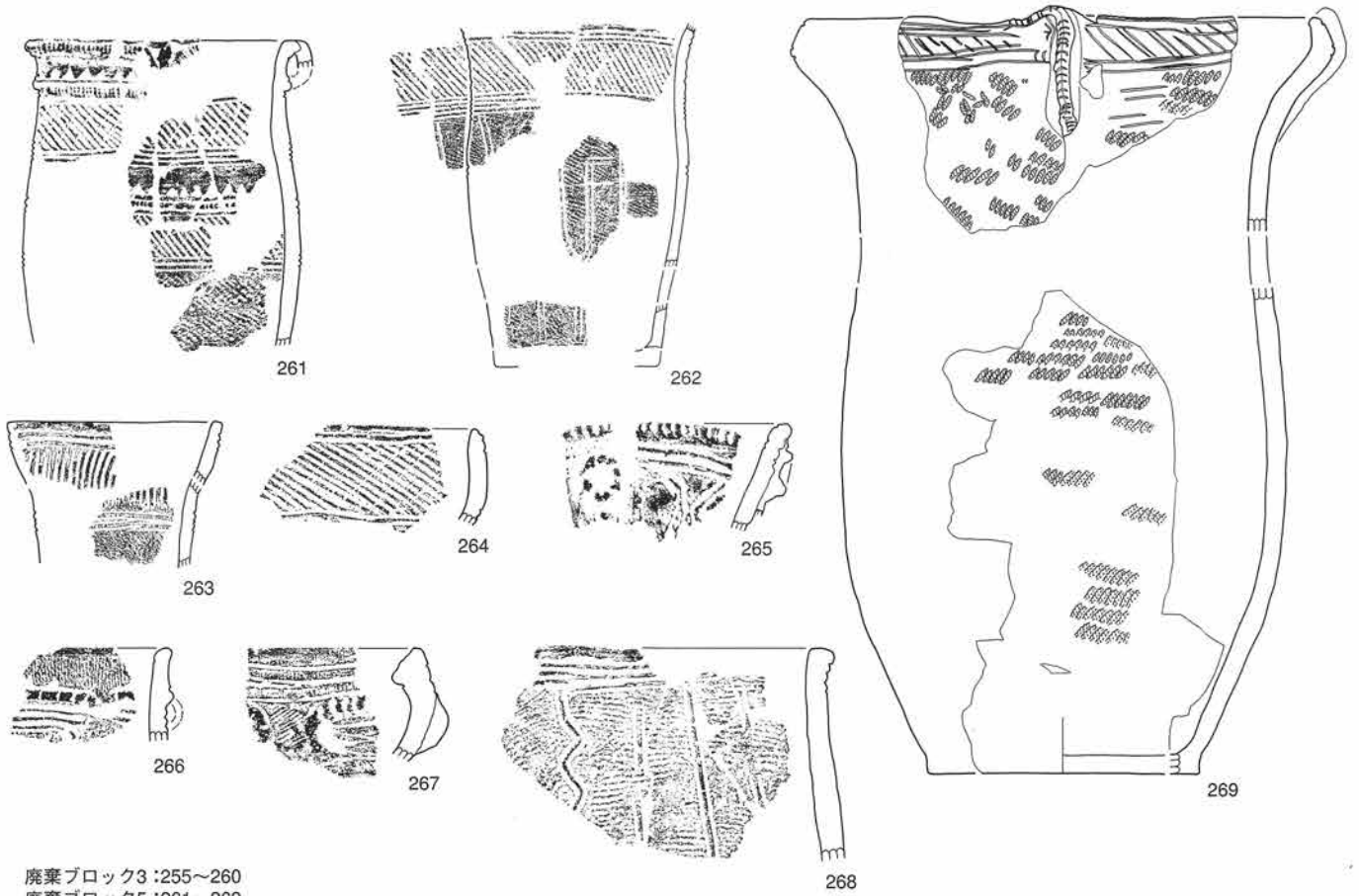
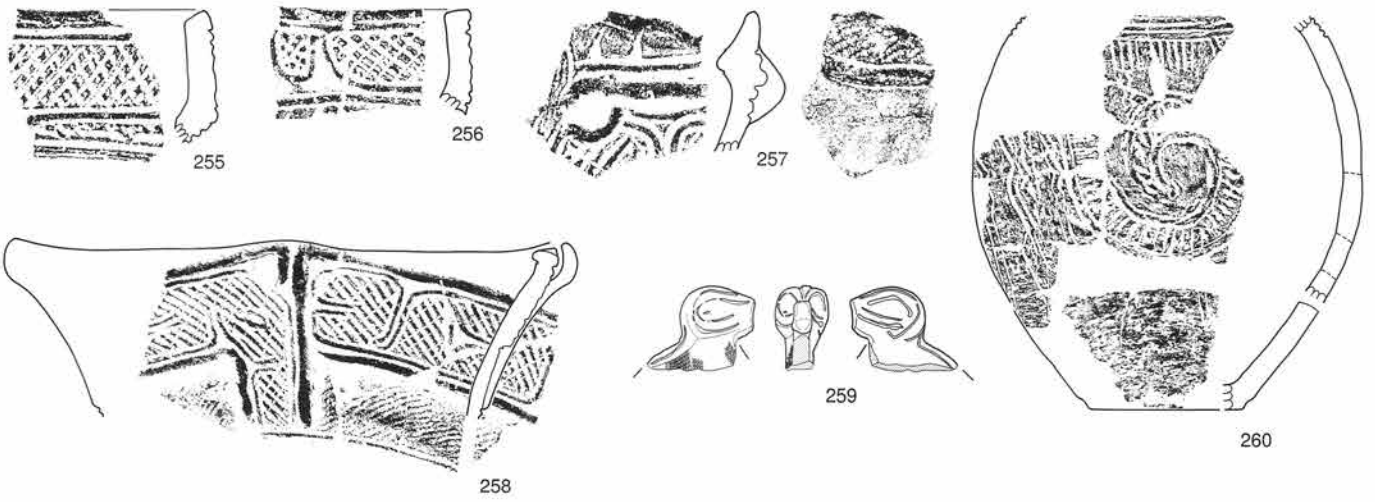

廃棄ブロック3 :255~260
 廃棄ブロック5 :261~269

0 1:4 (258・260~263・269) 20cm

0 1:3 15cm



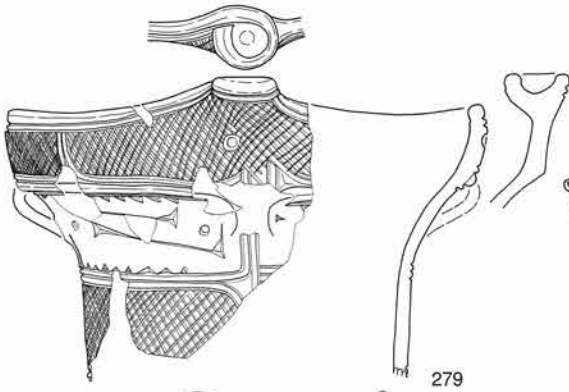

279

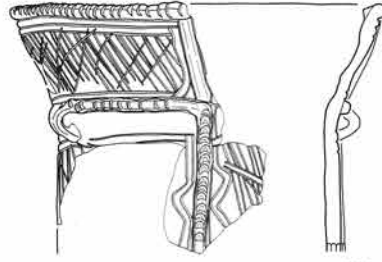

280

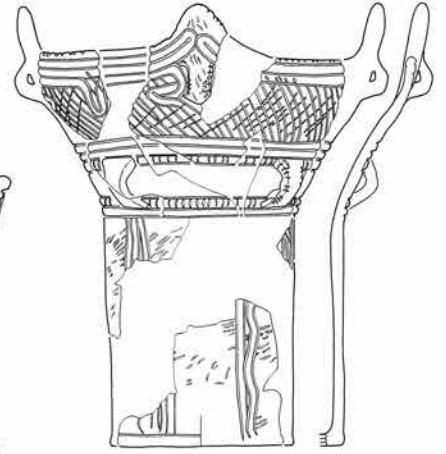

281

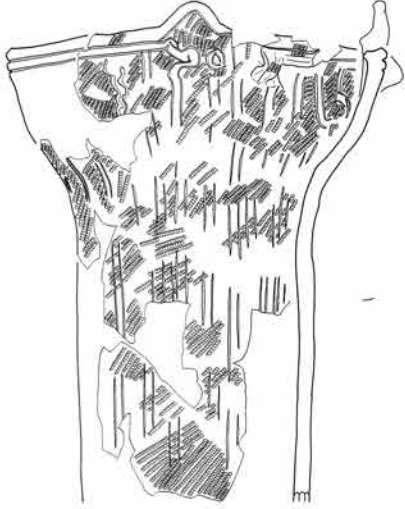

282



283

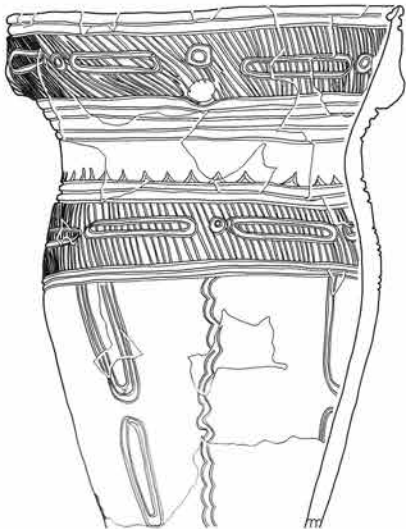

284



285

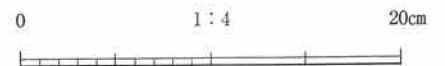

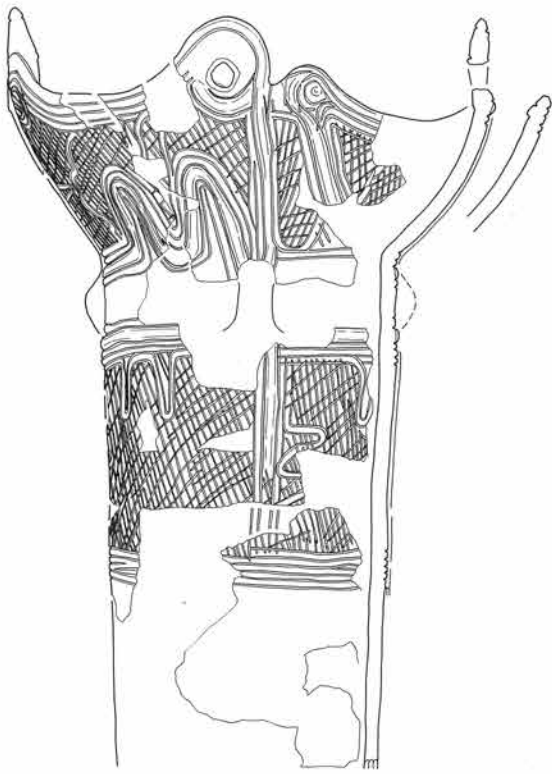

286

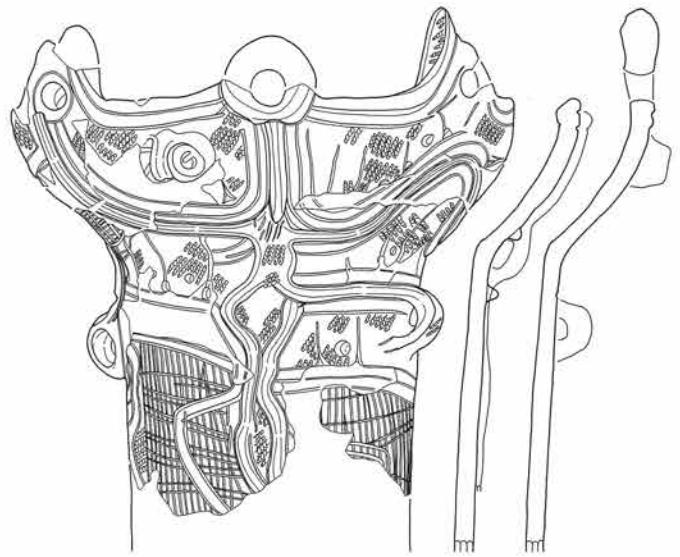

287

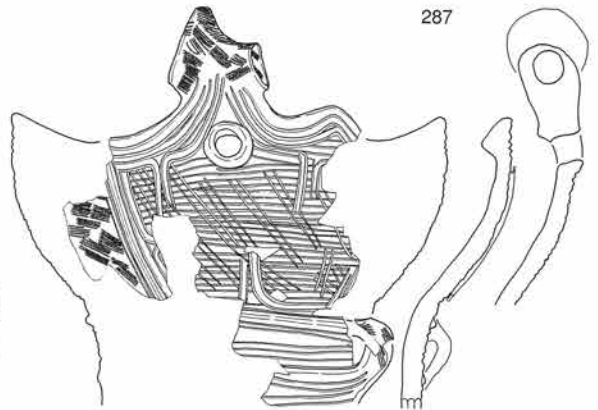

289

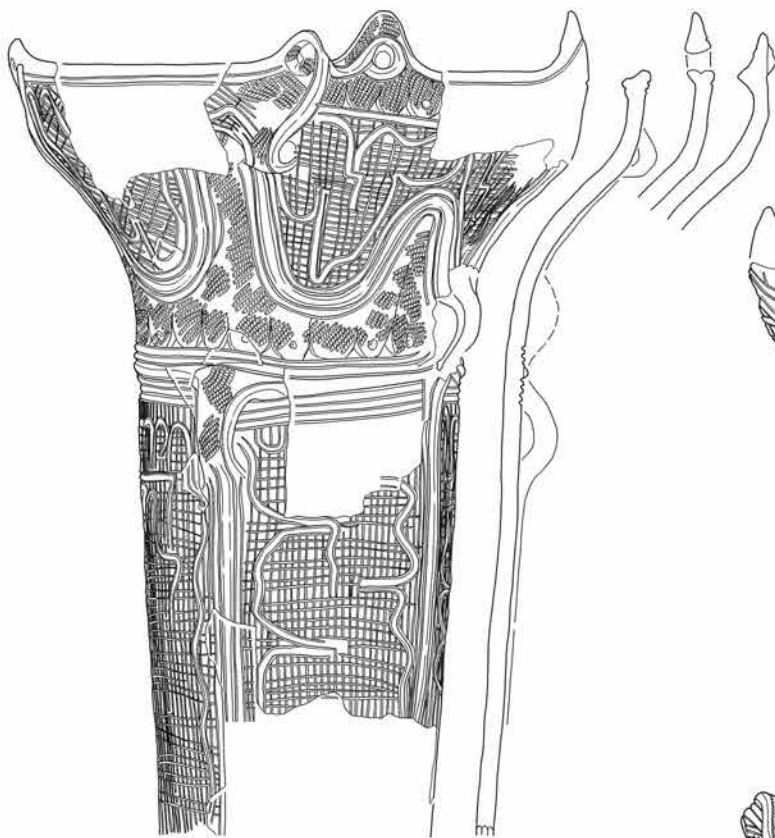

288

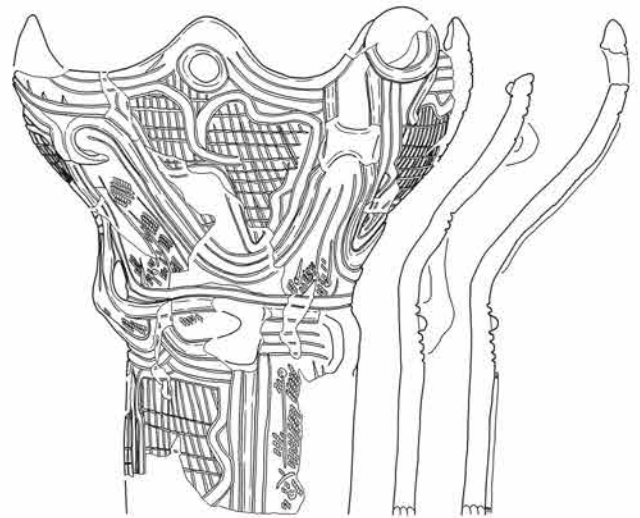

290

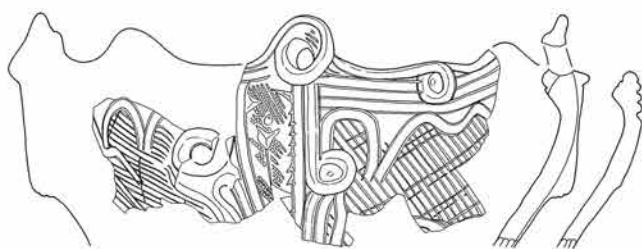

291

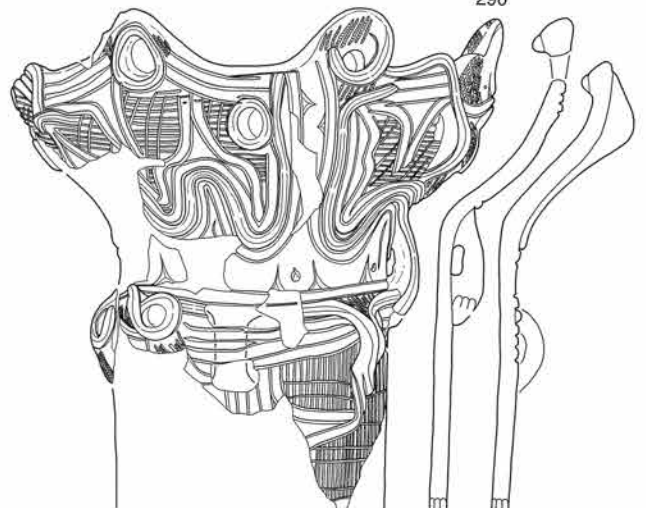

292

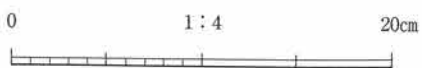



293

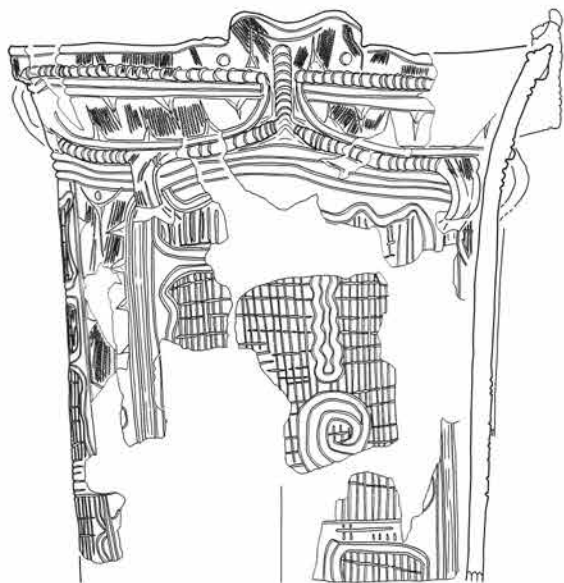

294

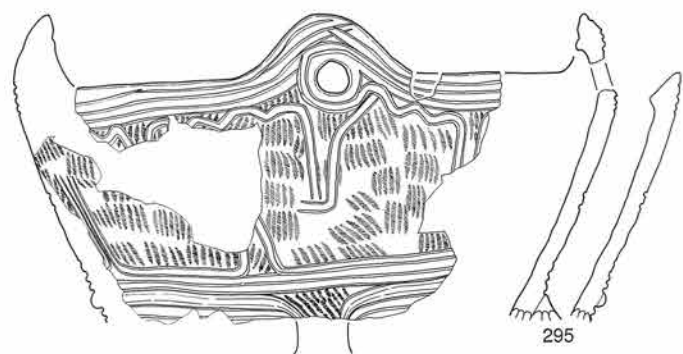

295

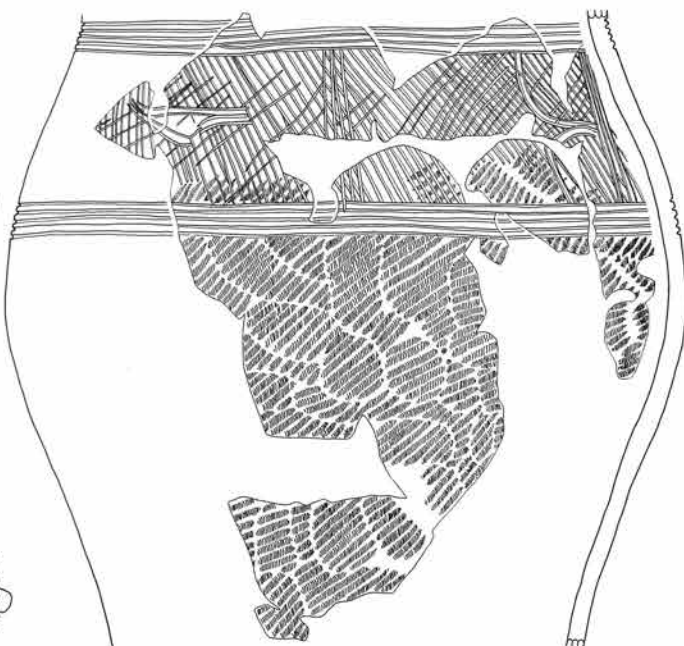

296

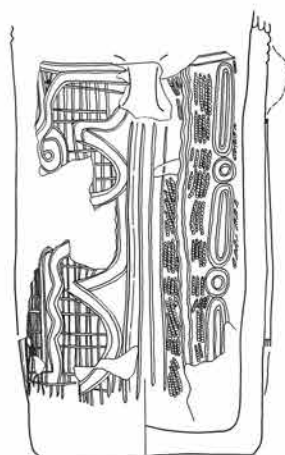

297

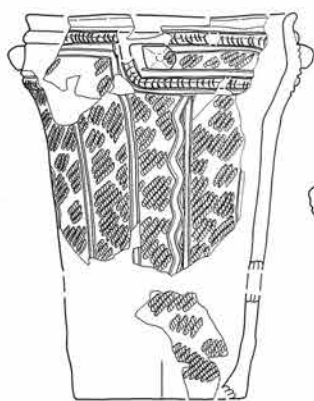

298



299

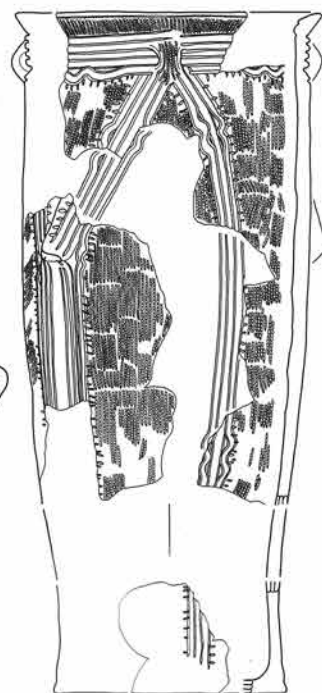

300

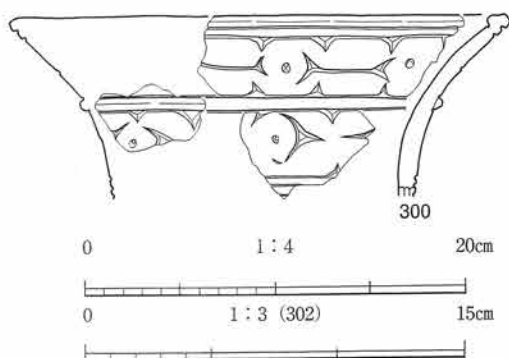

301

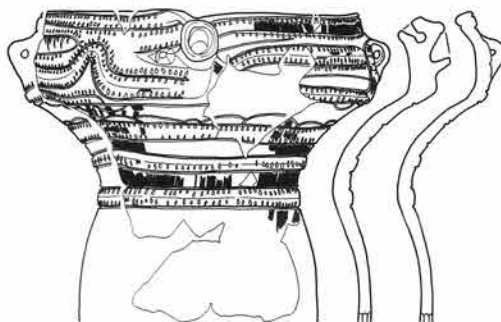
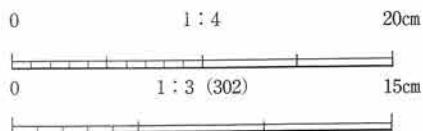

302

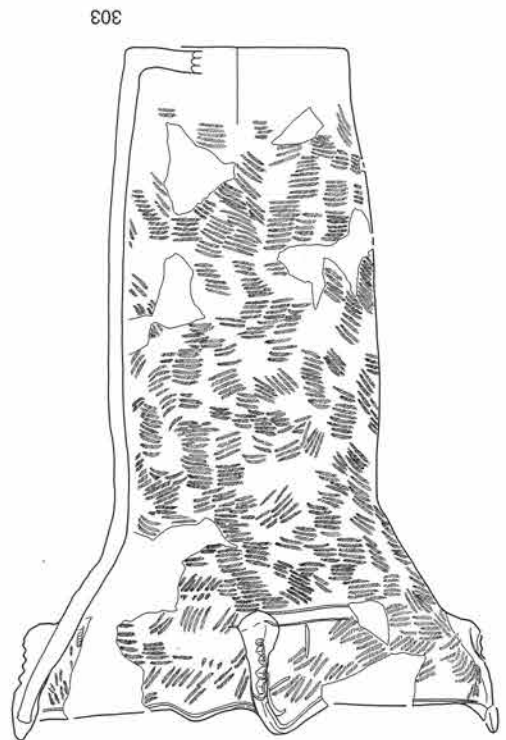
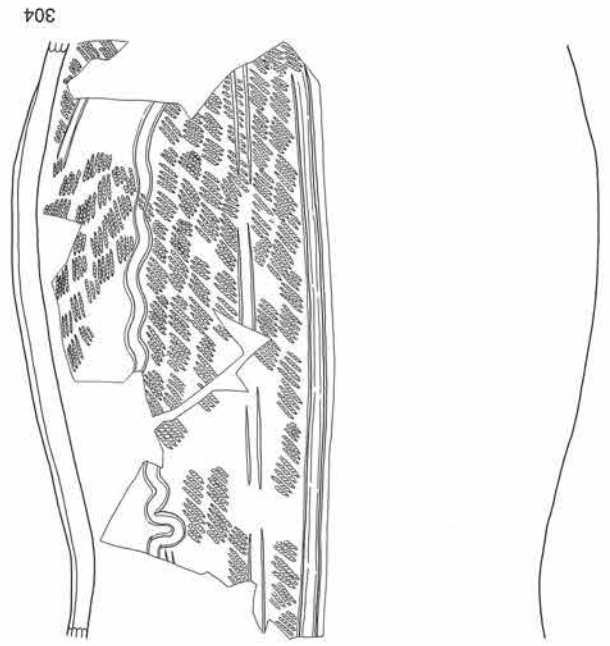
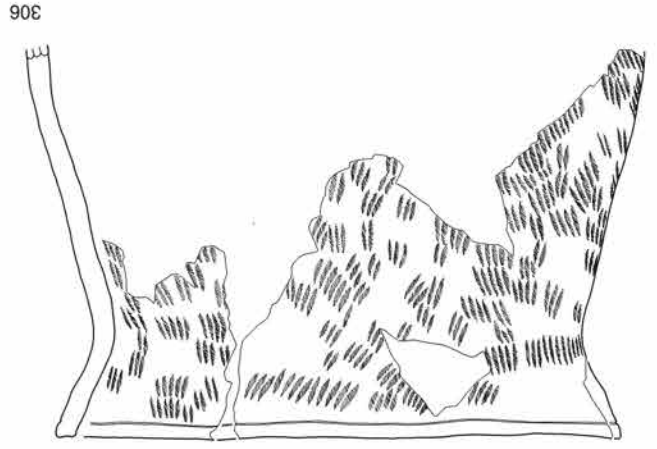

0 1 : 4 20cm

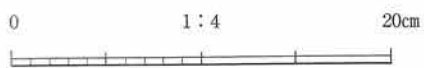

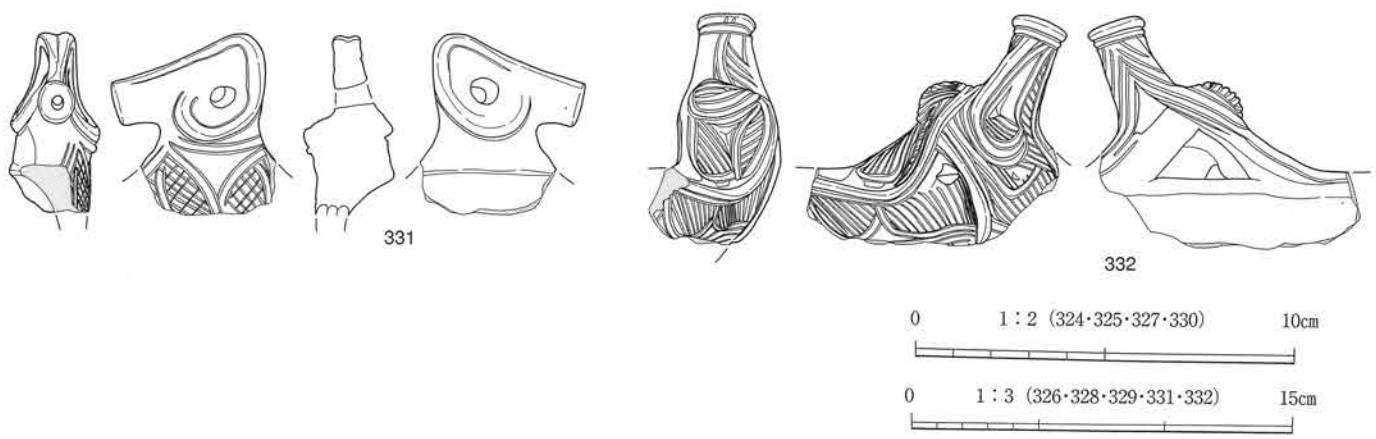
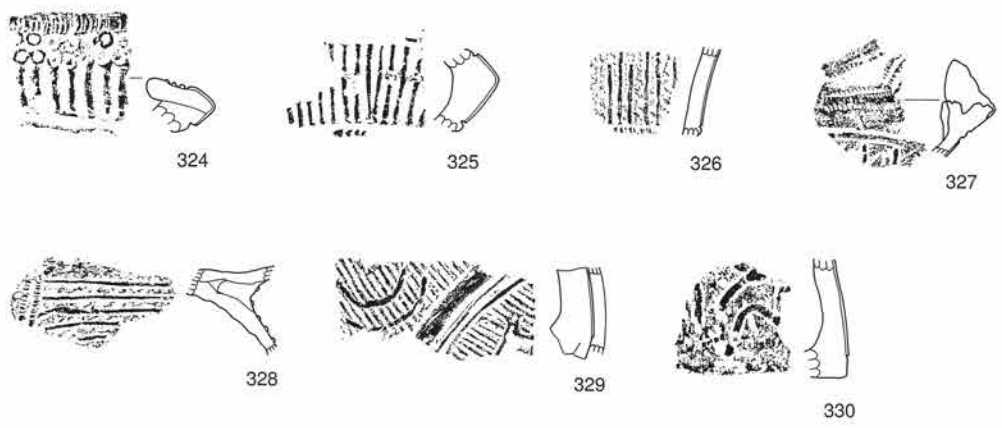
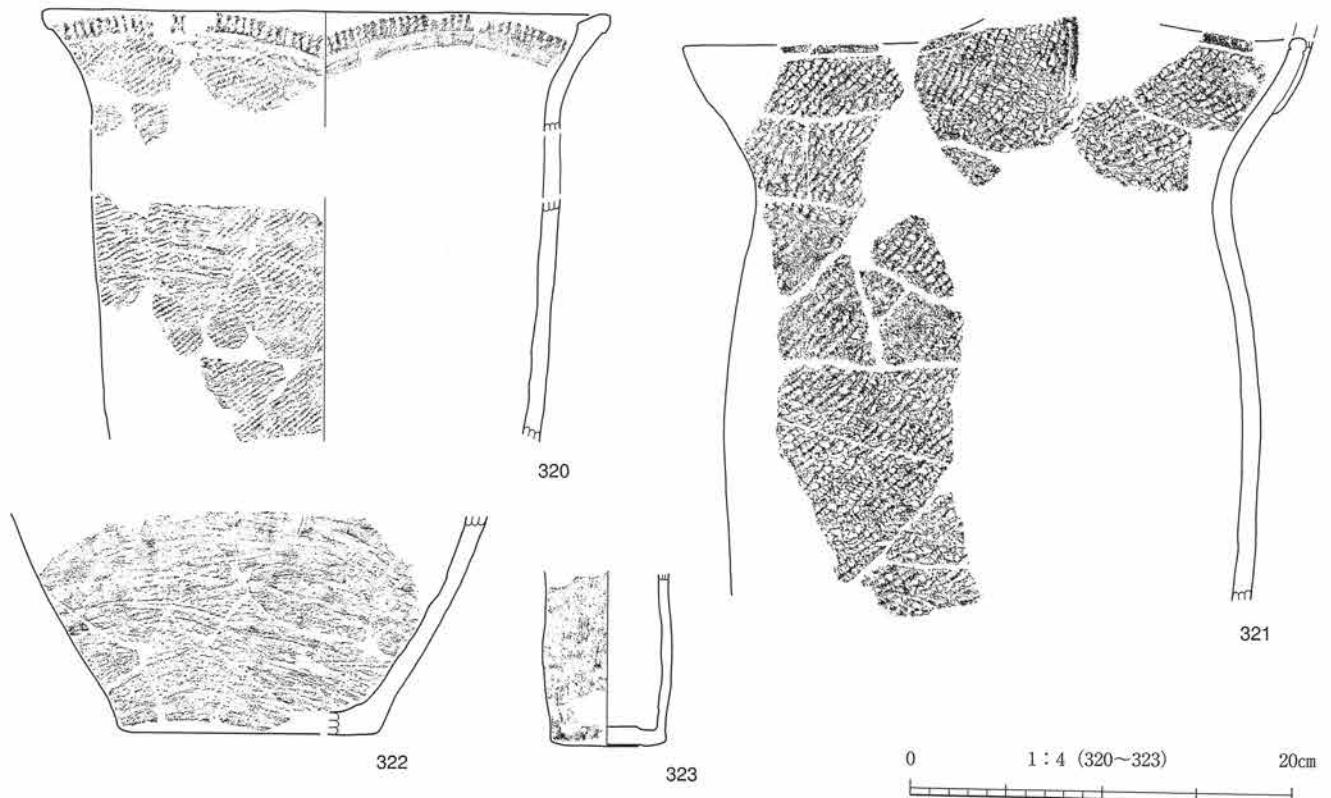

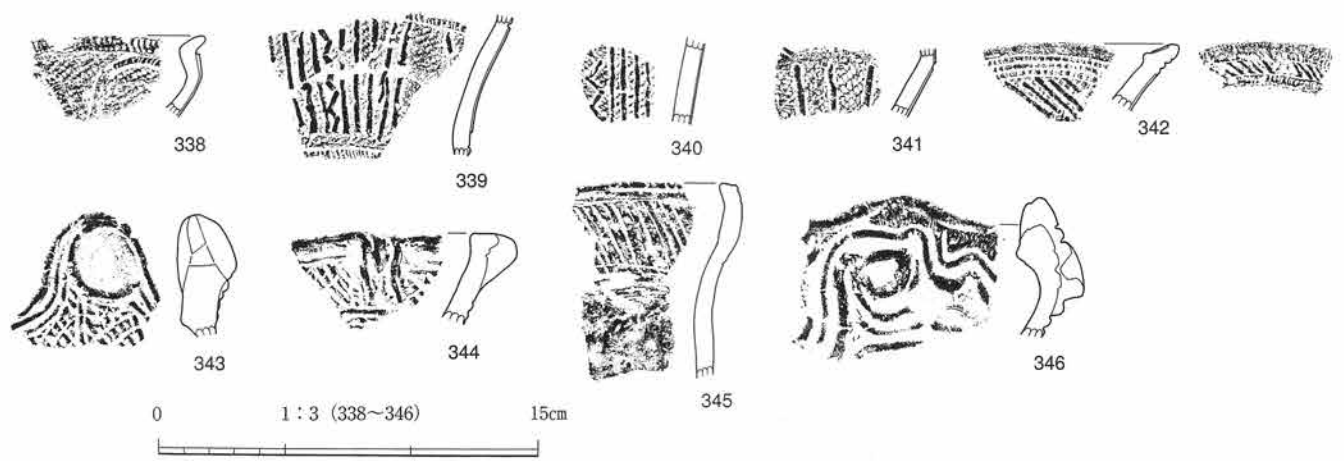
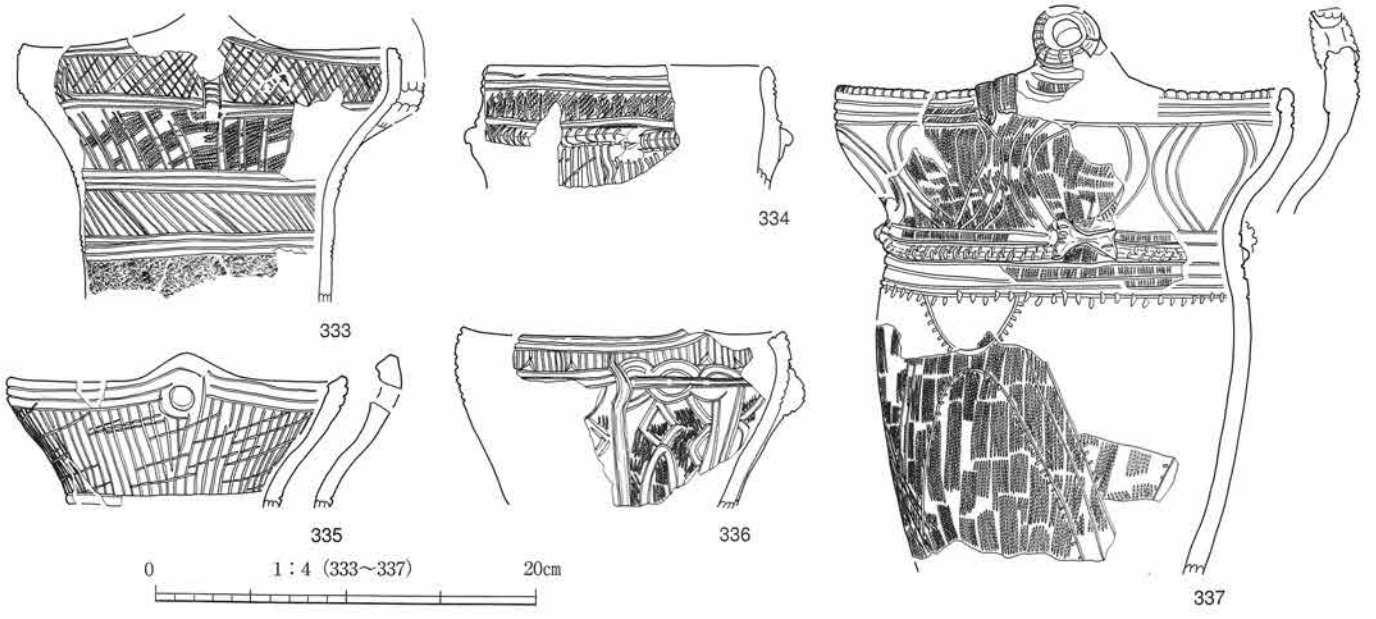

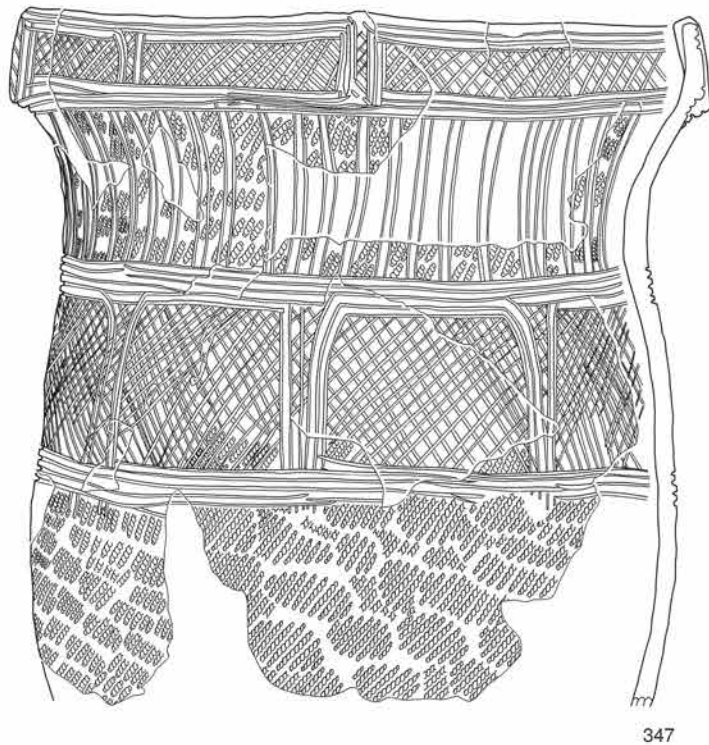

347

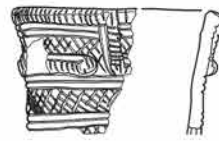

348

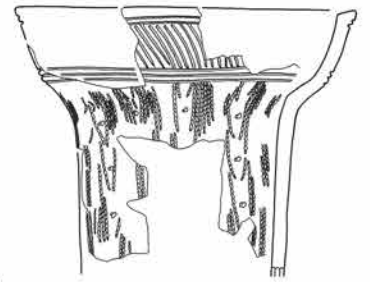

349



350

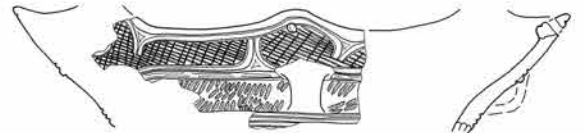

351

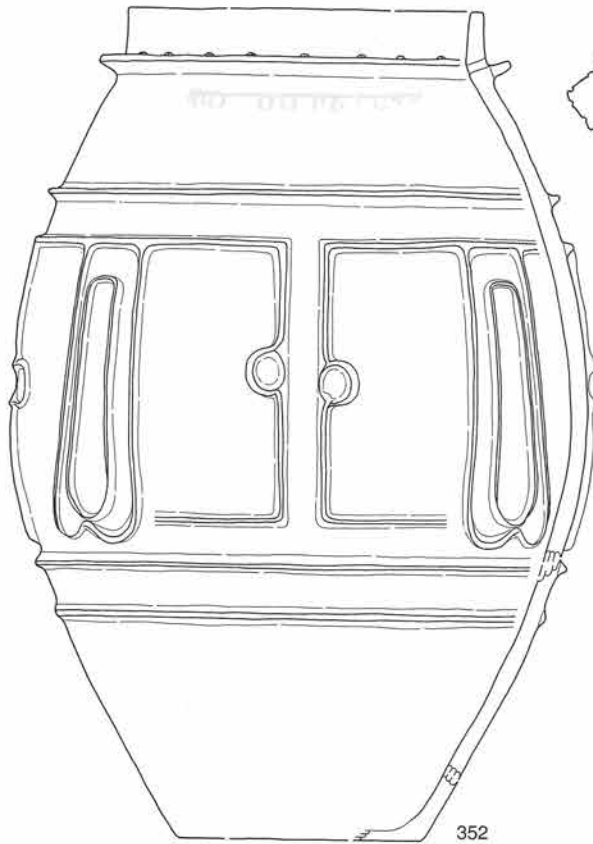

352

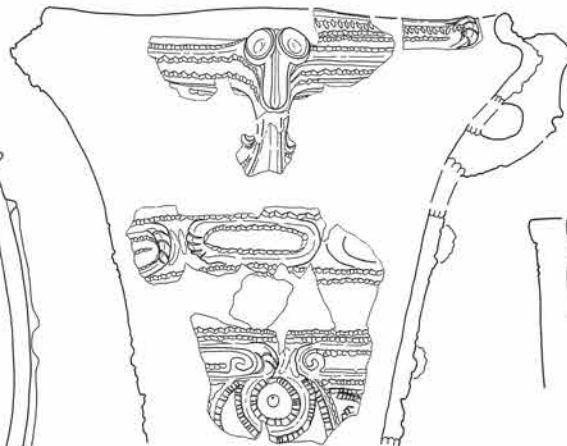

353

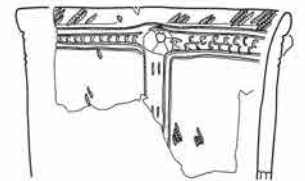

354

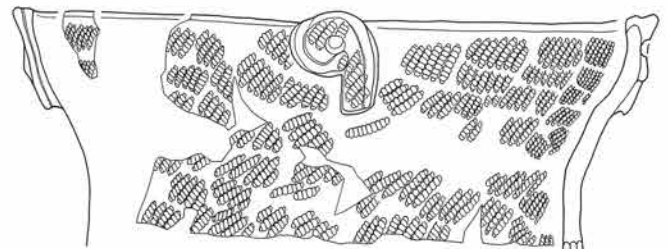

355

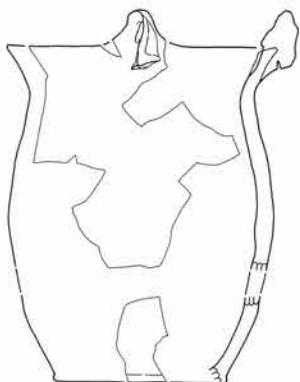

356

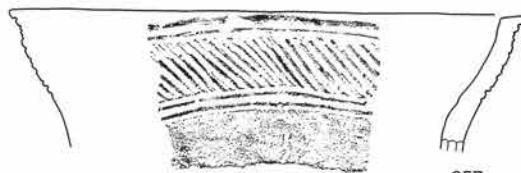

357

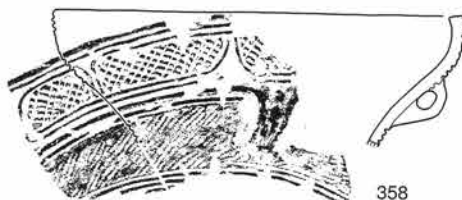

358

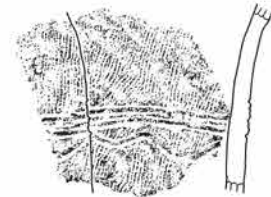

359

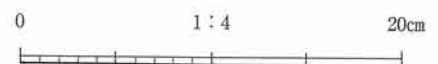



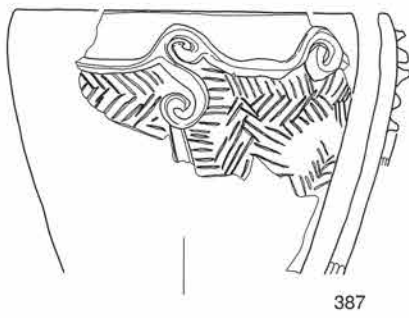

387

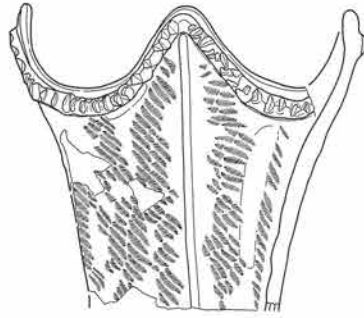

388

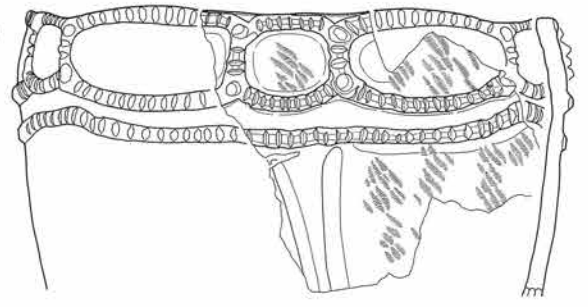

389



390

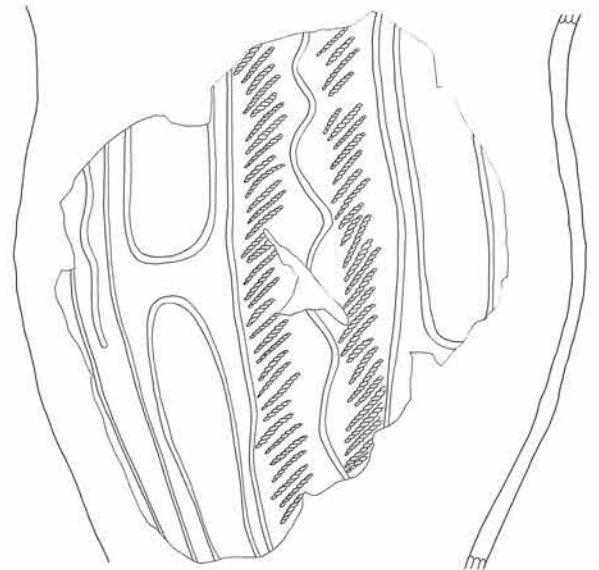

391

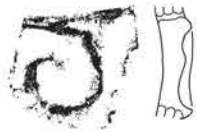

392

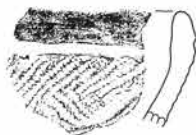

393



394

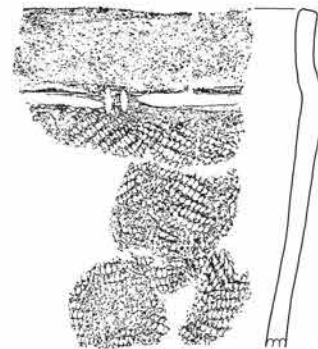

395

0 1:4 20cm



0 1:3 (392~395) 15cm



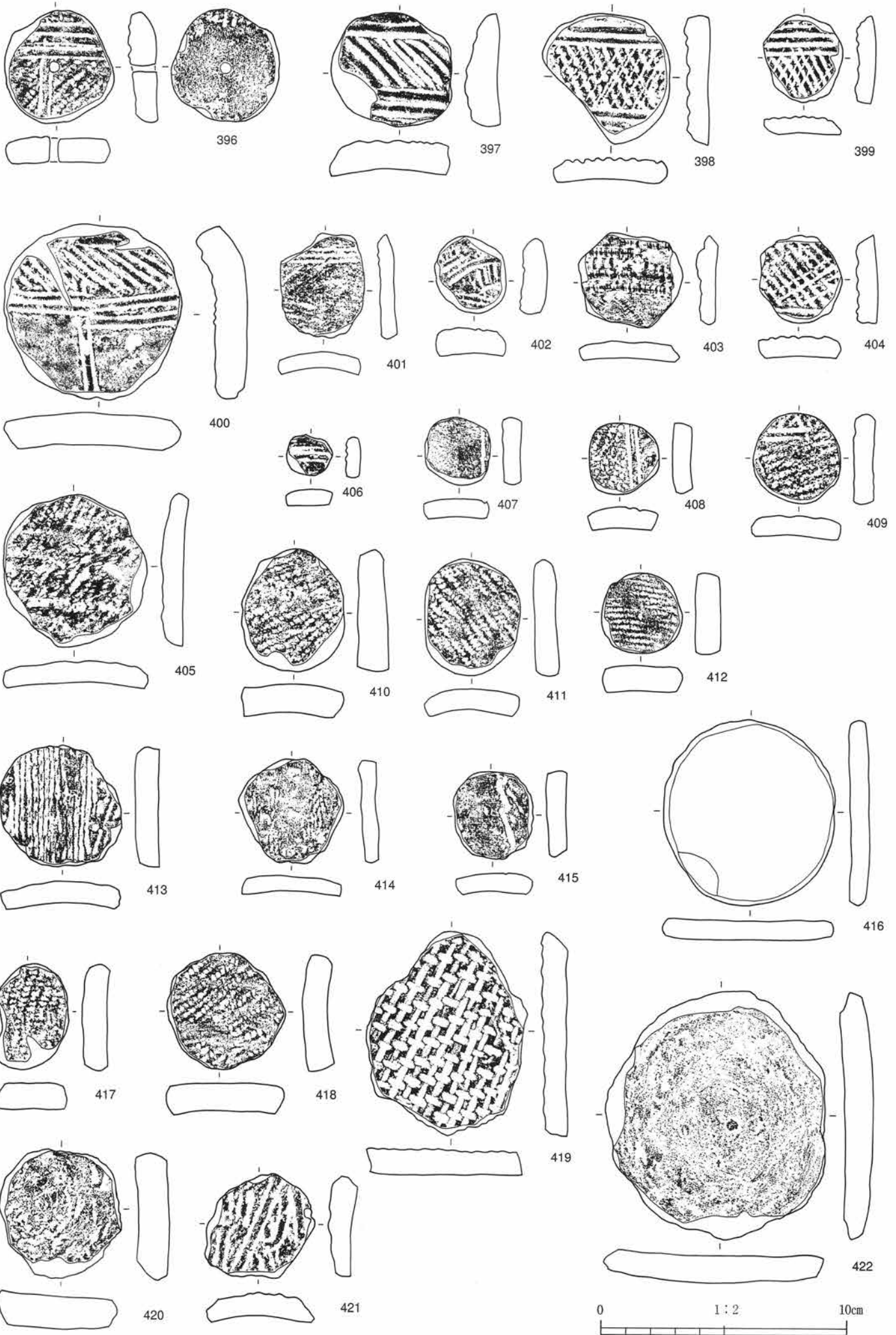

0 1:2 10cm

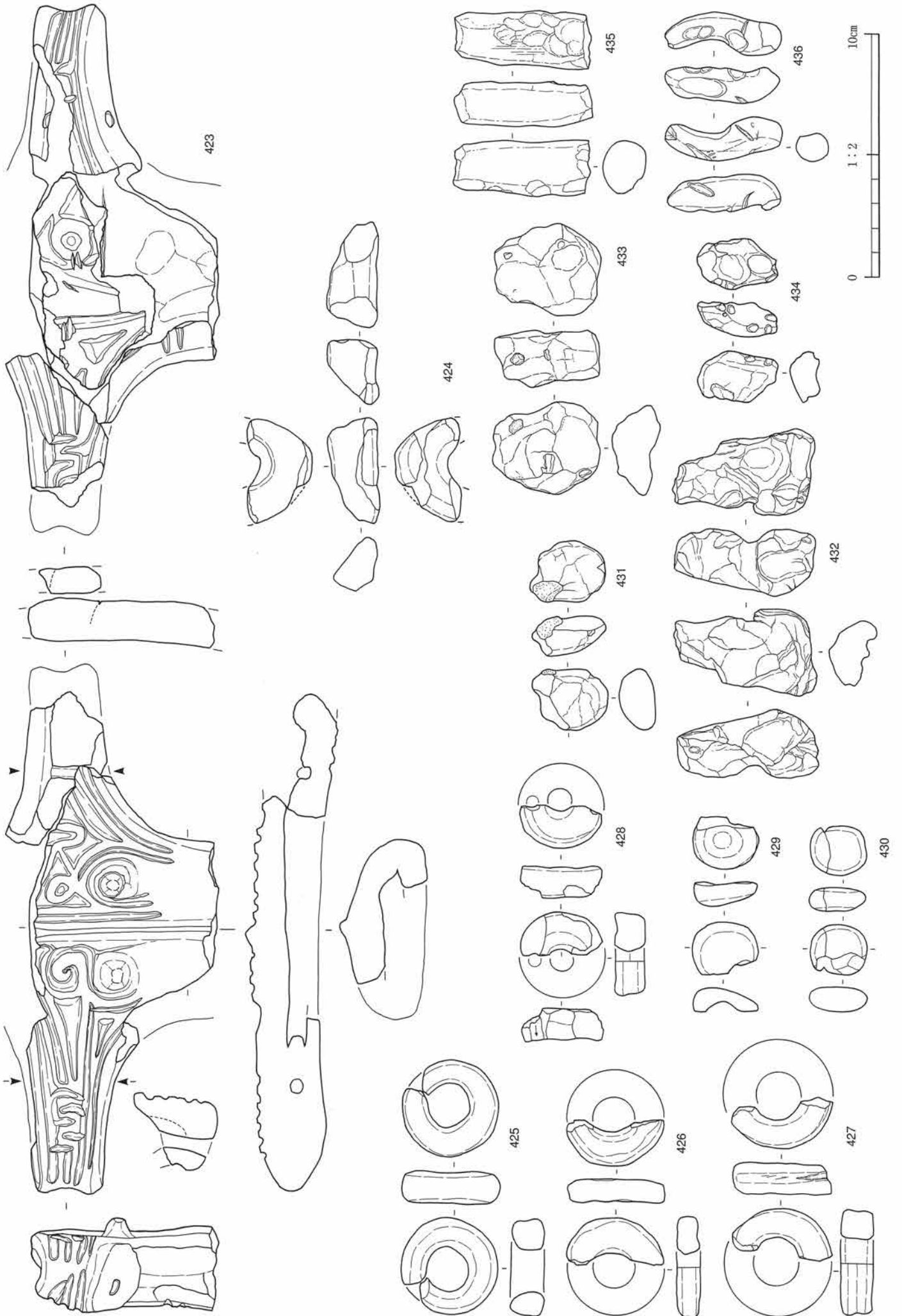

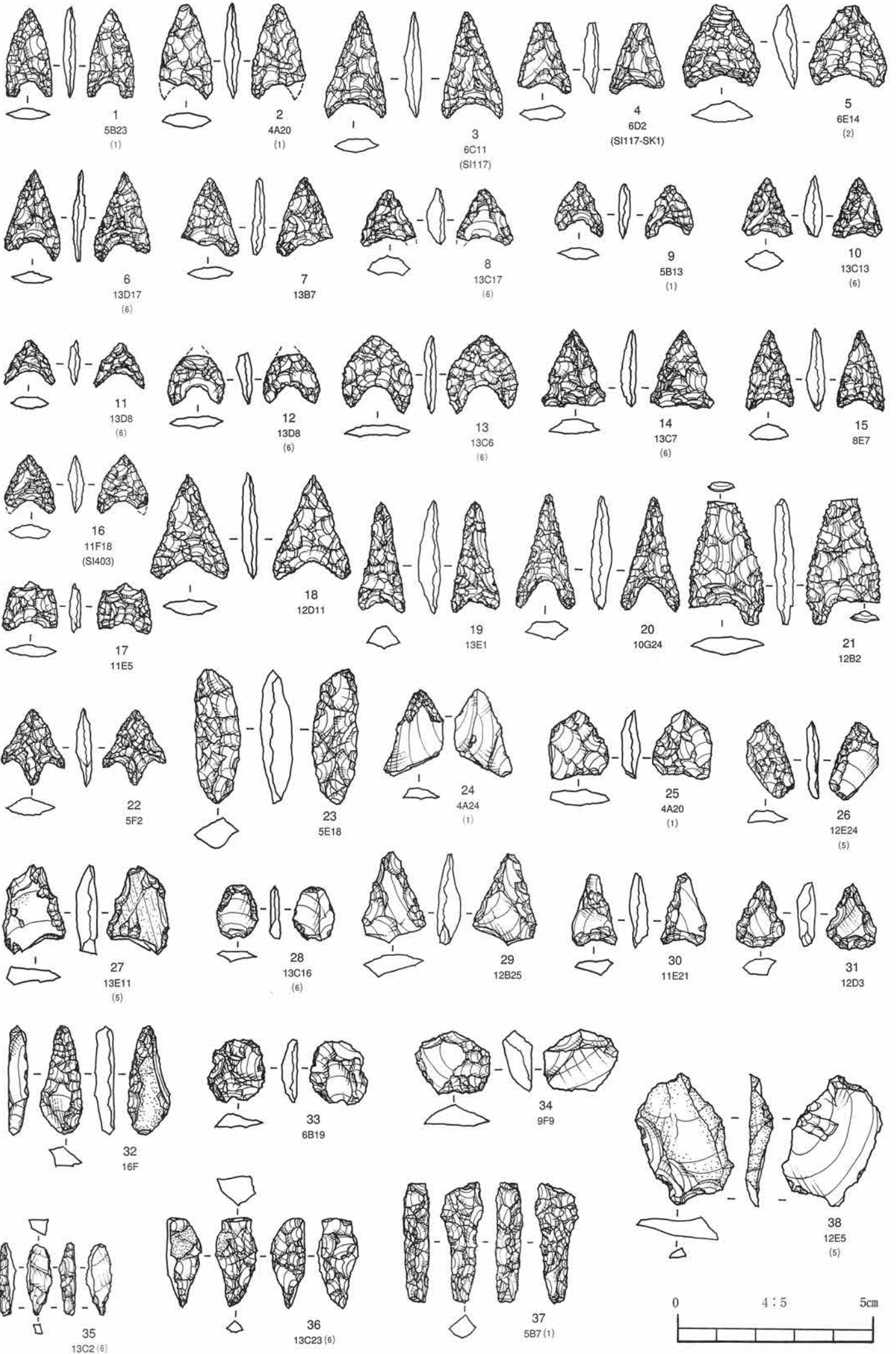



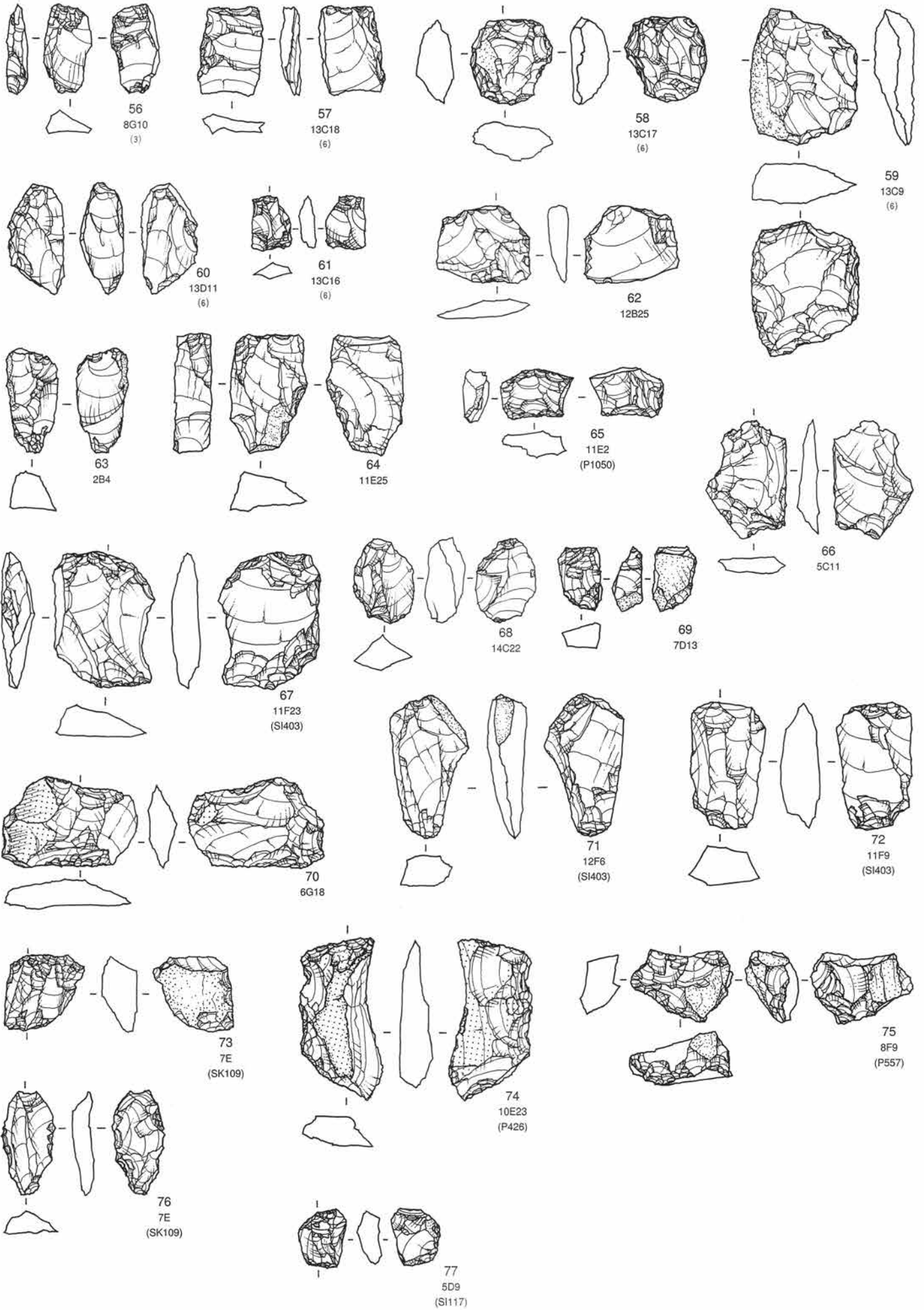

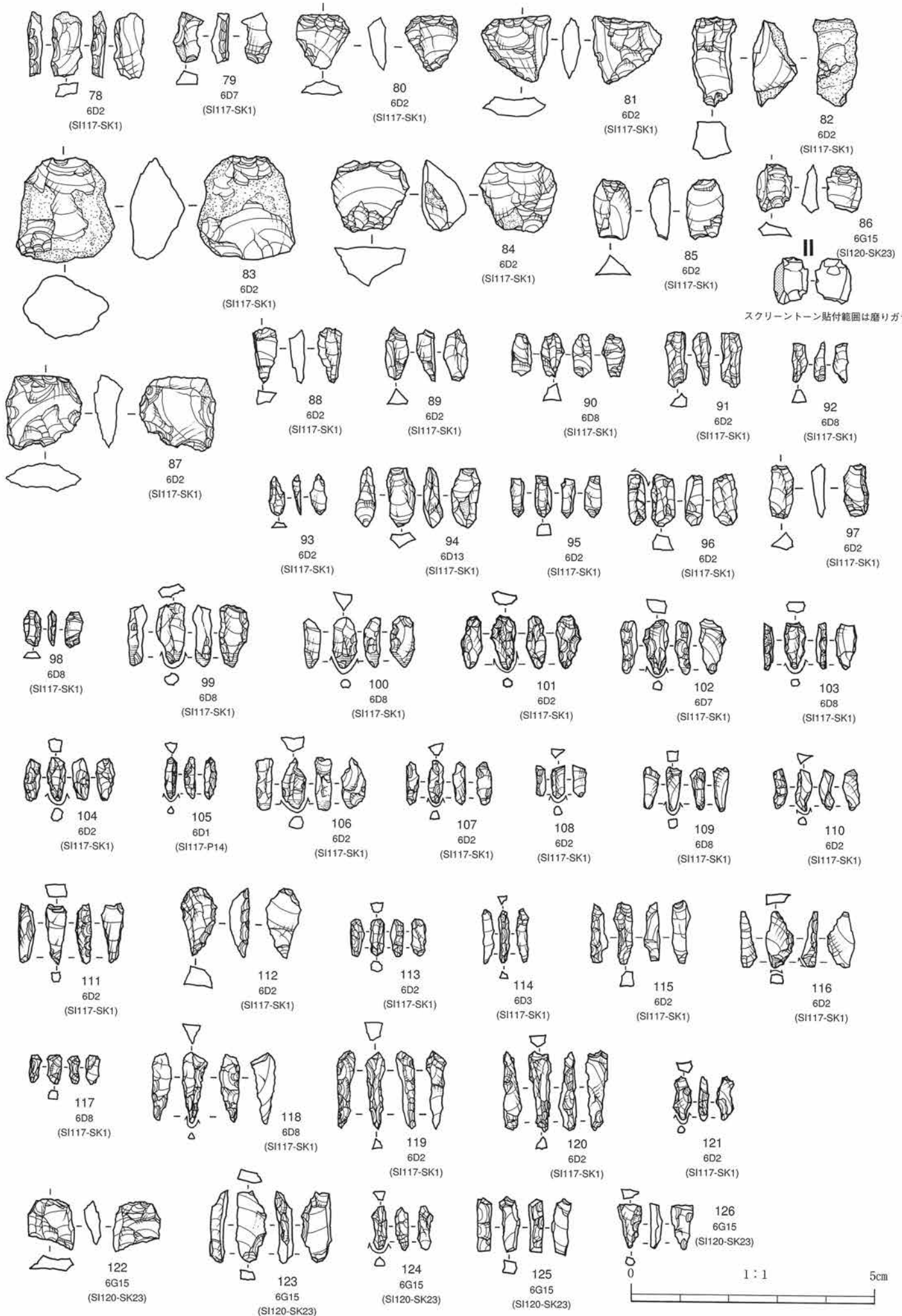

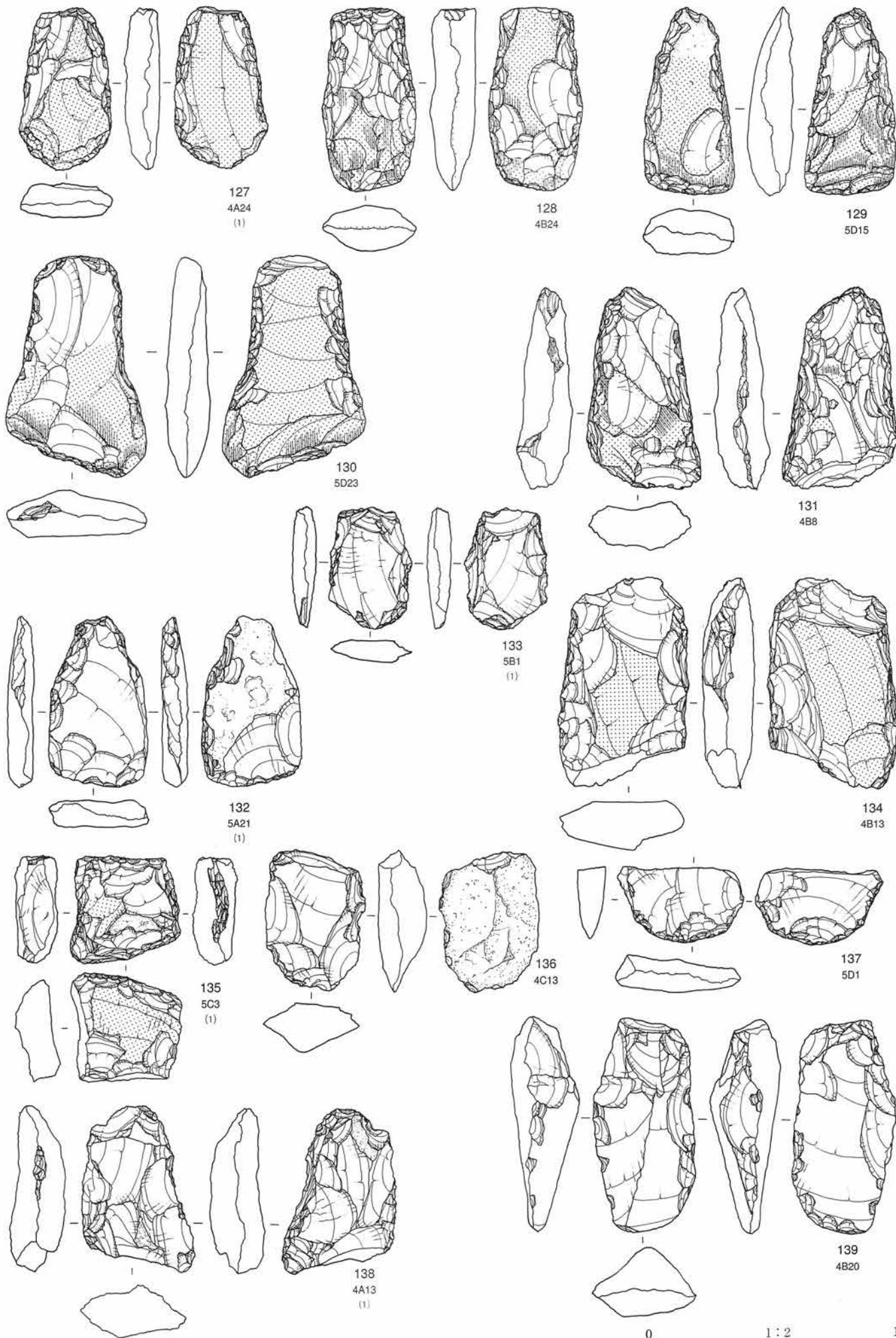

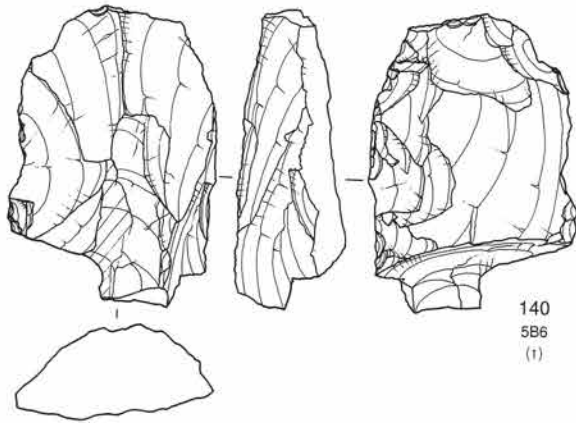

140
5B6
(1)

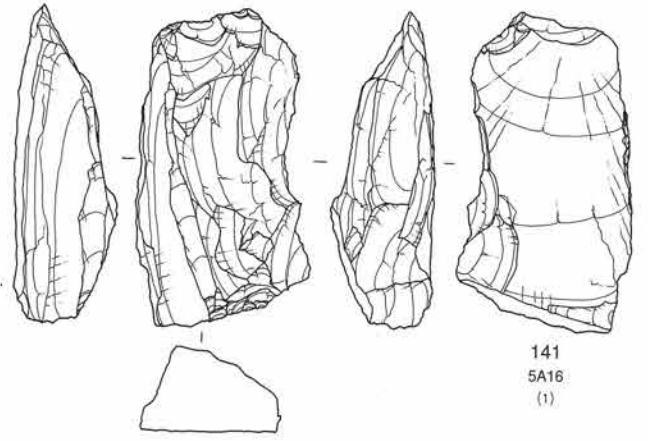

141
5A16
(1)

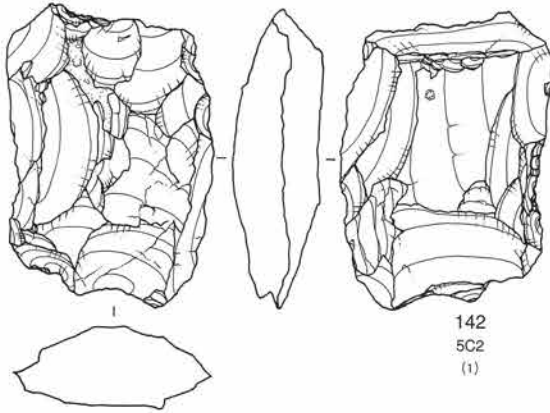

142
5C2
(1)

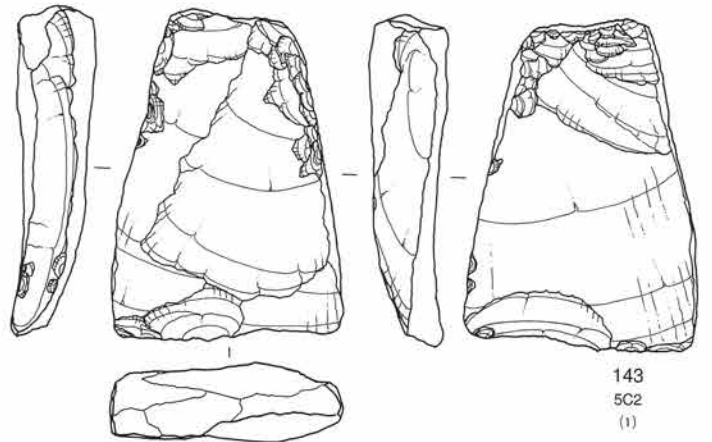

143
5C2
(1)

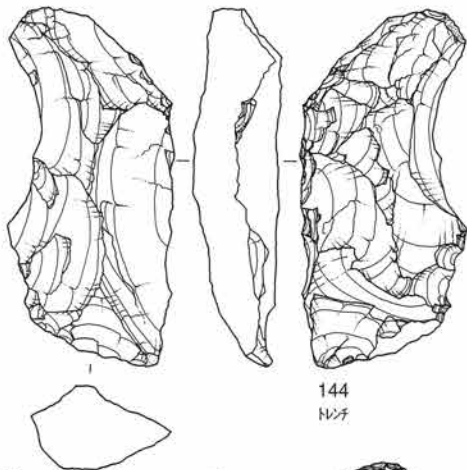

144
N27

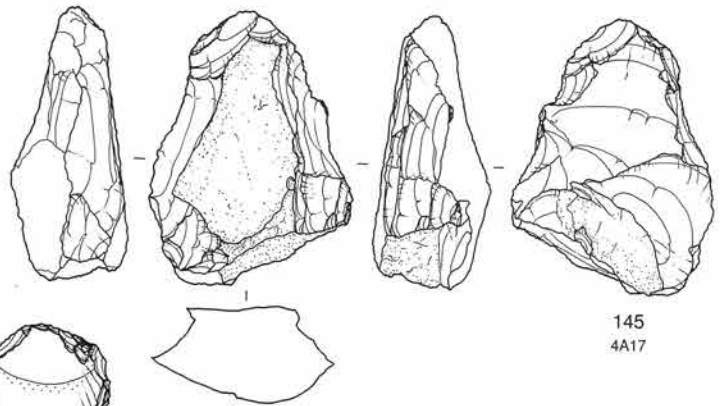

145
4A17

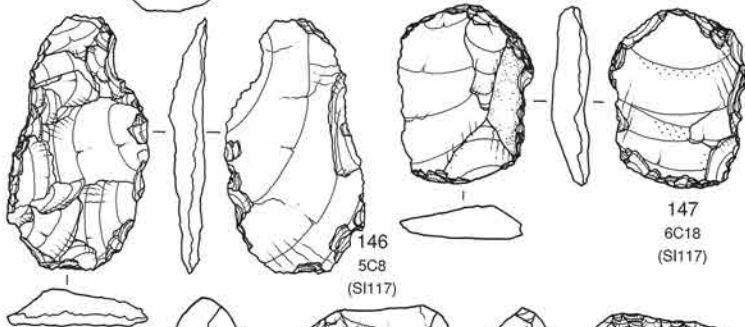

146
5C8
(SI117)

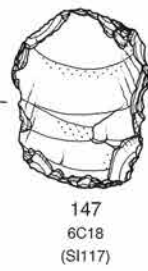

147
6C18
(SI117)

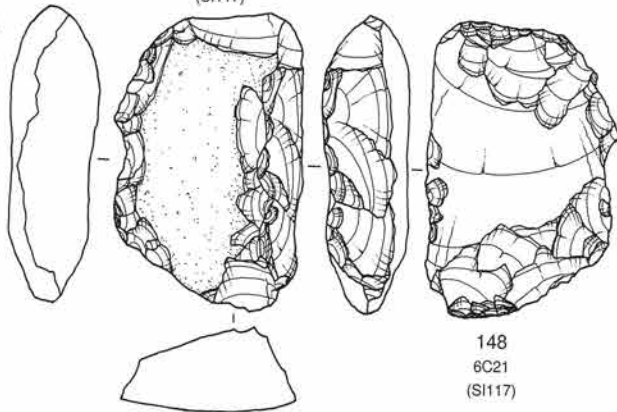

148
6C21
(SI117)

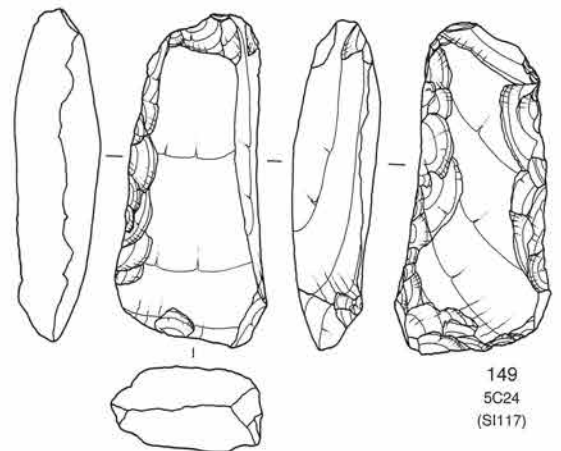

149
5C24
(SI117)

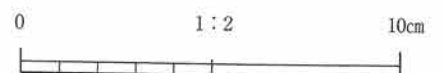

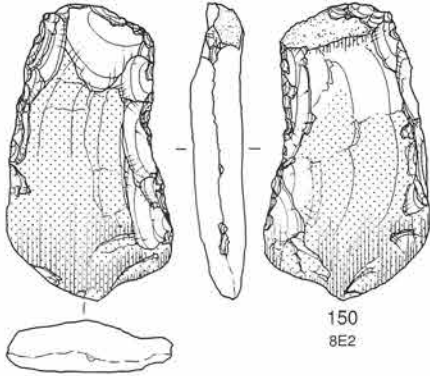

150
8E2

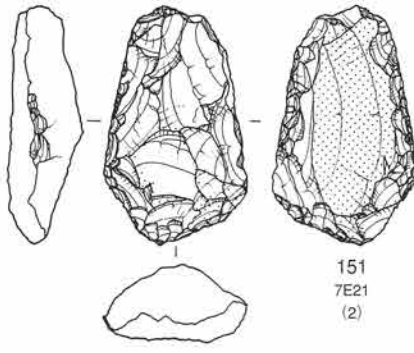

151
7E21
(2)

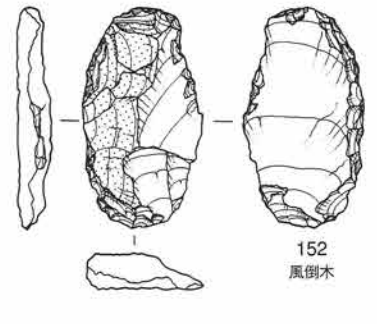

152
風倒木

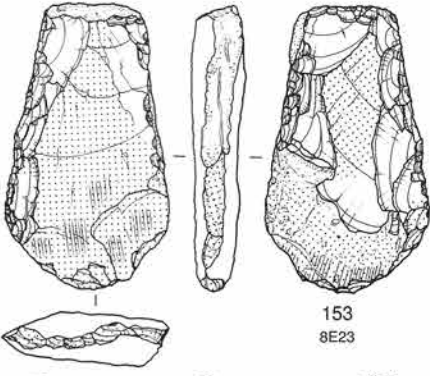

153
8E23

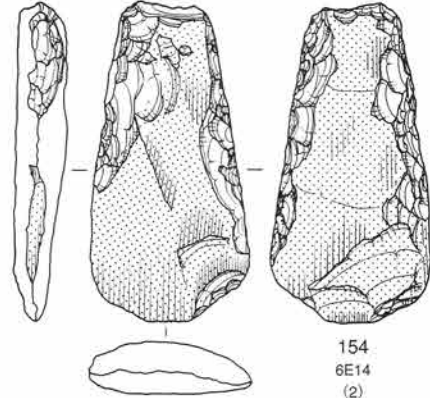

154
6E14
(2)

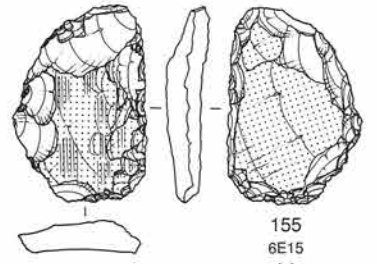

155
6E15
(2)

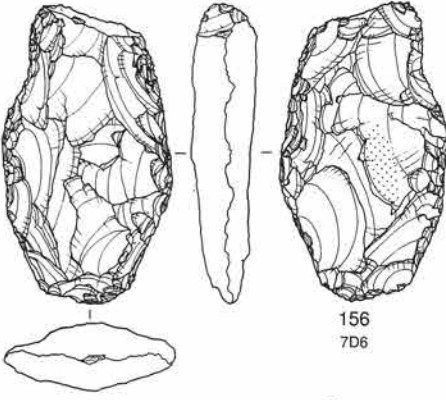

156
7D6

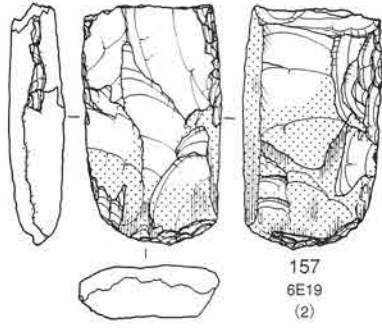

157
6E19
(2)

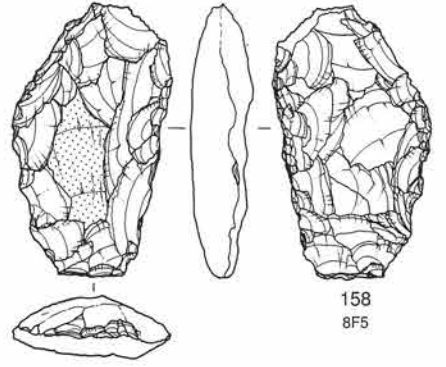

158
8F5

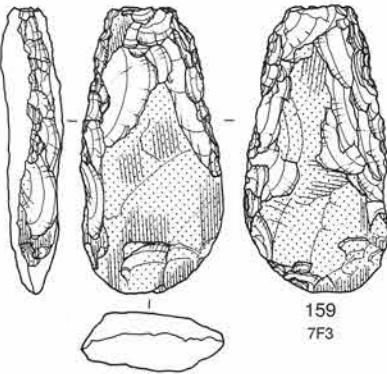

159
7F3

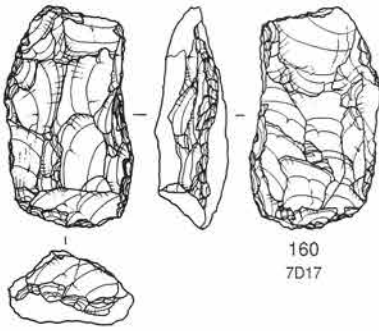

160
7D17

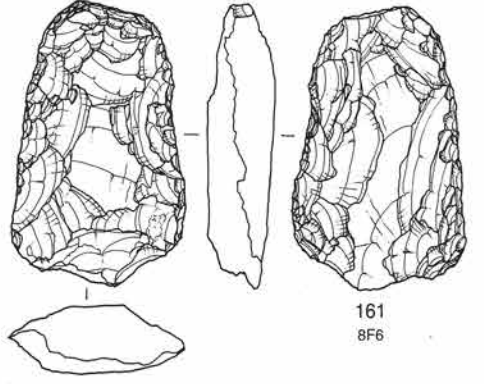

161
8F6

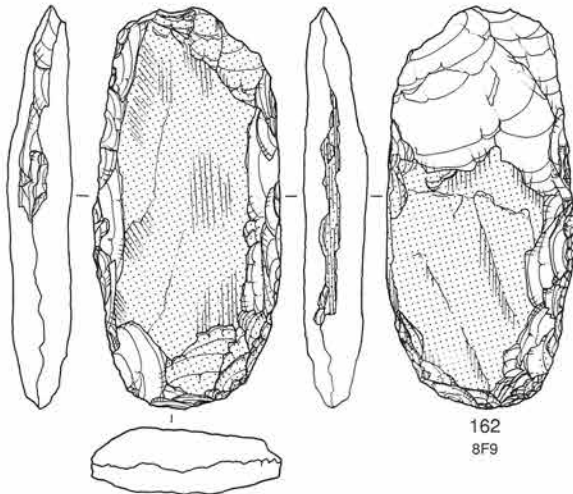

162
8F9

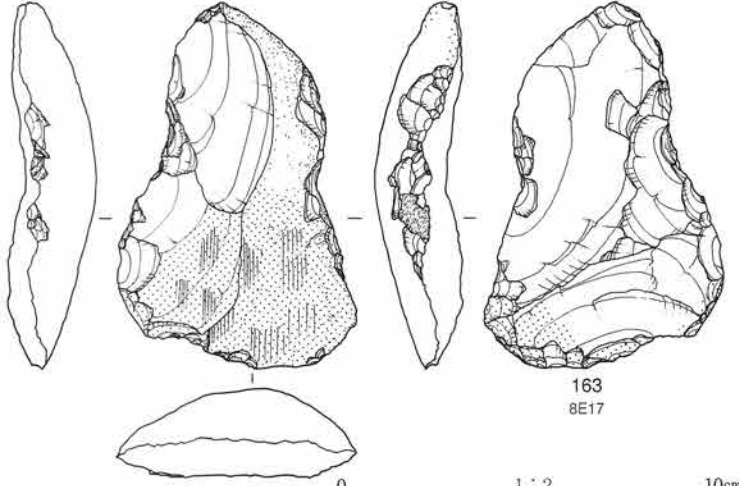

163
8E17

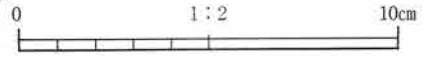

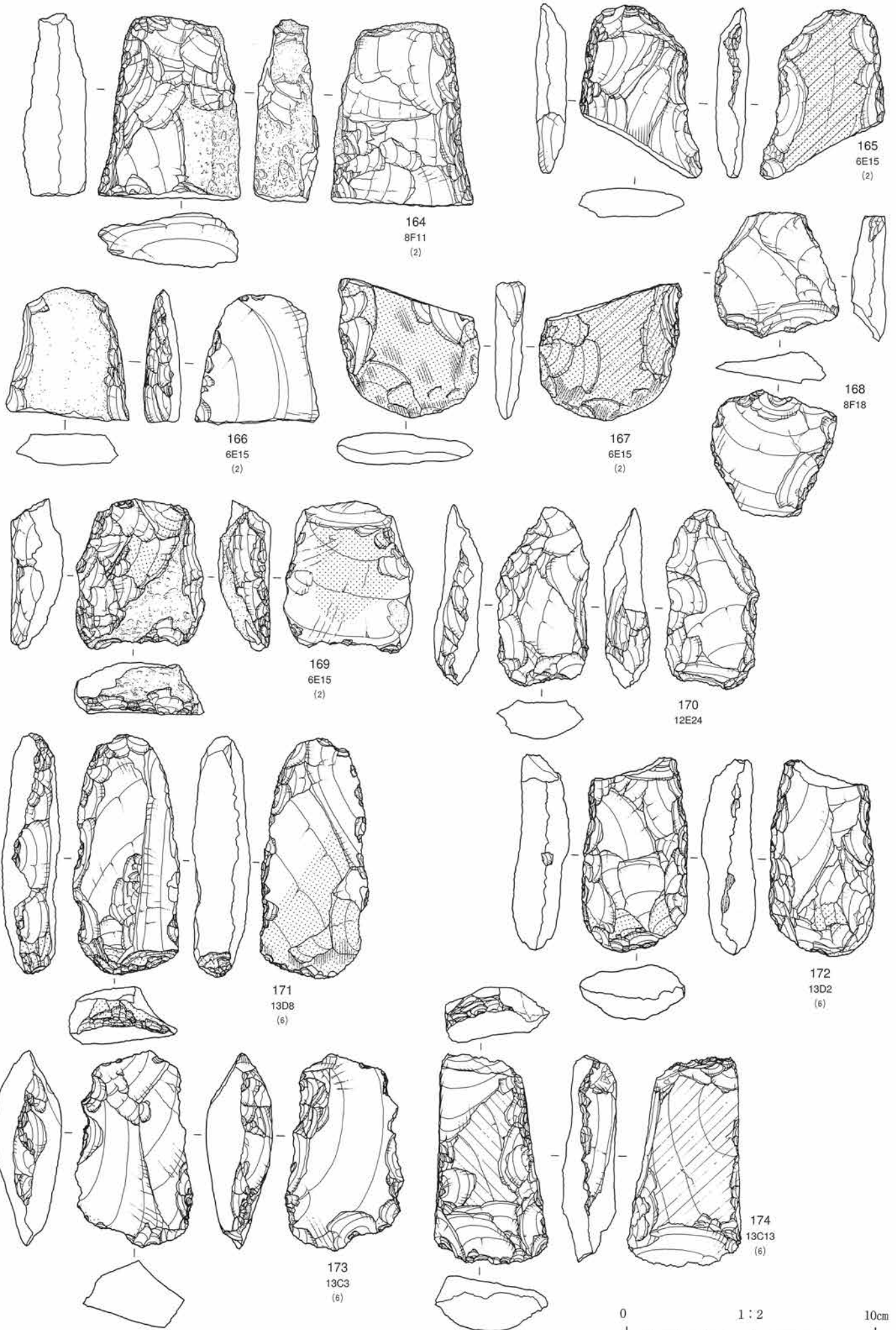

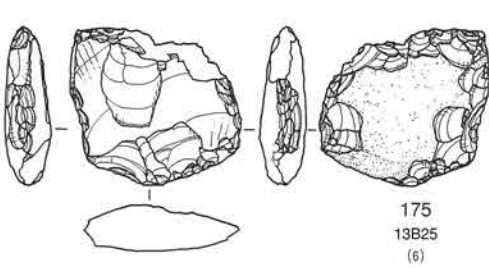

175
13B25
(6)

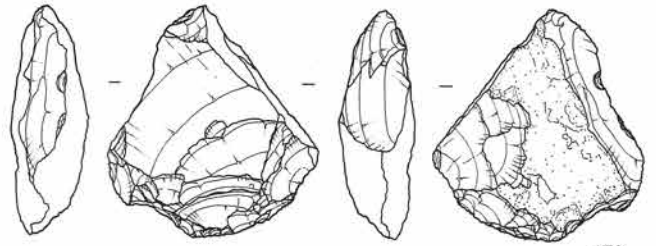

176
13C14
(6)

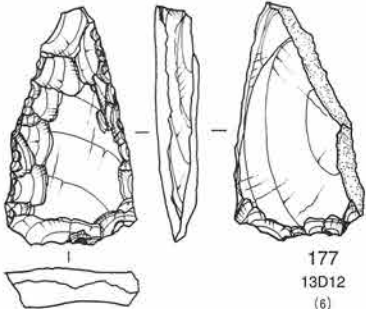

177
13D12
(6)

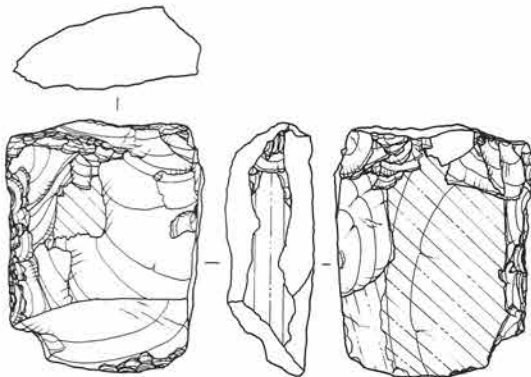

178
13C14
(6)

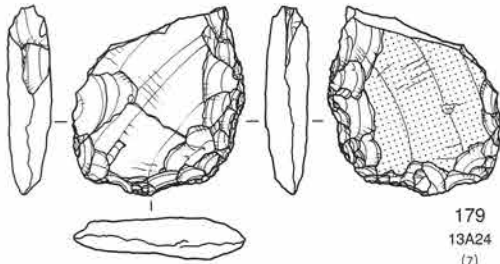

179
13A24
(7)

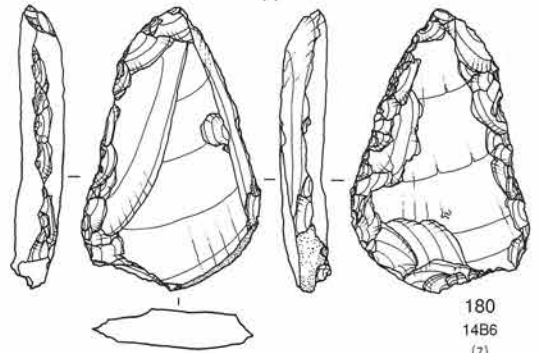

180
14B6
(7)

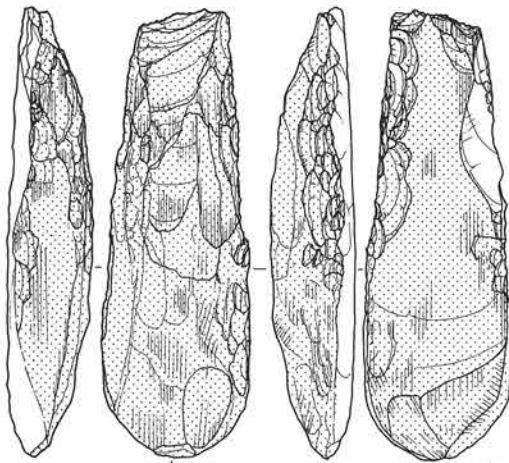

181
10G2

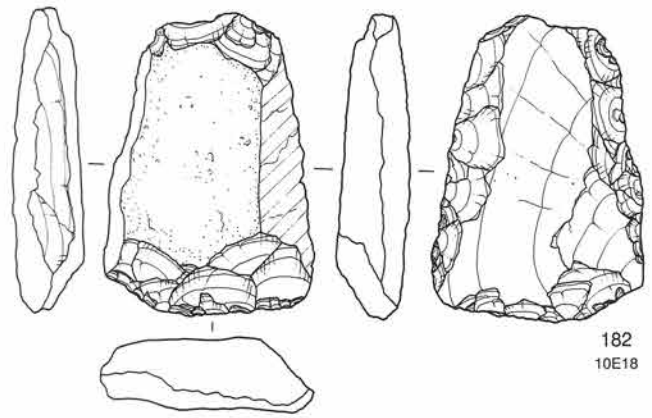

182
10E18



183
12E19

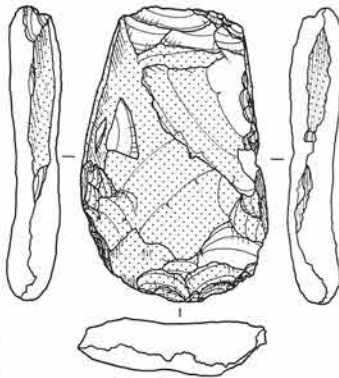

184
12E1

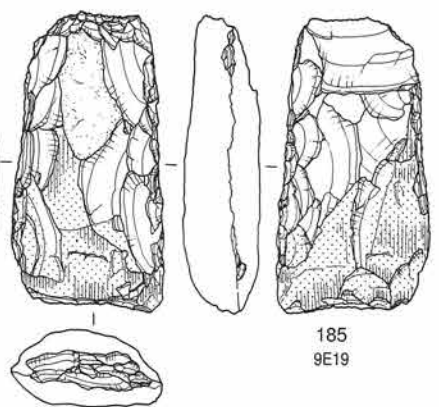

185
9E19

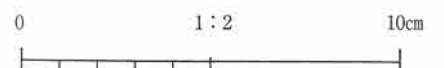

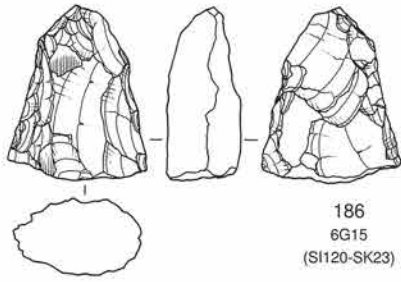

186
6G15
(SI120-SK23)

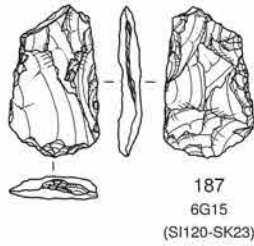

187
6G15
(SI120-SK23)

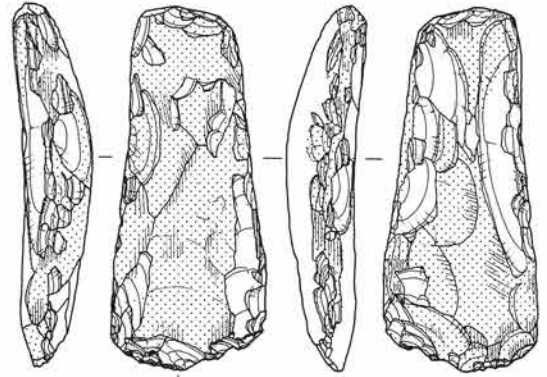

188
12F6
(SI403)

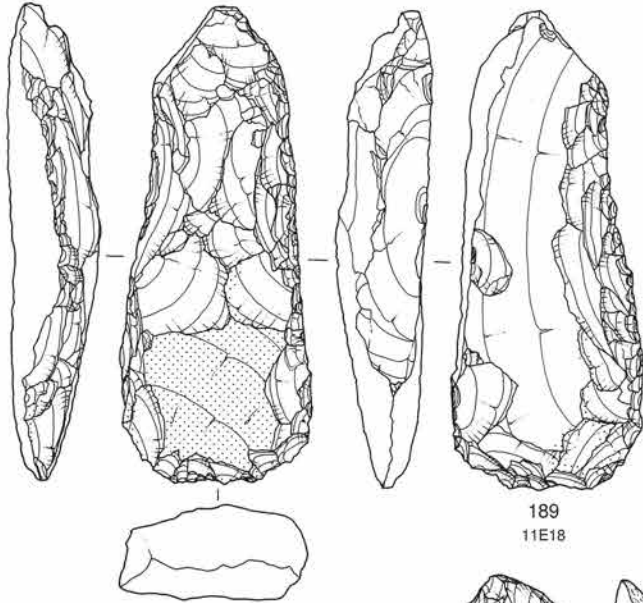

189
11E18

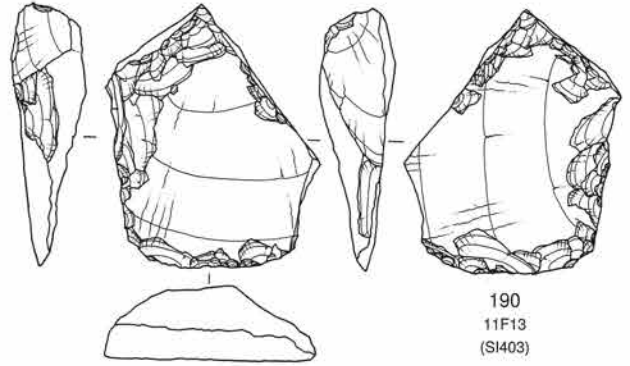

190
11F13
(SI403)

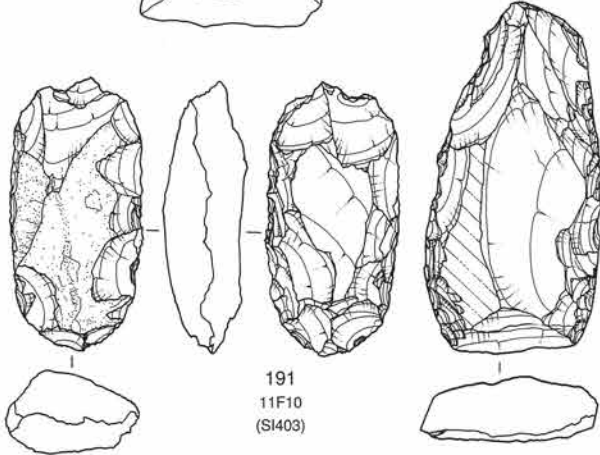

191
11F10
(SI403)

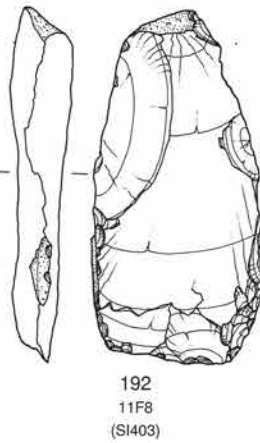

192
11F8
(SI403)

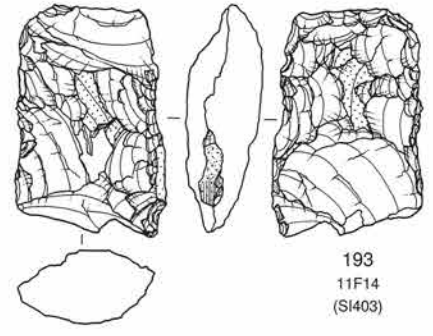

193
11F14
(SI403)

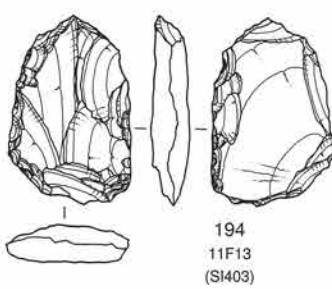

194
11F13
(SI403)

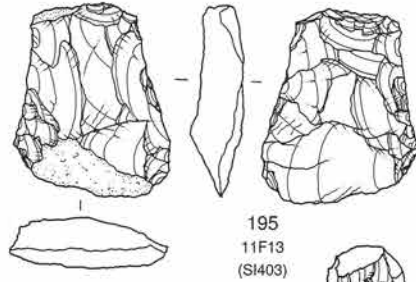

195
11F13
(SI403)

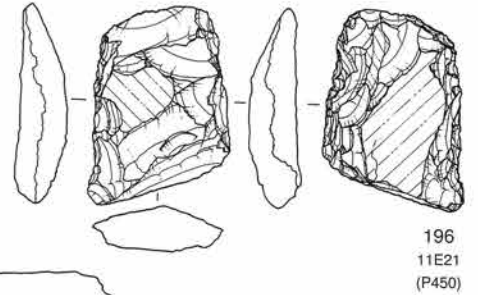

196
11E21
(P450)

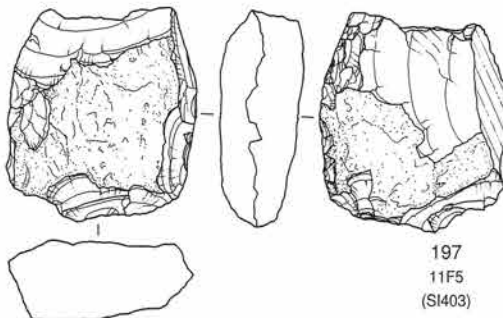

197
11F5
(SI403)

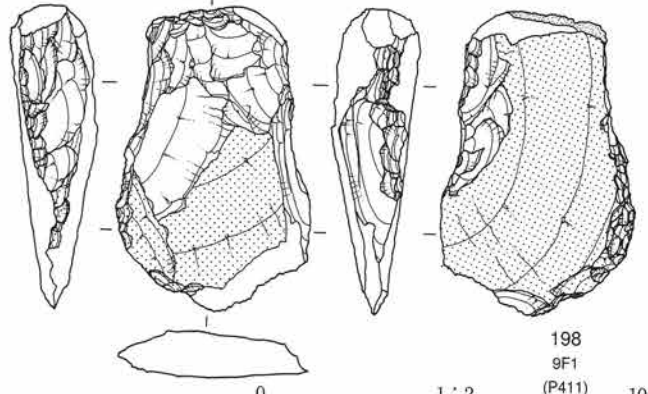

198
9F1
(P411)

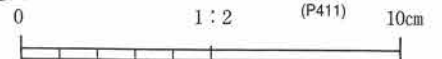

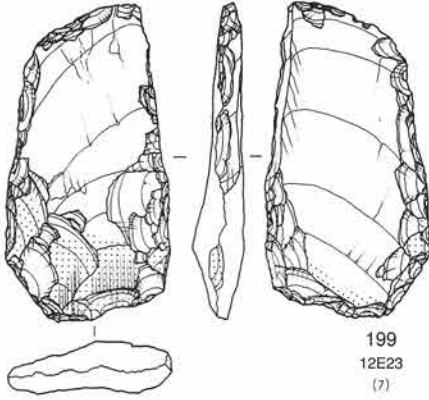

199
12E23
(7)

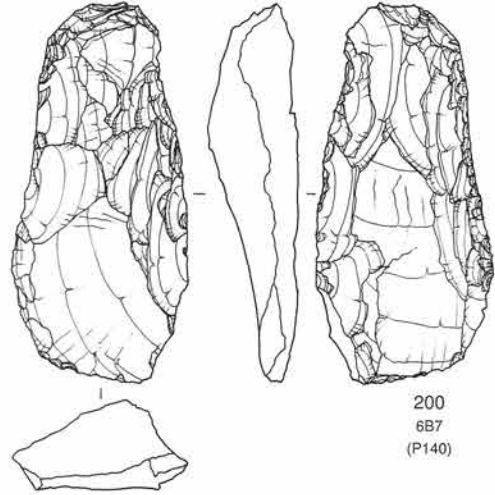

200
6B7
(P140)

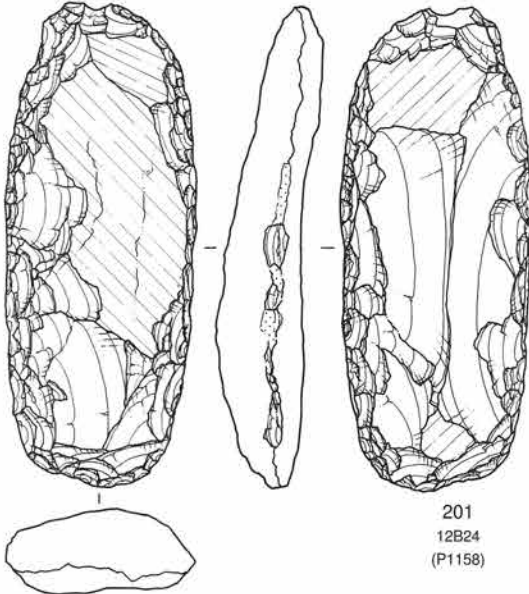

201
12B24
(P1158)

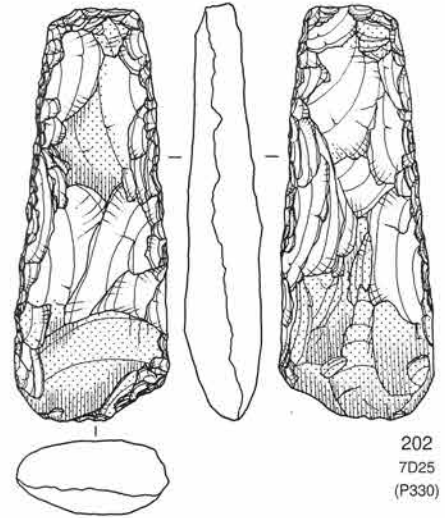

202
7D25
(P330)

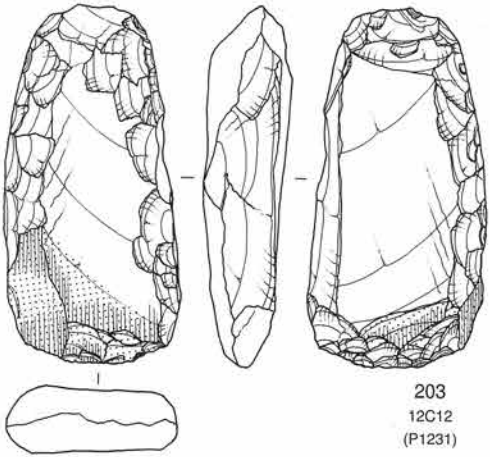

203
12C12
(P1231)

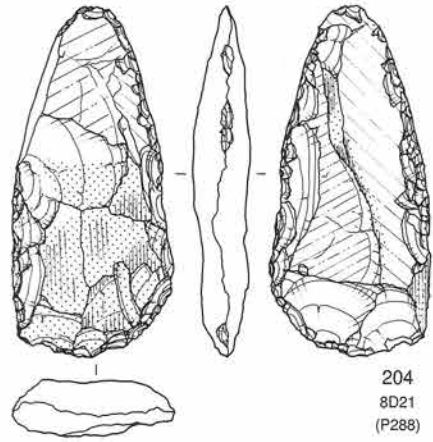

204
8D21
(P288)

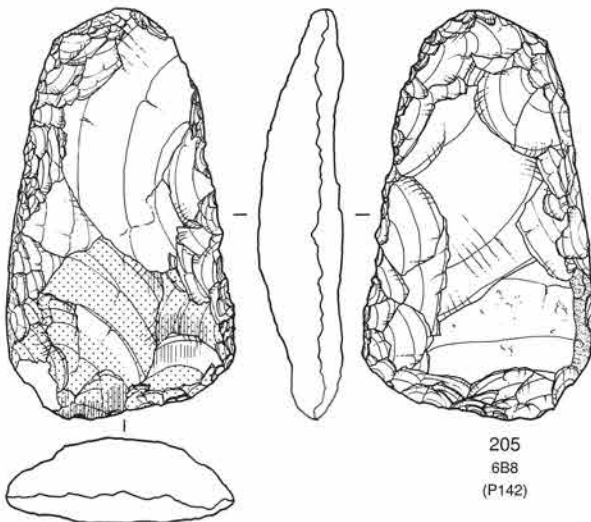

205
6B8
(P142)

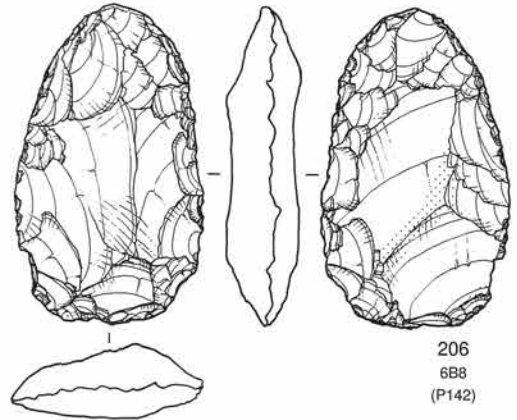

206
6B8
(P142)

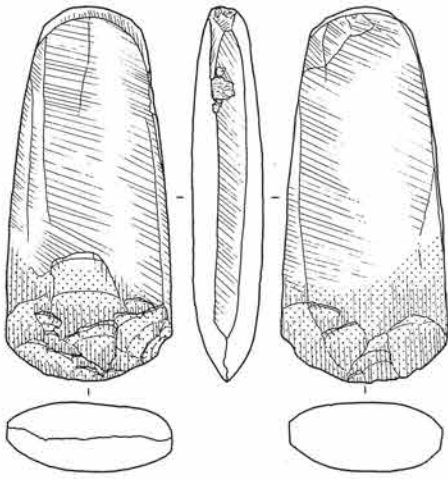

207
5A22
(1)

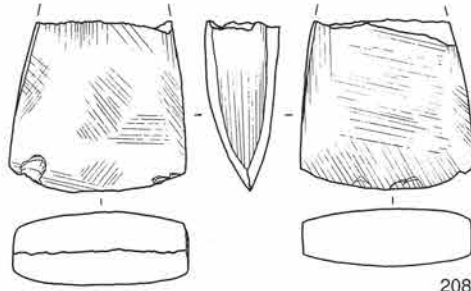

208
7F15

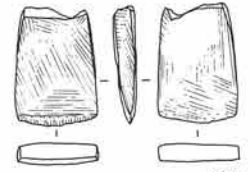

209
9G6
(3)

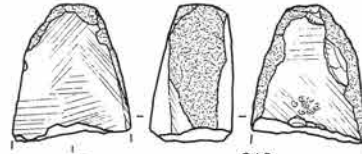

210
13C3

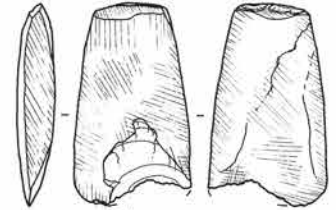

211
13D13
(6)

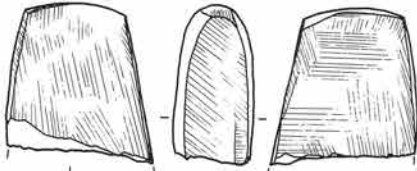

212
5C22

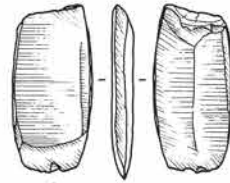

213
13D8
(6)

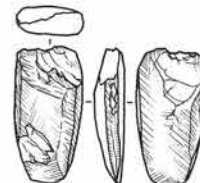

214
13C18
(6)

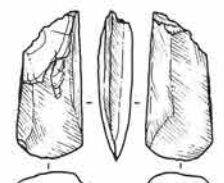

215
13D8
(6)

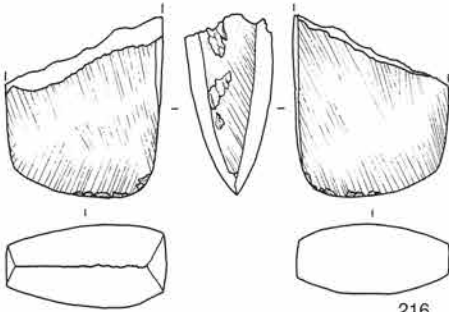

216
13B15
(7)

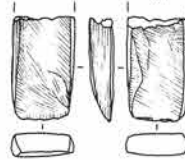

217
13C17
(6)

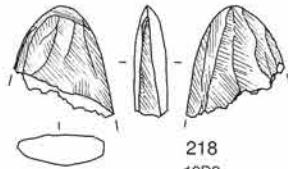

218
13D2
(6)

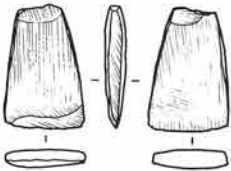

219
14B11
(7)

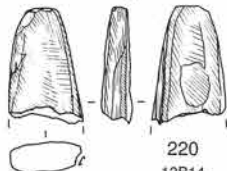

220
13B14
(7)

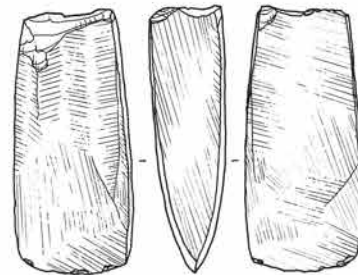

221
9C2

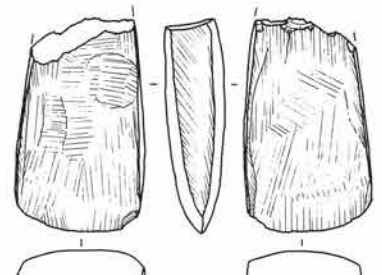

222
9F14

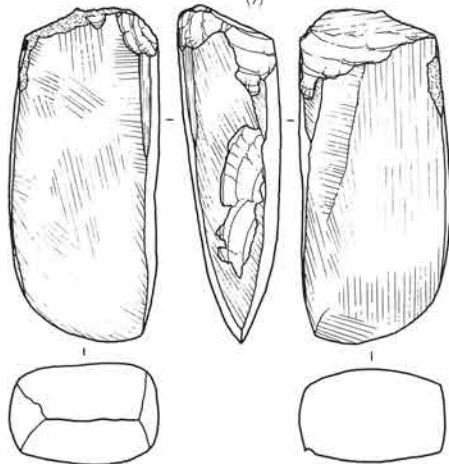

223
12E11

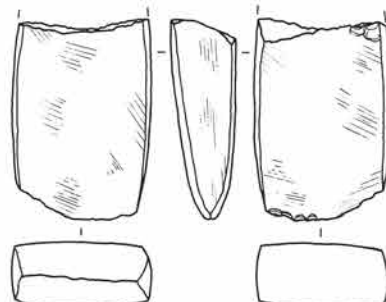

224
9E25

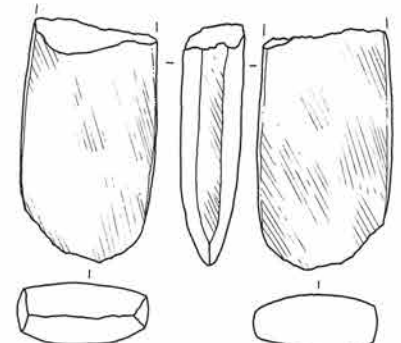

225
8E12

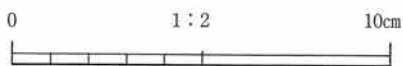



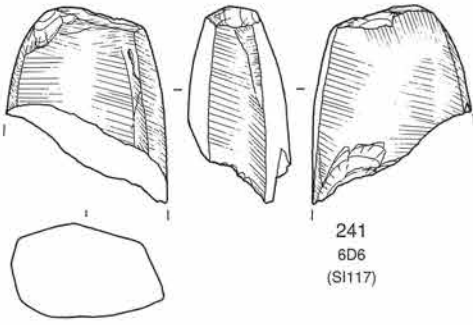

241
6D6
(SI117)

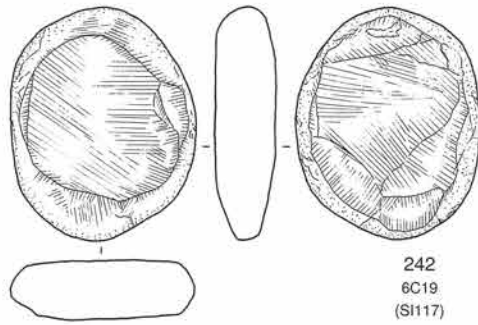

242
6C19
(SI117)

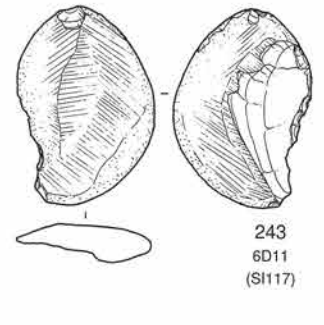

243
6D11
(SI117)

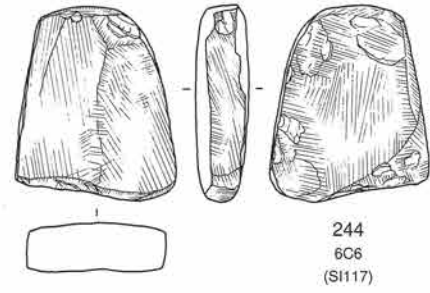

244
6C6
(SI117)

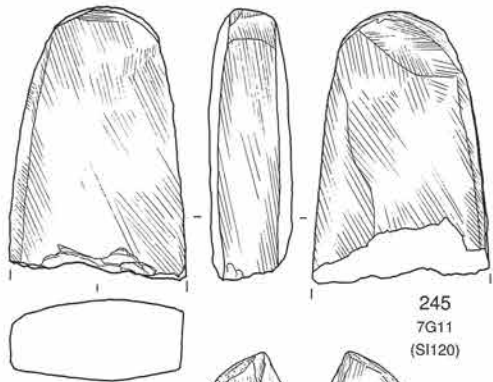

245
7G11
(SI120)



246
11F13
(SI403)

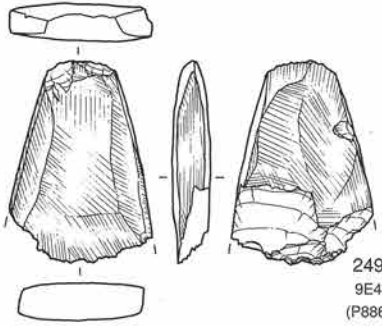

249
9E4
(P886)

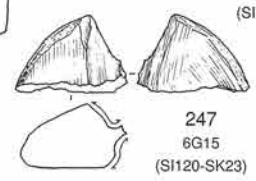

247
6G15
(SI120-SK23)

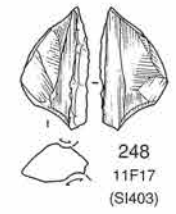

248
11F17
(SI403)

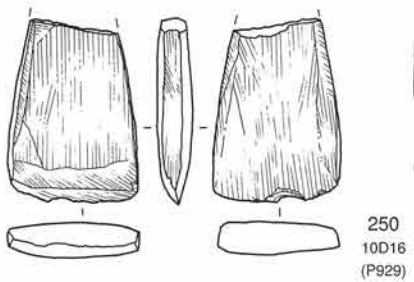

250
10D16
(P929)

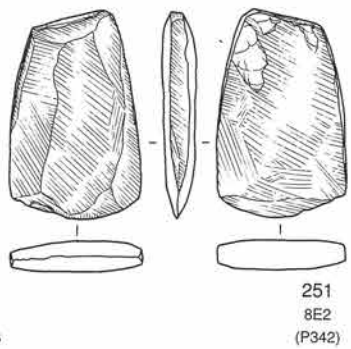

251
8E2
(P342)

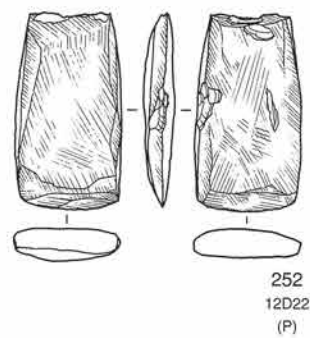

252
12D22
(P)

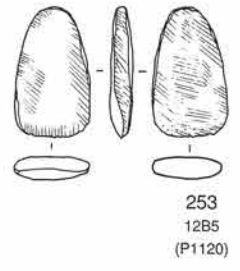

253
12B5
(P1120)

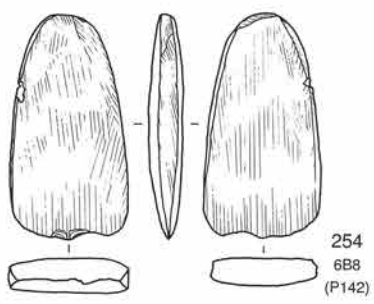

254
6B8
(P142)

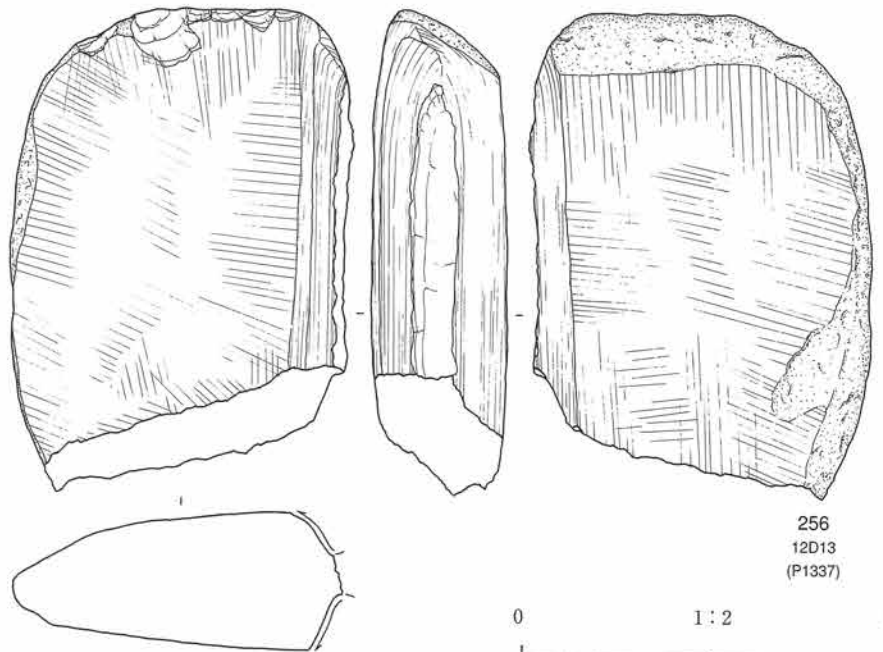

256
12D13
(P1337)

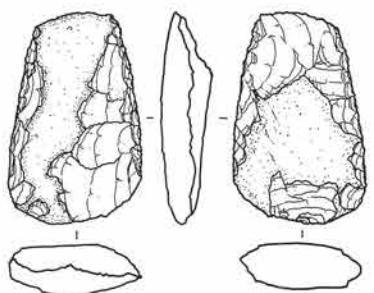

255
8C11

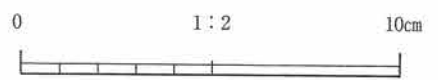

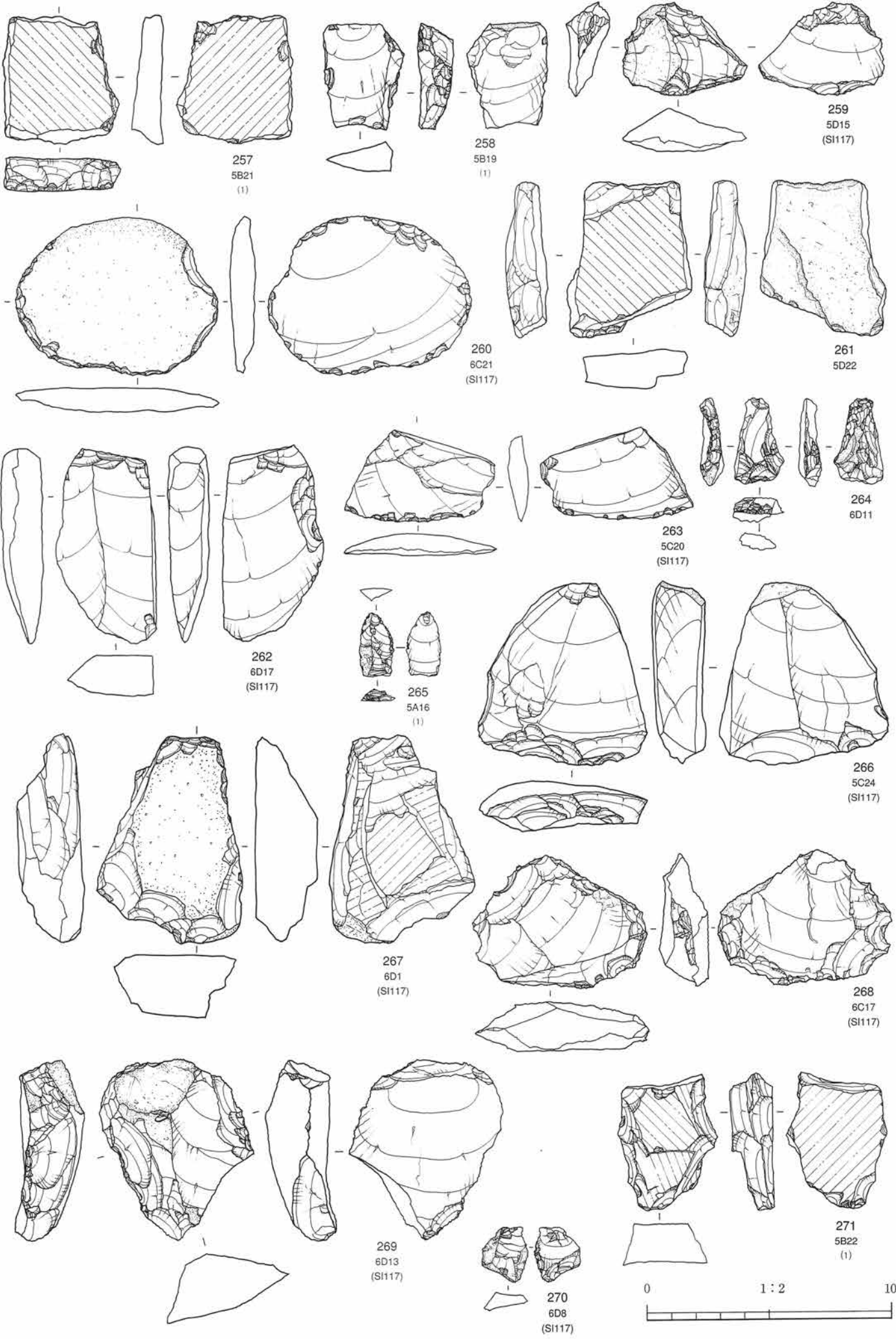

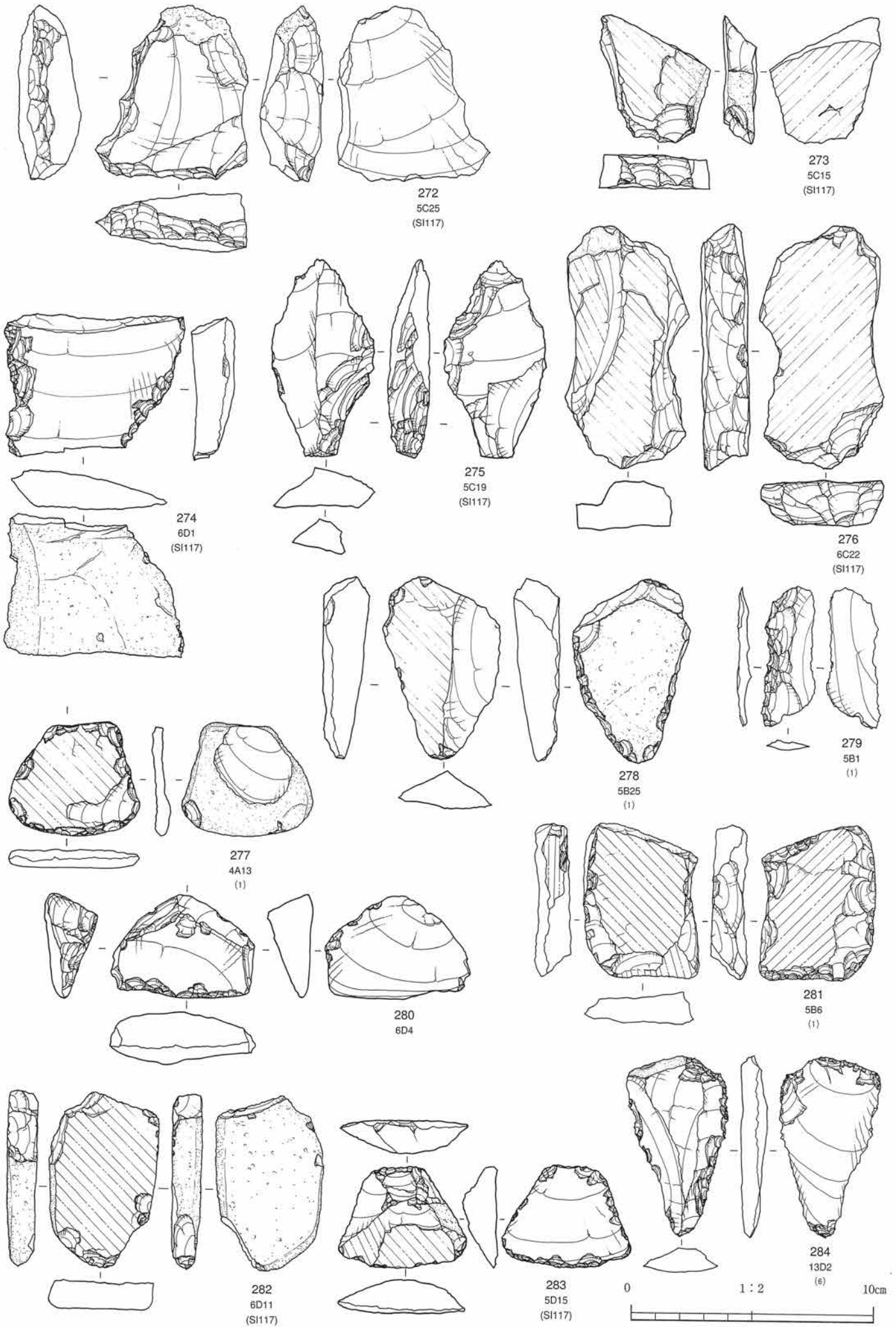

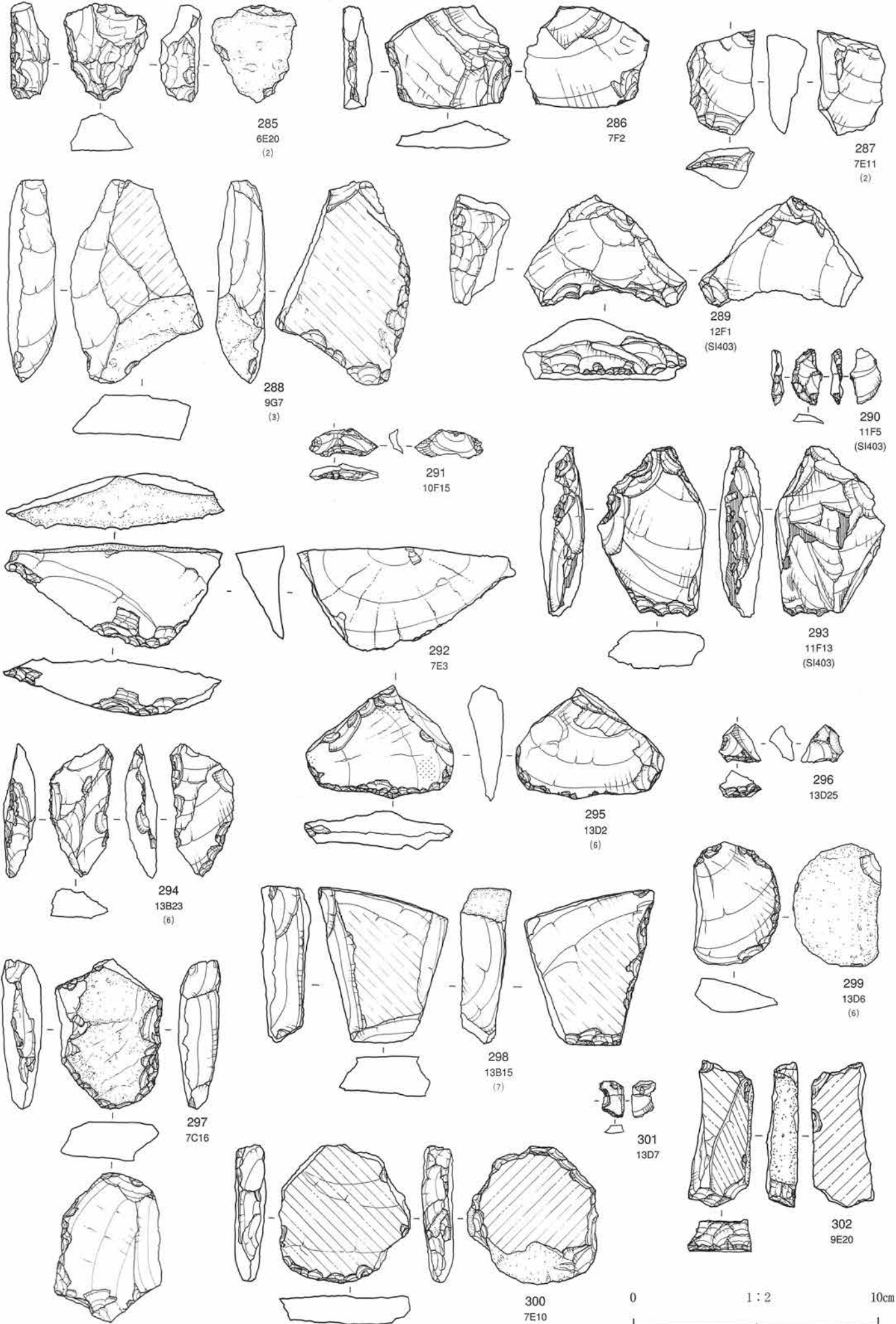

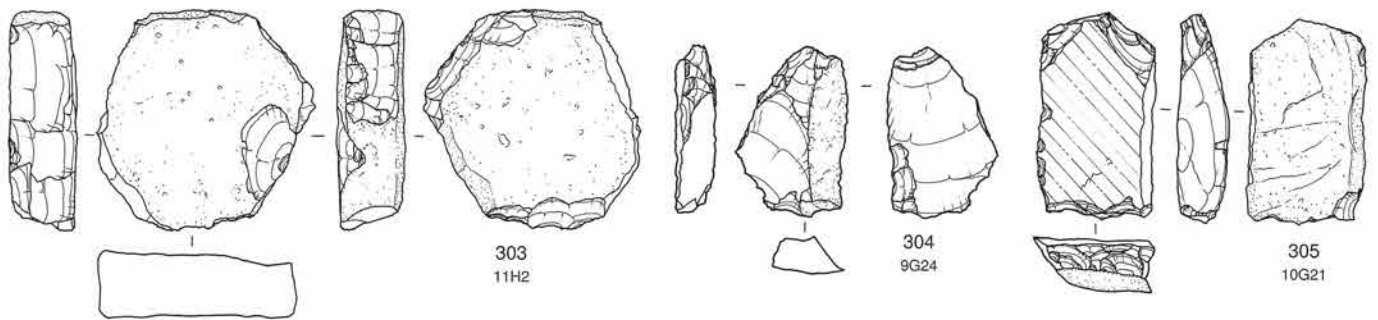

303
11H2

304
9G24

305
10G21

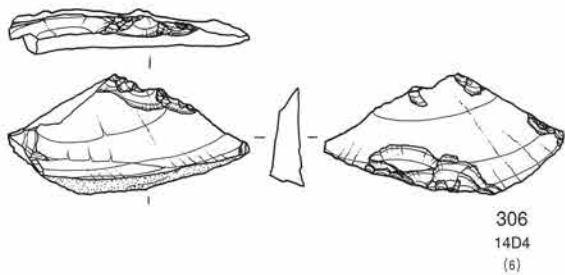

306
14D4
(6)

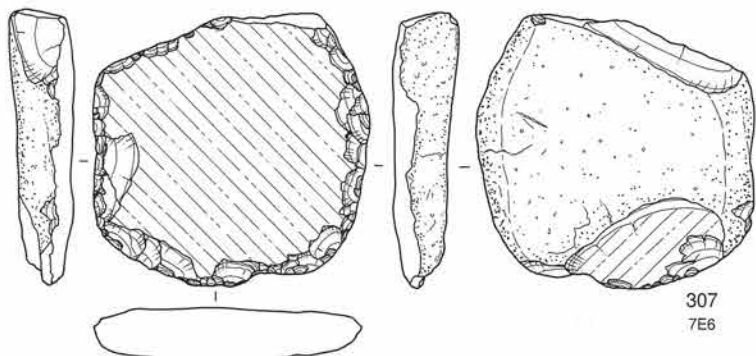

307
7E6

308
8D17

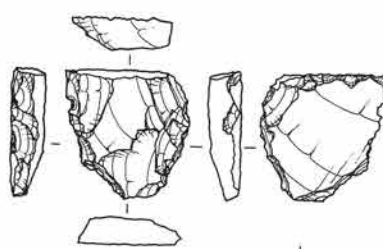

309
6B12
(P146)

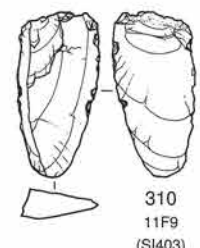

310
11F9
(SI403)

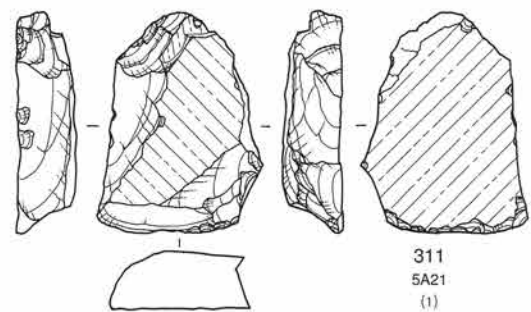

311
5A21
(1)

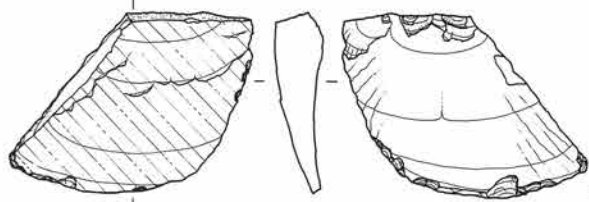

312
11F16
(4)

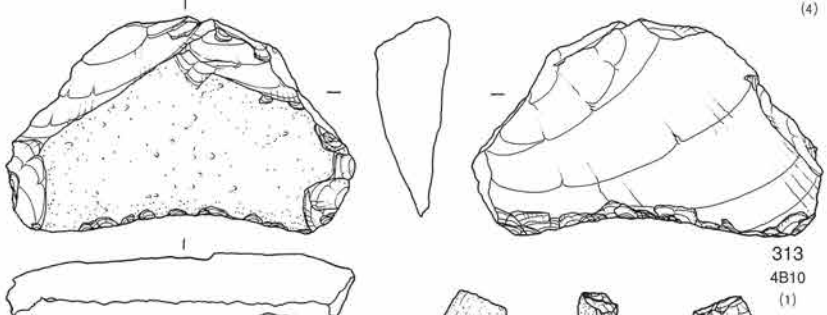

313
4B10
(1)

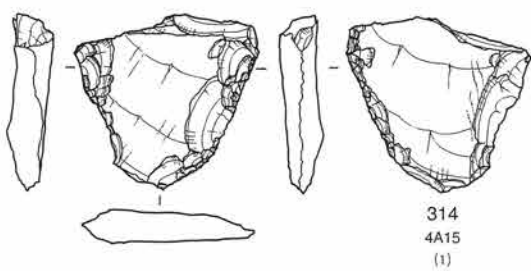

314
4A15
(1)

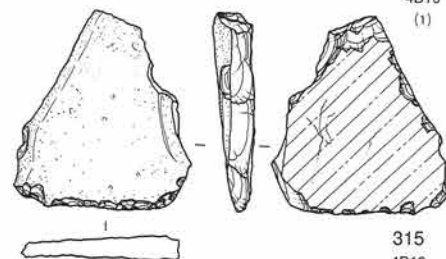

315
4B19

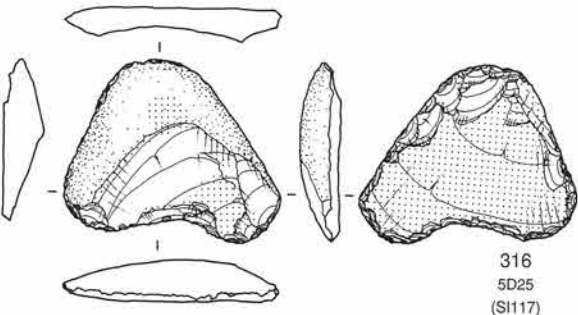

316
5D25
(SI117)

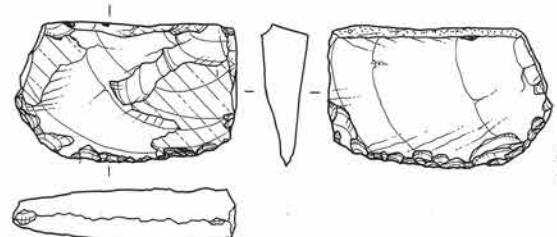

317
5B1
(1)

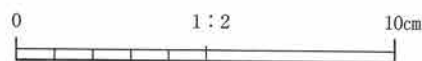

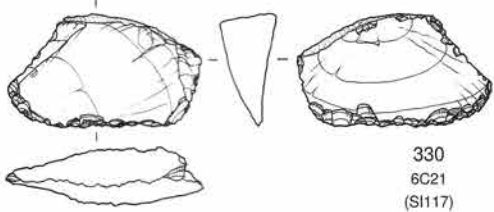
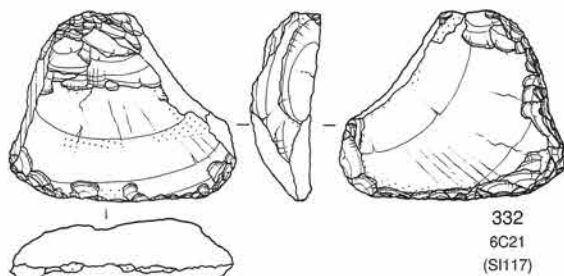
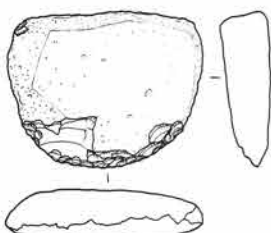
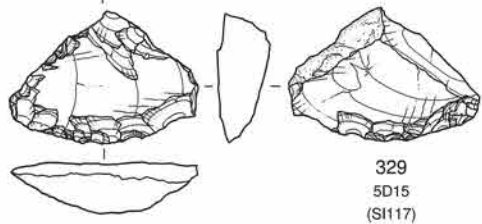
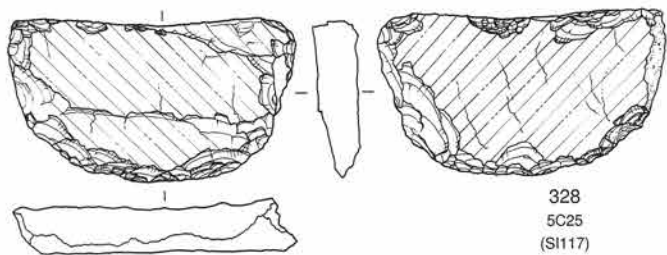
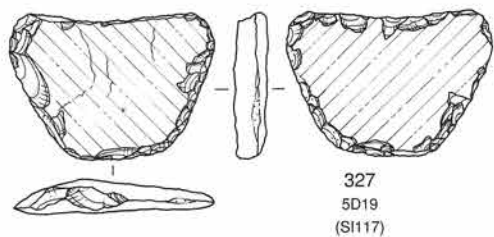
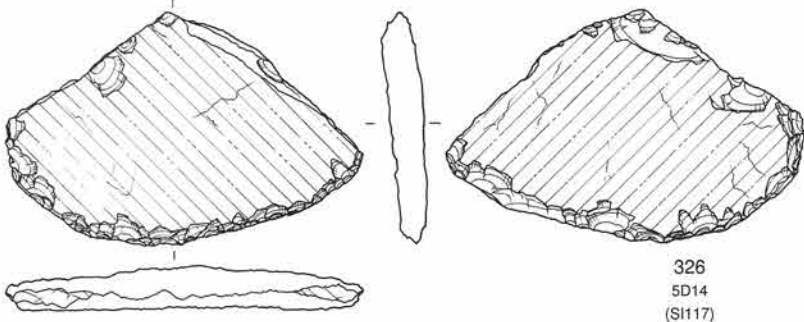
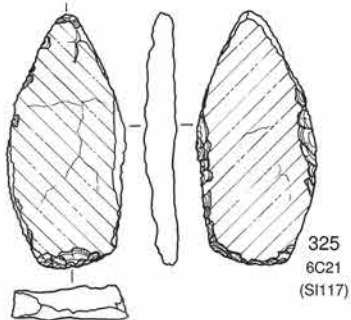
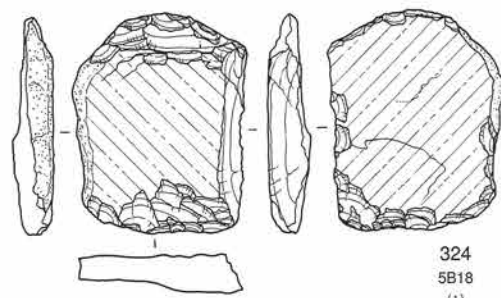
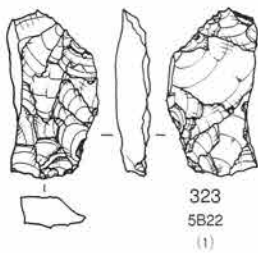
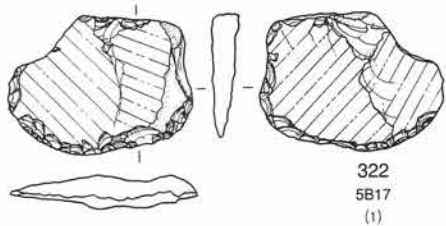
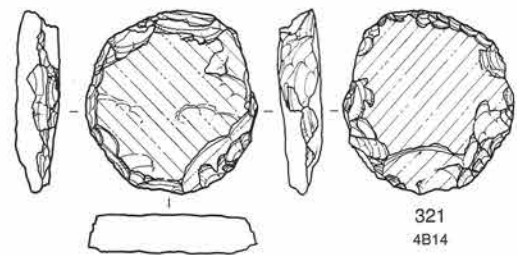
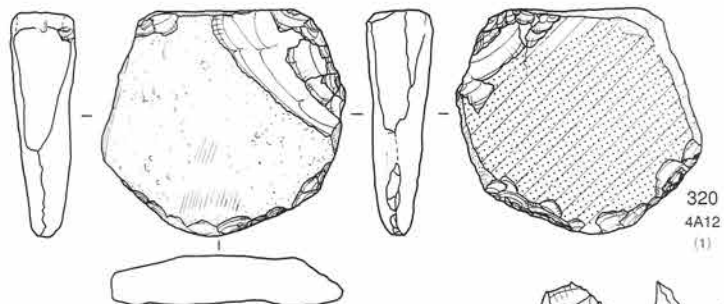
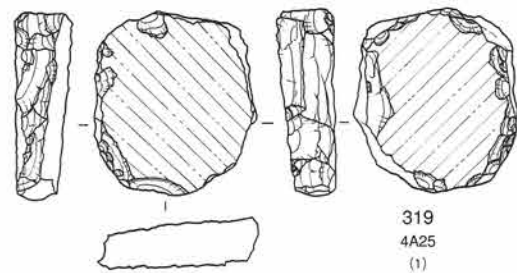
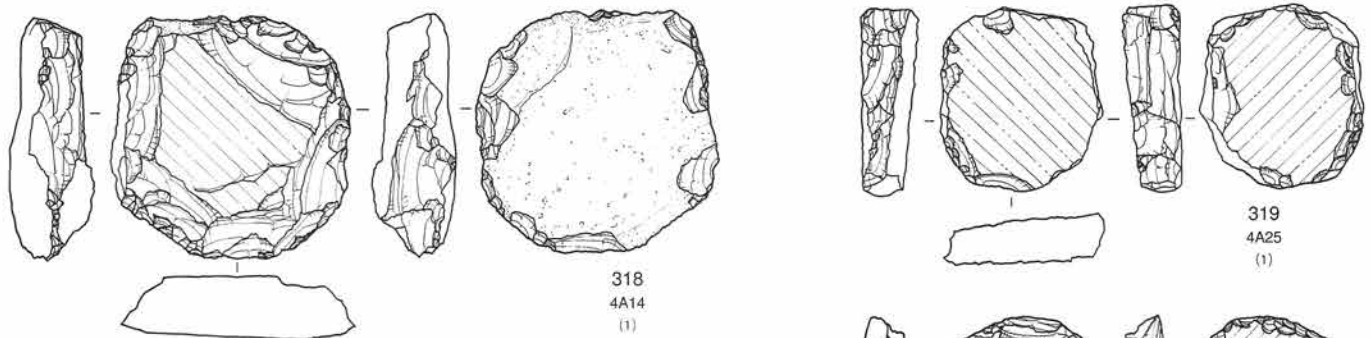

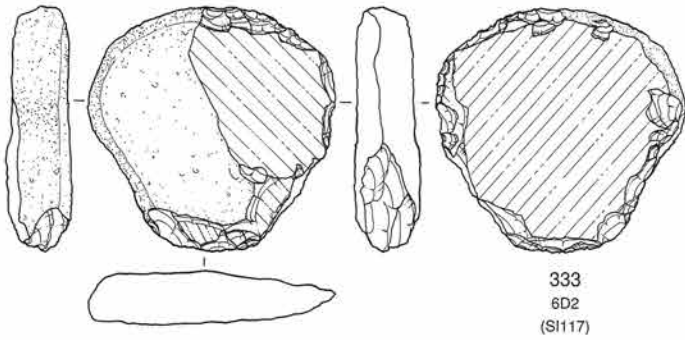

333
6D2
(SI117)

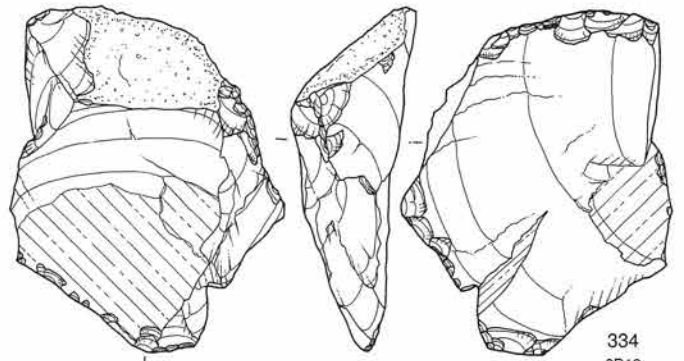

334
6D13
(SI117)

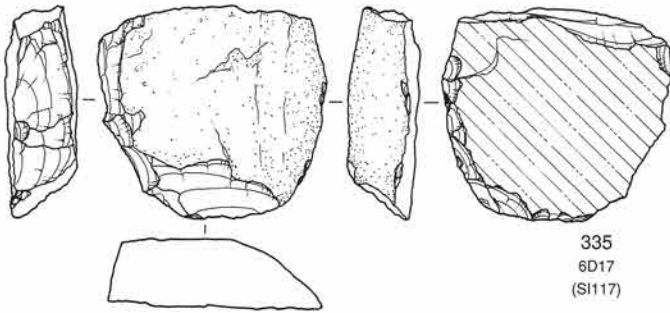

335
6D17
(SI117)

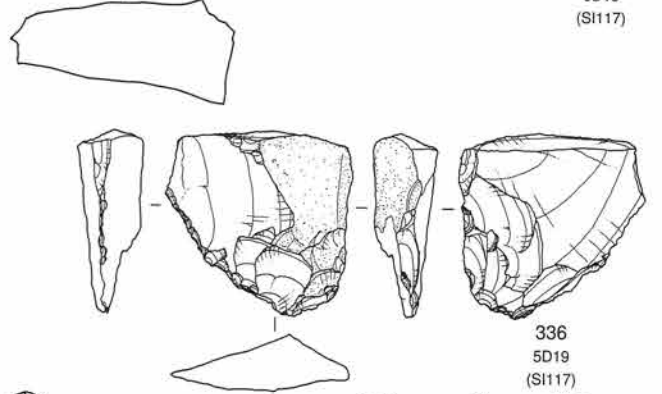

336
5D19
(SI117)

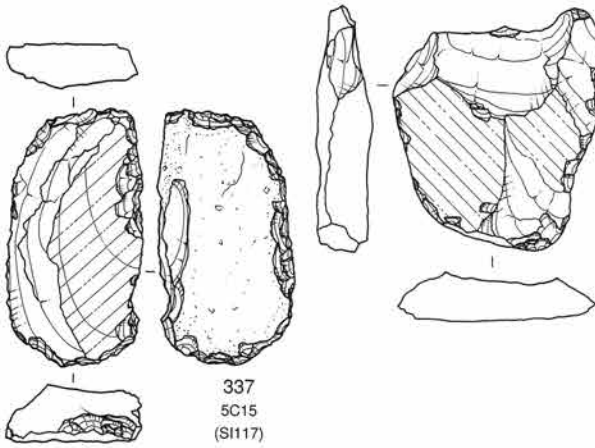

337
5C15
(SI117)

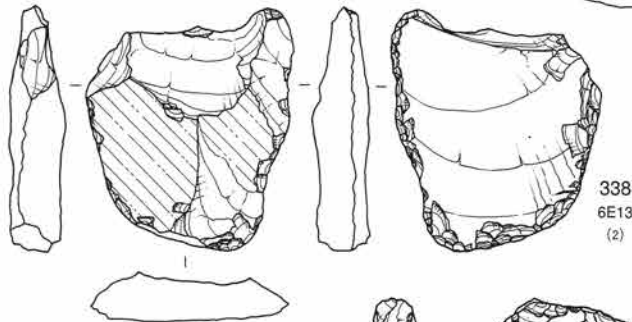

338
6E13
(2)

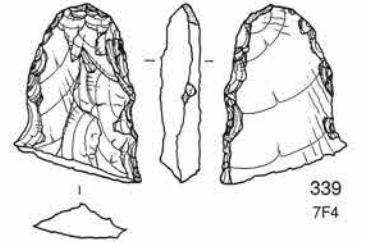

339
7F4

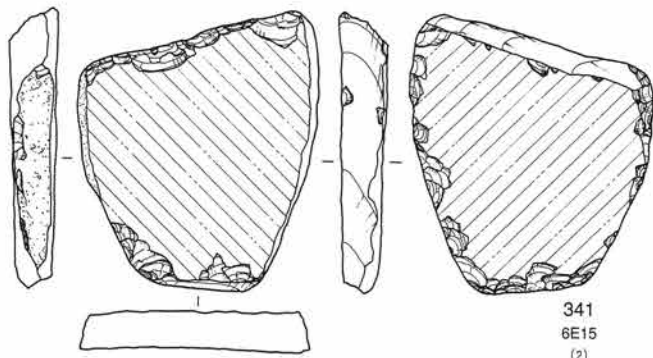

341
6E15
(2)

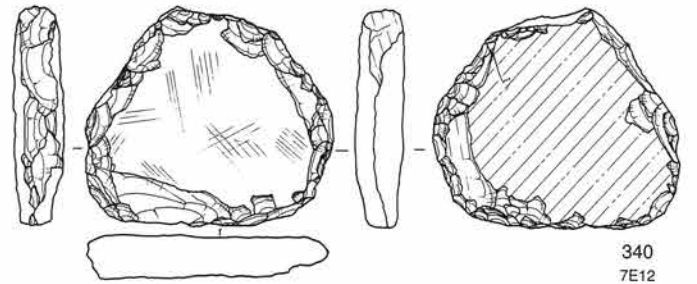

340
7E12

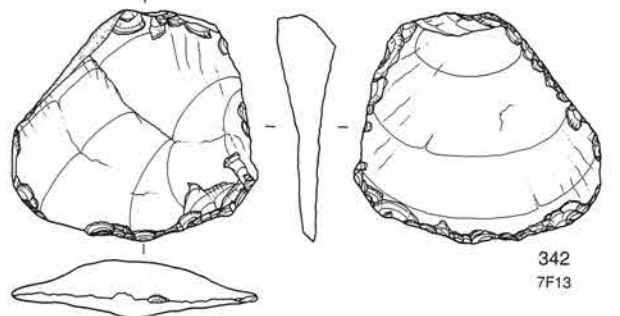

342
7F13

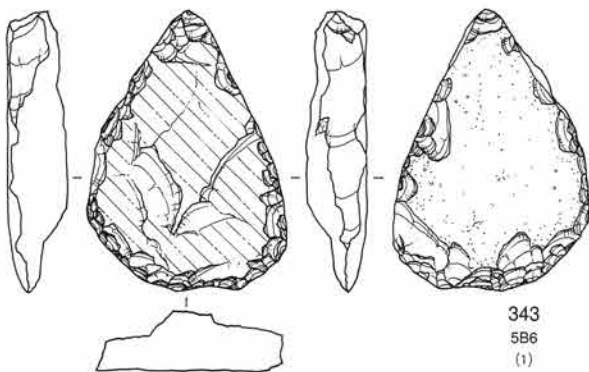

343
5B6
(1)

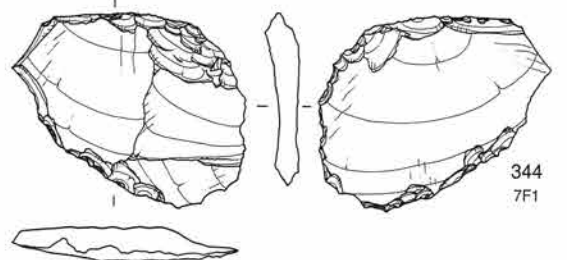

344
7F1

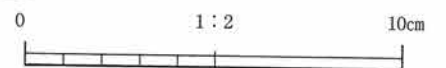

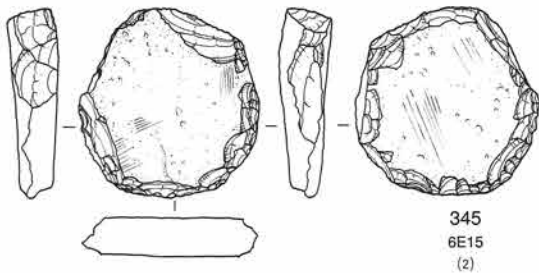

345
6E15
(2)

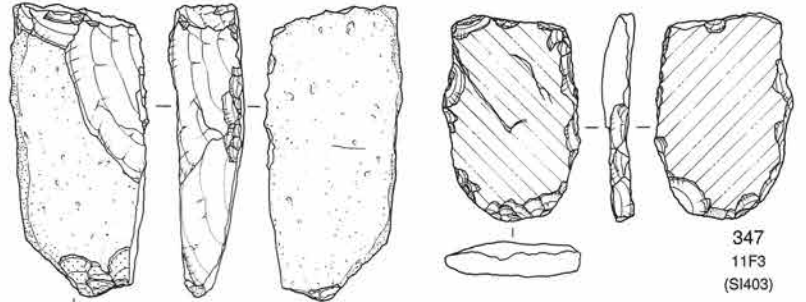

346
8G10
(3)

347
11F3
(SI403)

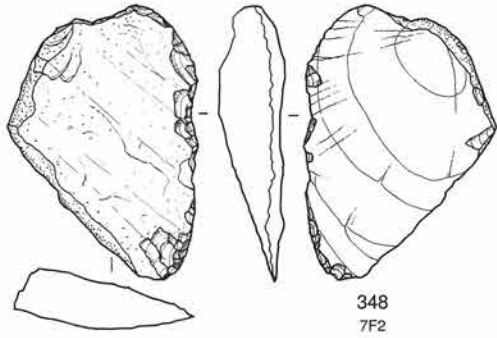

348
7F2

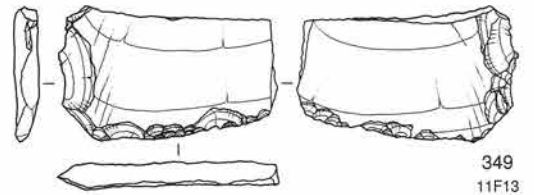

349
11F13
(SI403)

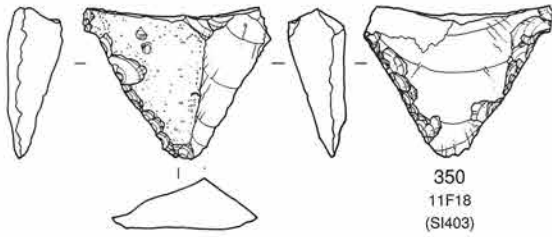

350
11F18
(SI403)

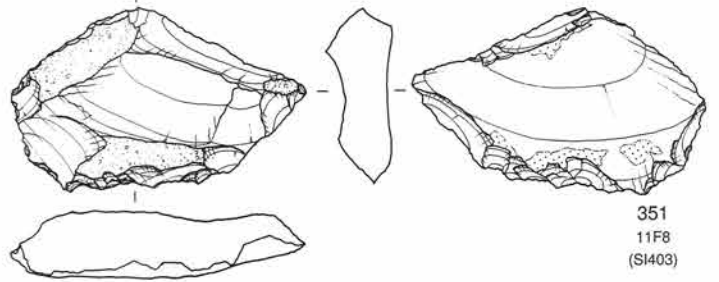

351
11F8
(SI403)

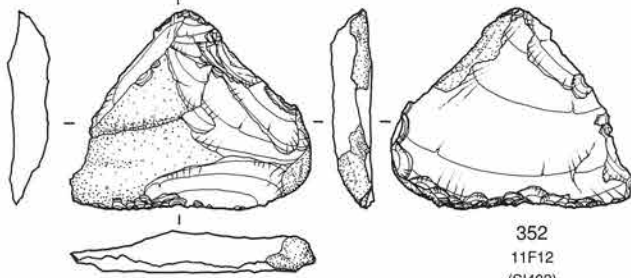

352
11F12
(SI403)

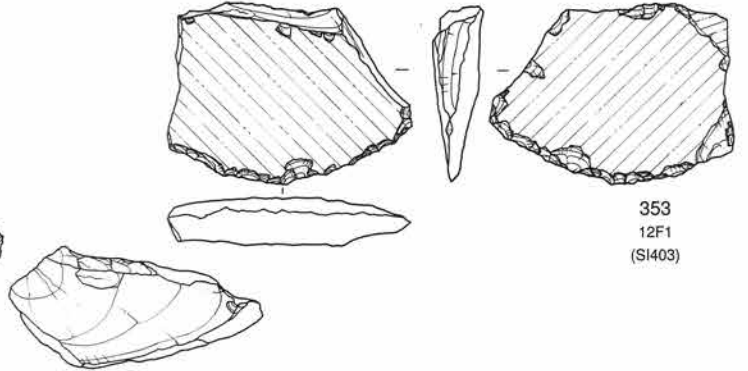

353
12F1
(SI403)

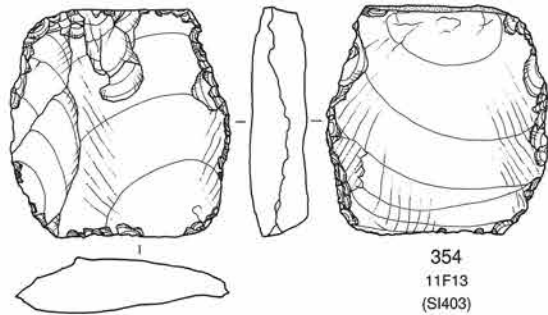

354
11F13
(SI403)

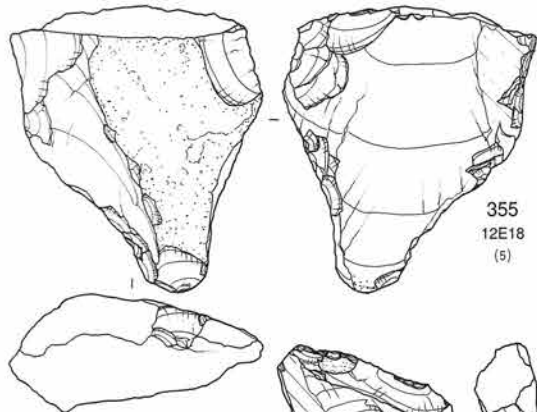

355
12E18
(5)

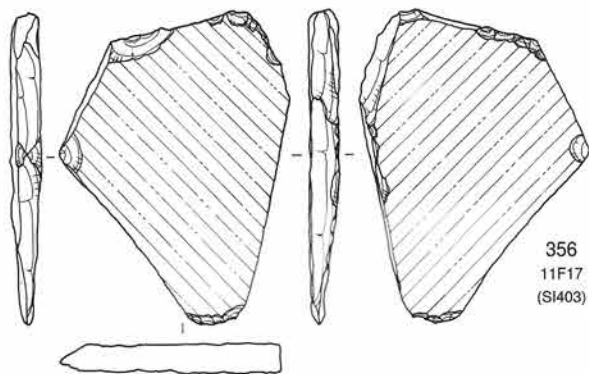

356
11F17
(SI403)

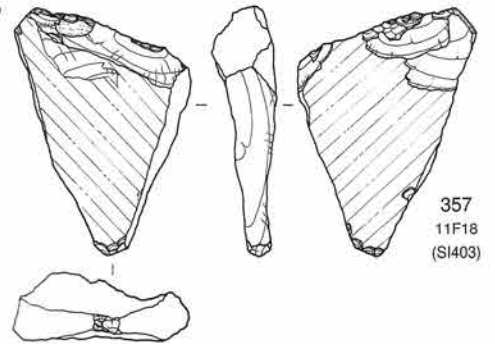

357
11F18
(SI403)

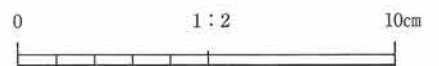

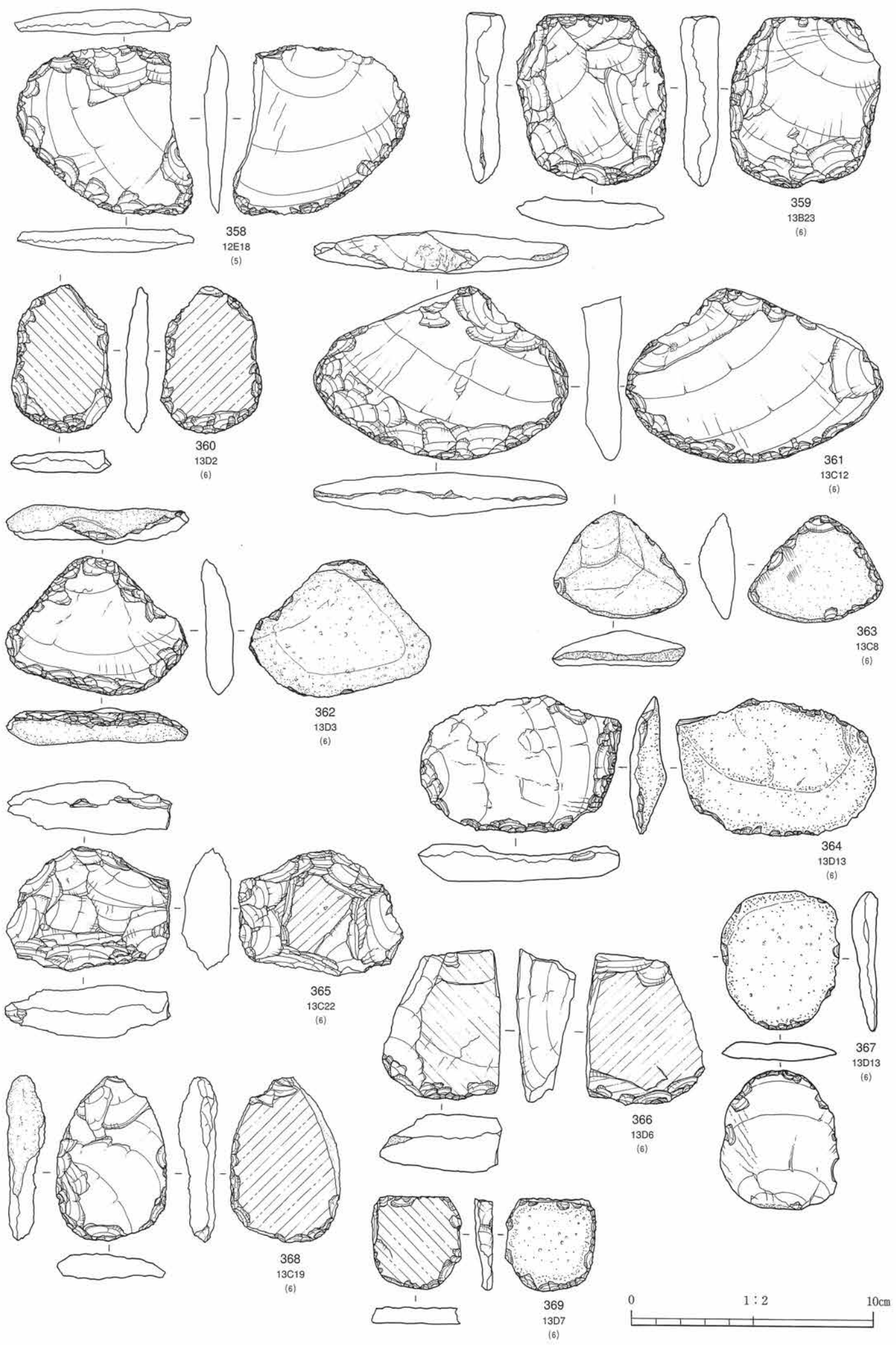

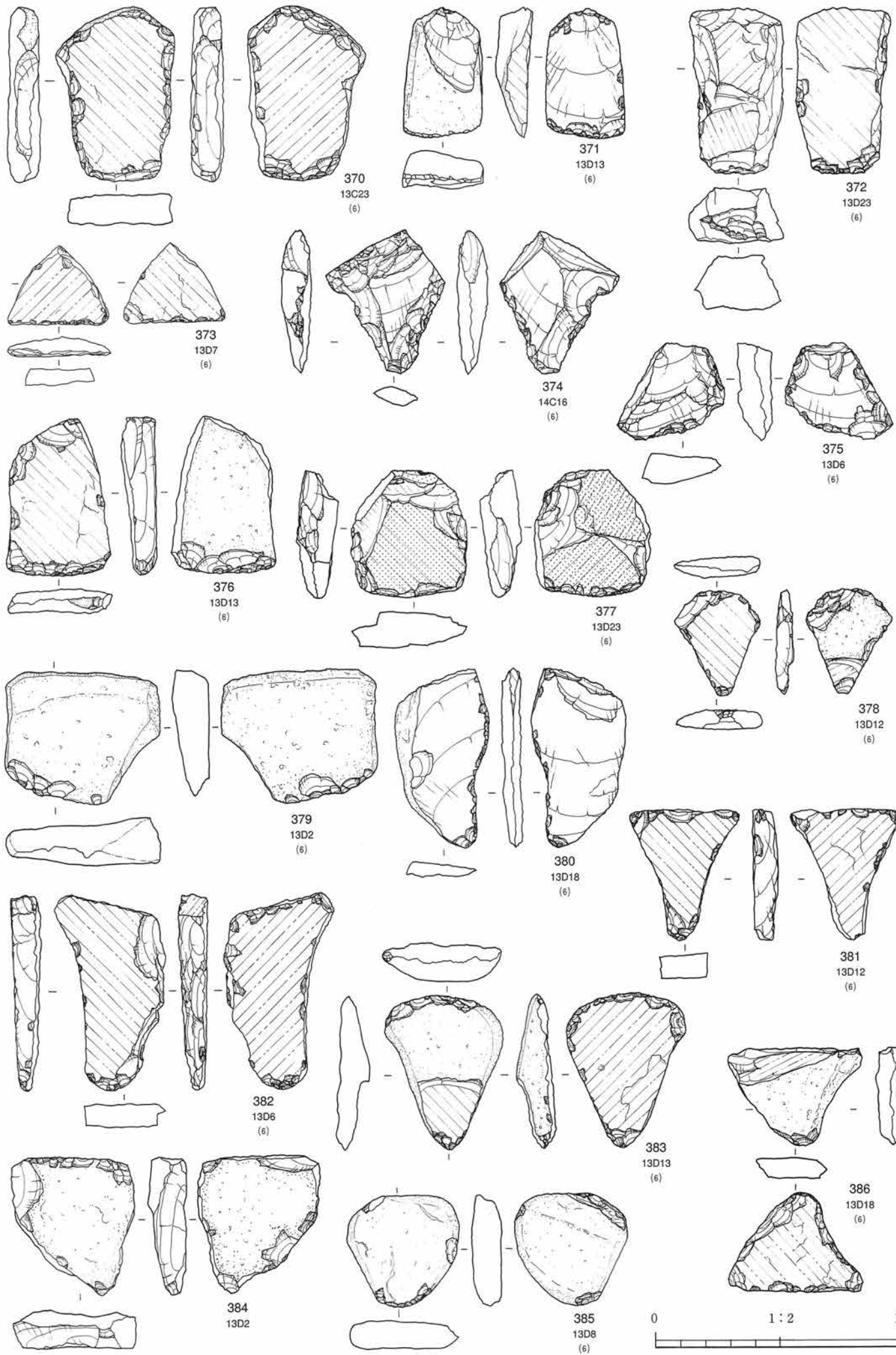

0 1 : 2 10cm

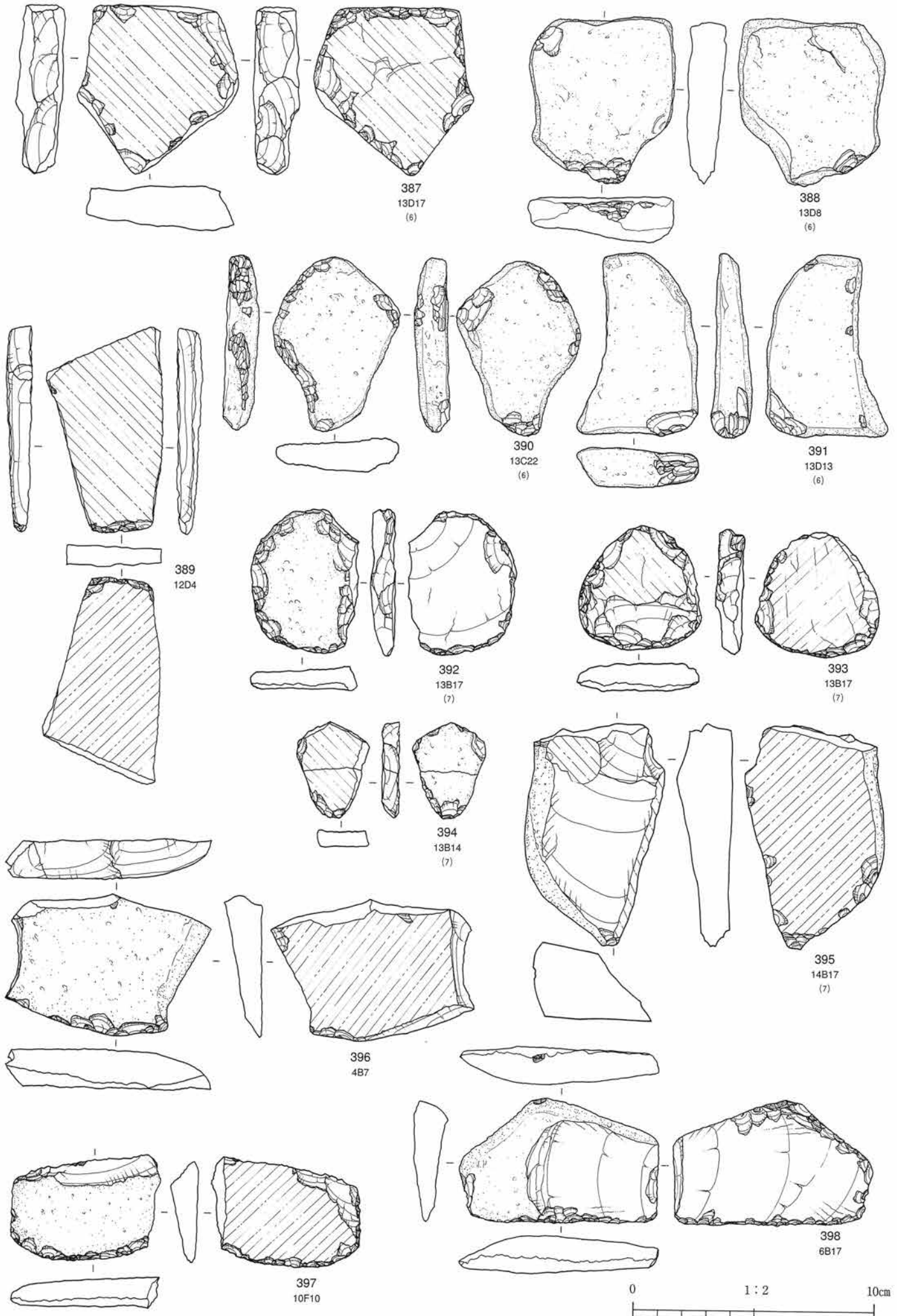

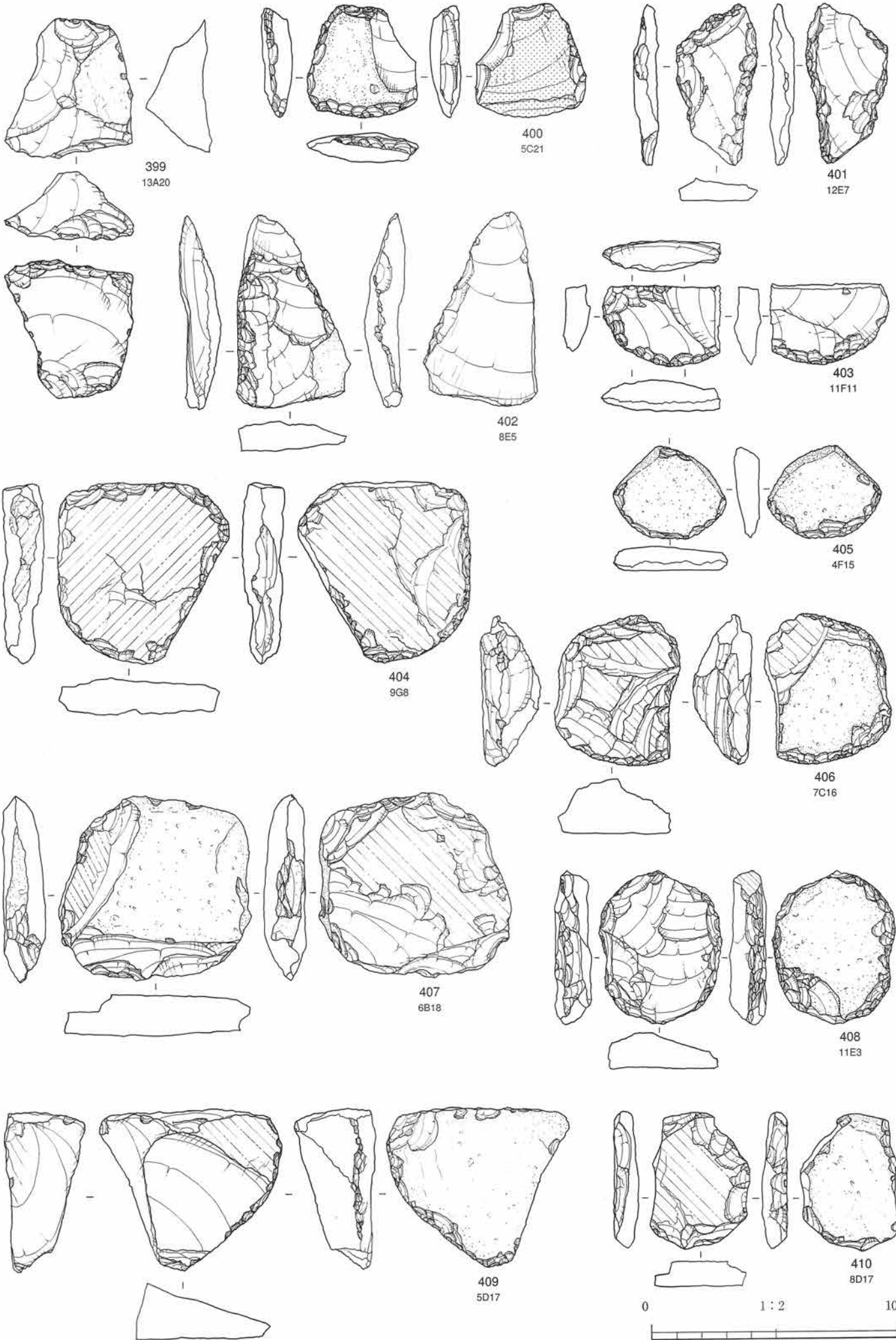

0 1:2 10cm

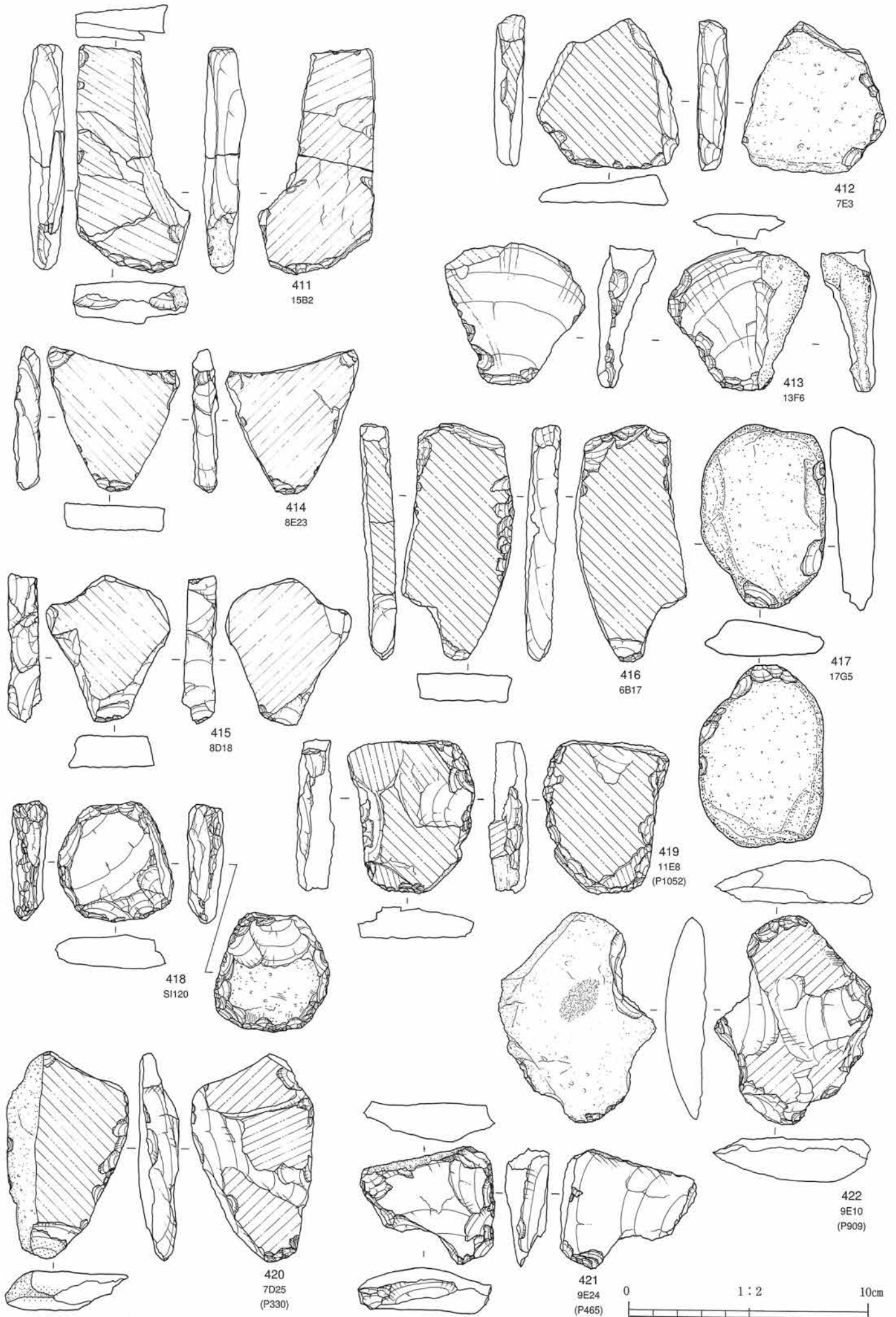

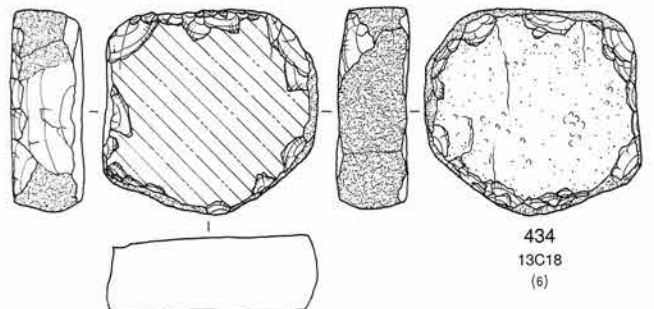
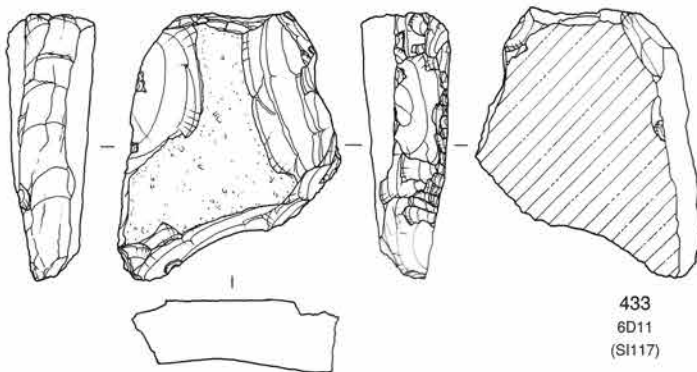
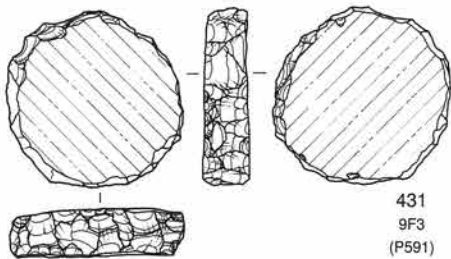
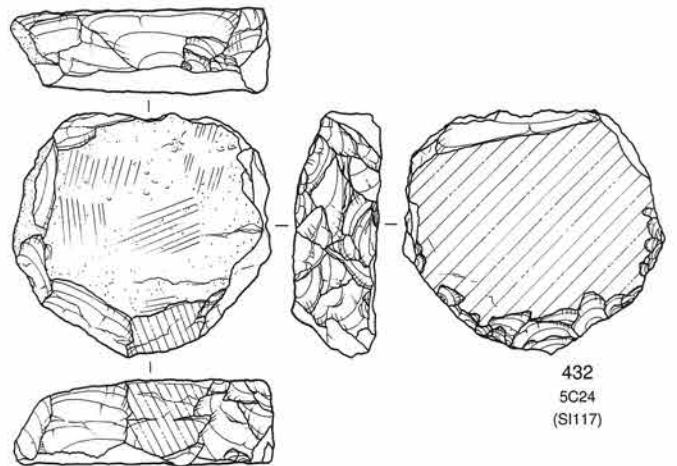
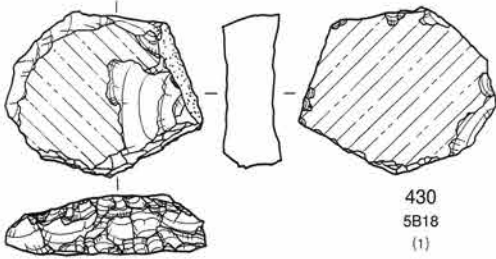
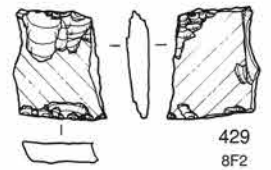
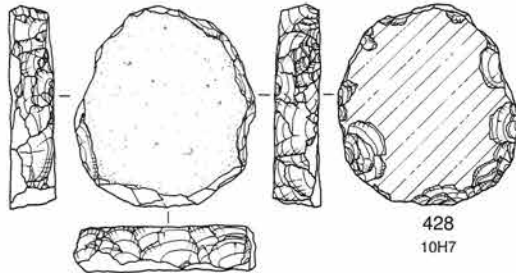
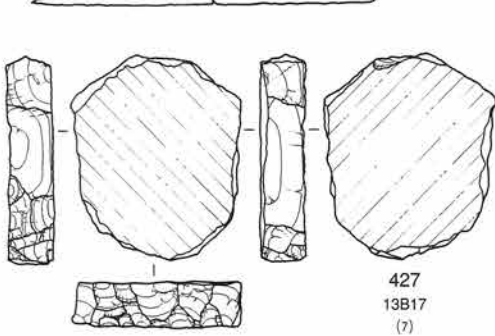
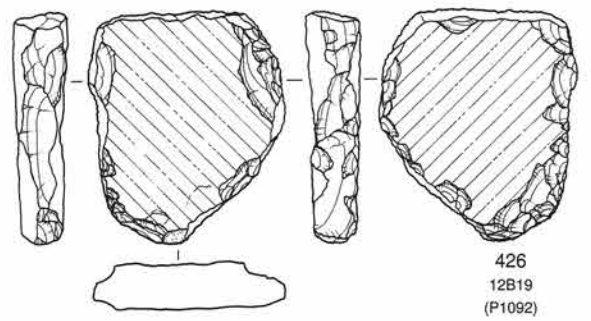
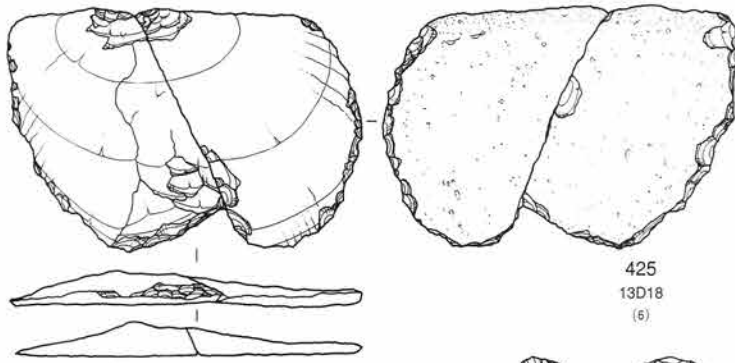
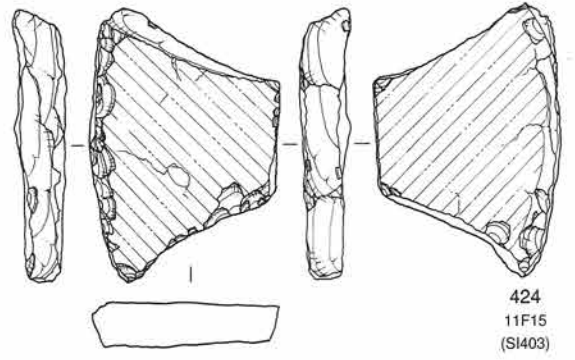
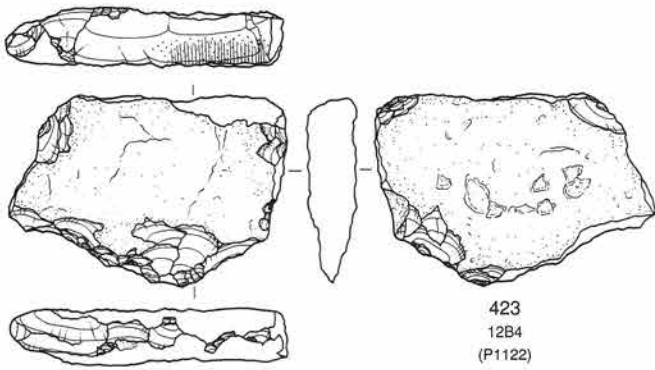

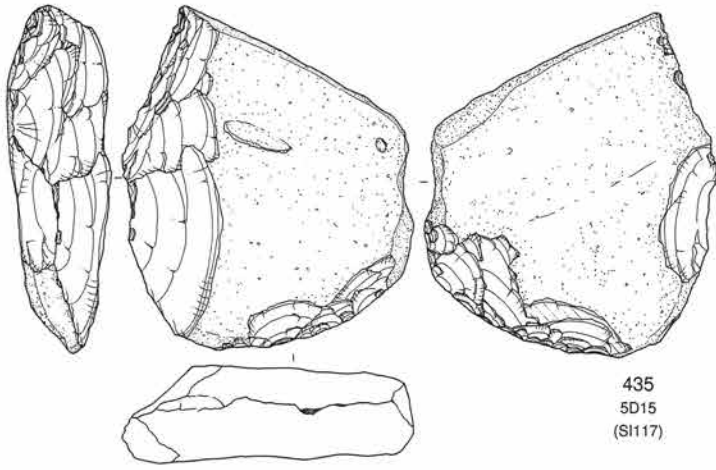

435
5D15
(SI117)

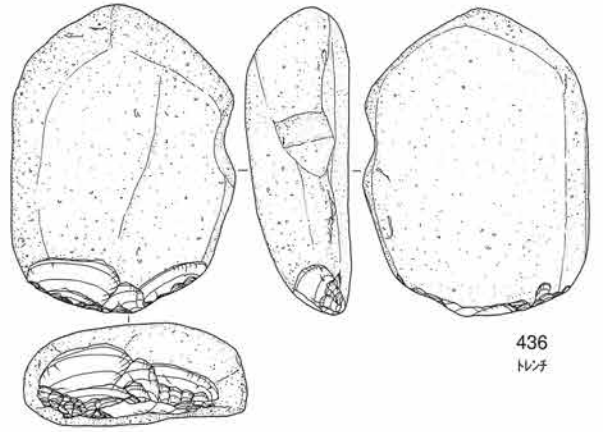

436
トシテ

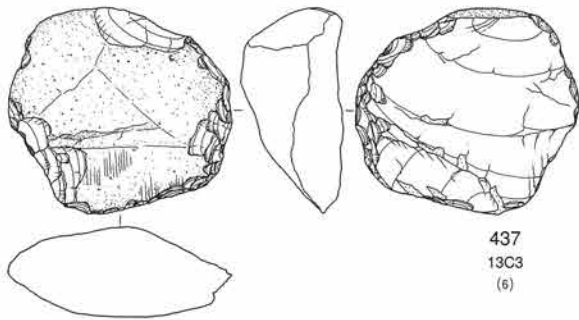

437
13C3
(6)

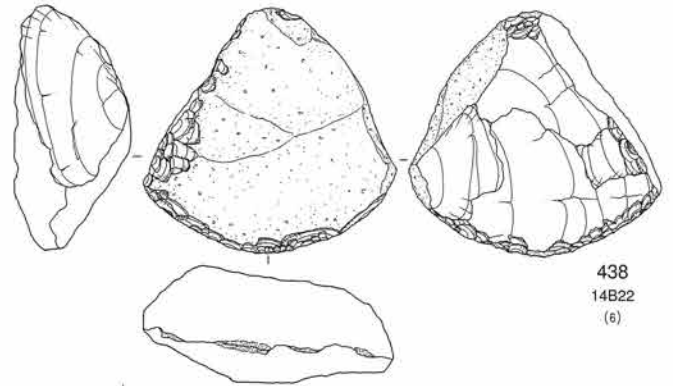

438
14B22
(6)

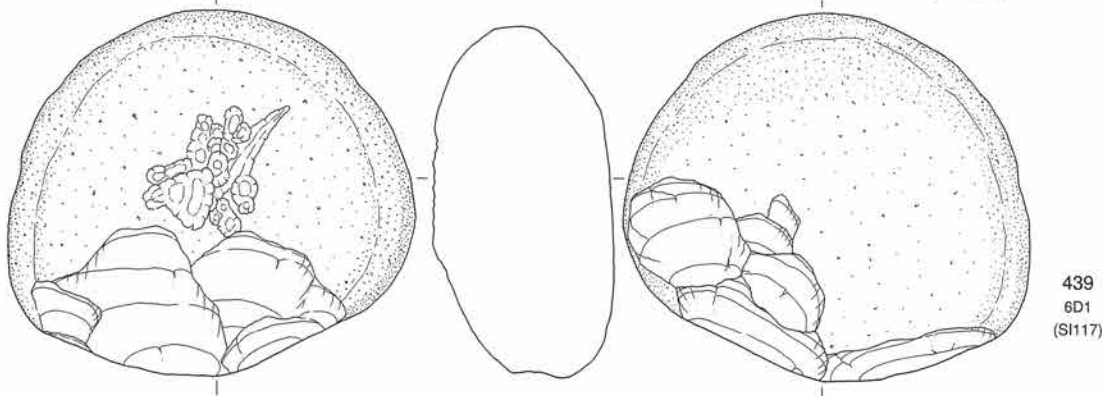

439
6D1
(SI117)

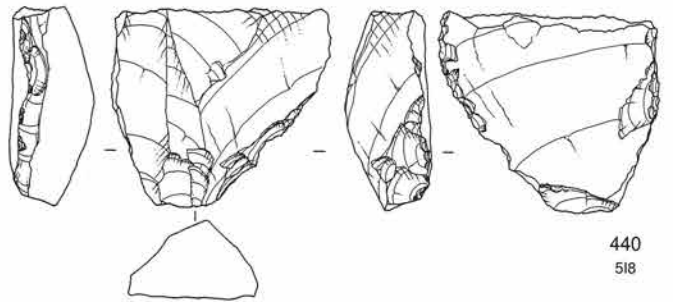

440
518

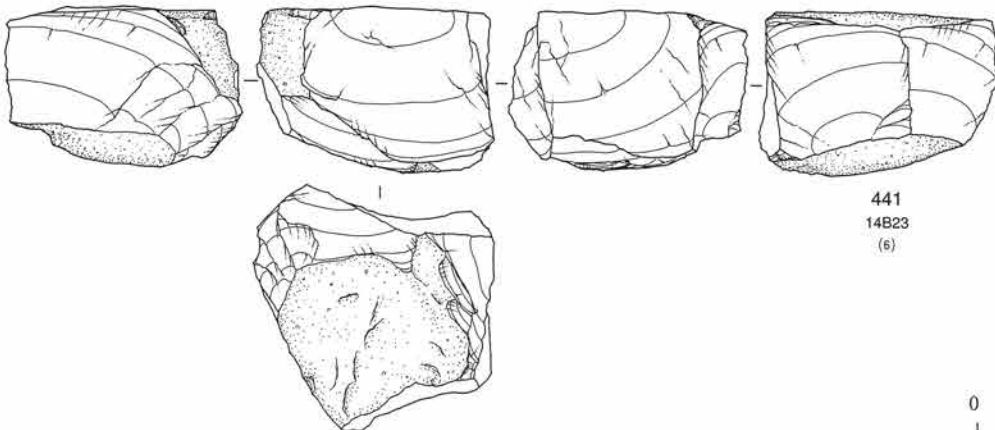

441
14B23
(6)

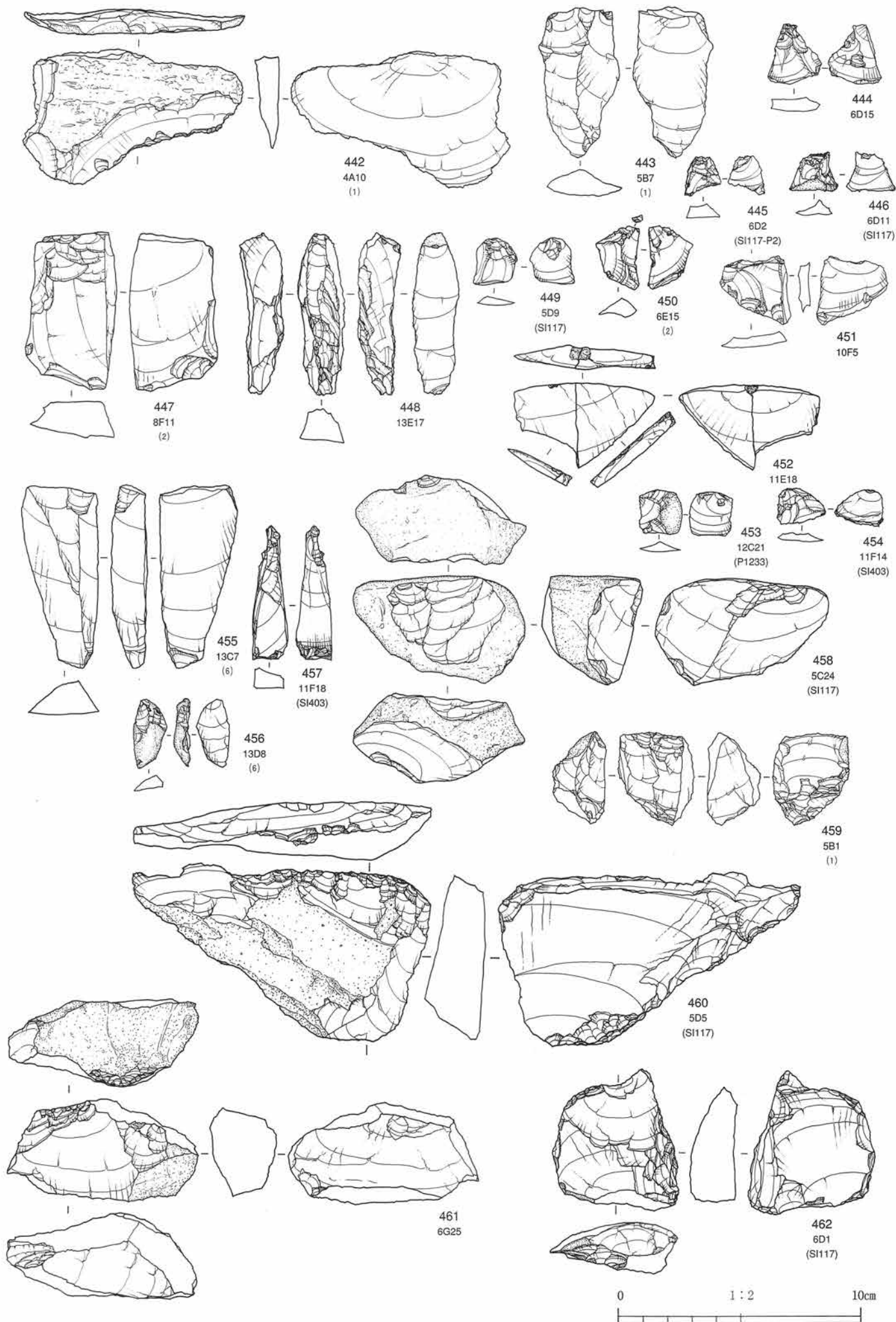

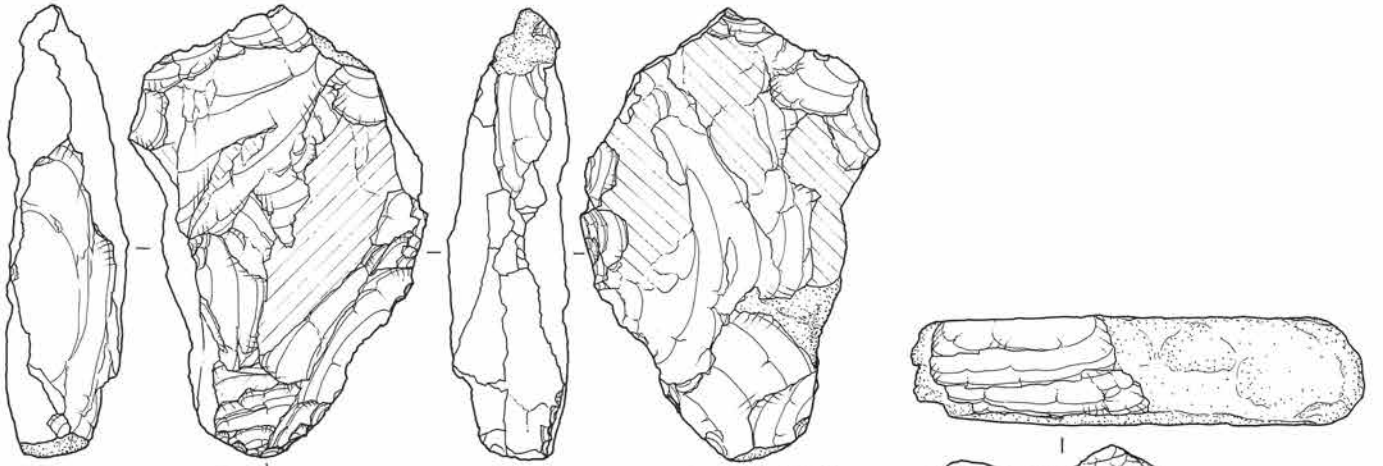

463
5B11
(1)

464
4B5
(1)

465
3F18

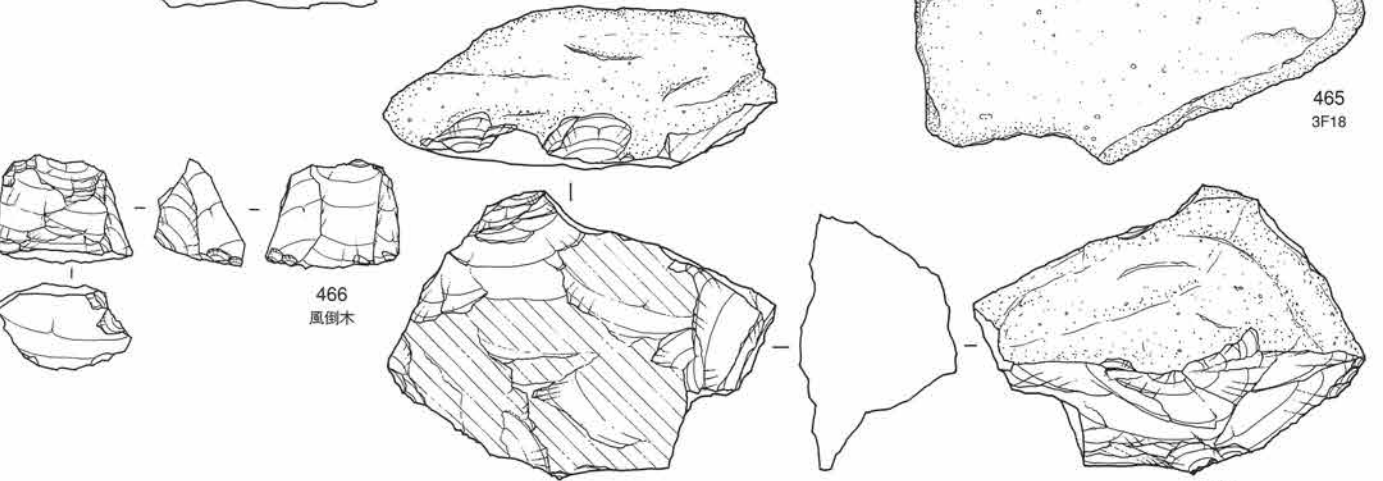
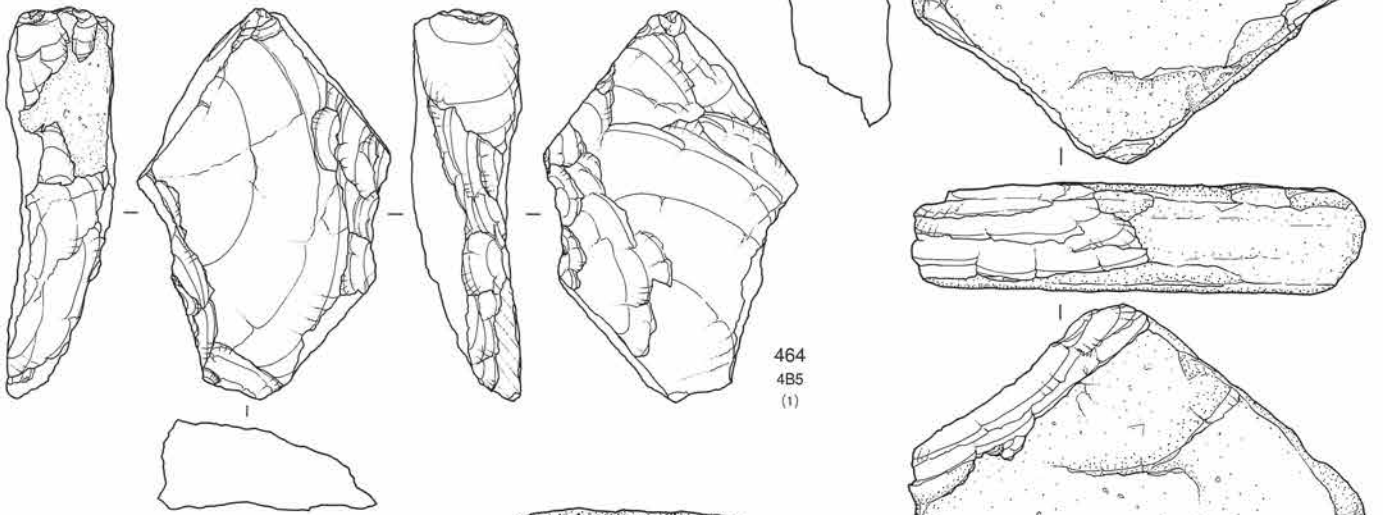

466
風倒木

467
4A20
(1)

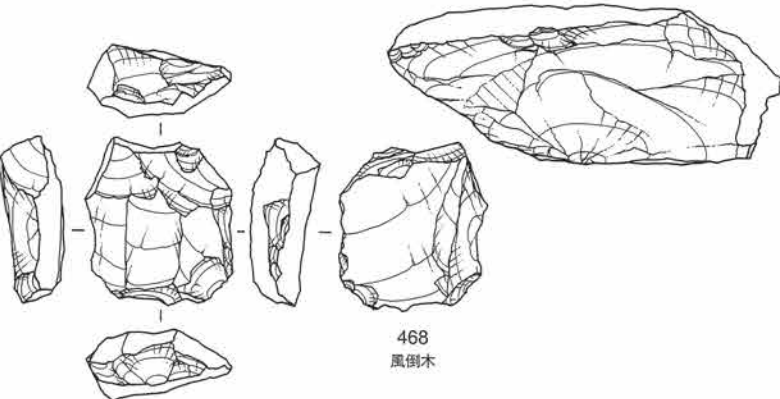

468
風倒木

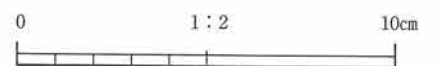

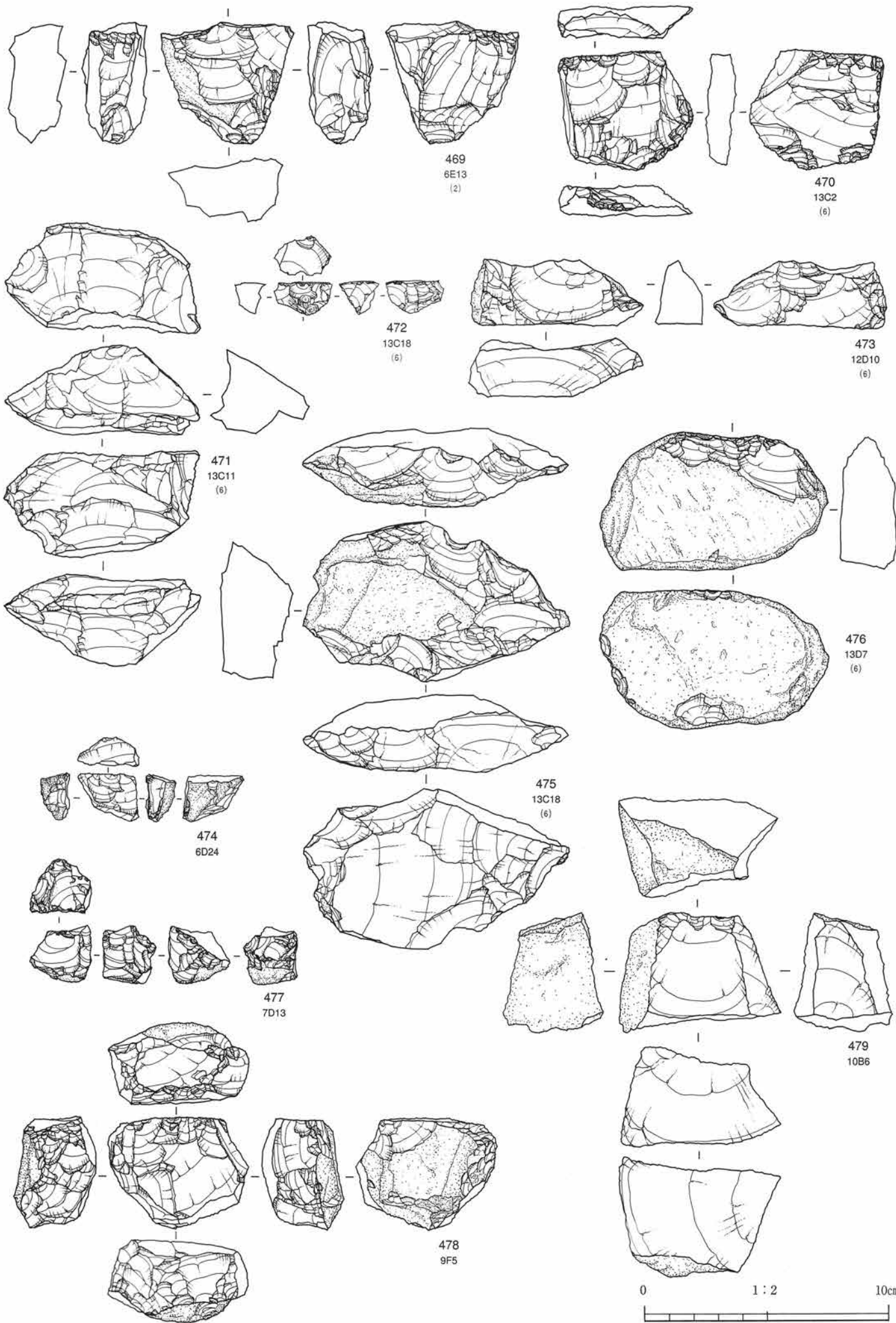

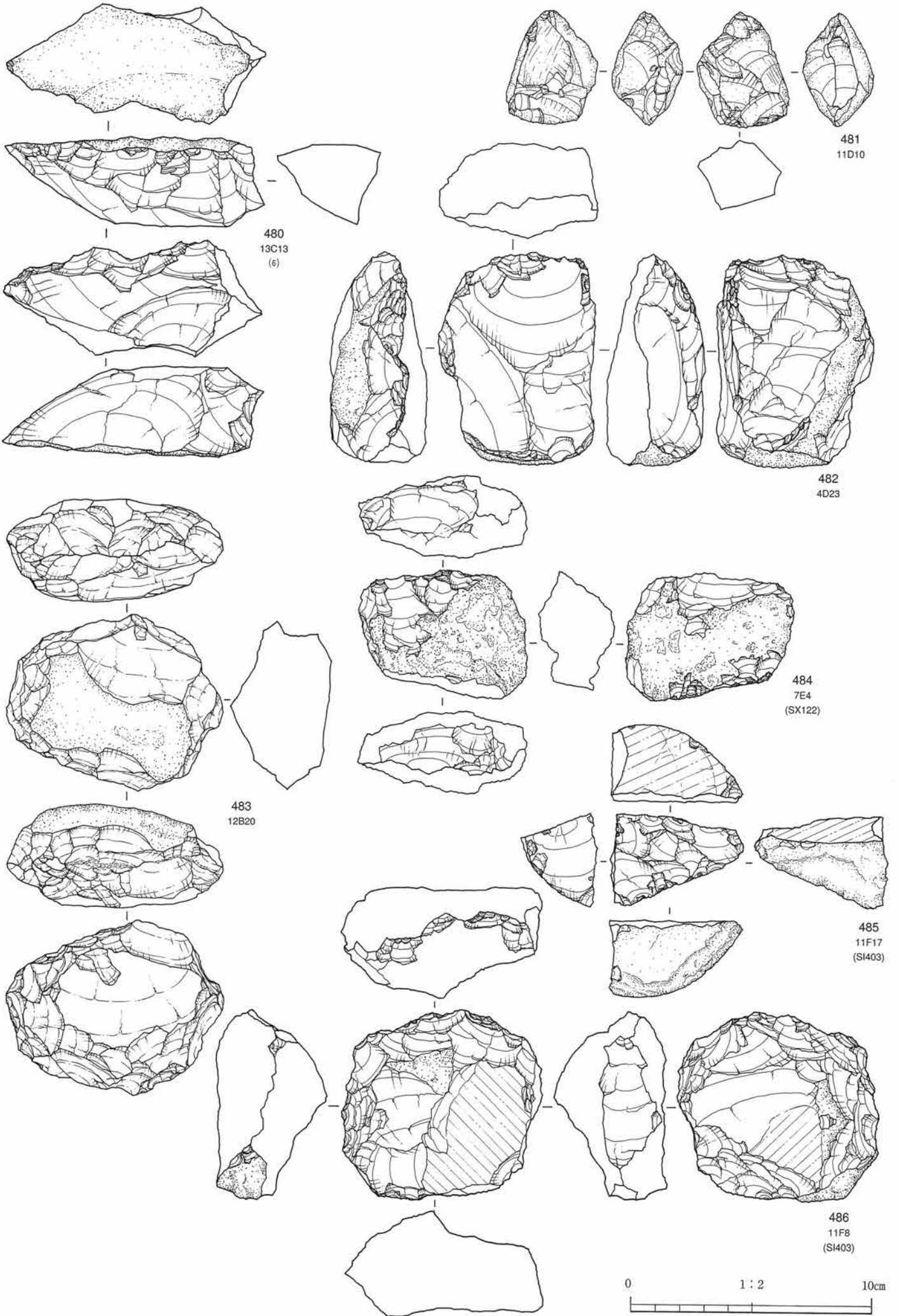

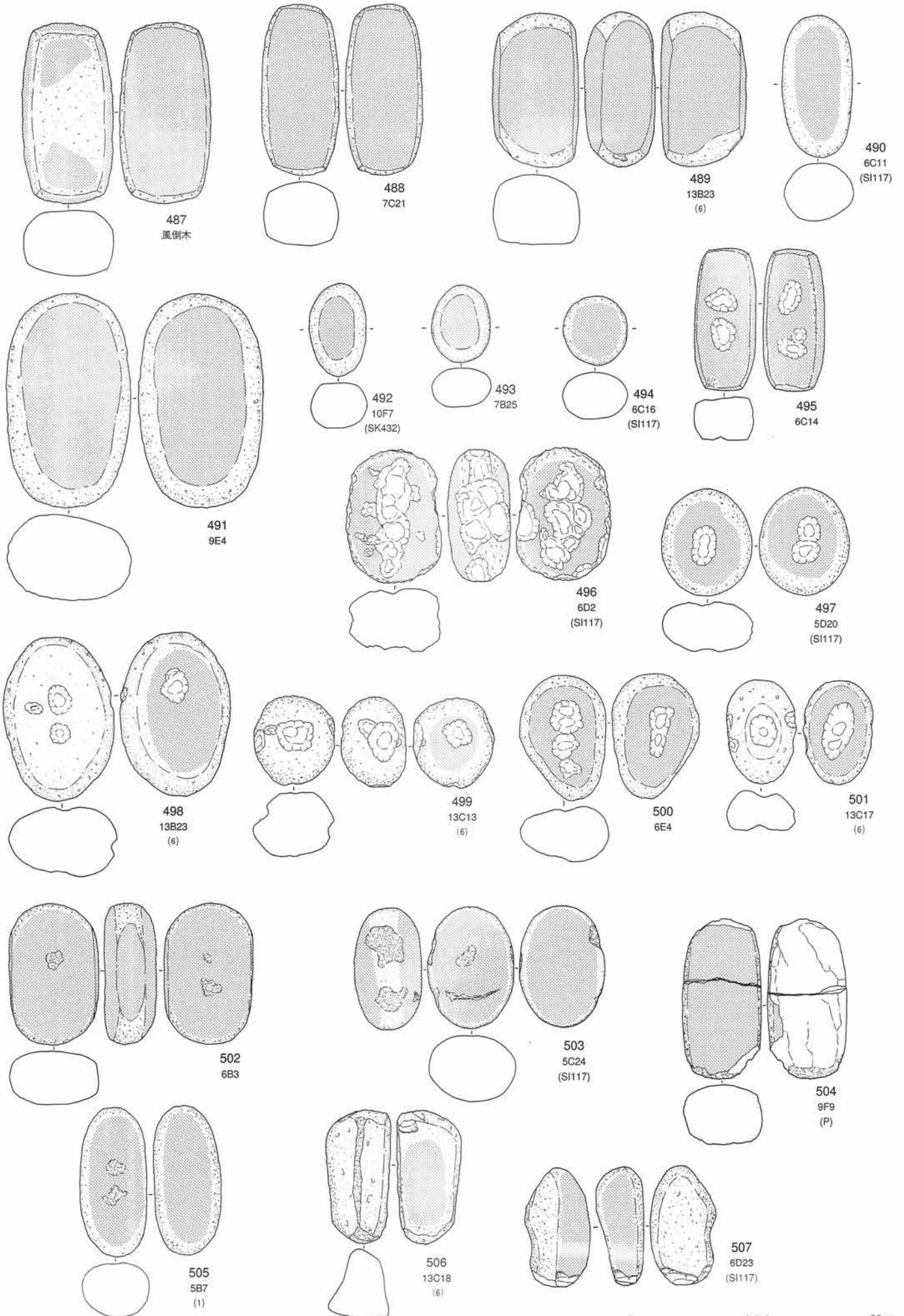

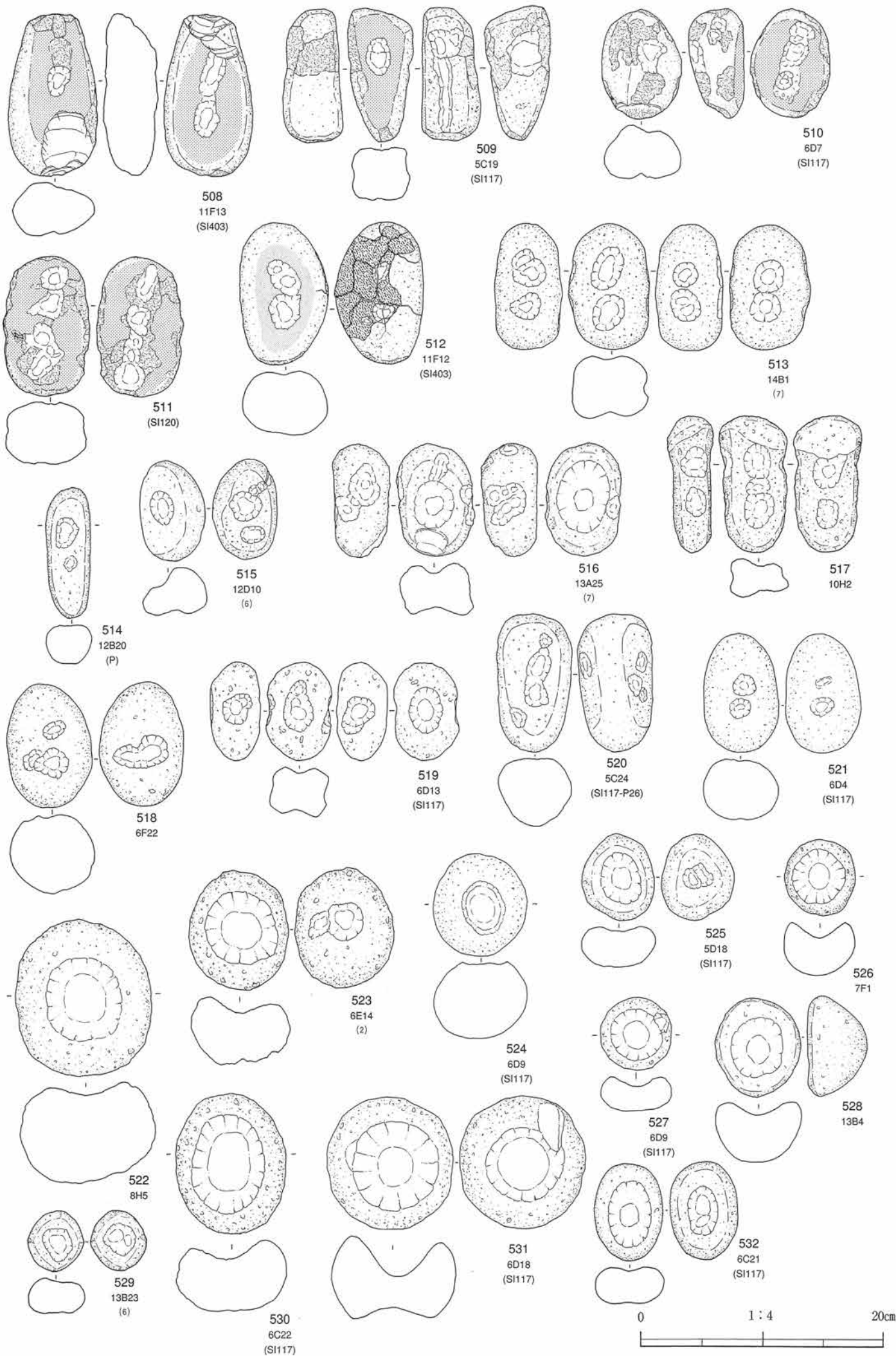

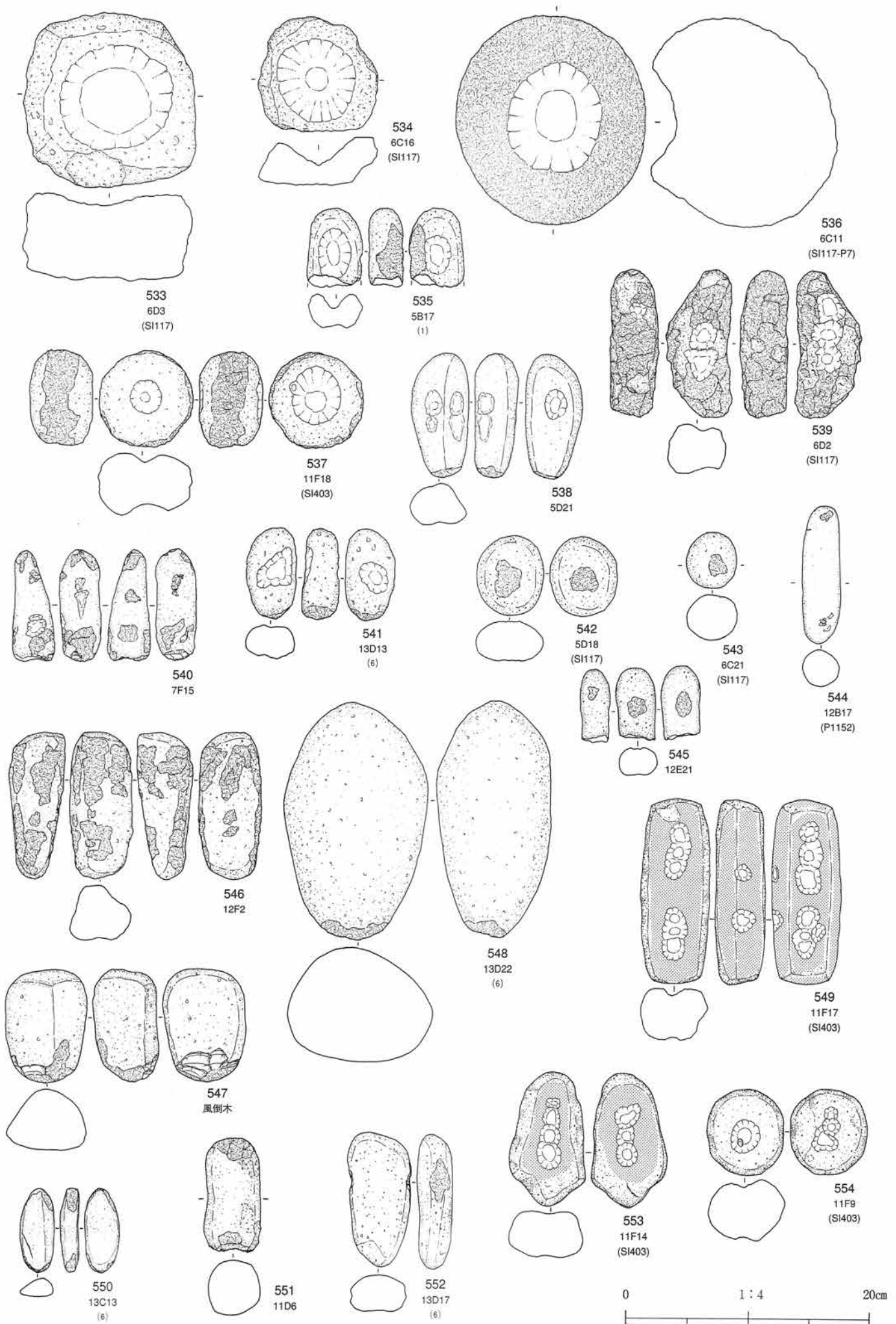

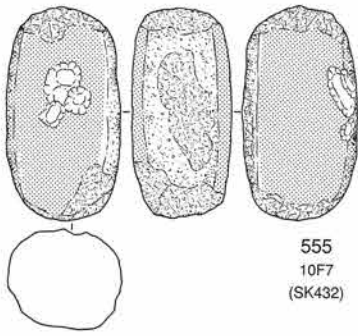

555
10F7
(SK432)

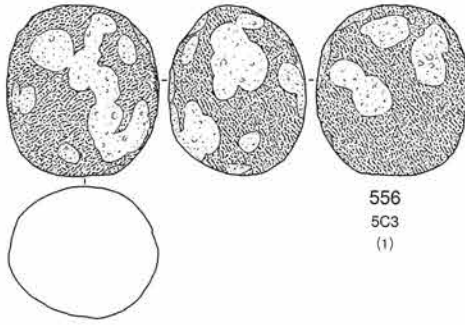

556
5C3
(1)

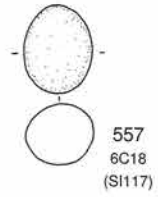

557
6C18
(SI117)

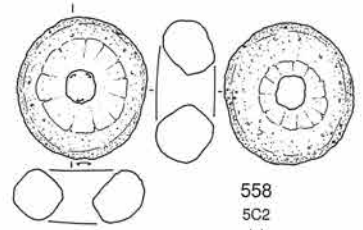

558
5C2
(1)

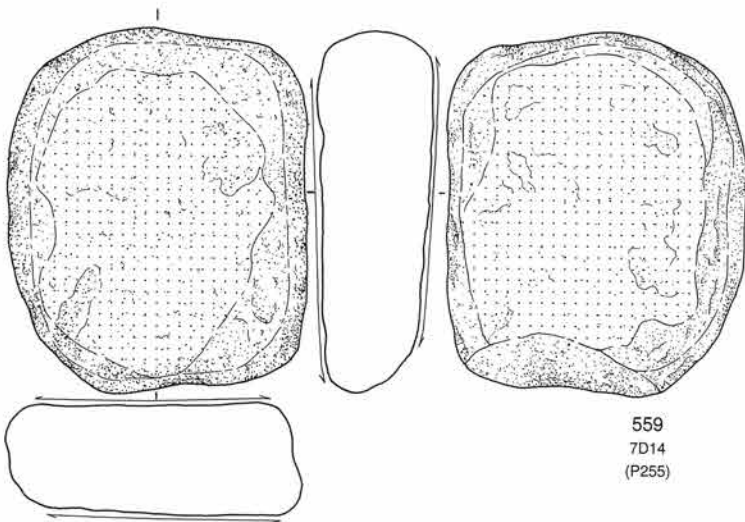
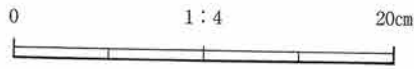

559
7D14
(P255)

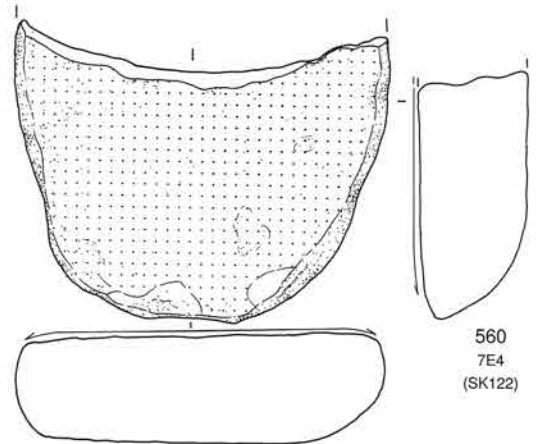

560
7E4
(SK122)

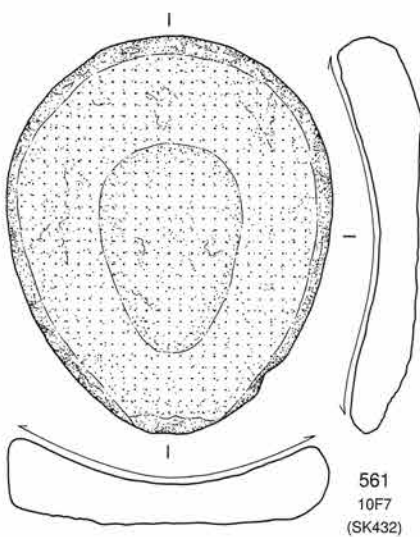

561
10F7
(SK432)

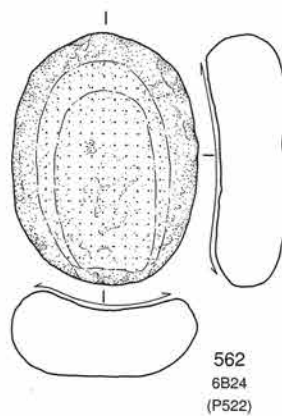

562
6B24
(P522)

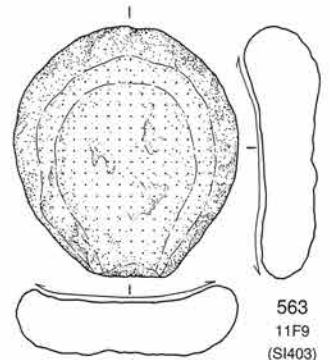

563
11F9
(SI403)

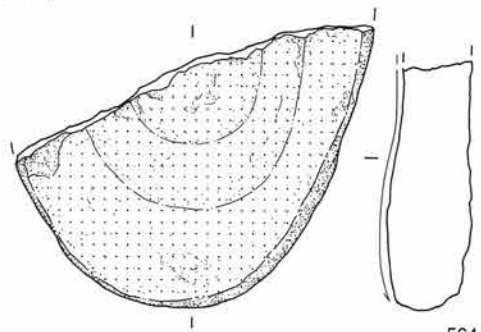

564
11F5
(SI403)

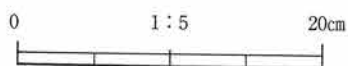

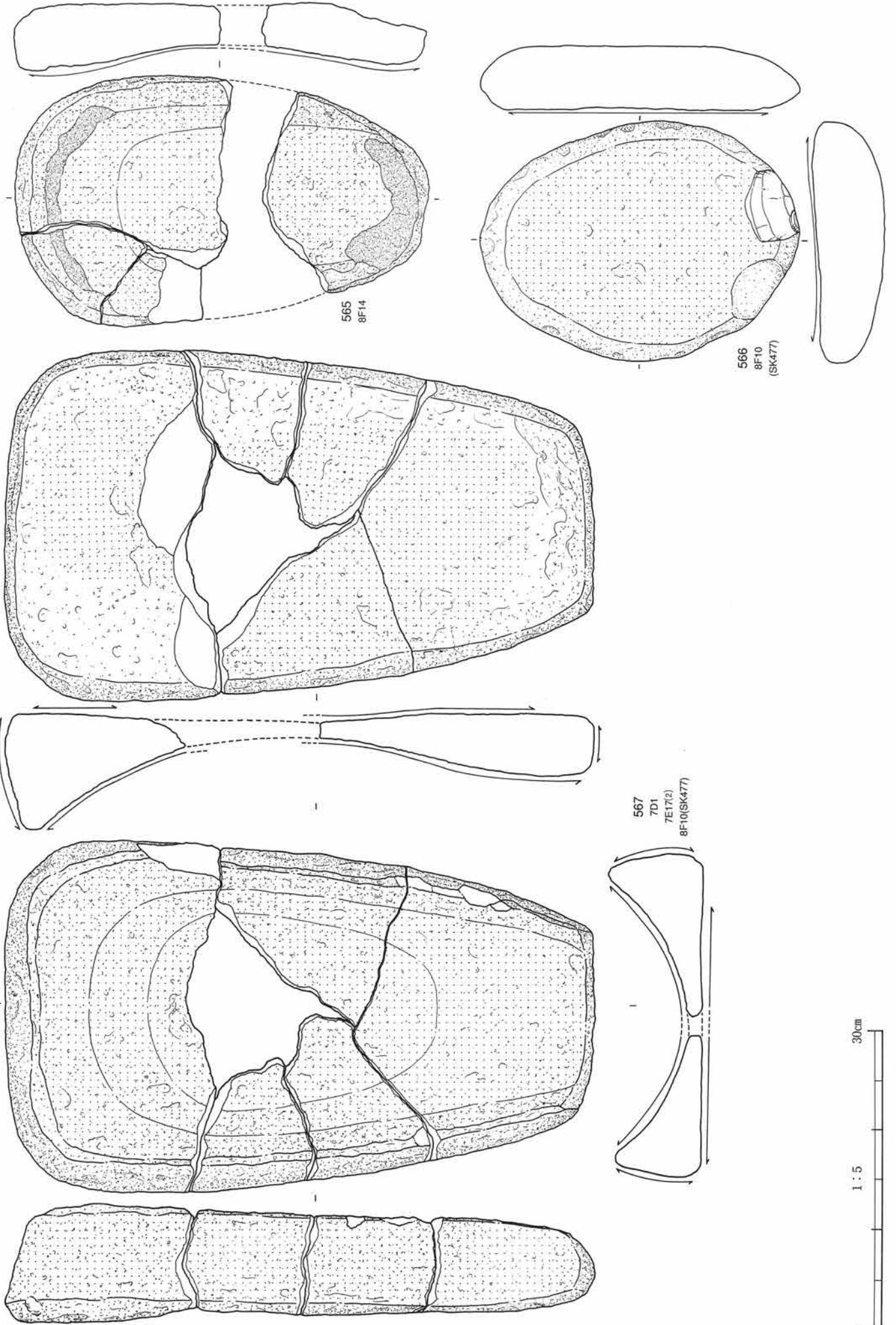

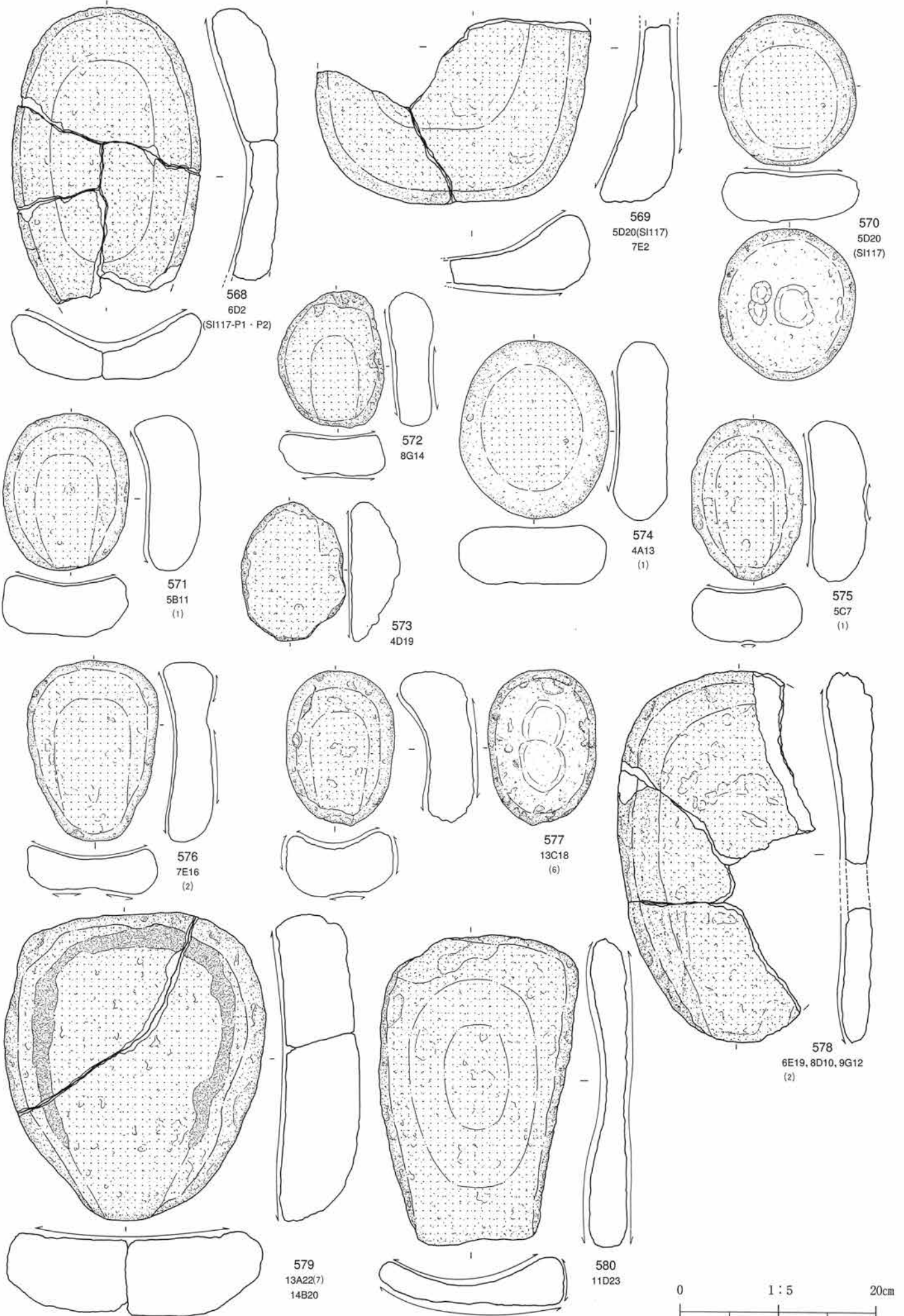

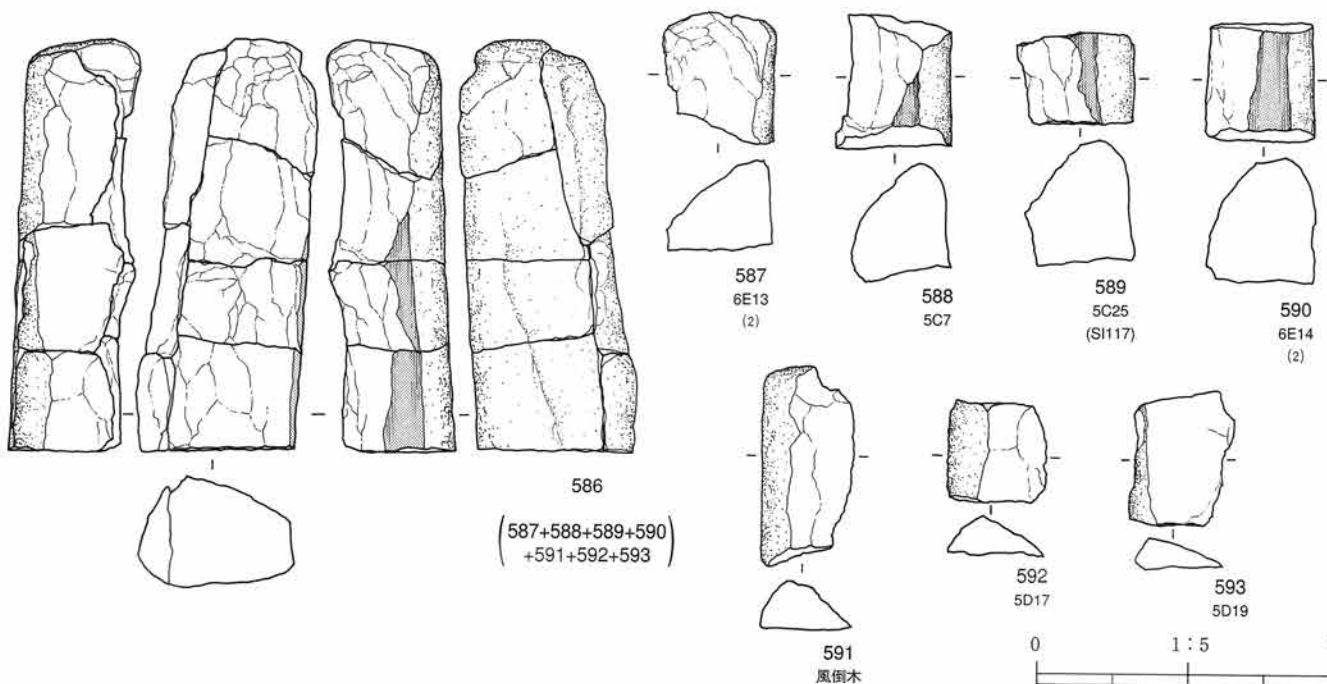
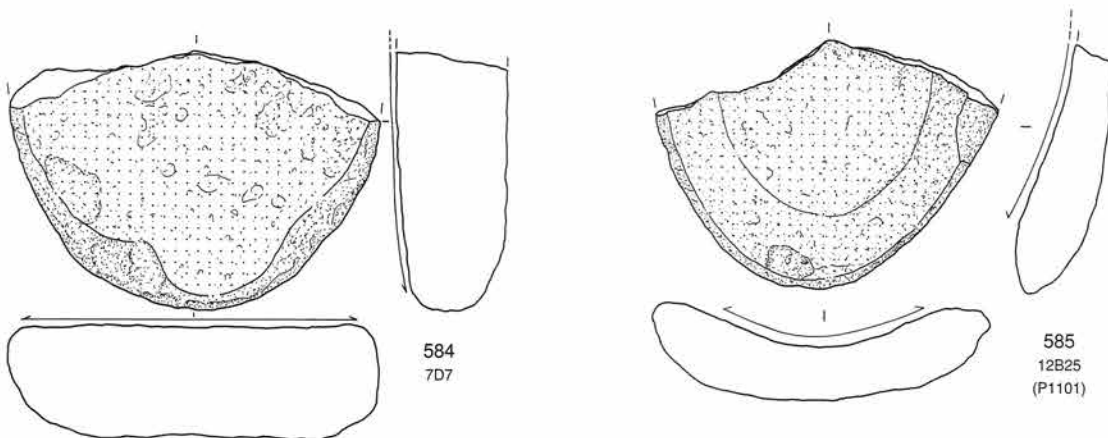
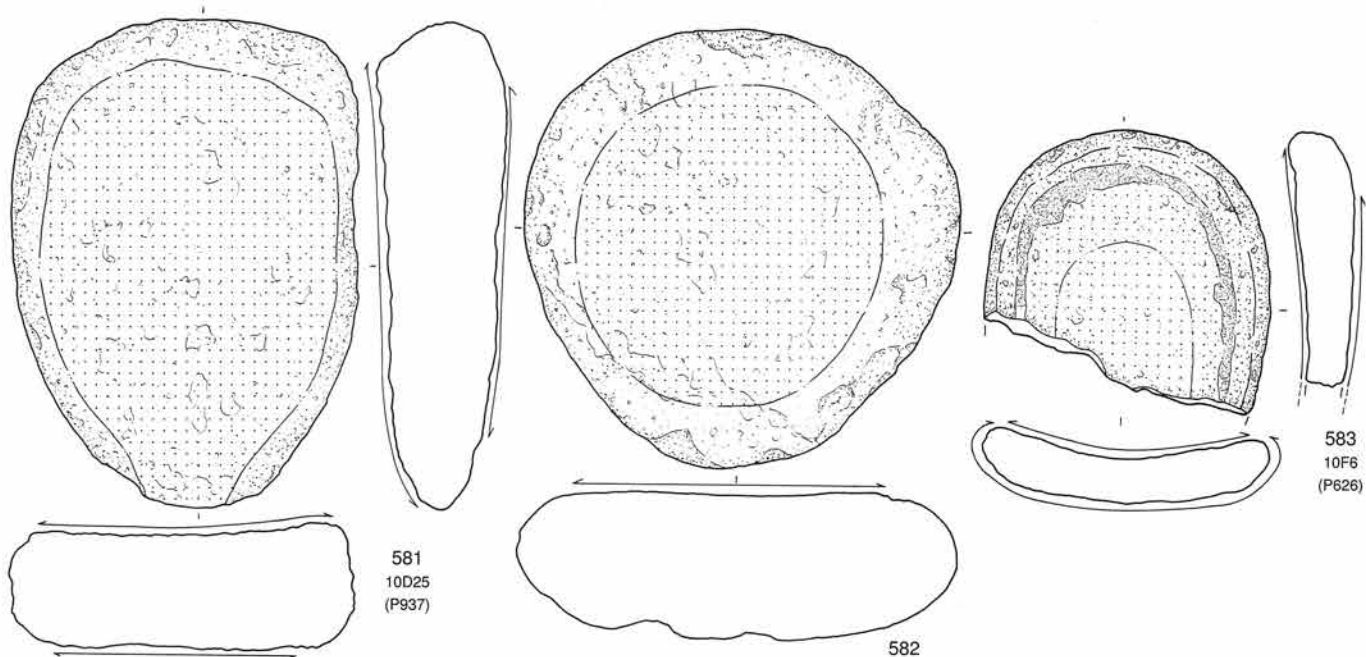

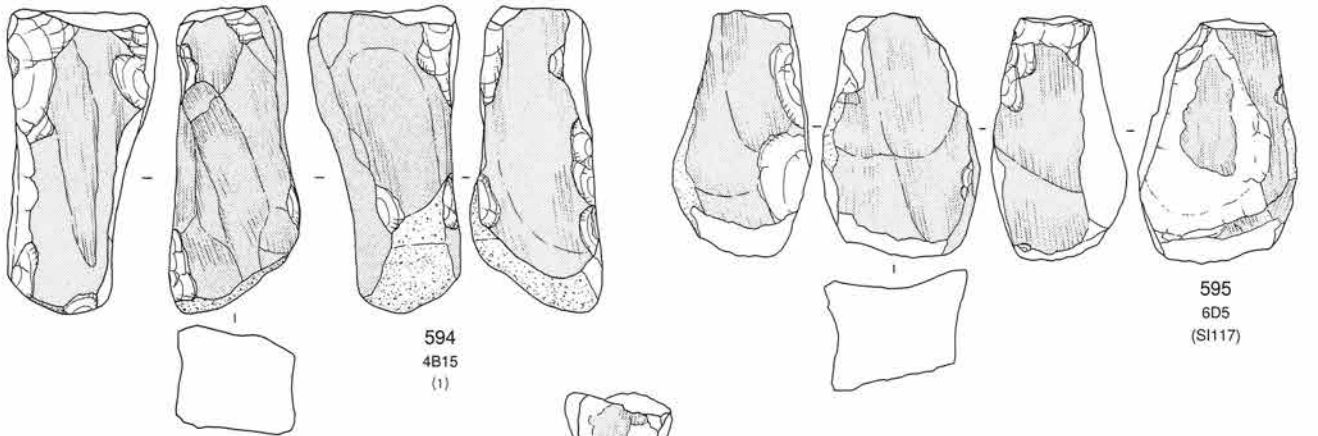

594
4B15
(1)

595
6D5
(SI117)

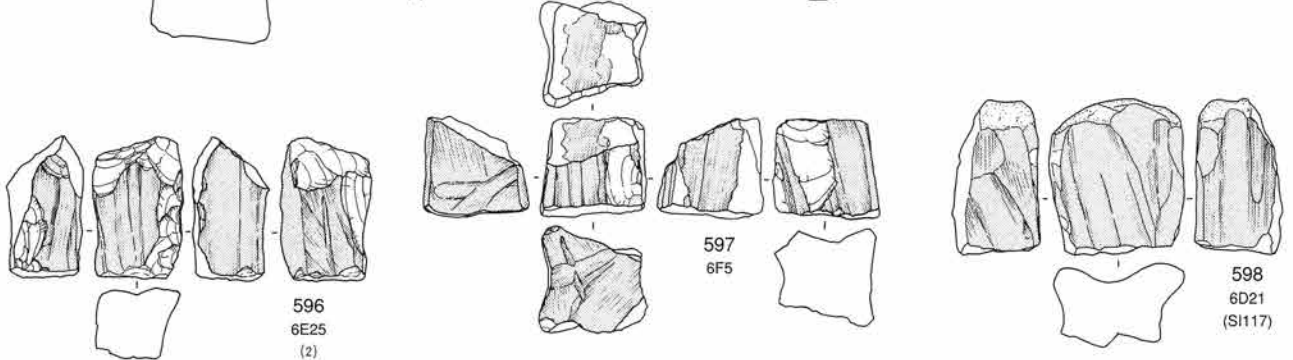

596
6E25
(2)

597
6F5

598
6D21
(SI117)

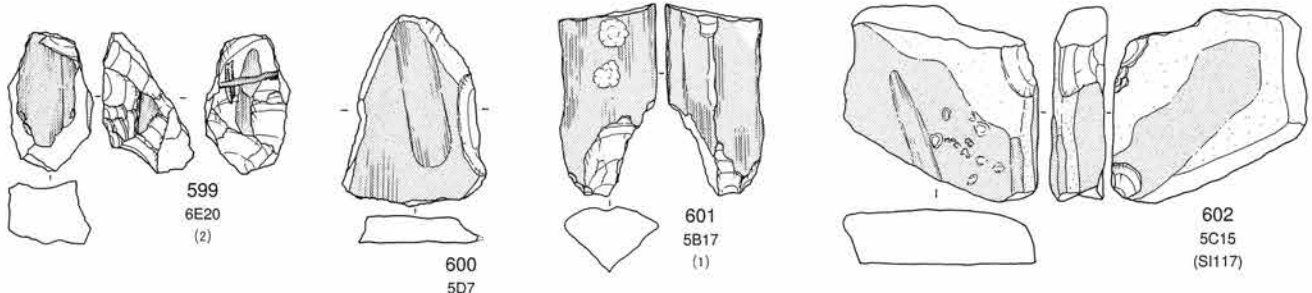

599
6E20
(2)

600
5D7

601
5B17
(1)

602
5C15
(SI117)

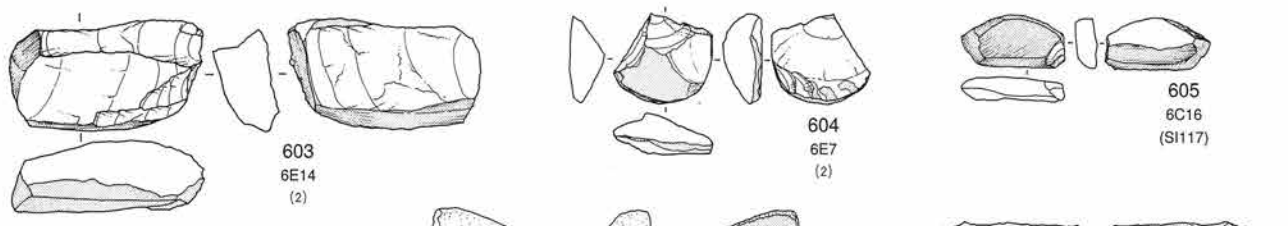

603
6E14
(2)

604
6E7
(2)

605
6C16
(SI117)

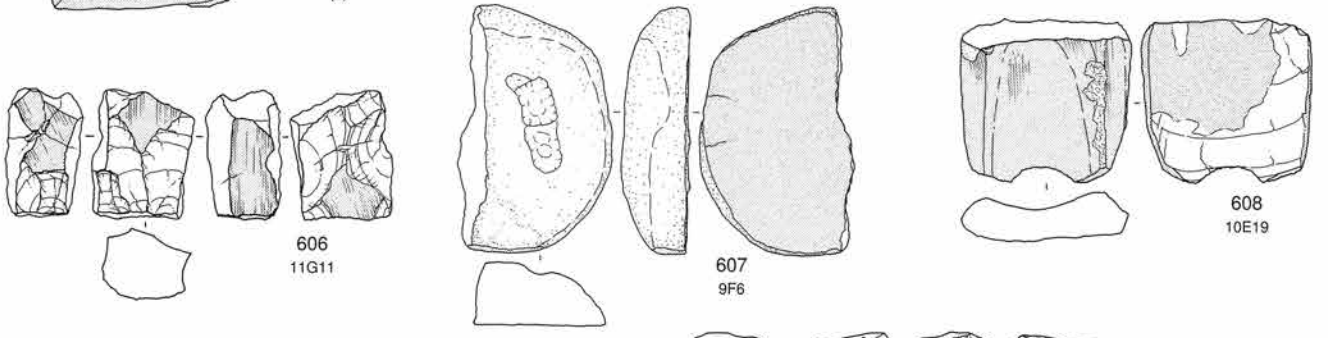

606
11G11

607
9F6

608
10E19

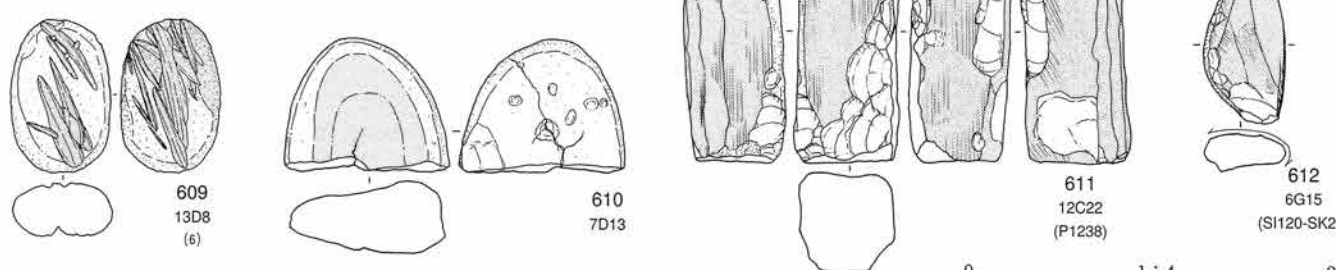

609
13D8
(6)

610
7D13

611
12C22
(P1238)

612
6G15
(SI120-SK23)

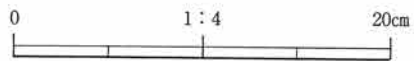

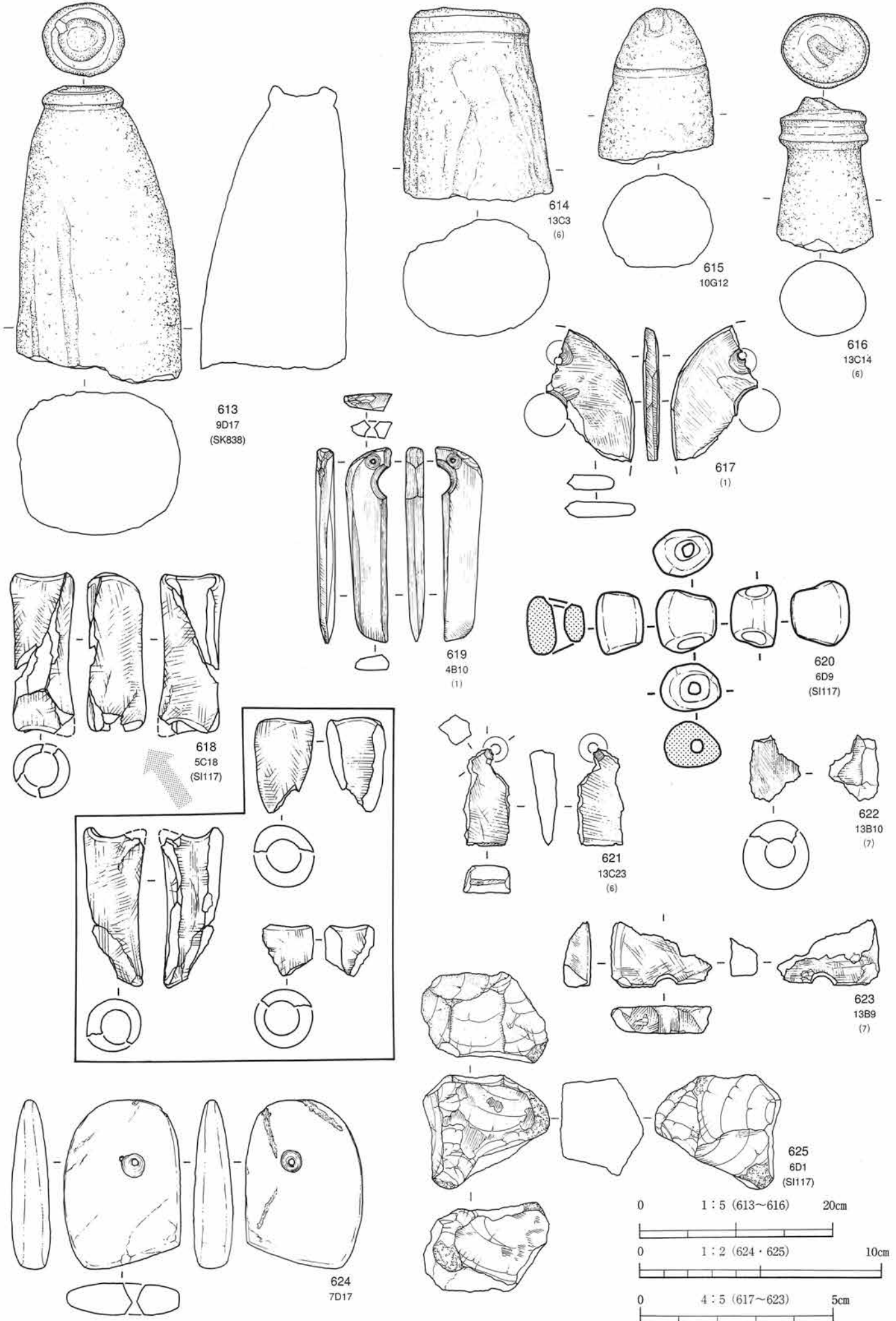



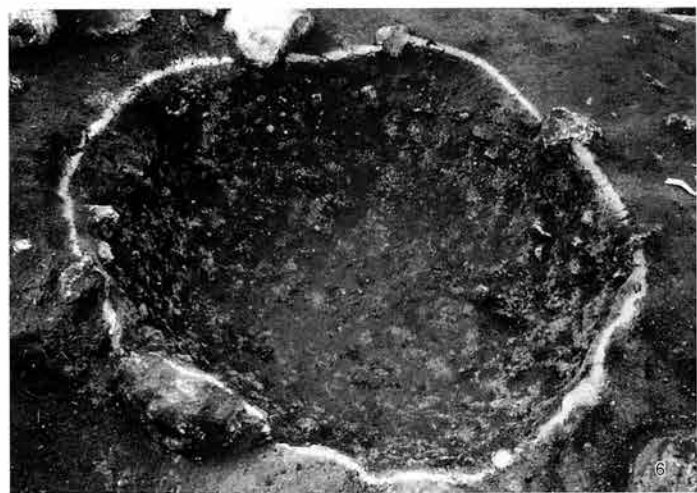
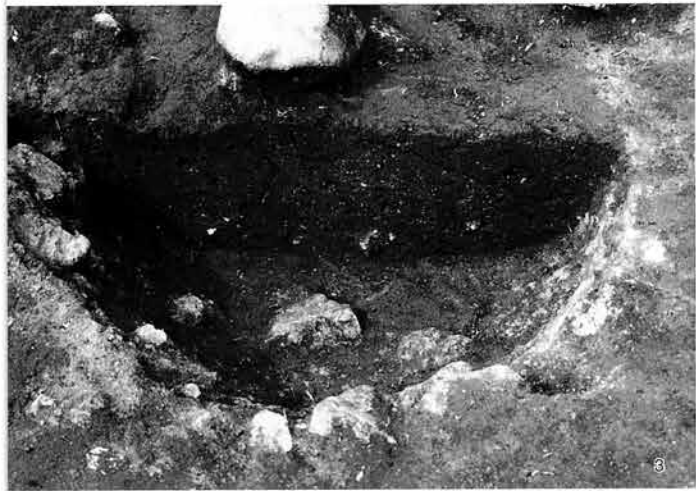
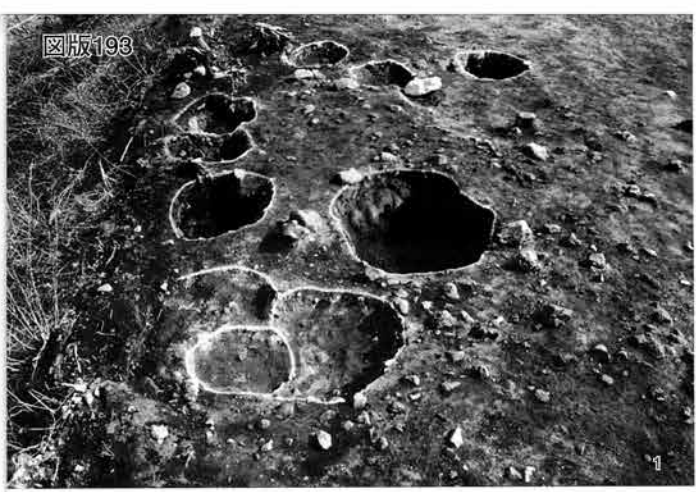

1 土坑群 完掘 (南から)
 3 SK003 半截 (東から)
 5 SK004 半截 (西から)
 7 SK005 半截 (南から)

2 土坑群 完掘 (東から)
 4 SK003 完掘 (東から)
 6 SK004 完掘 (東から)
 8 SK005 土器出土状況 (南から)

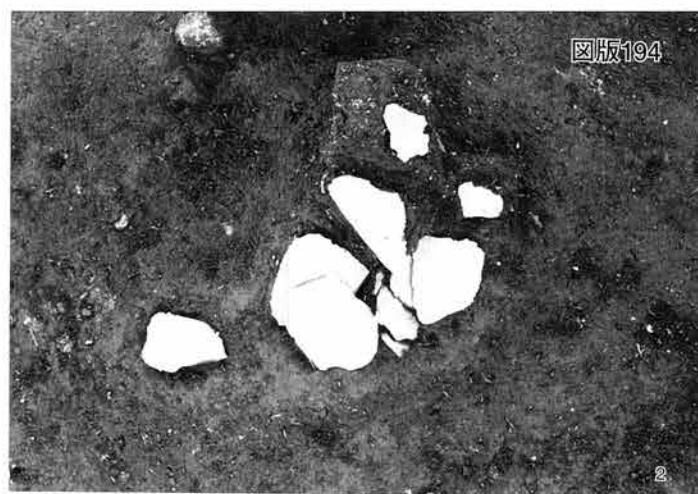

1 SK005 完掘 (南から)
3 SK006 半截 (西から)
5 SK007 半截 (南から)
7 SK010 半截 (東から)

2 SK006 石器出土状況 (北から)
4 SK006 完掘 (南から)
6 SK007 完掘 (南から)
8 SK010 完掘 (西から)

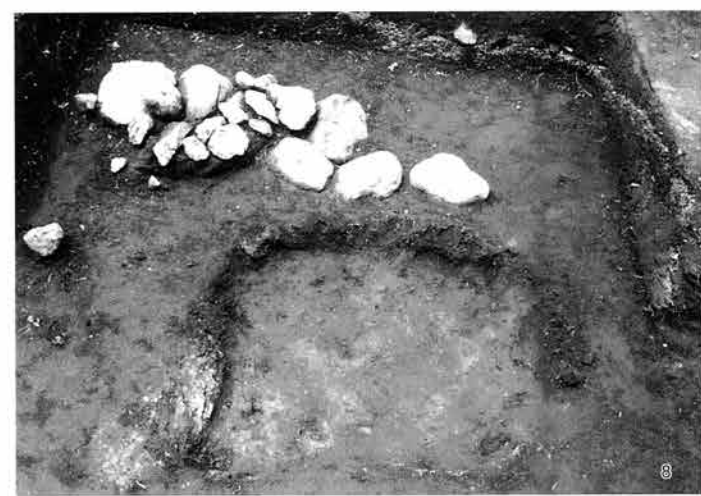
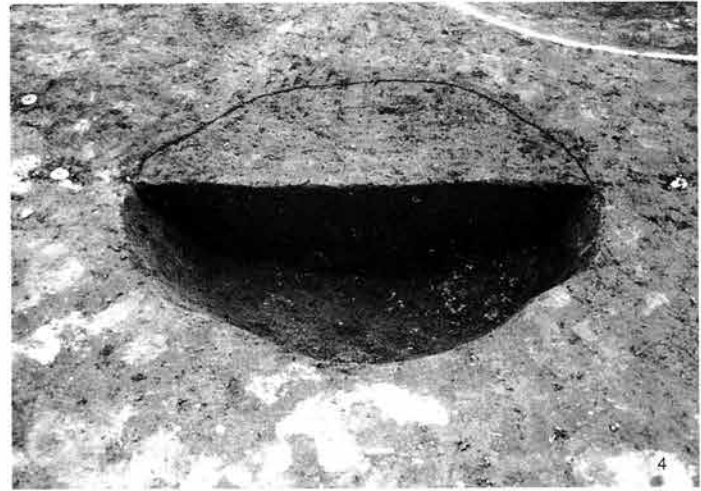

1 SK011・SK012 半截(東から)
 3 SK012 完掘(東から)
 5 SK116 土器出土状況(北から)
 7 SS400 礫検出状況(東から)

2 SK011 完掘(西から)
 4 SK001 半截(東から)
 6 SK116 土器出土状況(西から)
 8 SS400 完掘(東から)

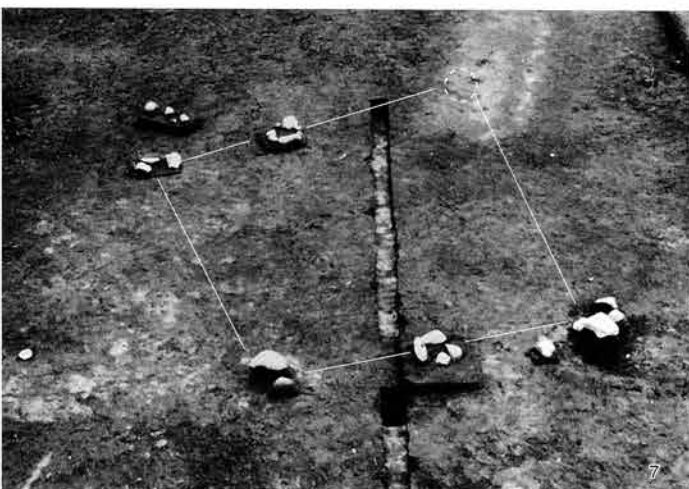
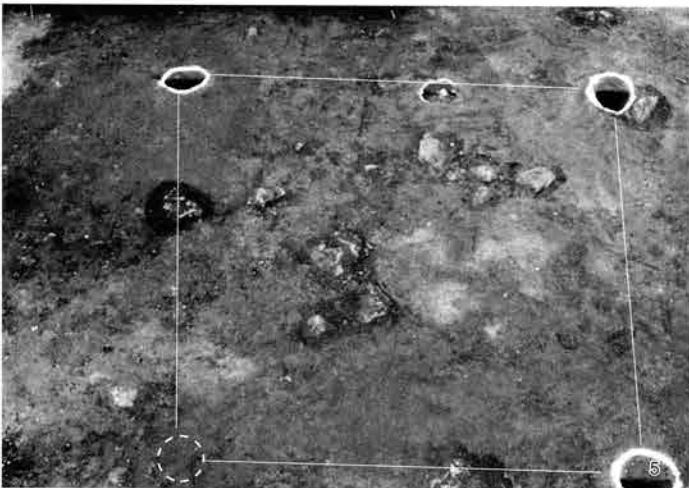
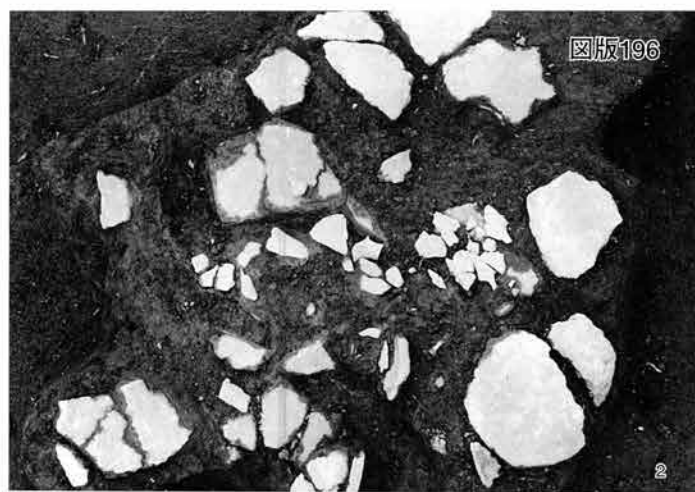
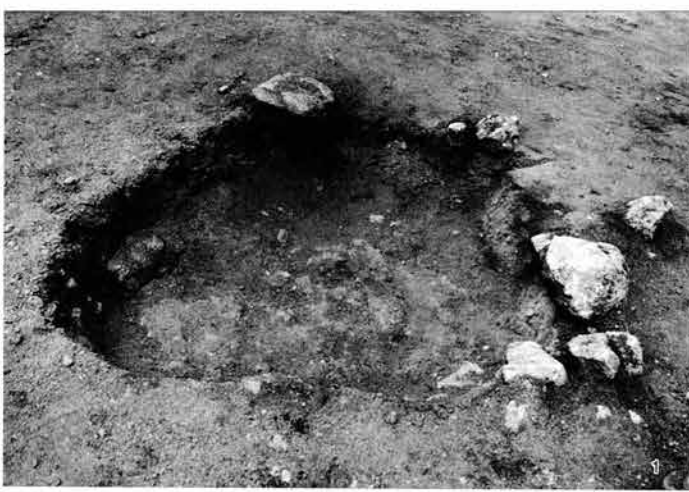

1 SK402 完掘 (南から)
 3 SX124 検出 (東から)
 5 SB 1 半截 (東から)
 7 SB 3 配石検出状況 (南から)

2 SX124 石器出土状況 (北東から)
 4 SX124 半截 (東から)
 6 SB 2 完掘 (北から)
 8 SB 3 完掘 (南から)

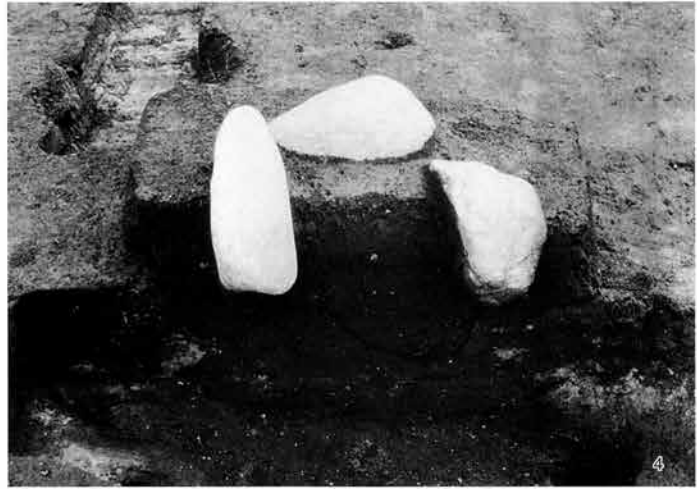
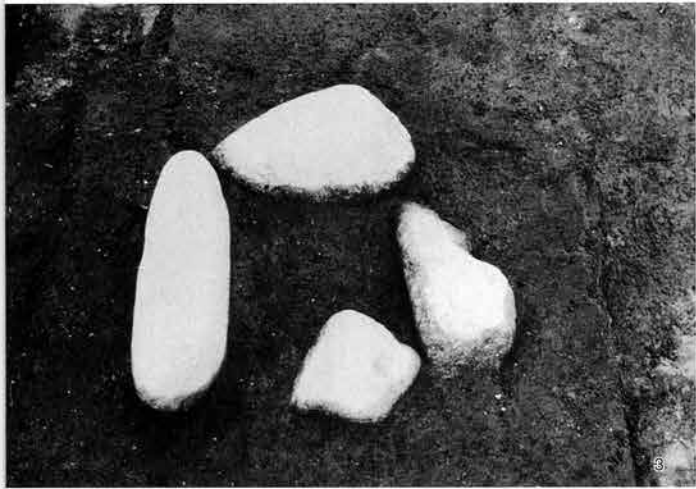
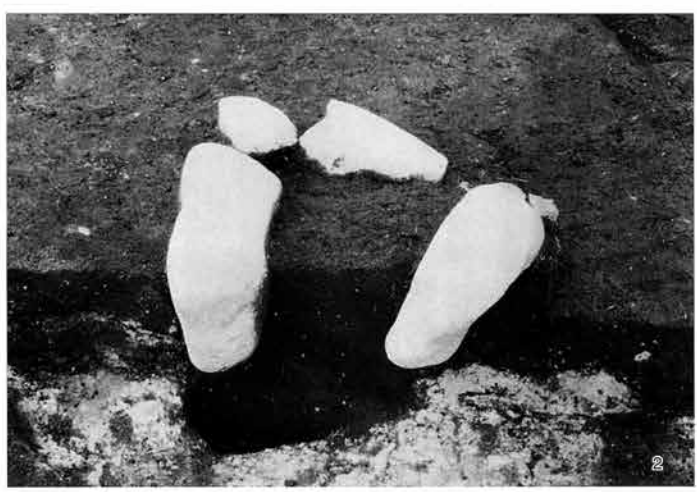
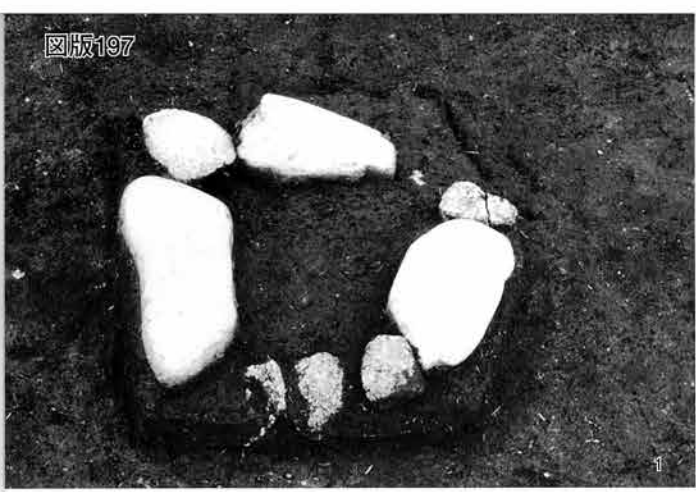

1 SB3-SS703 検出状況 (東から)
 3 SB3-SS700 検出状況 (南から)
 5 SB3-SS704 検出状況 (南から)
 7 SB3-SS701 検出状況 (北から)

2 SB3-SS703 半截 (東から)
 4 SB3-SS700 半截 (南から)
 6 SB3-SS704 半截 (南から)
 8 SB3-SS702 検出状況 (南から)

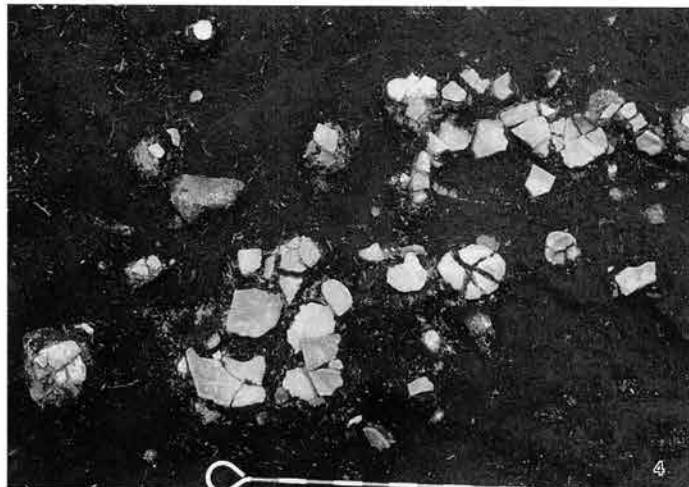
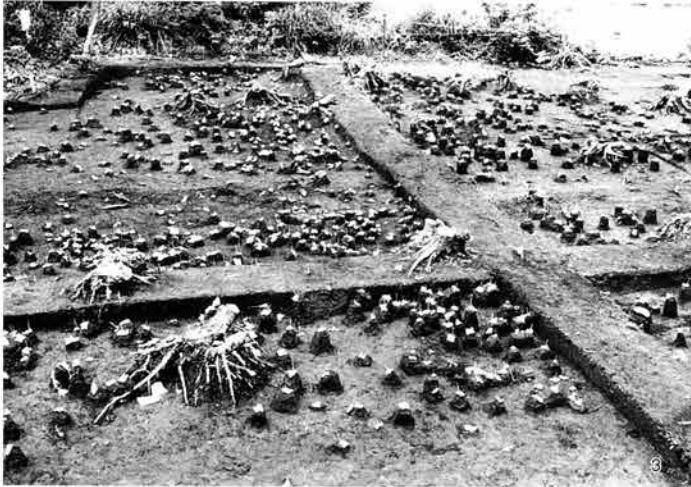
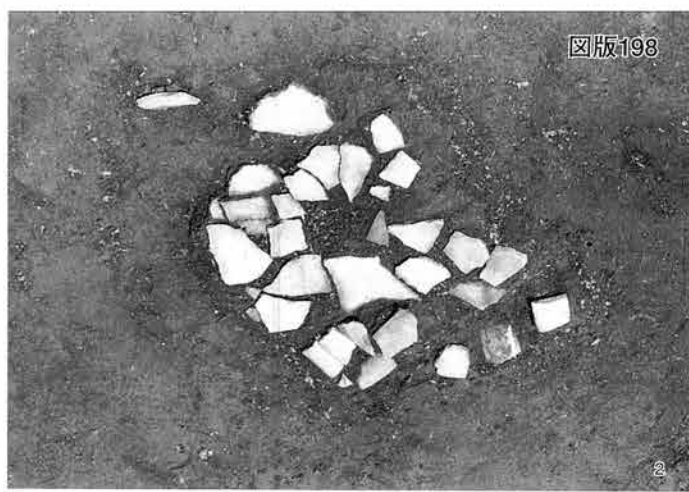

1 上層ブロック1 遺物出土状況 (東から)
3 上層ブロック2 遺物出土状況 (西から)
5 上層ブロック2・3・4 遺物出土状況 (南から)
7 上層ブロック9 遺物出土状況 (西から)

2 上層ブロック1 遺物出土状況 (東から)
4 上層ブロック2 遺物出土状況 (東から)
6 上層ブロック8 遺物出土状況 (南西から)
8 上層ブロック11 遺物出土状況 (南から)

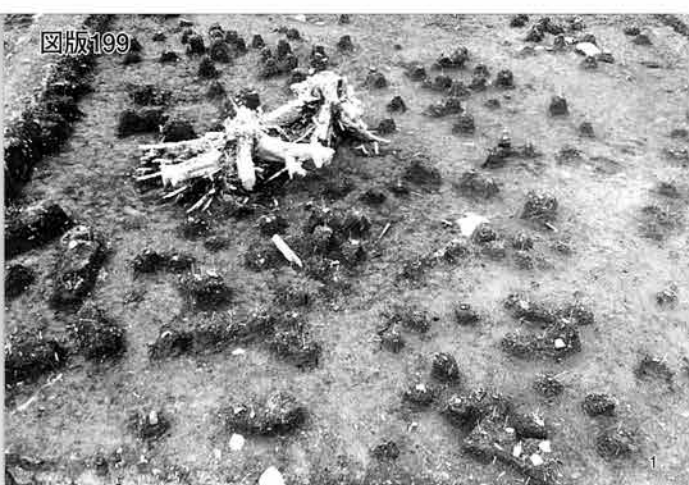

1 上層ブロック12 遺物出土状況(南から)
 3 上層ブロック14 一括土器出土状況(土器No.368)(南から)
 5 上層調査前風景(南から)
 7 平成5年度上層完掘状況(北から)

2 上層ブロック14 遺物出土状況(南から)
 4 上層9~14E~Fグリッド遺物出土状況(南から)
 6 平成7年度上層調査風景(北から)
 8 平成7年度上層完掘状況(南から)

SK005

1

1:4

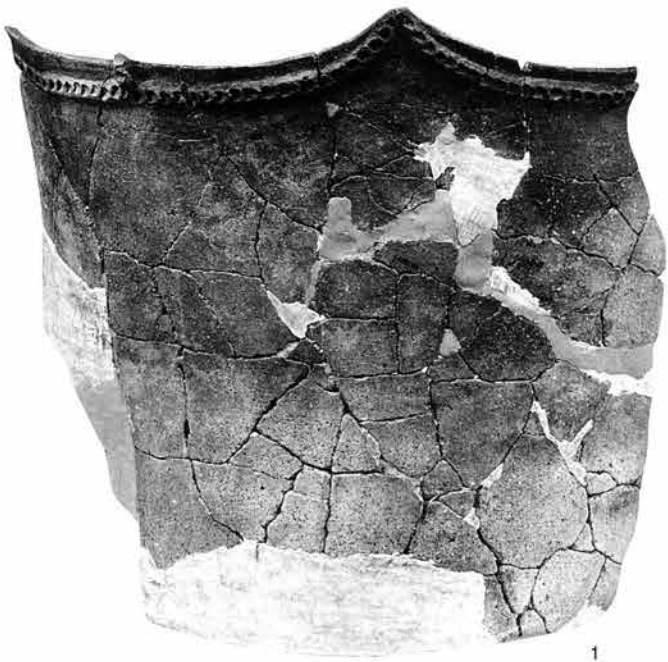

1

SK006

2・5

1:3

3・4

1:4

SK007

6

1:4

7・8

1:3



2



9

SX116

9・10

1:4



3

SX124

11

1:3

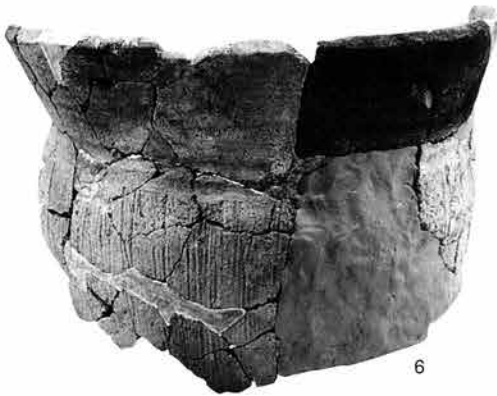

6



10



8



4



11



5



7

ブロック1
12~16
1:3
17~20
1:4



12



17



20



19



13



14



15



18



16



21



22



23



24



25



26



28



27

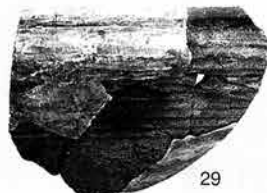

29



30



31



32



33

ブロック2
21~33
1:3

ブロック2

34~41

45・50

1:3

42~44

46~49

1:4

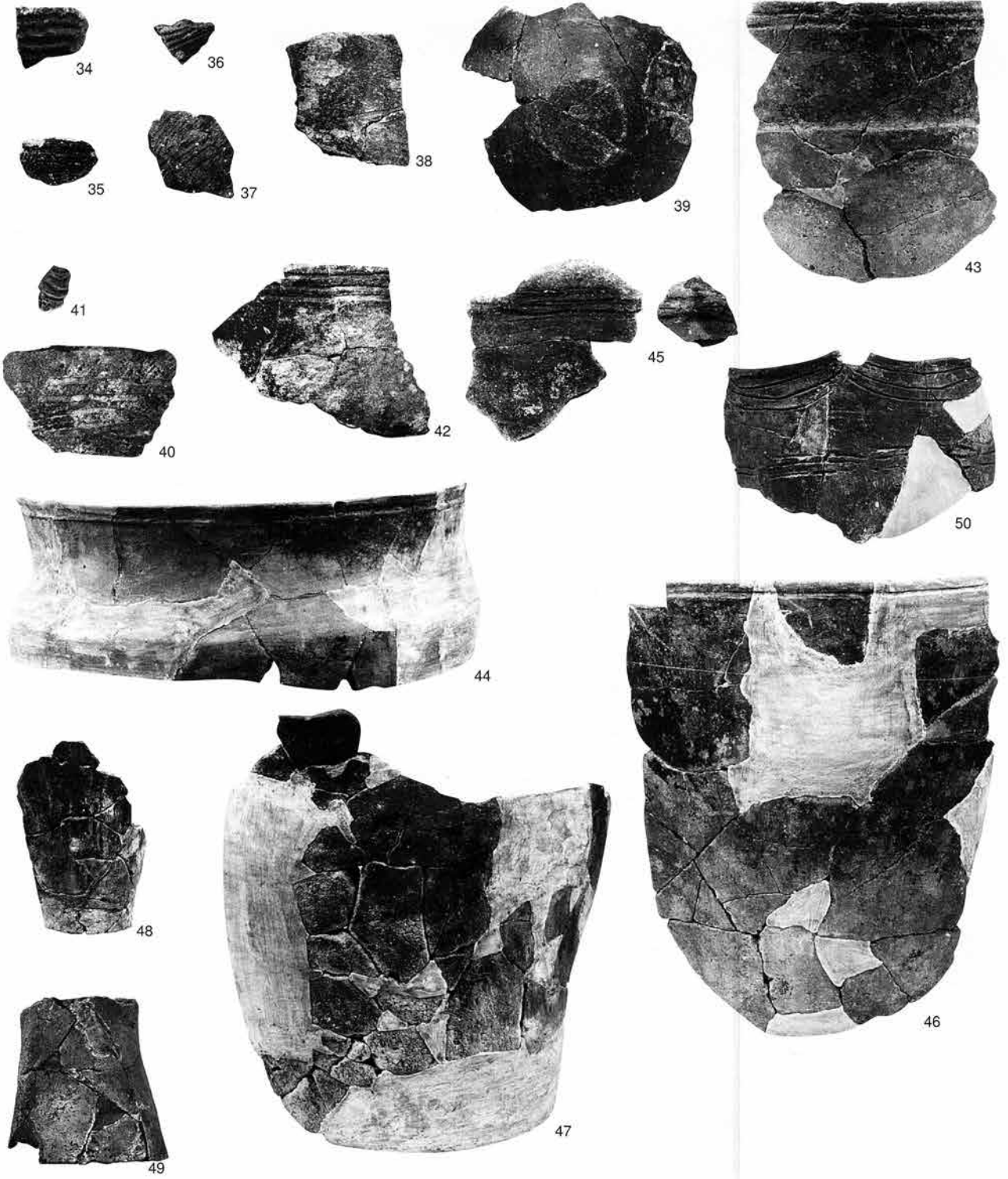

ブロック3

51~61

1:3

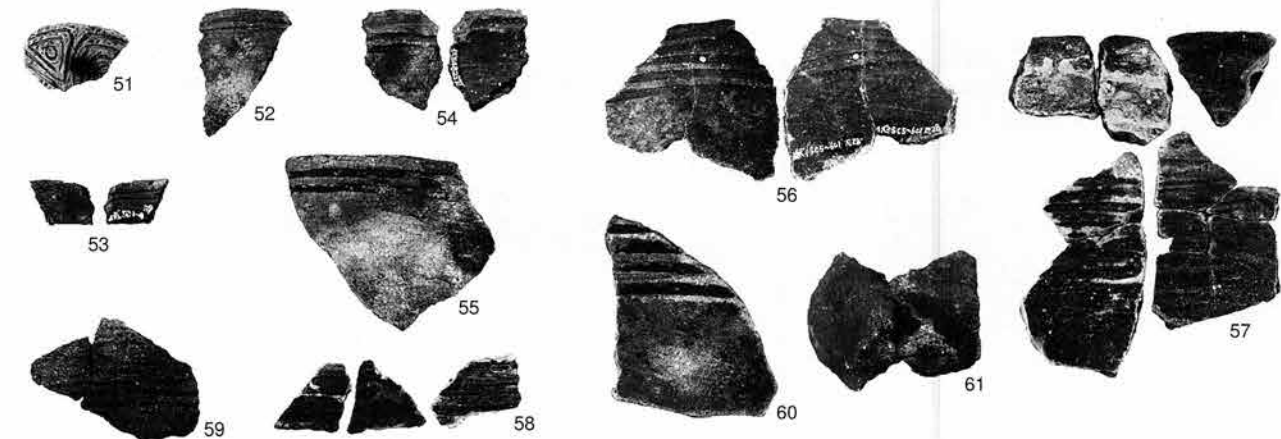

ブロック3

62~66

68~97

1:3

67・70

1:4

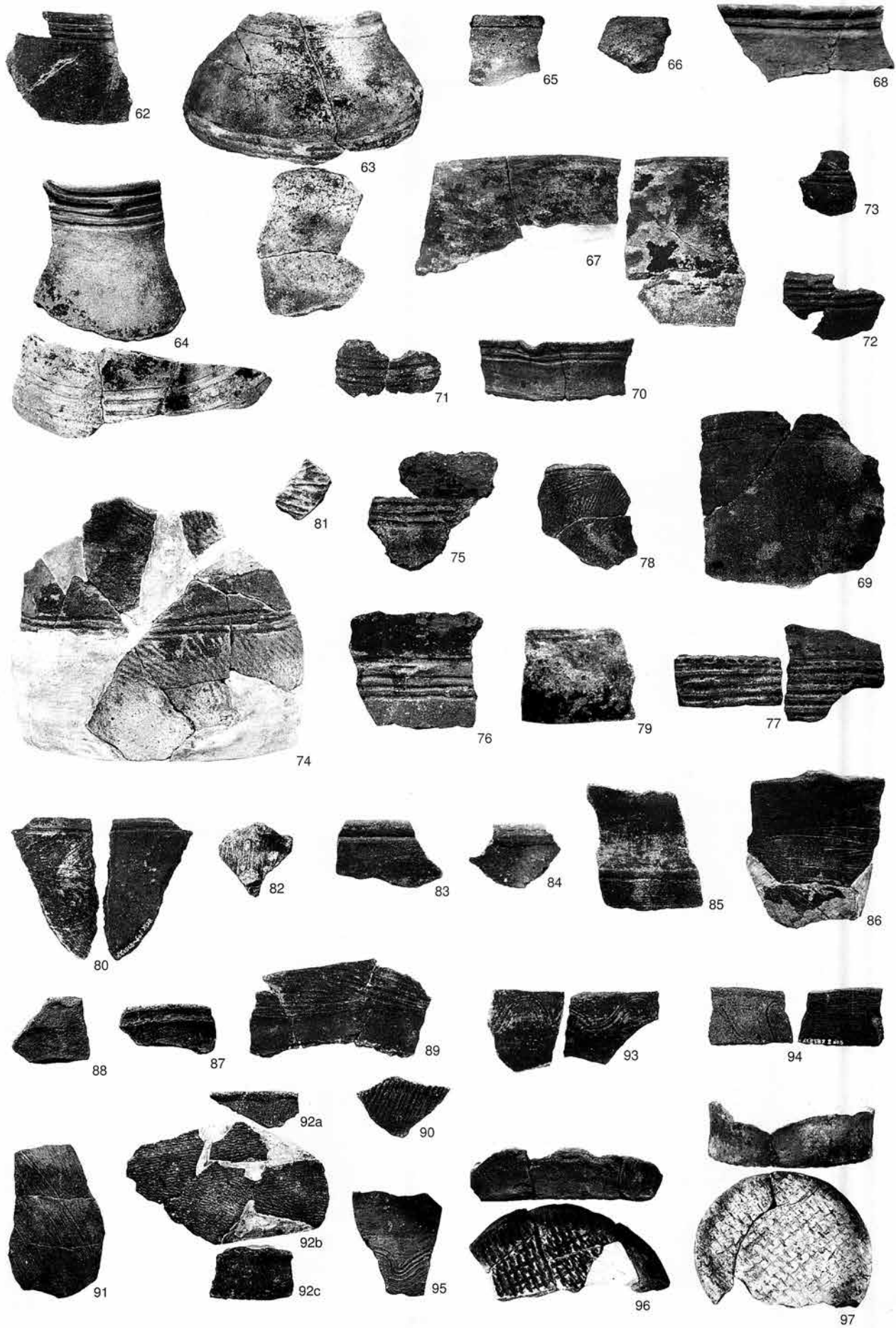

ブロック4
98~104
106~110
1:3
105
1:4

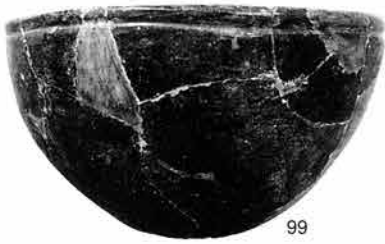

99



100



104

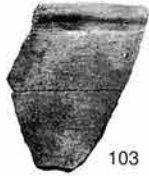

103



101



102



105

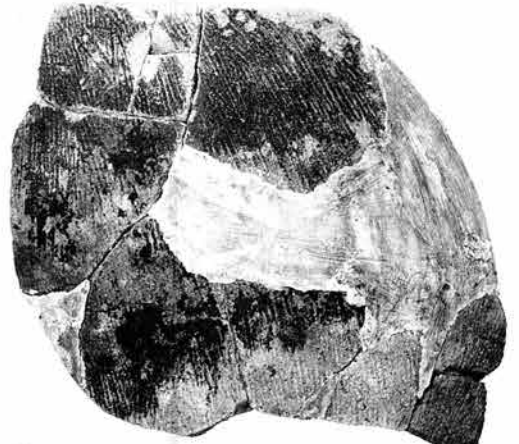

106



107



108



109

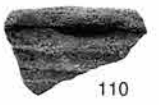

110

ブロック5
111・133
1:4
112~132
1:3



111



112



115



114



116



117



118



119



120



123



113



121



122



126



125



128



124



127



132



131



129



130



133

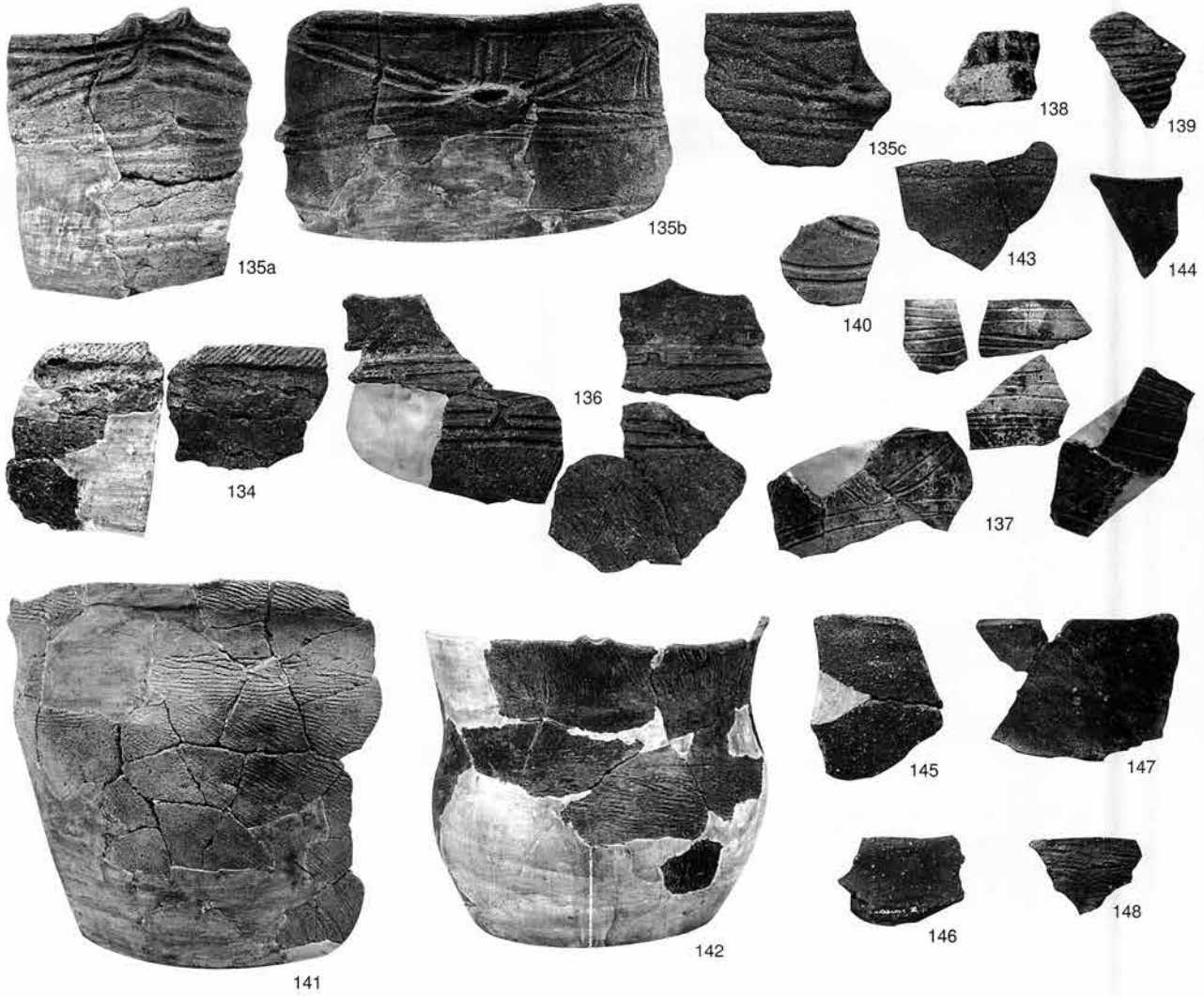

ブロック5
134~140
143~148
1 : 3

141・142
1 : 4

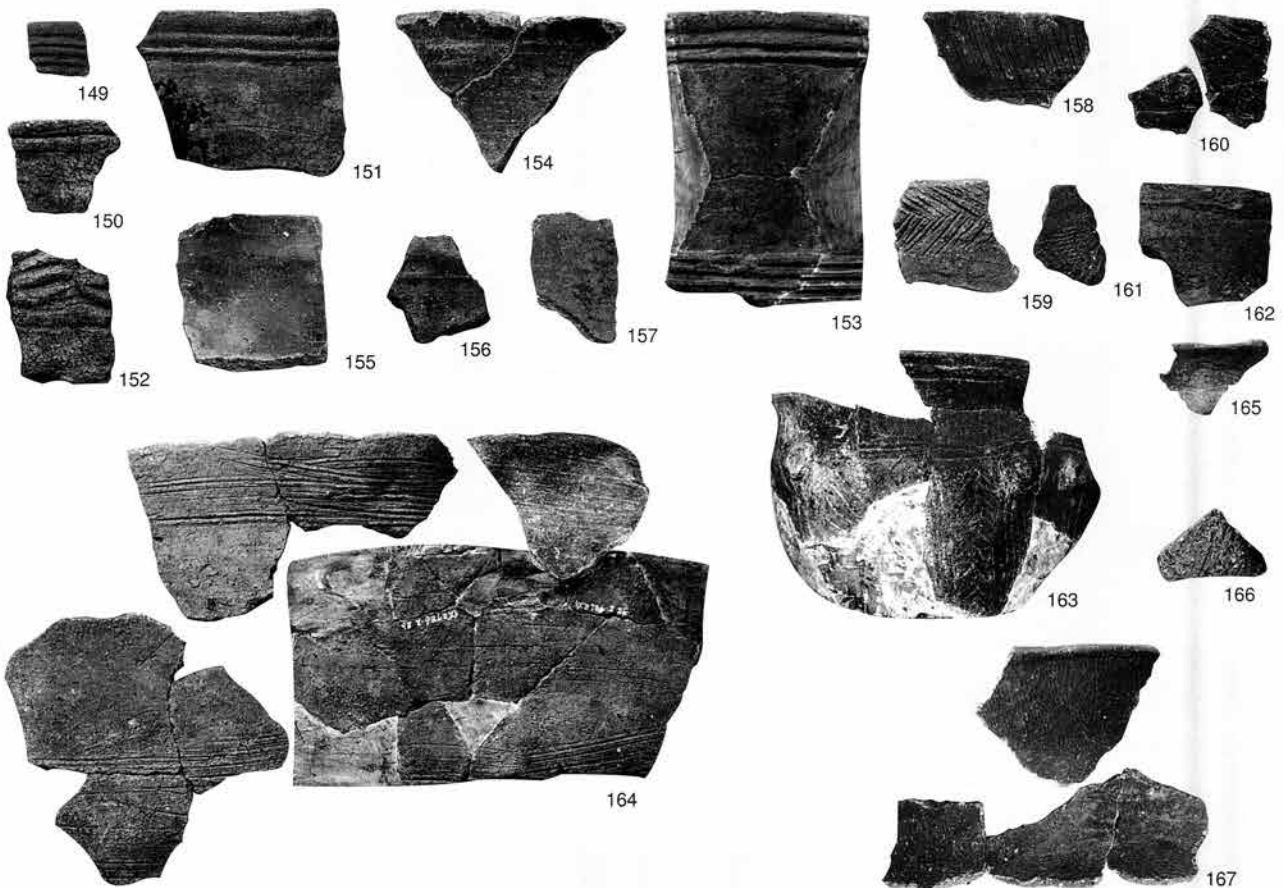

ブロック6
149~167
1 : 3

ブロック6
168~171
1:3

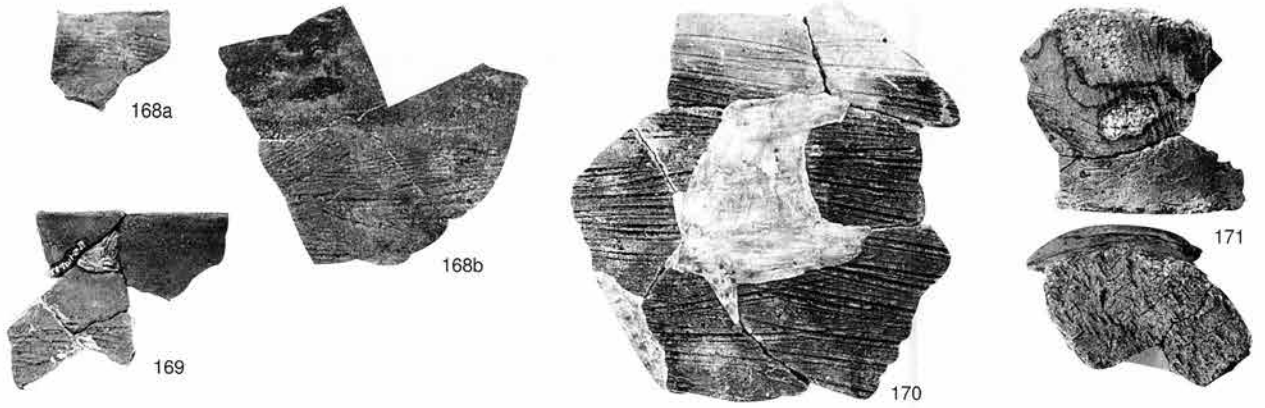

ブロック7
172~189
191・193
194
1:3
190・192
1:4

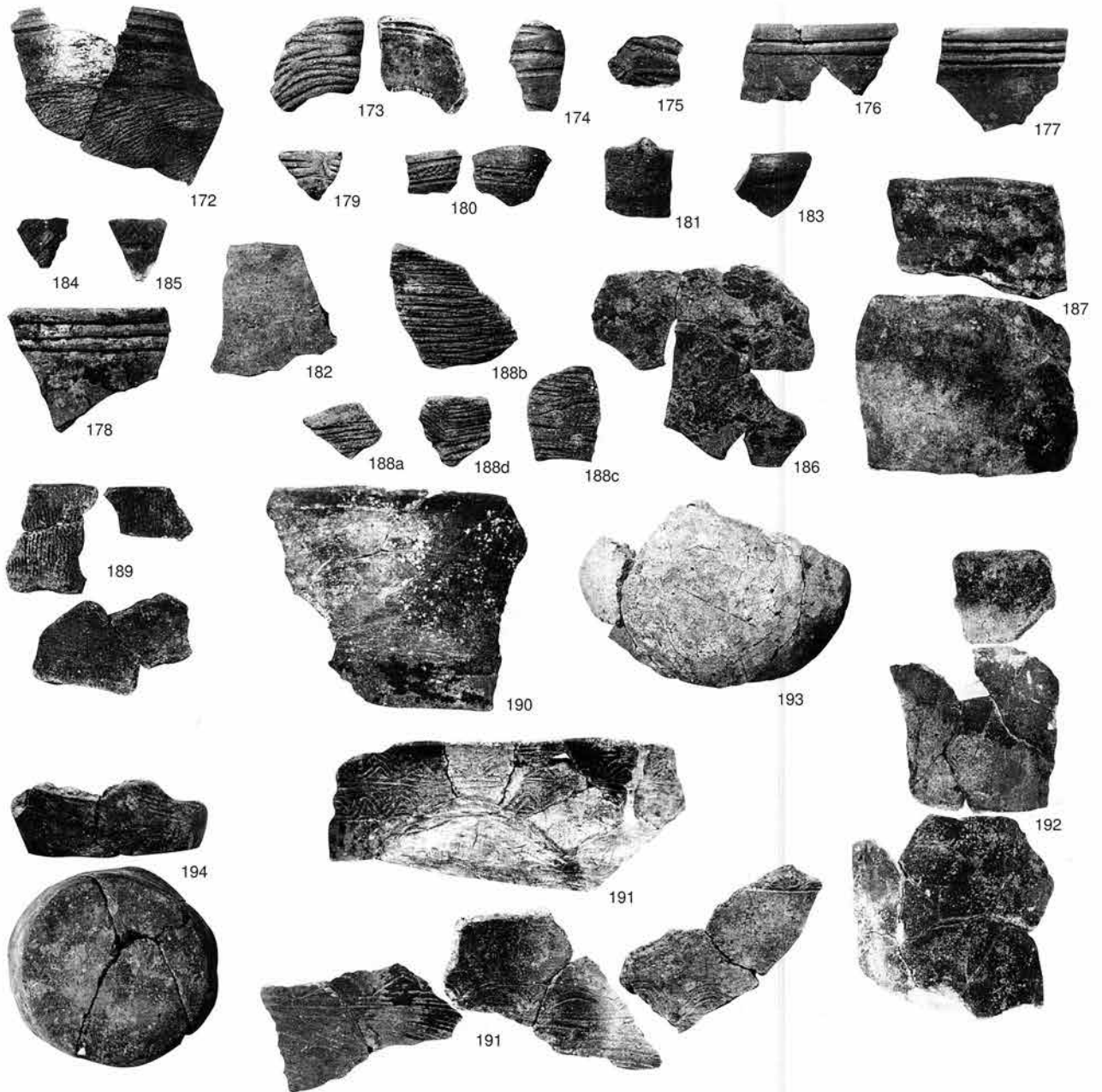



195



196



197

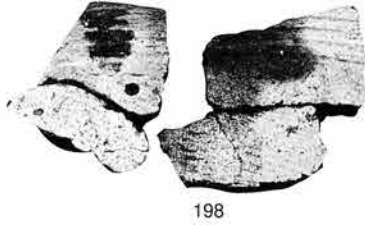

198



199



200



202



198



201



203



204



205



206



207



208



209



210



211



212



213



214



215



216

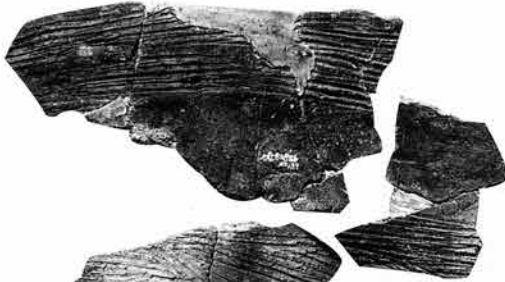

217



218

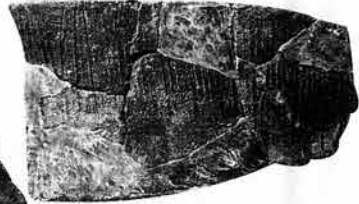

220



223



219



222



221a



221b

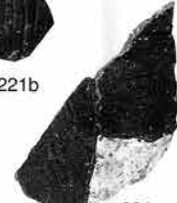

221c

ブロック 8
195~204
207~214
216~223
1:3

205~215
1:4

ブロック 8
224~226
228~234
236~240
1:3

227・235
1:4



224



225

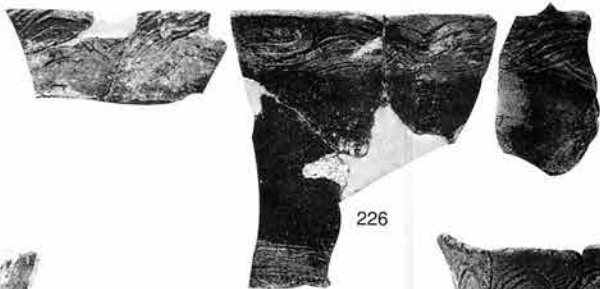

226

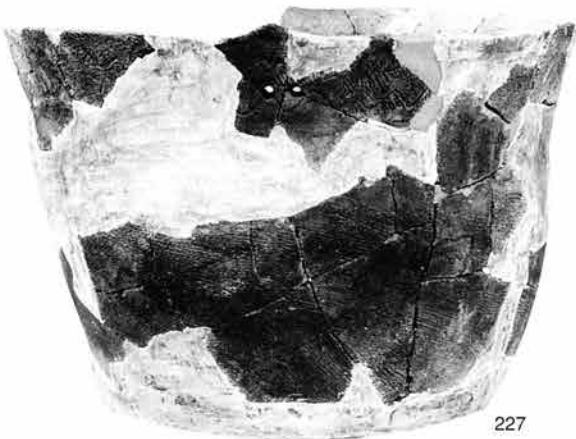

227



228



229



230



231



233a

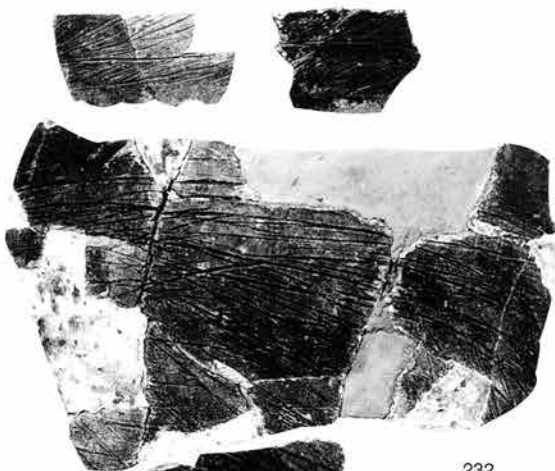

233b



233c



234



235



236



238



239



240



241



242



244



ブロック 8
241~246
1:3



ブロック 9
247~255
257~259
261~263
265・268
269・274
275
1:3



256・260
264・266
267・271
1:4

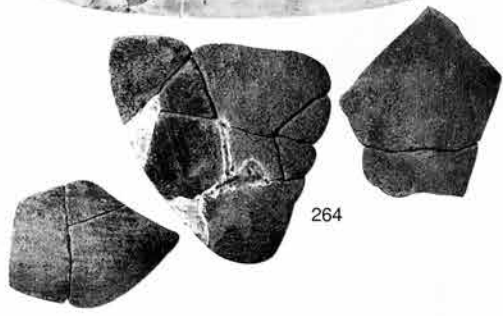
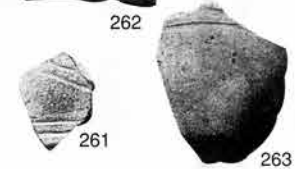
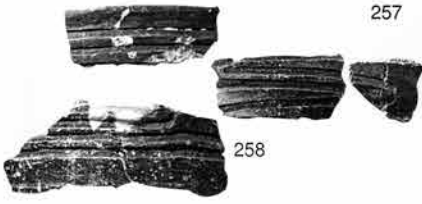

ブロック9
270・272
1:4



270



273

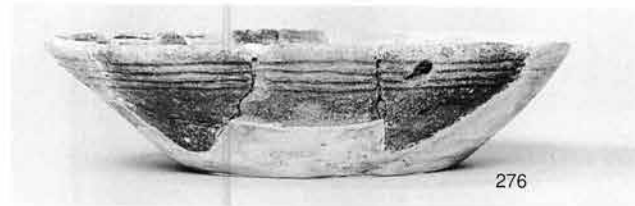

276

ブロック10
276~284
286
288~291
1:3



272

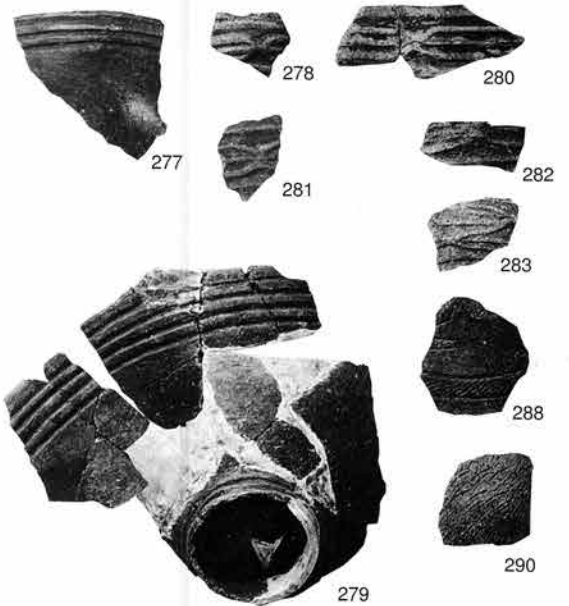

277

278

280

281

282

283

288

290

279

289

291



284



285



286



287

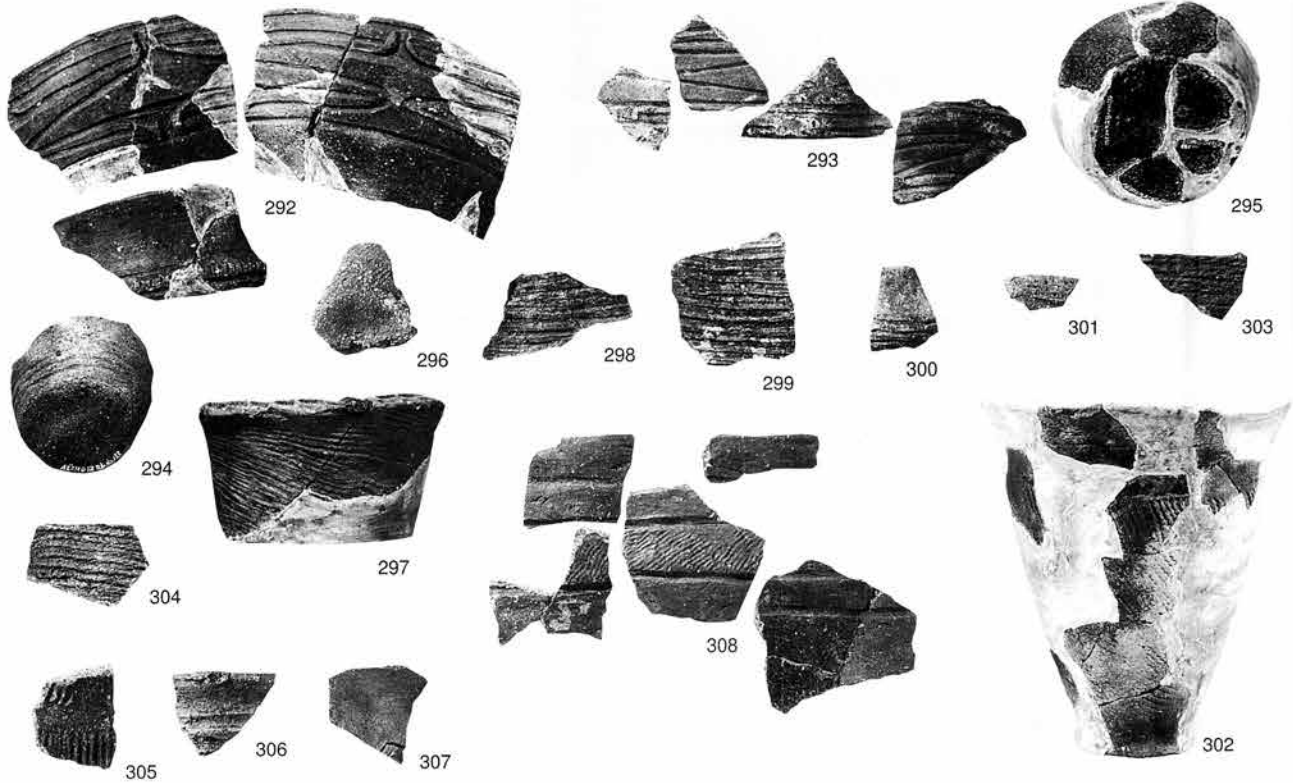

ブロック11
292~294
296~301
303~308
1:3

295・302
1:4

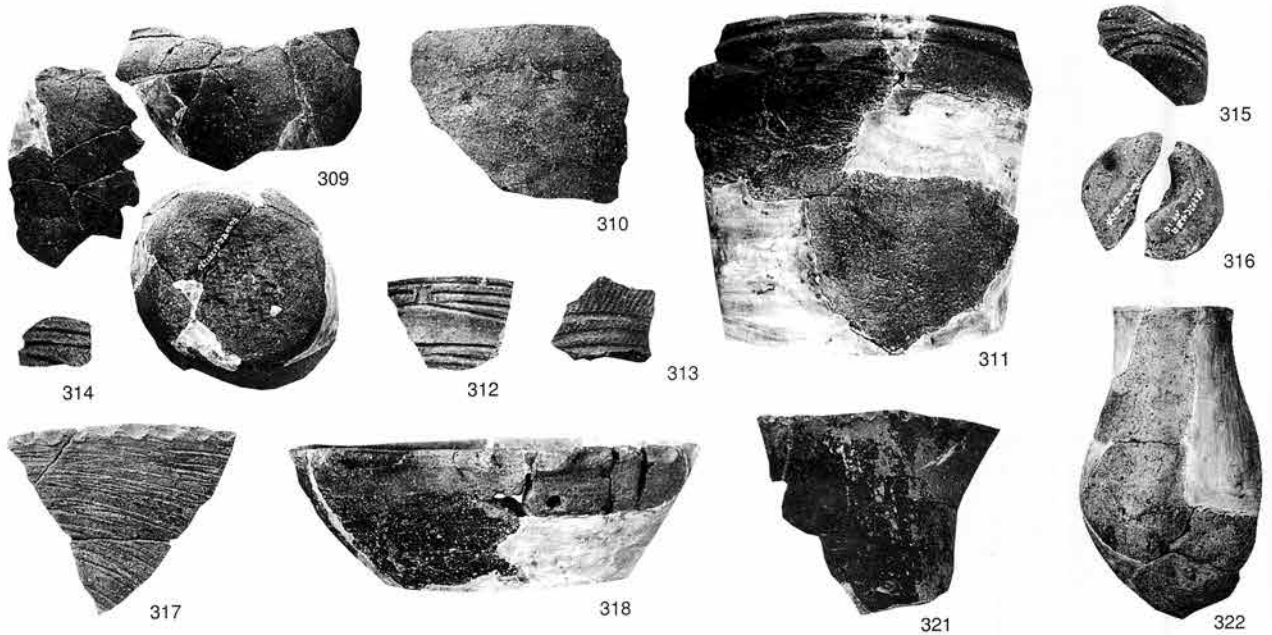

ブロック12
309・323
1:4

310~322
1:3



ブロック12
324~326
328~338
340
342~345
1:3

327・341
1:4

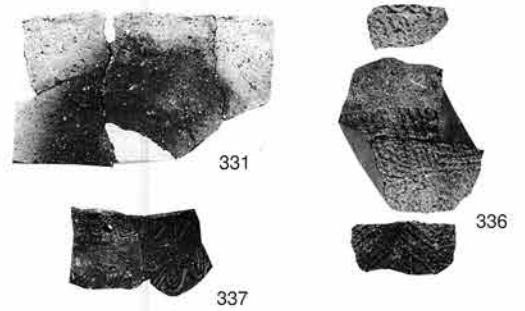
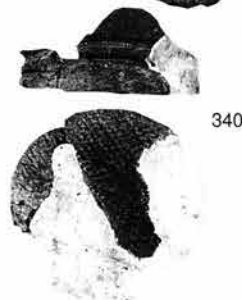
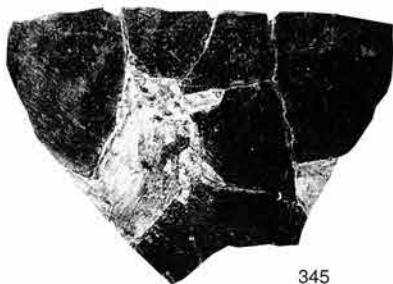
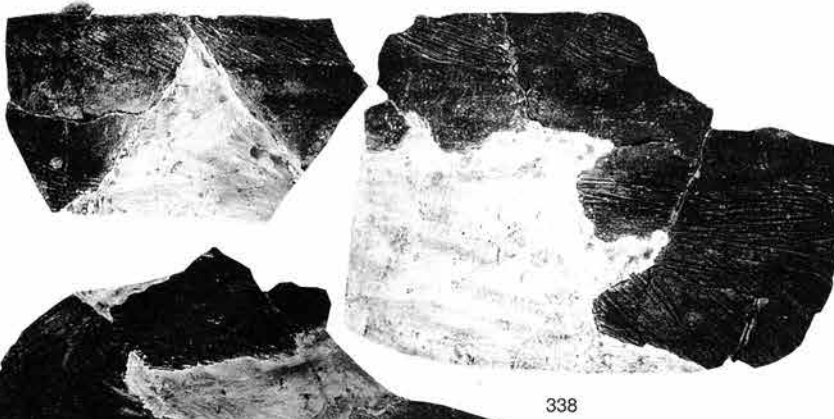
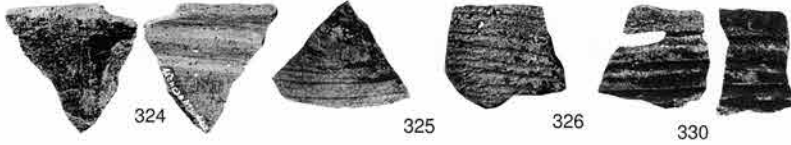

ブロック12
339
346~348
1:3



348

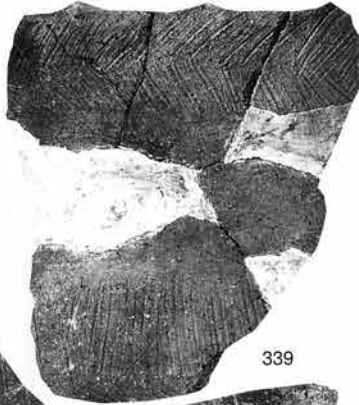

339



347



339



346

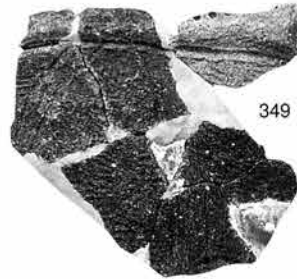

349



350



352



351



355



353



354a



360



356



354b



357



359



361



362



362

ブロック13
349~357
359~362
1:3
358
1:4



358

ブロック14
363・366
367
369~374
1:3

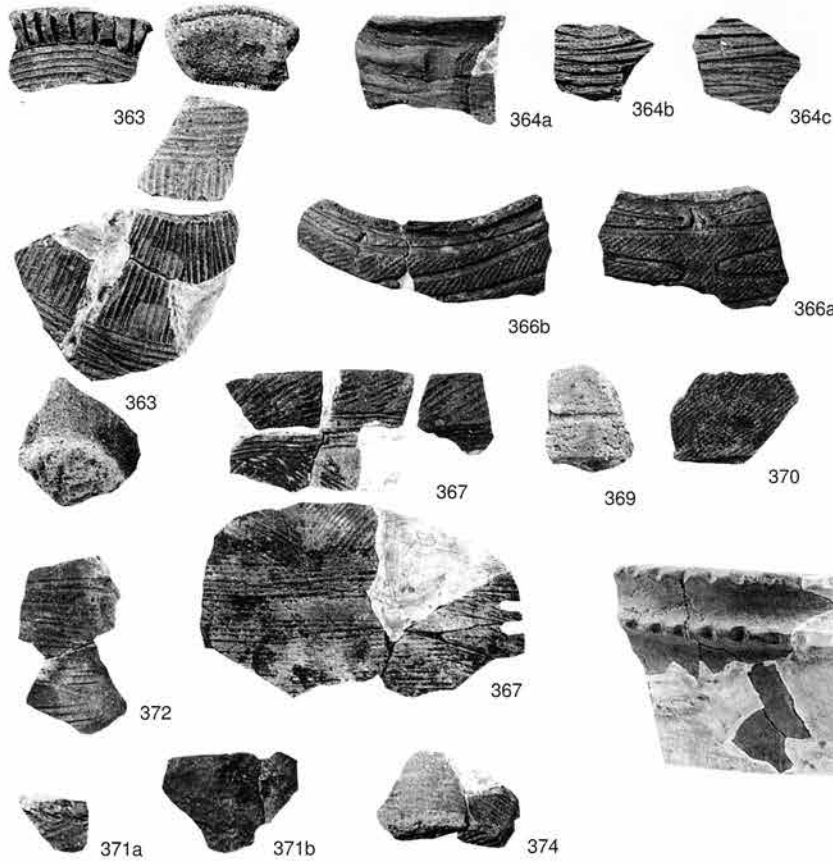

364・365
368
1:4

ブロック外
375・378
1:4
376・377
379~385
1:3

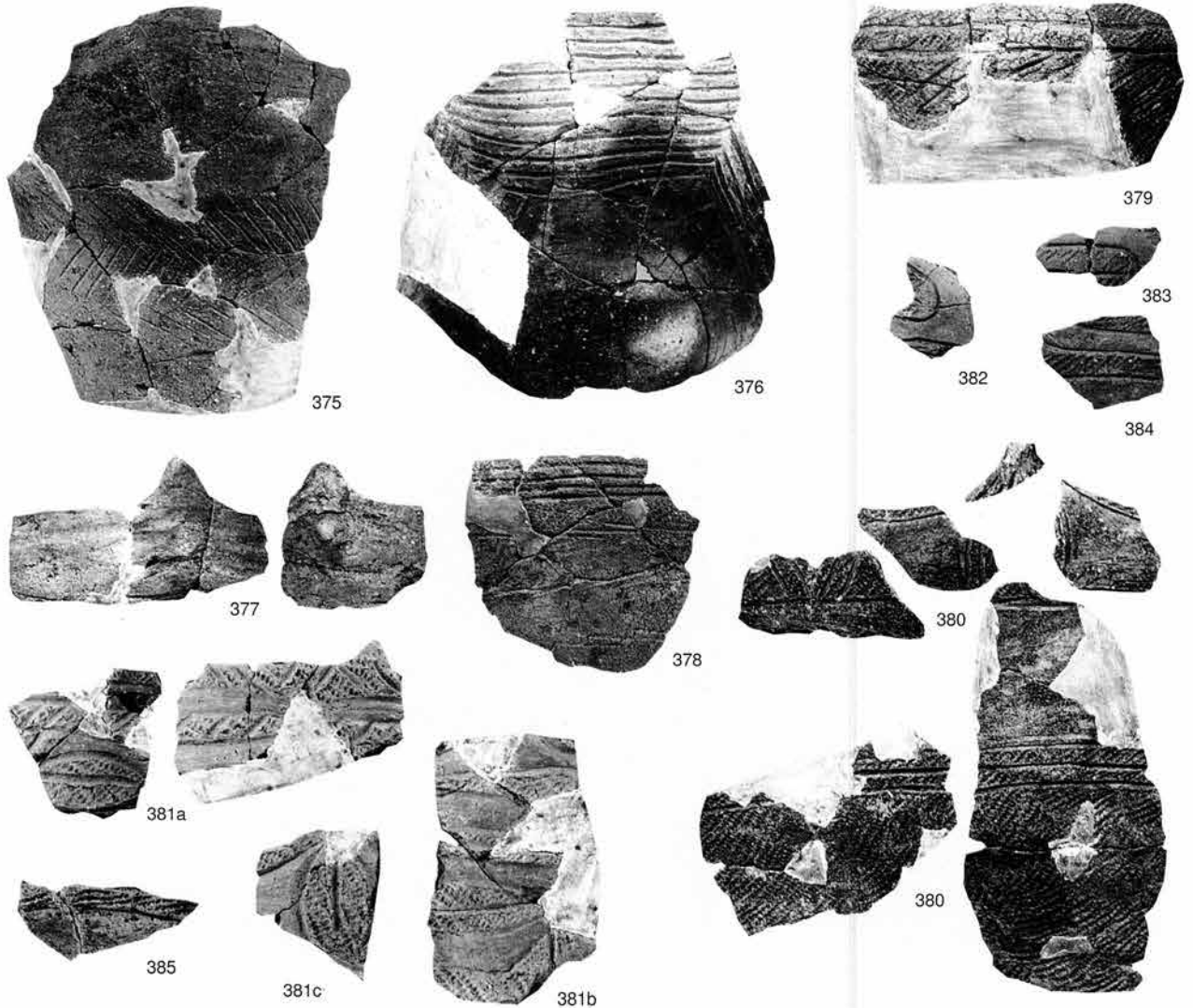

ブロック外
 386~390
 392~394
 396~408
 413・414
 416
 1 : 3

391・395
 409・410
 412
 1 : 4

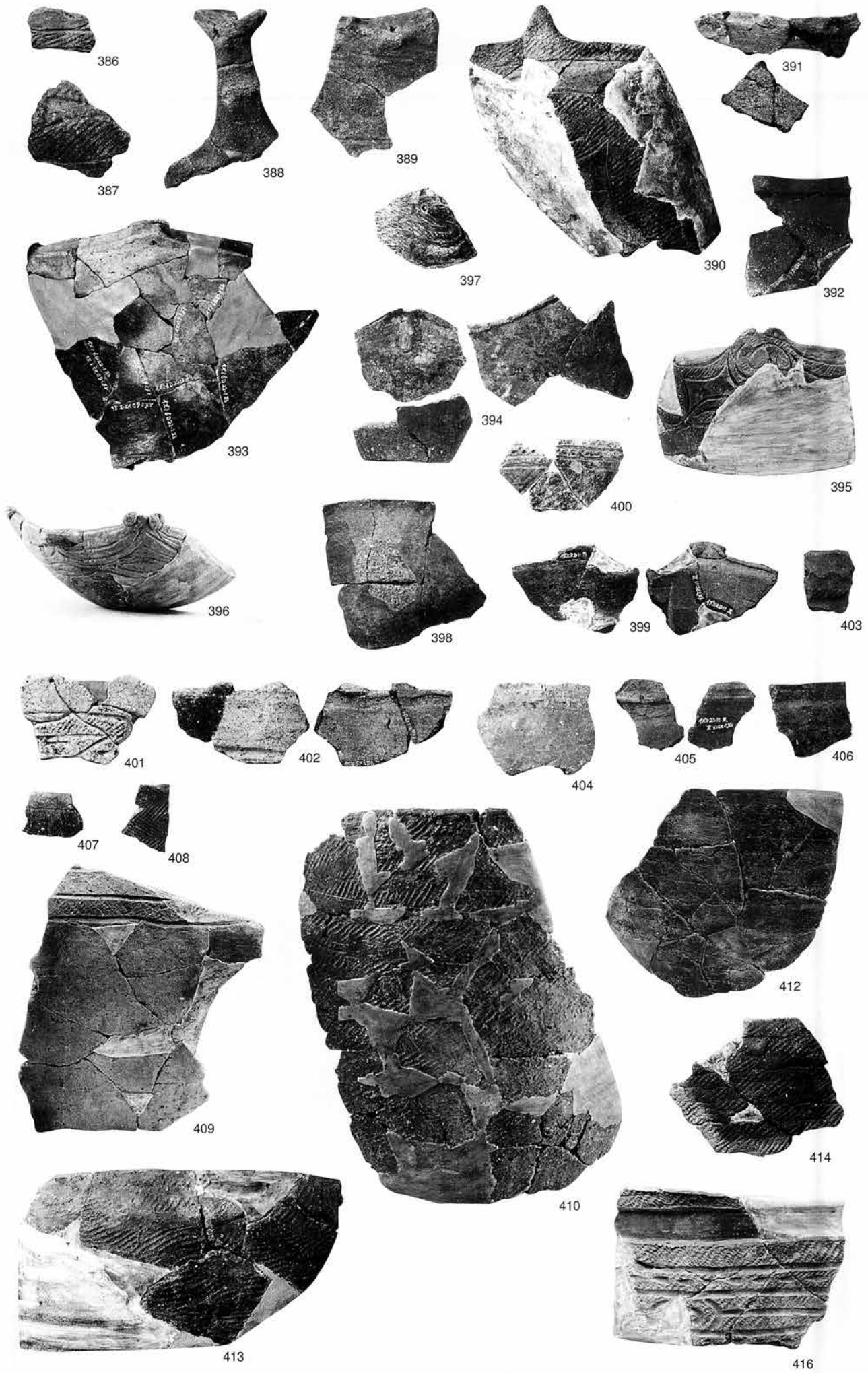

413

416

ブロック外
411・415
431
433~435
1:4

417~430
432
436~442
1:3



411



415



417



418



420



421



423



419



422



424



425



426



427



428



429



430



432



433



431

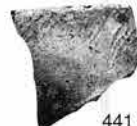

441

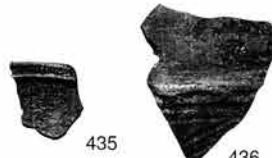

435



436



437

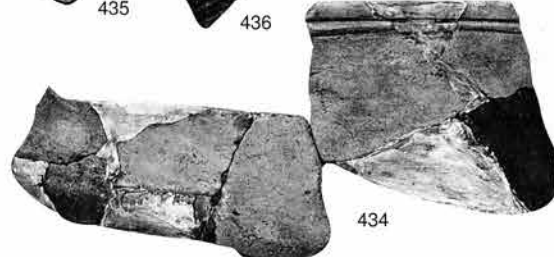

434



442



438



440



439



ブロック外
443~482
1:3



443

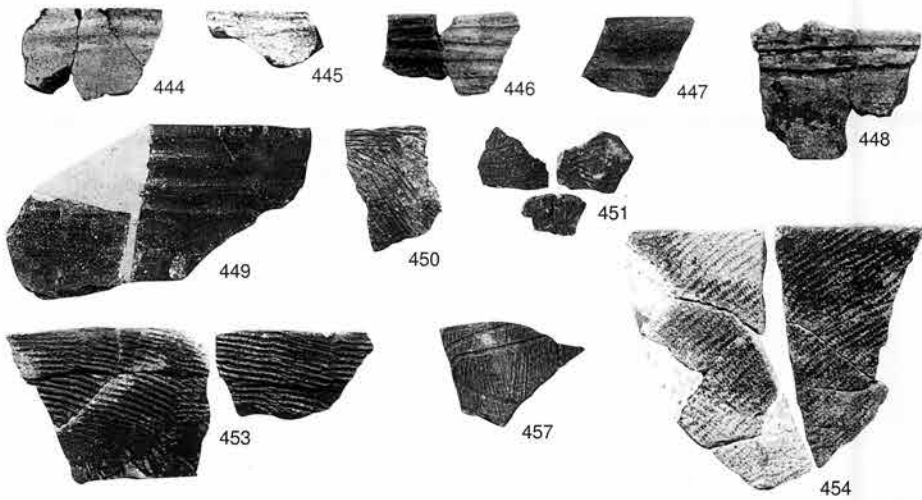

444 445 446 447 448
449 450 451
453 457 454

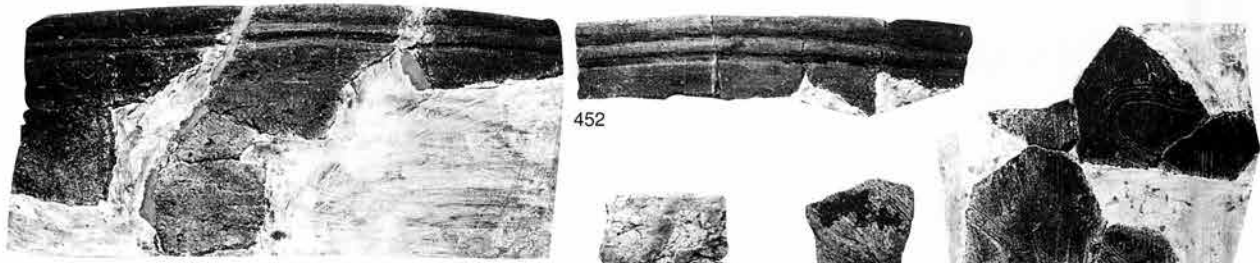

452



459 455 458 463 464



460 462 461 465 466



467 468 469 470 471 472 473 474 475



476a 476b 477a 477c 477b 478 479



480 481 482

上層 土製品

483~493

1:2

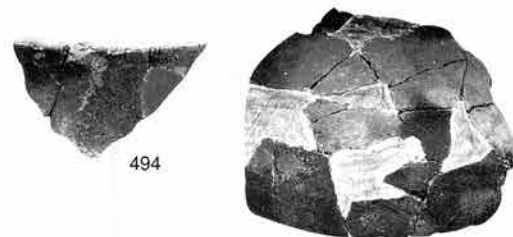

古墳時代
以降の遺物

494

497~523

1:3

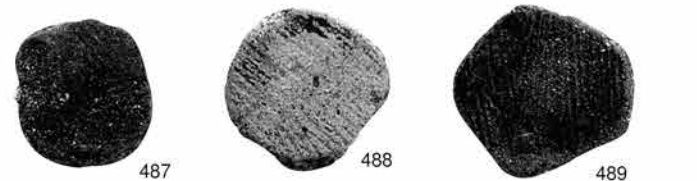

495・496

1:4

524

2:3

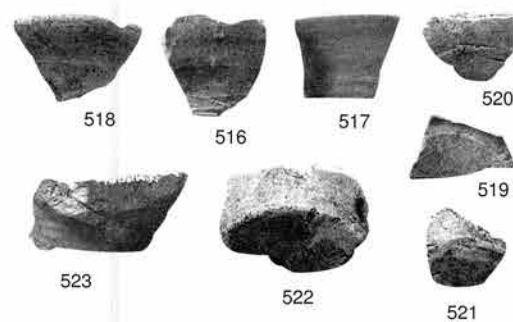
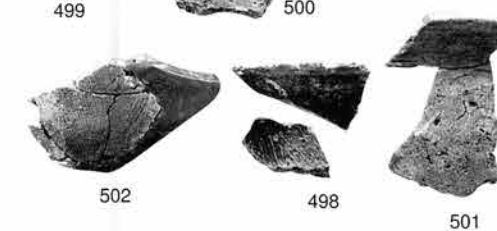
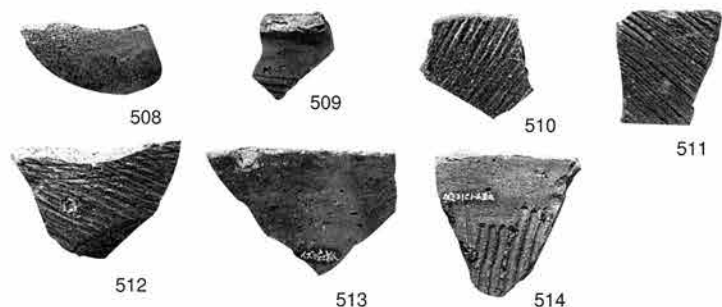

上層石製品

1~6

1:2

7~12

5:4

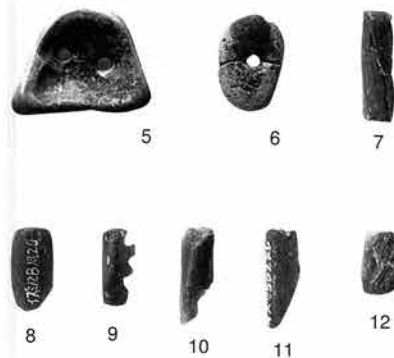



SK006
 楔形石器
 13~15

スクレイパー
 16~23

剥片
 24~26

微細剥離痕
 ある剥片
 27

石核
 28

打製石斧
 29
 1:2

SX124
 石鏃
 30~33

楔形石器
 34~42

スクレイパー
 43

微細剥離痕
 ある剥片
 44・45・47

剥片
 46
 48~51

石核
 52
 4:5

石鏃
53~84
86~125
4:5

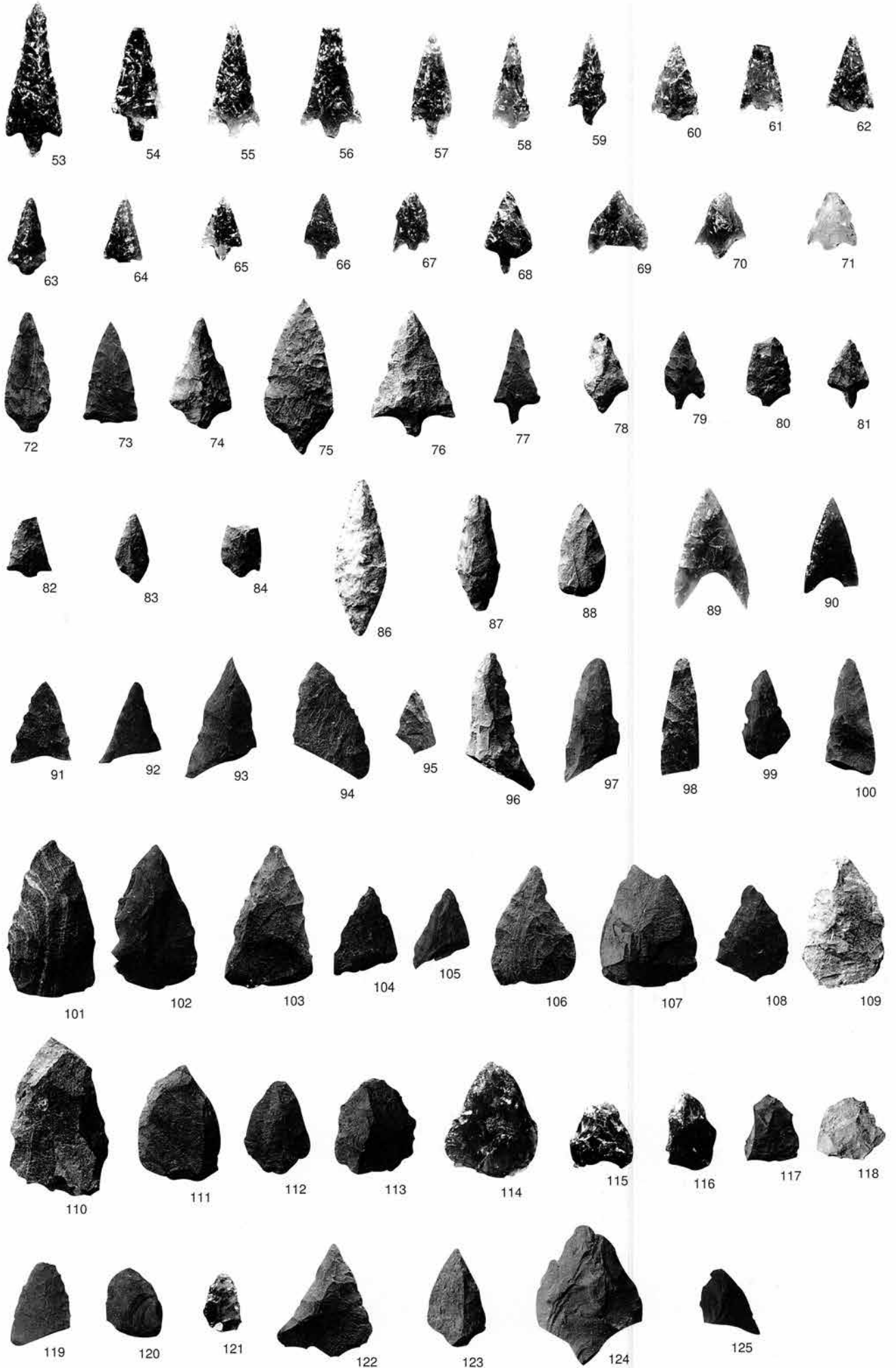

石錐
126~133
楔形石器
134~181
4:5

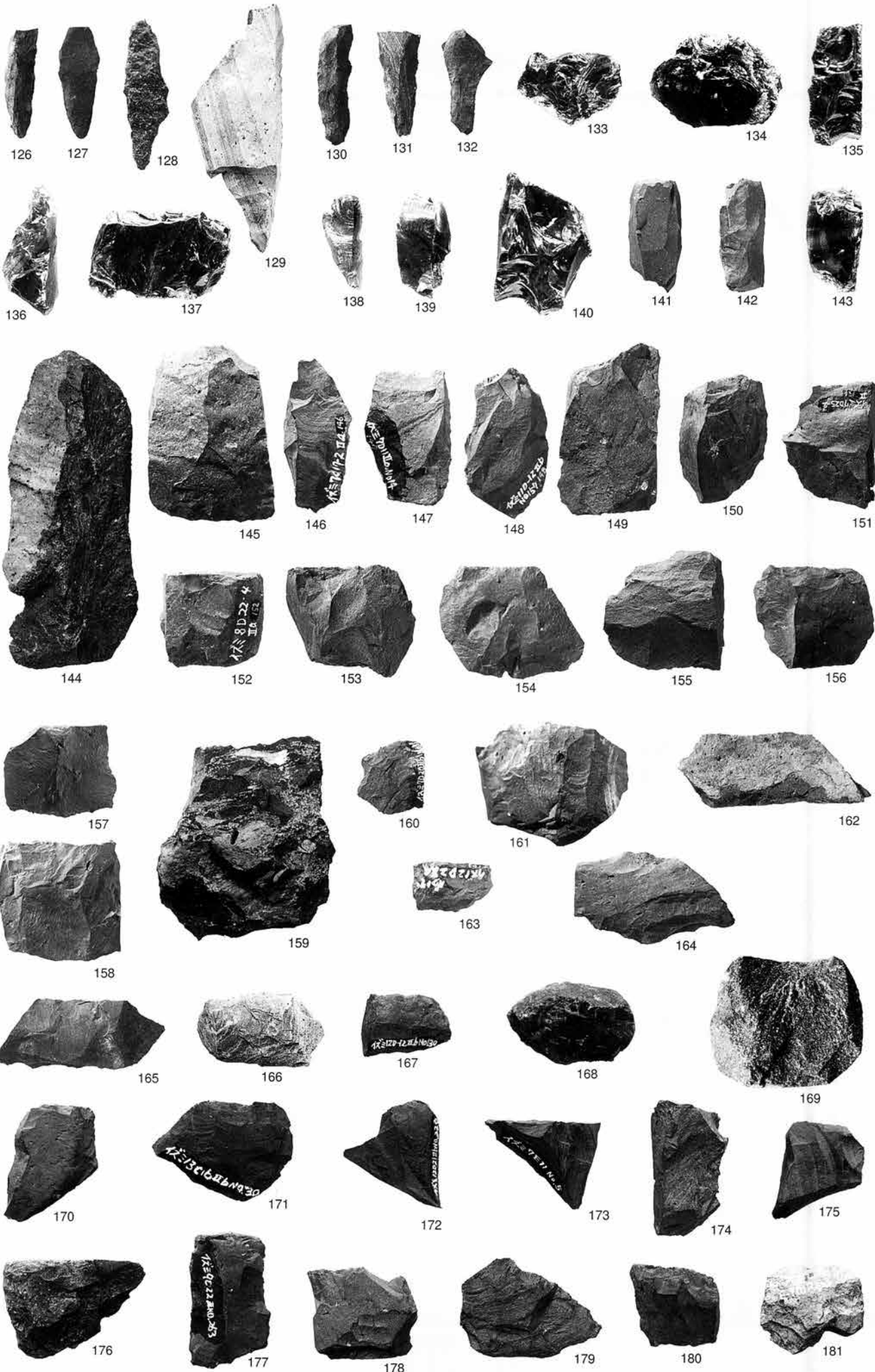

打製石斧
182~200

磨製石斧
201~212
1:2



182



183



184



185



186



187



188



189



190



191



192



193



194



195



196



197



198



199



200



201



202



203



204



205



206



207



208



209



210



211



212

磨製石斧
213~219

スクレイパー
220~248
1:2

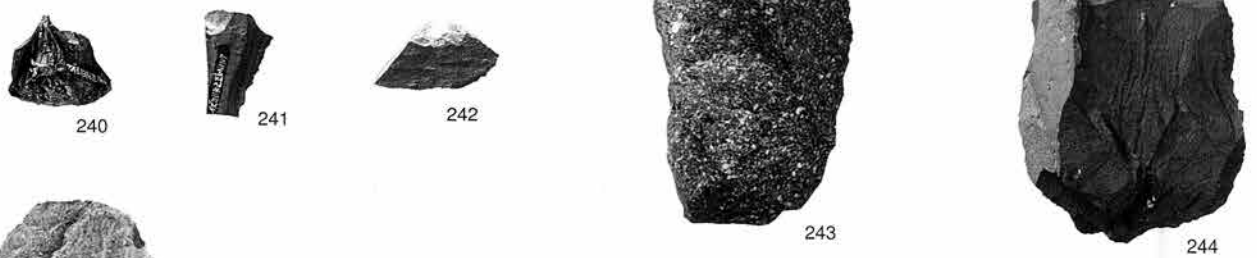
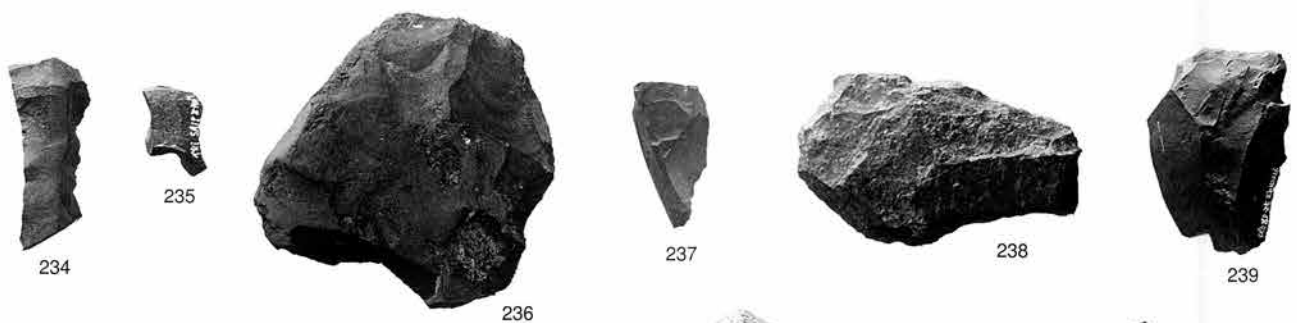
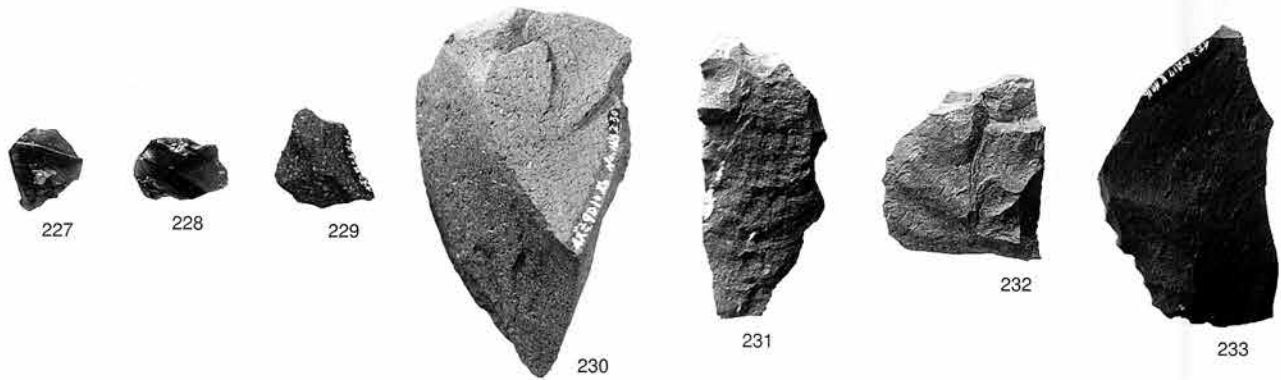
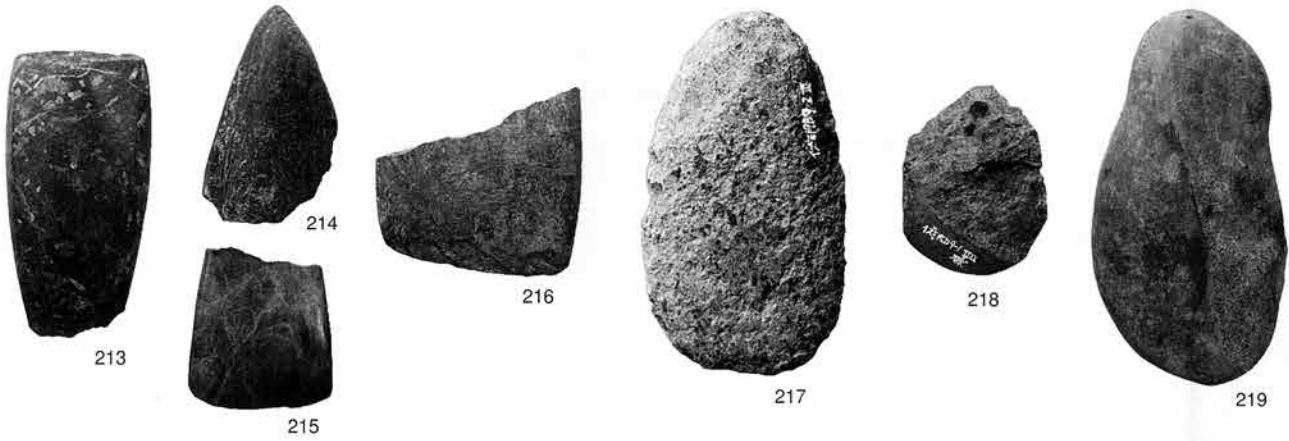

両面調整石器

249~265
267
269~276

スクレイパー

266・268

微細剥離痕
ある剥片

277~284
289

剥片

285~288
290・291
1:2

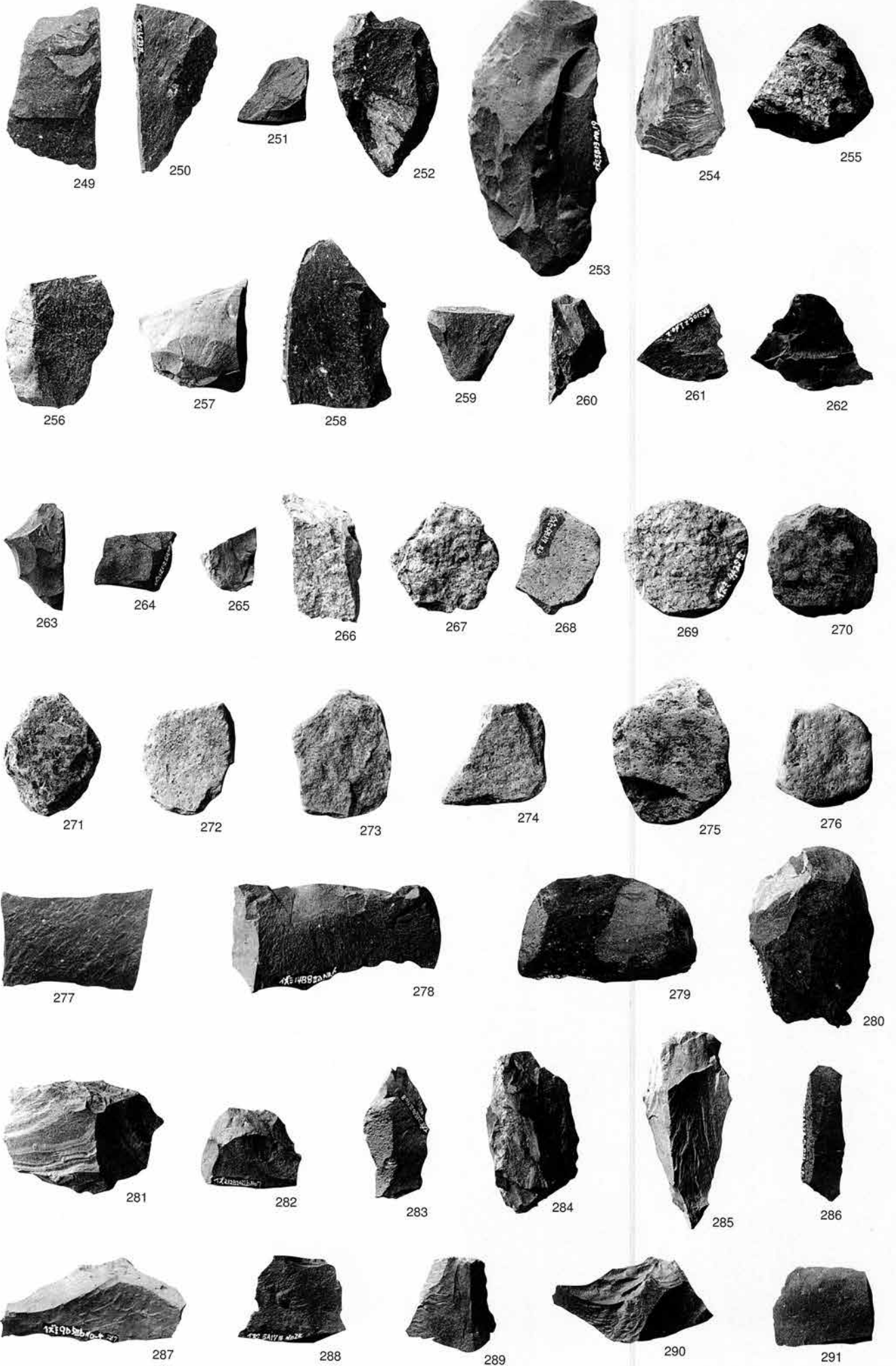

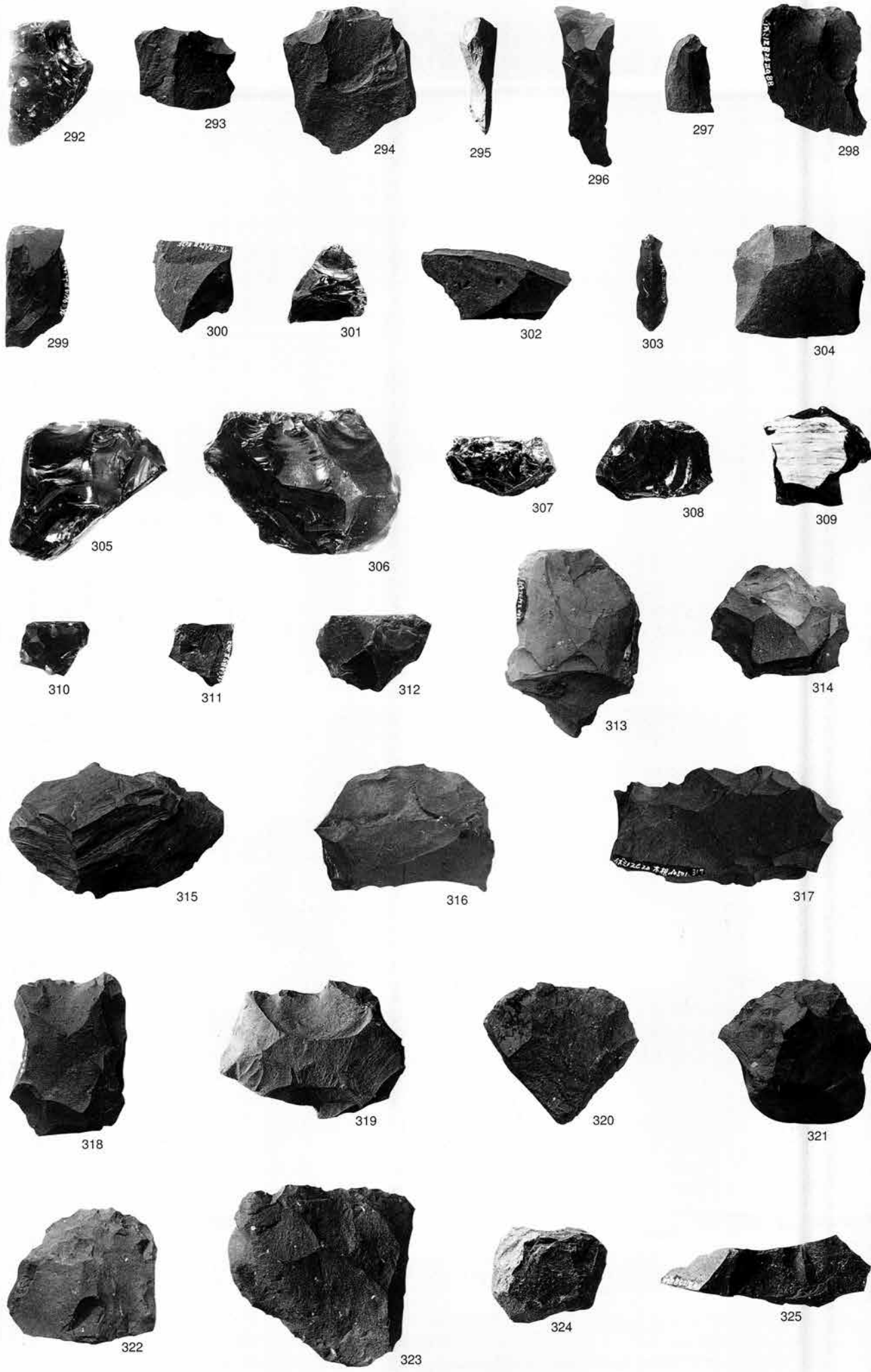

剥片
292~296
298~301
303

微細剥離痕
ある剥片
297・302
304

石核
305~325
1:2

石核
326~339
1:2



326



327



328



329



330



331



332



333

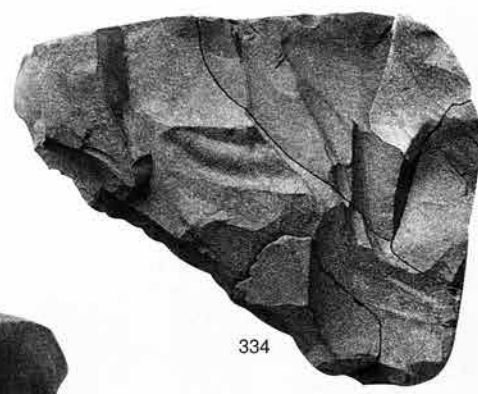

334



334a



334b



335



336



334c



334d



334e



337



338



339

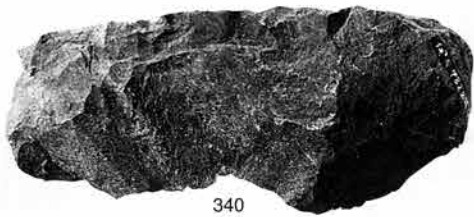

340



341



342



343

石核類
340~343
346

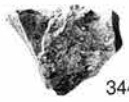

344



345



346



341+342+343

楔形石器
344・345
1:2



355



356



357



358



359



360



361



362

磨石類
355~387

石皿
388
石鏃形石器
389



363



364



365



366



367



368



369



370



371

砥石
390~397
1:4



372



373



374



375



376



377



378



379



380



381



382



383



384



385



386



387



388



389



390



391



392



393



394



395



396



397



1



2

1 下層完掘状況(北上から)
2 土層断面(9ラインF.G.H)(北から)



1 SI117 調査状況 (東から)

3 SI117 遺物出土状況 (2層) (東から)

5 SI117 土層断面 (東から)

2 SI117 土層断面 (東から)

4 SI117 土層断面 (南から)

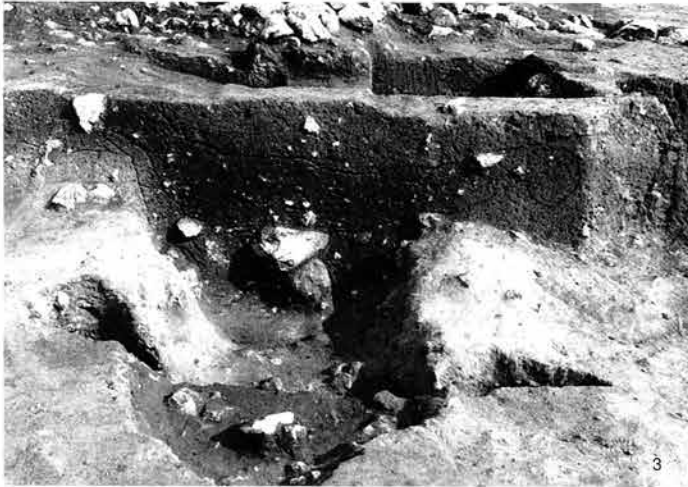
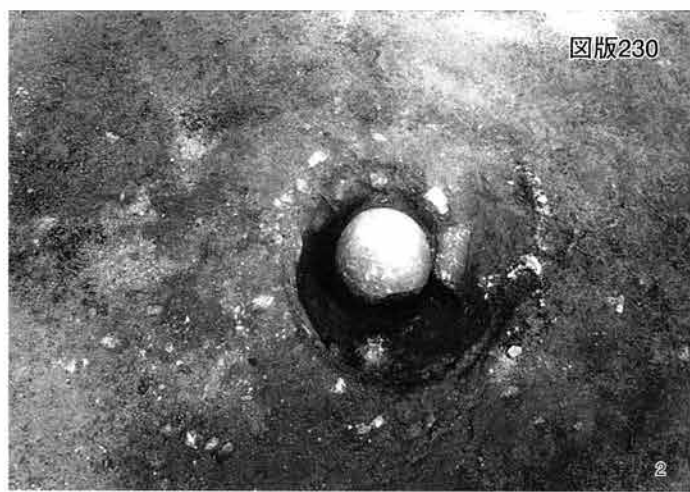

1 SI117 一括土器出土状況(5C20の「リット」)(東から)
 3 SI117-SK1 半截状況(北から)
 5 SI117-P2 半截状況(南東から)
 7 SI117-P41 半截状況(東から)

2 SI117-P7 磨石類出土状況(東から)
 4 SI117-SK1・P2・P3・P4 完掘状況(北から)
 6 SI117-P2・P3・P4 完掘状況(南東から)
 8 SI117-P47 半截状況(南西から)

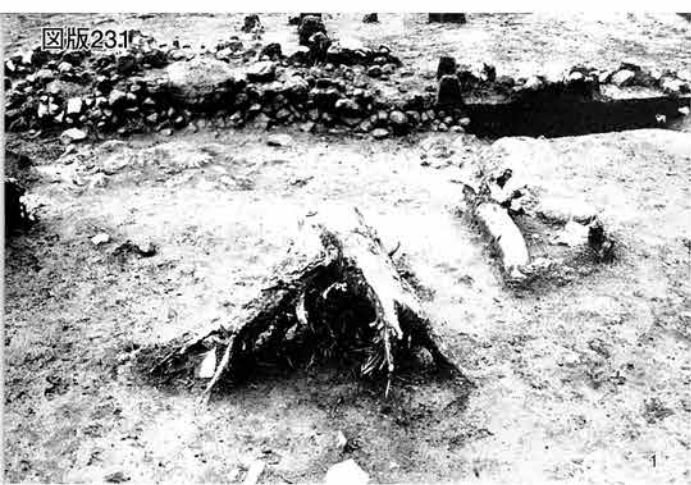

1 SI117 東側周堤検出状況（上層調査時）（南から）

3 SI117 東側周堤遺物出土状況（東から）

5 SI117 調査風景・完掘状況（南東から）

2 SI117 東側周堤土層断面（北から）

4 SI117 東側周堤B'層礫出土状況（北東から）

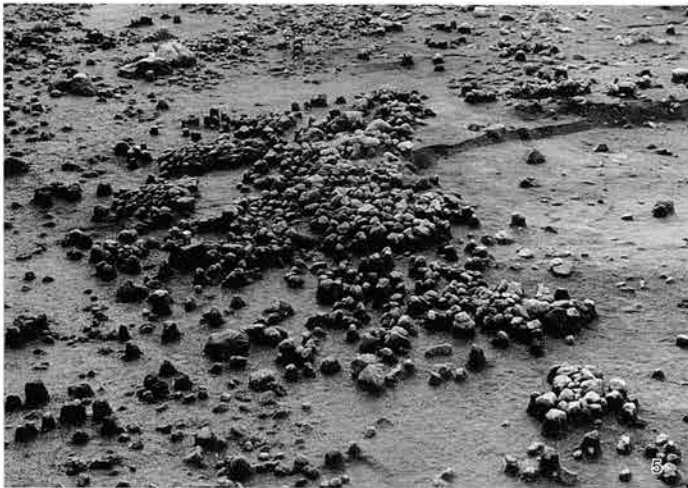
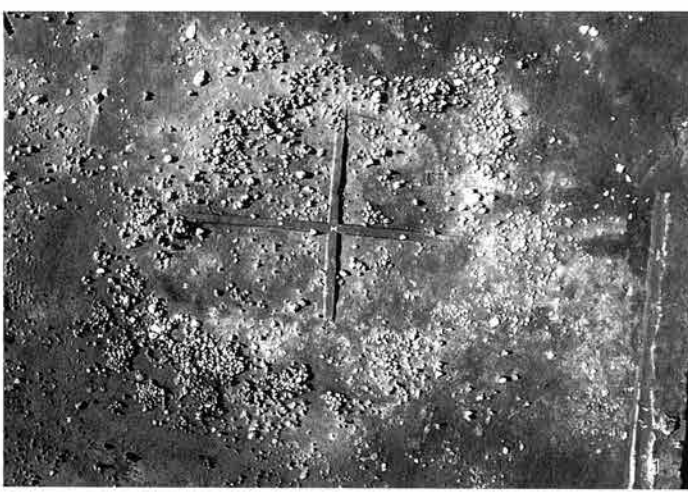

1 SI120 検出状況 (真上から)
 3 SI120 床面検出状況 (南東から)
 5 SI120 西側周堤礫出土状況 (東から)
 7 SI120 調査状況 (西上から)

2 SI120 土層断面 (南から)
 4 SI120 土層断面 (東から)
 6 SI120 調査状況 (西から)
 8 SI120 調査状況 (南上から)

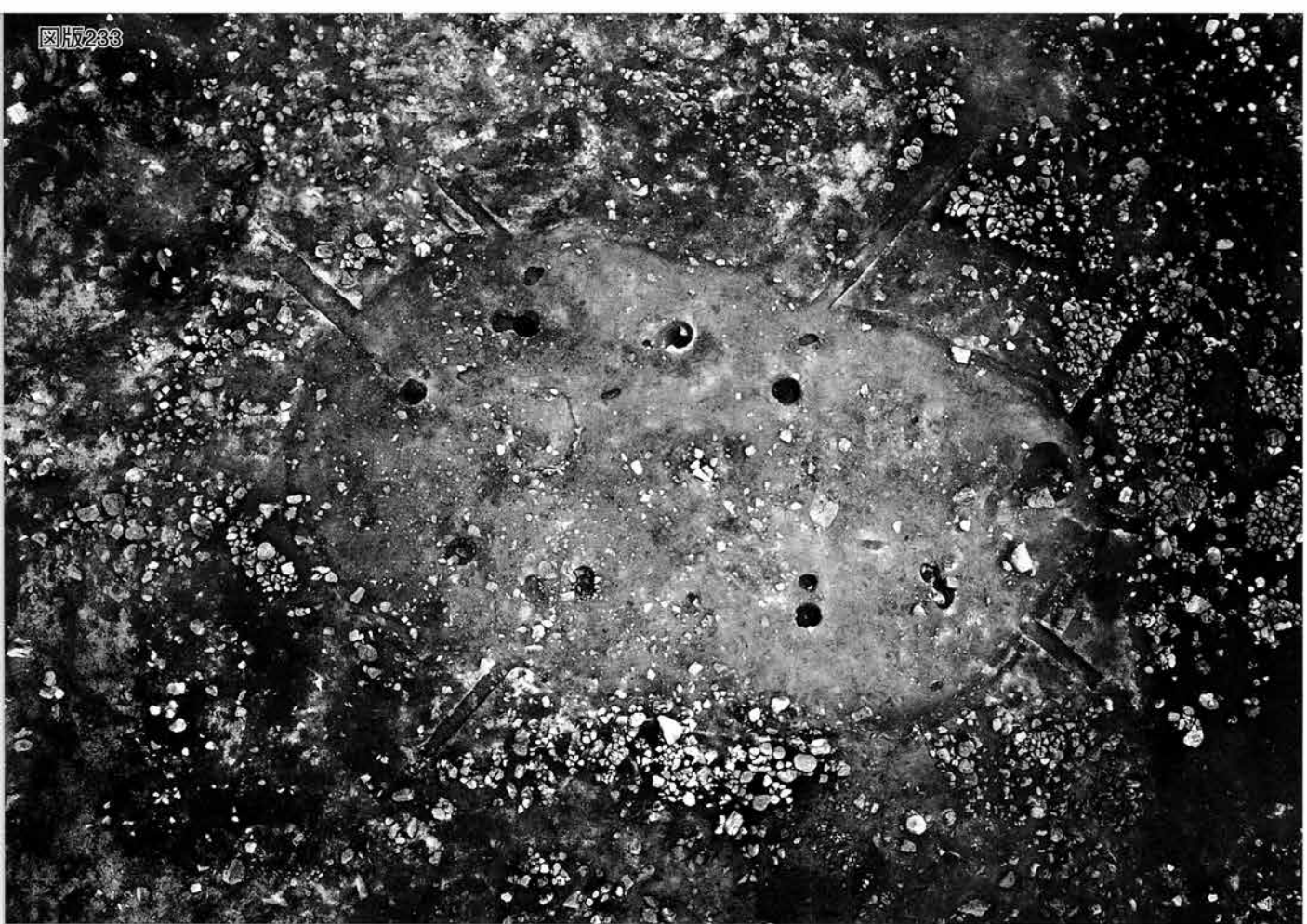

1 SI120 調査状況 (真上から)
 2 SI120-SK23 半截状況 (南から)
 4 SI120-P13・P14 半截状況 (南から)

3 SI120-SK23 完掘状況 (南から)
 5 SI120 遺物出土状況 (7G17'リット) (北から)



1 SI120-周堤・P39土層断面 (北から)
3 SI120-周堤・P46土層断面 (南から)
5 SI120 完掘状況 (南から)

2 SI120-周堤礫出土状況 (南から)
4 SI120-垂木尻ビット (P24~31) 完掘状況 (南西から)

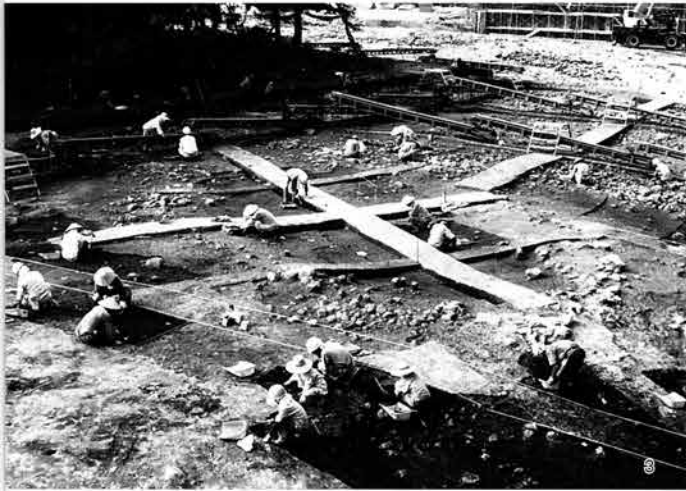

1 SI403 検出状況 (IV層が小判形に残る) (南から)
 3 SI403 調査風景 (南から)
 5 SI403 完掘状況 (南から)

2 SI403 調査風景 (IV層掘り下げ) (南から)
 4 SI403 礎出土状況 (南から)



1 SI403 土層断面 (周堤A①・B'層) 南から
 3 SI403 土層断面 (4a・4b・4c・5c③層ほか) (南から)

2 SI403 土層断面 (3a・3b・5c①・5c③層ほか) (南から)
 4 SI403 土層断面 (5c⑤・周堤A⑤層ほか) (南から)

5 SI403 土層断面 (南から)

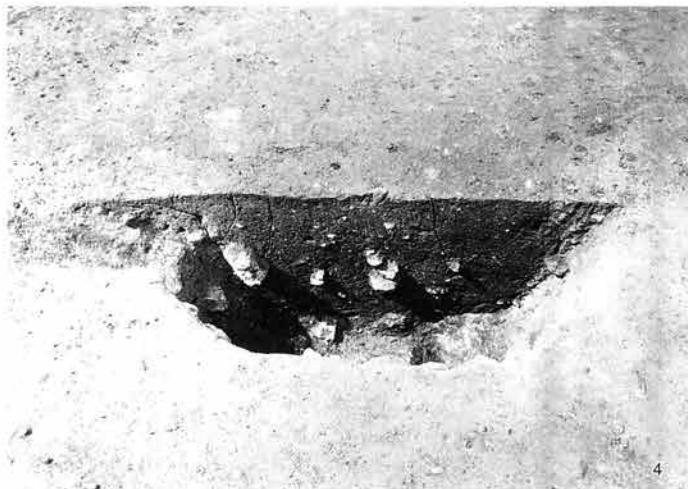

1 SI403 土層断面 (5c④・5d・周堤A④・B層、P80) (北東から)

3 SI403-SK10 半截状況 (北東から)

5 SI403-P6 半截状況 (西から)

7 SI403 周堤遺物出土状況 (北から)

2 SI403 炭化物出土状況 (西から)

4 SI403-P1 半截状況 (北東から)

6 SI403-P14 半截状況 (南東から)

8 SI403 周堤下遺物出土状況 (土器No.71) (東から)



1 SI403 周堤A⑤'層礫出土状況(東から)
3 SI403-P50 土層断面(東から)
5 SI403 完掘状況(南西から)

2 SI403 垂木灰ピット検出状況(南西から)
4 SI403 南側垂木灰ピット(P53~59)完掘状況

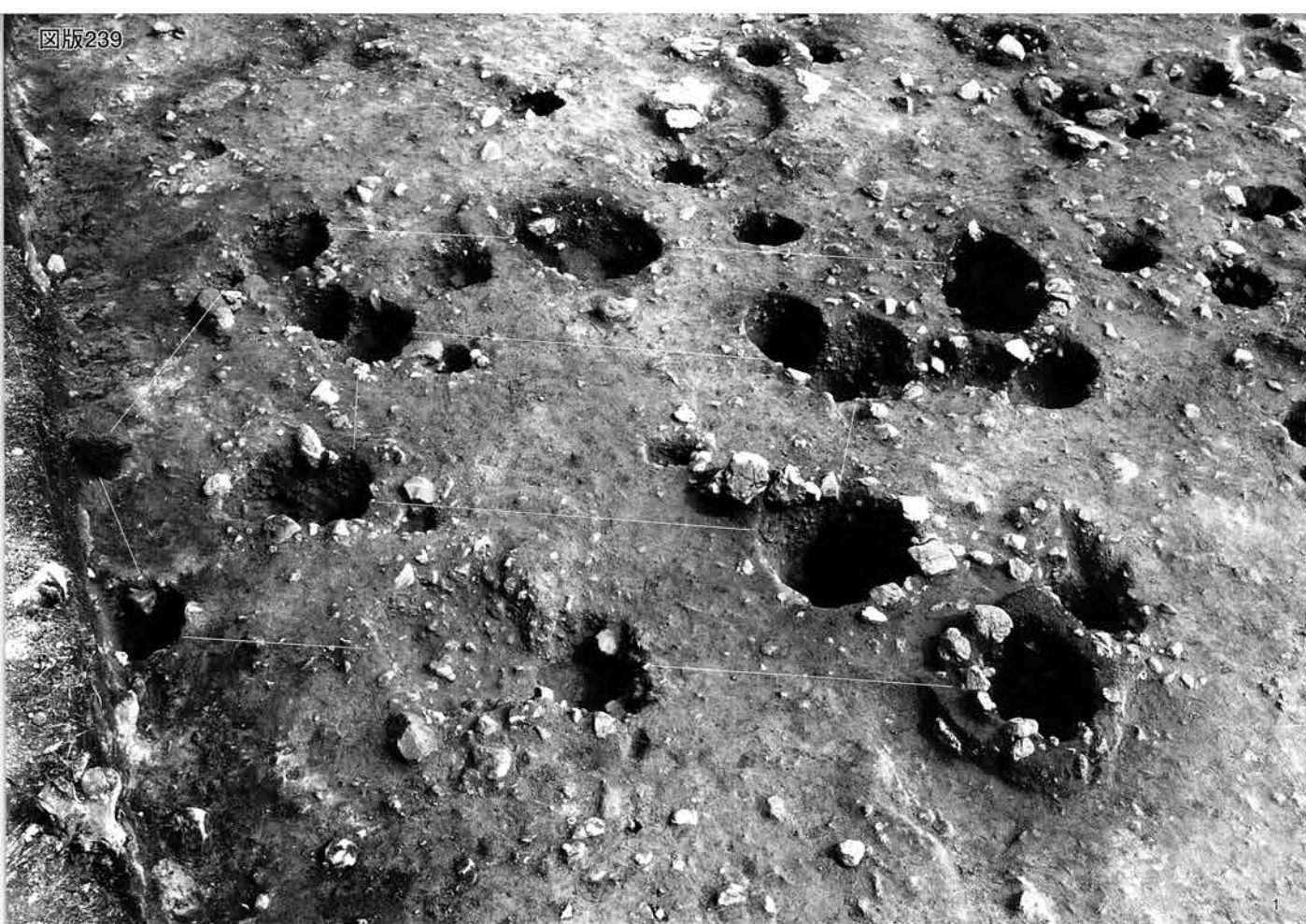

1 SB6 完掘状況 (南から)
 2 SB6-P658 半截状況 (東から)
 4 SB7・SB8 完掘状況 (南西から) (破線がSB8)

3 SB6-P369 半截状況 (東から)
 5 SB8-P152 半截状況 (南西から)

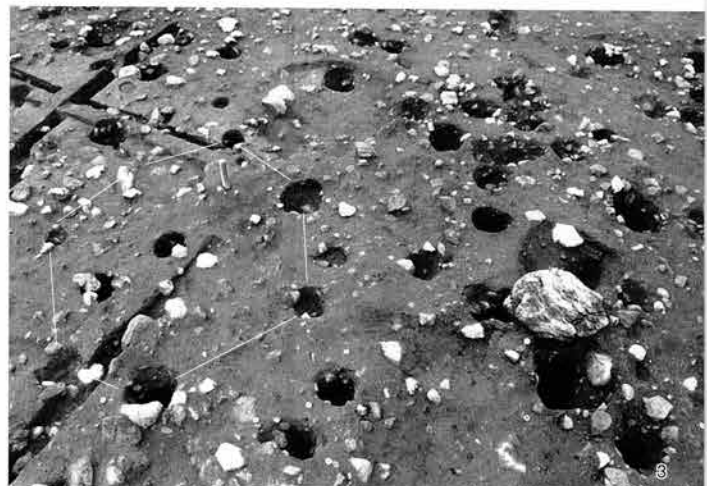

1 SB10 完掘状況 (南西から)
2 SB9 完掘状況 (南西から)
4 SB12 完掘状況 (南西から)

3 SB11 完掘状況 (南西から)
5 SB12-P310 半截状況 (西から)



1 SB13 完掘状況 (南西から)
 3 SB16 完掘状況 (北東から)
 5 SB17 完掘状況 (真上から)

2 SB14・SB15 完掘状況 (南西から) (破線がSB14)
 4 SB18 完掘状況 (南から)

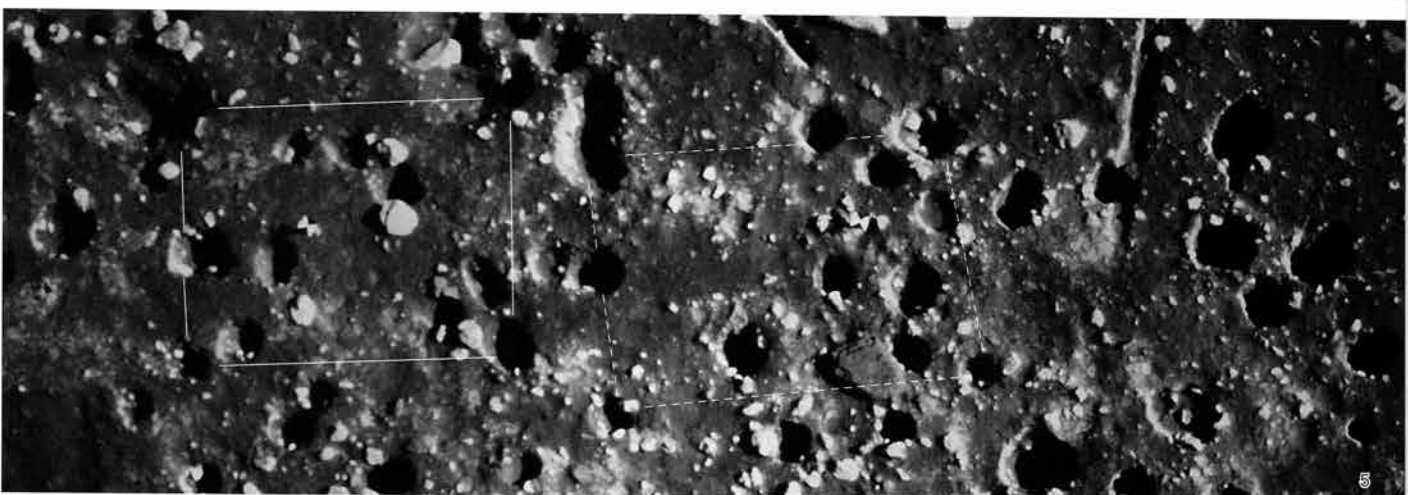

- 1 SB19 完掘状況 (東から)
- 2 SB19-P122 半截状況 (南から)
- 3 SB20 完掘状況 (北から)
- 4 SB20-P338AB 半截状況 (南から)
- 5 SB21・SB22 完掘状況 (真上から) (破線がSB22)
- 6 SB21-P343 半截状況 (北東から)
- 7 SB22-P794 半截状況 (西から)

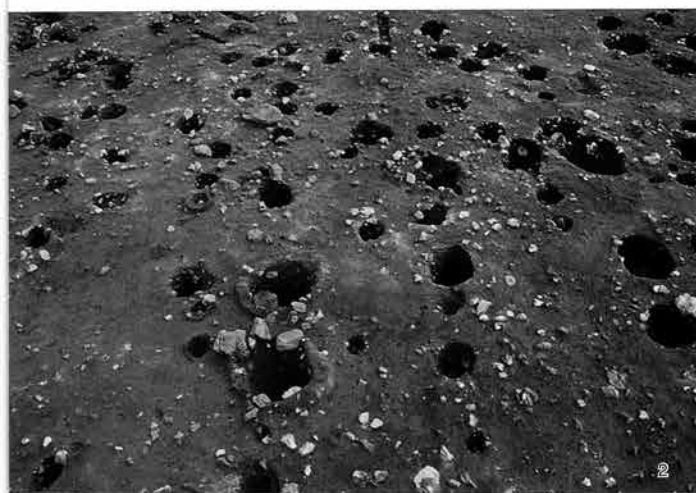
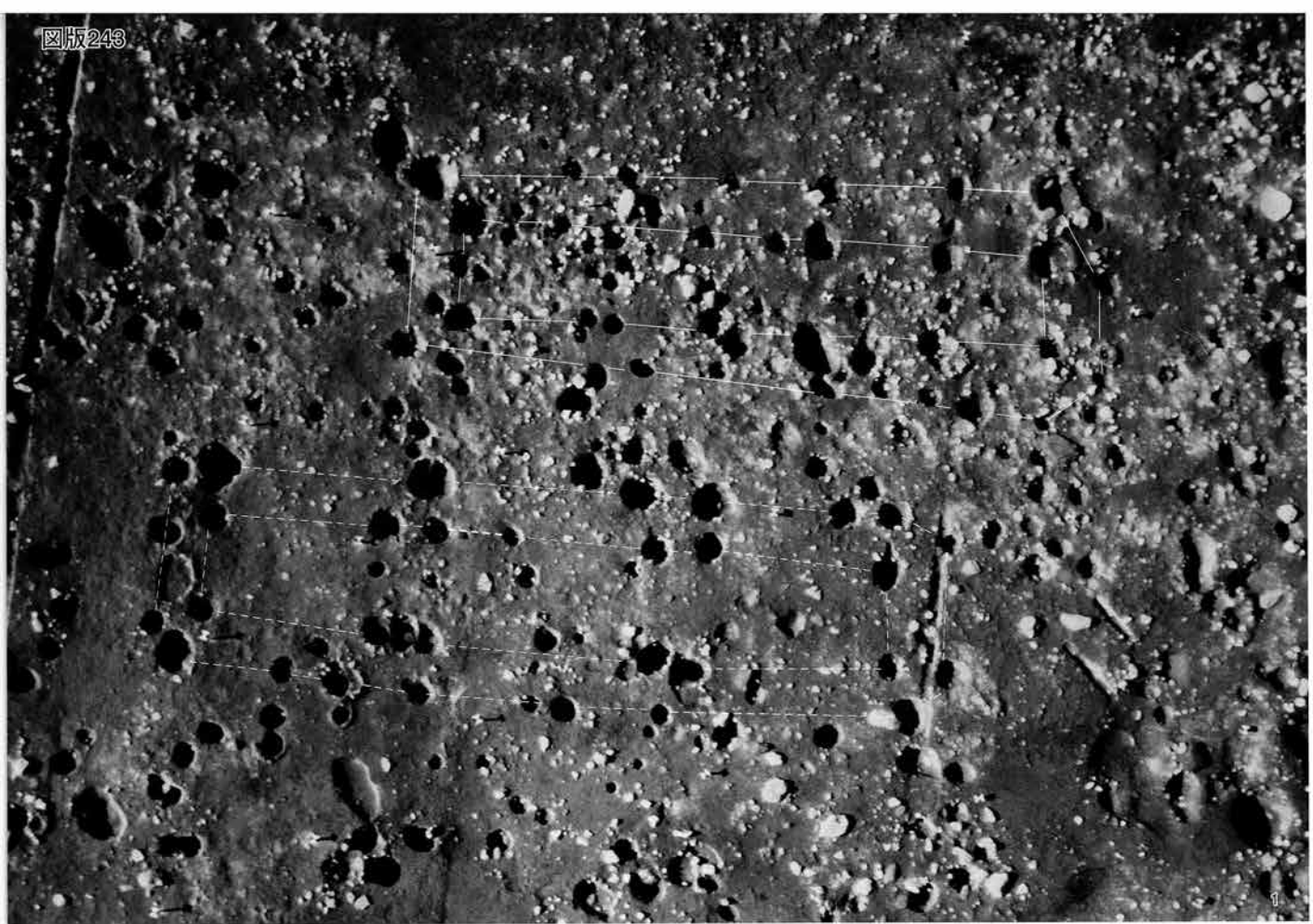

1 SB23・SB24 完掘状況(真上から)(破線がSB24)
 2 SB23 完掘状況(西から)
 4 SB23-P752 上部半截状況(南東から)

3 SB23 完掘状況(東から)
 5 SB23-P752・P753 礫出土状況(南から)

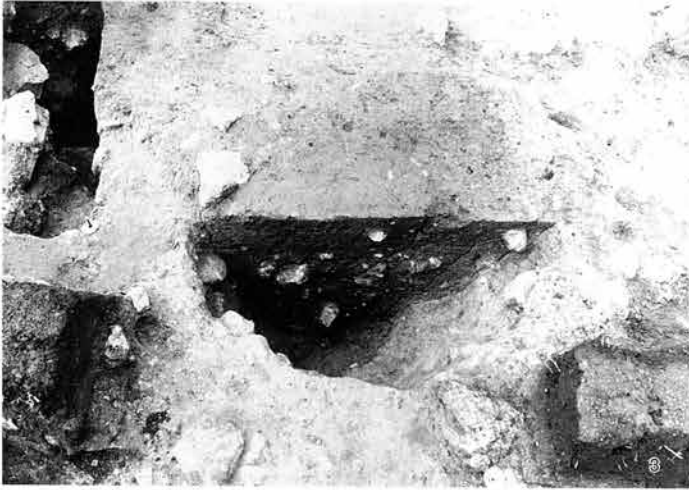

1 SB23-P753 完掘状況(東から)
3 SB23-P943 半截状況(東から)
5 SB24-P963 半截状況(南から)
7 SB24-P968 完掘状況(東から)

2 SB23-P927 半截状況(東から)
4 SB24-P889B 半截状況(南から)
6 SB24-P976 半截状況(南から)
8 SB24-P960・P977・P959完掘状況(東から)

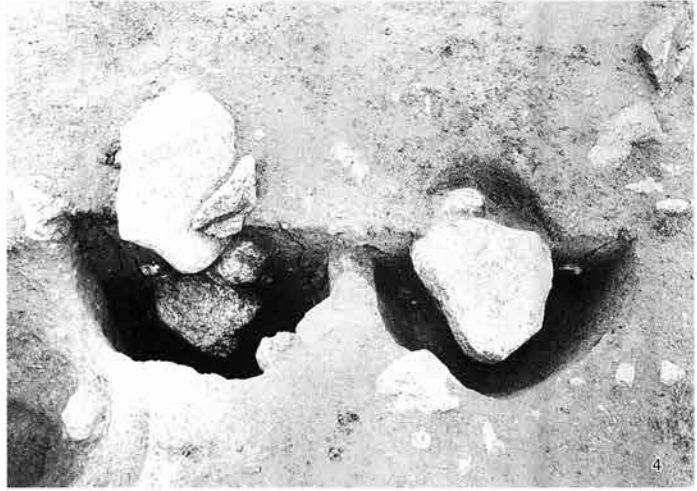
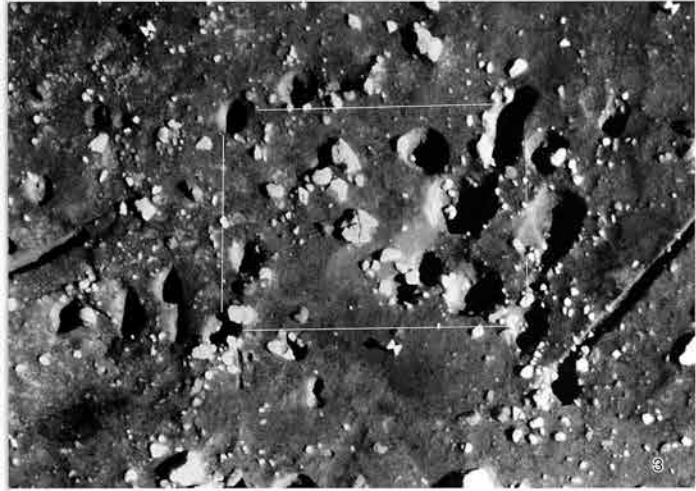

1 SB25 完掘状況(東から)
 3 SB26 完掘状況(真上から)
 5 SB24・SB27 完掘状況(東から)(破線がSB24)

2 SB25-P888 半截状況(東から)
 4 SB27-P591・P592 半截状況(西から)

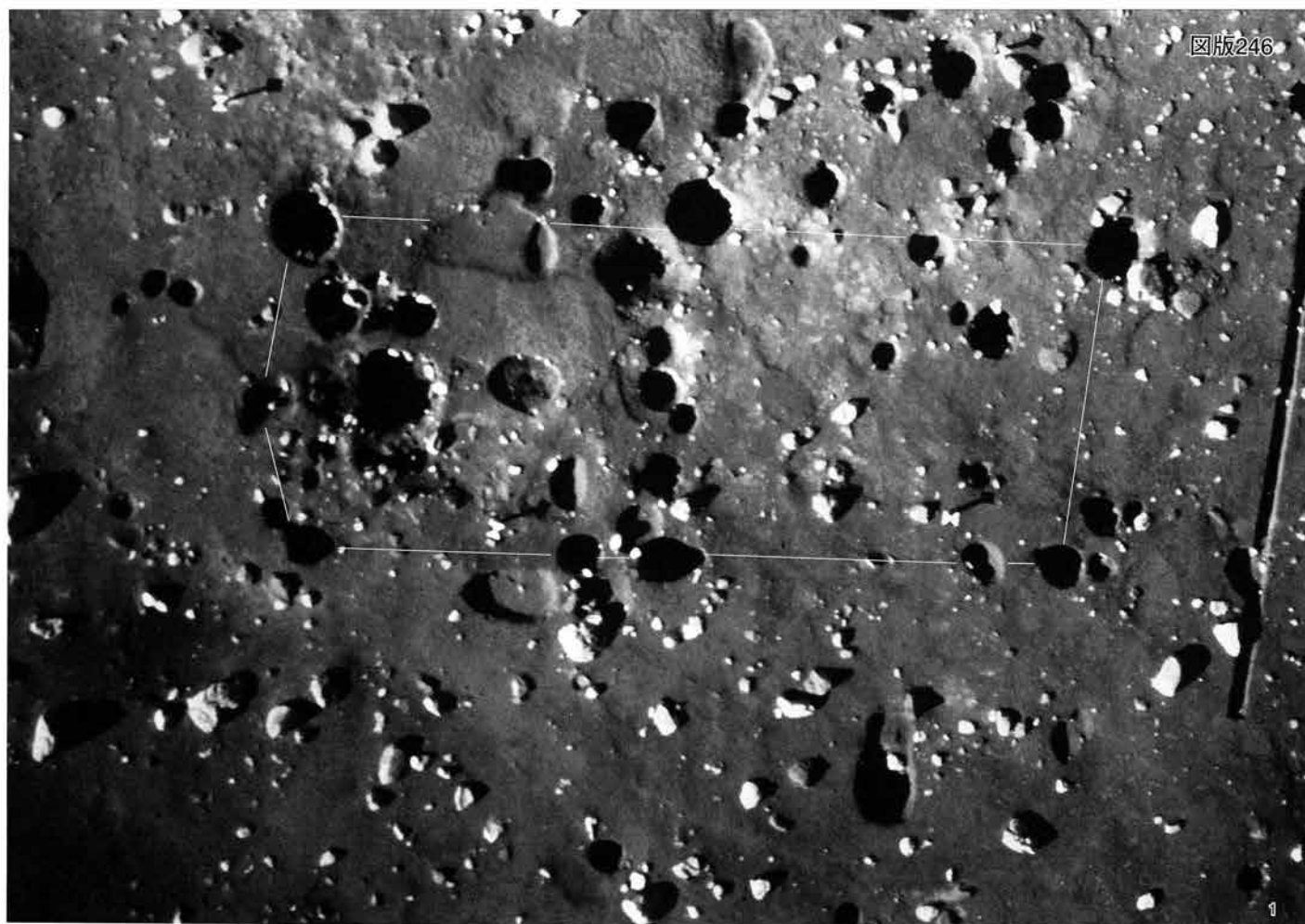

1 SB28 完掘状況(真上から)
2 SB29・SA1 完掘状況(北から)

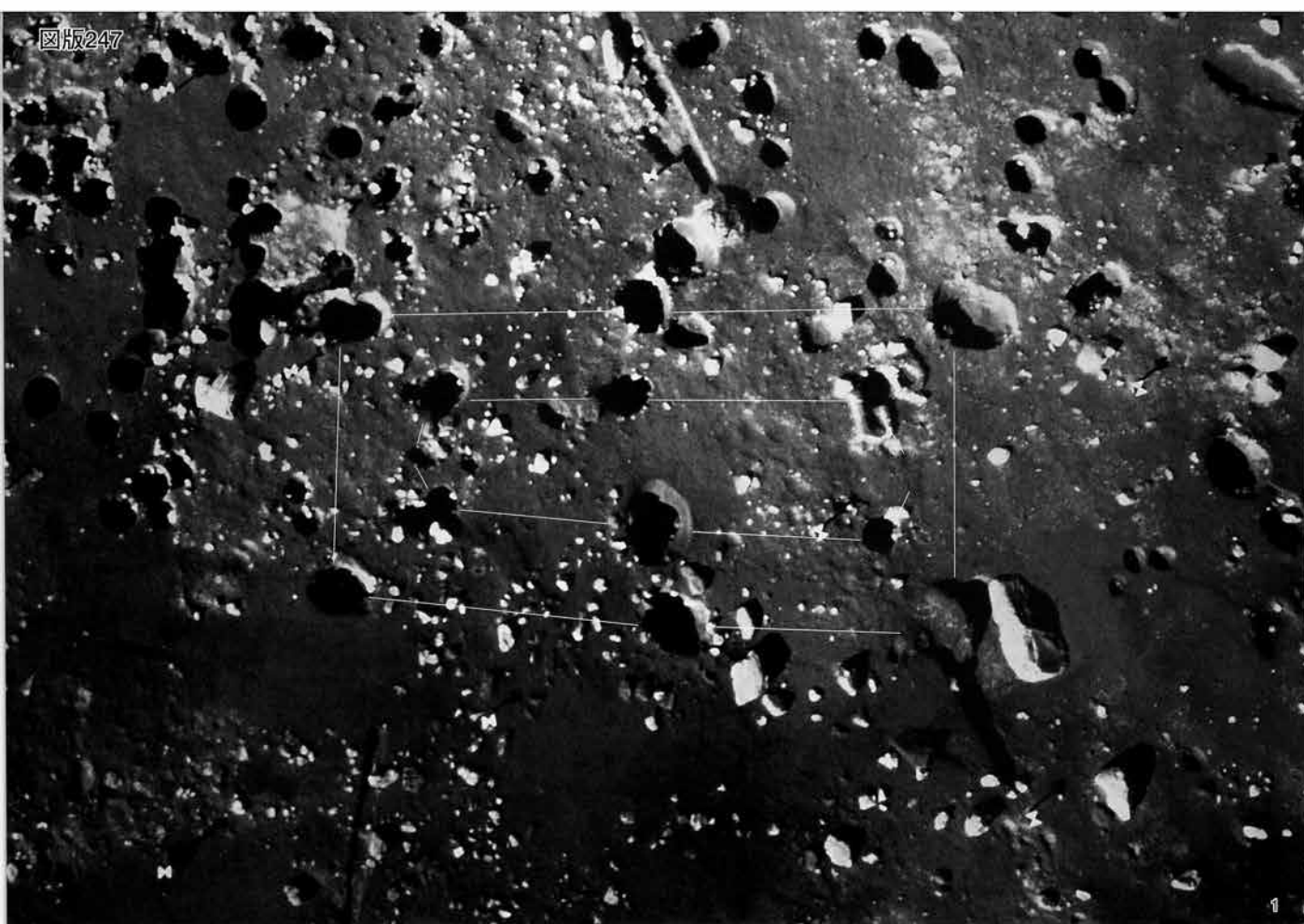

1



2



3



4



5

1 SB31 完掘状況 (真上から)
 2 SB31-P450 半截状況 (南西から)
 4 SB31-P452 半截状況 (南東から)

3 SB31-P451 半截状況 (南東から)
 5 SB30 完掘状況 (南東から)



1 SB32 完掘状況 (南東から)

2 SB32-P971 礫出土状況 (南から)

4 SB32-P974 半截状況 (東から)

3 SB32-P973 半截状況 (東から)

5 SB32-P1061 半截状況 (南から)

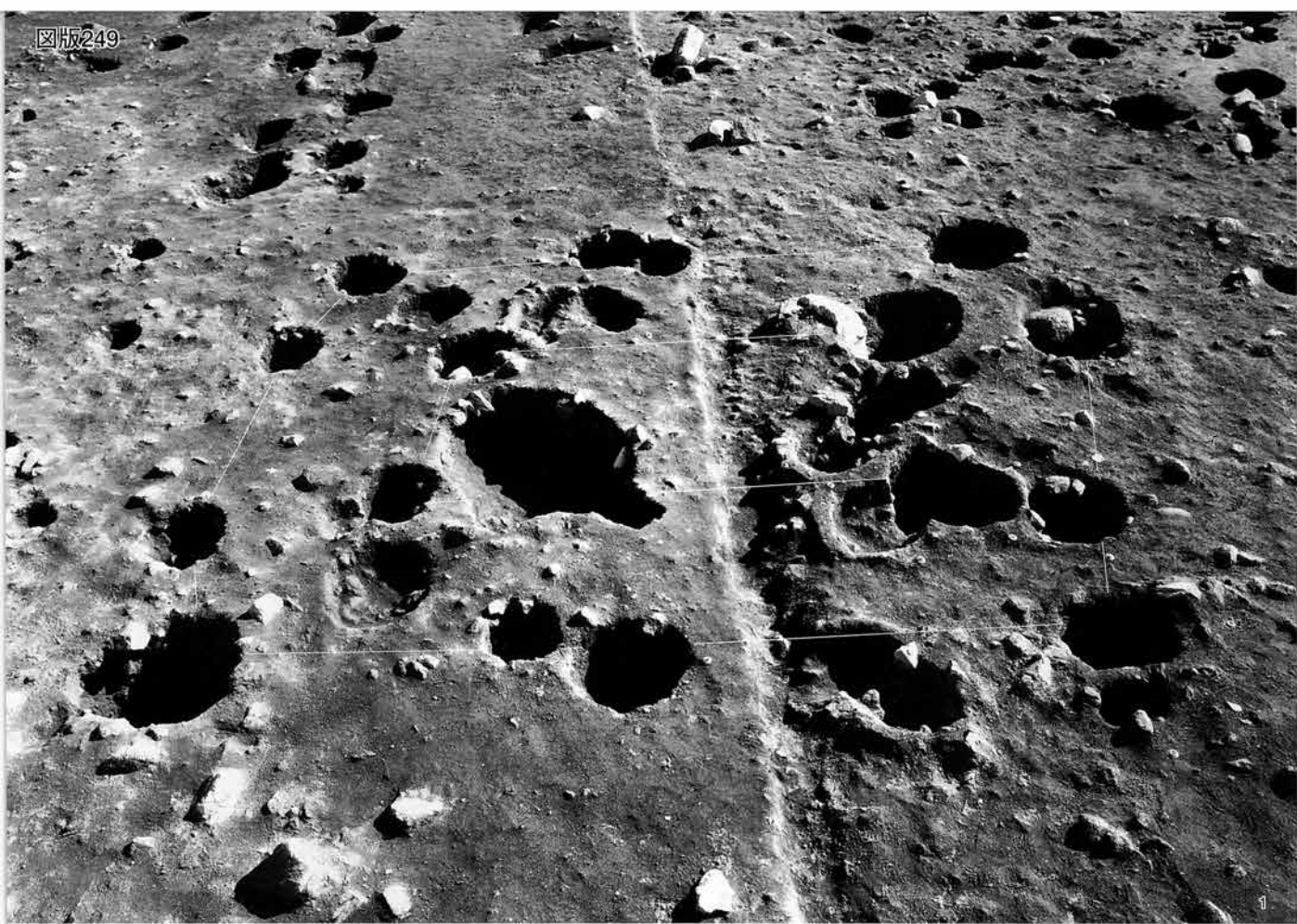

1



2



3



4



5

1 SB33 完掘状況 (北西から)
 2 SB33-P918 半掘状況 (西から)
 4 SB33-P944 半掘状況 (南から)

3 SB33-P926 半掘状況 (南西から)
 5 SB33-P1026 半掘状況 (南から)



1



2



3



4



5

1 SB34・SB35 完掘状況(南から)(破線がSB35)
2 SB34-P1001・P1002 半截状況(西から)
4 SB36 完掘状況(南から)

3 SB34-P1067付近 VI層中炭化木出土状況(南東から)
5 SB36-P1297 半截状況(北から)

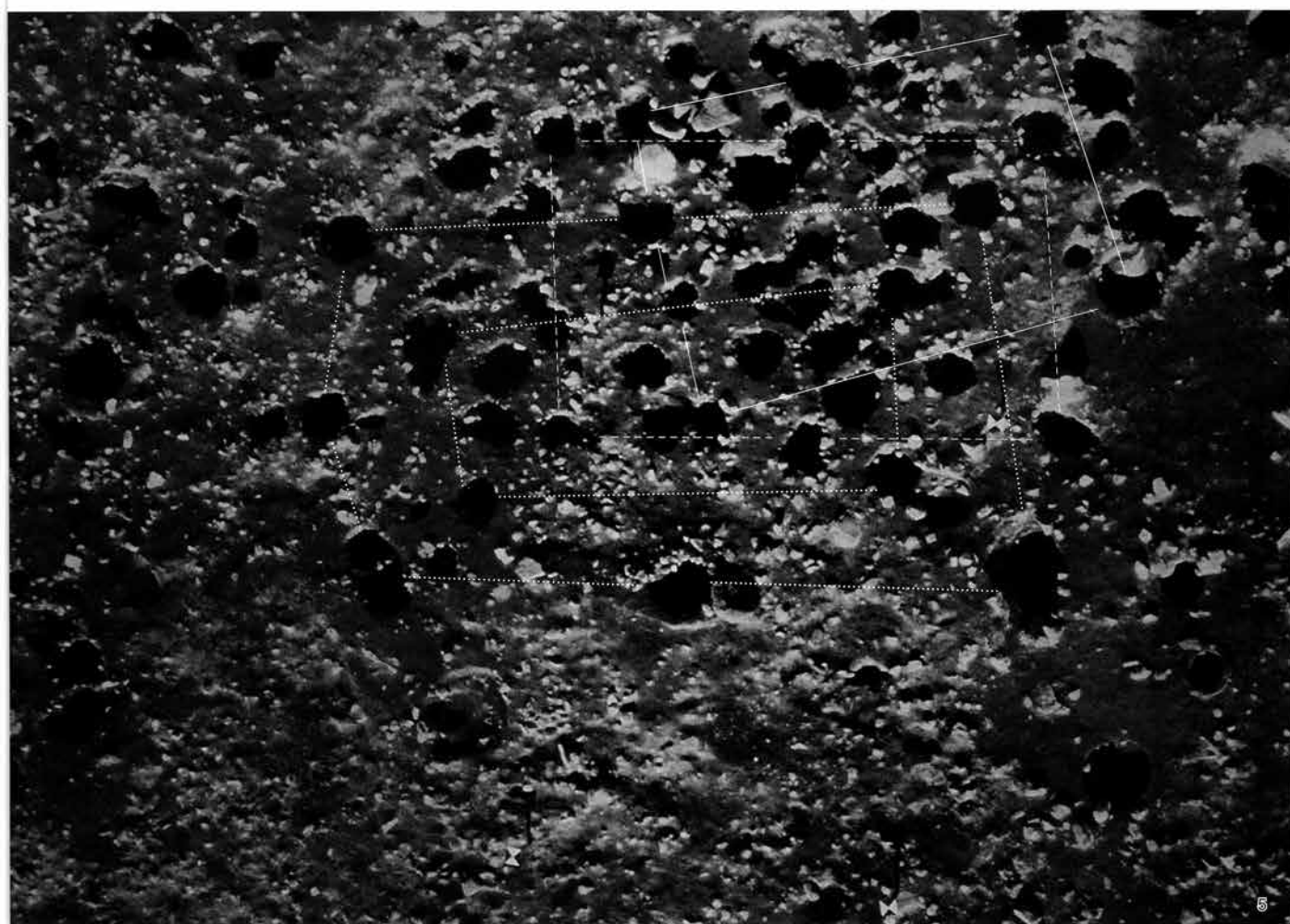
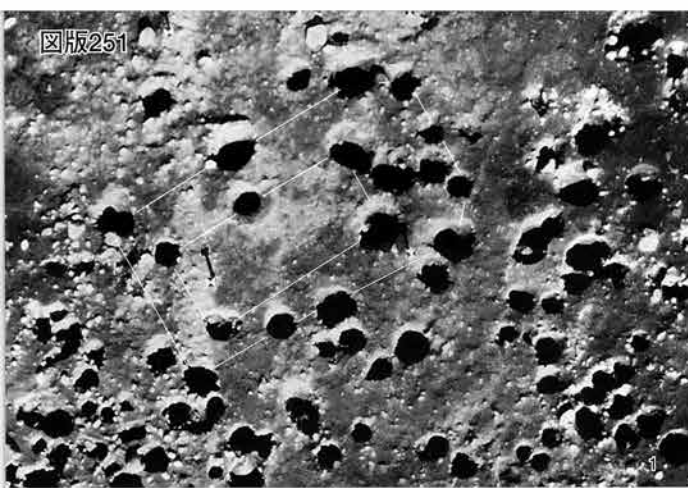

1 SB37 完掘状況 (真上から)
 3 SB38-P1319BC 半截状況 (東から)
 5 SB38・SB39・SB40 完掘状況 (真上から)
 (破線がSB39、点線がSB40)

2 SB37-P1230 半截状況 (西から)
 4 SB39-P1258 半截状況 (北から)

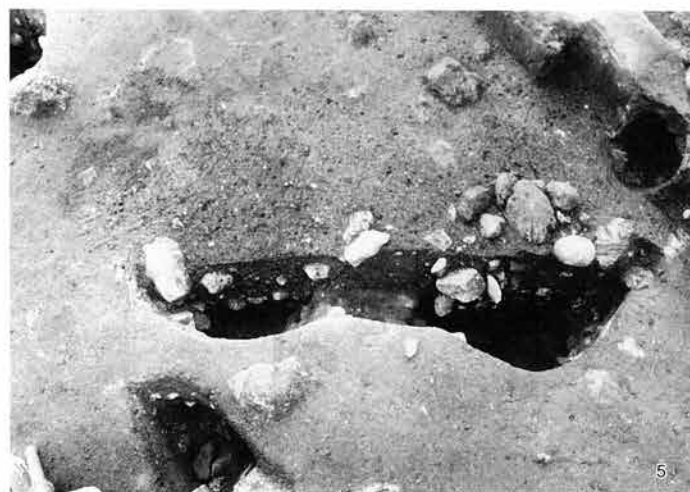

1 SB41・SB42 完掘状況(北から)(破線がSB42)
2 SB41-P1151 半截状況(南西から)

3 SB42-P1124・P1125 半截状況(東から)
4 SB42-P1094 炭化材出土状況(北から)
5 SB43-P1132AB・P1133 半截状況(北東から)

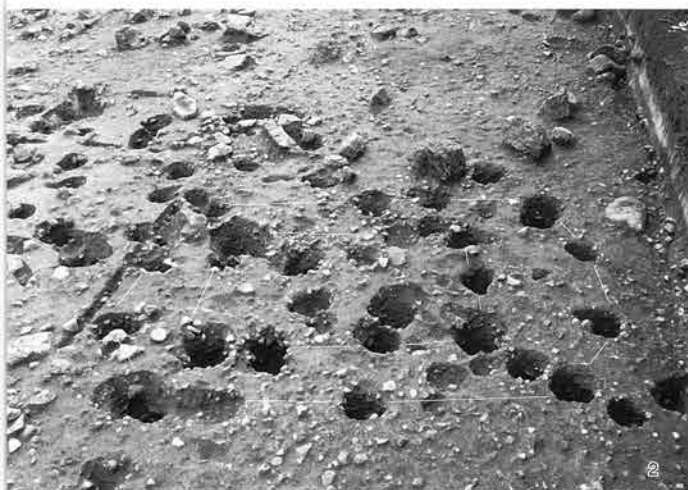
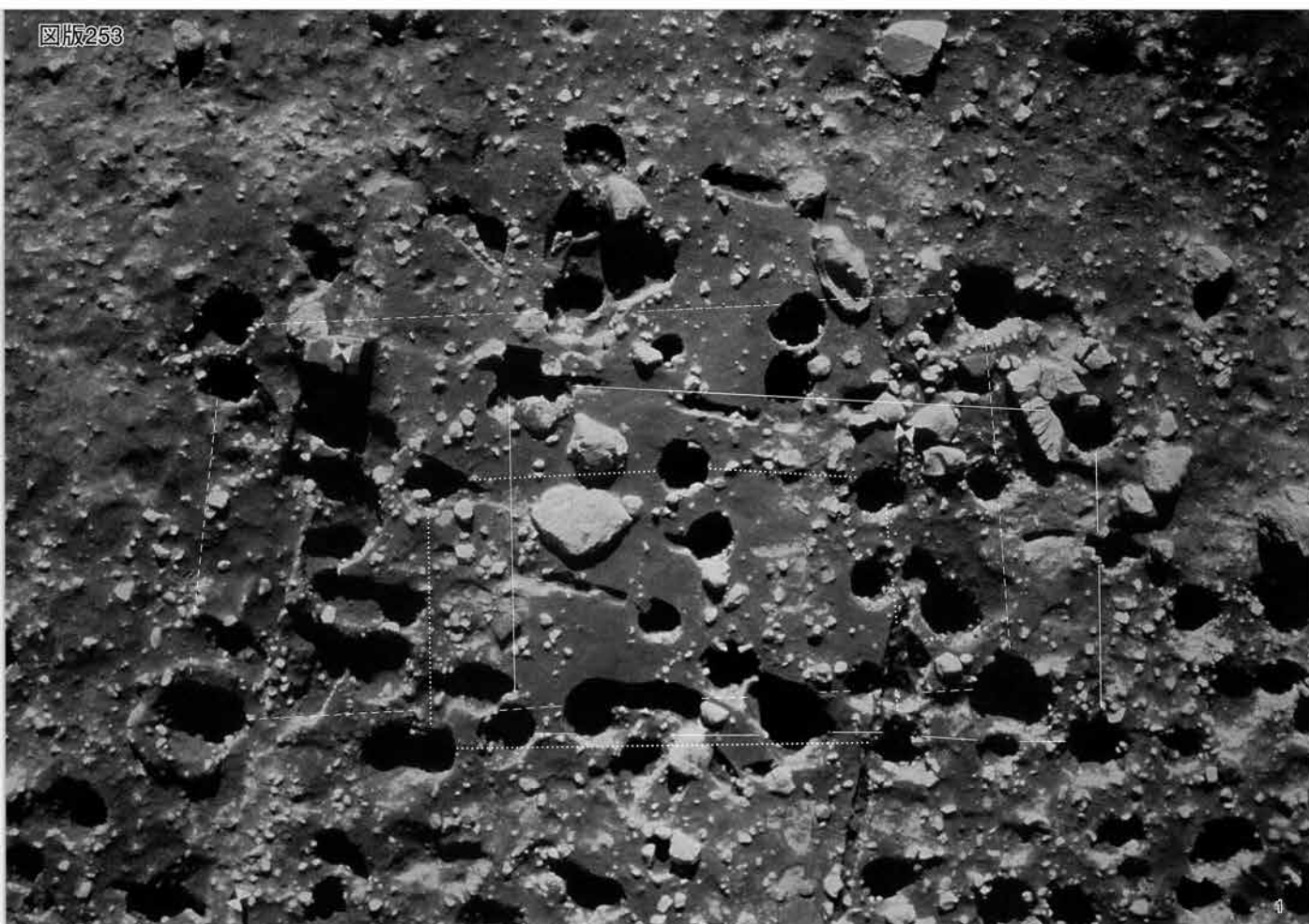

1 SB42・SB43・SB44 完掘状況(真上から)
 (破線がSB42、点線がSB44)
 2 SB45 完掘状況(北から)
 4 SB45-P1120 遺物出土状況(北東から)

3 SB45-P1116・P1117 半截状況(北から)
 5 SB46 完掘状況(南東から)

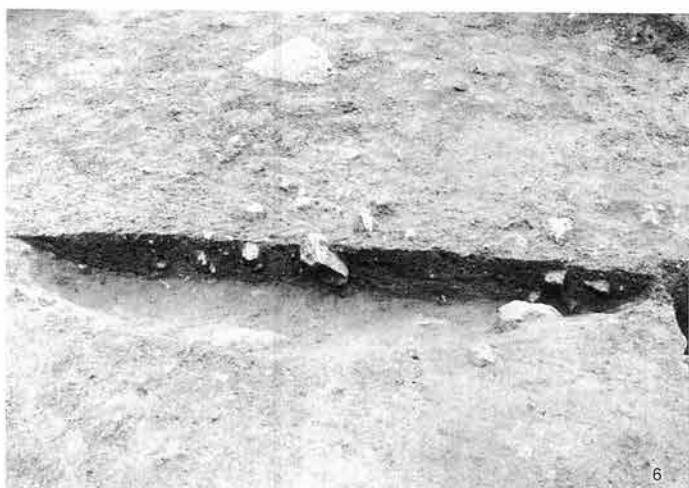
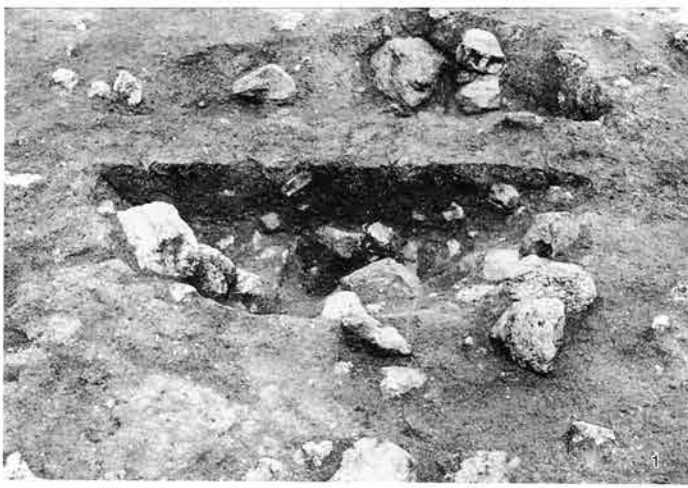

1 SK205 半截状況 (南東から)
3 SK414 土器出土状況 (南から)
5 SK962 完掘状況 (南から)
7 SK431 完掘状況 (北西から)

2 SK269 半截状況 (北西から)
4 SK953 半截状況 (東から)
6 SK648 半截状況 (南東から)
8 SK442 完掘状況 (東から)

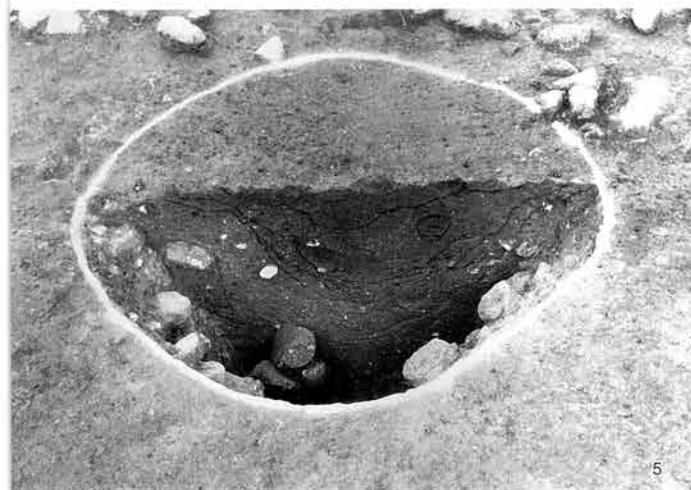

1 SK474 半截状況(東から)
 3 SK1282 半截状況(北から)
 5 SK123 半截状況(南から)
 7 SK838 半截状況(南から)

2 SK1288 半截状況(北から)
 4 SK1343 半截状況(南から)
 6 SK123 完掘状況(南から)
 8 SK838 石棒・搬入礫出土状況(南から)

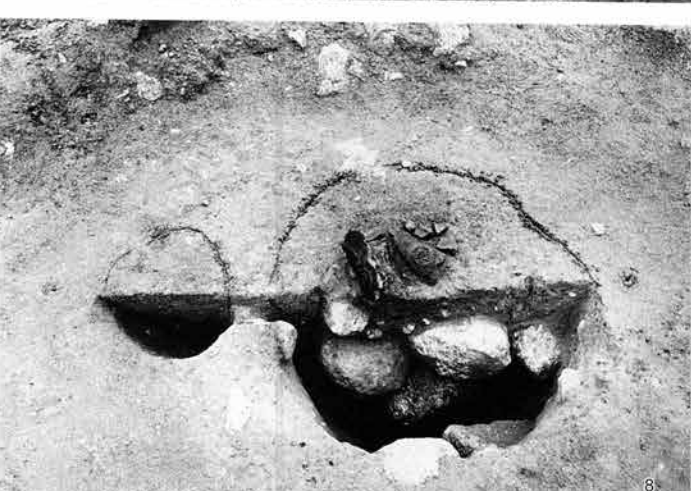
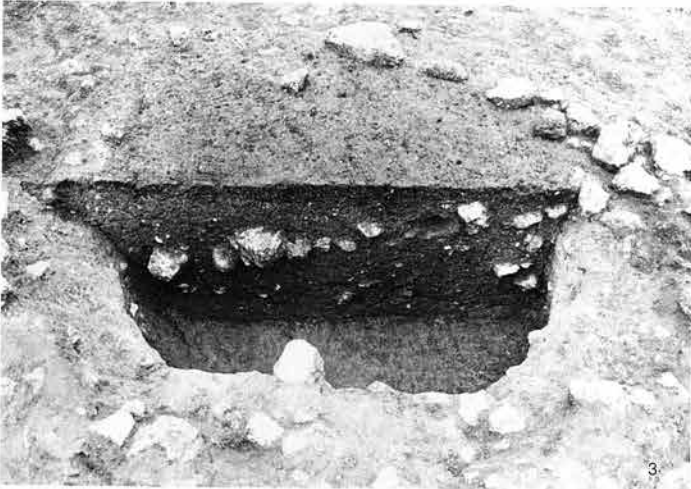

1 SK477 半截状況 (北東から)
 3 SK917 半截状況 (南東から)
 5 SK952B 半截状況 (南から)
 7 SK432 半截状況 (南東から)

2 SK477 石皿出土状況 (北東から)
 4 SK917 完掘状況 (南東から)
 6 SK951 半截状況 (南から)
 8 P593 (右) 半截状況 (南東から)

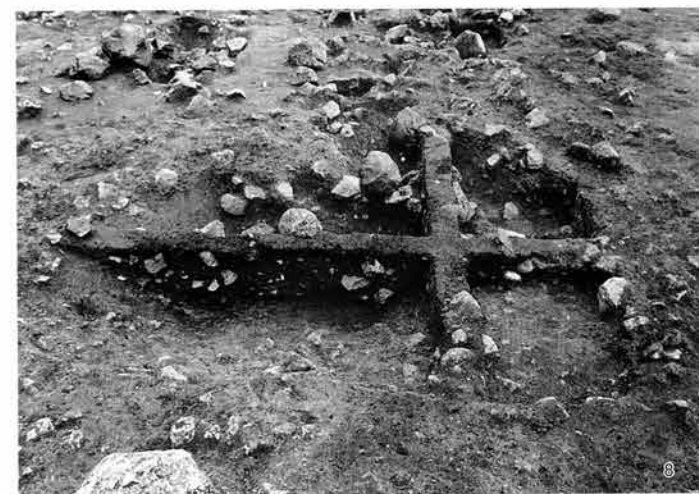

1 SK460・SK461 礫出土状況(東から)
 3 SK462 西側土層断面(西から)
 5 SK473 半截状況(東から)
 7 SK473 完掘状況(東から)

2 SK460 半截状況(南から)
 4 SK462 礫出土状況(西から)
 6 SK472 半截状況(東から)
 8 SK994 土層断面(南から)

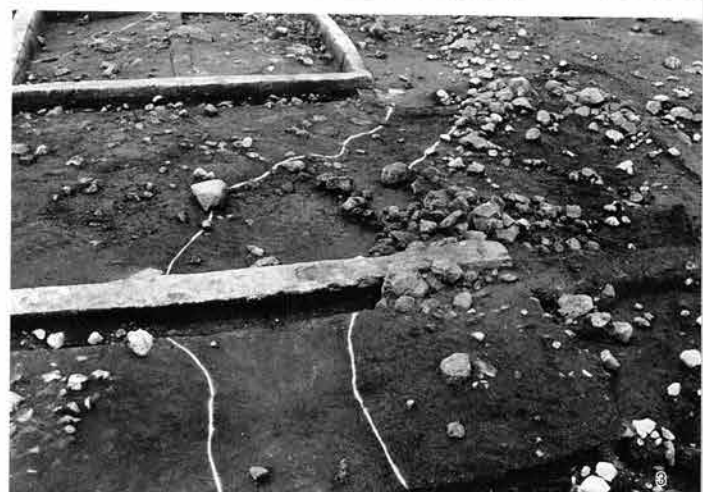
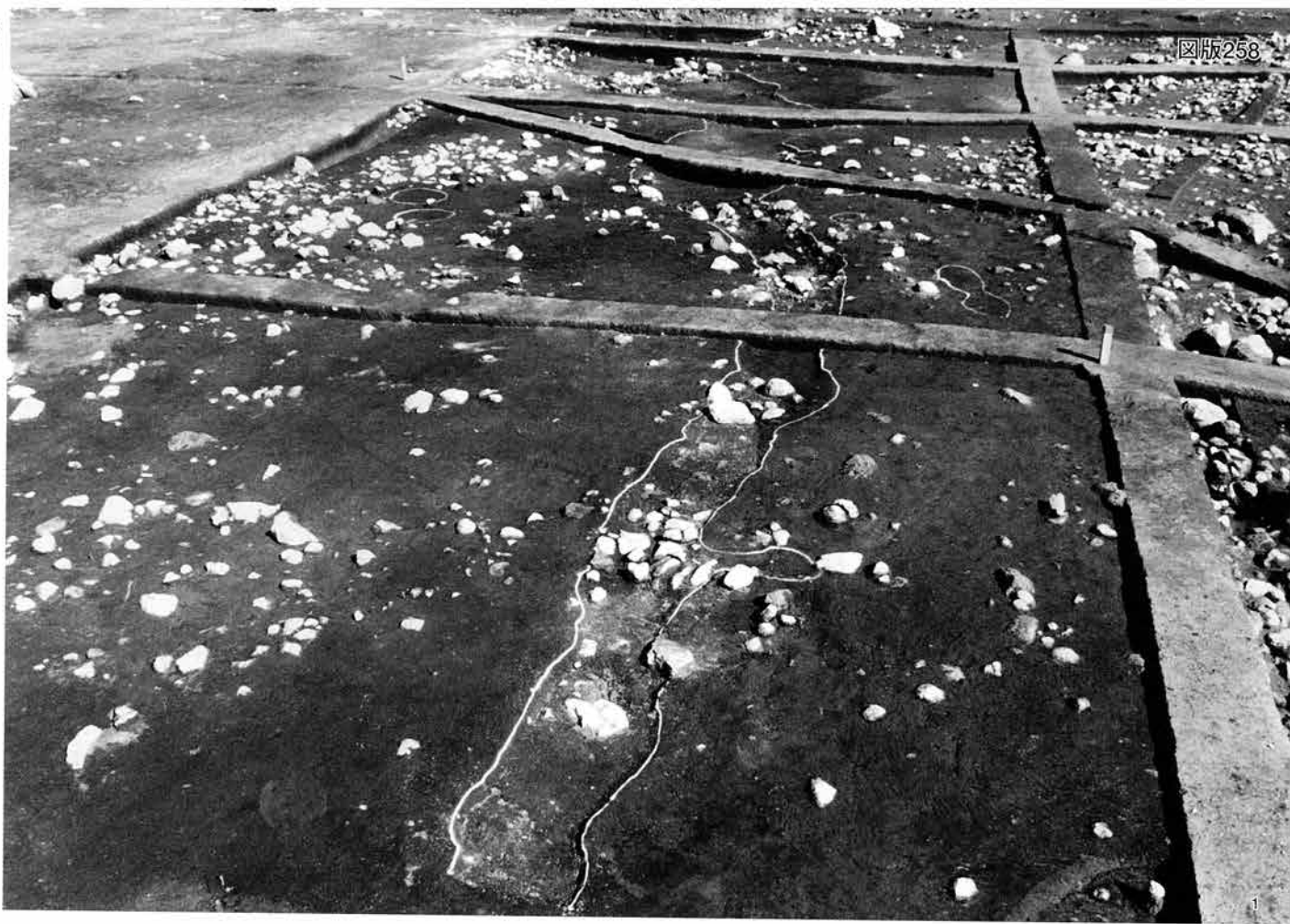

1 SD404・SD405 完掘状況(南から)
2 SD404 完掘状況(南から)
4 SD404 土層断面(南から)

3 SD404 完掘状況(南西から)
5 SD405 土層断面(南から)



1 廃棄ブロック1・2 礫出土状況(北上から)
2 廃棄ブロック2 礫出土状況(東から)

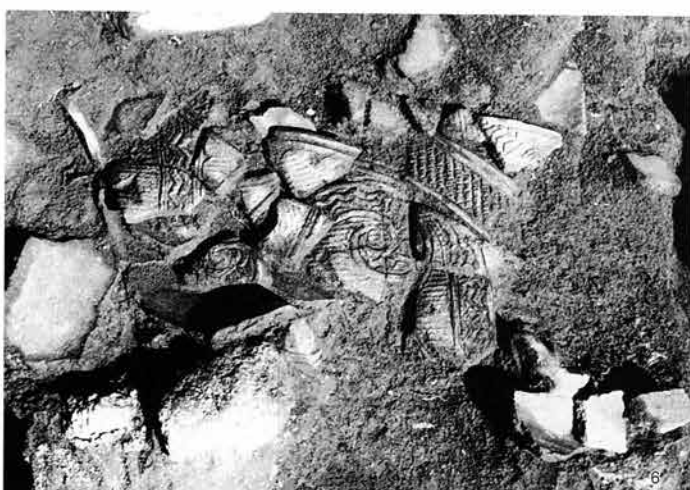

1 廃棄ブロック1 土層断面(北から)
 3 廃棄ブロック1 礫出土状況(南から)
 5 廃棄ブロック1 礫出土状況・土層断面(東から)
 7 廃棄ブロック2 遺物出土状況(東から)

2 廃棄ブロック1 土層断面(北から)
 4 廃棄ブロック1 礫出土状況・土層断面(東から)
 6 廃棄ブロック1 一括土器出土状況(5A11グリッド)(東から)
 8 廃棄ブロック2 礫出土状況・土層断面(東から)

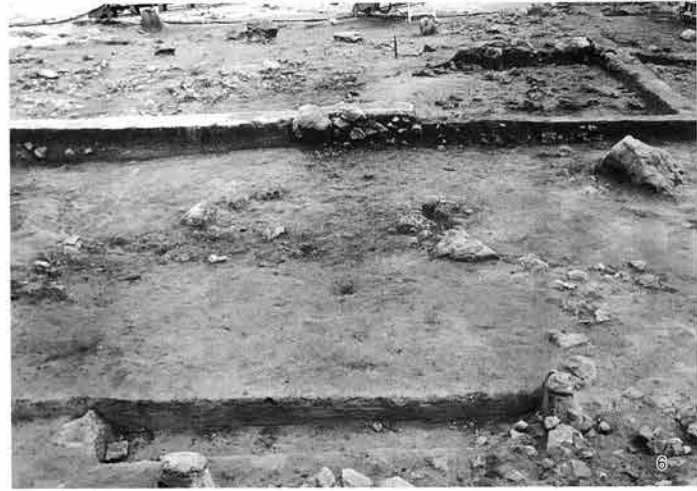

1 廃棄ブロック3 遺物出土状況(南から)
 3 廃棄ブロック4 土層断面(北から)
 5 廃棄ブロック5A 遺物・礫出土状況(南西から)
 7 廃棄ブロック5B 土層断面(南から)

2 廃棄ブロック3 遺物出土状況(西から)
 4 廃棄ブロック4 土層断面(北から)
 6 廃棄ブロック5A 土層断面(南から)
 8 廃棄ブロック5B 土層断面(南から)

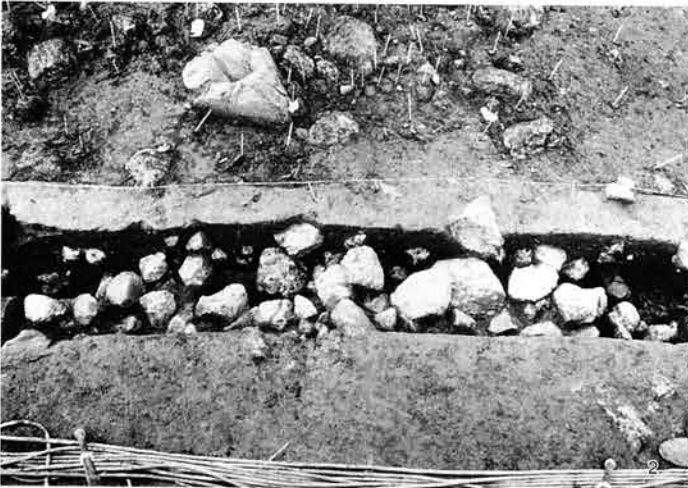

2 廃棄ブロック6 礫出土状況(東から)
4 廃棄ブロック6 検出状況(南西から)

1 廃棄ブロック6・7 検出状況(東から)
3 廃棄ブロック6 土層断面(東から)
5 廃棄ブロック6 土層断面(東から)

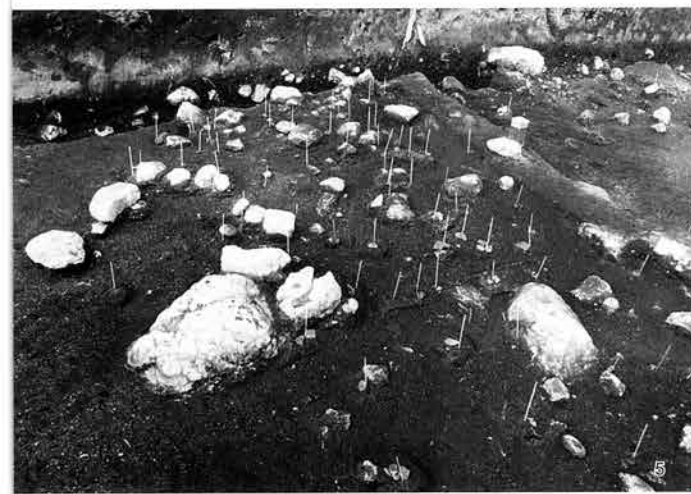
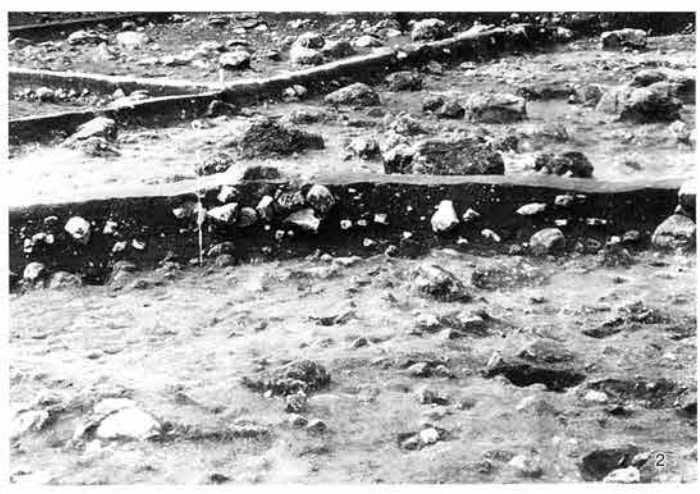

1 廃棄ブロック6 土層断面(東から)
 3 廃棄ブロック6 一括土器出土状況(13D7*リット)(東から)
 5 廃棄ブロック7 遺物出土状況(南東から)
 7 廃棄ブロック7 土層断面(東から)

2 廃棄ブロック6 土層断面(東から)
 4 廃棄ブロック6 馬頭石棒出土状況(13C7*リット)(西から)
 6 廃棄ブロック7 土層断面(南から)
 8 廃棄ブロック7 土層断面(東から)

SI117
1~11
1:4



1



2



6



4



5



3



7



8



9



10



11

SI117
12~24
1:4



12



14



15



19



18



13



16



17



18



20



21



22



24

SI117
25~28
1:4



SI117
29~31
37
1:4

32~36
1:3



29



31



30

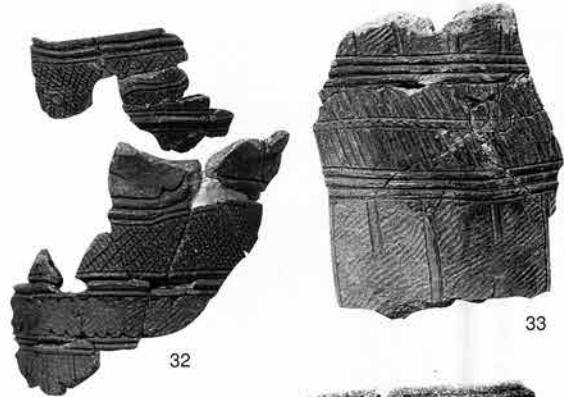

32

33



35



34



37



36

SH117
38・39
51
1:4



40~50
52~55
1:3

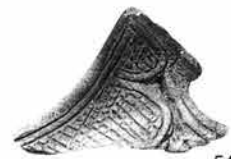

SH120
56~63
1:3

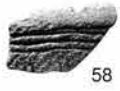

SI403
64~67
1:4



SI403
68~72
76
1:4



68



72



69



70



76



71

SI403
73~75
77~84
88
1:4



S1403
86・87
89~93
95
1:4
85
1:3



86



87



95

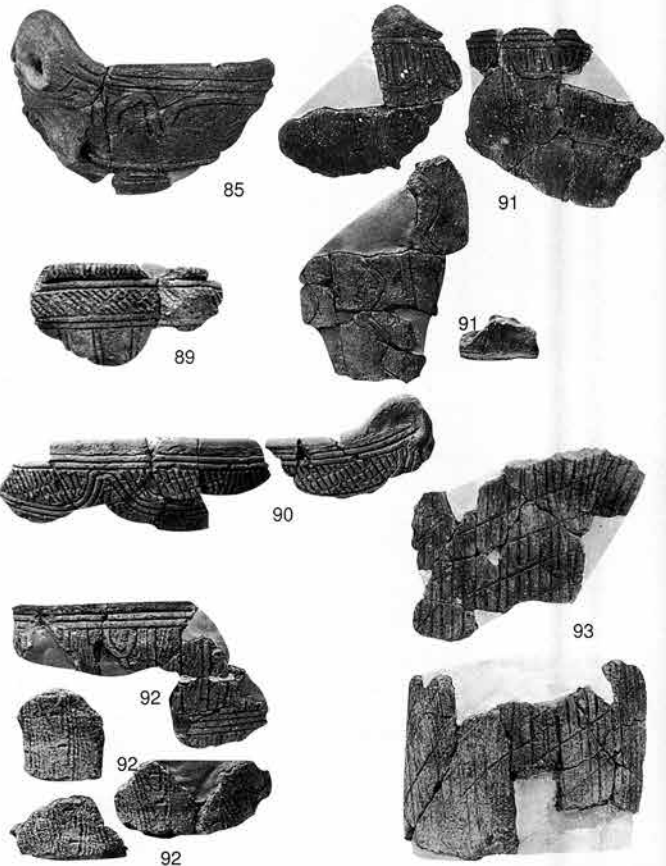

85

91

89

91

90

93

92

92

92

SI403
94
96~99
101~117
1:3
100
1:4



100



94

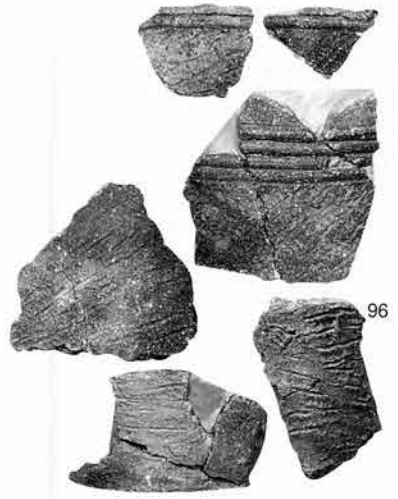

96



97

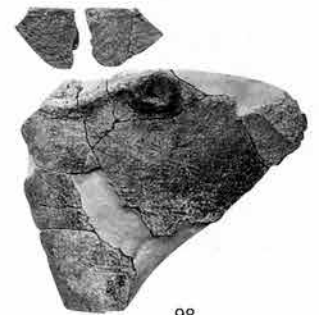

98



101



102



103



104



99



105



106



107



108



109



110



111



113



112



117



114



115

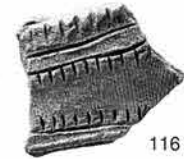

116



118



119



120



121



122



123



124

廃棄ブロック4
118~124
1:3



135



136
P593

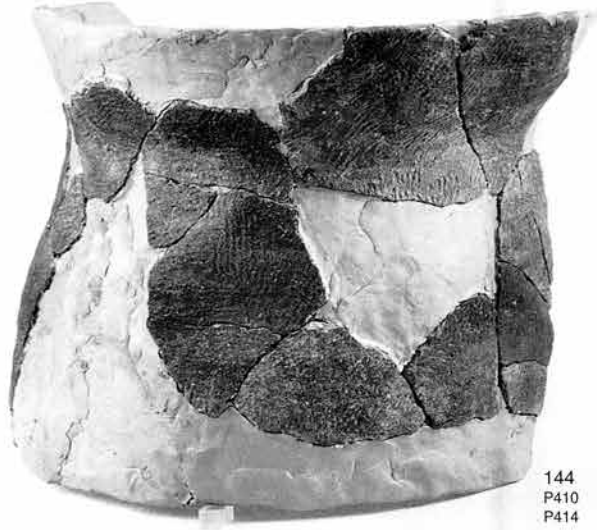

144
P410
P414



141
SD404



131
P1235



133
P1063



125
P968・P976



126
P1052

127
P1120



128
P311



129
P240



130
P1120



132
P415



134
P122



137
P426



130
P1120



138
P122



139
P1113



140
SD405

Pit
125~134
136~139
144

廃業ブロック外
135

SD405
140

SD404
141
1:4

SD404
142・148
155

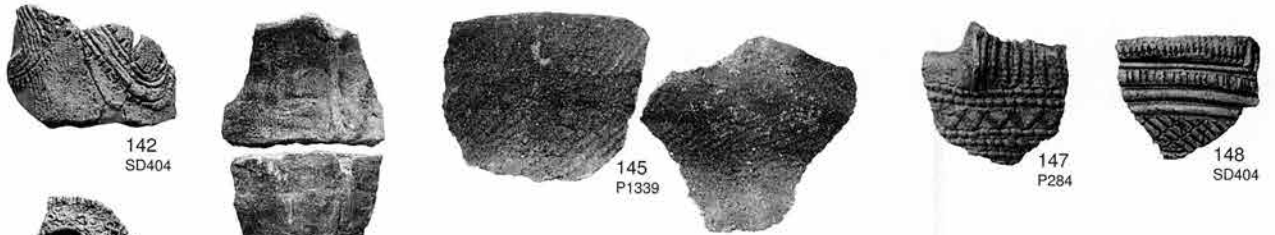

Pit
143・145
147・149
151~154
156~161

廃棄ブロック外
146

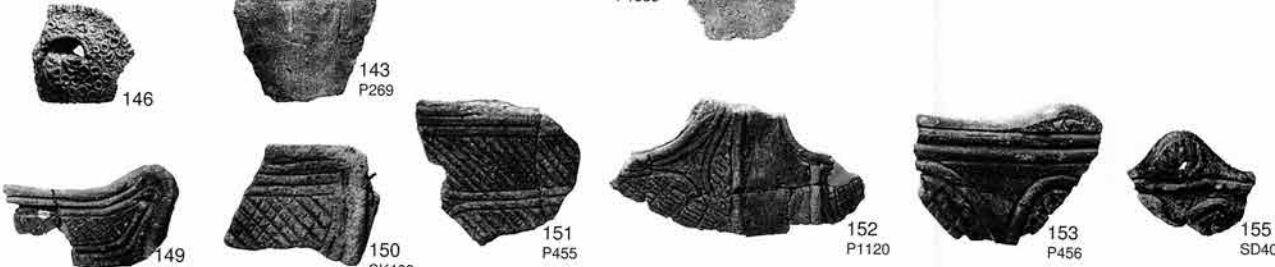

SK460
150

SK462
162~165

SK432
166・167
1:3

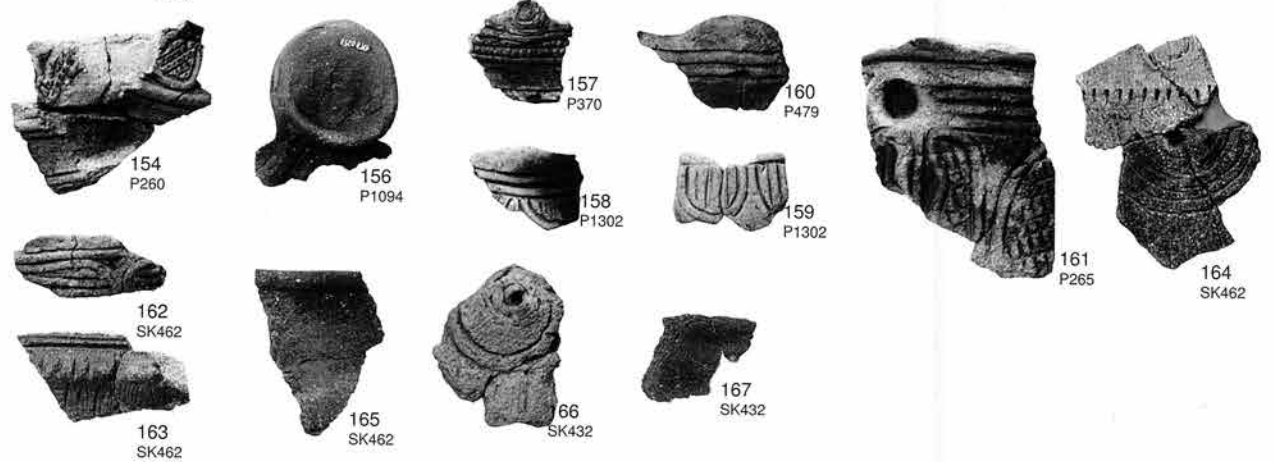

廃棄ブロック1
168~170
174・175
1:4

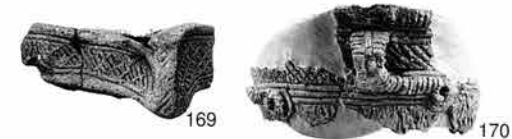

廃業ブロック1
173・176
178~184
186
1:4



173



181



179



182



178



183



180



184



186



176

廃棄ブロック1

171・172

177・185

187~189

191~194

196~201

211

1:4

190

1:3



187



190



211



196



177



188



172



192



171



185



189



191



193



194



197



198

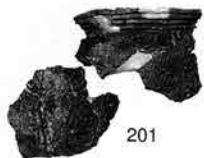

201



199



200

廃棄ブロック1

195
202~210
1:4

212~230
1:3

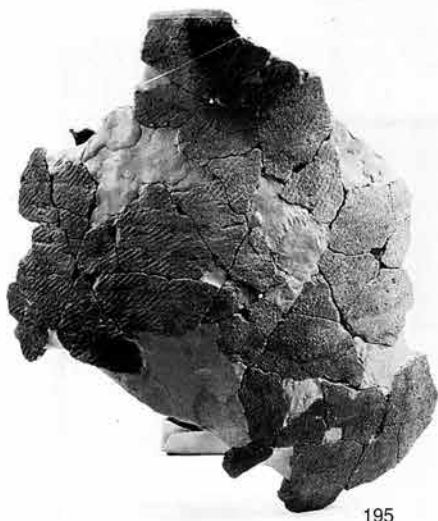

195

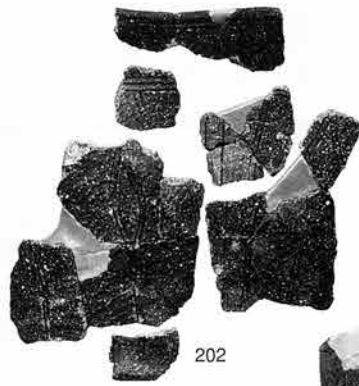

202



203



204



205



206



207



210



209



208



212



213



210



220



215

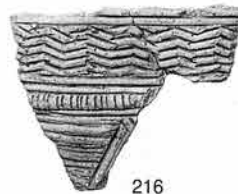

216



218



210



214



219



221



222



225



223



224



226



229



227



228



230

廃棄ブロック2
231~241
243・244
1:4

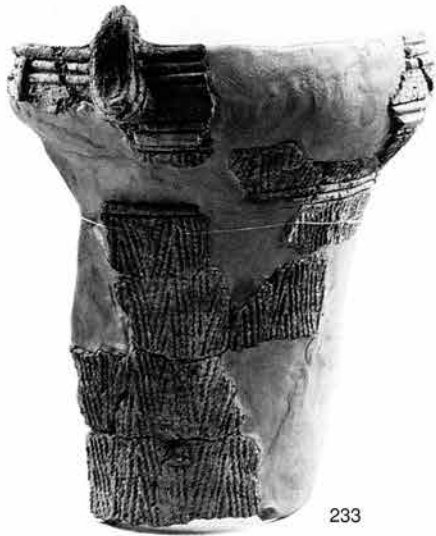

233



231



234



241



235



237



243



238



232



239



240



236



244



242



246

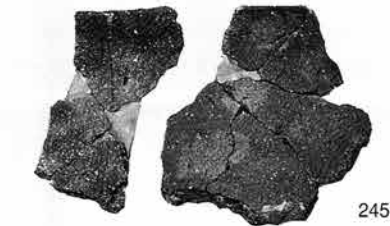

245



245



250



247



248



249



251



254



252



253



255



256



257



259



258



260



261



263



268



262



264



265



266



267



269

廃棄ブロック 2

242

245~247

1:4

248~254

1:3

廃棄ブロック 3

255~257

259

1:3

258・260

1:4

廃棄ブロック 5

261~263

269

1:4

264~268

1:3

廃棄ブロック6
270~278
280・283
1:4



270



271



272



277



273



278



274



275



276



280



283

廃棄ブロック6
279・281
282・284
285・287
290
1:4



284



281



282



285



279

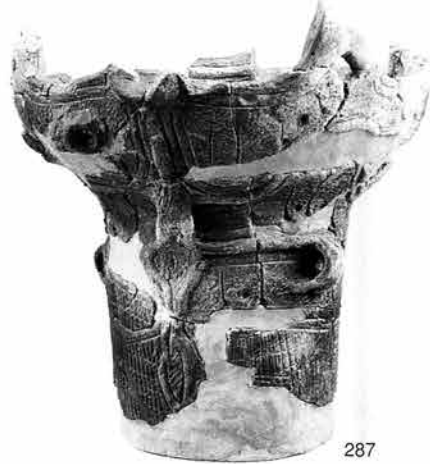

287



290

廃業ブロック6

286・288

289・292

294・296

1:4



286



288



292



294



296



289

廃棄ブロック 6

293・301

297~299

303~305

306

1:4

302

1:3



293



297



298



299



302



303



301



306



305

廃業ブロック 6
291・295
300・304
307~314
316・317
322
1:4



295



291



300



304



308



311



307



309



313



312



314



316



322



310





318



315



319



323

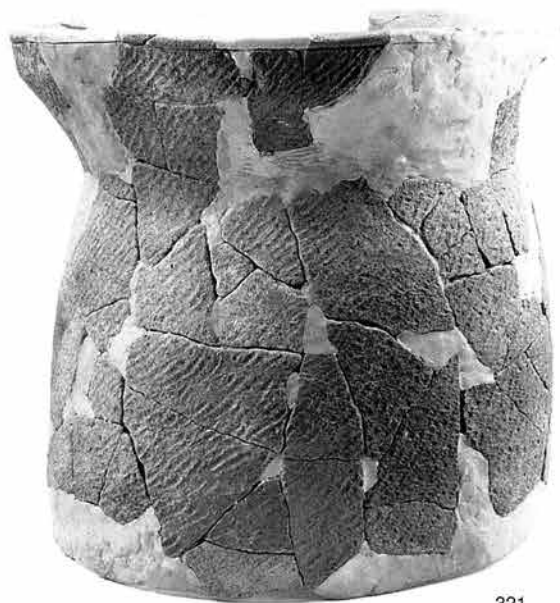

321



328



329



330

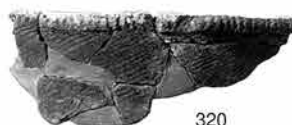

320



332



324



325



326



327



331



廃棄ブロック 6
318~321
315・323
1:4

324・325
327・330
1:2

326・328
329・331
332
1:3



333



338



338



345



341



335



336



343



340



342



344



339



346



337

廃棄ブロック 7
333~337
1:4

338~346
1:3

廃棄ブロック外

347~359

1:4

360~378

380

1:3



347

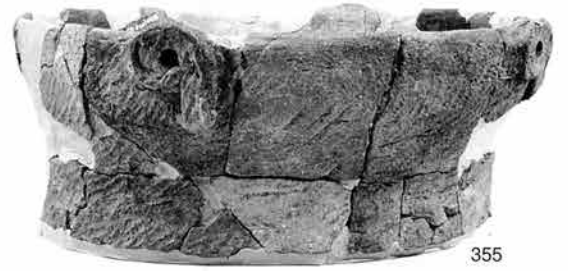

355



349



350



351



348



352



353



354



359

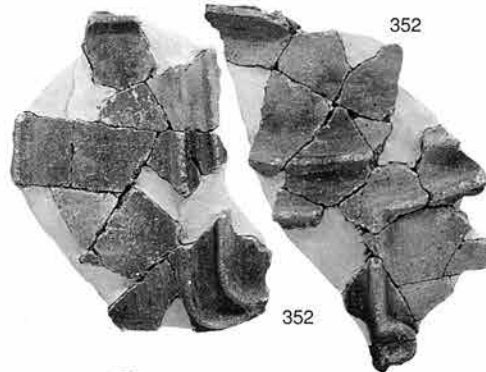

352



358



360



356



363



357



361



362



365



364



366



367



374



372



373



368



370



377



378



371



375



376



380

廃業ブロック外

379

381~386

392~395

1:3

387~391

1:4



379



382



384

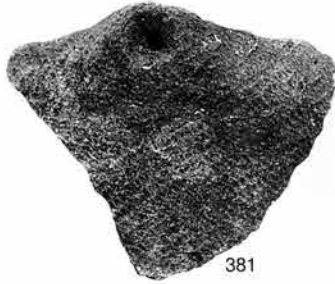

381



383



385

386



388



387



391



395

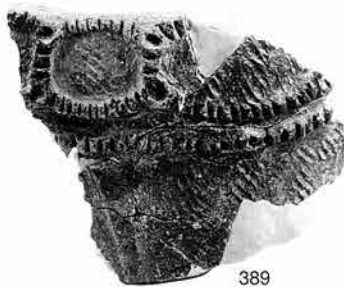

389



390



392

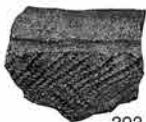

393



394



土製品
396~436
1:2

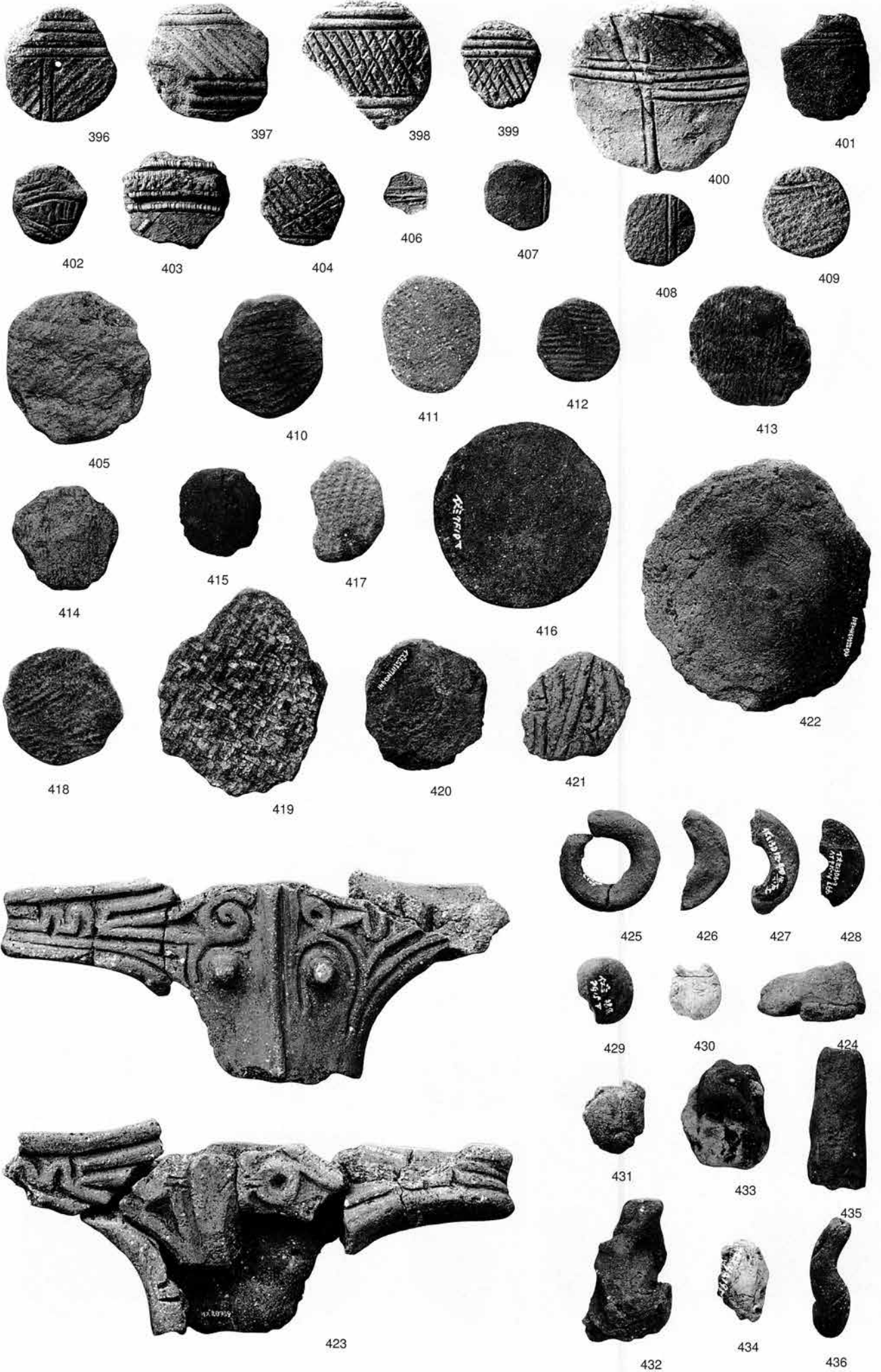



石鏃
1~9

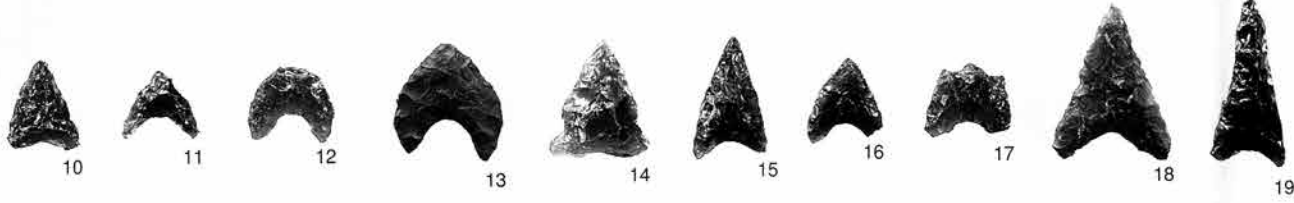

石鏃
35~38

尖頭器
39~41

石匙
42~44



楔形石器
45~55
4:5

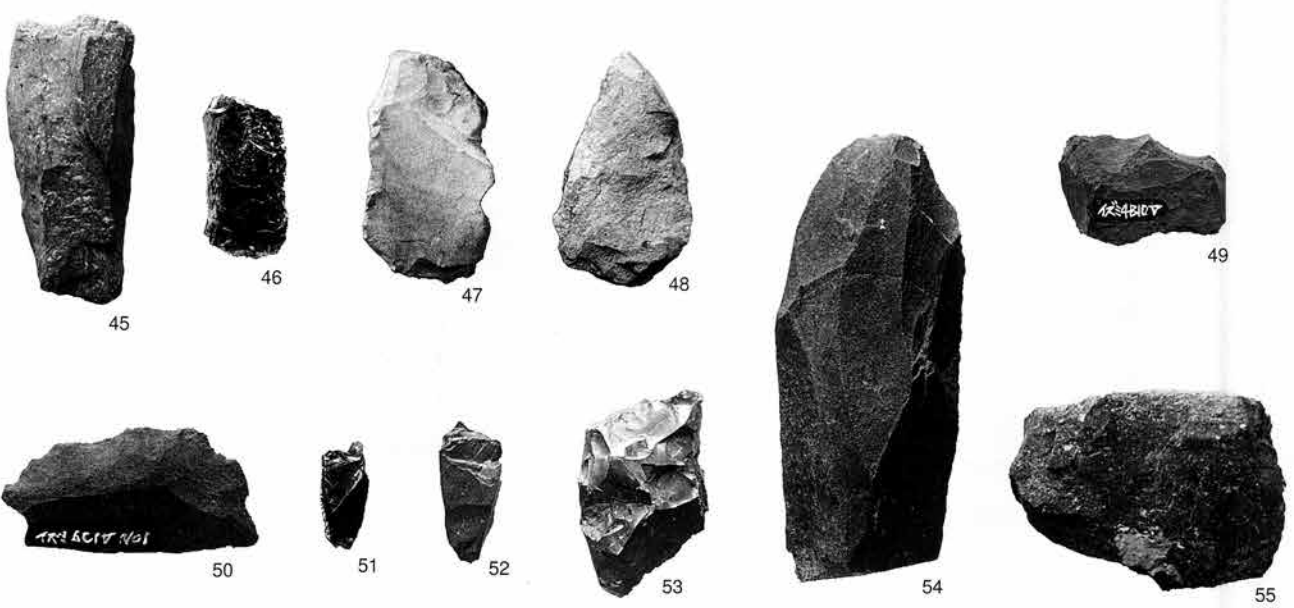
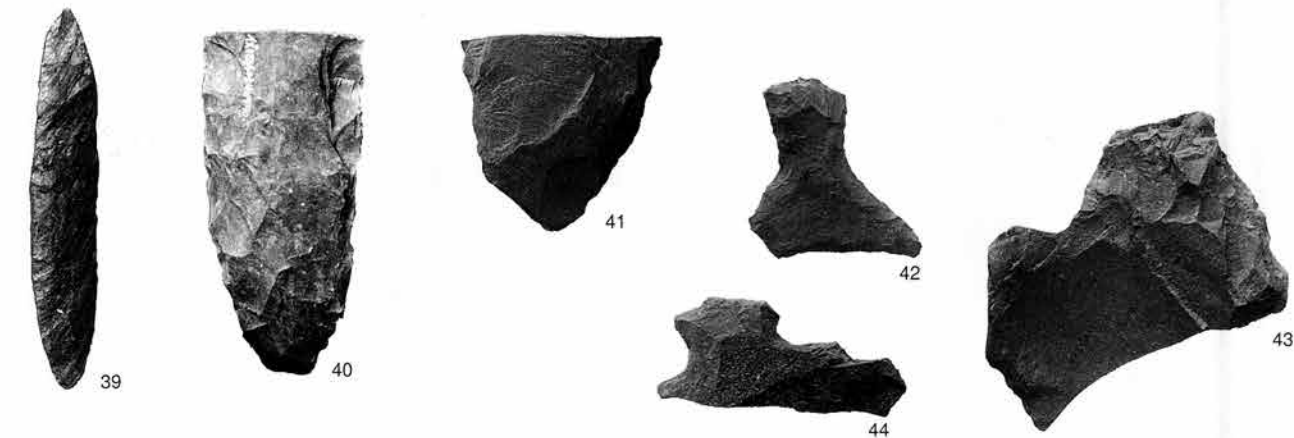

4:5

楔形石器

56~77

80~87

4:5

打製石斧

127~138

1:2

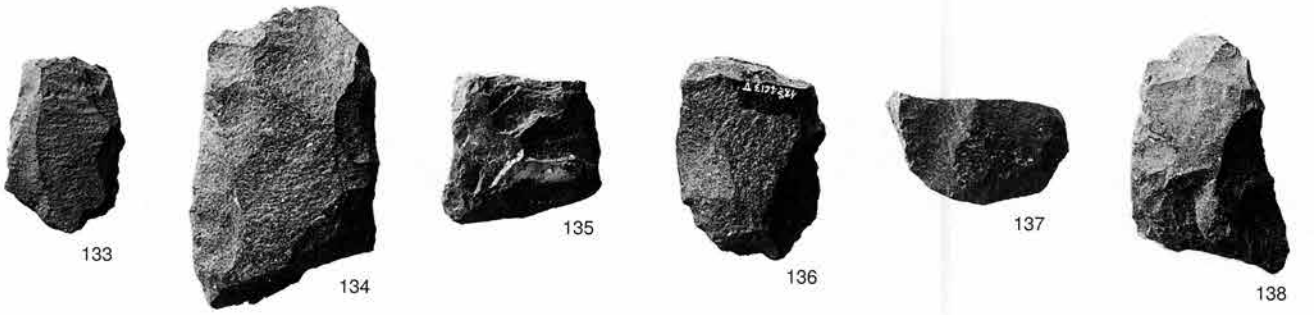
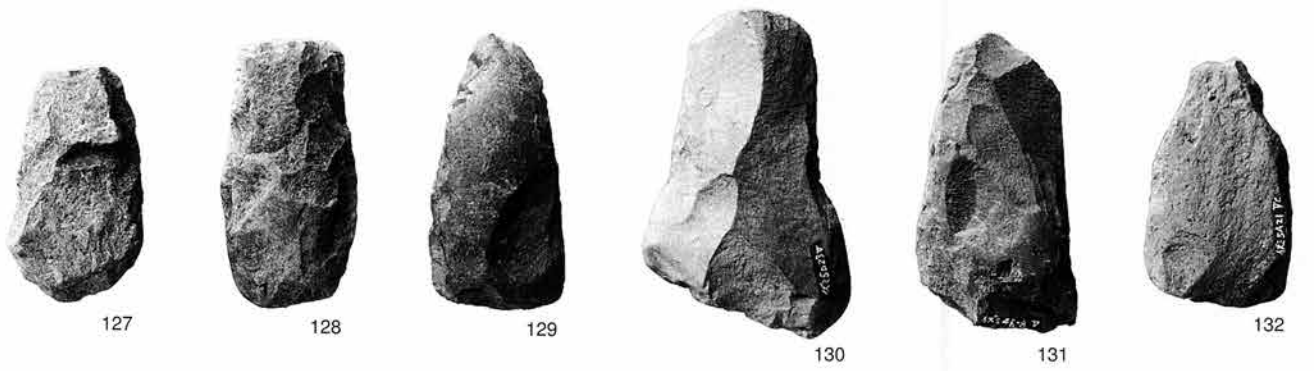
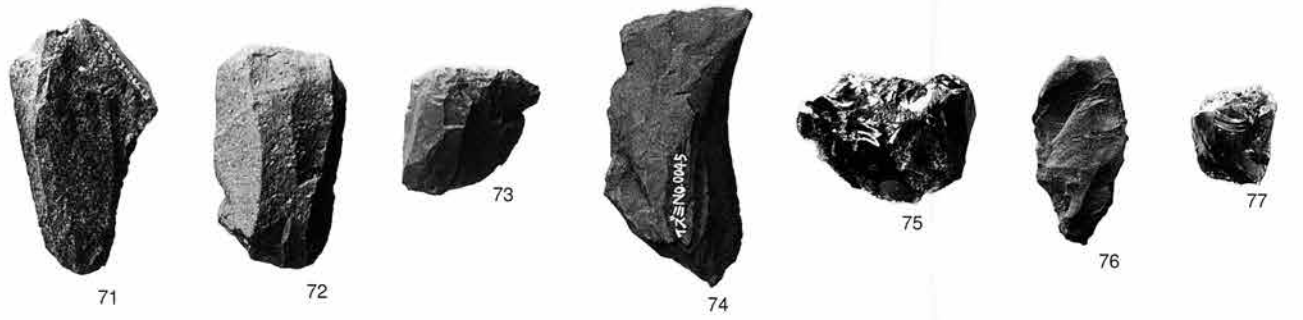
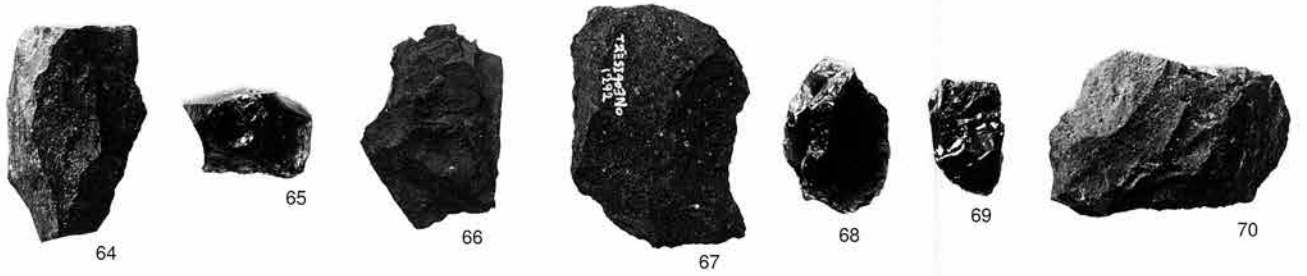

打製石斧
139~170
1:2



139



140



141



142



143



144



145



146



147



148



149



150



151



152



153



154



155



156



157



158



159



160



161



162



163



164



165



166



167



168



169



170

打製石斧
171~201
1:2



171



172



173



174



175



176



177



178



179



180



181



182



183



184



185



186



187



188



189



190



191



192



193



194



195



196



197



198



199



200



201

打製石斧
202~206

磨製石斧
207~240
1:2



202



203



204



205



206



207



208



209



210



211



212



213



214



215



216



217



218



219



220



221



222



223



224



225



226



227



228



229



230



231



232



233



234



235



236



237



238



240



239

磨製石斧
241~256

スクレイパー
257~277
1:2

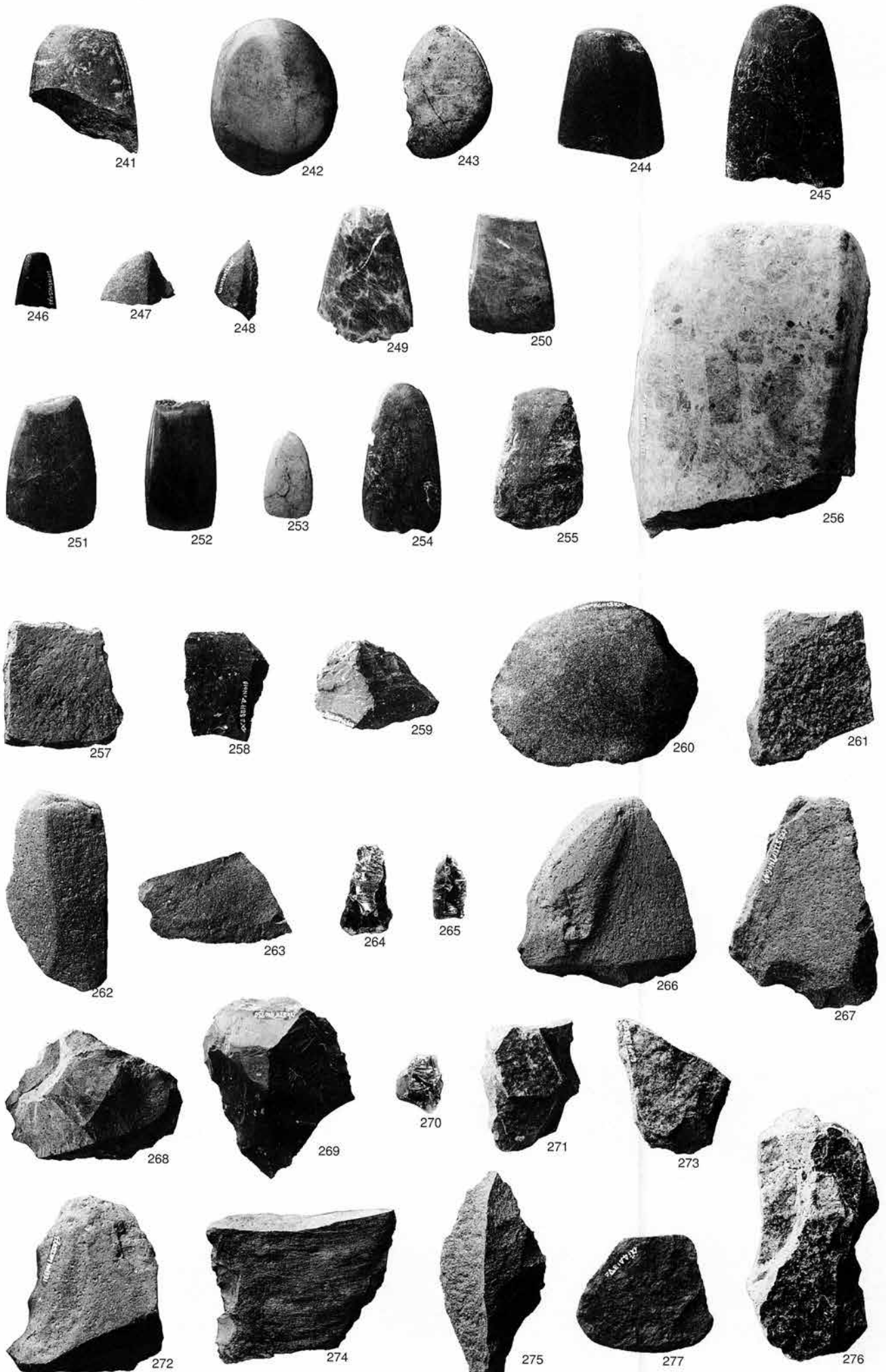

スクレイパー
278~309

微細刺雑痕
ある剝片
310~312

両面調整石器
313~319
1:2

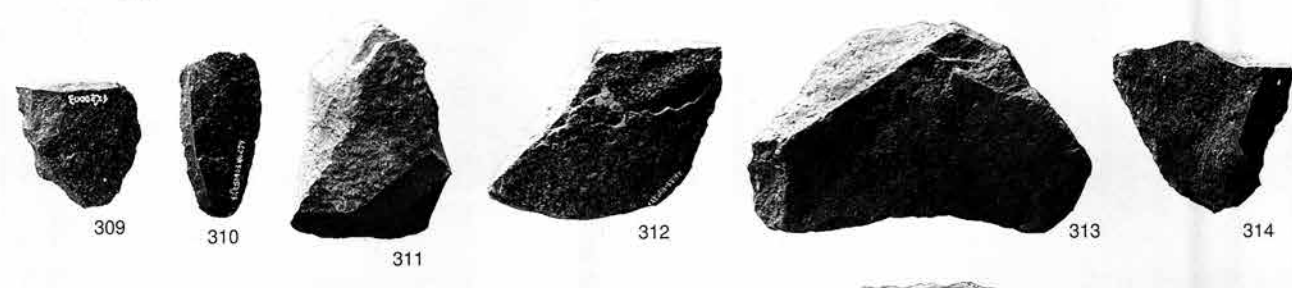
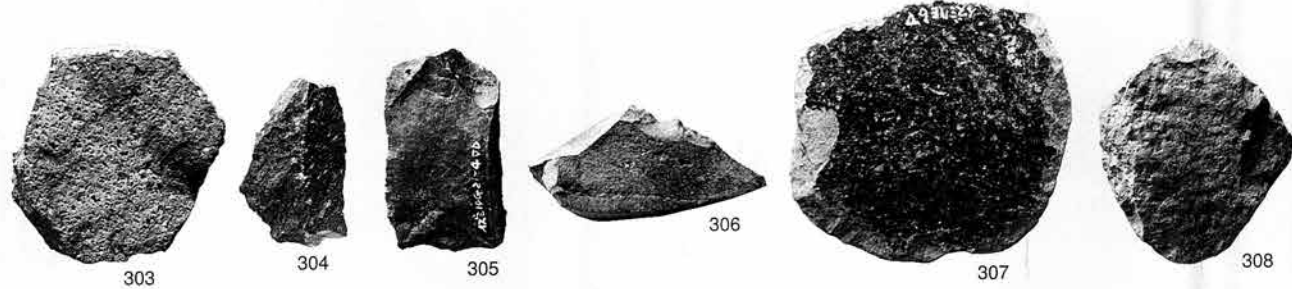
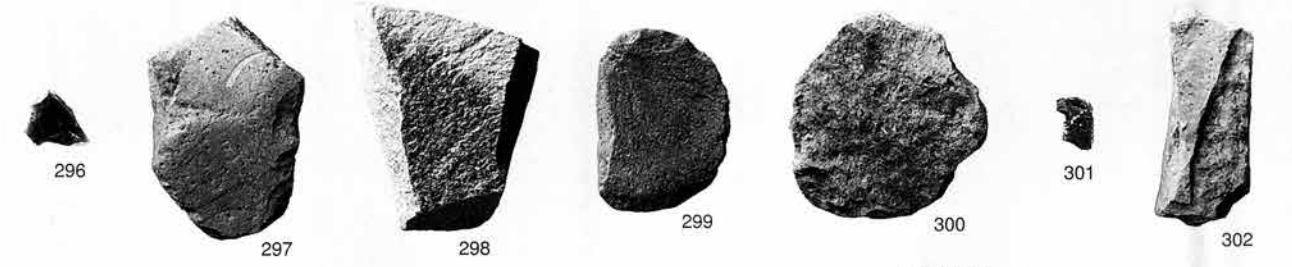
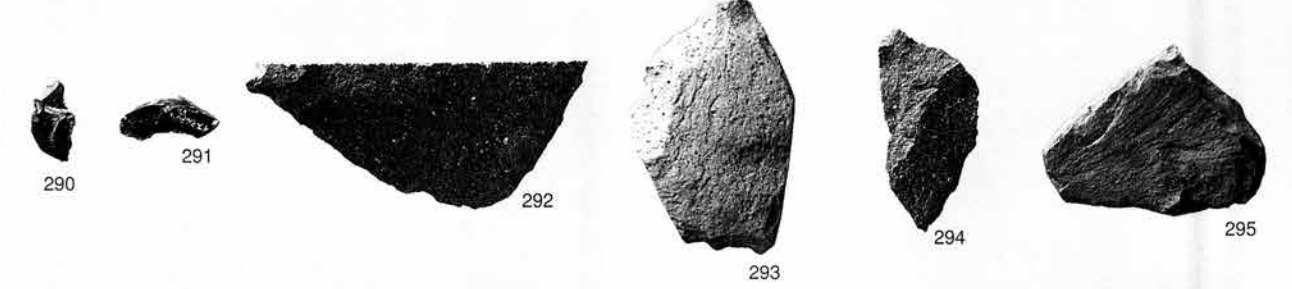
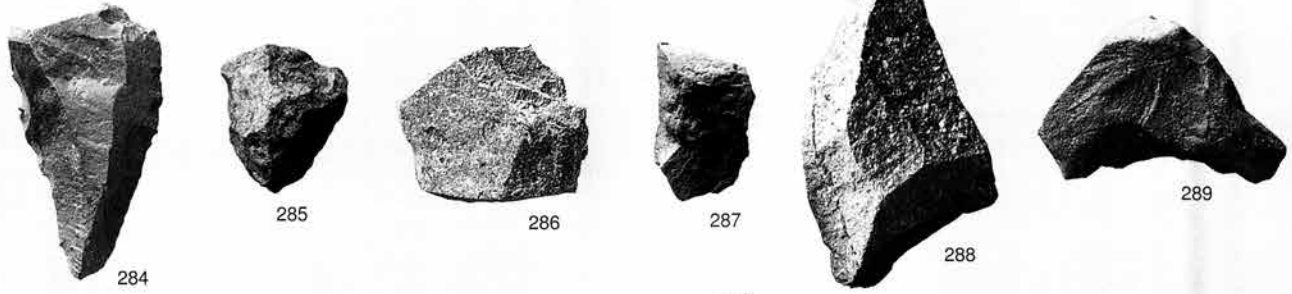
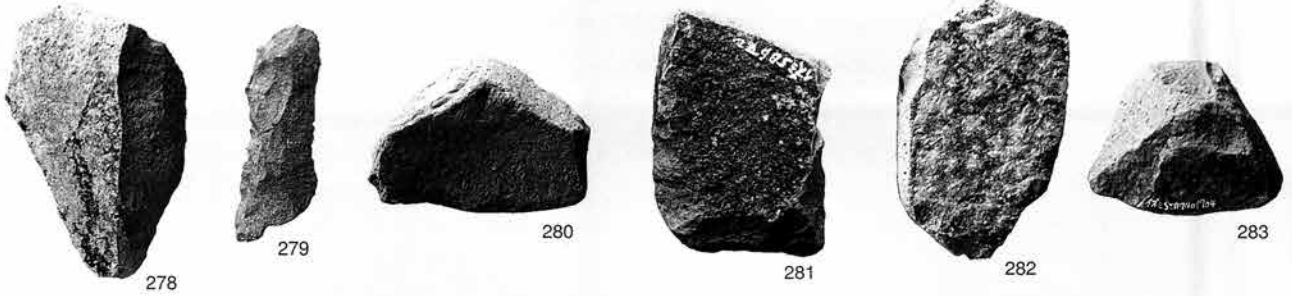

両面調整石器
320~351
1:2



320



321

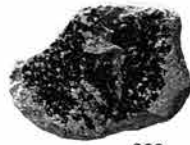

322



323



324



325



326



327



328



329



330



331



332



333



334



335



336



337



338



339



340



341



342



343



344



345



346



347



348



349



350



351

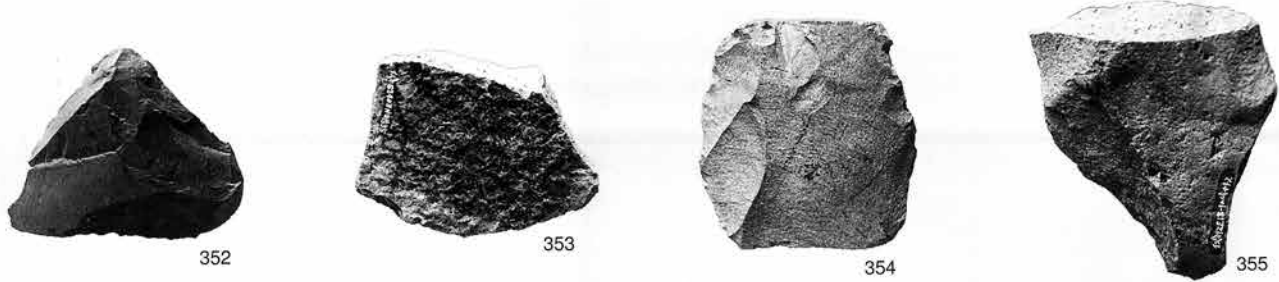

両面調整石器
352~361
364~383
1:2



スクレイパー
362
1:2

周縁敲打調整石器
363
1:2

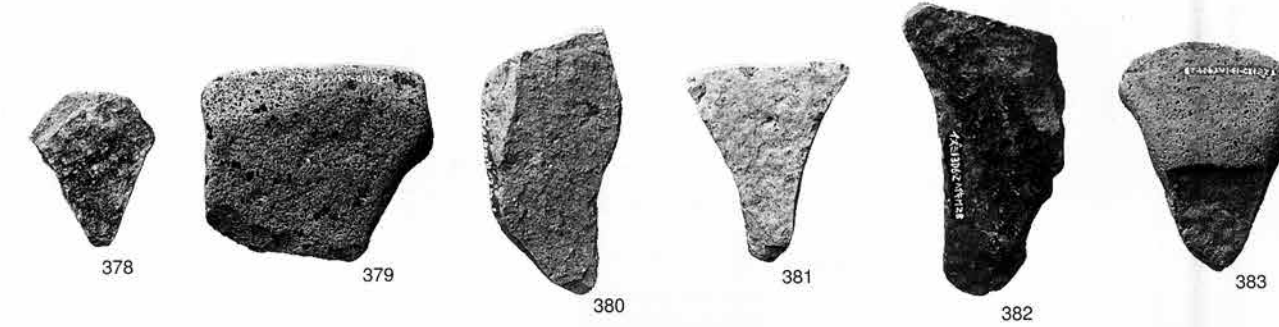
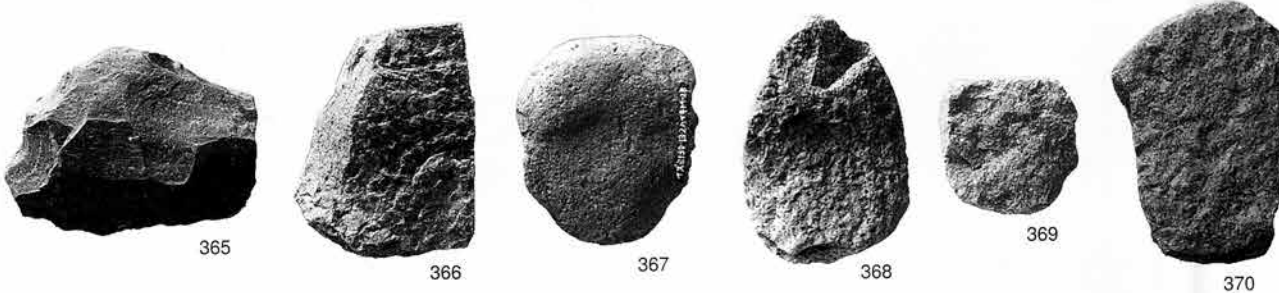
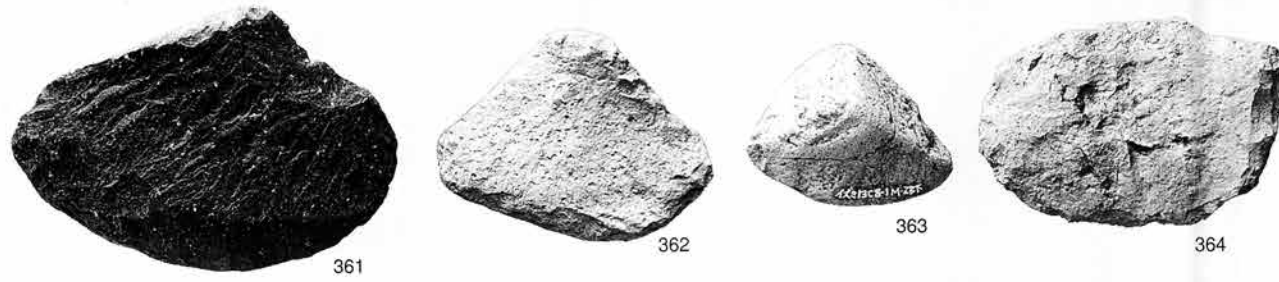

両面調整石器

384~387

389~413

スクレイパー

388

1:2



384



385



386



387



388



389



390



391



392



393



394



395



396



397



398



399



400



401



402



403



404



405



406



407



408

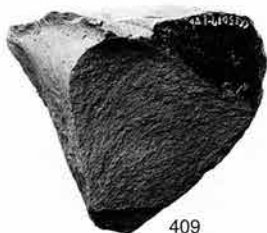

409



410



411



412



413

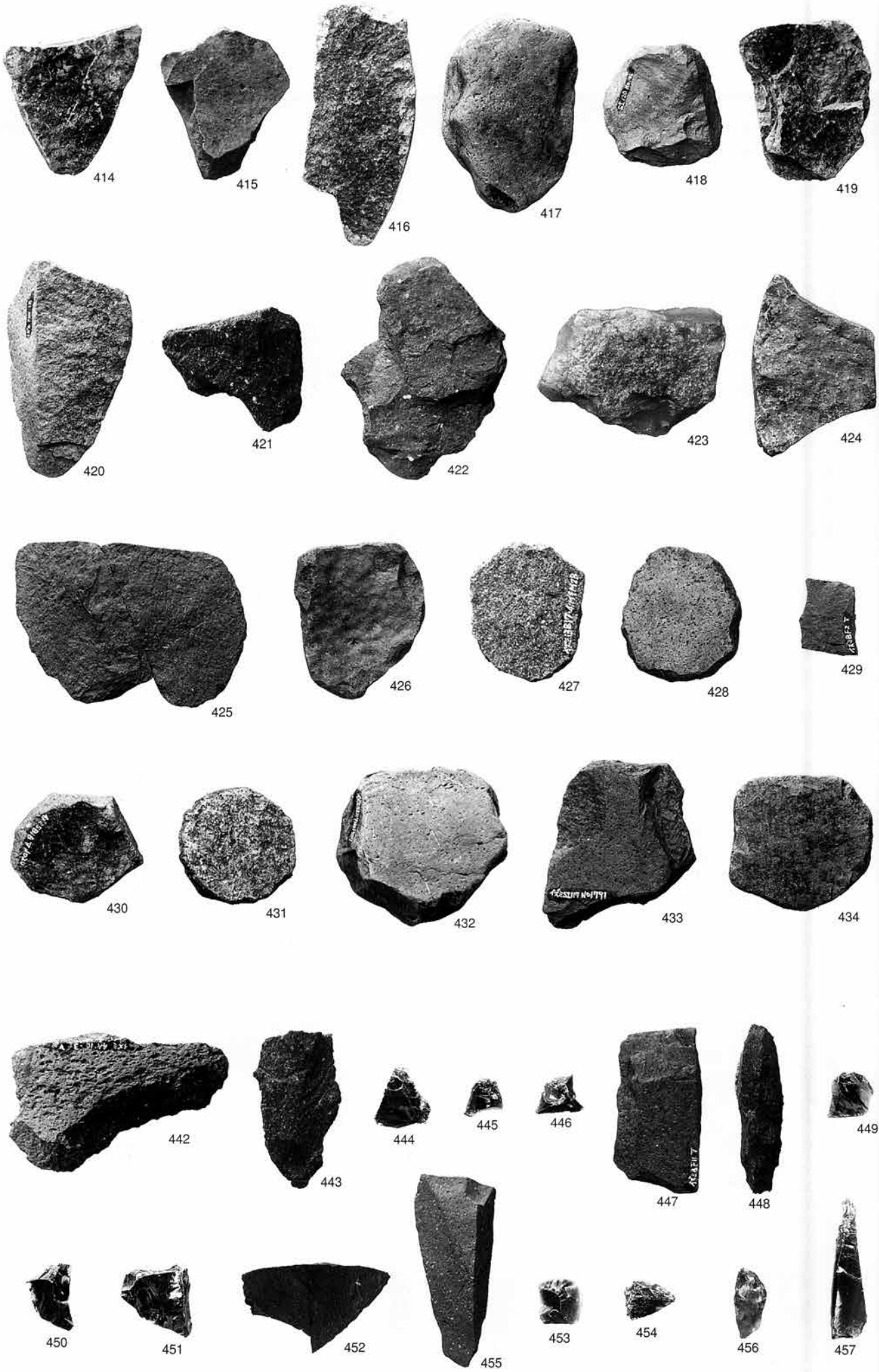

両面調整石器
414~423
425

折衝調整石器
424・426・429

対向調整石器
427・428
430・433

周縁敲打調整
石器
434

微細剝離痕
ある剥片
442

剥片
443~457

礫器
435~439
スクレイパー
440
石核
441
458~464
1:2



435



436



437



438



439



440



441



458



459



462



460



461



464



463

石核
465~486
1:2

磨石類
487~494
1:4



465



466



468



467



469



470



471



472



473



474



477

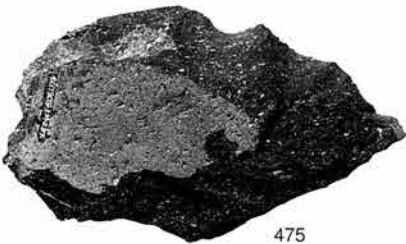

475



476



478



479



480



481



482



483



484



485



486

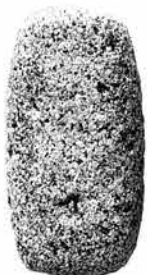

487



488



489



490



491



492



493



494

磨石類
495~543
1:4

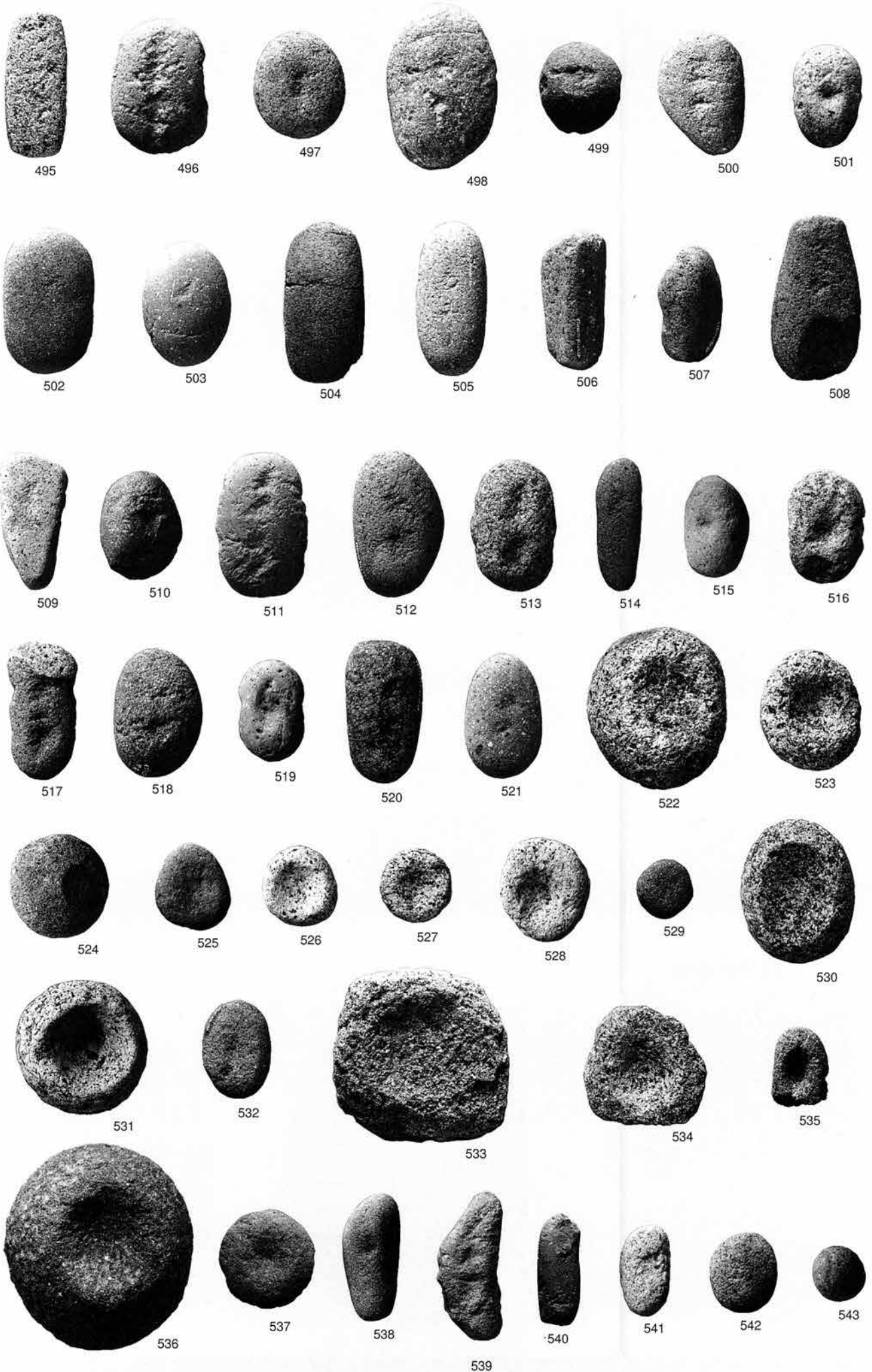

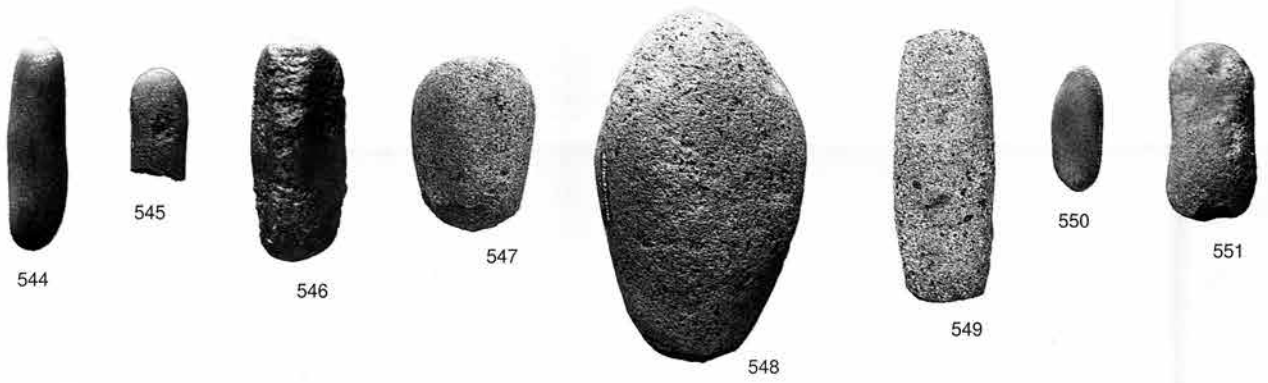

磨石類
544~555

丸石
556・557

環状石製品
558
1:4

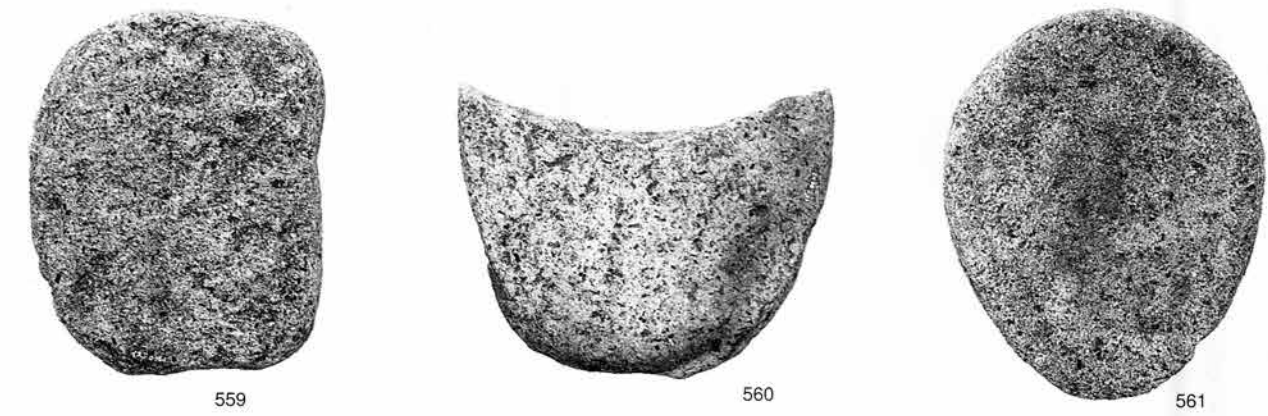

石皿
559~566
568
1:5

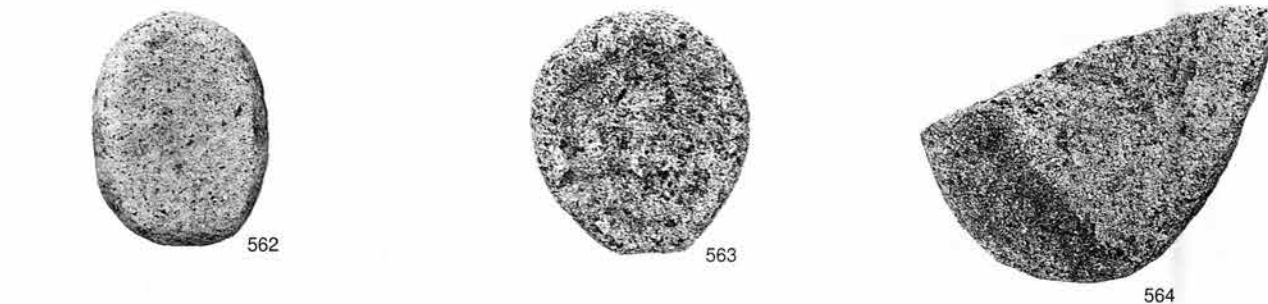

石皿
567
569~582
1:5



567

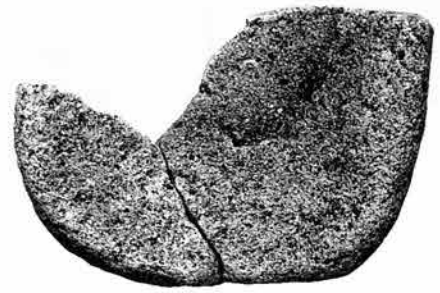

569

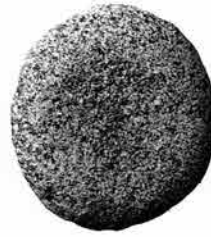

570



571



572



573



574



575



576



577



578



579



580



581



582



583



584



585

石皿
583~585

砥石
586~612
1:4

石棒
613~616
1:5

玉類
617~623
4:5

玉類
624
1:2

翡翠原石
625
1:2



586



587



588



589



590



594



595



591



592



593



596



597



598



599



600



601



602



603



604



605



606



607



608



609



610



611



612



613



614



617



618



619



620



615



616



621



622



623

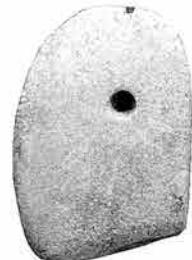

624



625

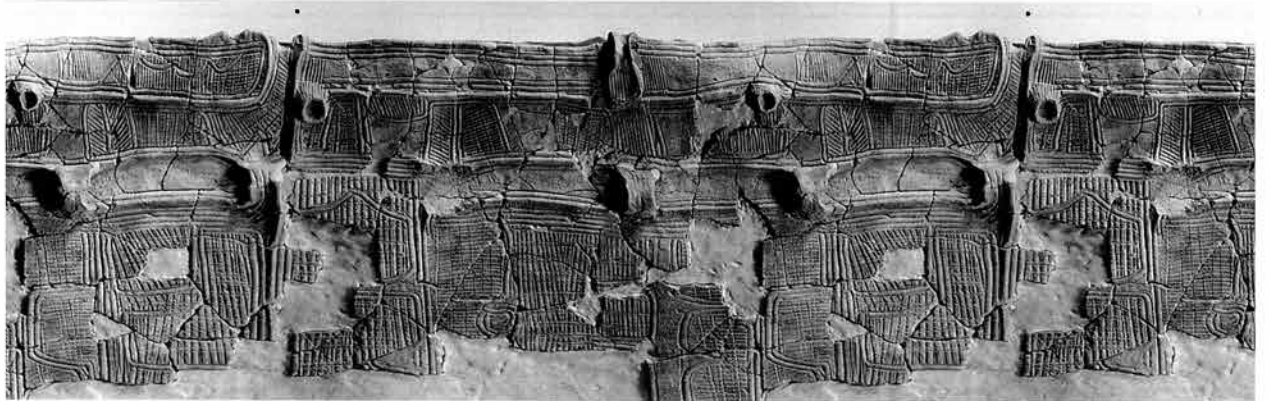
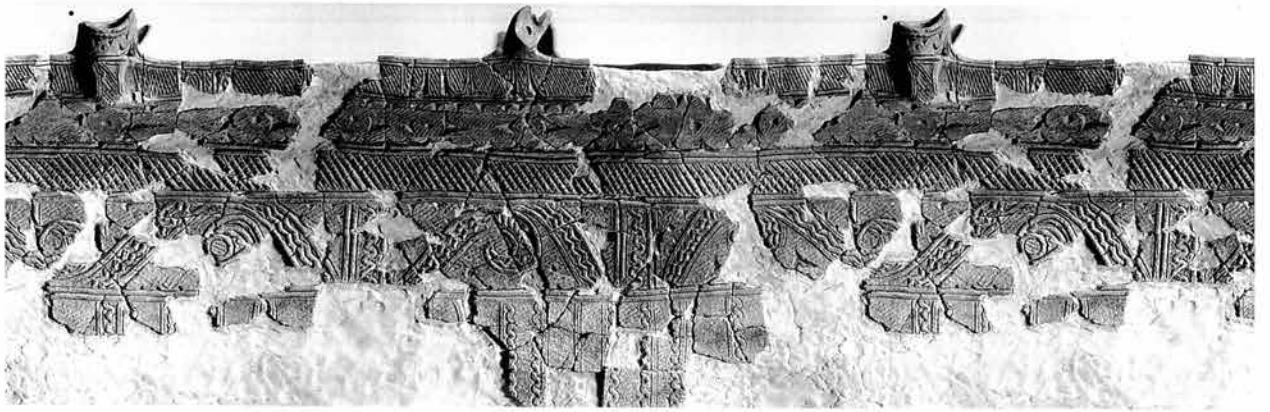

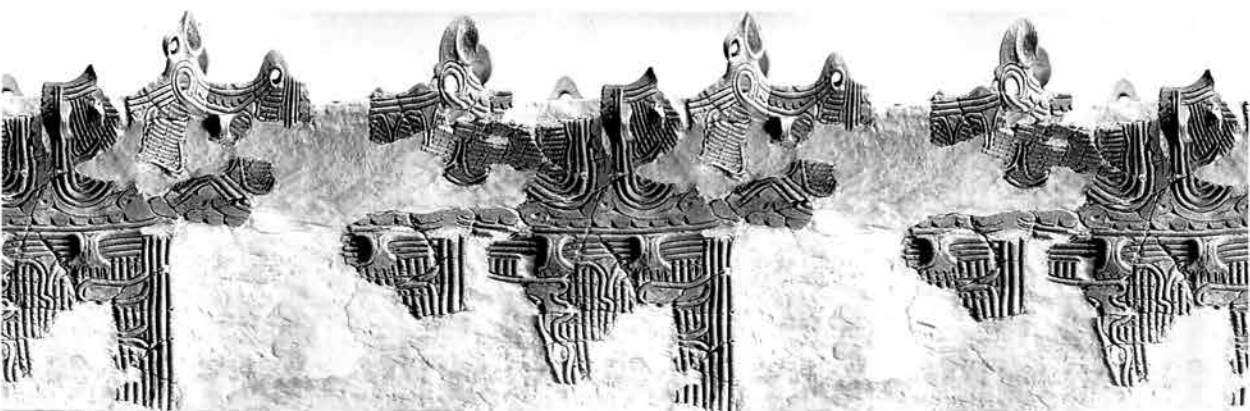
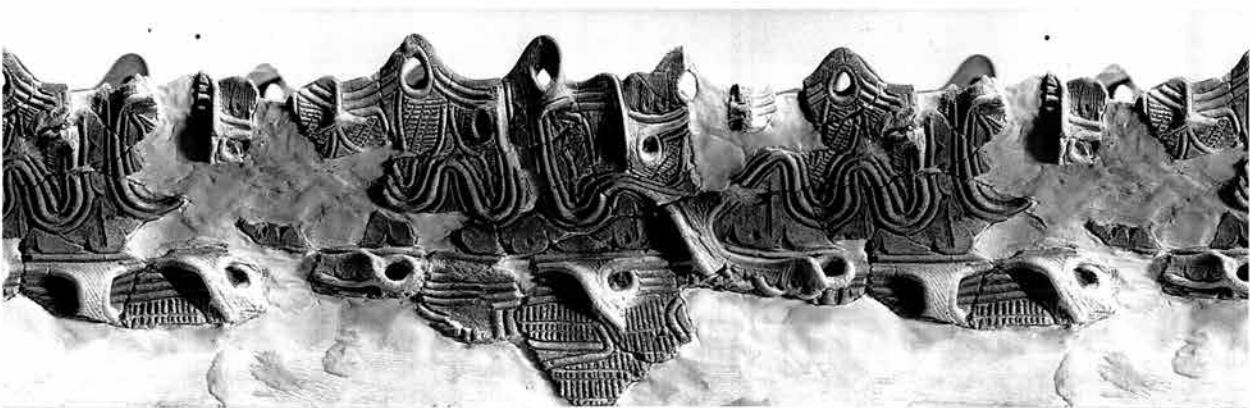
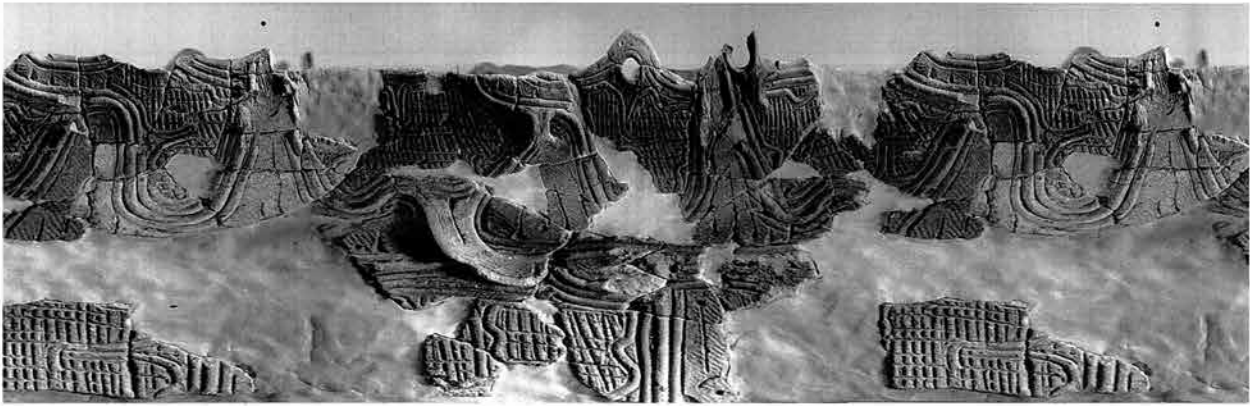
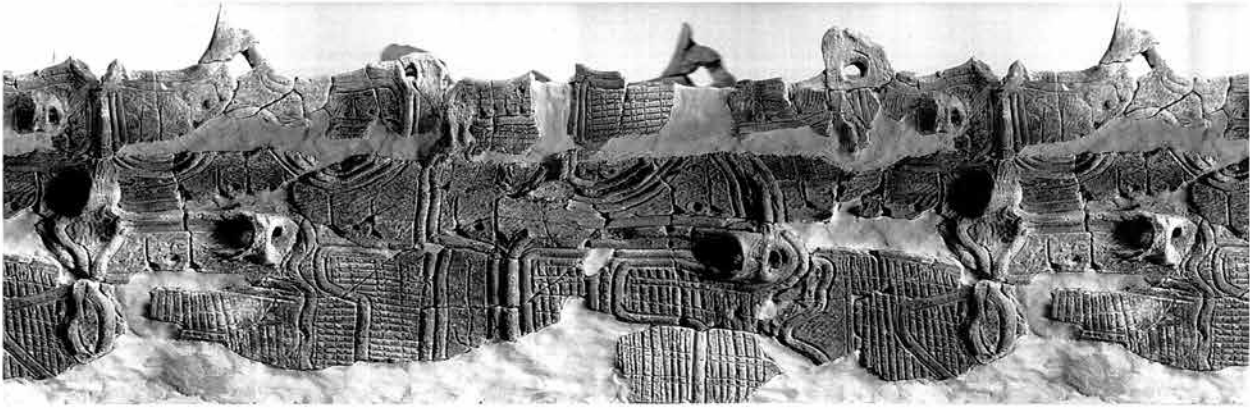

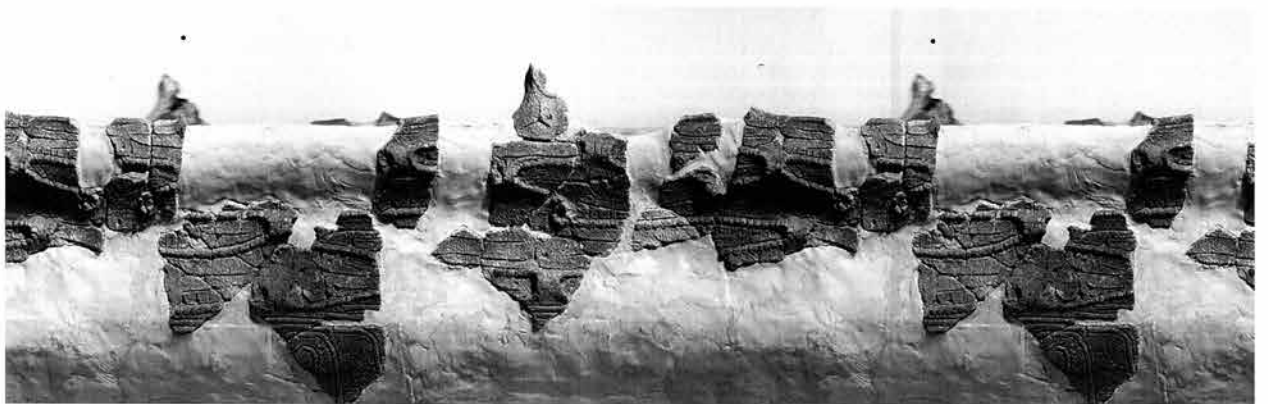

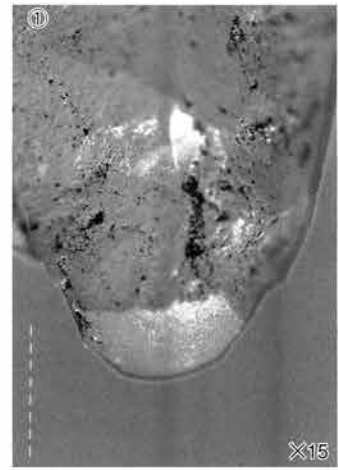
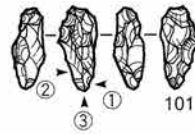
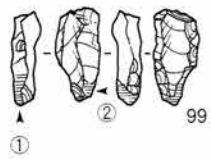

全体

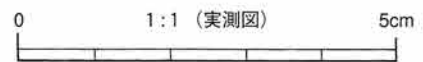
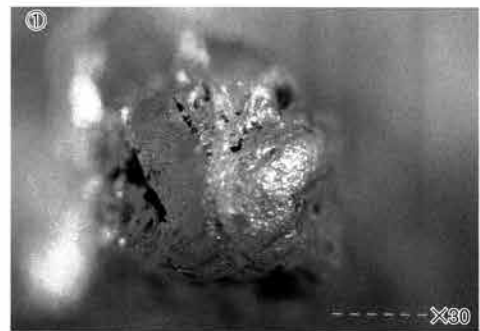
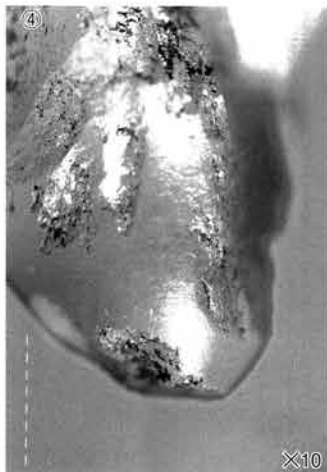
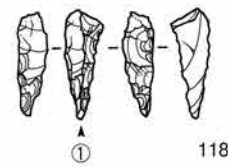
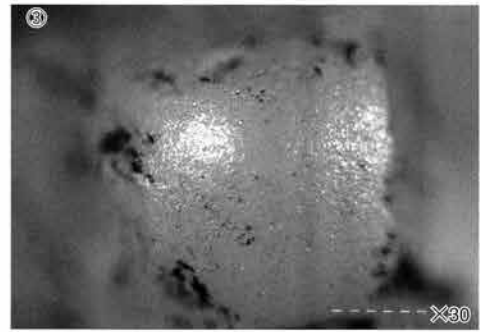
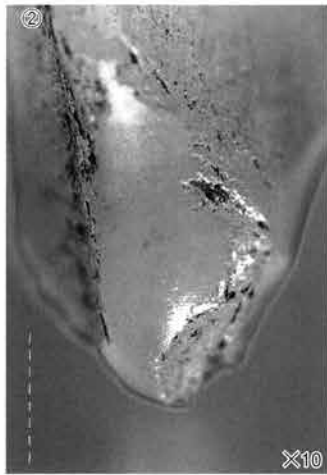
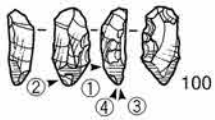
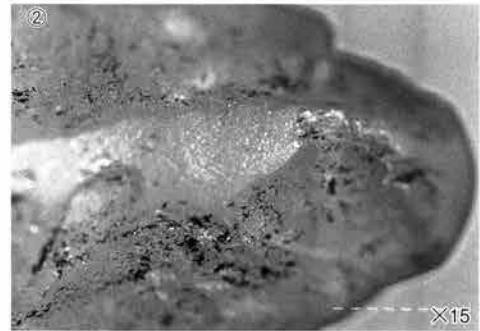

新潟県埋蔵文化財調査報告書 第93集

上信越自動車道関係発掘調査報告書 V
和泉 A 遺跡 (図版編)

平成11年 3 月30日印刷

発行・編集

新潟県教育委員会

〒950-8570 新潟市新光町 4 番地 1

電話 025 (285) 5511

平成11年 3 月31日発行

(財) 新潟県埋蔵文化財調査事業団

〒956-0845 新潟市大字金津93番地 1

電話 0250 (25) 3981

印刷・製本

(株) 第一印刷所

〒950-8724 新潟市和合町 2 丁目 4 番18号

電話 025 (285) 7161