

中央自動車道長野線
埋蔵文化財発掘調査報告書 3

—塩尻市内その2—

吉田川西遺跡

図版編

1989

日本道路公団名古屋建設局
長野県教育委員会
(財)長野県埋蔵文化財センター



例 言

- 1 本書は、吉田川西遺跡の発掘報告書の図版編である。
- 2 実測図をはじめとした図類には「図版」、写真には「PL」をつけ、それぞれ通し番号がふってある。
- 3 図の縮尺については、それぞれに示してある。
- 4 掲載した地図は、日本道路公団作成の中央自動車道長野線平面図(1:1000)、塩尻市発行の都市計画図(1:10000)をもとに作成したほか、建設省国土地理院発行の2万5千分の1および5万分の1地形図を使用した。
- 5 遺構図の凡例は以下に示した通りである。なお、大地区及びグリッドの設定については、本文編第1章でふれてある。
- 6 遺構の中で示す数値(例640.0m)は標高を示す。
- 7 遺物番号は図版、PLともに一致している。これは本文編も同様である。なお、図版中でII層出土の3の場合は、PLではII・3のように省略してある。また、図版中の遺物番号にアンダーラインのある遺物は、PLにも掲載されている。
- 8 遺物図の表現方法は、本文編の各遺物の項で説明されている。
- 9 PLのうち、古代の土器および中・近世の焼物、金属製品は約1:3を原則としている。
- 10 遺構写真の撮影は調査研究員が主に行ったが、PL 1~15は中央航業株式会社が航空測量の際に撮影したものである。



図 版 目 次

- 図版 1 吉田川西遺跡の位置 1 (1:150000)
図版 2 遺跡の位置 2・遺跡の範囲 (1:10000)
図版 3 周辺の地形と発掘調査範囲 (1:3000)
図版 4 古代遺構全体図 (1:800)
図版 5 古代遺構割り付け図
図版 6 古代遺構図 I (1:360)
図版 7 古代遺構図 II
図版 8 古代遺構図 III
図版 9 古代遺構図 IV
図版 10 古代遺構図 1 (1:120)
図版 11 古代遺構図 2
図版 12 古代遺構図 3 [古代遺構図 4 の断面図]
図版 13 古代遺構図 4
図版 14 古代遺構図 5 [古代遺構図 6 の断面図]
図版 15 古代遺構図 6
図版 16 古代遺構図 7
図版 17 古代遺構図 8 [古代遺構図 7 の断面図]
図版 18 古代遺構図 9
図版 19 古代遺構図 10
図版 20 古代遺構図 11
図版 21 古代遺構図 12 [古代遺構図 11 の断面図]
図版 22 古代遺構図 13
図版 23 古代遺構図 14
図版 24 古代遺構図 15 [古代遺構図 13・14 の断面図]
図版 25 古代遺構図 16
図版 26 古代遺構図 17
図版 27 古代遺構図 18 [古代遺構図 17 の断面図]
図版 28 古代遺構図 19 [古代遺構図 20 の断面図]
図版 29 古代遺構図 20
図版 30 古代遺構図 21
図版 31 古代遺構図 22
図版 32 古代遺構図 23
図版 33 古代遺構図 24 [古代遺構図 23 の断面図]
図版 34 古代遺構図 25 [古代遺構図 26 の断面図]
図版 35 古代遺構図 26
図版 36 古代遺構図 27 [古代遺構図 28 の断面図]
図版 37 古代遺構図 28
図版 38 古代遺構図 29
図版 39 古代遺構図 30
図版 40 古代遺構図 31 [古代遺構図 29・30・32 の断面図]
図版 41 古代遺構図 32
図版 42 古代遺構図 33 [古代遺構図 34 の断面図]
図版 43 古代遺構図 34
図版 44 古代遺構図 35
図版 45 古代遺構図 36 [古代遺構図 35 の断面図]
図版 46 古代遺構図 37
図版 47 古代遺構図 38
図版 48 古代遺構図 39 [古代遺構図 37・38 の断面図]
図版 49 中世遺構全体図
図版 50 中・近世遺構割り付け図
図版 51 中・近世遺構図 1
図版 52 中・近世遺構図 2
図版 53 中・近世遺構図 3
図版 54 中・近世遺構図 4
図版 55 中・近世遺構図 5
図版 56 中・近世遺構図 6
図版 57 中・近世遺構図 7
図版 58 中・近世遺構図 8
図版 59 中・近世遺構図 9
図版 60 中・近世遺構図 10
図版 61 中・近世遺構図 11
図版 62 中・近世遺構図 12
図版 63 中・近世遺構図 13
図版 64 中・近世遺構図 14
図版 65 中・近世遺構図 15
図版 66 中・近世遺構図 16
図版 67 中・近世遺構図 17
図版 68 中・近世遺構図 18
図版 69 中・近世遺構図 19
図版 70 中・近世遺構図 20
図版 71 中・近世遺構図 21
図版 72 近世整地土層上面遺構図 (1:360)
図版 73 近世整地土層上面遺構図 1 (1:120)
図版 74 近世整地土層上面遺構図 2
図版 75 近世整地土層上面遺構図 3
図版 76 古代以前遺物 1
図版 77 古代以前遺物 2
図版 78 古代遺物 土器 1 (SB01・02・03)
図版 79 古代遺物 土器 2 (SB04・05)
図版 80 古代遺物 土器 3 (SB05・06・07)
図版 81 古代遺物 土器 4 (SB09・10・11)

- 图版82 古代遺物 土器 5 (SB12·13·14)
 图版83 古代遺物 土器 6 (SB14·15)
 图版84 古代遺物 土器 7 (SB16·17·18·19)
 图版85 古代遺物 土器 8 (SB19·20·21·22·23·
 24)
 图版86 古代遺物 土器 9 (SB25·26·27·28)
 图版87 古代遺物 土器10 (SB28·29·30)
 图版88 古代遺物 土器11 (SB30·31·32)
 图版89 古代遺物 土器12 (SB32)
 图版90 古代遺物 土器13 (SB32)
 图版91 古代遺物 土器14 (SB32)
 图版92 古代遺物 土器15 (SB32)
 图版93 古代遺物 土器16 (SB32·33·35·36·37)
 图版94 古代遺物 土器17 (SB37·38·39·40·41·
 42·43)
 图版95 古代遺物 土器18 (SB43·44·45)
 图版96 古代遺物 土器19 (SB45·46·47·48)
 图版97 古代遺物 土器20 (SB49·50)
 图版98 古代遺物 土器21 (SB51·52·53·55)
 图版99 古代遺物 土器22 (SB55·56·57·58·59)
 图版100 古代遺物 土器23 (SB59·60·61·63)
 图版101 古代遺物 土器24 (SB64·65·66)
 图版102 古代遺物 土器25 (SB66·67·68·69)
 图版103 古代遺物 土器26 (SB70·71·72·73)
 图版104 古代遺物 土器27 (SB74·75)
 图版105 古代遺物 土器28 (SB76·77·78·79)
 图版106 古代遺物 土器29 (SB80)
 图版107 古代遺物 土器30 (SB80·81·83)
 图版108 古代遺物 土器31 (SB83·84)
 图版109 古代遺物 土器32 (SB85·86·87)
 图版110 古代遺物 土器33 (SB87·88·89·90·91)
 图版111 古代遺物 土器34 (SB91·93·94)
 图版112 古代遺物 土器35 (SB94·95)
 图版113 古代遺物 土器36 (SB96·97·98·99)
 图版114 古代遺物 土器37 (SB99)
 图版115 古代遺物 土器38 (SB100·101·102)
 图版116 古代遺物 土器39 (SB102·103·104·105·
 106)
 图版117 古代遺物 土器40 (SB107·108·109·110)
 图版118 古代遺物 土器41 (SB111)
 图版119 古代遺物 土器42 (SB111·112·113)
 图版120 古代遺物 土器43 (SB114·115)
 图版121 古代遺物 土器44 (SB115·116·117·118)
 图版122 古代遺物 土器45 (SB119·120·121·122·
 123·124)
 图版123 古代遺物 土器46 (SB125·126·127·128·
 129·130·132)
 图版124 古代遺物 土器47 (SB133·134·135·136·
 137·139)
 图版125 古代遺物 土器48 (SB140·141)
 图版126 古代遺物 土器49 (SB141·142·143)
 图版127 古代遺物 土器50 (SB144·145·146)
 图版128 古代遺物 土器51 (SB147·148·150·154·
 156·157)
 图版129 古代遺物 土器52 (SB158·159·160·161)
 图版130 古代遺物 土器53 (SB162·163·164·165·
 166)
 图版131 古代遺物 土器54 (SB167·168)
 图版132 古代遺物 土器55 (SB169·170·171·172·
 174)
 图版133 古代遺物 土器56 (SB175·176·177·178·
 179·180·181·182)
 图版134 古代遺物 土器57 (SB183·184)
 图版135 古代遺物 土器58 (SB185·186·187)
 图版136 古代遺物 土器59 (SB188·189·190)
 图版137 古代遺物 土器60 (SB191·192·193)
 图版138 古代遺物 土器61 (SB194·195·196·197)
 图版139 古代遺物 土器62 (SB198·199·200·201)
 图版140 古代遺物 土器63 (SB201·202·203·204·
 207·209)
 图版141 古代遺物 土器64 (SB209·210·211·212·
 213·214)
 图版142 古代遺物 土器65 (SB215·216)
 图版143 古代遺物 土器66 (SB217·218·219·220·
 221·222·224)
 图版144 古代遺物 土器67 (SB225·226·227)
 图版145 古代遺物 土器68 (SB227·228·230)
 图版146 古代遺物 土器69 (SB232·233)
 图版147 古代遺物 土器70 (SB234)
 图版148 古代遺物 土器71 (SB235·236·237·238·
 239·240·241·242·243·244·245)
 图版149 古代遺物 土器72 (SB246)
 图版150 古代遺物 土器73 (SB246·247·248)
 图版151 古代遺物 土器74 (SB249·250·251·252·
 256)
 图版152 古代遺物 土器75 (SB258·259·260)
 图版153 古代遺物 土器76 (SB261·262·263)
 图版154 古代遺物 土器77 (SB264)
 图版155 古代遺物 土器78 (SB265·266·267·268·
 269·271)

- 図版156 古代遺物 土器79 (SK)
 図版157 古代遺物 土器80 (SK)
 図版158 古代遺物 土器81 (SK)
 図版159 古代遺物 土器82 (SK)
 図版160 古代遺物 土器83 (SK)
 図版161 古代遺物 土器84 (SK)
 図版162 古代遺物 土器85 (墓)
 図版163 古代遺物 土器86 (SD)
 図版164 古代遺物 土器87 (SD)
 図版165 古代遺物 土器88 (SD・NR)
 図版166 古代遺物 土器89 (ST・SX)
 図版167 古代遺物 土器90 (遺構外F・G・H地区)
 図版168 古代遺物 土器91 (遺構外I・K・L・M地区)
 図版169 古代遺物 土器92 (遺構外M・N地区)
 図版170 古代遺物 土器93 (遺構外N・O地区)
 図版171 古代遺物 土器94 (遺構外O地区)
 図版172 古代遺物 土器95 (遺構外O・P・S地区)
 図版173 古代遺物 土器96 (遺構外S・T・Z地区)
 図版174 金属製品1 (SB01~30)
 図版175 金属製品2 (SB31・32)
 図版176 金属製品3 (SB32~68)
 図版177 金属製品4 (SB66~74)
 図版178 金属製品5 (SB78~115)
 図版179 金属製品6 (SB101~170)
 図版180 金属製品7 (SB167~256)
 図版181 金属製品8 (SB262~266・SK・SD・SM)
 図版182 金属製品9 (SD・NR・II層)
 図版183 金属製品10 (II層)
 図版184 金属製品11 (II・I層)
 図版185 金属製品12 (I層)
 図版186 金属製品13 (I層)
 図版187 金属製品14 (近世遺構)
 図版188 金属製品15 (近世遺構)
 図版189 銭貨
 図版190 鍛冶関係資料1 (羽口・鉄滓)
 図版191 鍛冶関係資料2 (砥石)
 図版192 鍛冶関係資料3 (砥石)
 図版193 古代遺物 文字関係資料1 (墨書土器1)
 図版194 古代遺物 文字関係資料2 (墨書土器2)
 図版195 古代遺物 文字関係資料3 (墨書土器3)
 図版196 古代遺物 文字関係資料4 (墨書土器4)
 図版197 古代遺物 文字関係資料5 (墨書土器5)
 図版198 古代遺物 文字関係資料6 (墨書土器6)
 図版199 古代遺物 文字関係資料7 (墨書土器7)
 図版200 古代遺物 文字関係資料8 (墨書土器8)
 図版201 古代遺物 文字関係資料9 (墨書土器9)
 図版202 古代遺物 文字関係資料10 (墨書土器10)
 図版203 古代遺物 文字関係資料11 (墨書土器11)
 図版204 古代遺物 文字関係資料12 (刻書・篋書土器1)
 図版205 古代遺物 文字関係資料13 (刻書・篋書土器2)
 図版206 古代遺物 文字関係資料14 (刻書・篋書土器3)
 図版207 古代遺物 文字関係資料15 (筆・硯1)
 図版208 古代遺物 文字関係資料16 (硯2)
 図版209 古代遺物 文字関係資料17 (硯3)
 図版210 古代遺物 文字関係資料18 (硯4)
 図版211 古代遺物 土製品・木製品
 図版212 中・近世遺物1 (焼物1)
 図版213 中・近世遺物2 (焼物2)
 図版214 中・近世遺物3 (焼物3)
 図版215 中・近世遺物4 (焼物4)
 図版216 中・近世遺物5 (焼物5)
 図版217 中・近世遺物6 (焼物6)
 図版218 中・近世遺物7 (焼物7)
 図版219 中・近世遺物8 (焼物8)
 図版220 中・近世遺物9 (焼物9)
 図版221 中・近世遺物10 (焼物10)
 図版222 中・近世遺物11 (焼物11)
 図版223 中・近世遺物12 (焼物12)
 図版224 中・近世遺物13 (焼物13)
 図版225 中・近世遺物14 (焼物14・石製品1)
 図版226 中・近世遺物15 (石製品2)
 図版227 中・近世遺物16 (石製品3)
 図版228 中・近世遺物17 (石製品4)

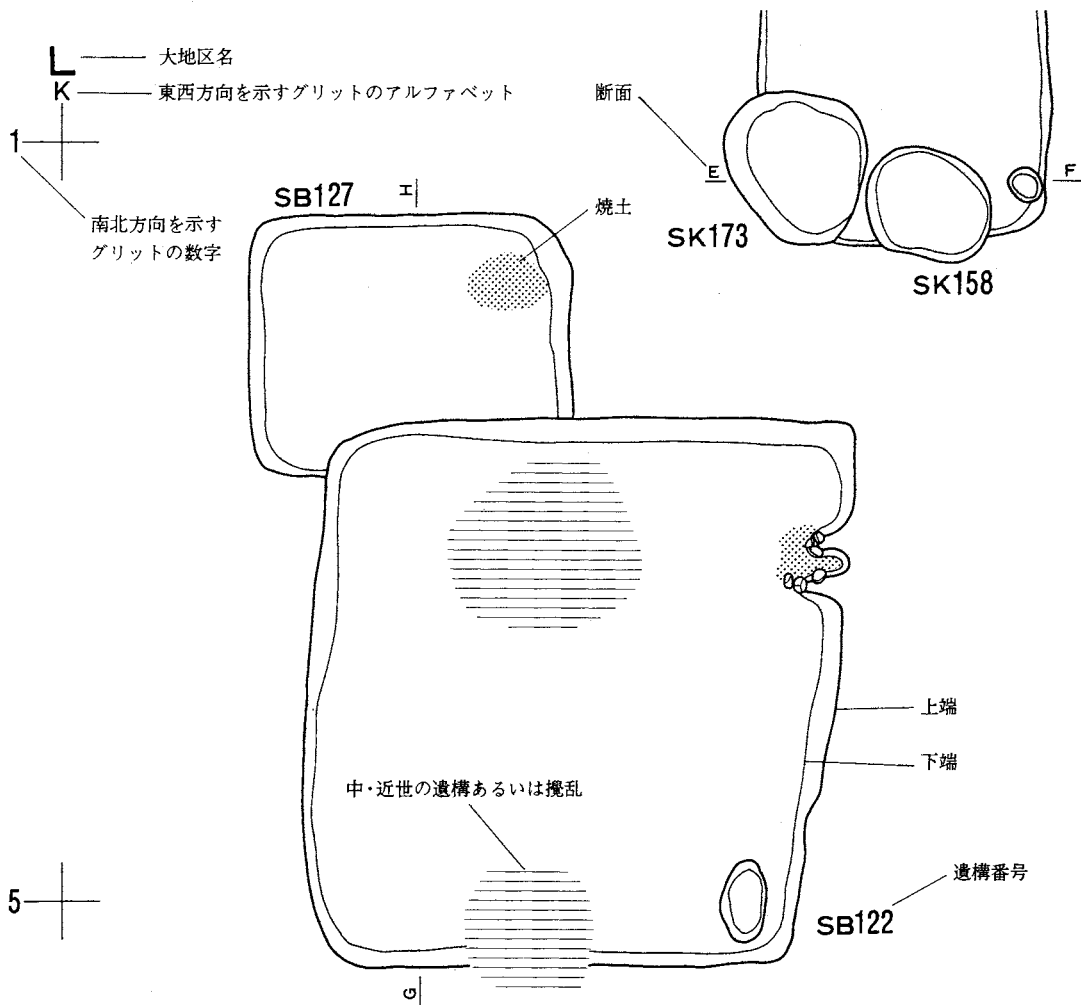
写真図版目次

- | | |
|--|---|
| PL 1 遺跡全景 | PL40 古代遺構25(SB232・234カマド、SB234、SB249) |
| PL 2 調査区全景 | PL41 古代遺構26(SB242・249カマド、SB250、SB258) |
| PL 3 遺構垂直写真1 (N地区、N・S地区) | PL42 古代遺構27 (SB259、SB264、SB266) |
| PL 4 遺構垂直写真2 (O地区東部、O地区南部) | PL43 古代遺構28 (ST201、ST204、ST206) |
| PL 5 遺構垂直写真3 (M地区、K・L地区) | PL44 古代遺構29 (ST208、O地区北東部柱穴群、ST205) |
| PL 6 遺構垂直写真4 (L・M地区、M地区西部) | PL45 古代遺構30(SD17、SD19・25、SM01、SK128) |
| PL 7 遺構垂直写真5 (O地区、S地区) | PL46 古代遺構31(SX21、SK21、SK42、SK73、SK84、SK218) |
| PL 8 遺構垂直写真6 (O地区北部、O地区南部) | PL47 中・近世遺構1 (ST05、SB1121、SB1179) |
| PL 9 遺構垂直写真7 (G地区、L地区) | PL48 中・近世遺構2 (SD02、ST02、SK1123、SK1252) |
| PL10 遺構垂直写真8 (F・G地区、K・L地区) | PL49 中・近世遺構3 (SK1231~1236、SK1141・1142、SK1217、SK1221、SK1244) |
| PL11 遺構垂直写真9 (O地区北部、O地区南部) | PL50 中・近世遺構4 (近世整地土層上面遺構) |
| PL12 遺構垂直写真10 (N地区北部、N地区南部) | PL51 中・近世遺構5 (ST2004、ST2001、ST2003) |
| PL13 遺構垂直写真11 (H・M地区、M地区) | PL52 中・近世遺構6 (整地土層上面礫分布、ST2002) |
| PL14 遺構垂直写真12 (H地区、L・M地区) | PL53 中・近世遺構7 (SE01、SK2013) |
| PL15 遺構垂直写真13 (G地区、M地区) | PL54 古代以前遺物 (縄文時代、弥生時代) |
| PL16 古代遺構1 (SB05、SB14) | PL55 古代土器1 (SB01~05) |
| PL17 古代遺構2 (SB17、SB20、SB21) | PL56 古代土器2 (SB05~16) |
| PL18 古代遺構3 (SB22、SB23、SB26) | PL57 古代土器3 (SB11~18) |
| PL19 古代遺構4 (SB27、SB29、SB30) | PL58 古代土器4 (SB17~22) |
| PL20 古代遺構5 (SB19・28カマド、SB32) | PL59 古代土器5 (SB22~31) |
| PL21 古代遺構6 (SB32、SB33、SB40) | PL60 古代土器6 (SB32・33) |
| PL22 古代遺構7 (SB42、SB44、SB48) | PL61 古代土器7 (SB35~45) |
| PL23 古代遺構8 (SB45・49カマド、SB49、SB50) | PL62 古代土器8 (SB45~49) |
| PL24 古代遺構9 (SB56、SB59、SB58) | PL63 古代土器9 (SB49~59) |
| PL25 古代遺構10 (SB58・83カマド、SB63、SB66) | PL64 古代土器10 (SB59~66) |
| PL26 古代遺構11 (SB69、SB70、SB71) | PL65 古代土器11 (SB69~72) |
| PL27 古代遺構12 (SB73、SB74、SB76) | PL66 古代土器12 (SB73~76) |
| PL28 古代遺構13 (SB81、SB85・86カマド、SB86) | PL67 古代土器13 (SB76~80) |
| PL29 古代遺構14 (SB95、SB95・112カマド、SB98) | PL68 古代土器14 (SB81~84) |
| PL30 古代遺構15 (SB99、SB100) | PL69 古代土器15 (SB84~88) |
| PL31 古代遺構16 (SB102、SB108、SB115) | PL70 古代土器16 (SB91~99) |
| PL32 古代遺構17 (SB118、SB128、SB129) | PL71 古代土器17 (SB99~102) |
| PL33 古代遺構18 (SB132、SB139、SB139・226カマド) | PL72 古代土器18 (SB103~114) |
| PL34 古代遺構19 (SB142、SB156、SB160) | PL73 古代土器19 (SB111~116) |
| PL35 古代遺構20 (SB144、SB162) | PL74 古代土器20 (SB115~128) |
| PL36 古代遺構21 (SB167、SB168、SB170) | PL75 古代土器21 (SB128~140) |
| PL37 古代遺構22 (SB187、SB188、SB188・230カマド) | PL76 古代土器22 (SB141~144) |
| PL38 古代遺構23 (SB200、SB209、SB210) | |
| PL39 古代遺構24 (SB213、SB227、SB232) | |

- PL77 古代土器23 (SB144~154)
- PL78 古代土器24 (SB158~170)
- PL79 古代土器25 (SB174~186)
- PL80 古代土器26 (SB184~188)
- PL81 古代土器27 (SB189~192)
- PL82 古代土器28 (SB194~207)
- PL83 古代土器29 (SB209~216)
- PL84 古代土器30 (SB226~227)
- PL85 古代土器31 (SB227~234)
- PL86 古代土器32 (SB237~248)
- PL87 古代土器33 (SB247~263)
- PL88 古代土器34 (SB263~268、SK128)
- PL89 古代土器35 (SK128、SM01、SK)
- PL90 古代土器36 (SK)
- PL91 古代土器37 (SX) 土製品・木製品
- PL92 金属製品1 (鎌)
- PL93 金属製品2 (鎌、鋤、斧、苧引鉄)
- PL94 金属製品3 (紡錘車)
- PL95 金属製品4 (刀子)
- PL96 金属製品5 (刀子、工具、他)
- PL97 金属製品6 (燧鉄、建築金具、馬具、鉄鐸、他)
- PL98 金属製品7 (鉄鏝)
- PL99 金属製品8 (鉄鏝)
- PL100 金属製品9 (釘)
- PL101 金属製品10 (その他)
- PL102 金属製品11 (近世)
- PL103 金属製品12 (銭貨)
- PL104 鍛冶関係資料1 (羽口、鉄滓)
- PL105 鍛冶関係資料2 (鉄滓)
- PL106 文字関係資料1 (墨書土器1)
- PL107 文字関係資料2 (墨書土器2)
- PL108 文字関係資料3 (墨書土器3)
- PL109 文字関係資料4 (墨書土器4)
- PL110 文字関係資料5 (墨書土器5)
- PL111 文字関係資料6 (刻書土器・窠書土器・硯・筆穂先)
- PL112 中・近世遺物1 (焼物1)
- PL113 中・近世遺物2 (焼物2)
- PL114 中・近世遺物3 (焼物3)
- PL115 中・近世遺物4 (焼物4)
- PL116 中・近世遺物5 (焼物5)
- PL117 中・近世遺物6 (焼物6)
- PL118 中・近世遺物7 (焼物7)
- PL119 中・近世遺物8 (焼物8)
- PL120 中・近世遺物9 (焼物9)
- PL121 中・近世遺物10 (焼物10)
- PL122 中・近世遺物11 (焼物11)
- PL123 中・近世遺物12 (焼物12)
- PL124 中・近世遺物13 (焼物13)
- PL125 中・近世遺物14 (焼物14)
- PL126 中・近世遺物15 (焼物15)
- PL127 中・近世遺物16 (焼物16)
- PL128 中・近世遺物17 (焼物17・石製品1)
- PL129 中・近世遺物18 (石製品2)
- PL130 鉄滓と鉄器の金属学的解析1
- PL131 鉄滓と鉄器の金属学的解析2
- PL132 鉄滓と鉄器の金属学的解析3
- PL133 鉄滓と鉄器の金属学的解析4
- PL134 鉄滓と鉄器の金属学的解析5

図 版

財富加

「財富加」

「財」と「富」とを「加える」ことを願う呪儀に係わる墨書であろう。当時の在地仏教は現世利益を求める傾向が強く、その一端の表れであろう。(SB46出土 墨書土器)



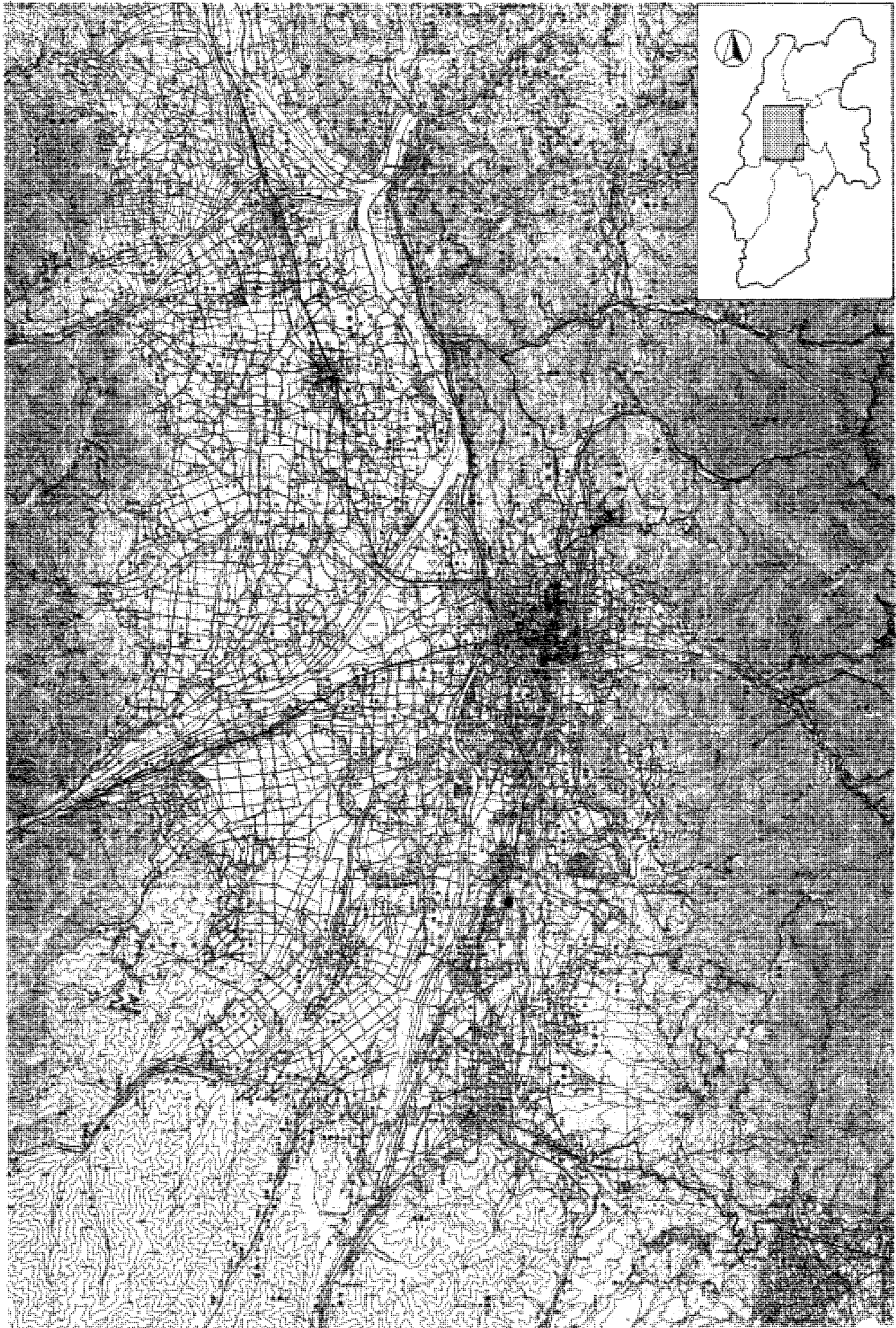

● 吉田川西遺跡

国土地理院発行 5 万分の 1 地形図「豊科・松本・塩尻」より作成



—は遺跡の範囲 1：調査範囲 2：塩尻市教育委員会調査地点
 塩尻市都市計画図より作成

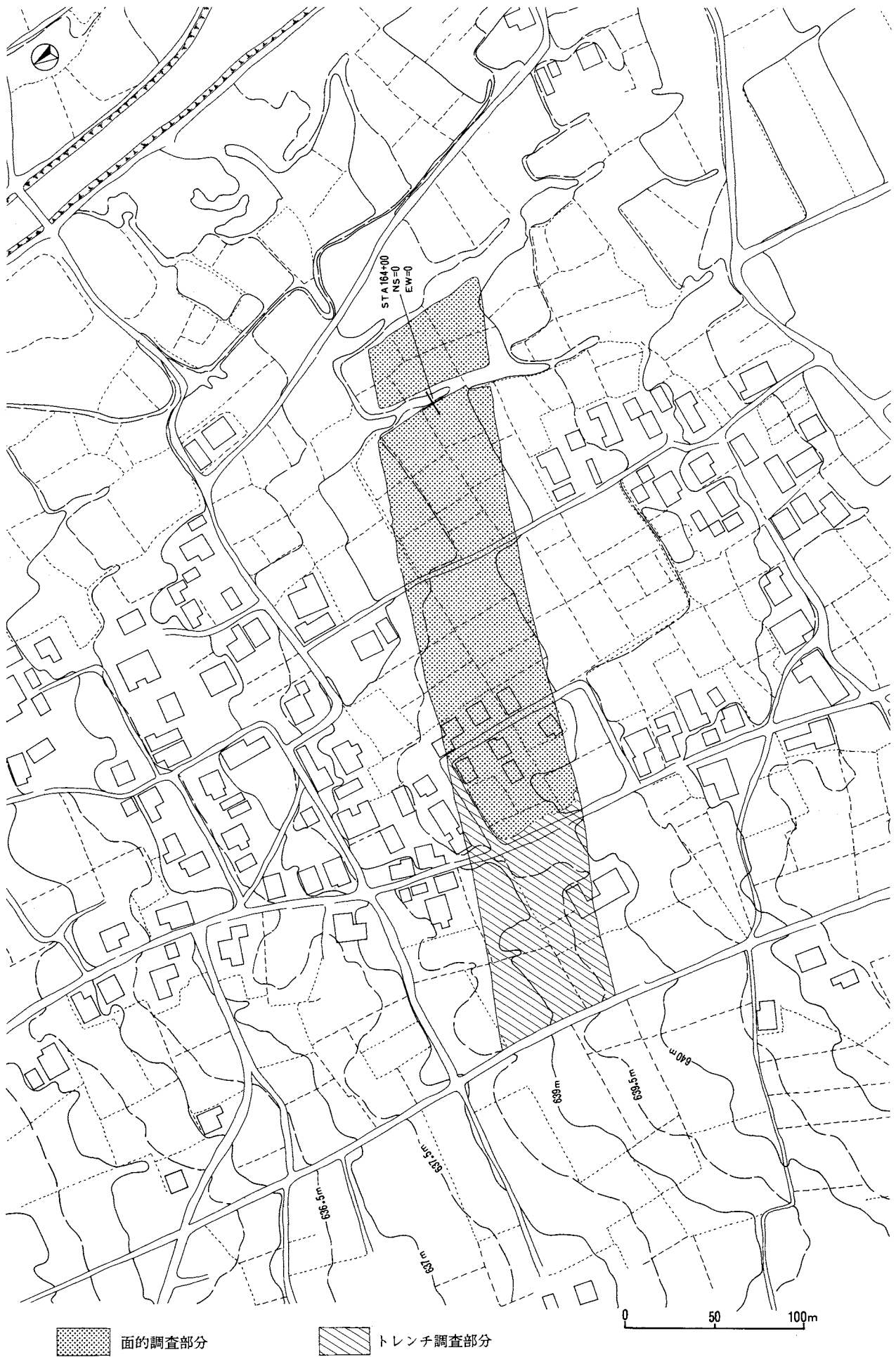



古代遺構割り付け図

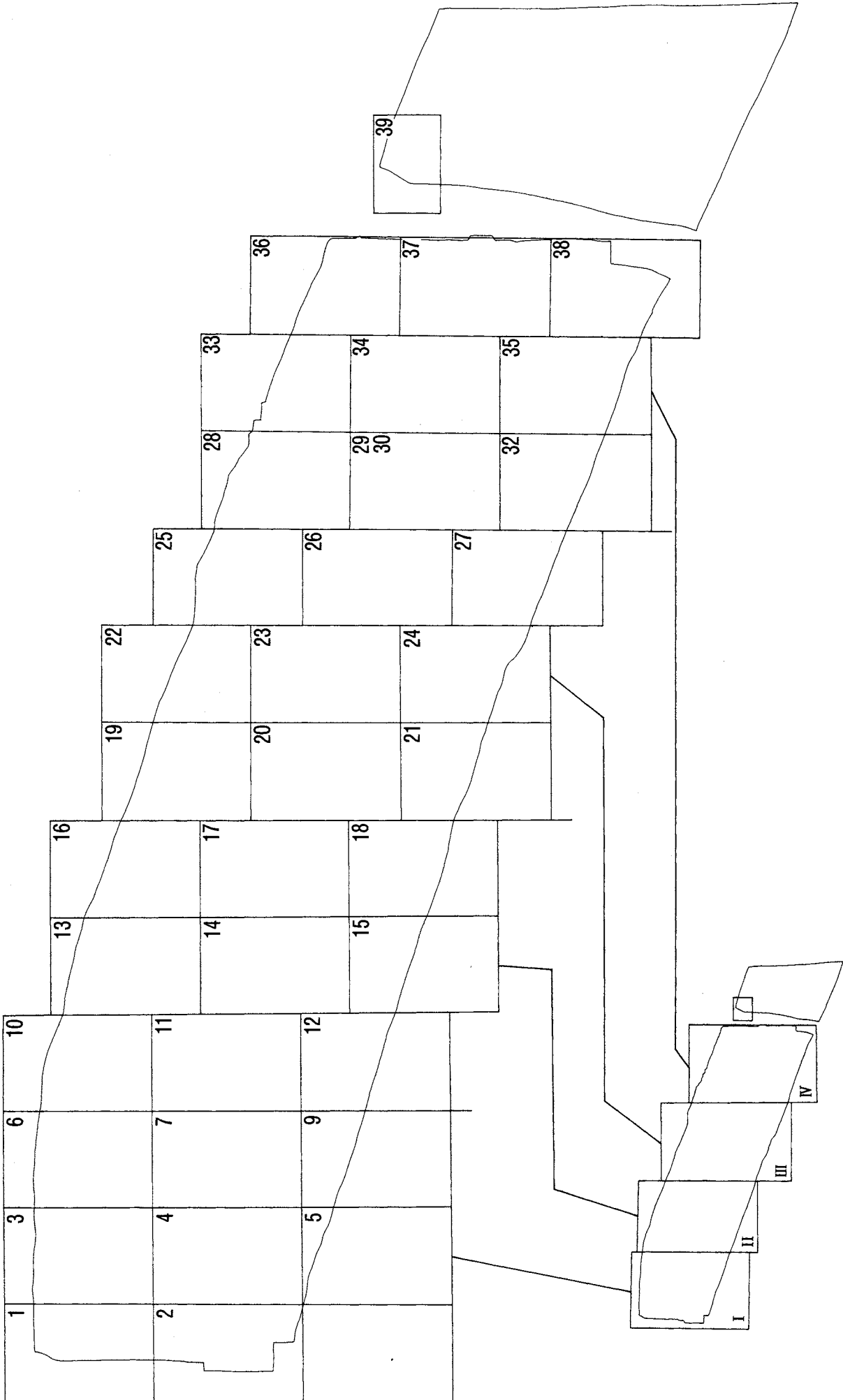

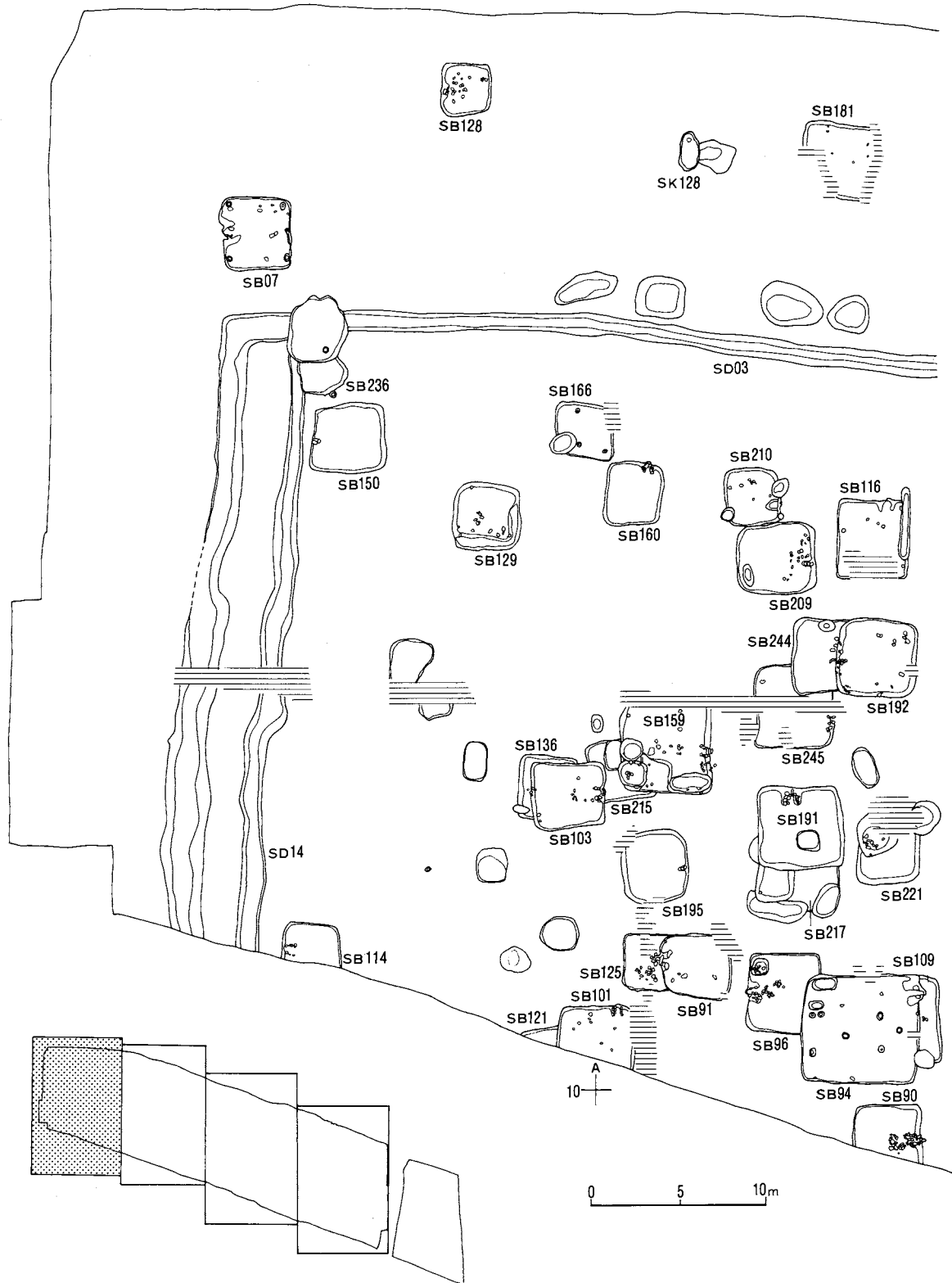

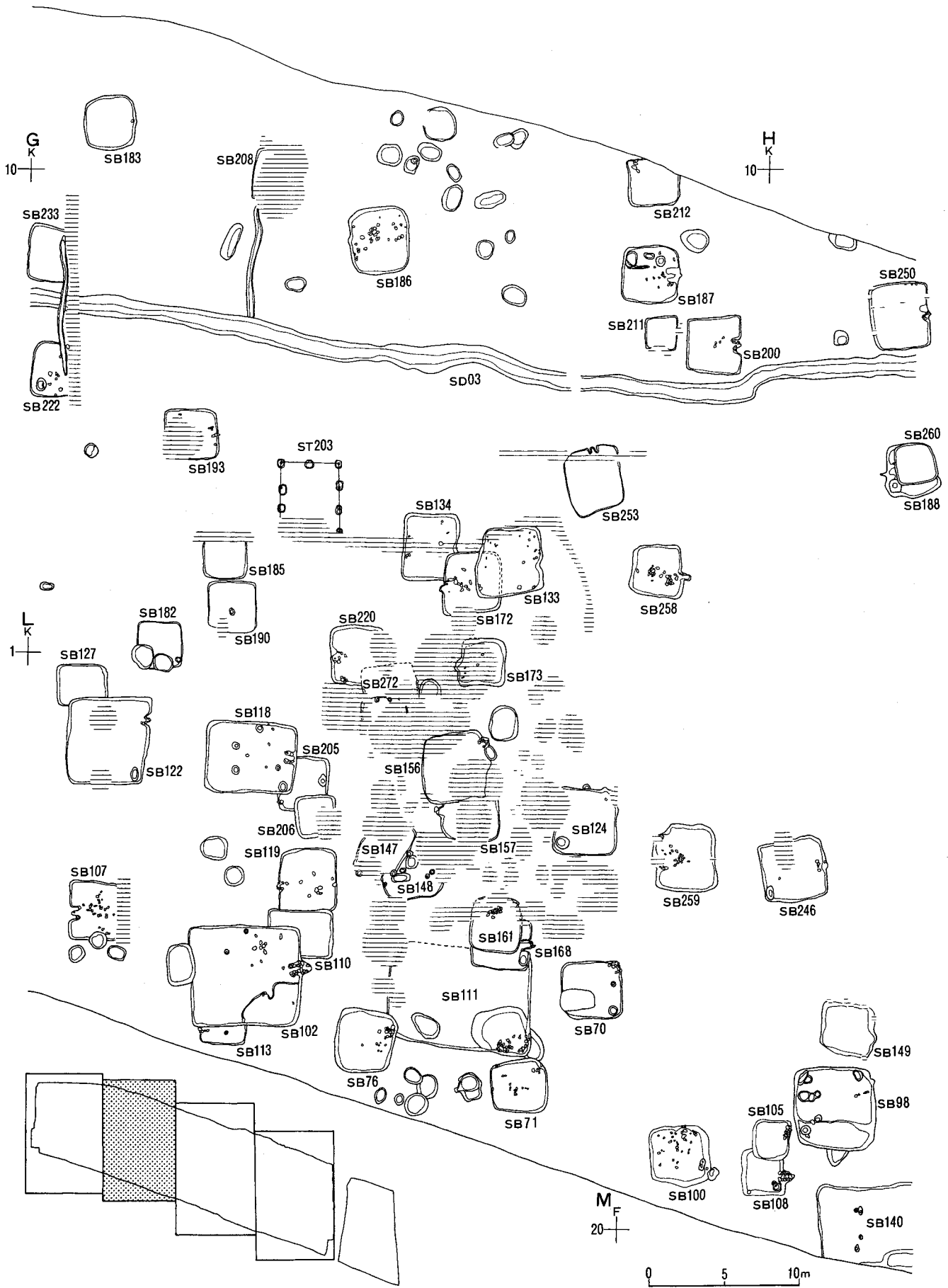

H
C
16

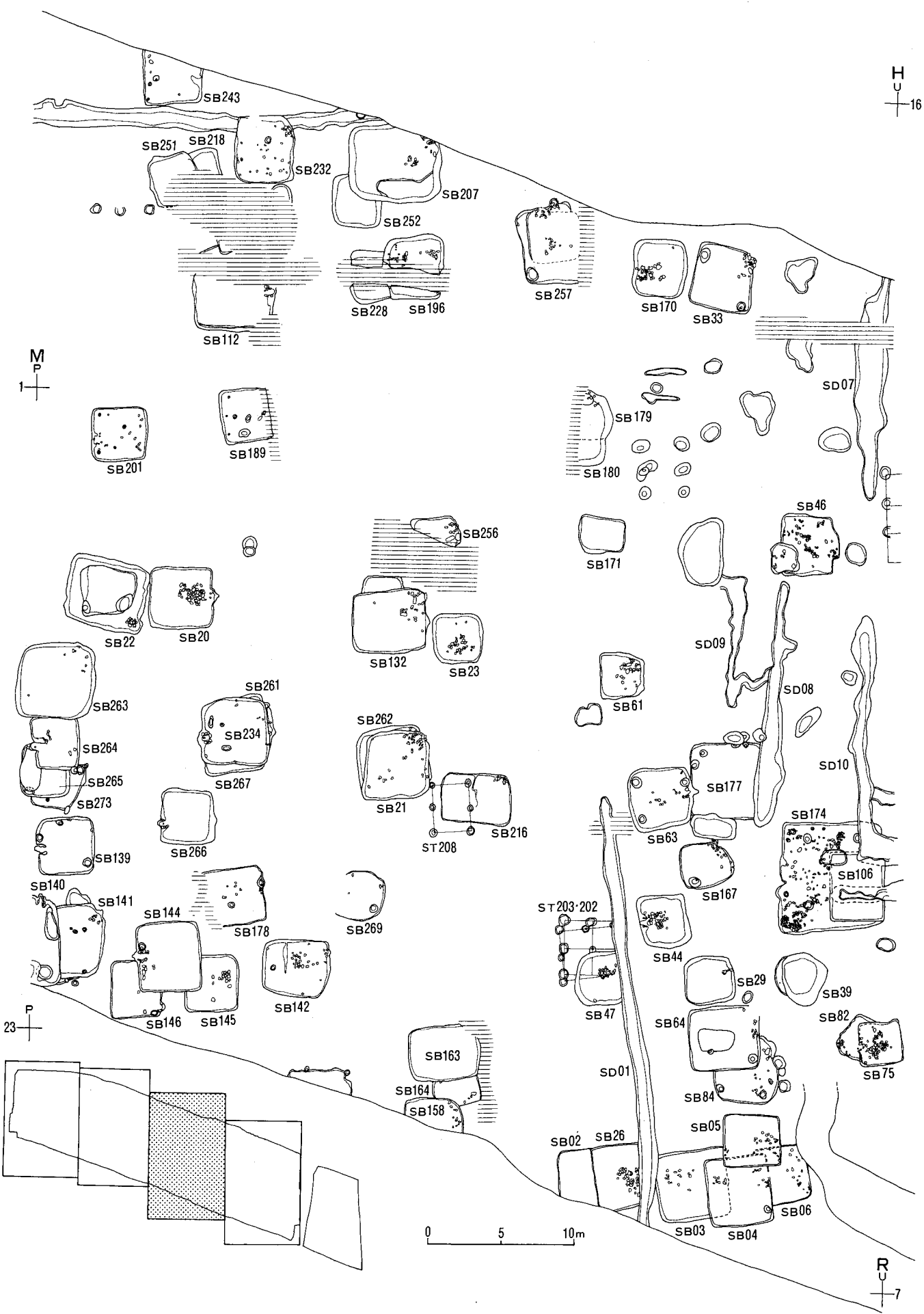

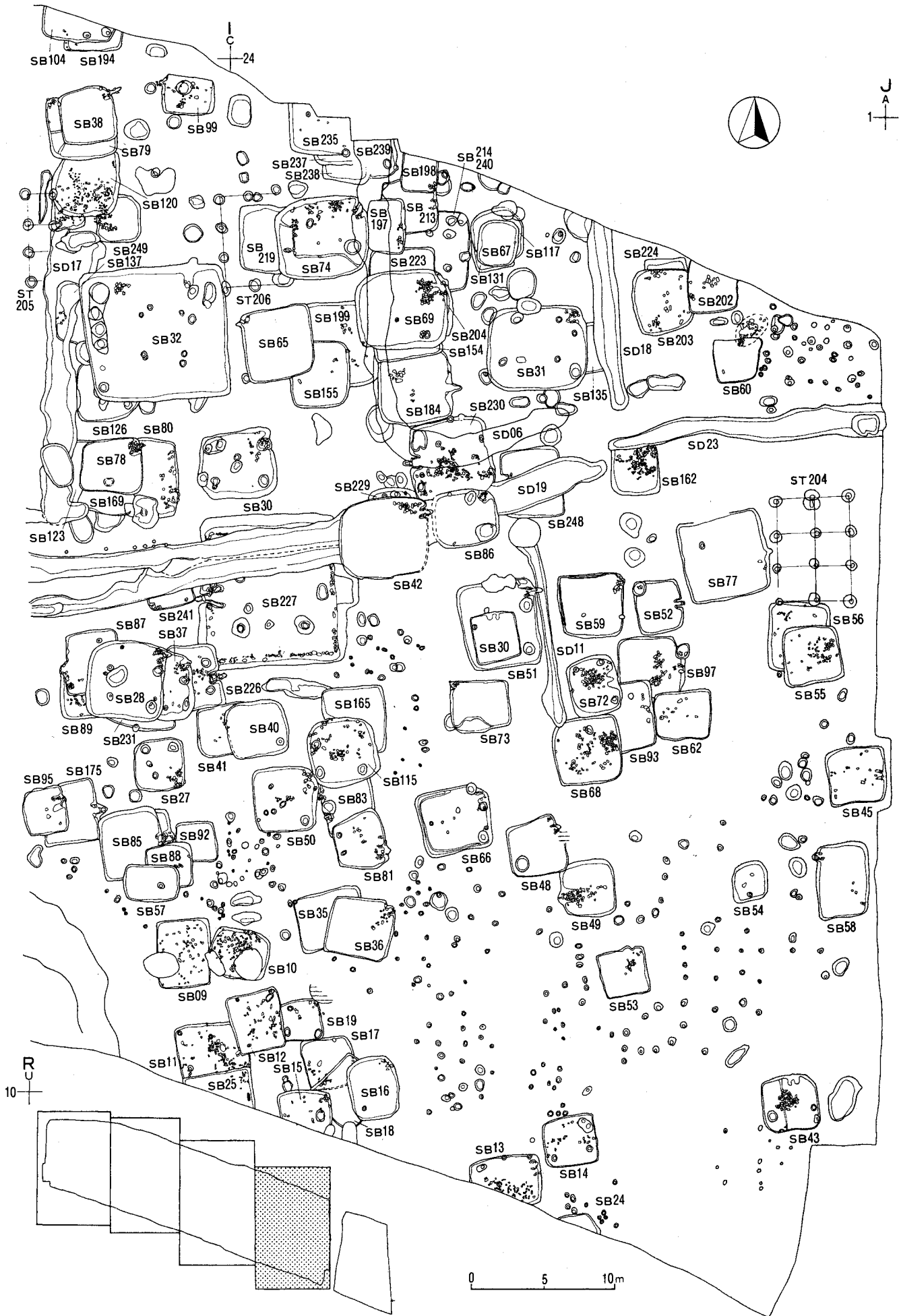

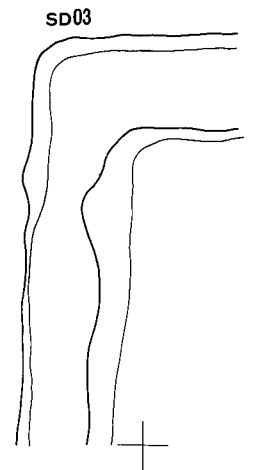
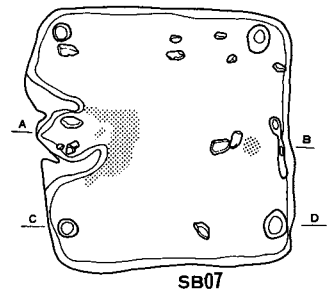
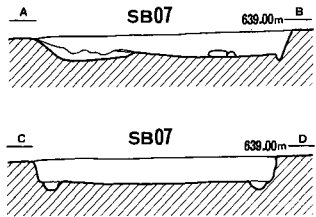
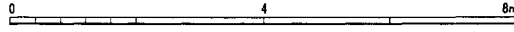
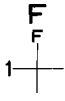

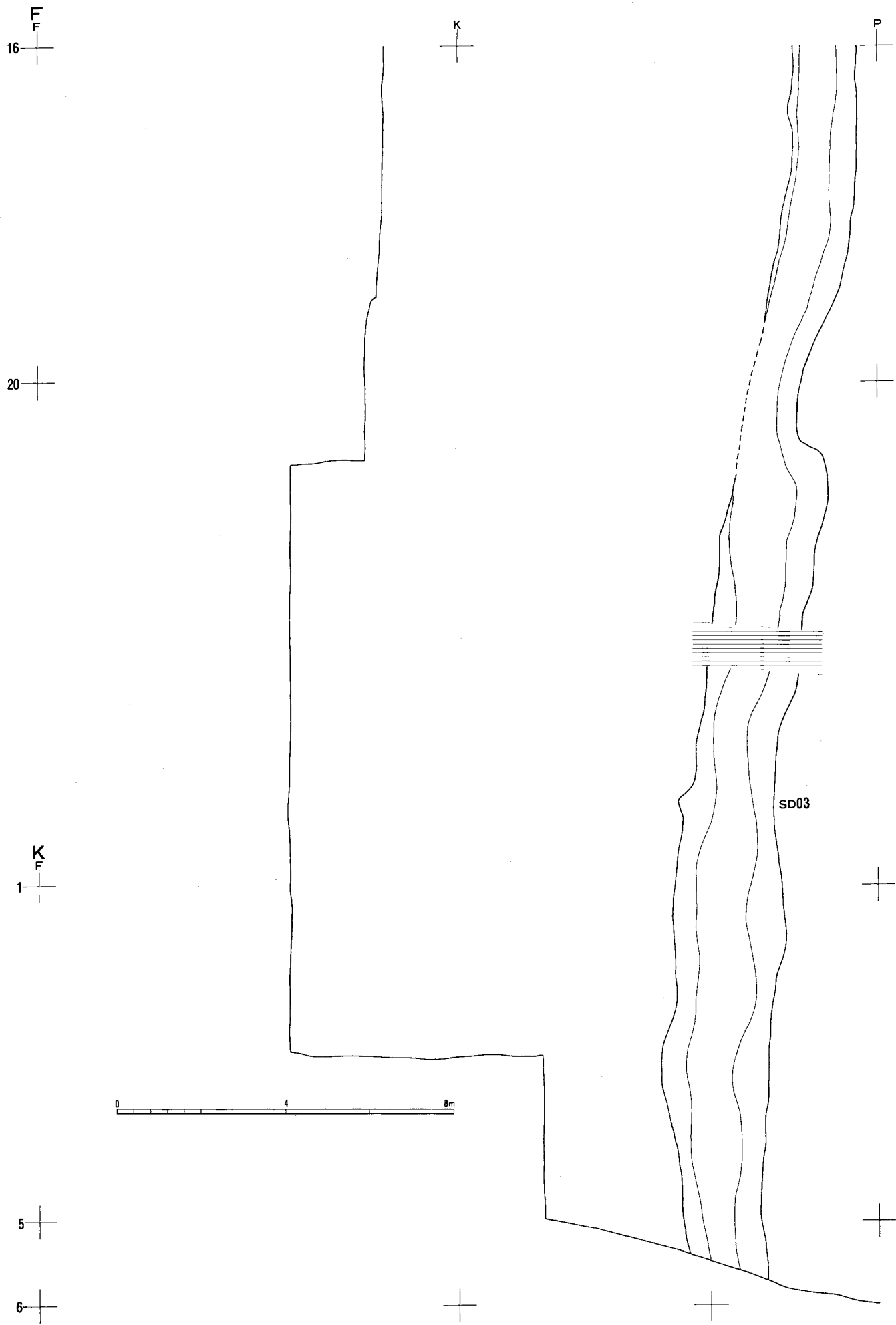



古代遺構図3 断面図

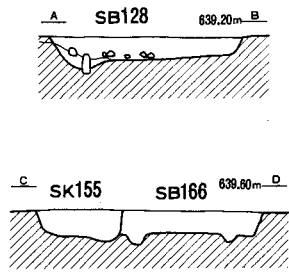

古代遺構図4 断面図

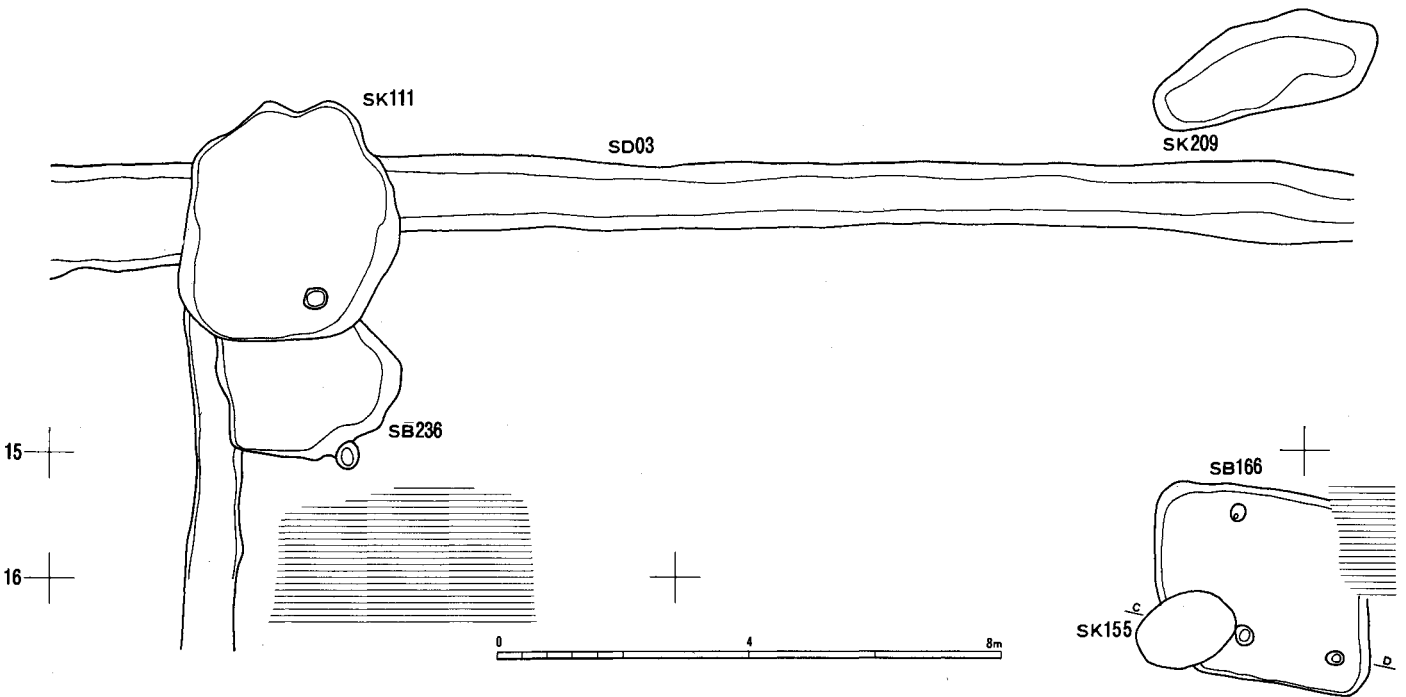
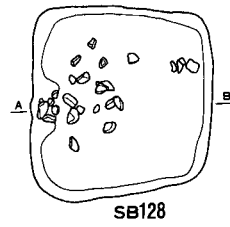
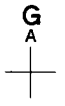
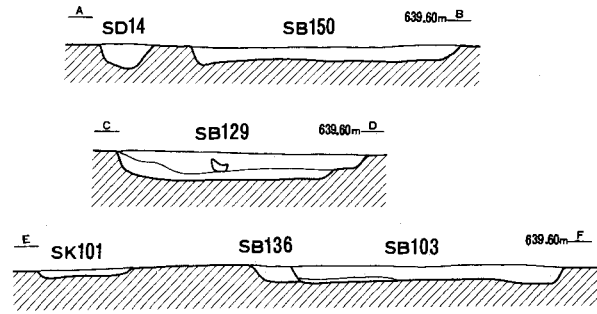

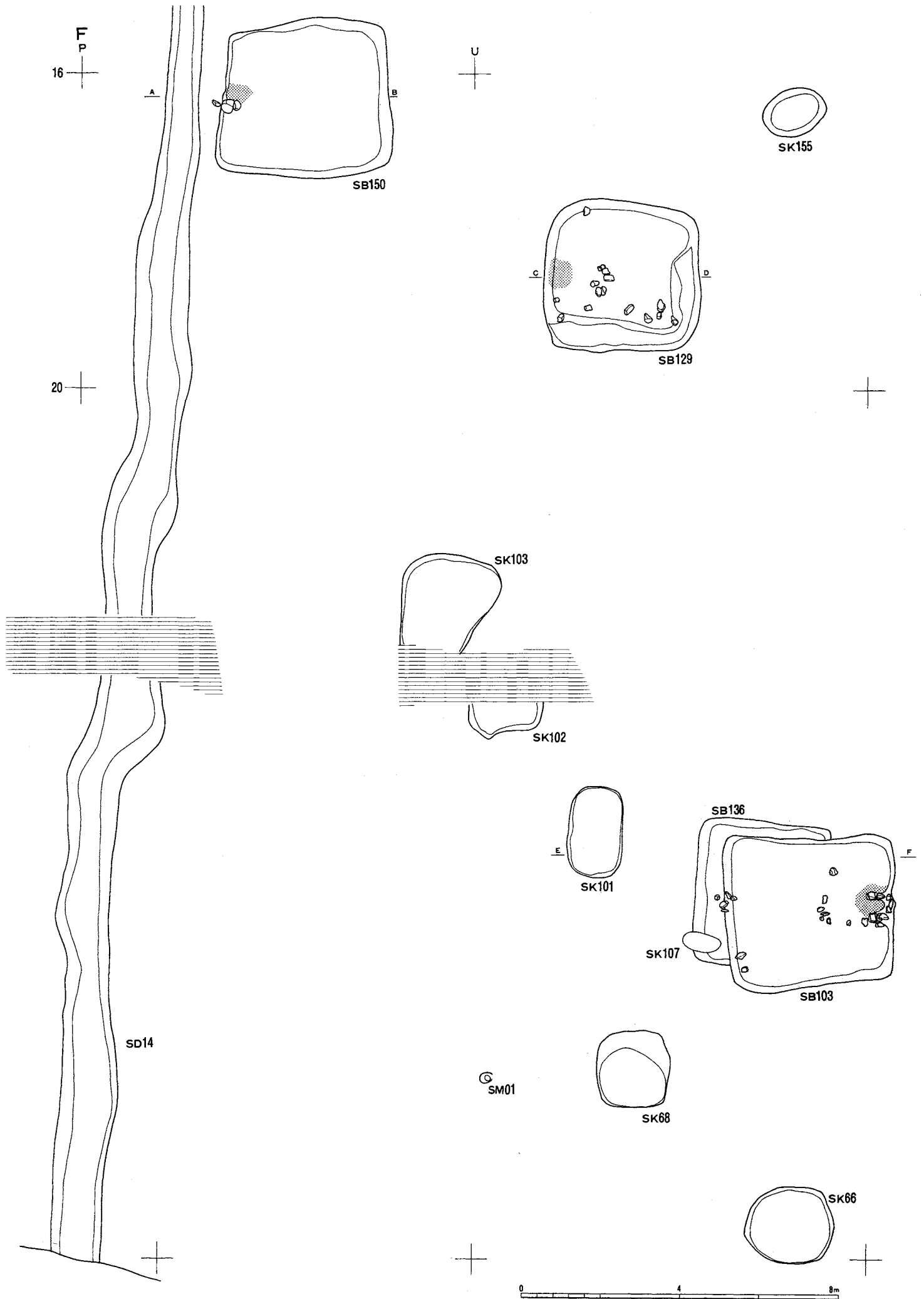

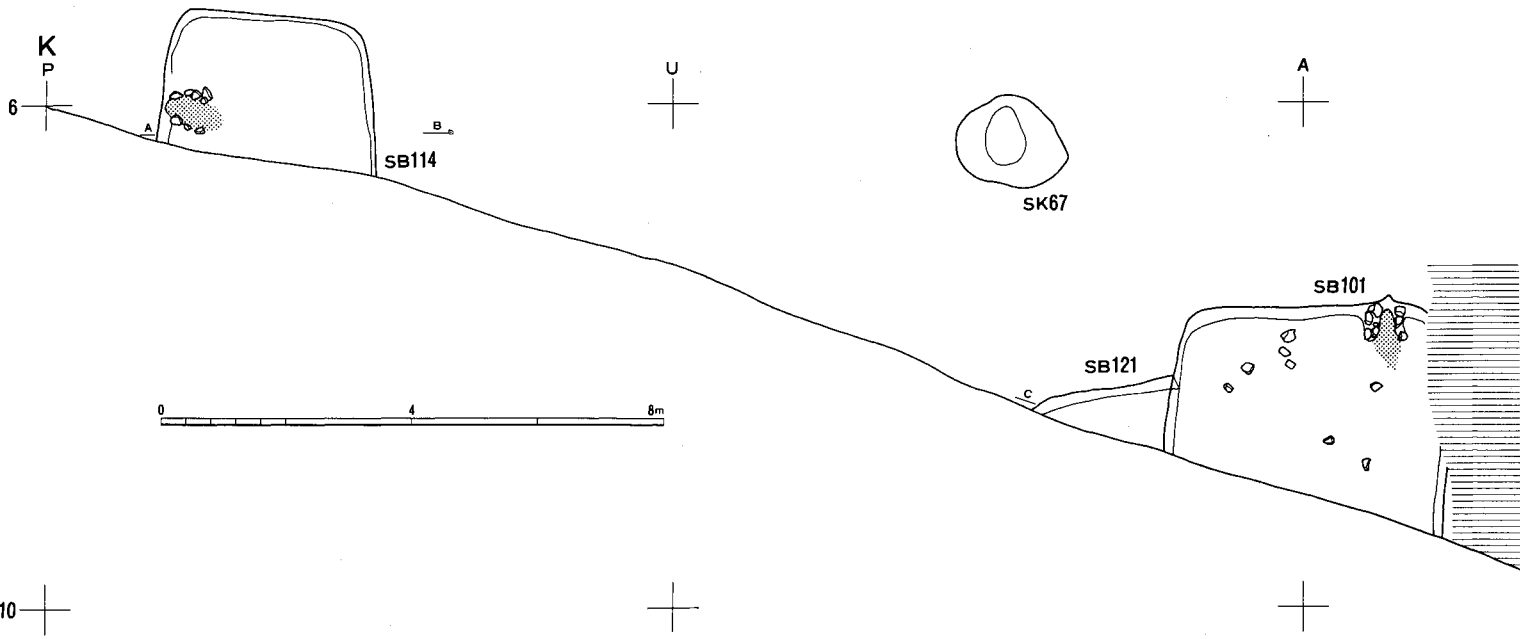

古代遺構図5 断面図

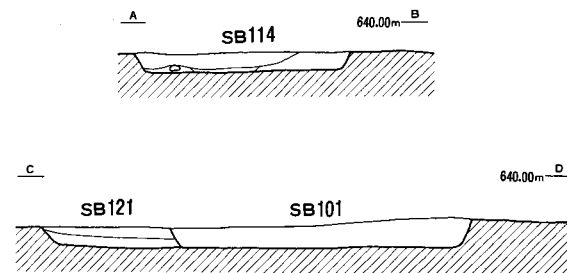

古代遺構図6 断面図



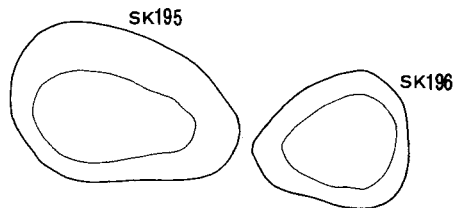
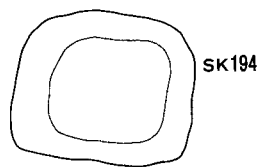
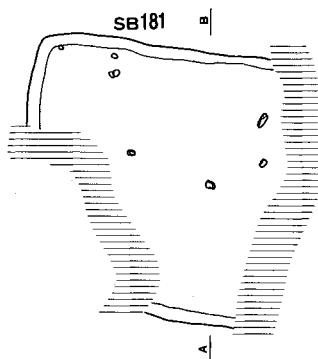
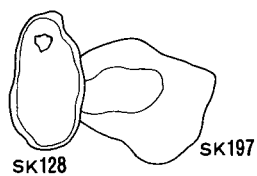
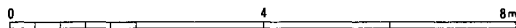

SD03



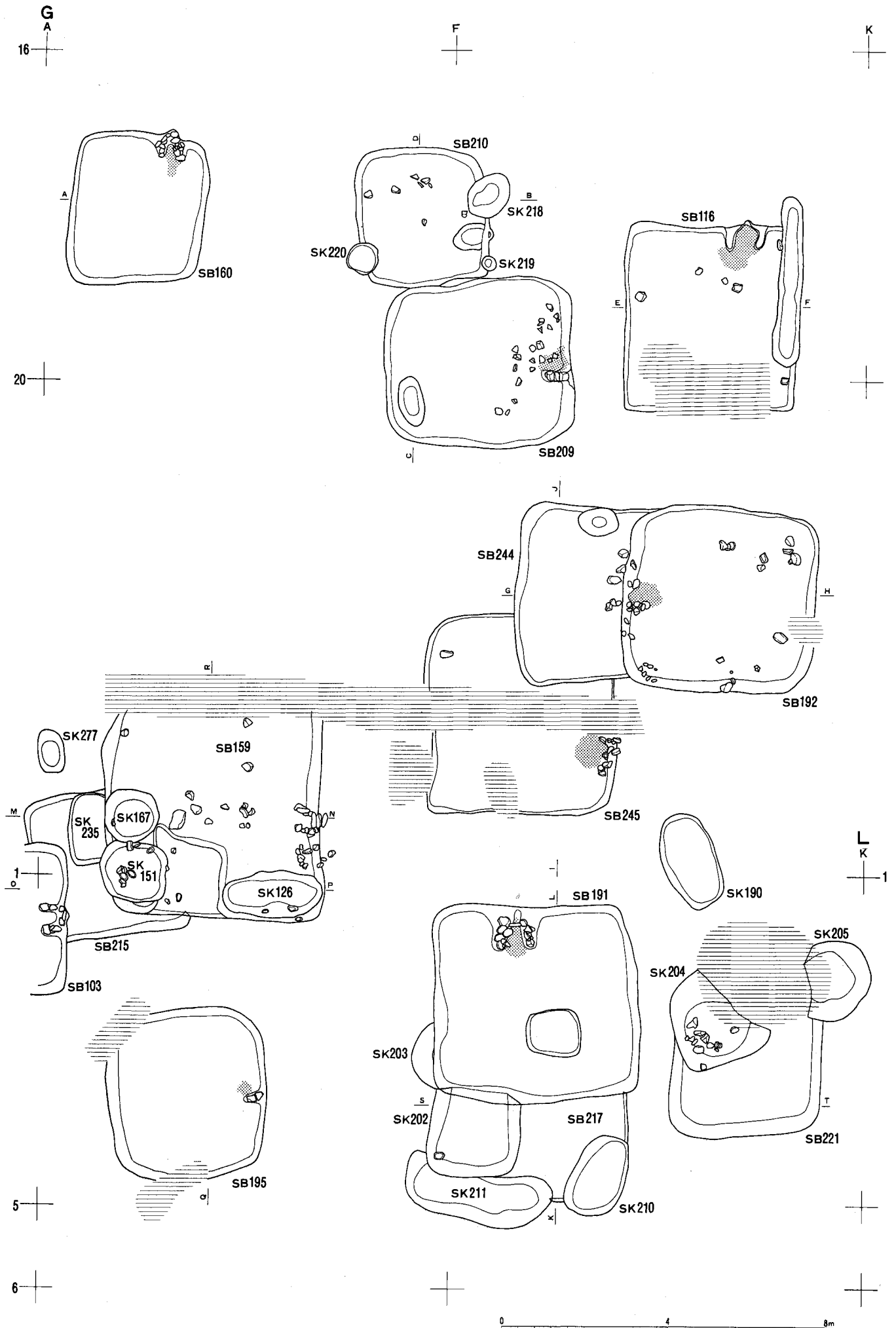

古代遺構図 7 断面図

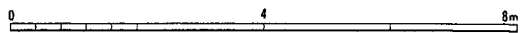
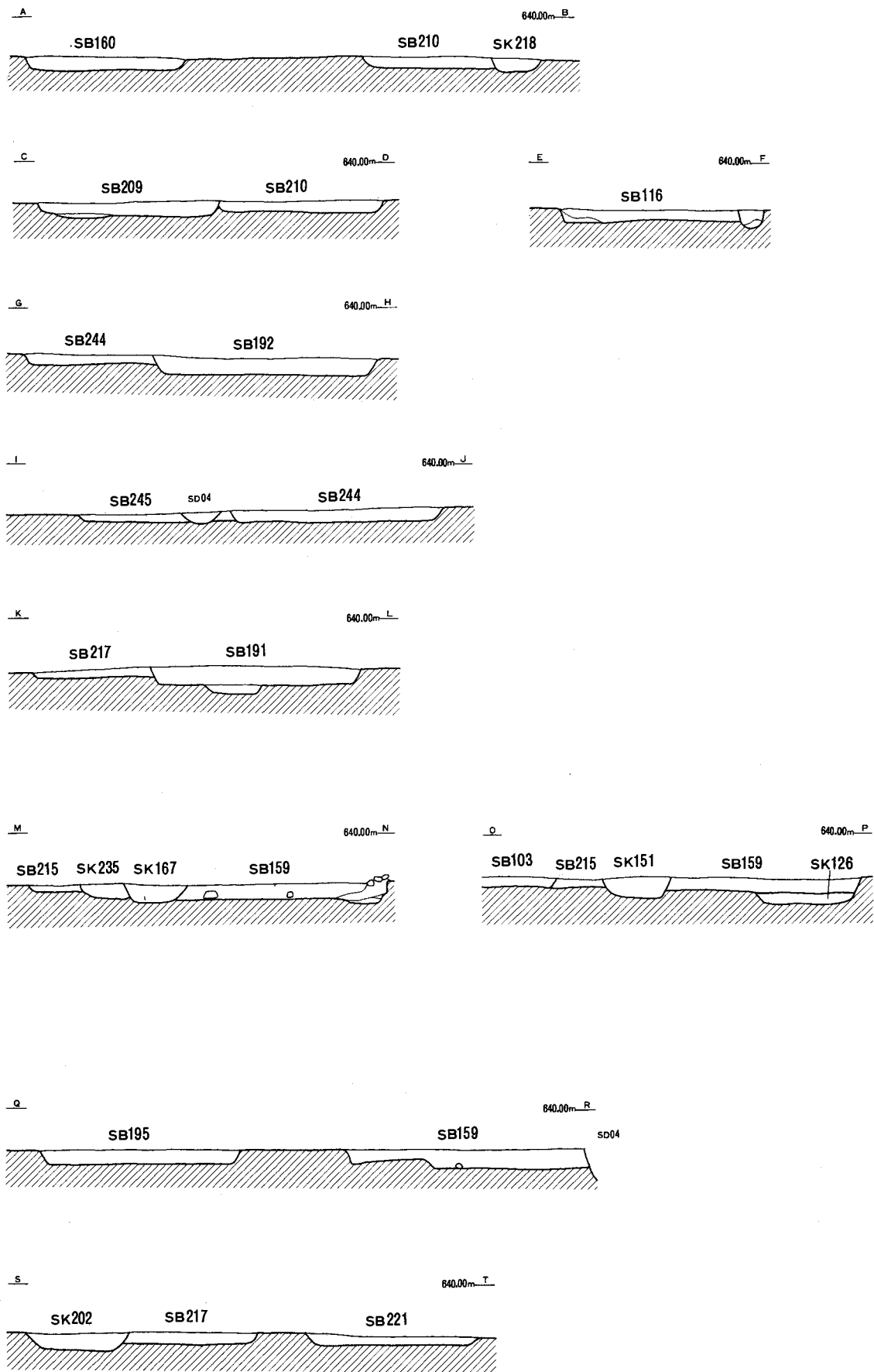

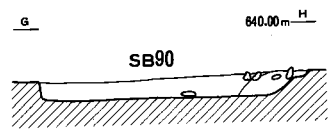
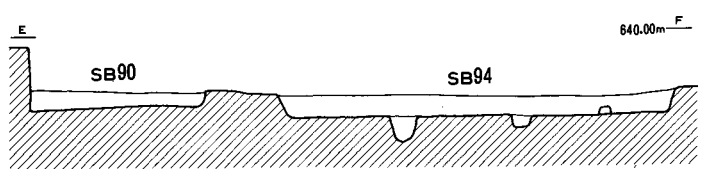
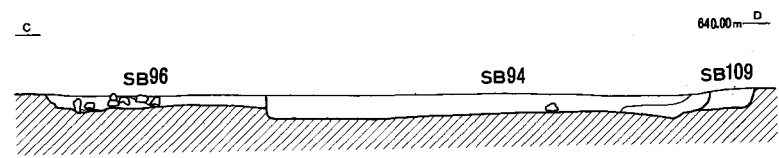
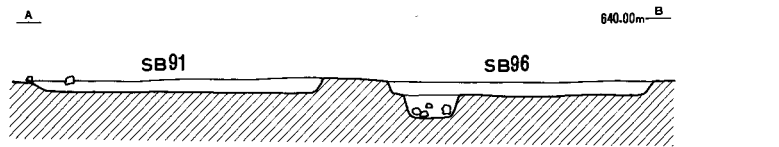
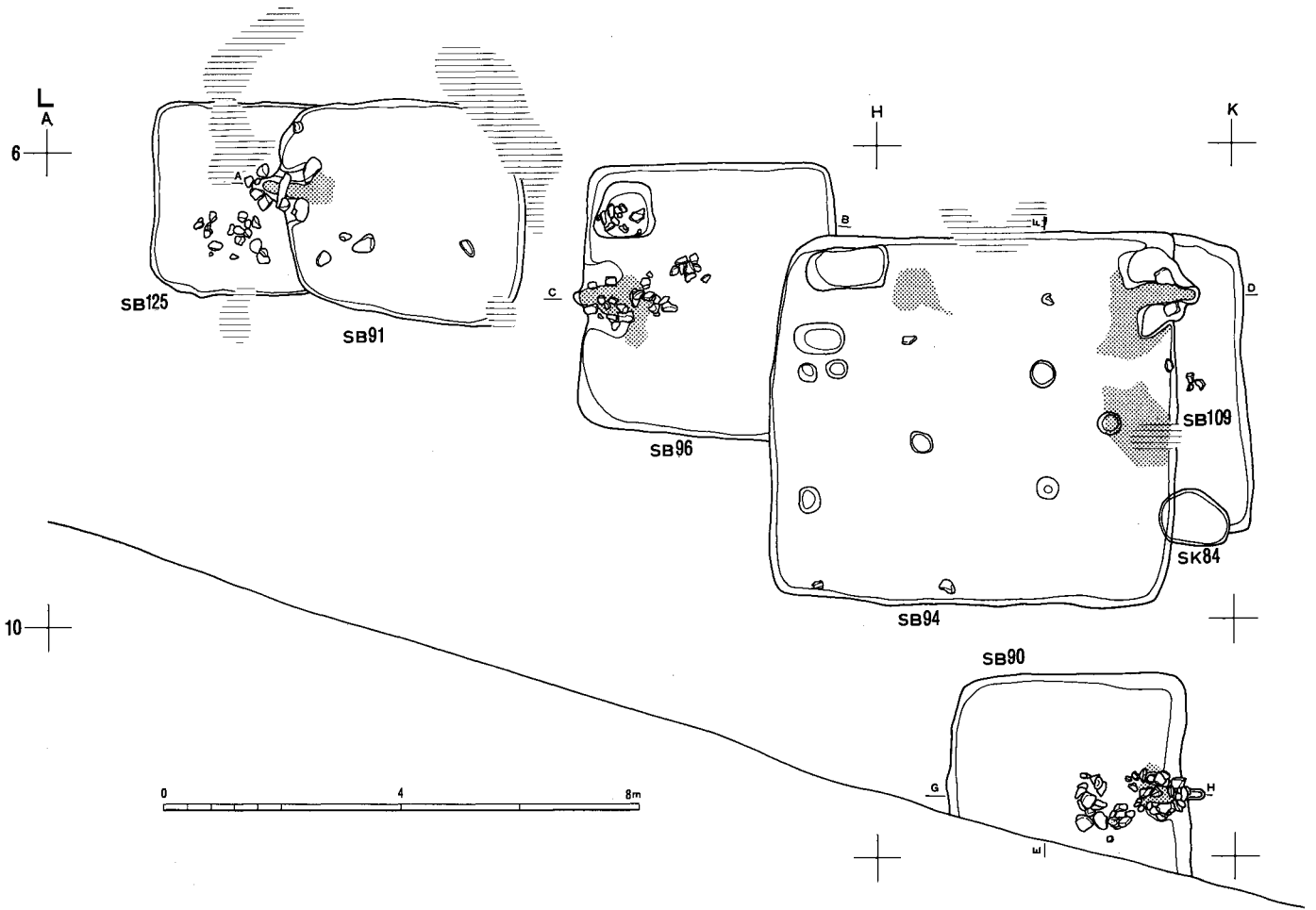

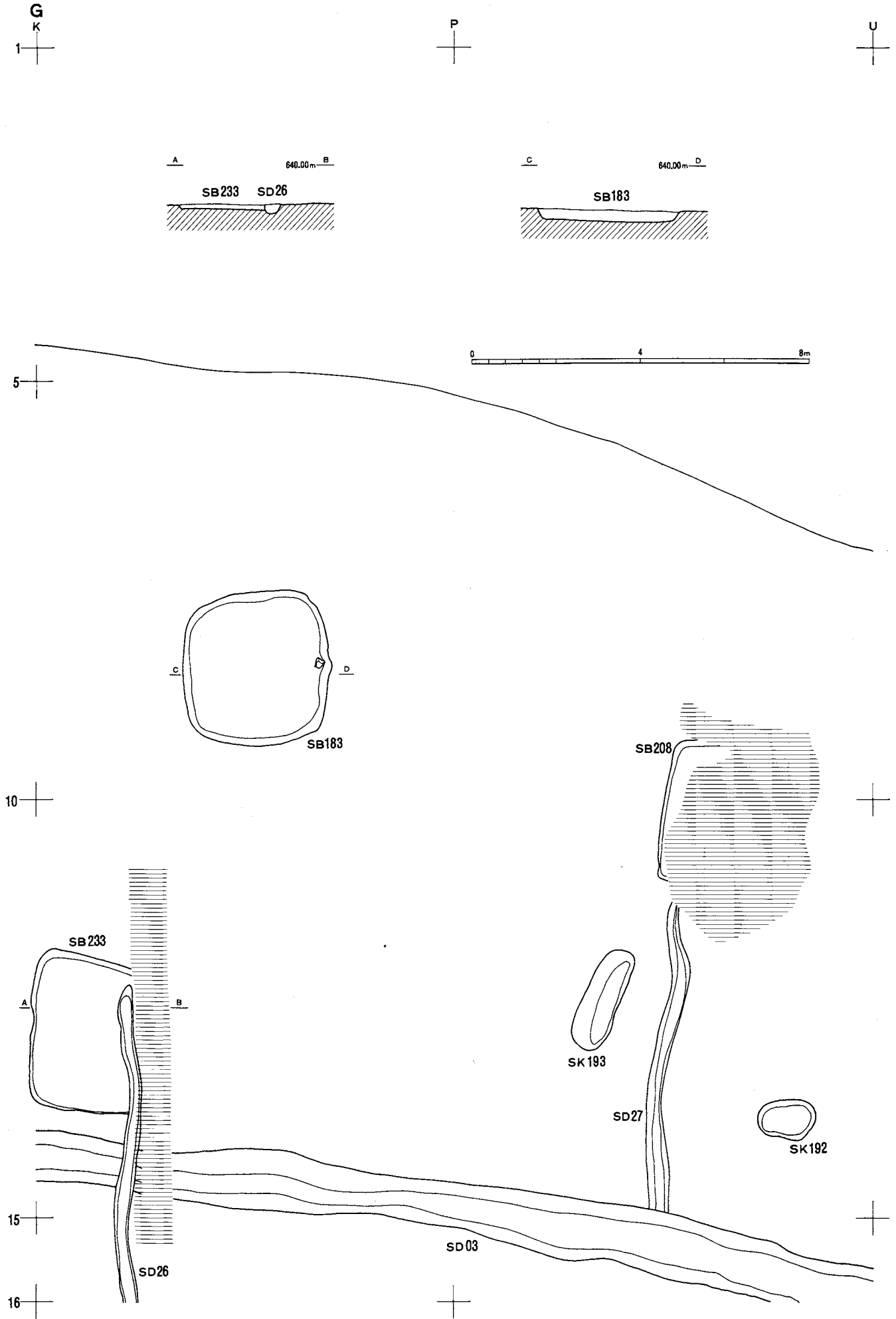

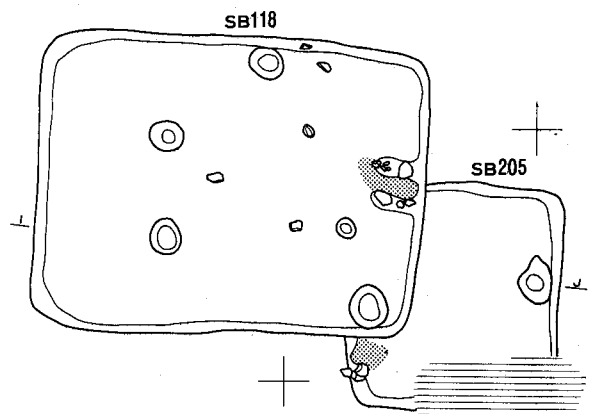
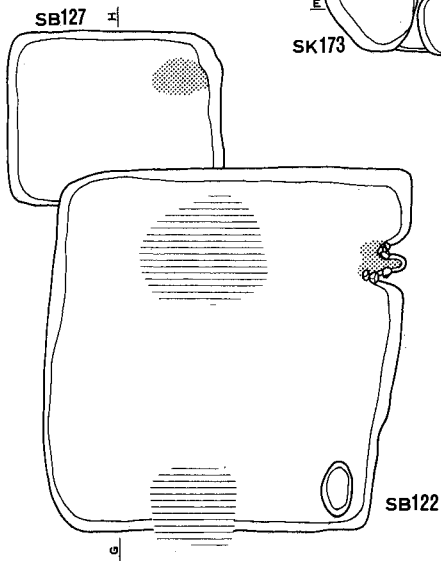
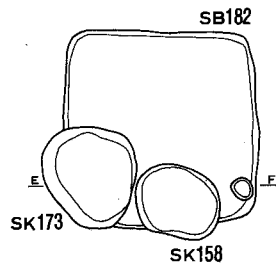
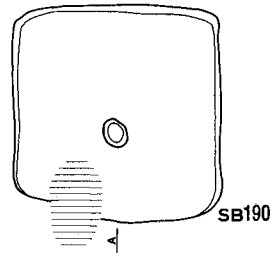
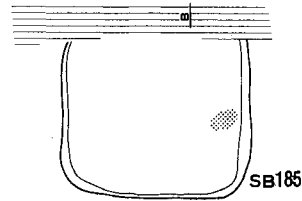
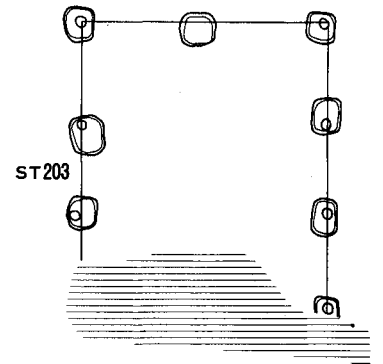
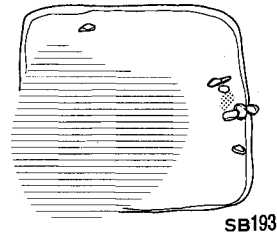
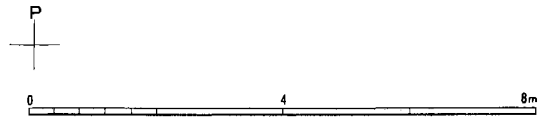
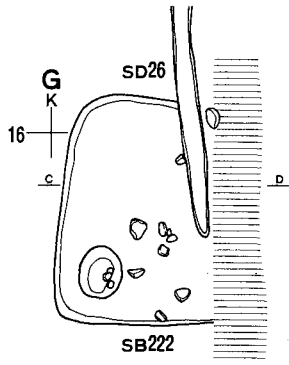

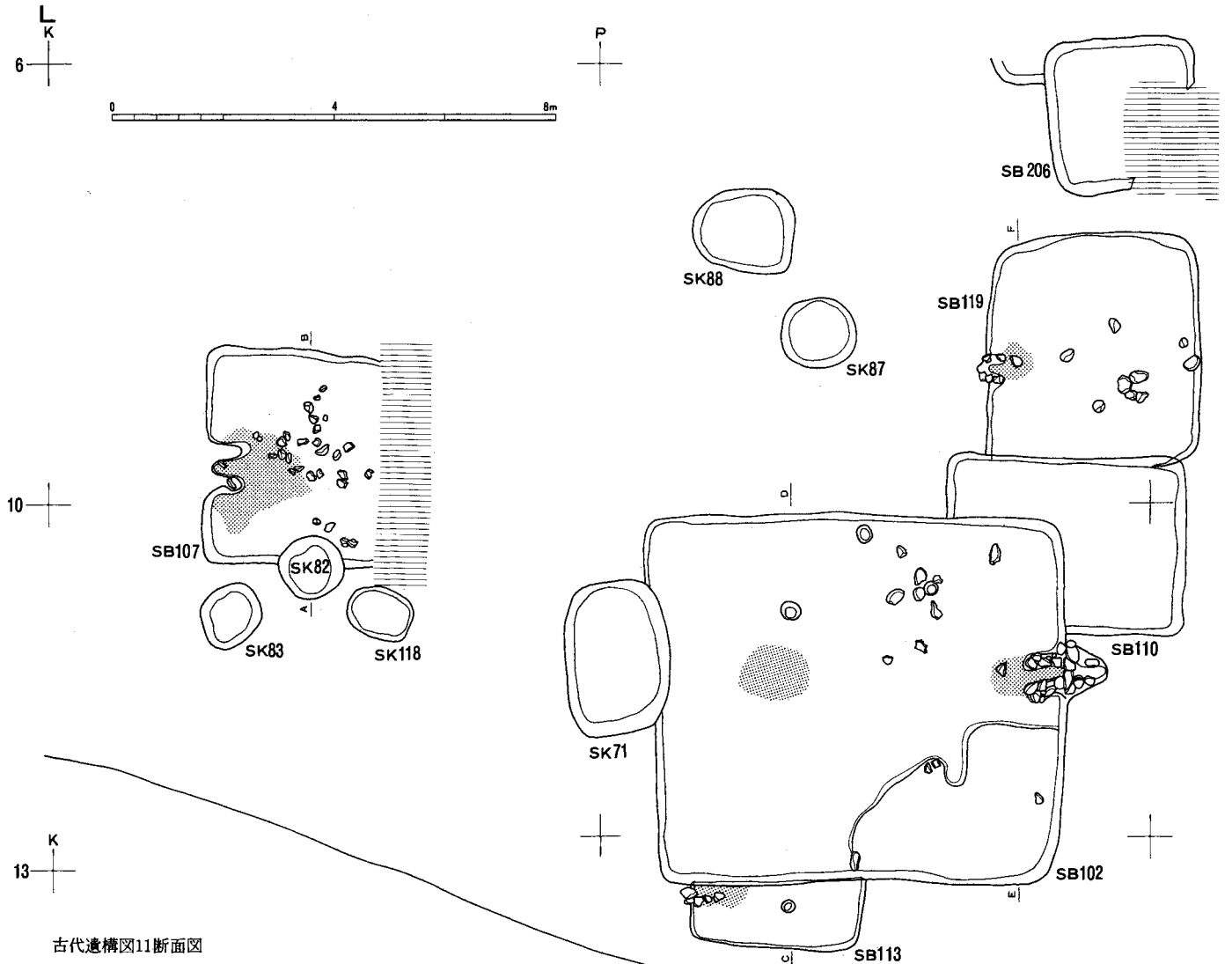

古代遺構図11断面図

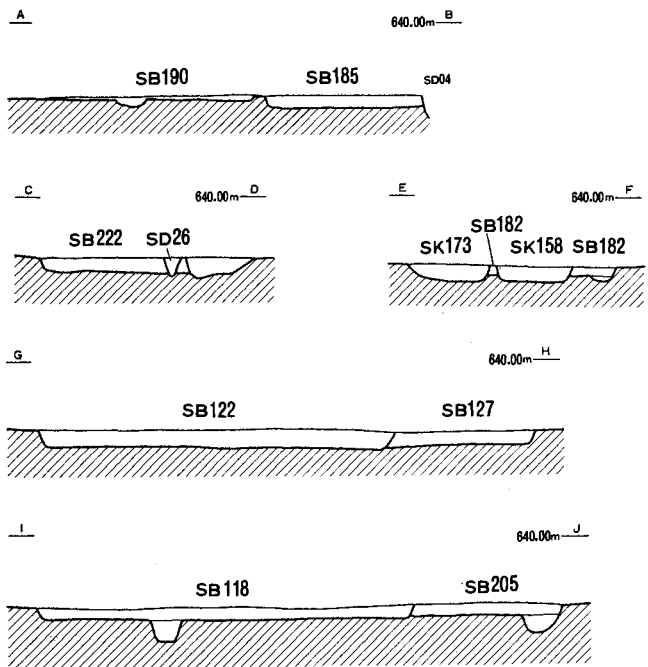

古代遺構図12断面図

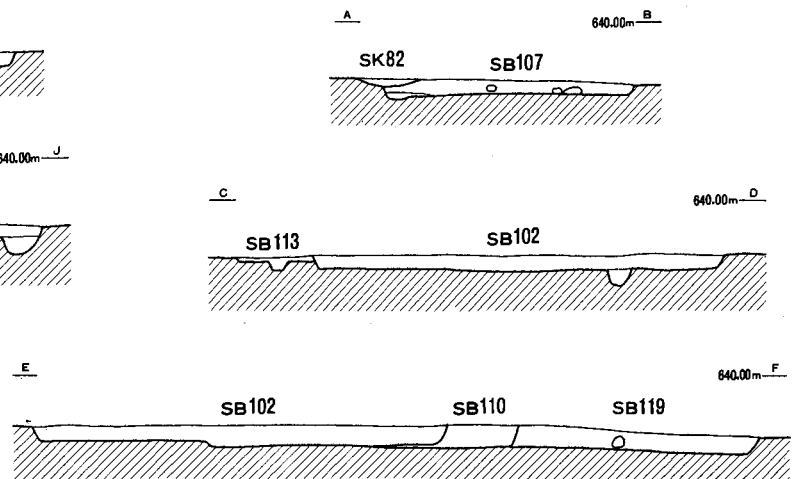

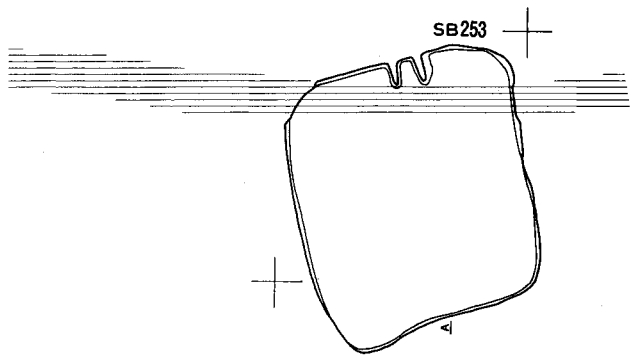
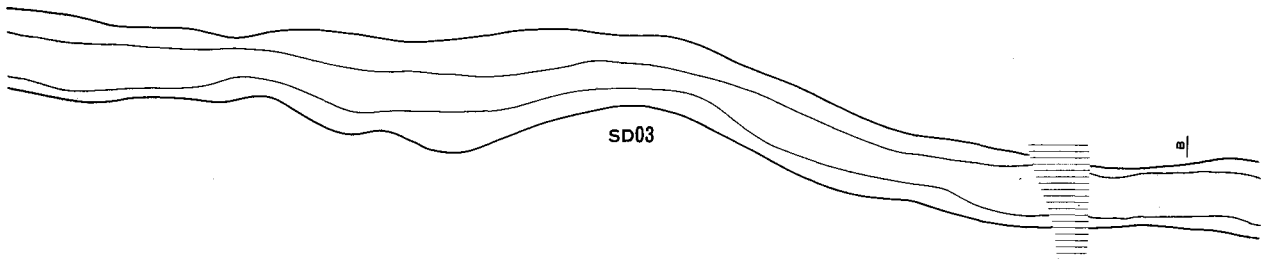
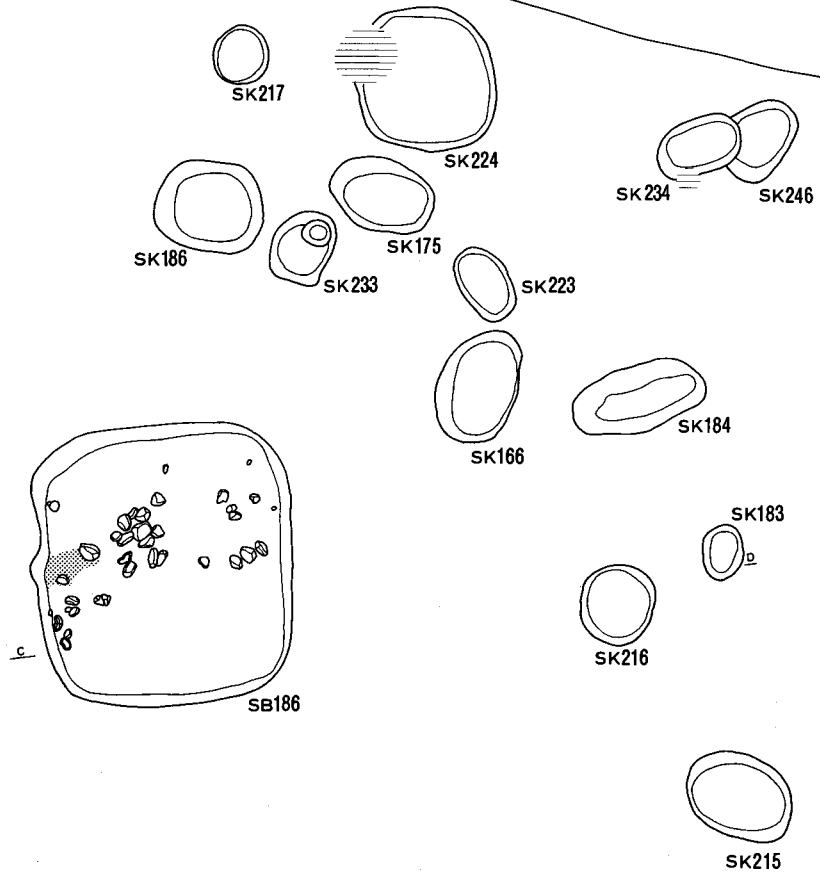
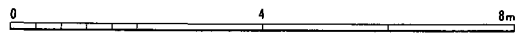
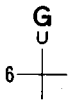

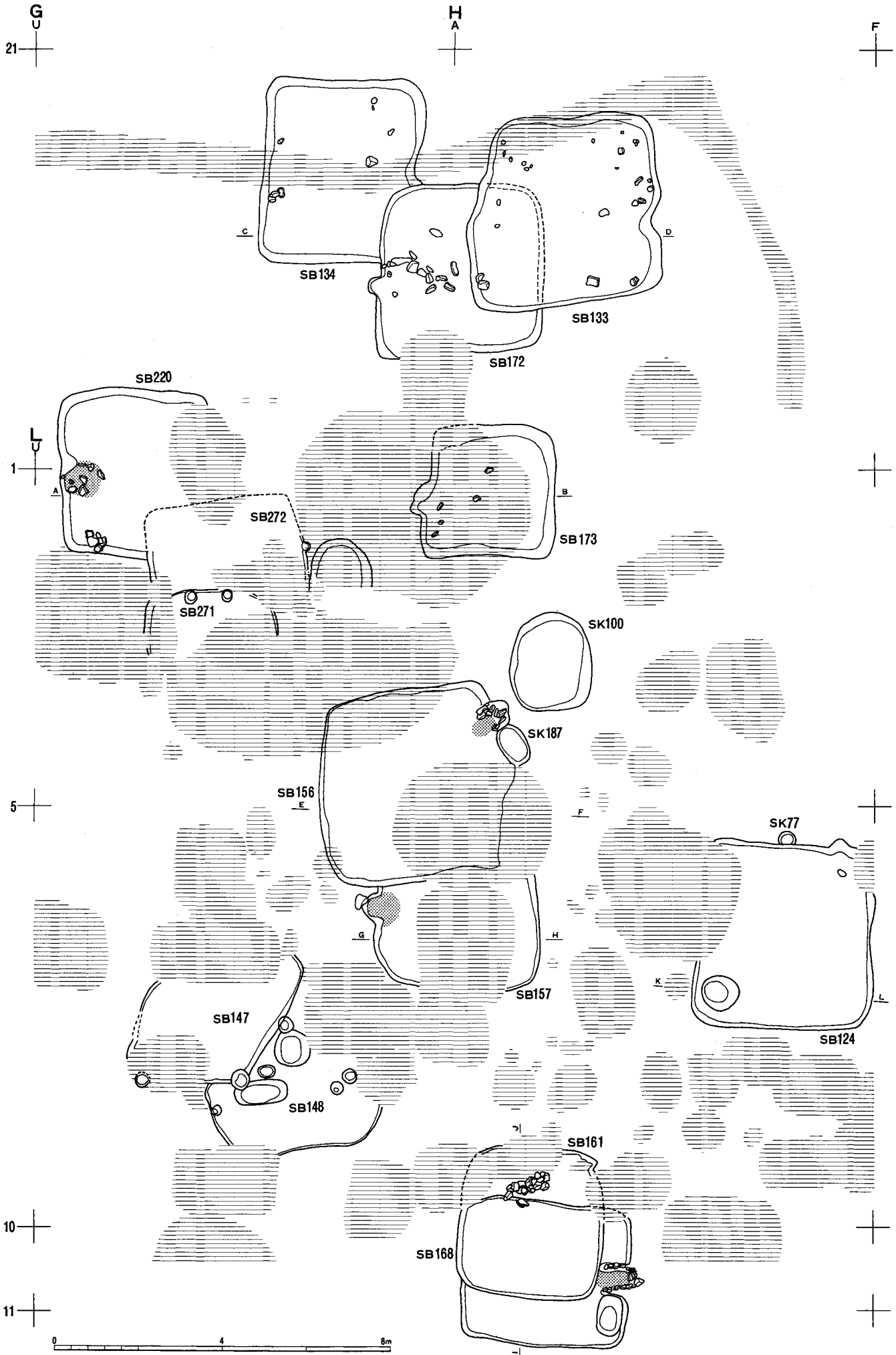

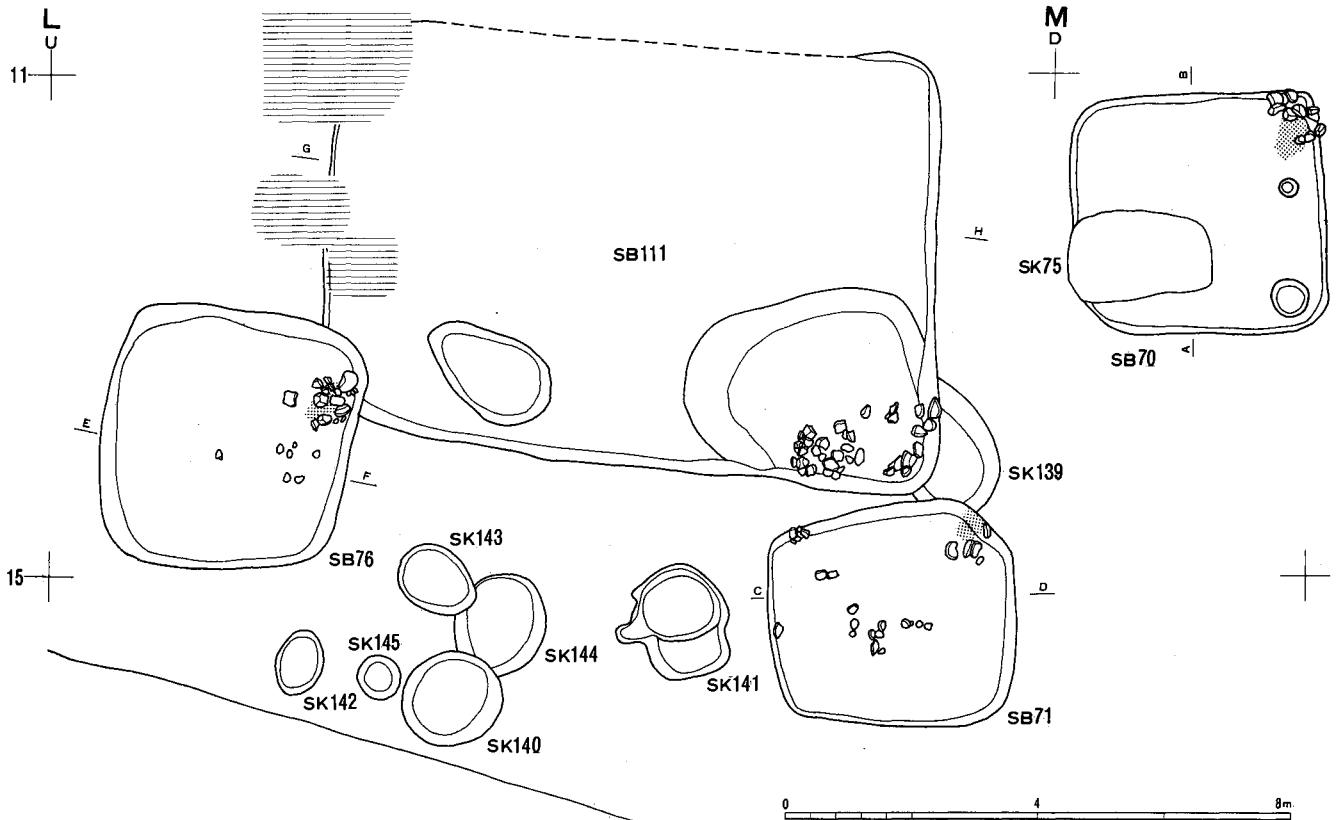

古代遺構図13断面図

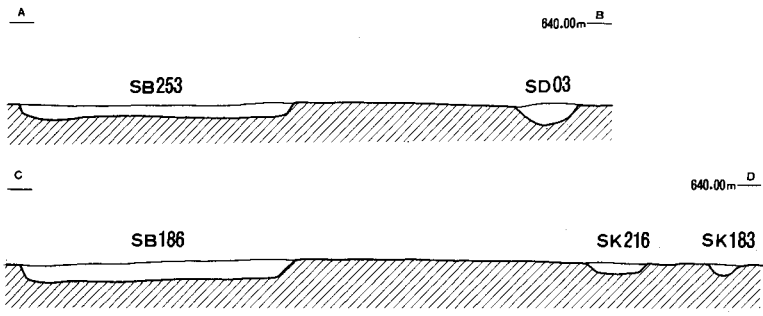

古代遺構図14断面図

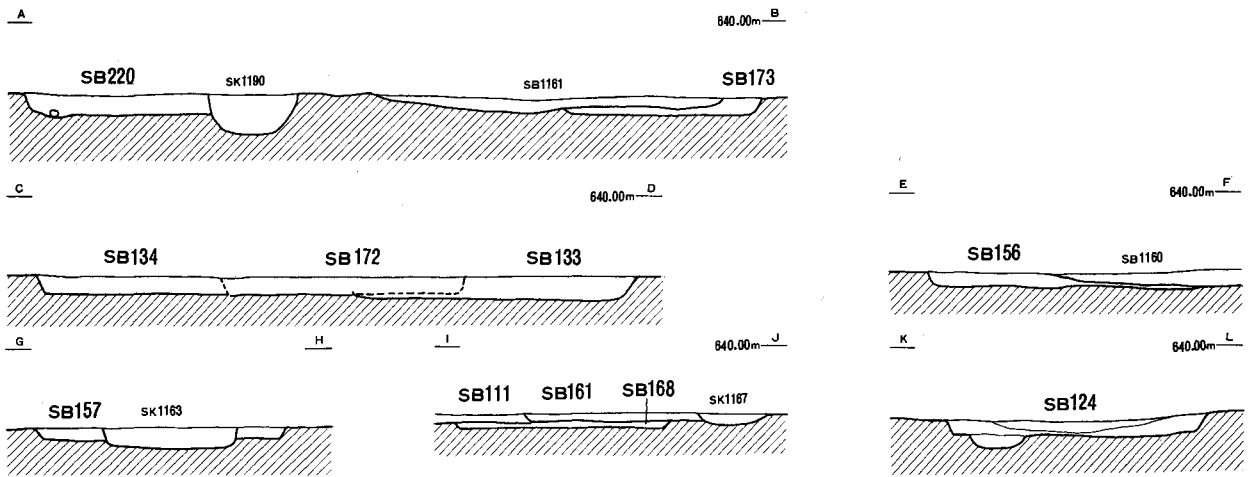

古代遺構図15断面図

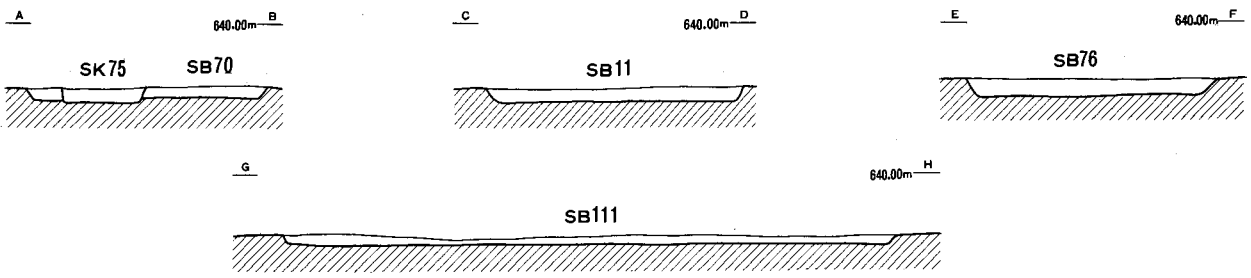

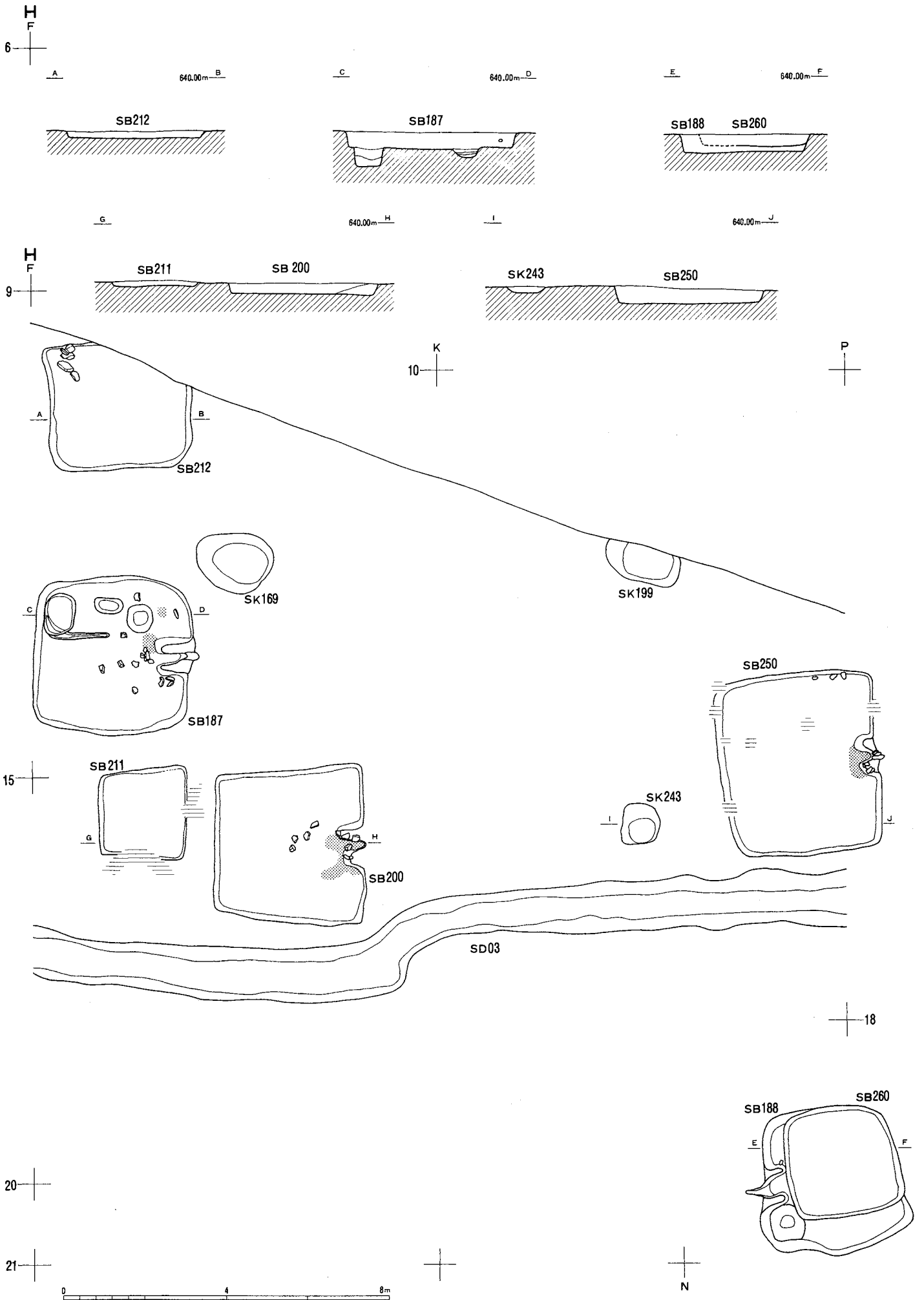

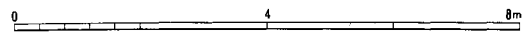
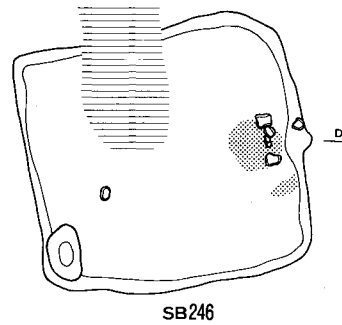
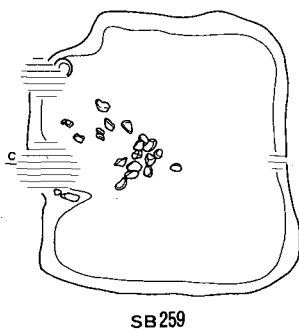
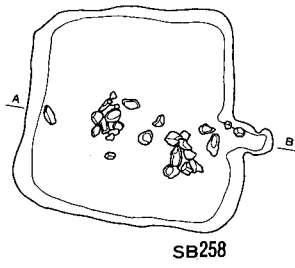

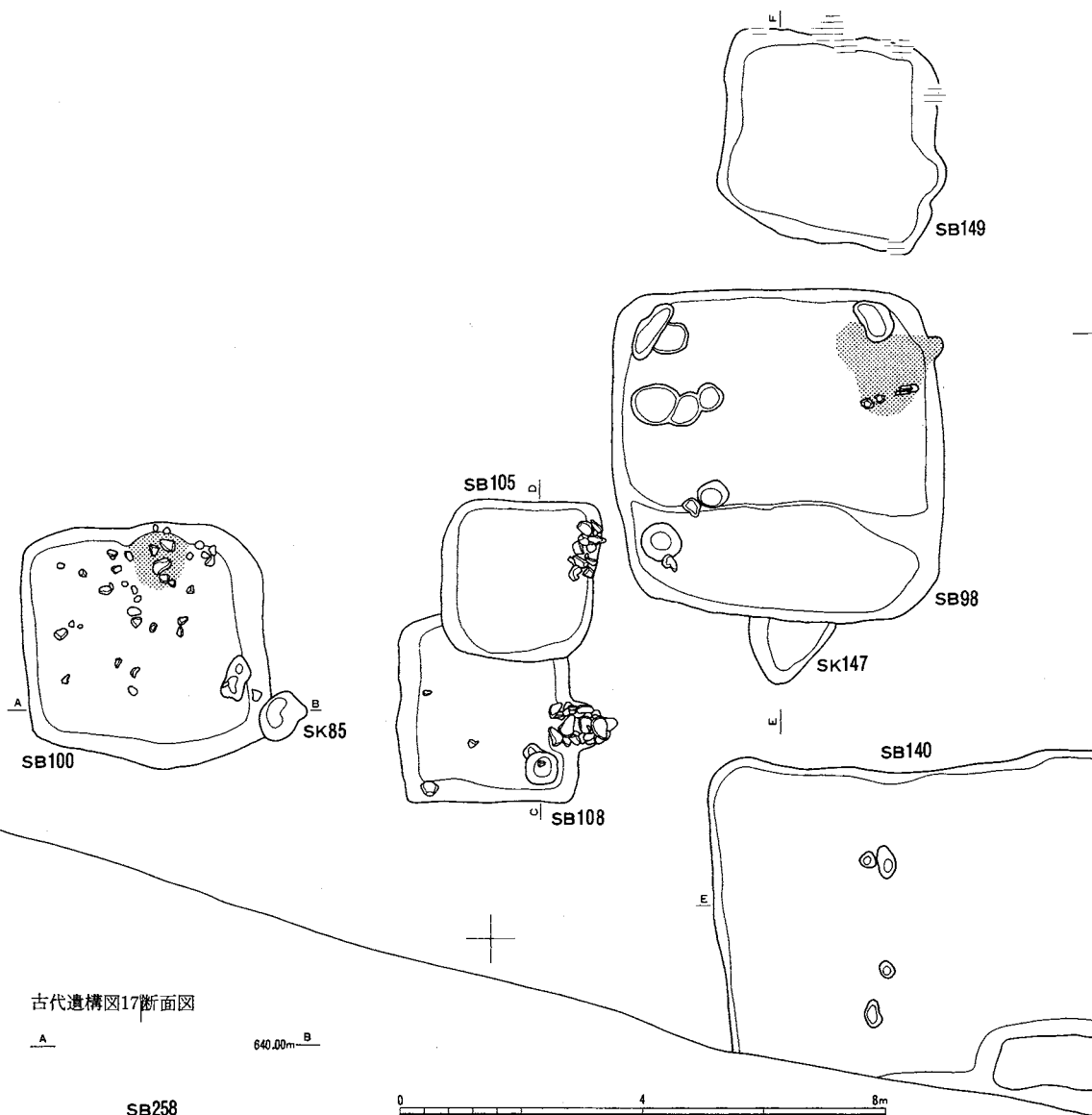

古代遺構図17断面図

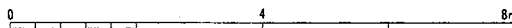
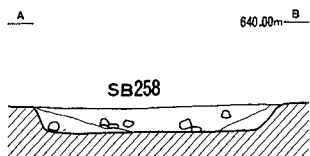

古代遺構図18断面図

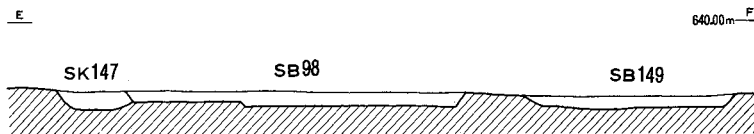
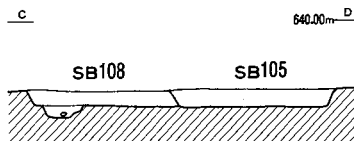
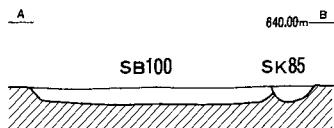

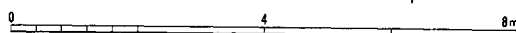
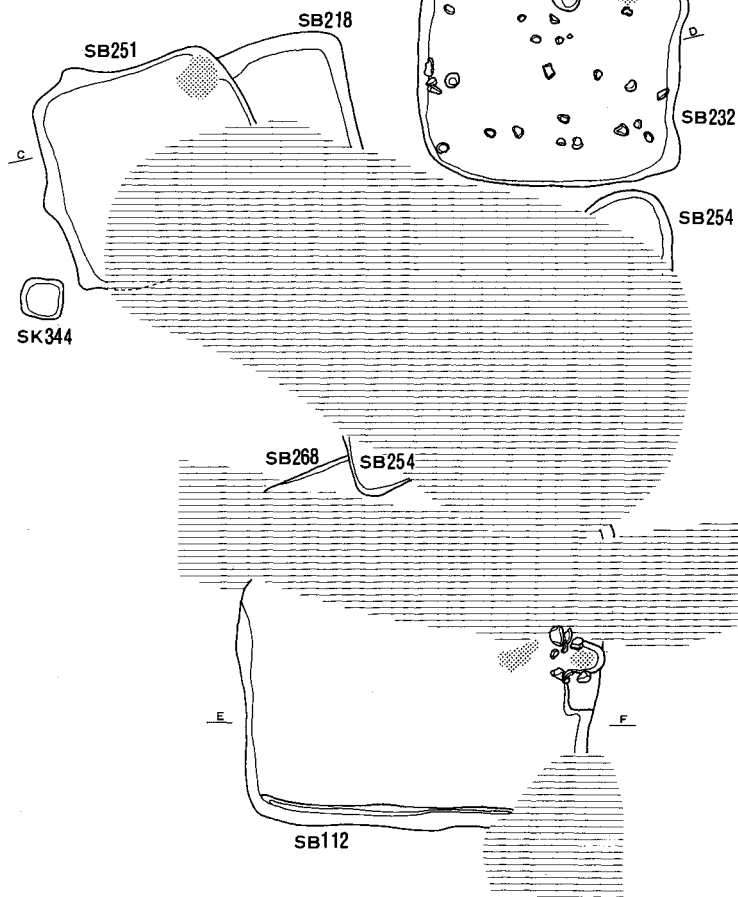
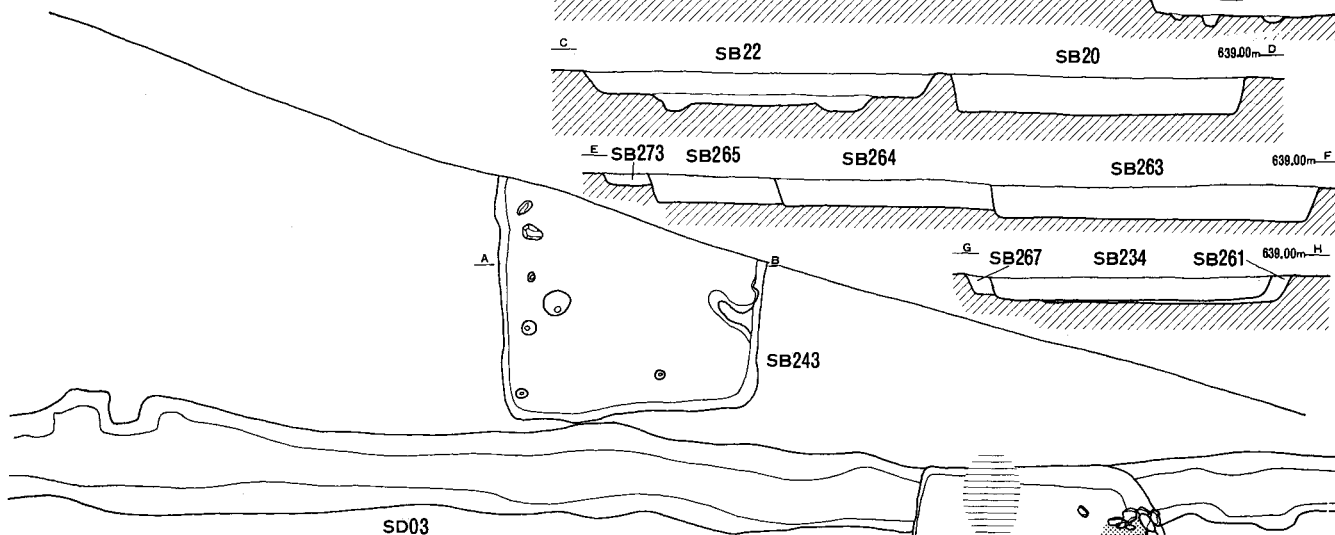
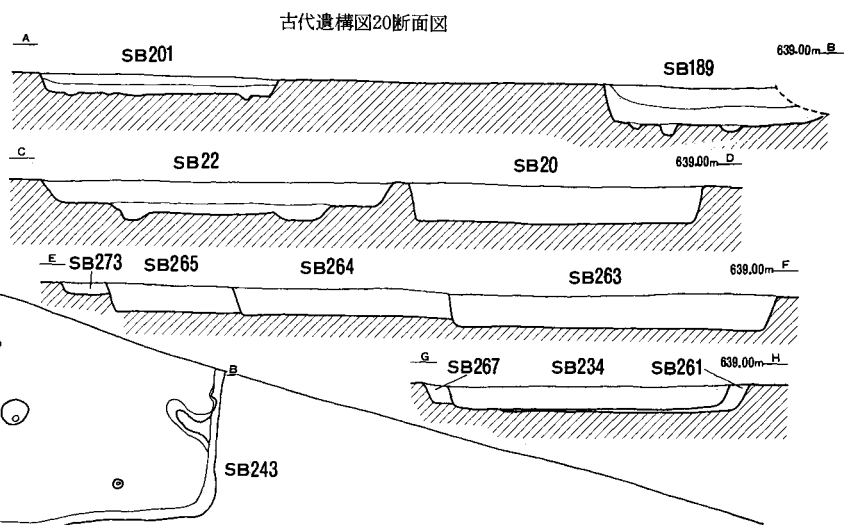
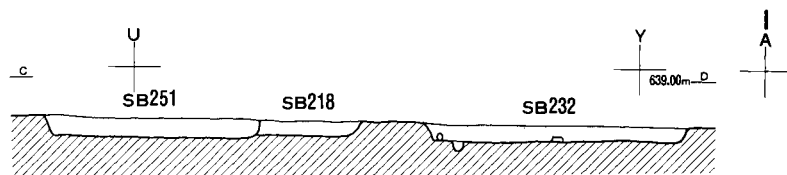
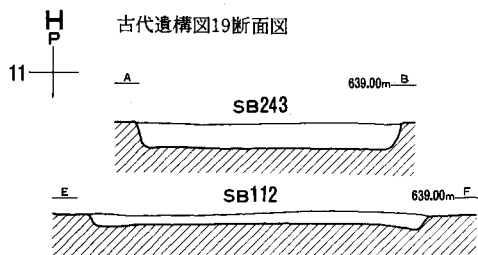

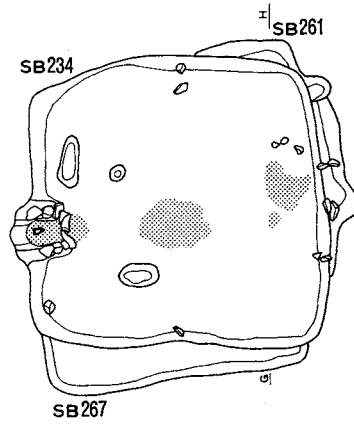
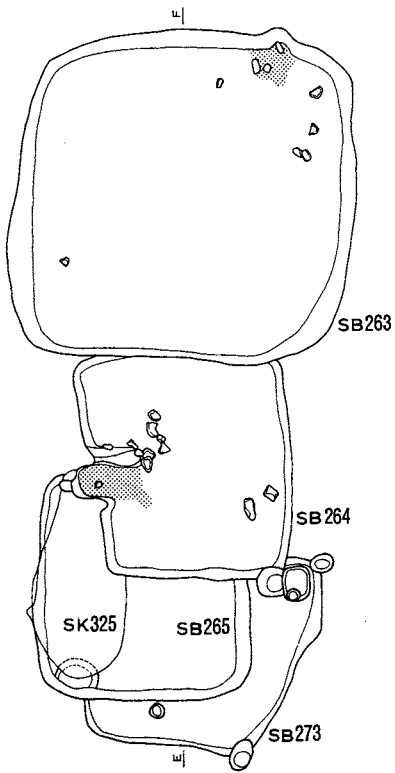
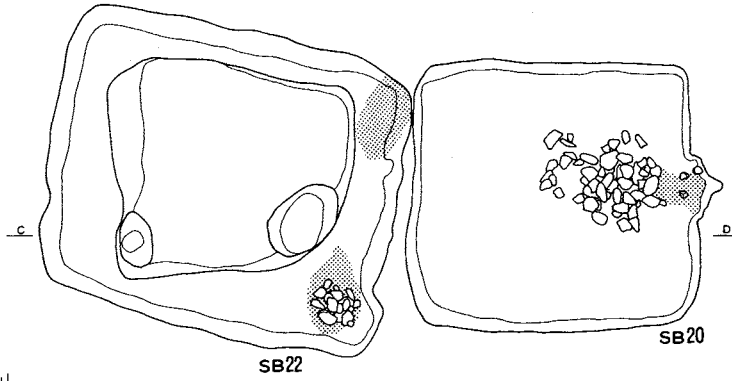
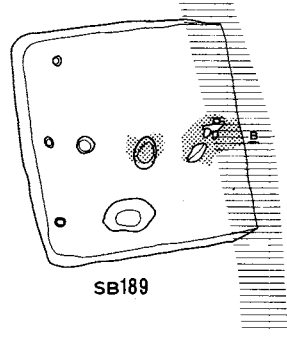
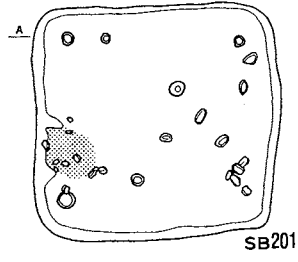
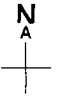
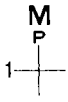

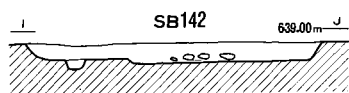
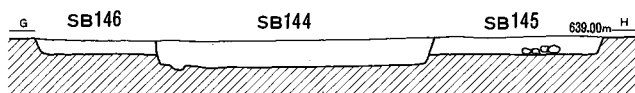
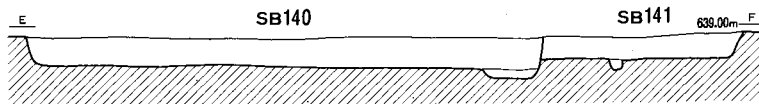
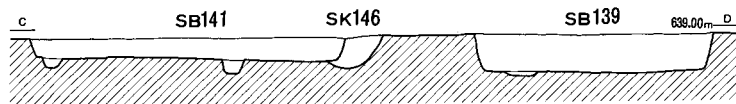
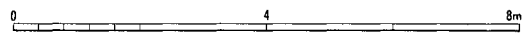
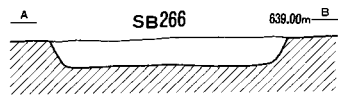
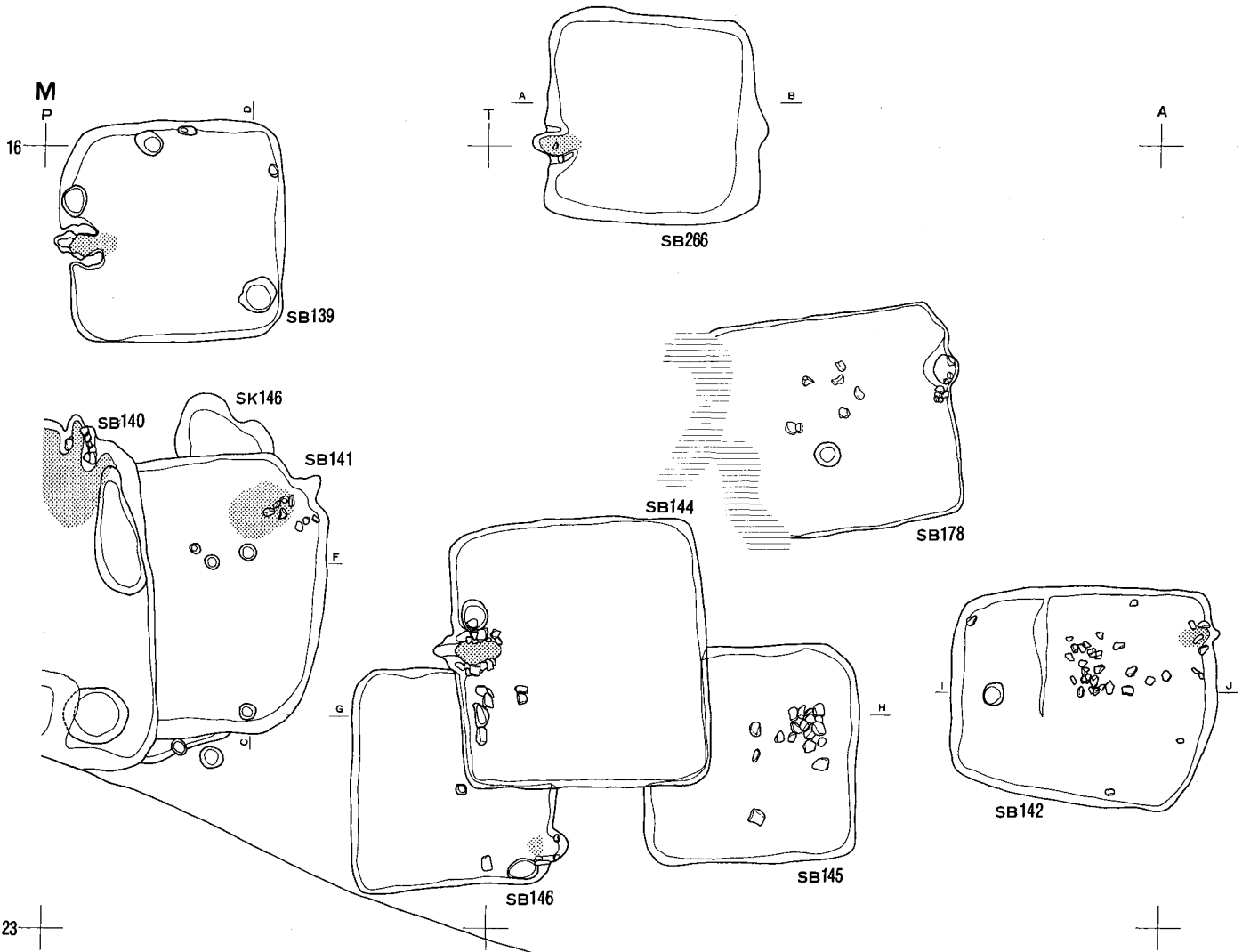

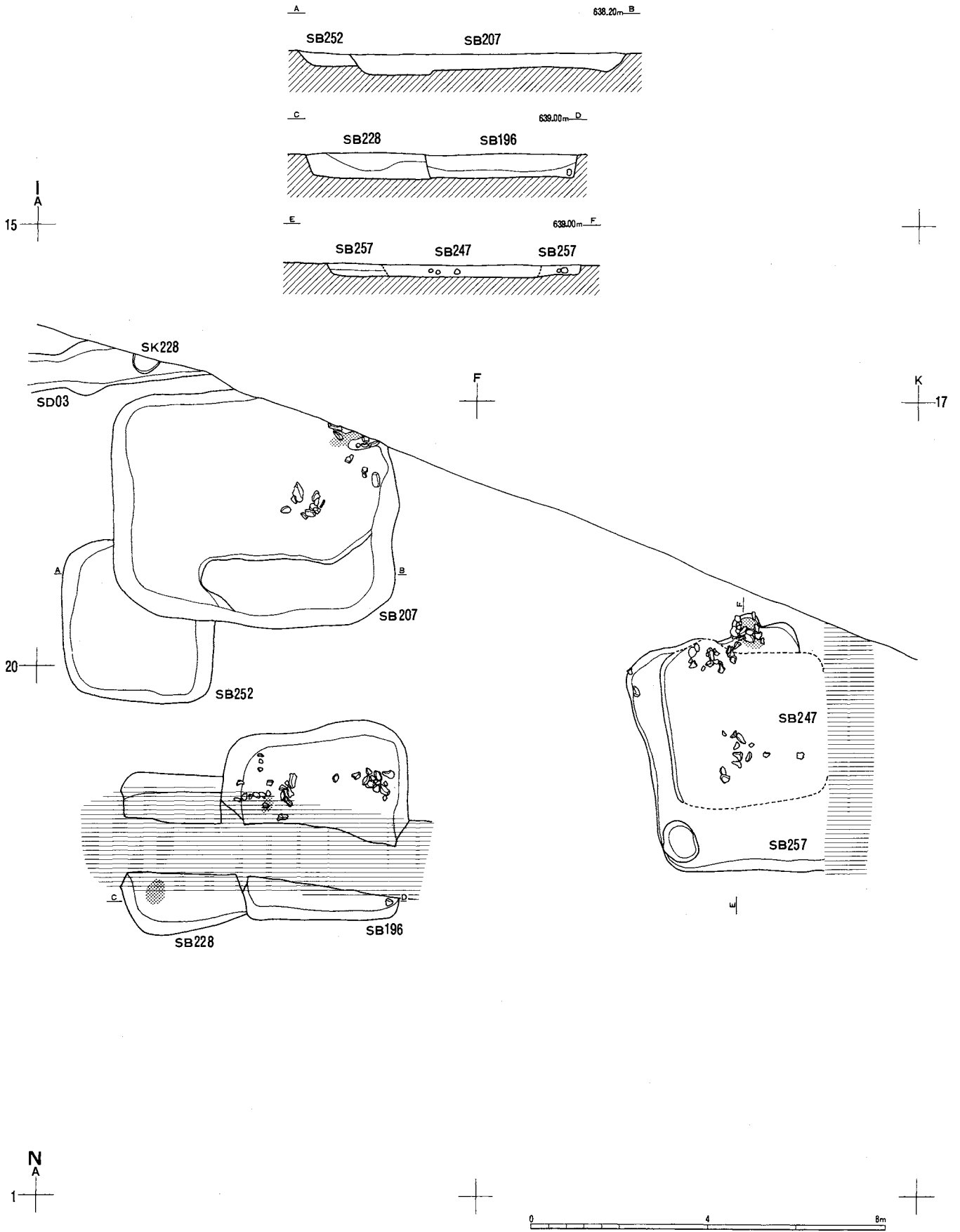

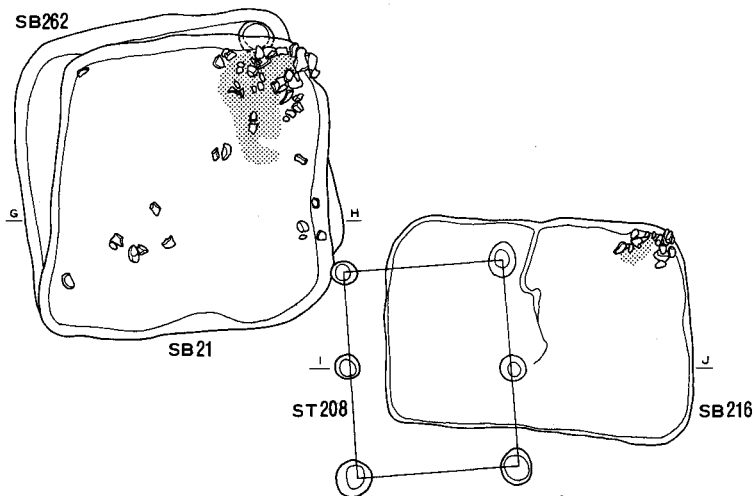
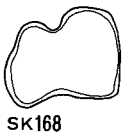
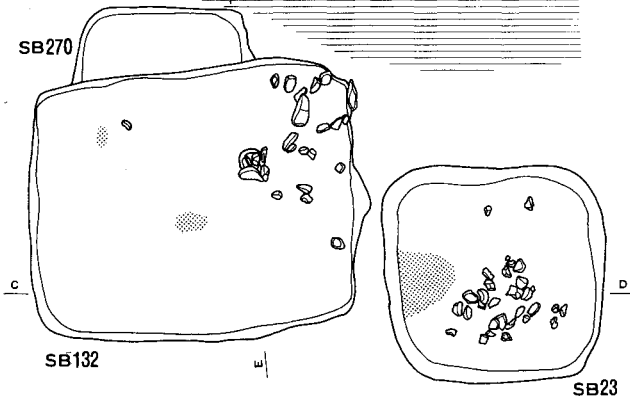
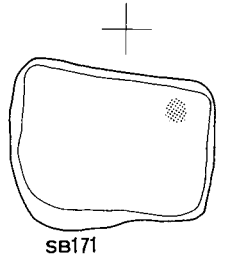
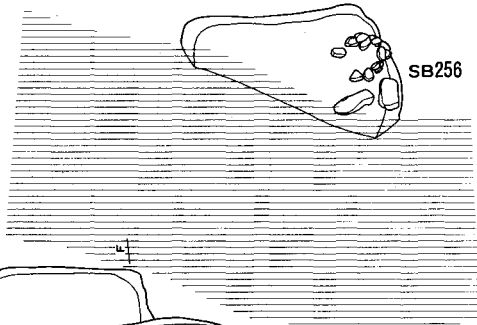
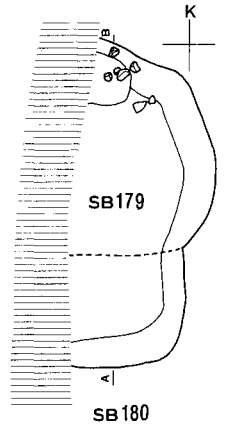

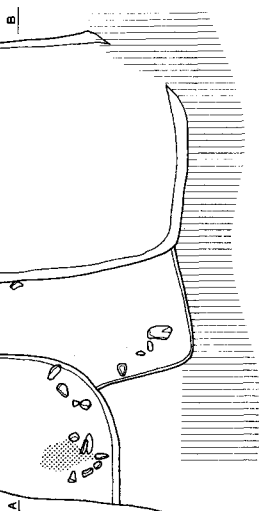
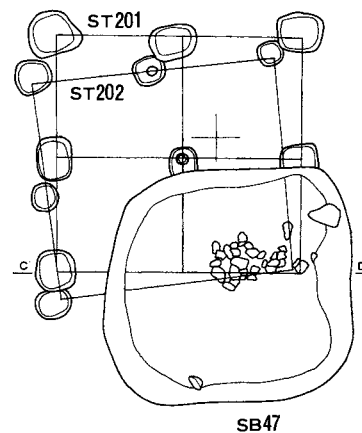
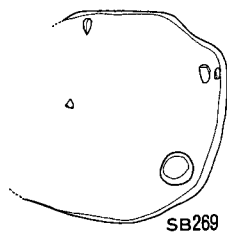
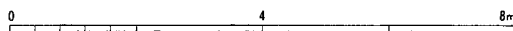
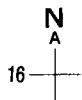

古代遺構図23断面図

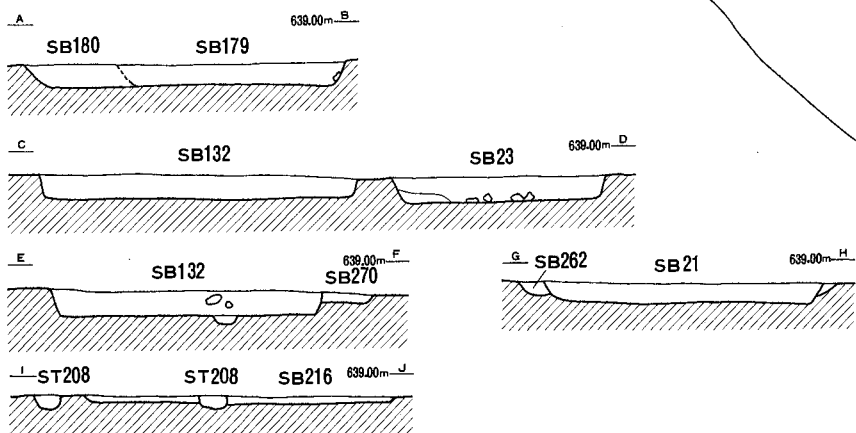

SB 02

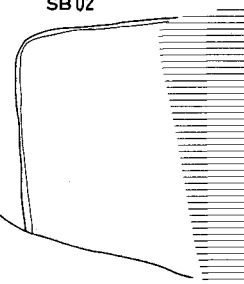

古代遺構図24断面図

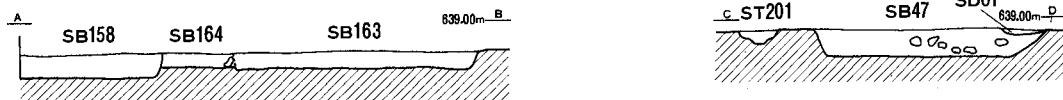



古代遺構図25断面図

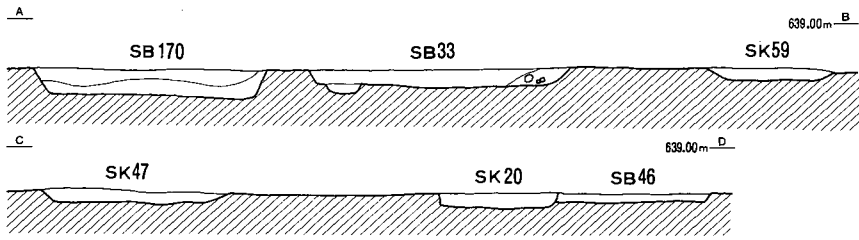

古代遺構図26断面図

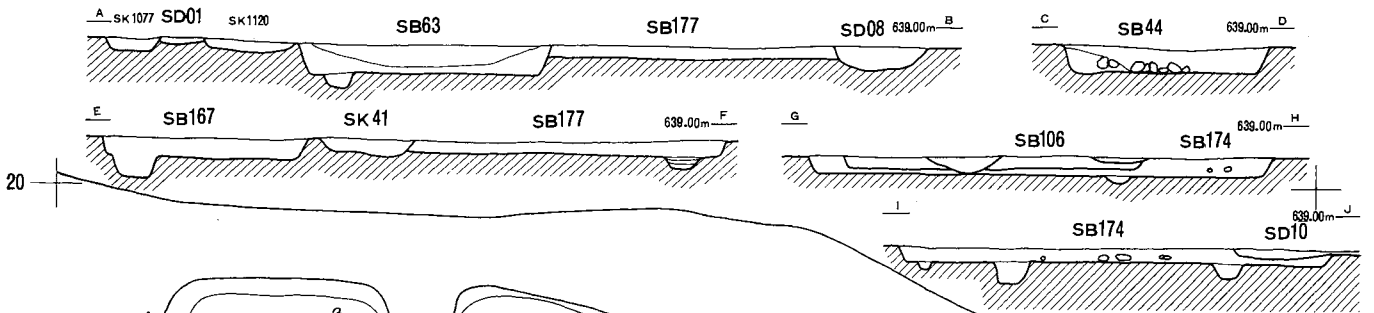

20

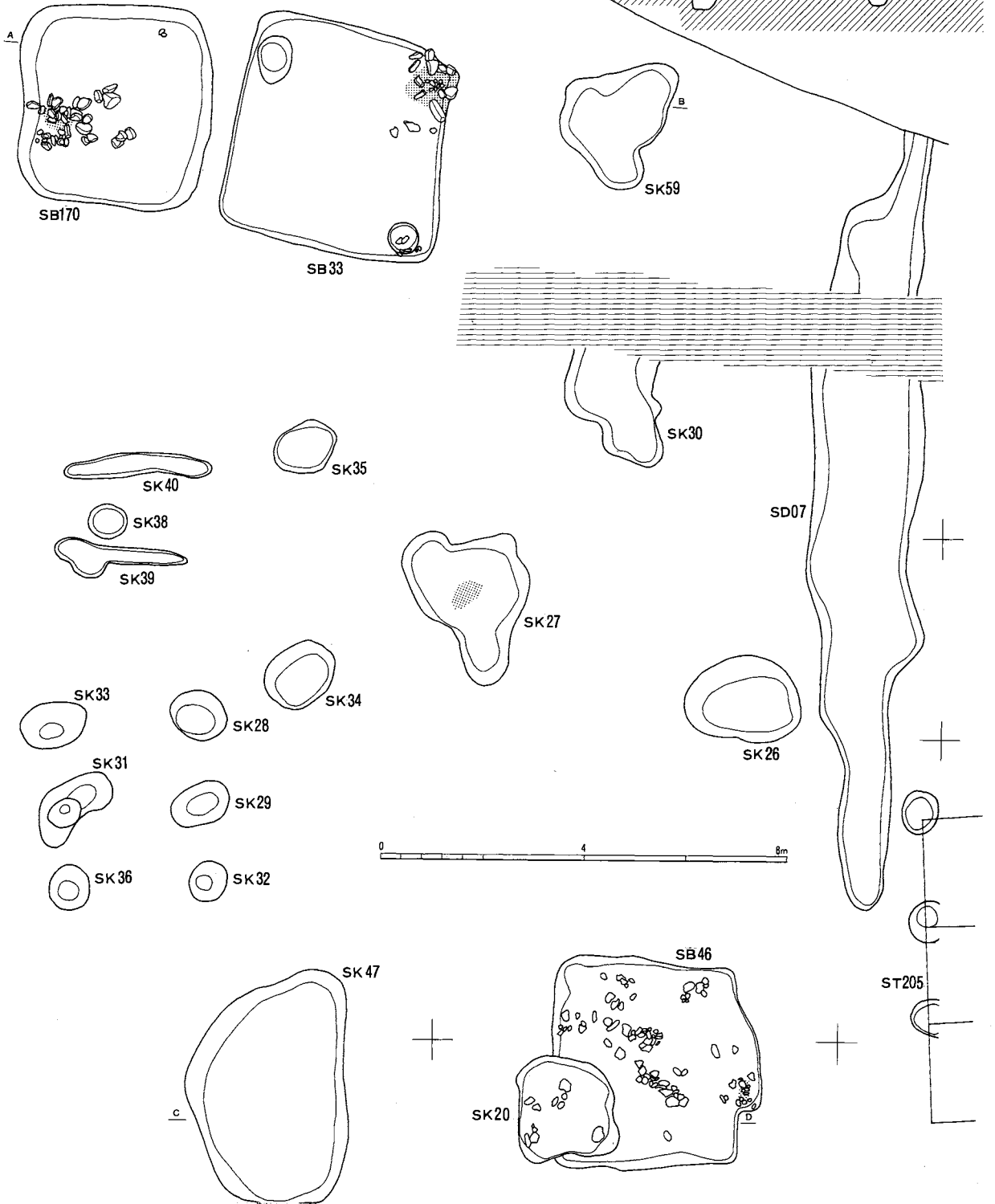



SK 21

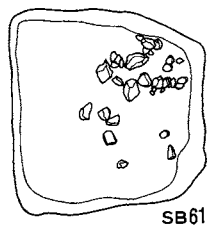

SB 61

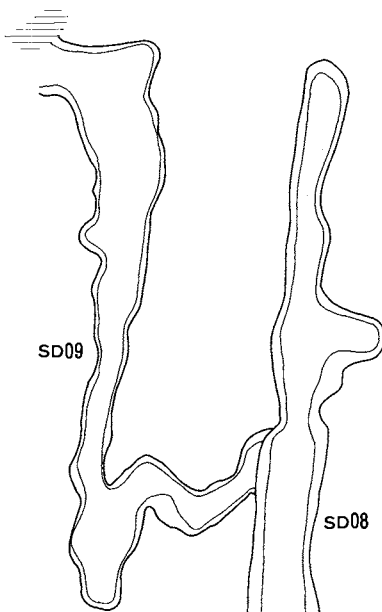

SD 09

SD 08



SK 22



SK 23

SK 161 SK 162 SK 163

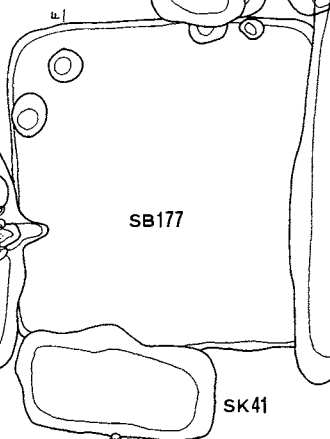

SB 177

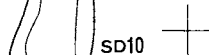

SD 10

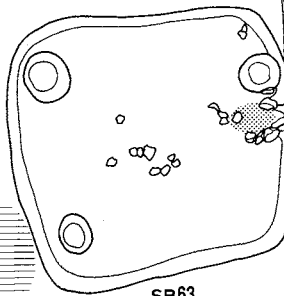

SB 63



SK 41



SD 01

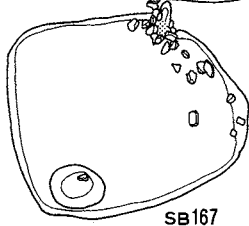

SB 167

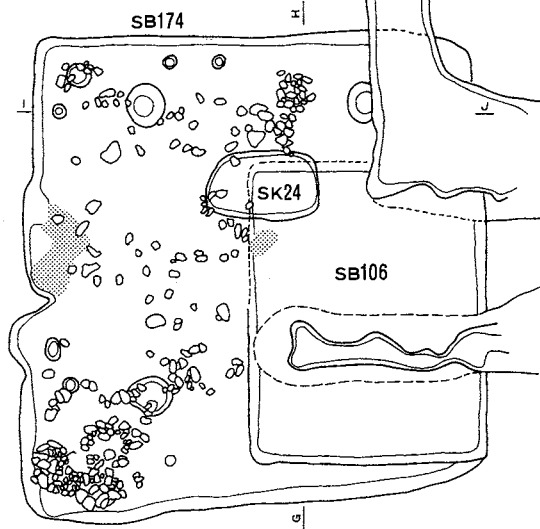

SB 174

SB 106

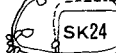

SK 24

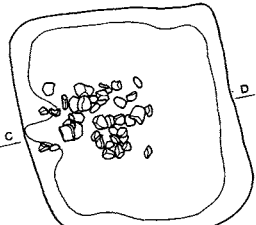

SB 44



SK 306

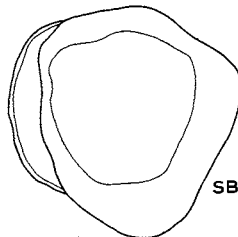

SB 39

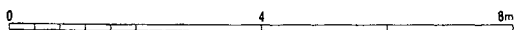

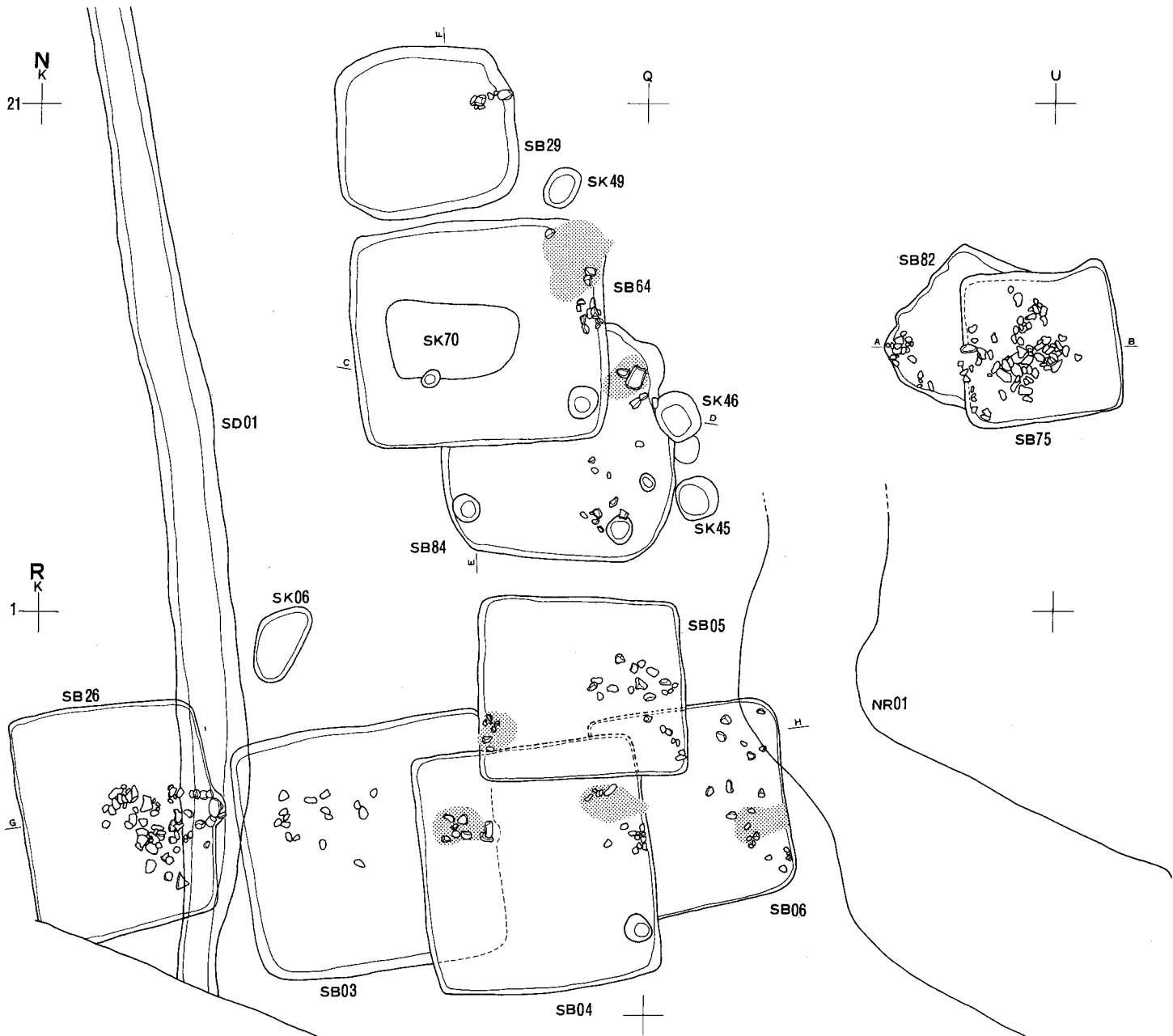

古代遺構図27断面図

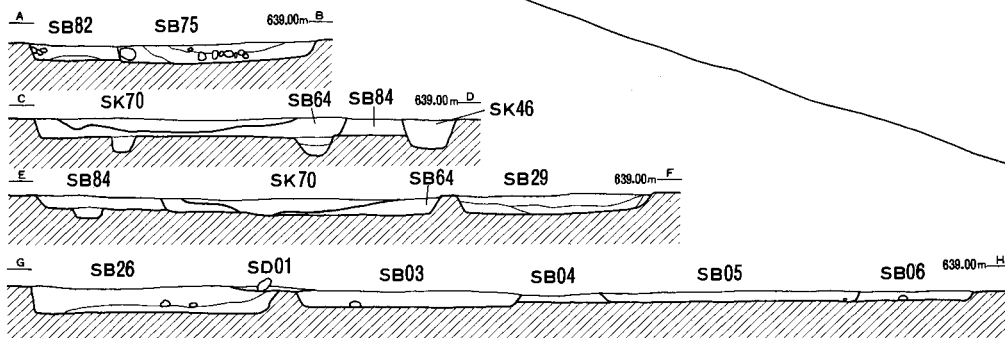

古代遺構図28断面図

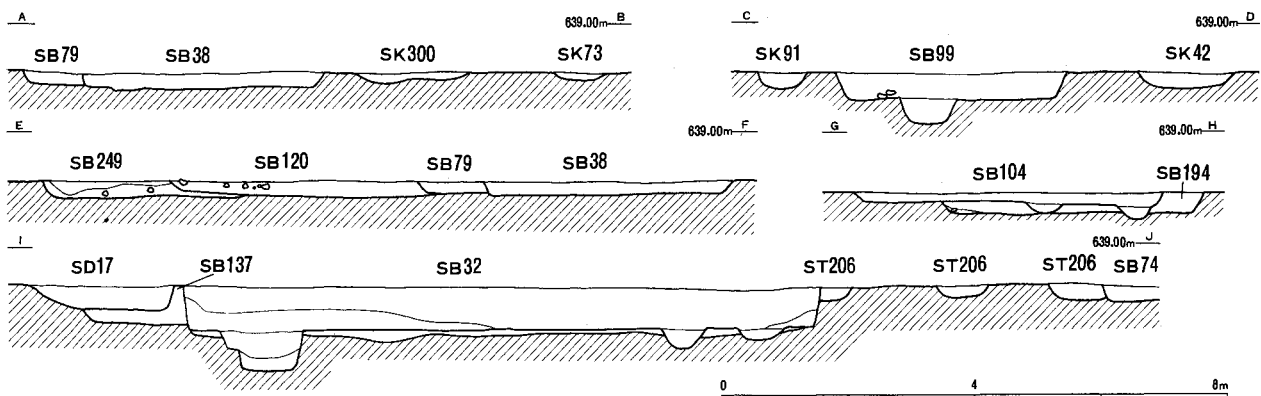

古代遺構図28断面図

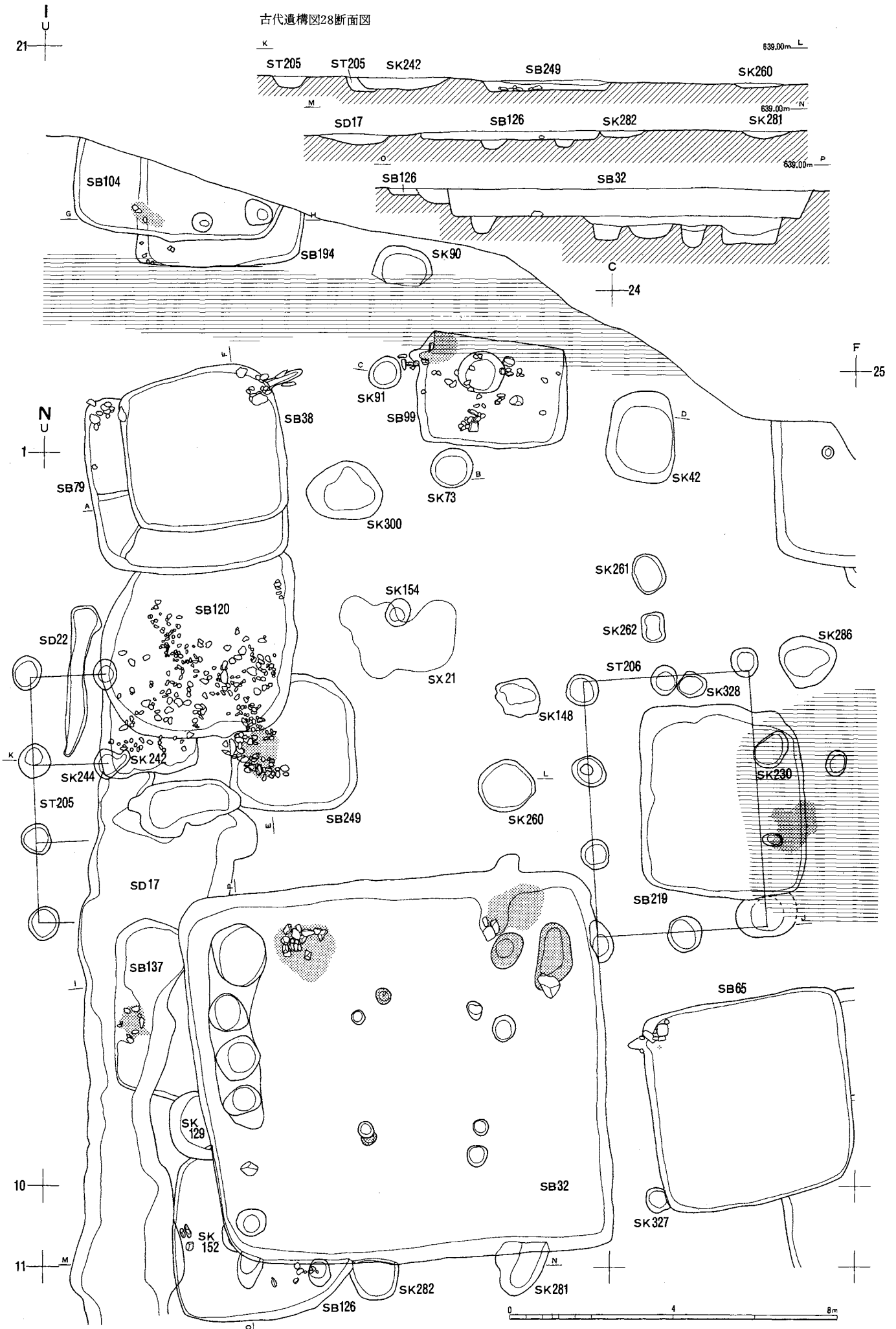

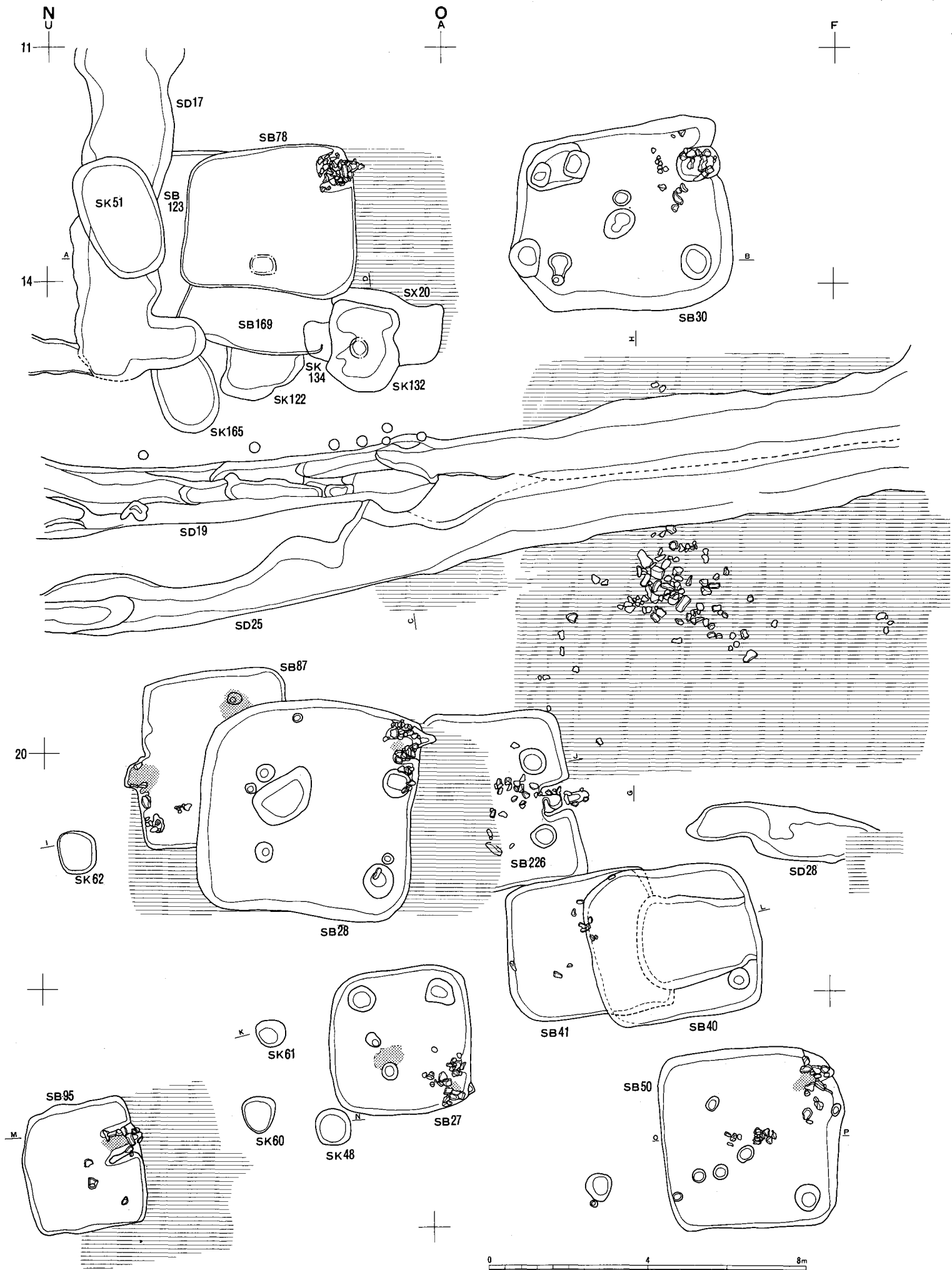

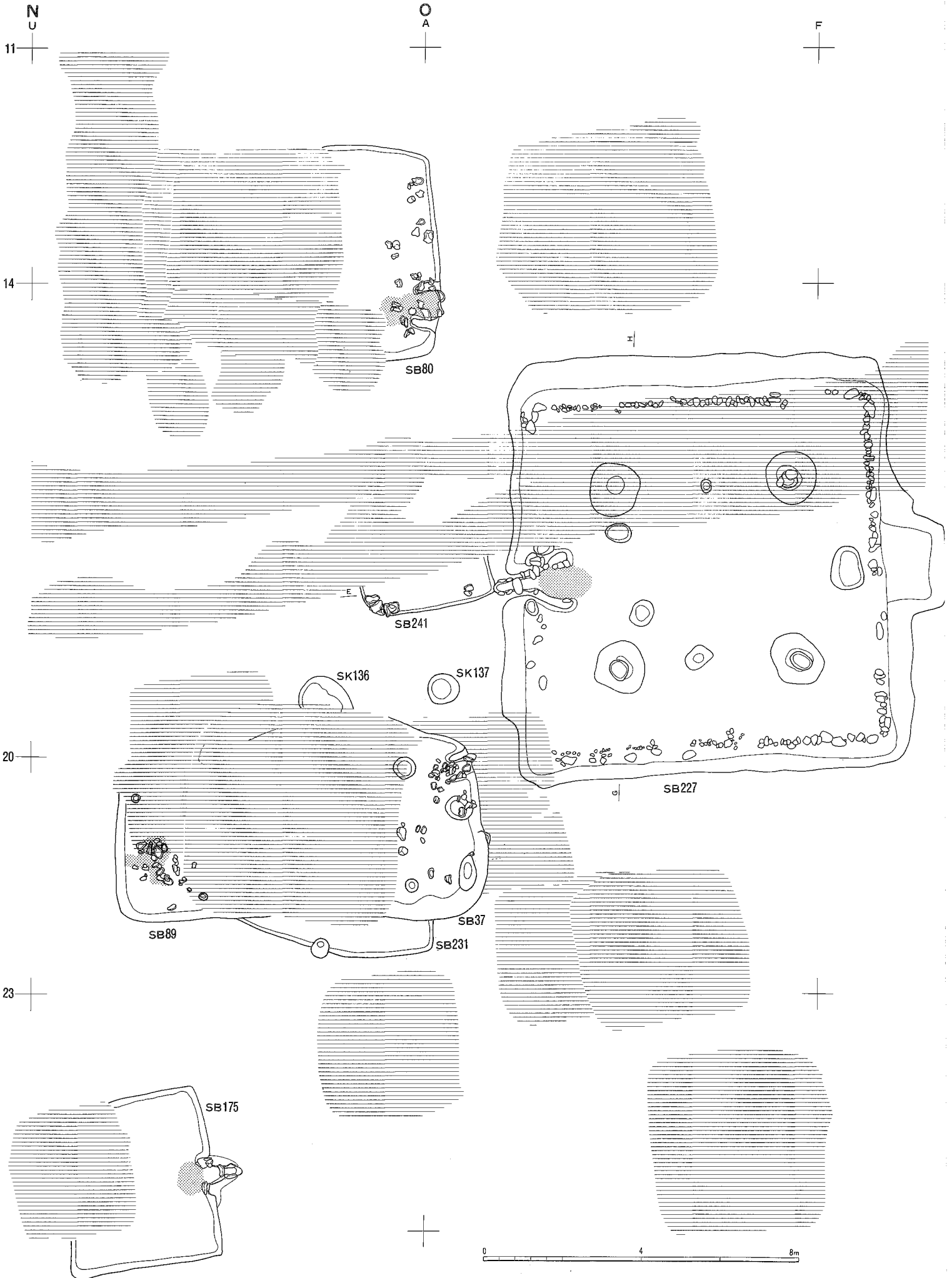

古代遺構図29・30断面図

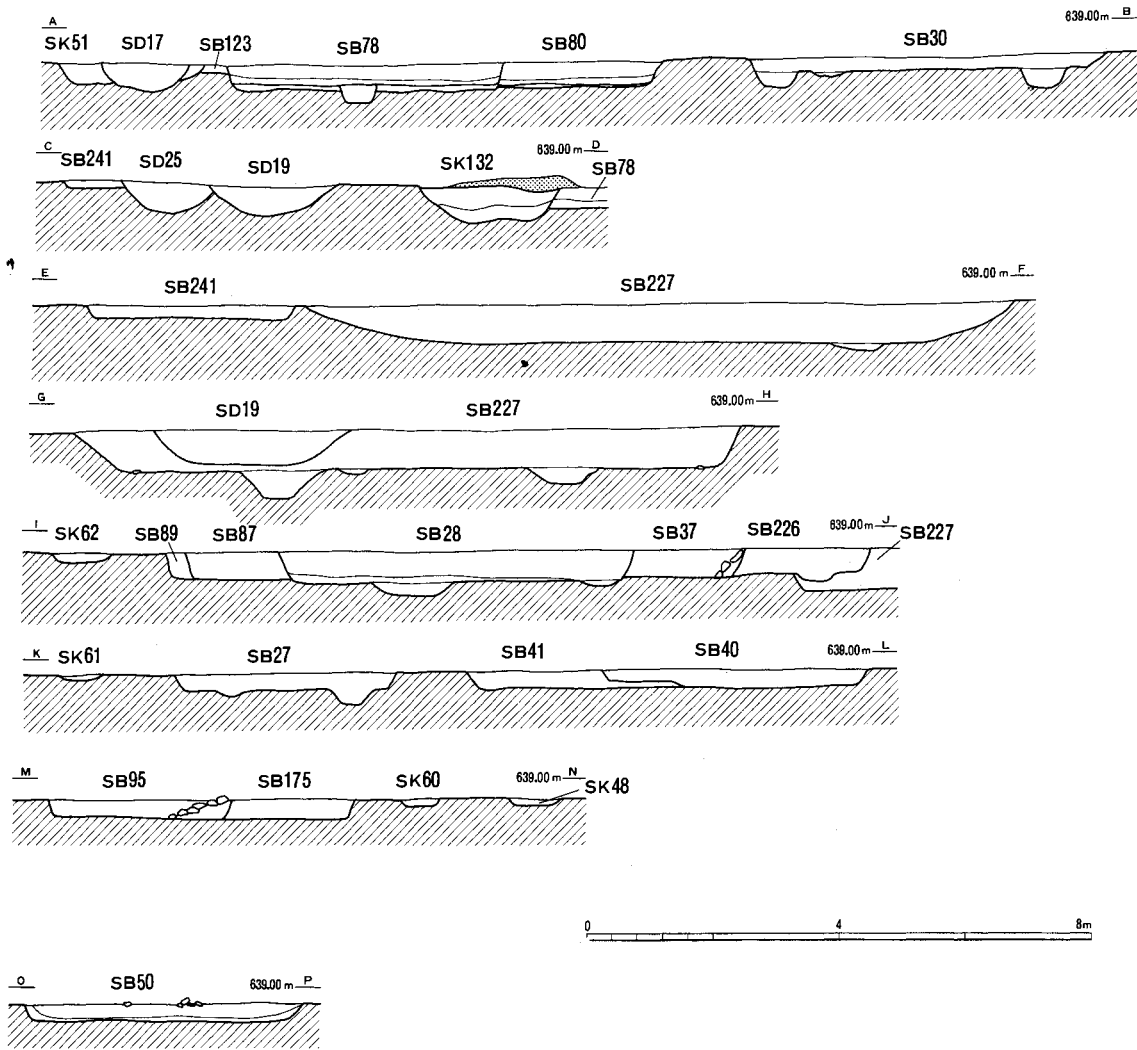

古代遺構図32断面図

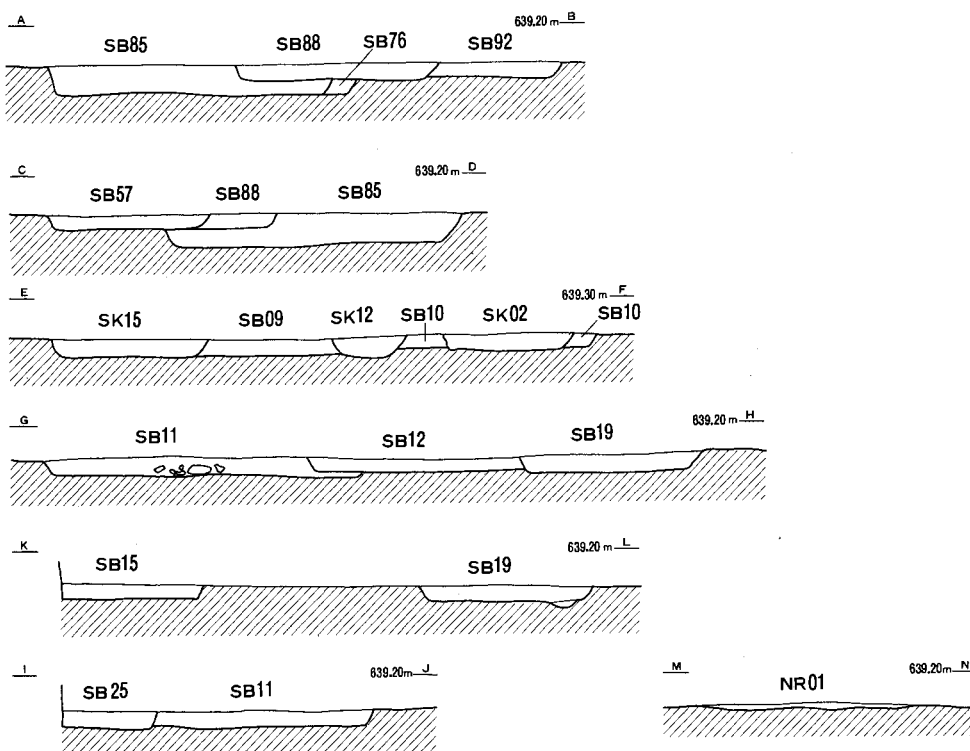

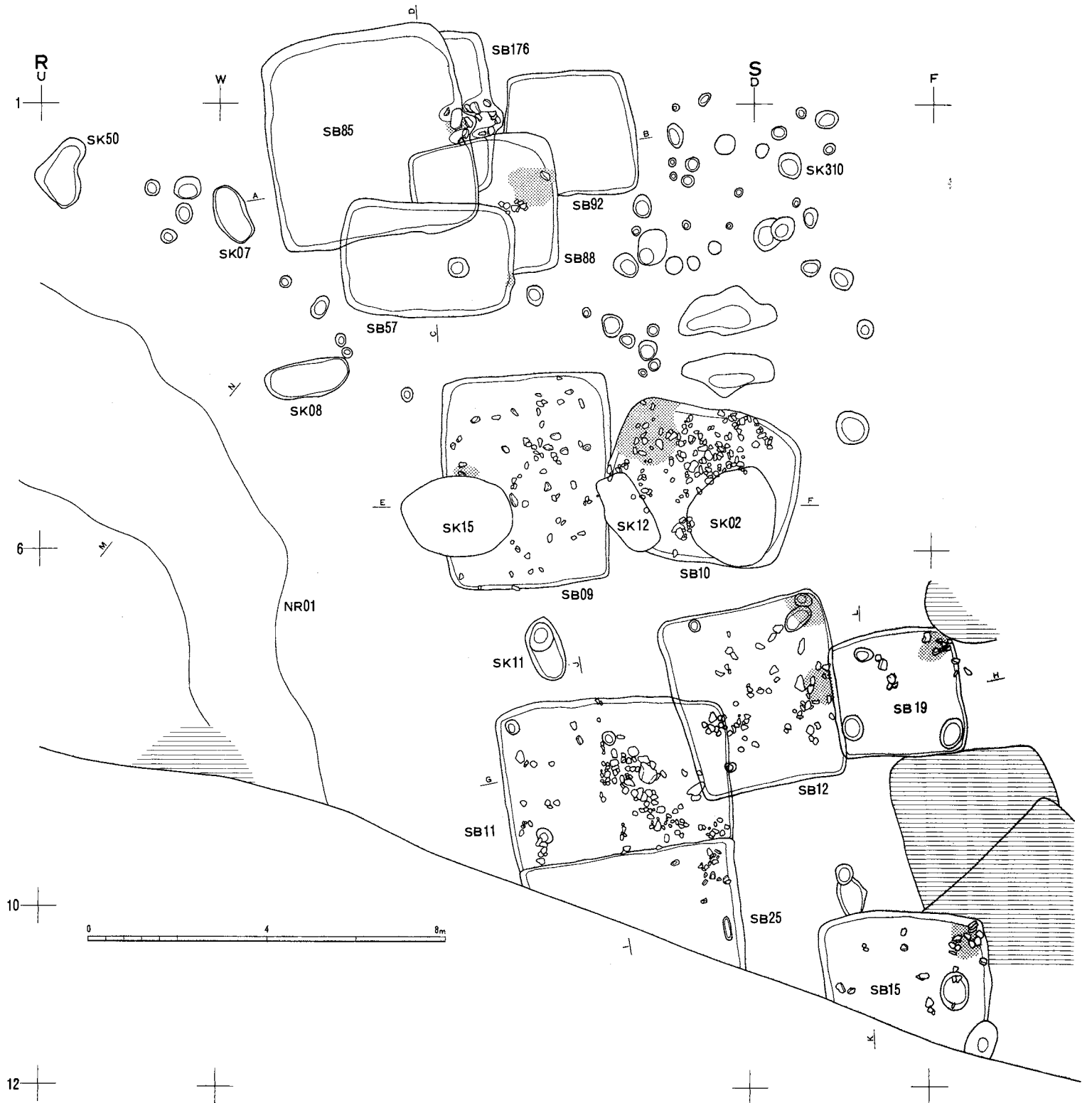

古代遺構図33断面図

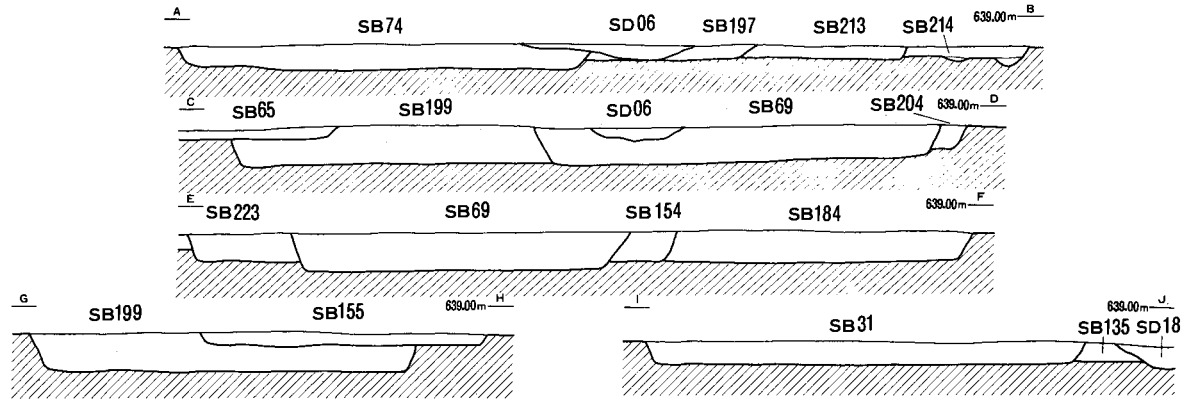

古代遺構図34断面図

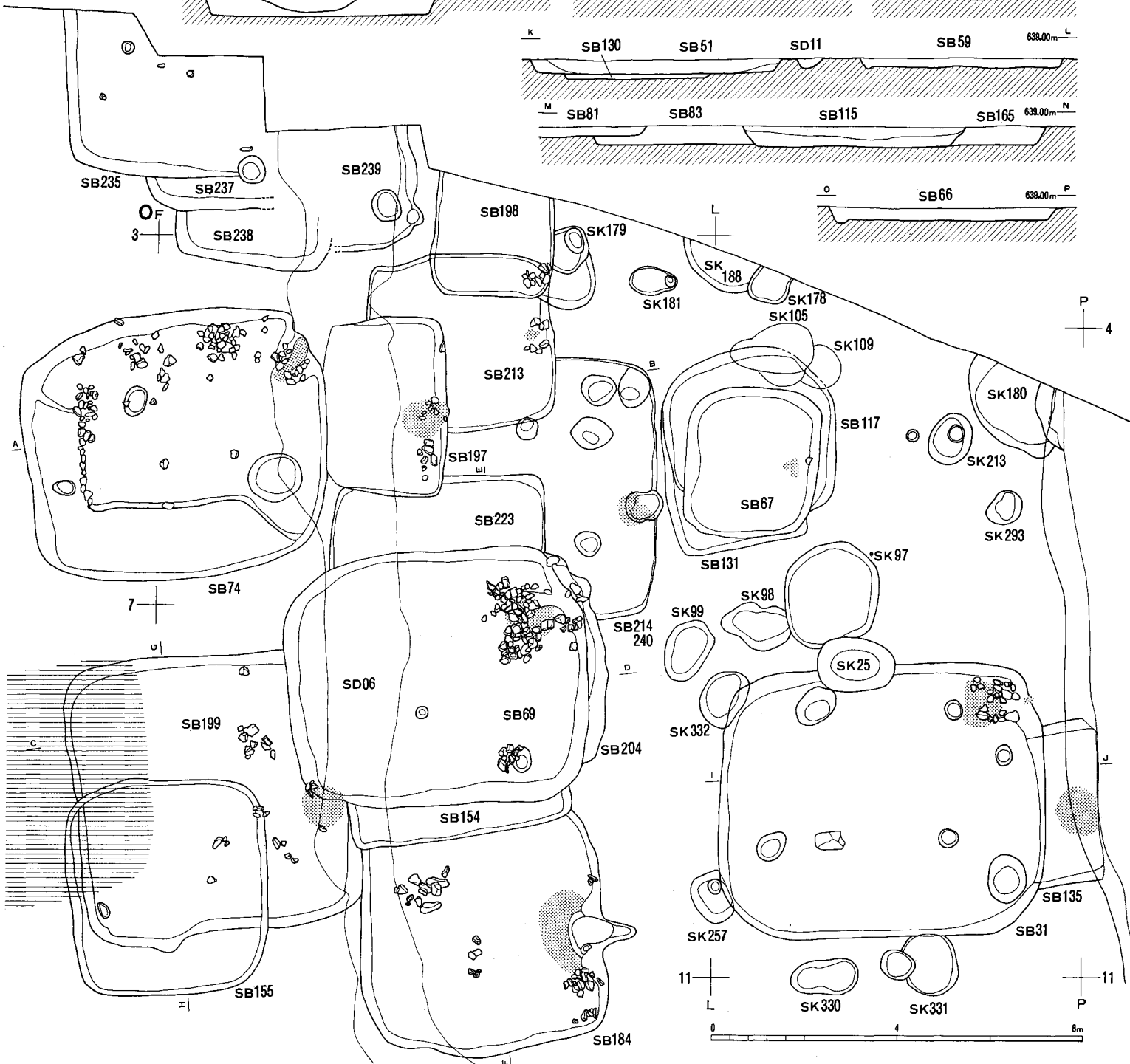
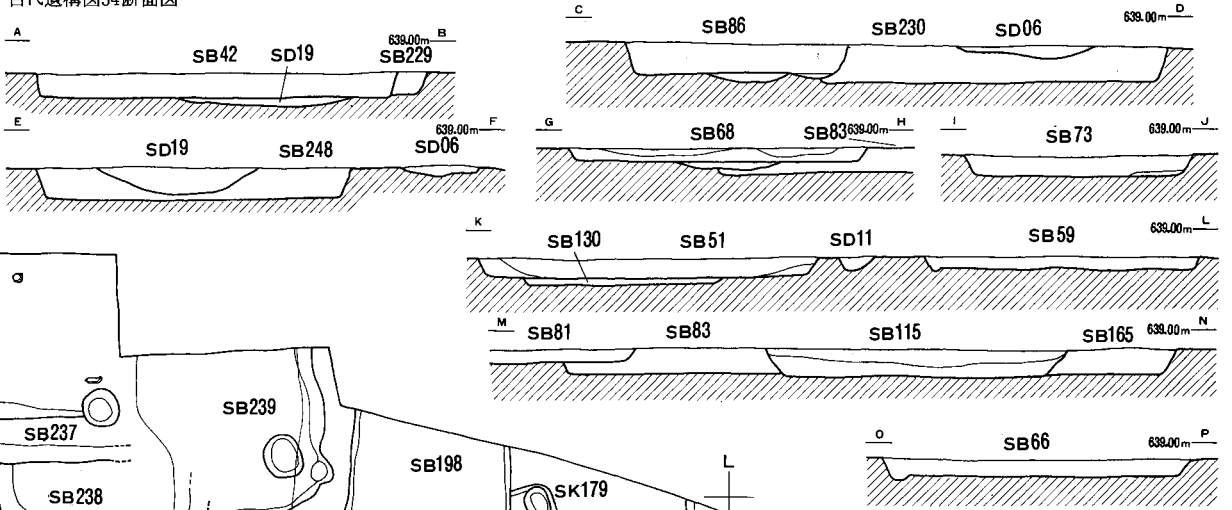

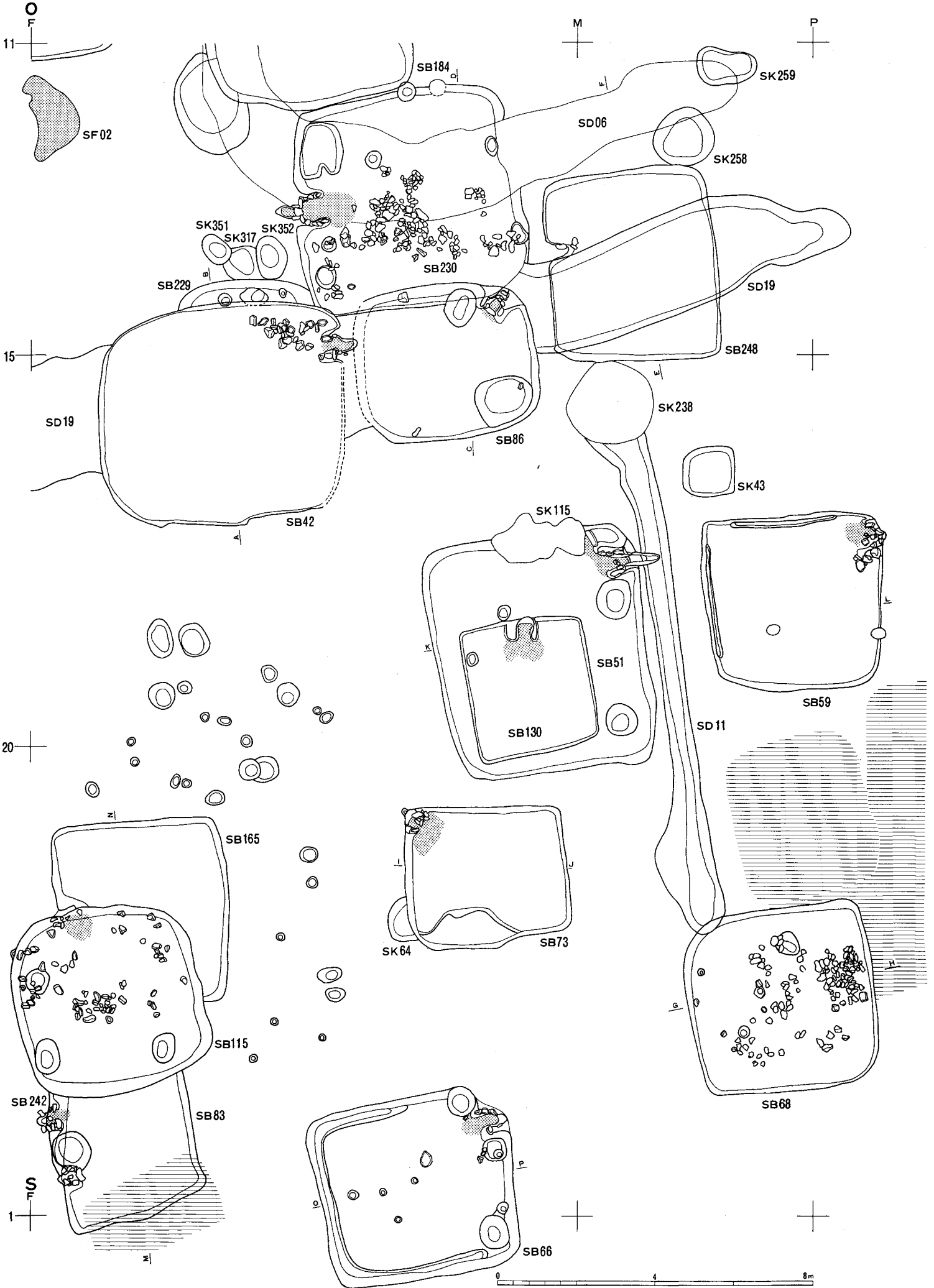

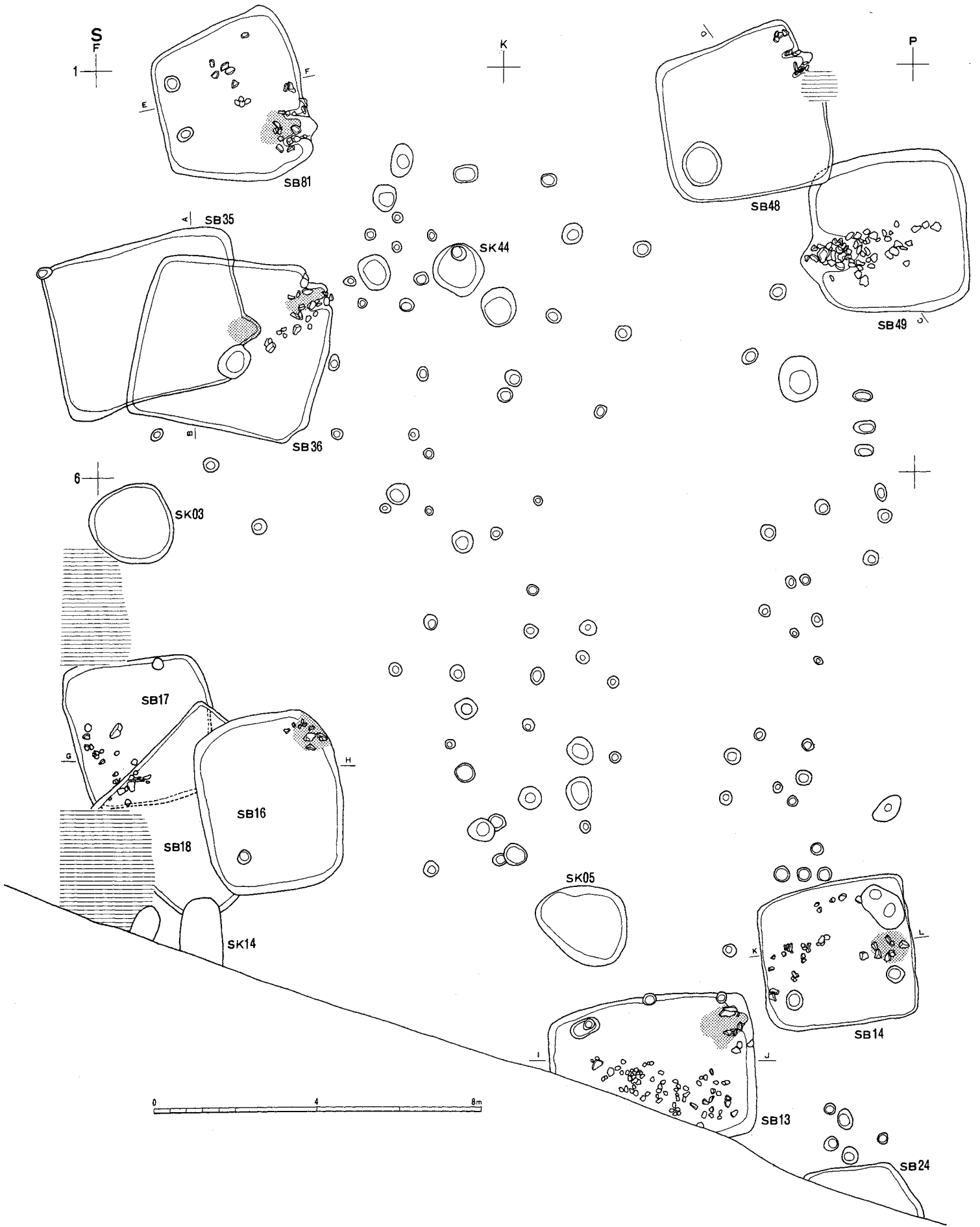



古代遺構図35断面図

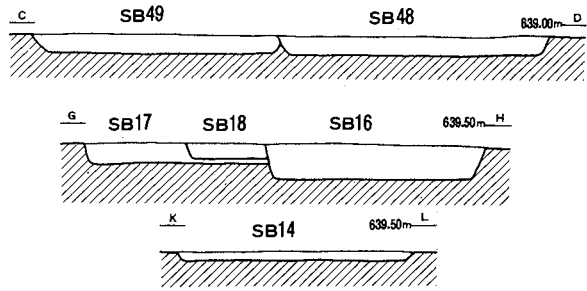
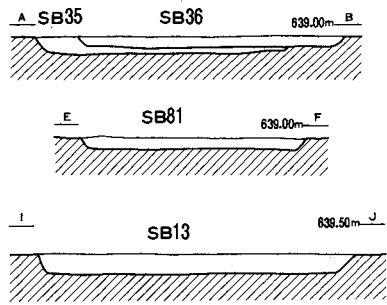

古代遺構図36断面図

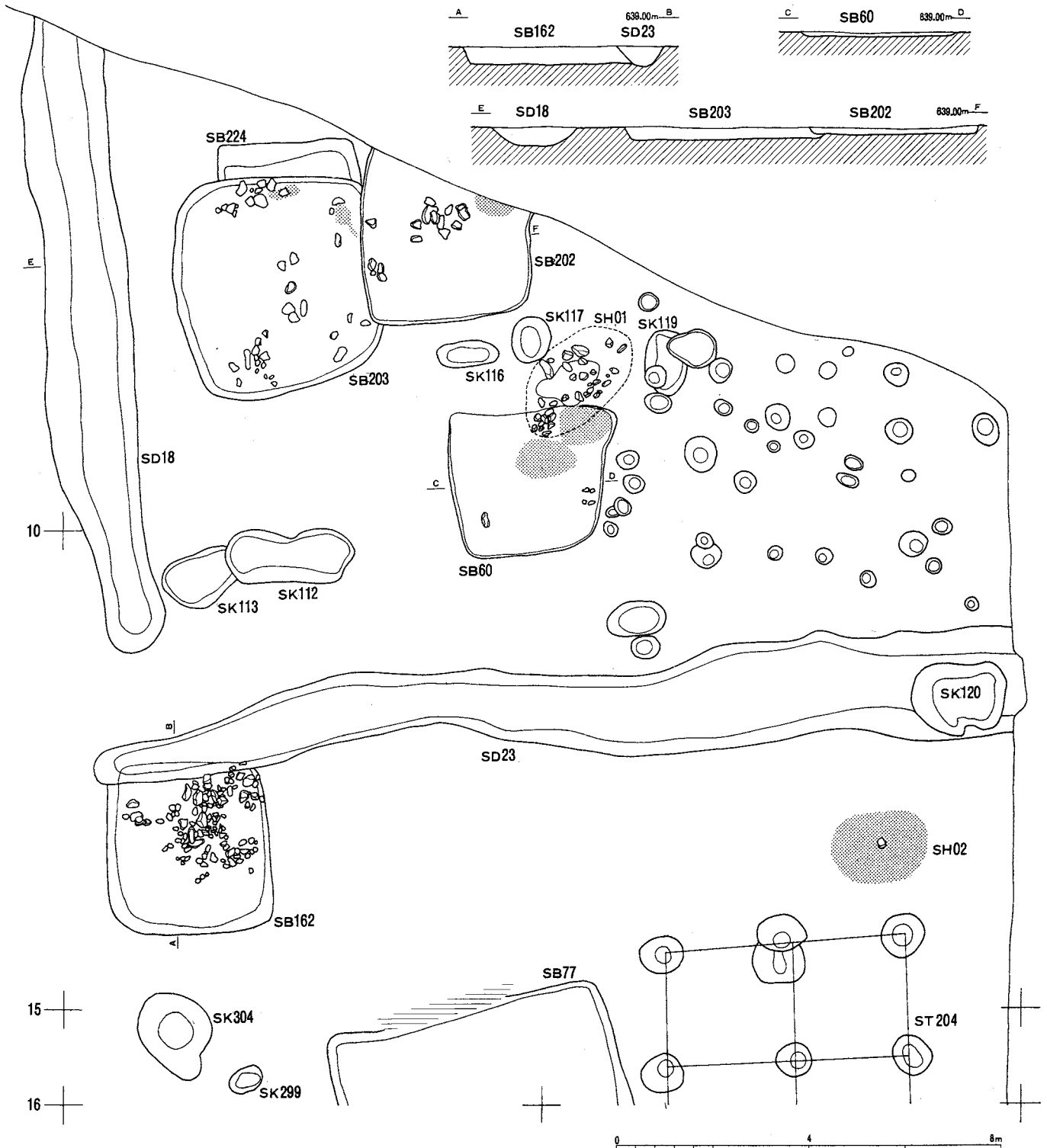
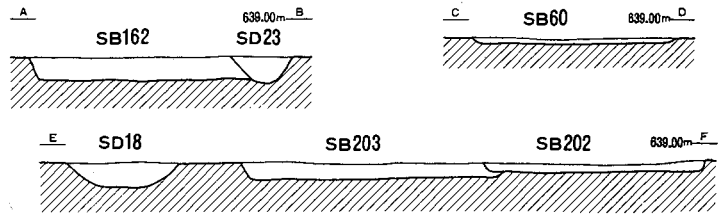

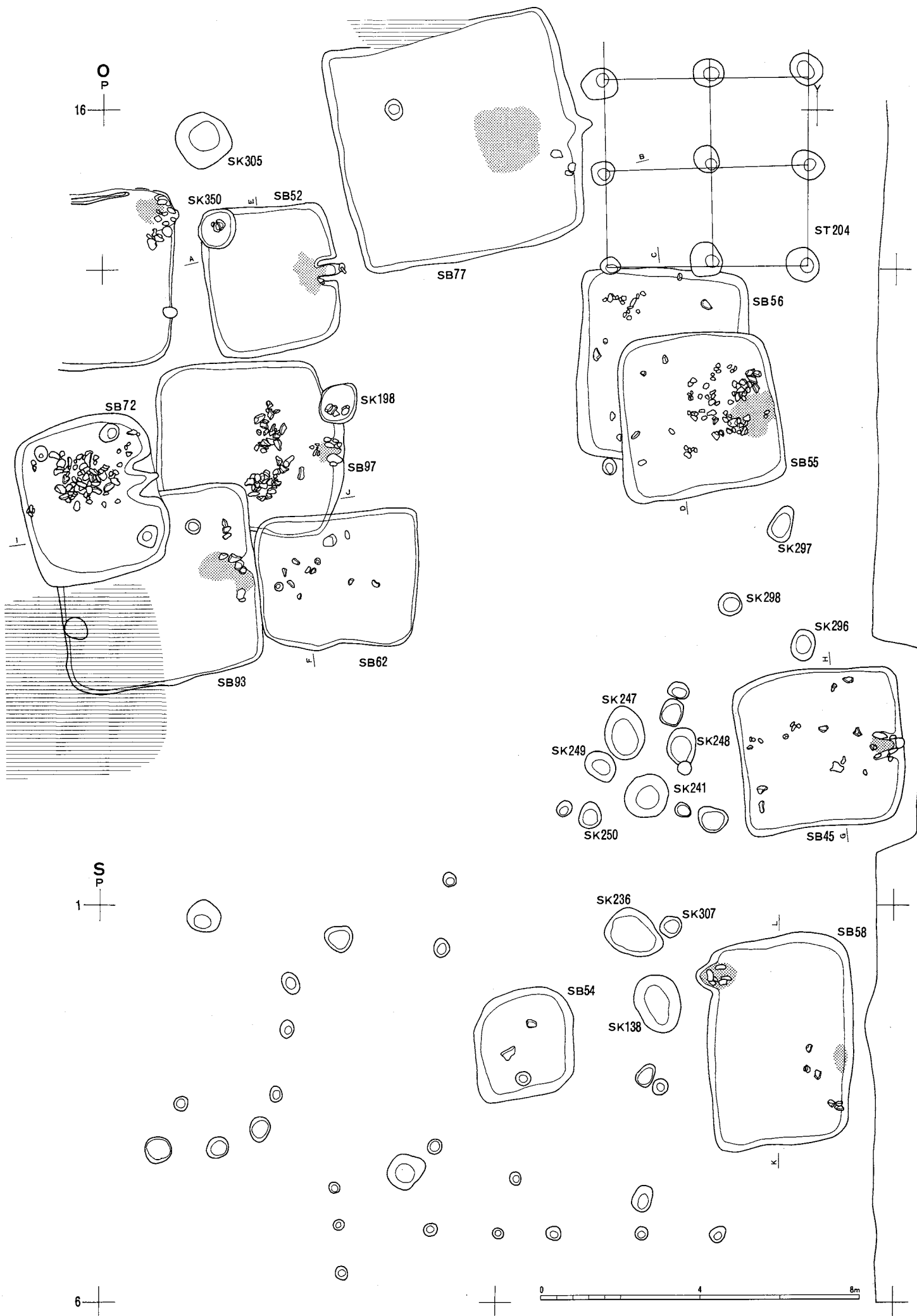

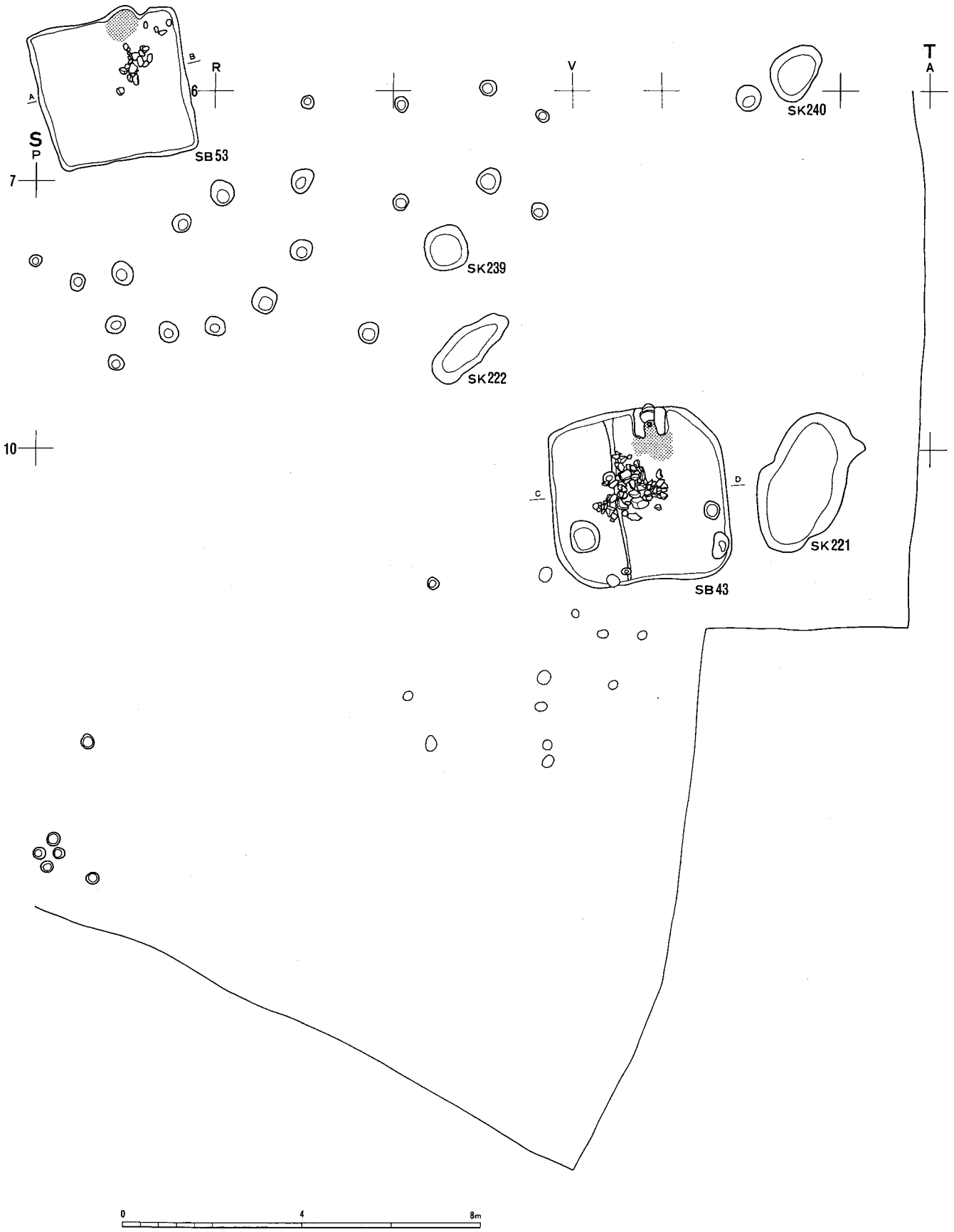

古代遺構図37断面図

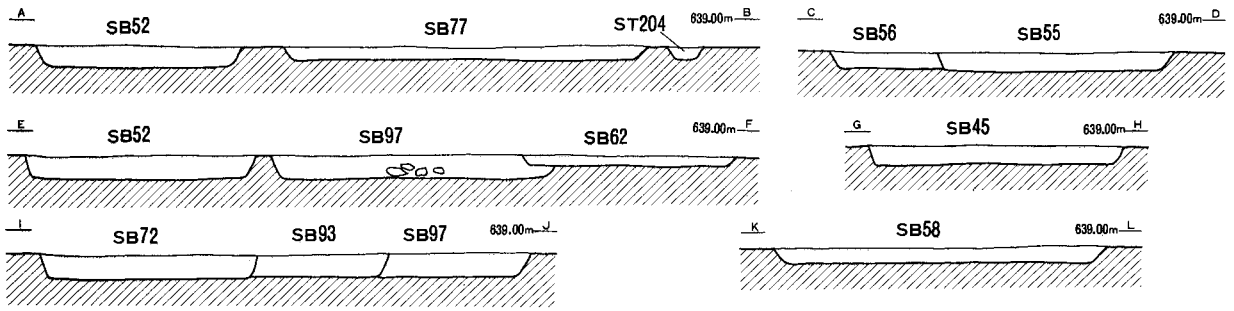

古代遺構図38断面図



古代遺構図39断面図

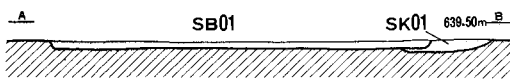

13 P
C

H

M

15

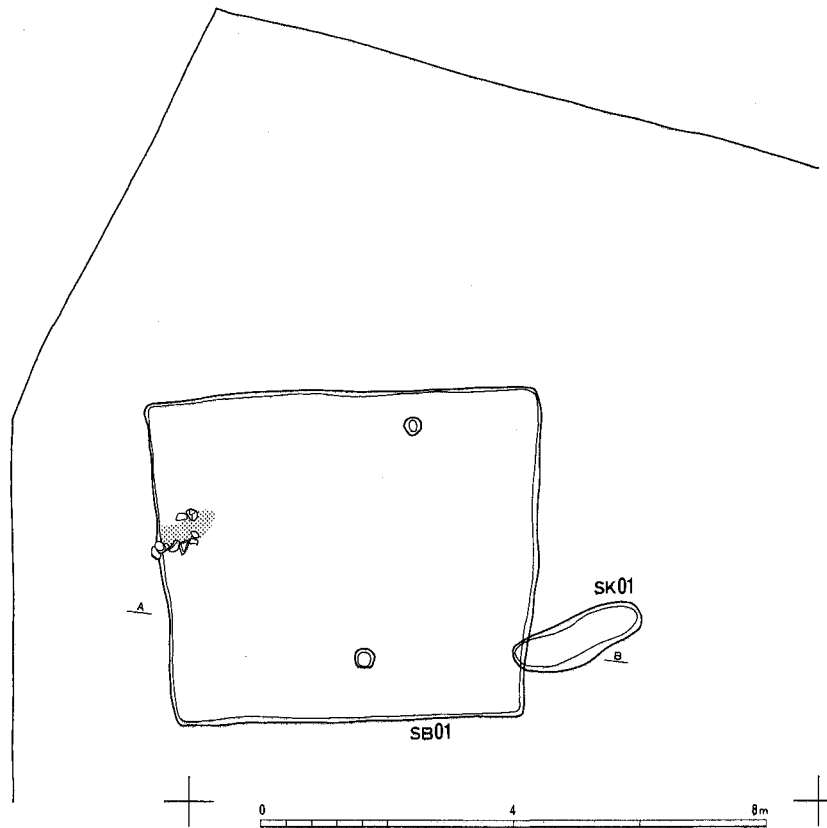

20

0 4 8m

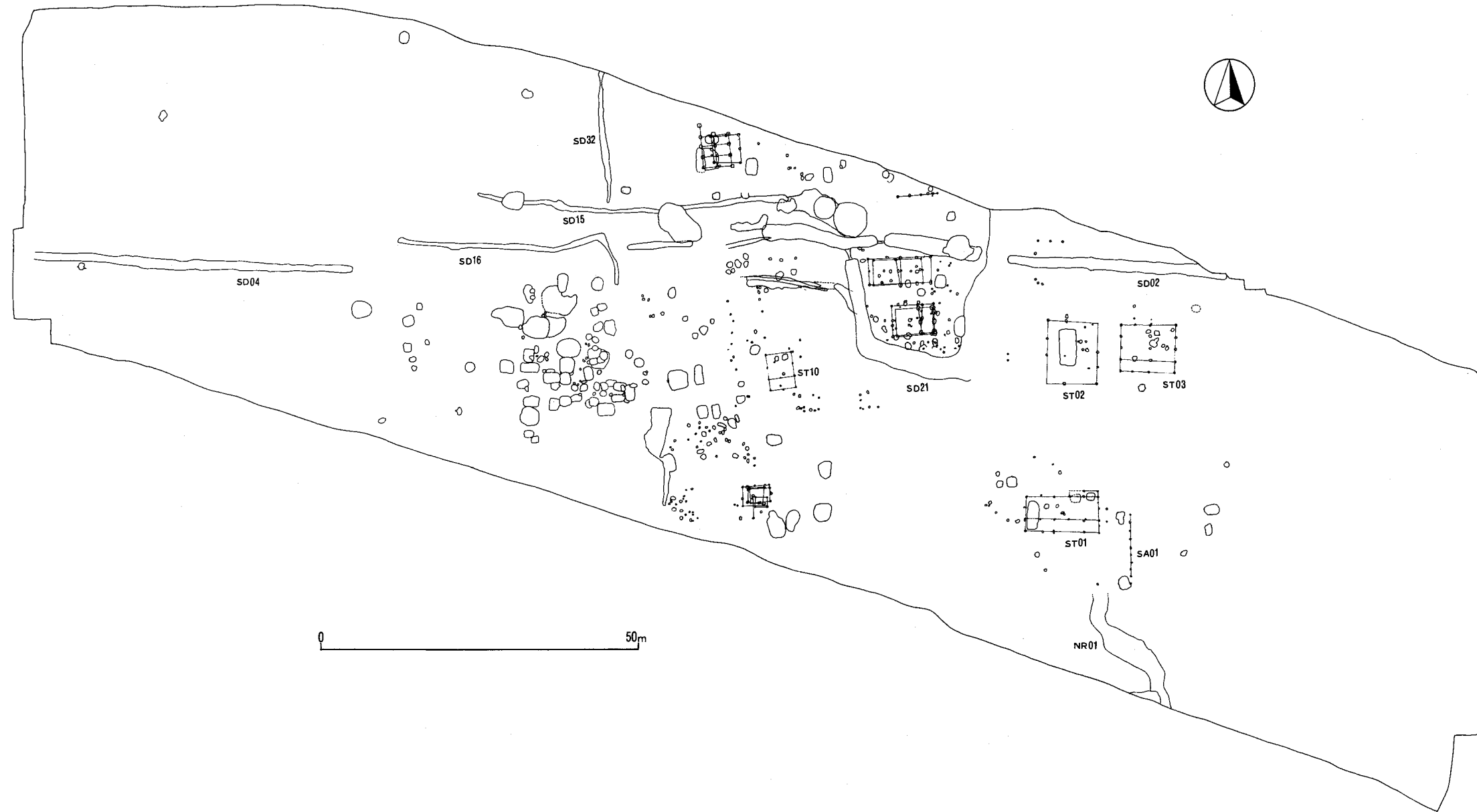

中・近世遺構割り付け図

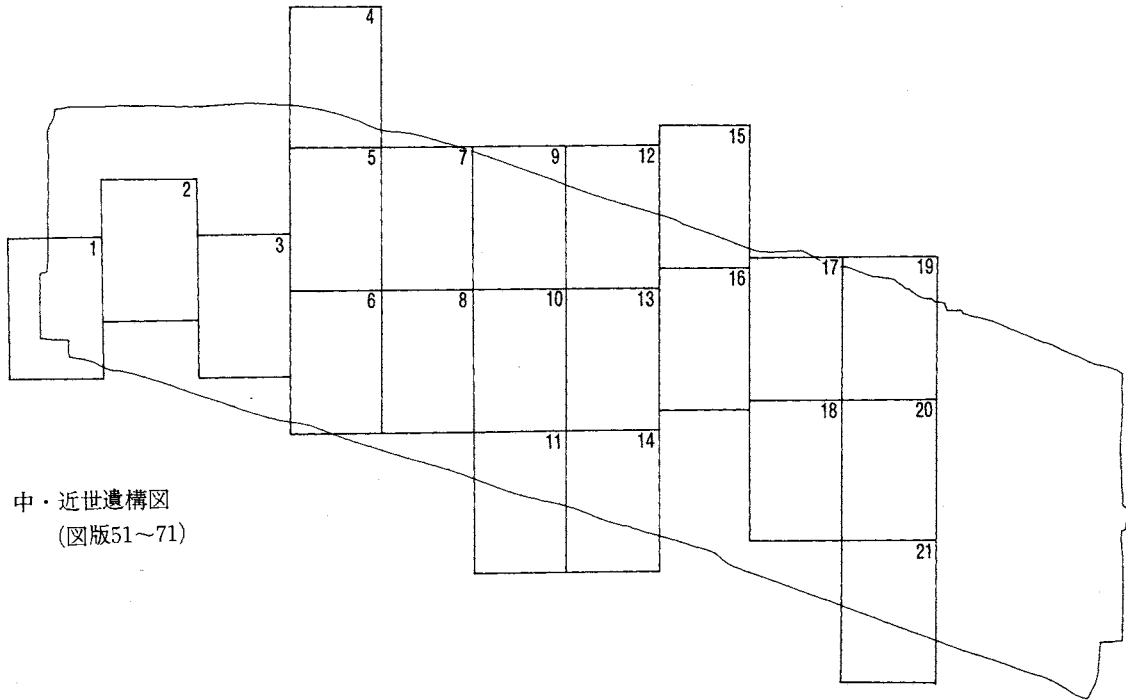

中・近世遺構図
(図版51~71)

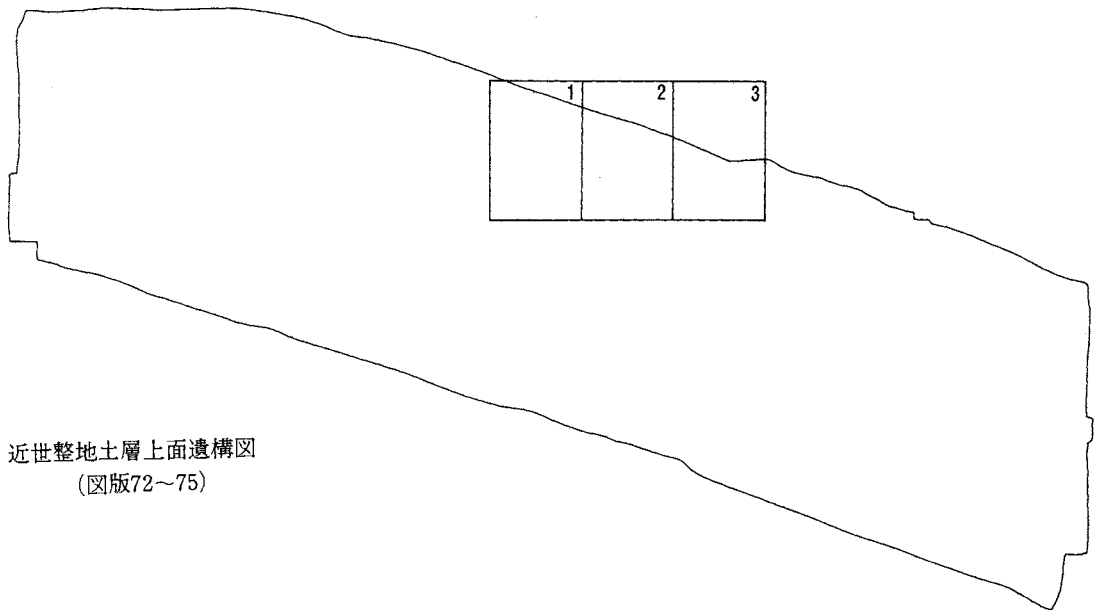

近世整地土層上面遺構図
(図版72~75)

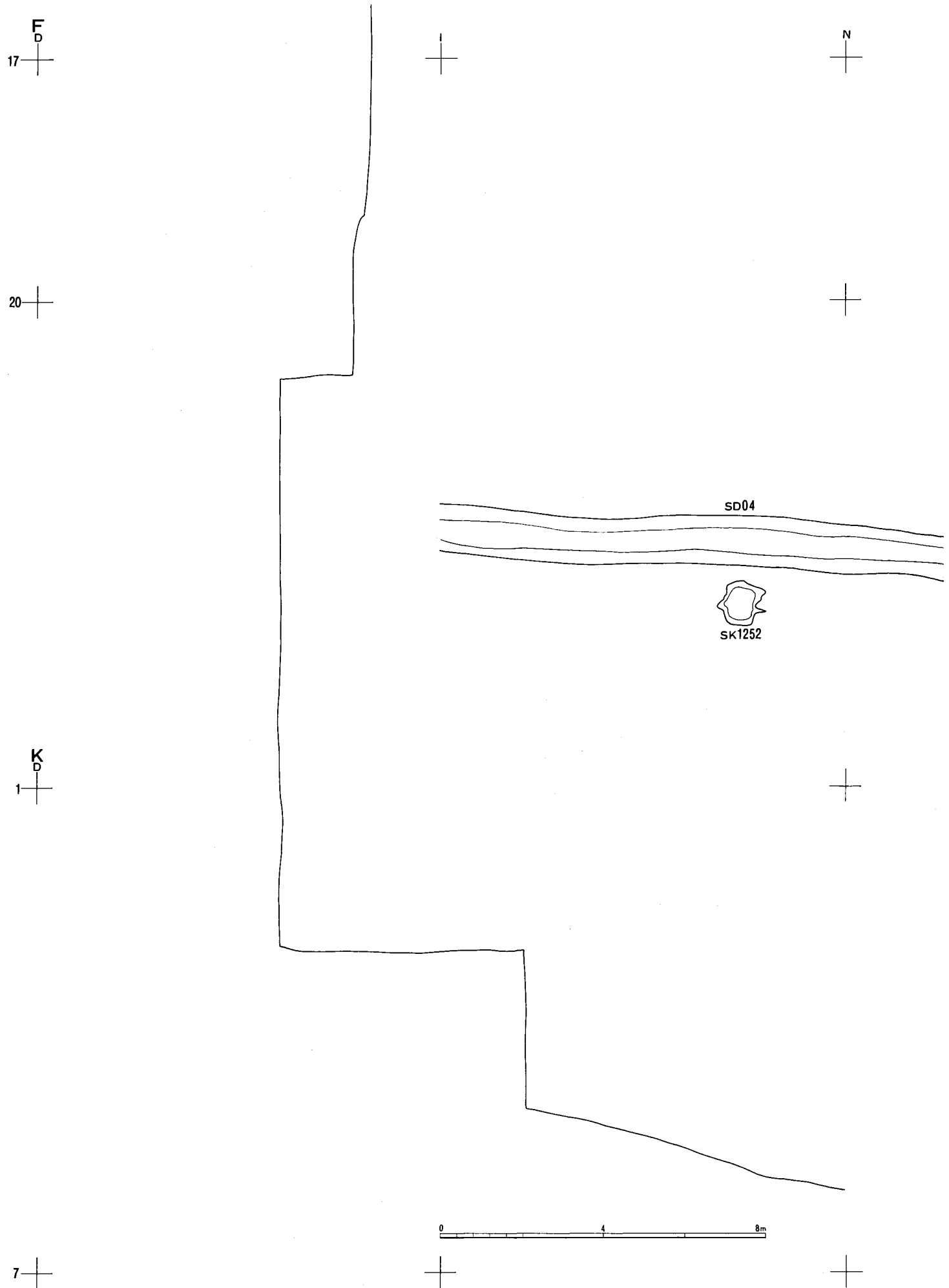



sk1162

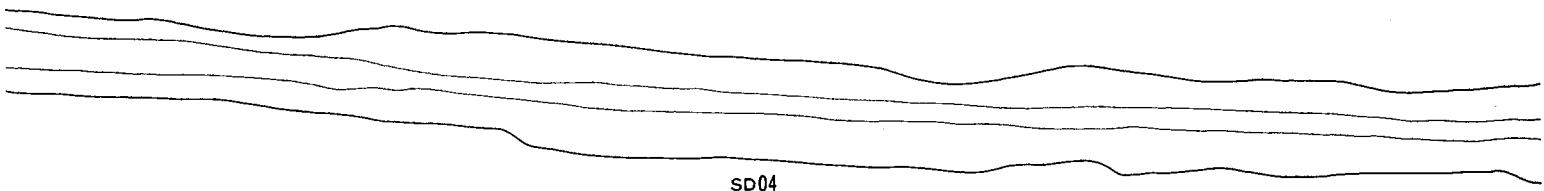

sd04

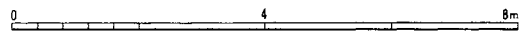

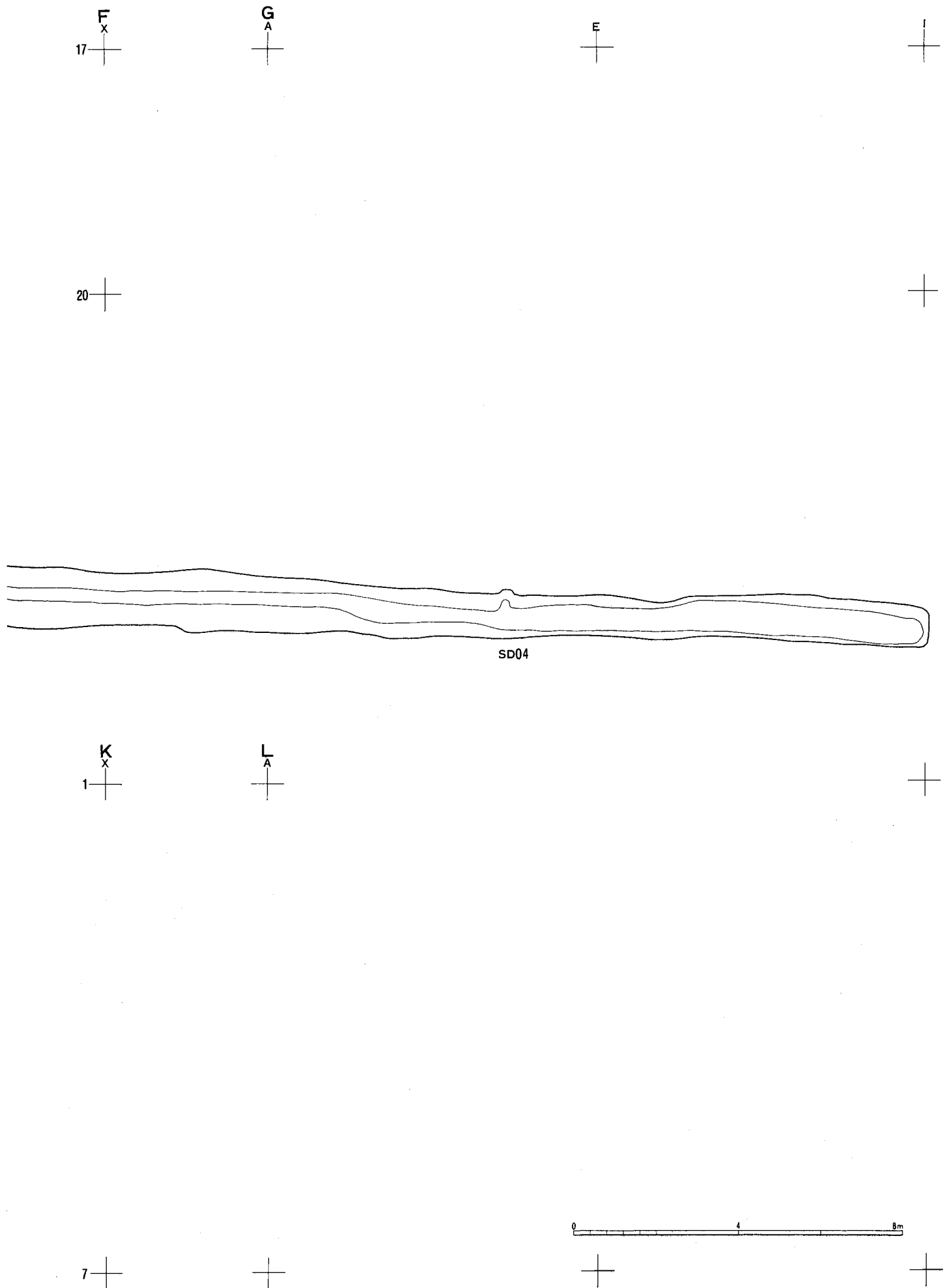

中·近世遺構図4 (1:120)

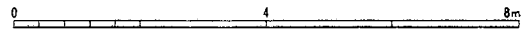

SK 1176



G
8

N

S

10



15

20

23

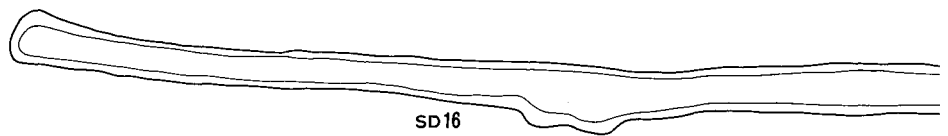

SD16



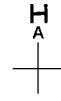
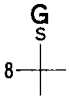

SK1180



SD32

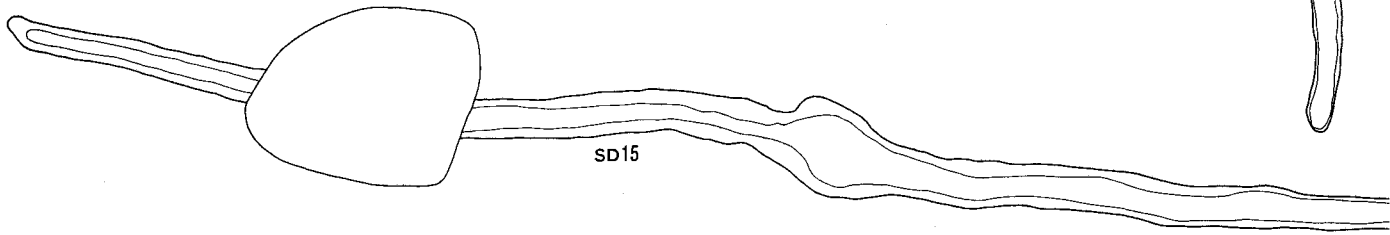

SD15

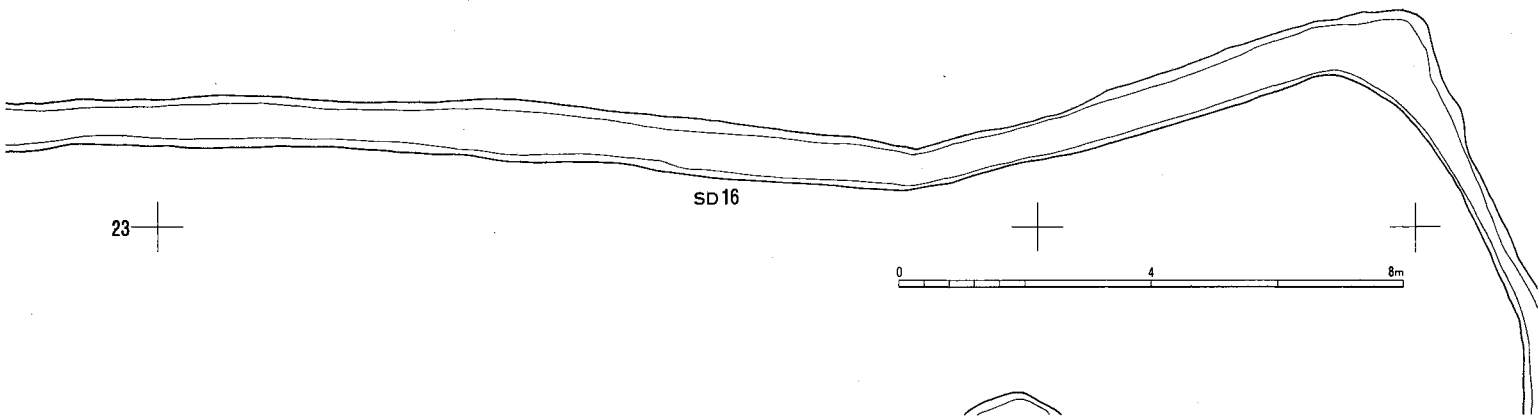

SD16

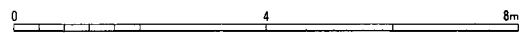

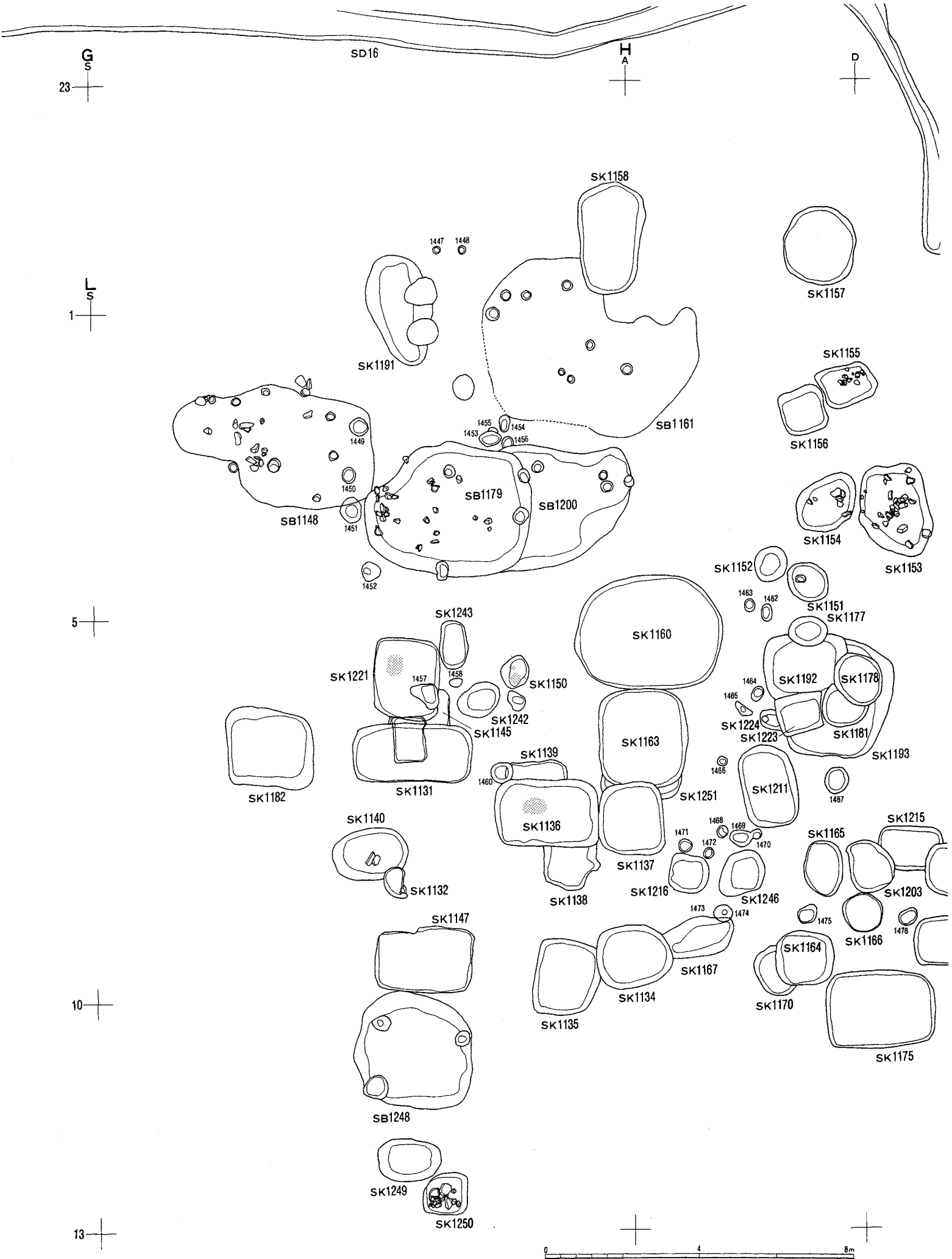

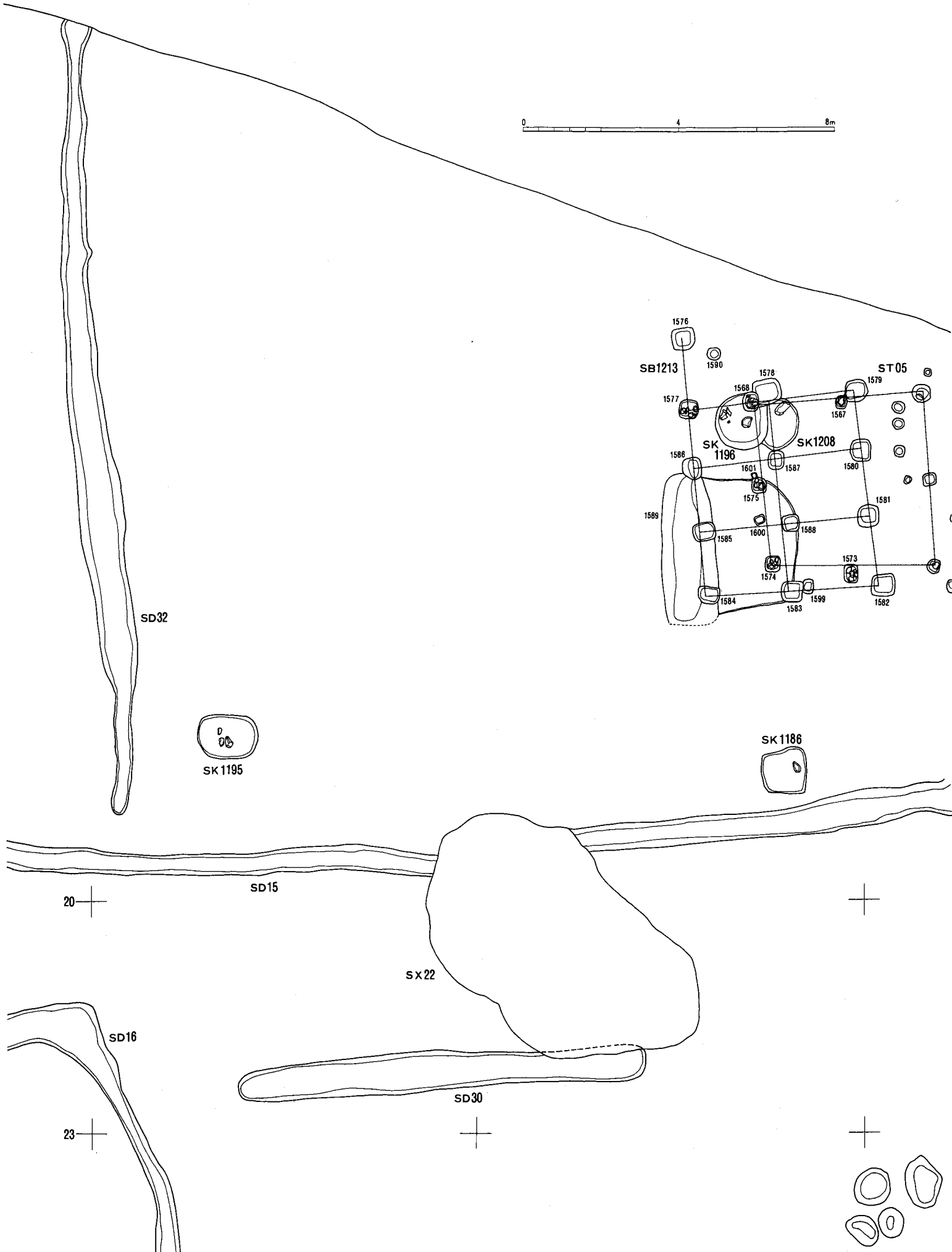
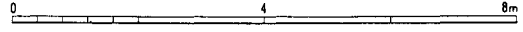
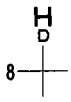

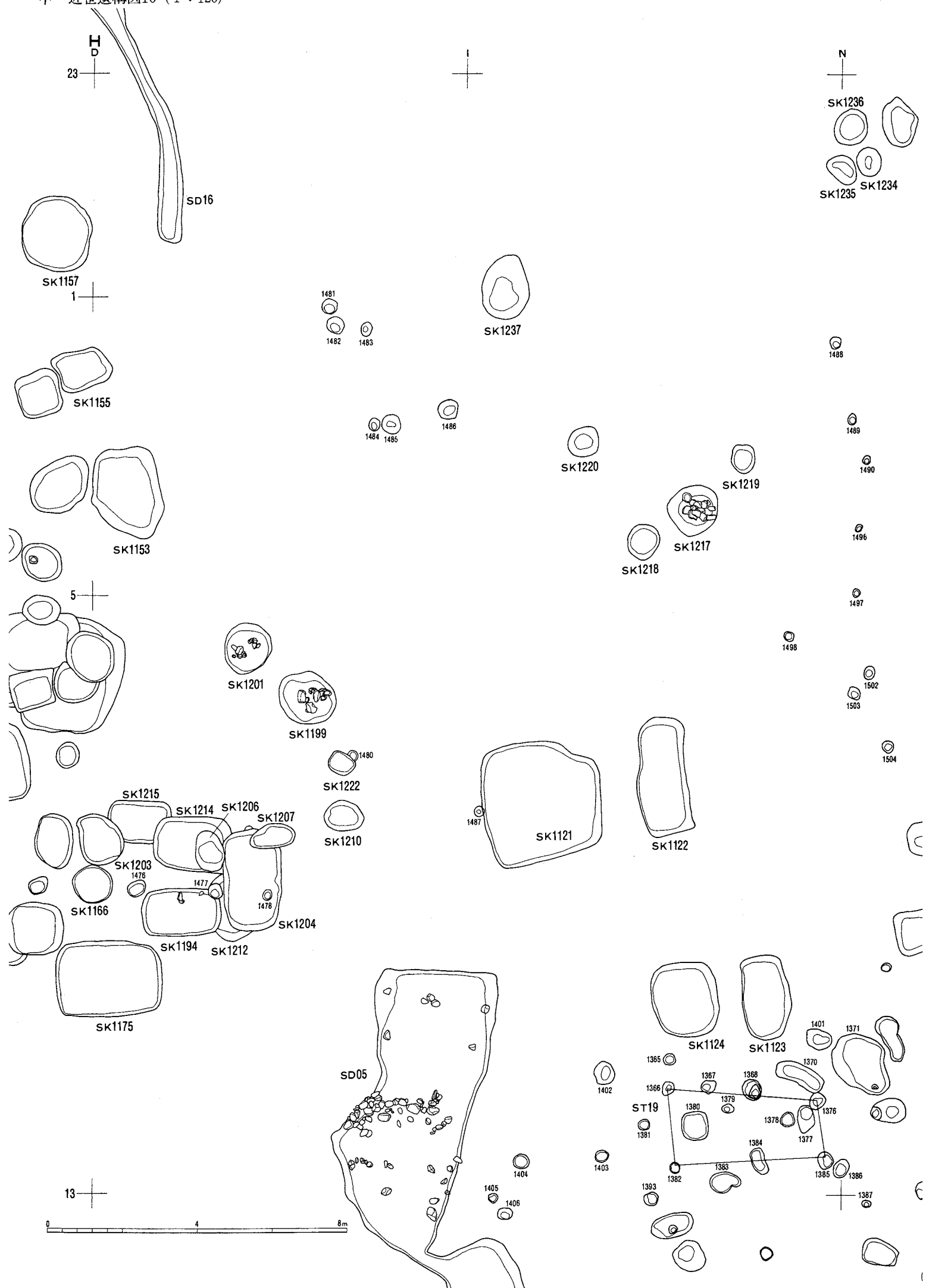

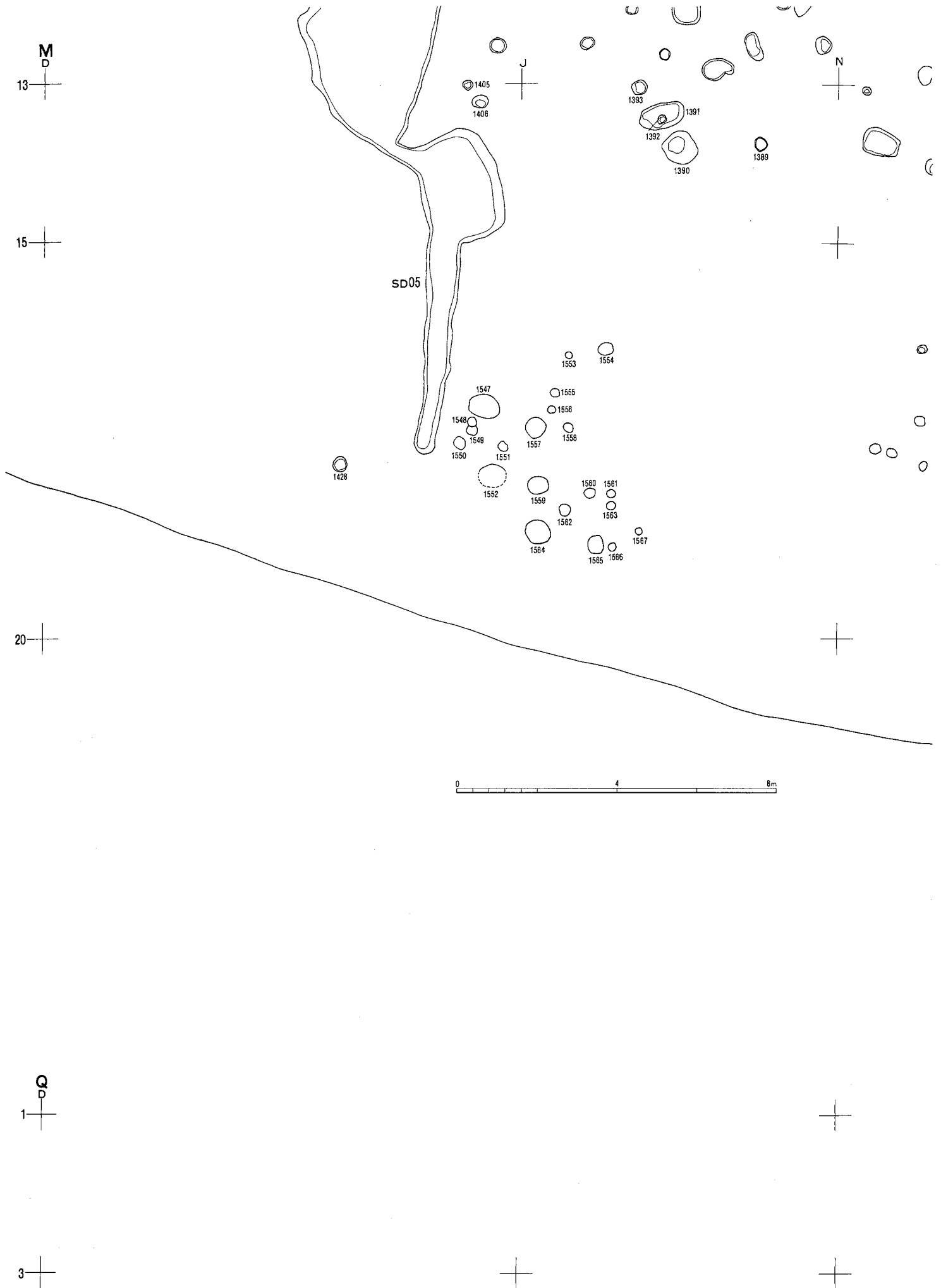

中・近世遺構図12 (1:120)

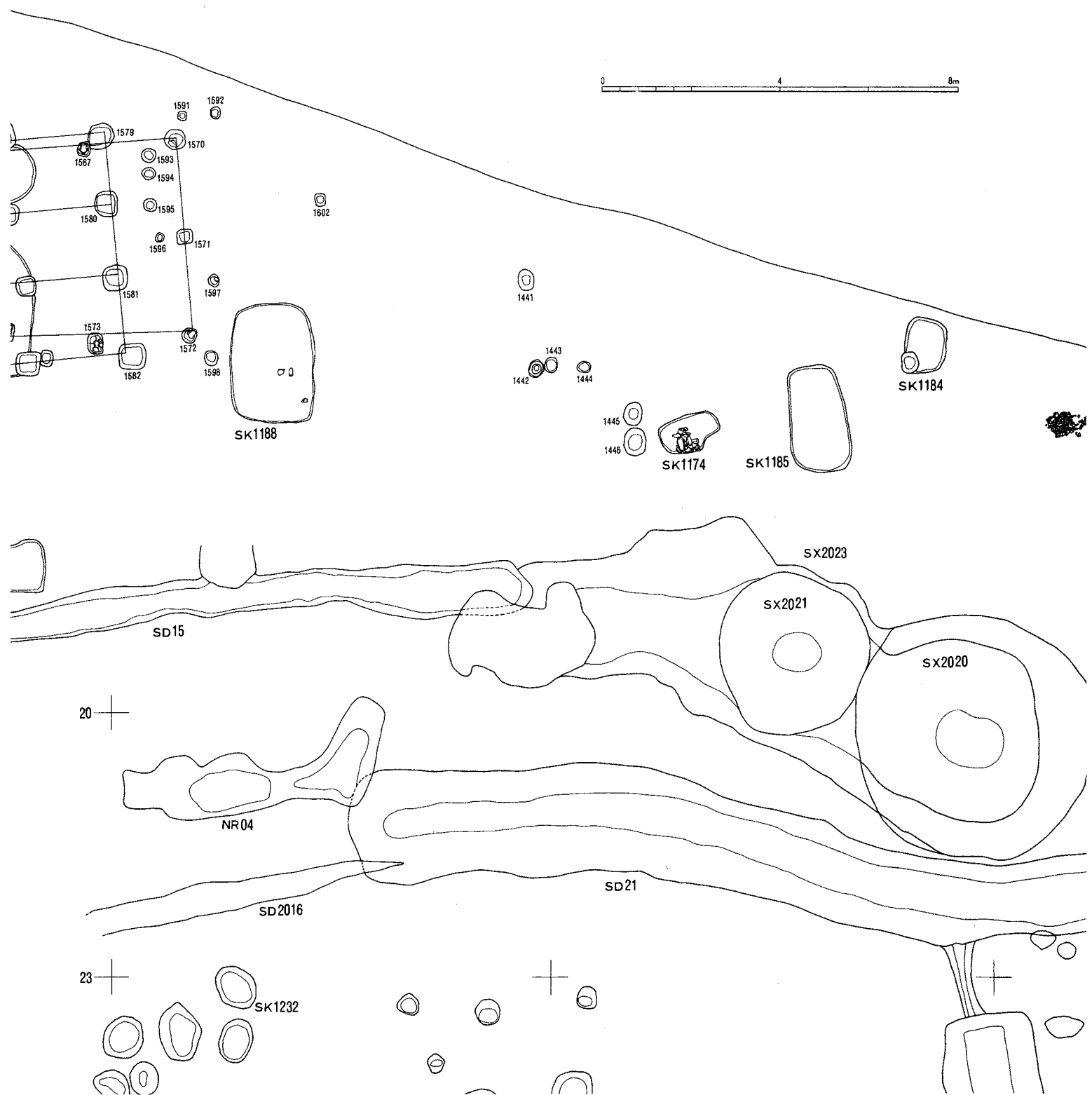
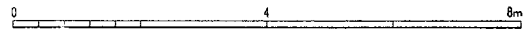

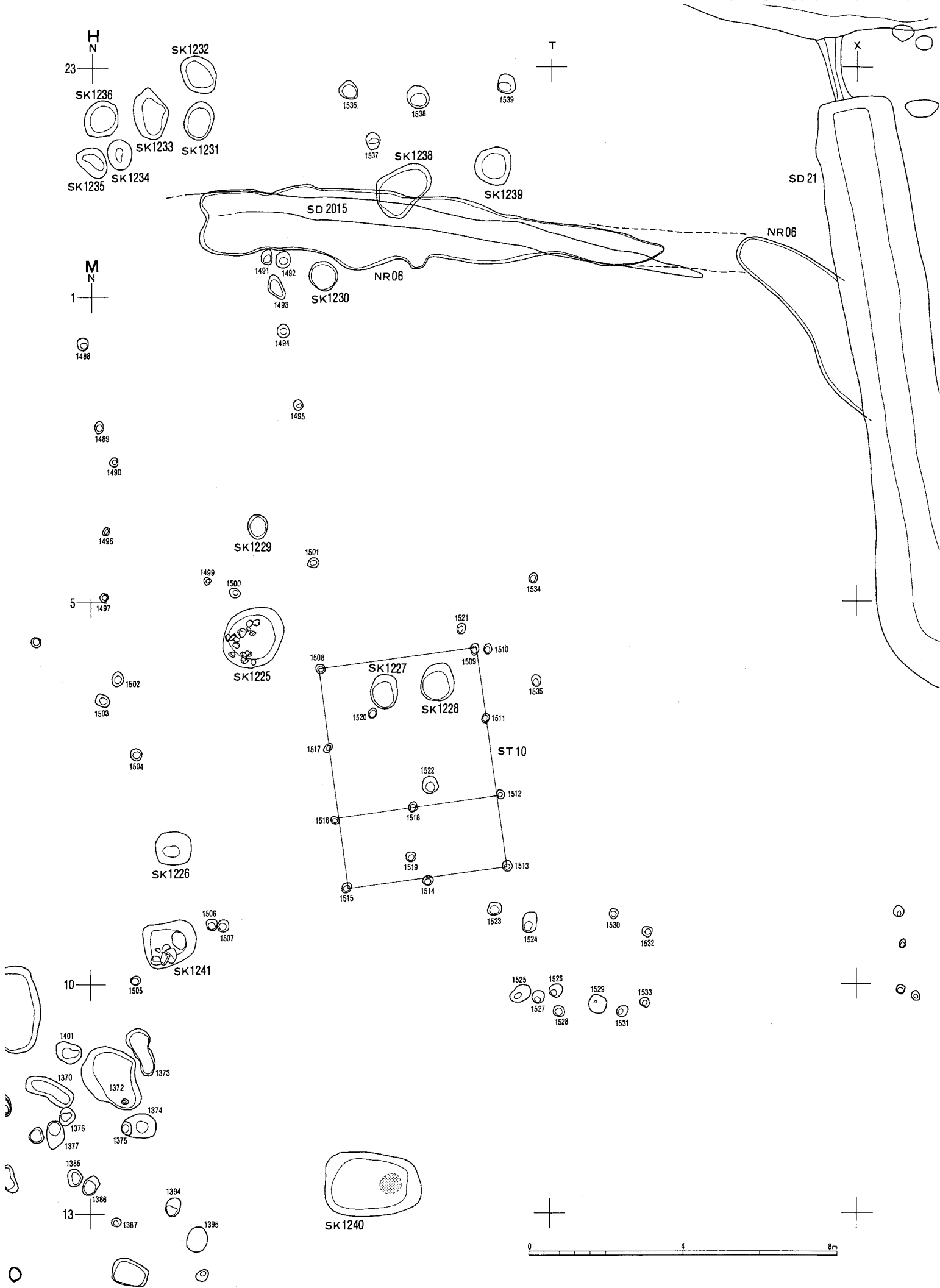

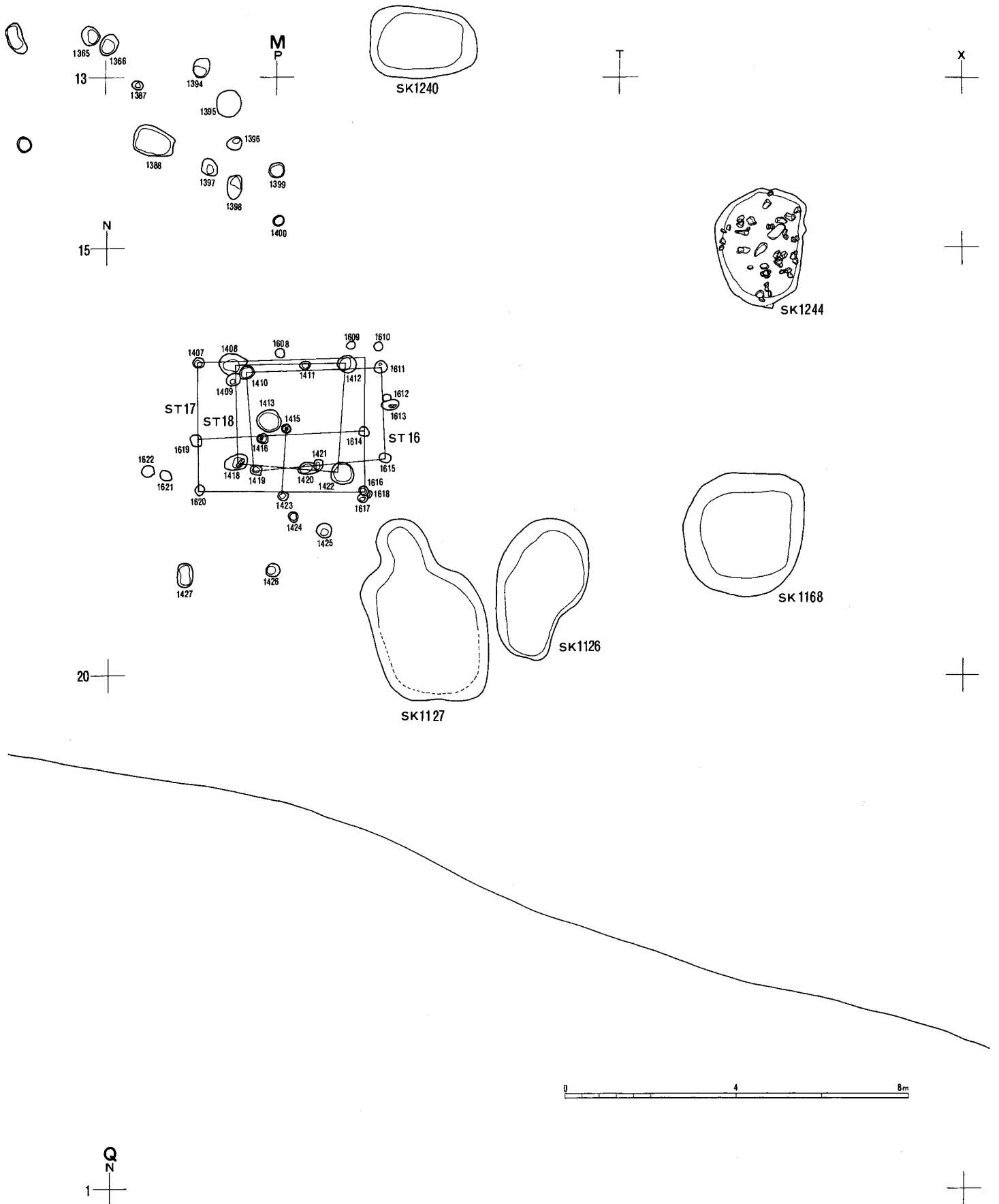

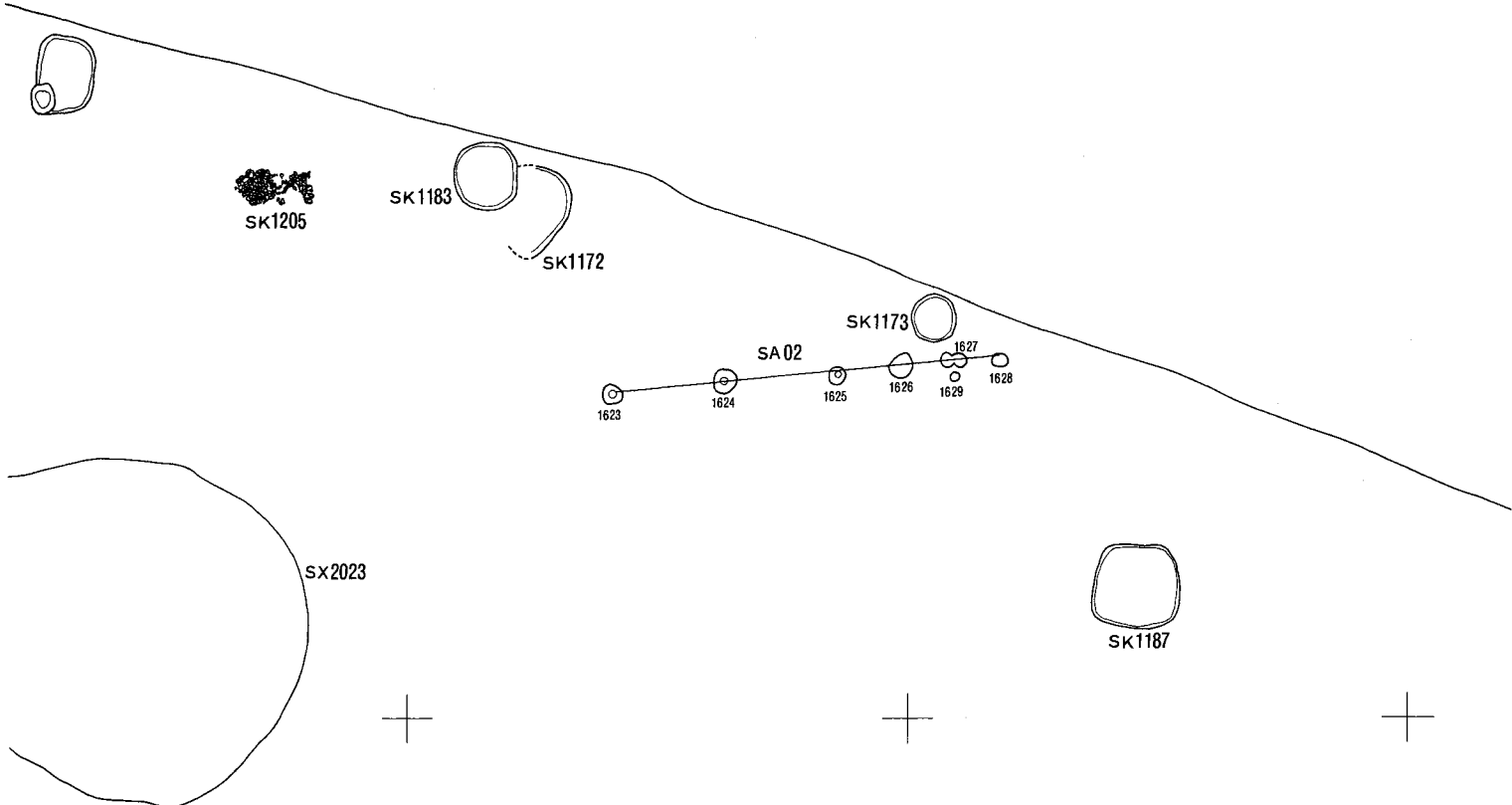
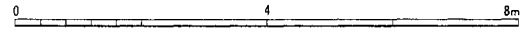
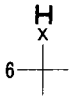

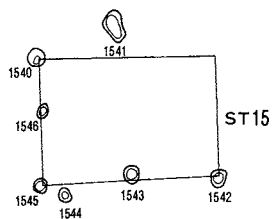
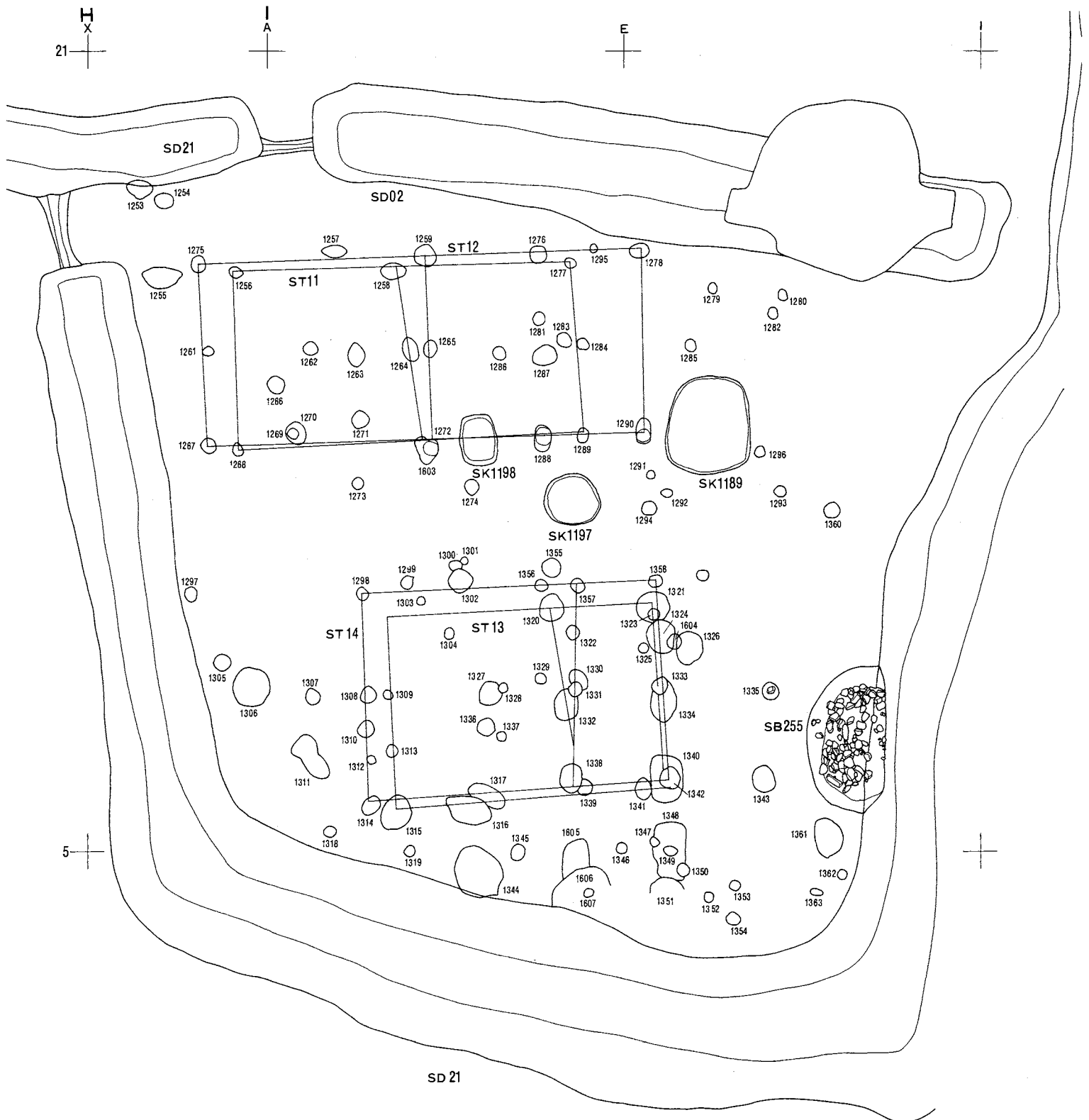

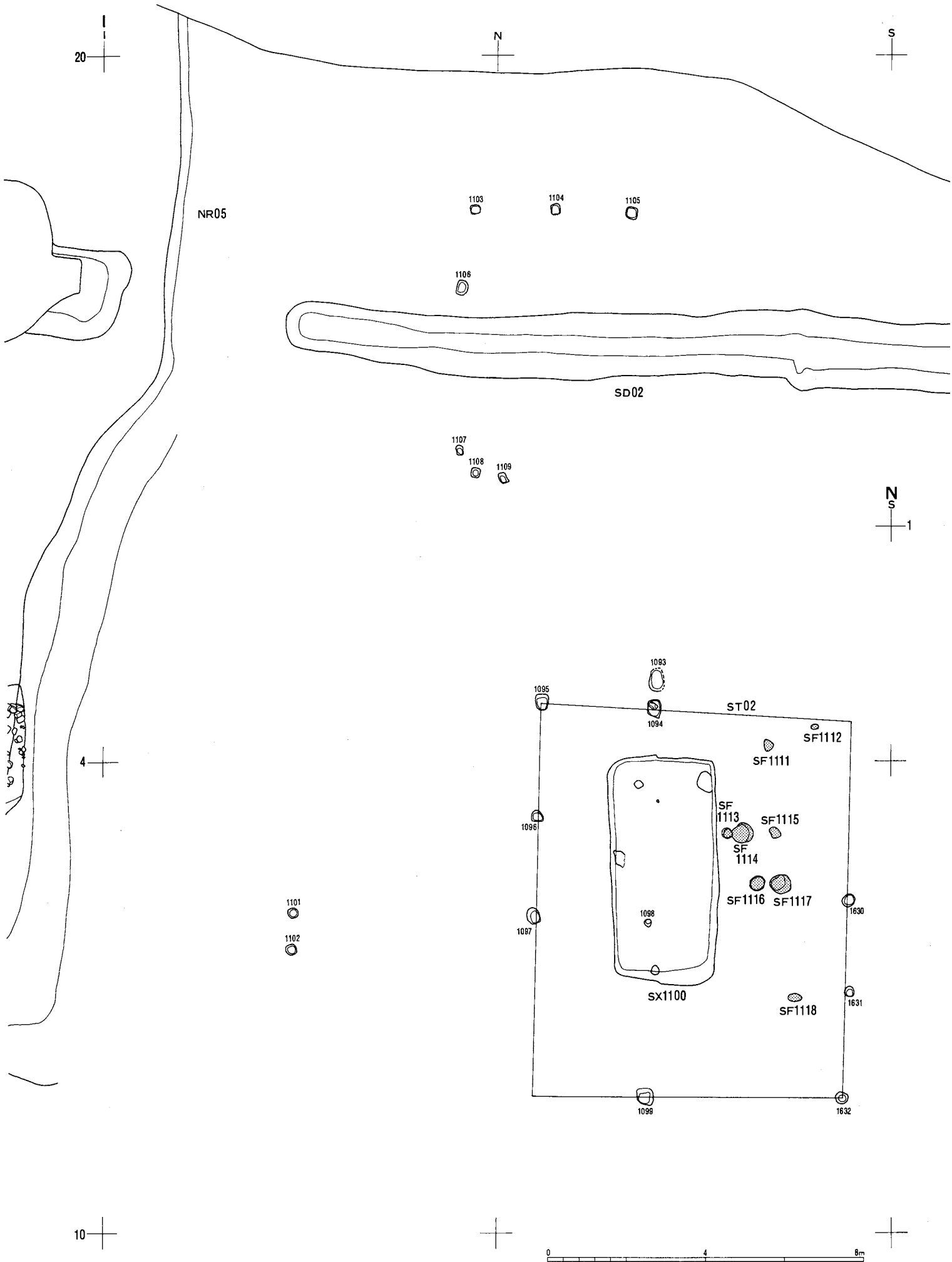

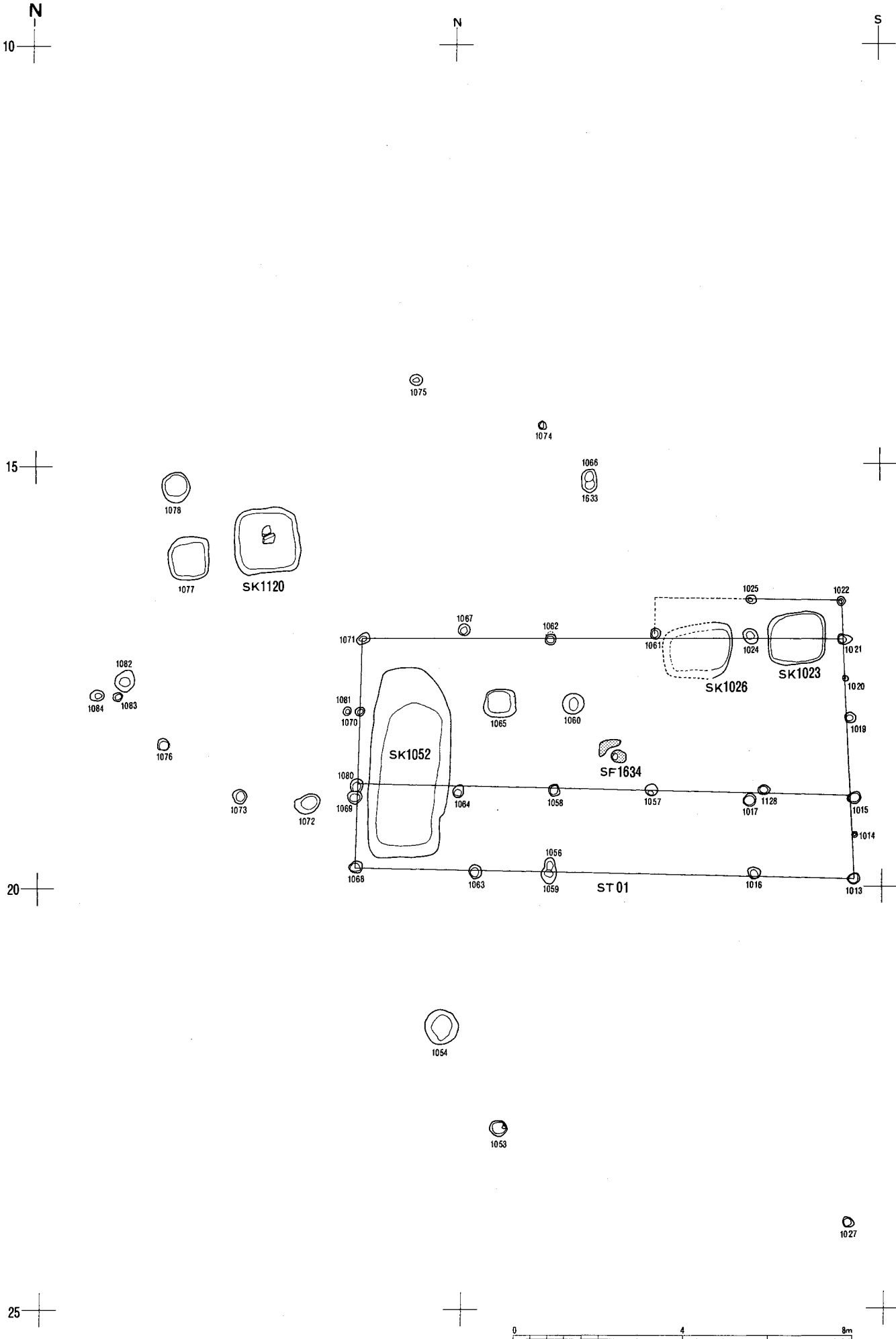

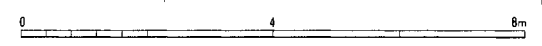
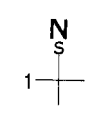
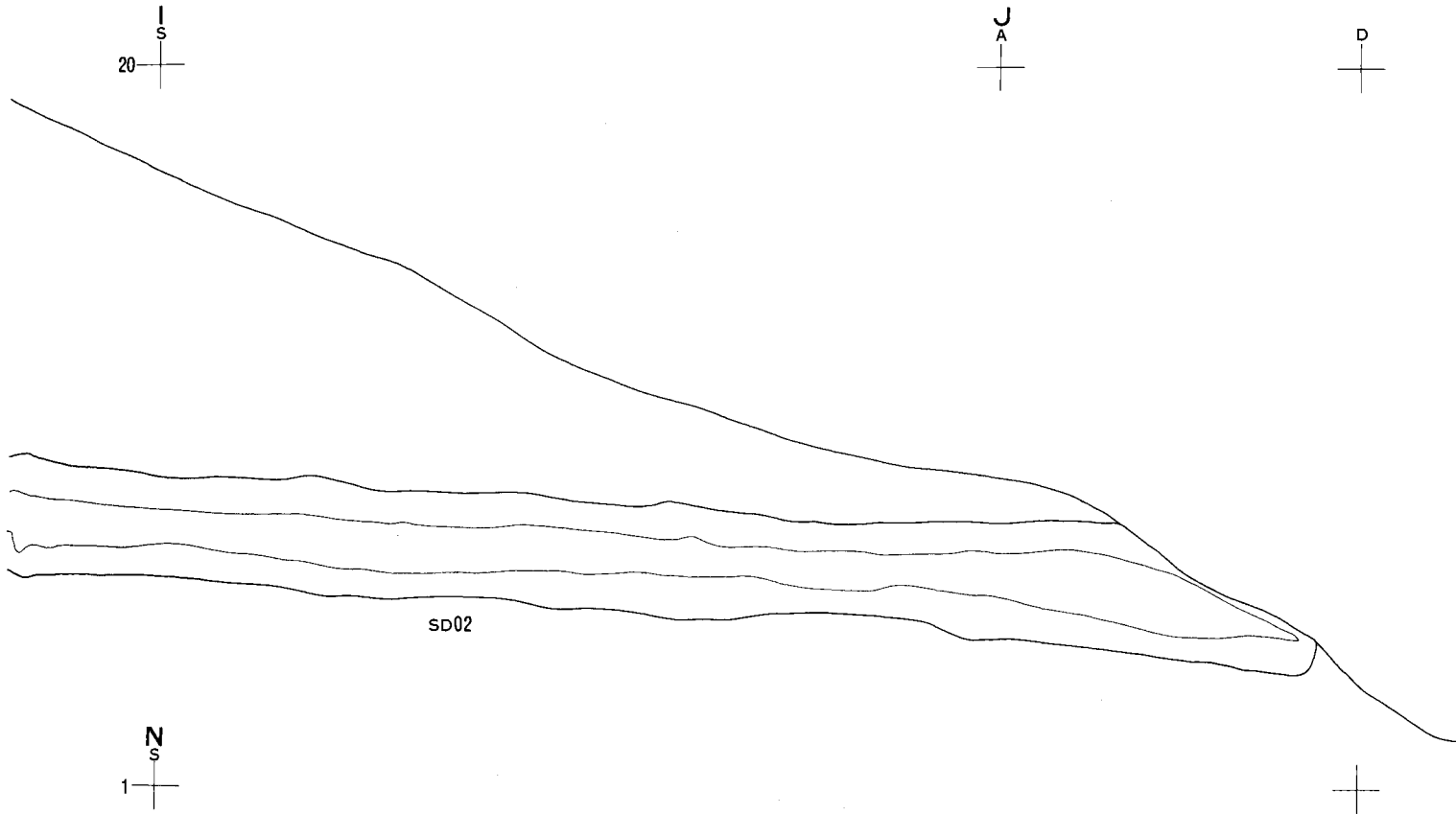

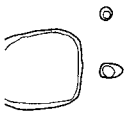
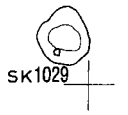

1018

1012



SK1011

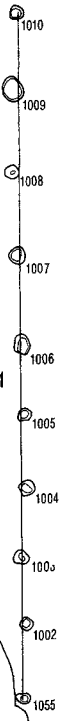

SA 01

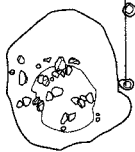

SK1001

1027

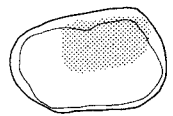

SK1051



SK1028



SK1079

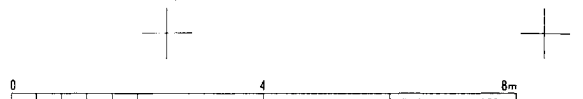

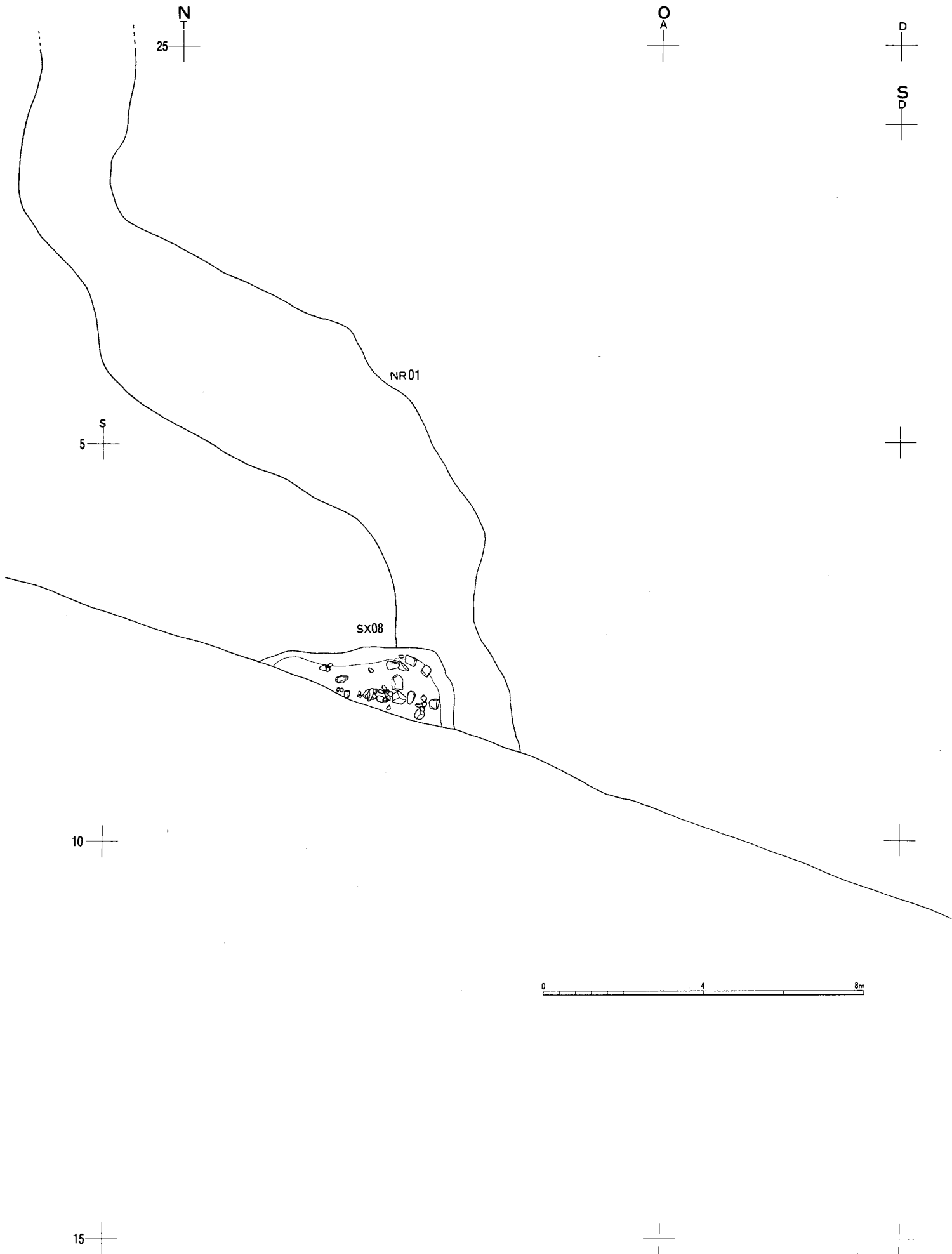

近世整地土層上面遺構図 (1:240)

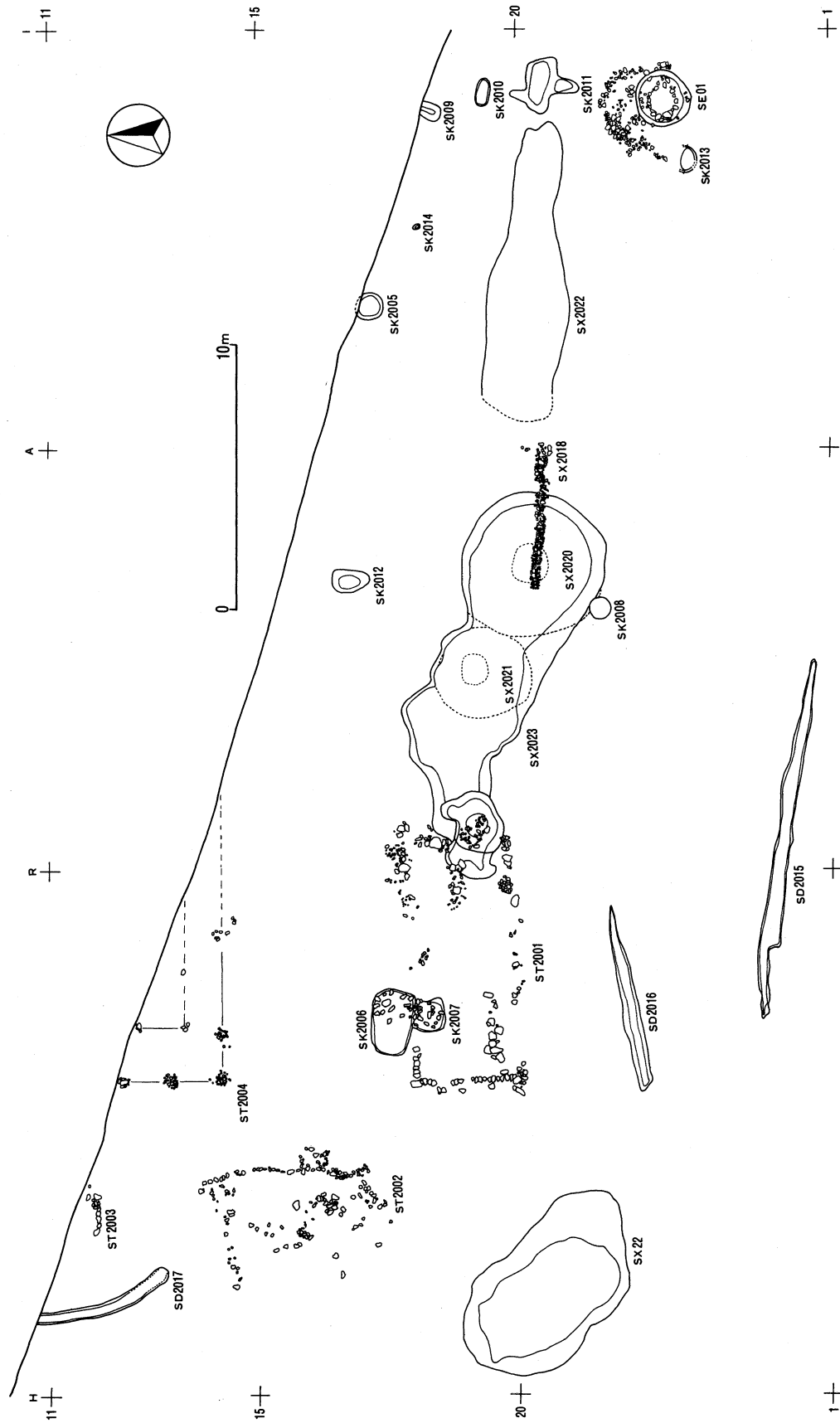

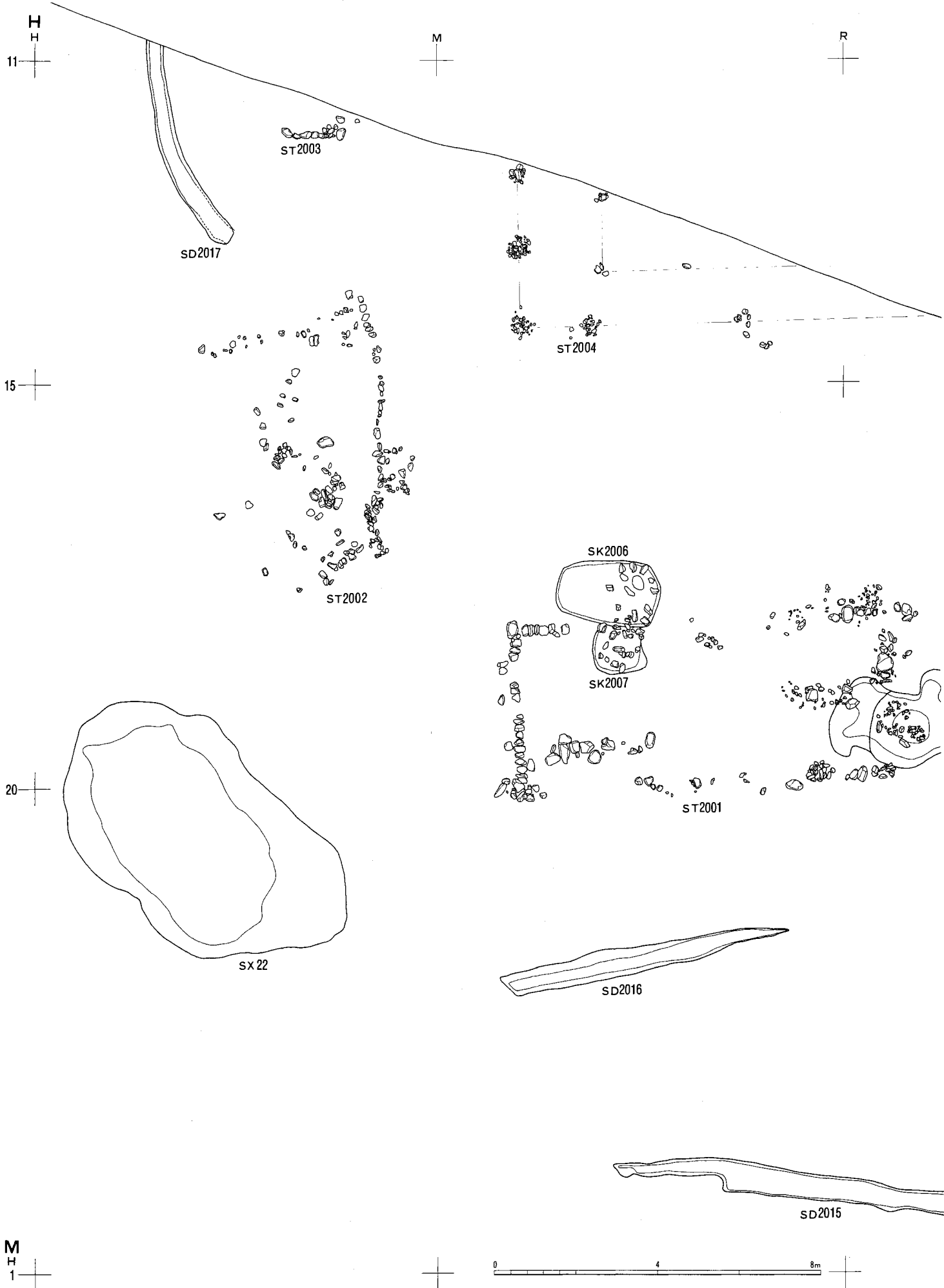

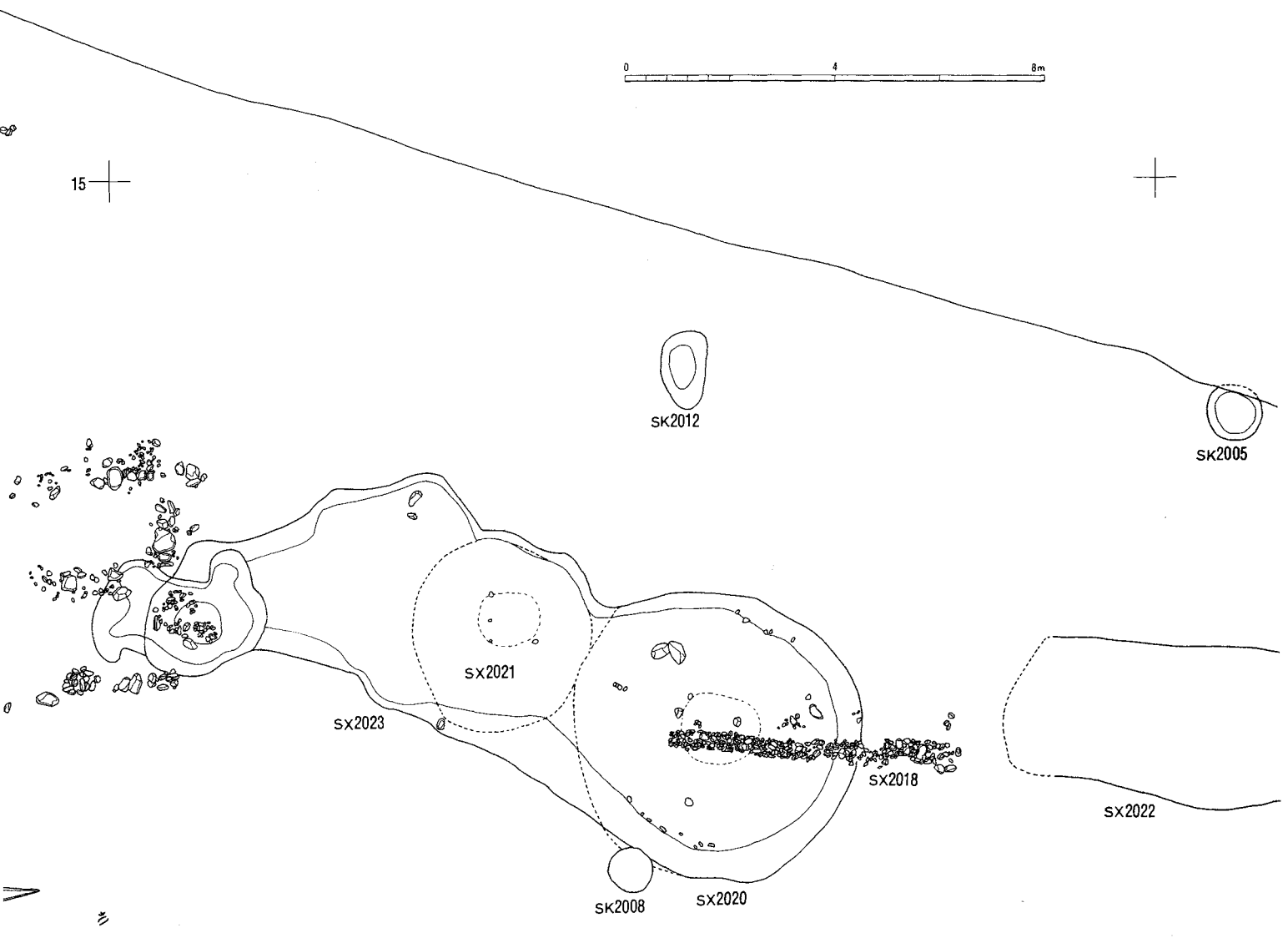
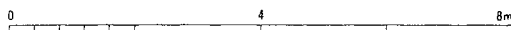

sx2021

sx2023

sx2018

sx2022

sk2008

sx2020

2015



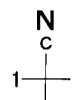
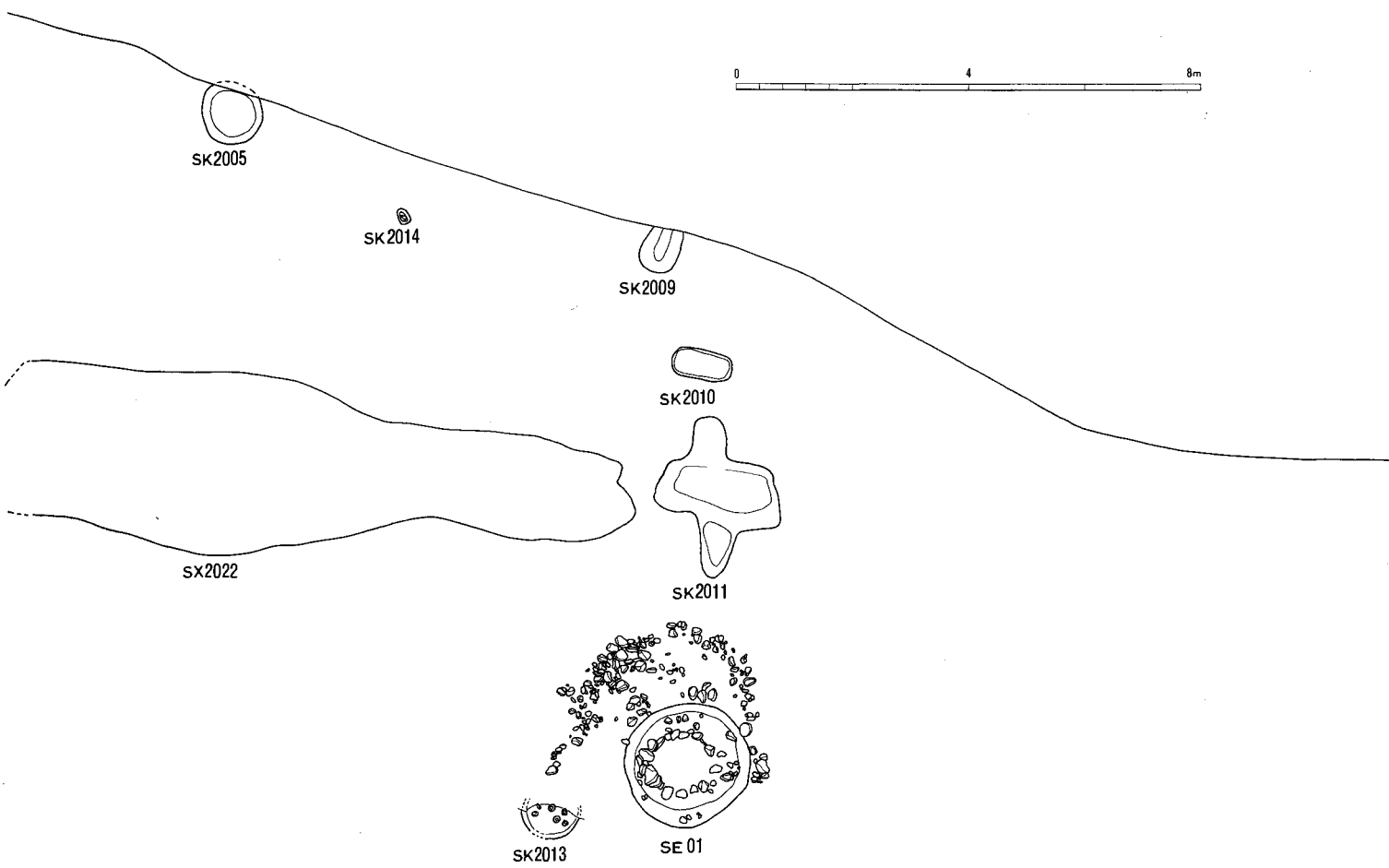
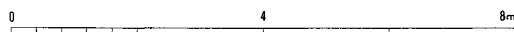
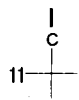

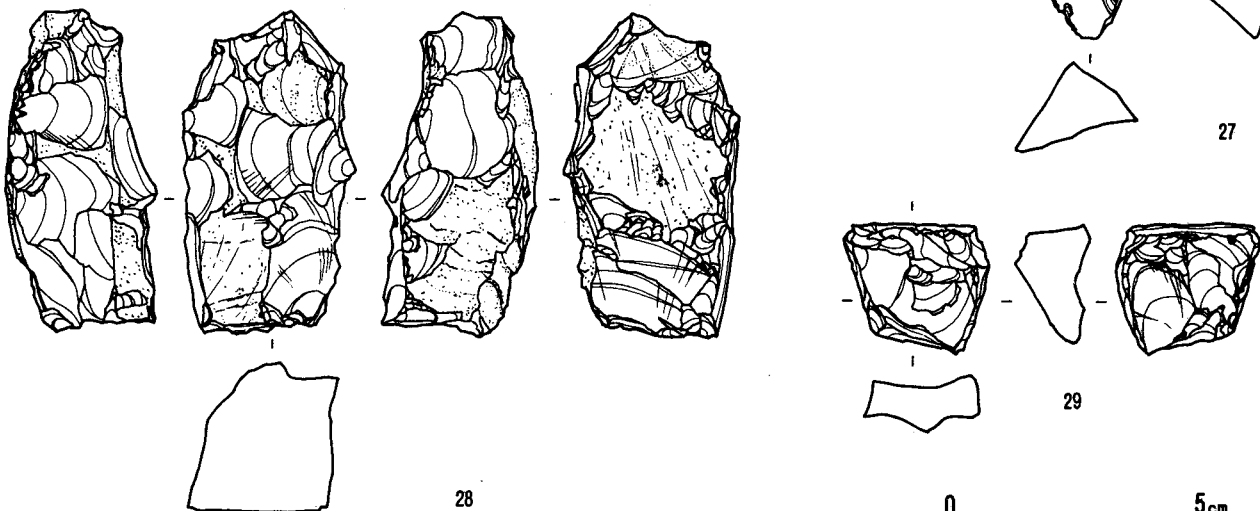
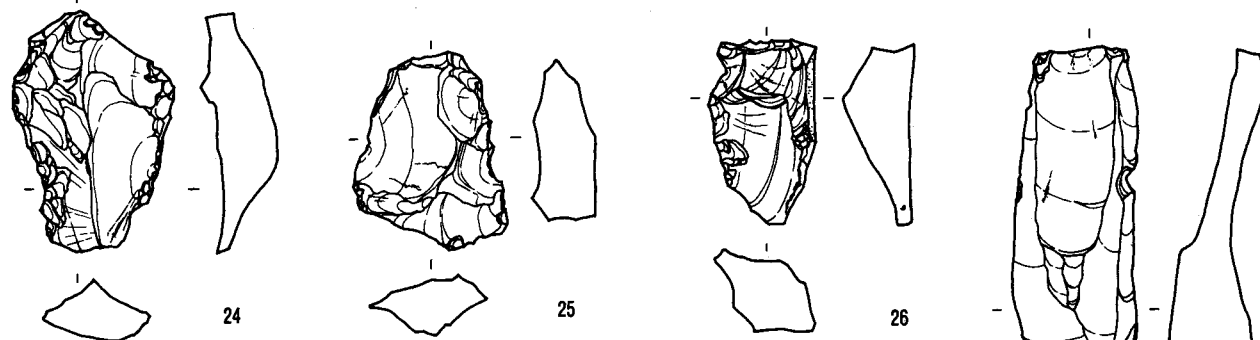
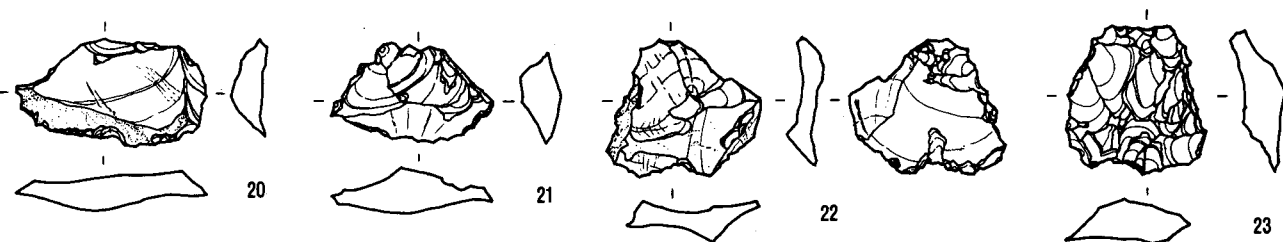
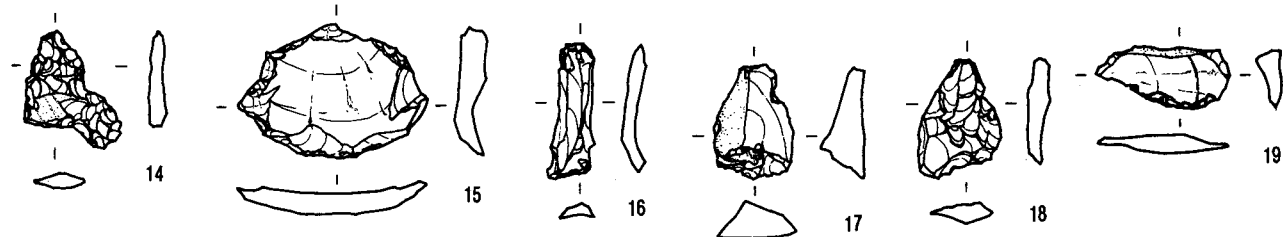
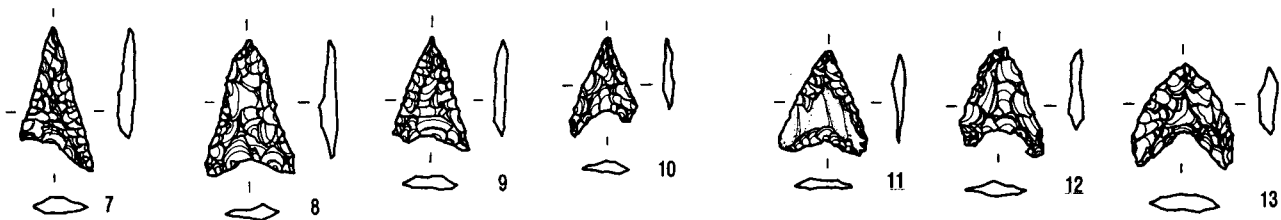
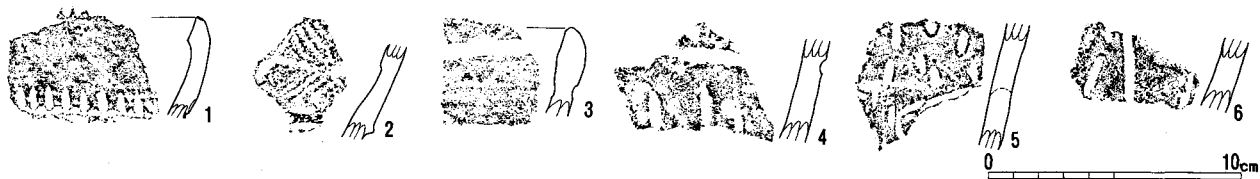

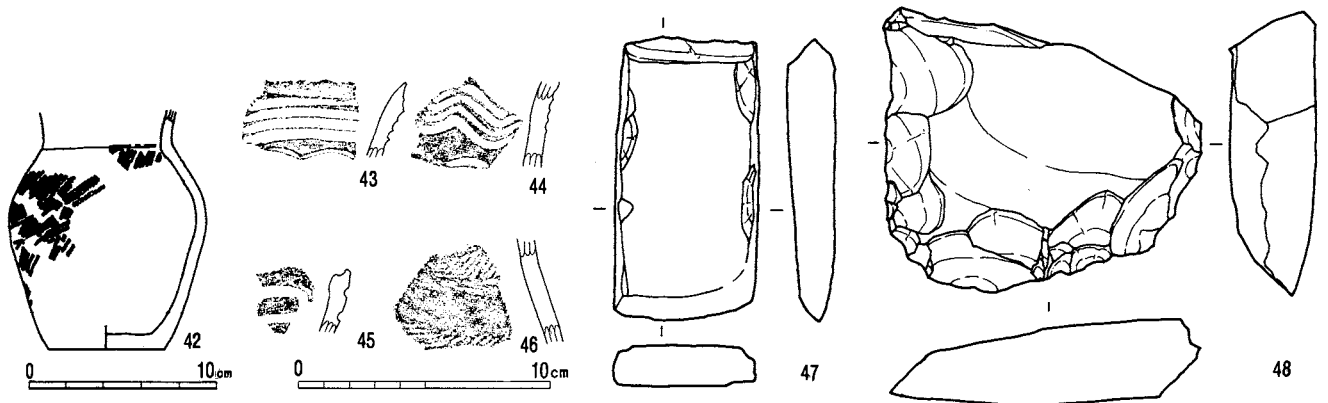
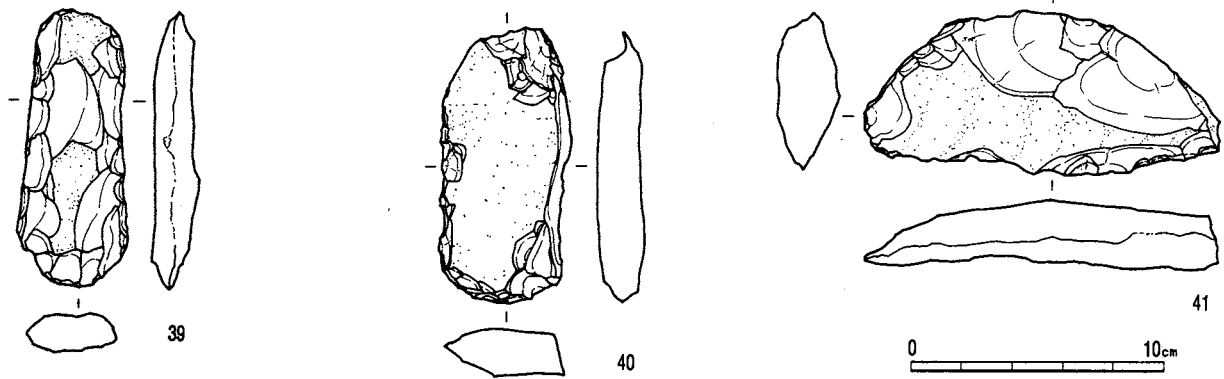
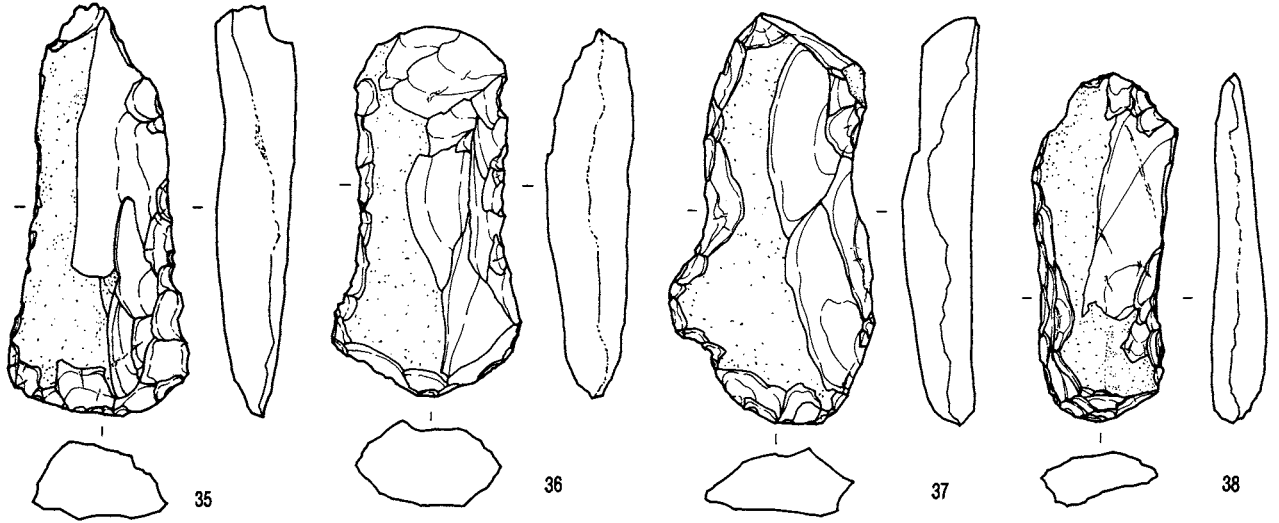
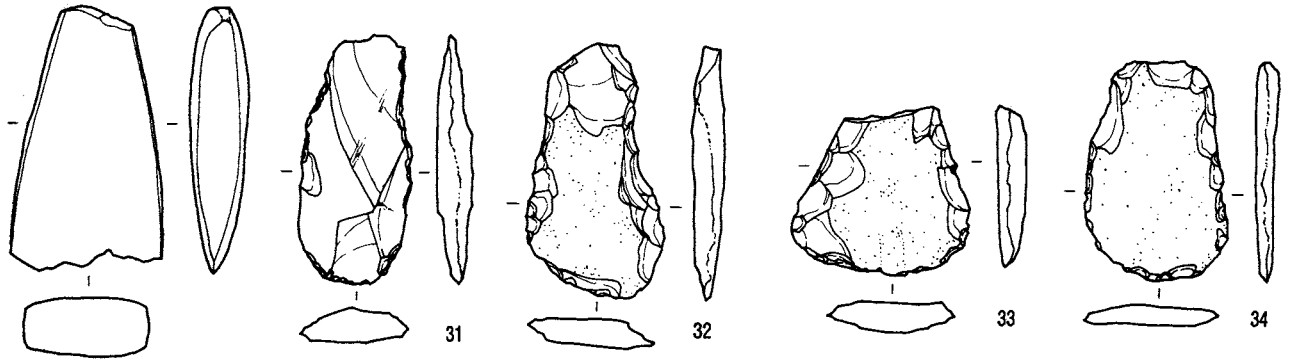

SB01 (1~26)

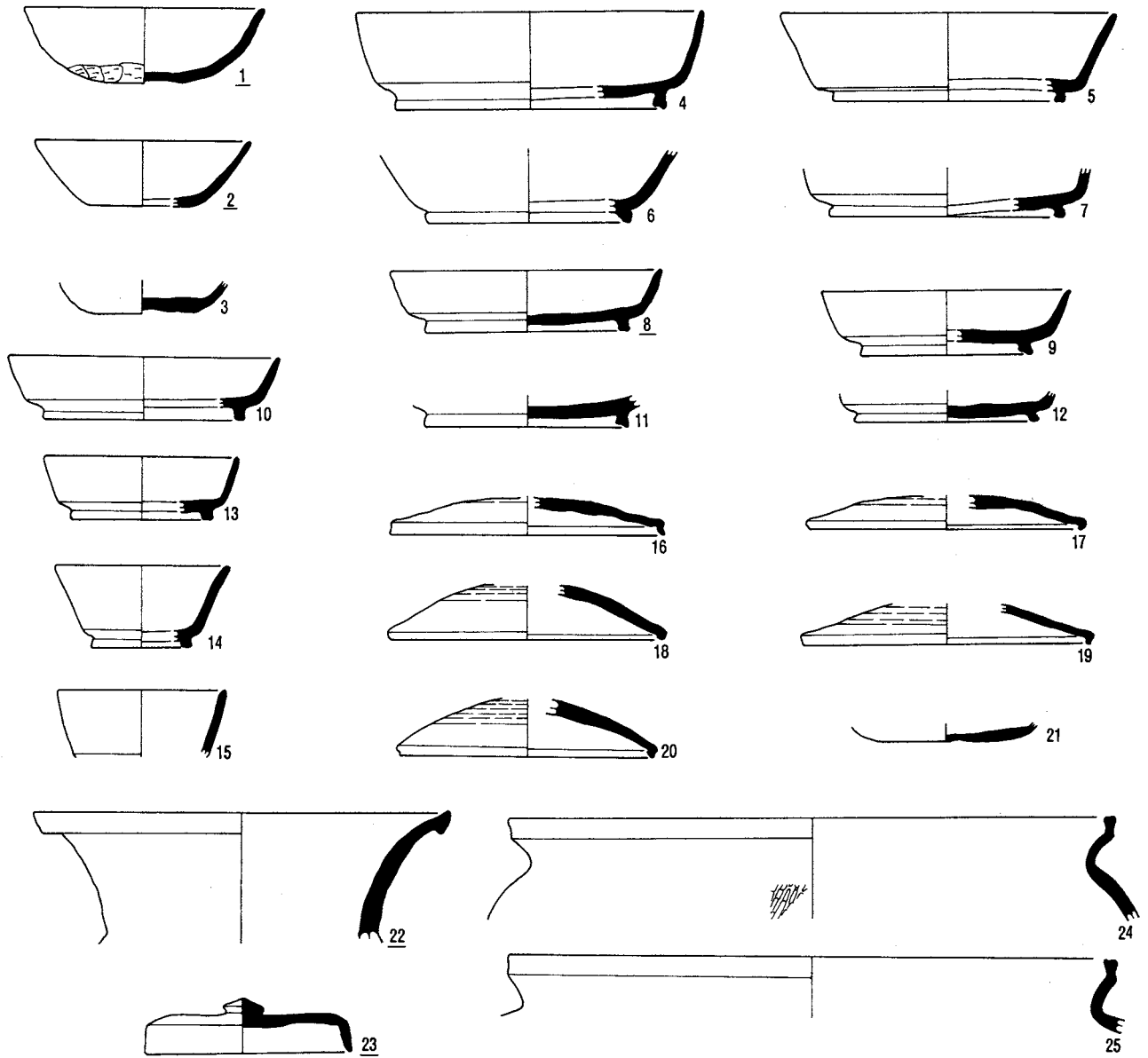

SB02 (1~4)

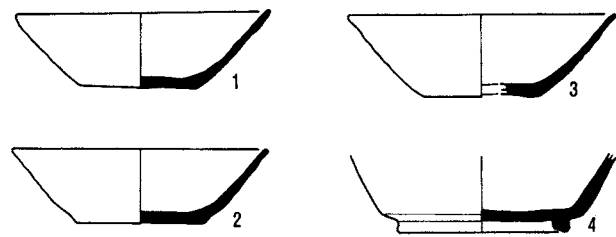

SB03 (1~8)

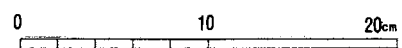
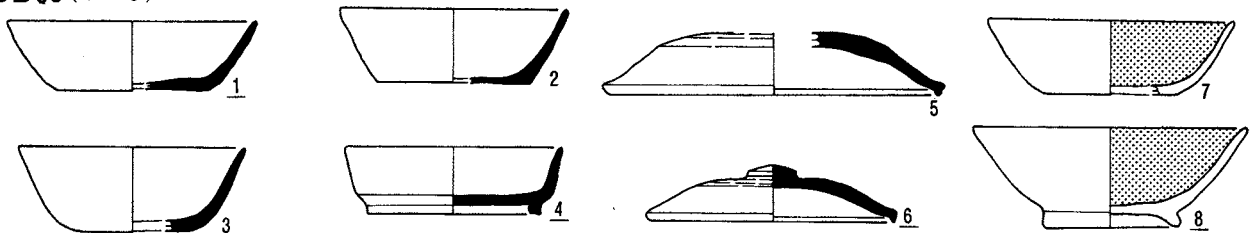

SB04 (1~21)

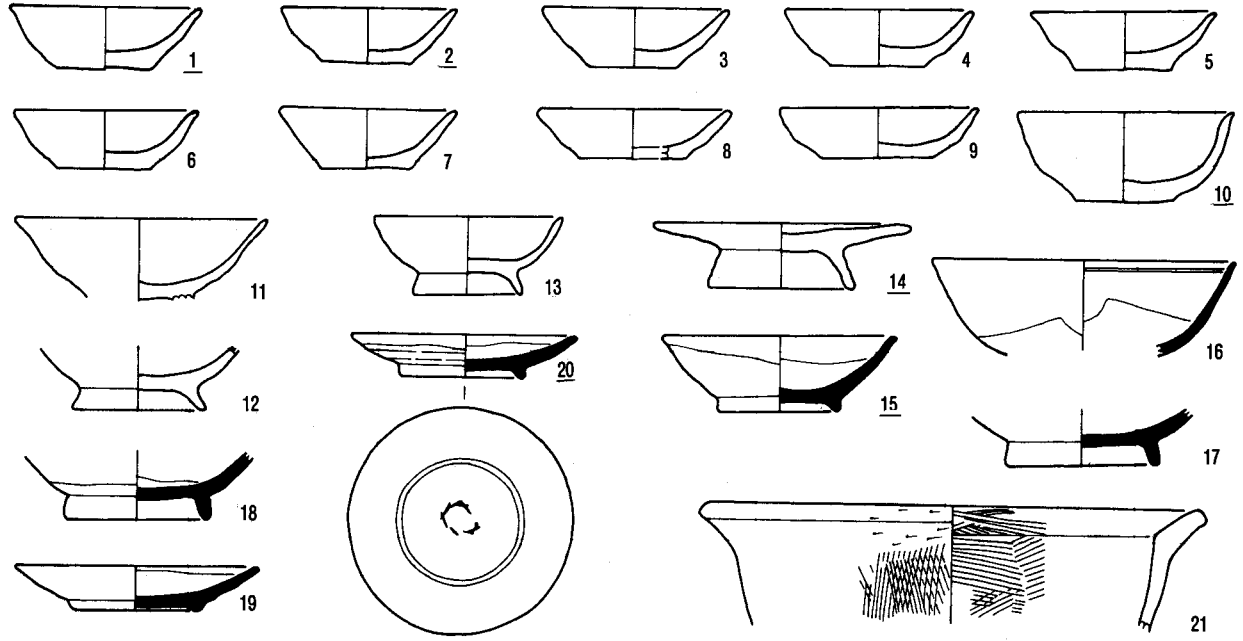

SB05 (1~57)

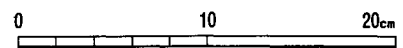
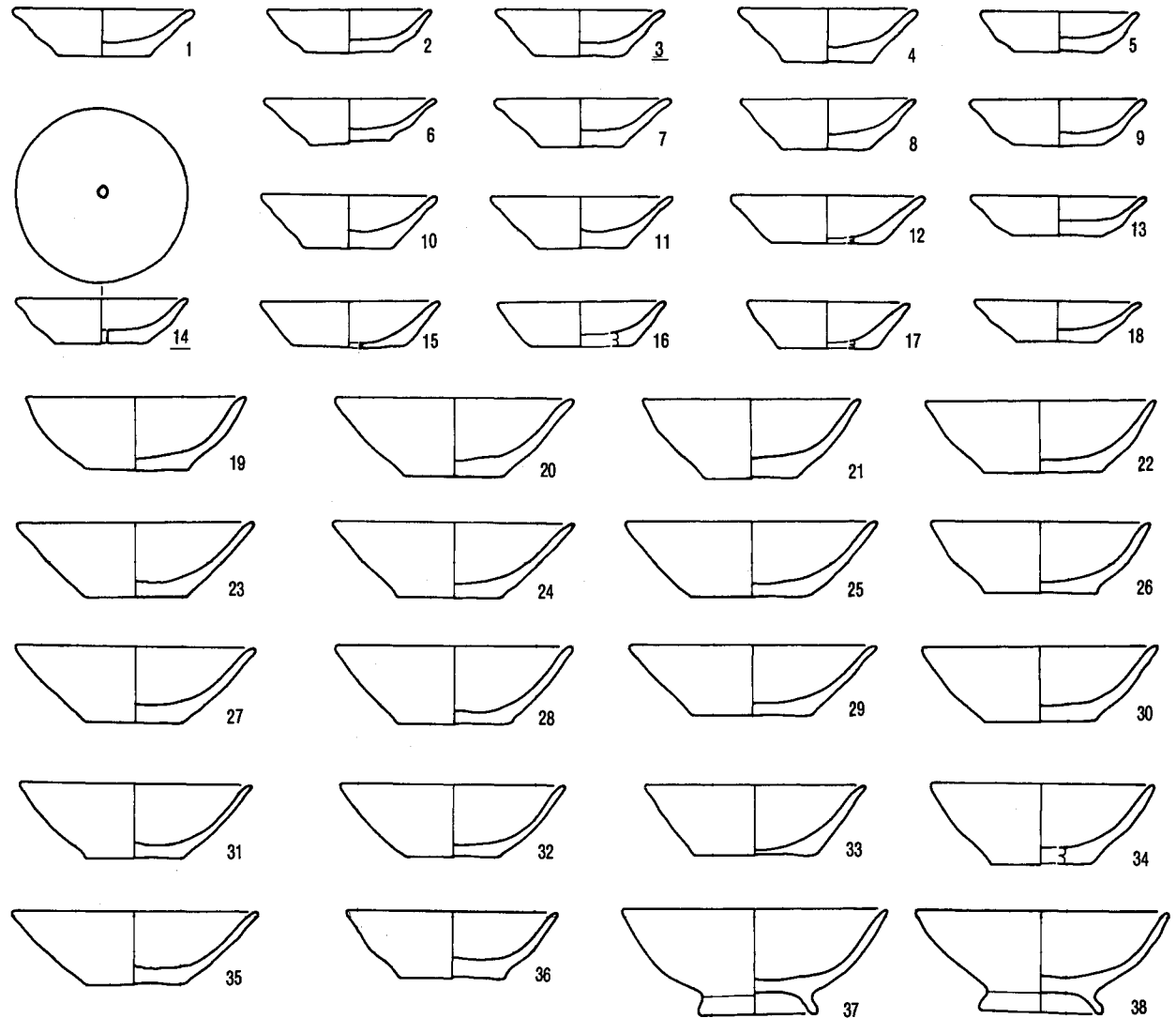

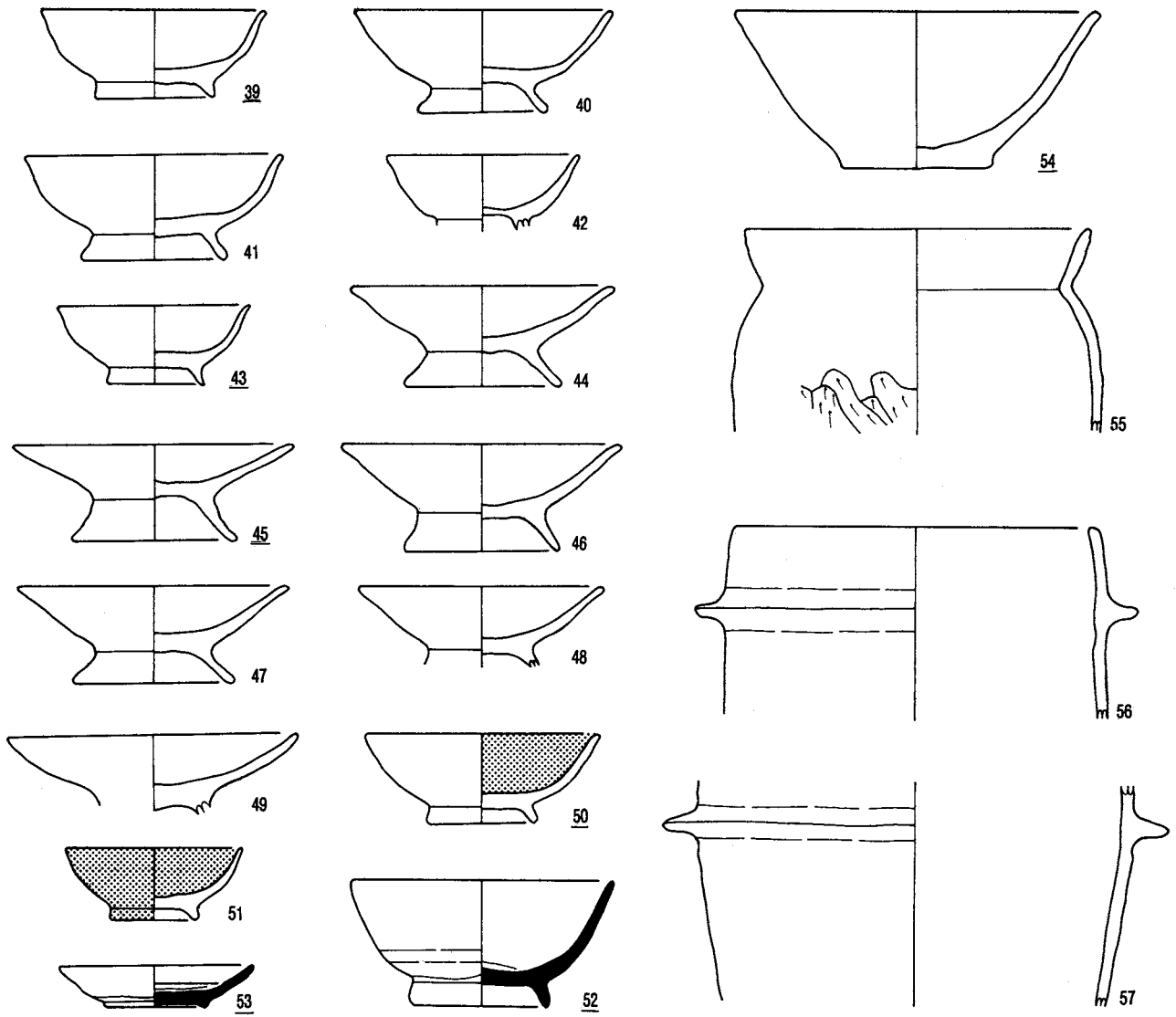

SB06 (1~8)

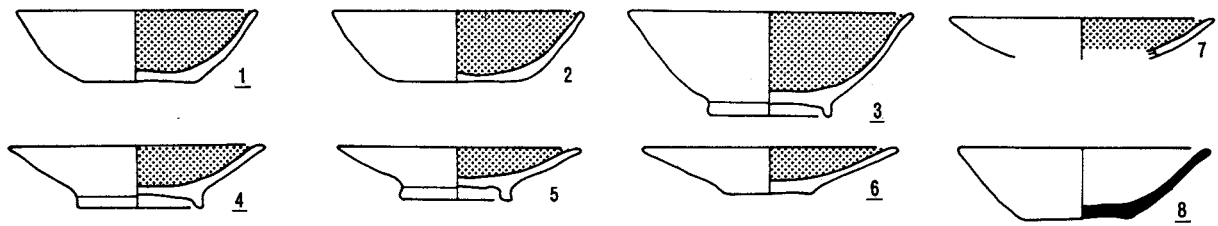

SB07 (1~13)

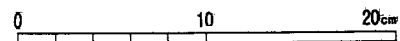
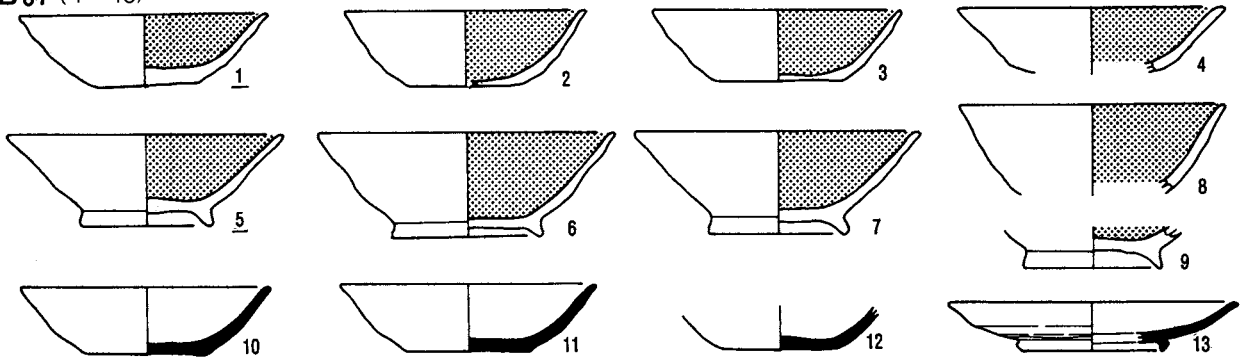

SB09 (1~6)

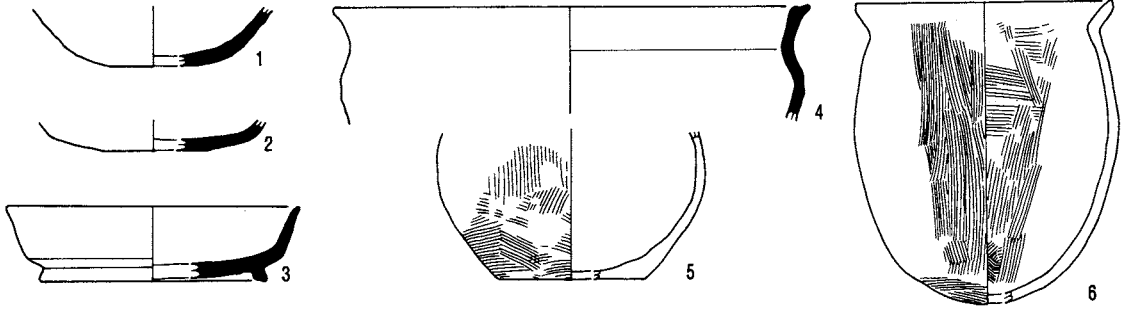

SB10 (1~12)

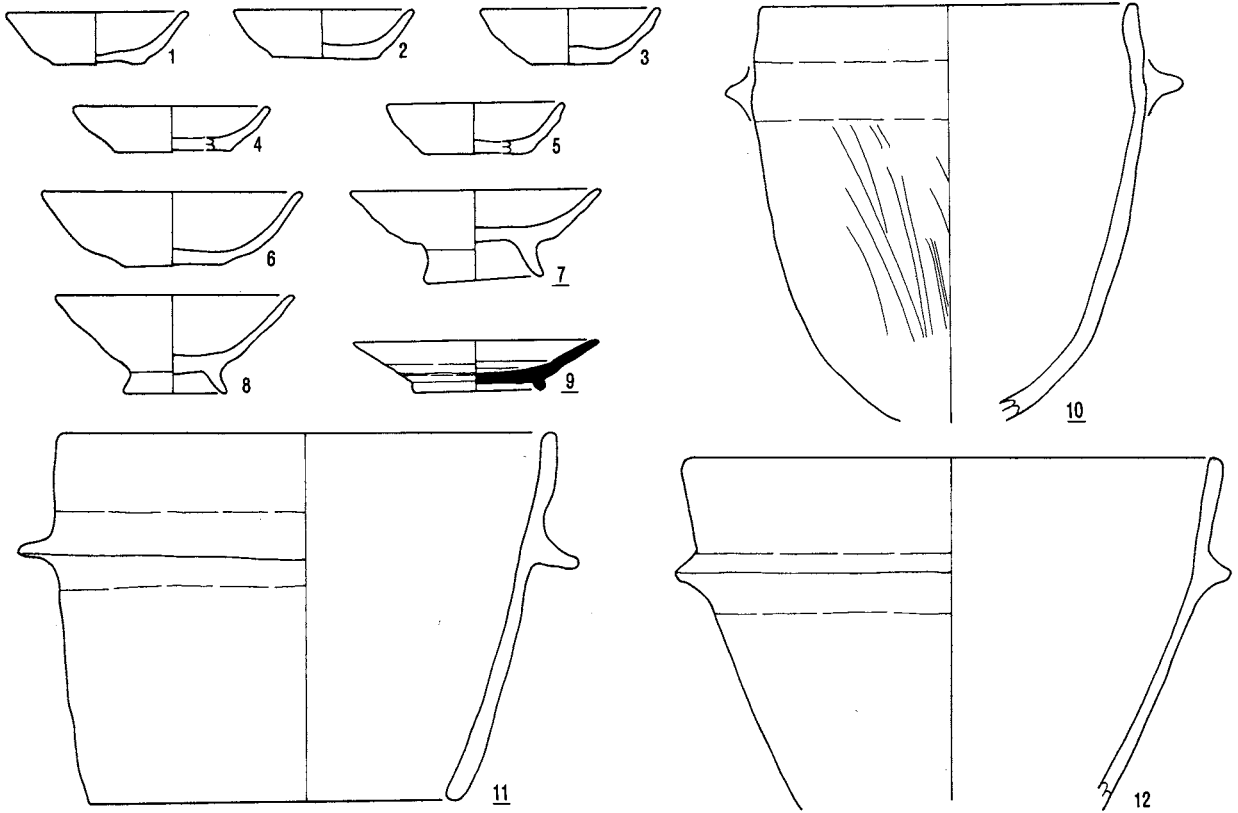

SB11 (1~8)

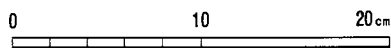
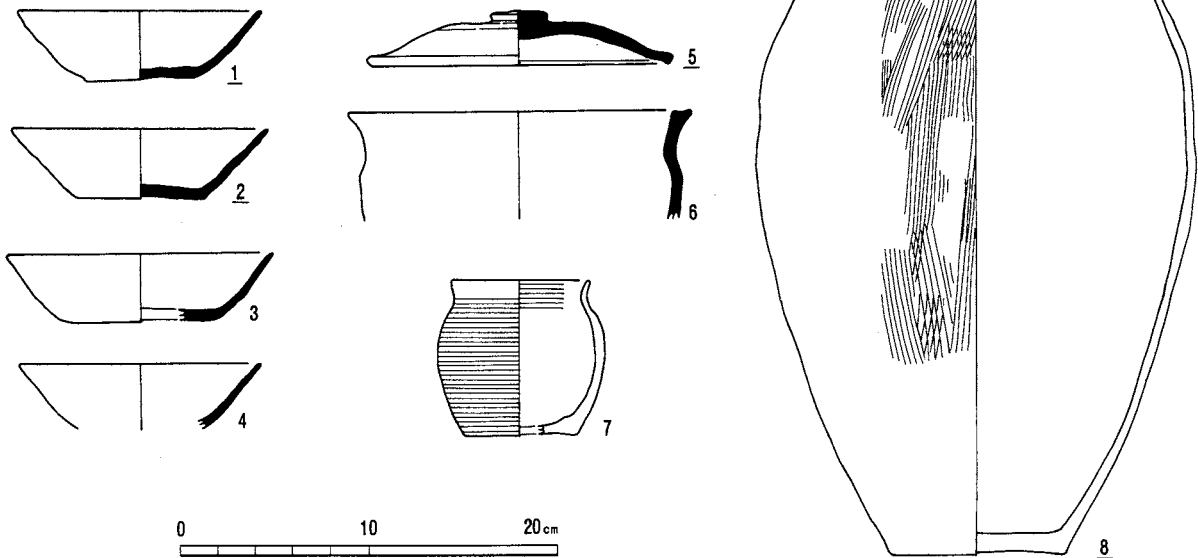

SB12 (1)

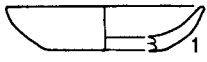

SB13 (1~18)

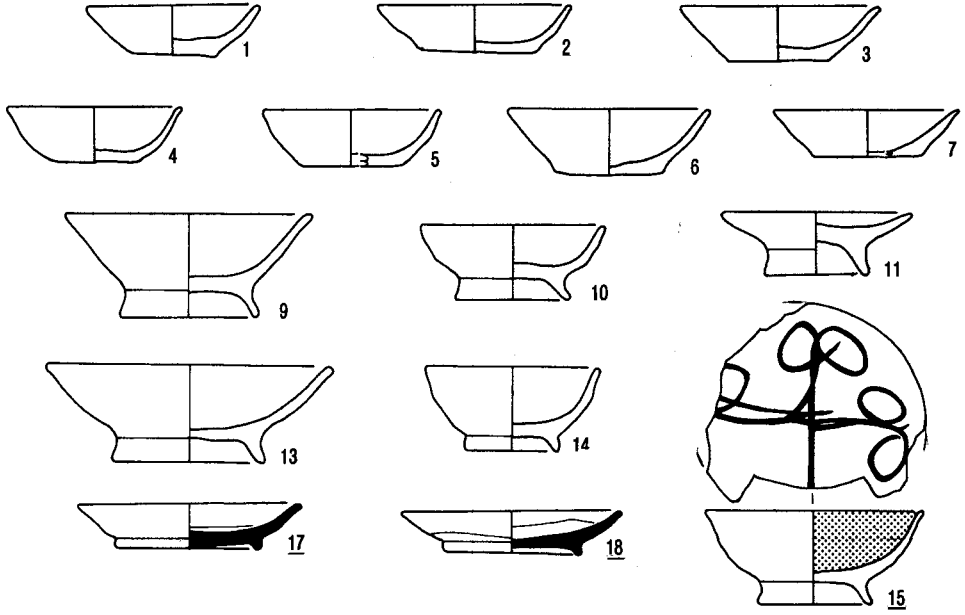

SB14 (1~42)

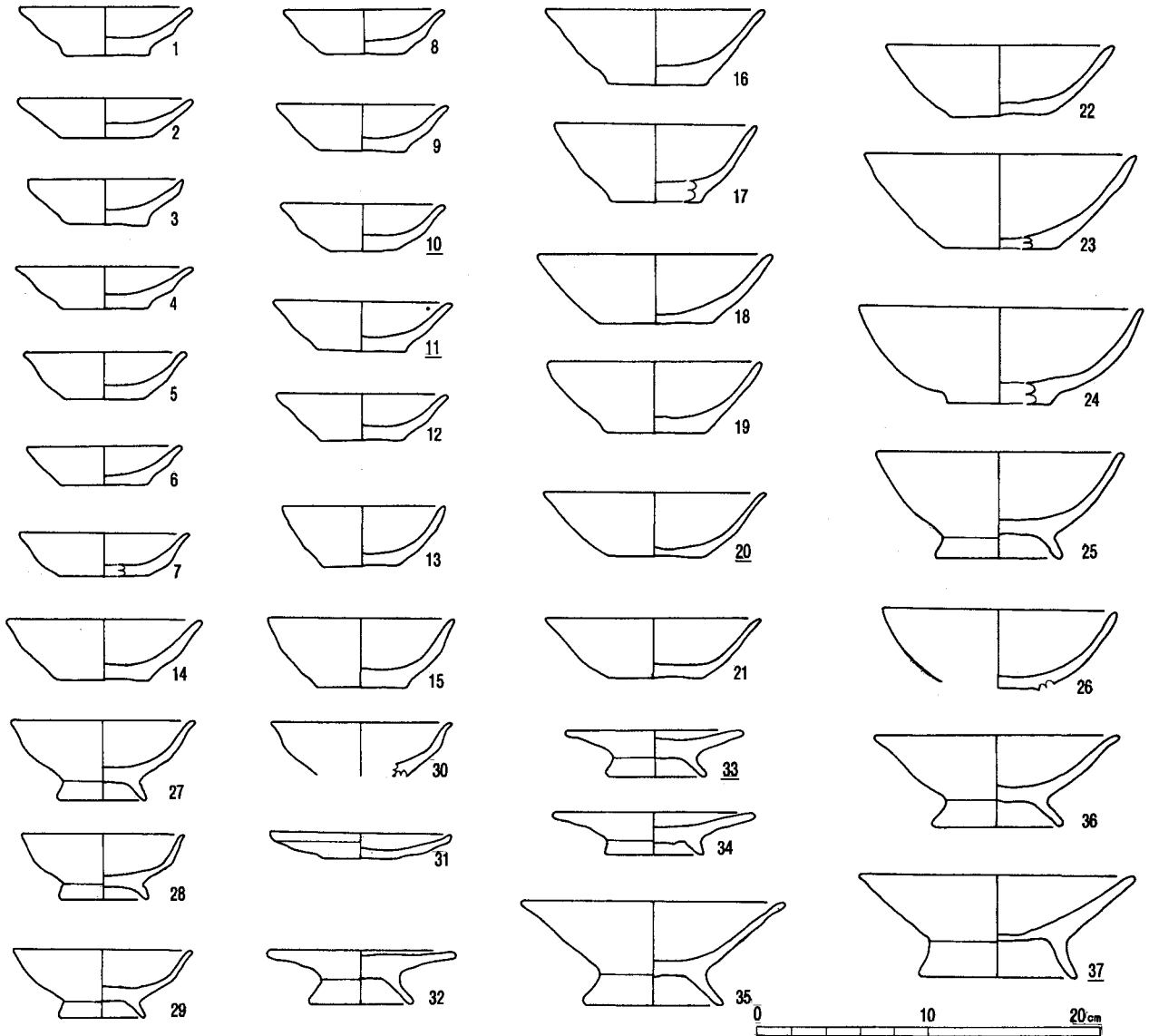

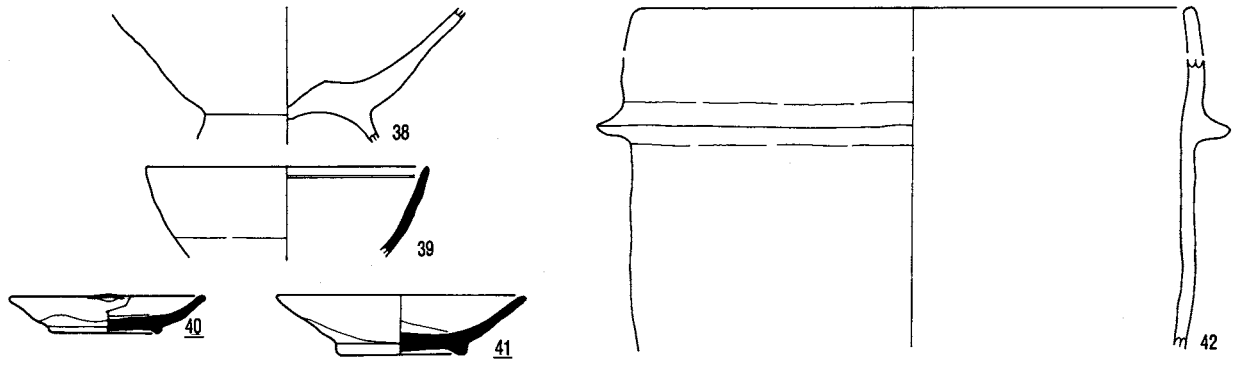

SB 15 (1~33)

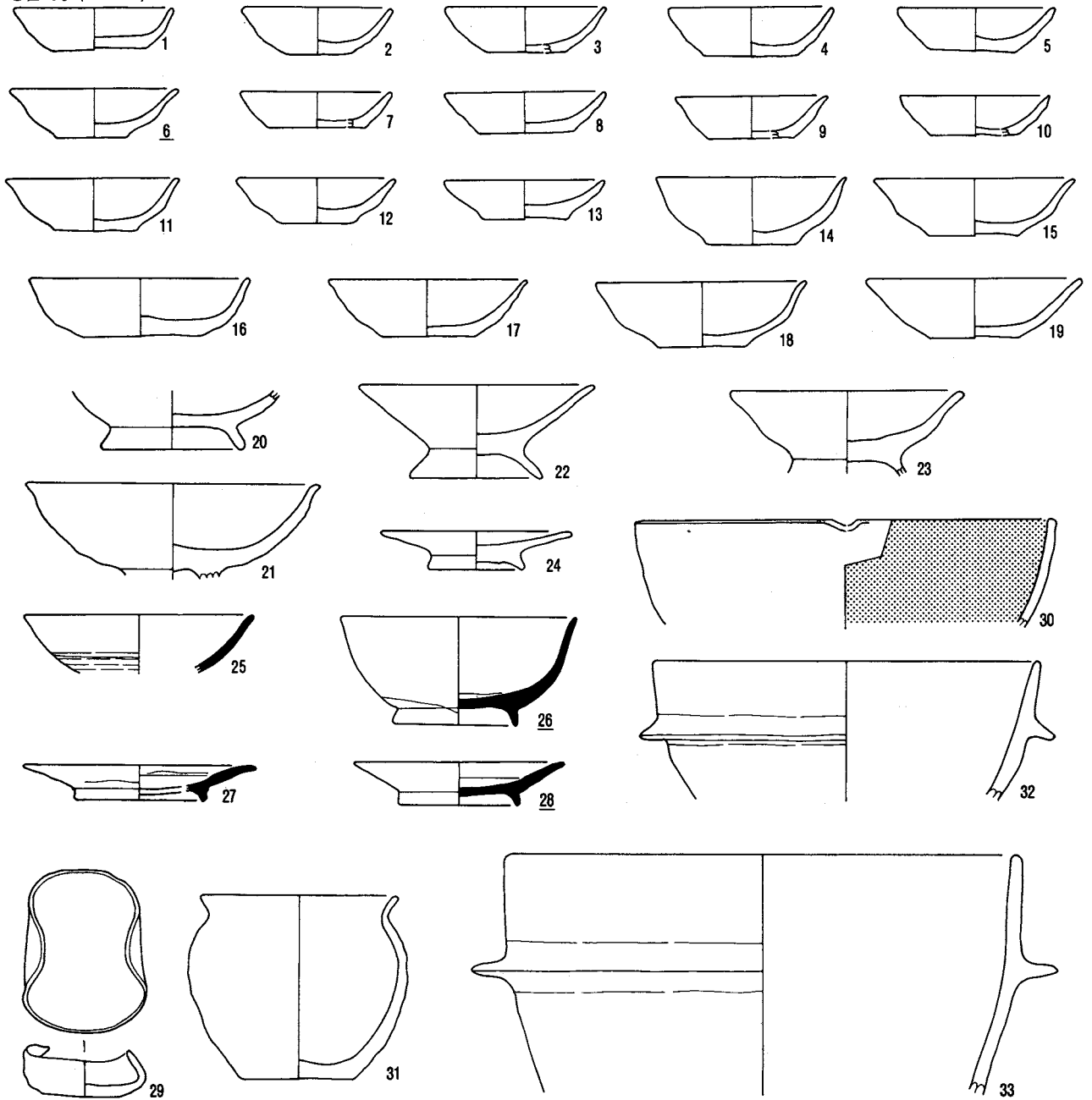

0 10 20cm

SB16 (1~12)

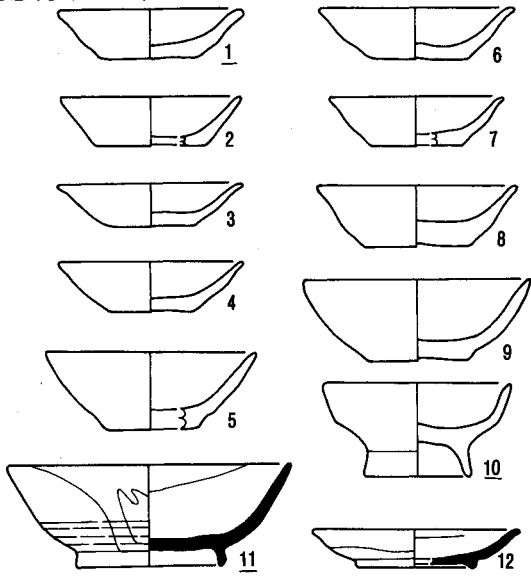

SB17 (1~9)

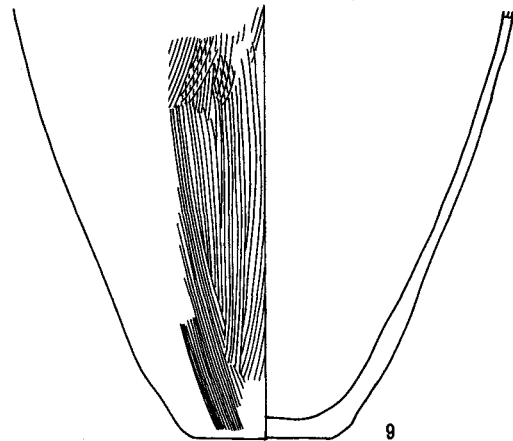
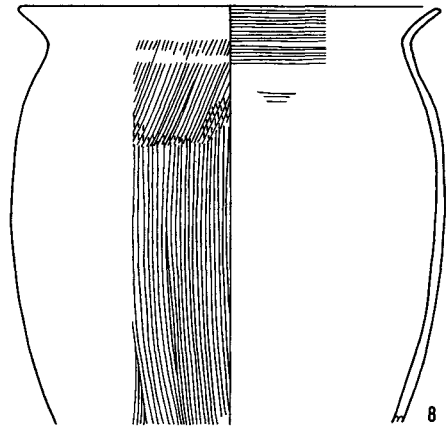
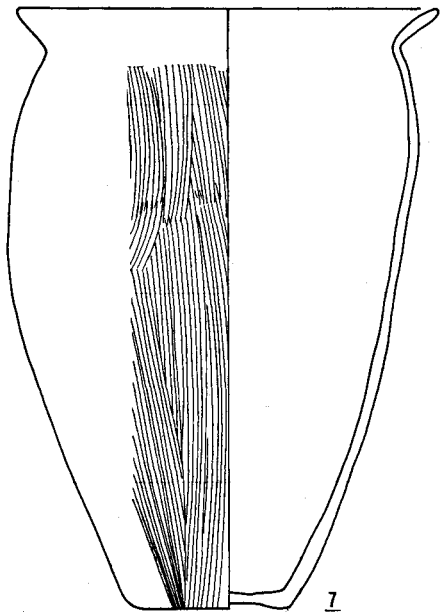
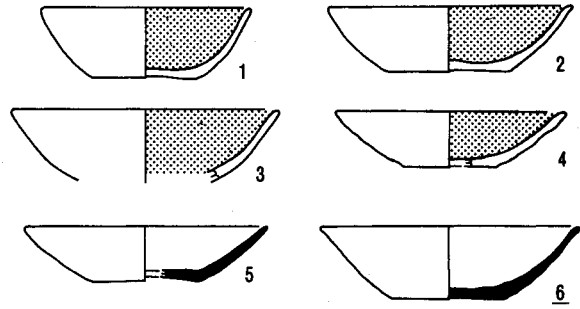

SB18 (1~6)

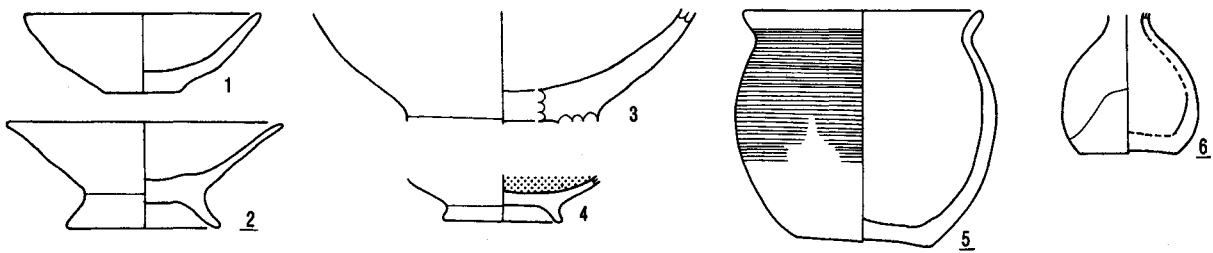

SB19 (1~7)

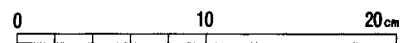
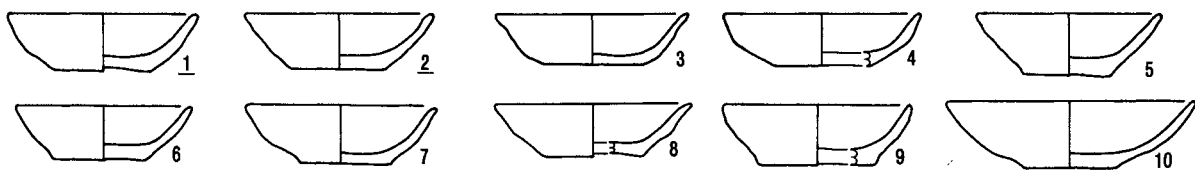

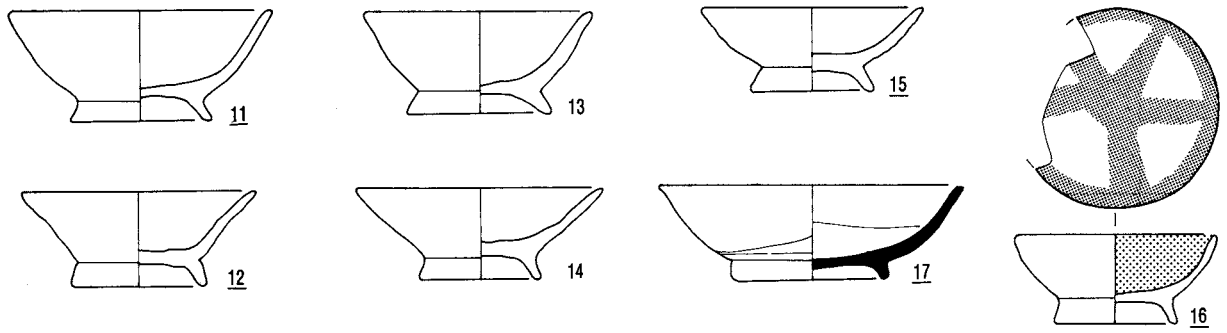

SB20 (1~5)

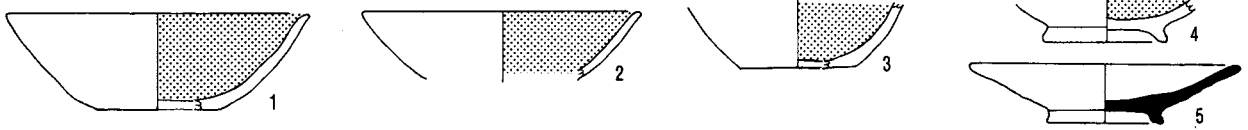

SB21 (1~20)

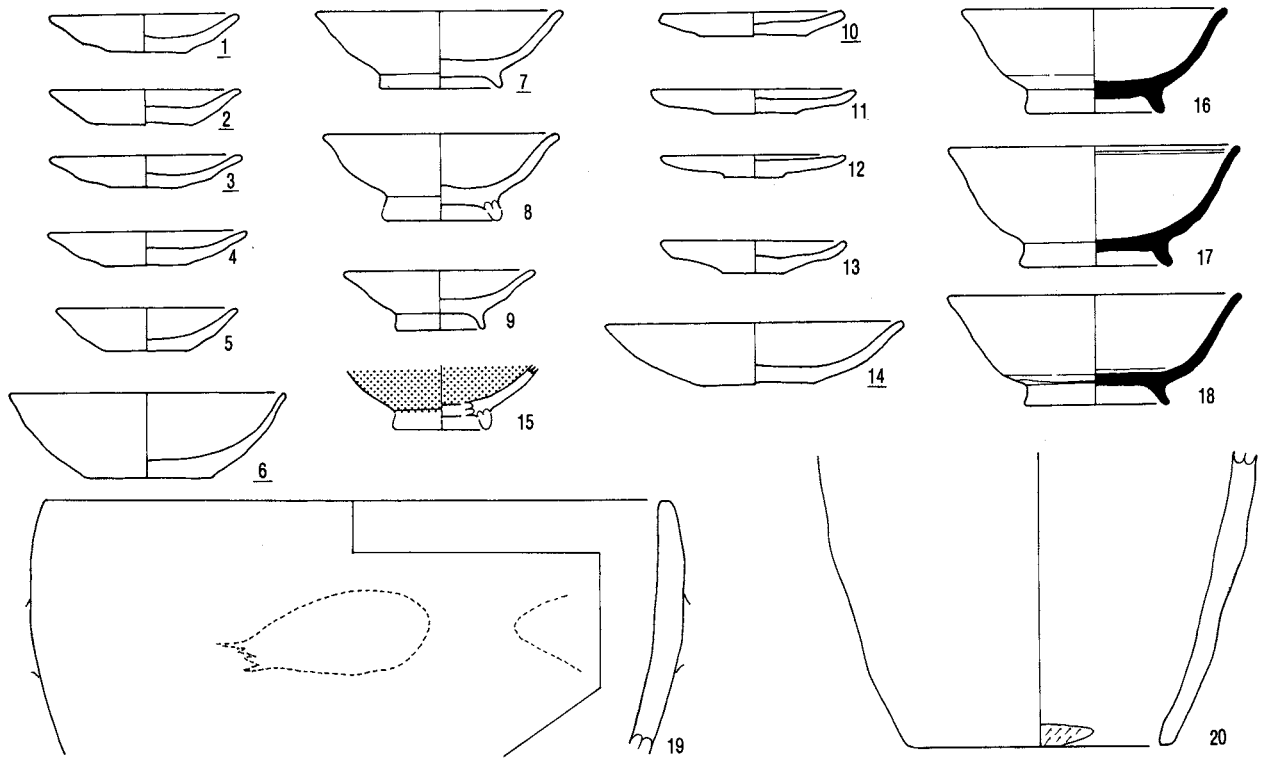

SB22 (1~13)

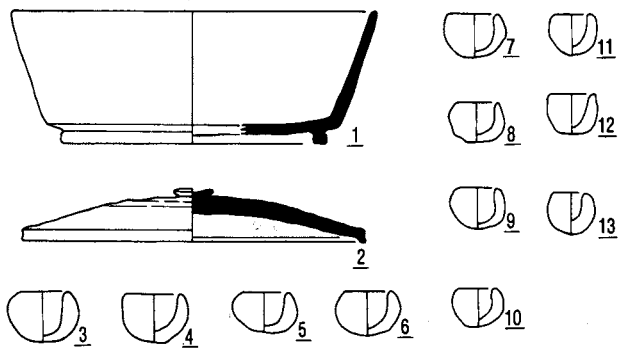

SB23 (1.2)



SB24 (1~4)

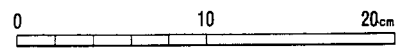
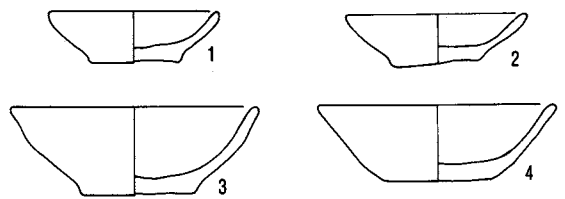

SB25 (1~3)

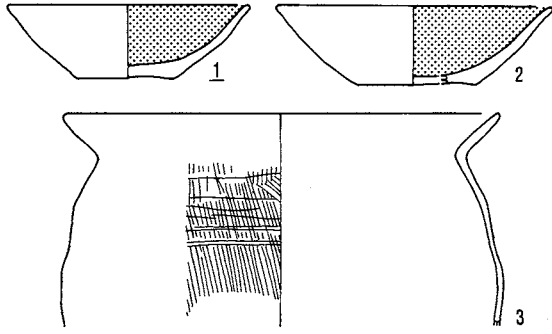

SB26 (1~12)

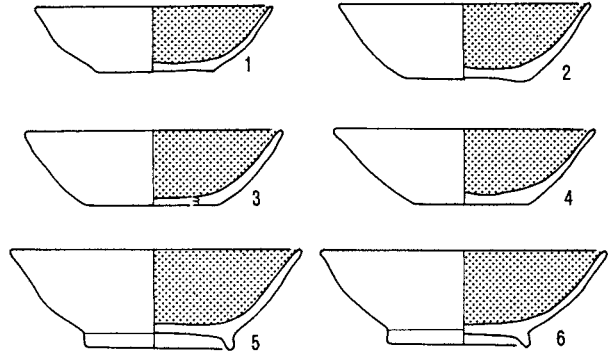

SB27 (1~7)

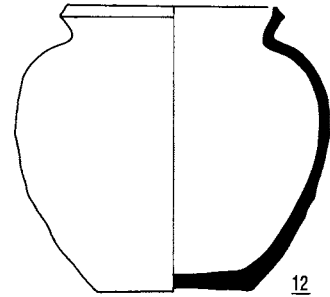
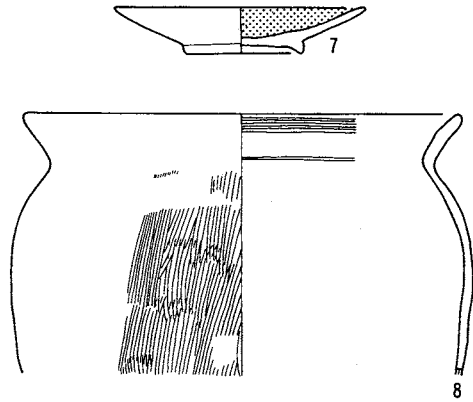
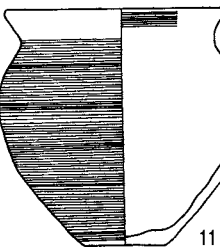
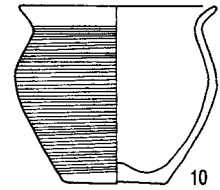
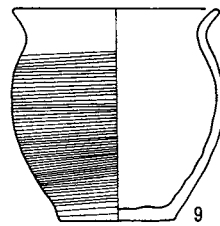
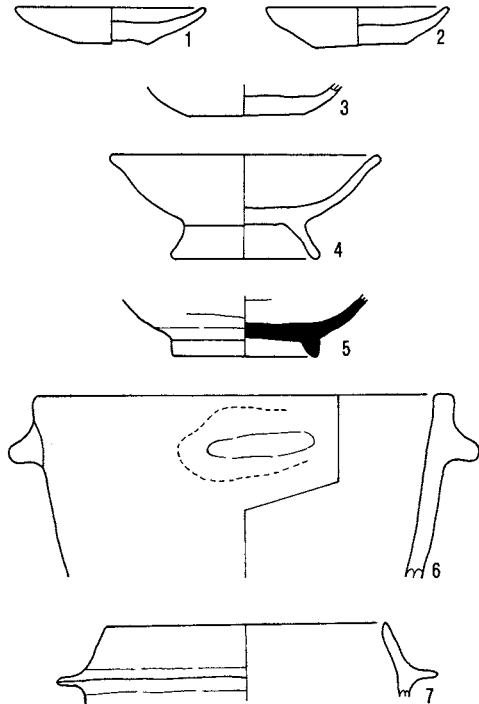

SB28 (1~22)

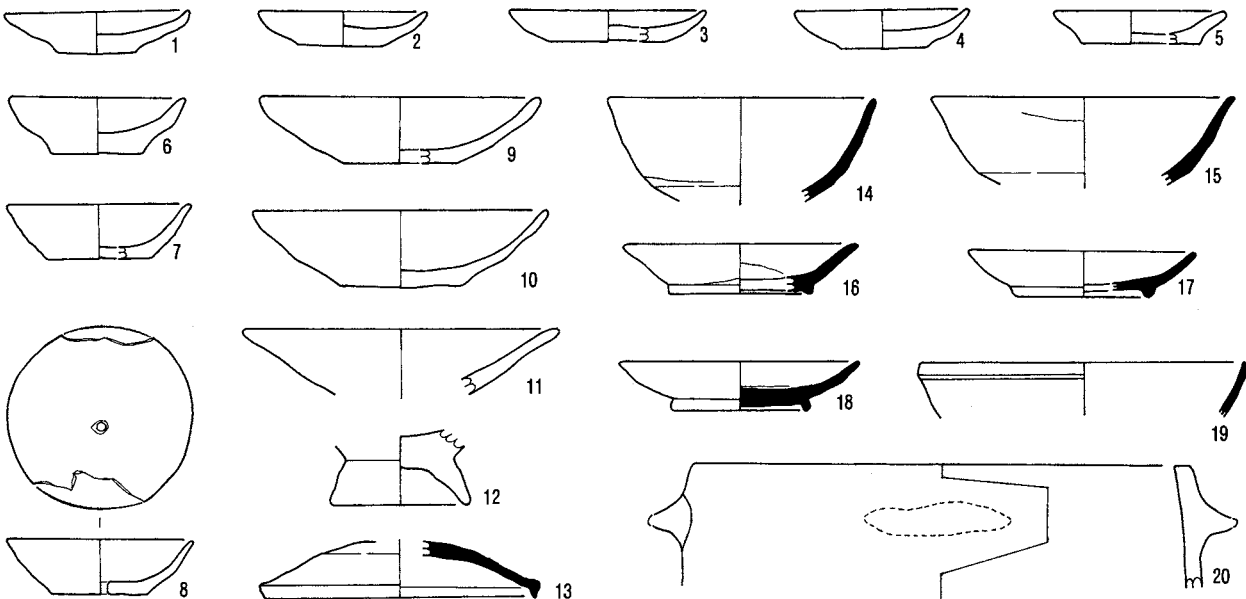

0 10 20cm

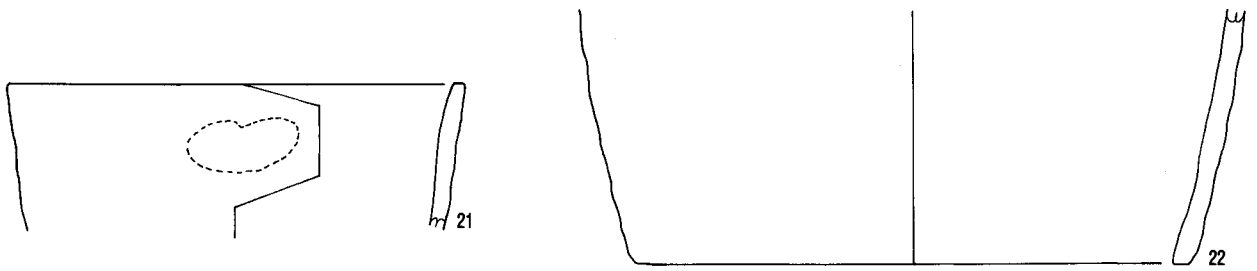

SB29 (1~29)

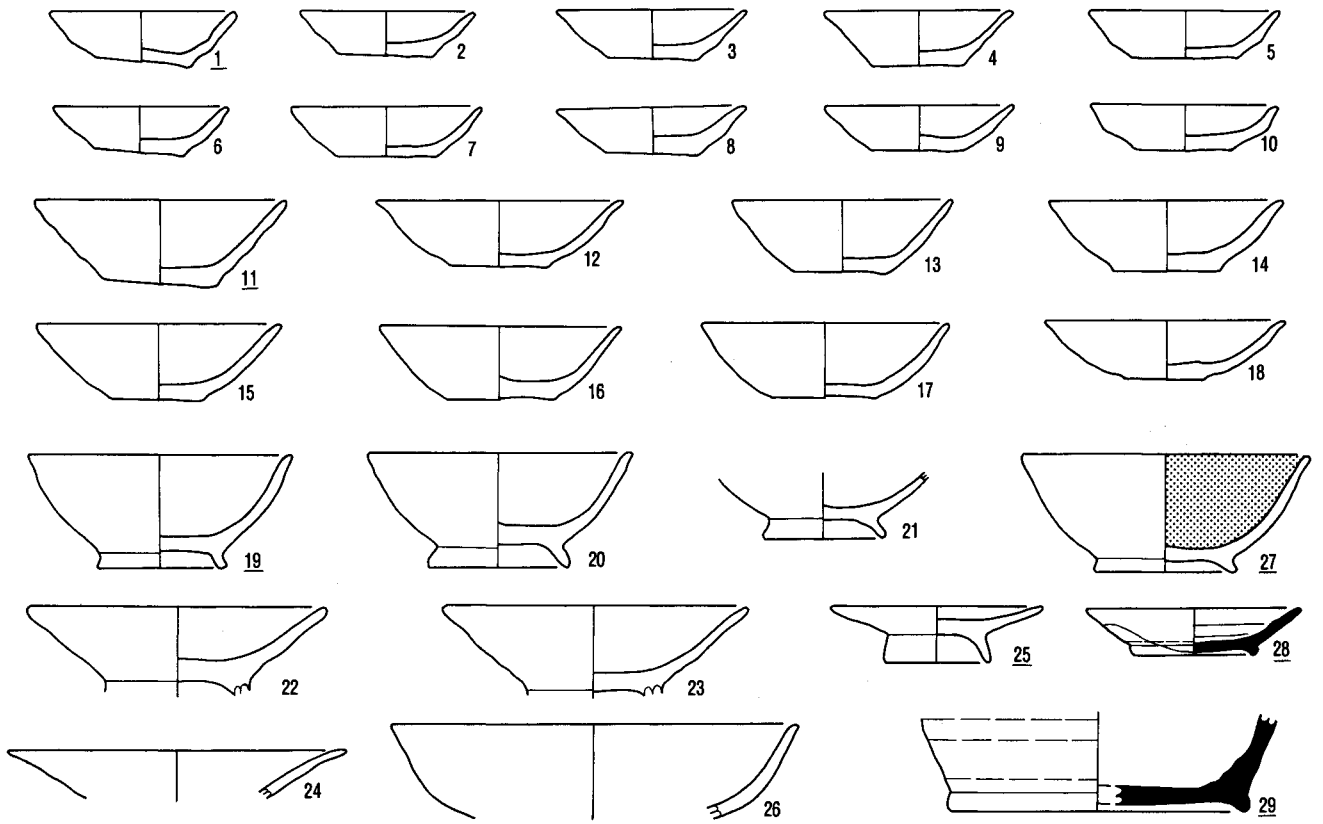

SB30 (1~54)

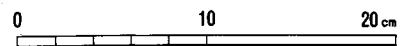
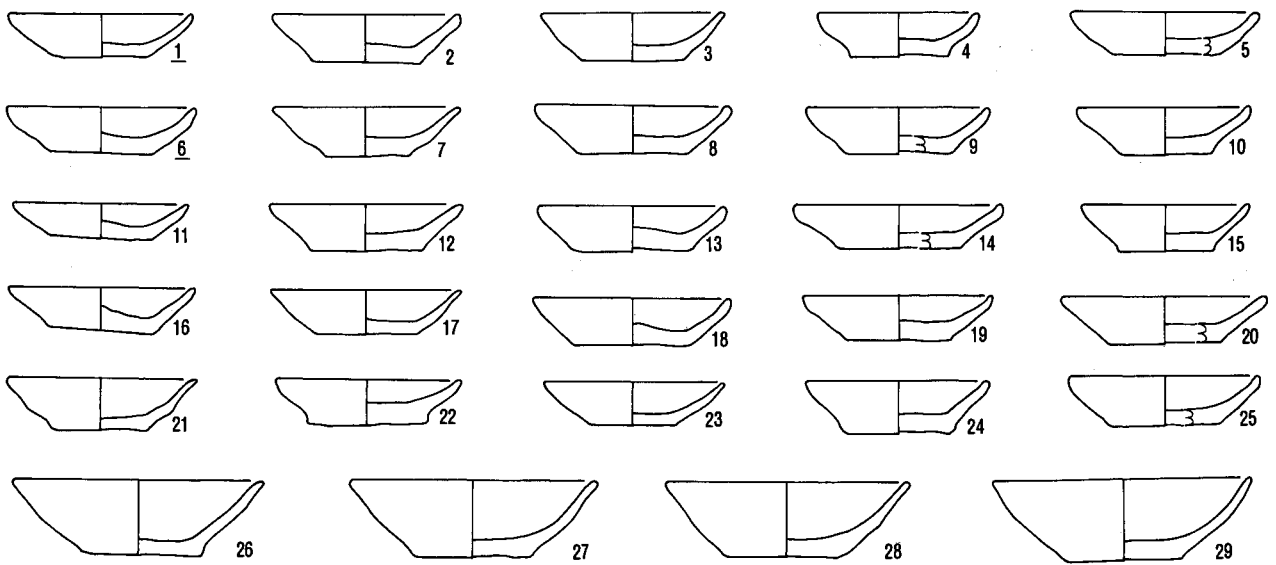

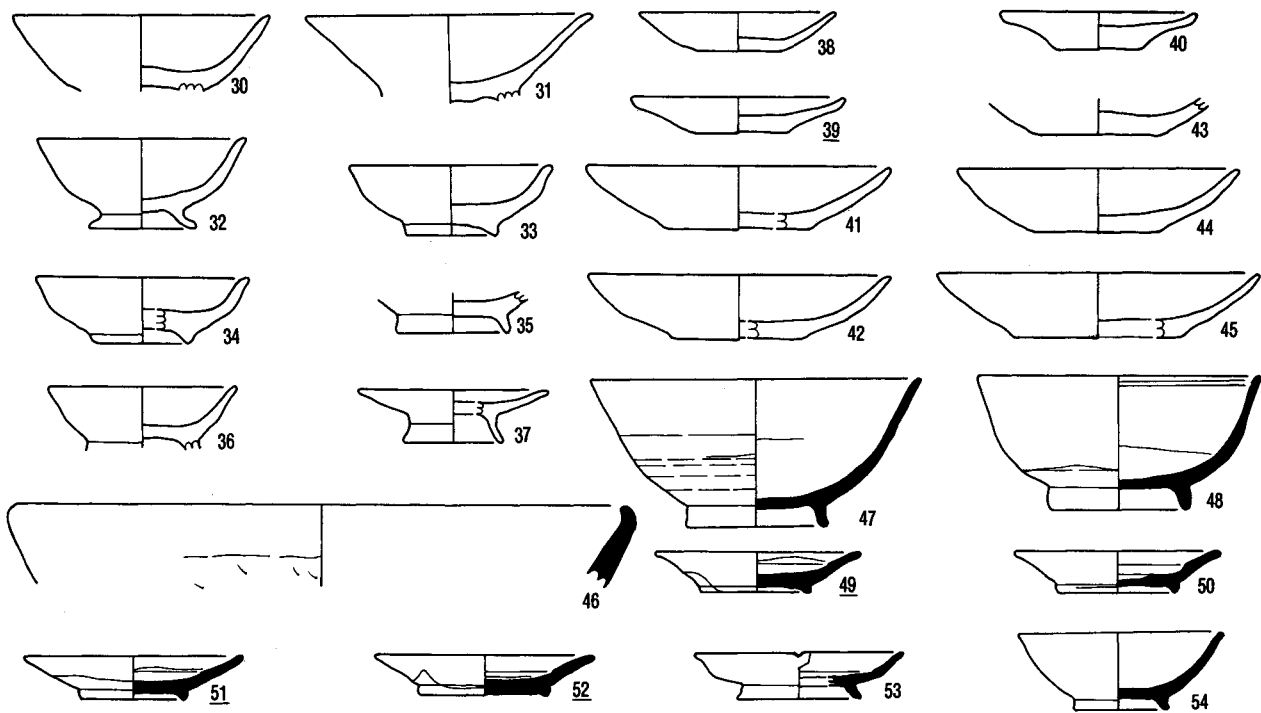

SB 31 (1~24)

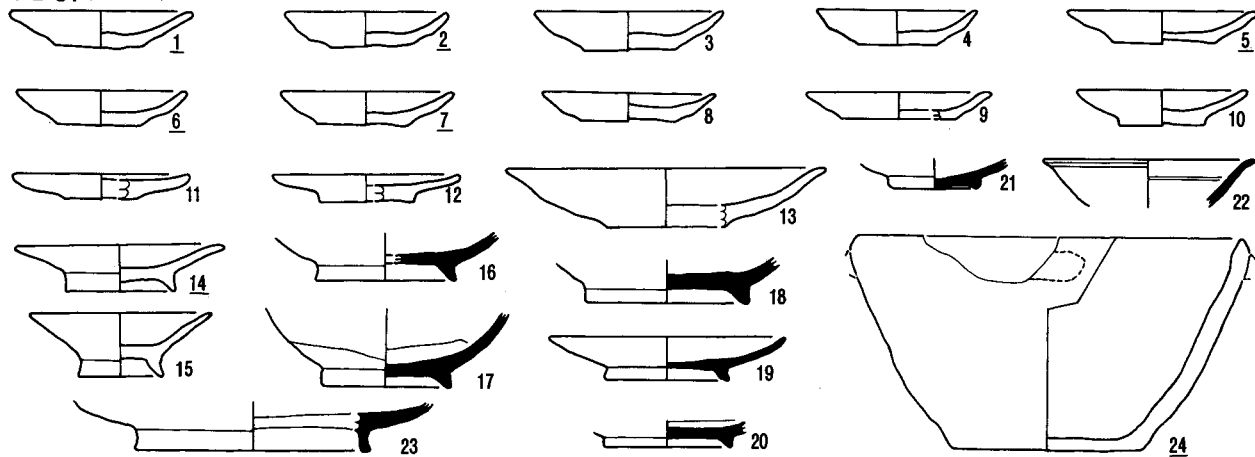

SB 32 (1~34)

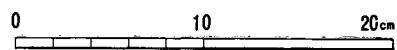
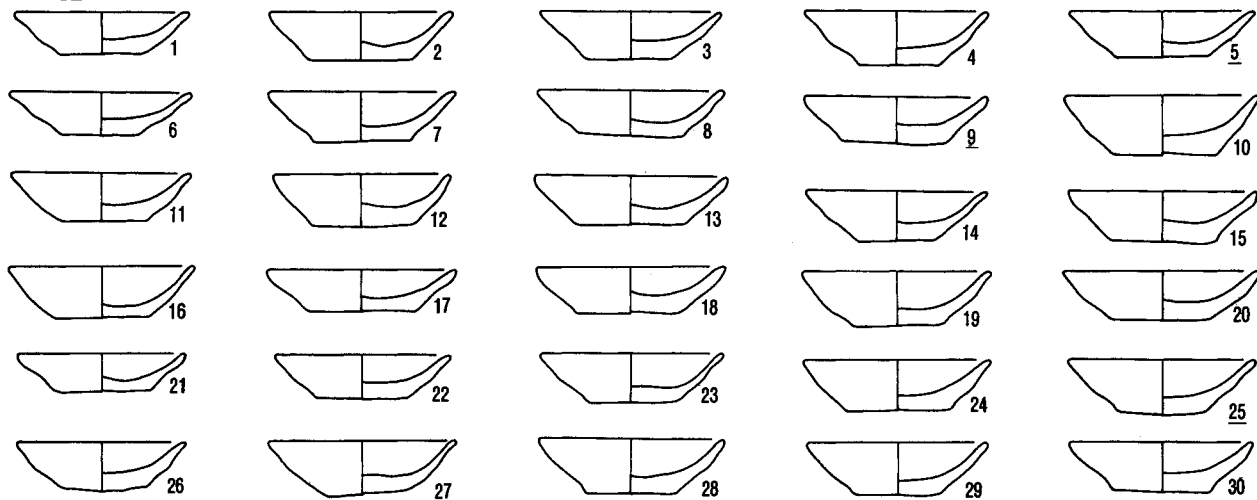

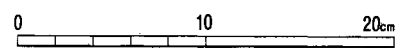
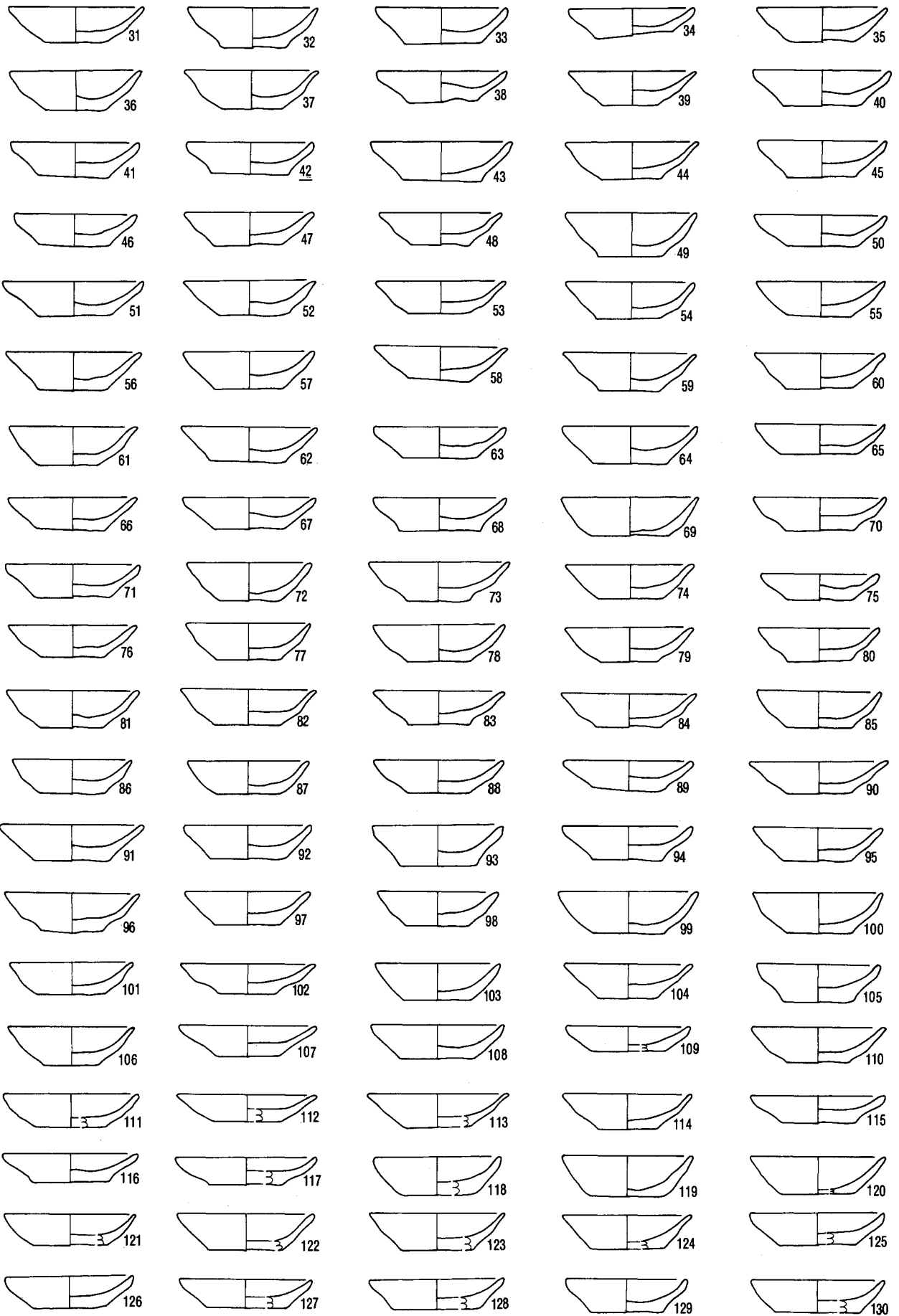

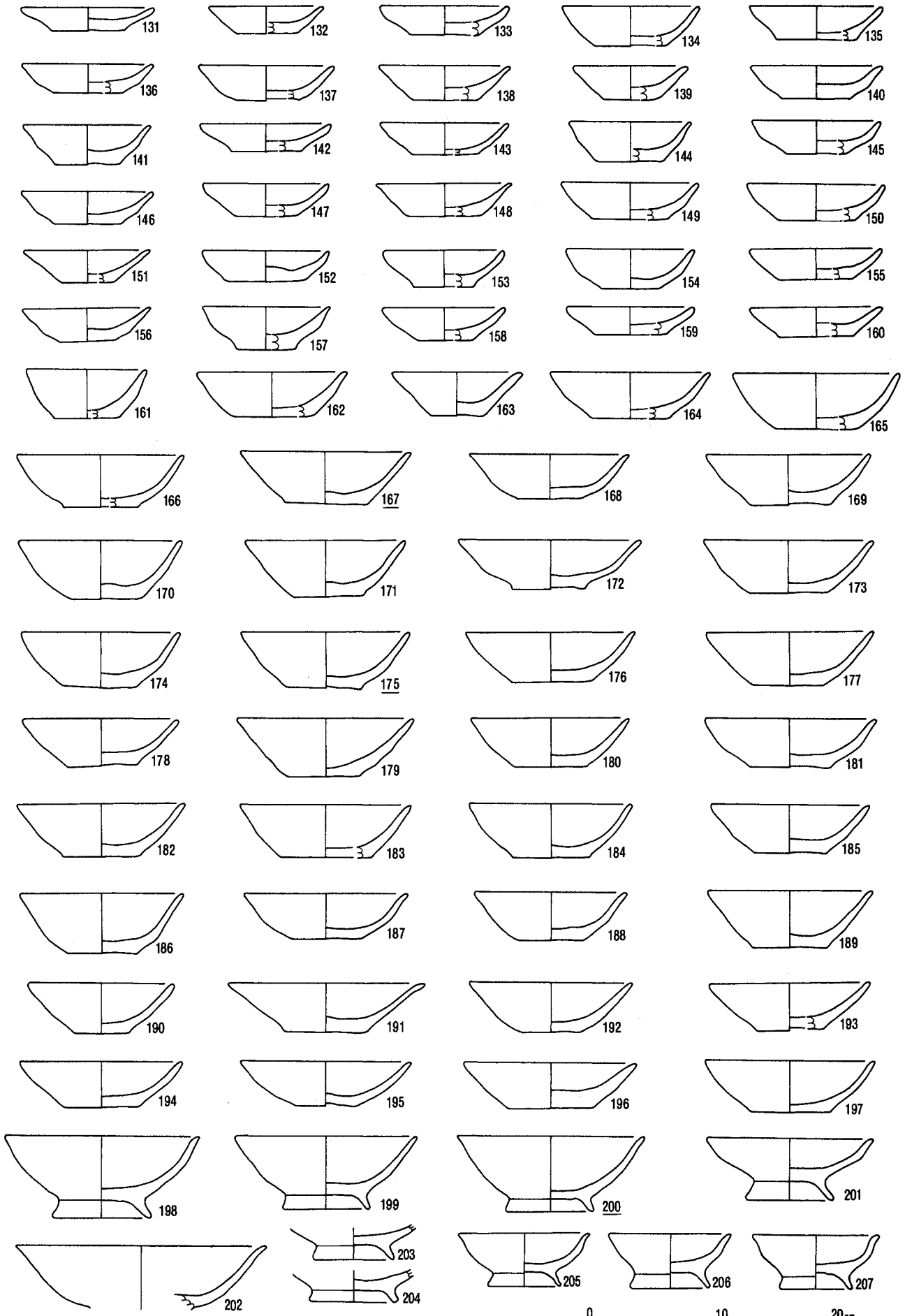

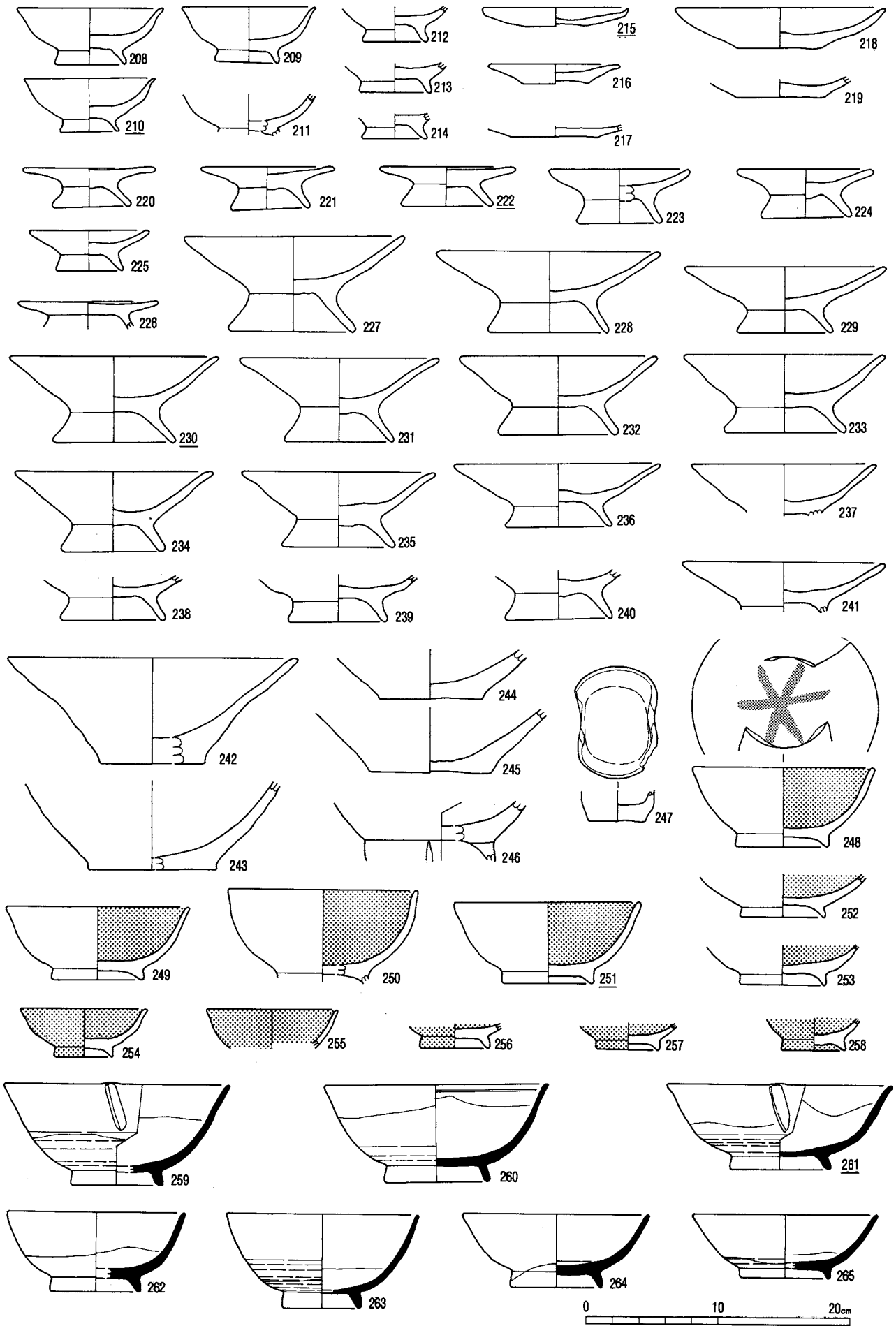

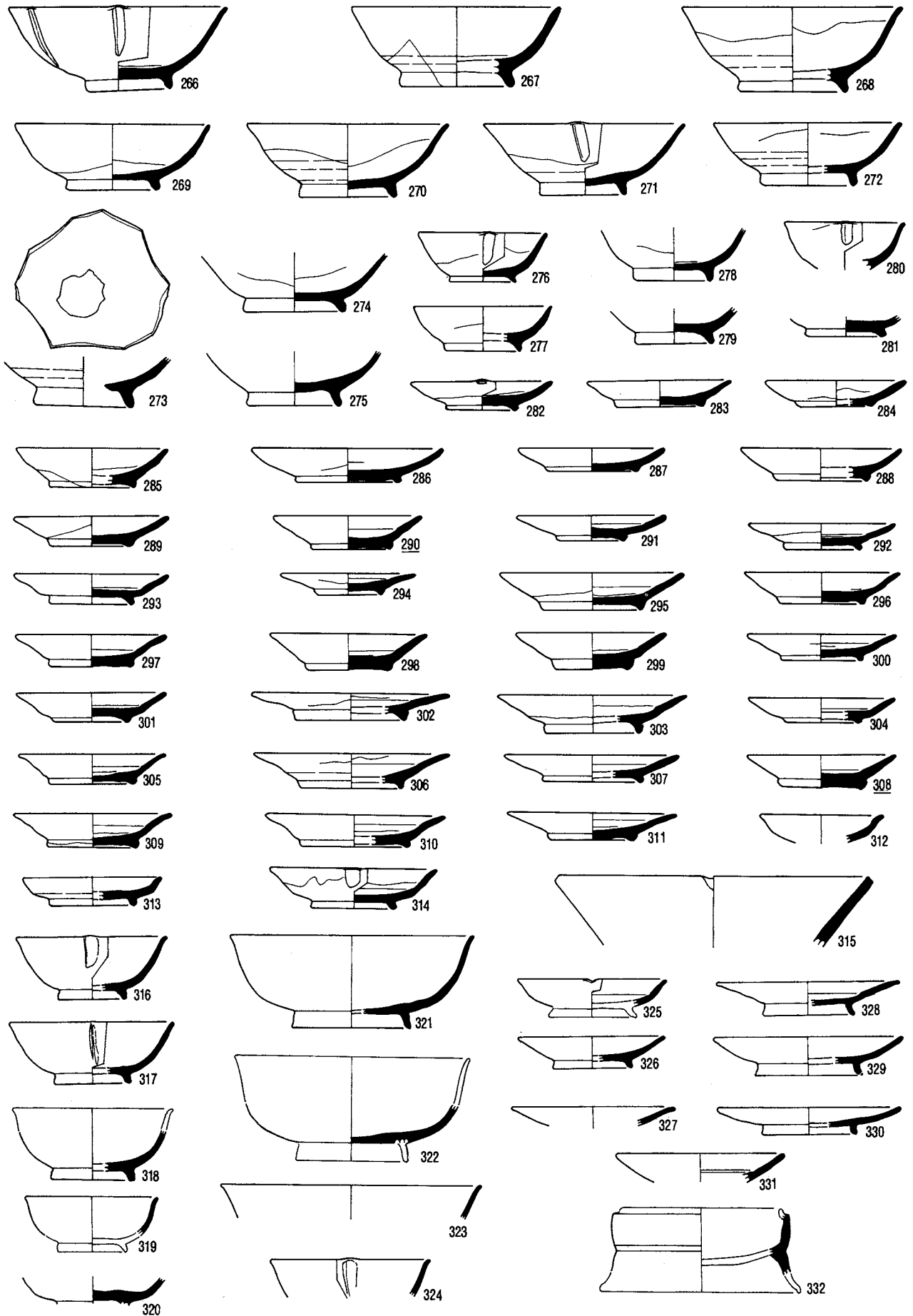

0 10 20cm

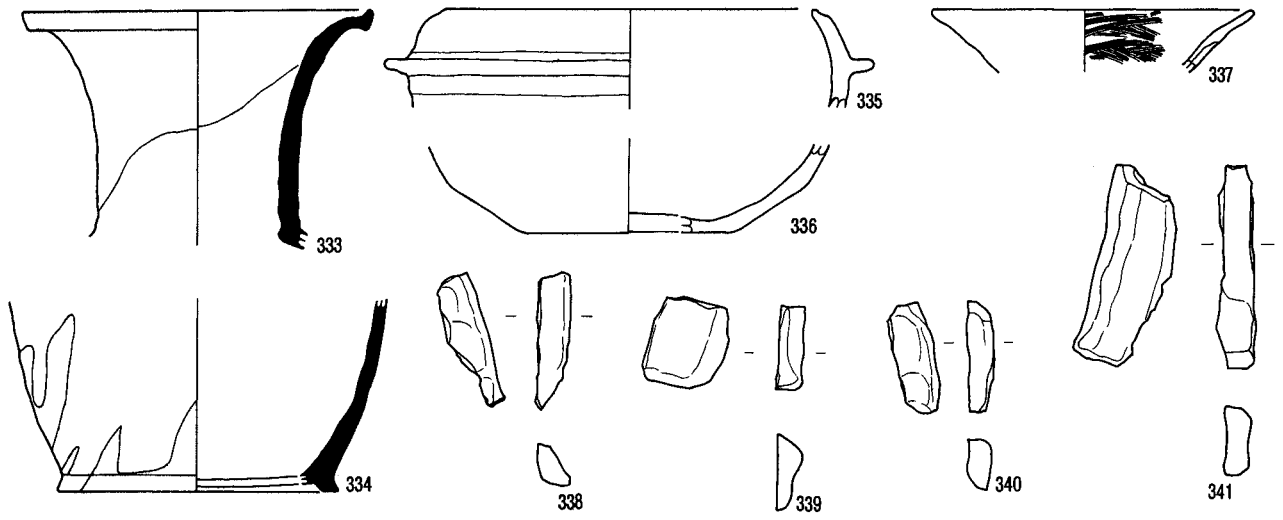

SB 33 (1)

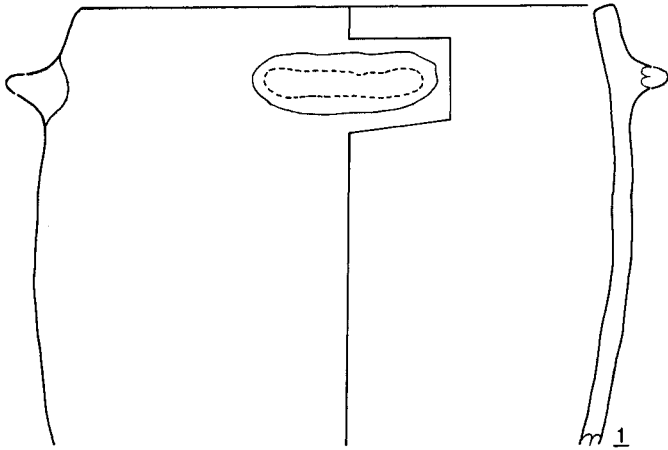

SB 35 (1~3)

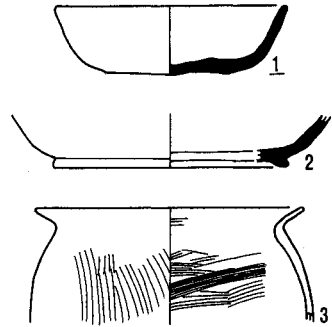

SB 36 (1~5)



SB 37 (1~29)

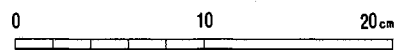
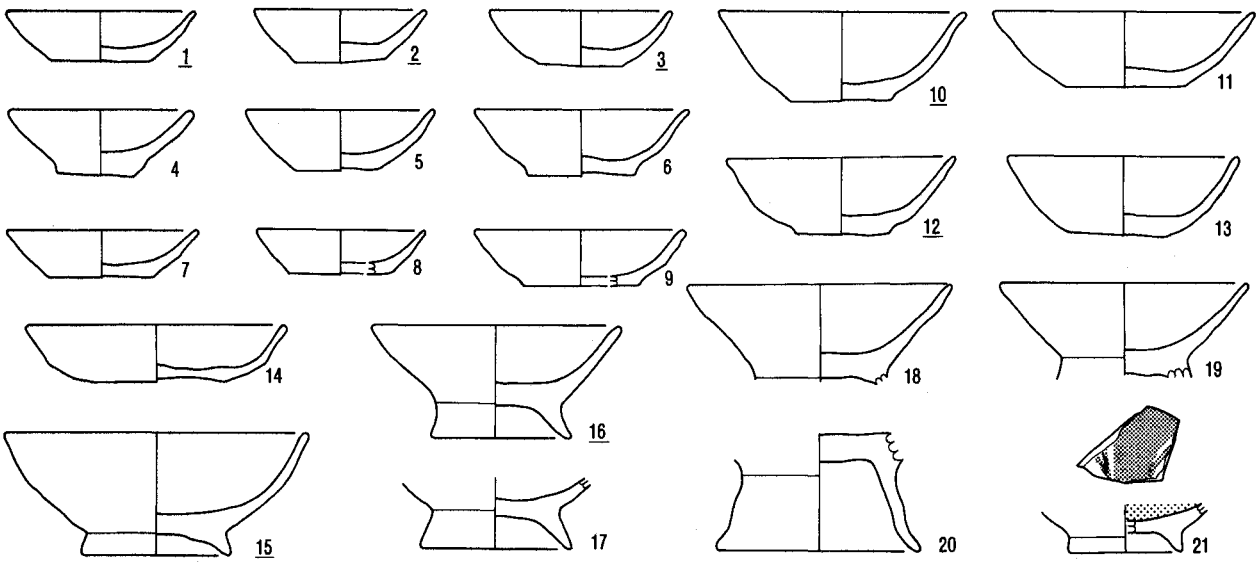

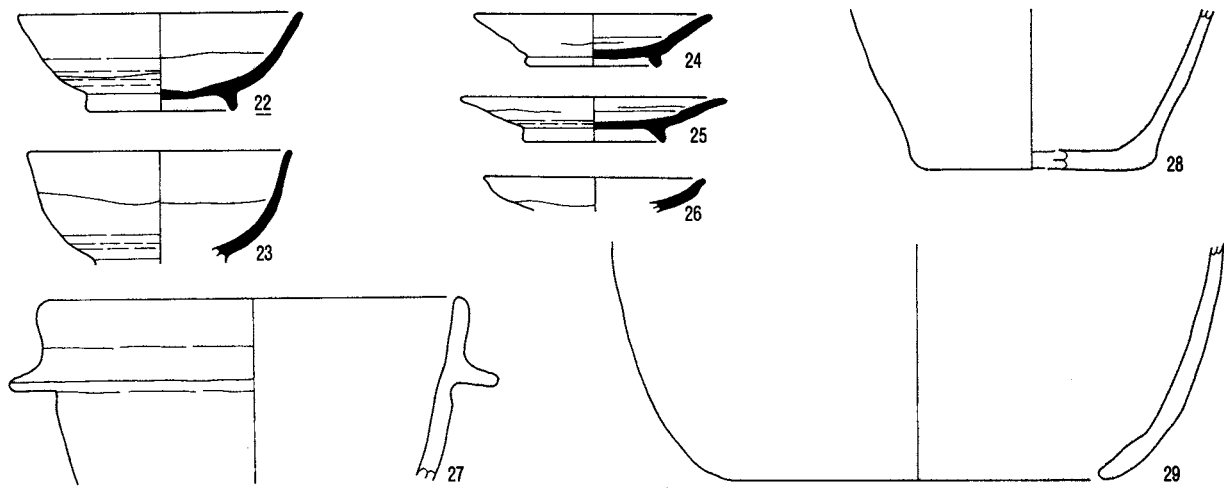

SB 38 (1~11)

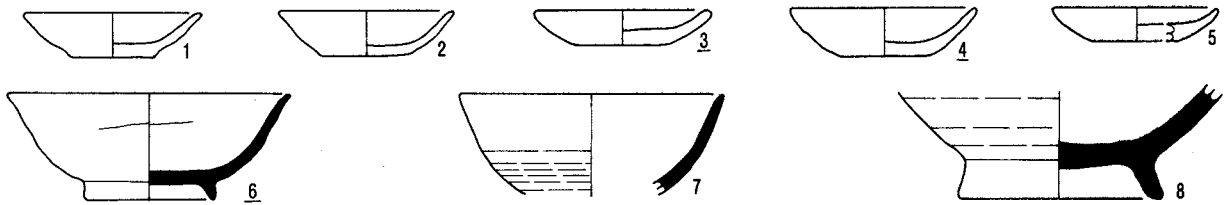

SB 39 (1)

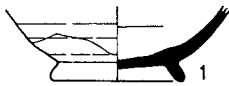

SB 42 (1~8)

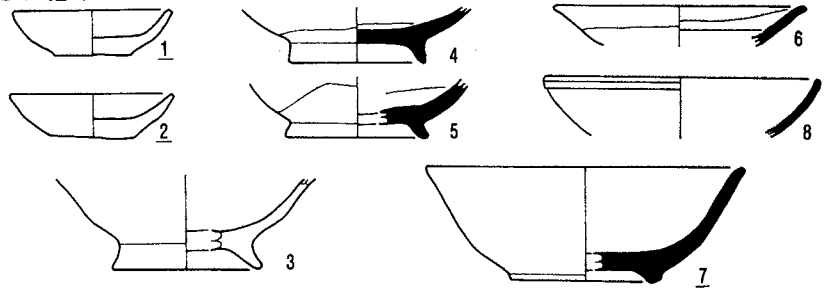

SB 40 (1~3)

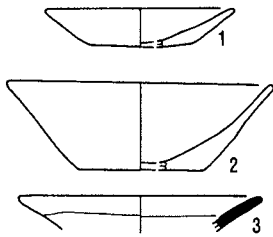

SB 41 (1~3)

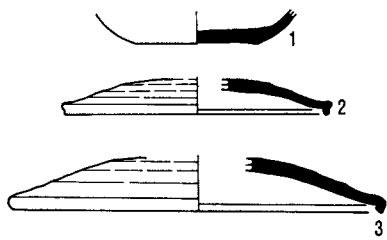

SB 43 (1~38)

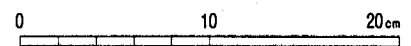
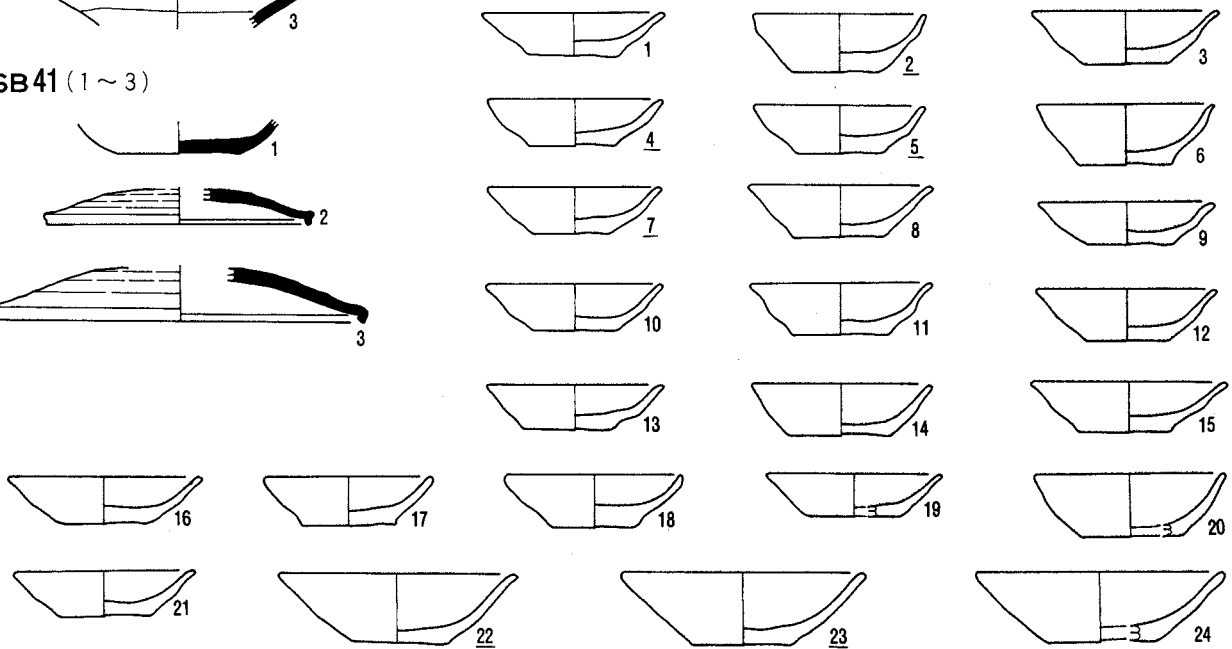

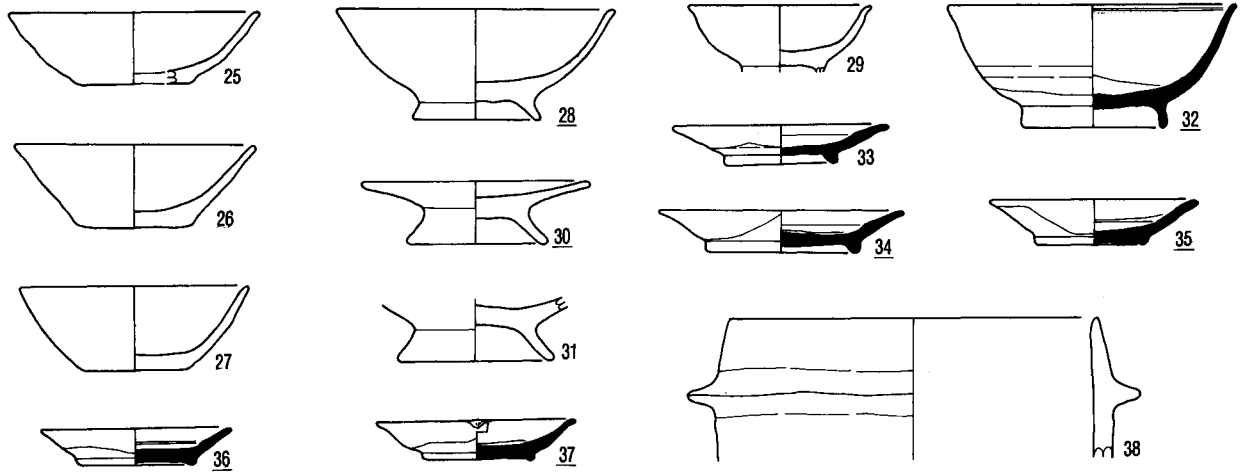

SB44 (1~23)

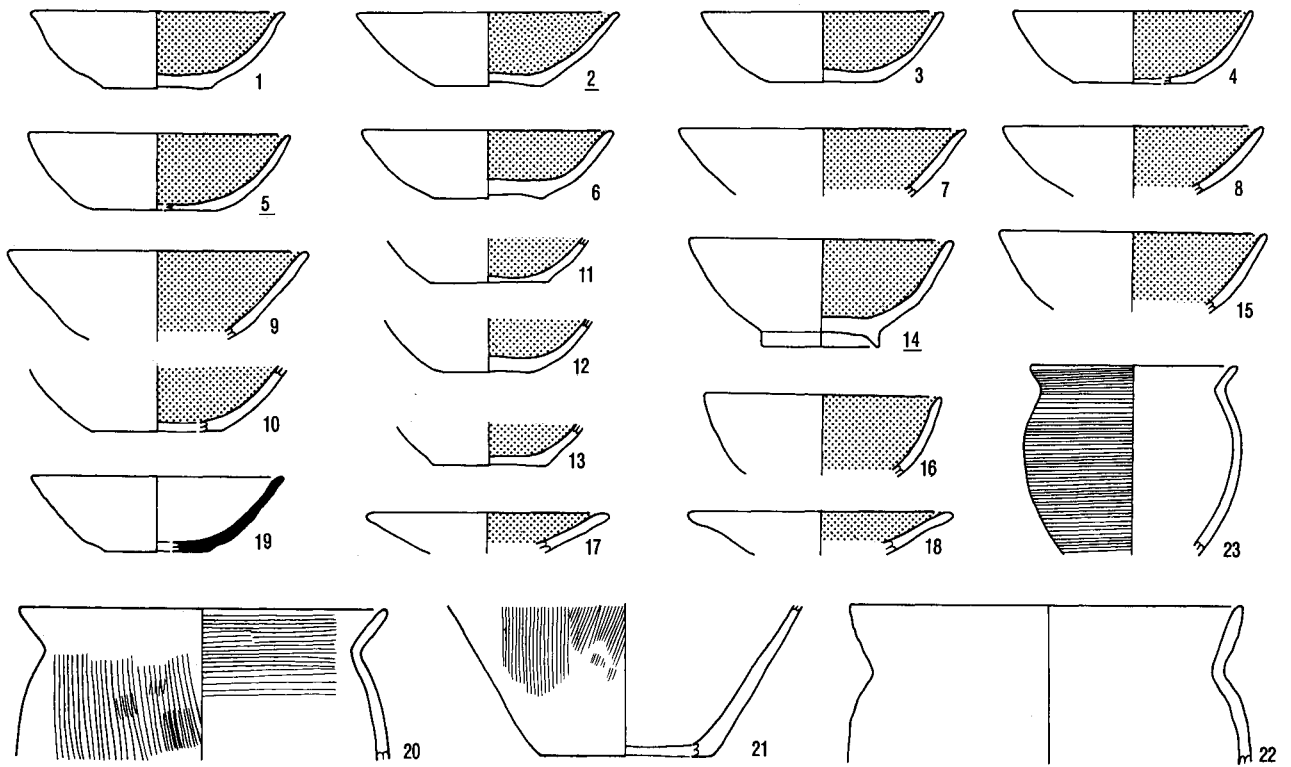

SB45 (1~8)

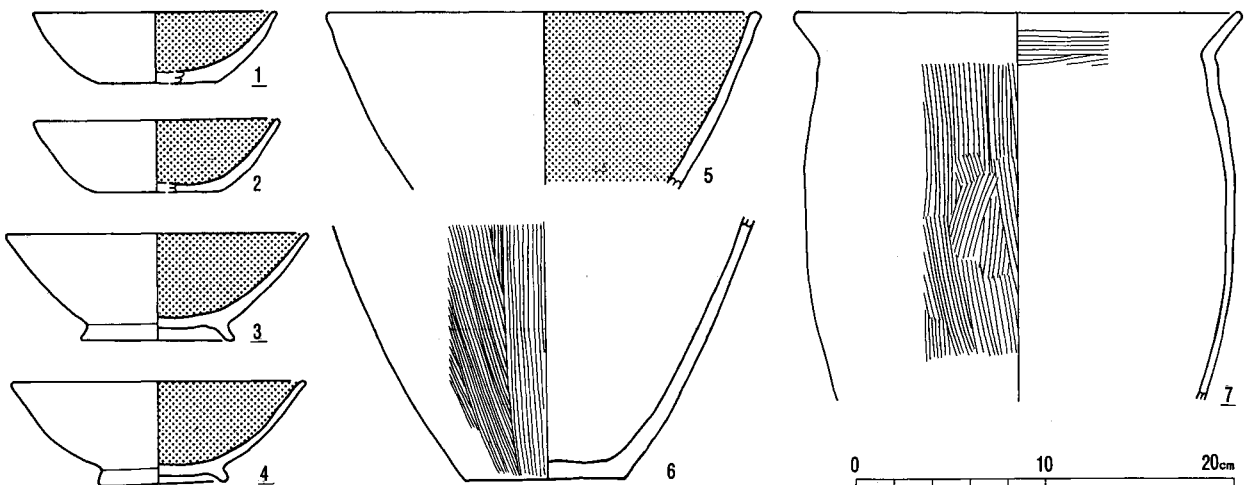

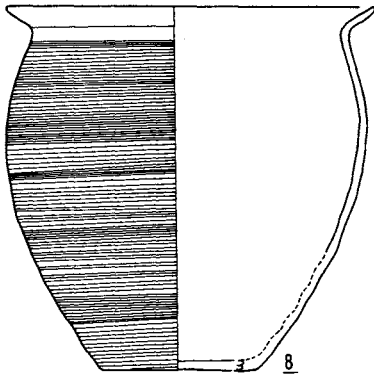

SB47 (1~19)

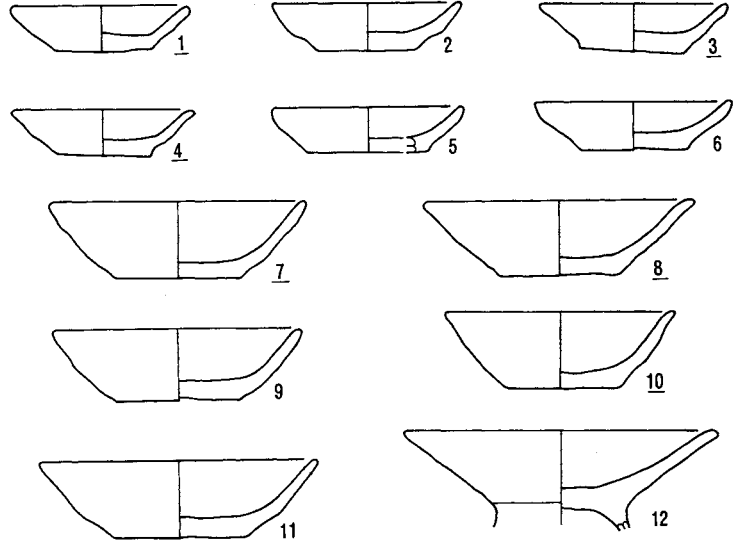

SB46

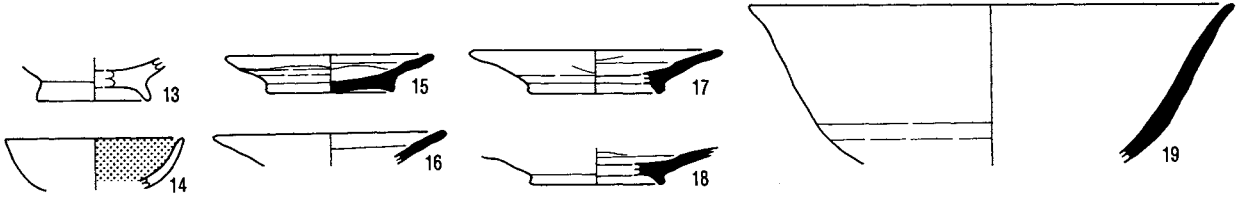
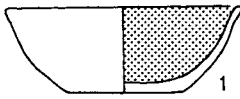

SB48 (1~19)

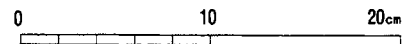
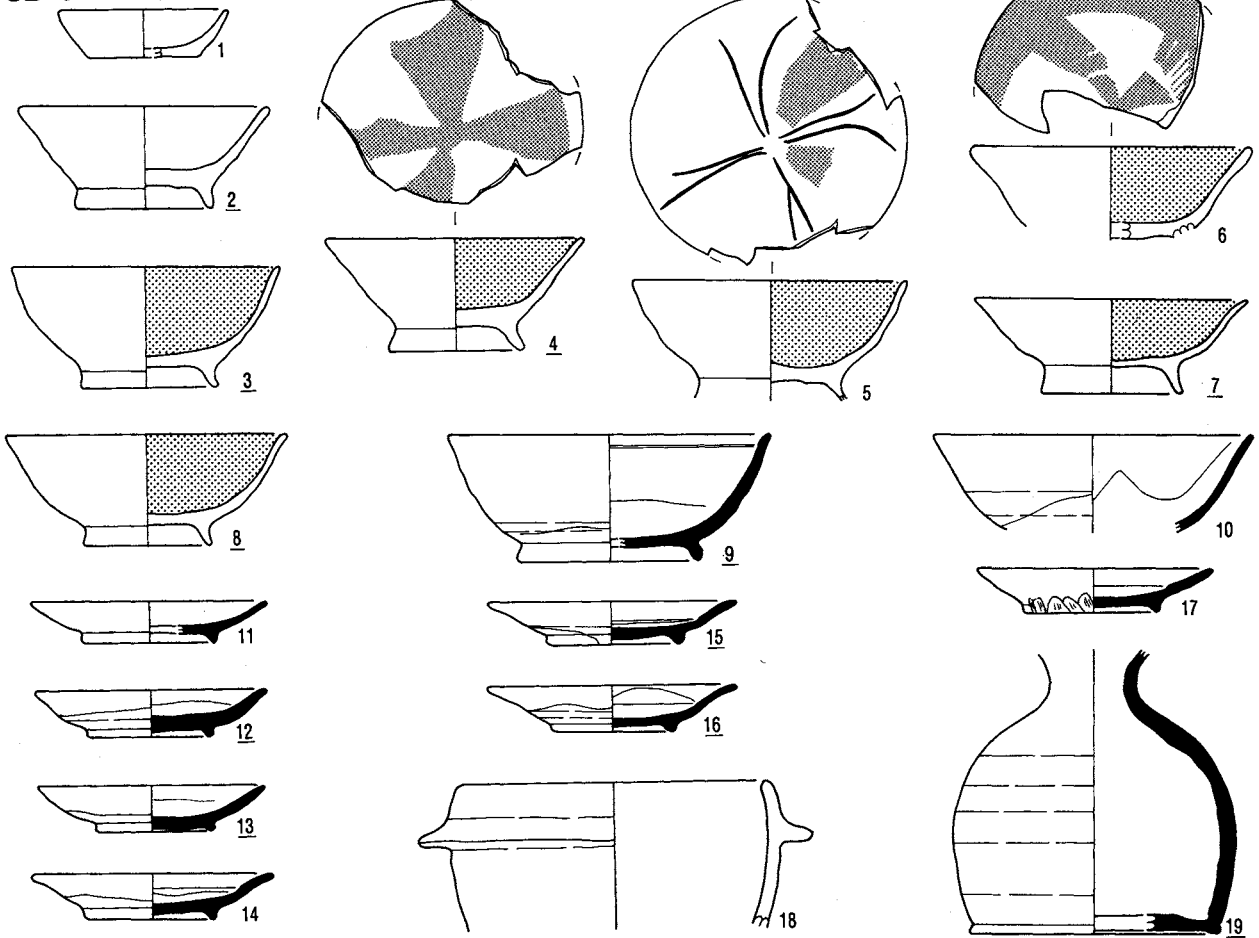

SB49 (1~21)

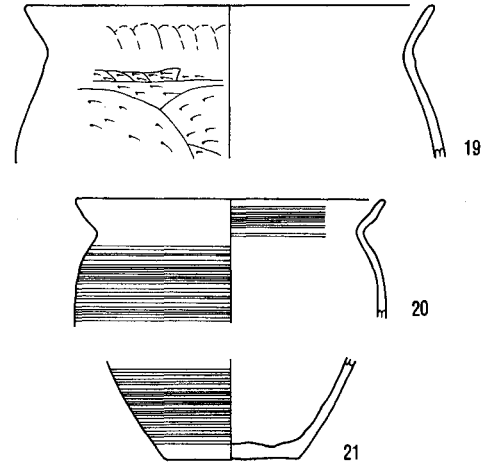
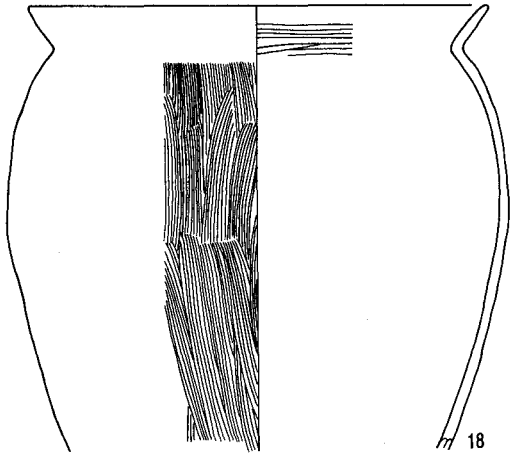
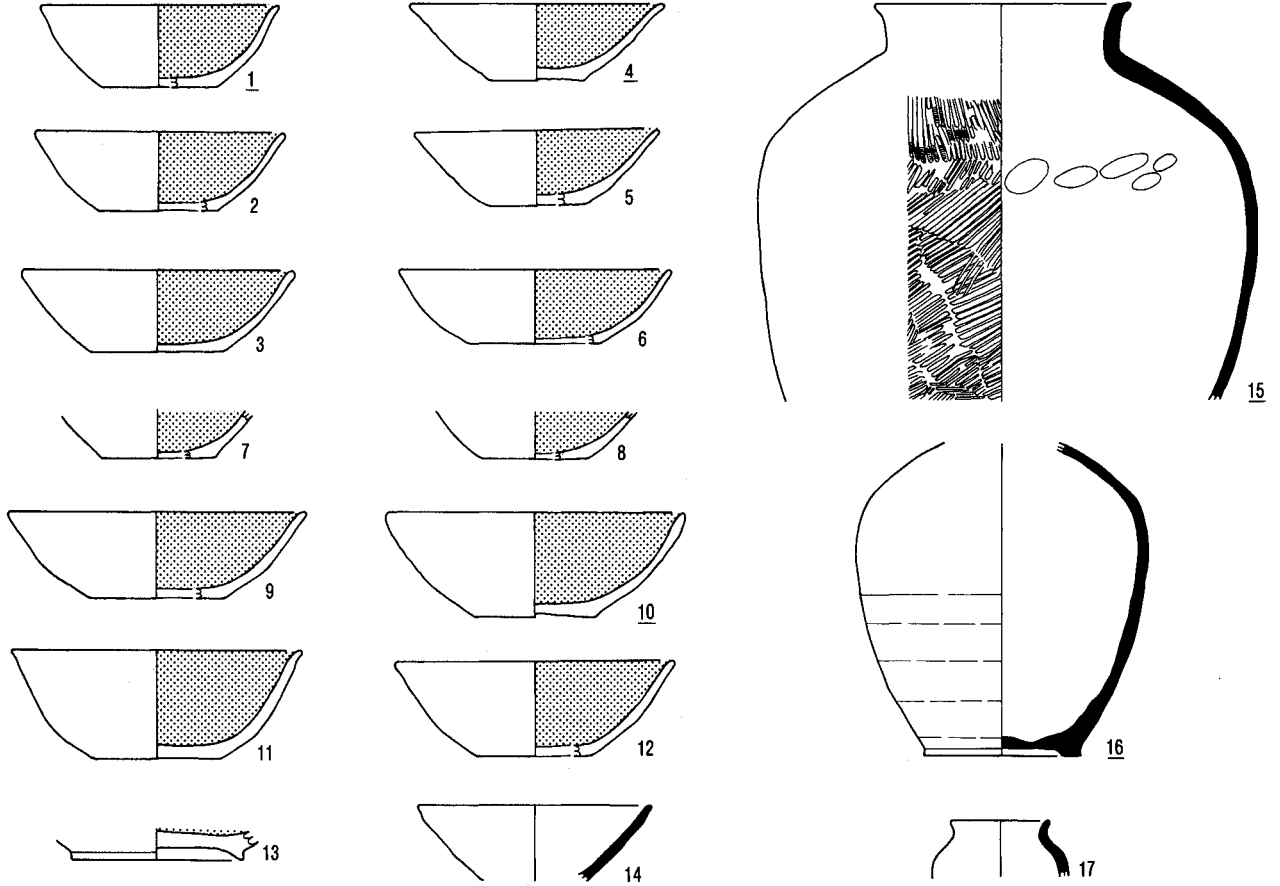

SB50 (1~8)

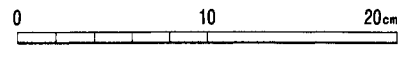
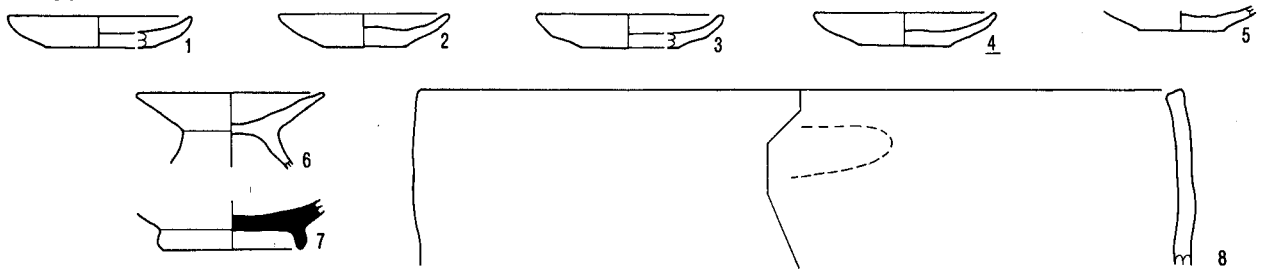

SB51 (1~8)

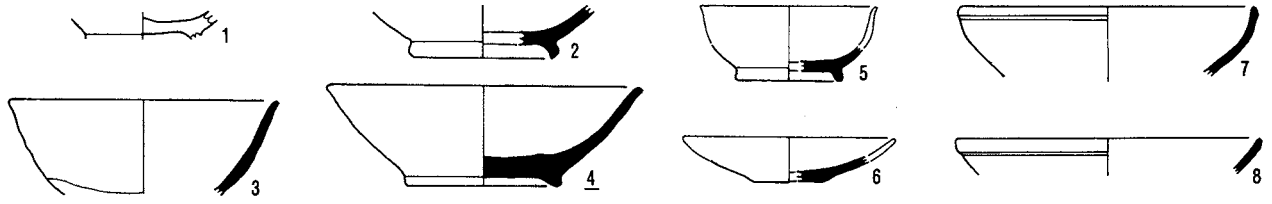

SB52 (1~26)

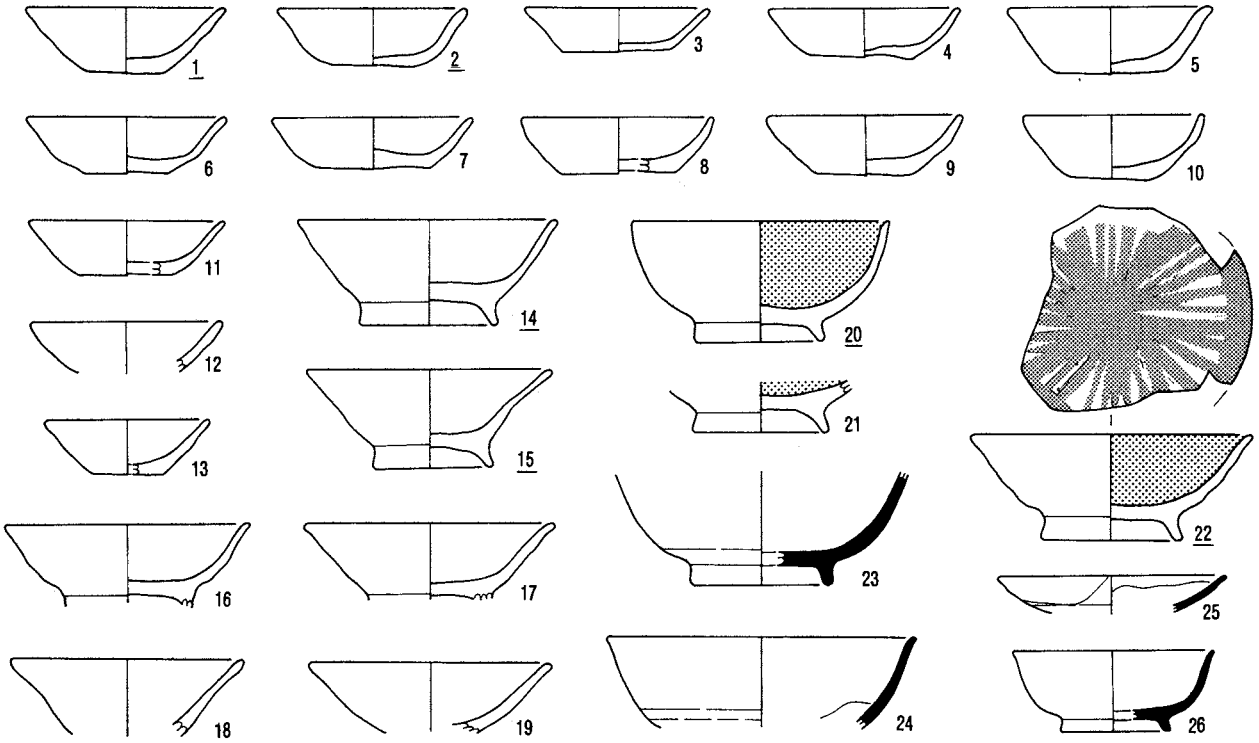

SB53 (1~6)

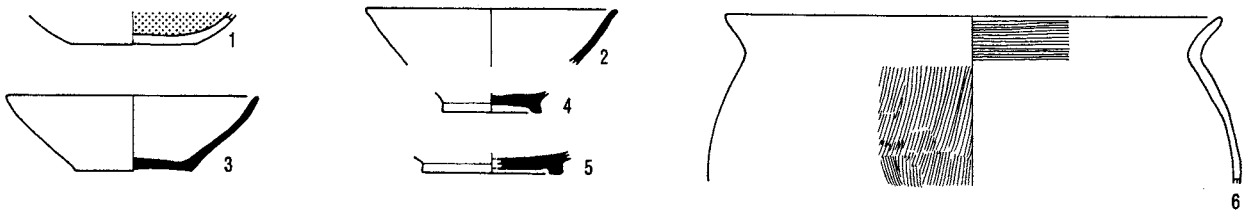

SB55 (1~13)

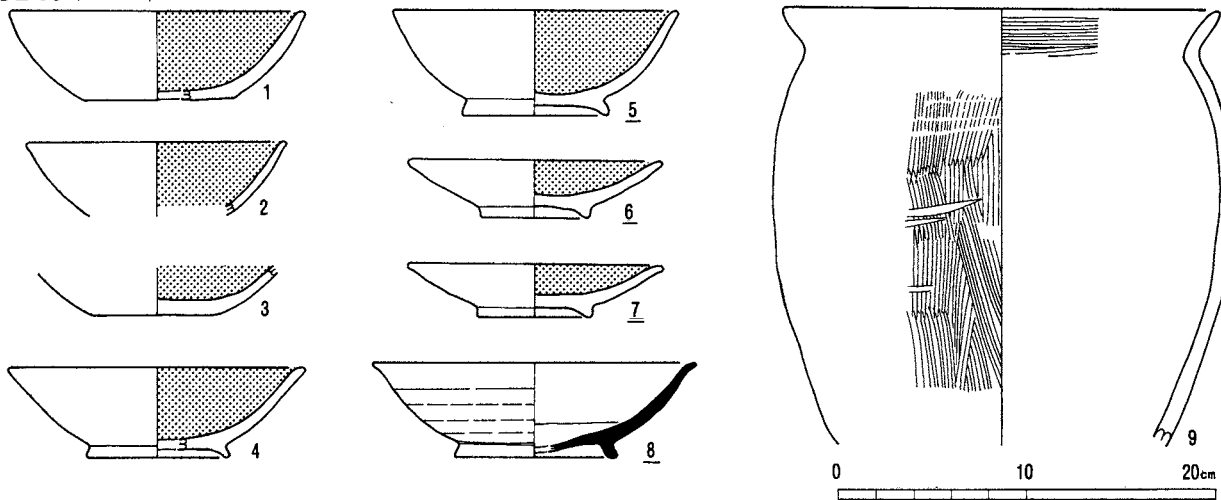

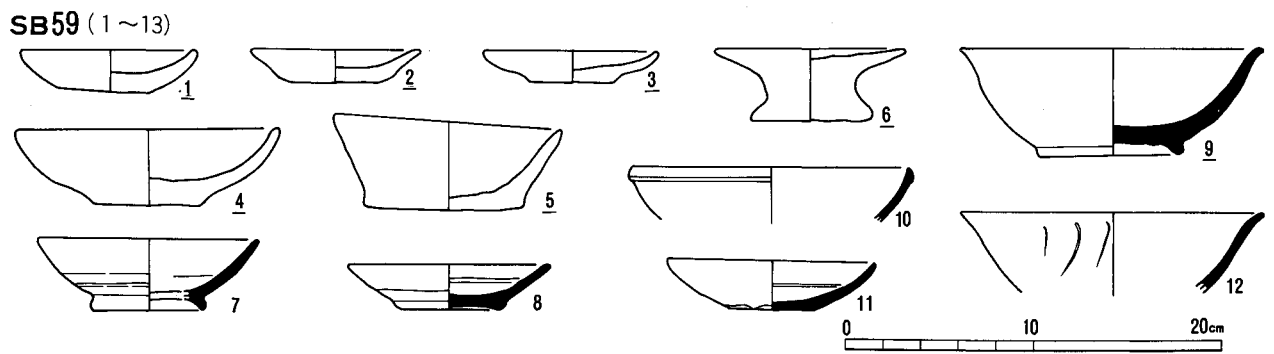
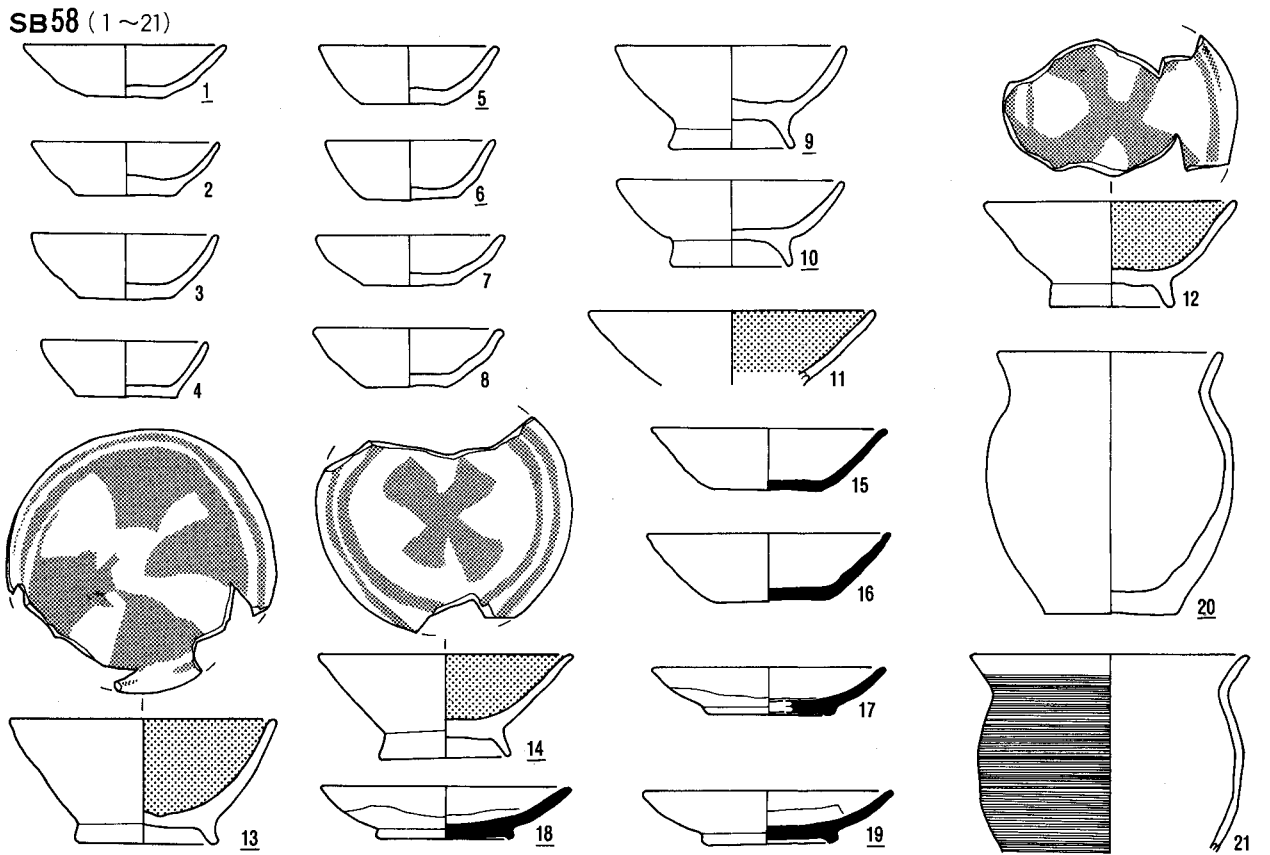
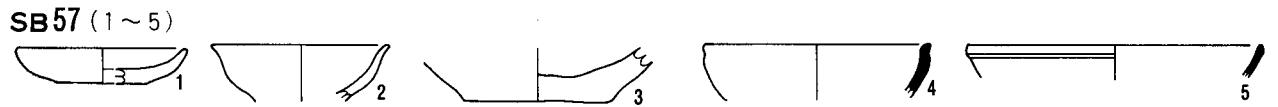
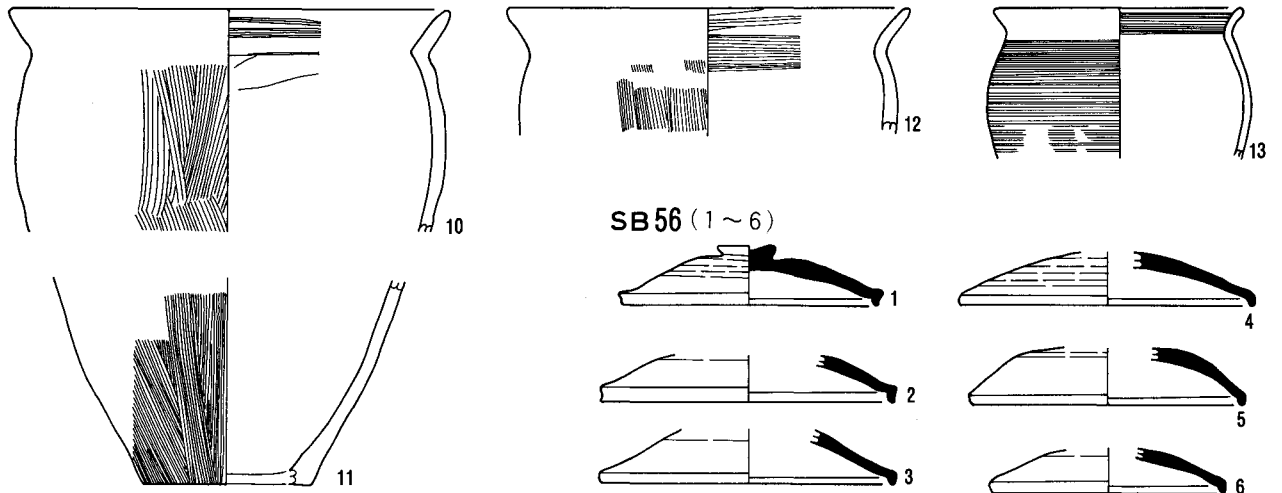

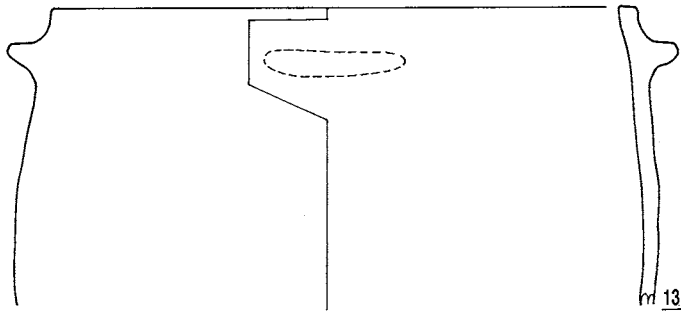

SB60 (1)

SB61 (1~13)

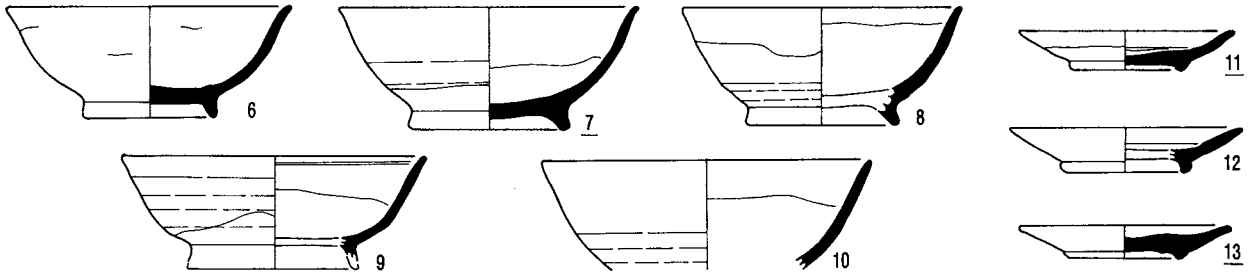
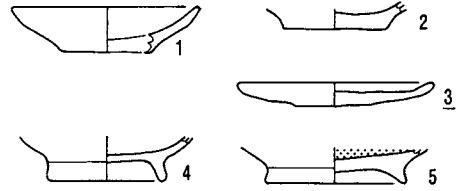

SB63 (1~47)

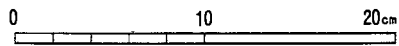
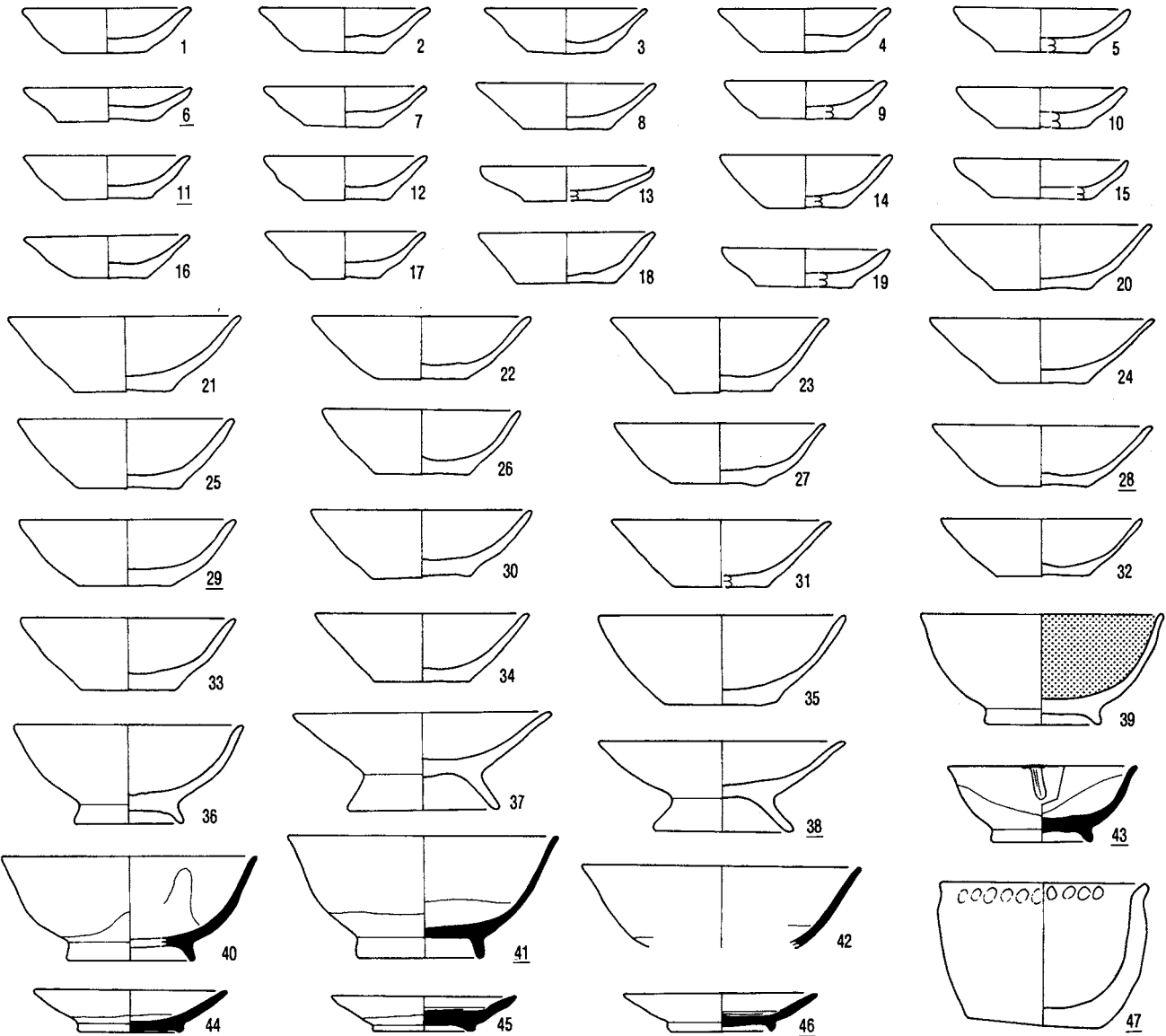

SB64 (1~10)

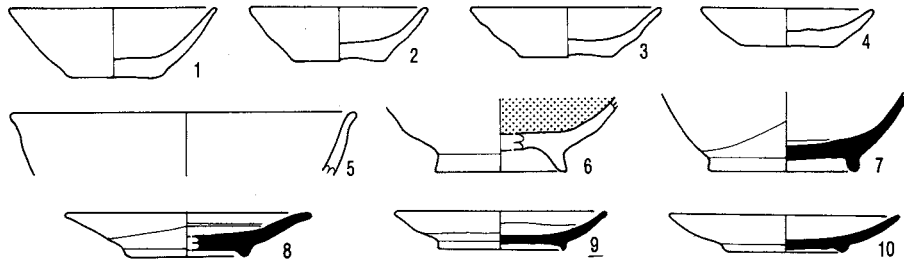

SB65 (1~3)

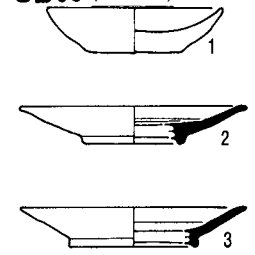

SB66 (1~40)

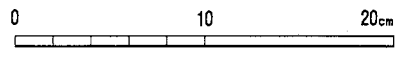
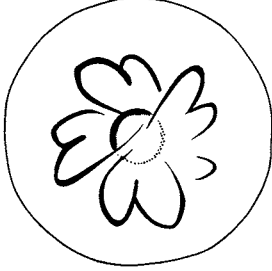
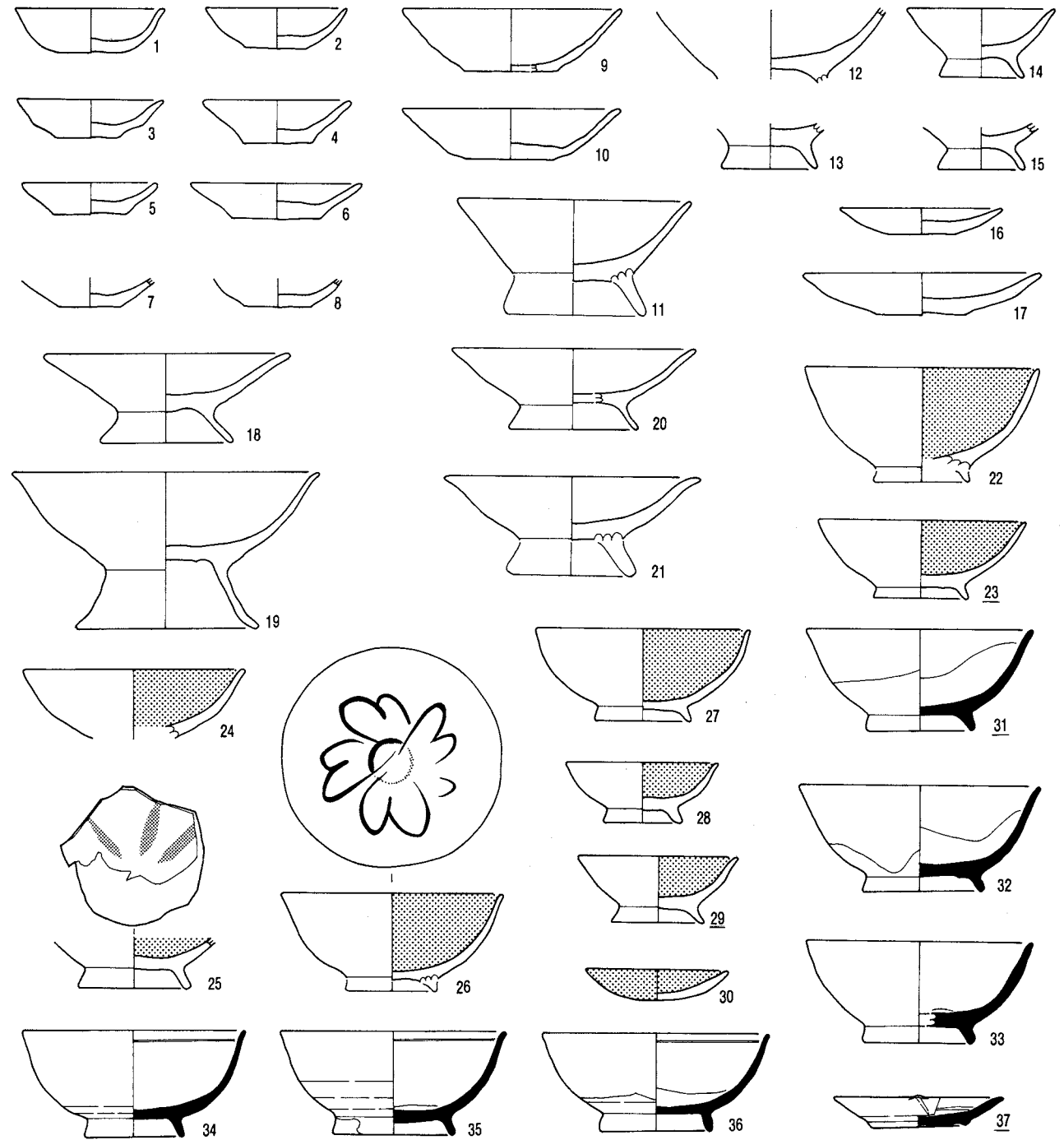

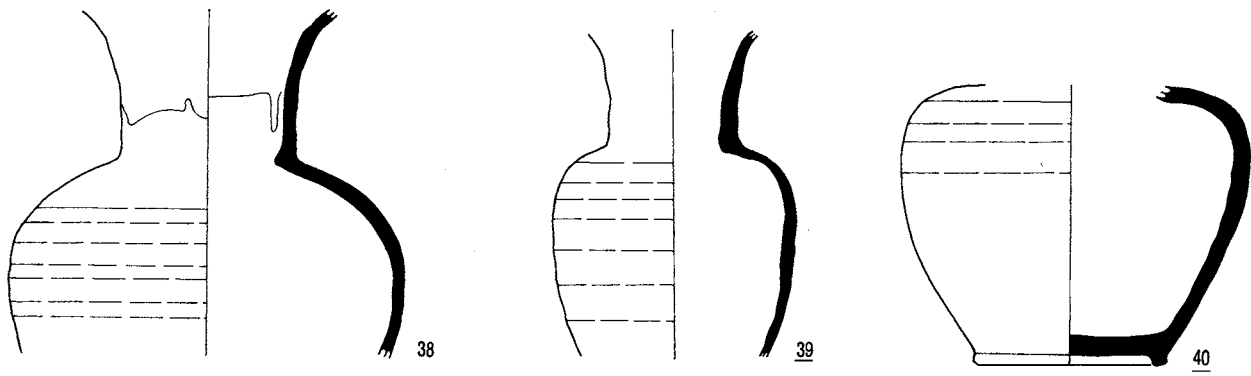

SB 67 (1.2)

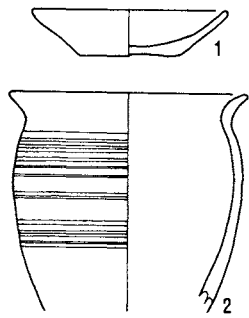

SB 68 (1~8)

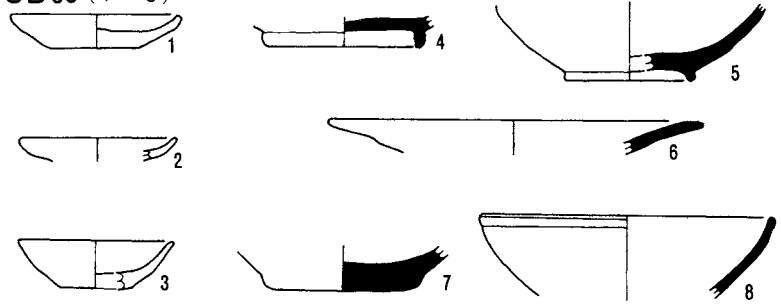

SB 69 (1~40)

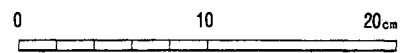
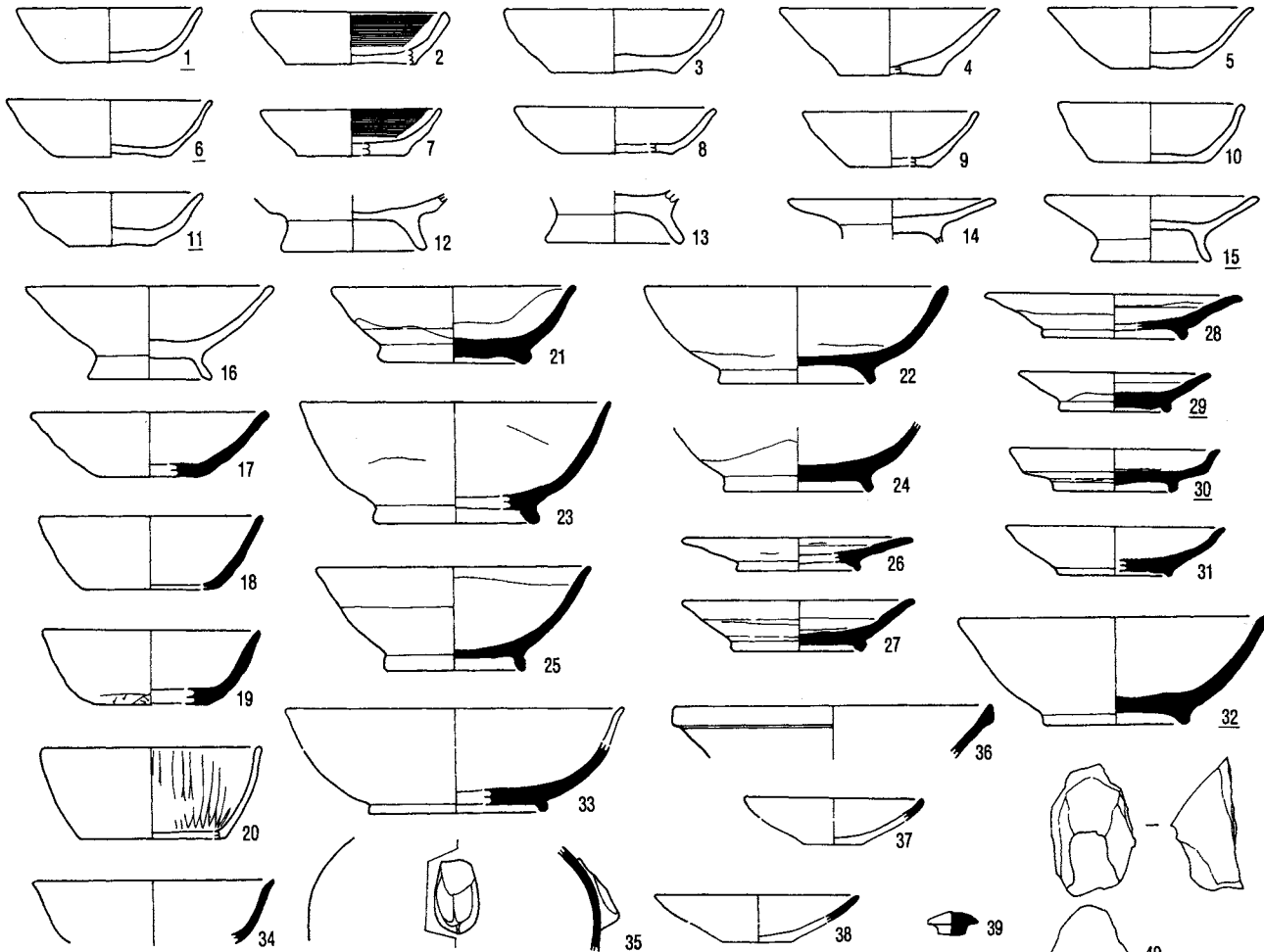

SB70 (1~5)

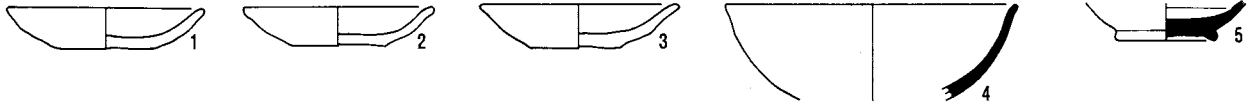

SB71 (1~7)

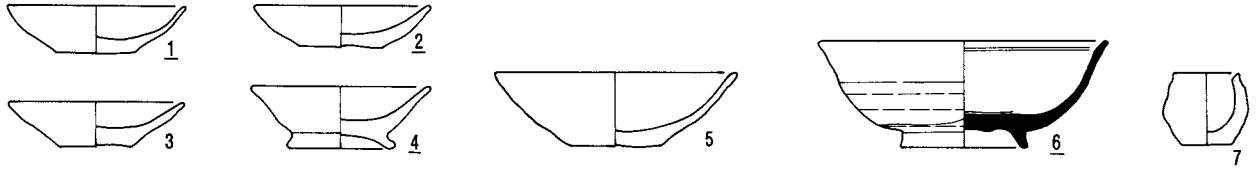

SB72 (1~11)

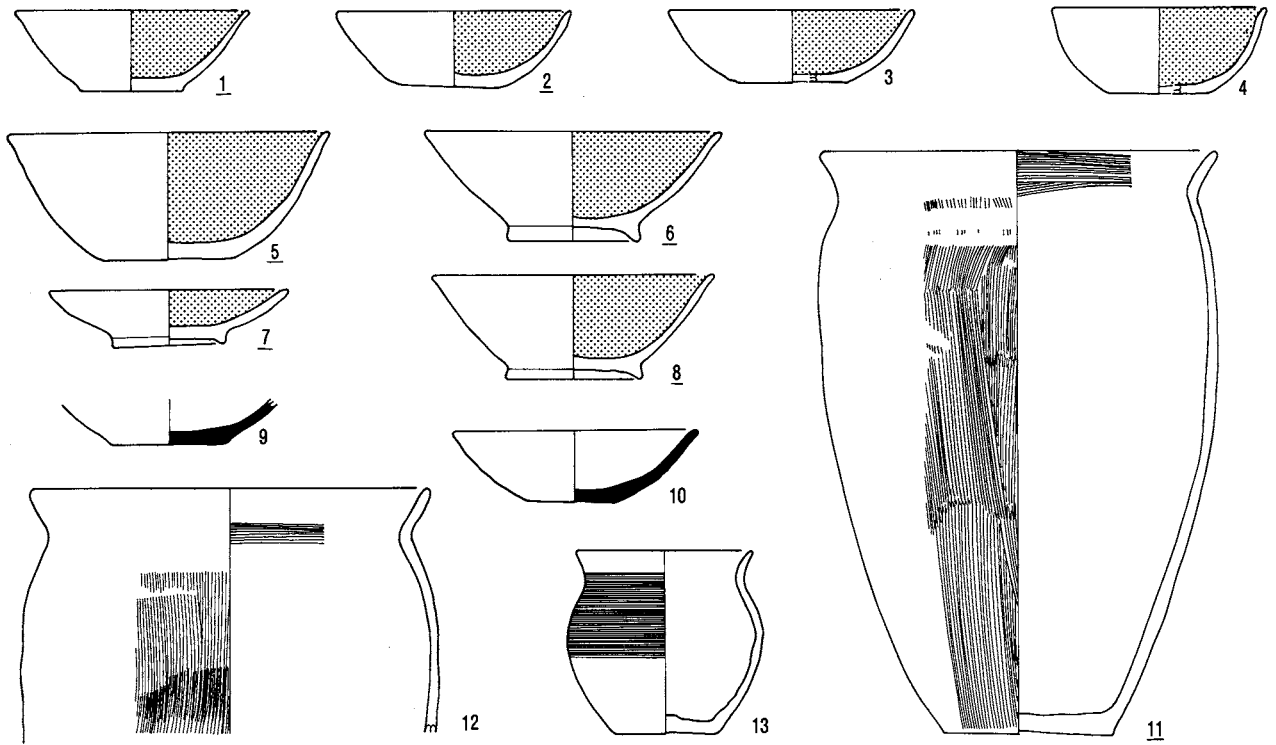

SB73 (1~12)

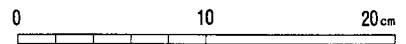
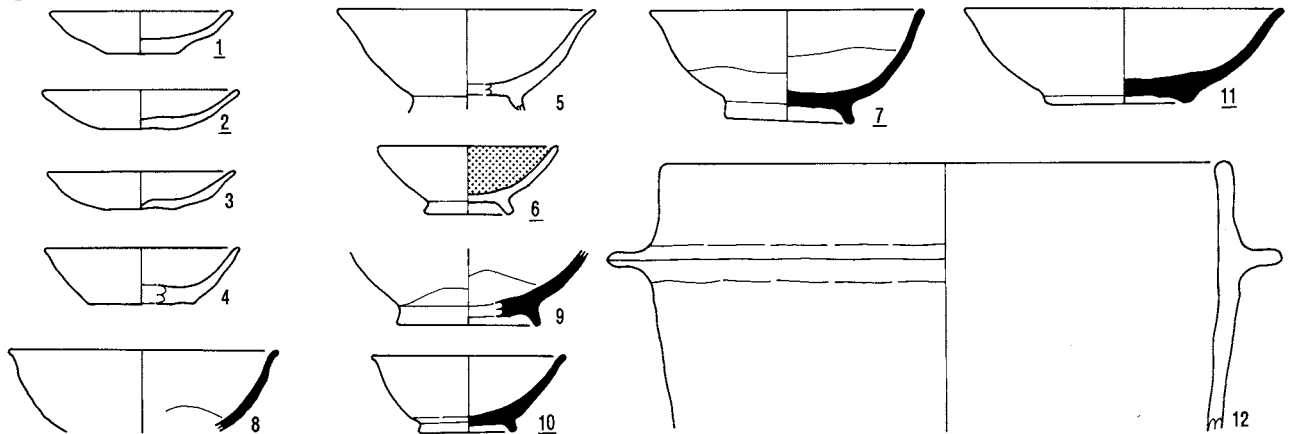

SB74 (1~47)

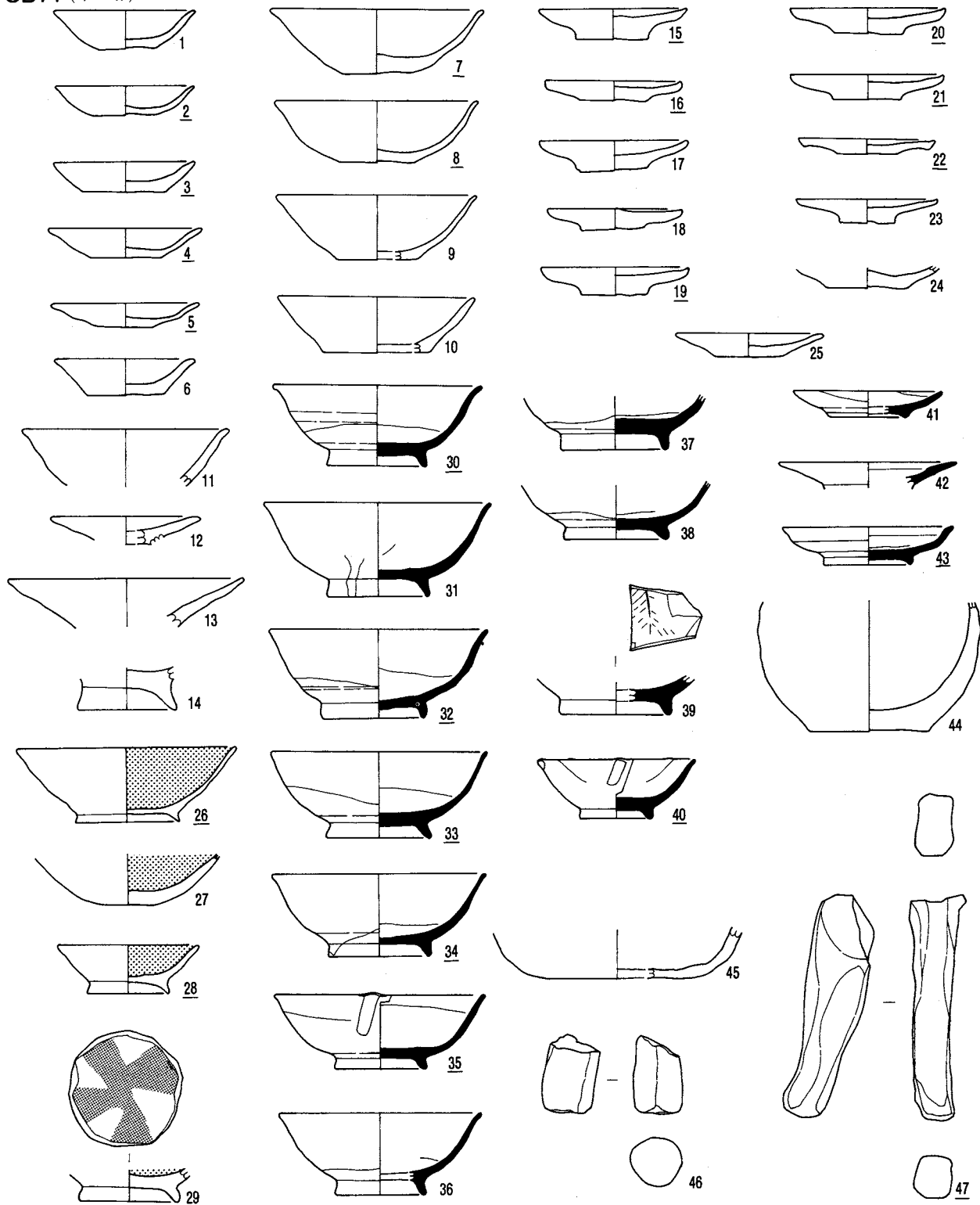

SB75 (1~4)

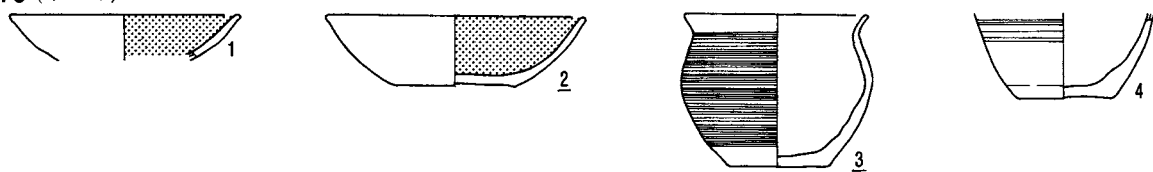

0 10 20cm

SB76 (1~11)

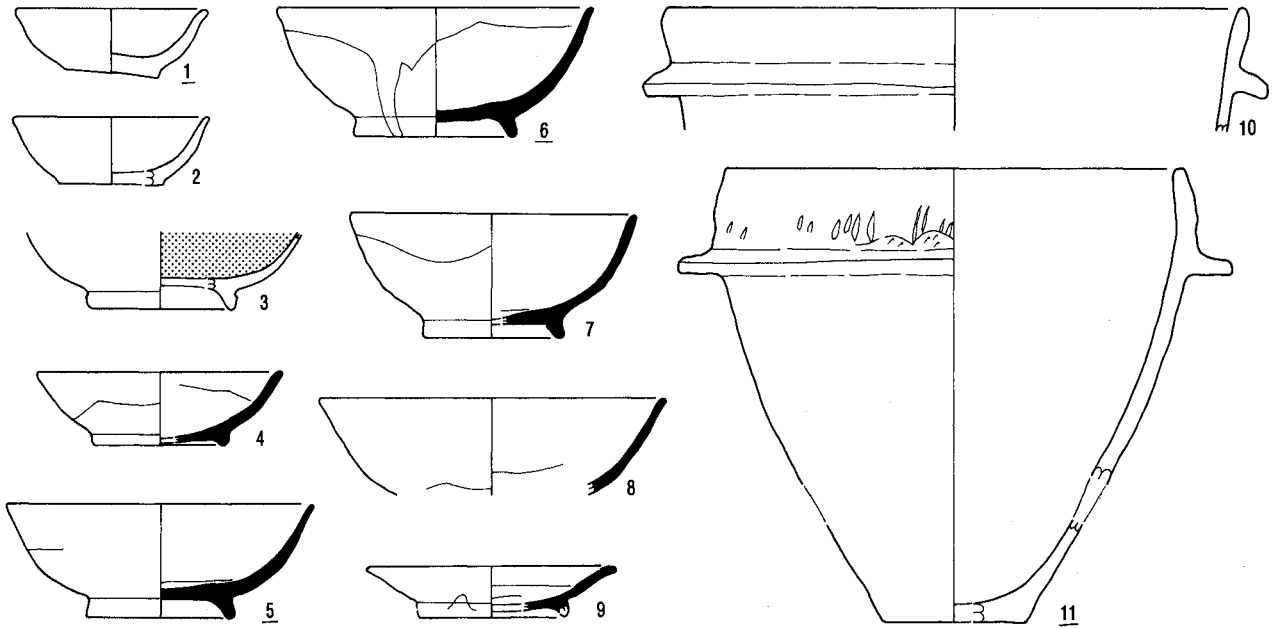

SB77 (1~11)

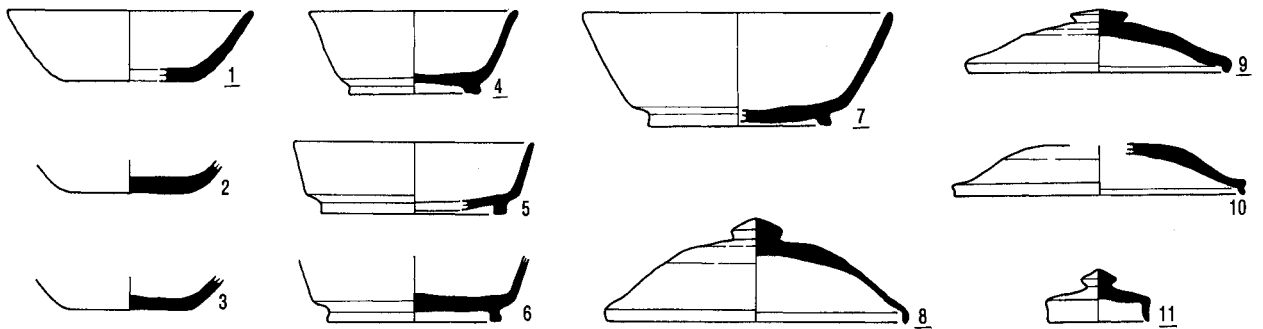

SB78 (1~14)

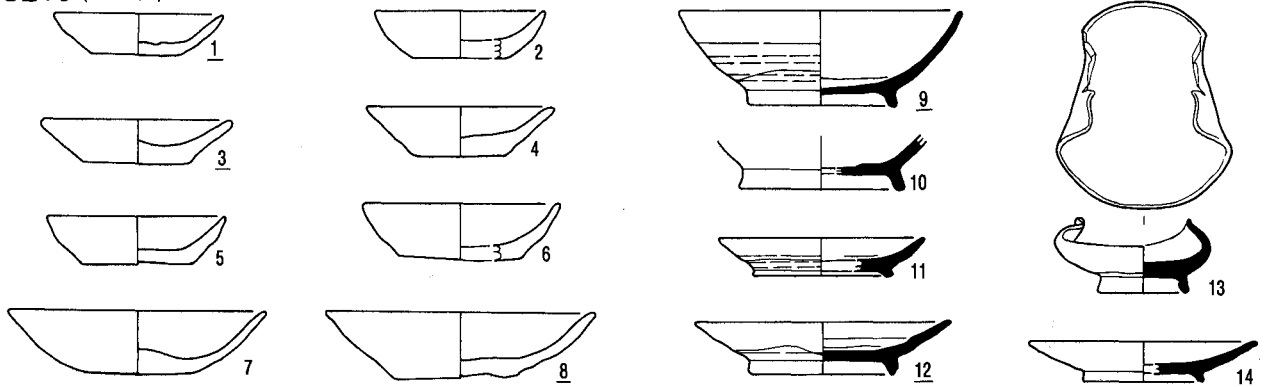

SB79 (1.2)

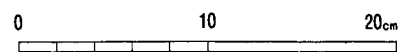

SB 80 (1~83)

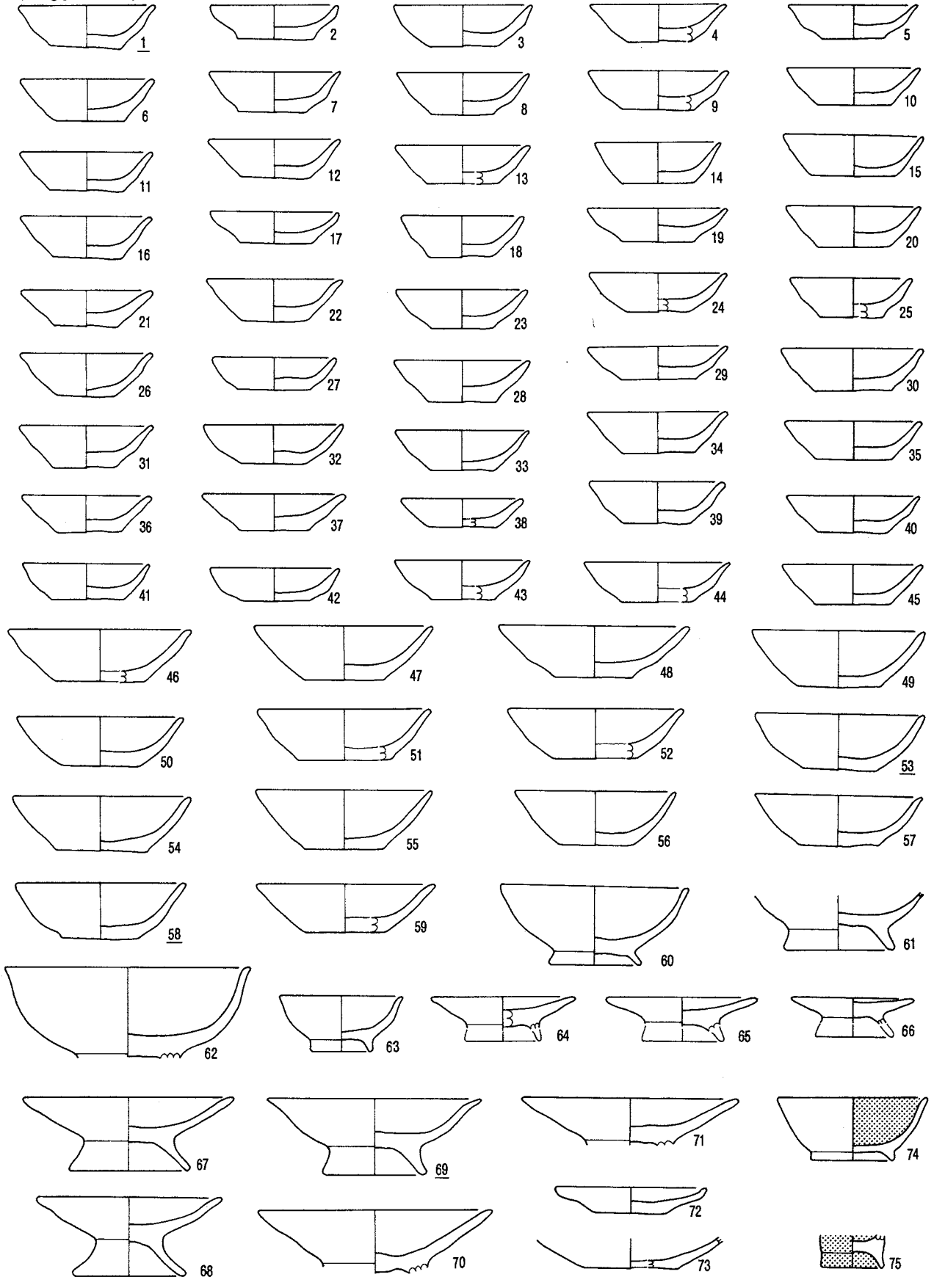

0 10 20cm

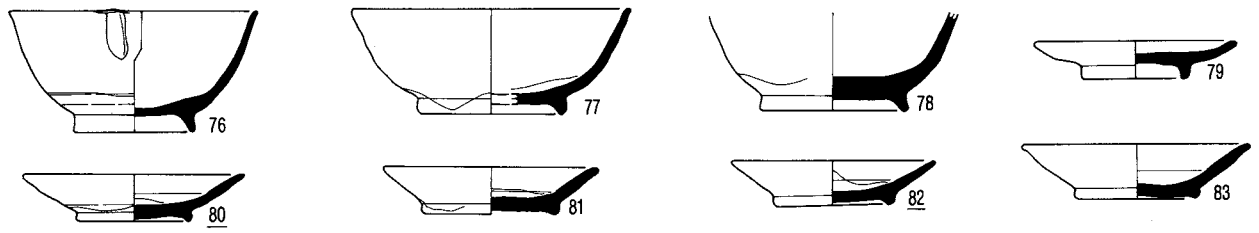

SB 81 (1~38)

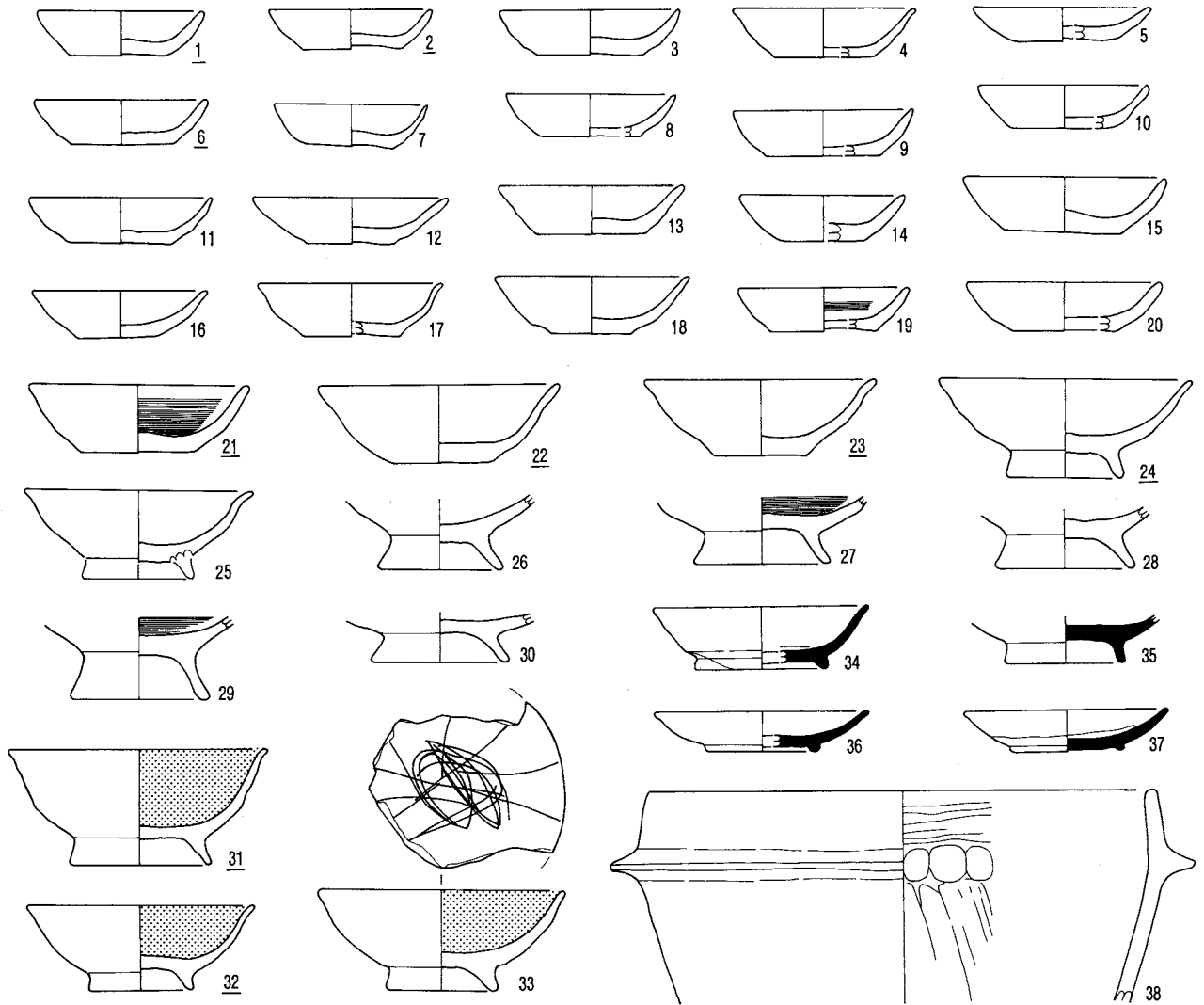

SB 83 (1~16)

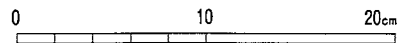
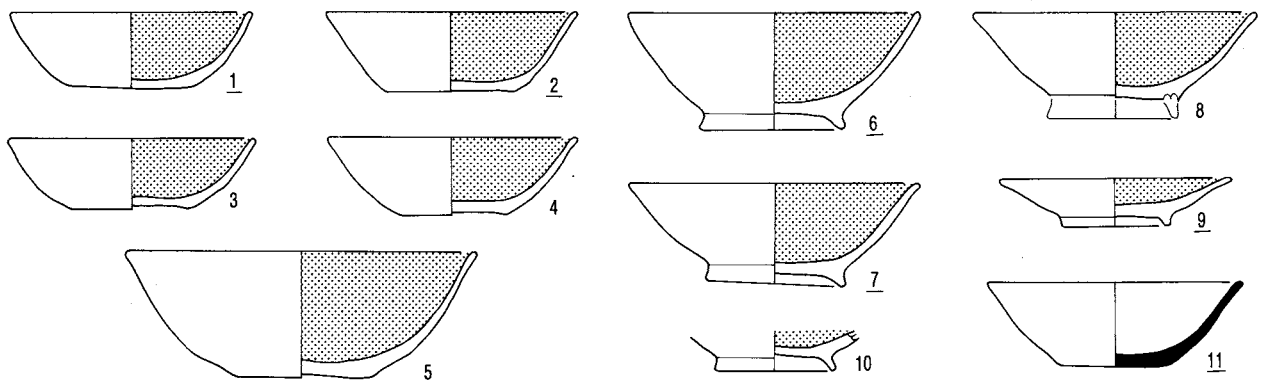

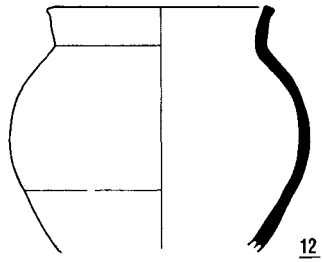

12

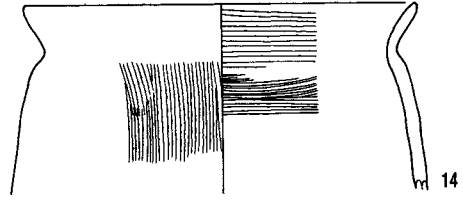

14

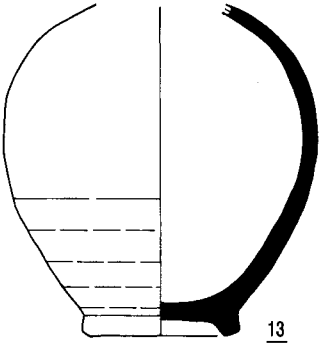

13

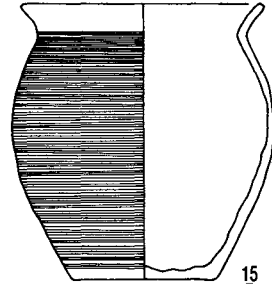

15



16

SB84 (1~40)

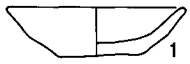

1

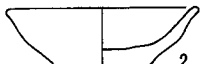

2

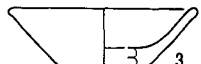

3



4



5



6

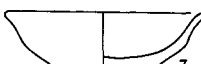

7

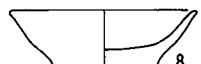

8

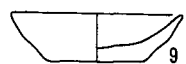

9



14



10

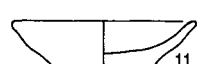

11



12

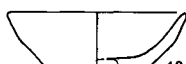

13

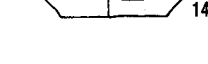

19

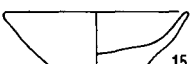

15



16

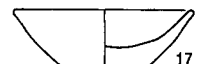

17



18



20



21

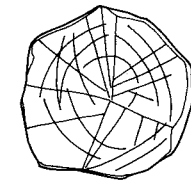

32

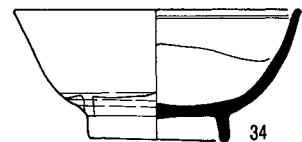

34

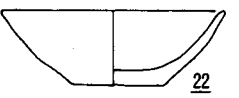

22

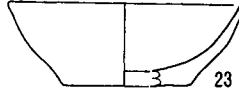

23



33

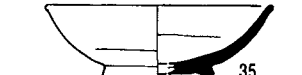

35

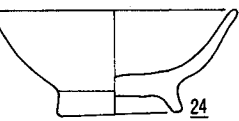

24

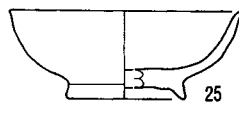

25



36

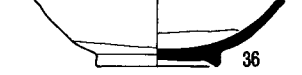

37

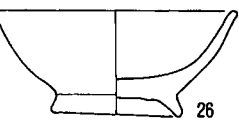

26



29

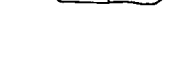

38



39

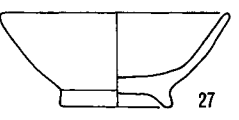

27

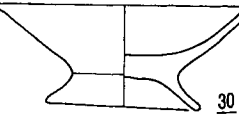

30



40



40

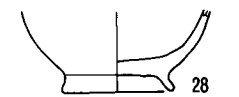

28

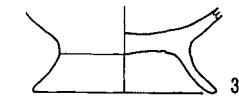

31

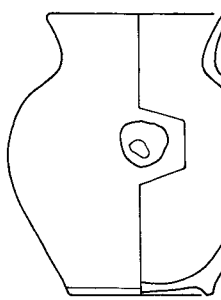

39

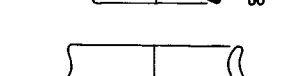

40

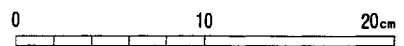

SB85 (1~16)

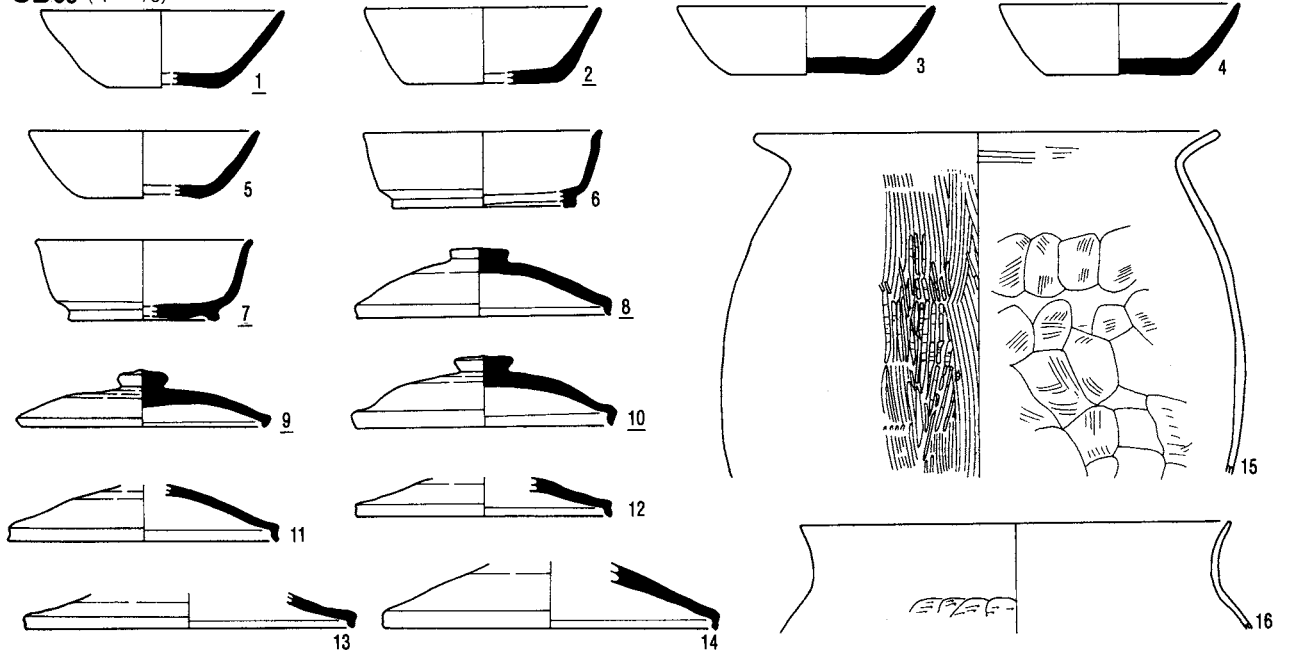

SB86 (1~25)

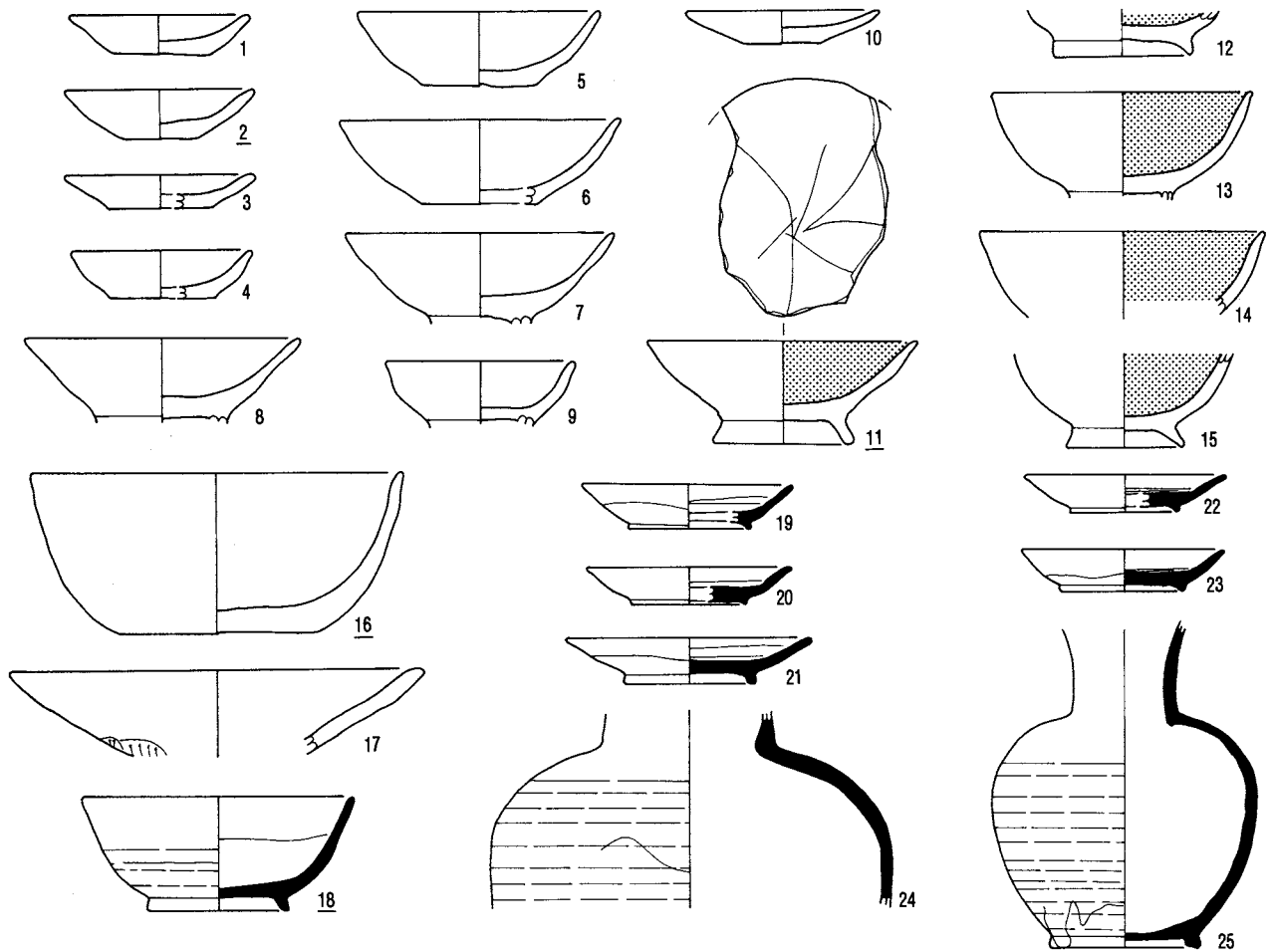

SB87 (1~10)

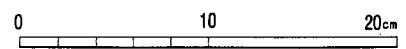
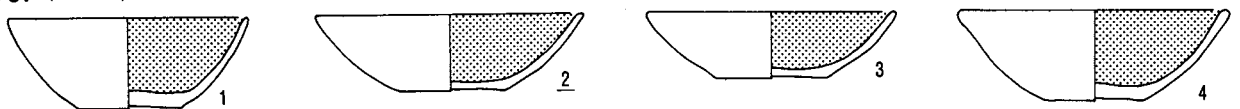

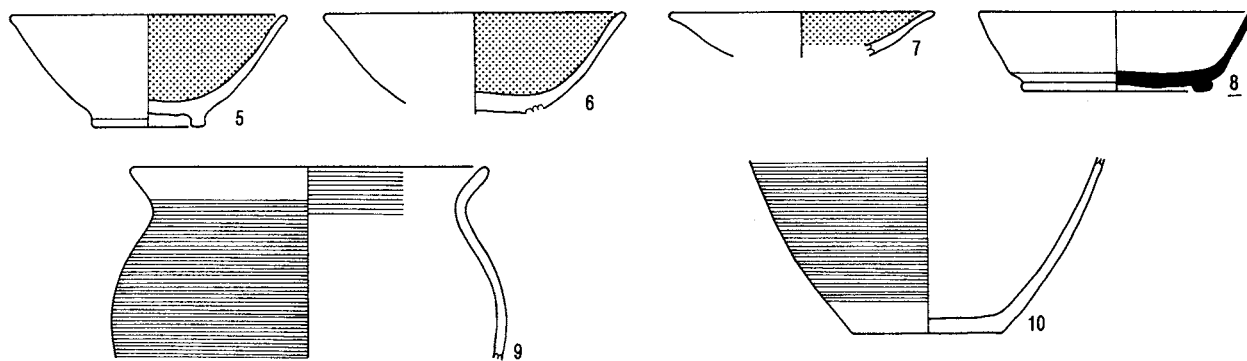

SB88 (1~22)

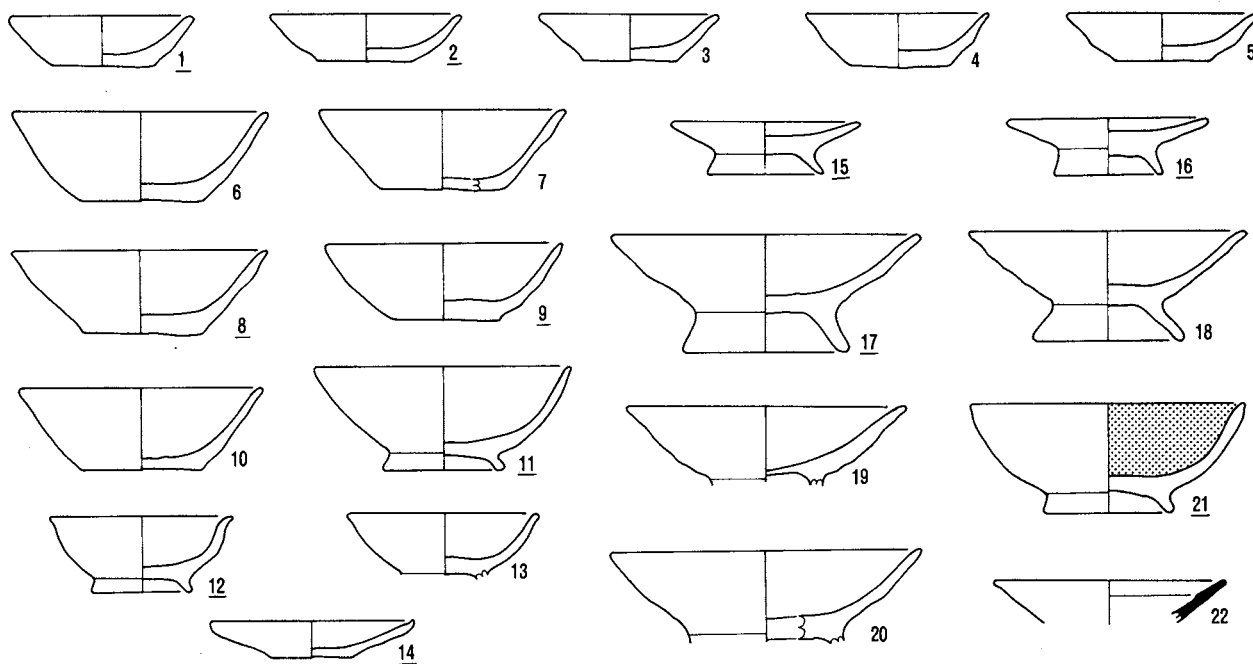

SB89 (1.2)

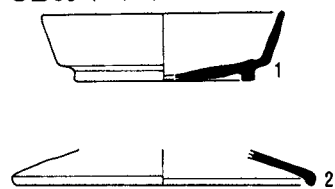

SB90 (1~5)

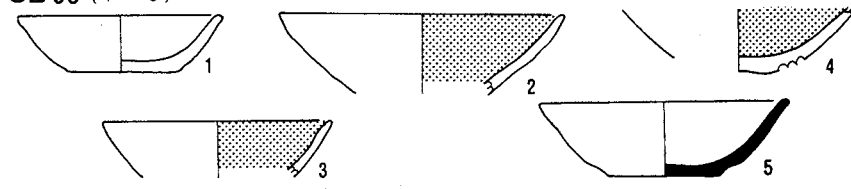

SB91 (1~29)

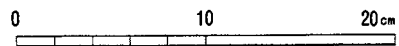
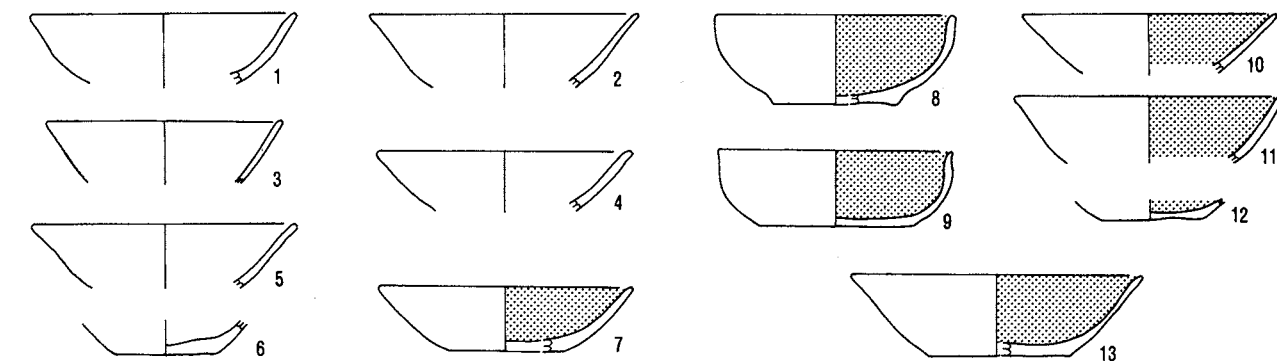

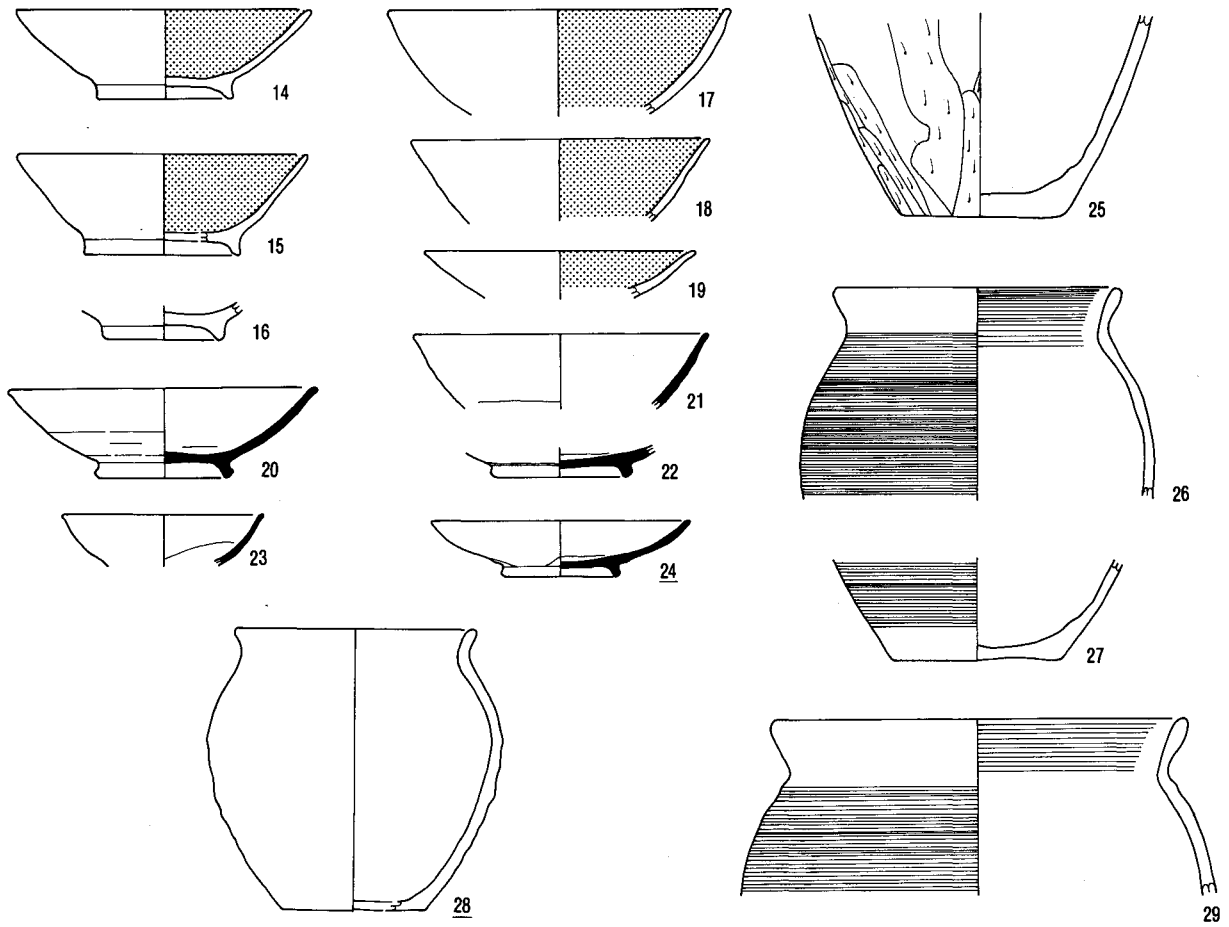

SB93 (1~13)

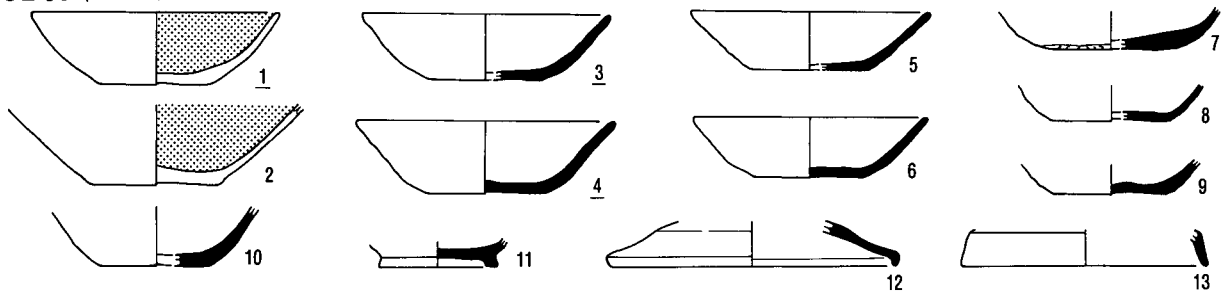

SB94 (1~41)

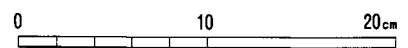
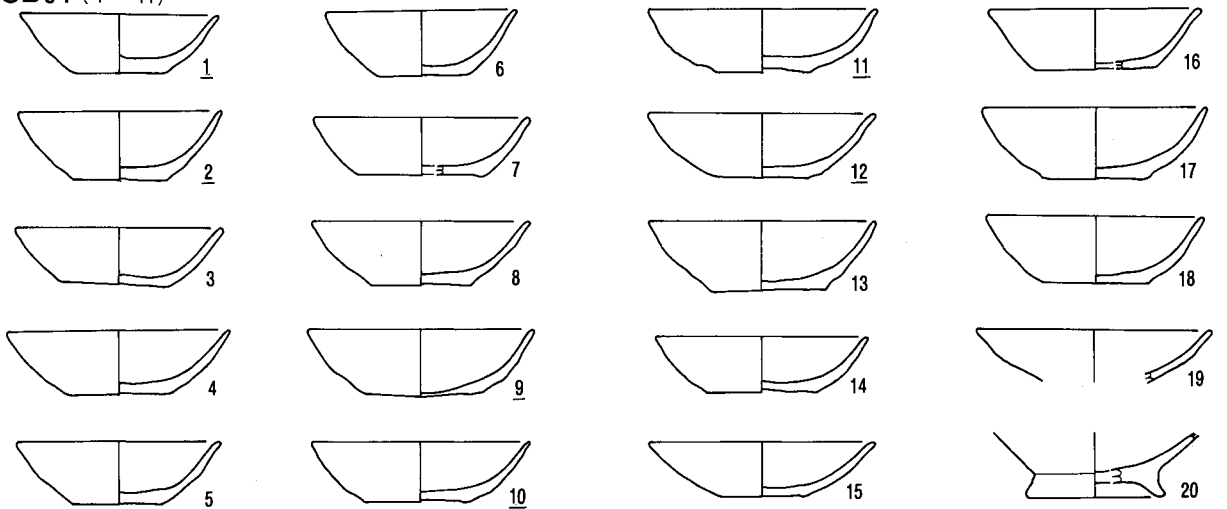

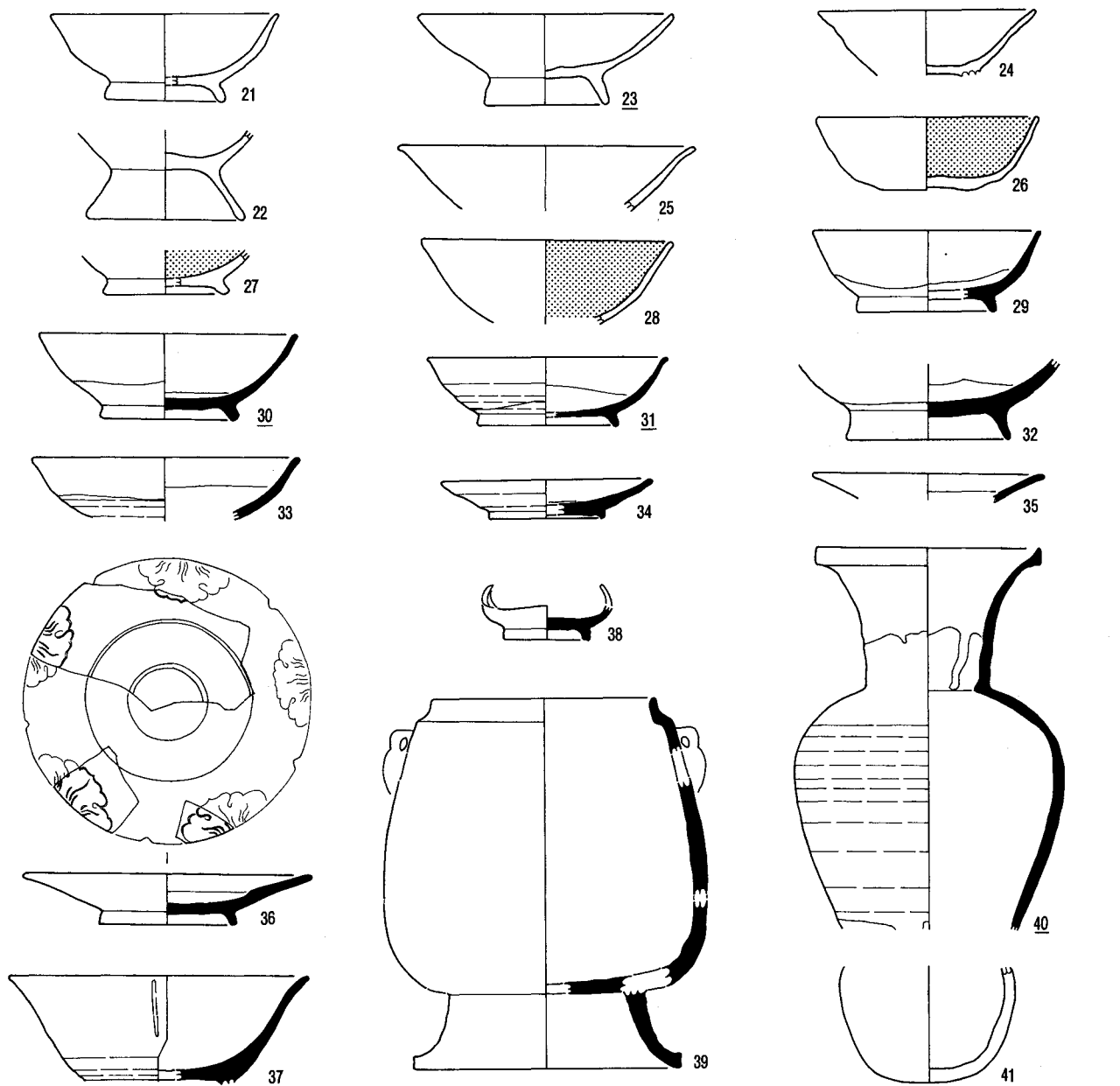

SB 95 (1~15)

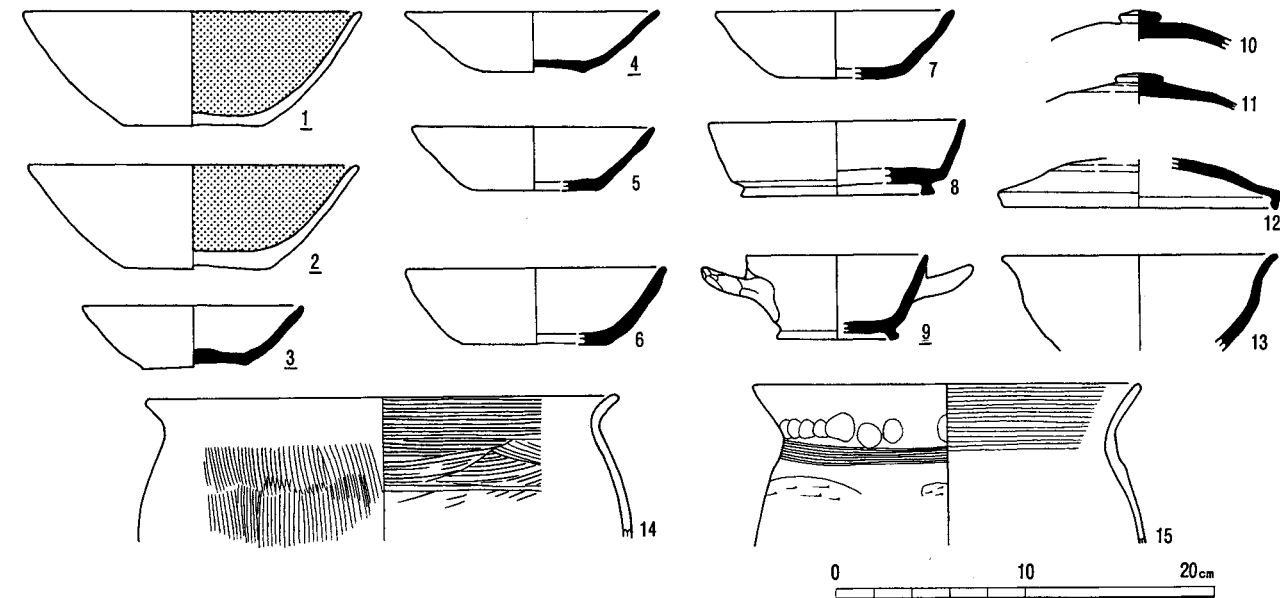

SB96 (1~18)

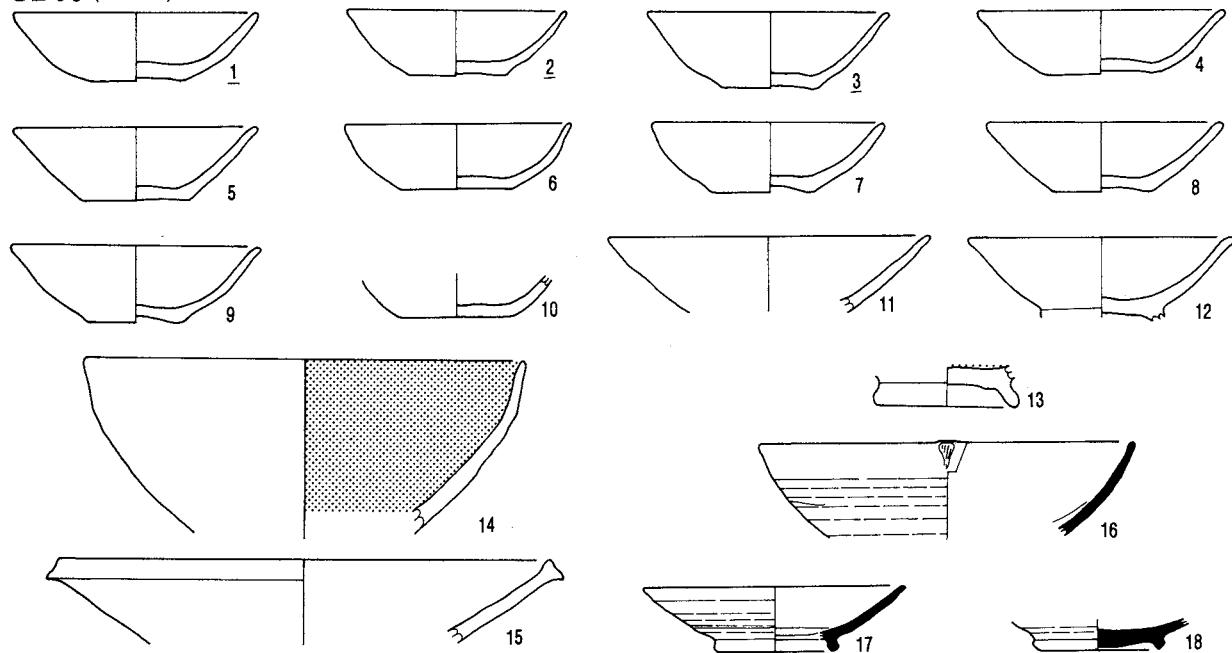

SB97 (1~8)

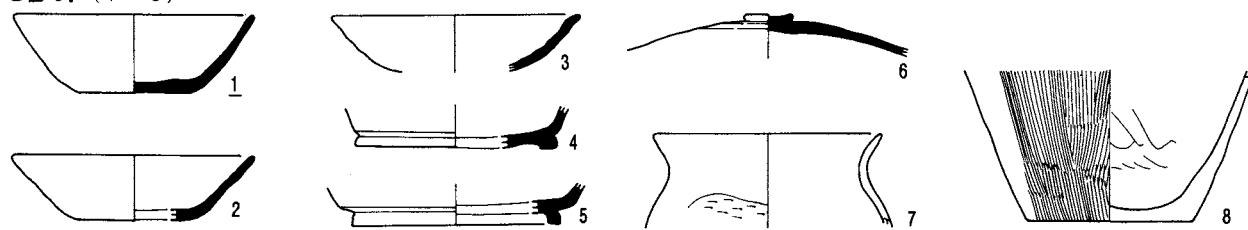

SB98 (1~8)

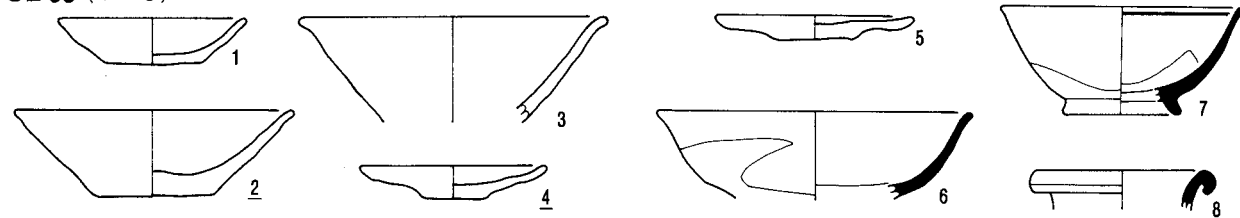

SB99 (1~94)

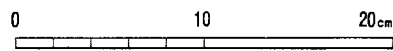
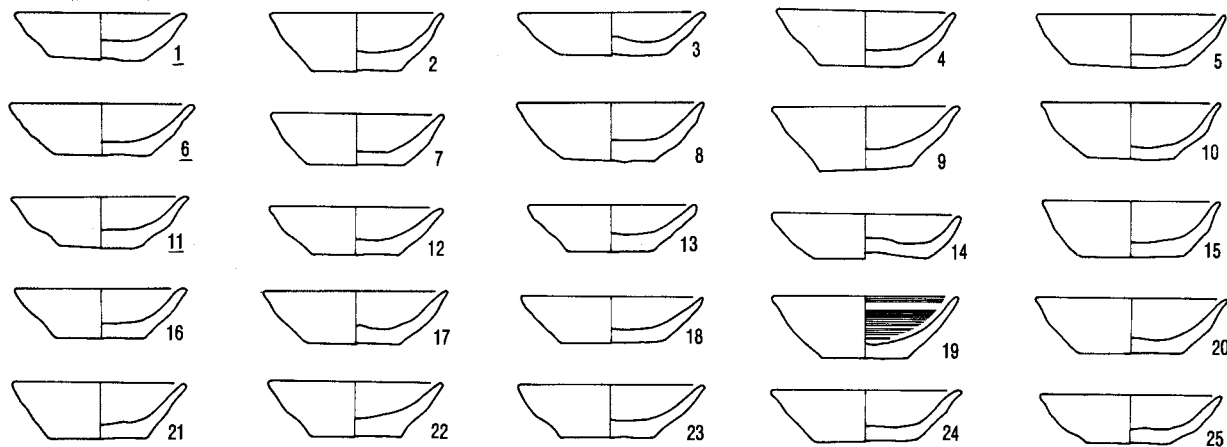

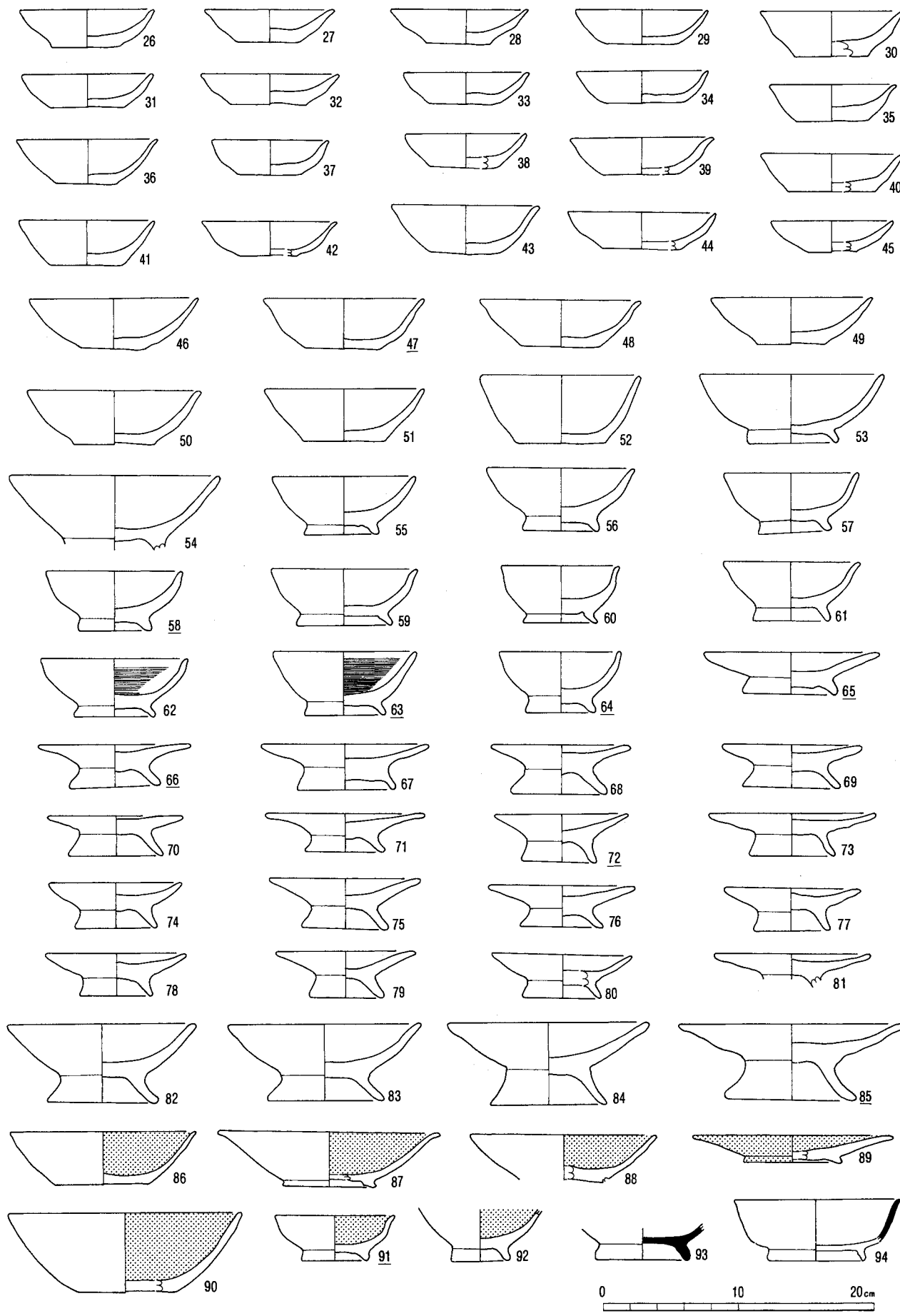

SB 100 (1~7)

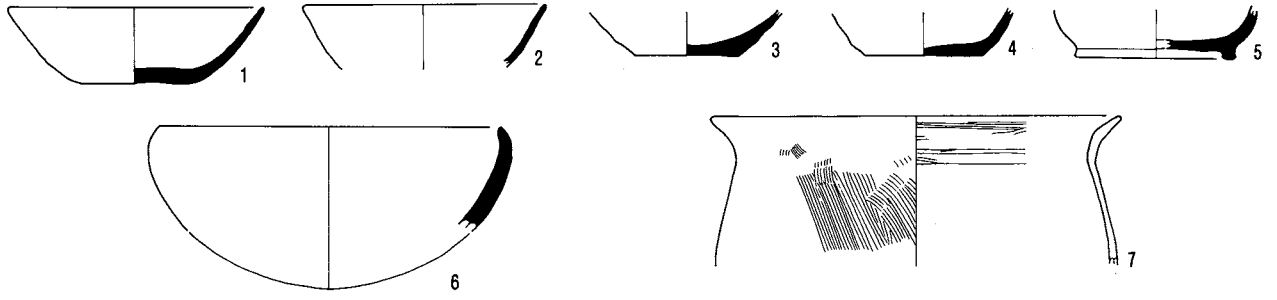

SB 101 (1~12)

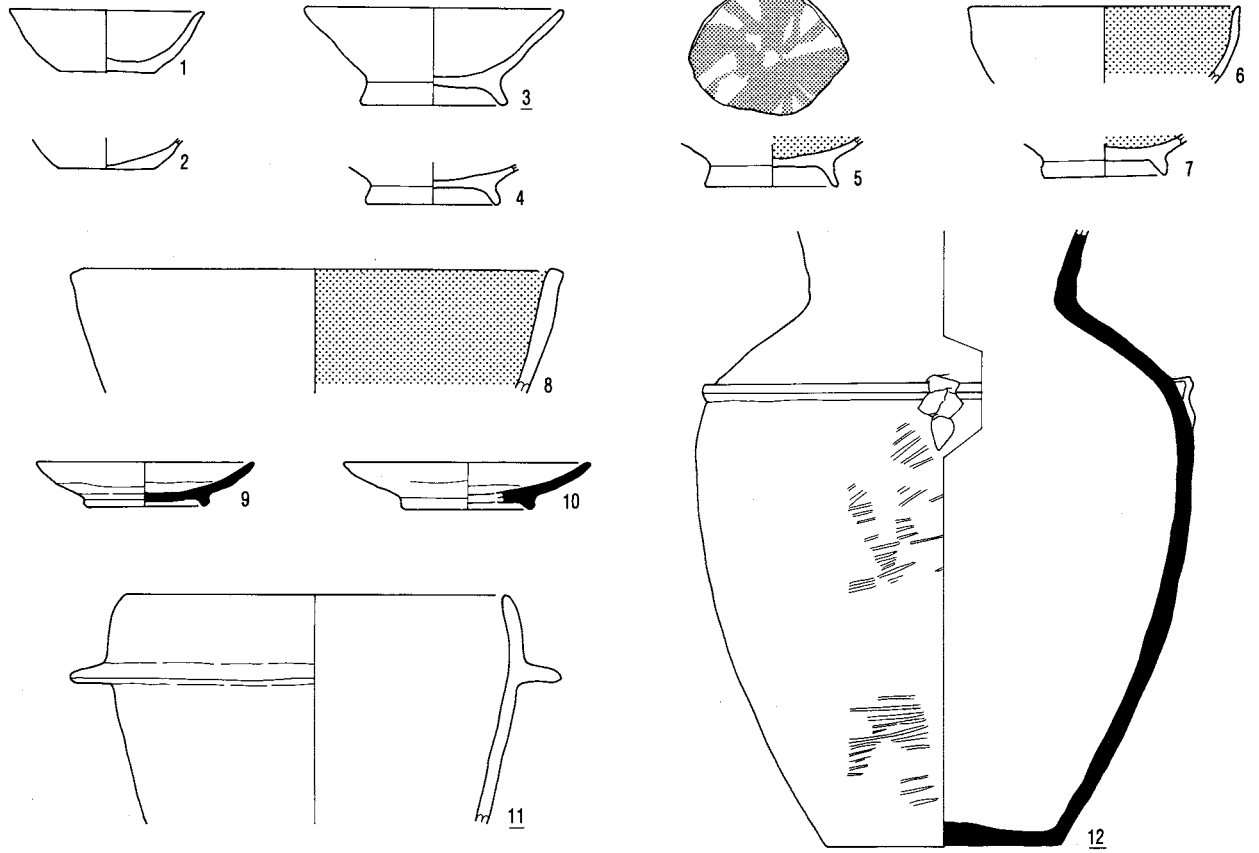

SB 102 (1~37)

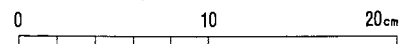
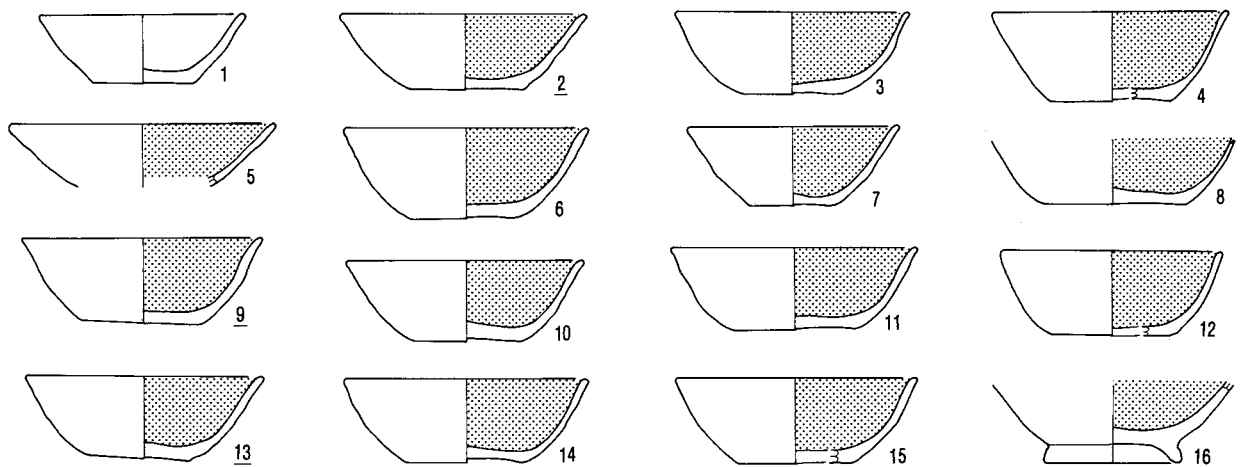

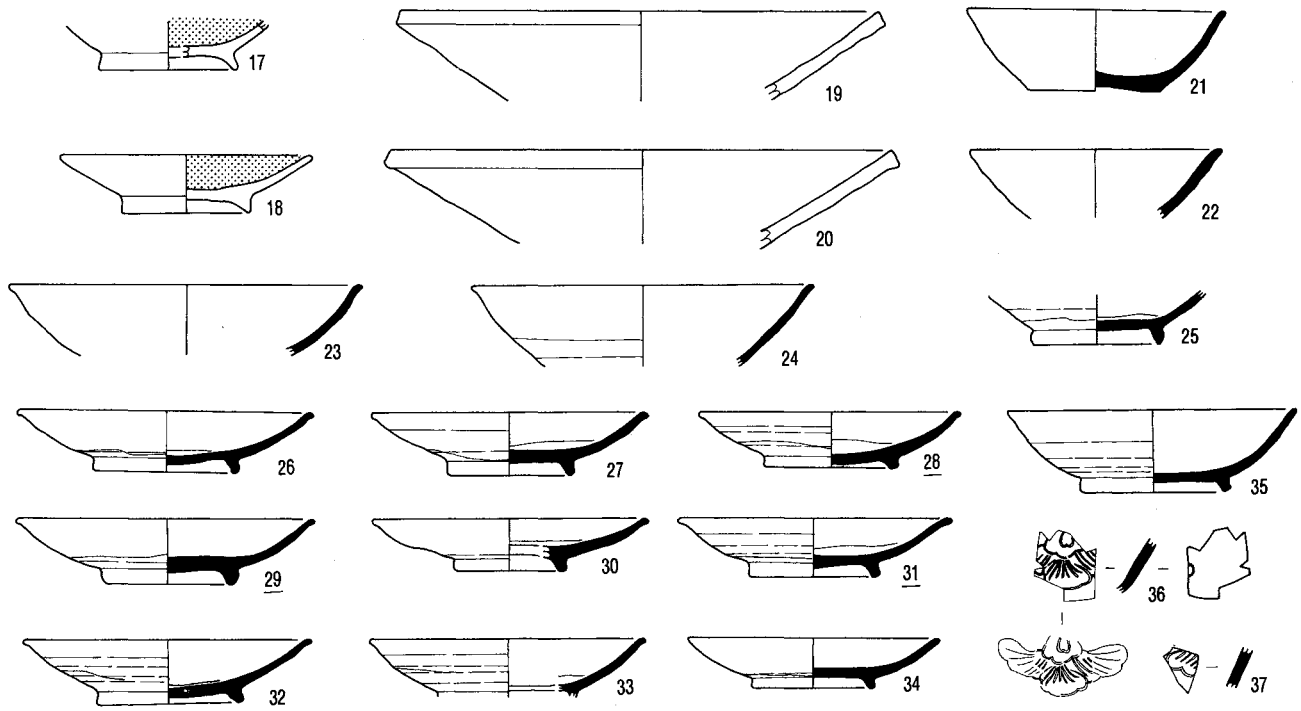

SB103 (1~18)

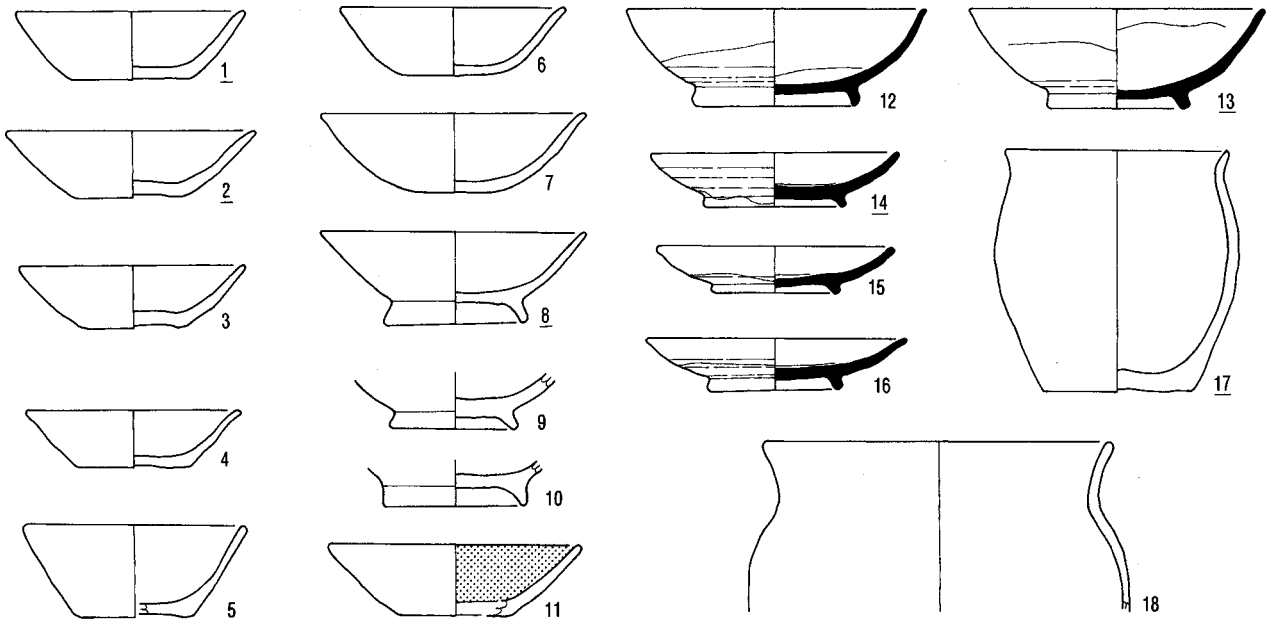

SB104 (1.2)

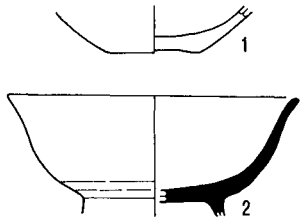

SB105 (1~3)



SB106 (1.2)

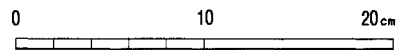
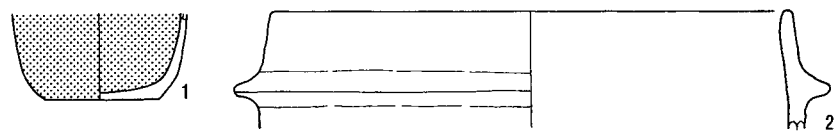

SB 107 (1~5)

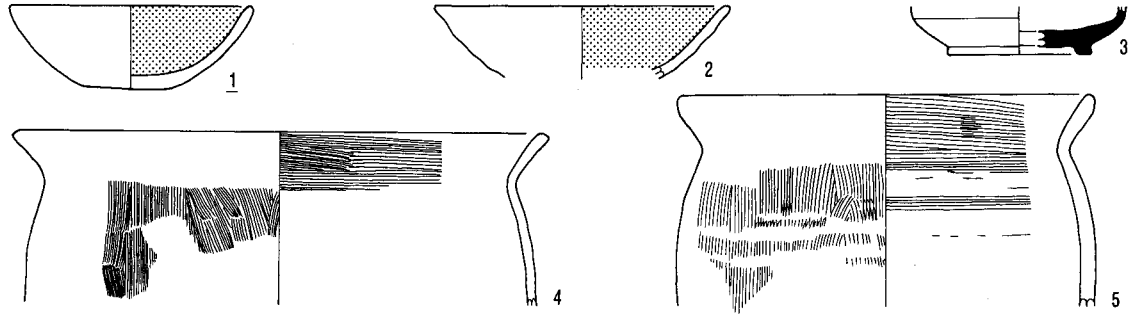

SB 108 (1~7)

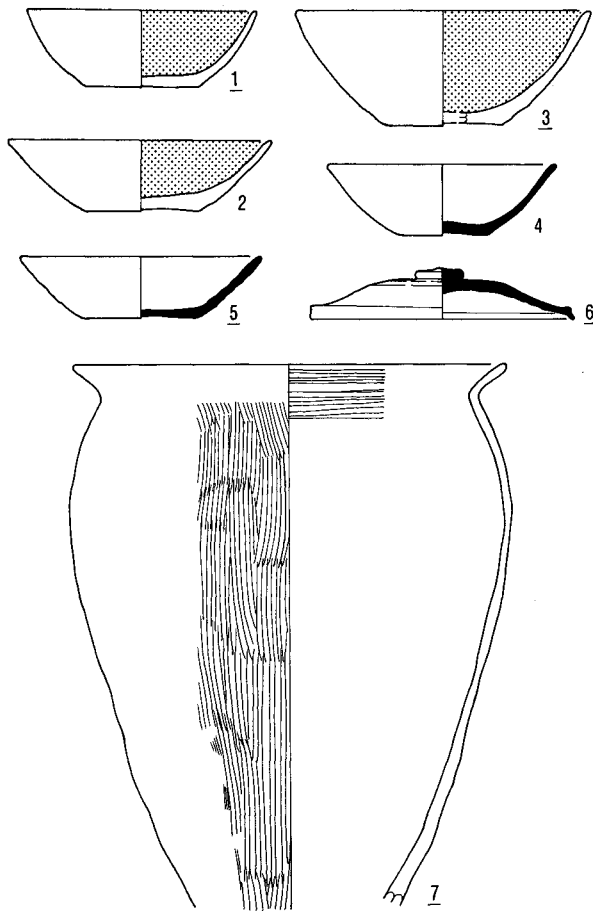

SB 109 (1~12)

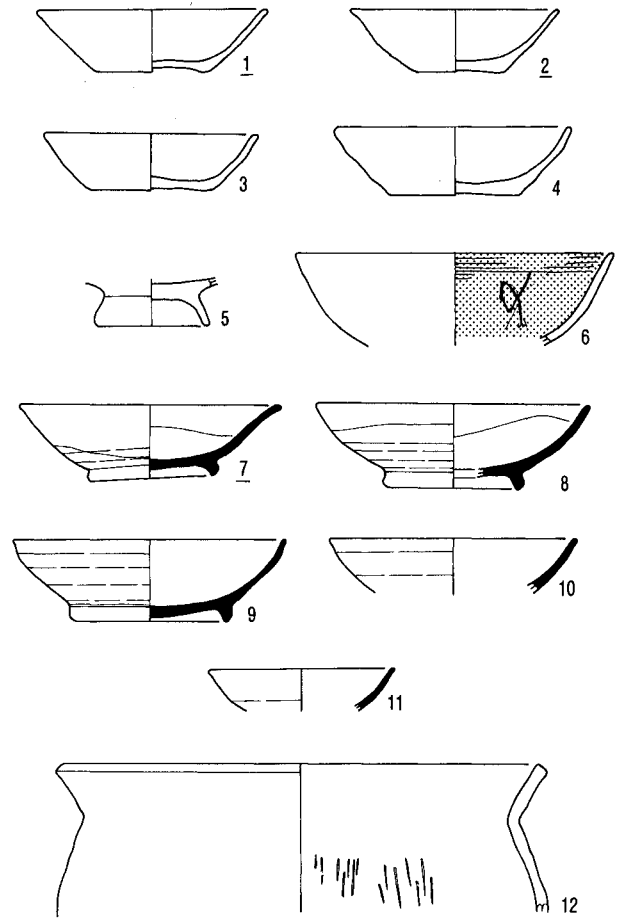

SB 110 (1~11)

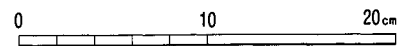
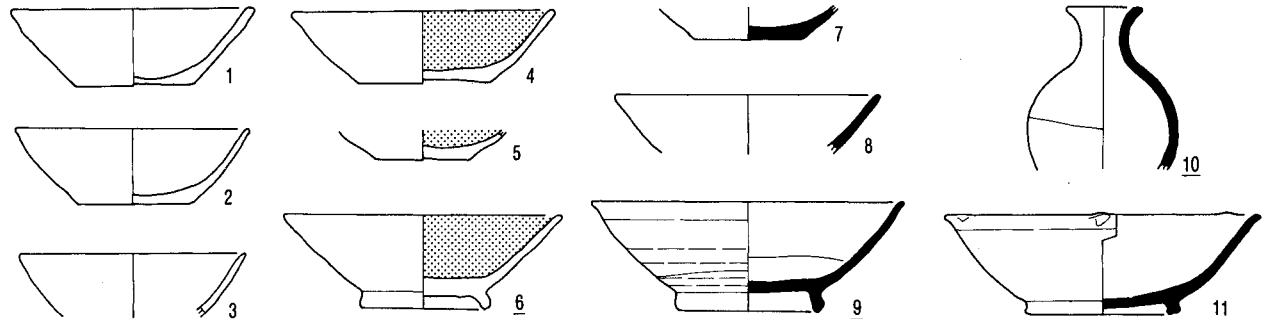

SB111 (1~86)

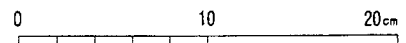

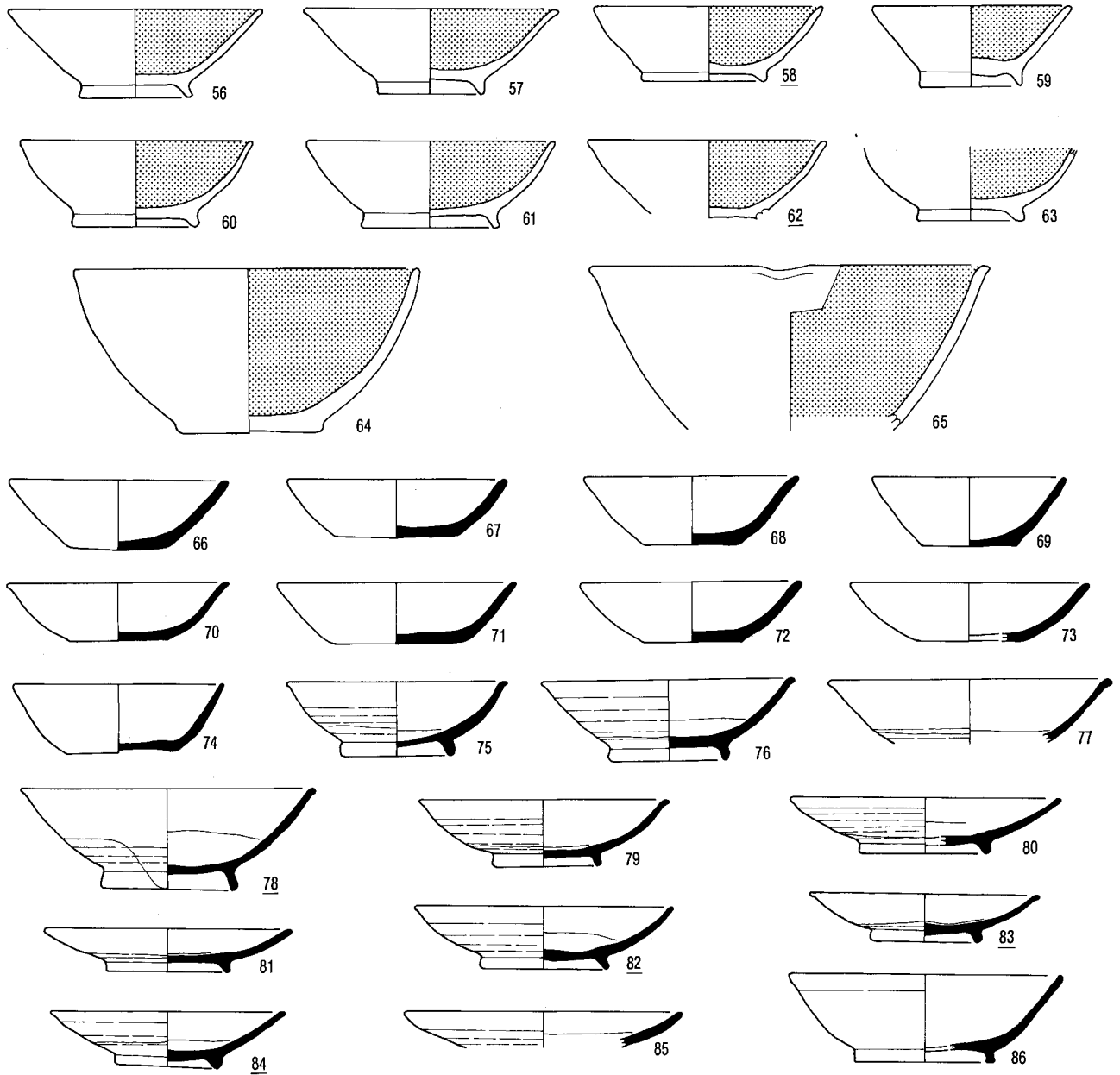

SB112 (1~5)

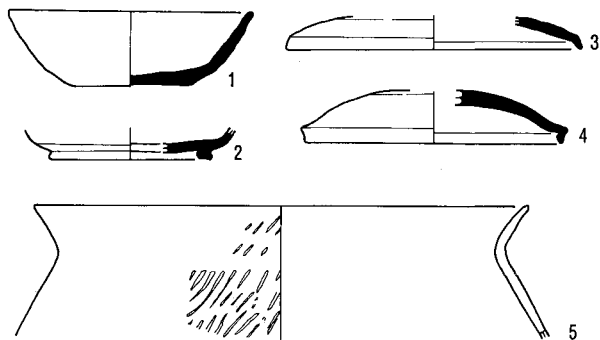

SB113 (1~3)

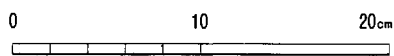
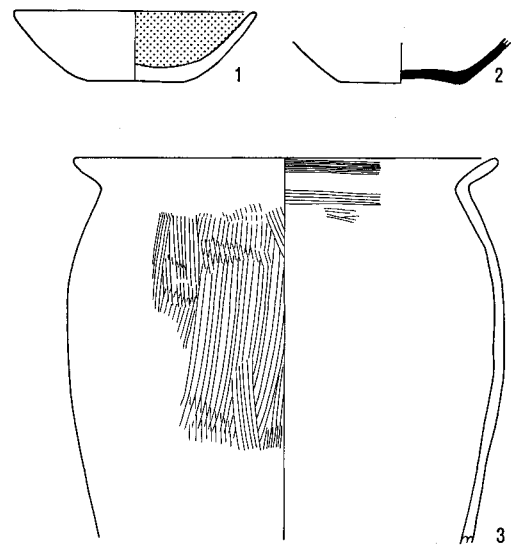

SB114 (1~23)

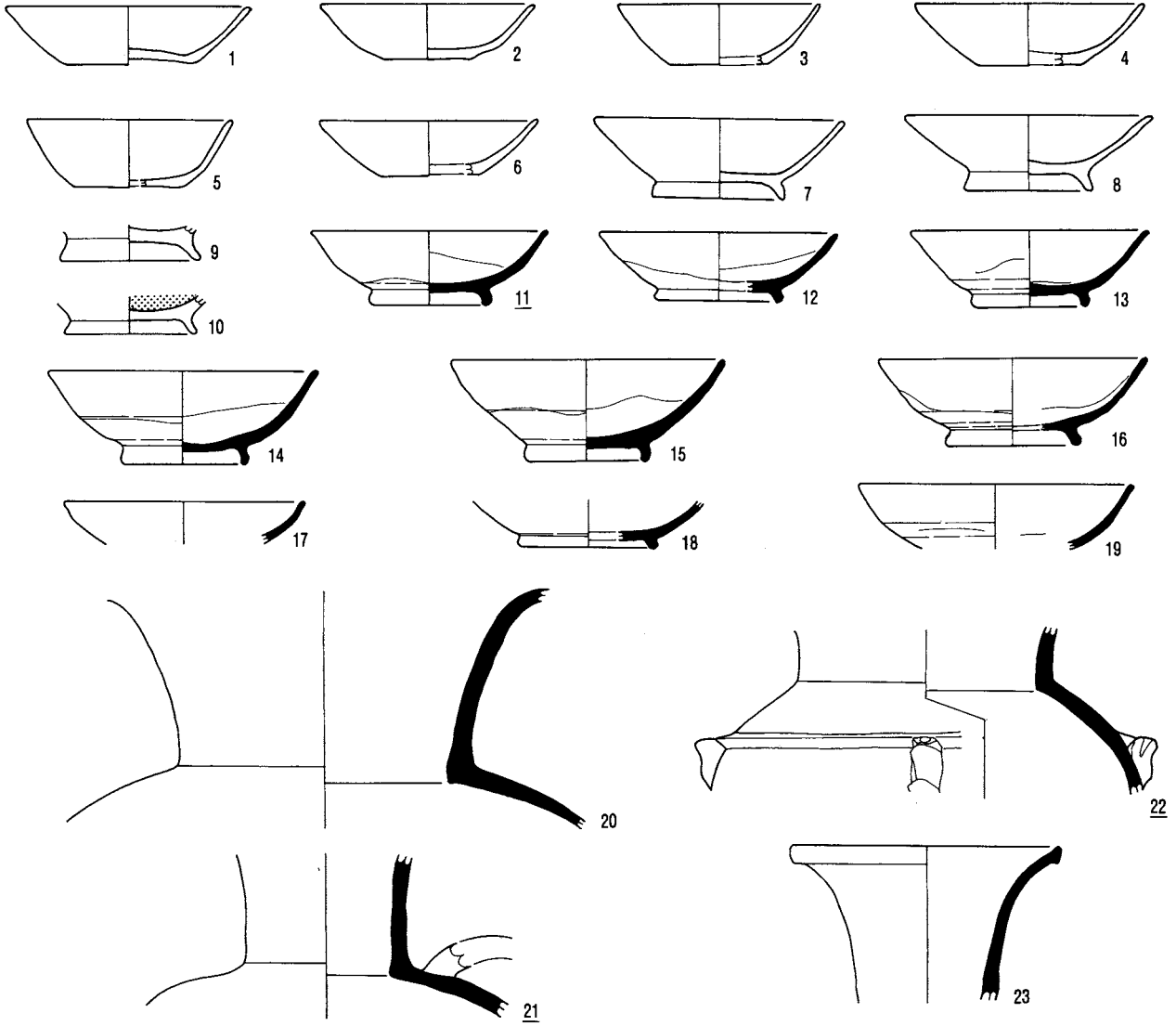

SB115 (1~38)

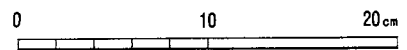
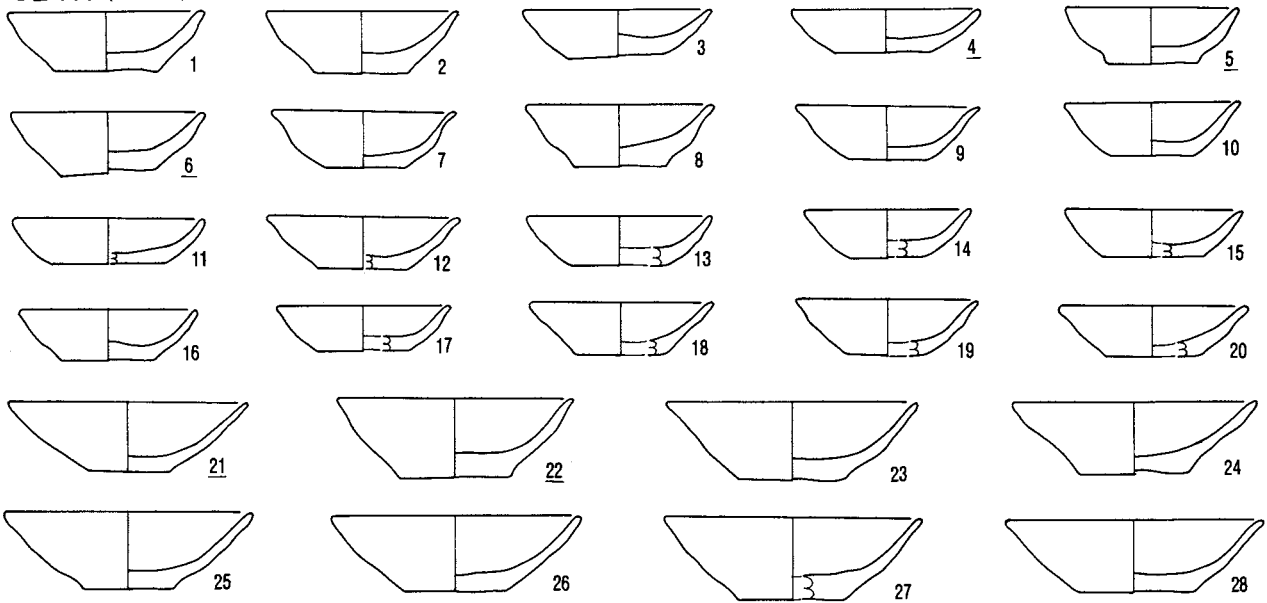

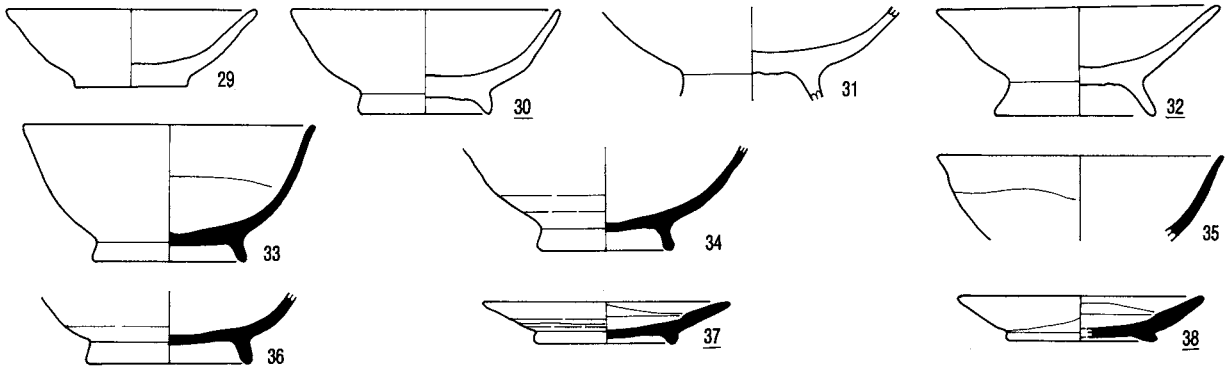

SB116 (1~17)

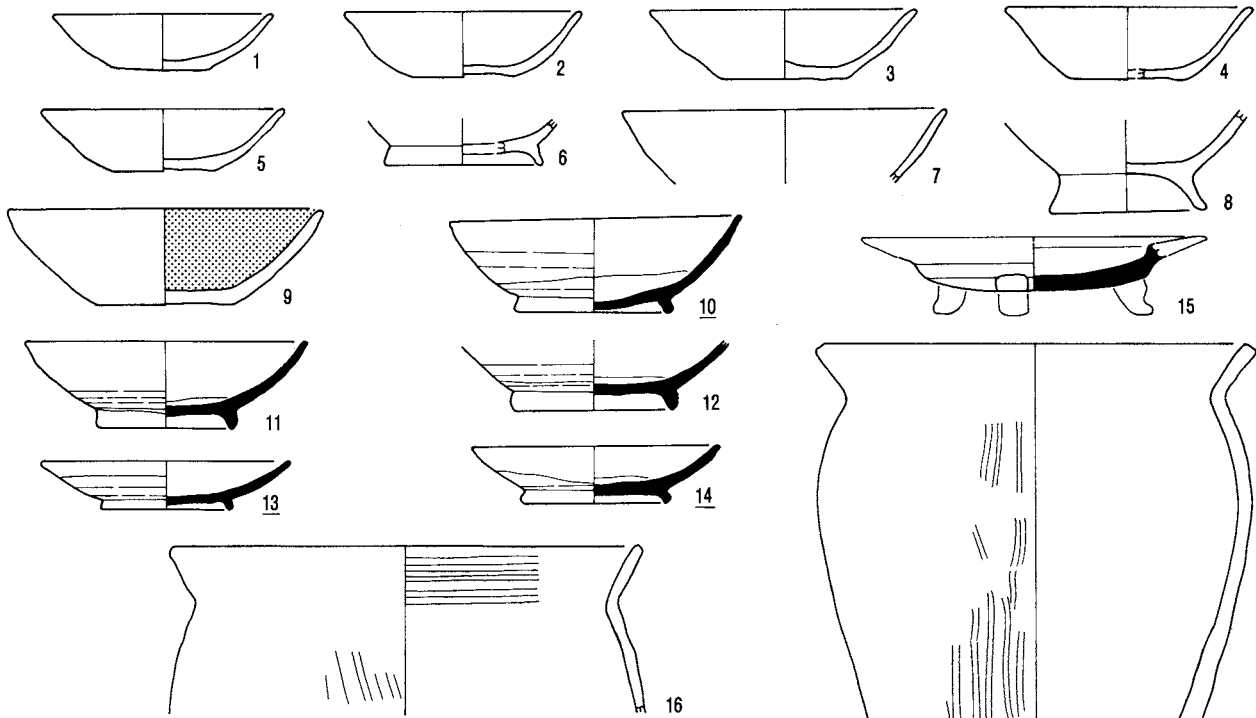

SB117 (1~3)

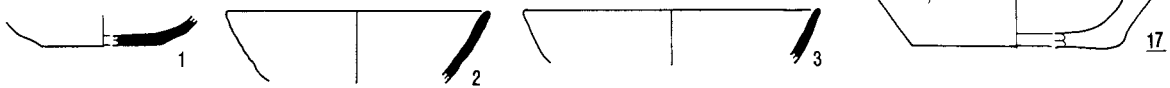

SB118 (1~18)

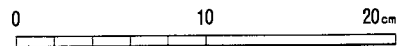
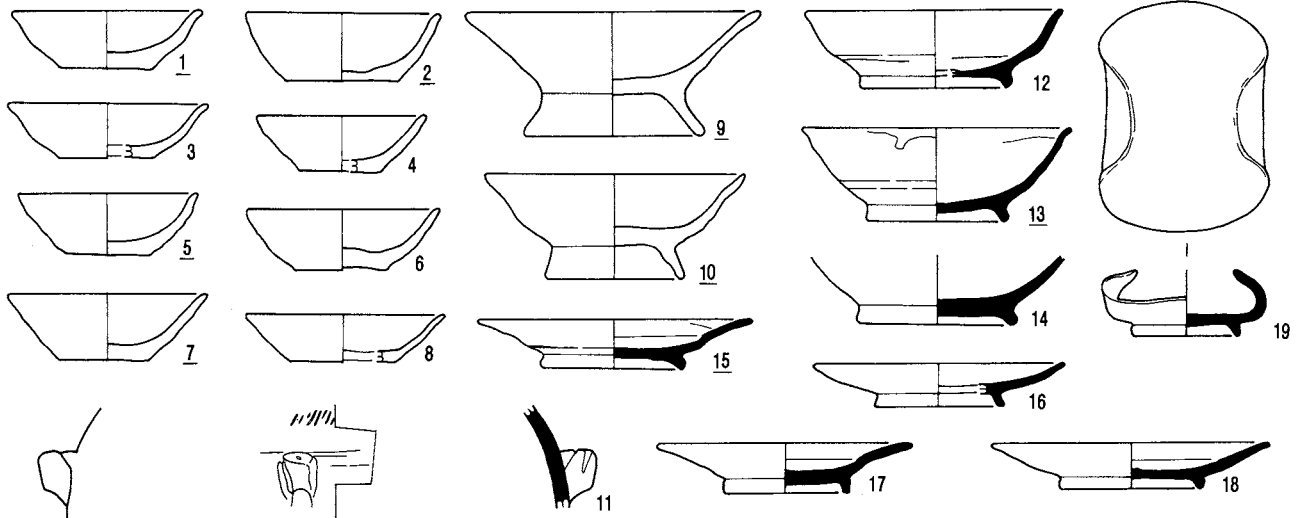

SB119 (1~8)

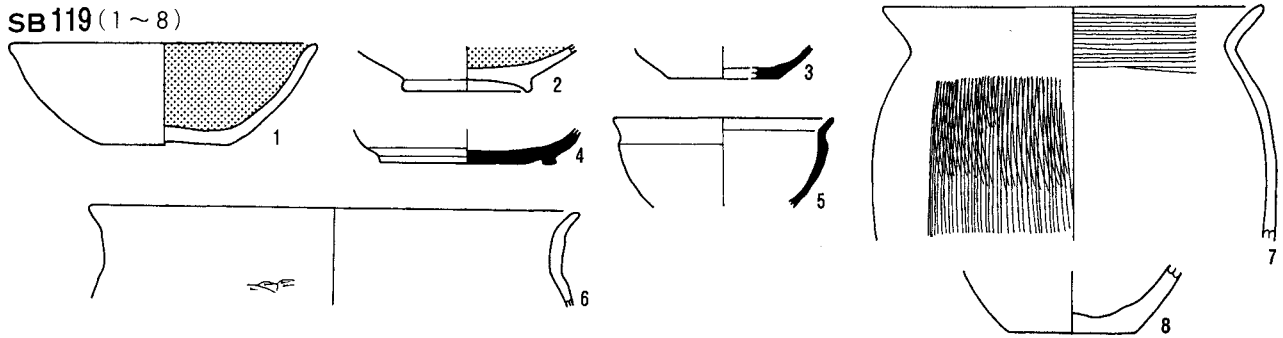

SB120 (1~23)

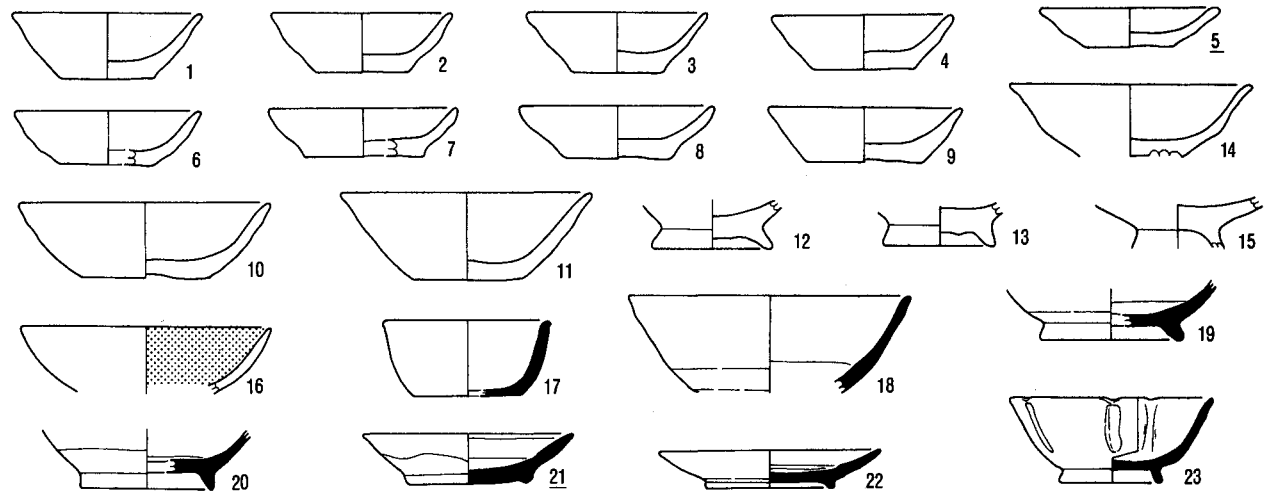

SB121 (1)

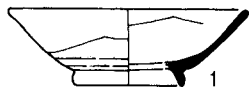

SB122 (1~5)

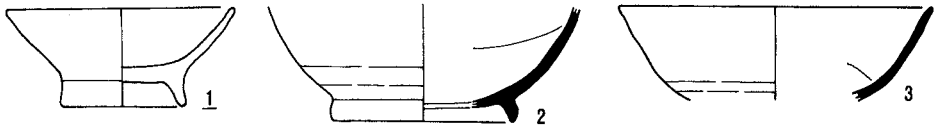

SB123 (1, 2)



SB124 (1~18)

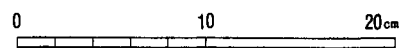
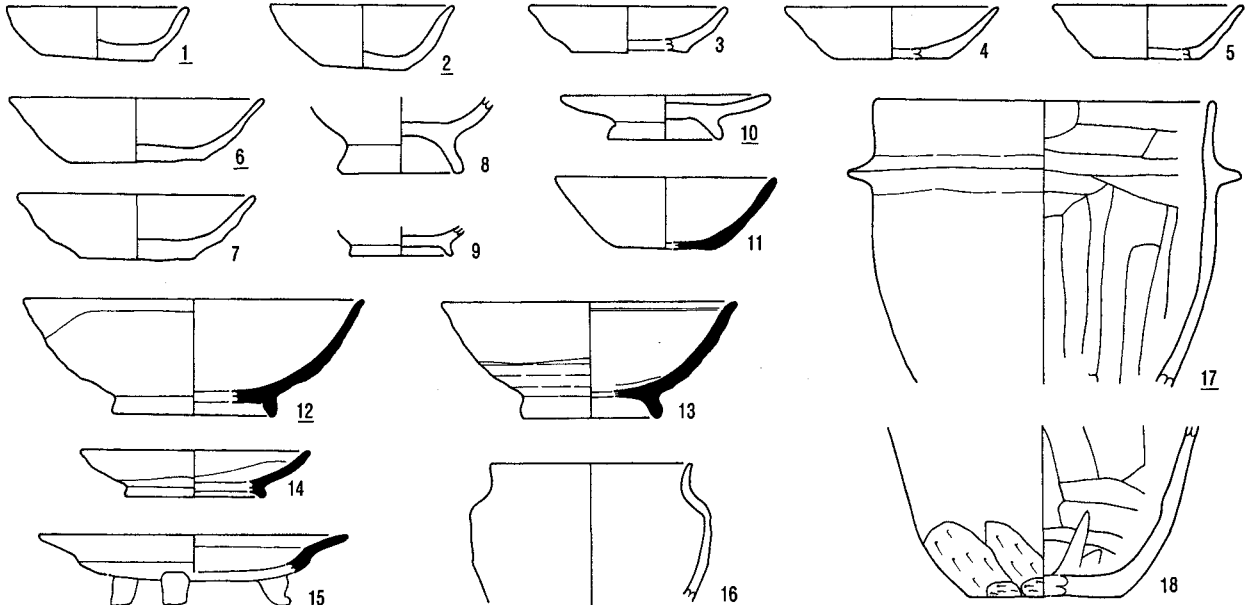

SB 125 (1~9)

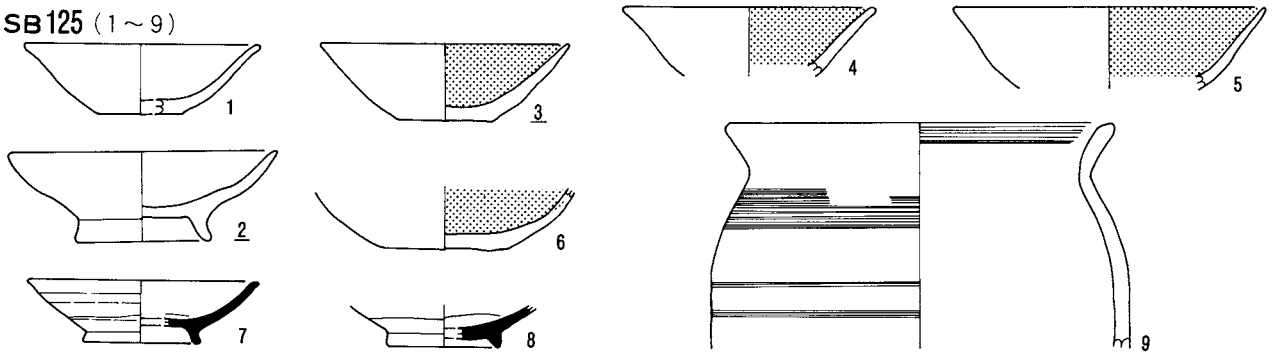

SB 126 (1~5)

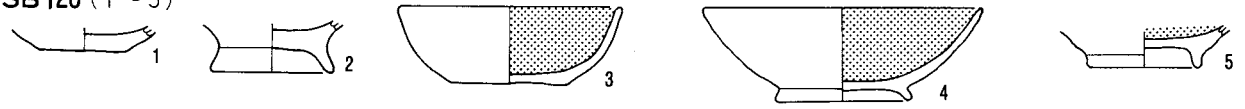

SB 127 (1~5)

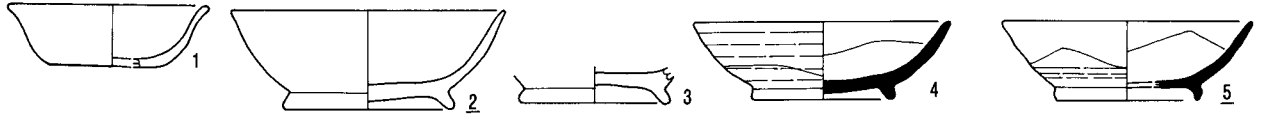

SB 128 (1~4)

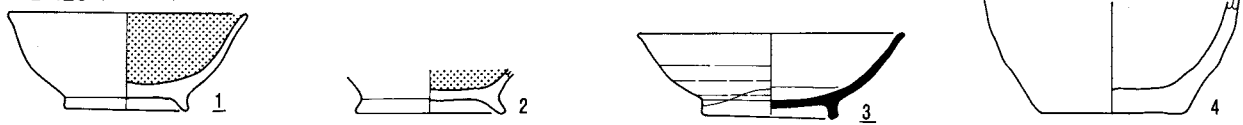

SB 129 (1~17)

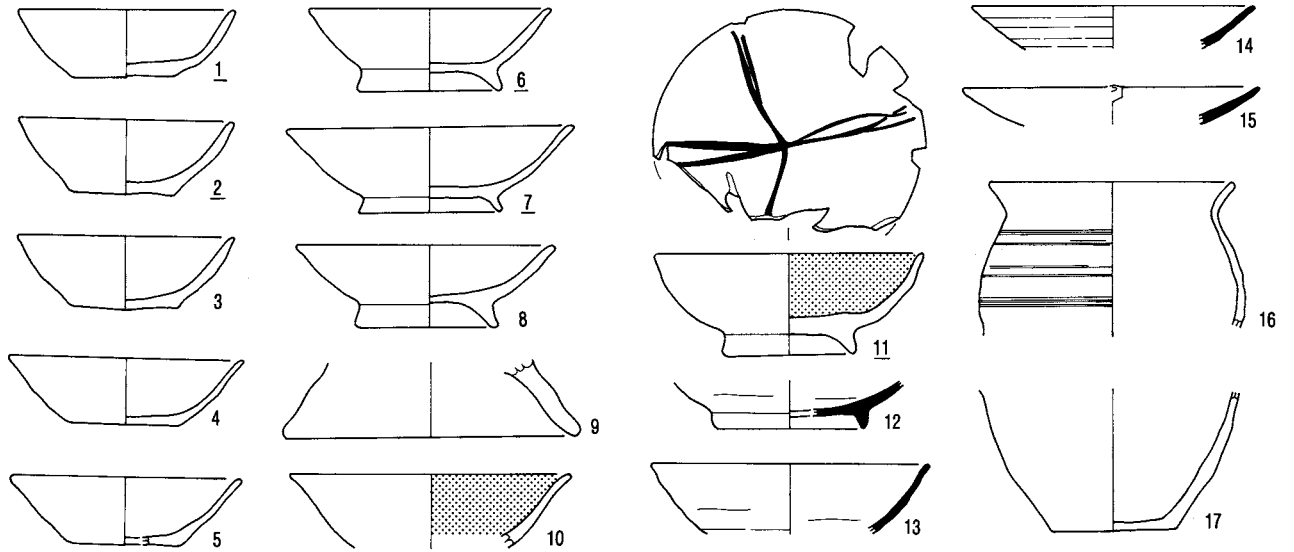

SB 130 (1)

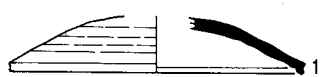

SB 132 (1~18)

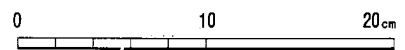
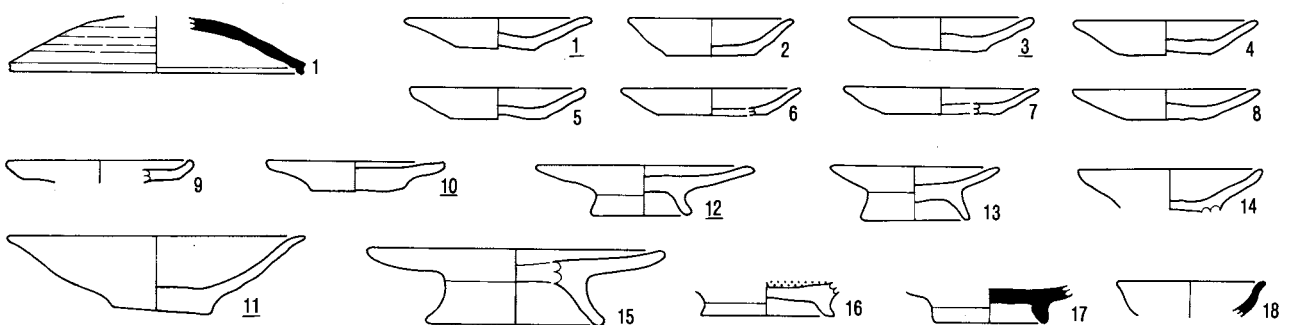

SB 133 (1~6)

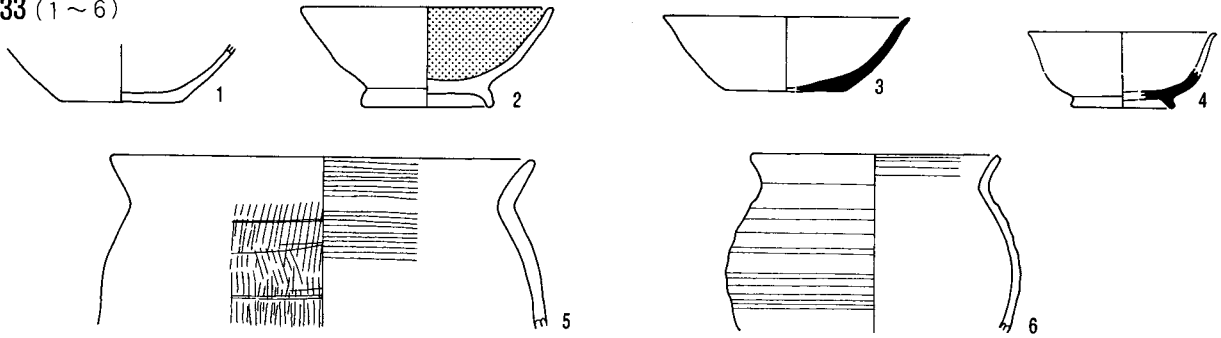

SB 134 (1~3)

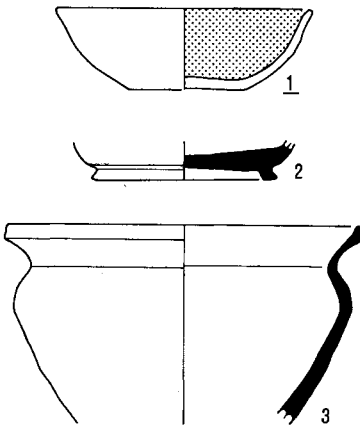

SB 135 (1~8)

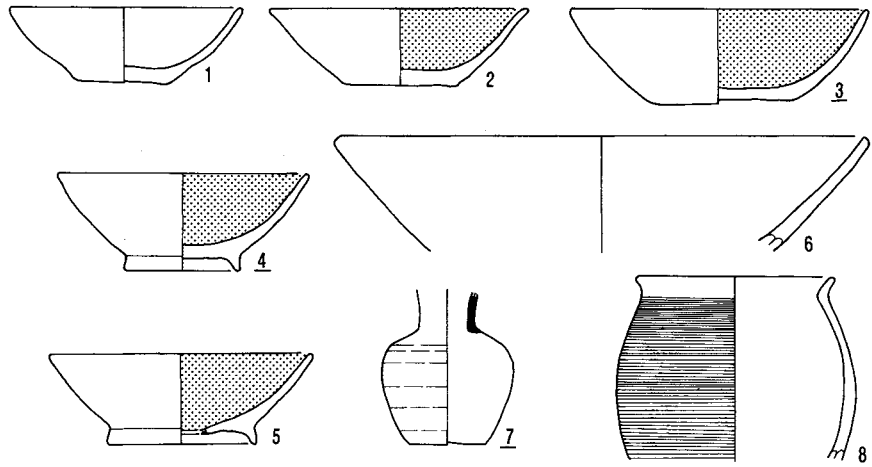

SB 136 (1~4)



SB 137 (1~4)



SB 139 (1~14)

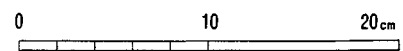
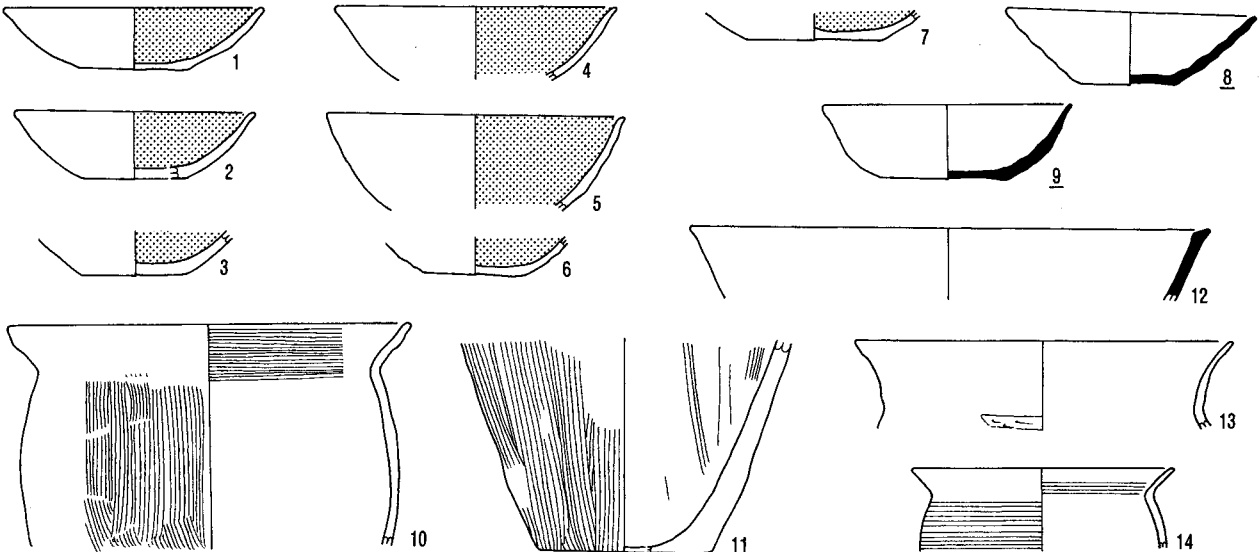

SB 140 (1~20)

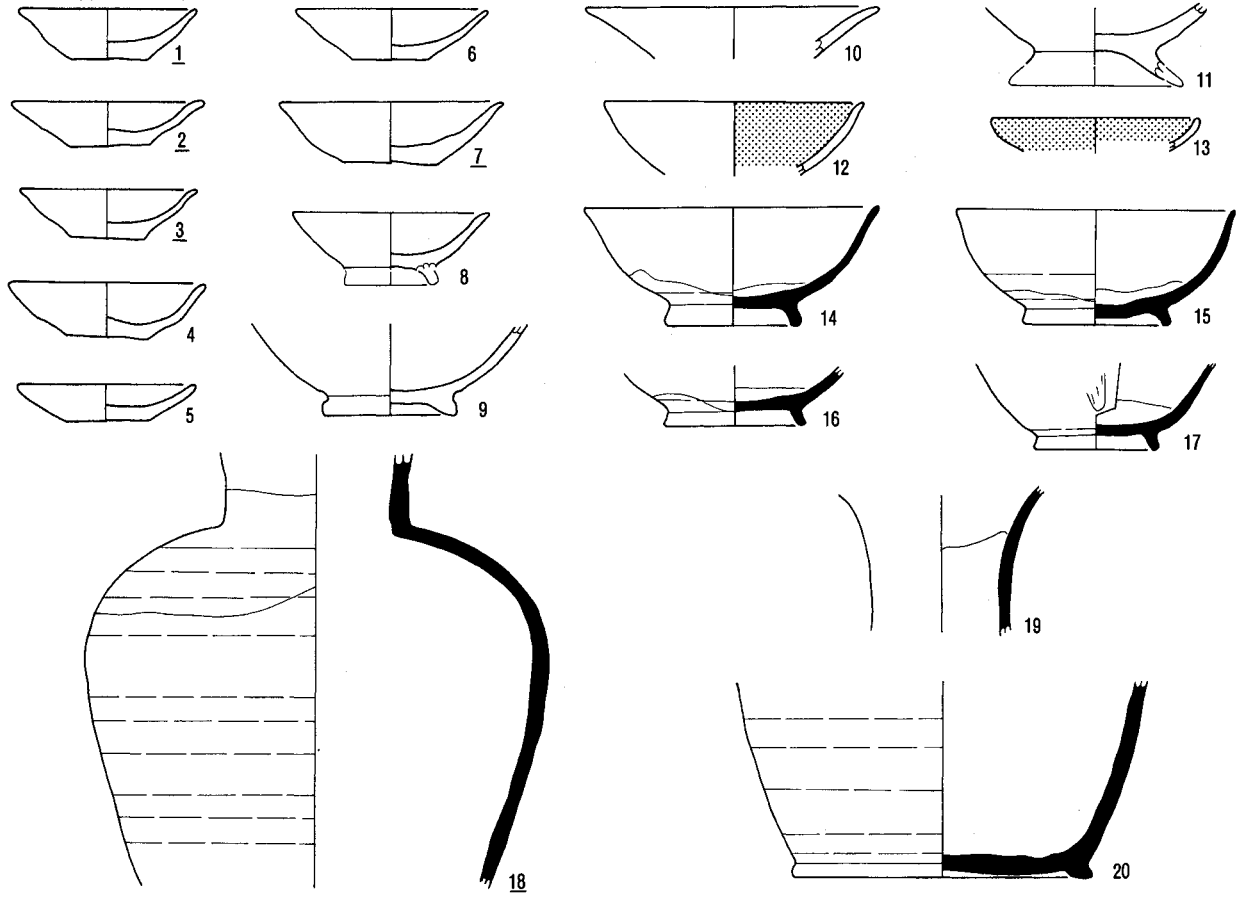

SB141 (1~31)

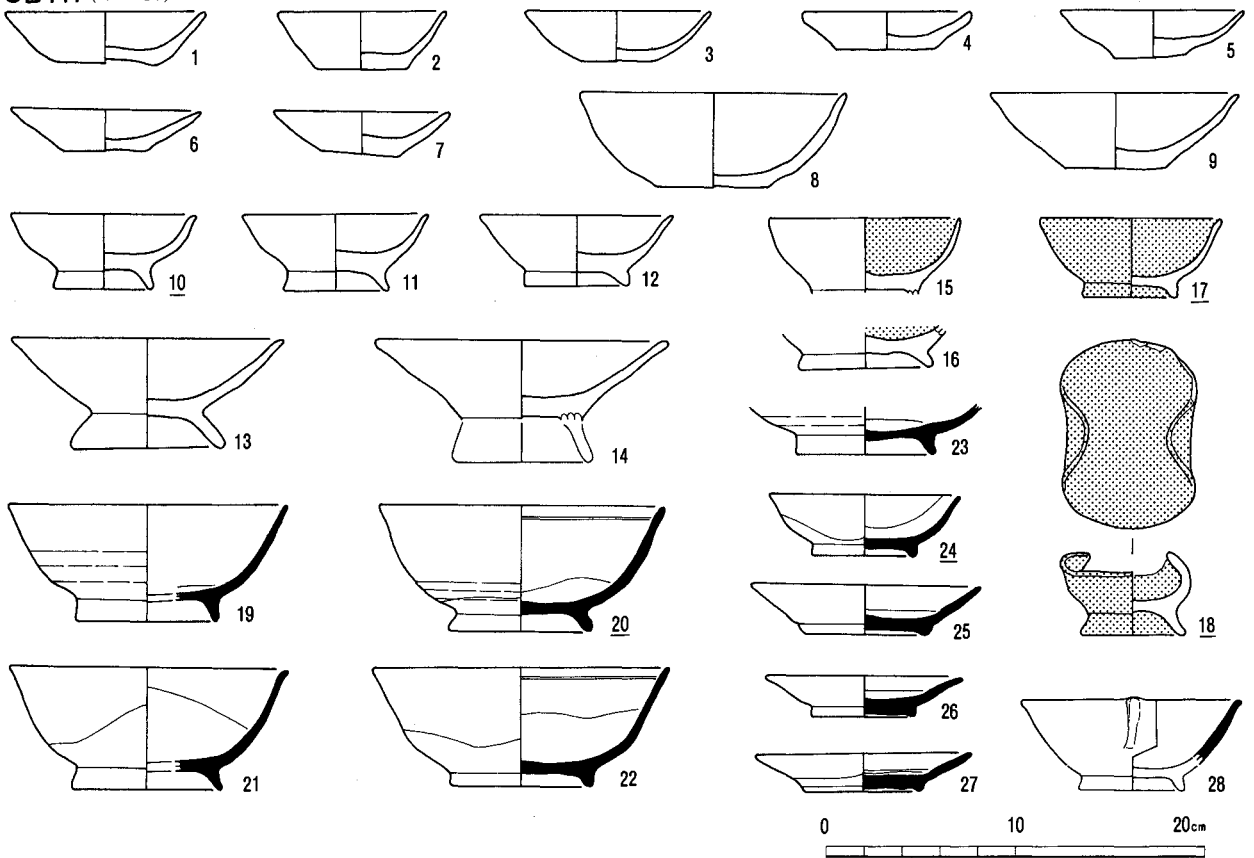

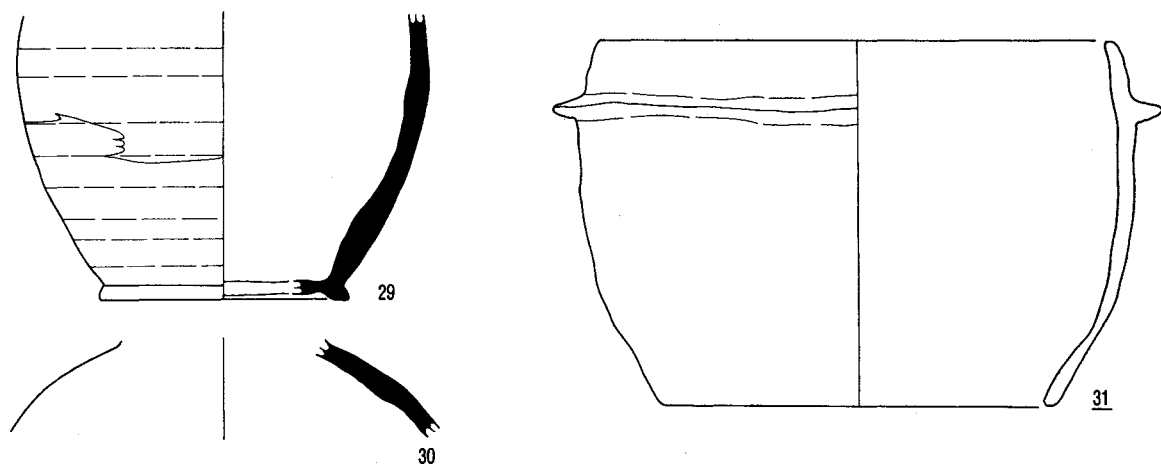

SB142 (1~28)

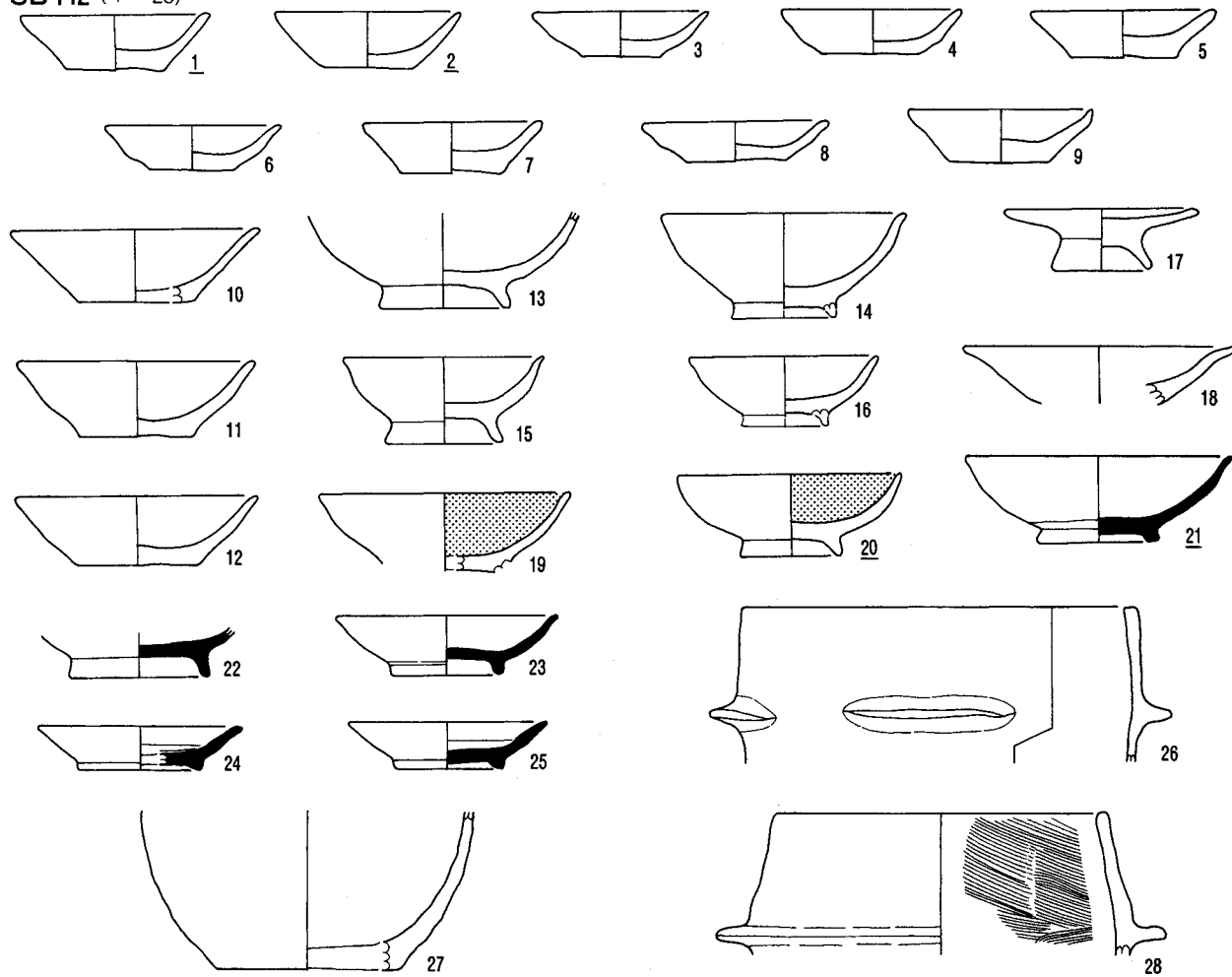

SB143 (1~3)

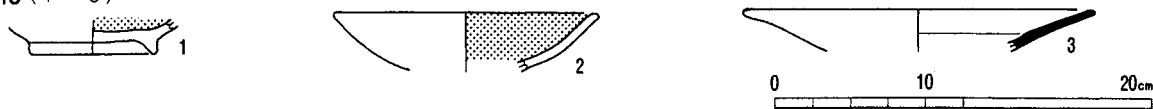

SB144 (1~28)

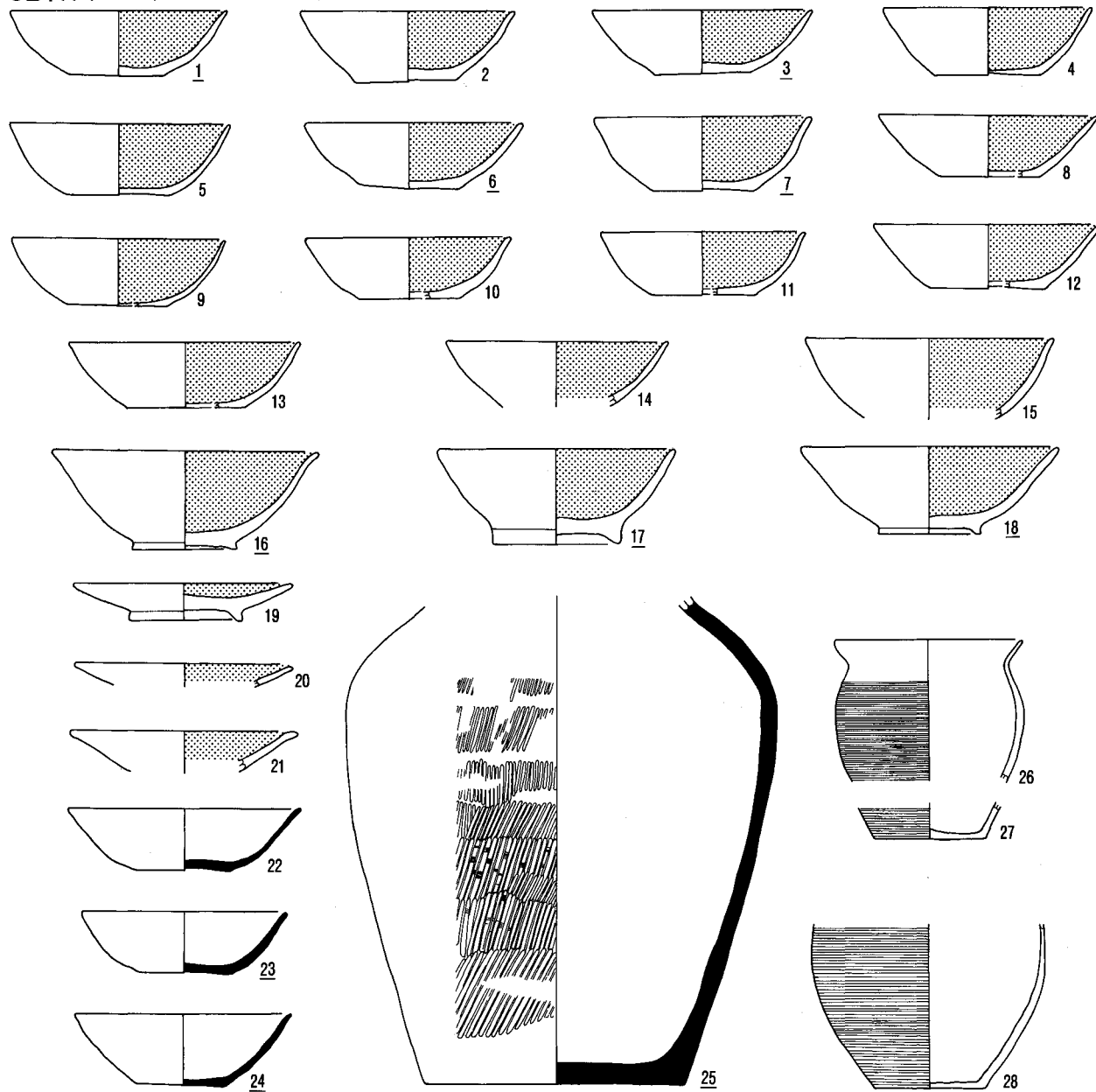

SB 145 (1~7)

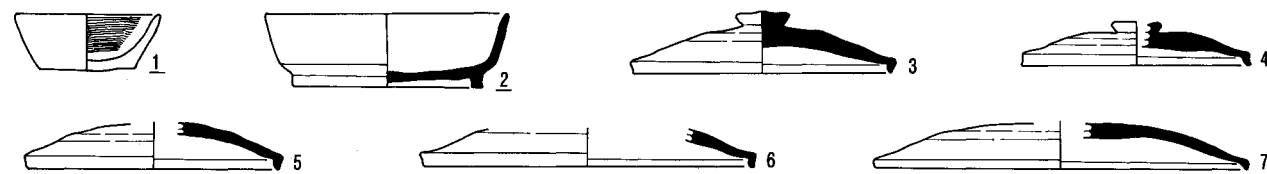

SB 146 (1~4)

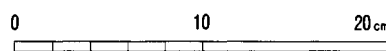
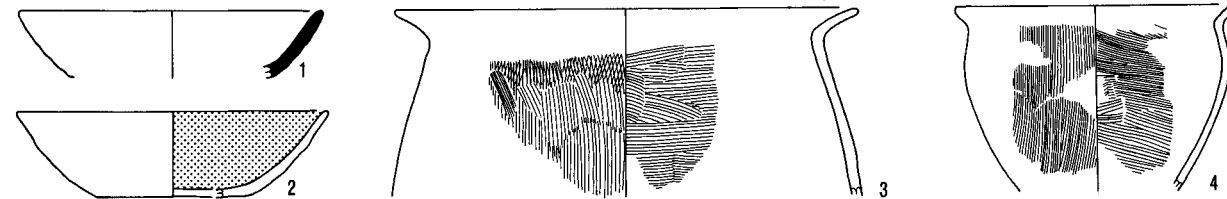

SB147 (1~4)

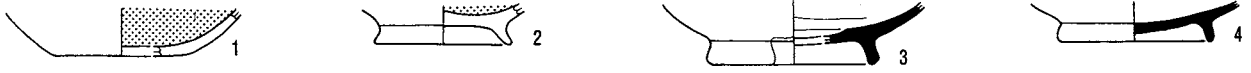

SB148 (1~3)

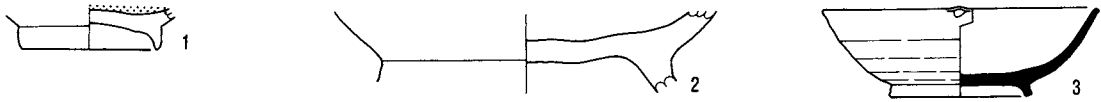

SB150 (1~8)

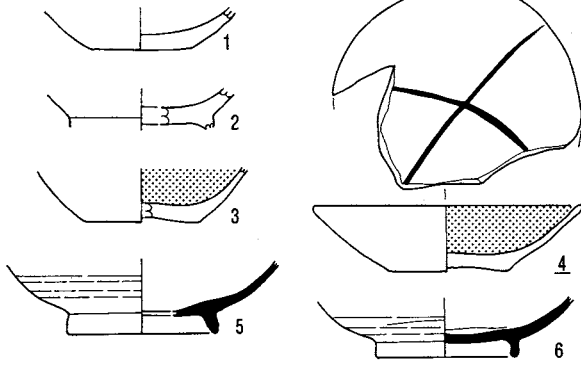

SB156 (1~8)

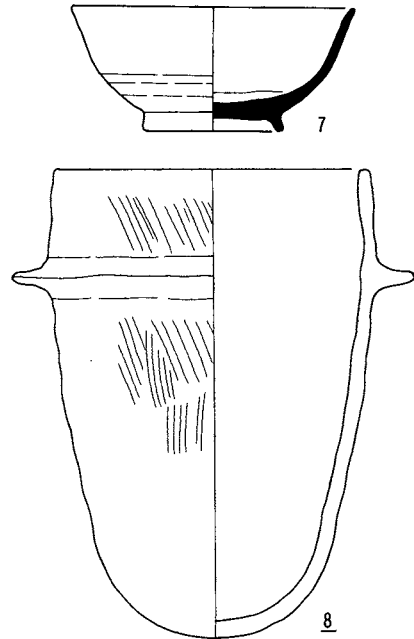
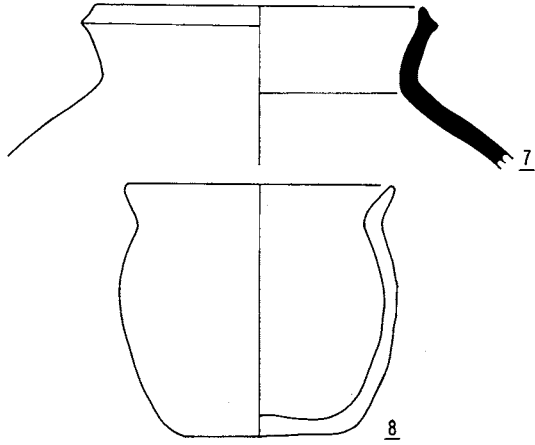
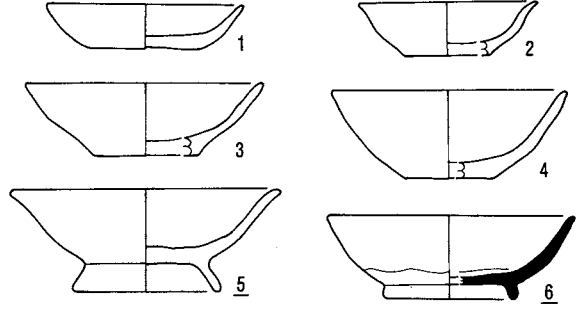

SB157 (1~5)

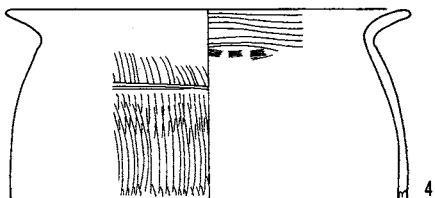
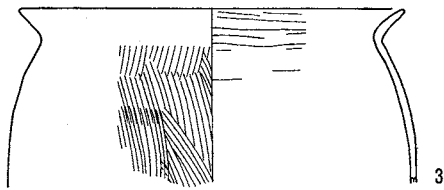

SB154 (1~8)

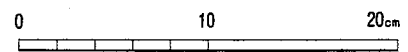
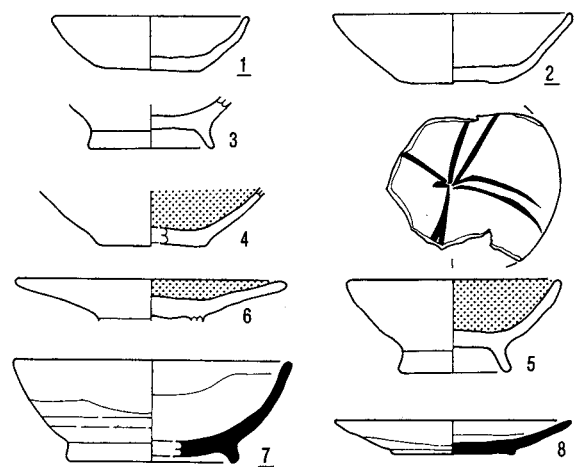

SB 158 (1~5)

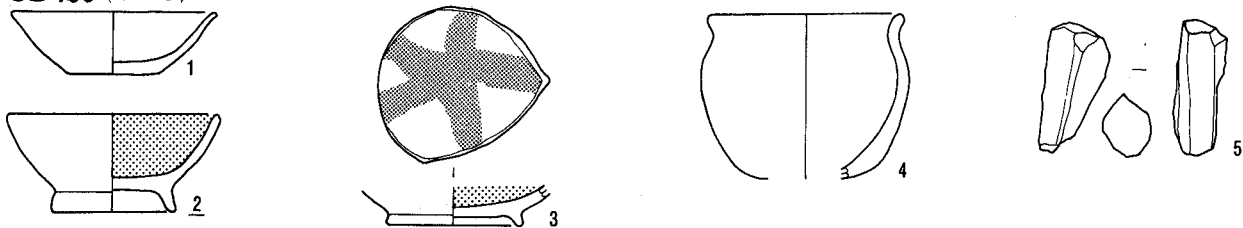

SB 159 (1~18)

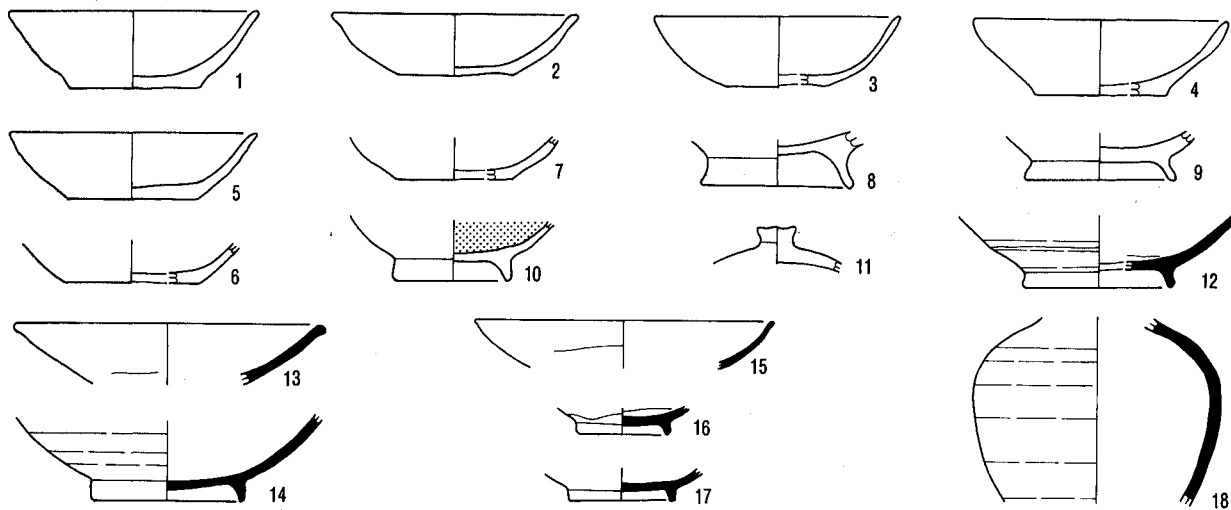

SB 160 (1~19)

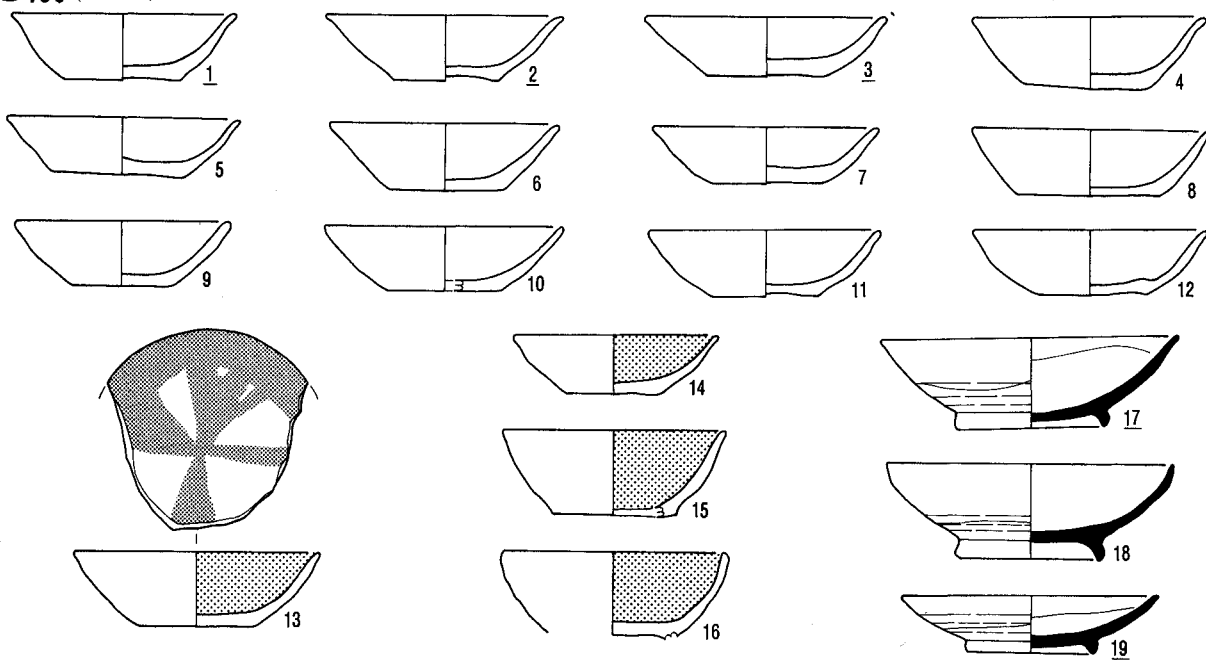

SB 161 (1~6)

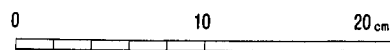
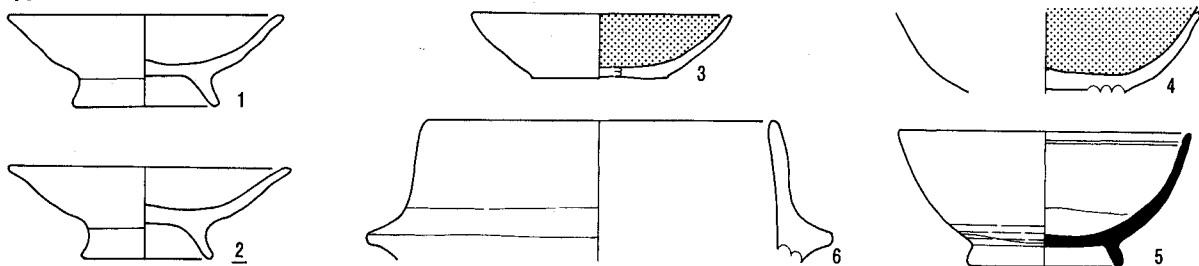

SB162 (1~5)

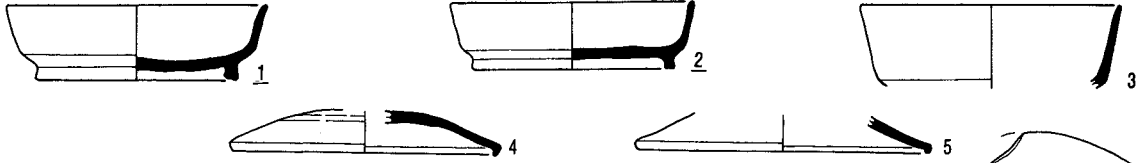

SB163 (1~6)

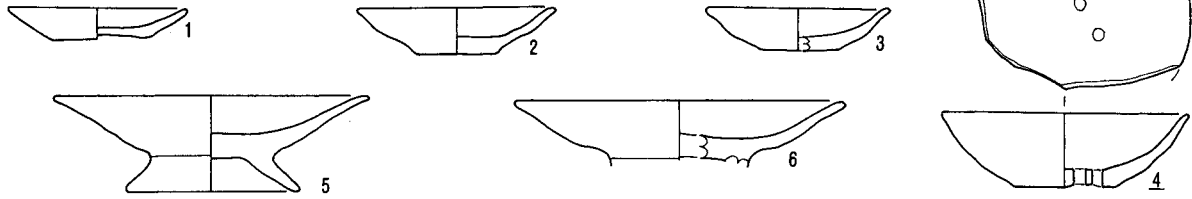

SB164 (1~12)

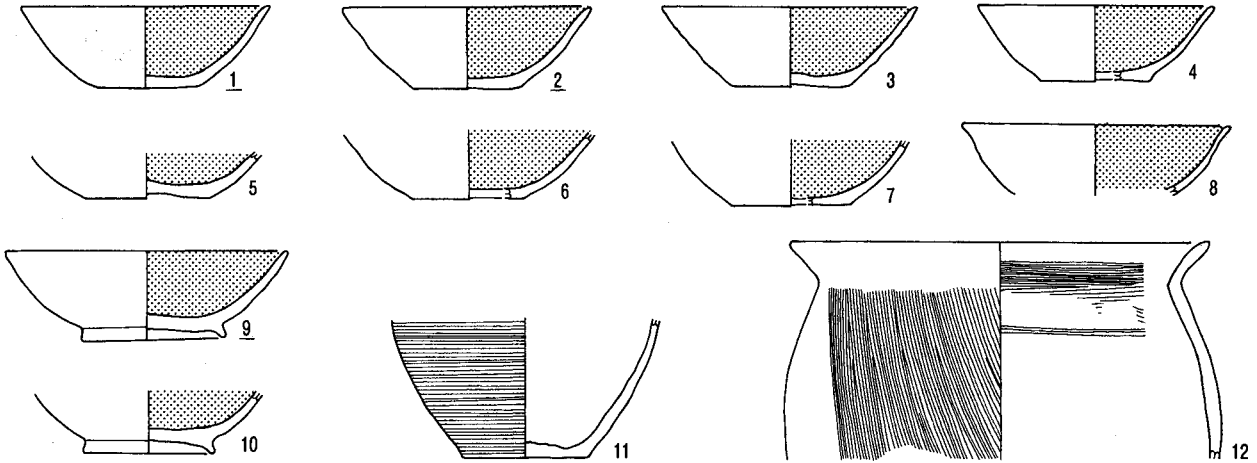

SB165 (1.2)

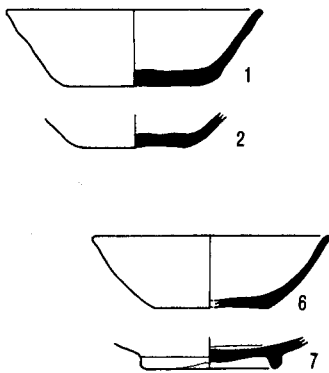

SB166 (1~10)

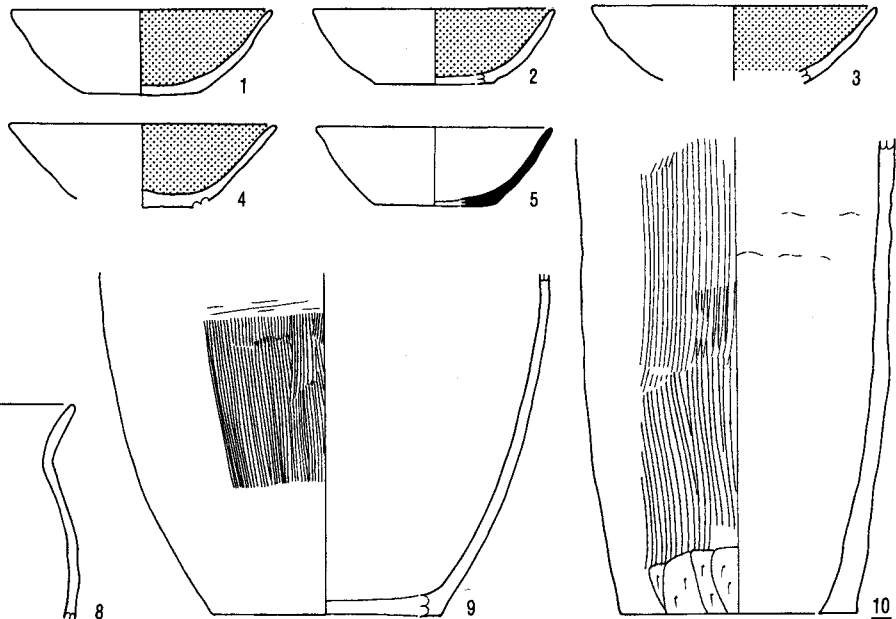

0 10 20 cm

SB 167 (1~50)

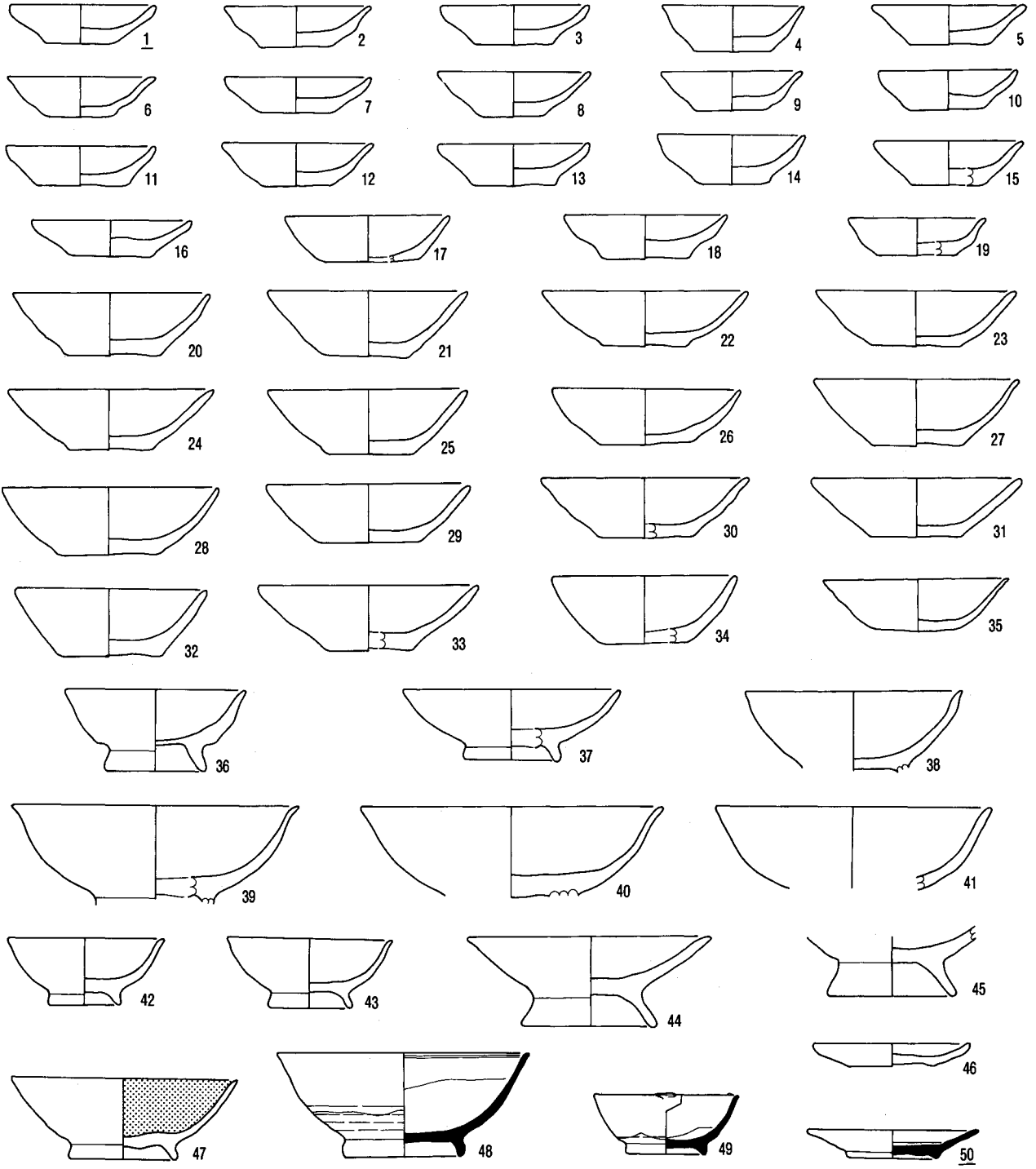

SB 168 (1~6)

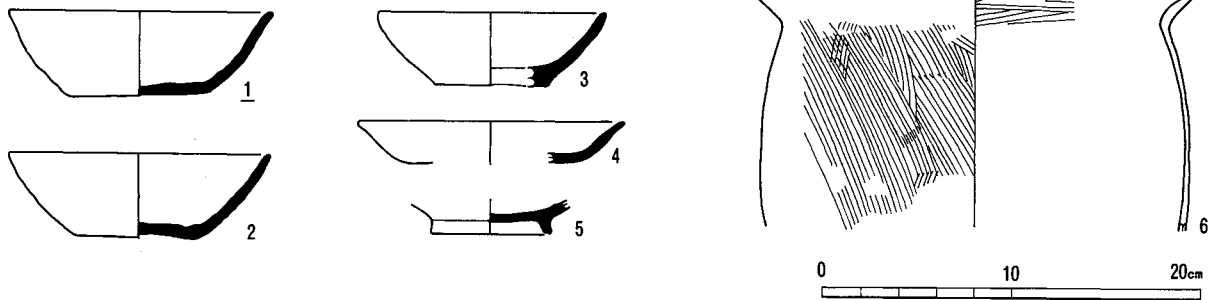

SB 169 (1~10)

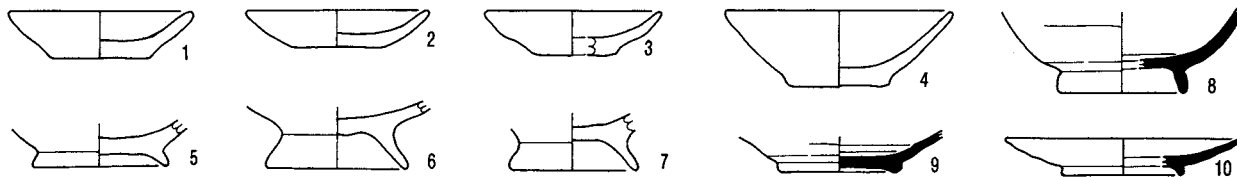

SB 170 (1~10)

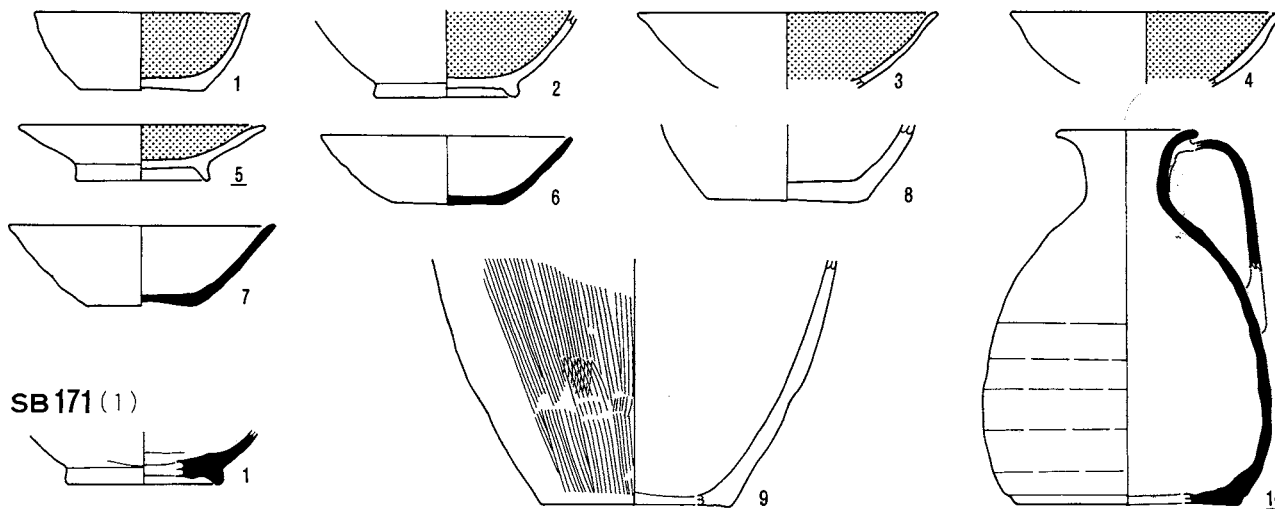

SB 171 (1)

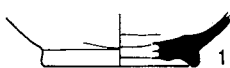

SB 172 (1~12)

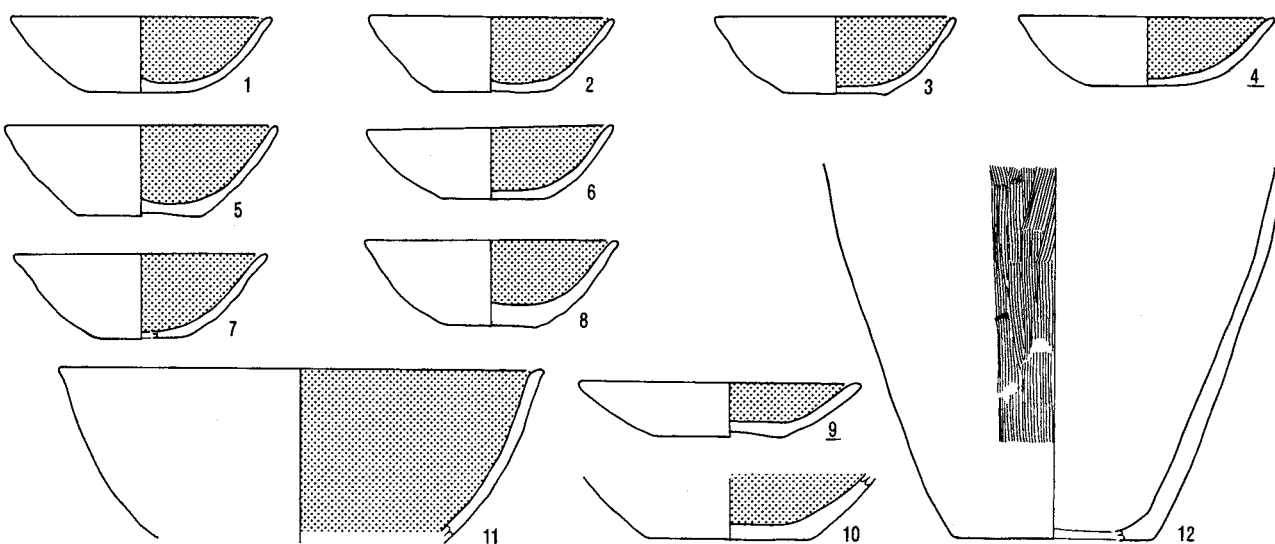

SB 174 (1~14)

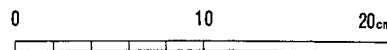
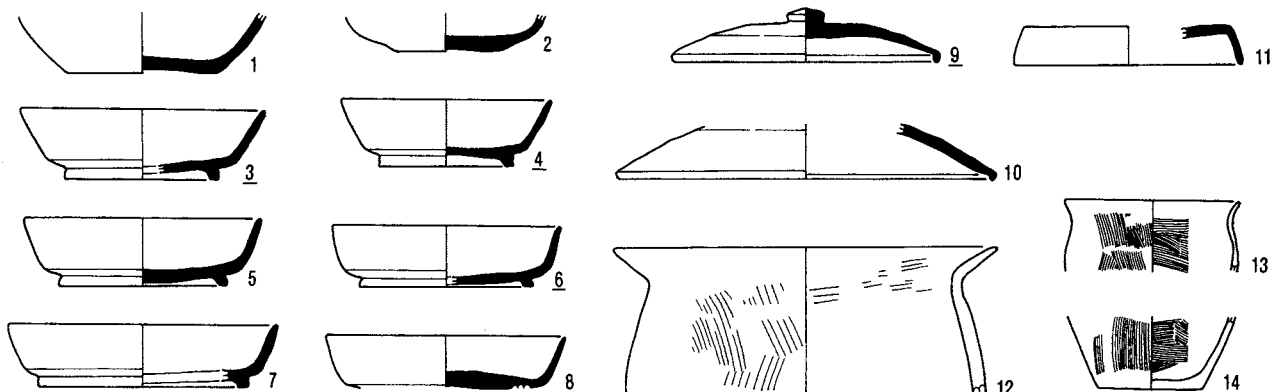

SB175 (1~9)

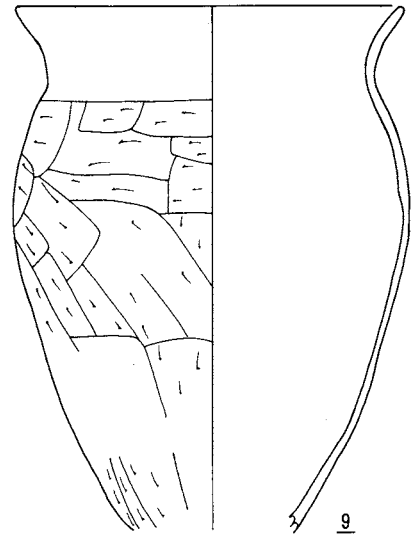
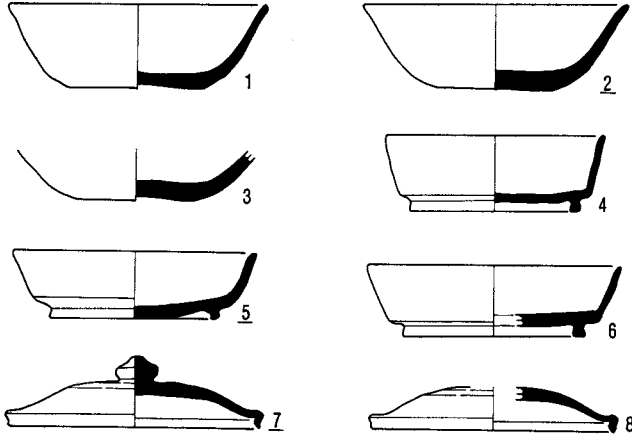

SB176 (1)

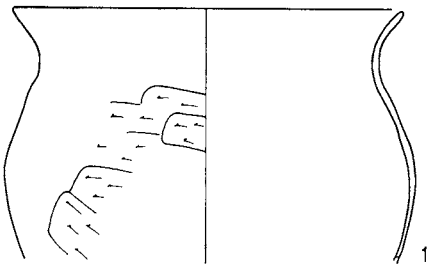

SB178 (1~8)

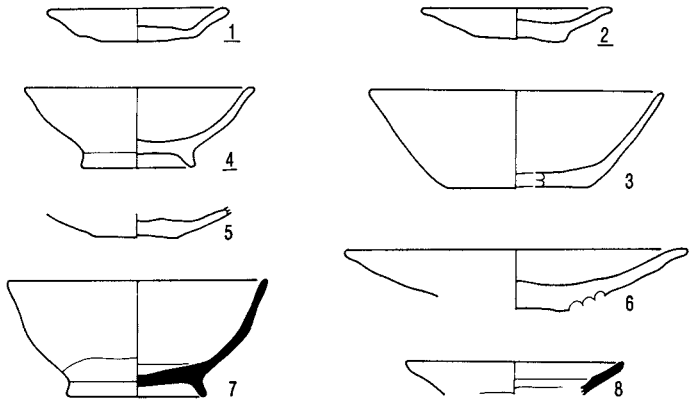

SB177 (1)

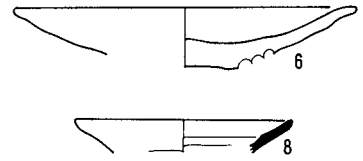
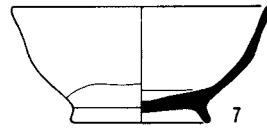

SB179 (1~7)

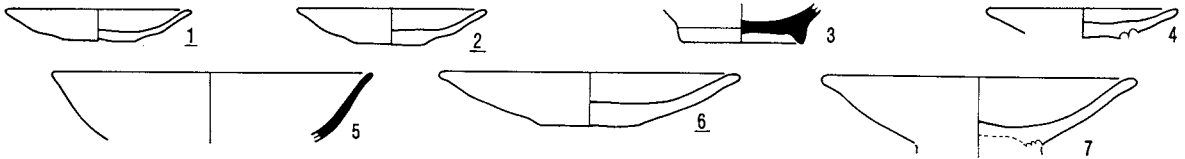

SB180 (1)



SB181 (1~12)

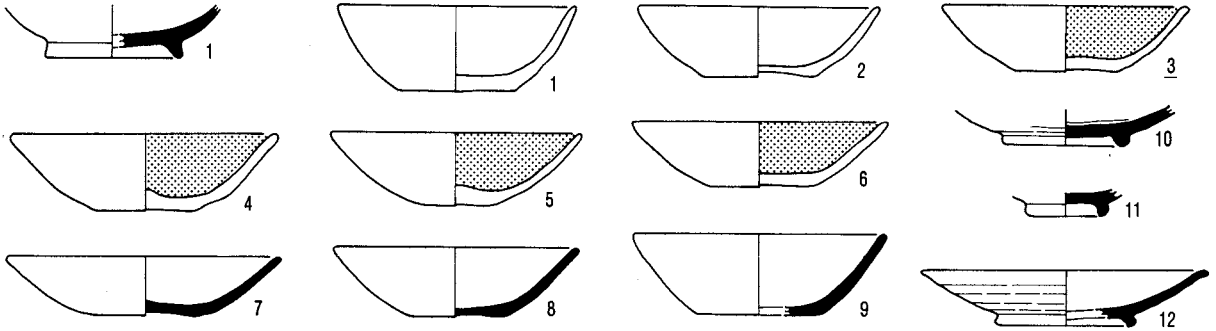

SB182 (1~3)

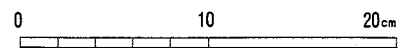
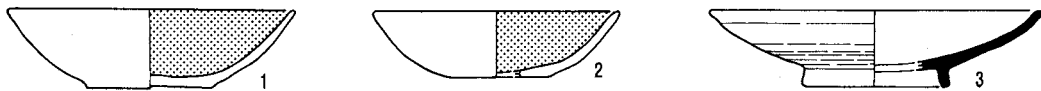

SB183 (1~13)

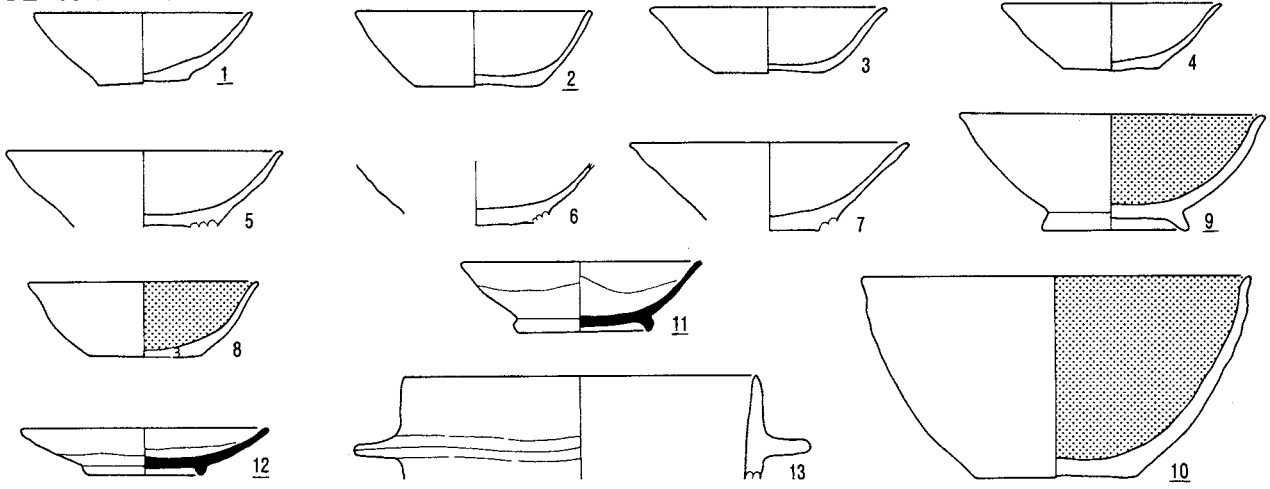

SB184 (1~20)

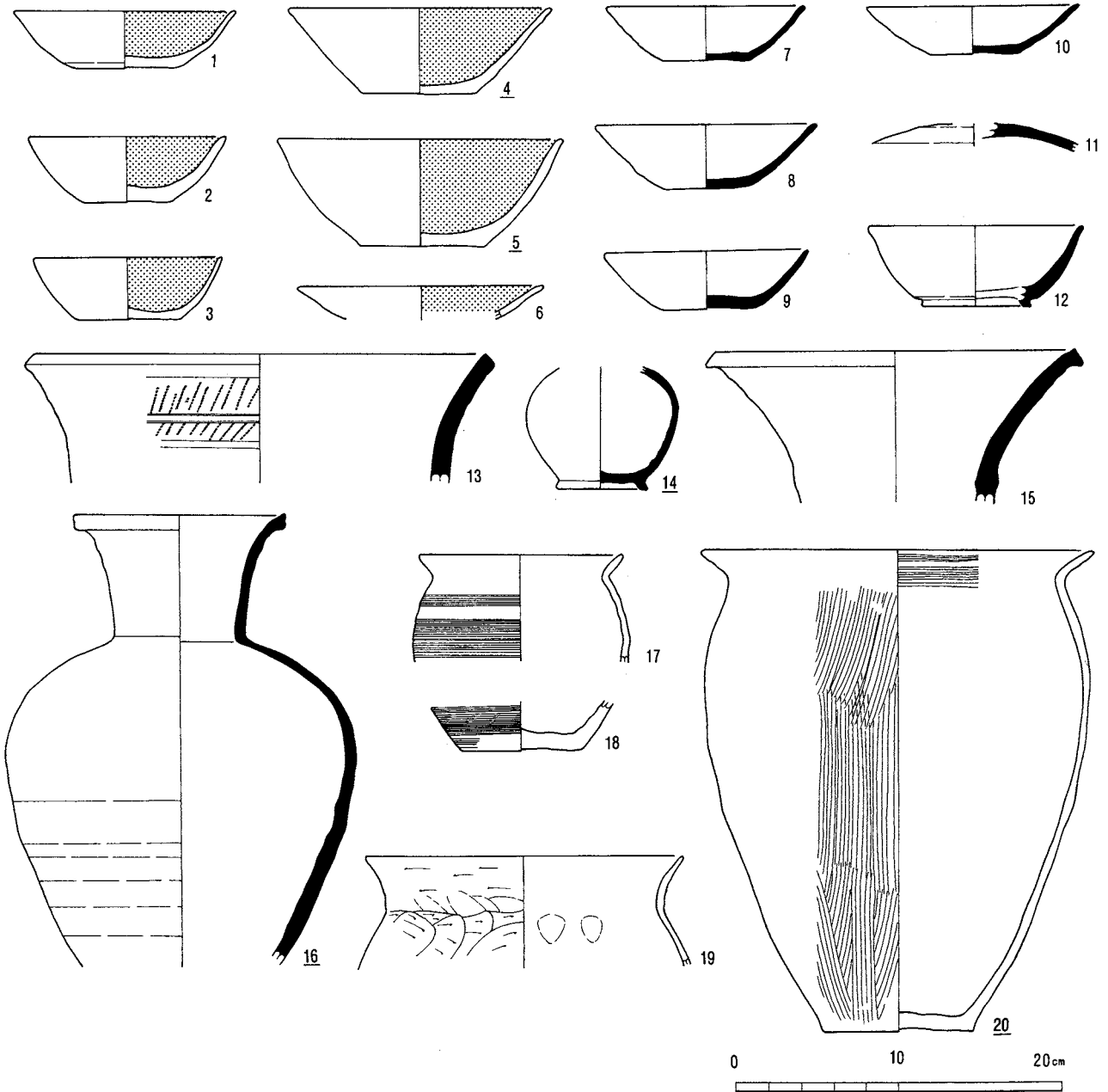

SB 185 (1~6)

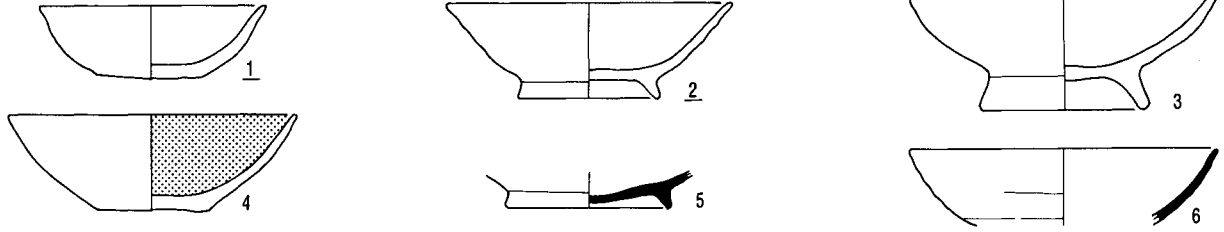

SB 186 (1~12)

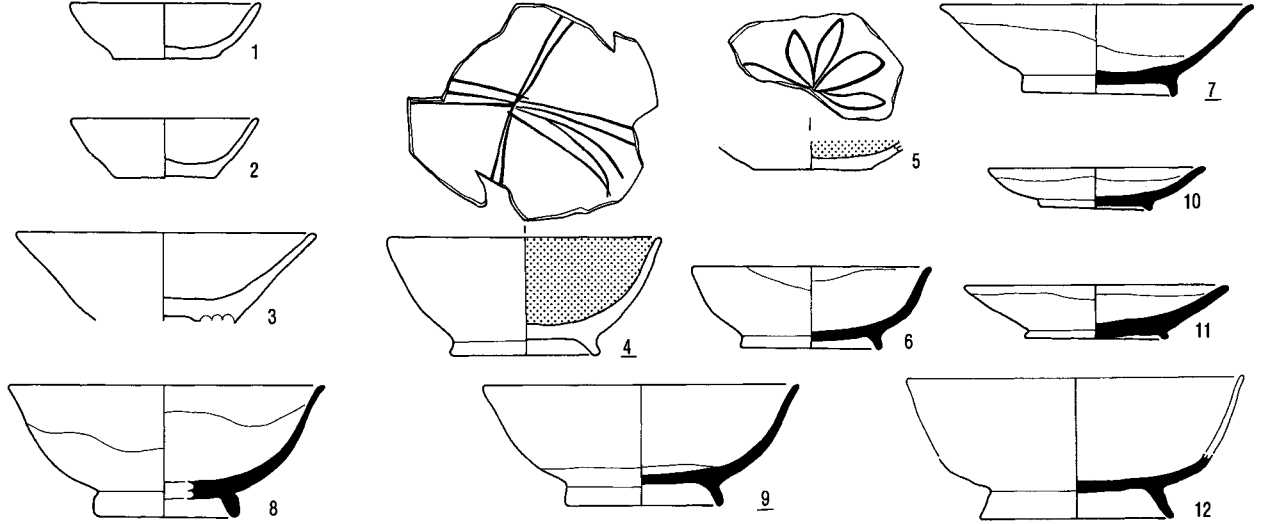

SB 187 (1~25)

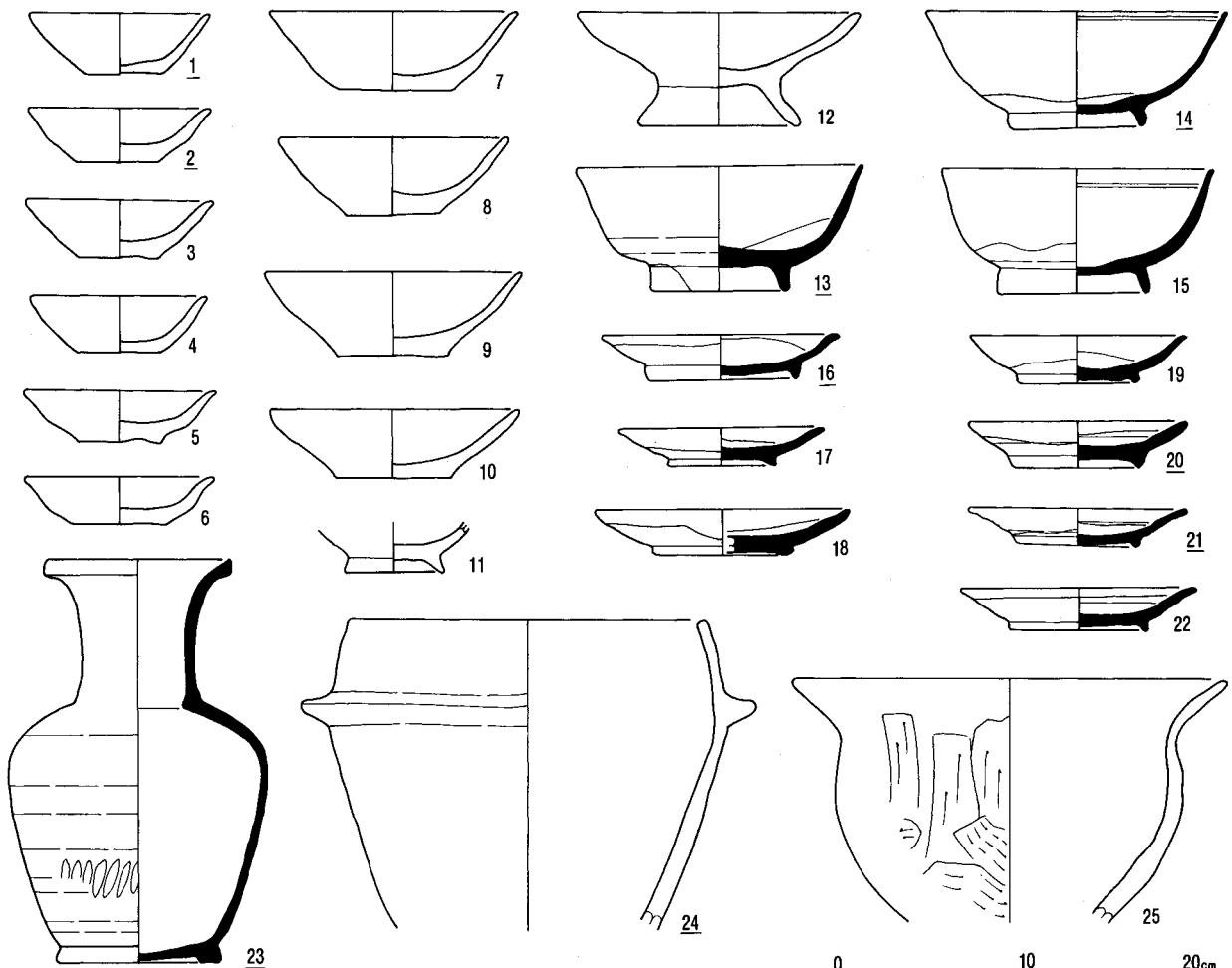

0 10 20cm

SB188 (1 ~ 10)

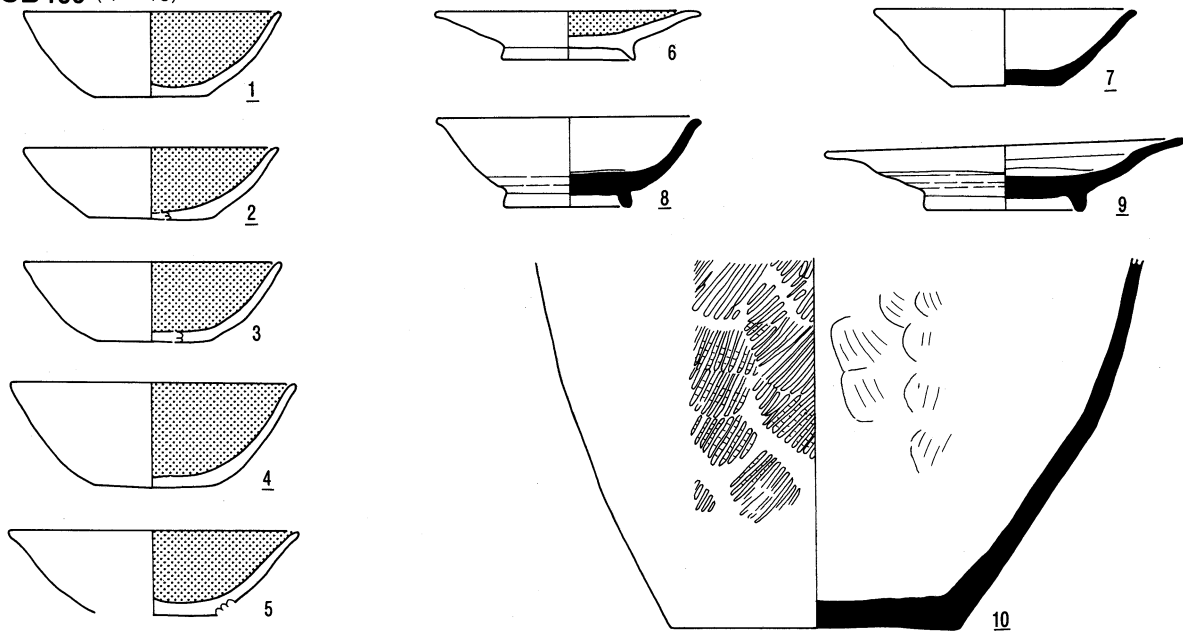

SB189 (1 ~ 15)

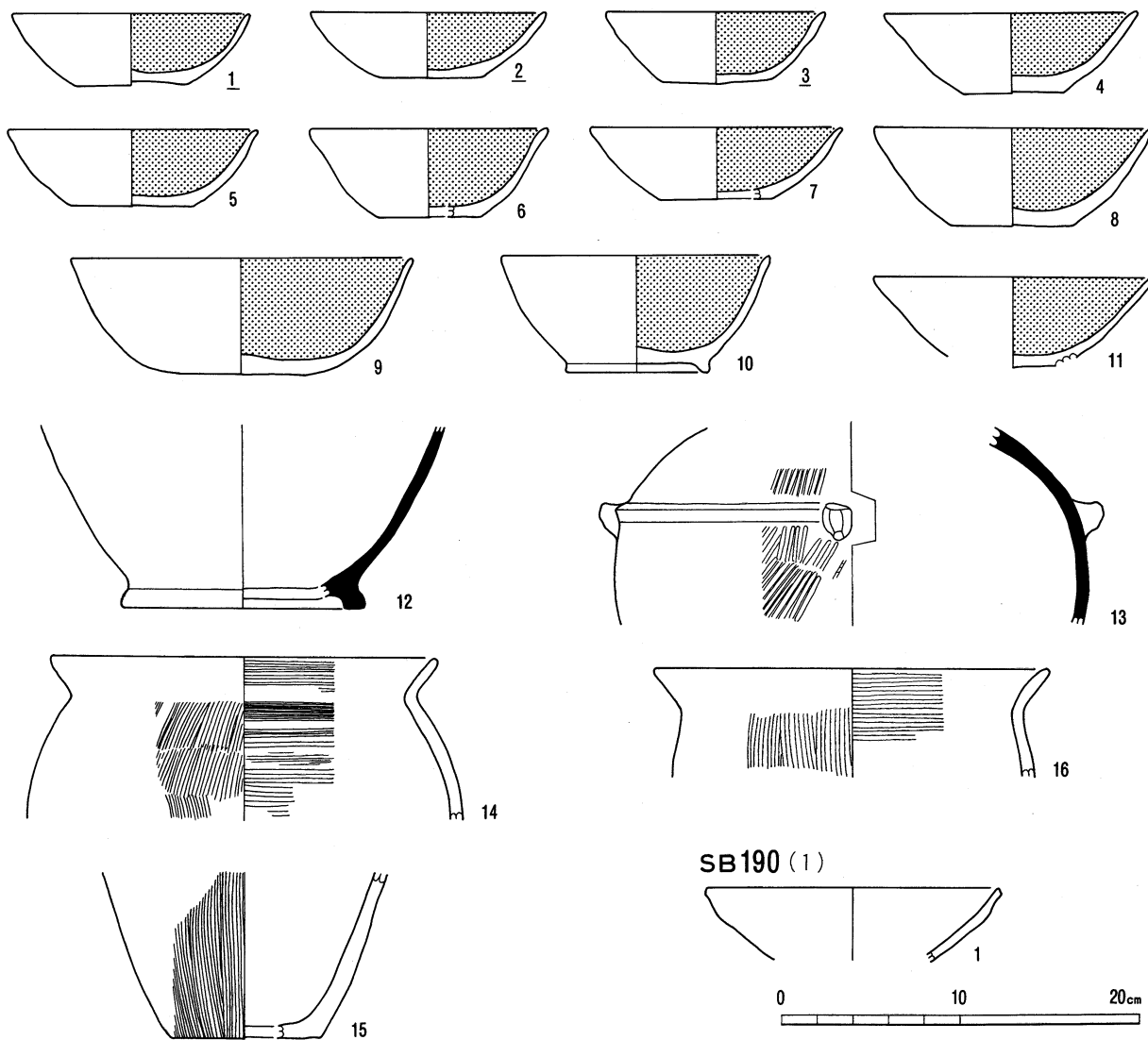

SB190 (1)

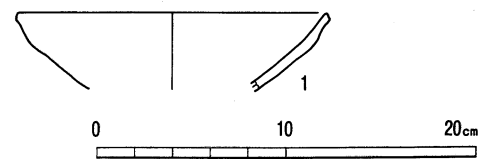

SB191 (1~18)

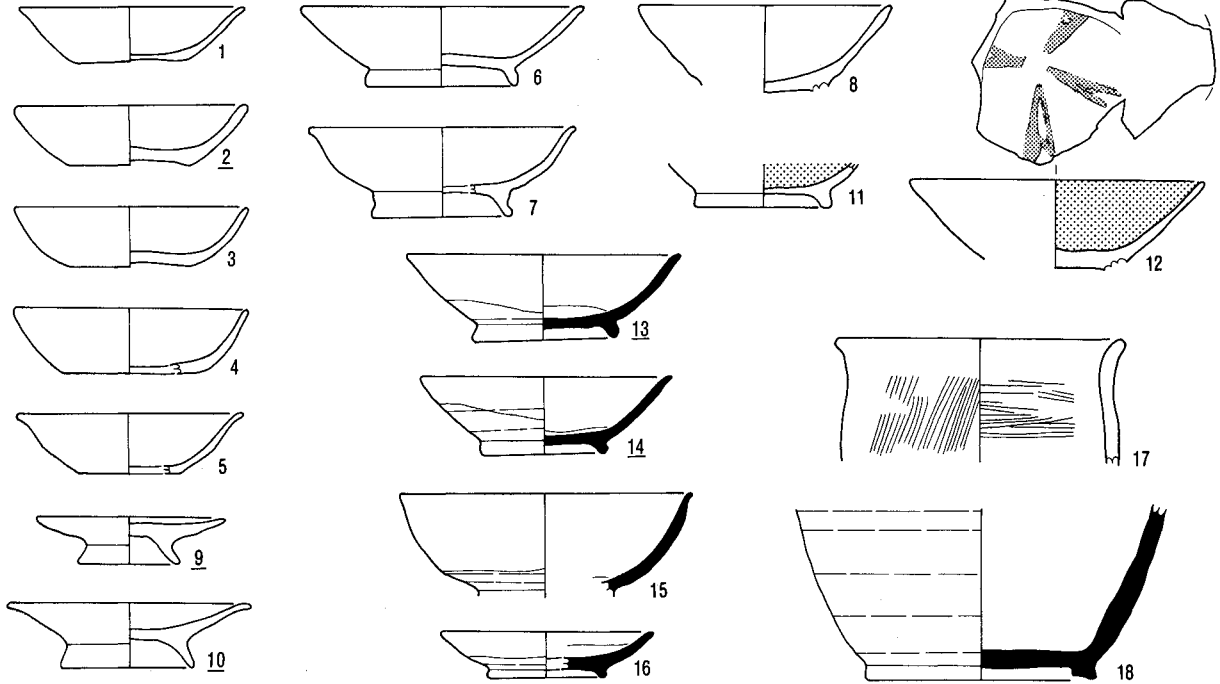

SB192 (1~10)

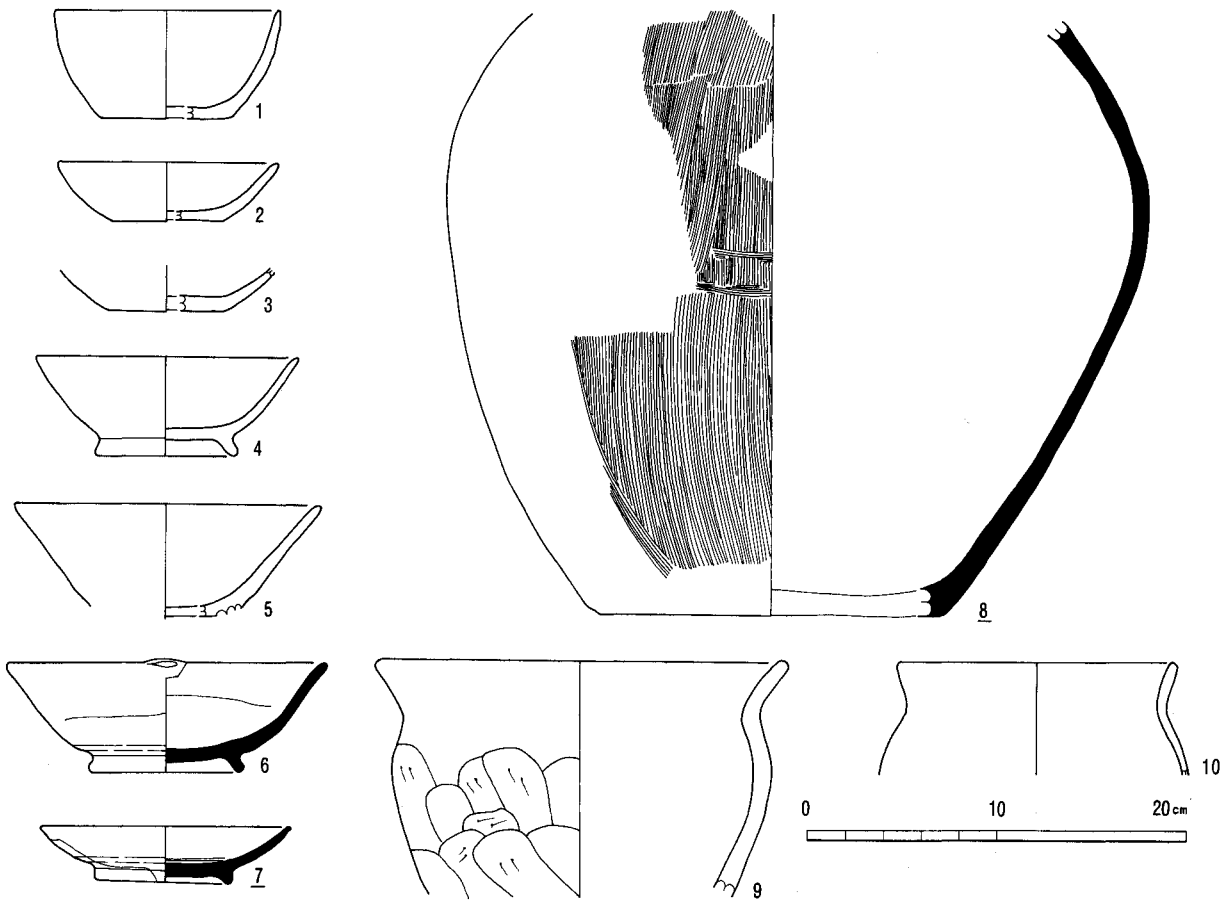

SB193 (1~4)

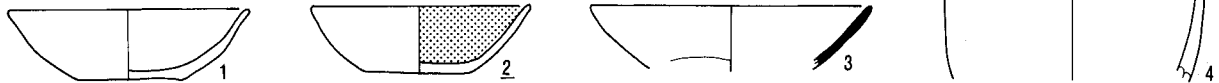

SB 194 (1~8)

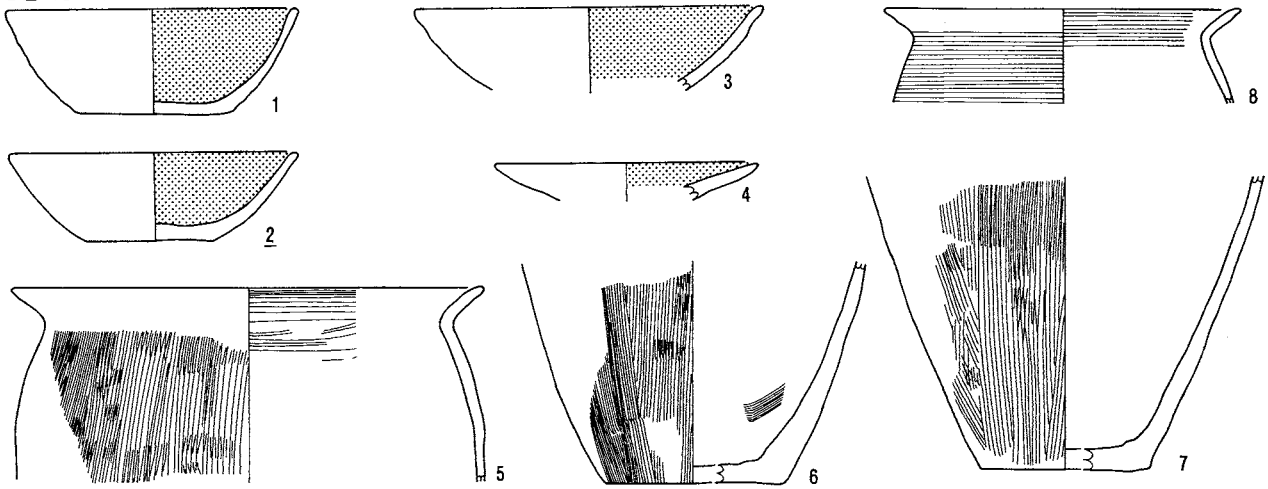

SB 195 (1~7)

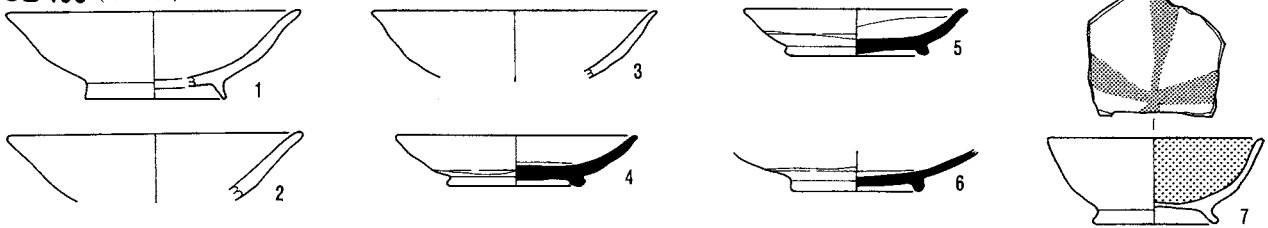

SB 196 (1~13)

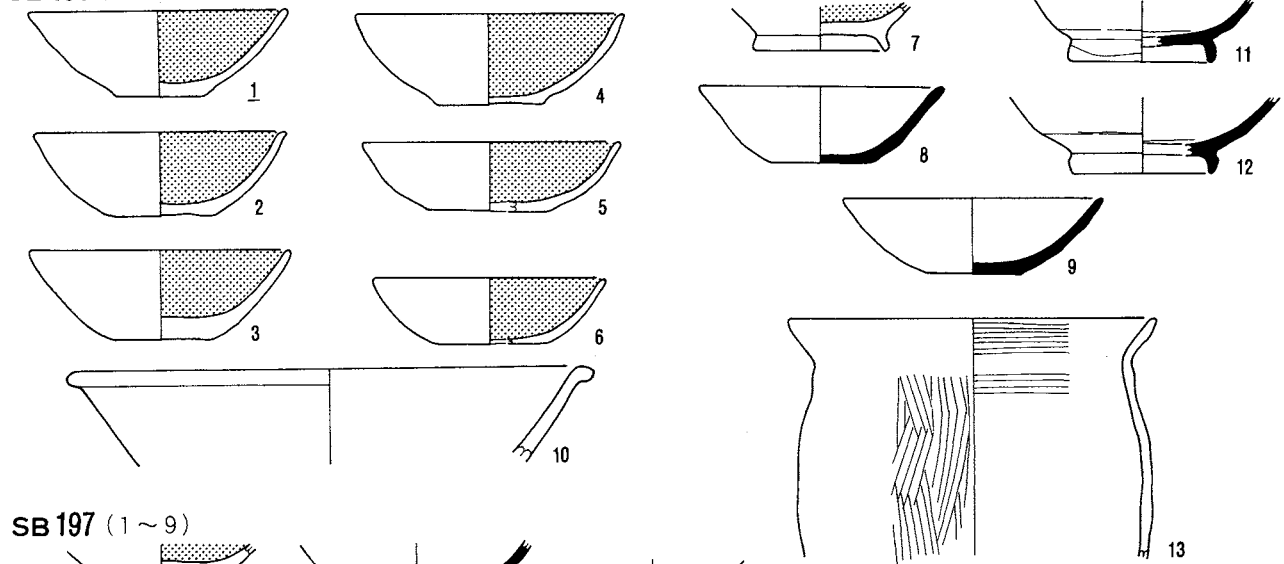

SB 197 (1~9)

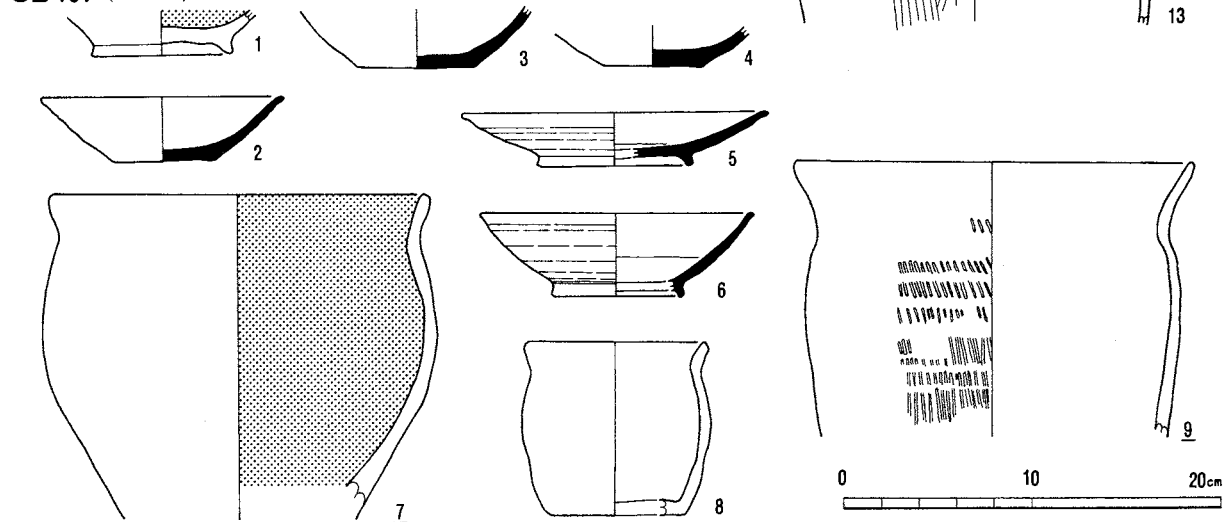

SB 198 (1~4)

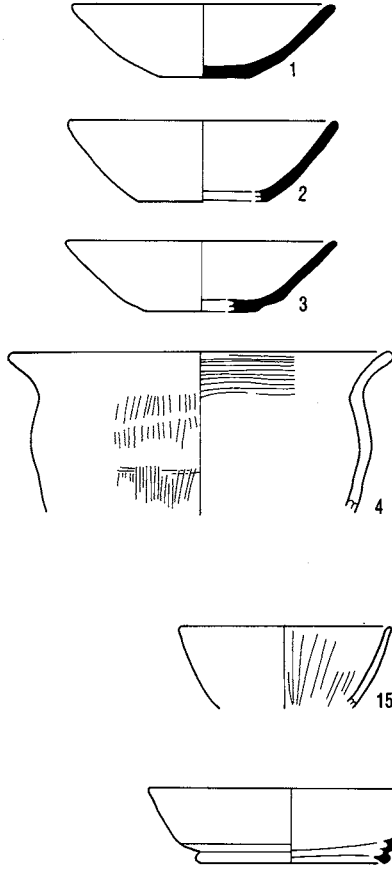

SB 199 (1~17)

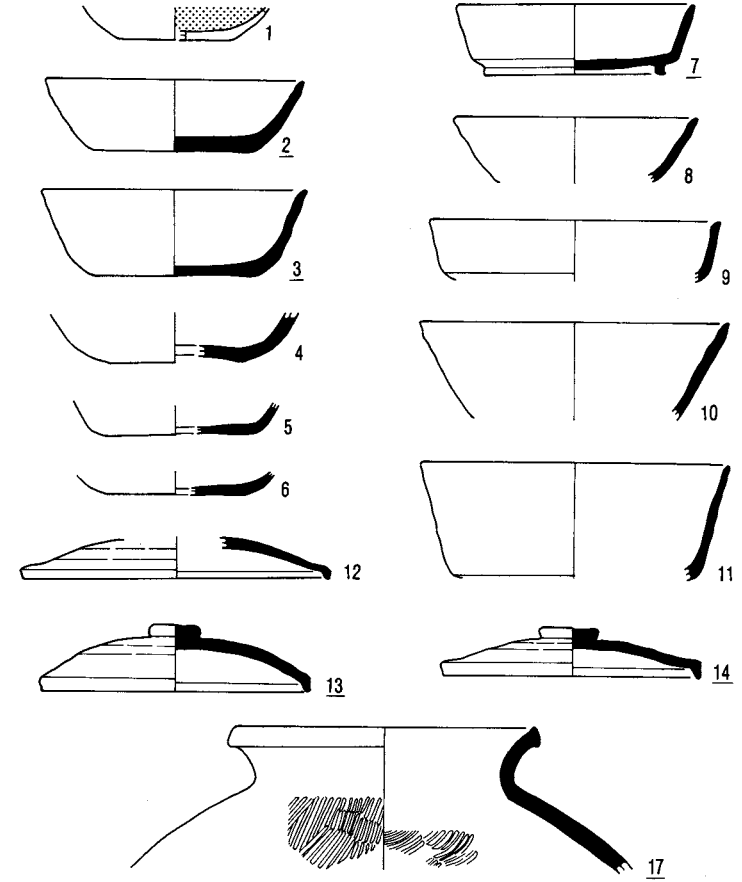

SB 200 (1~9)

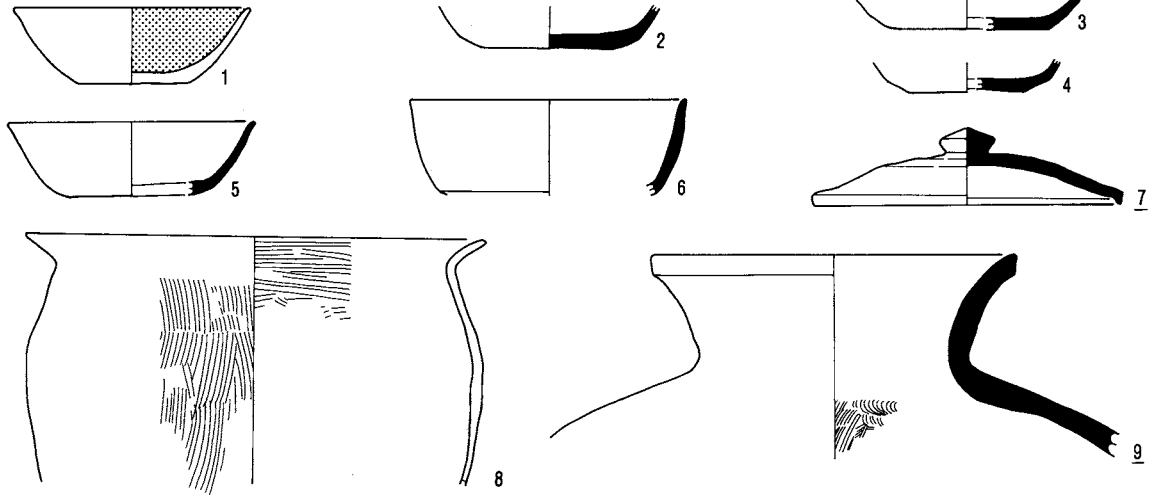

SB 201 (1~8)

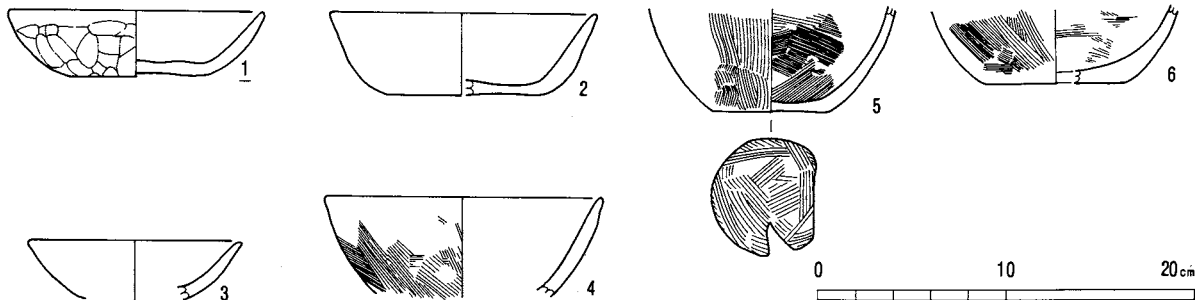

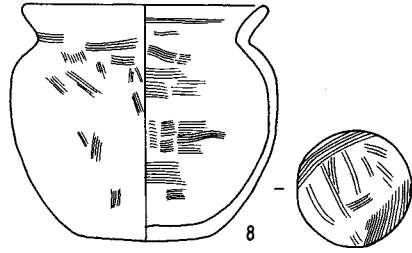
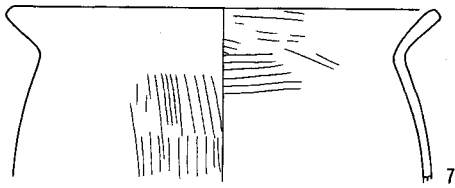

SB202 (1~7)

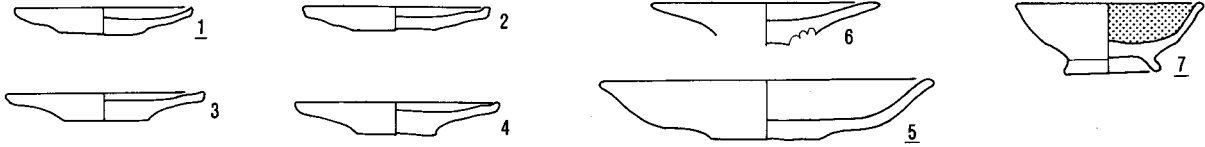

SB203 (1~7)

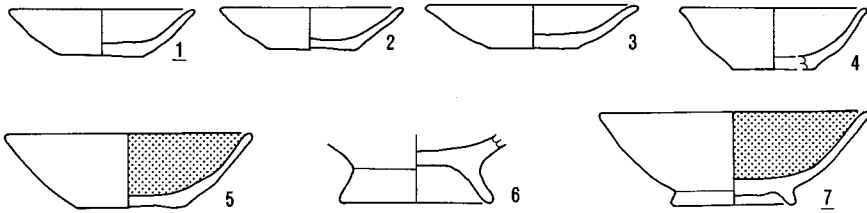

SB204 (1.2)

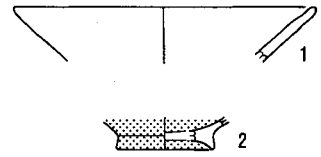

SB207 (1~15)

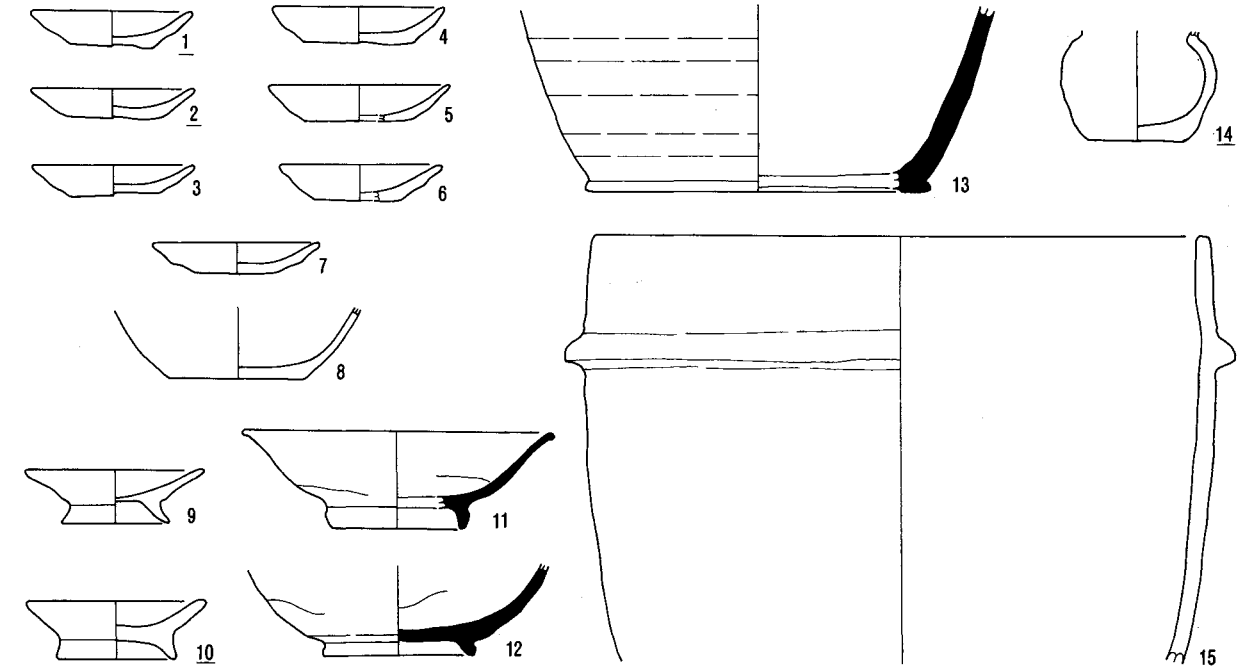

SB209 (1~11)

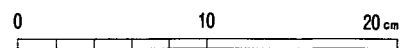
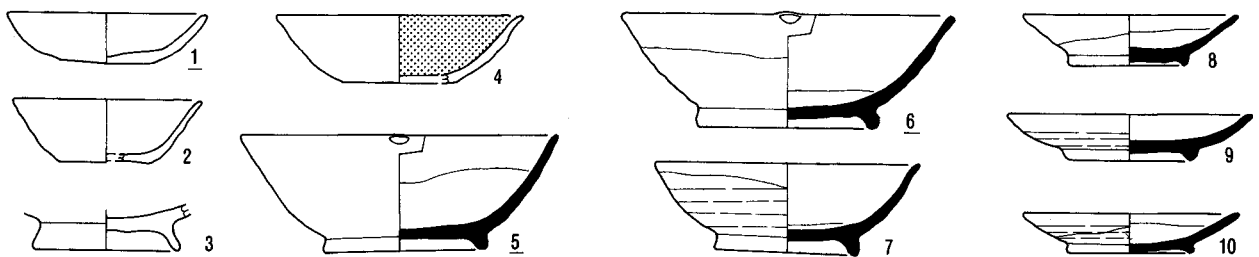

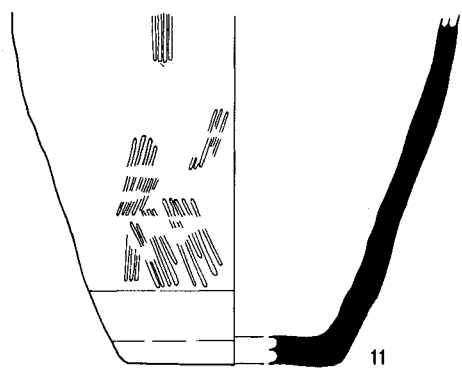

11

SB 211 (1~4)



1

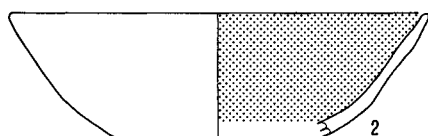

2

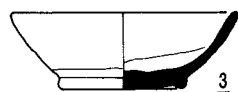

3

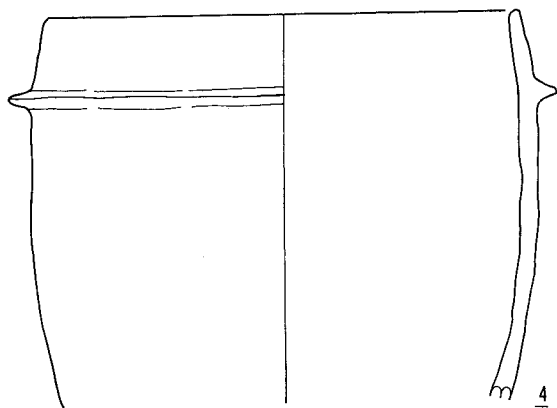

4

SB 212 (1)

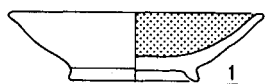

1

SB 214 (1)

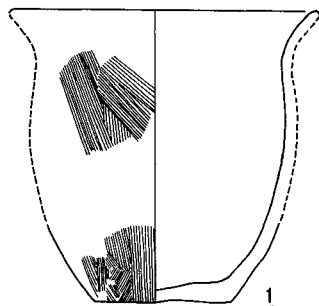

1

SB 210 (1~8)

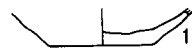

1



2

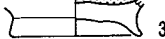
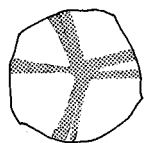

3

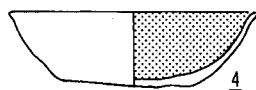

4

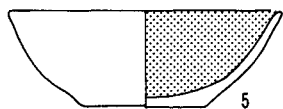

5

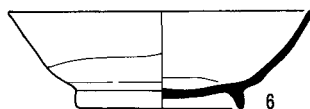

6

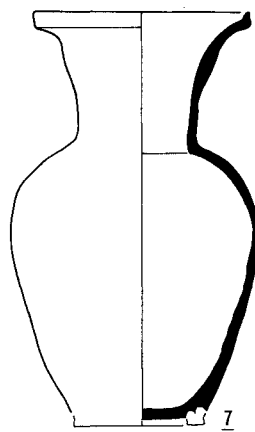

7

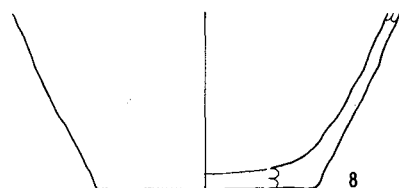

8

SB 213 (1~5)

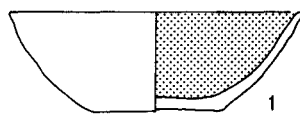

1

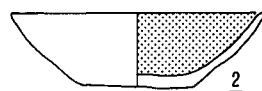

2

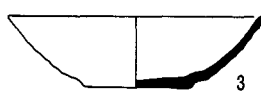

3

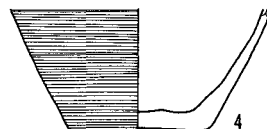

4

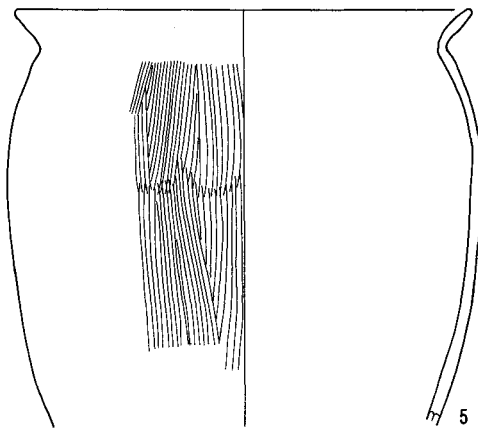

5

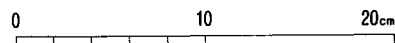

SB 215 (1~5)

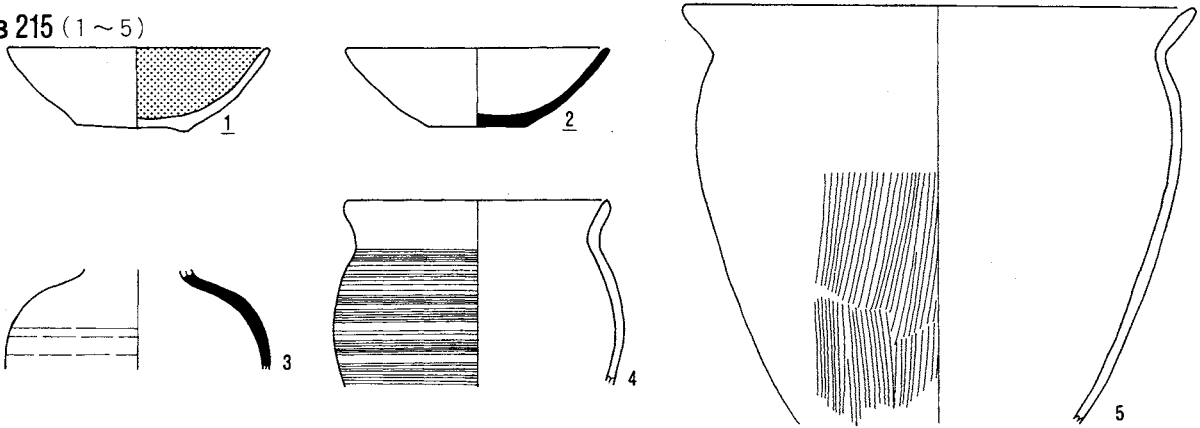

SB 216 (1~37)

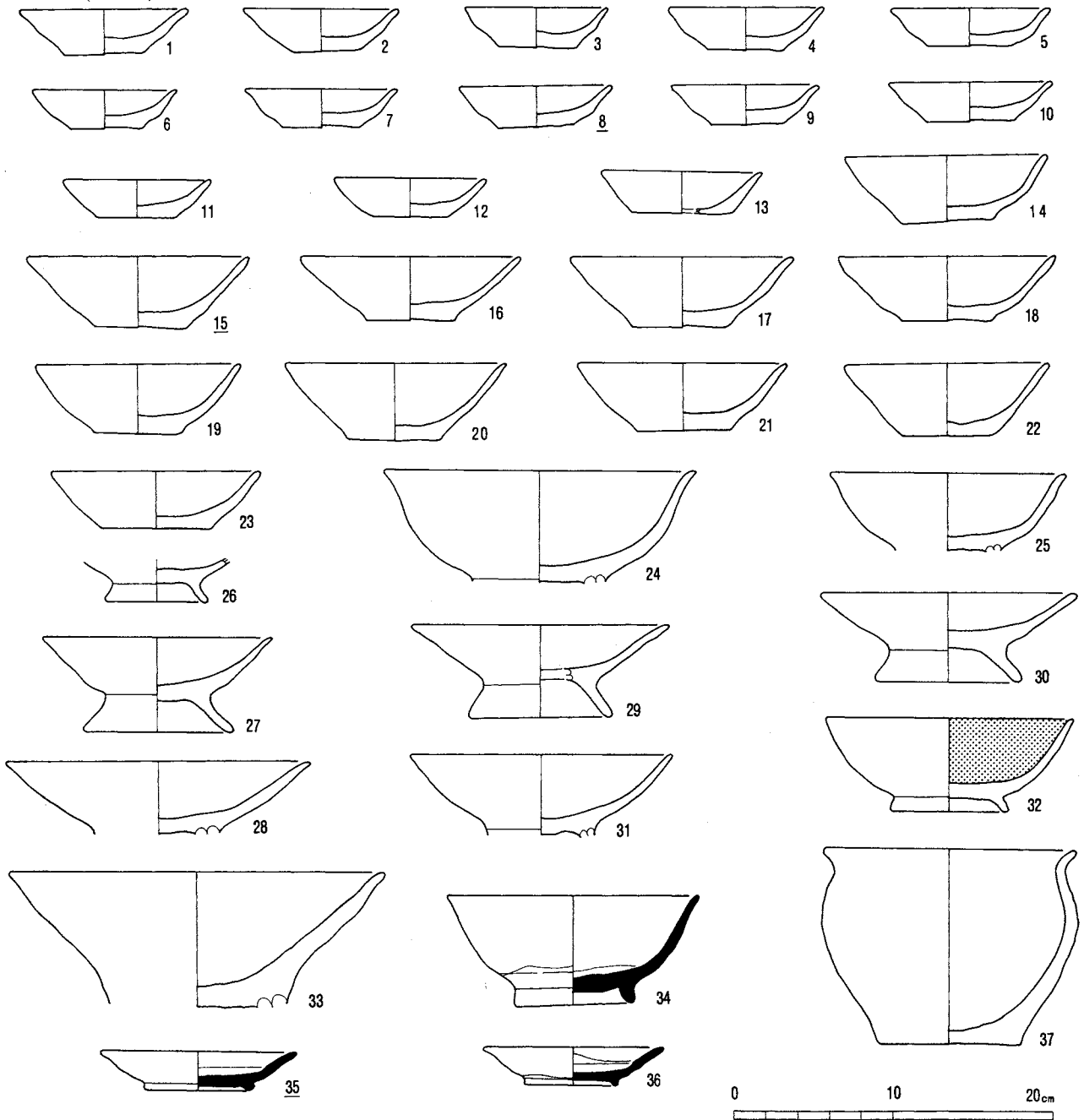

SB 217 (1~3)

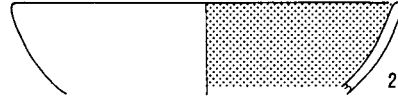
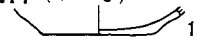

SB 218 (1)



SB 219 (1~7)

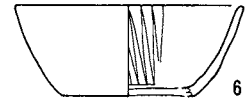
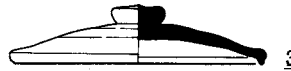

SB 220 (1)

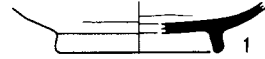

SB 221 (1.2)

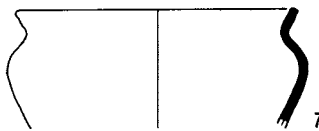
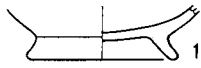

SB 222 (1~5)

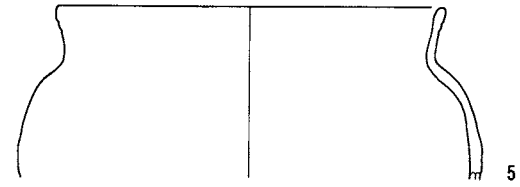
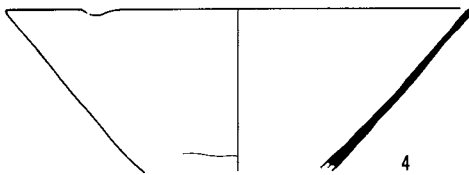
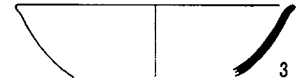
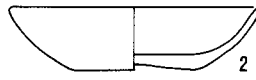
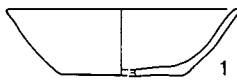

SB 224 (1~9)

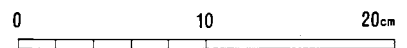
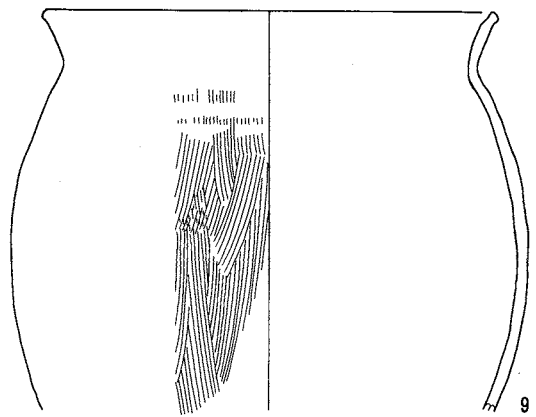
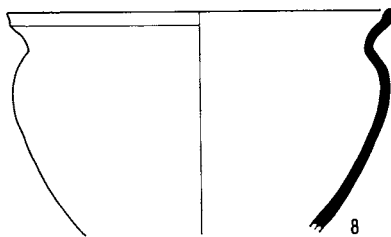
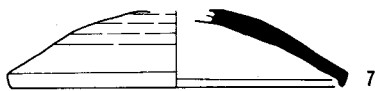
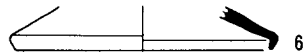
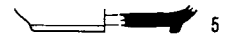
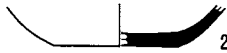
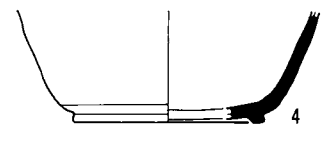
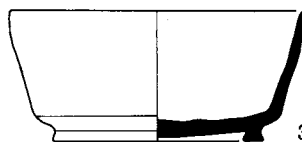

SB 225 (1~5)

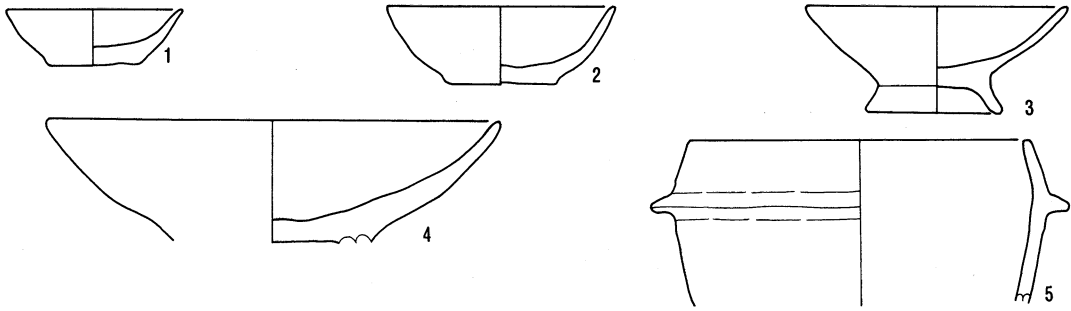

SB 226 (1~9)

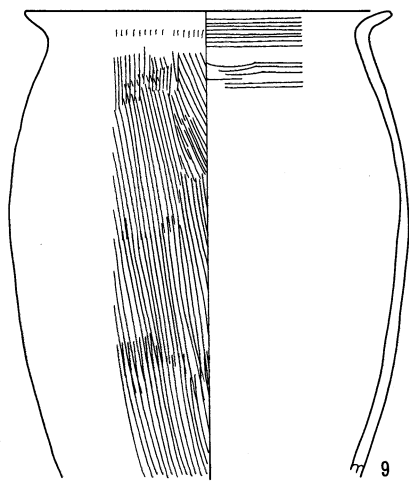
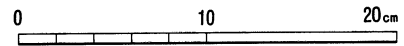
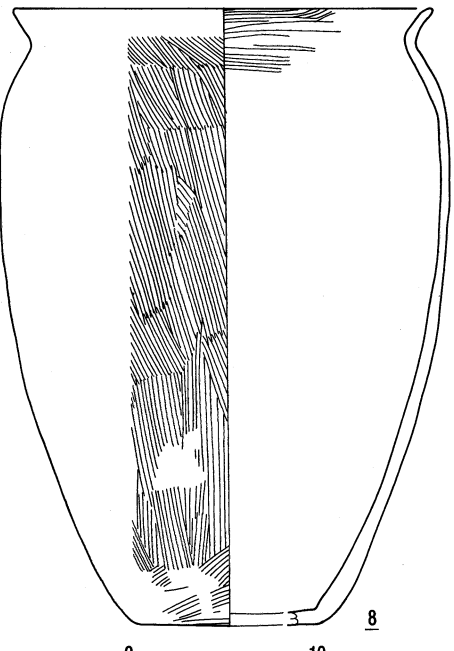
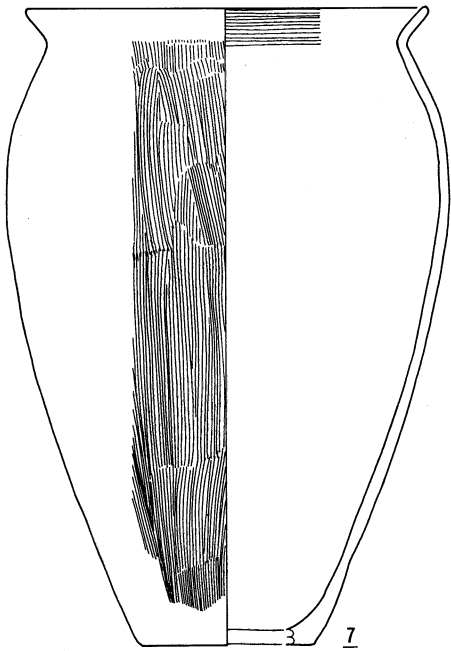
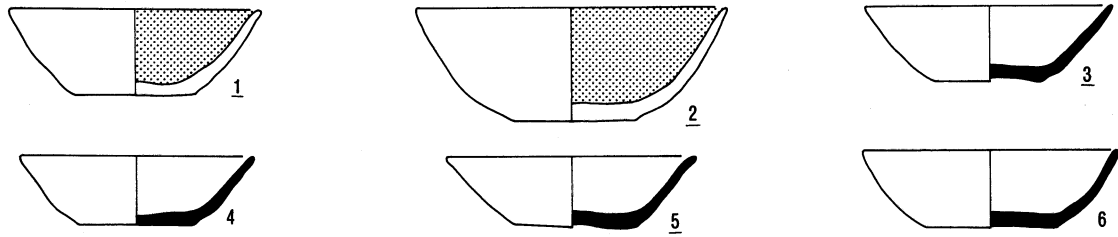

SB 227 (1~22)

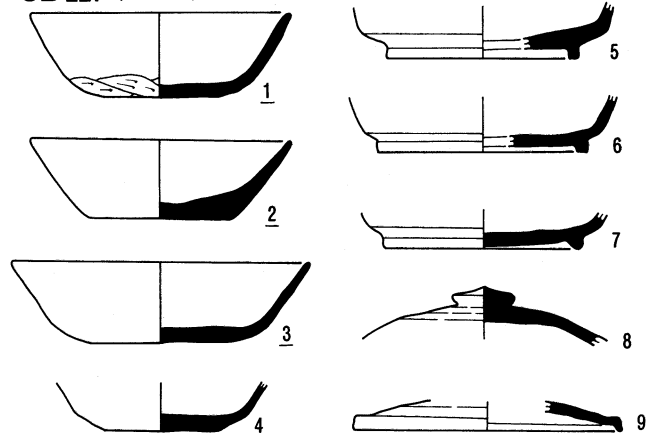

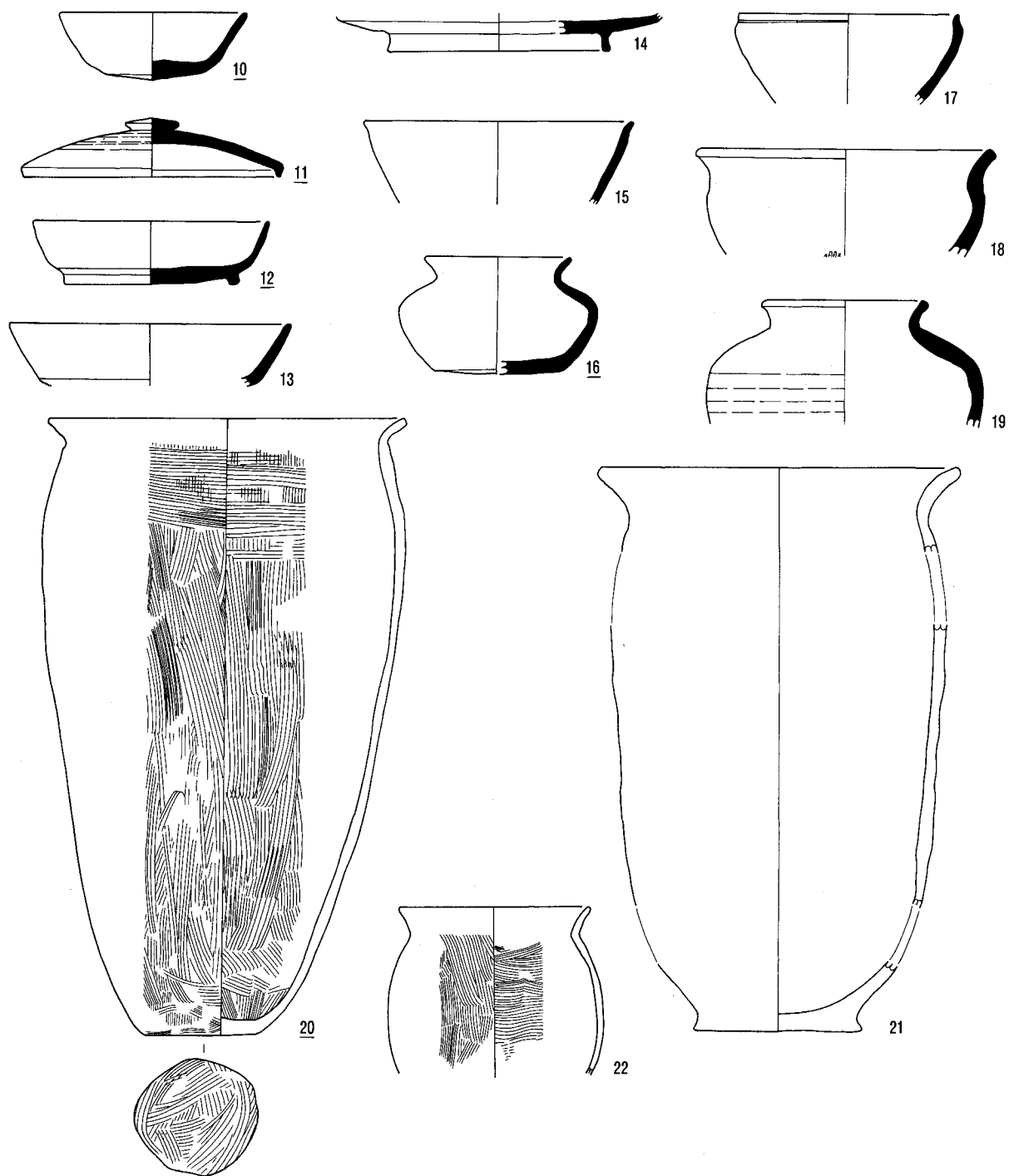

SB 228 (1)

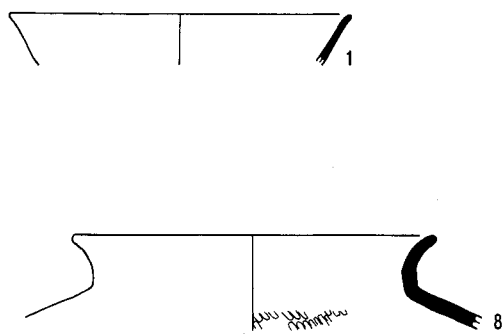

SB 230 (1~7)

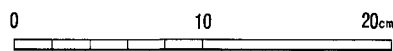
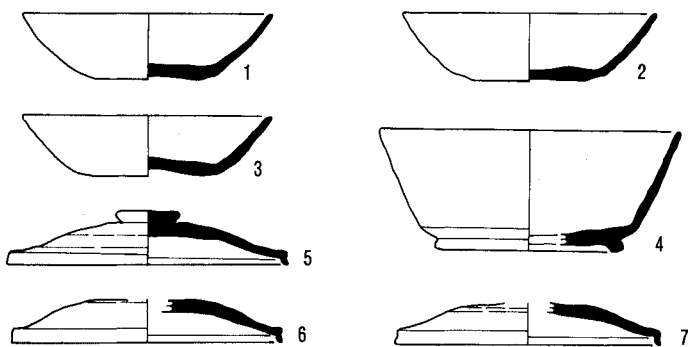

SB 232 (1~36)

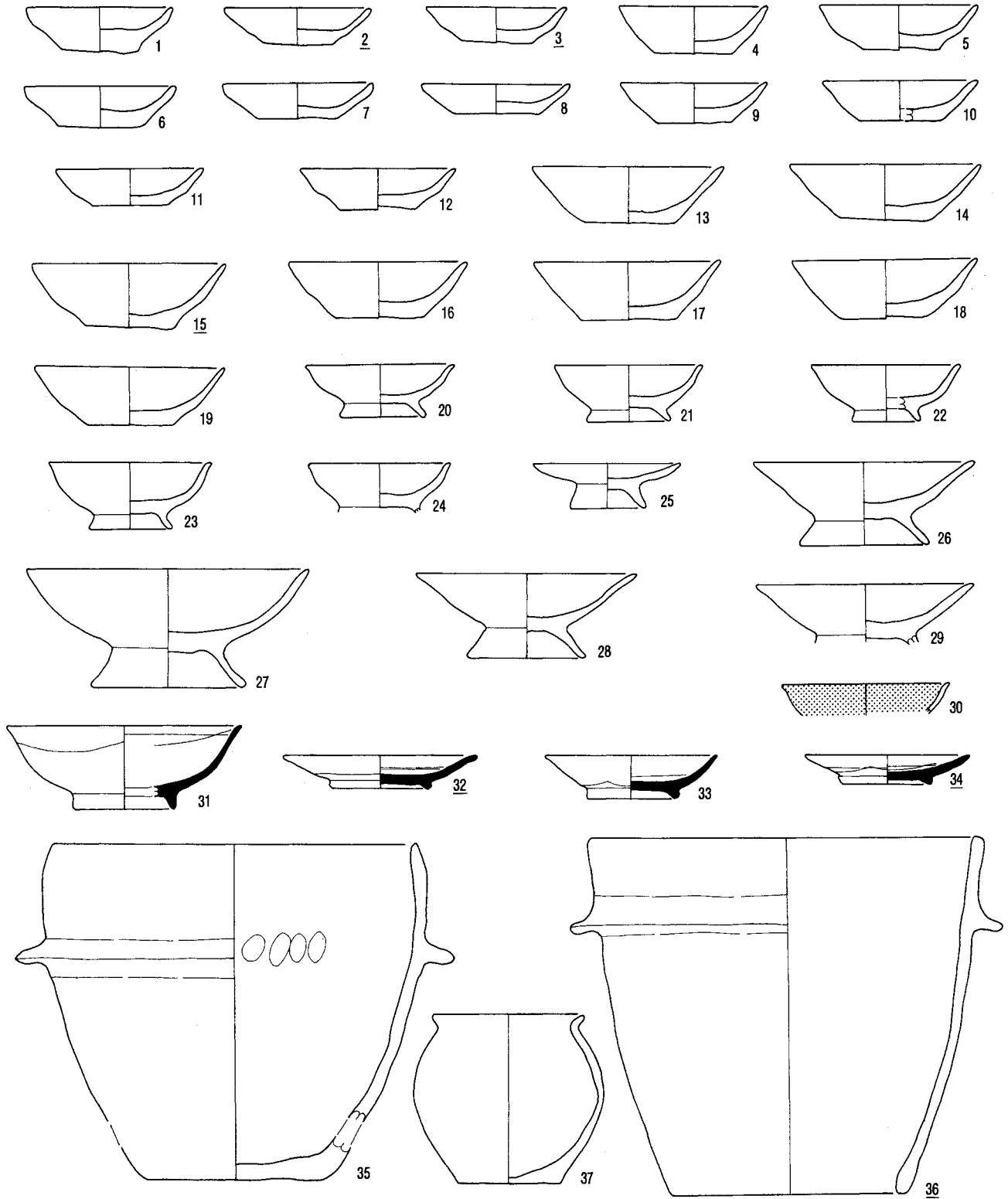

SB 233 (1~3)

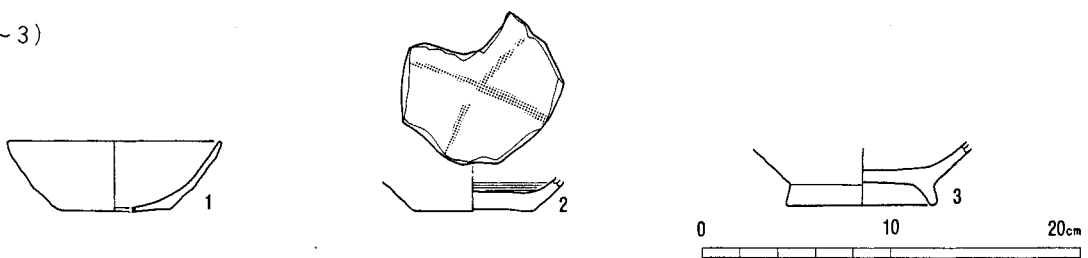

SB 234 (1~26)

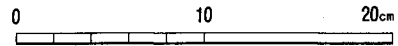
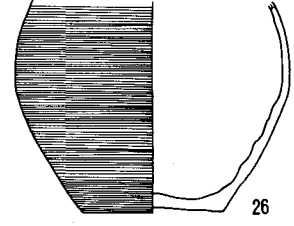
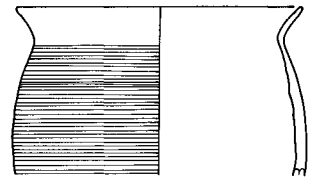
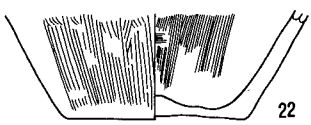
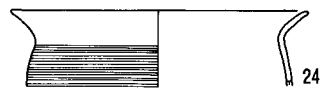
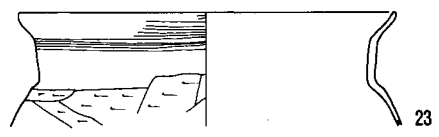
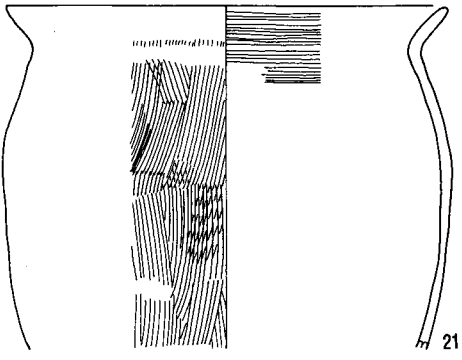
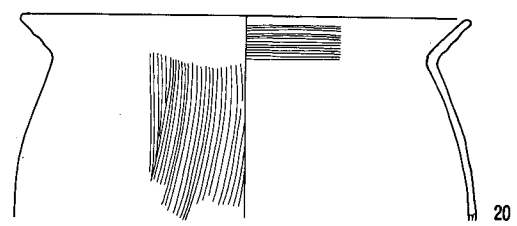
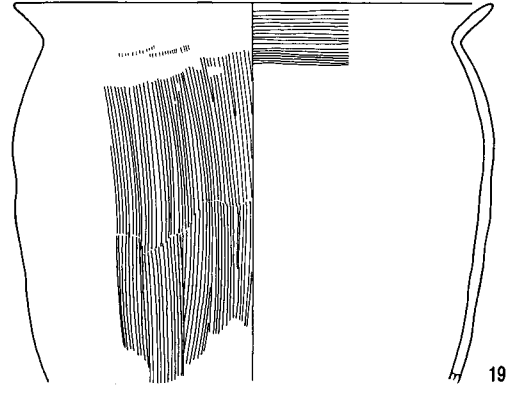
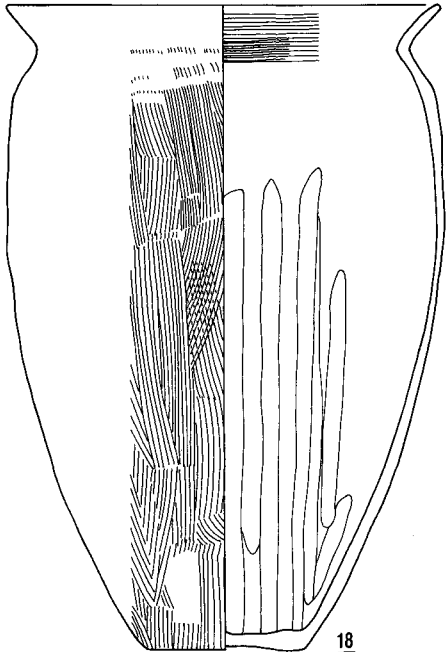
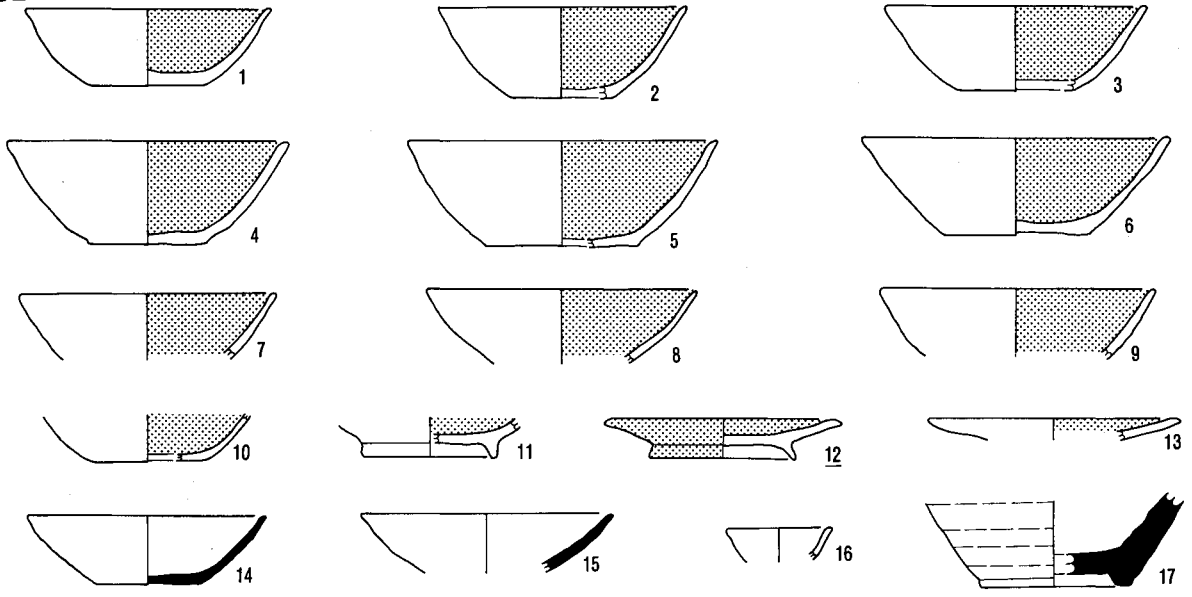

SB 235 (1~7)

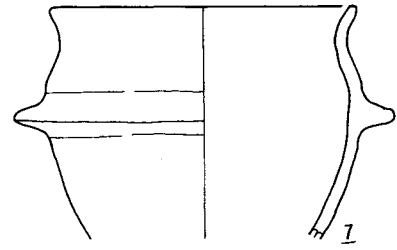
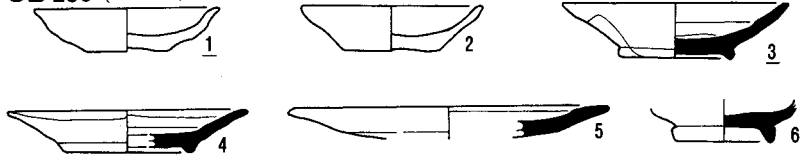

SB 236 (1~3)

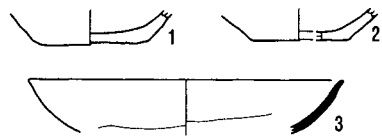

SB 237 (1~4)

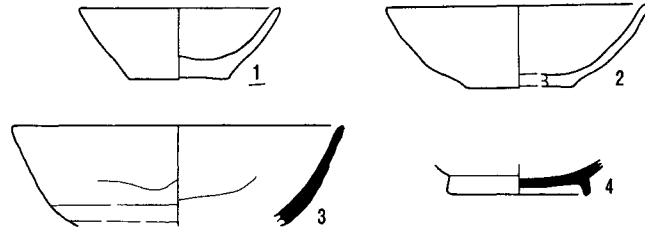

SB 238 (1)

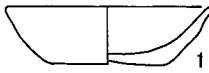

SB 239 (1)



SB 240 (1.2)

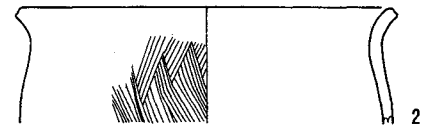

SB 241 (1.2)

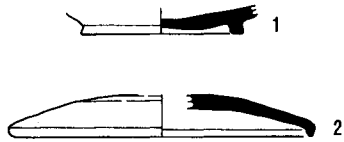

SB 242 (1~3)

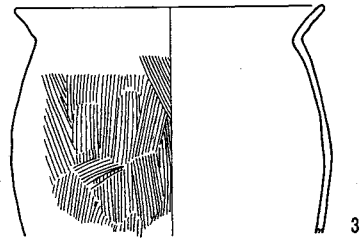
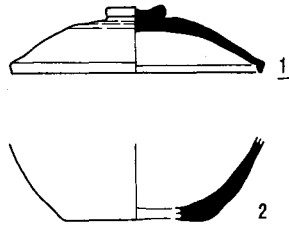

SB 243 (1~7)

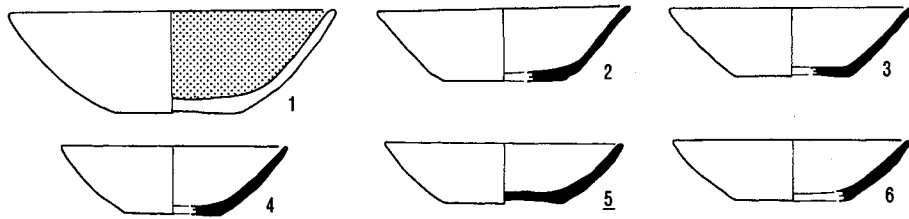

SB 244 (1~11)

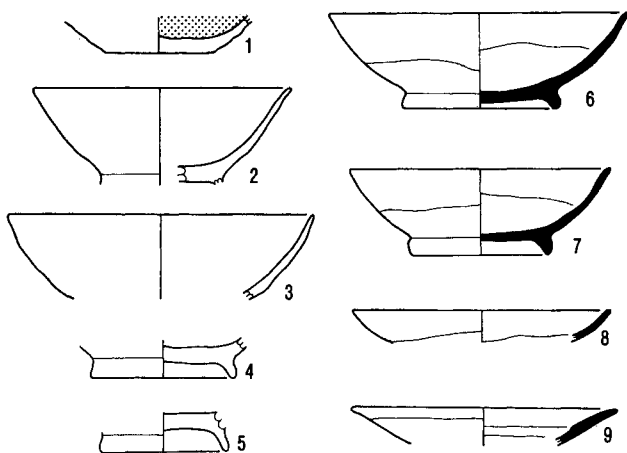

SB 245 (1.2)

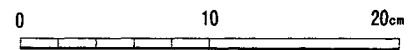
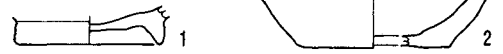

SB246 (1~16)

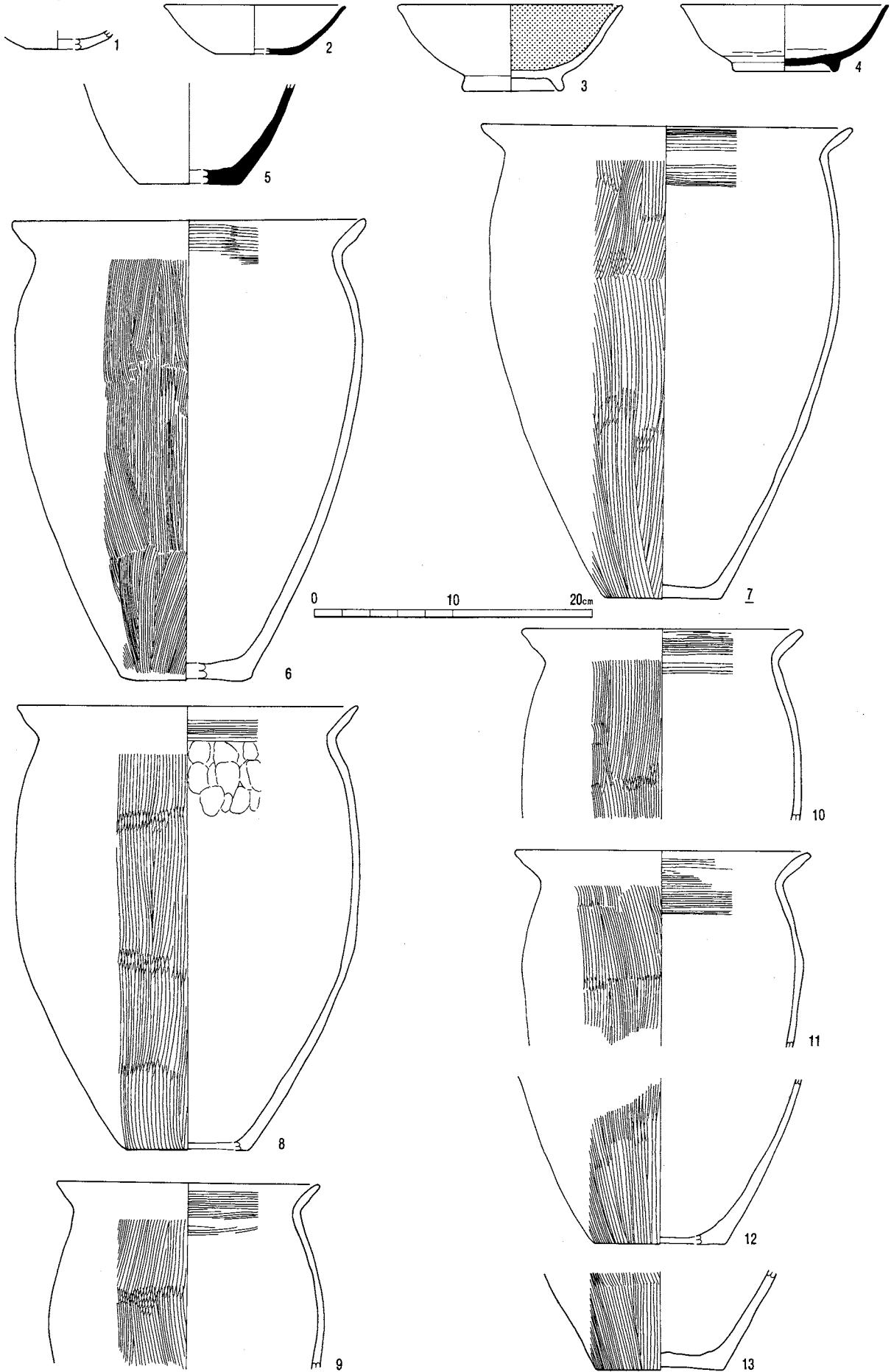

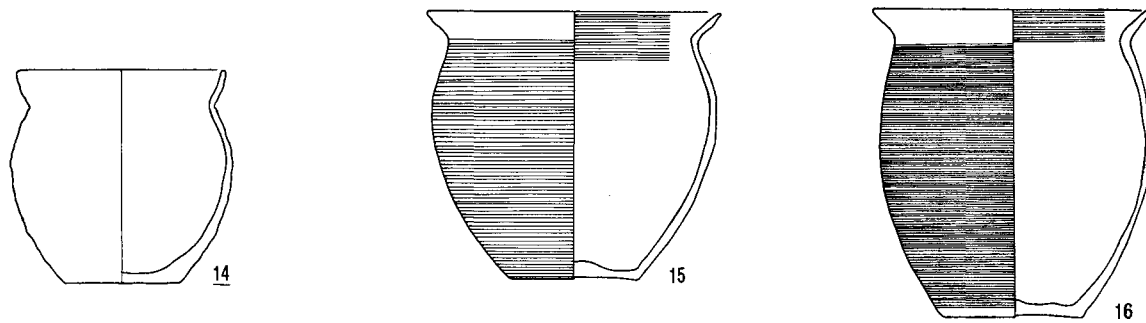

SB 247 (1~23)

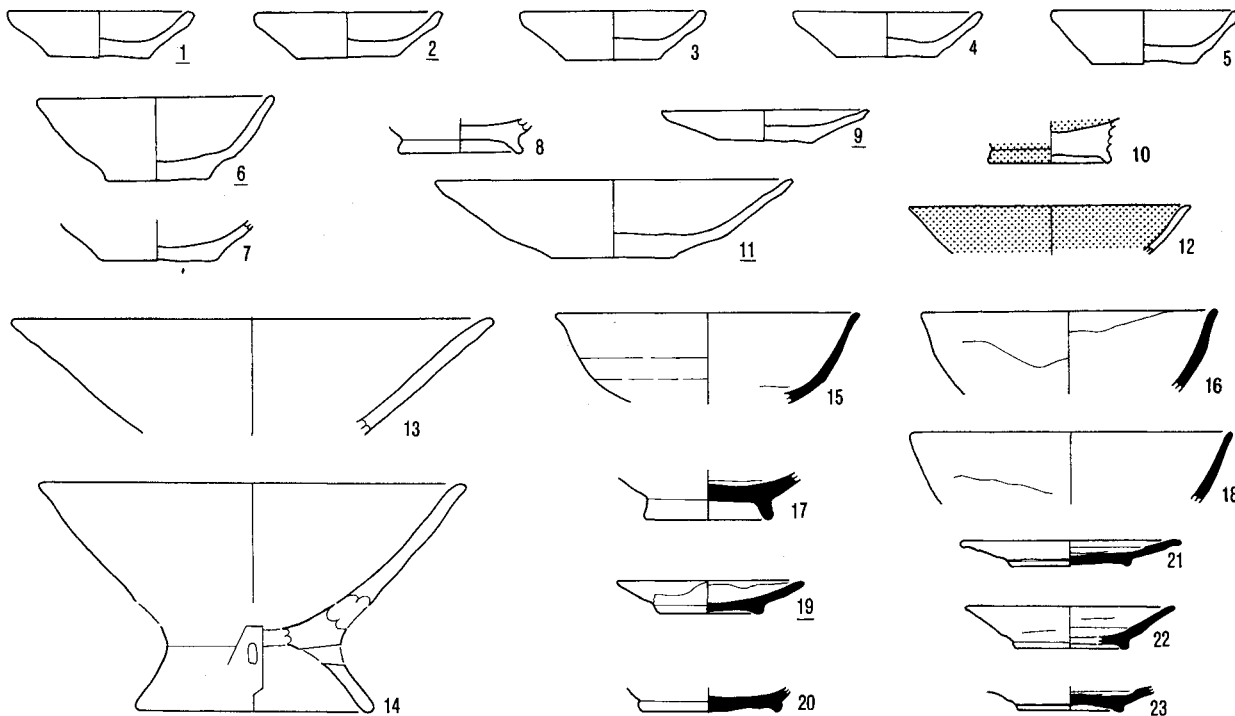

SB 248 (1~20)

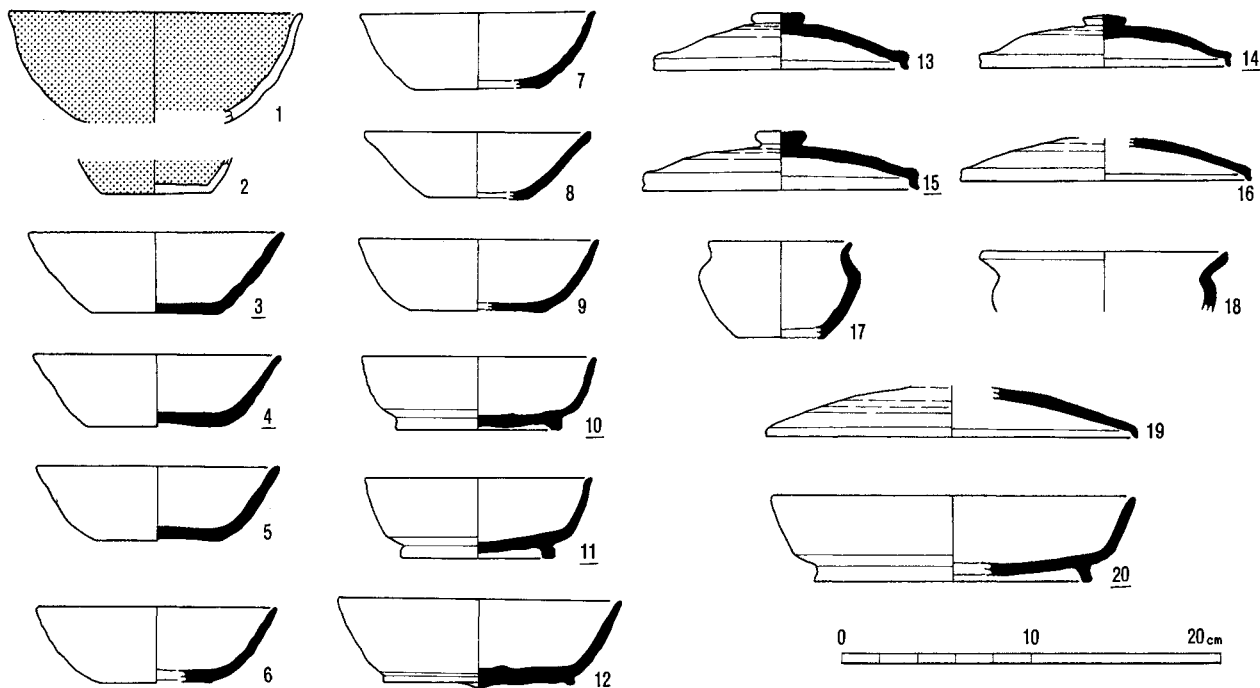

SB 249 (1~10)

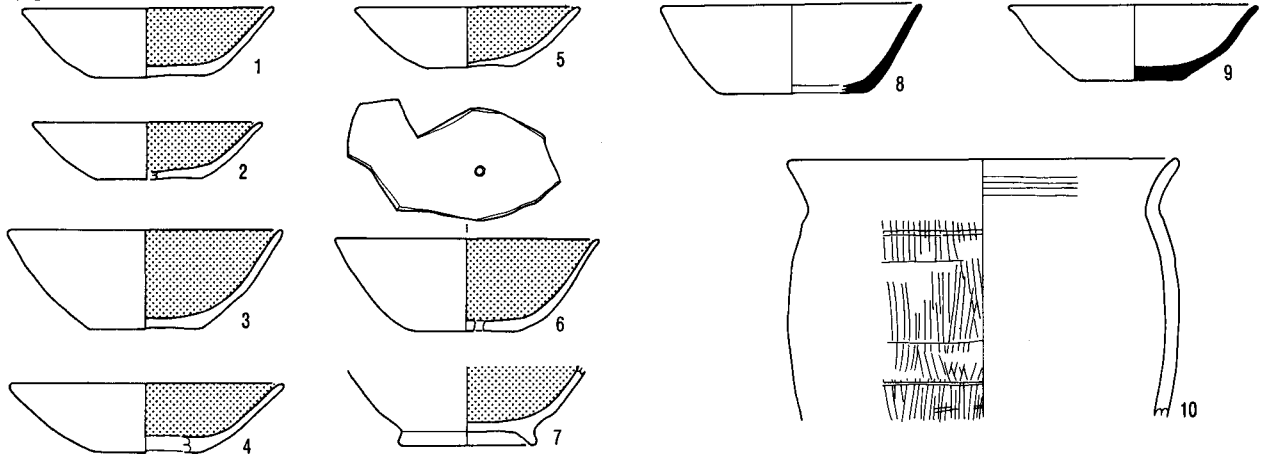

SB 250 (1~3)

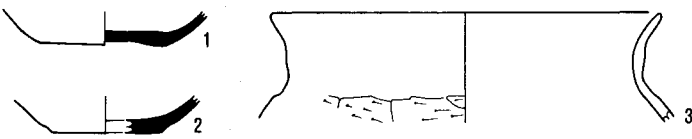

SB 251 (1.2)

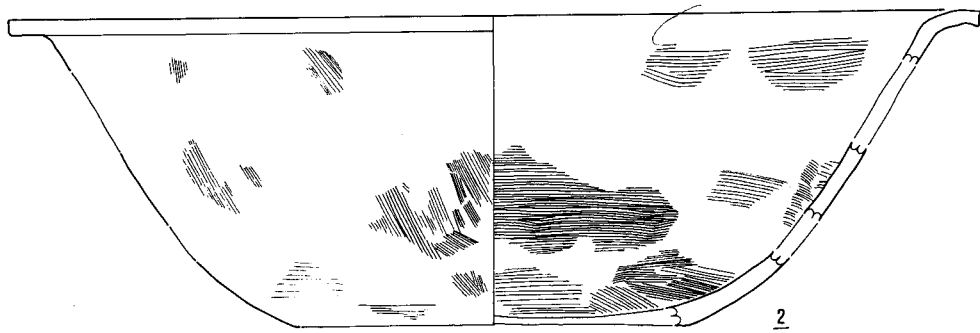
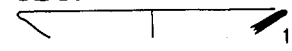

SB 252 (1~3)



SB 256 (1~15)

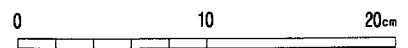
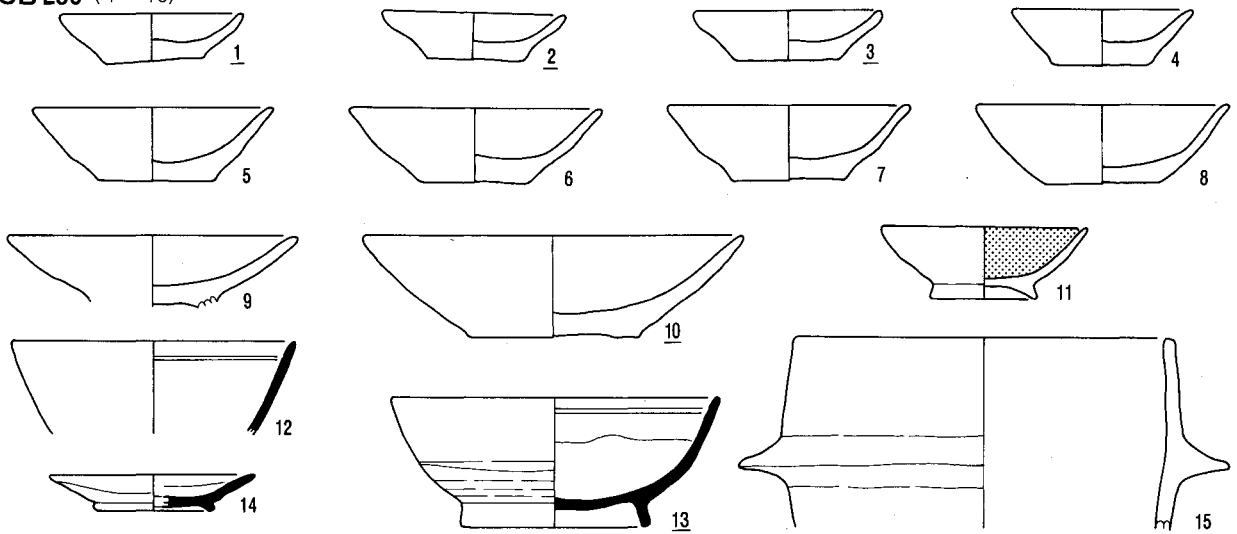

SB 258 (1~12)

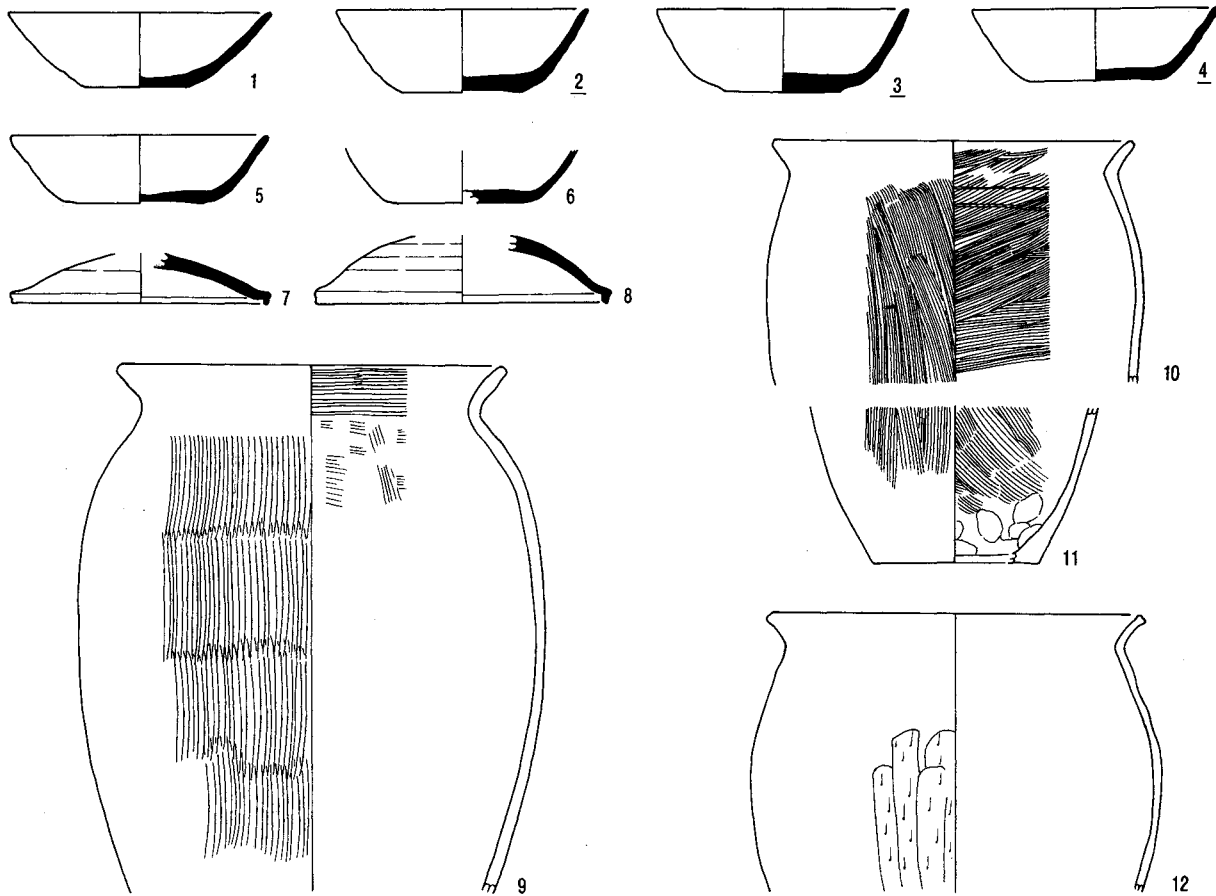

SB 259 (1~15)

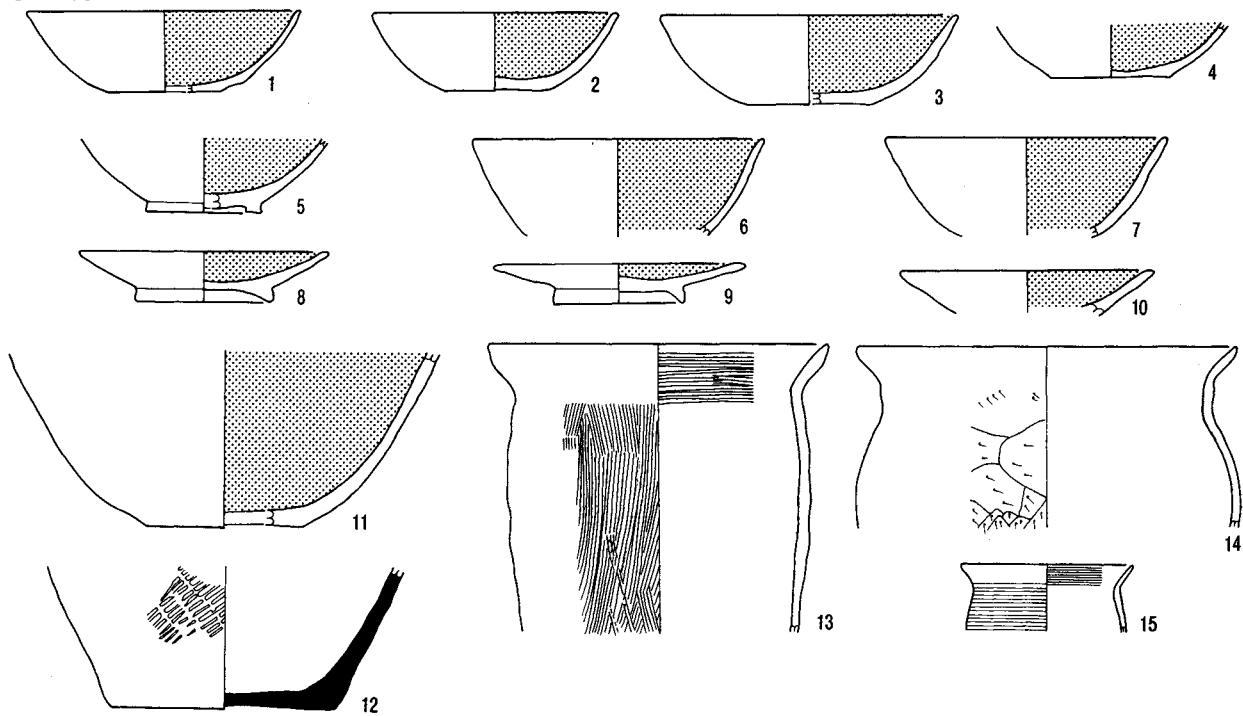

SB 260 (1~3)

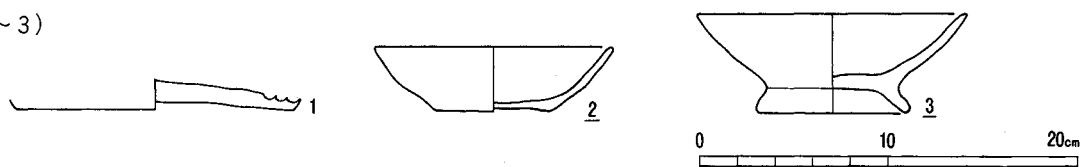

SB 261 (1.2)

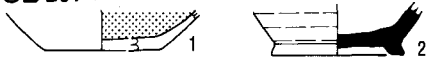

SB 262 (1~8)

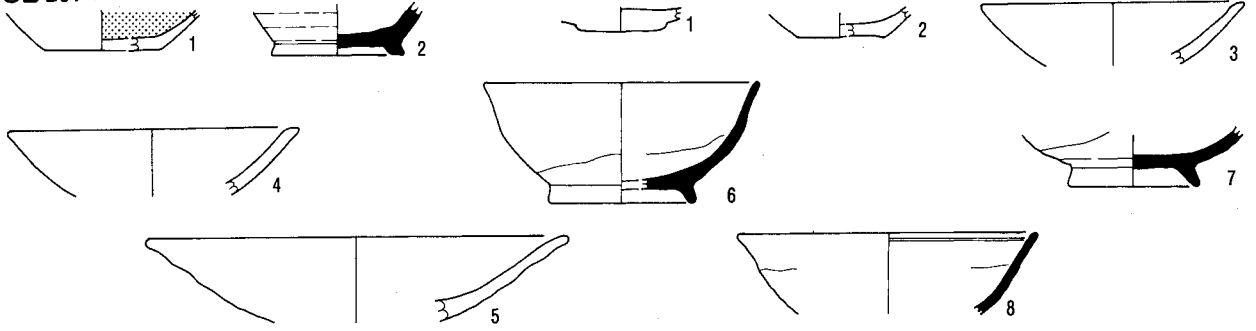

SB 263 (1~30)

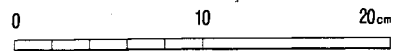
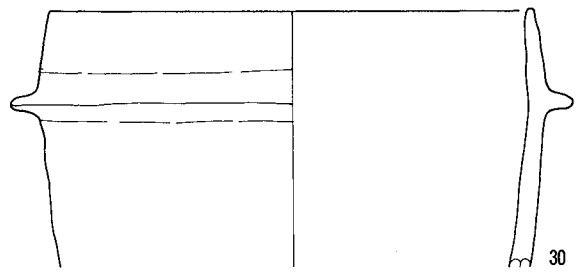
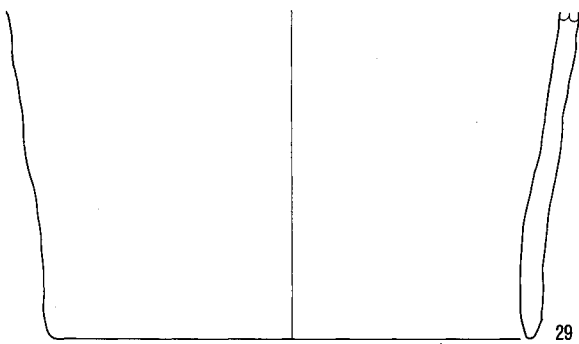
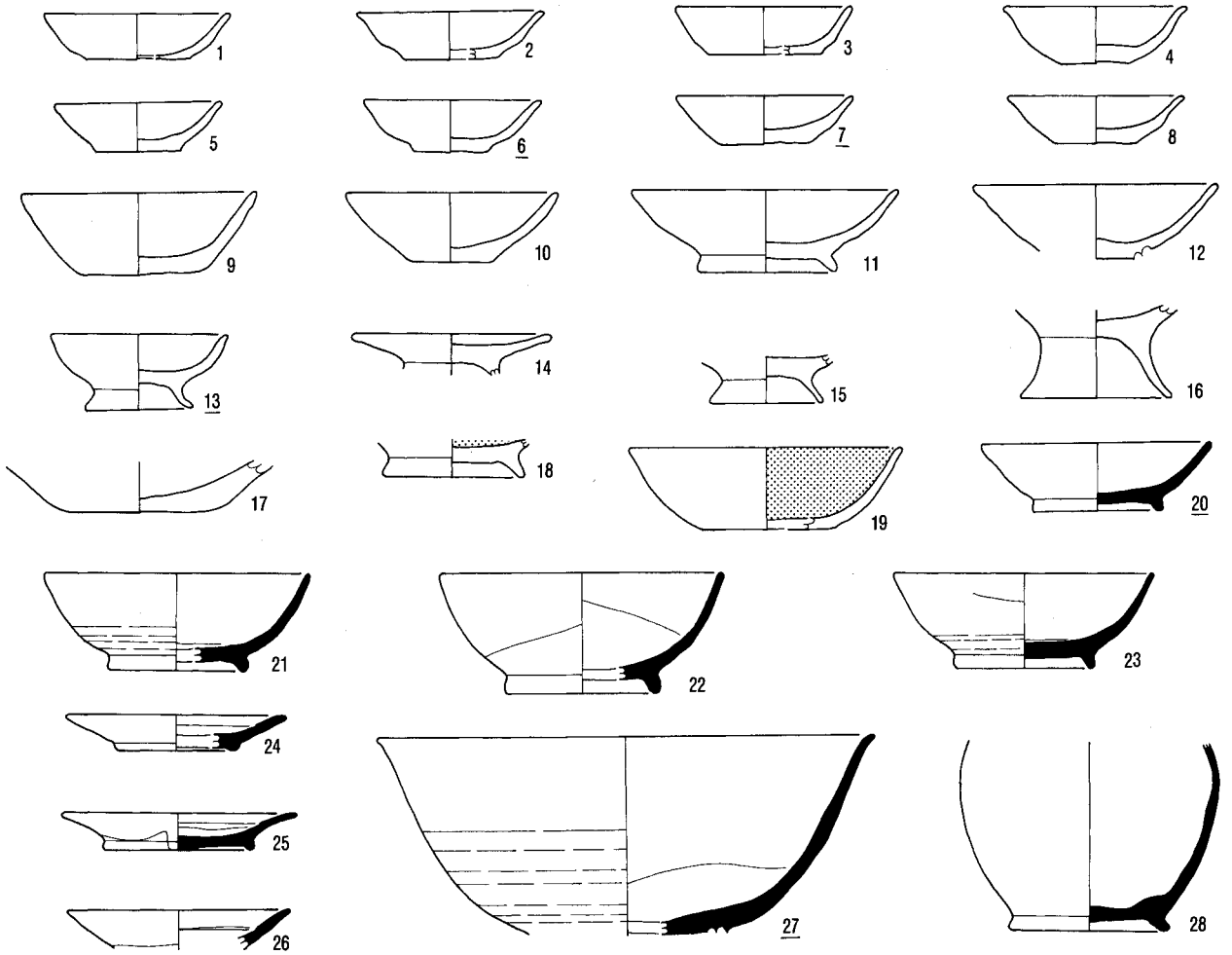

SB 264 (1~18)

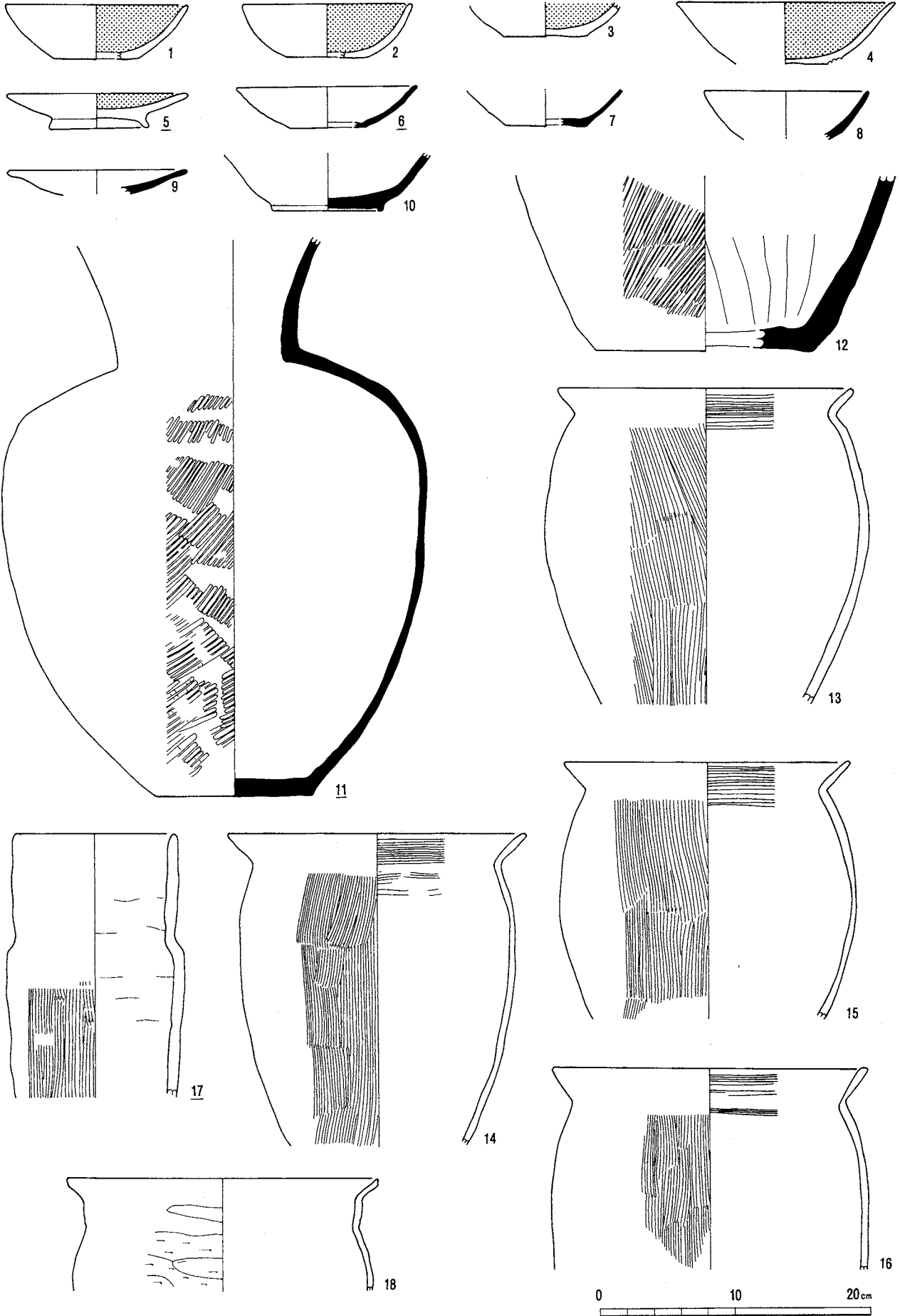

SB 265 (1~6)

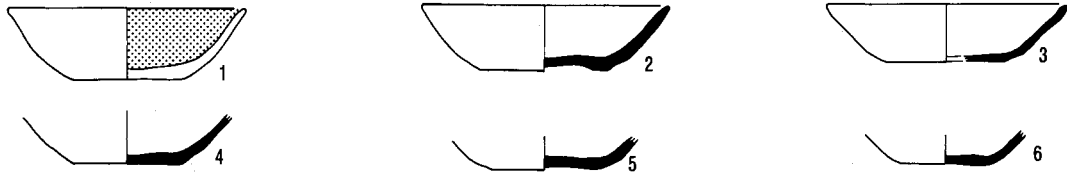

SB 266 (1~13)

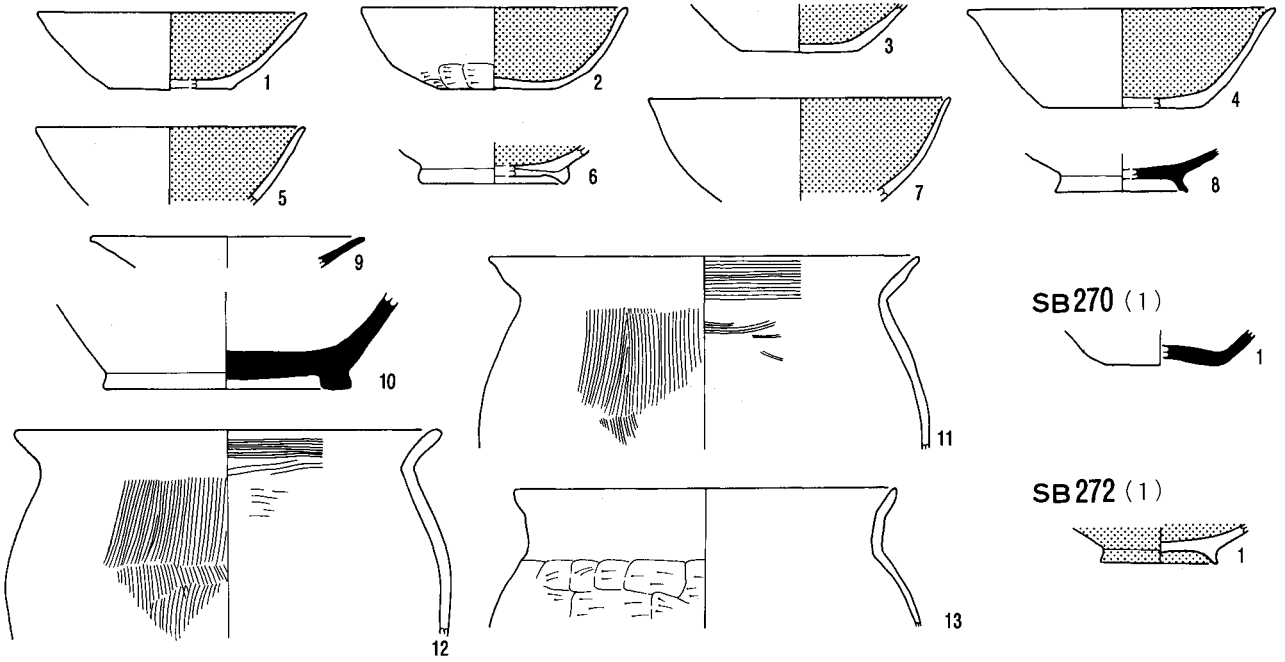

SB 270 (1)



SB 272 (1)



SB 267 (1.2)

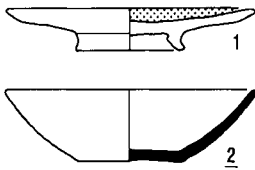

SB 269 (1.2)



SB 268 (1)



SB 271 (1~4)

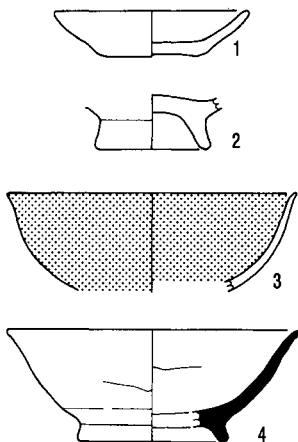

SB 26 (1)

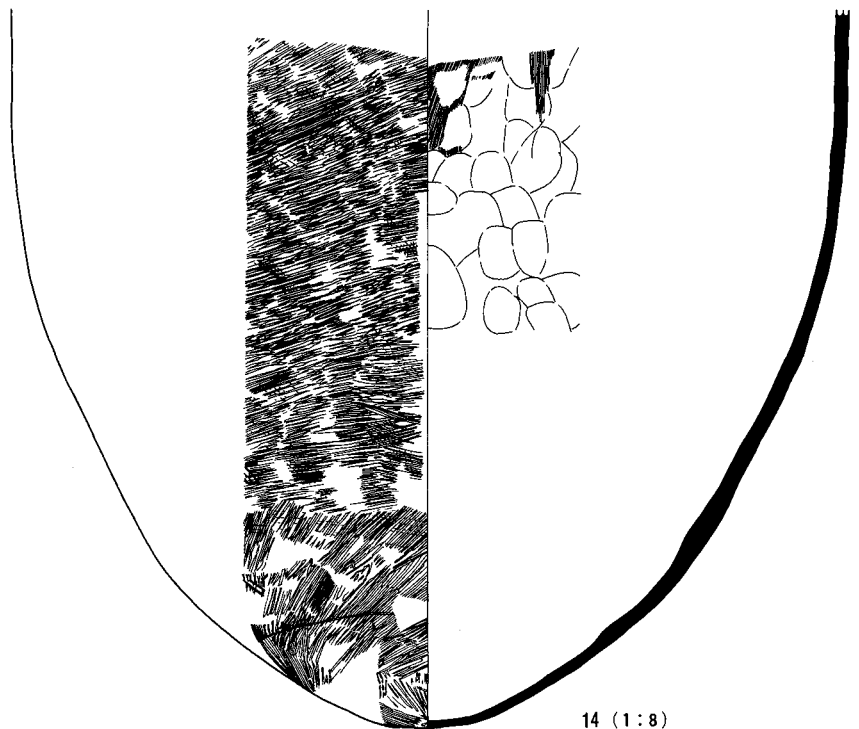

14 (1:8)

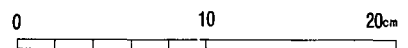

SK01 (1~3)

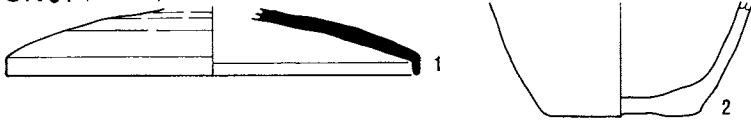

SK02 (1)

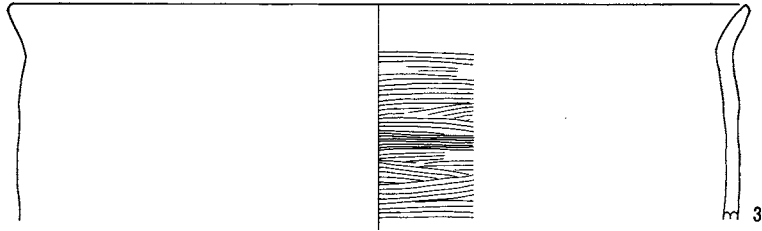

SK06 (1~4)

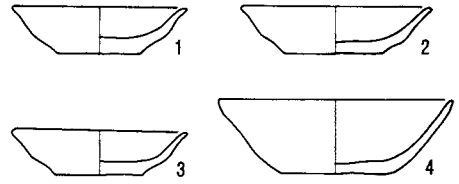

SK12 (1)

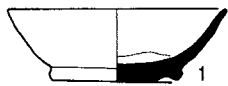

SK20 (1~3)



SK25 (1)



SK26 (1~10)

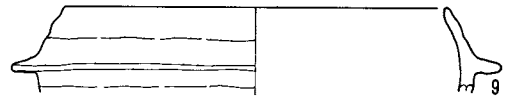
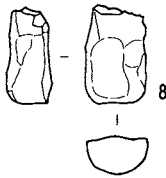
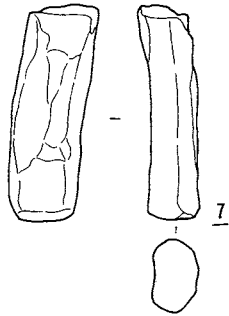
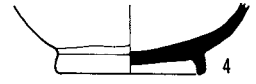
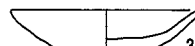

SK27 (1.2)

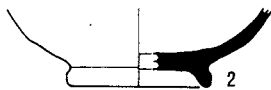
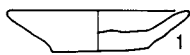

SK42 (1~3)

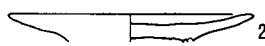
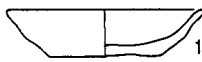

SK43 (1~5)

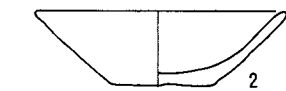
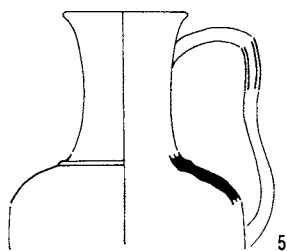
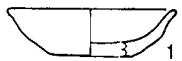

SK47 (1)

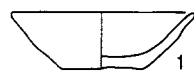

SK34 (1)

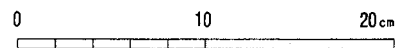
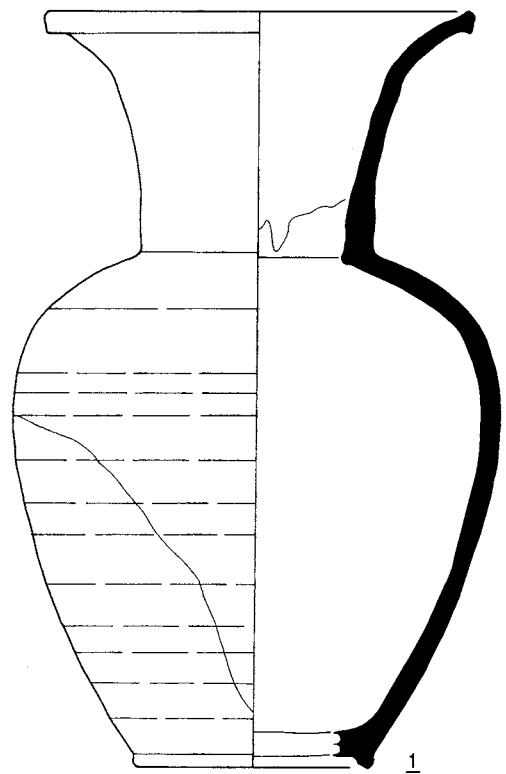

SK 49 (1.2)

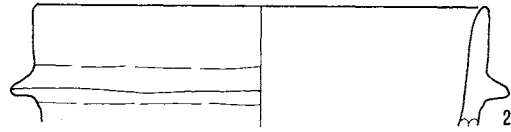
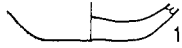

SK 51 (1~6)

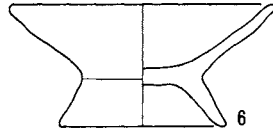
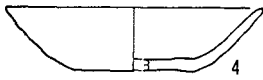
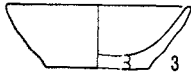

SK 64 (1~7)



SK 67 (1)

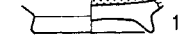

SK 73 (1)

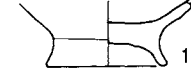

SK 66 (1.2)

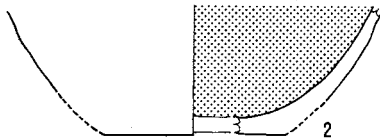
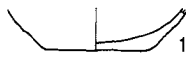

SK 68 (1~3)

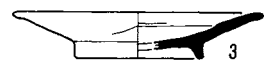
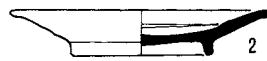

SK 85 (1)

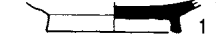

SK 87 (1)

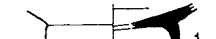

SK 88 (1)

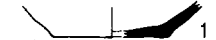

SK 84 (1~6)

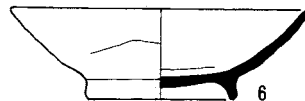
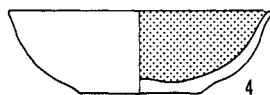
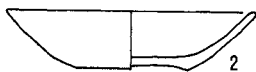
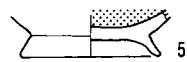
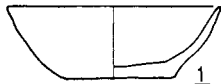

SK 97 (1)



SK 90 (1)

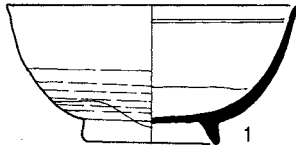

SK 91 (1~4)

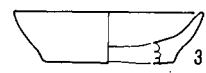
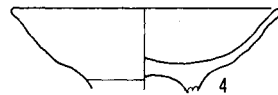
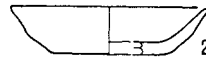

SK 100 (1.2)

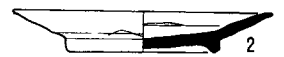
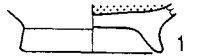

SK 102 (1~5)

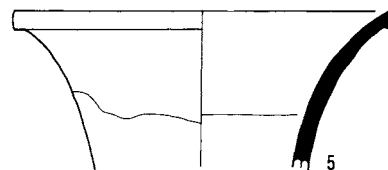
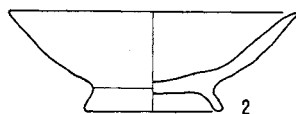

SK 101 (1~4)

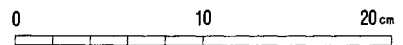
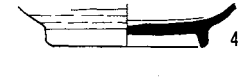

SK 103 (1~3)

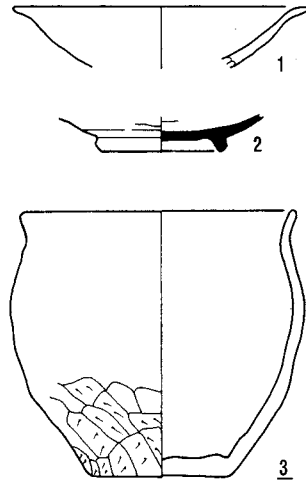

SK 107 (1~6)

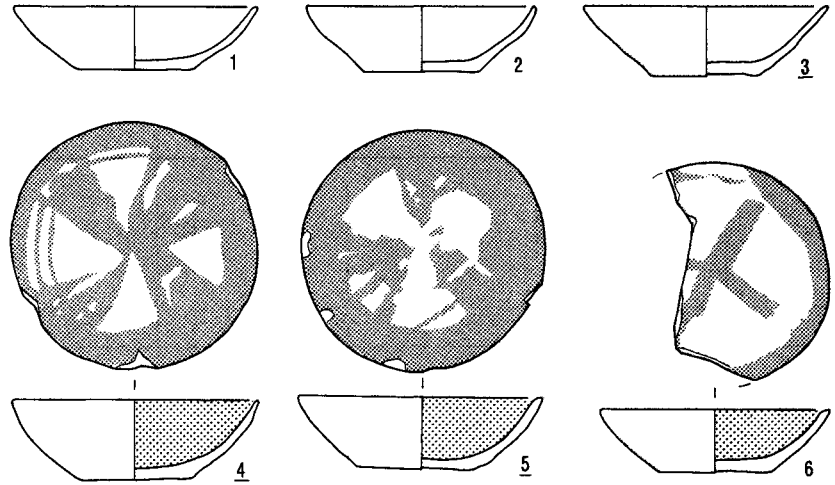

SK 104 (1)

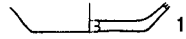

SK 118 (1~10)

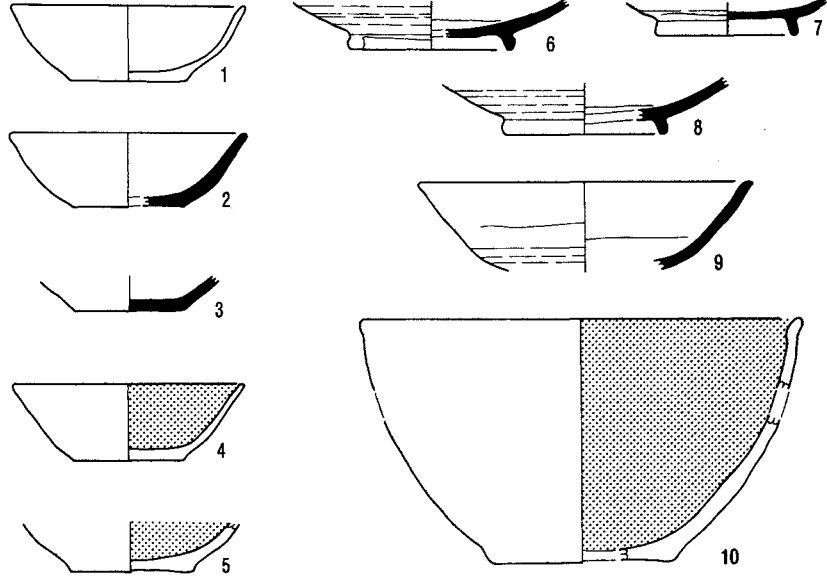

SK 112 (1.2)

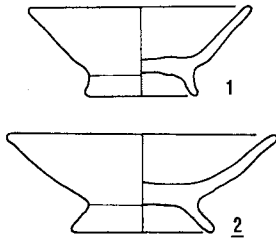

SK 115 (1)

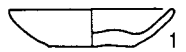

SK 117 (1)

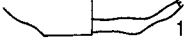

SK 120 (1~4)



SK 122 (1~30)

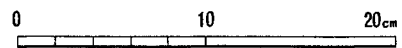
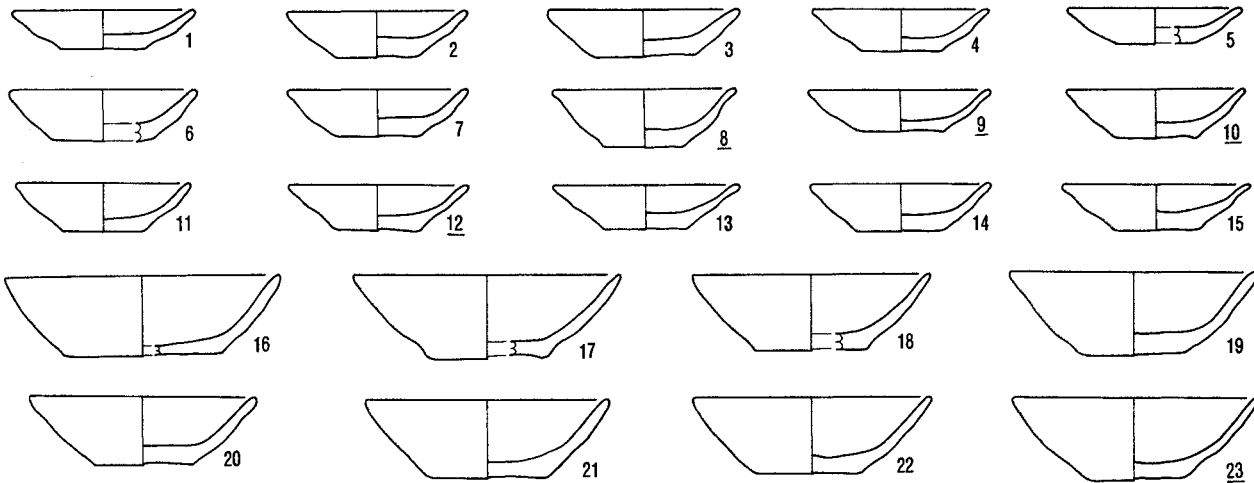

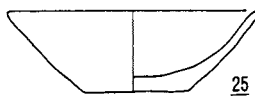
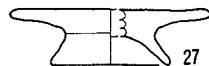
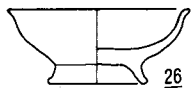

SK 126 (1~7)

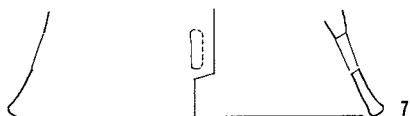
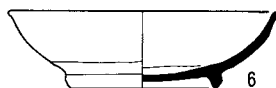
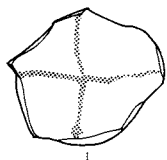
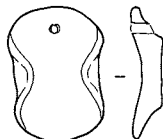
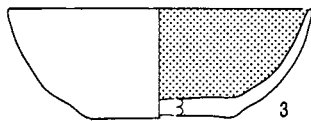

SK 129 (1~6)

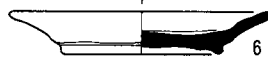
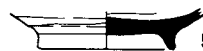
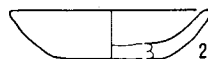
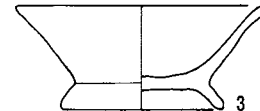

SK 141 (1)

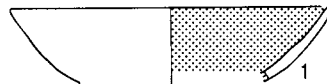

SK 146 (1)

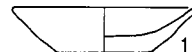

SK 132 (1~11)

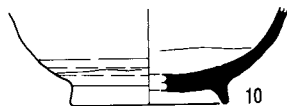
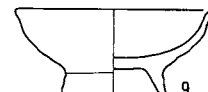
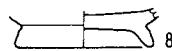
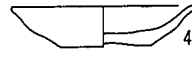
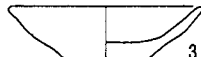
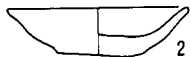
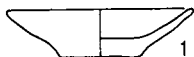

SK 148 (1.2)

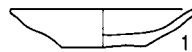

SK 151 (1.2)

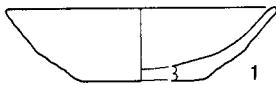

SK 154 (1.2)

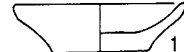

SK 155 (1~7)

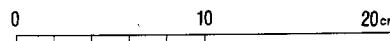
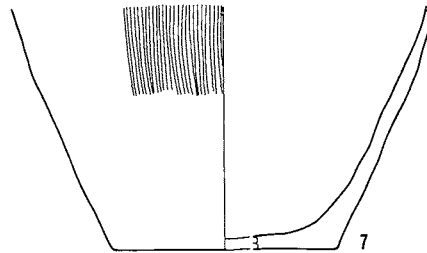
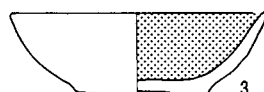
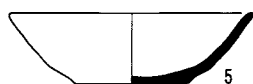
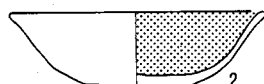
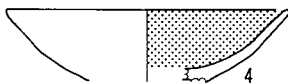
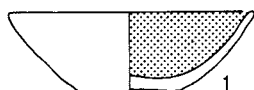

SK 158 (1)

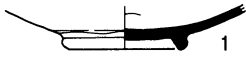

SK 182 (1.2)



SK 202 (1~5)

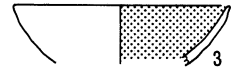
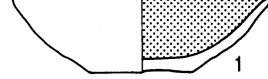

SK 167 (1.2)

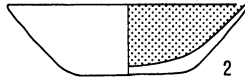
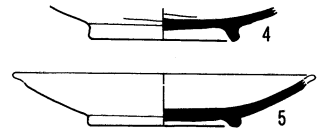
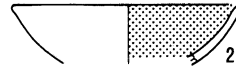
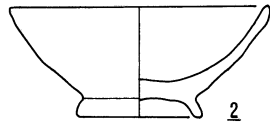
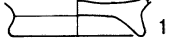

SK 188 (1)

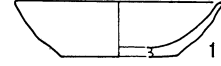

SK 204 (1~16)

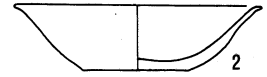
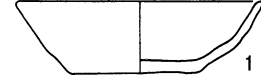

SK 178 (1~3)

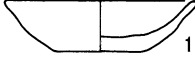

SK 187 (1.2)

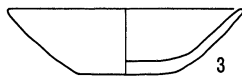
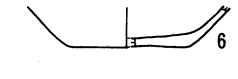
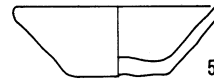
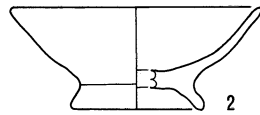
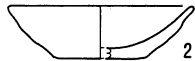
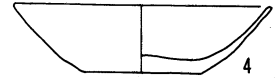
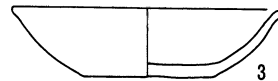
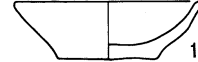

SK 199 (1)

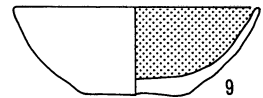
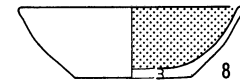
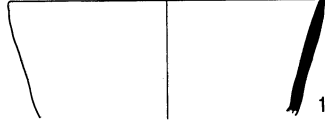

SK 203 (1~5)

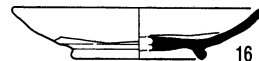
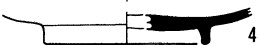
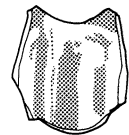
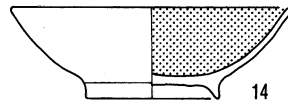
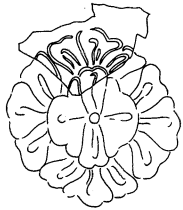
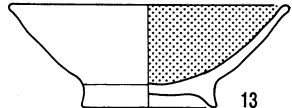
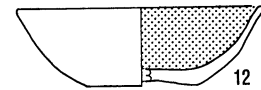
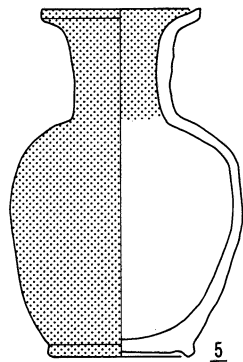
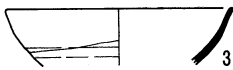
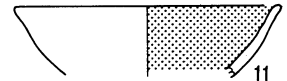
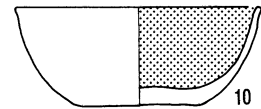

SK 209 (1~4)

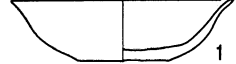

SK 211 (1~14)

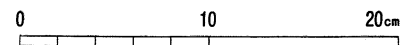
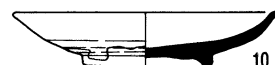
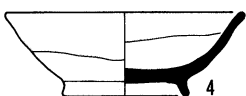
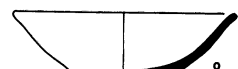
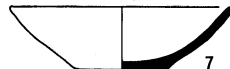
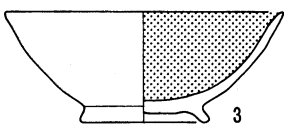
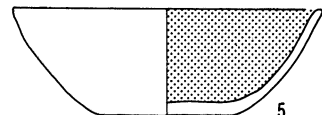
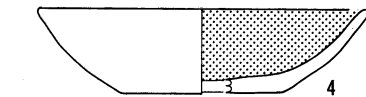
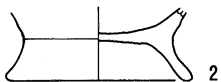
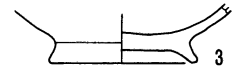
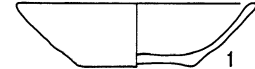

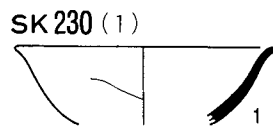
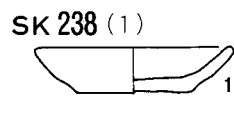
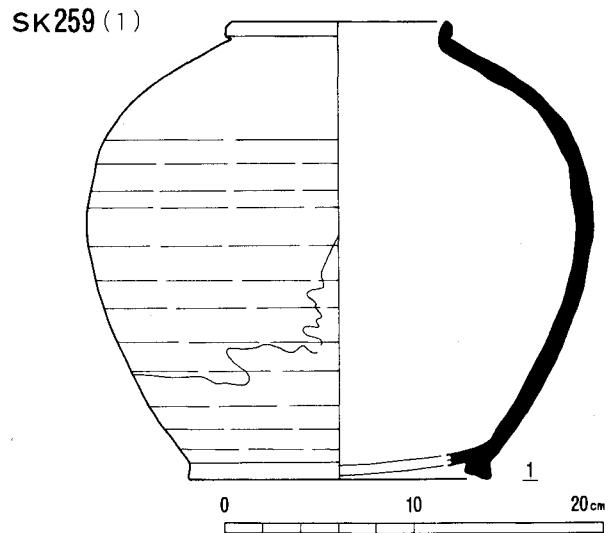
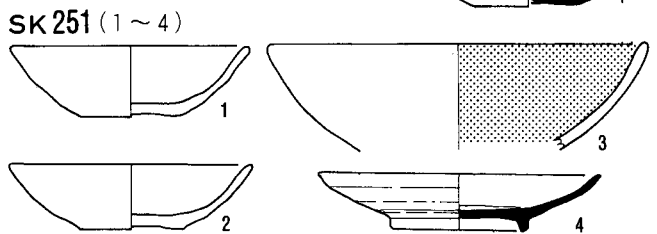
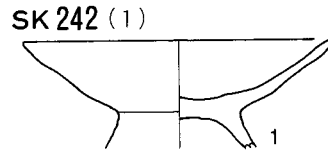
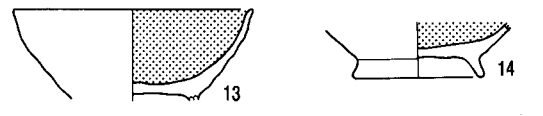
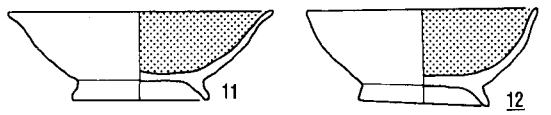
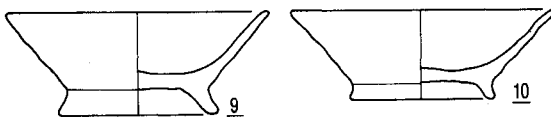
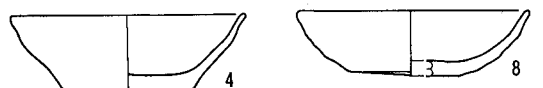
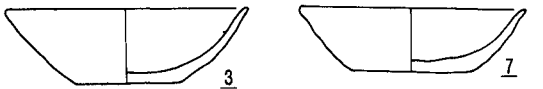
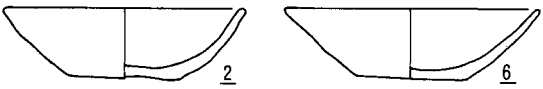
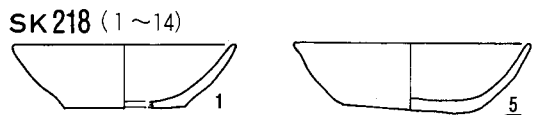
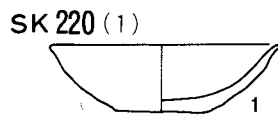
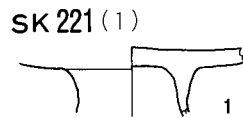
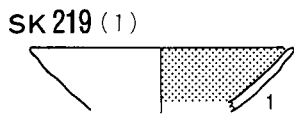
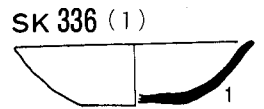
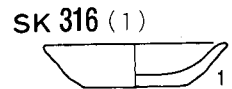
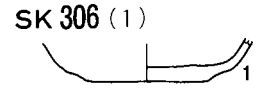
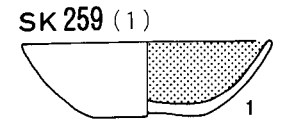
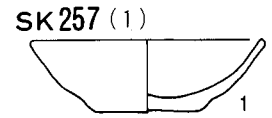
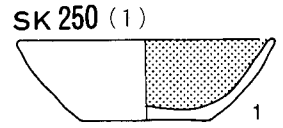
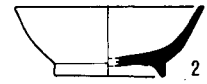
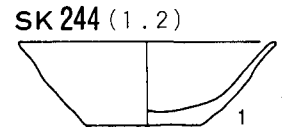
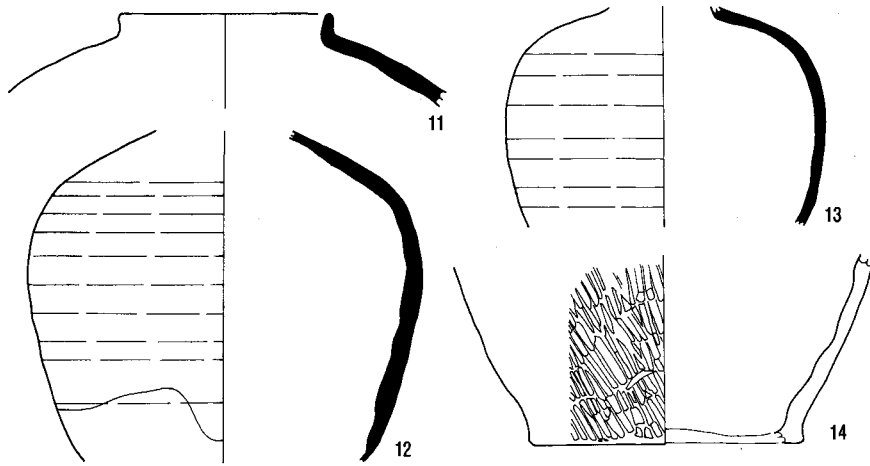

SK 128 (1~25)

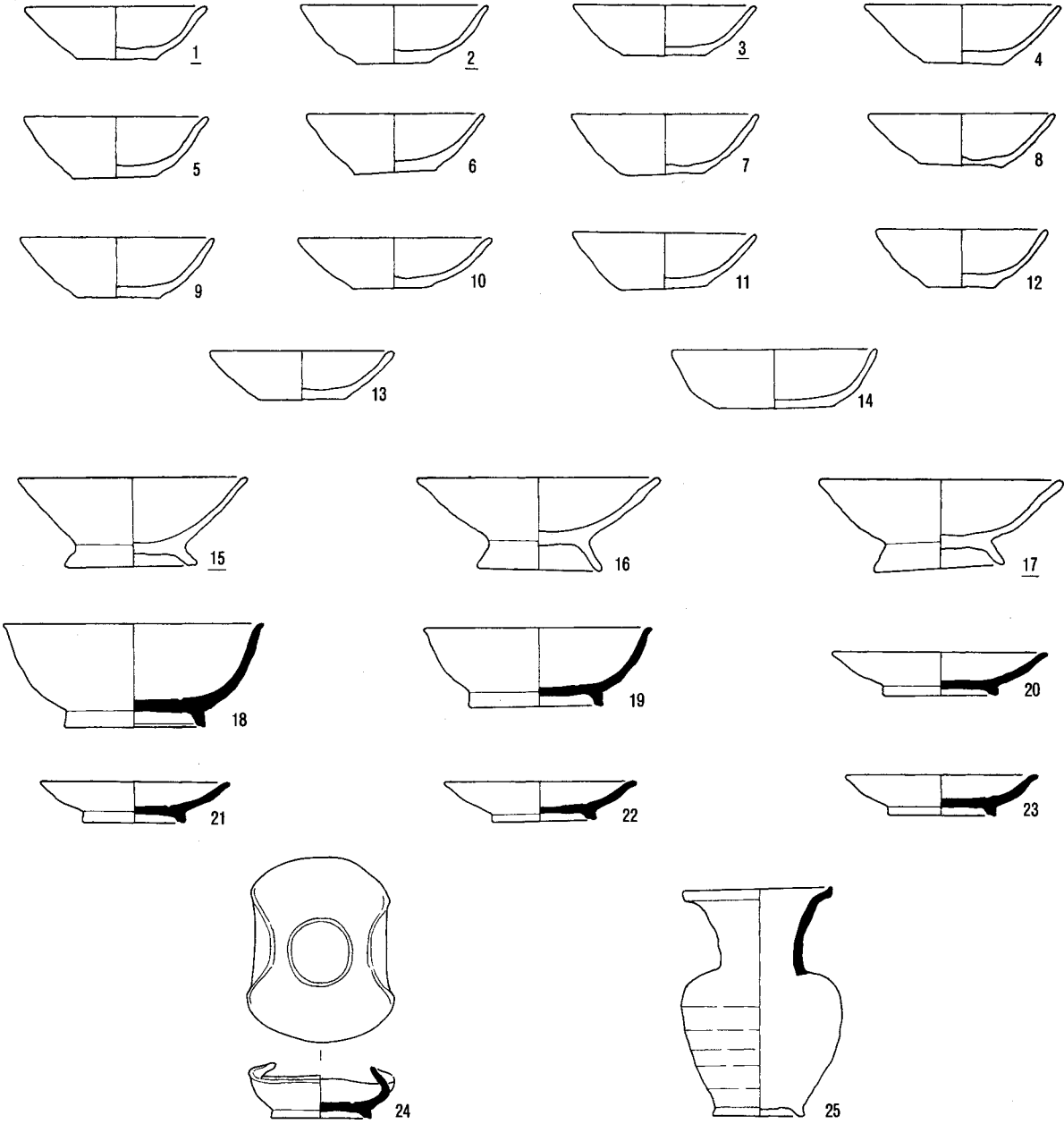

SM01 (1)

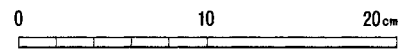
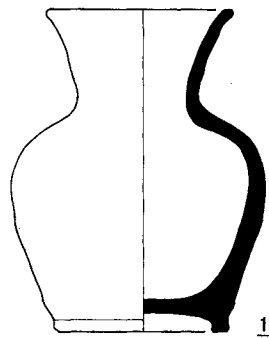

SD01 (1.2)

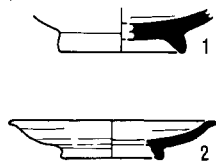

SD02 (1.2)

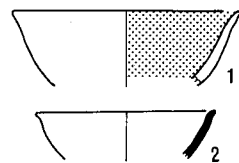

SD03 (1~14)

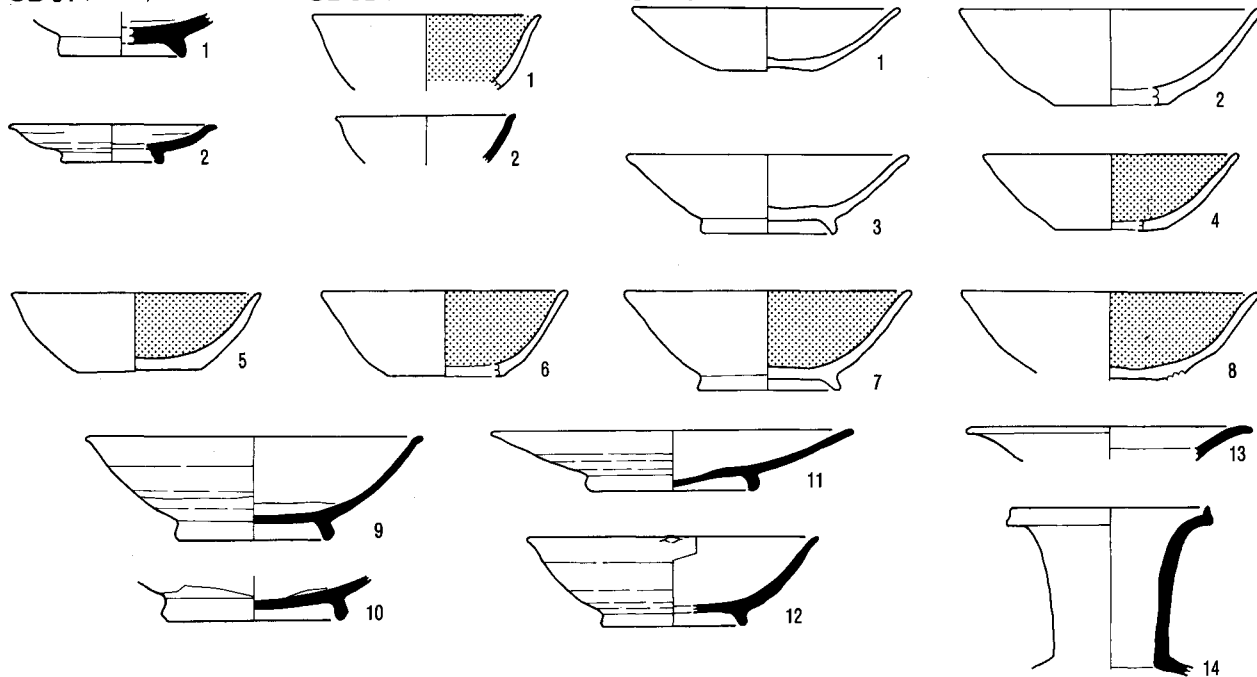

SD06 (1~8)

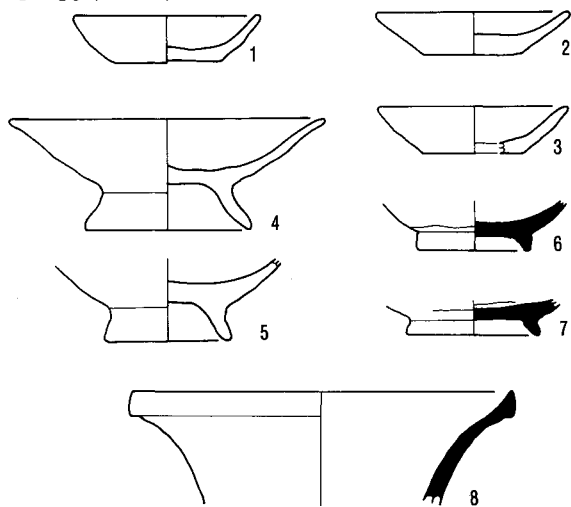

SD07 (1)

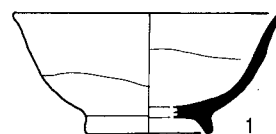

SD08 (1~9)

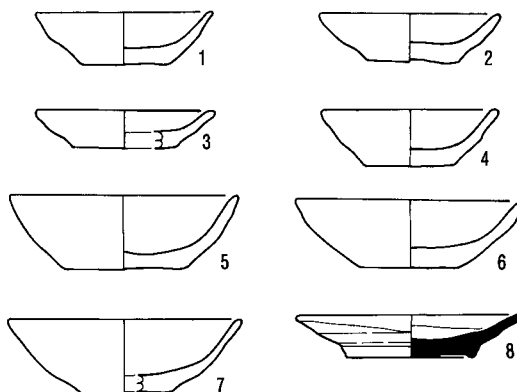

SD09 (1)



SD10 (1~4)

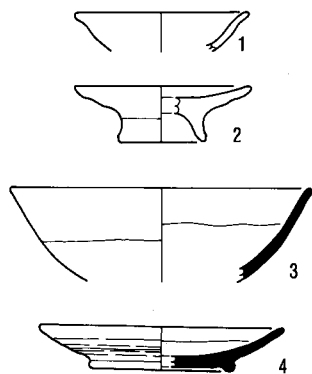

SD13 (1~3)

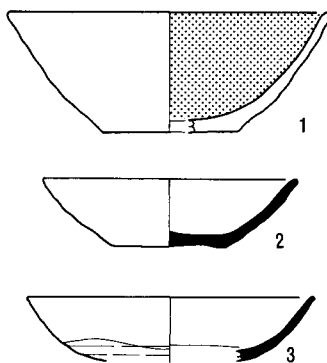

SD15 (1.2)

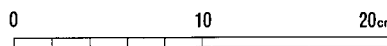
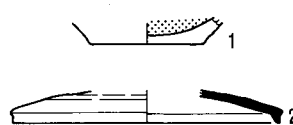

SD17 (1~65)

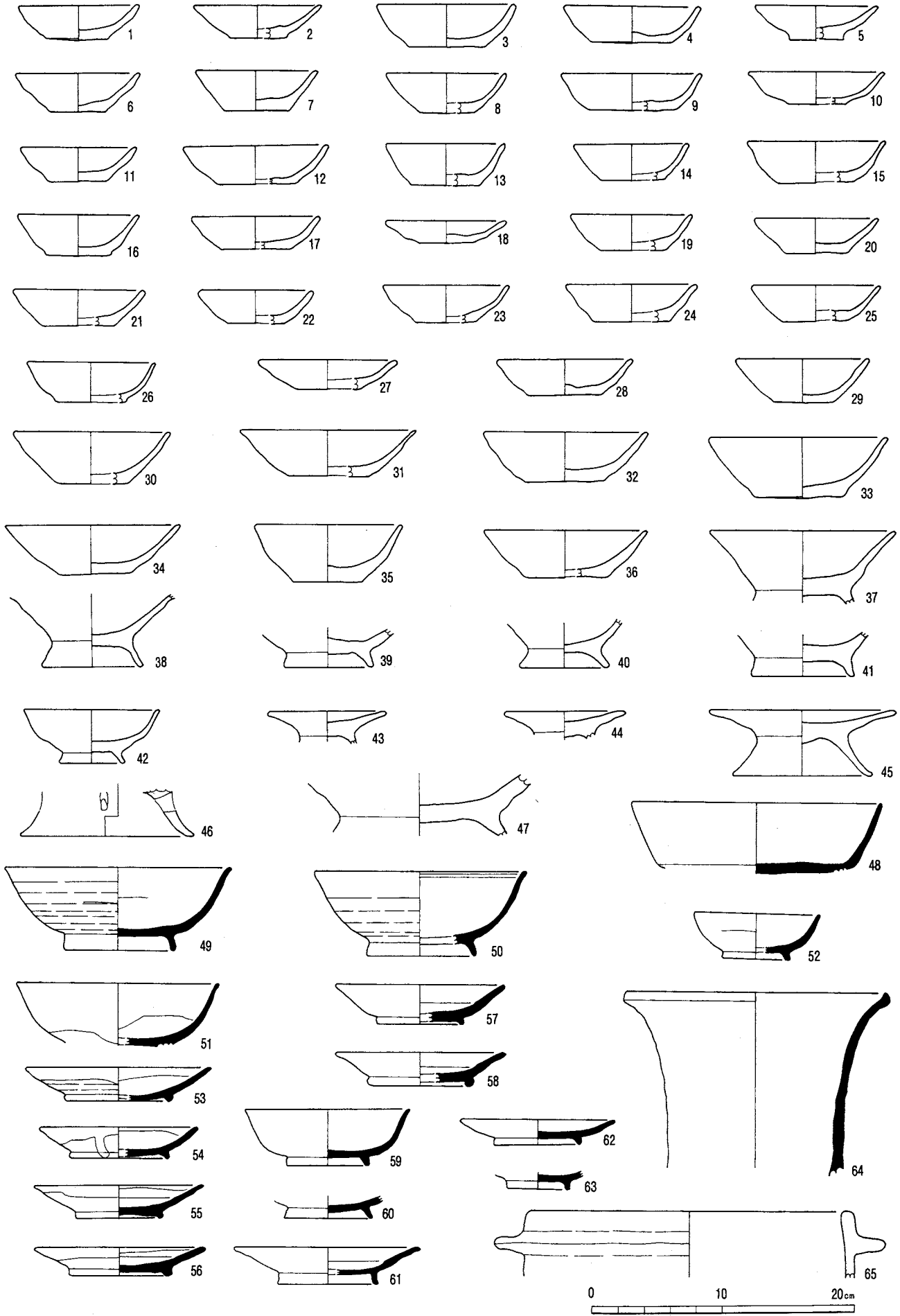

SD18 (1~10)

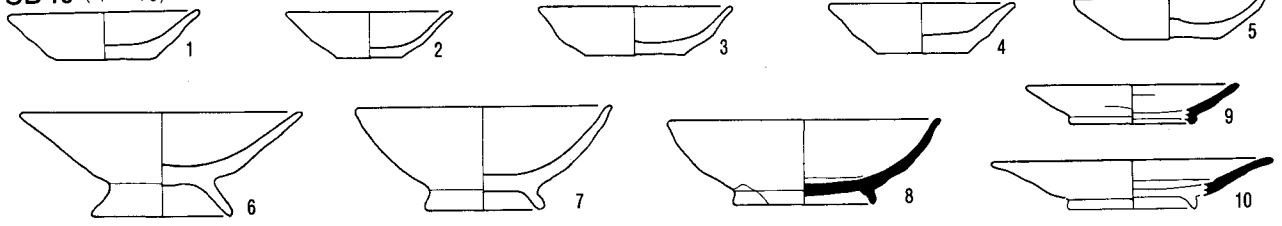

SD19 (1~9)

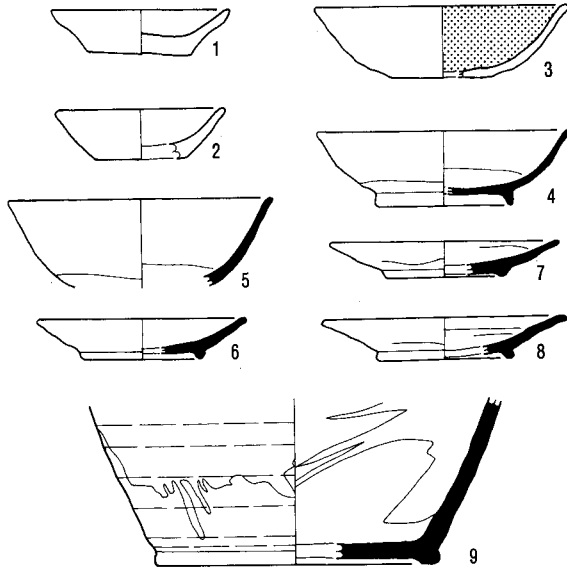

SD25 (1~18)

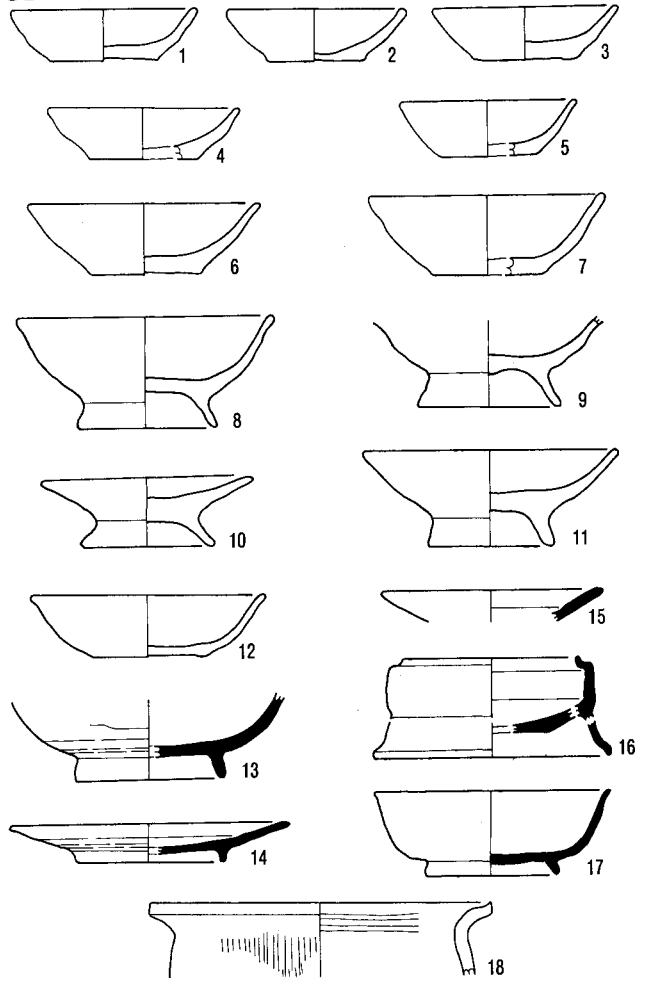

SD23 (1~4)

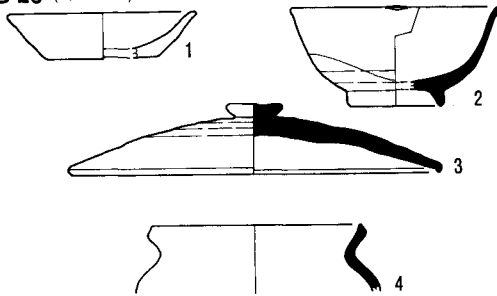

SD27 (1)

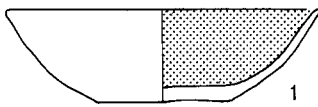

SD28 (1~3)

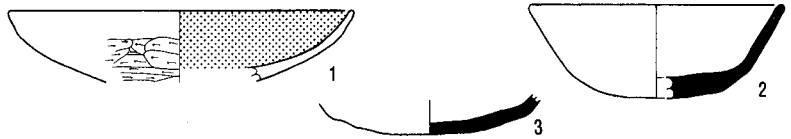

NR01 (1~3)

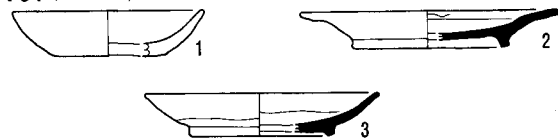

NR07 (1.2)

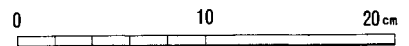
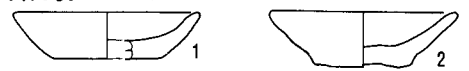

ST 203 (1)

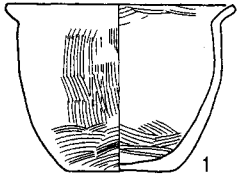

SX 21 (1~54)

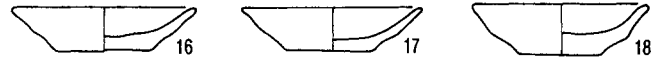
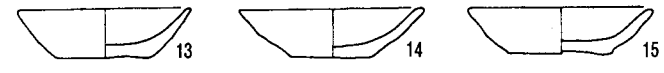

SX 20 (1~5)

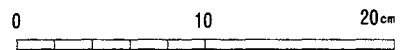
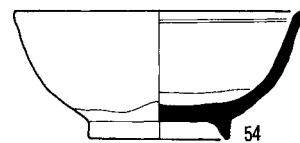
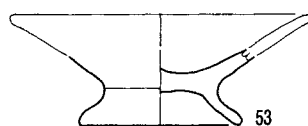
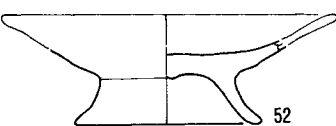
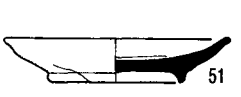
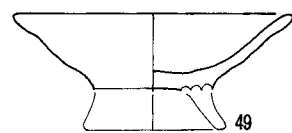
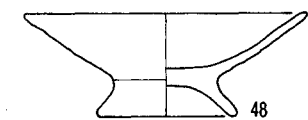
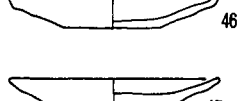
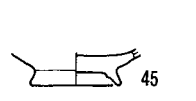
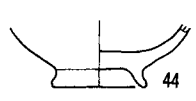
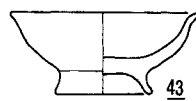
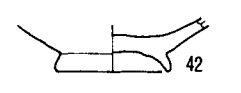
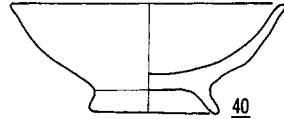
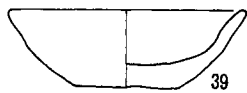
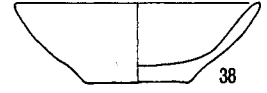
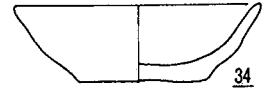
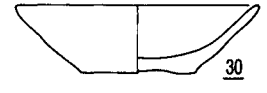
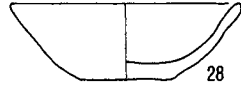
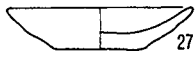
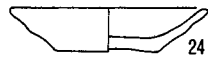
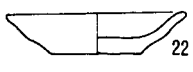
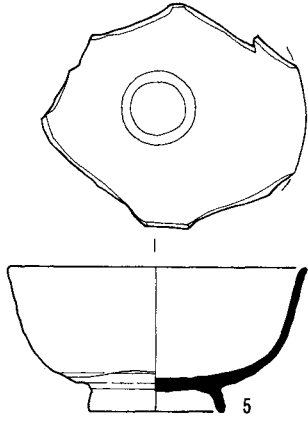
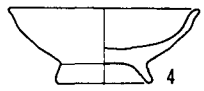
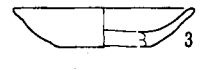
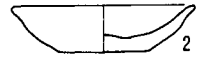

F地区 (1~8)

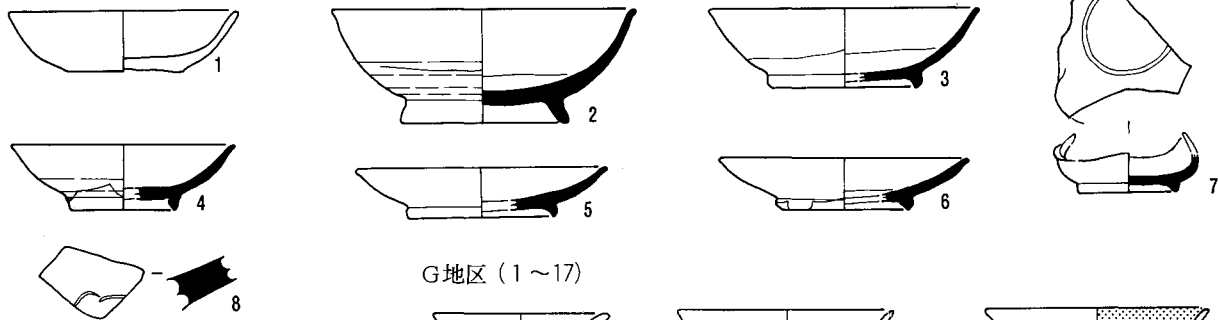

G地区 (1~17)

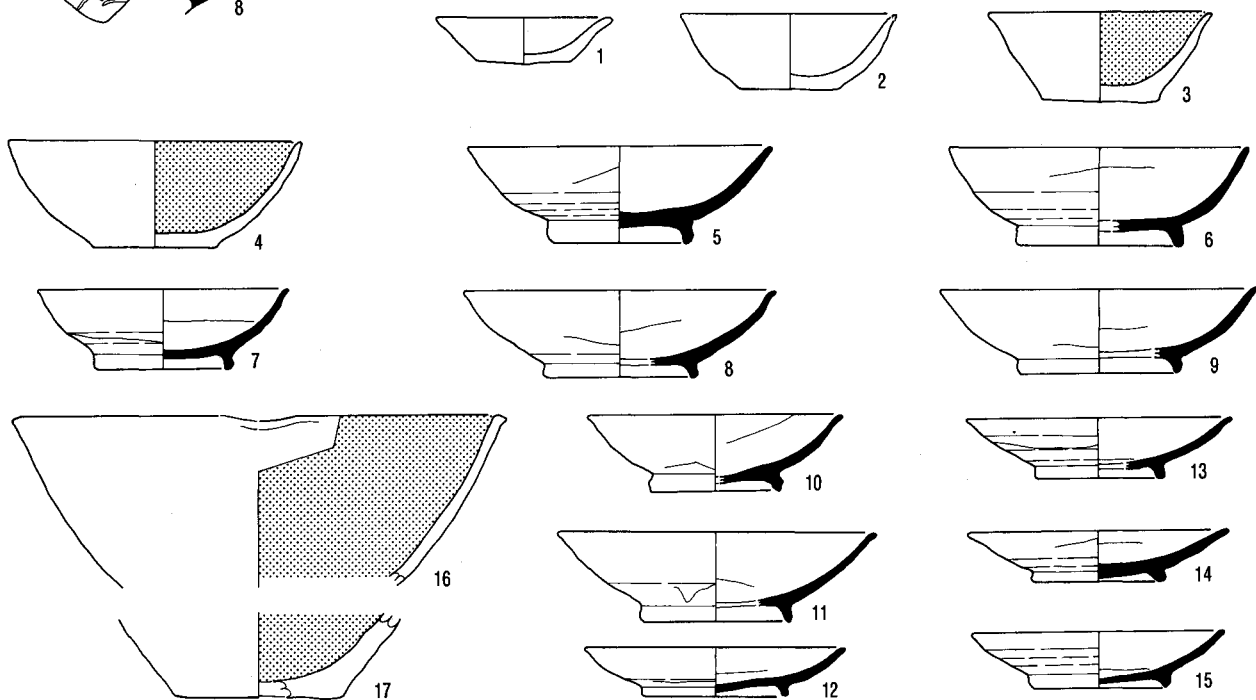

H地区 (1~17)

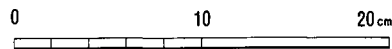
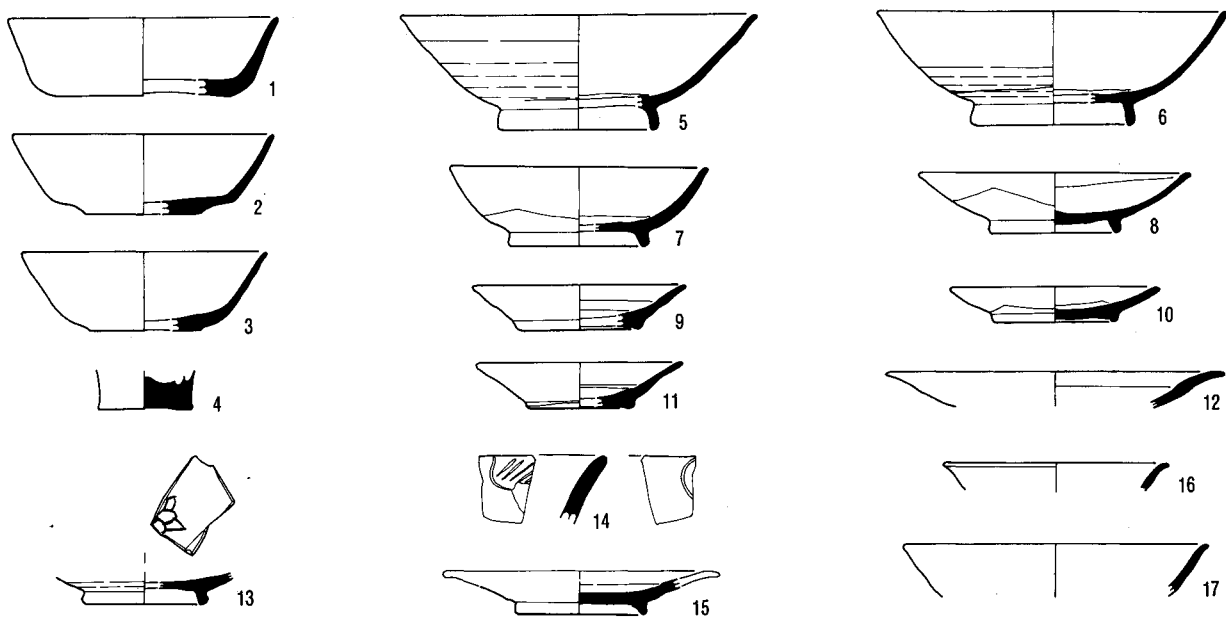

I地区 (1~14)

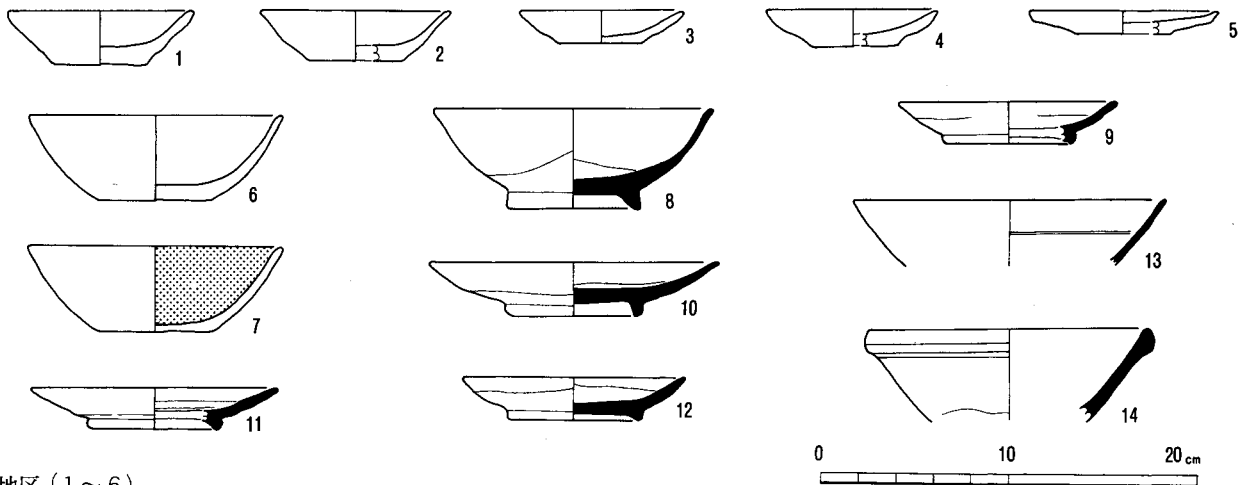

K地区 (1~6)

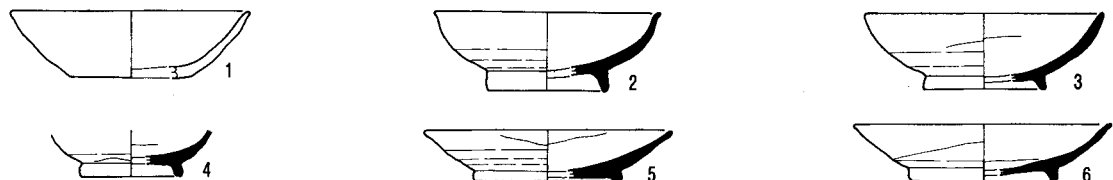

L地区 (1~28)

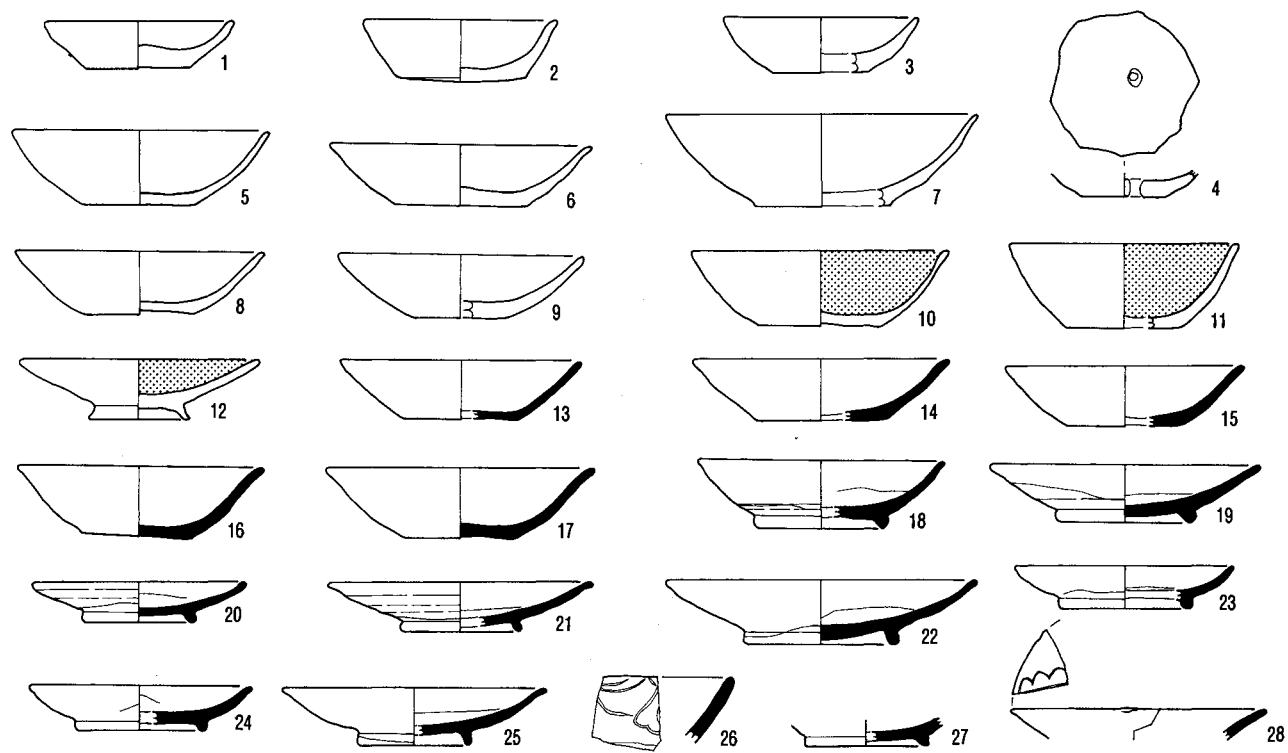

M地区 (1~40)

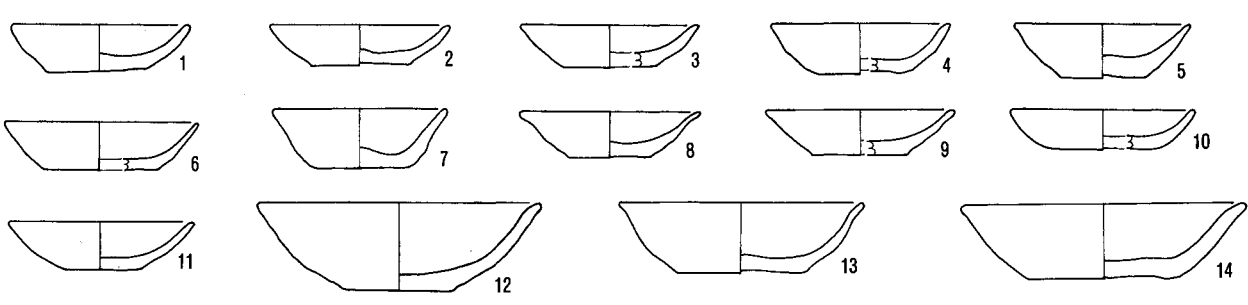

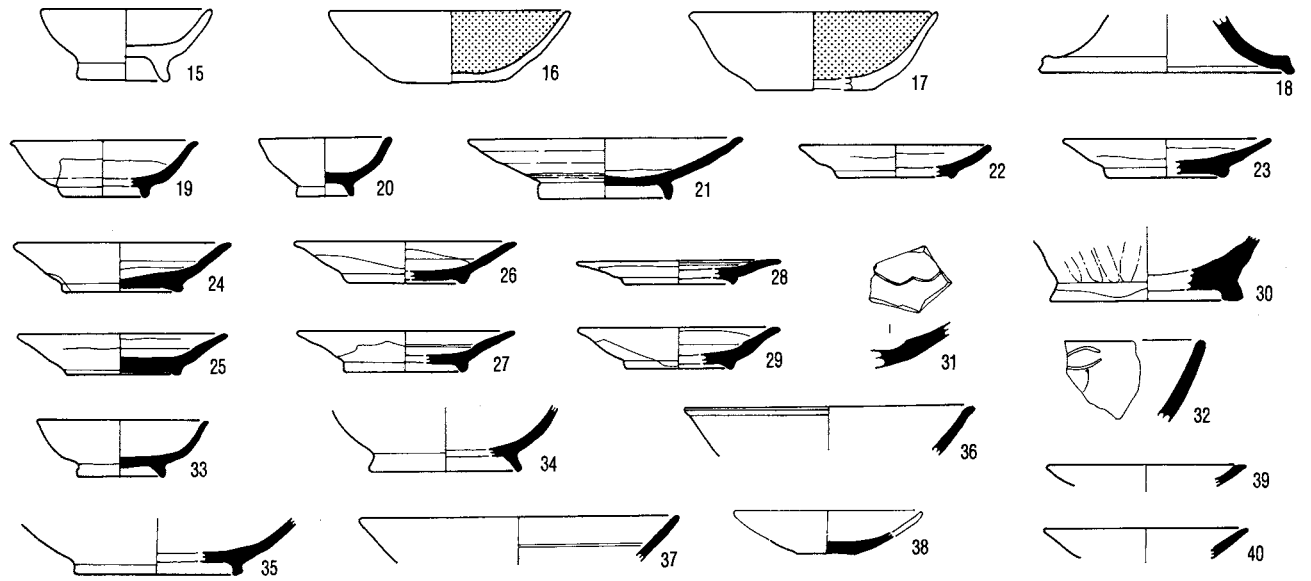

N地区 (1~79)

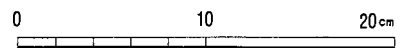
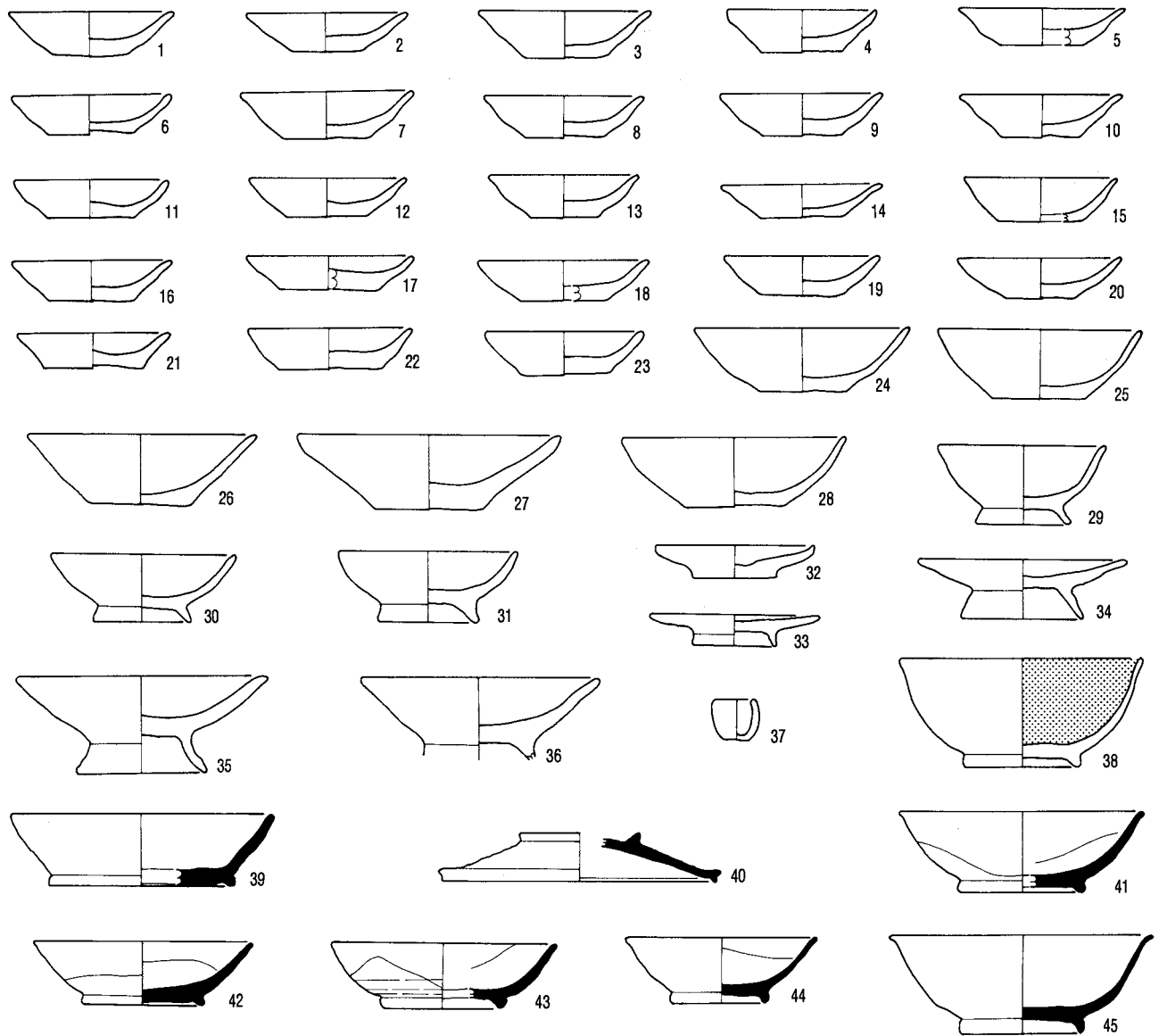

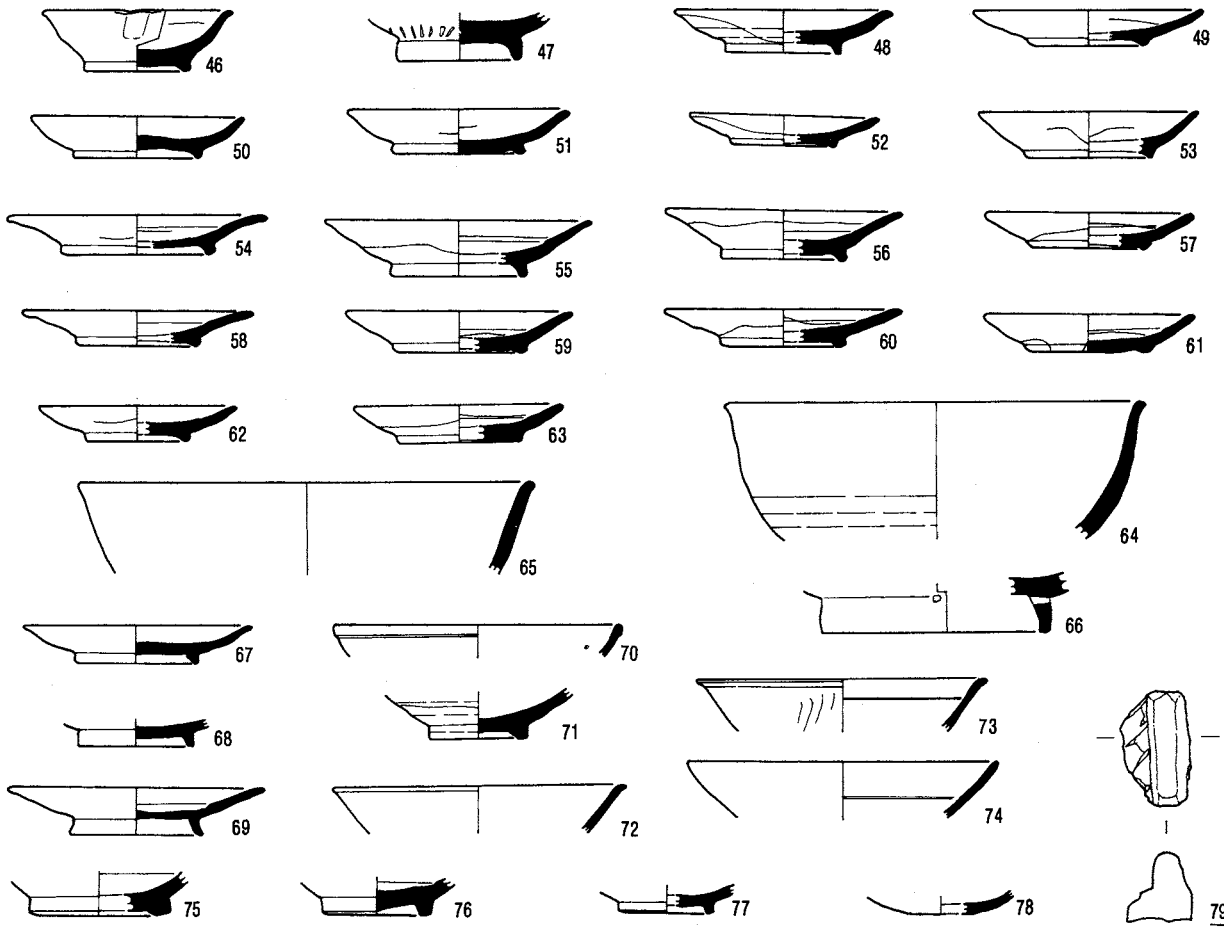

○地区 (1~129)

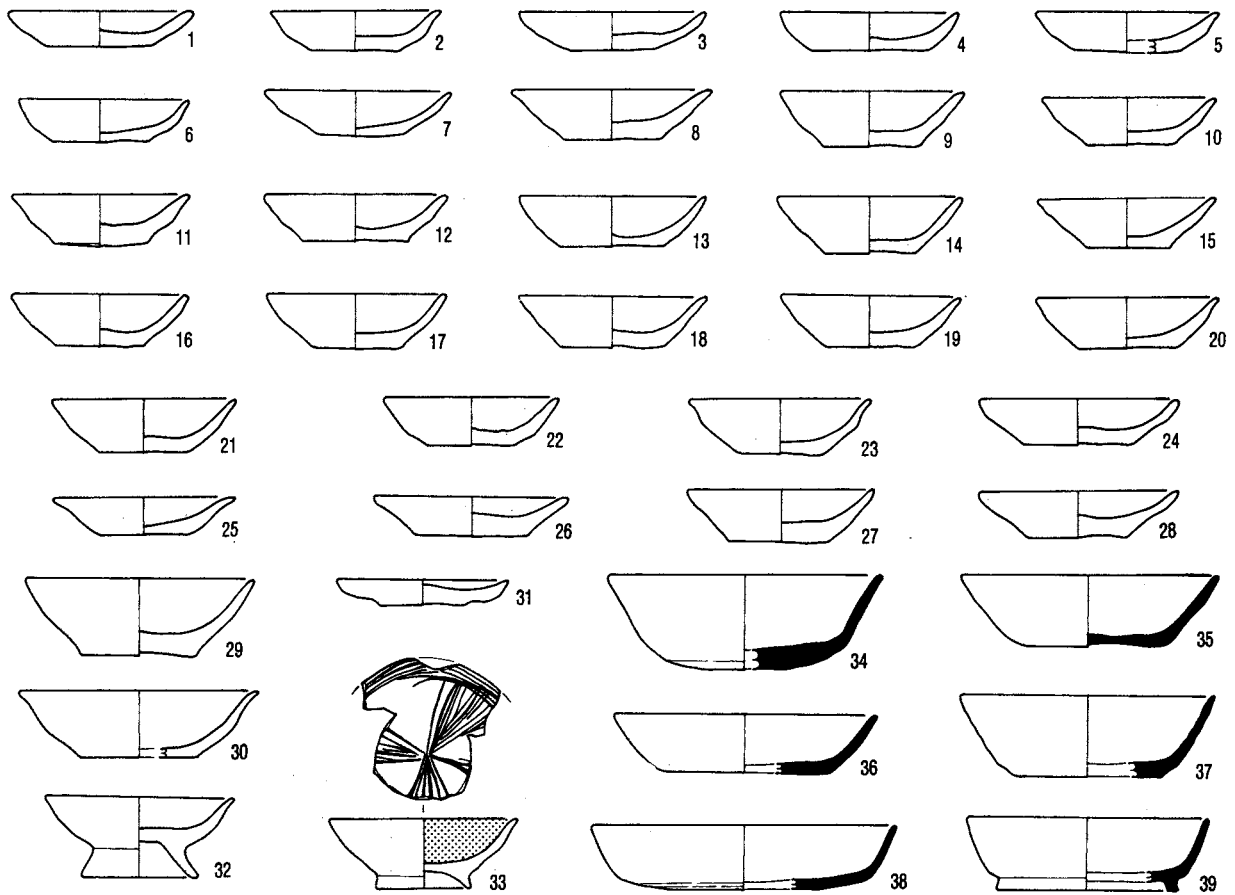

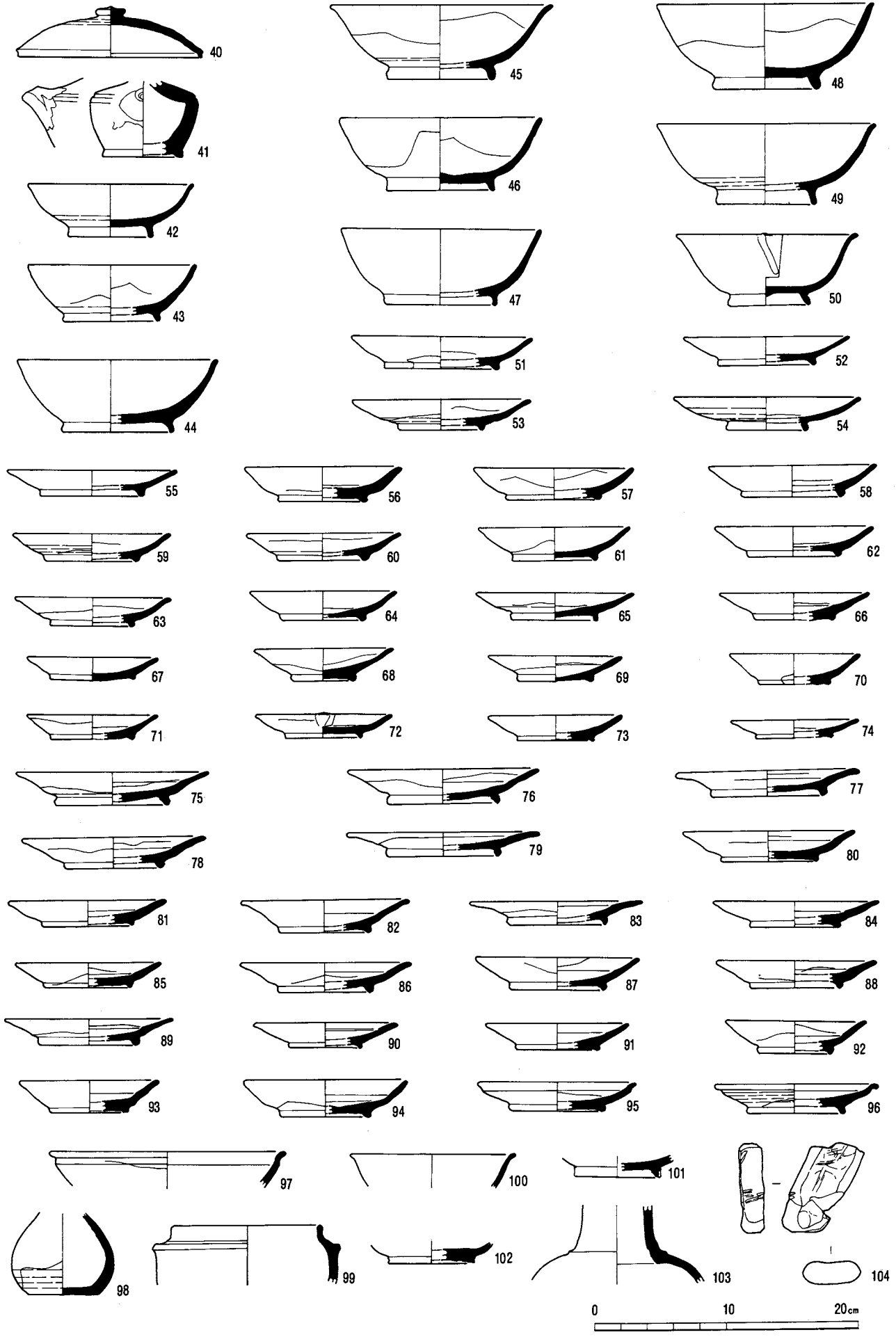

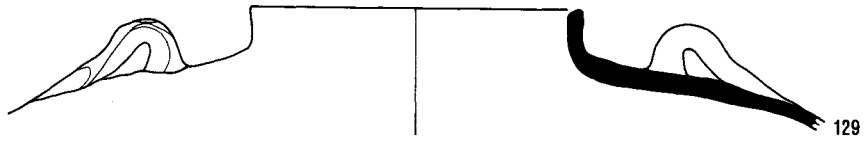
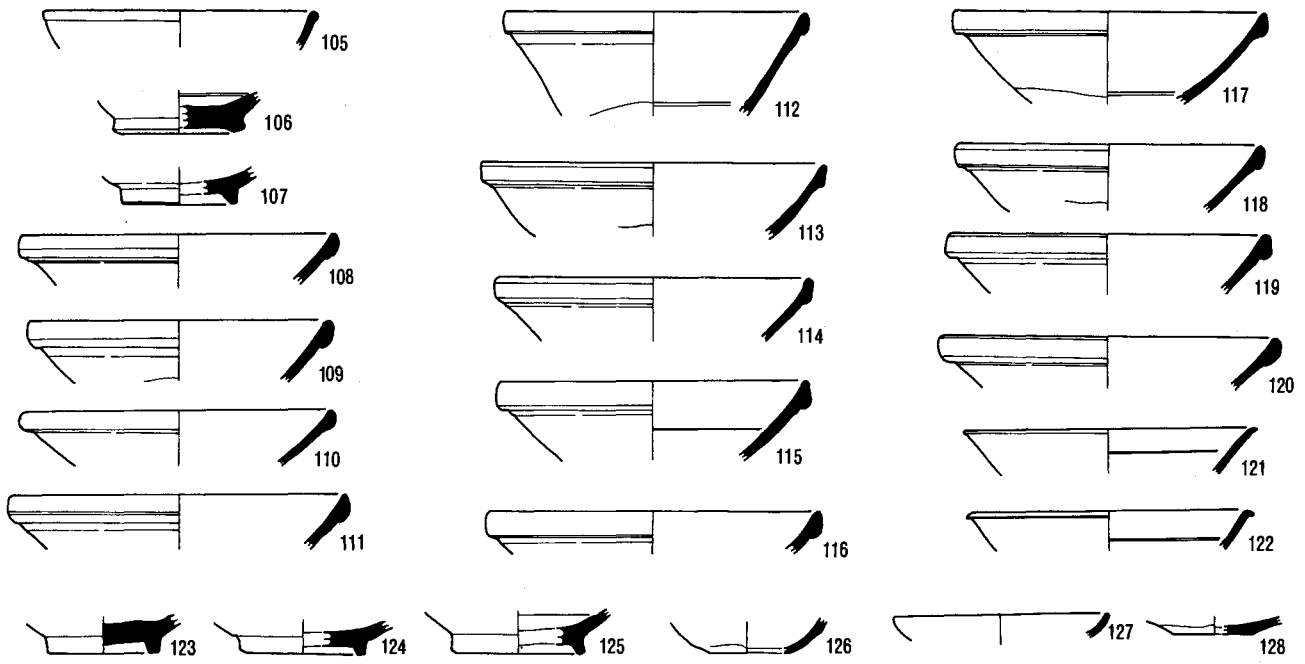

P地区 (1~7)

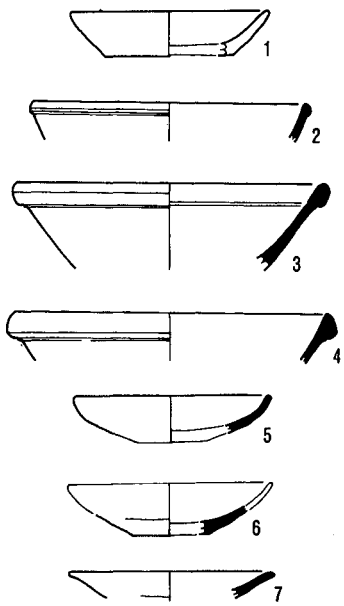

R地区 (1~10)

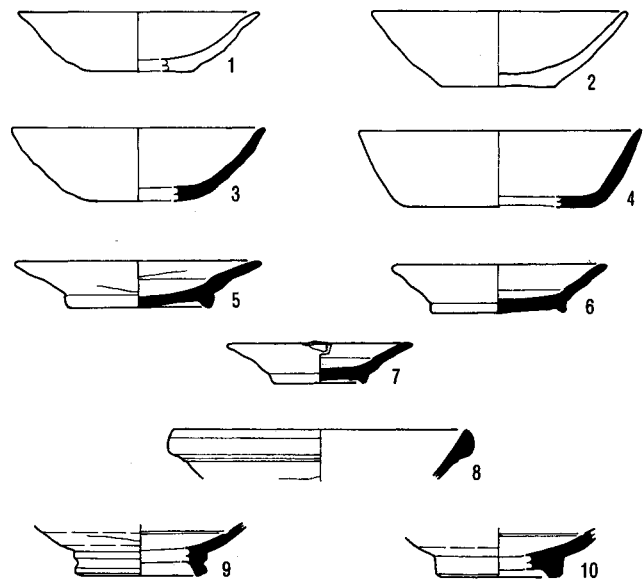

S地区 (1~44)

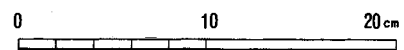
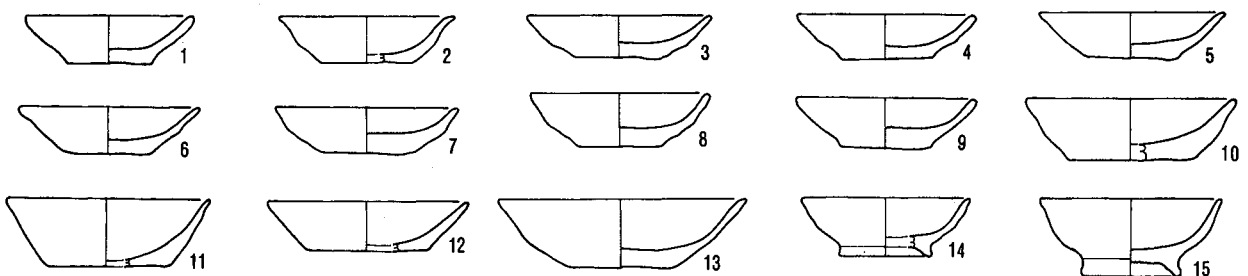

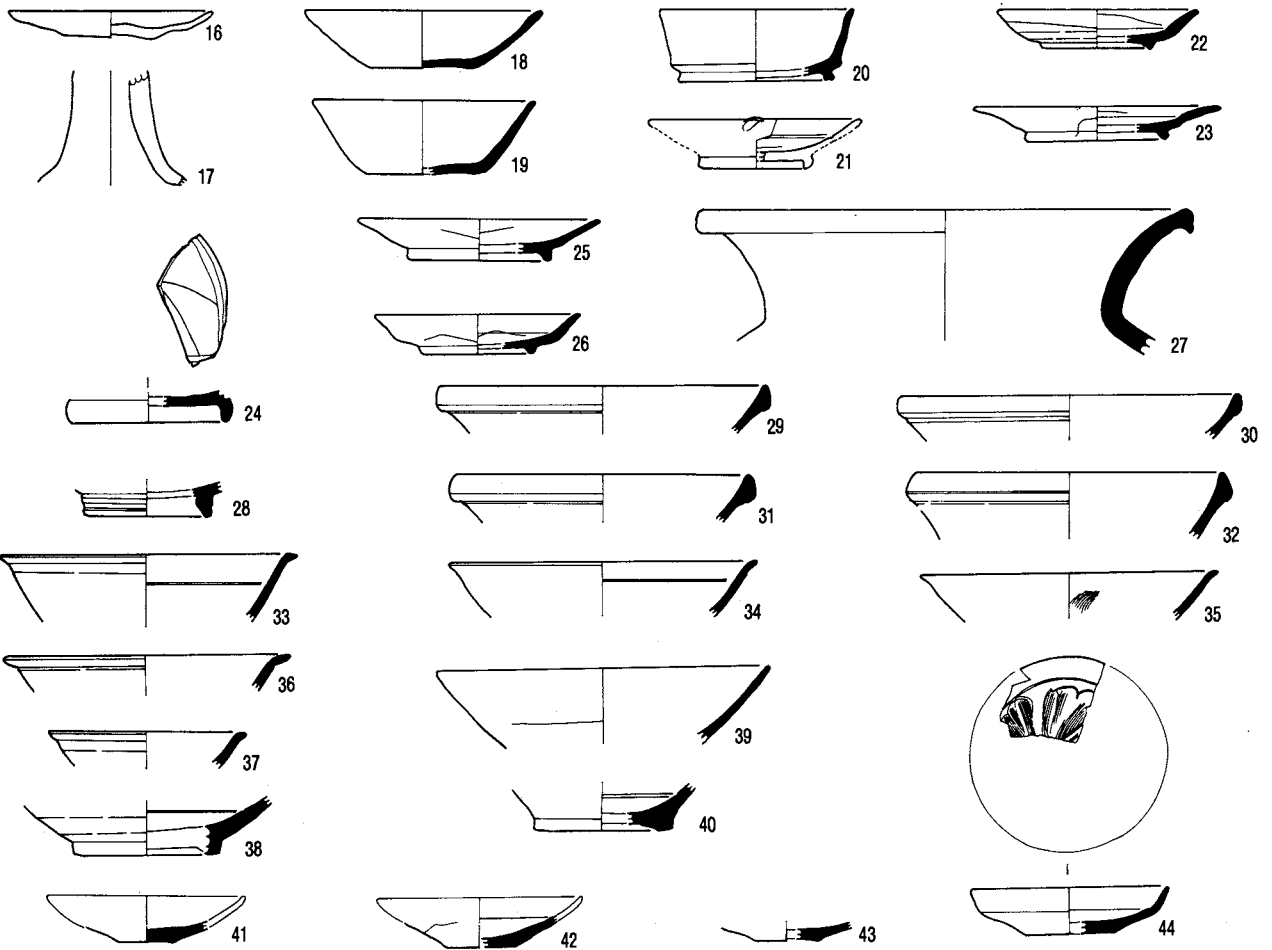

T地区 (1~7)

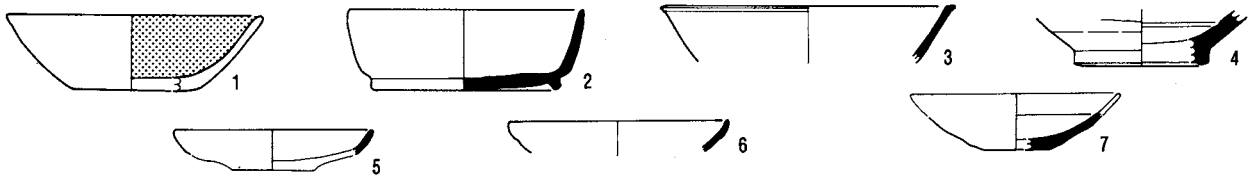

出土地点不明Z (1~20)

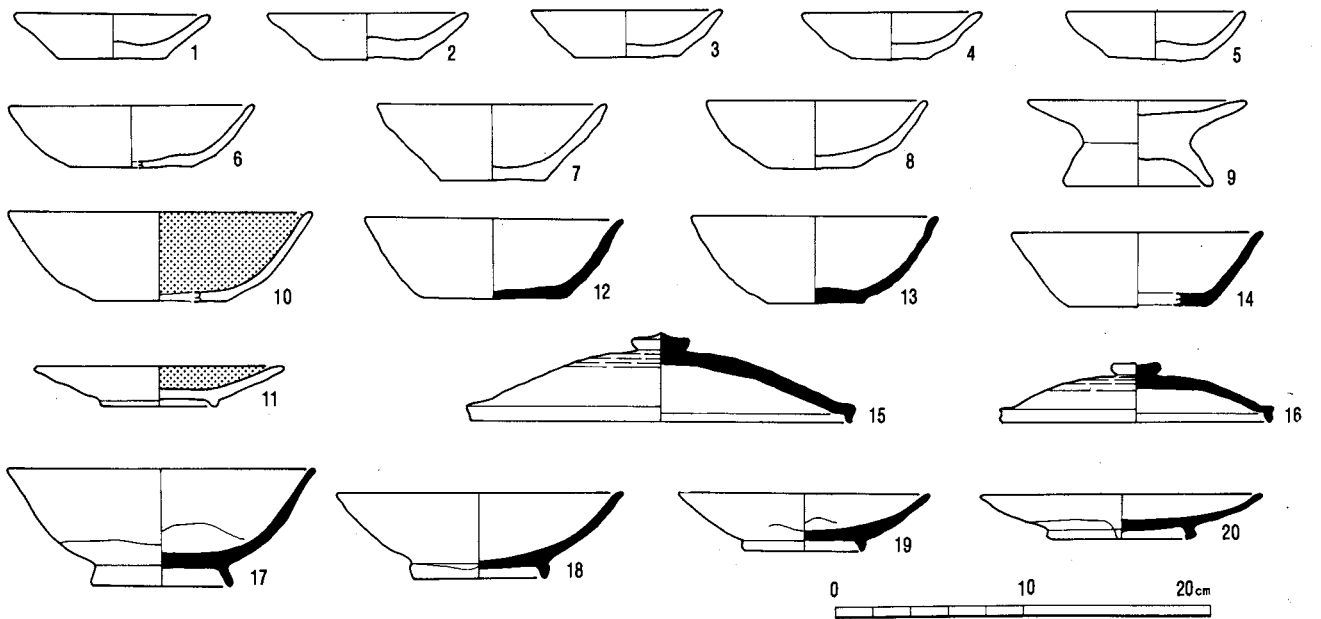

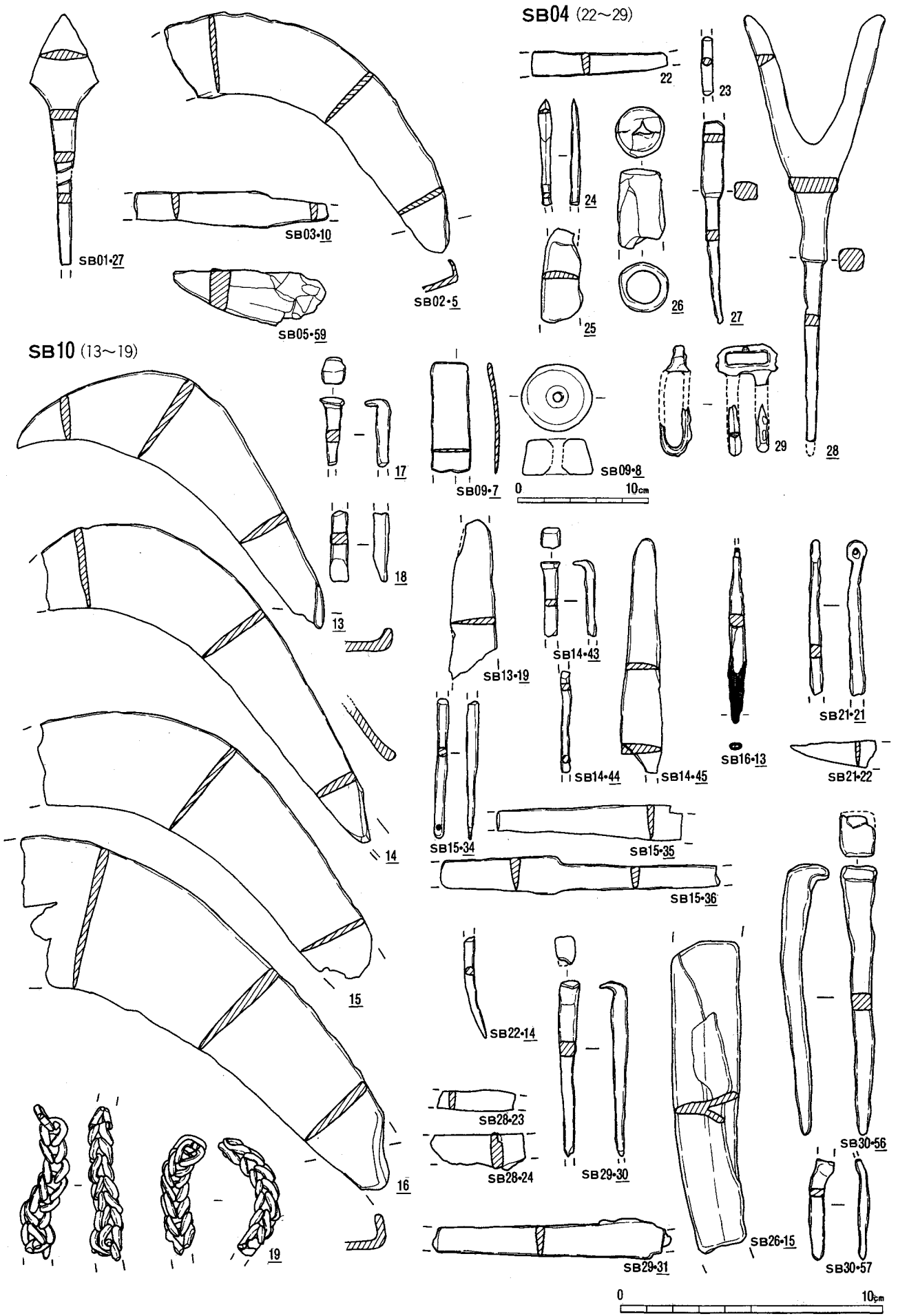

SB31 (25~34)

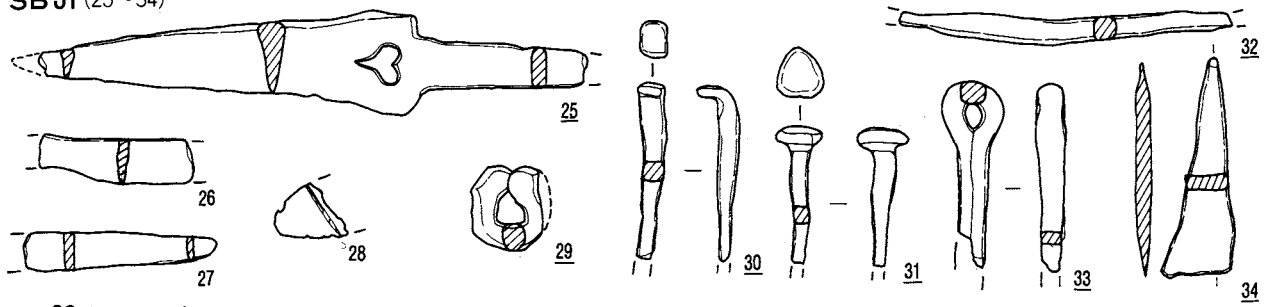

SB32 (345~393)

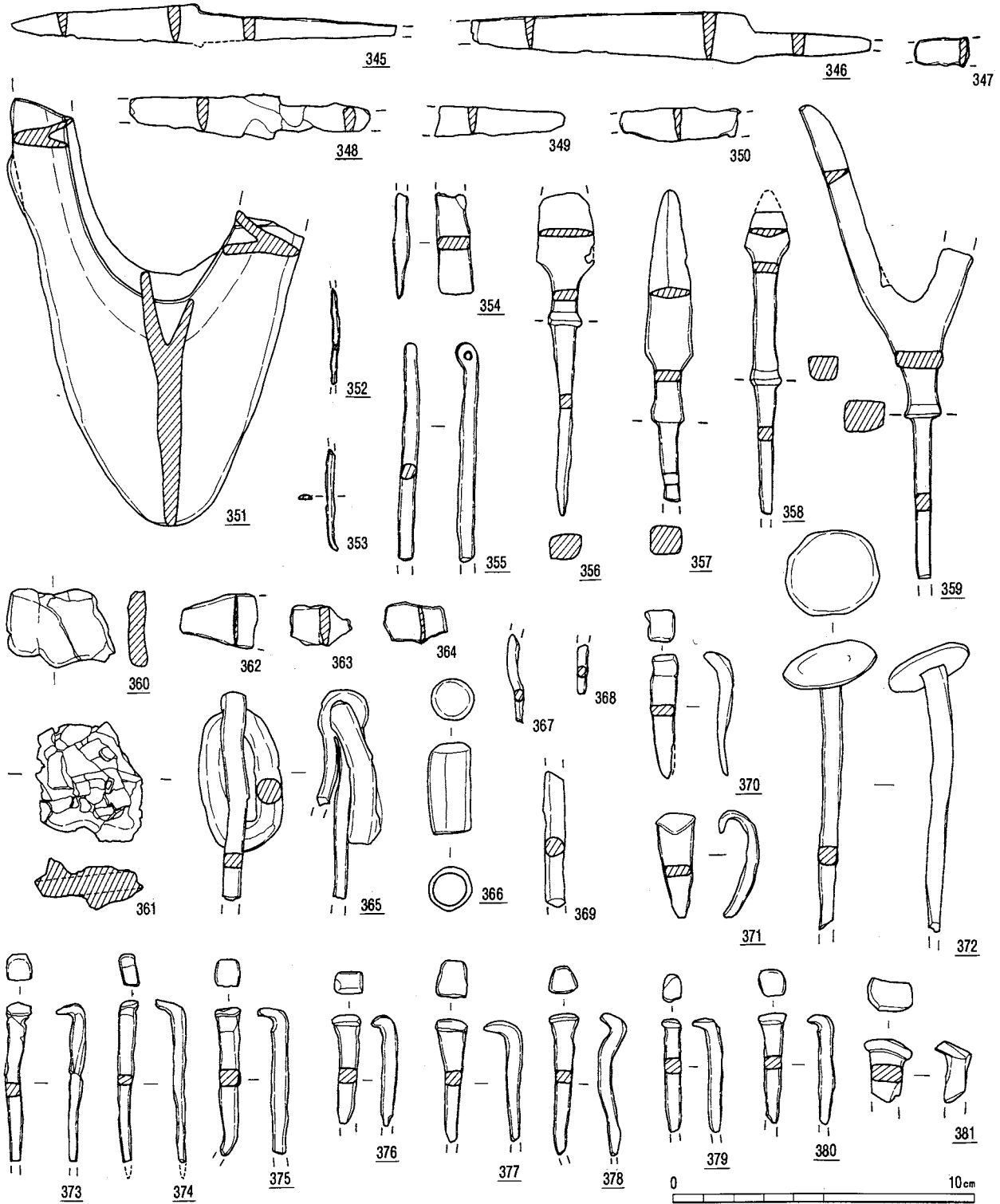

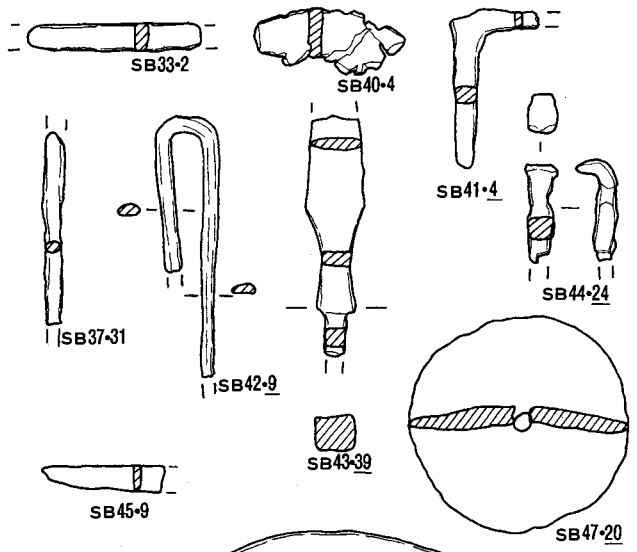
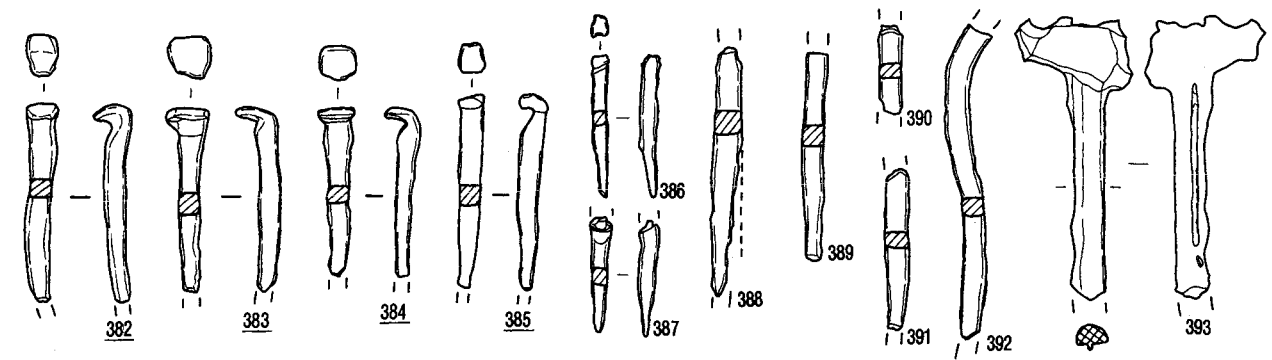

SB 48 (20~25)

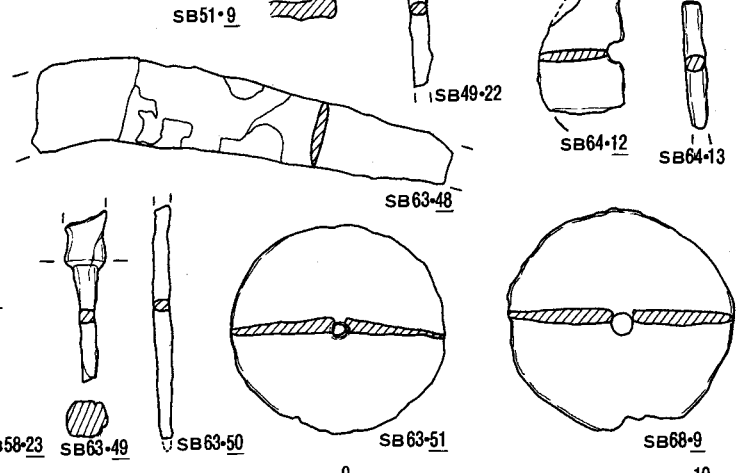
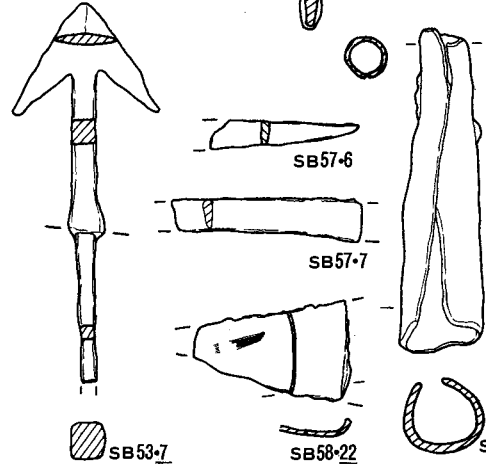
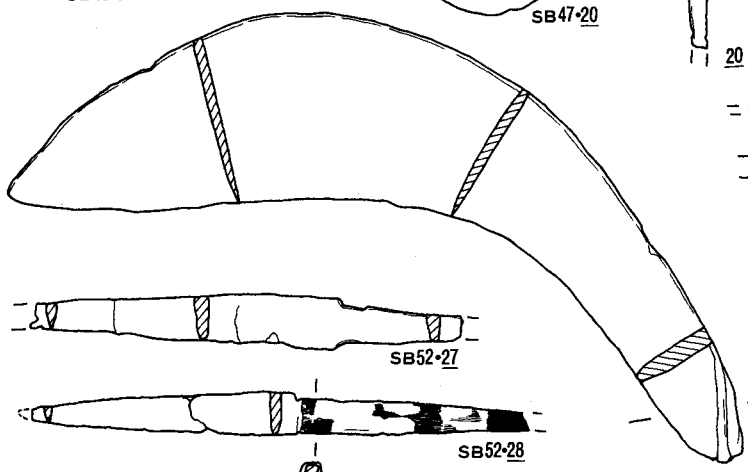
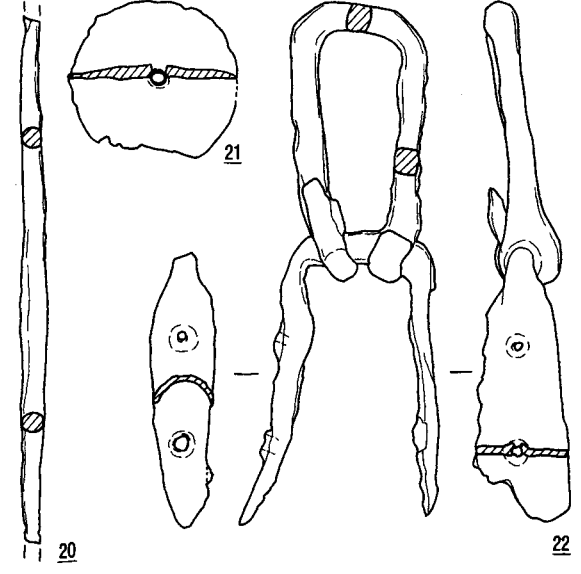

SB 66 (41~58)

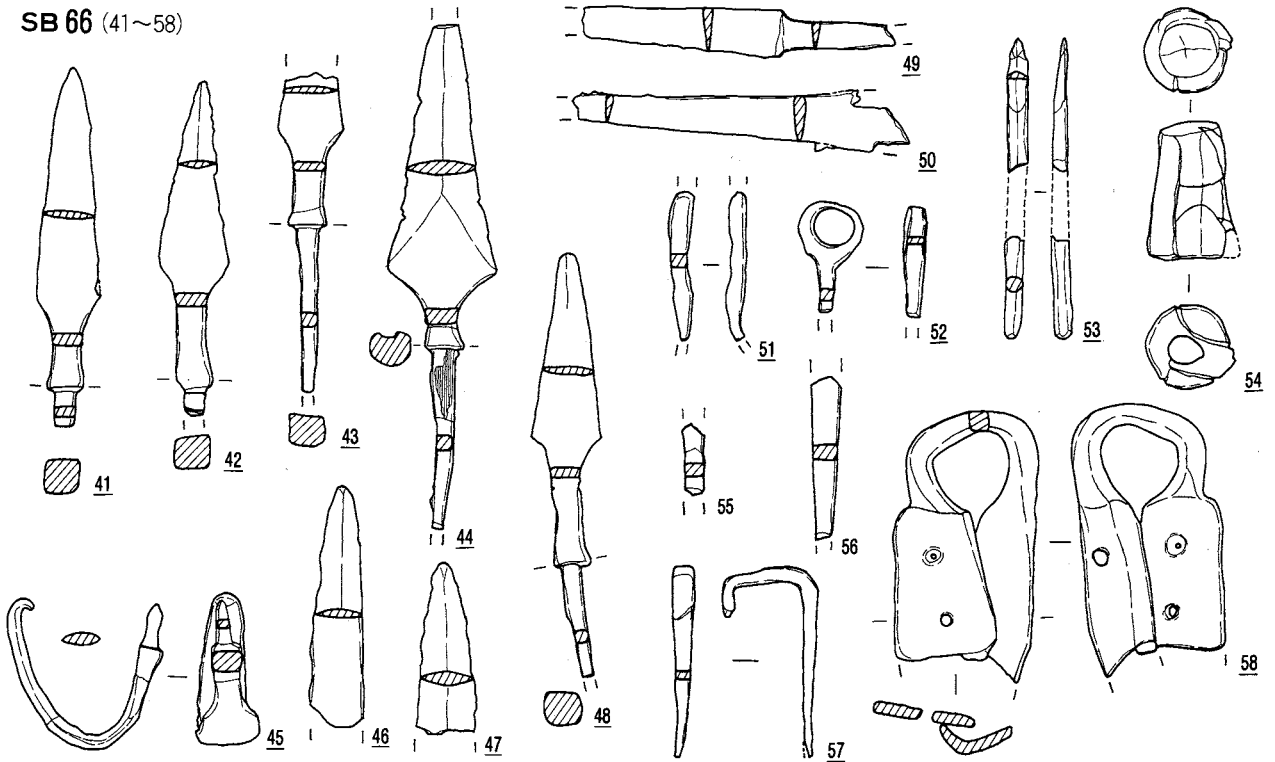

SB 69 (41~48)

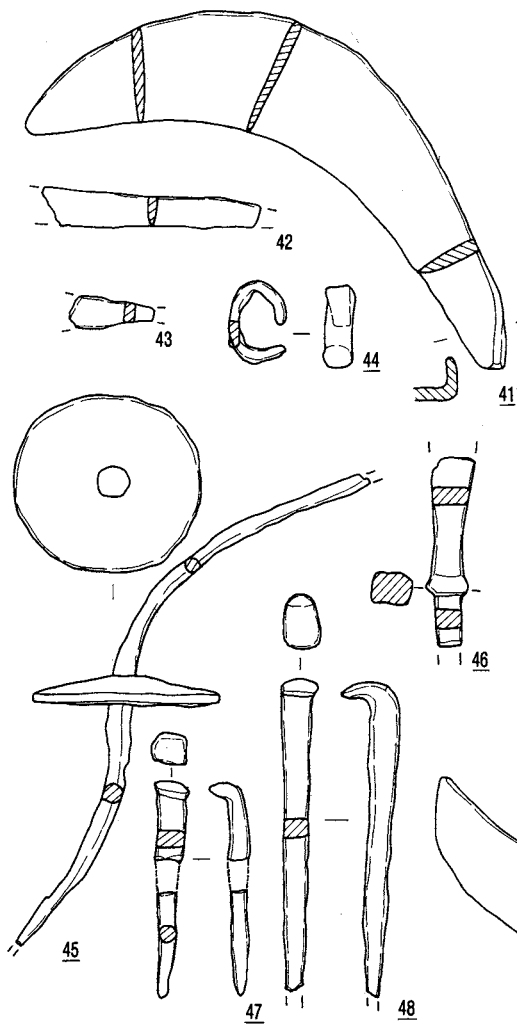

SB 71 (8~11)

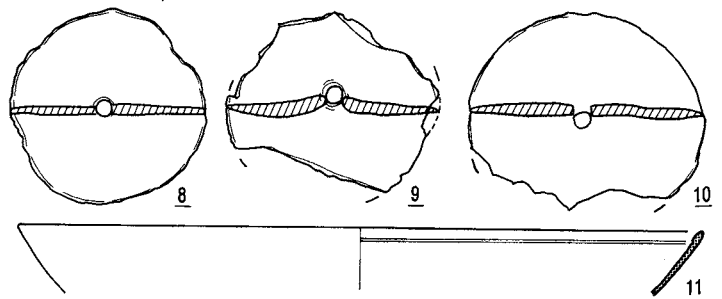

SB 72 (16.17)

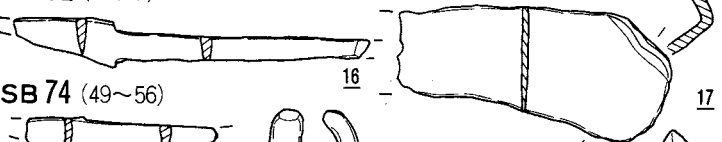

SB 74 (49~56)

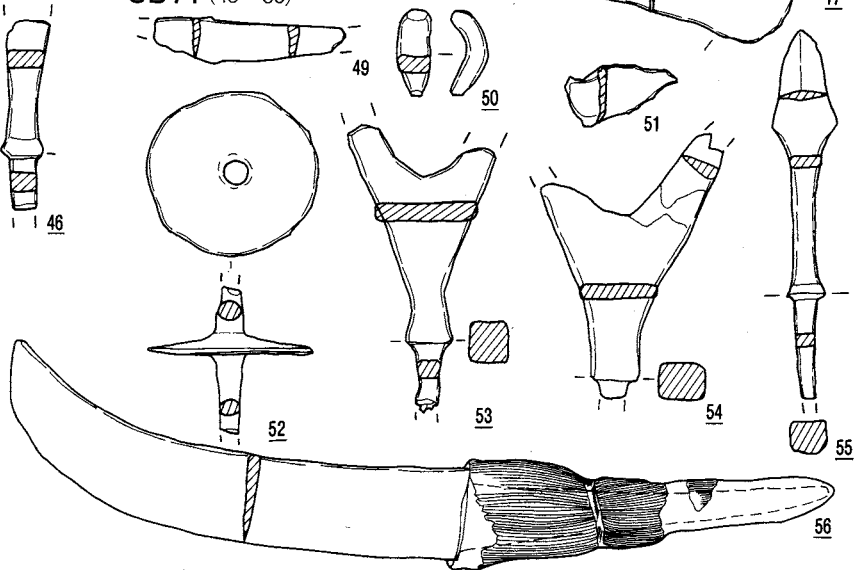

0 10cm

SB78 (16~21)

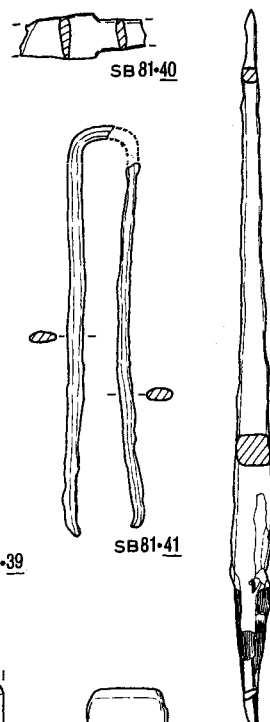
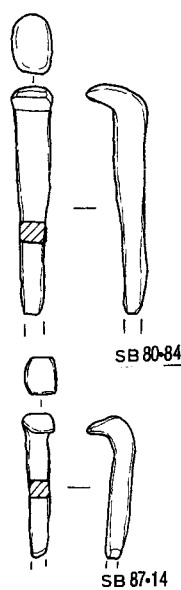
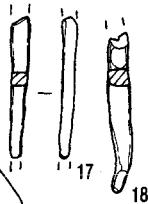
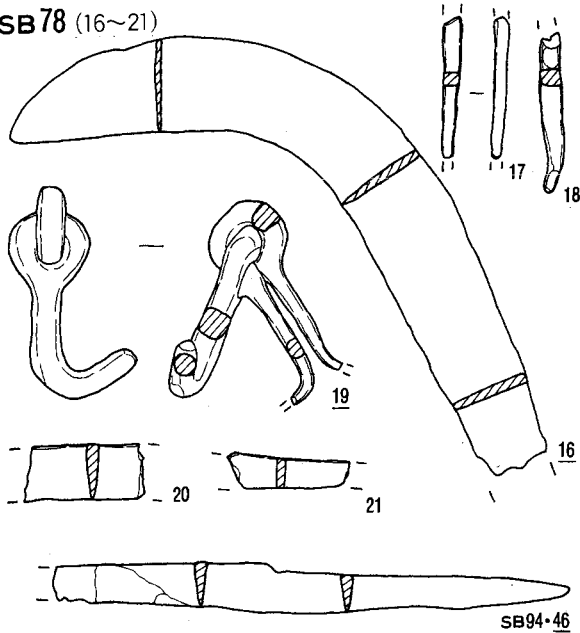

SB86 (26~32)

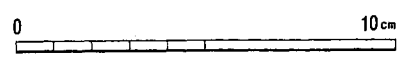
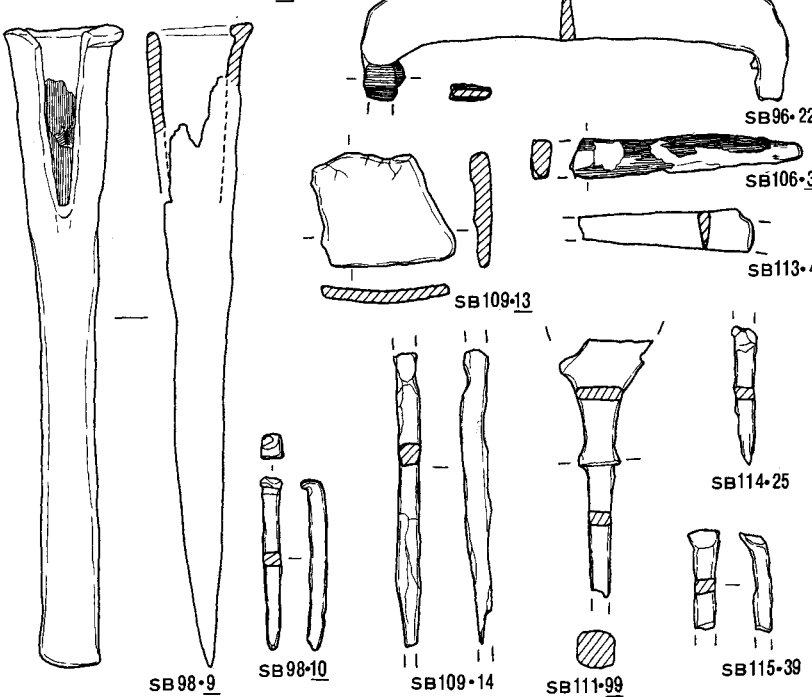
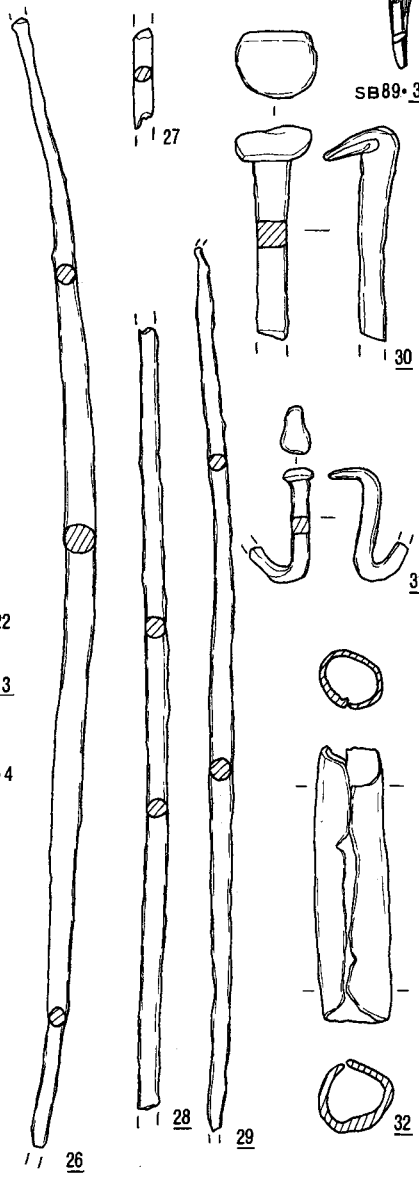
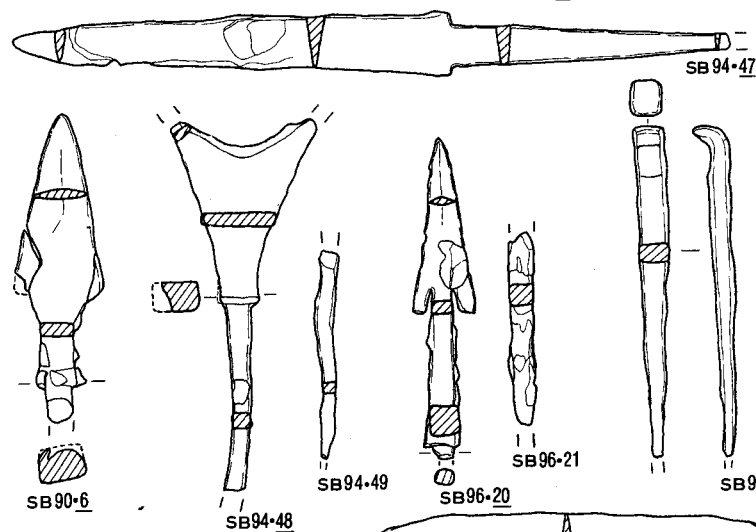

SB 101 (13~21)

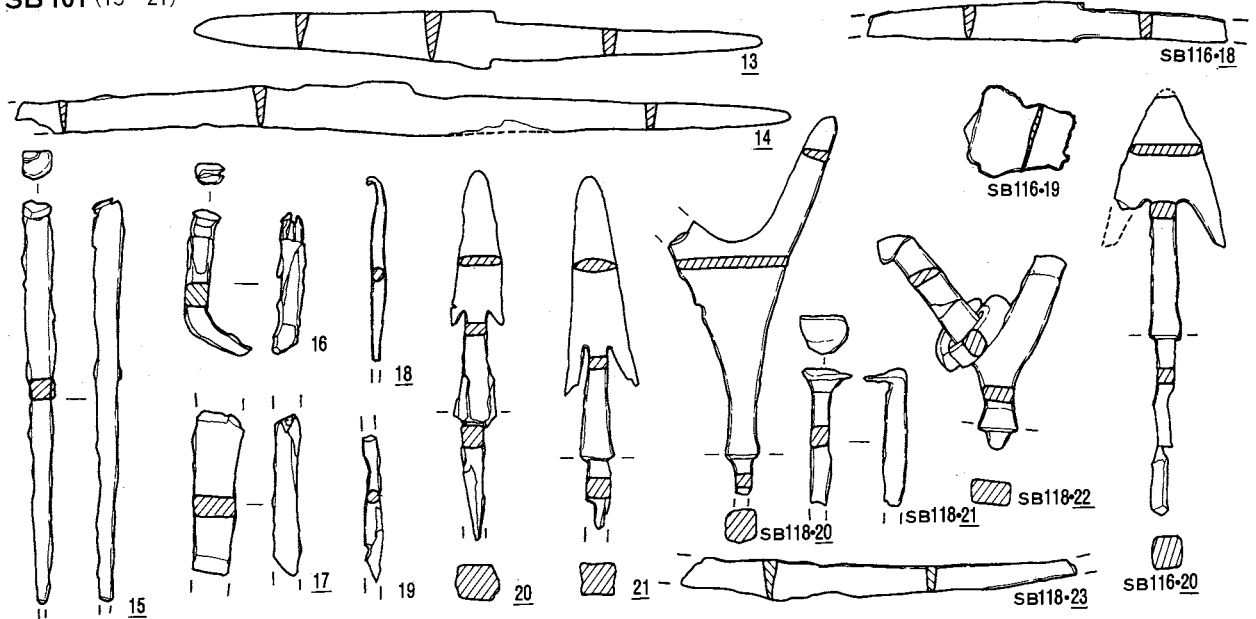

SB 129 (18~21)

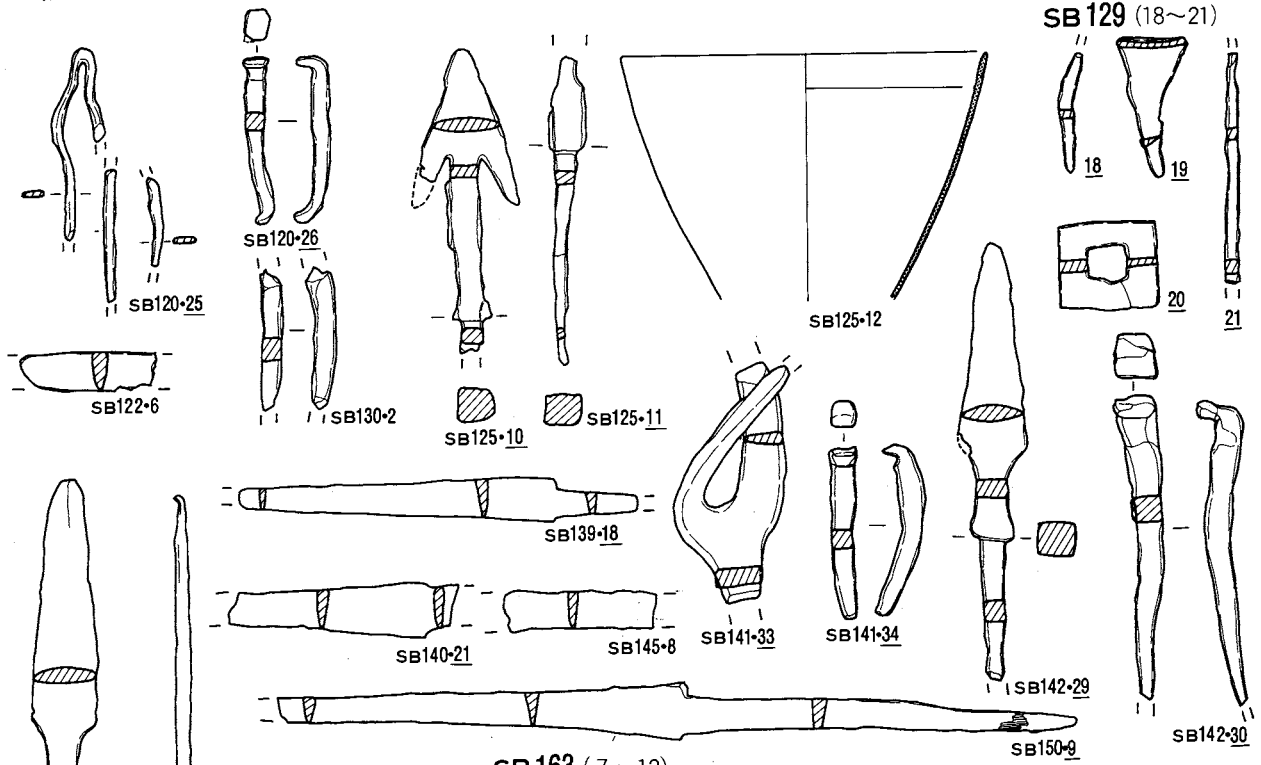

SB 163 (7~12)

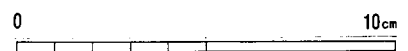
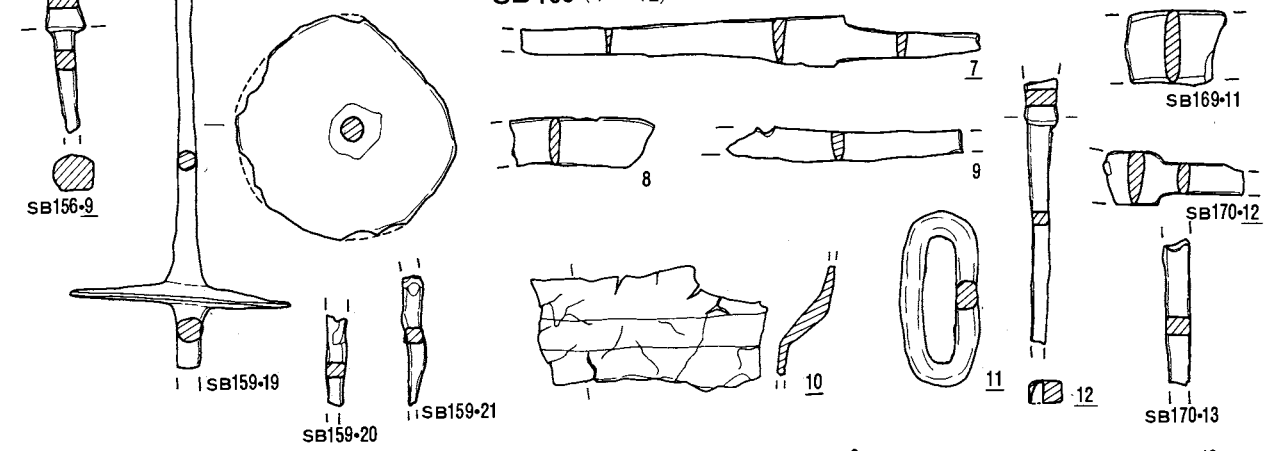

SB167 (51~55)

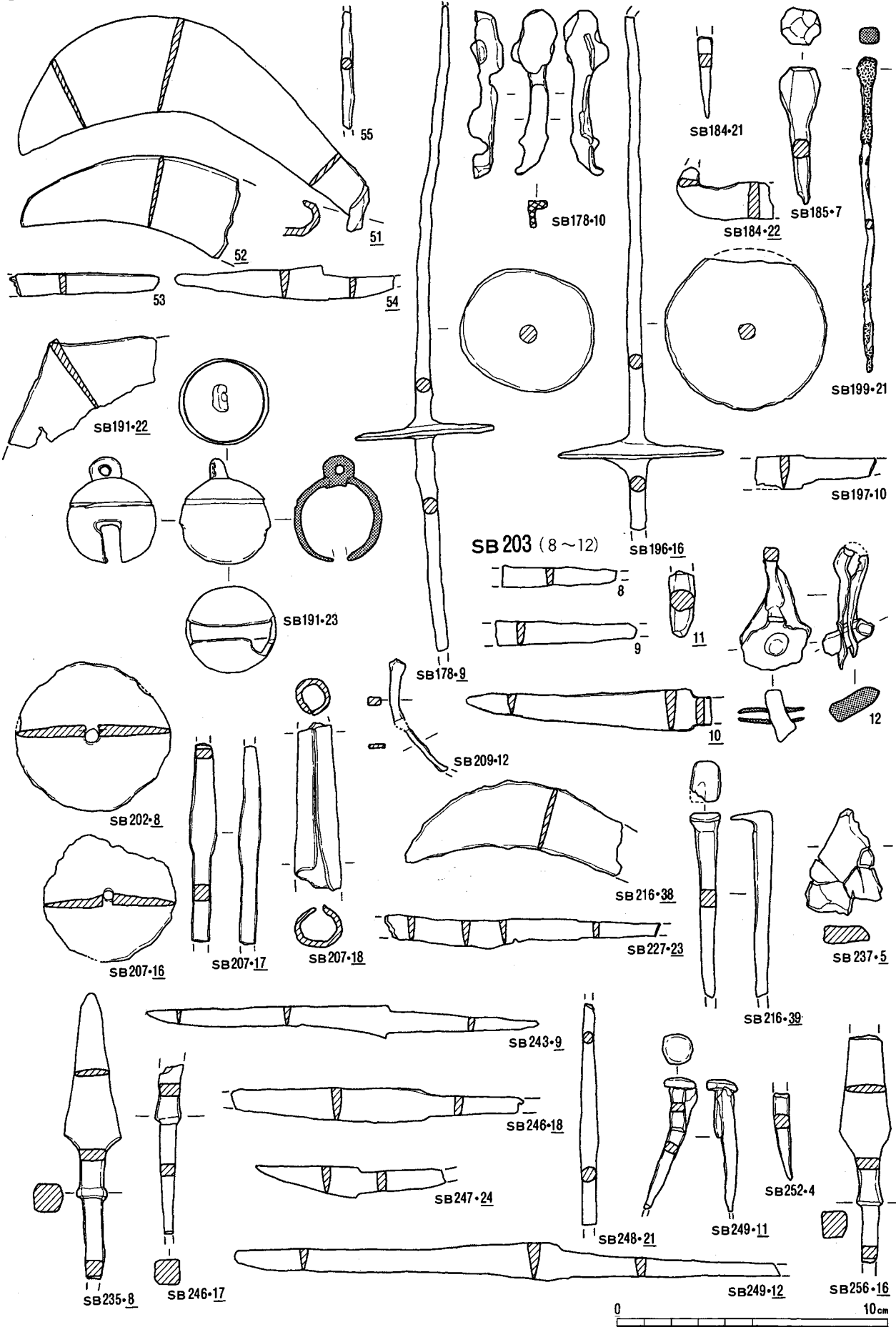

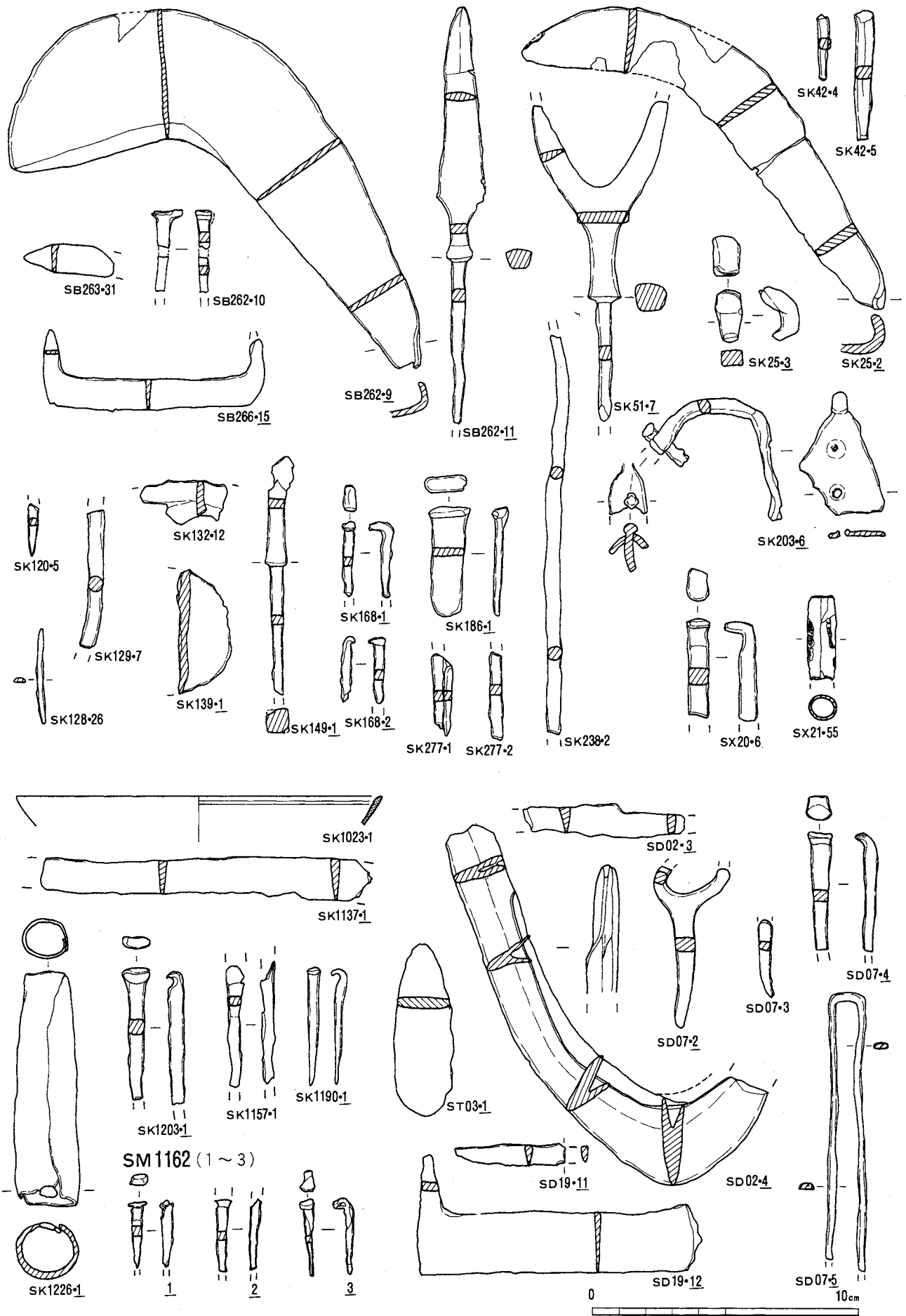

SD17 (67~73)

遺構外II層
(1~92)

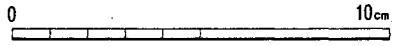
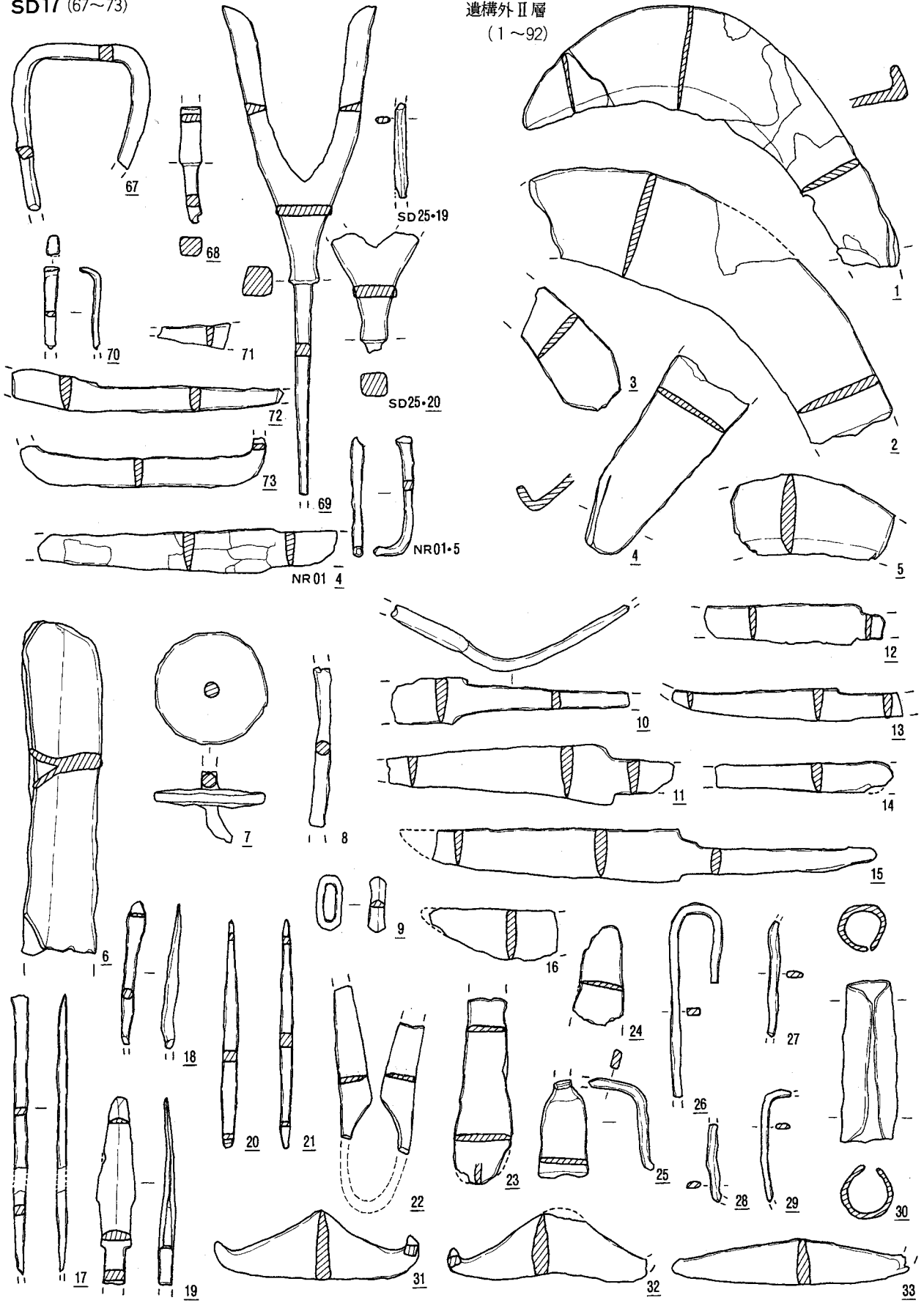

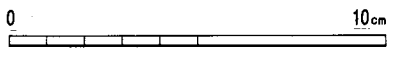
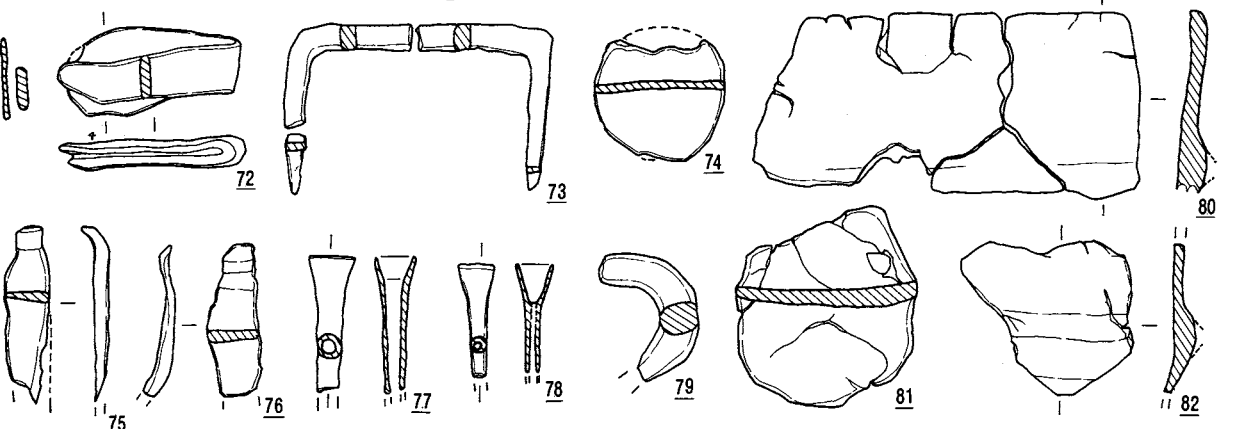
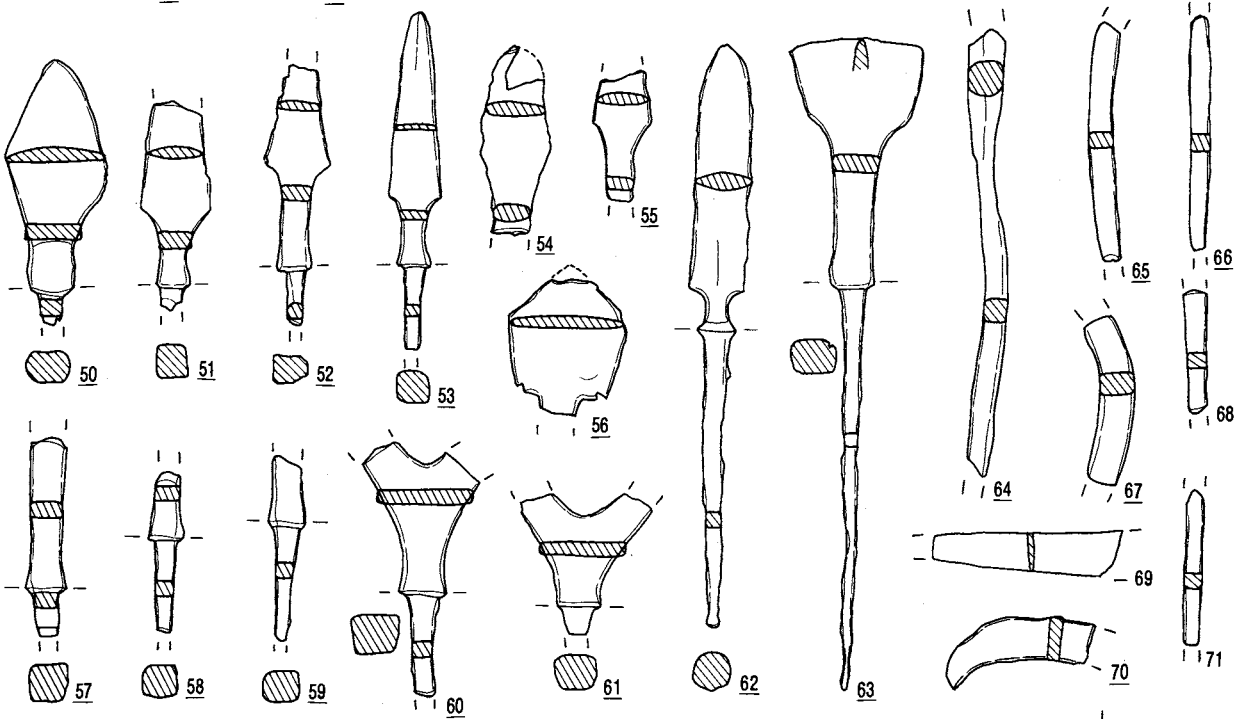
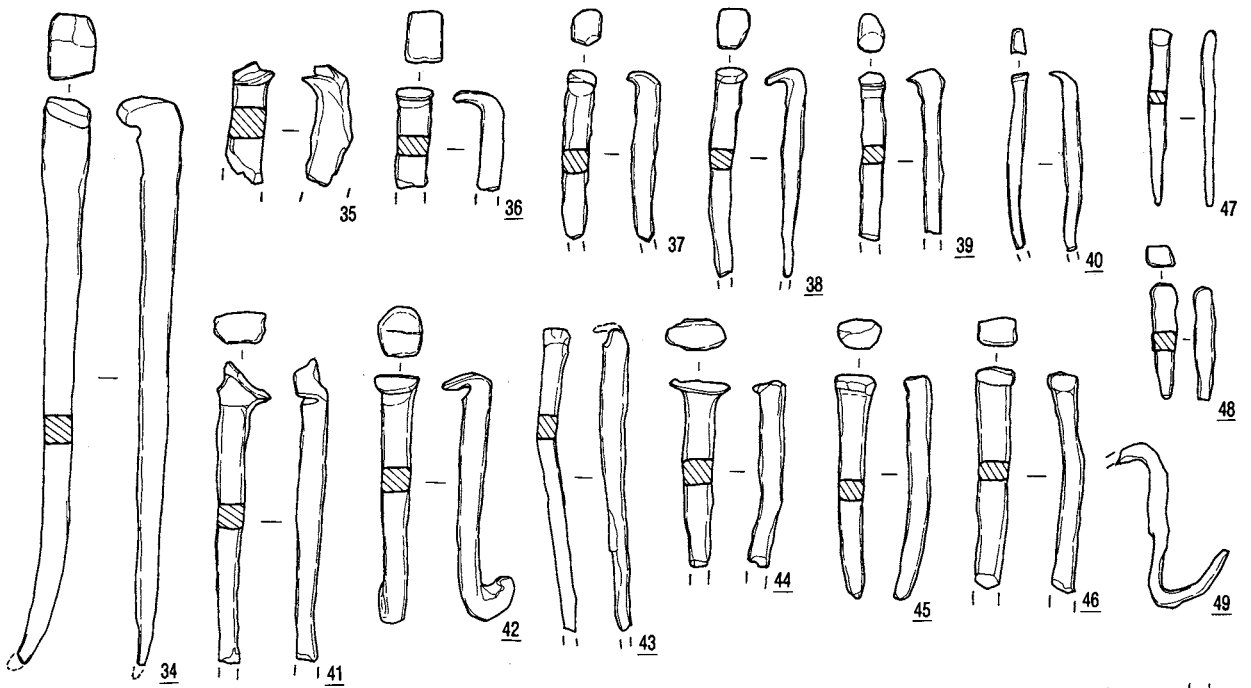

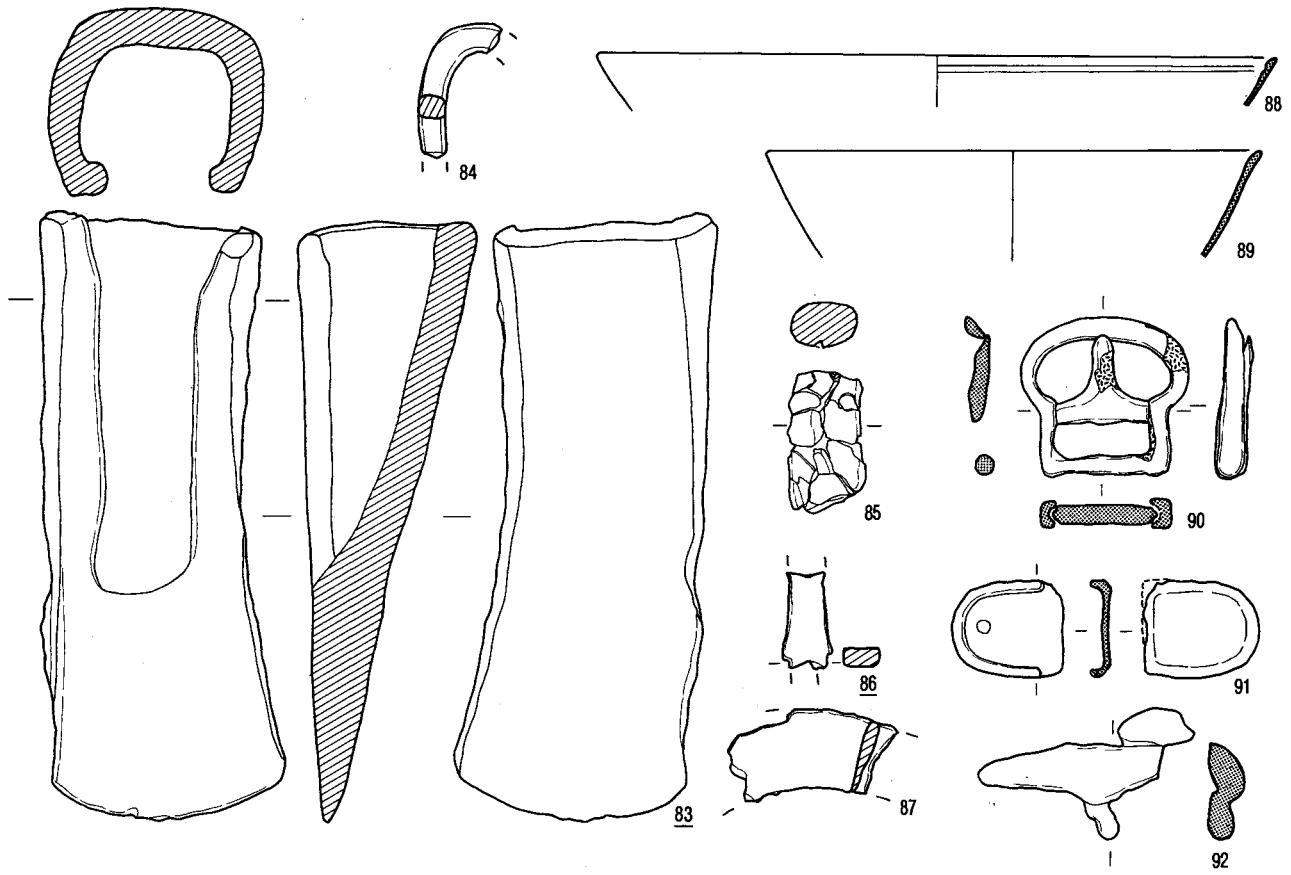

遺構外I層 (1~111)

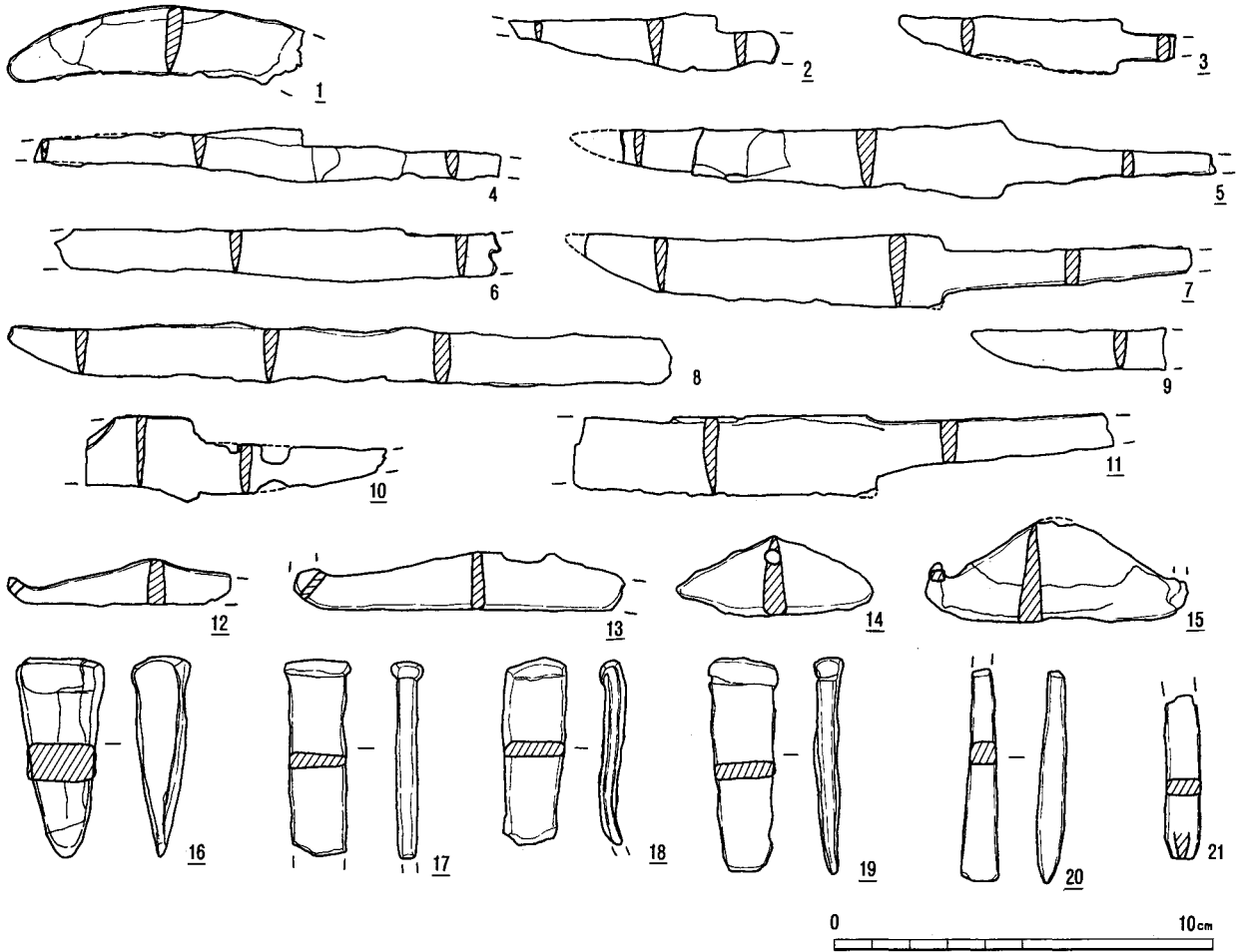

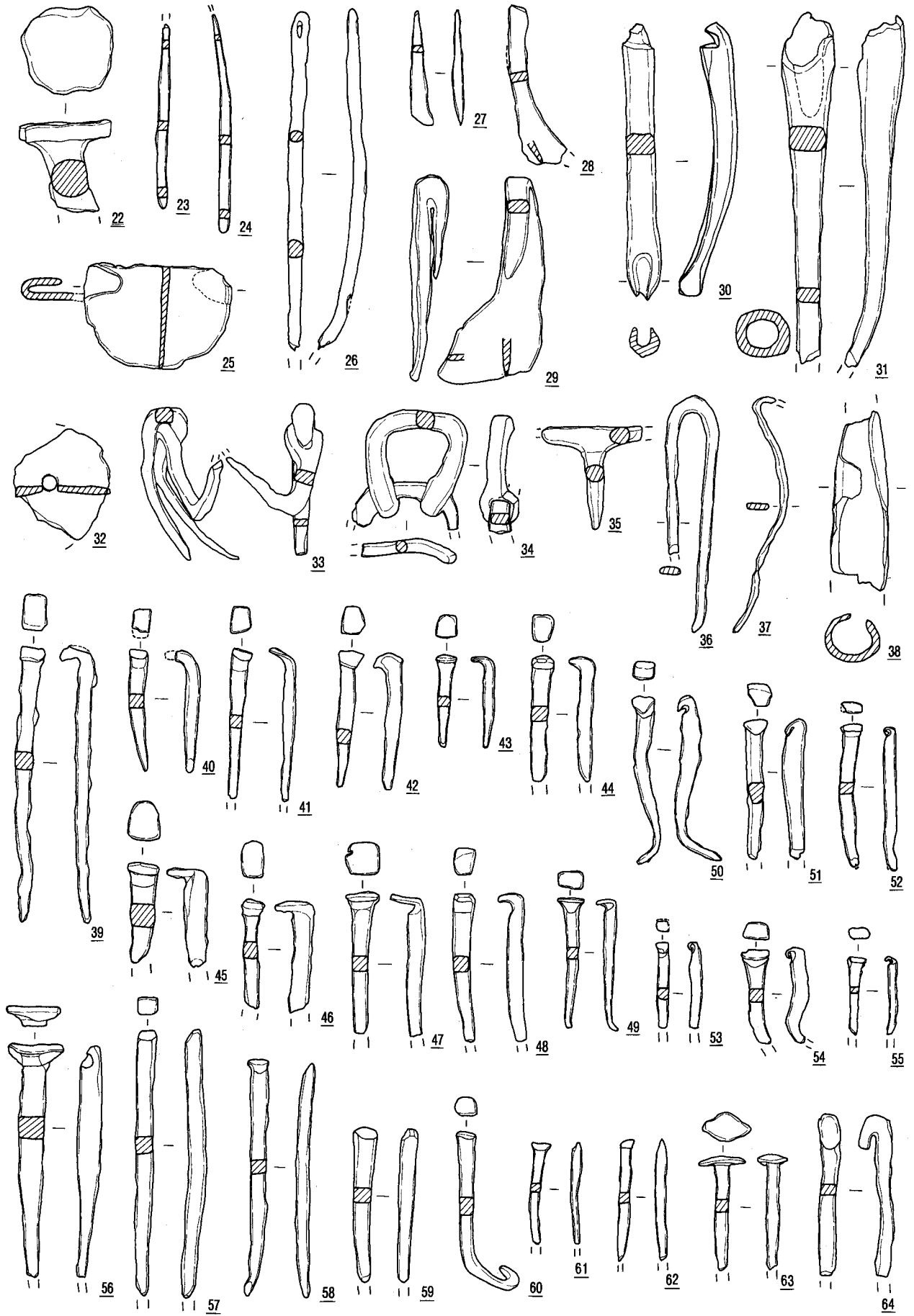

0 10cm

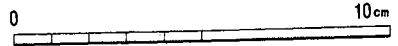
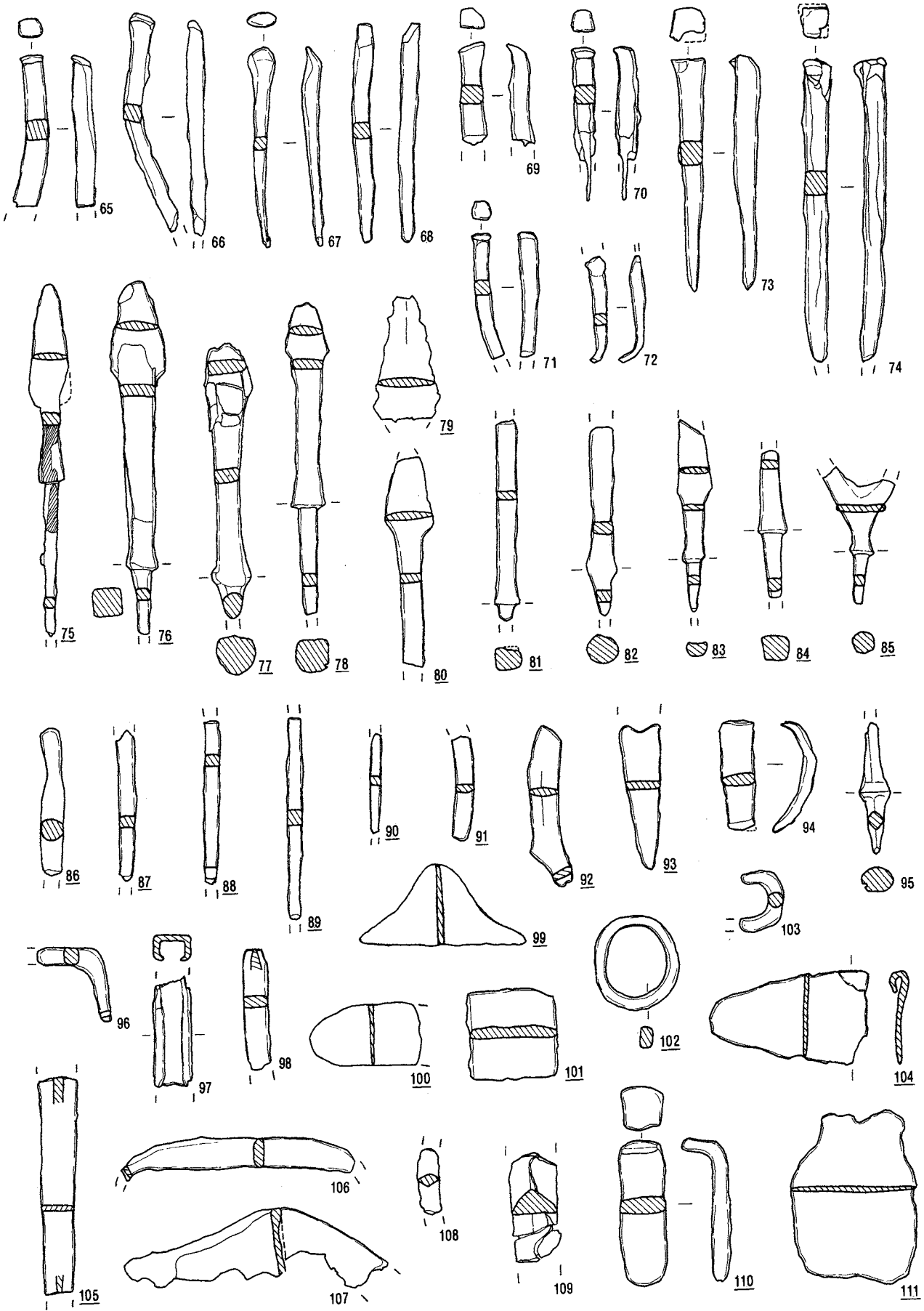

近世遺構 (1~81)

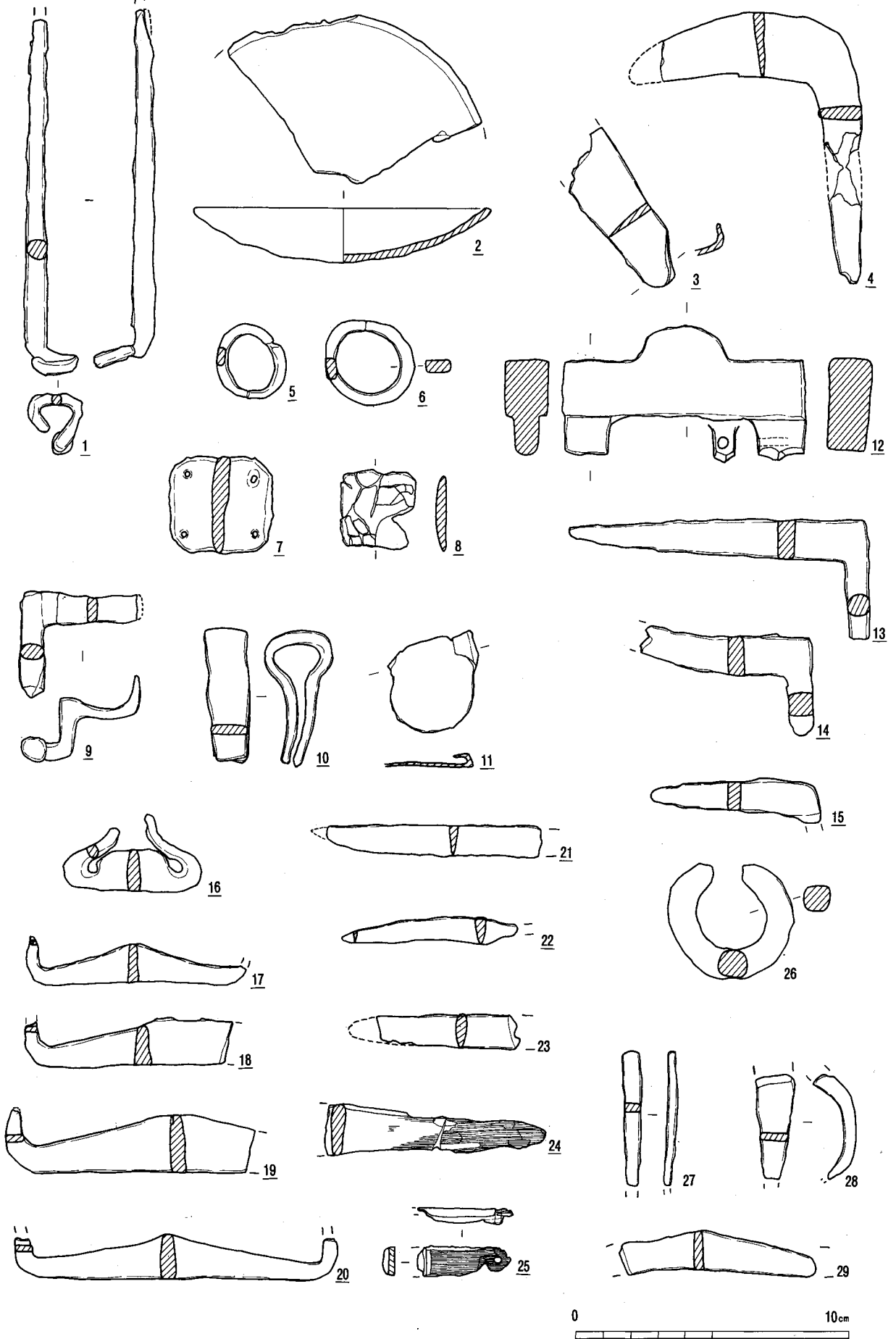

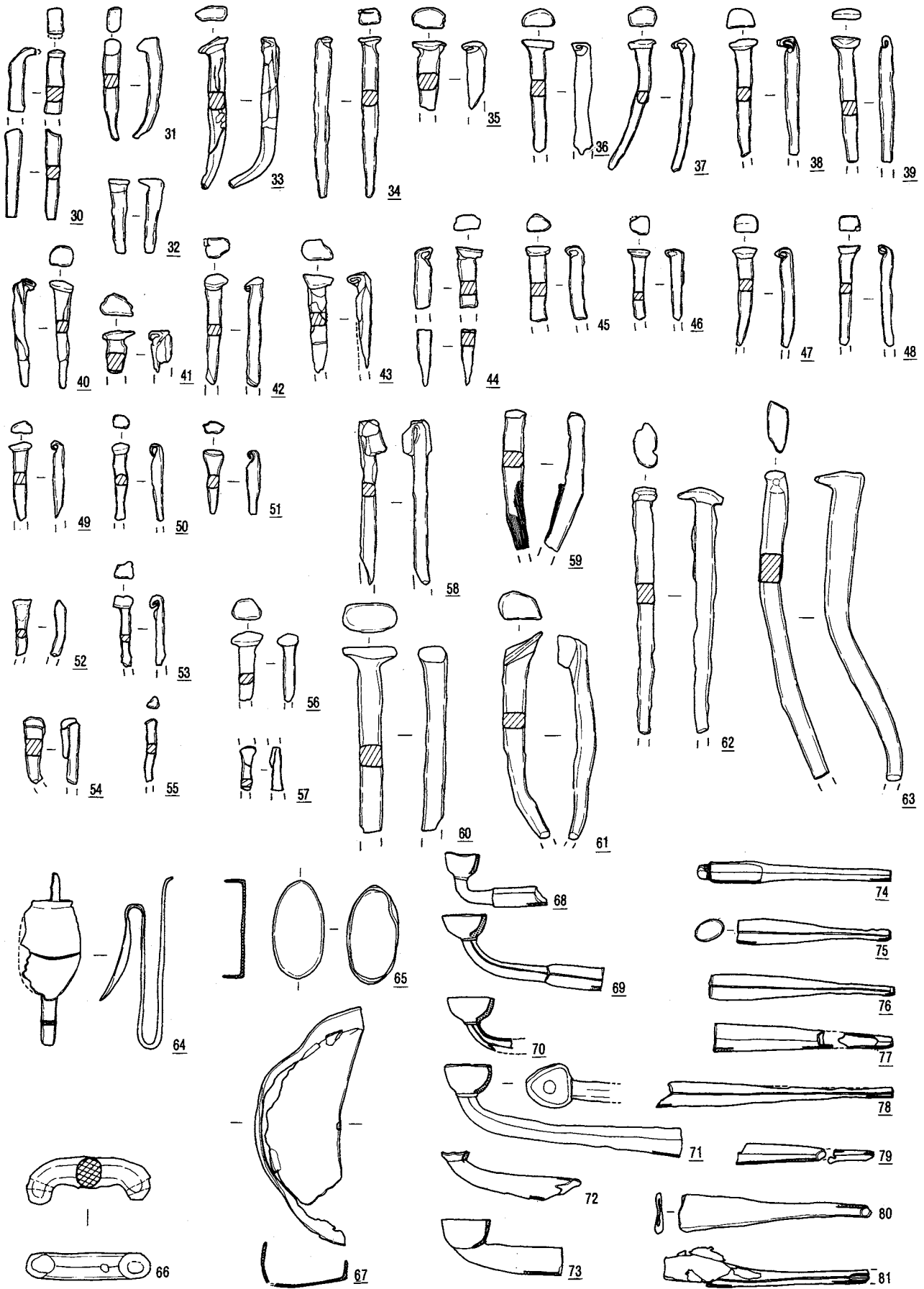

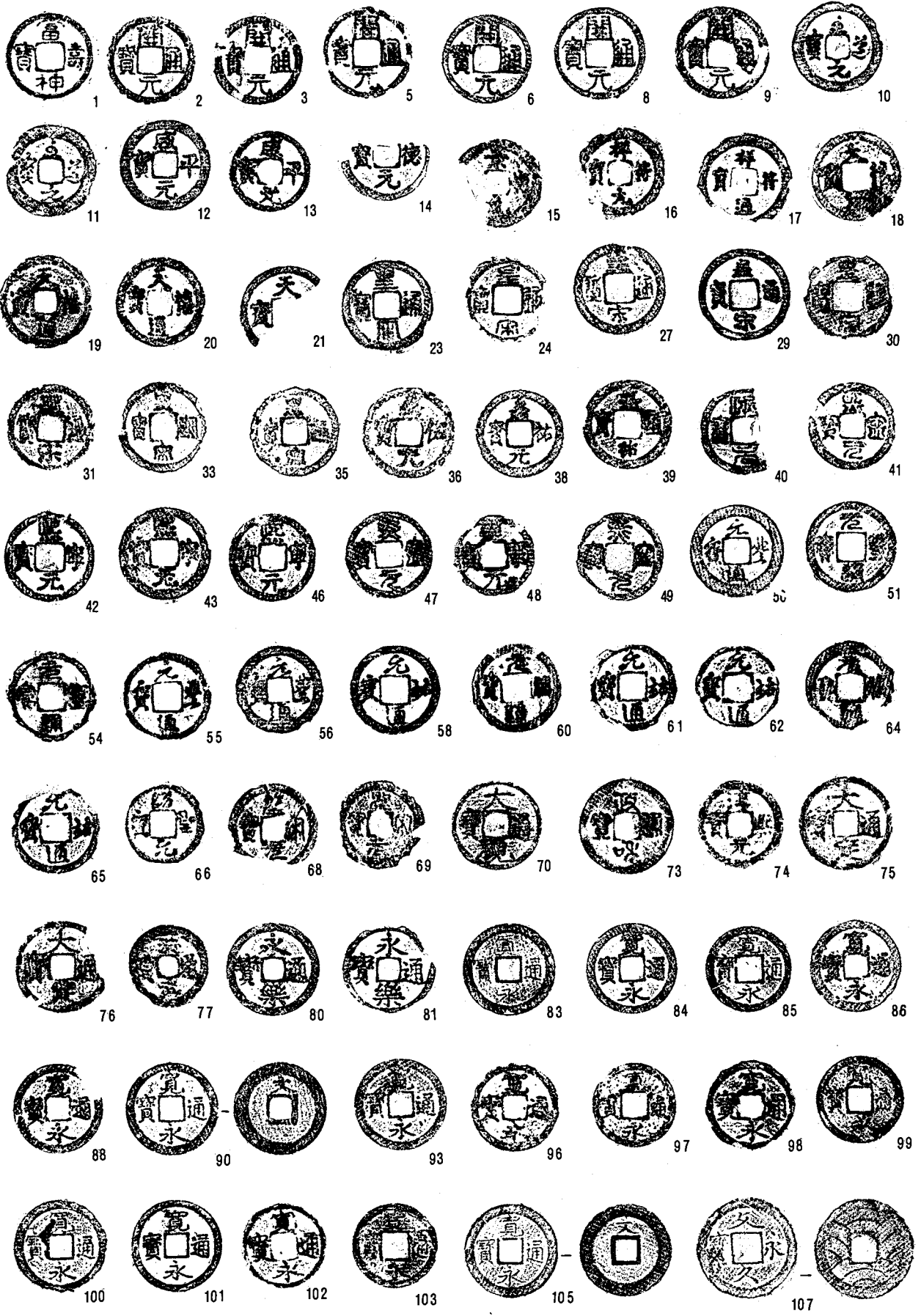

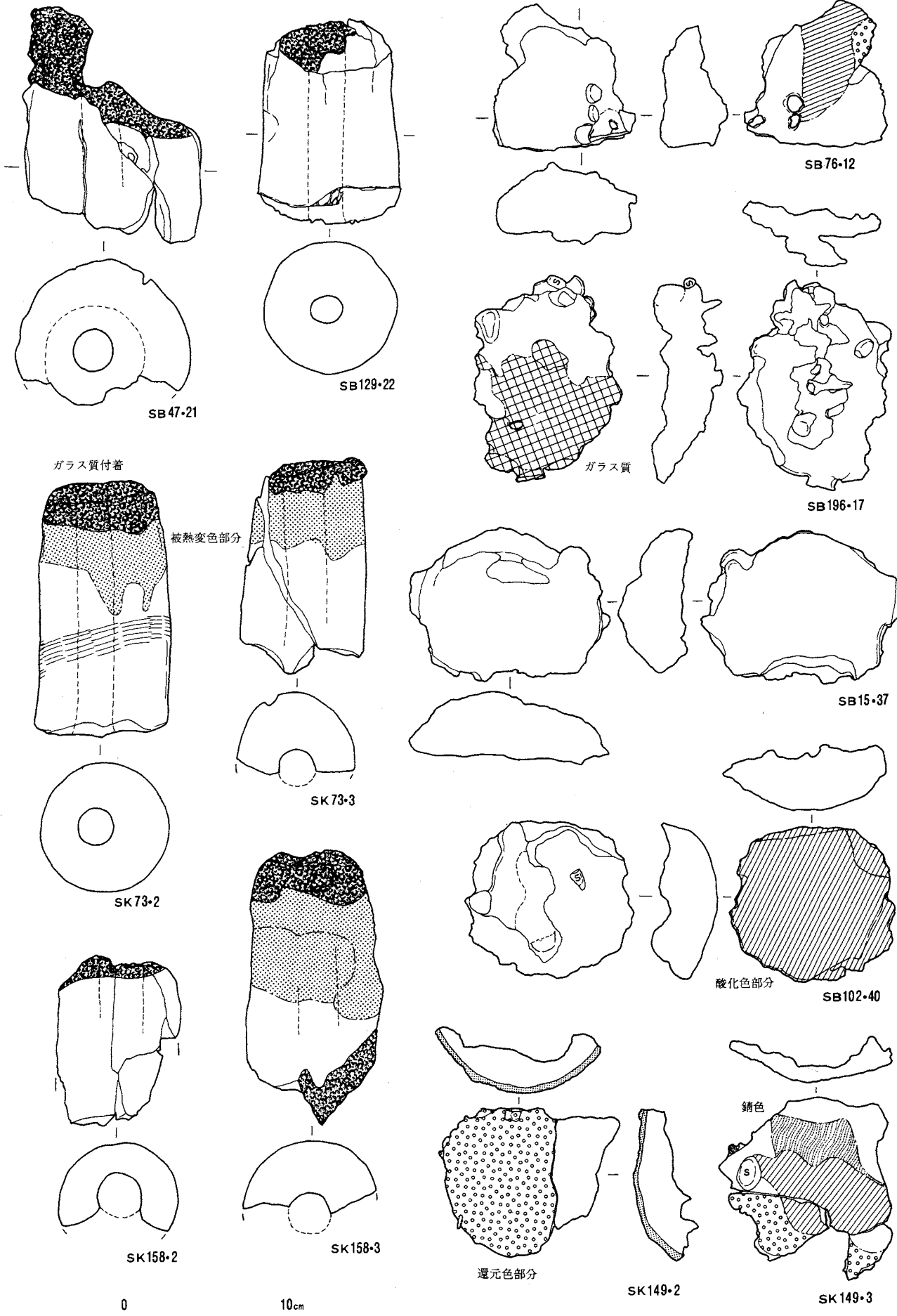

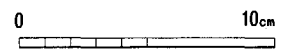
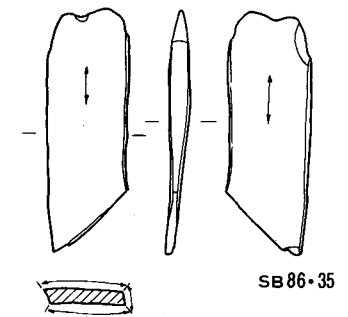
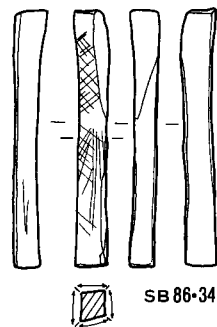
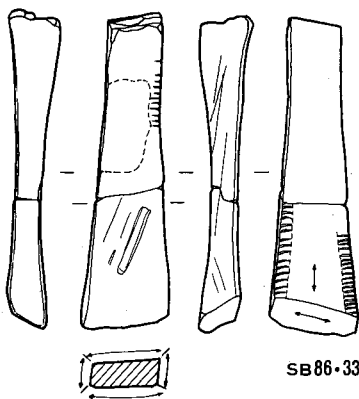
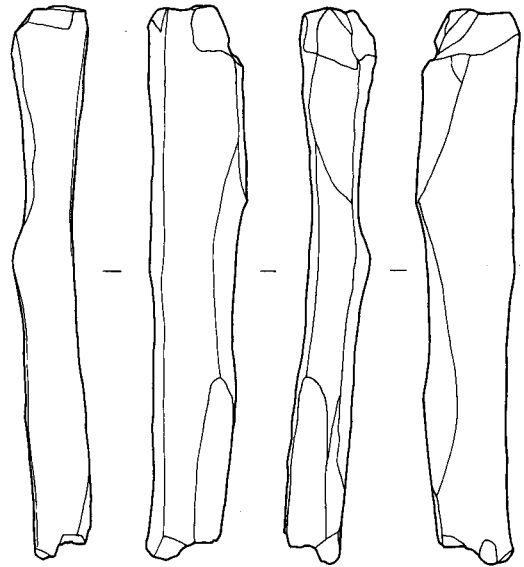
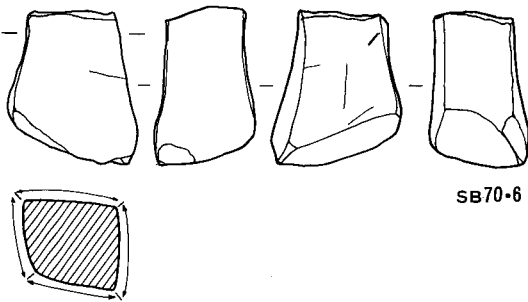
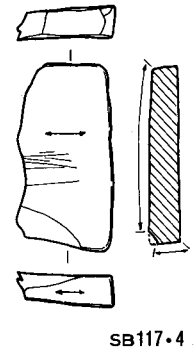
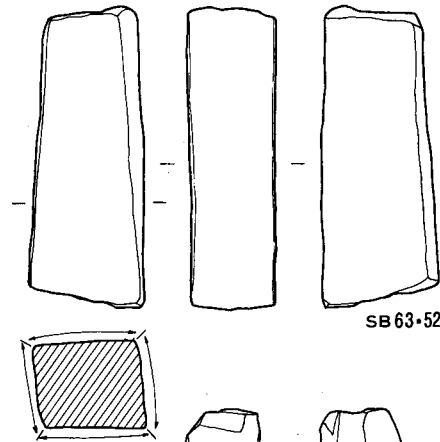
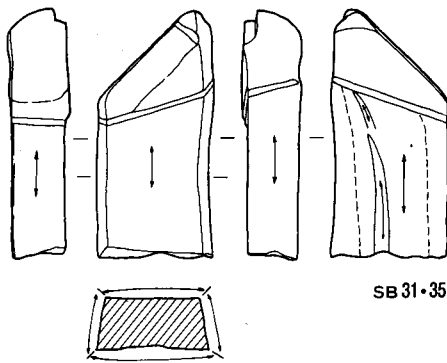
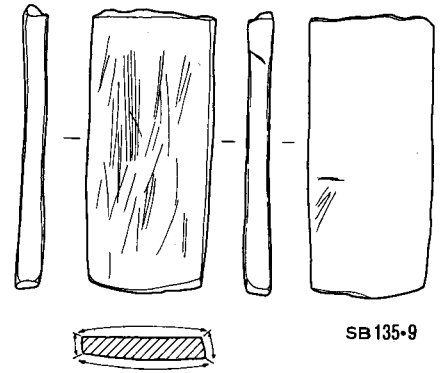
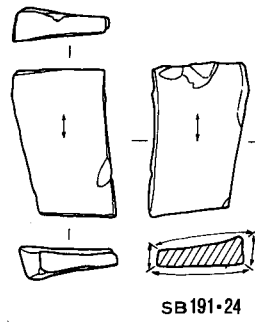
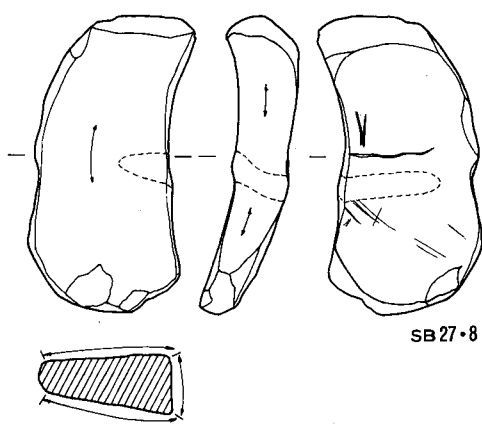

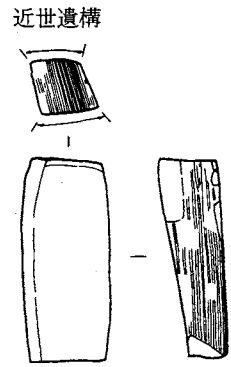
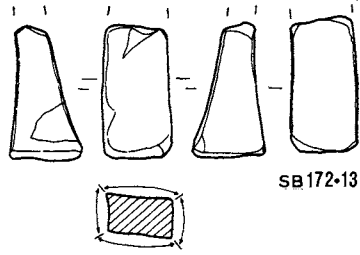
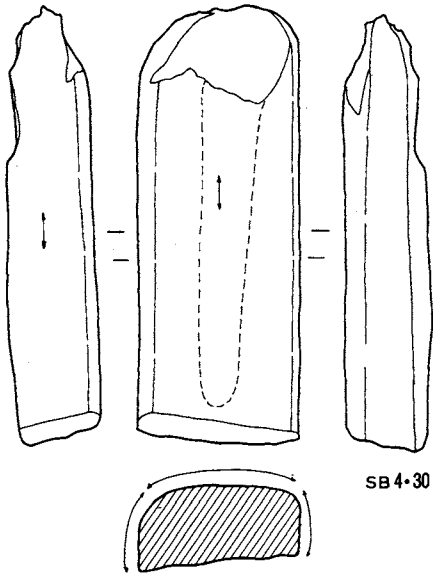

遺構外I層(1~7)

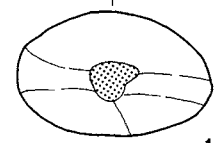
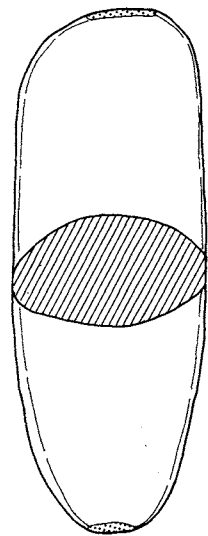
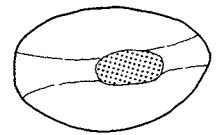
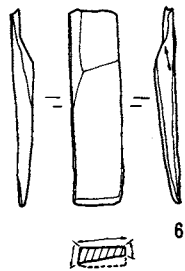
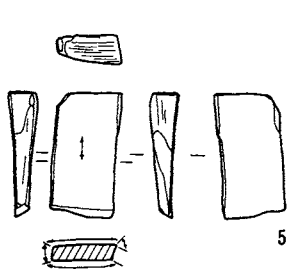
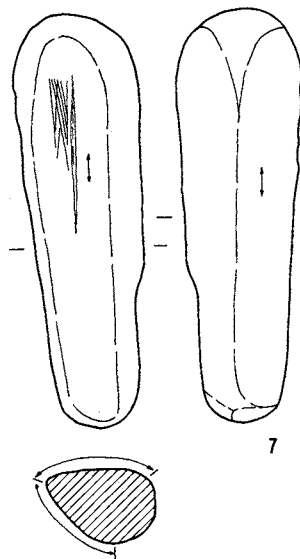
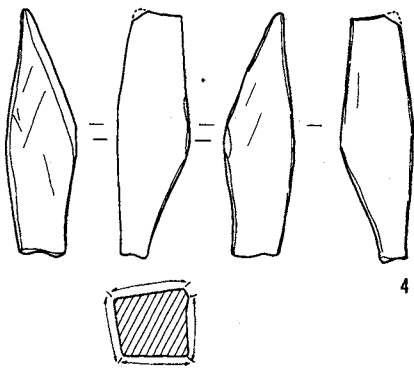
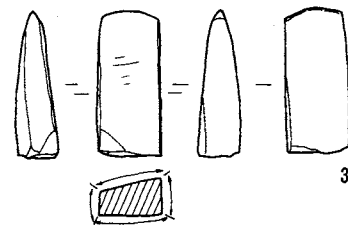
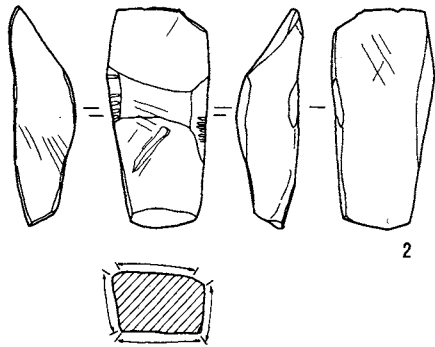
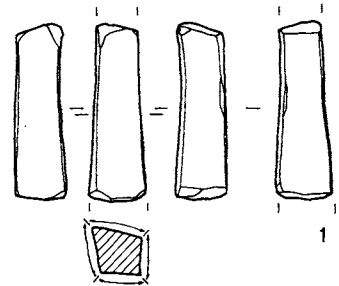
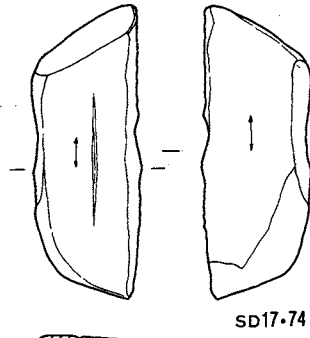

墨書土器

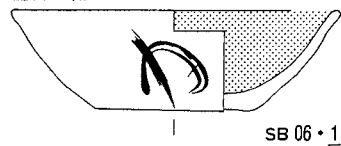

SB 06.1

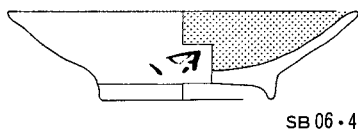
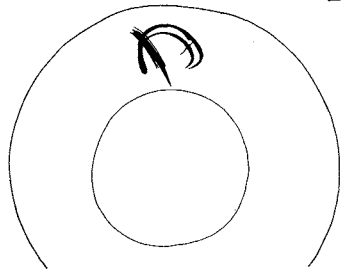

SB 06.4

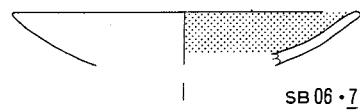
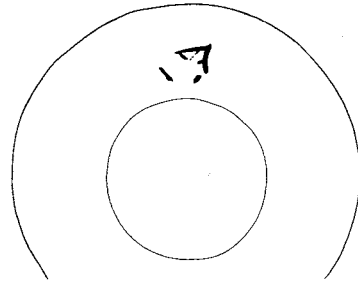

SB 06.7

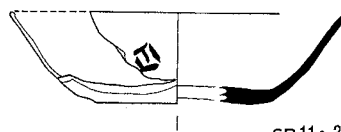
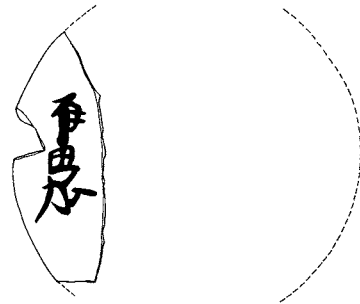

SB 11.3

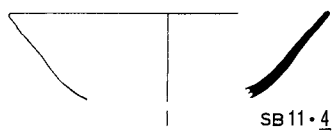
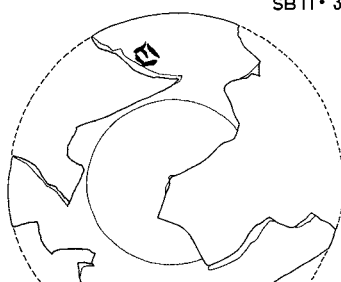

SB 11.4

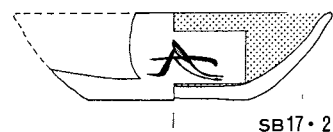
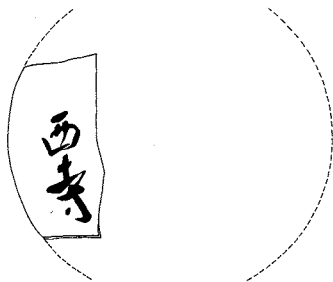

SB 17.2

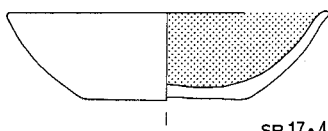
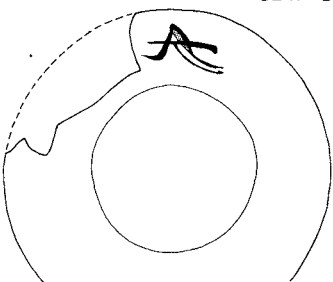

SB 17.4

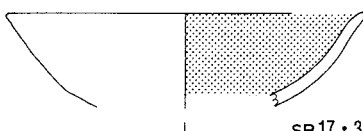
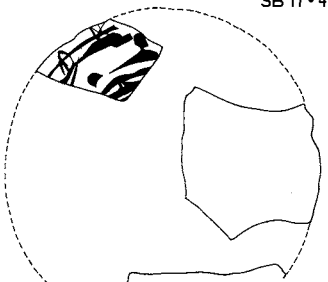

SB 17.3

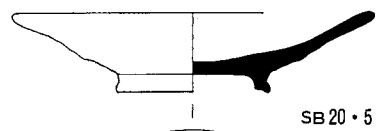
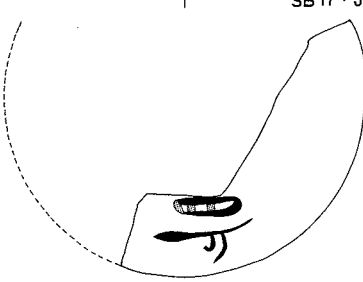

SB 20.5



SB 25.1

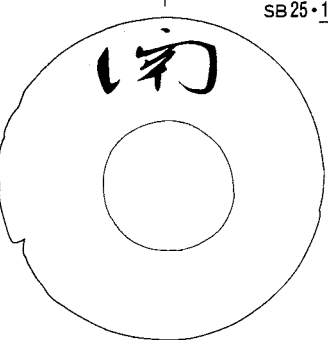

SB 25.4

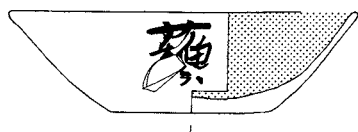

SB 26.4

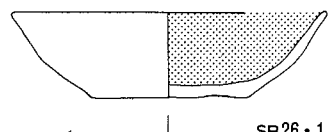
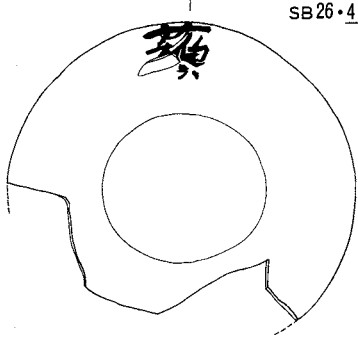

SB 26.1

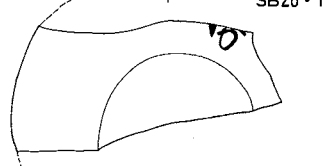

SB 20.6



SB 20.7



SB 26.13

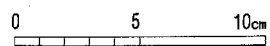

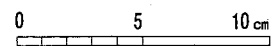
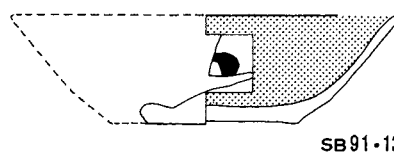
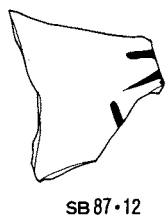
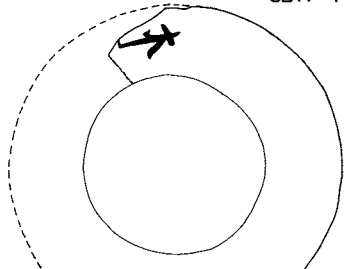
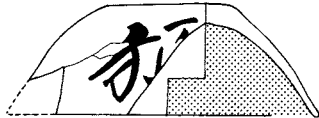
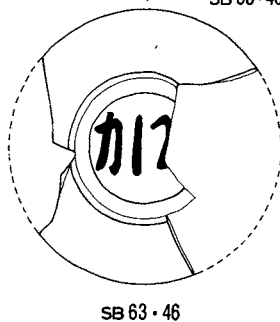
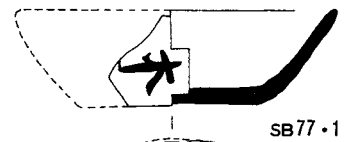
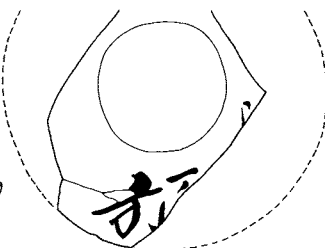
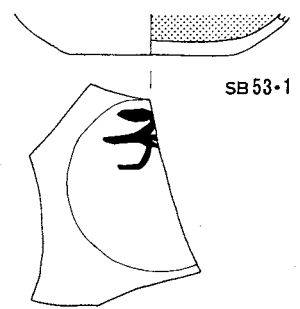
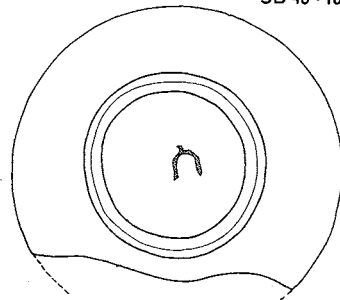
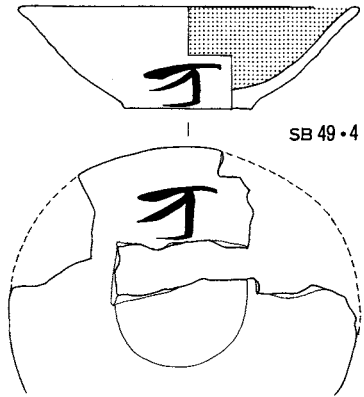
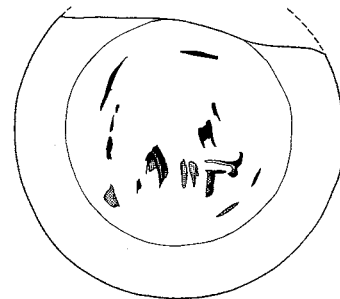
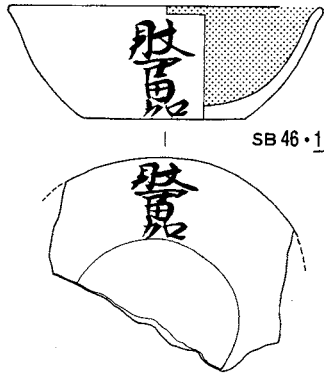
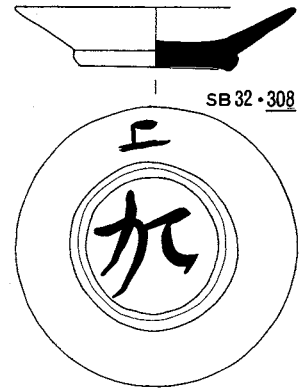
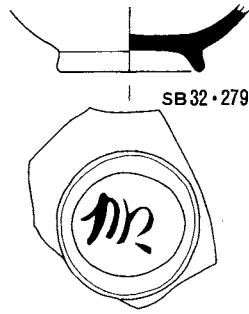
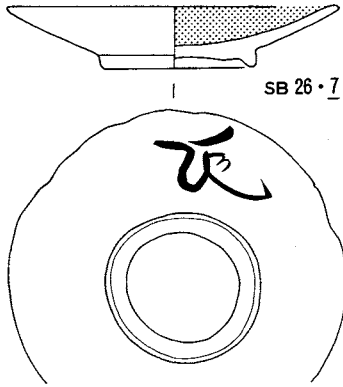

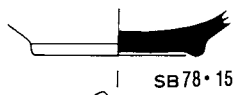

SB78・15

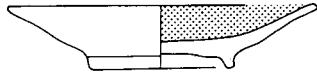

SB83・9

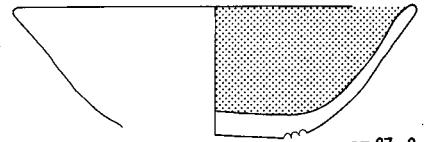
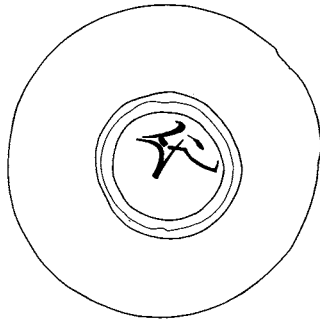

SB87・6

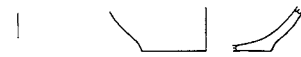

SB94・42



SB95・17

SB96・19

SB100・8



SB98・5

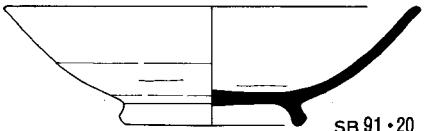
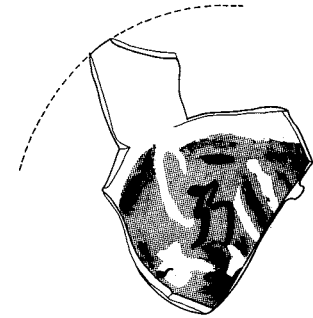
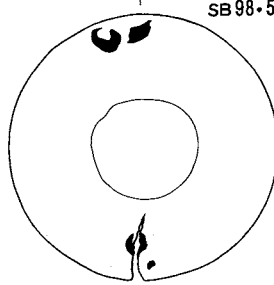

SB91・20

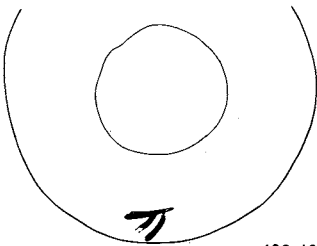

SB102・13

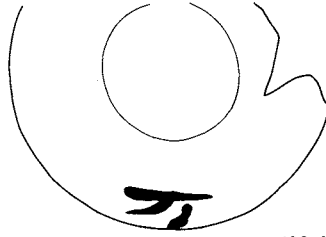

SB102・6

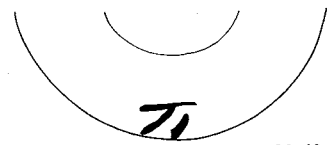

SB102・10

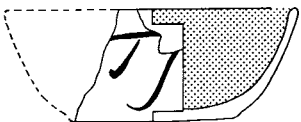
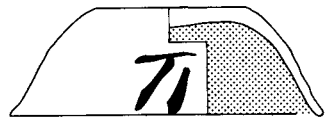
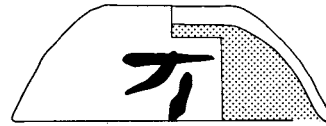
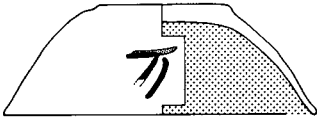

SB102・12

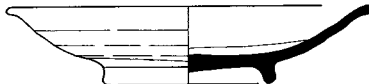

SB102・31



SB103・6



SB102・28

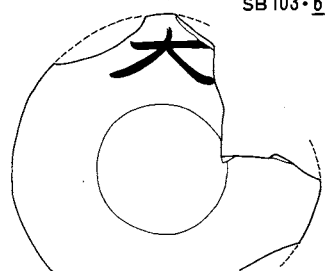
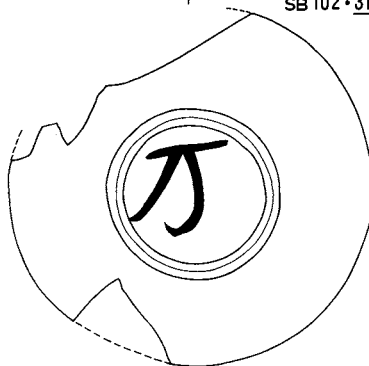

SB102・38



SB102・39

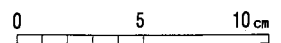

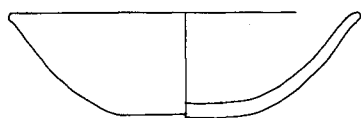

SB103·7

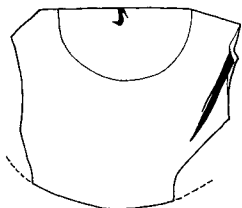

SB108·1



SB110·4



SB103·19



SB103·20



SB111·1

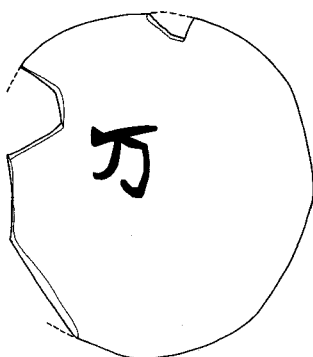

SB111·25

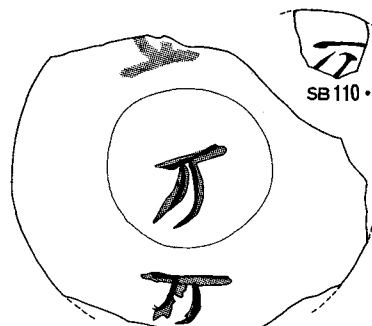

SB111·24

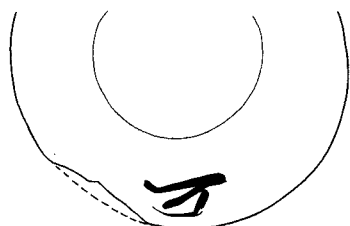

SB111·9

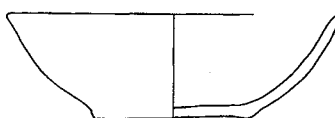
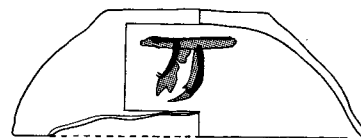
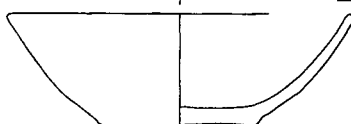

SB111·11

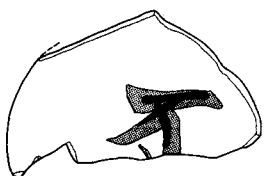
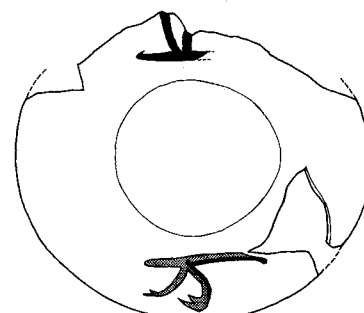

SB111·12

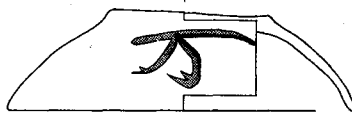
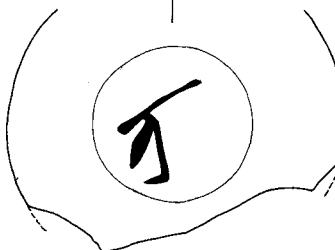

SB111·14

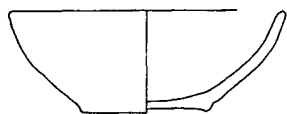

SB111·15



SB111·16

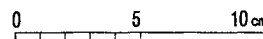
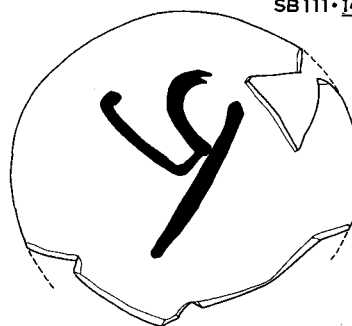
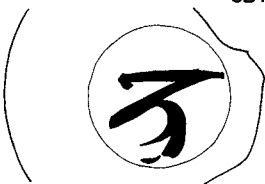

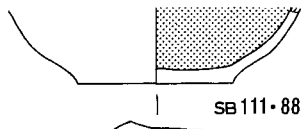

SB 111-88

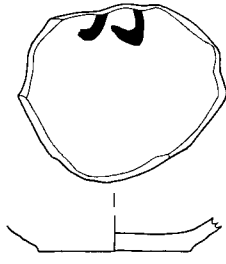
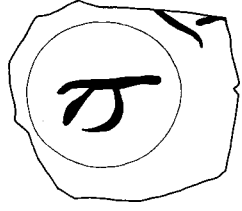

SB 111-89



SB 111-90

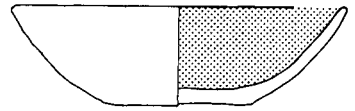

SB 111-29

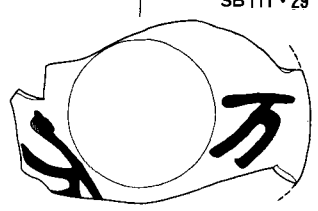

SB 111-61

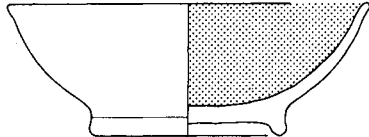

SB 111-60

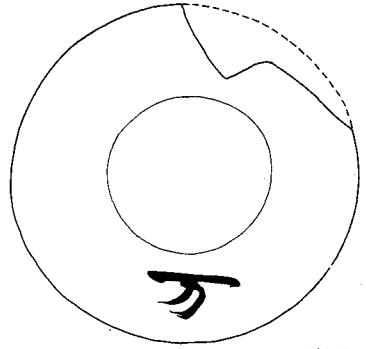
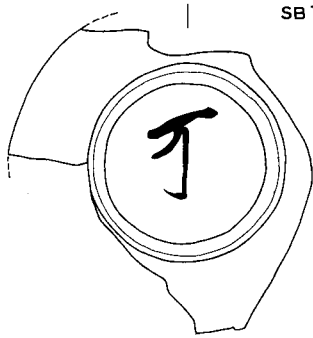

SB 111-31

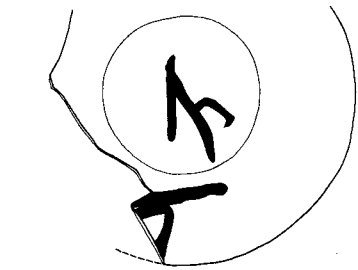
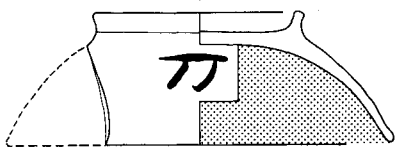

SB 111-36

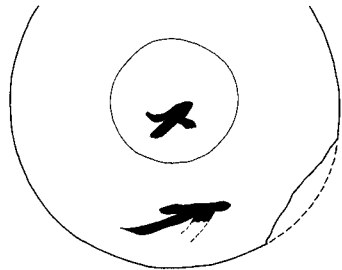
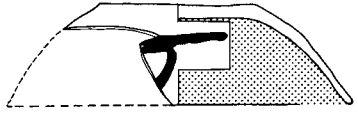

SB 111-35

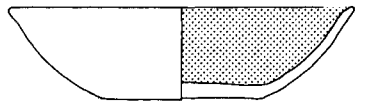
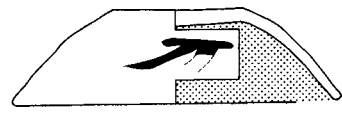

SB 111-37

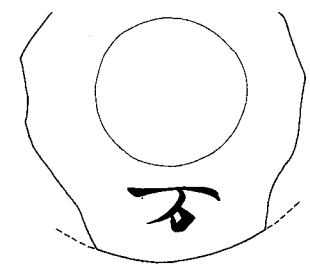
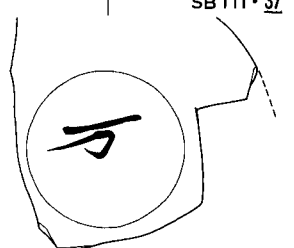

SB 111-39

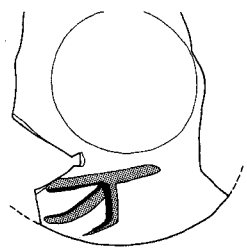
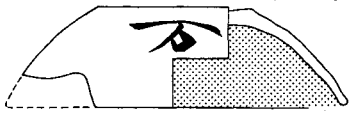

SB 111-40

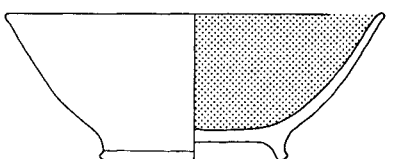
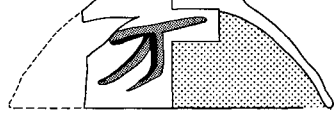

SB 111-54

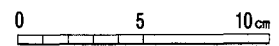
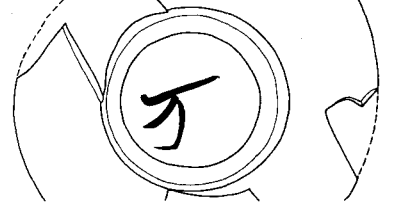

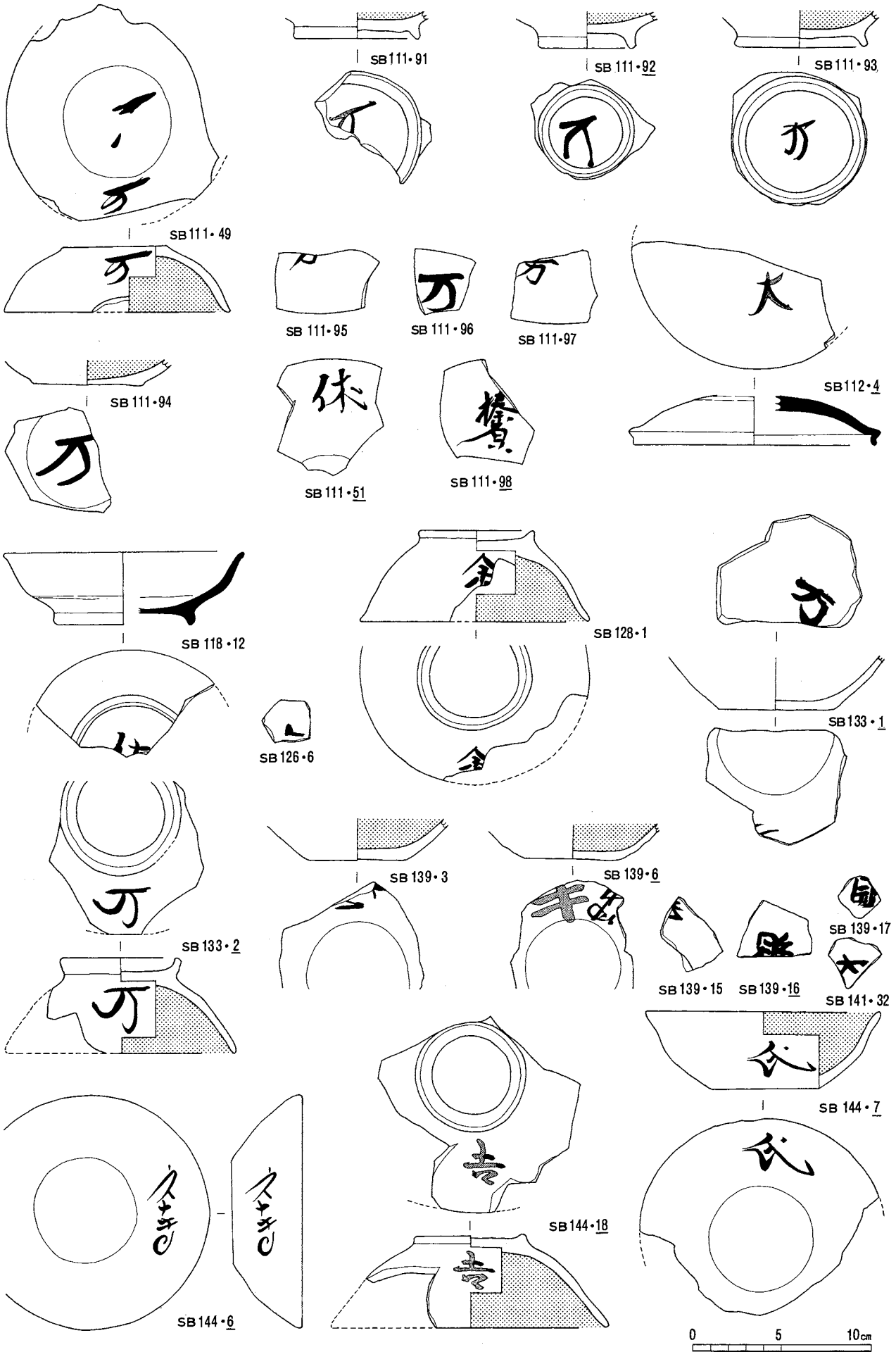

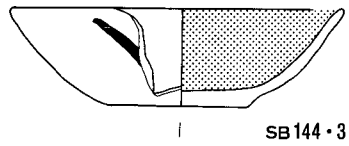

SB 144・3

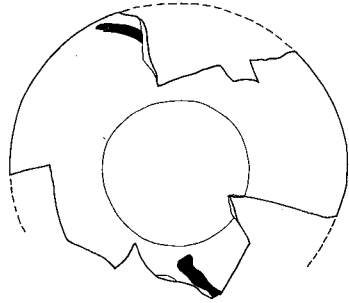

SB 144・20

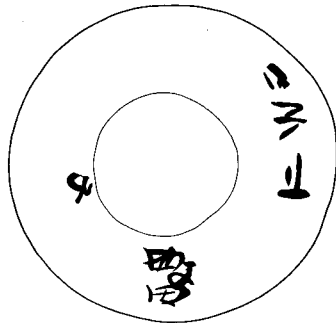

SB 144・23



SB 144・24

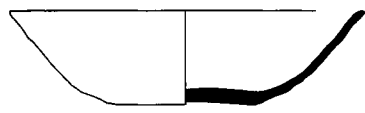

SB 144・22

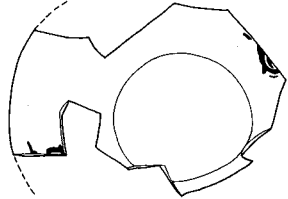

SB 144・14



SB 144・10

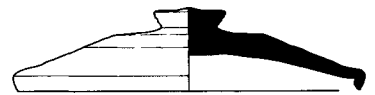

SB 145・3

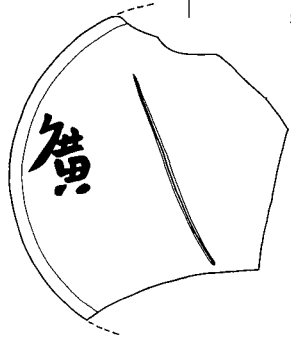

SB 160・15



SB 160・20



SB 160・21



SB 168・5



SB 170・11



SB 165・2

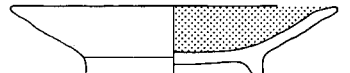
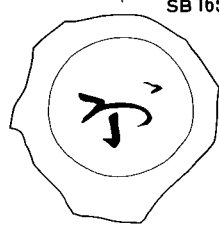

SB 170・5

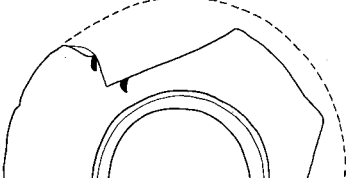

SB 168・2

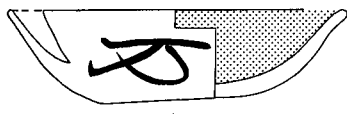
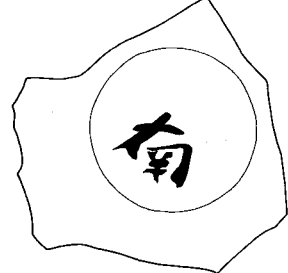

SB 172・4

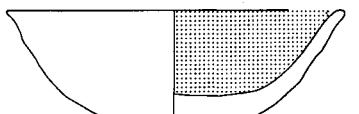
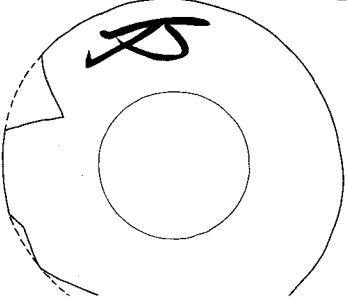

SB 172・8

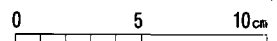
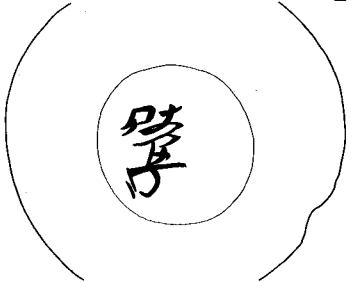

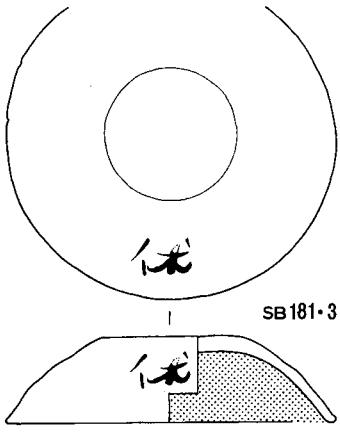

SB 181-3

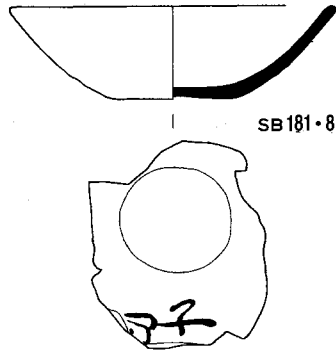

SB 181-8

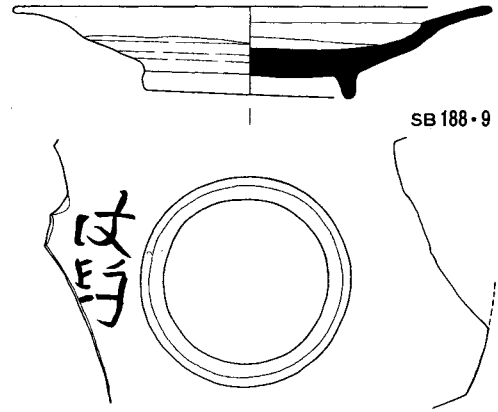

SB 188-9



SB 188-1

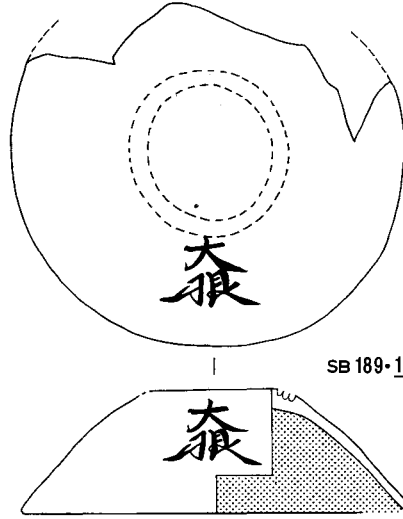

SB 189-11

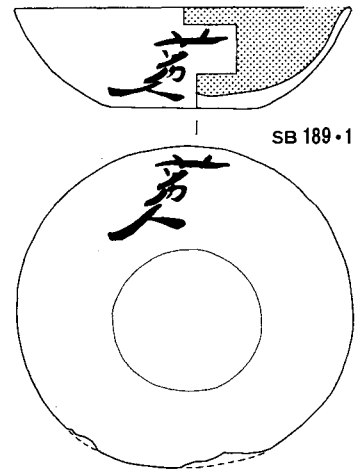

SB 189-1

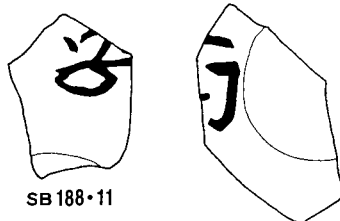

SB 188-11



SB 191-19



SB 195-1

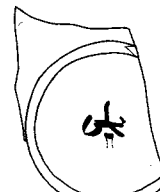

SB 195-6

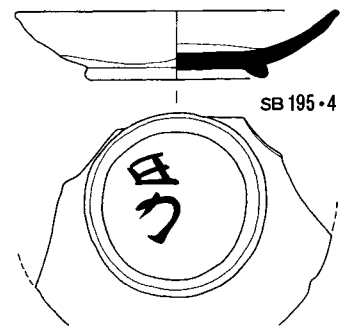

SB 195-4



SB 191-21



SB 196-14



SB 196-15

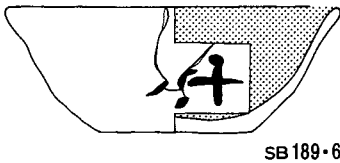

SB 189-6



SB 196-9

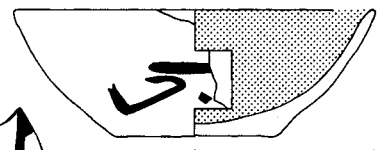

SB 210-5

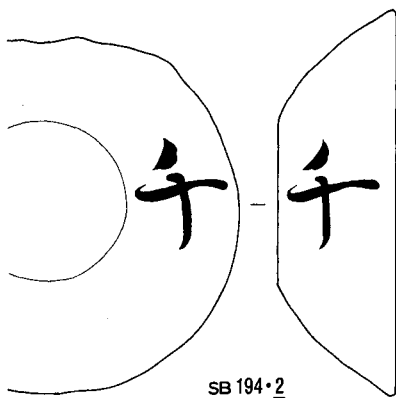

SB 194-2



SB 199-20

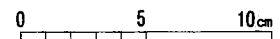
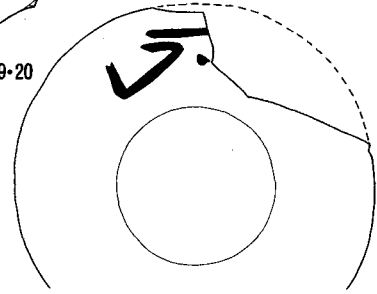

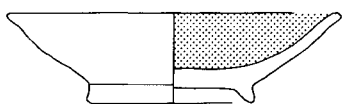

SB 212-1

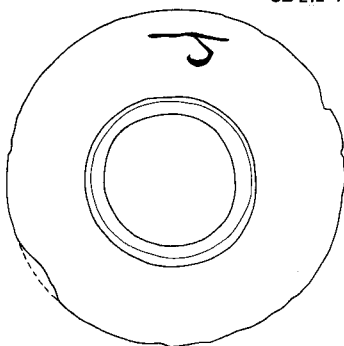

SB 233-3

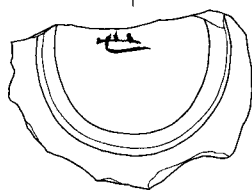

SB 243-3



SB 243-8



SB 250-2



SB 252-3



SB 259-16



SB 261-2

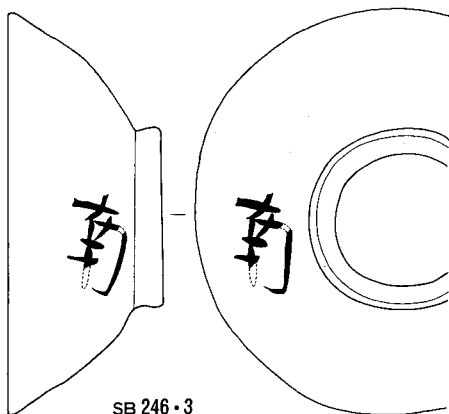

SB 246-3

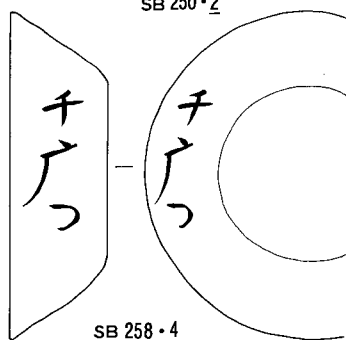

SB 258-4

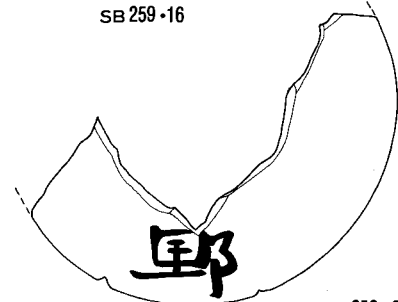

SB 259-6

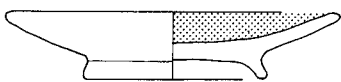

SB 264-5

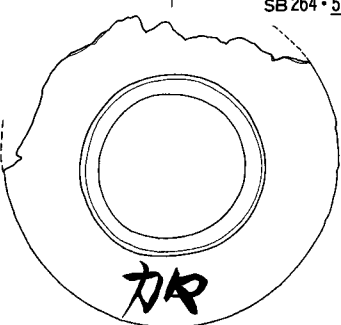

SB 265-1

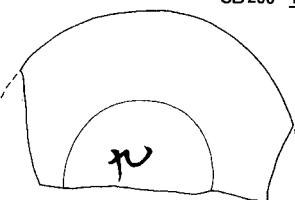

SB 265-3



SB 264-19



SB 267-2

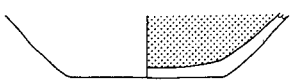

SB 266-3

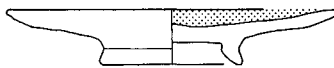
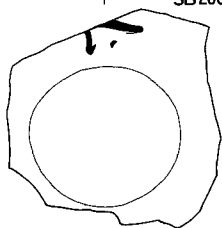

SB 267-1

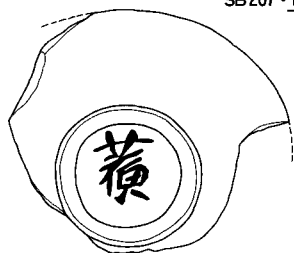

SB 266-14

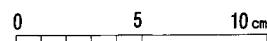
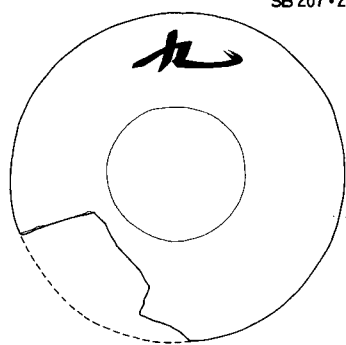

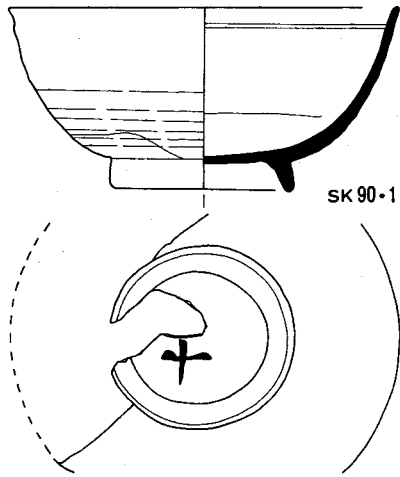

SK 90-1

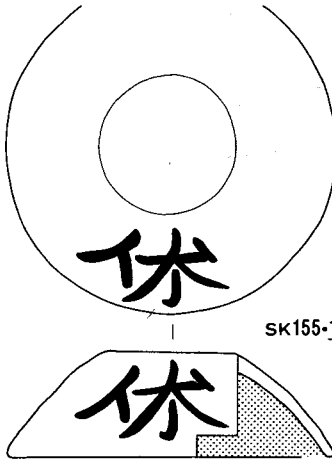

SK 155-1

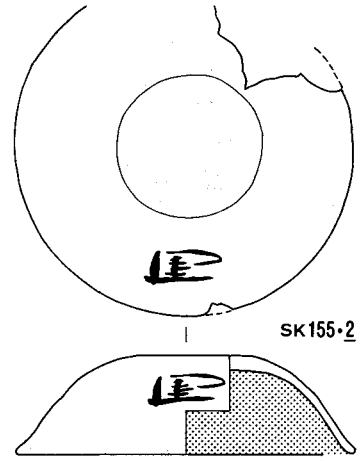

SK 155-2

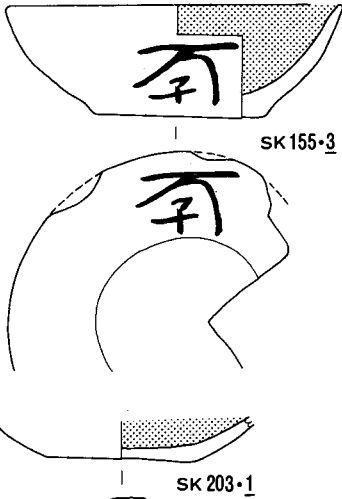

SK 155-3

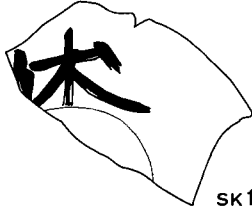

SK 155-4

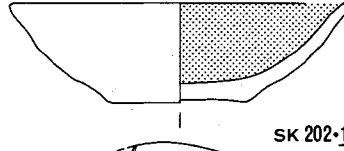

SK 202-1



SK 202-2



SK 203-1

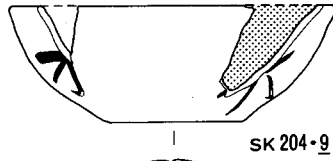

SK 204-9



SK 204-11



SK 202-3



SK 202-6

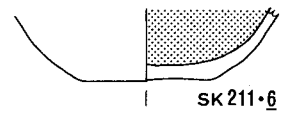

SK 211-6



SK 336-1



SK 259-2



SD 02-1



SD 03-15



SD 03-16



SD 03-17

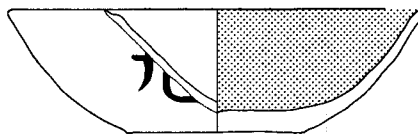

SD 27-1

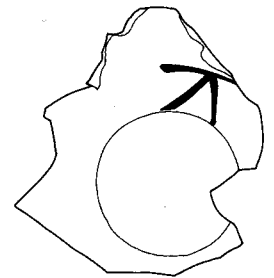

SD 03-4

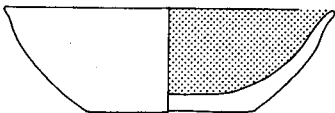

SD 03-5



SD 19-10



SD 27-2

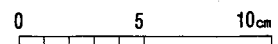

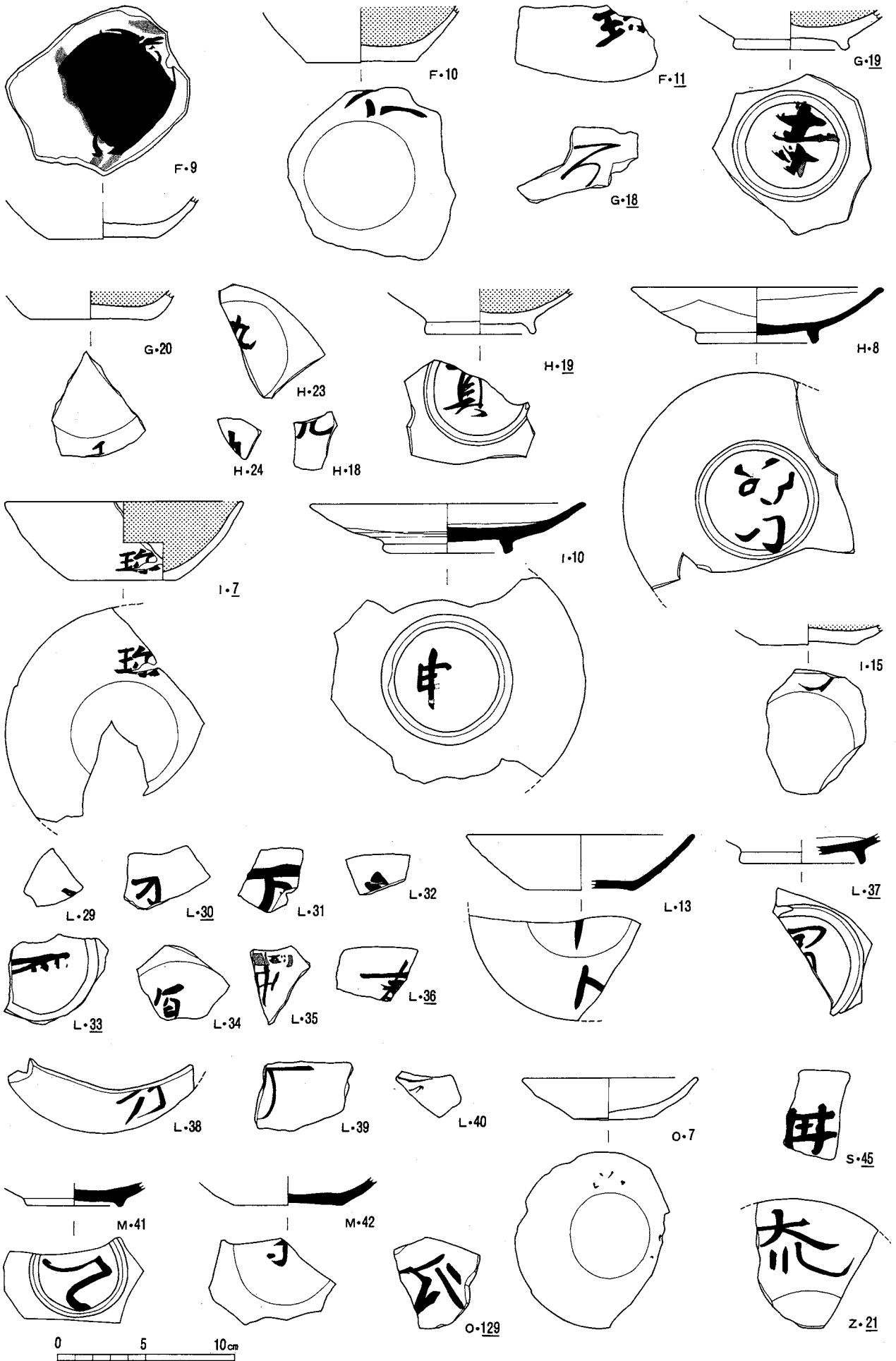

刻書土器

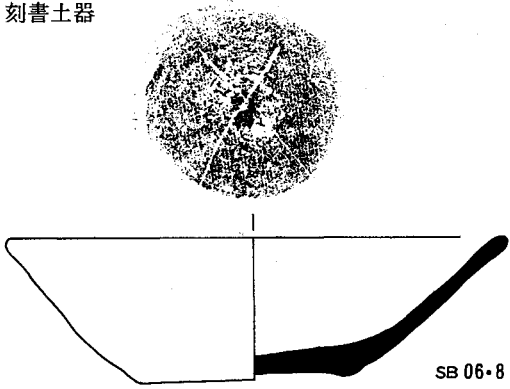

SB 06-8

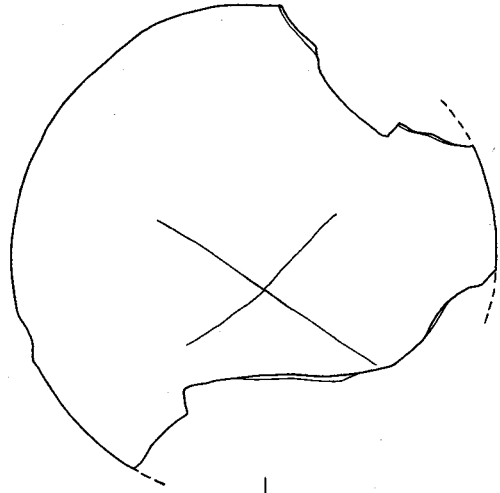

SB 72-2

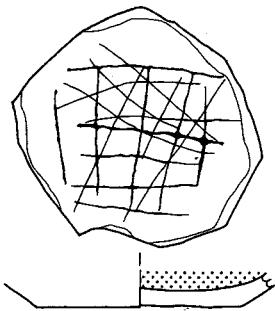

SB 72-14



SB 87-3



SB 87-5

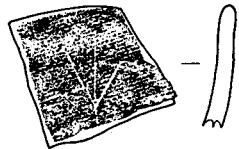

SB 87-11



SB 111-56

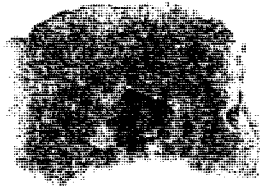

SB 111-62

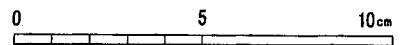

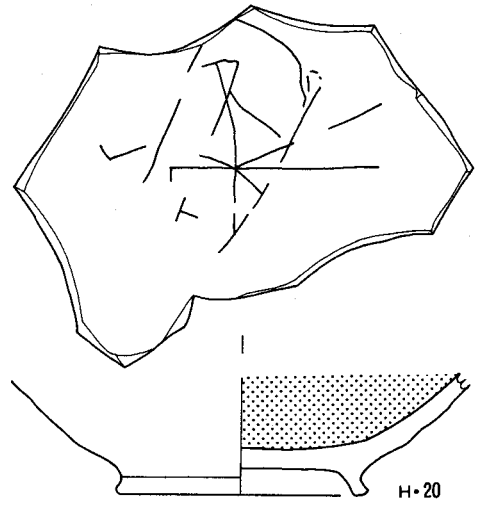
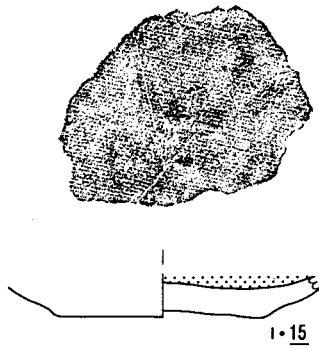
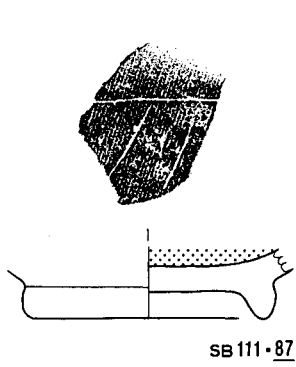
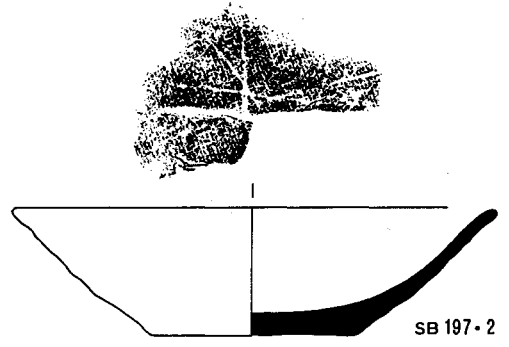
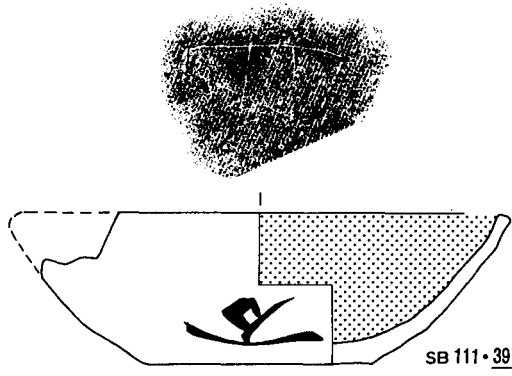

篋書土器

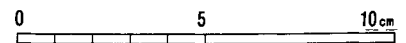
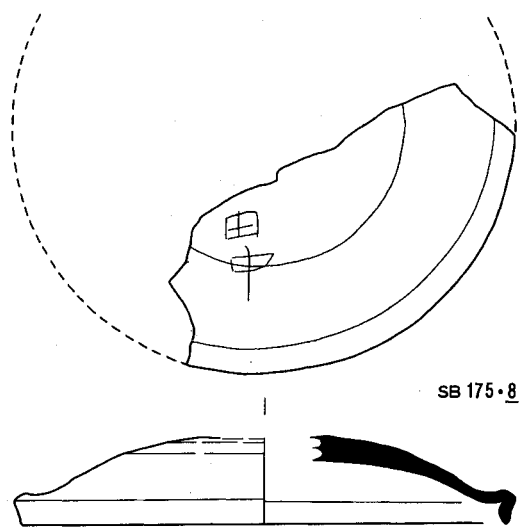
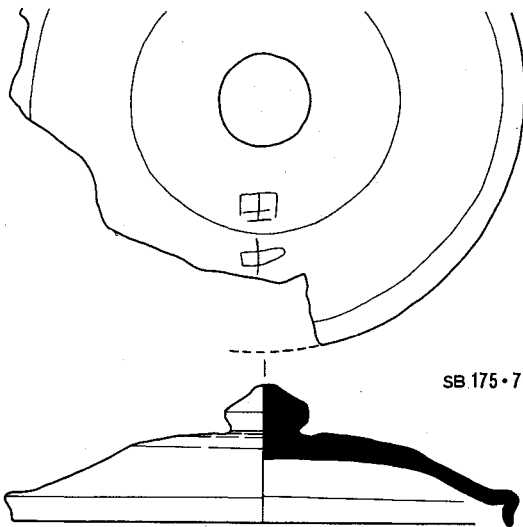
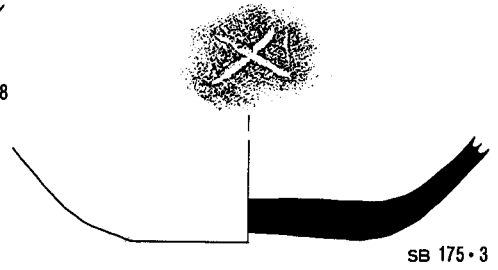
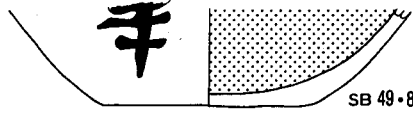

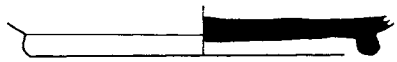

SB 199-18

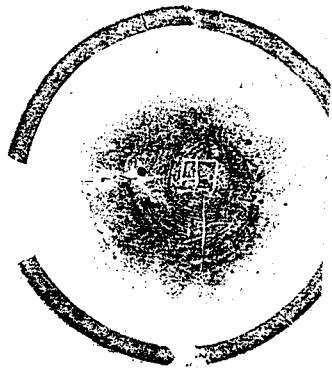

SB 199-19

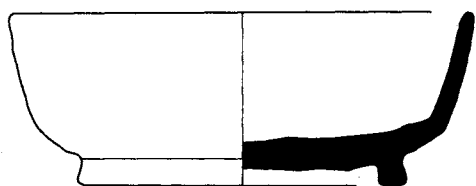

SK 254-1

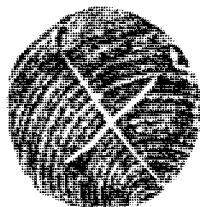

SD 17-66

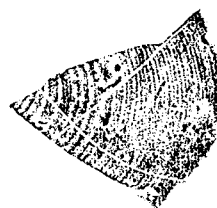

G-21



s-46

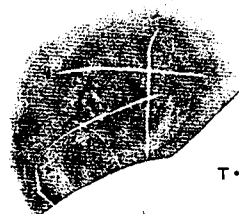

T-2

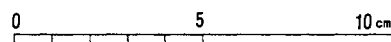
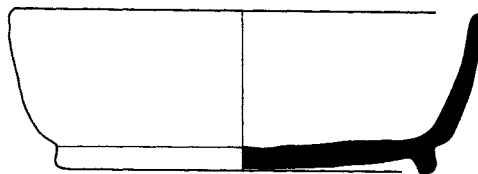

筆, 硯

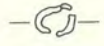
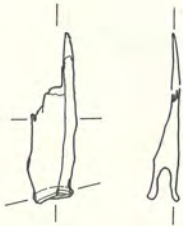

SB 32-395

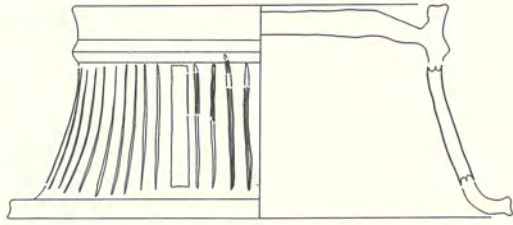

O-135

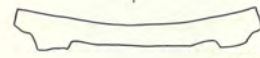
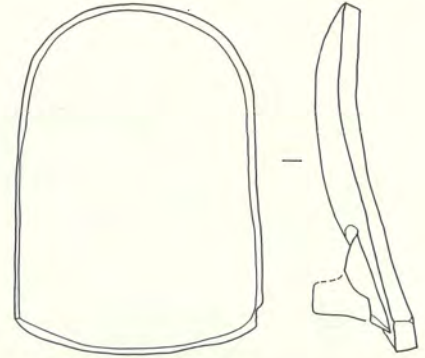

O-134

転用硯

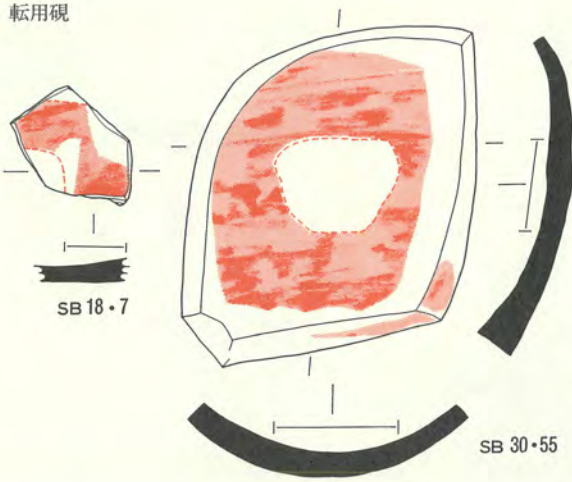

SB 18-7

SB 30-55

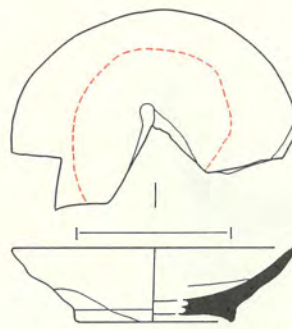

SB 32-285

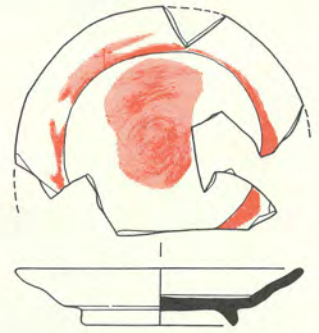

SB 32-293

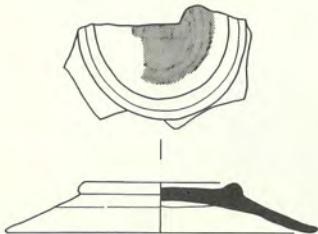

SB 32-311



SB 32-342



SB 32-343



SB 32-344

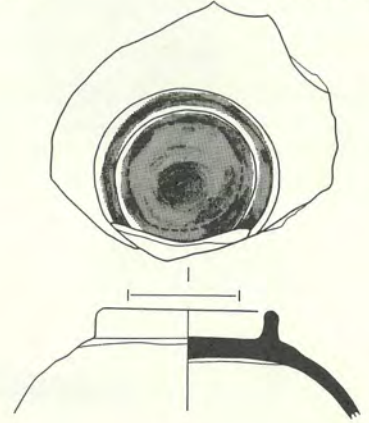

SB 36-3

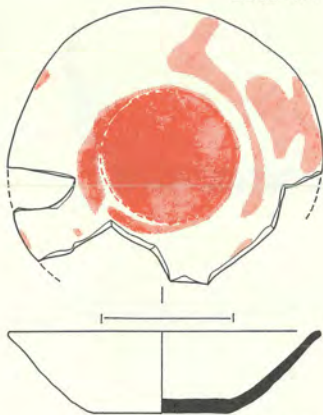

SB 58-15

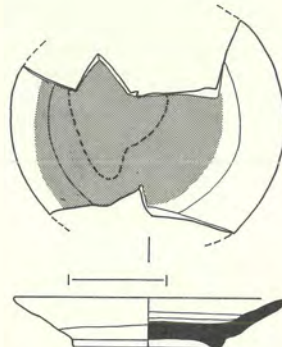

SB 63-45

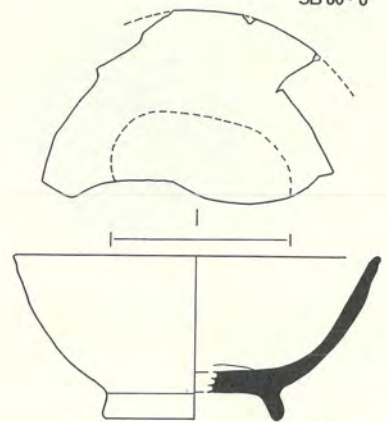

SB 66-33

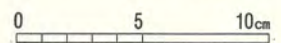

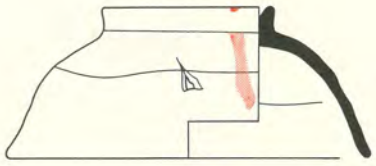

SB 73・7

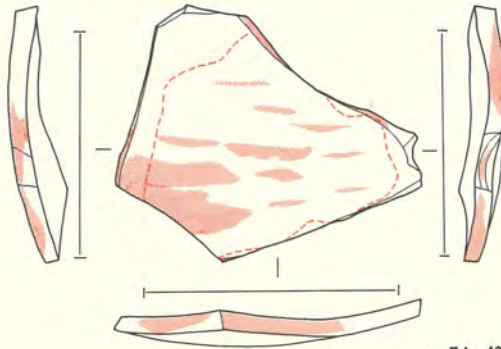

SB 74・48

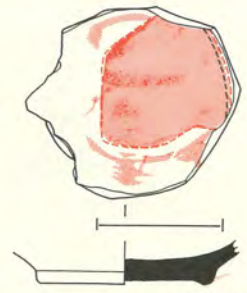

SB 78・15

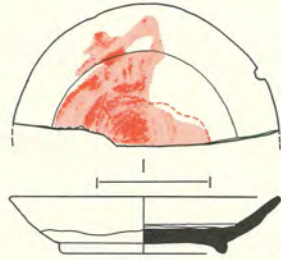

SB 86・23

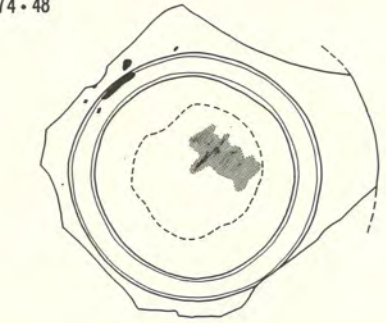

SB 87・8

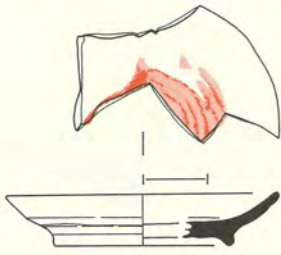

SB 78・11

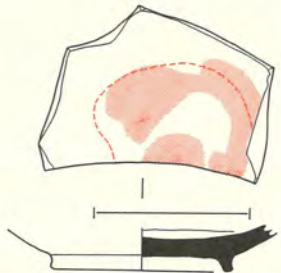

SB 94・45

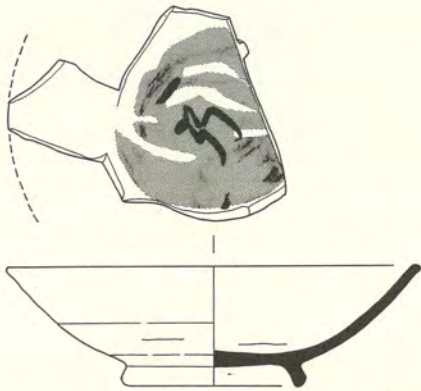

SB 91・20



SB 96・10

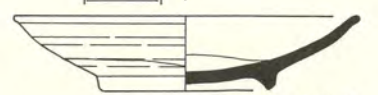

SB 102・28

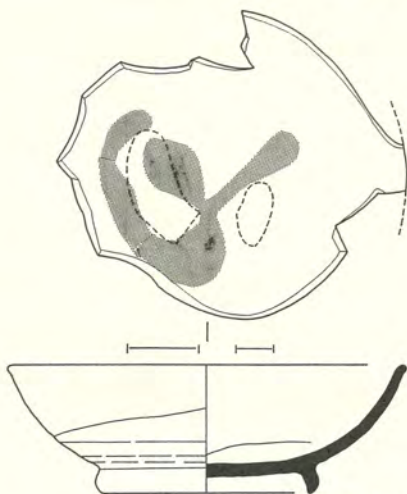

SB 103・12

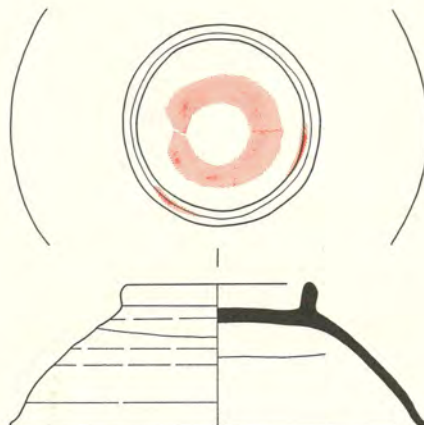

SB 110・9

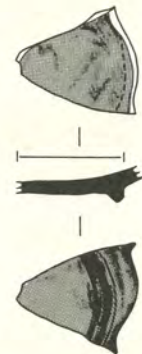

SB 114・24

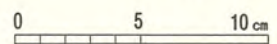

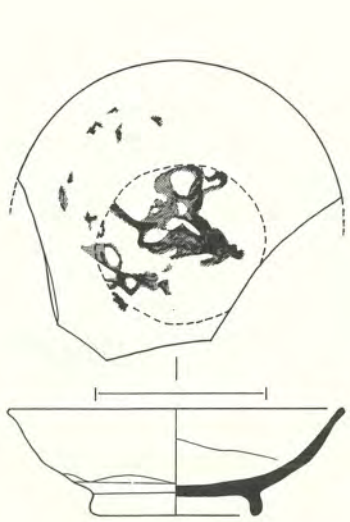

SB 114・11

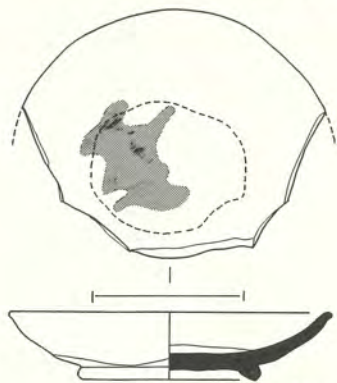

SB 195・4

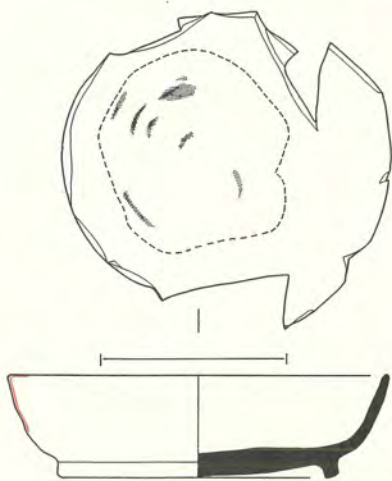

SB 227・12

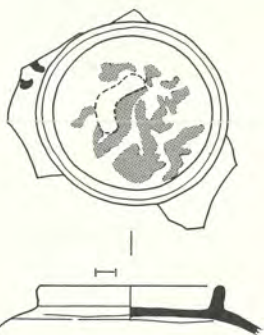

SK 118・7

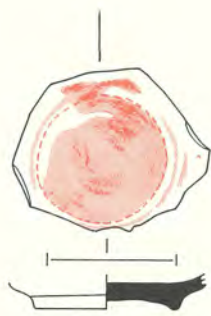
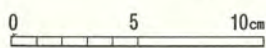

SB 120・24

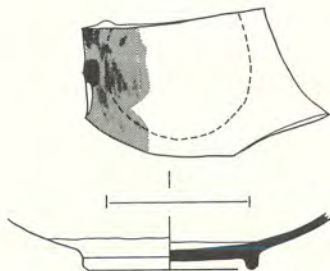

SB 195・6

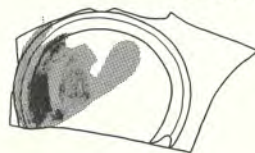

SB 227・8

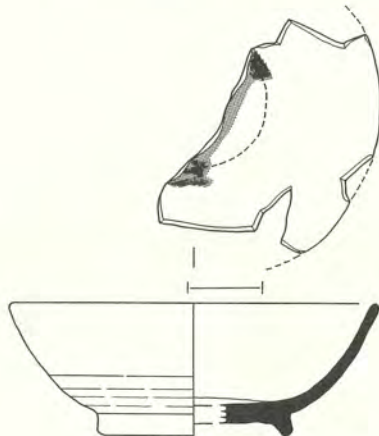

SB 263・21

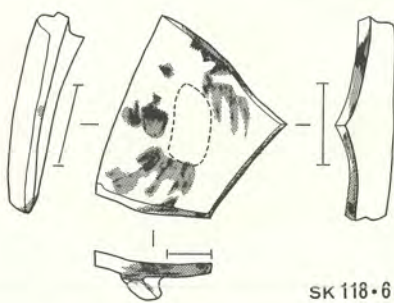

SK 118・6

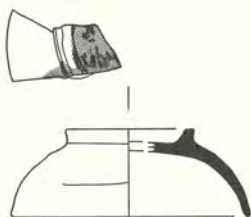

SD 17・52

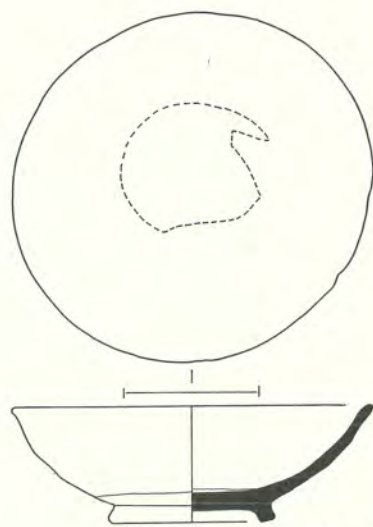

SB 142・21

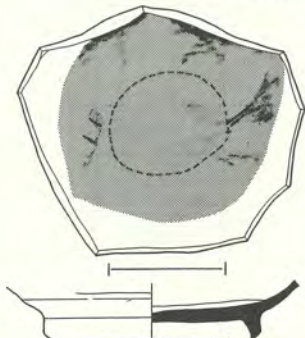
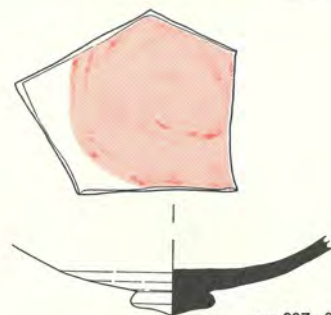

SK 101・4

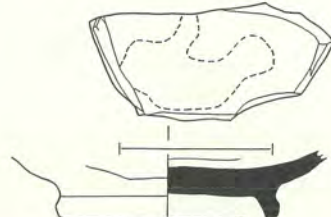

SK 120・4

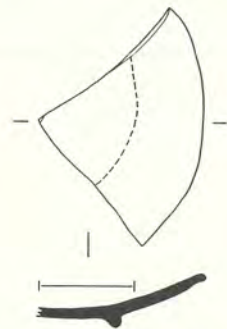

SD 17・53

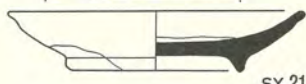

SX 21-51

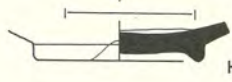

H-21

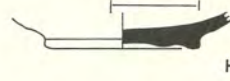
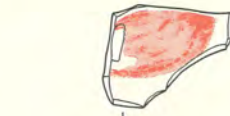

H-22



I-16

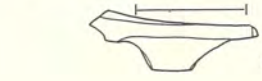
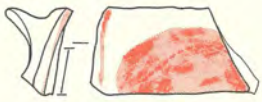

I-17

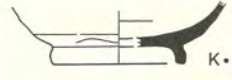

K-4

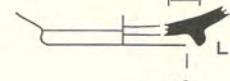

L-41

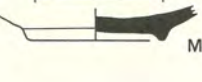
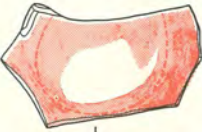

M-41

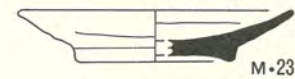

M-23

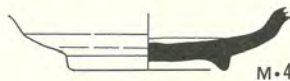
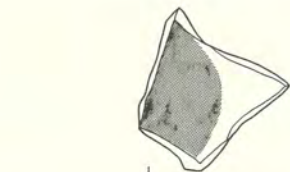

M-43

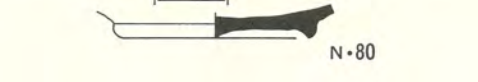
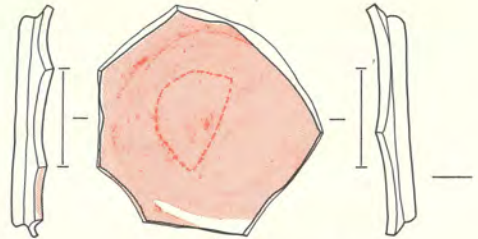

N-80

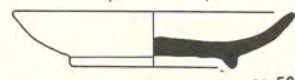

N-50

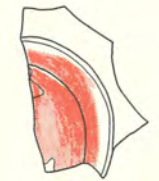

O-130



O-132

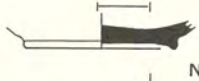
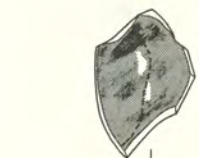

N-81



O-131



O-133

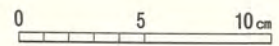

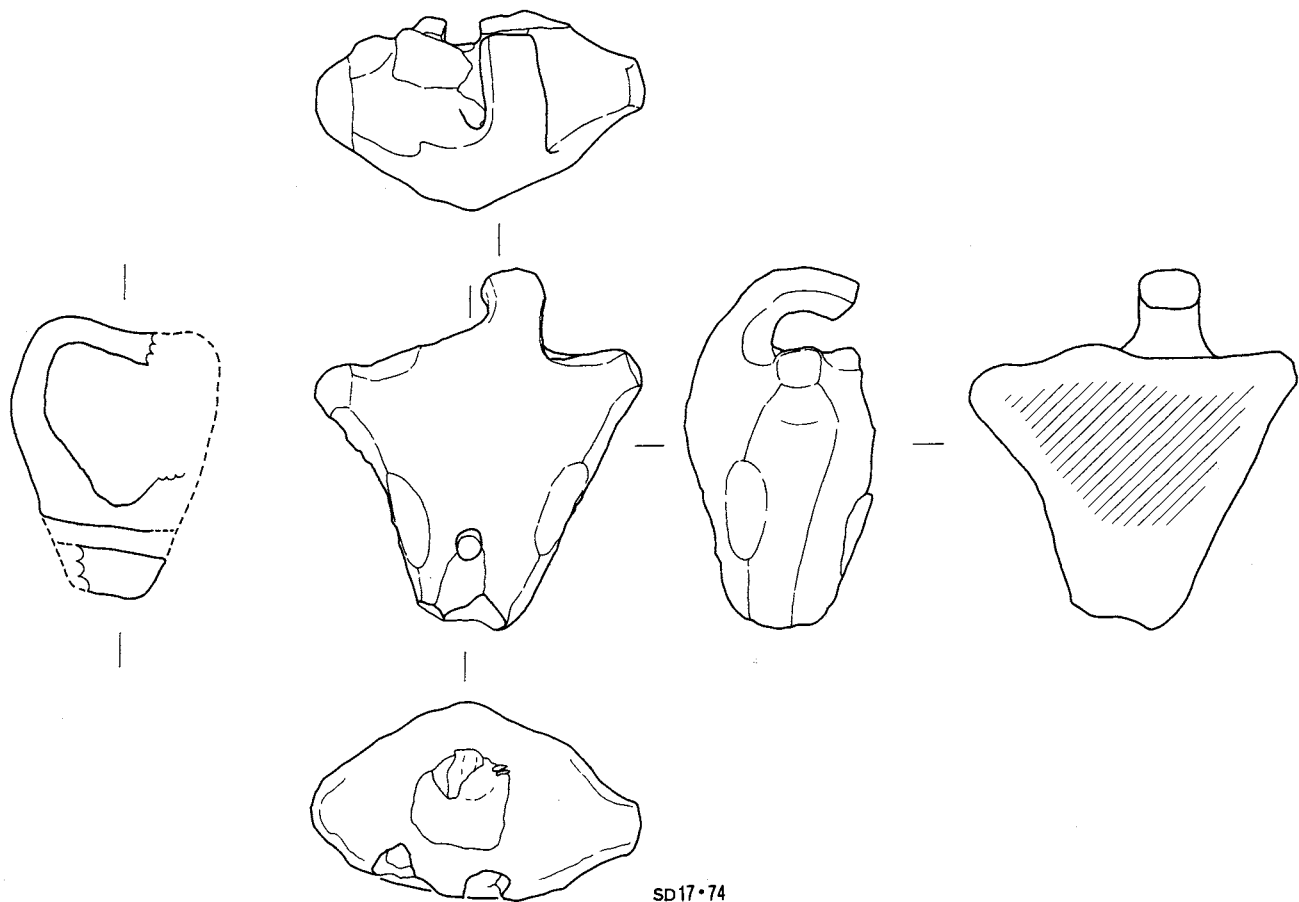

SD17・74

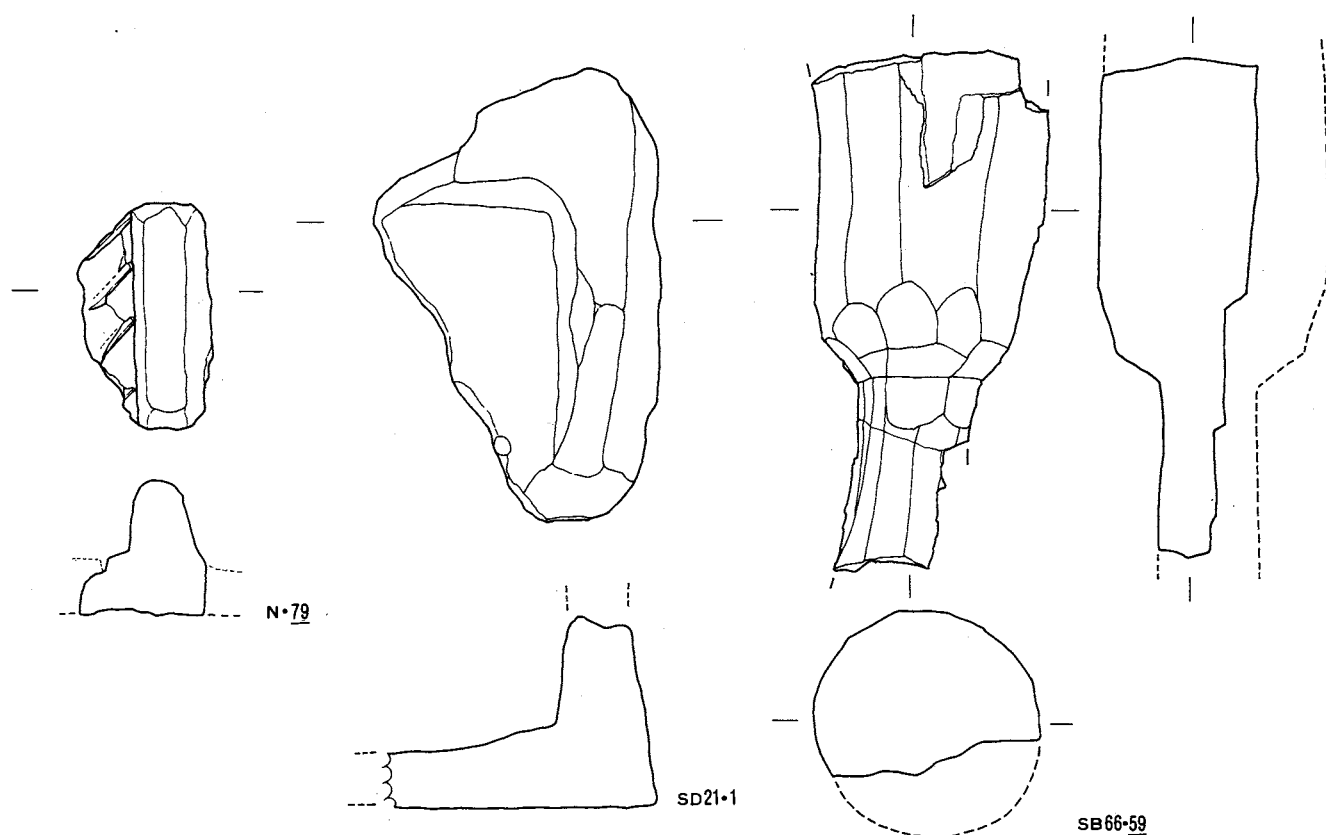

N・79

SD21・1

SB66・59

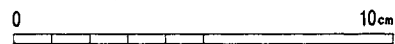

SK 1136 (1)



SB 1148 (1)

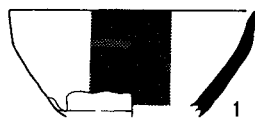

SK 1178 (1.2)



SK 1221 (1.2)

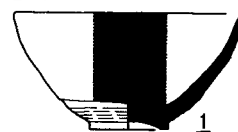

SK 1249 (1)



SB 1179 (1.2)



SK 1141 (1)

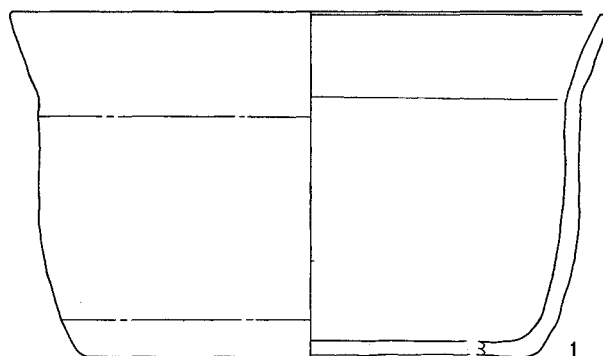

SK 1182 (1)

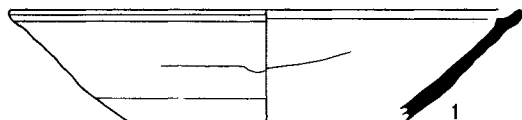

SK 1153 (1)

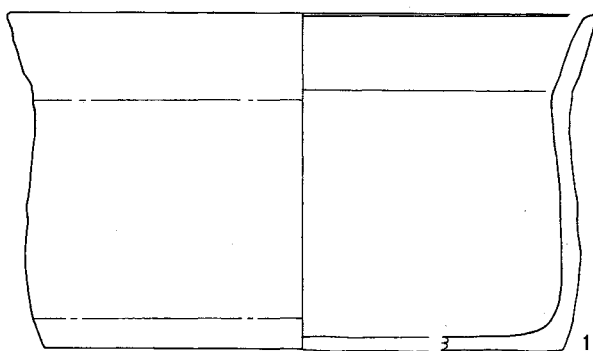

SK 1217 (1)

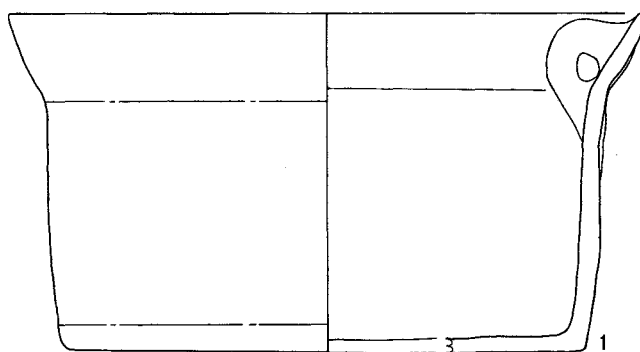

SK 1190 (1~6)

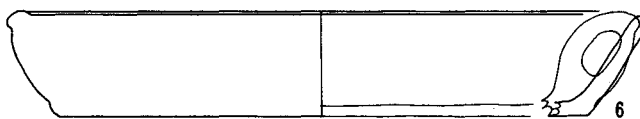
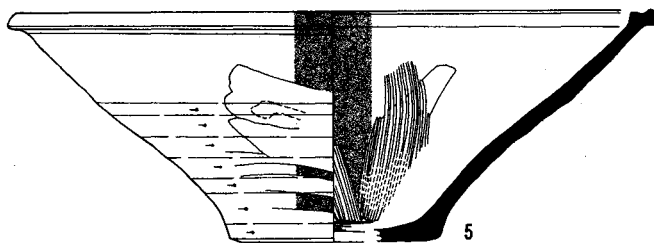
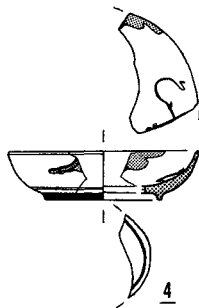

SD 04 (1~6)

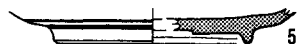
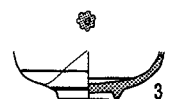
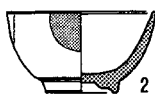
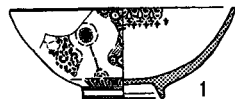

SD 30 (1~5)

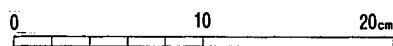
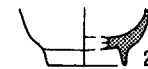

SX 08 (1~5)

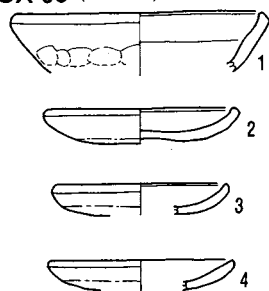

SK 1244 (1~4)

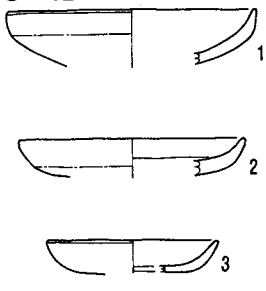

SB 255 (1)

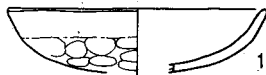

SK 1208 (1)



SK 1241 (1)

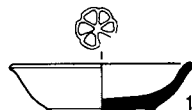

SK 1240 (1)

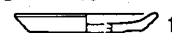

SK 1188 (1)

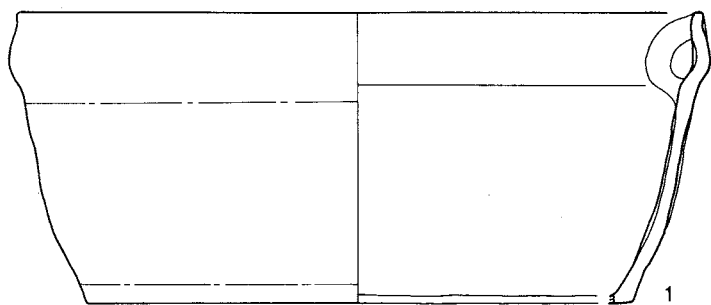

SK 1174 (1)



SK 1196 (1)



SX 22 (1.2)

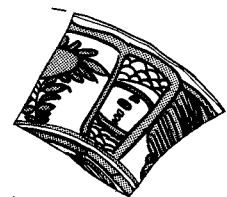
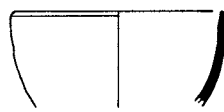

SK 2013 (1~6)

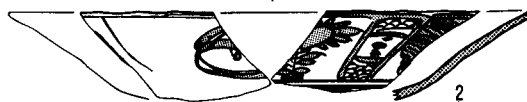
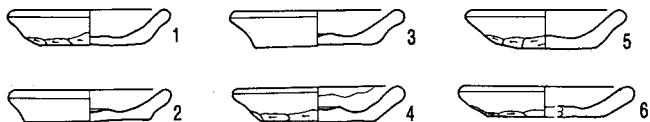

SK 2014 (1)

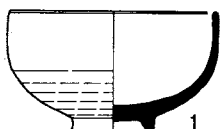

SK 2007 (1)



SD 21 (1~9)

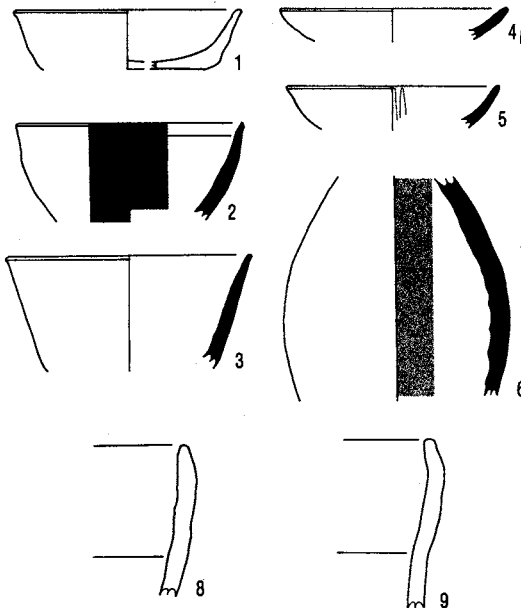

ST 03 (1.2)

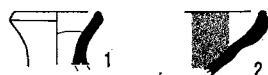

SD17 (1)



SD 02 (1.2)

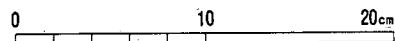
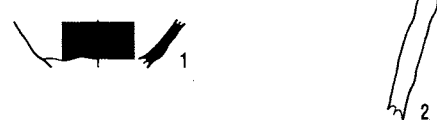

SD 32 (1)

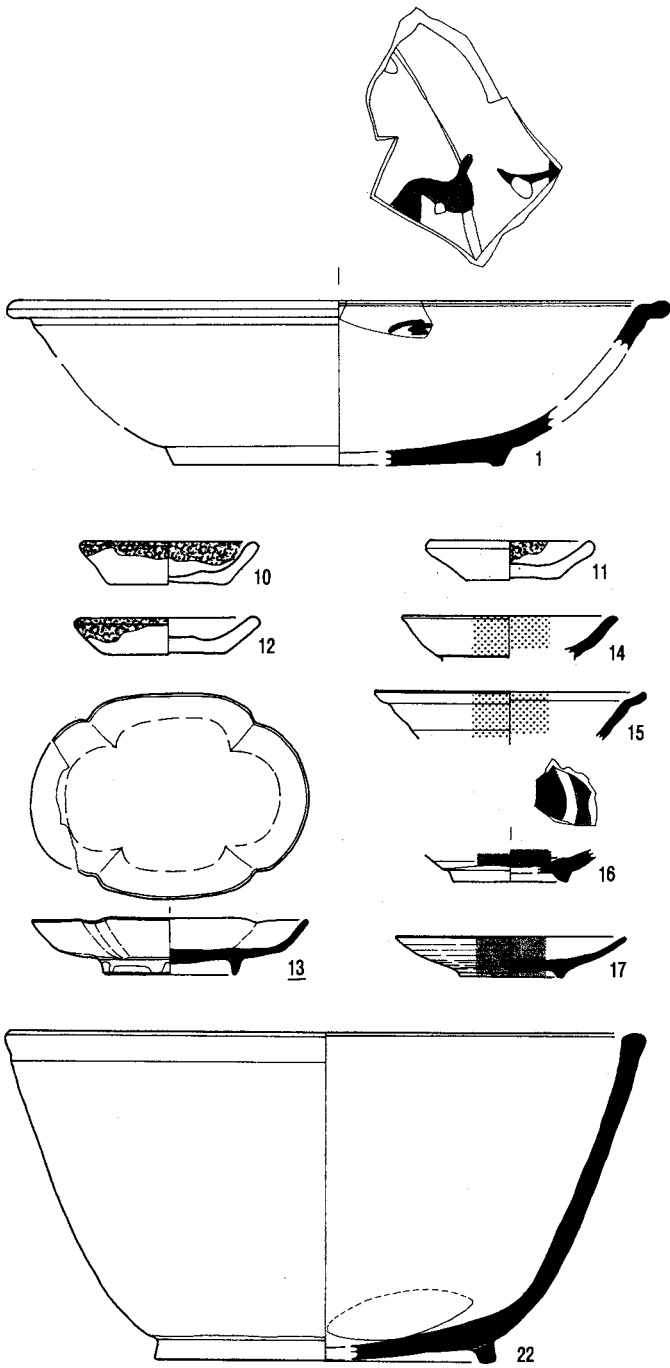

SX 2023 (1~25)

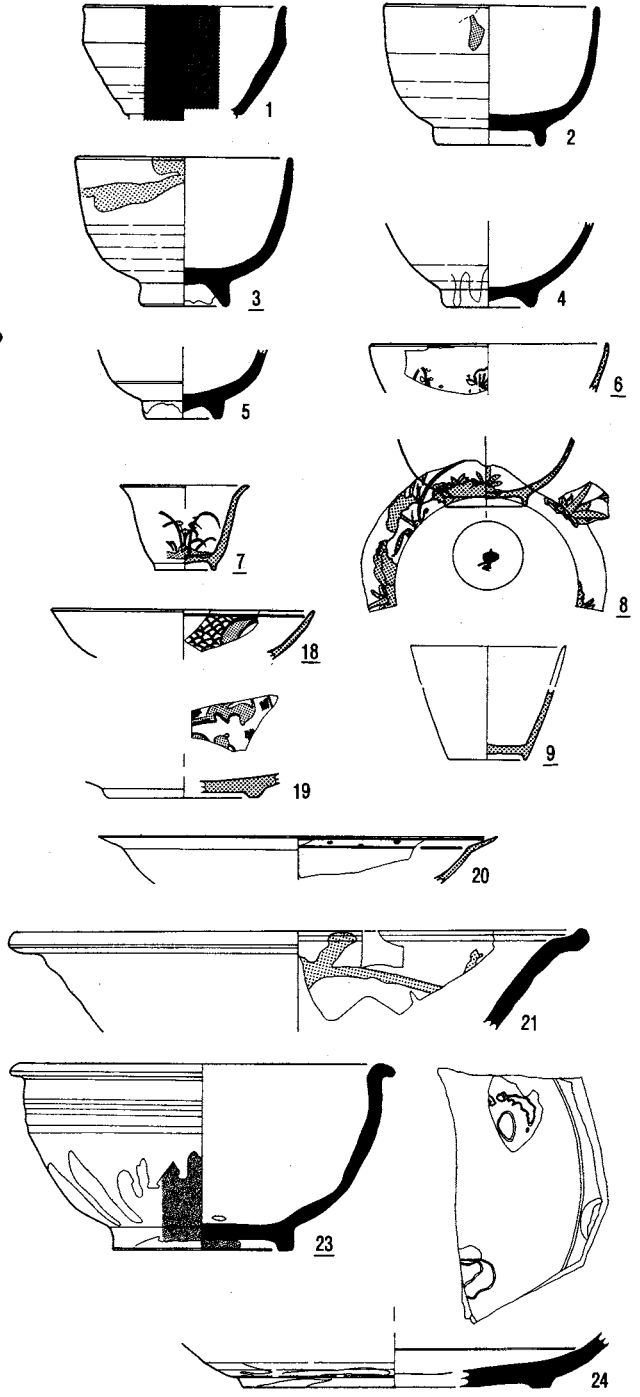

SX 2020.2021 (1~27)

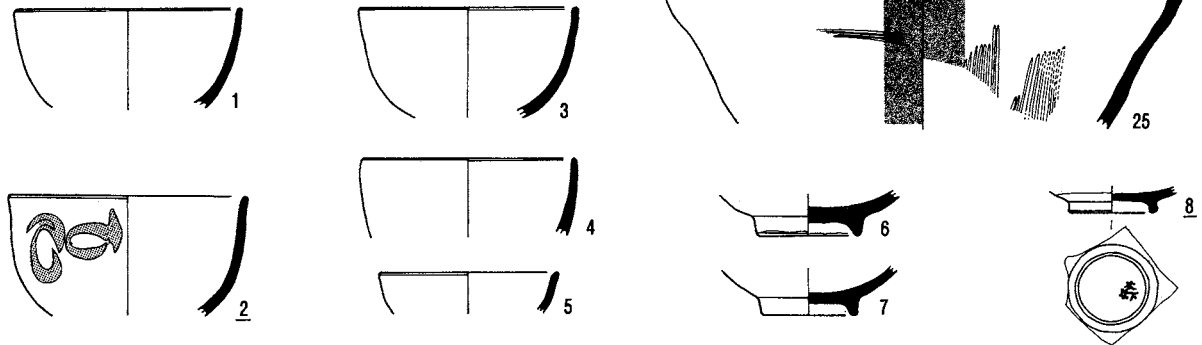

0 10 20cm

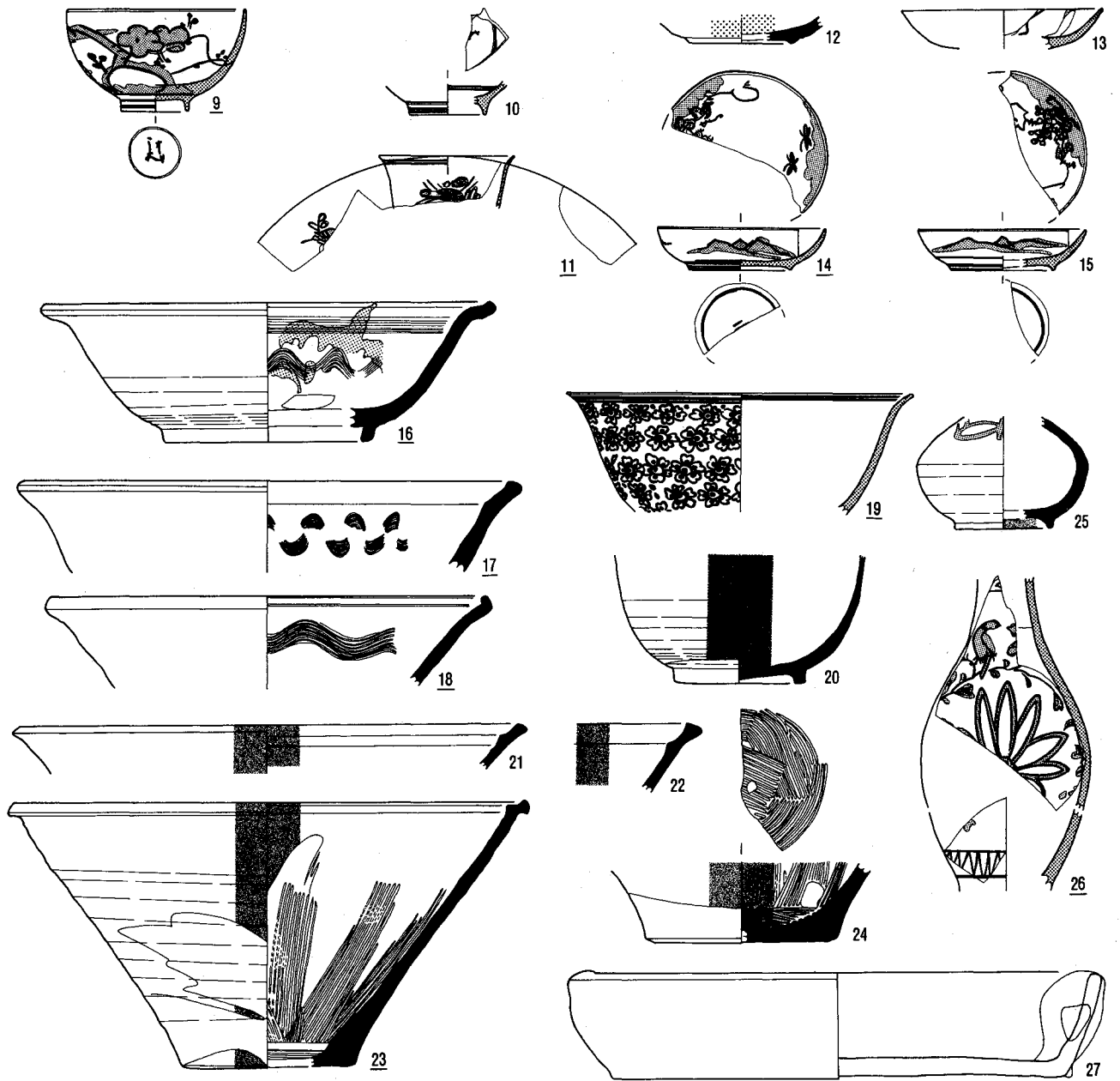

SK 2005 (1~8)

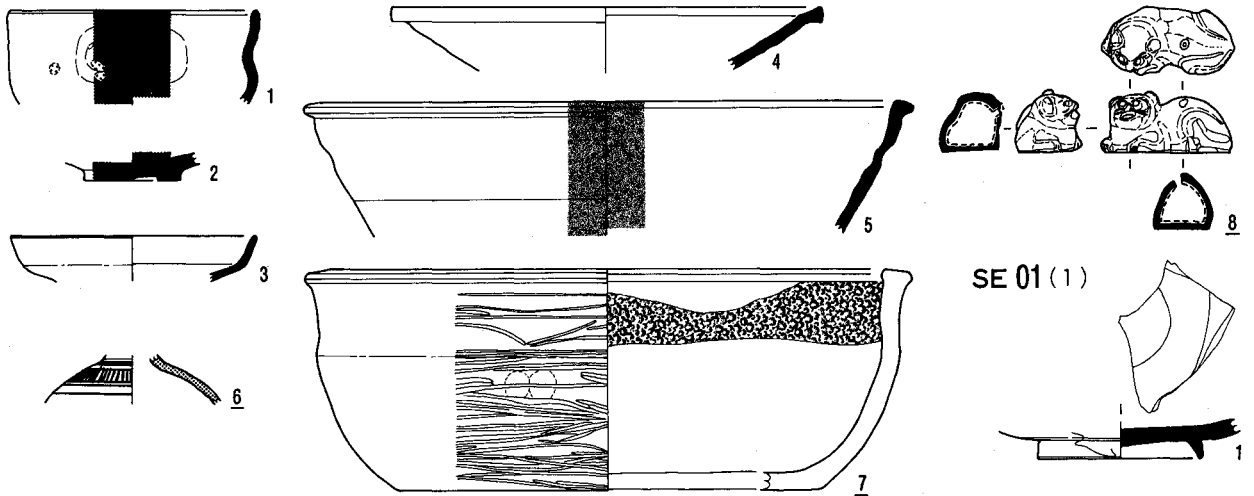

SE 01 (1)

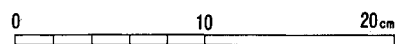
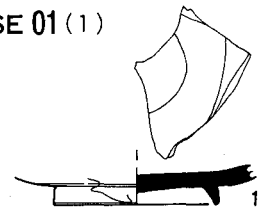

遺構外II層 (1~36)

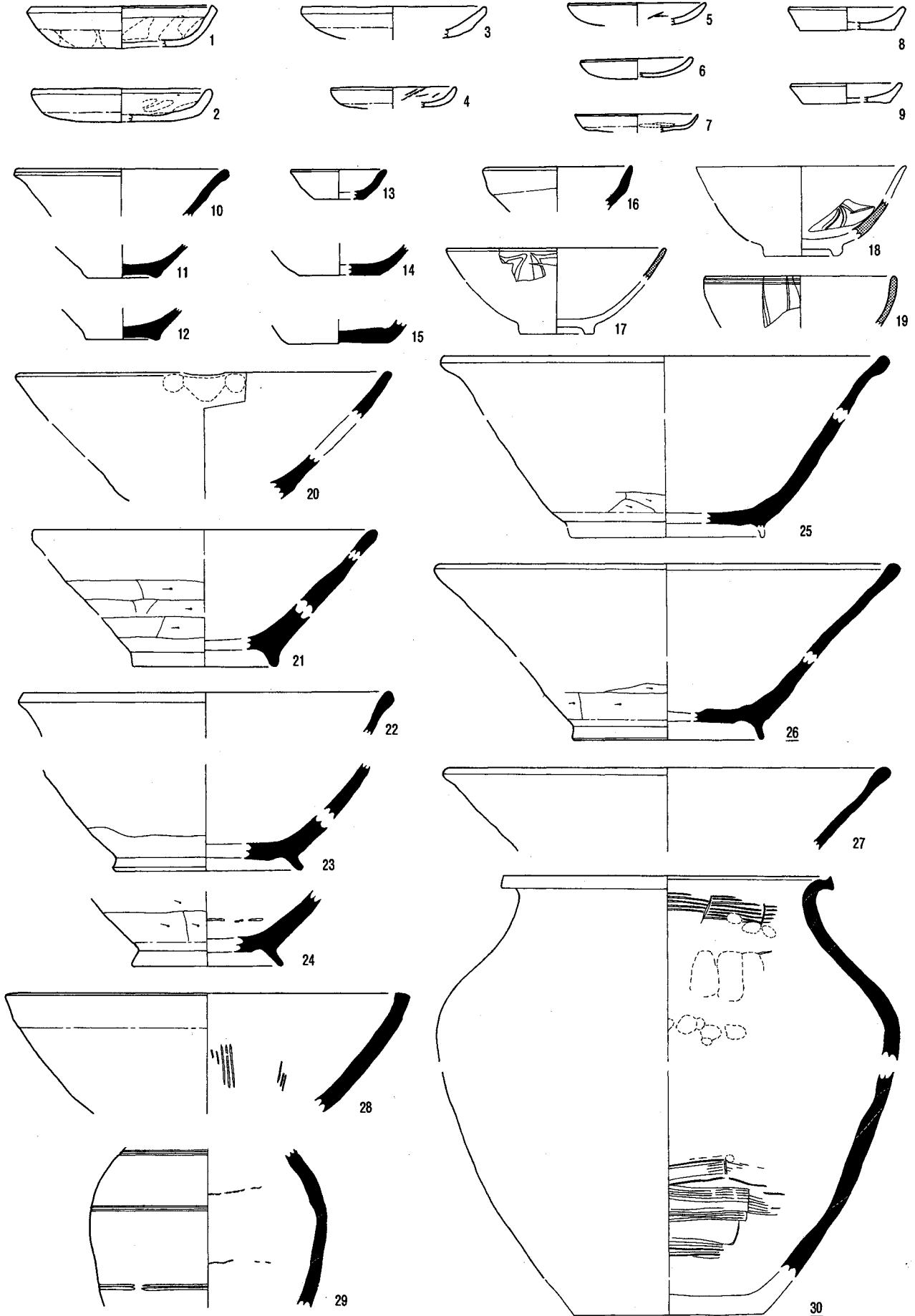

0 10 20 cm

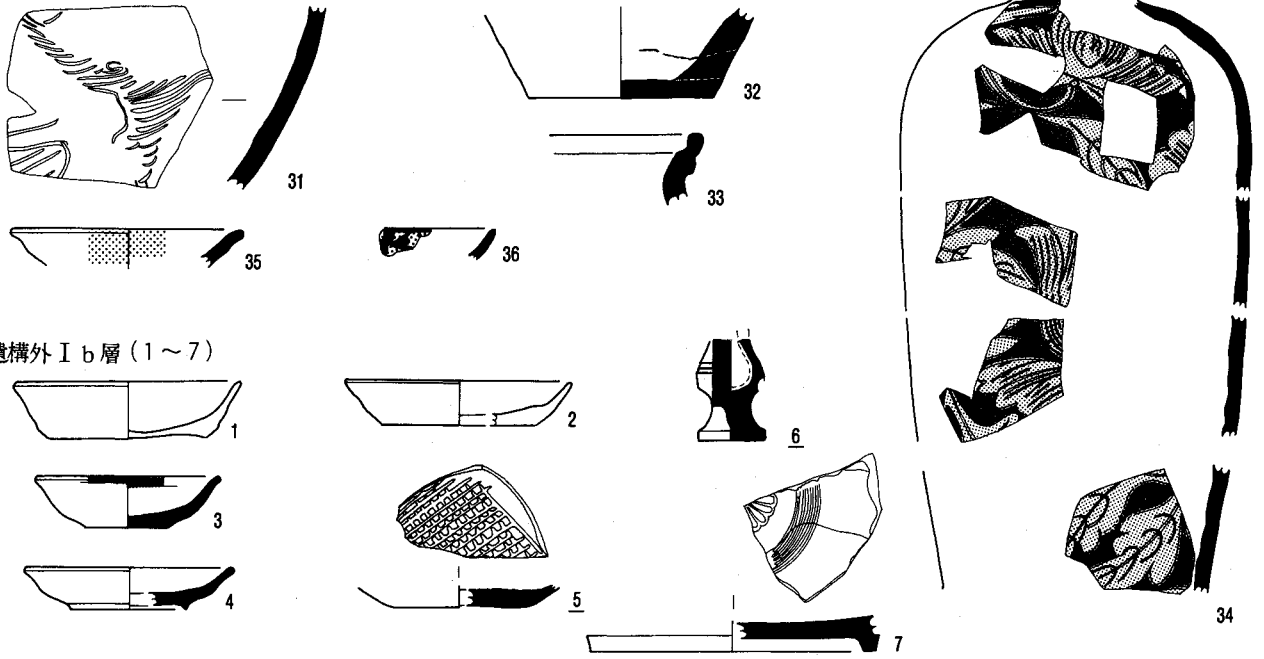

遺構外 I b 層 (1~7)

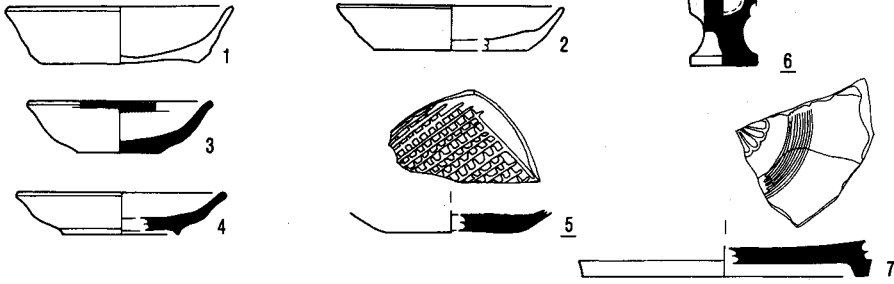

遺構外 I 層 (1~305)

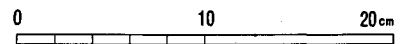
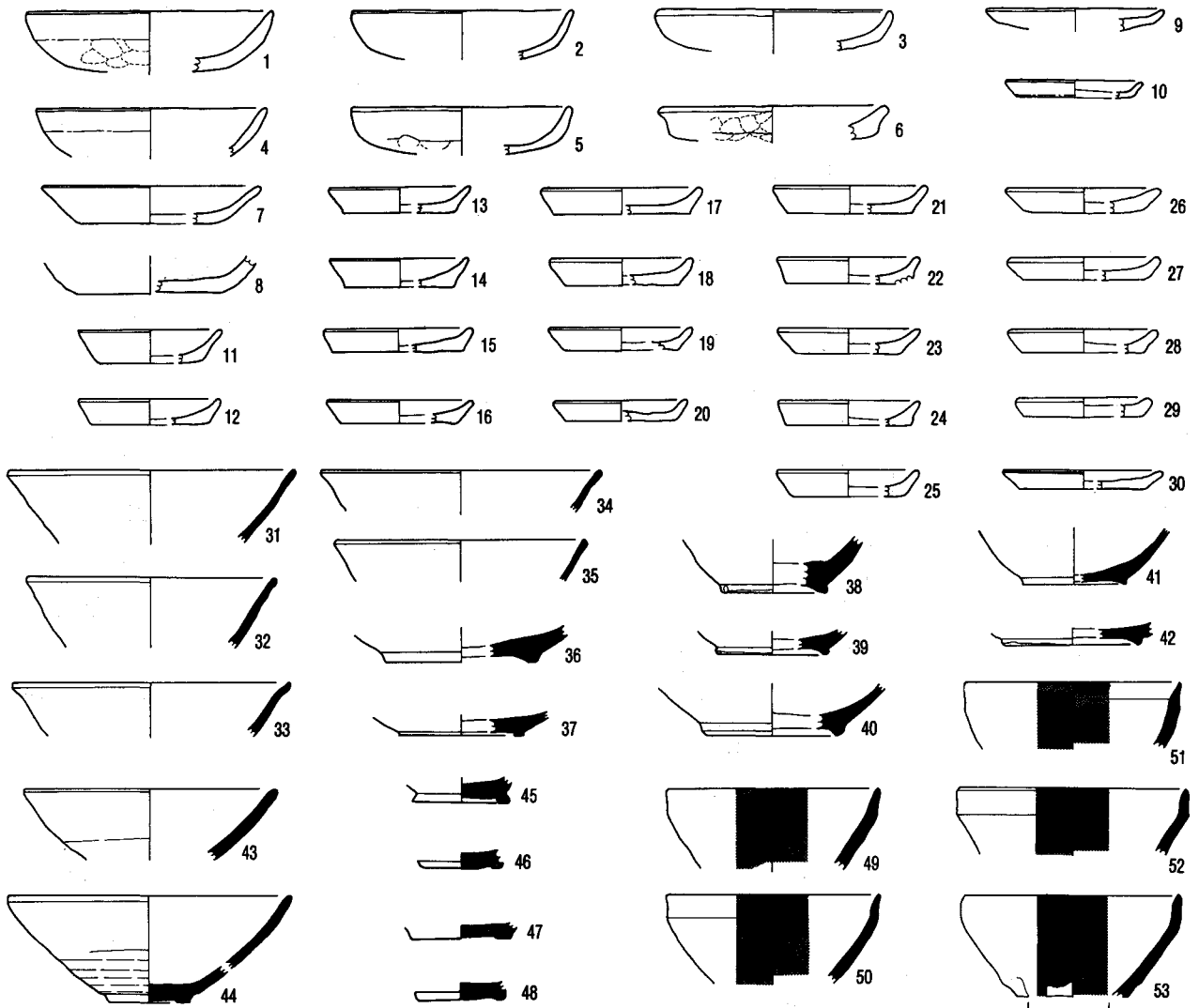

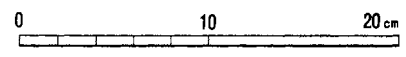
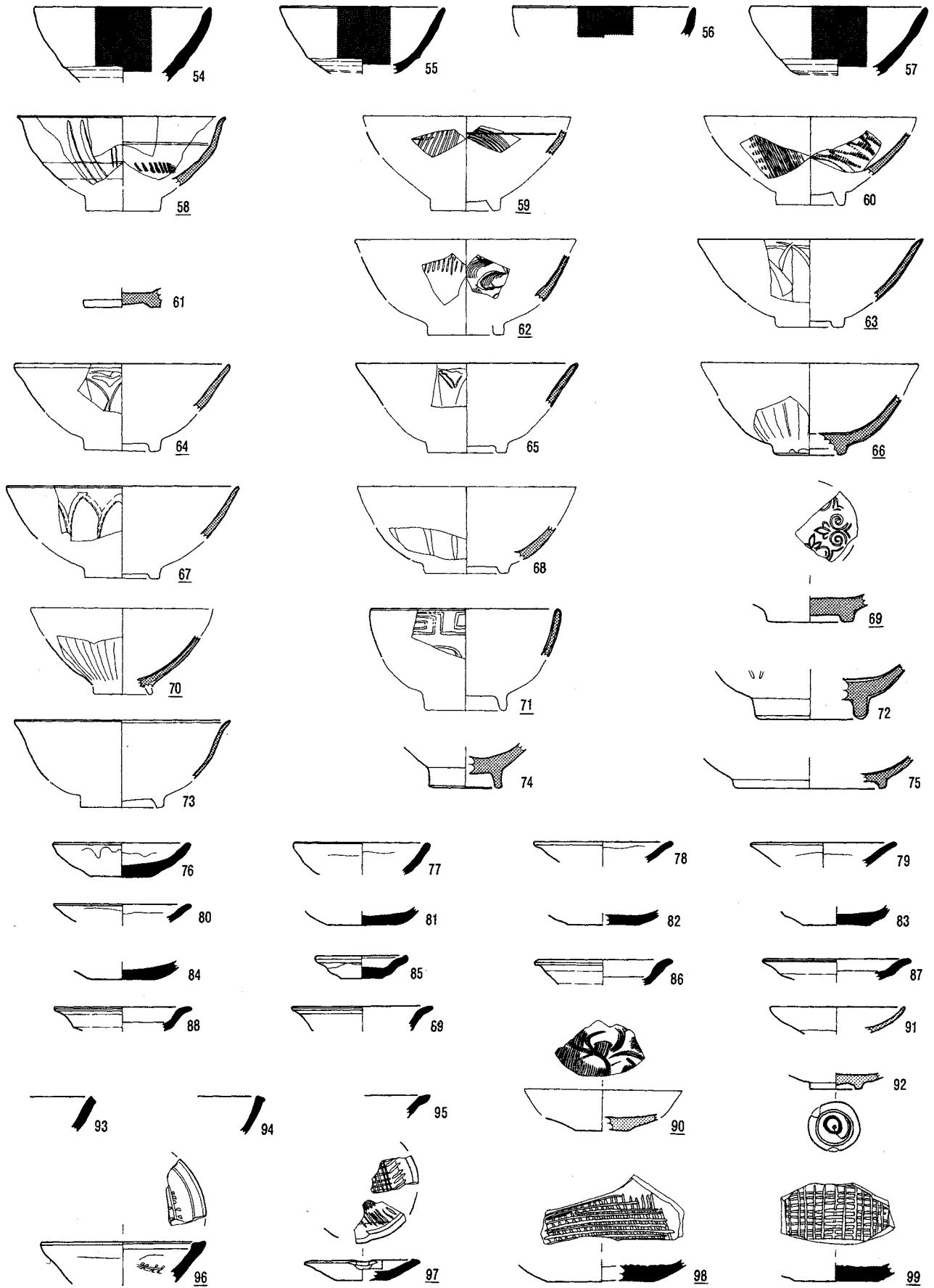

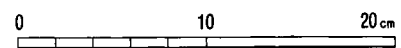
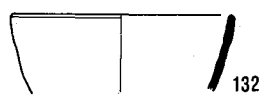
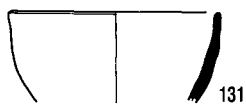
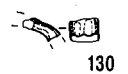
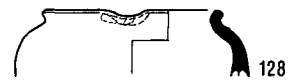
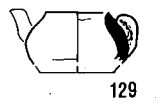
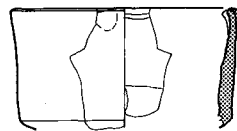
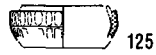
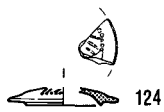
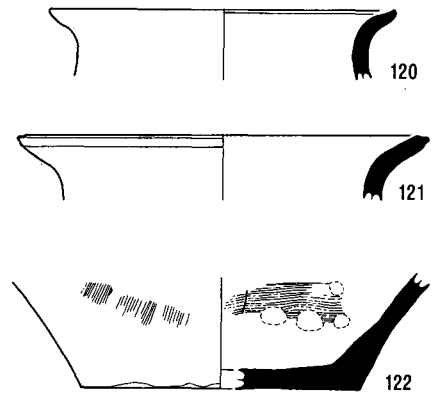
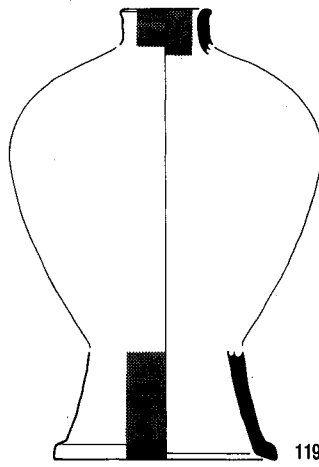
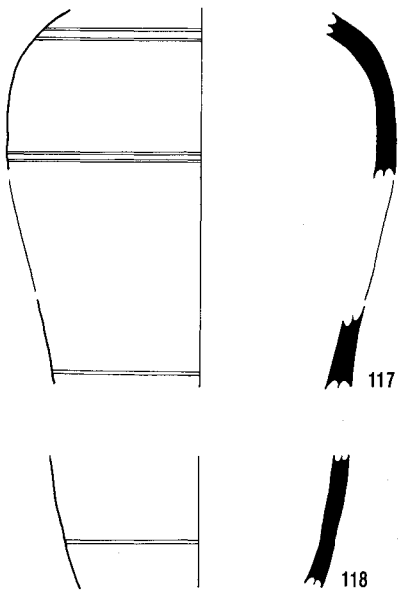
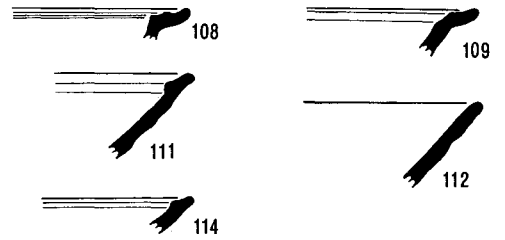
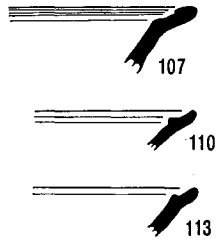
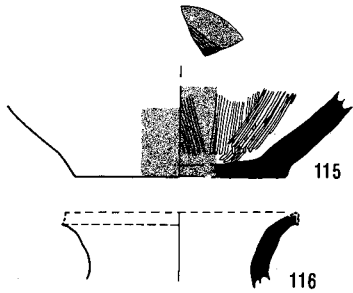
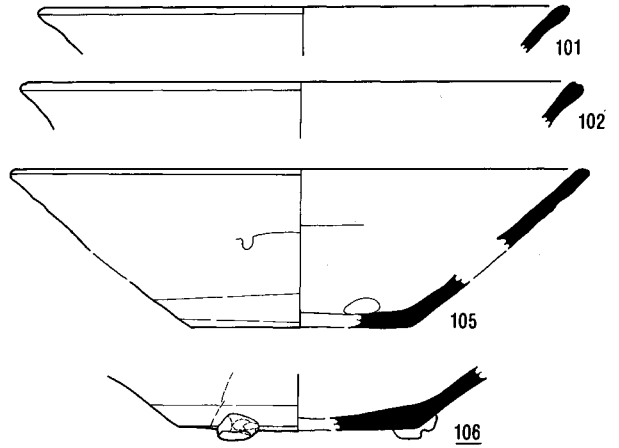
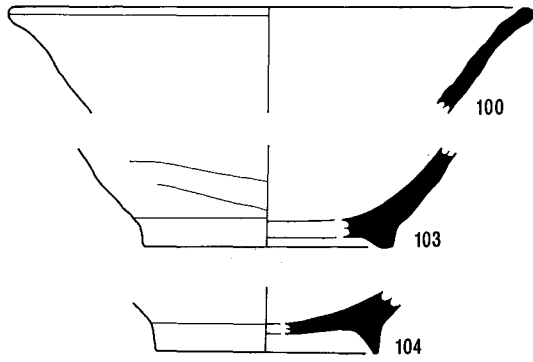

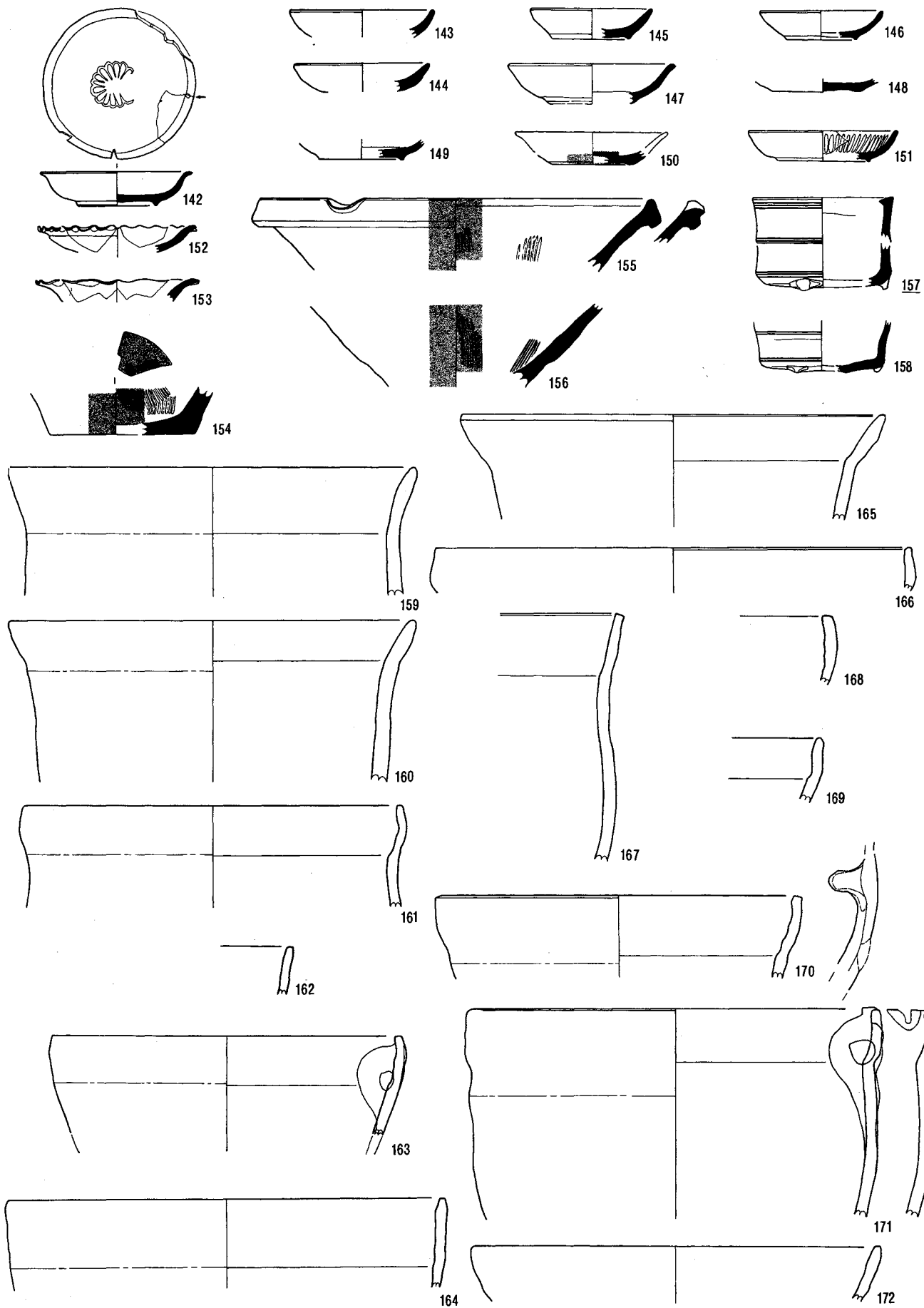

0 10 20cm

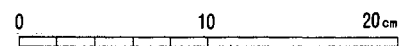
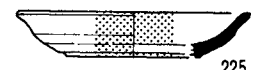
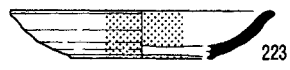
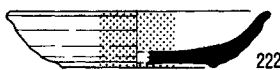
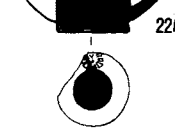
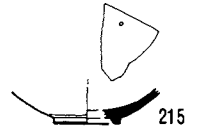
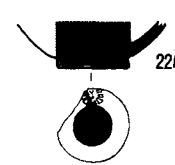
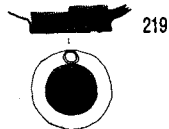
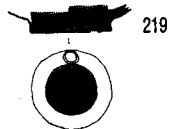
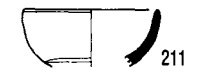
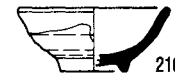
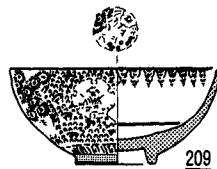
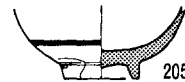
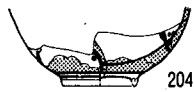
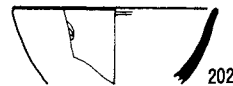
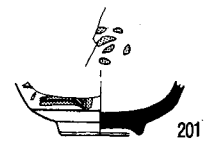
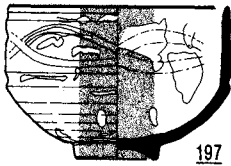
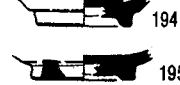
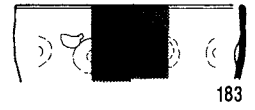
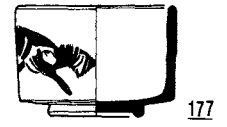
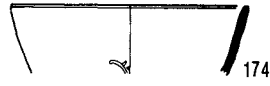
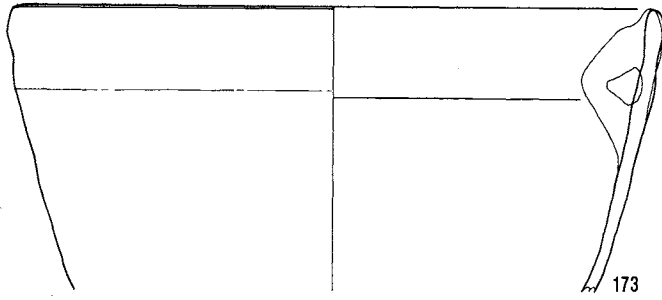

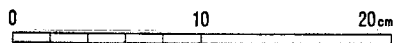
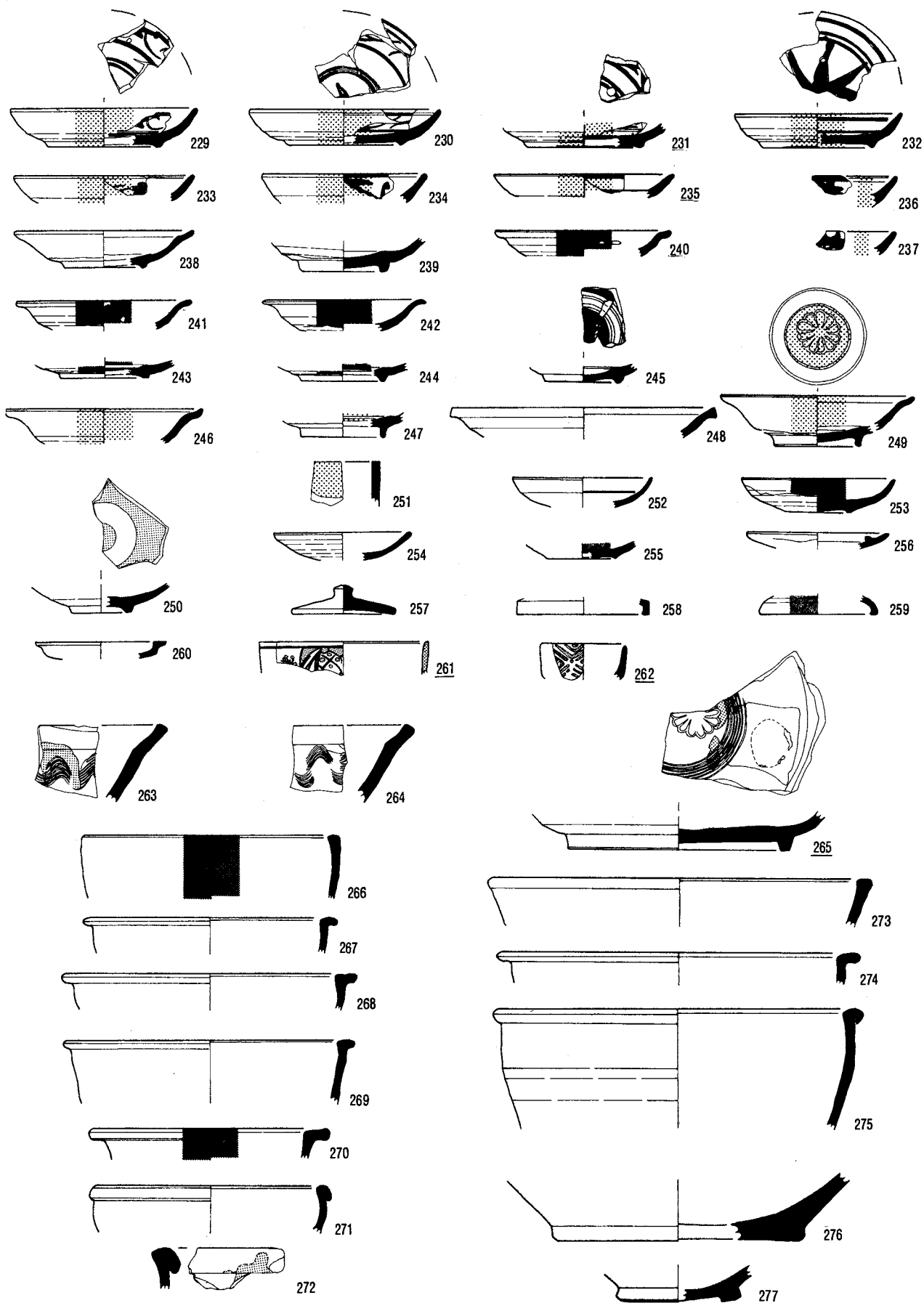

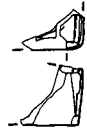
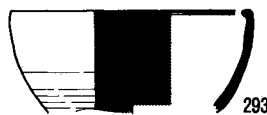
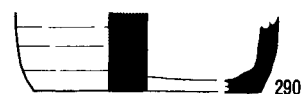
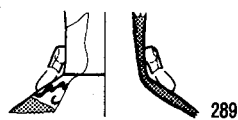
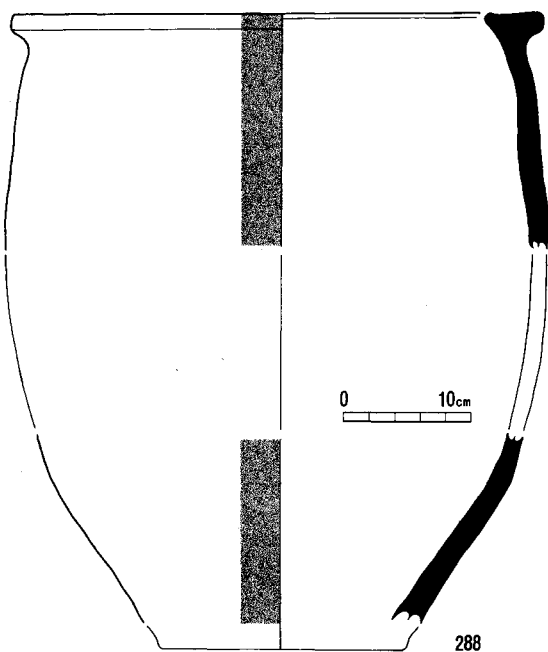
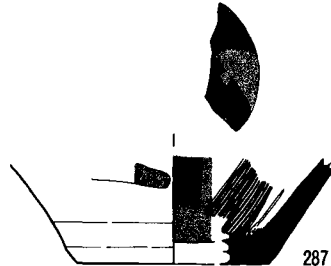
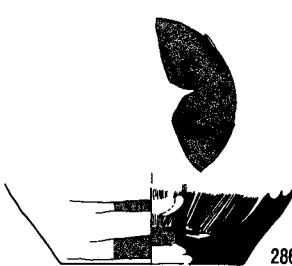
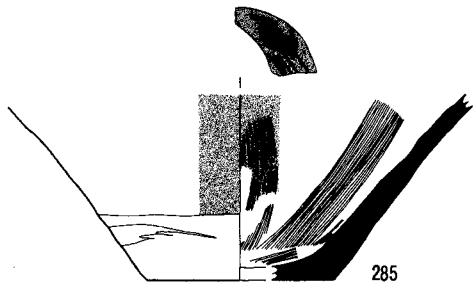
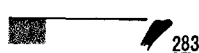
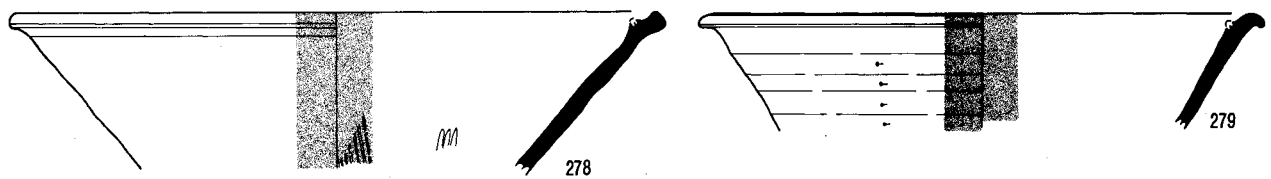

295

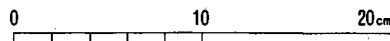
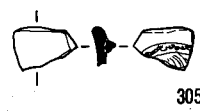
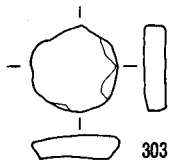
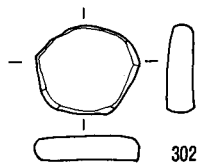
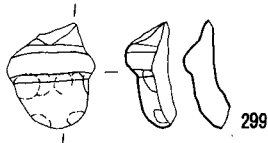
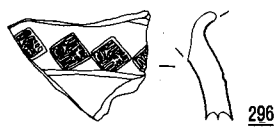
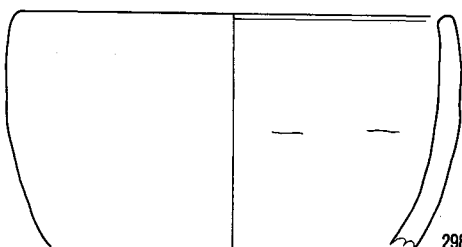

近世整地土層(1~69)

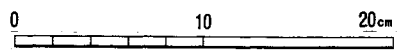
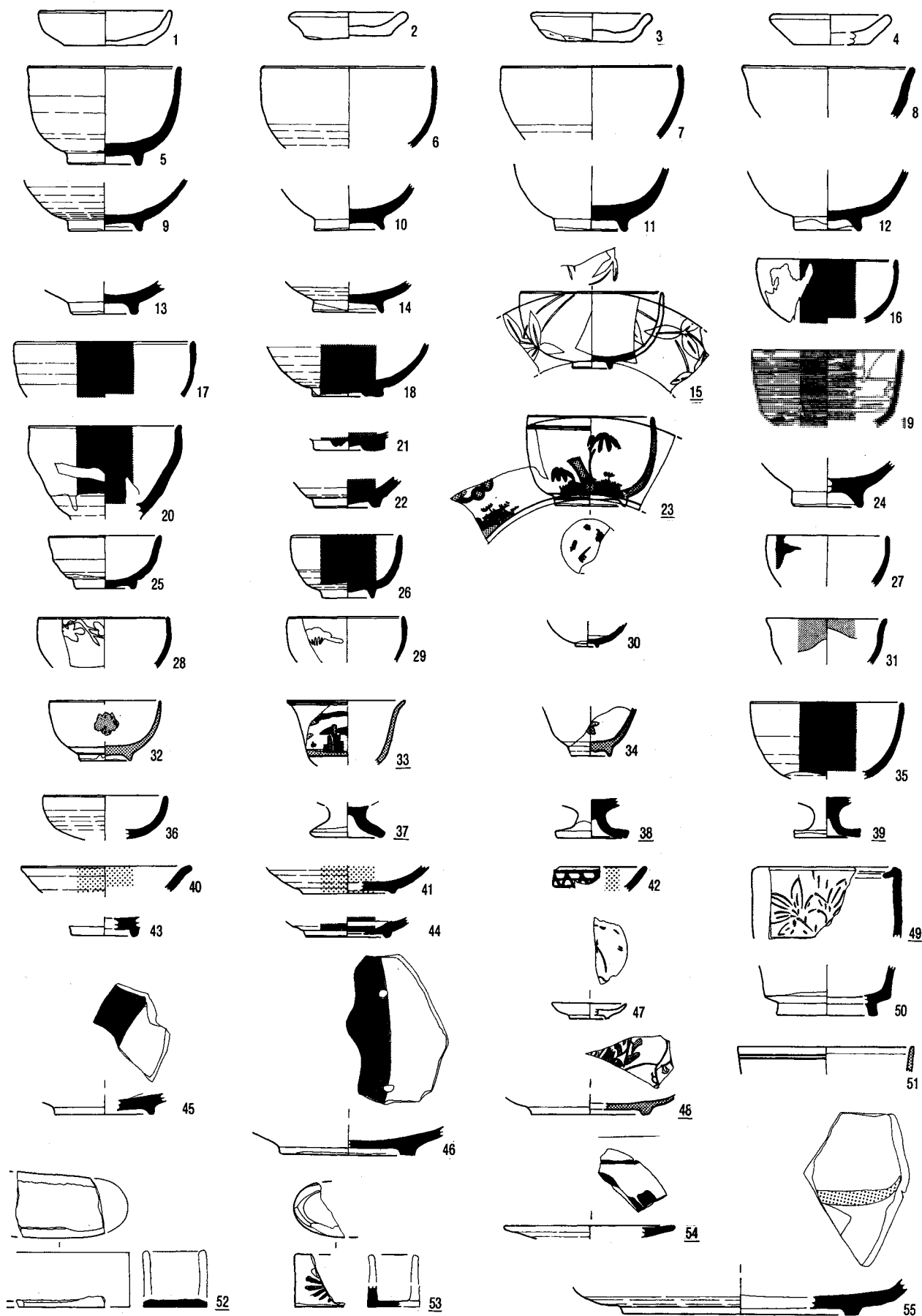

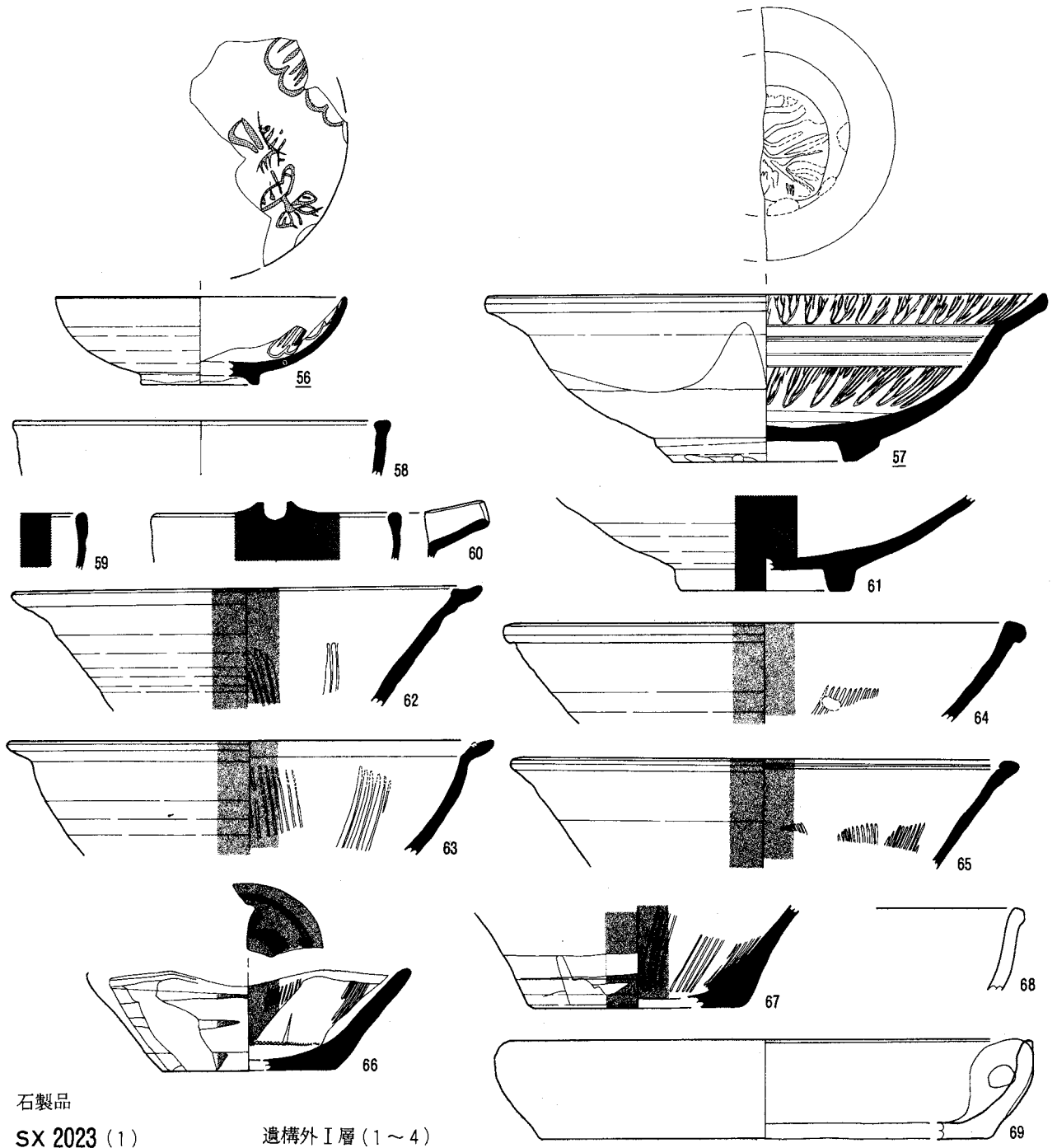

石製品

SX 2023 (1)

遺構外I層(1~4)

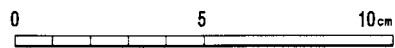
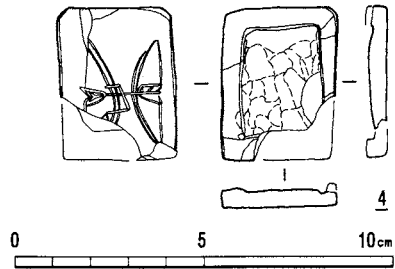
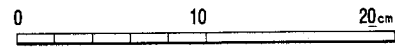
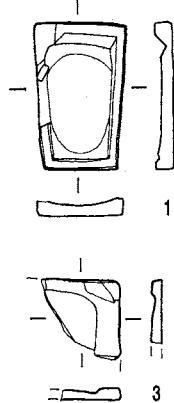
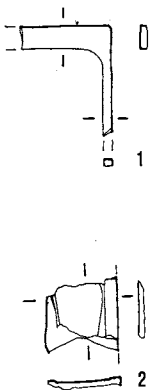

近世整地土層

(1.2)

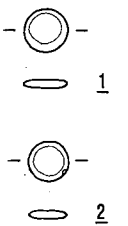

SX 22 (1)

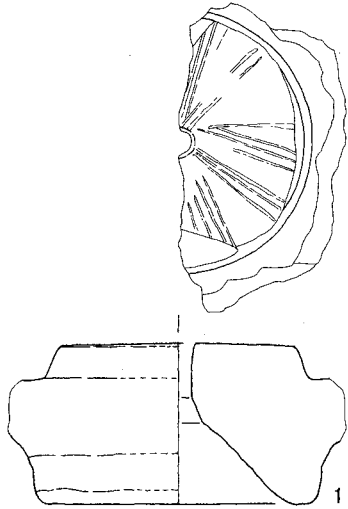

SK 1221 (1)

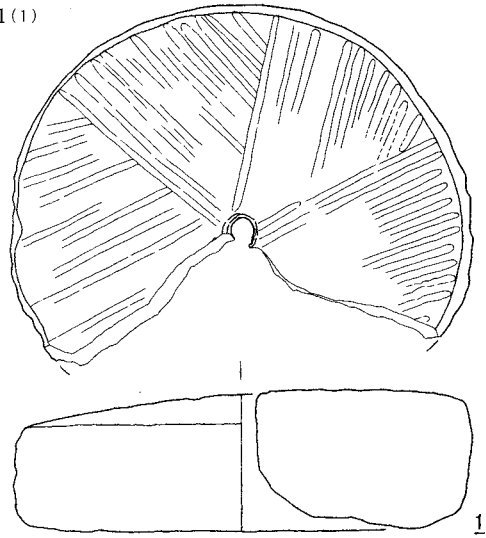

遺構外 (1~22)

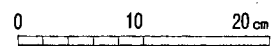
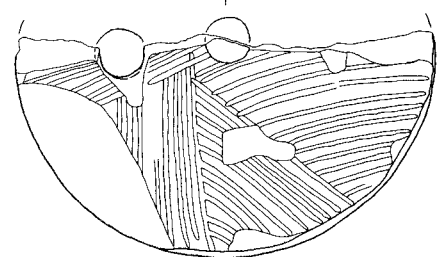
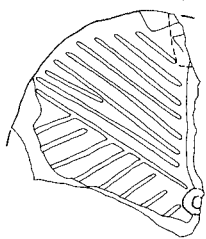
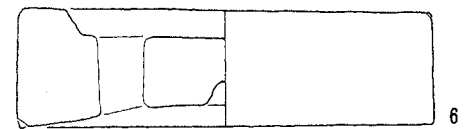
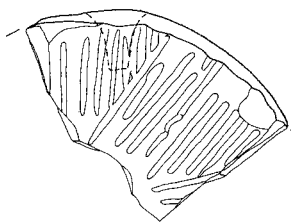
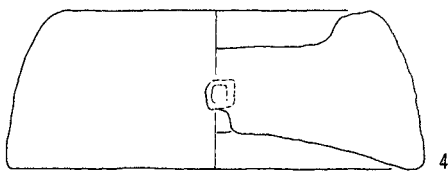
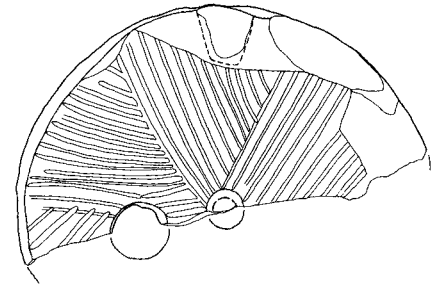
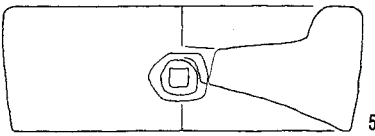
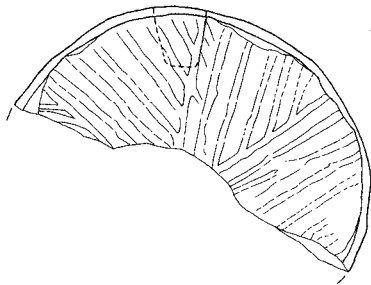
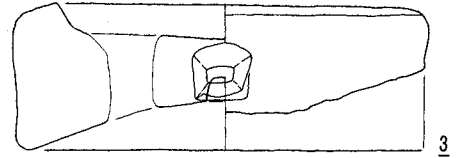
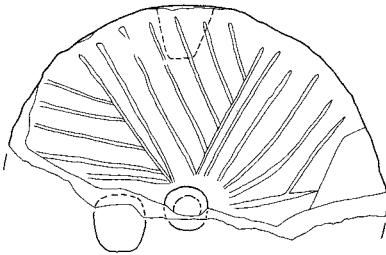
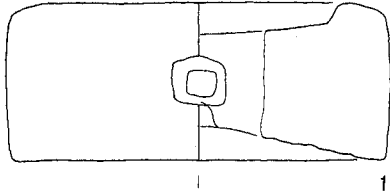
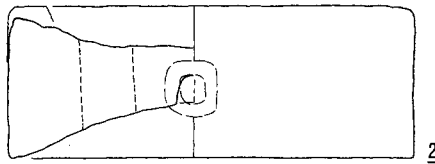

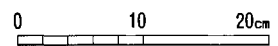
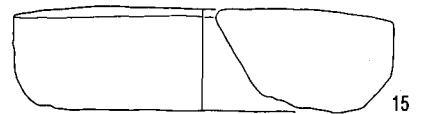
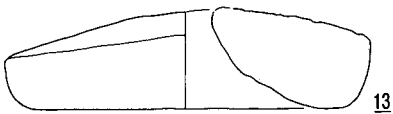
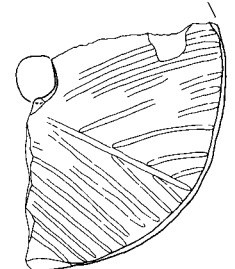
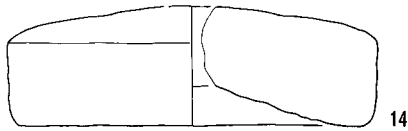
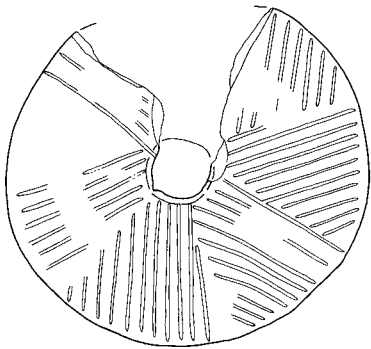
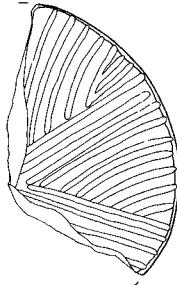
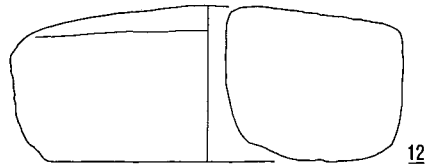
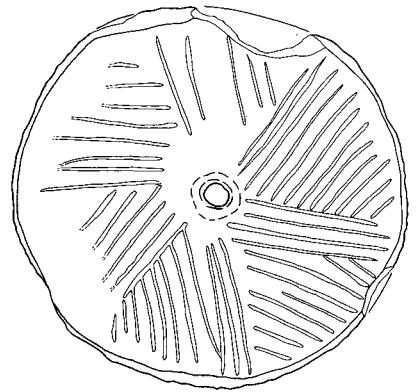
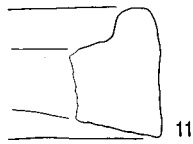
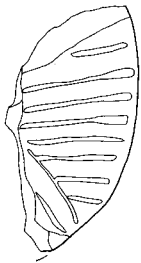
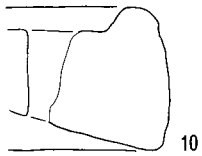
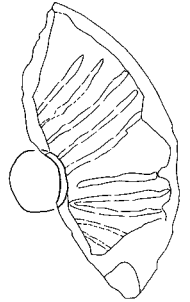
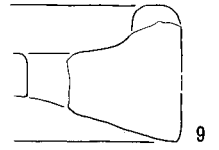
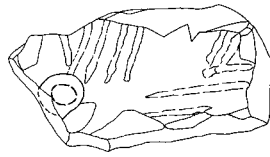
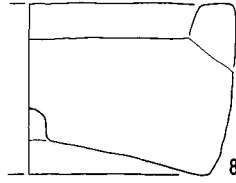
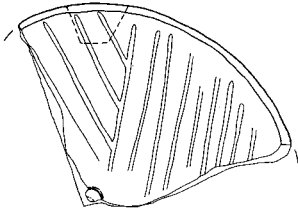
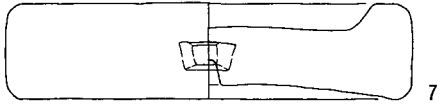

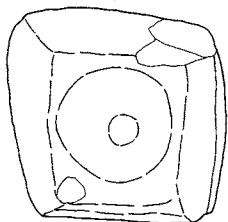
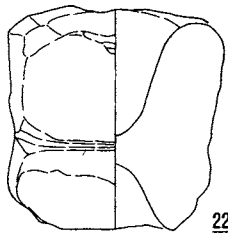
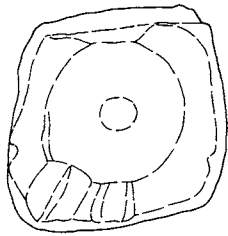
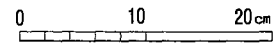
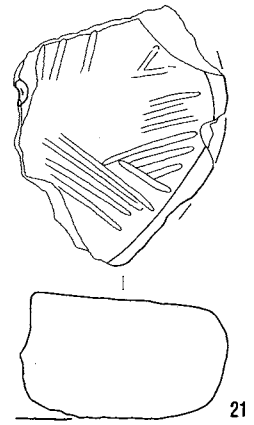
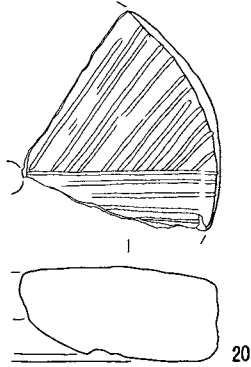
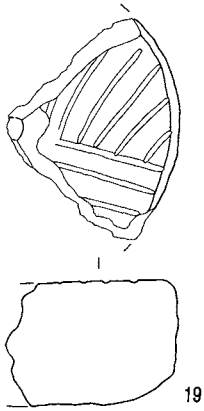
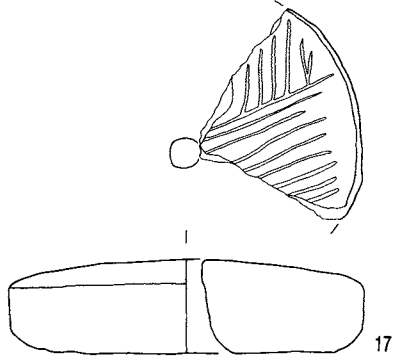
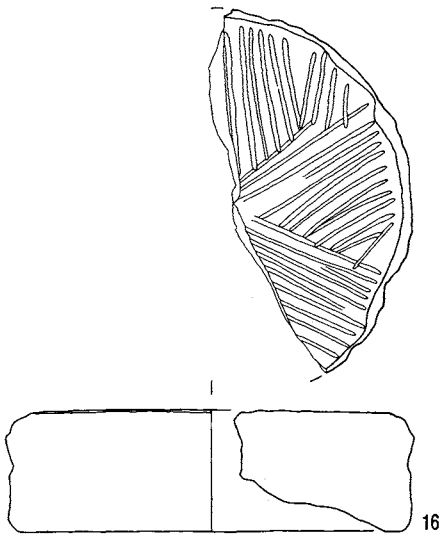

22

写真図版
(P L)

榛原

「榛原」

「はりはら」あるいは「はいはら」と読むことができる。後者の場合は「埴原牧」との関係が考えられる。(SB111出土 墨書土器)



1. 遺跡全景
(南より)



2. 遺跡全景
(東より)



1. 調査区全景
(北より)



2. 調査区全景
(東より)





O地区
東部



O地区
南部



M地区



K・L地区



L・M
地区



M地区
西部



O地区



S地区



O地区
北部



O地区
南部



G地区



L地区

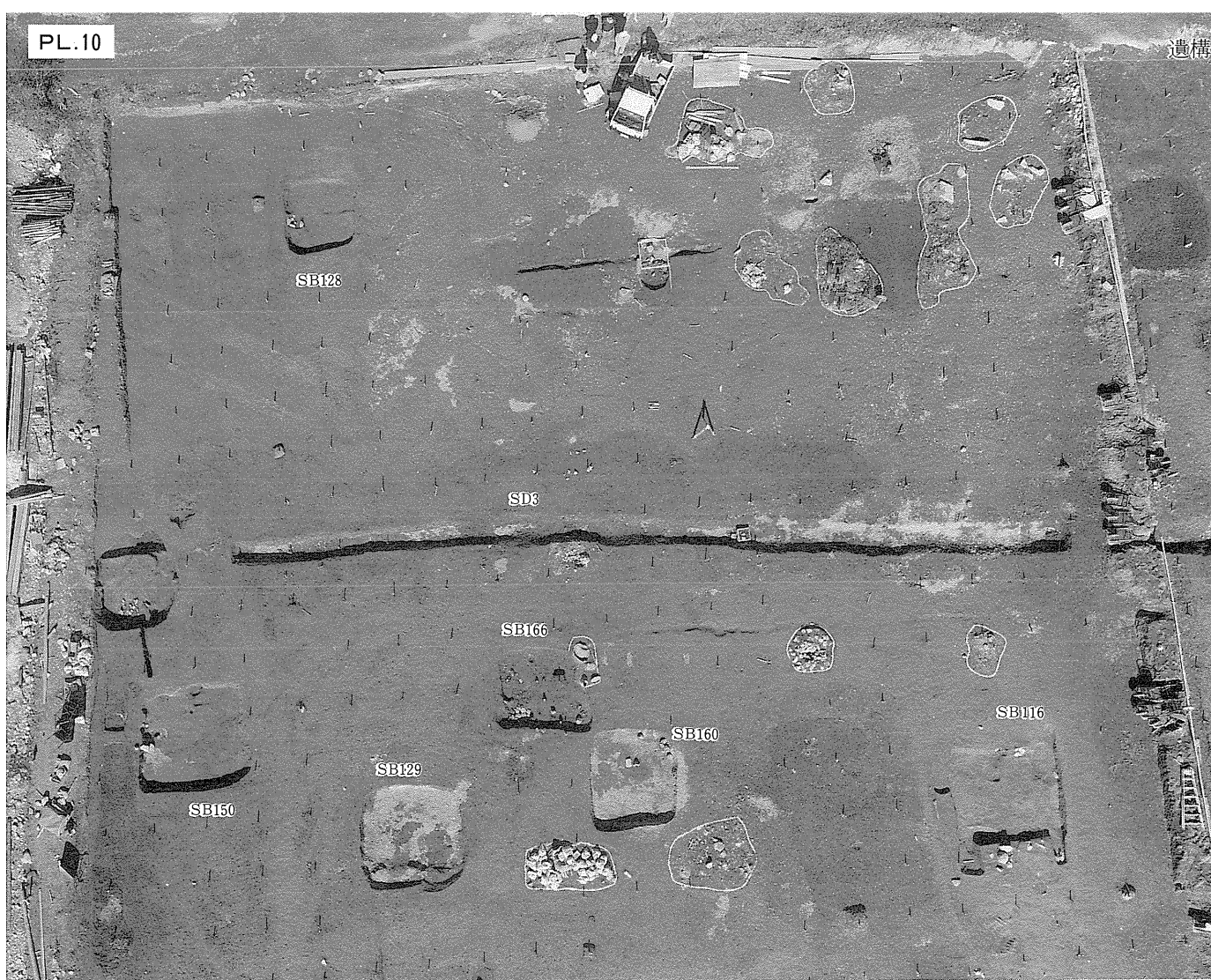

F・G地区

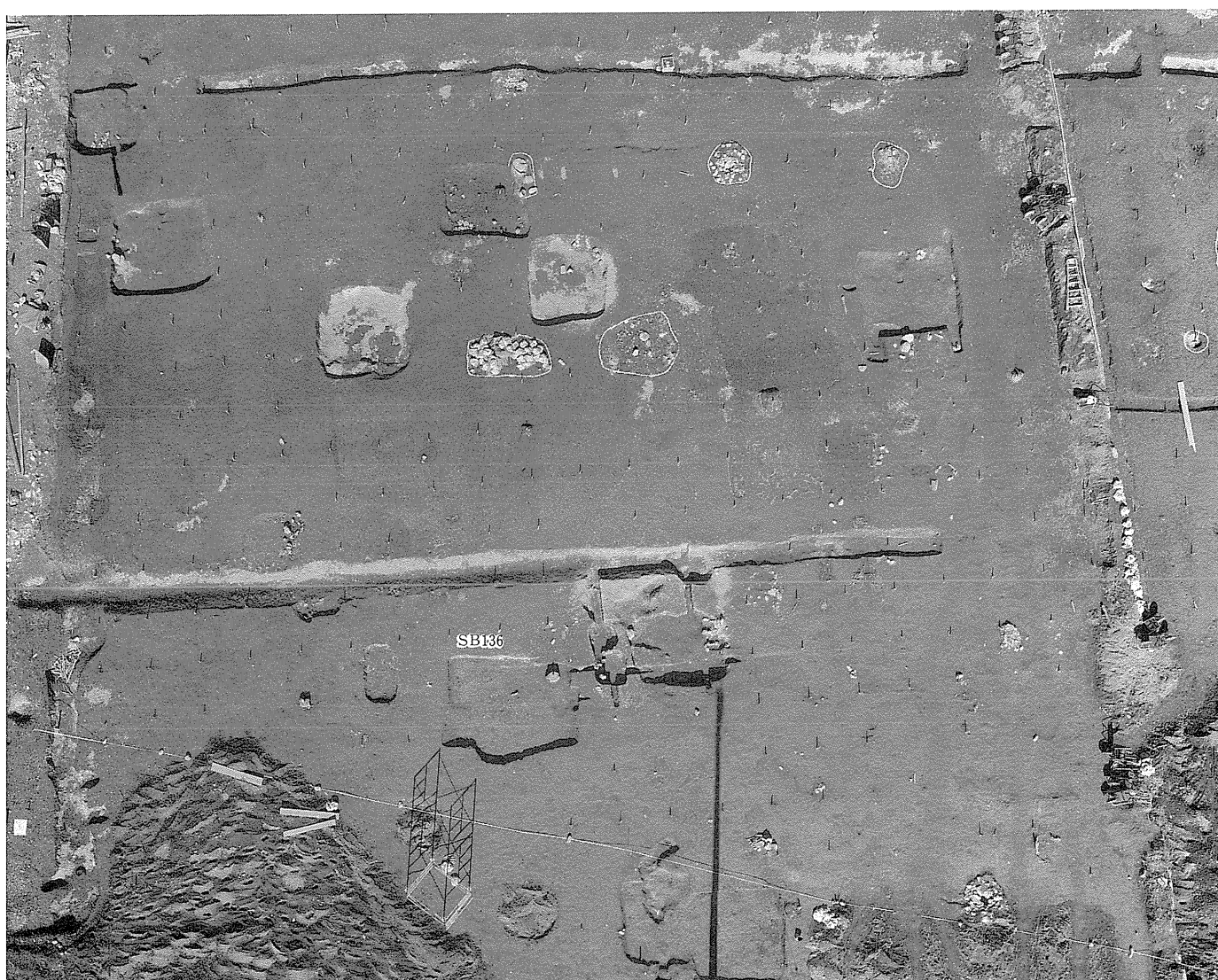

K・L地区



O地区
北部

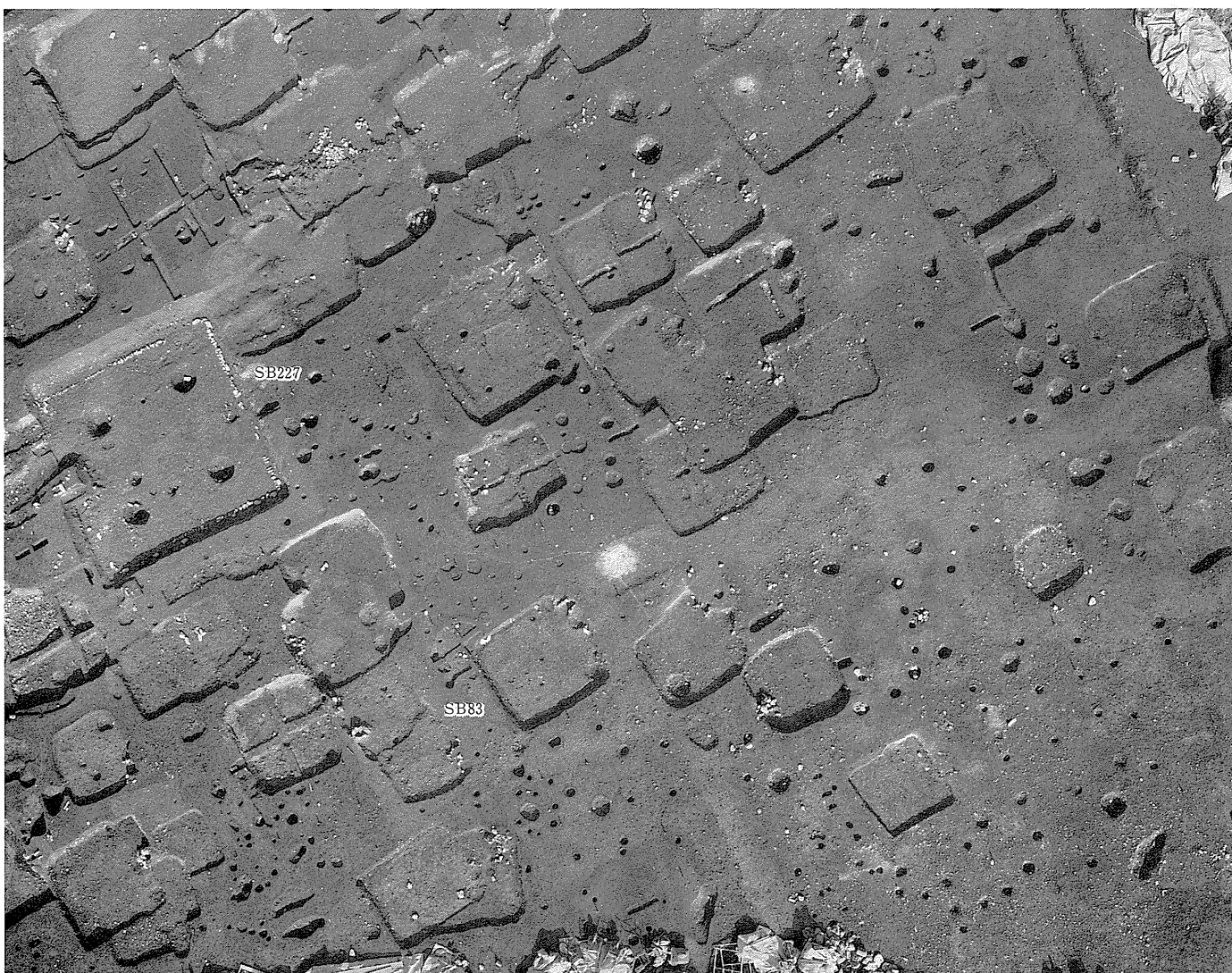

O地区
南部

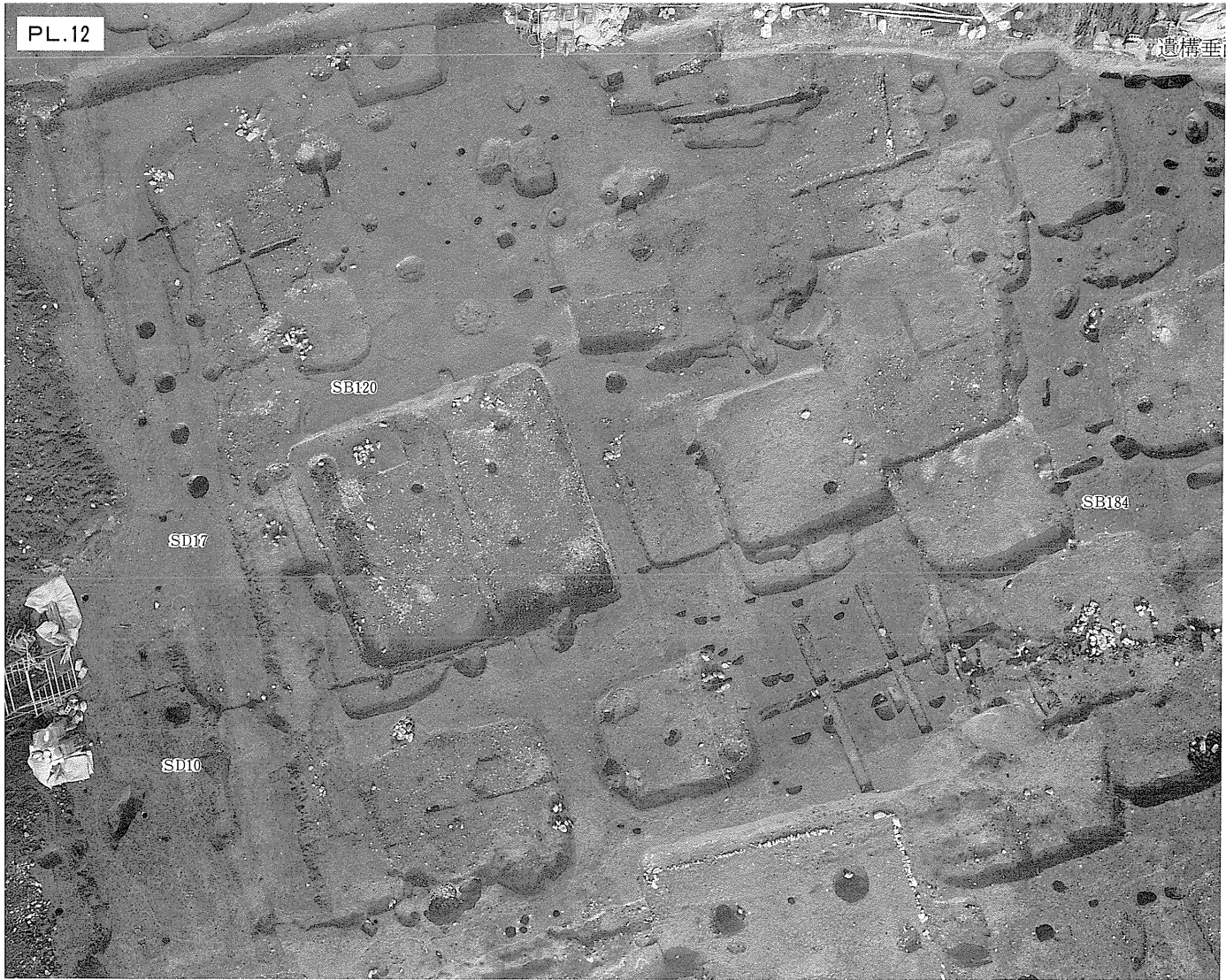

N地区



N地区
南部



H・M
地区



M地区



H地区



L・M地区



G地区



M地区

PL.16



古代遺構1

SB05
(西より)

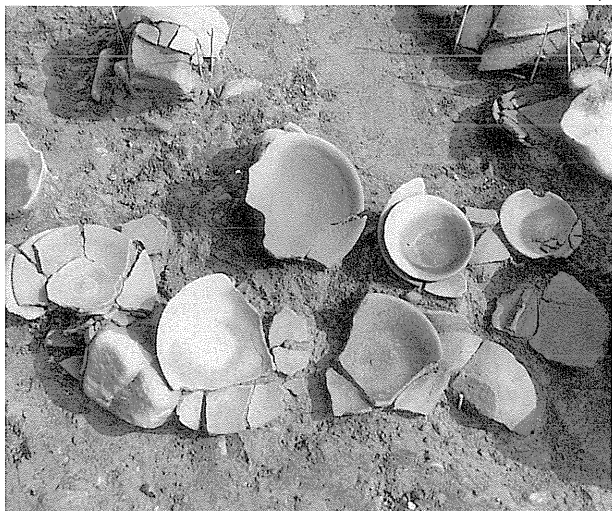

SB05 遺物出土状況

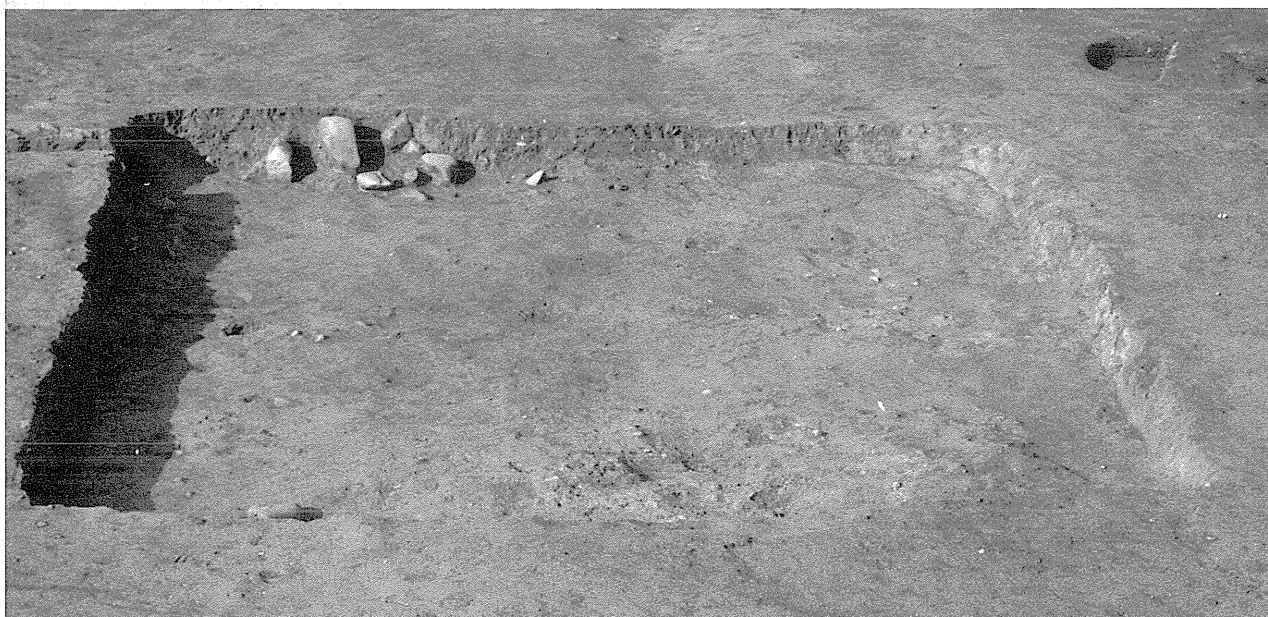

SB05
(東より)



SB14
(南より)



SB17
(東より)

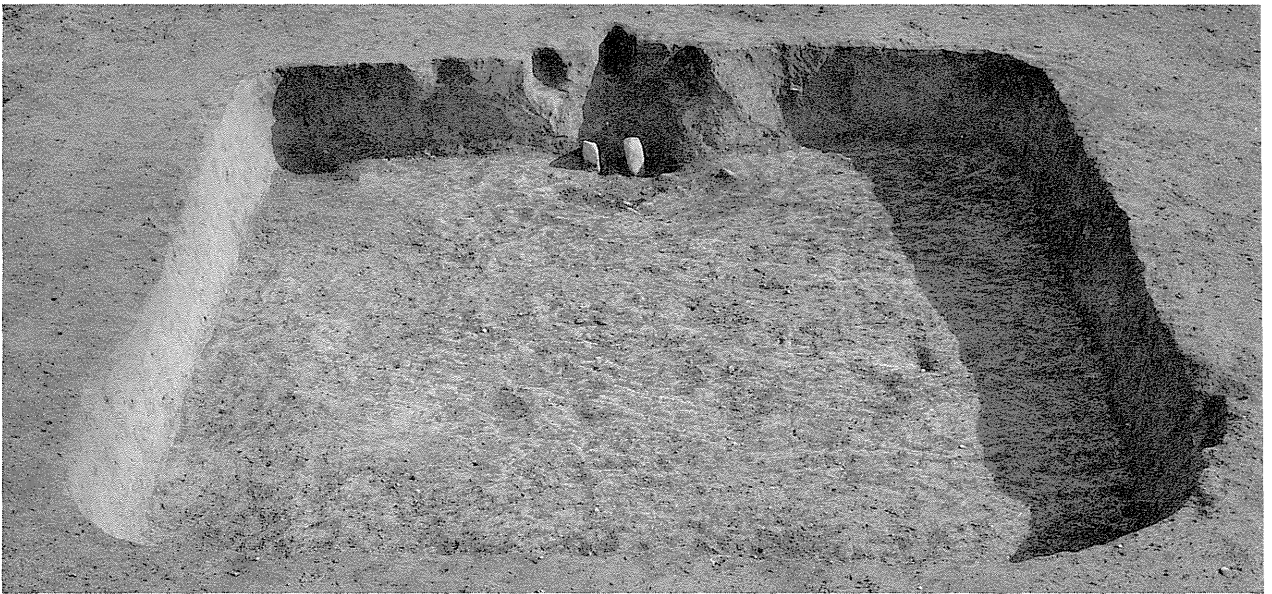

SB20
(西より)



SB21
(東より)

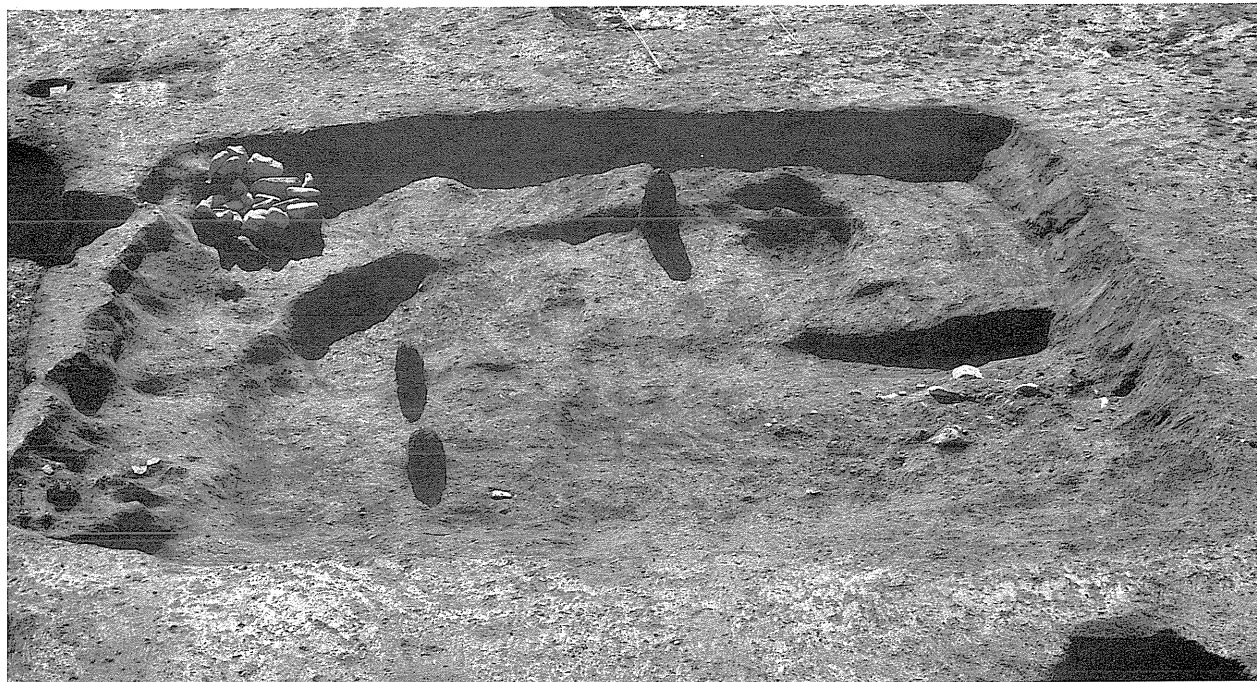

SB22
(西より)



SB23
(北より)



SB26
(西より)

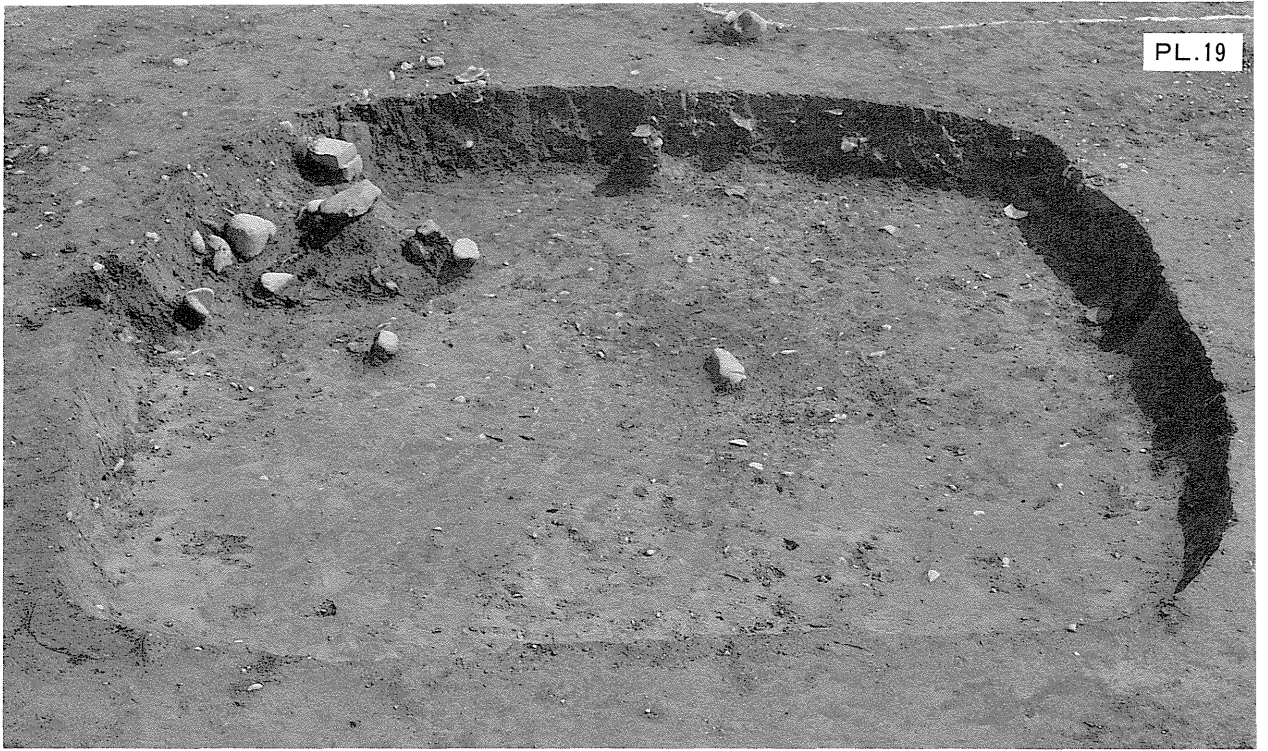

SB27
(東より)



SB29
(西より)



SB30
(西より)

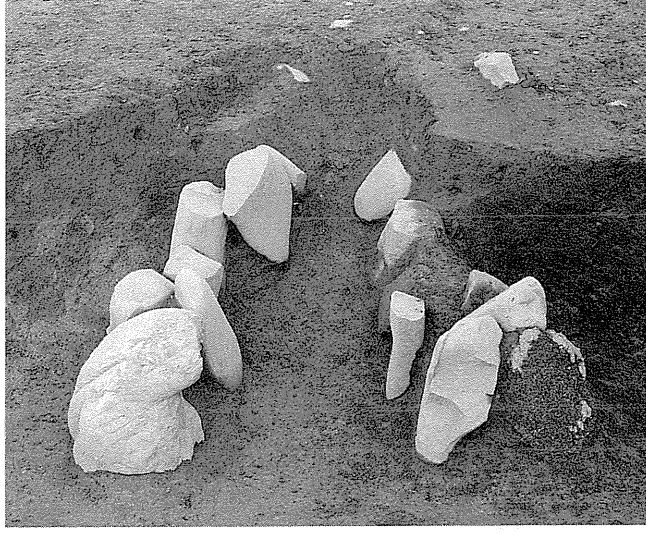

左 SB19 カマド
右 SB28 カマド

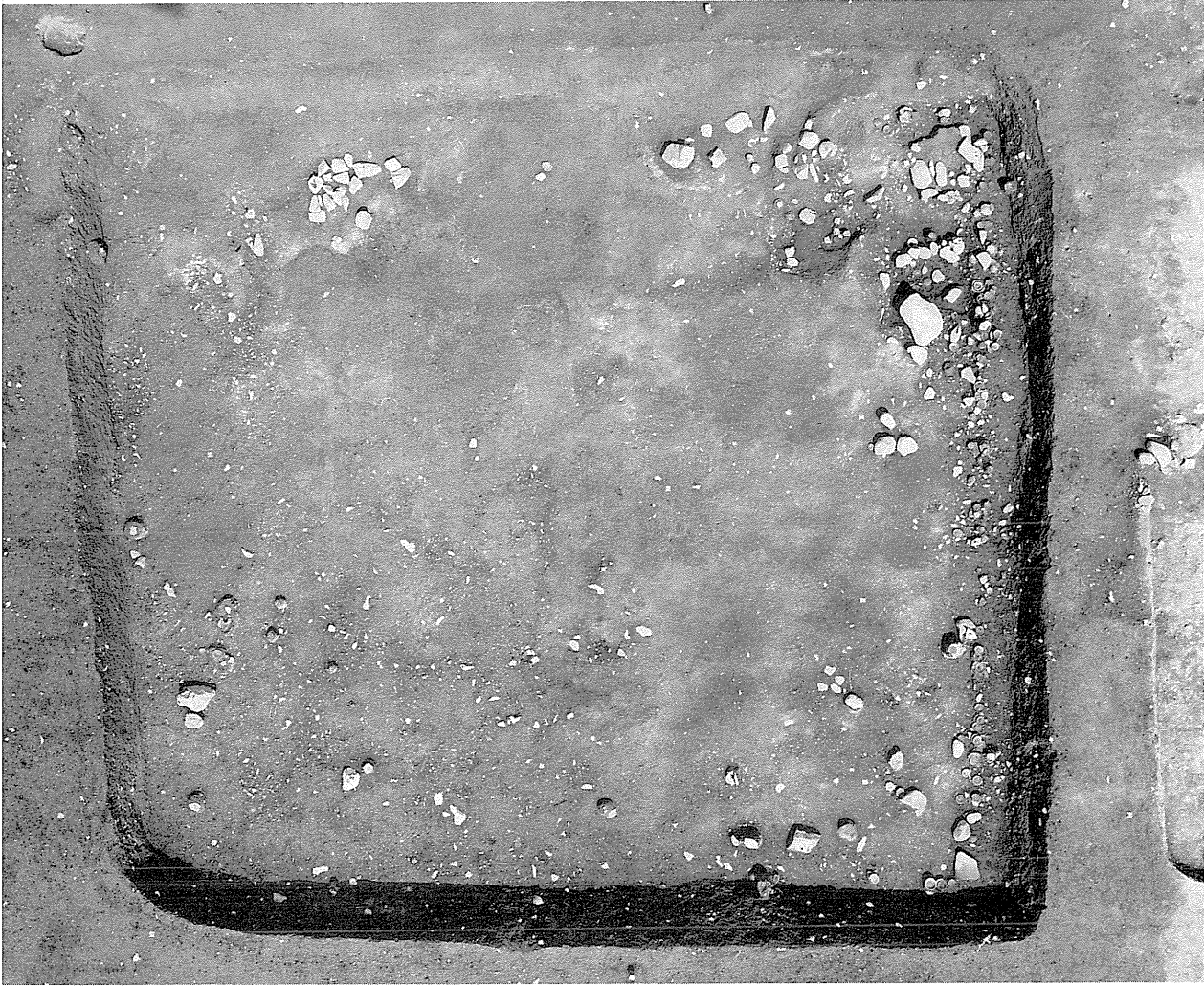

SB32 垂直写真

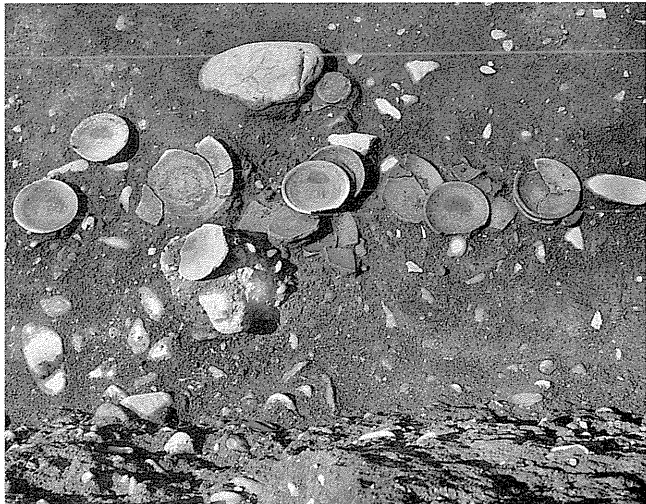

SB32
遺物出土状況

古代遺構6



SB32
遺物出土状況



SB32
遺物出土状況



SB33
(西より)



SB40
(西より)

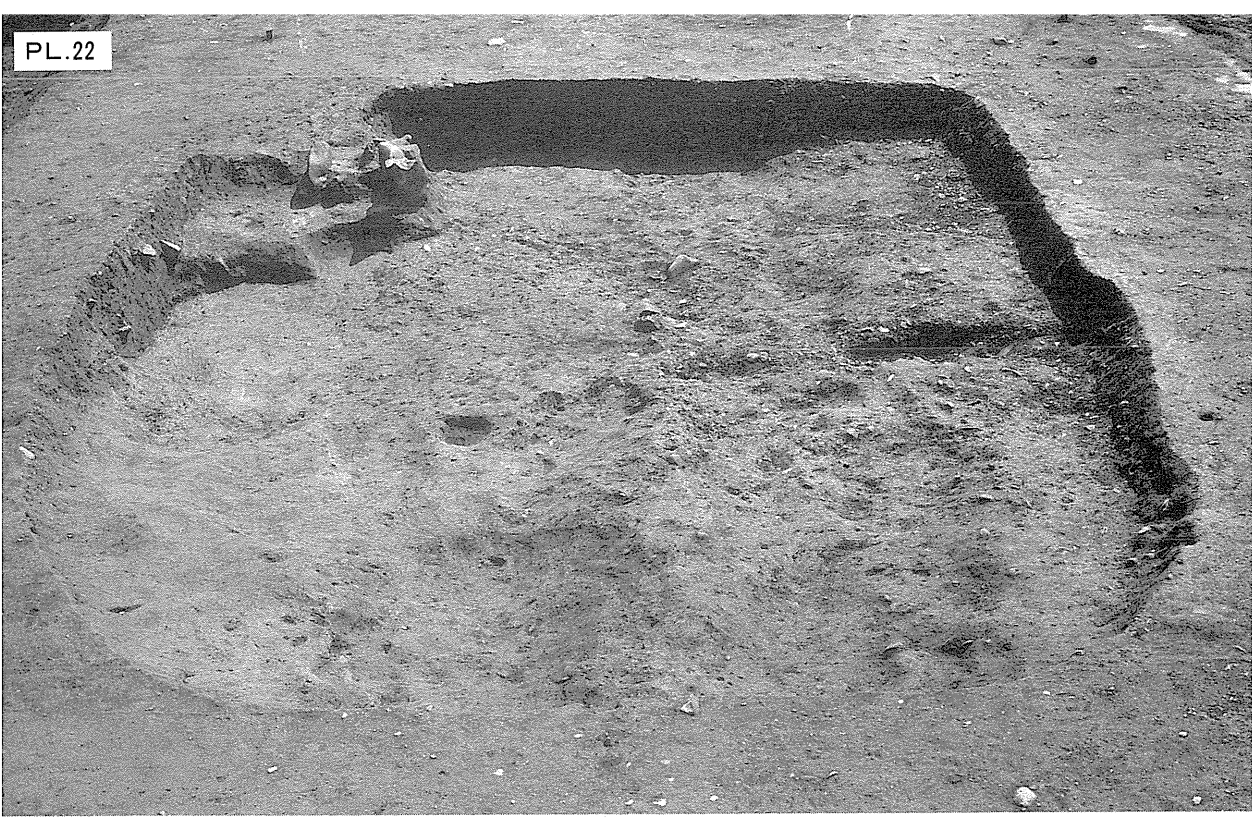

SB42
(西より)



SB44
(東より)



SB48
(西より)

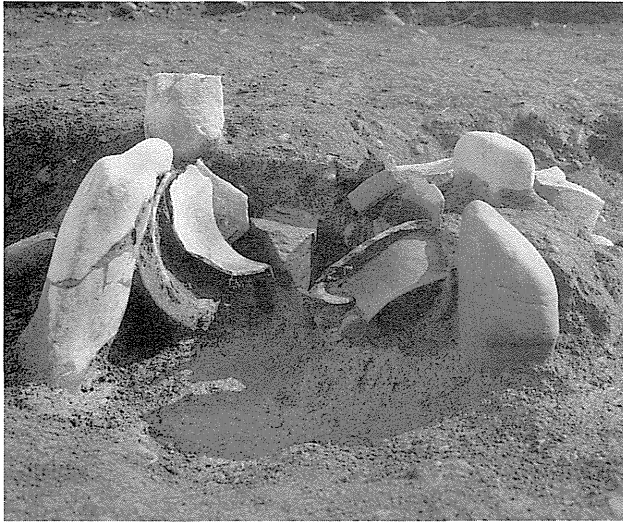

左 SB45 カマド
右 SB49 カマド

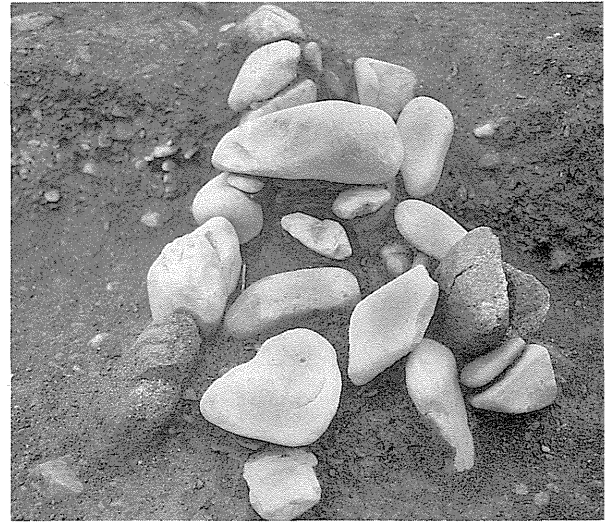

SB49
(東より)



SB50
(西より)

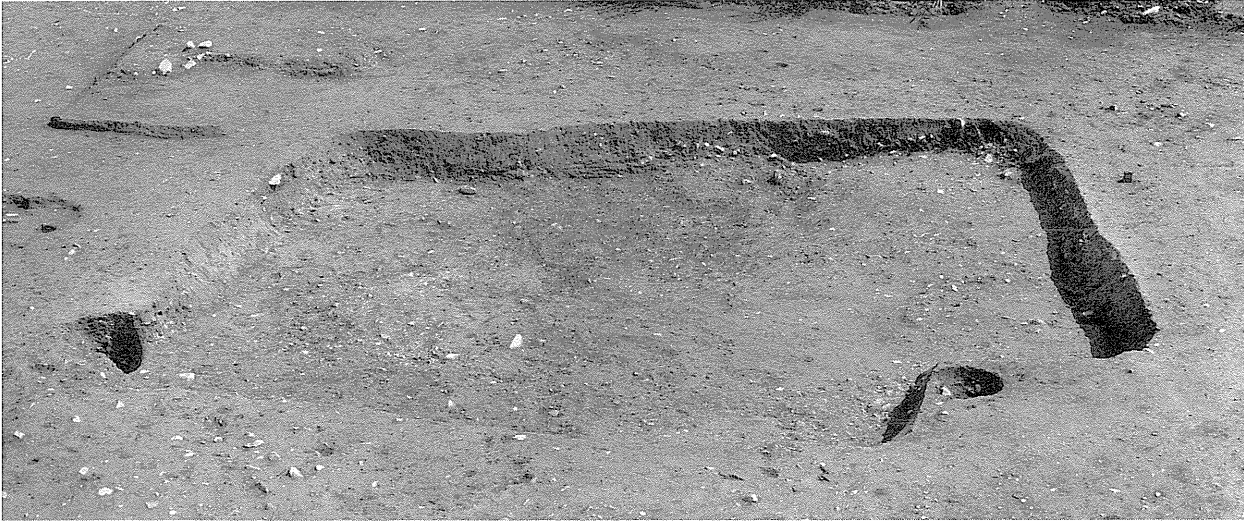

SB56
(南より)



SB59
(南より)



SB58
(東より)

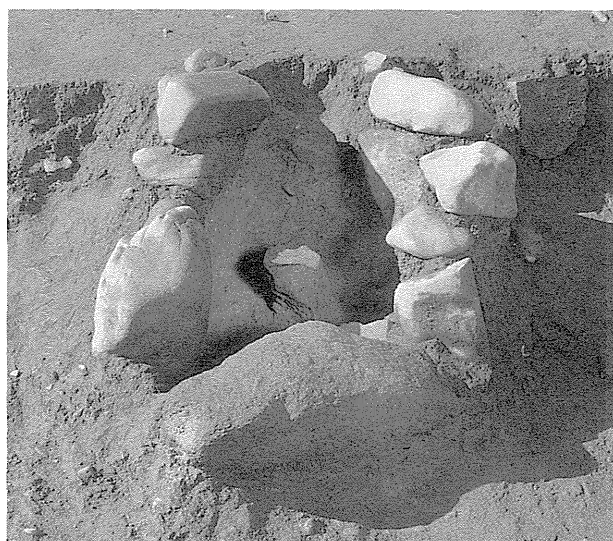

左 SB58 カマド
右 SB83 カマド



SB63
(西より)



SB66
(西より)

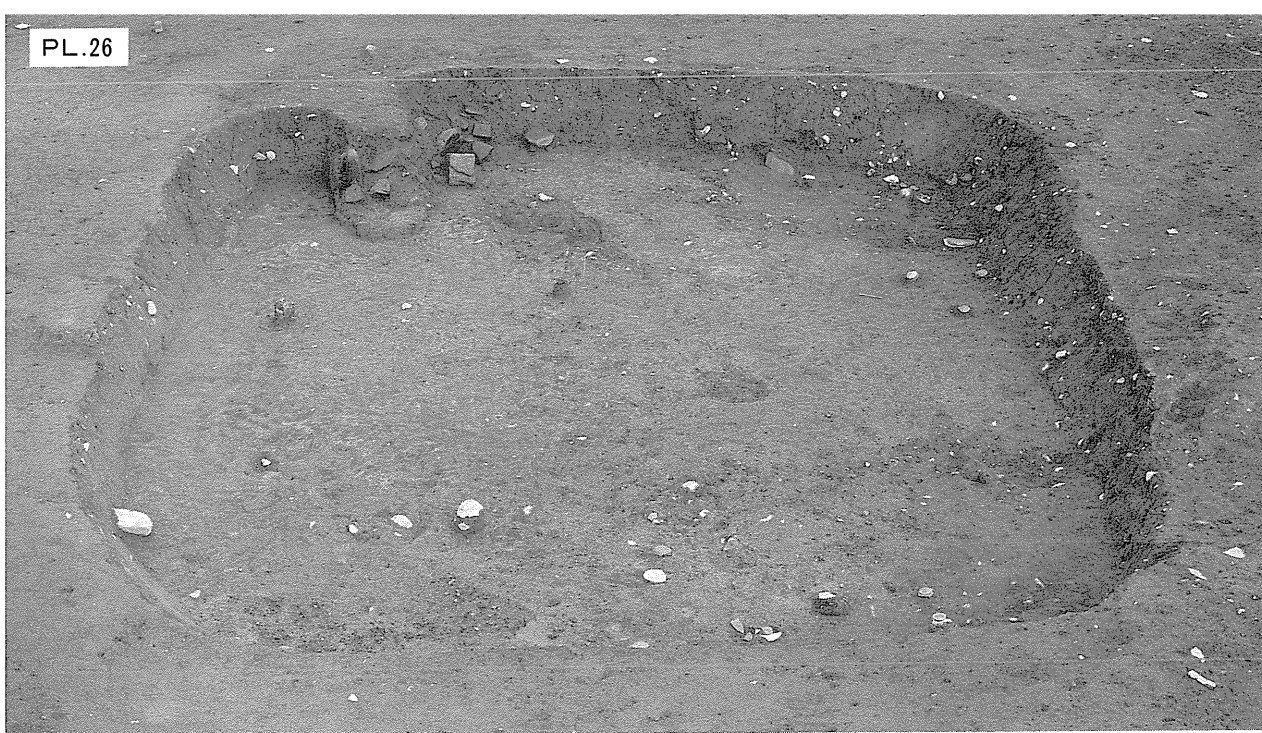

SB69
(西より)



SB70
(西より)



SB71
(東より)



SB73
(南より)



SB74
(南より)



SB76
(南より)



SB81
(西より)

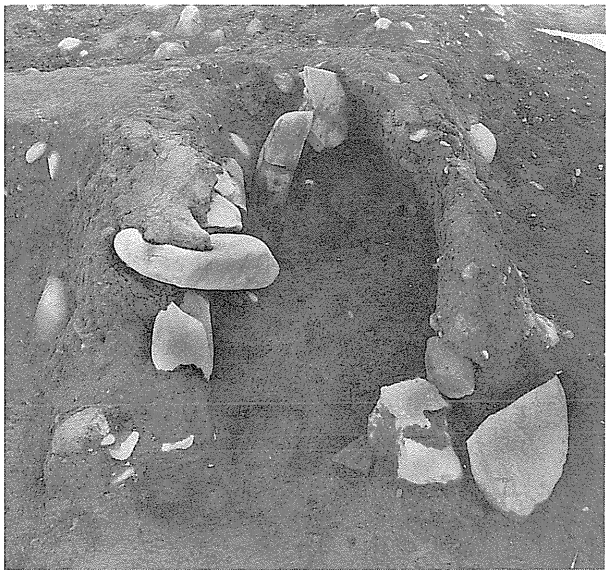

左 SB85 カマド
右 SB86 カマド



SB86
(西より)



SB95
(西より)



左 SB95 カマド
右 SB112 カマド

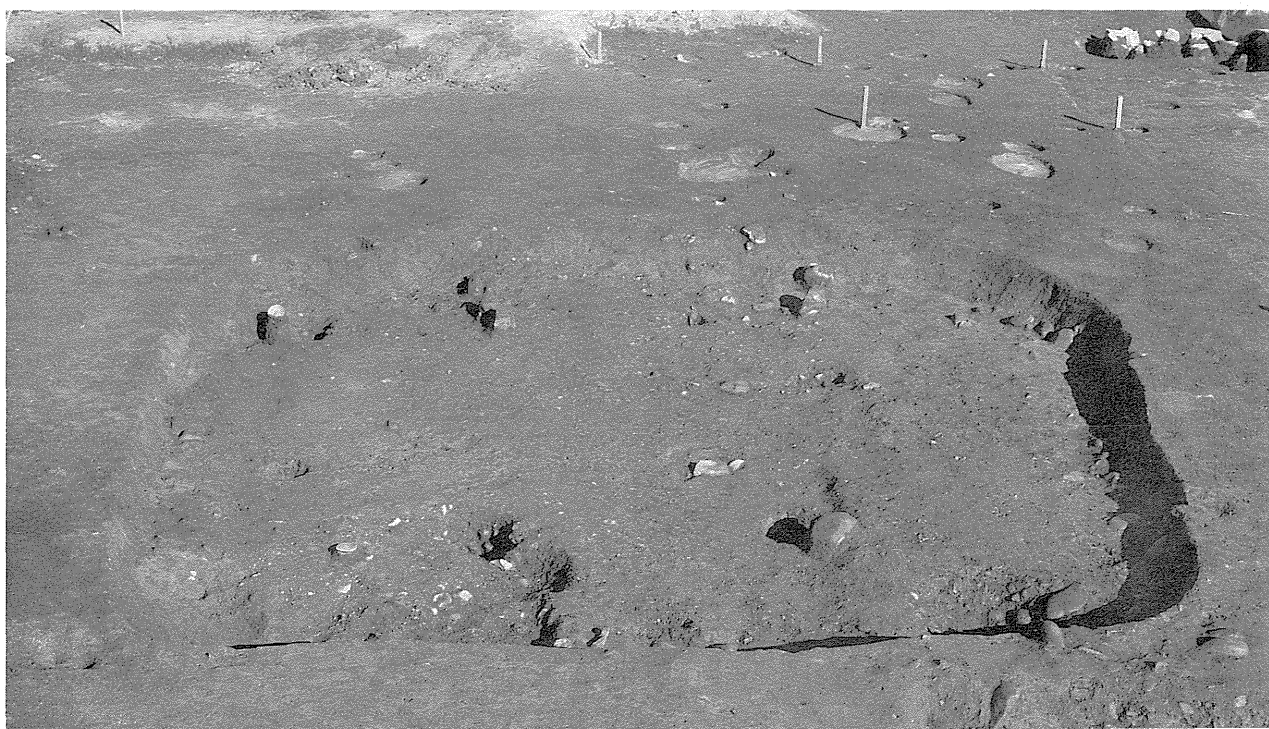
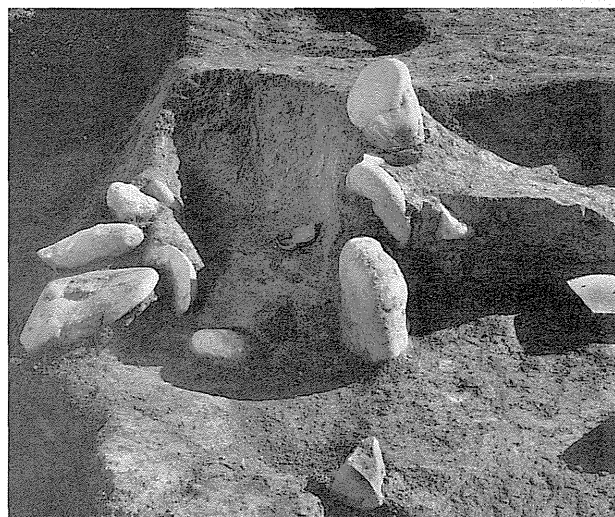

SB98
(西より)

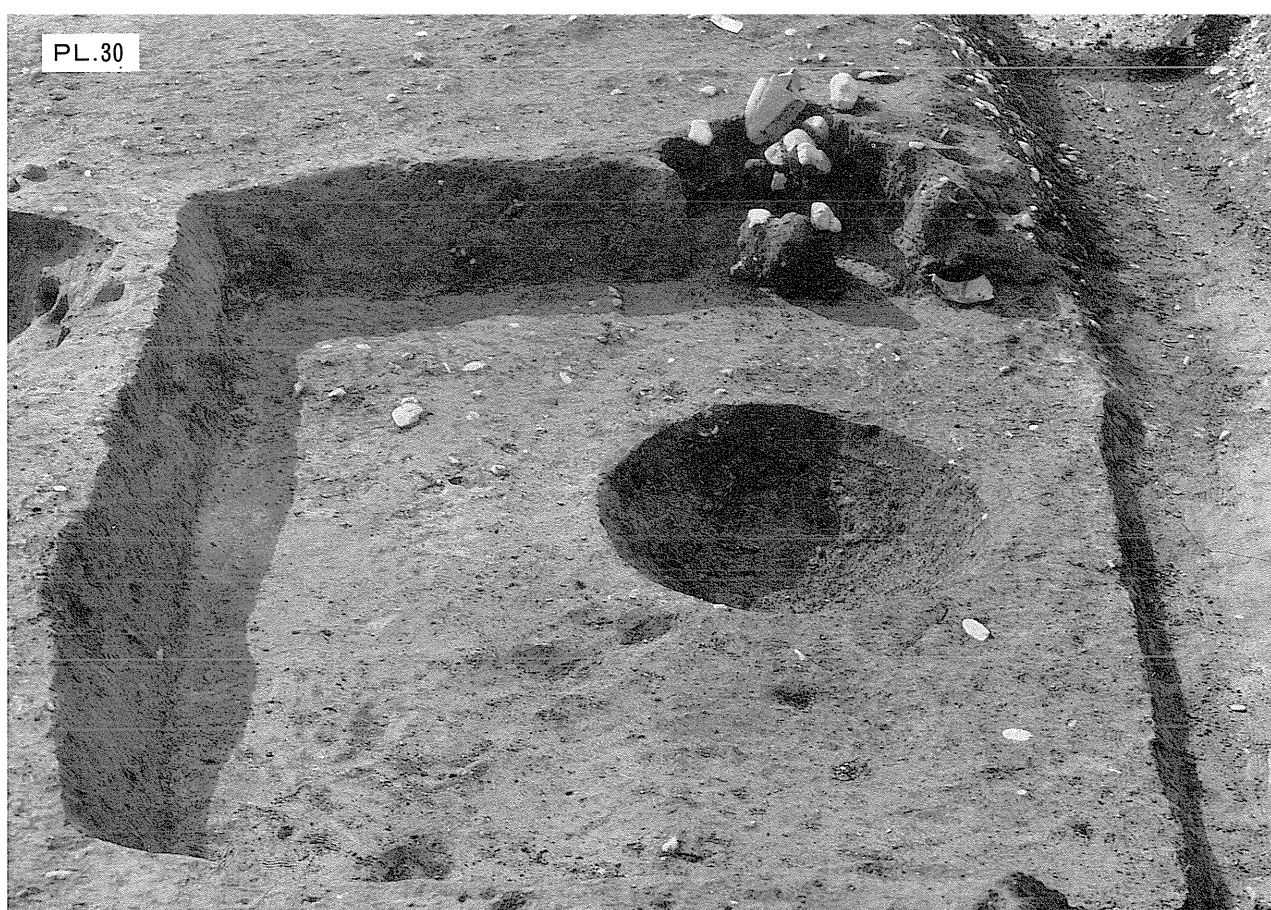

SB99
(東より)

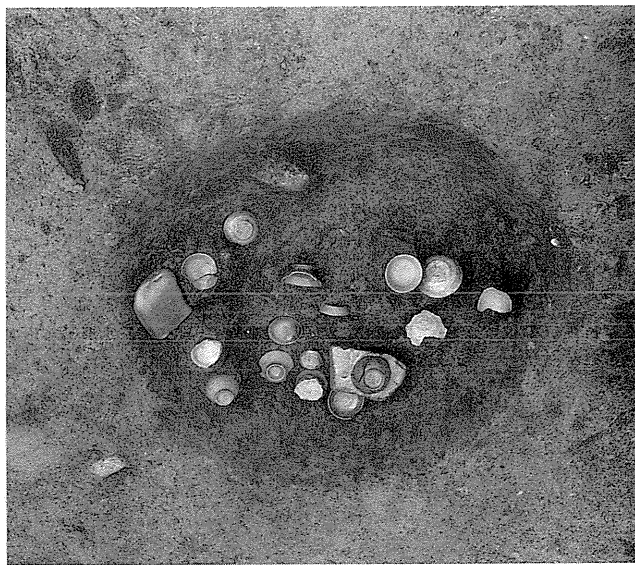

SB99
遺物出土状況

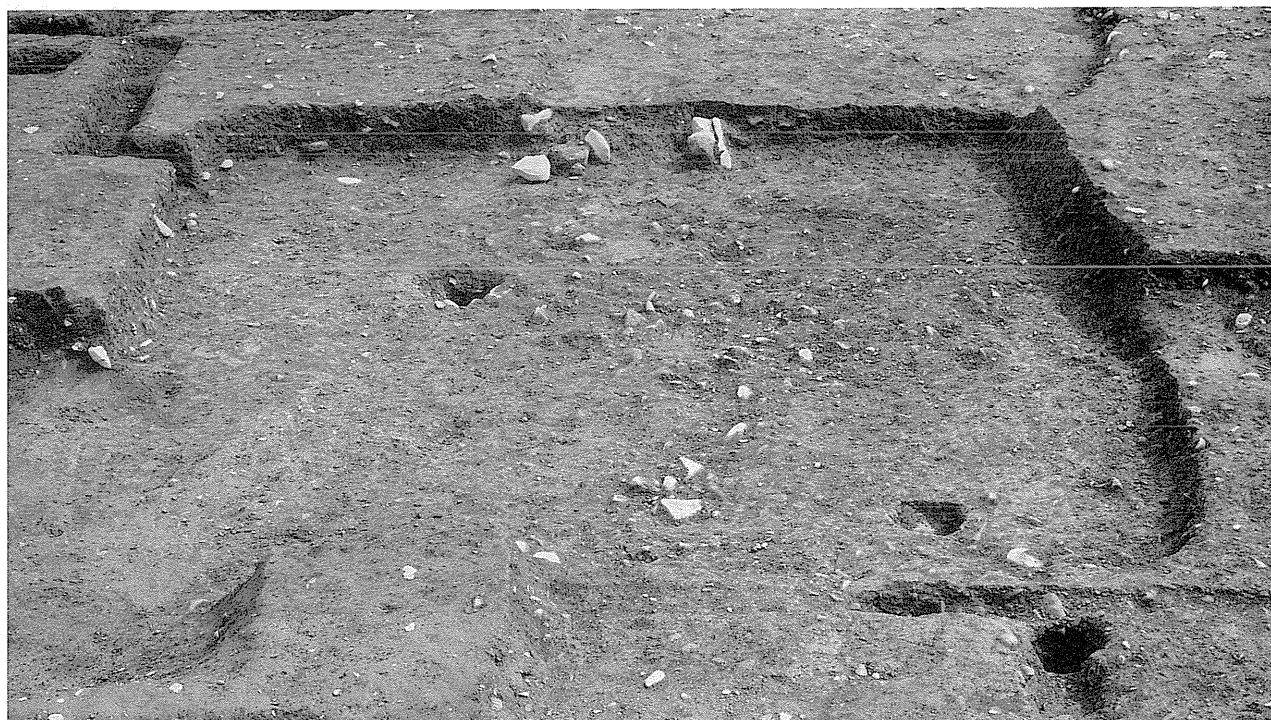

SB100
(南より)

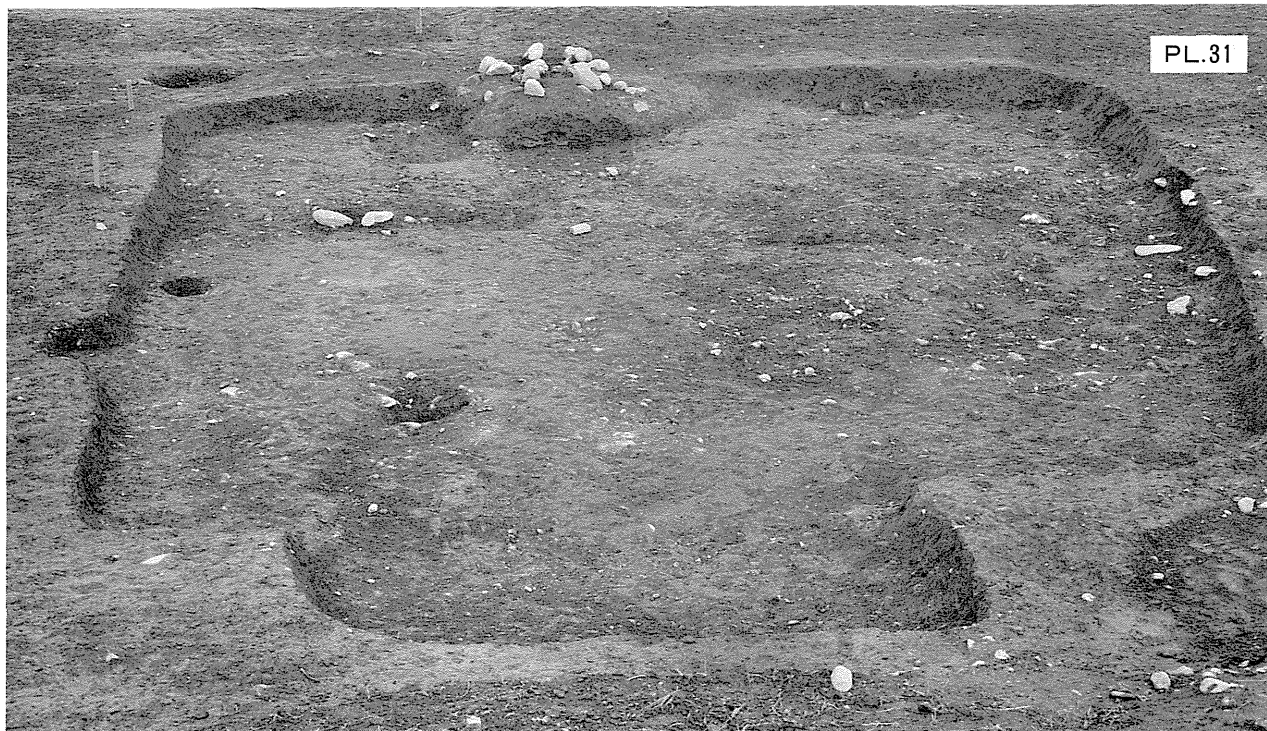

SB102
(西より)



SB108
(西より)



SB115
(東より)



SB118
(西より)



SB128
(東より)



SB129
(西より)

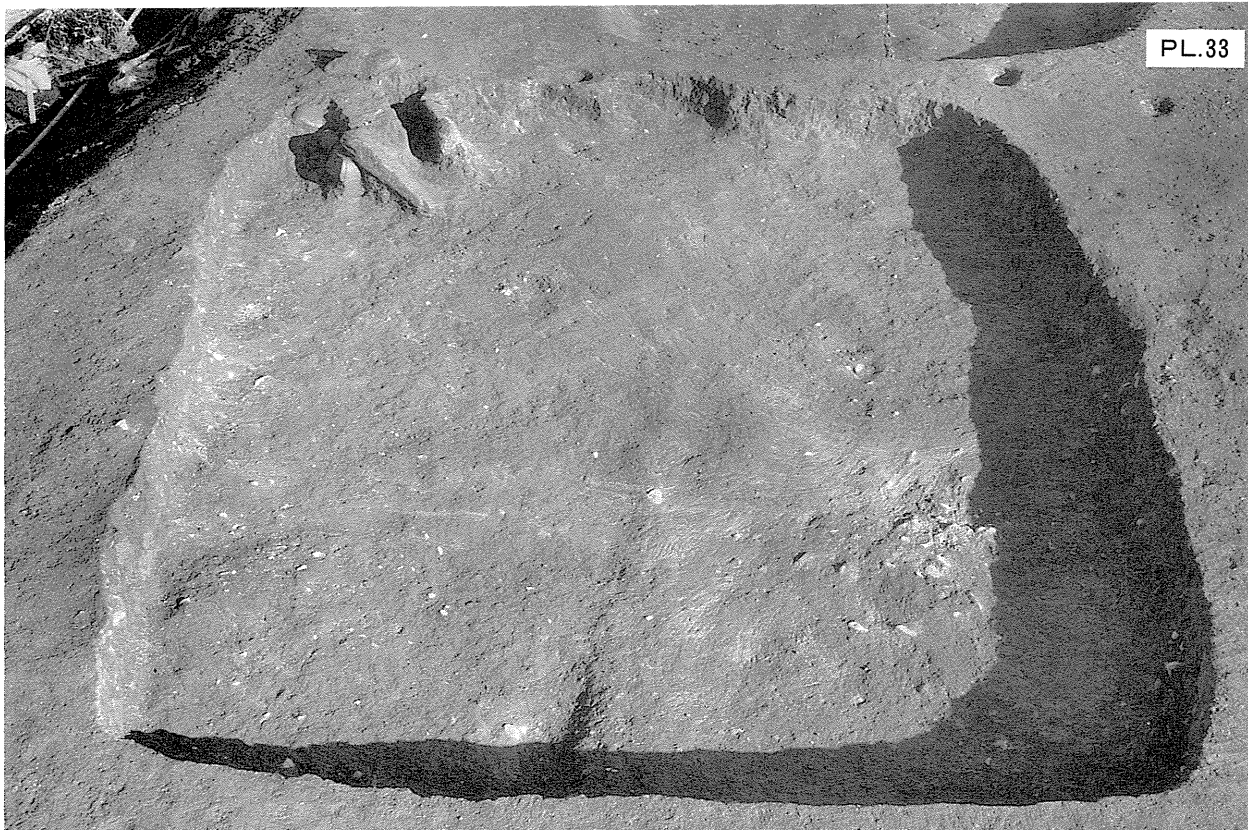

SB132
(西より)

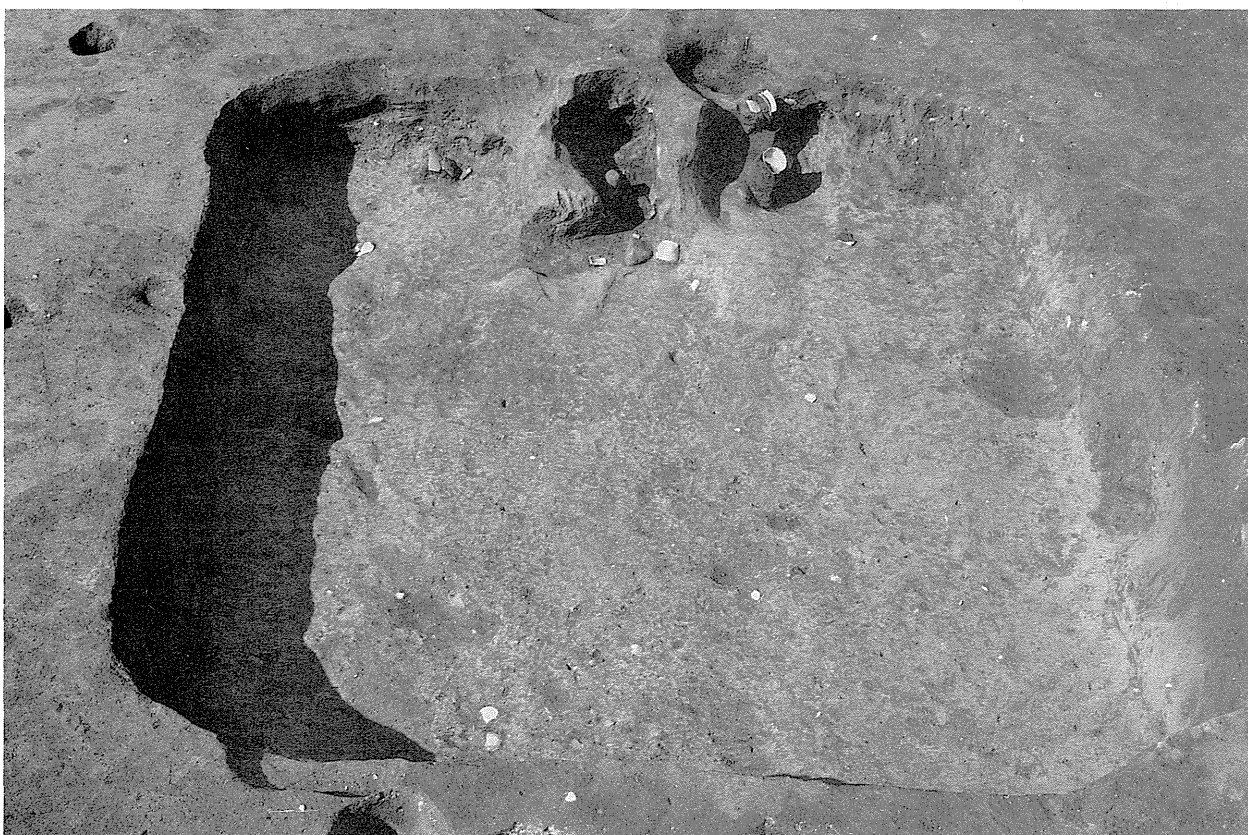

SB139
(東より)



左 SB139 カマド



右 SB226 カマド

PL.34



古代遺構 19

SB142
(西より)



SB156
(西より)



SB160
(南より)



SB144
(東より)



SB162
礫・遺物出土状況
(東より)



SB162
(東より)



SB167
(南より)



SB168
(西より)



SB170
(東より)

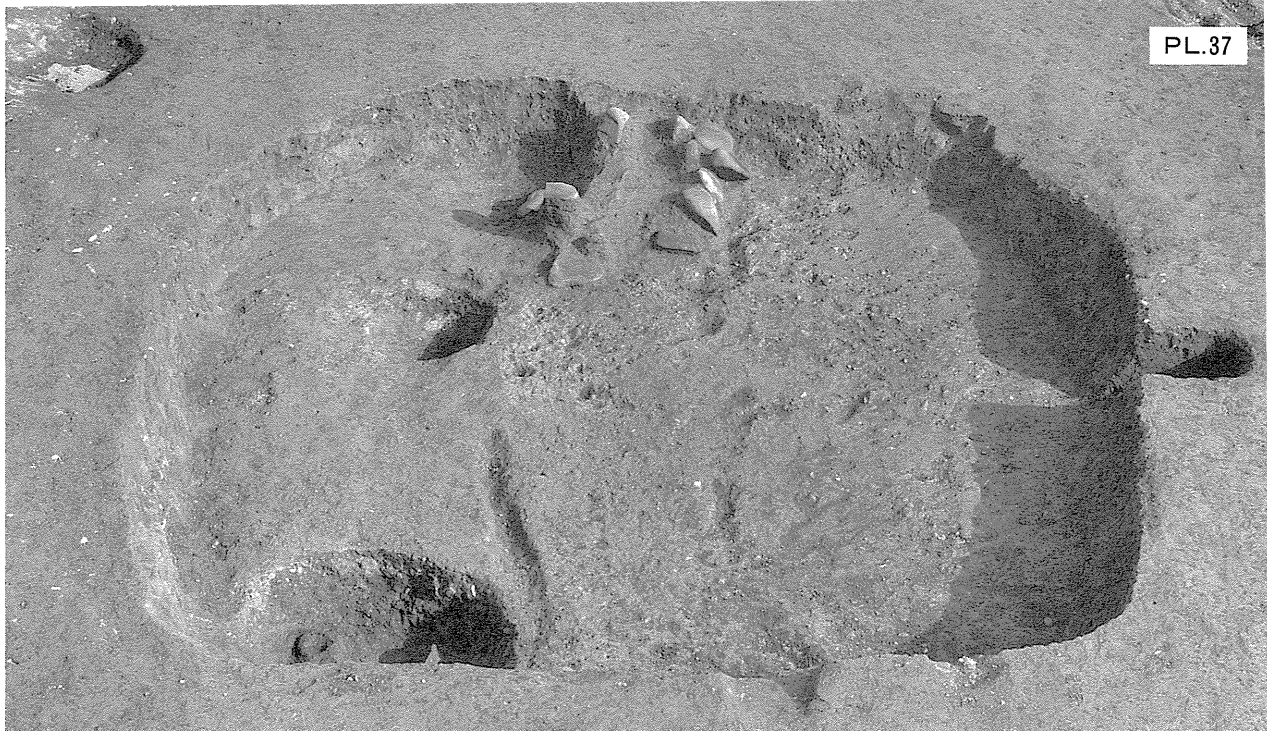

SB187
(西より)



SB188
(東より)



左 SB188 カマド
右 SB230 カマド

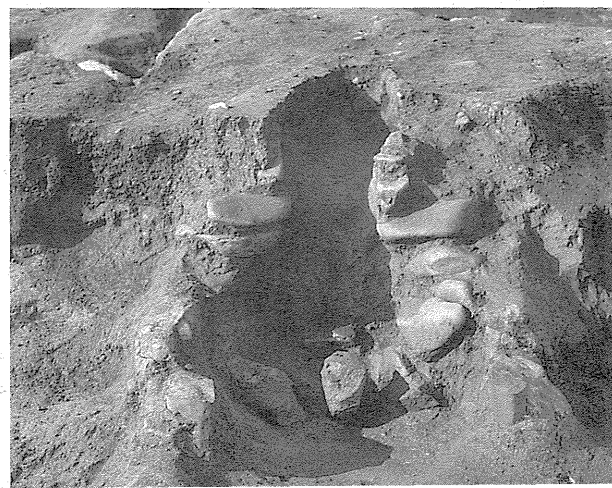



SB200
(西より)



SB209
(東より)



SB210
(西より)



SB213
(西より)



SB227
(東より)



SB232
(西より)

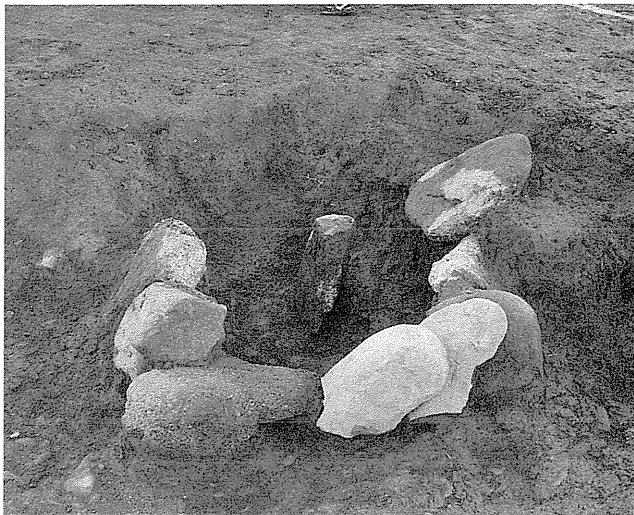

左 SB232 カマド
右 SB234 カマド



SB234
(東より)

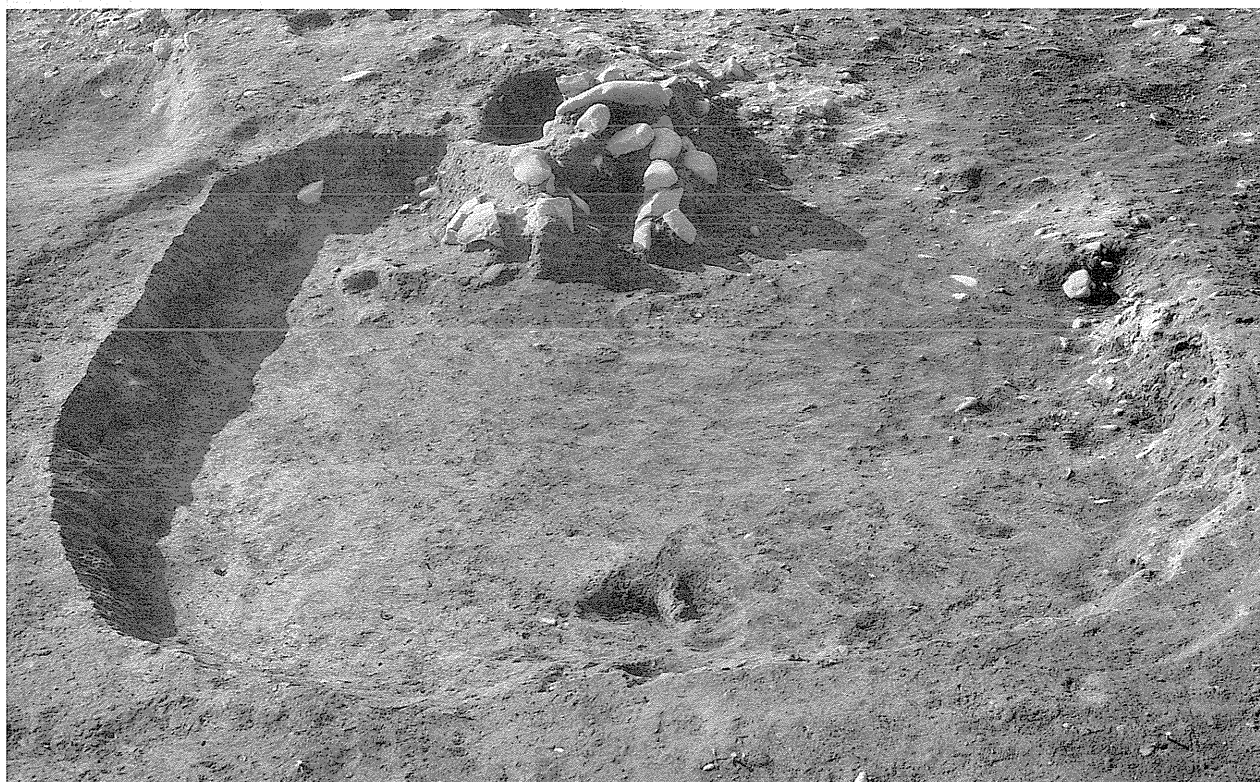

SB249
(東より)



左 SB242 カマド



右 SB249 カマド



SB250
(西より)

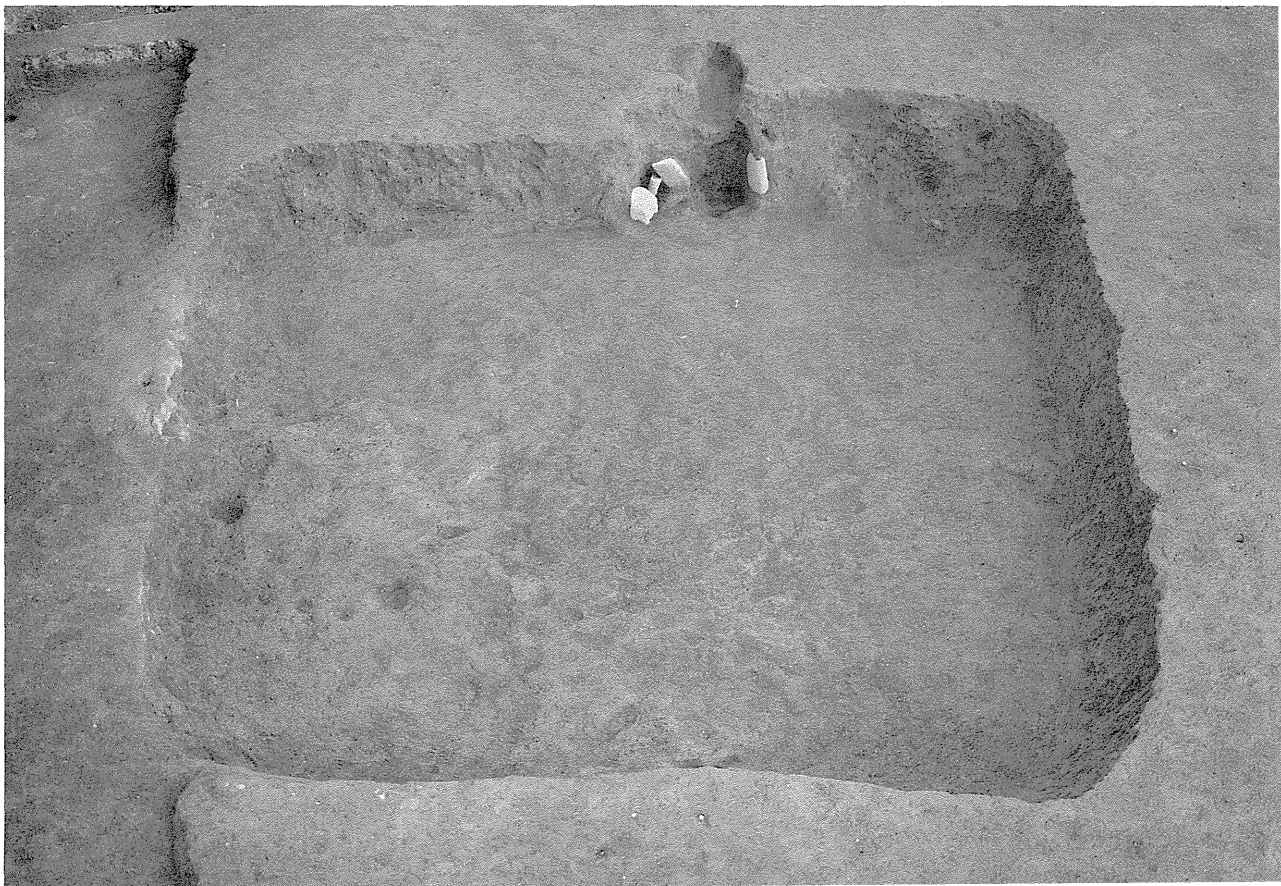

SB258
(西より)

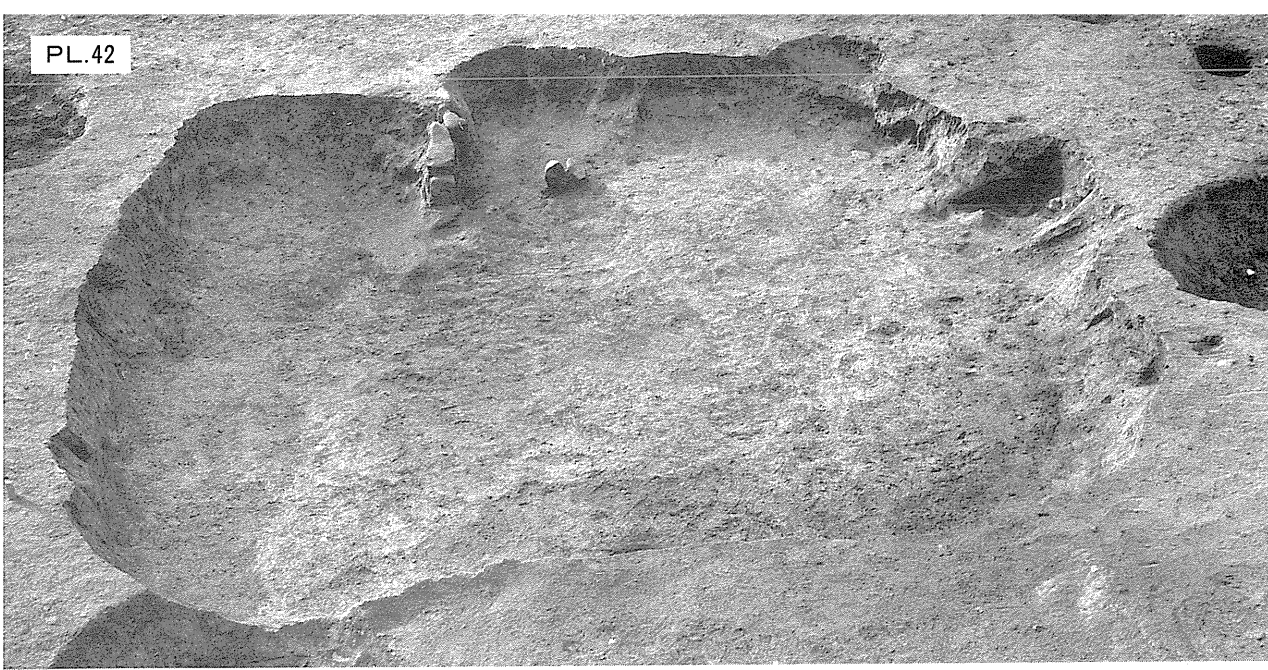

SB259
(東より)

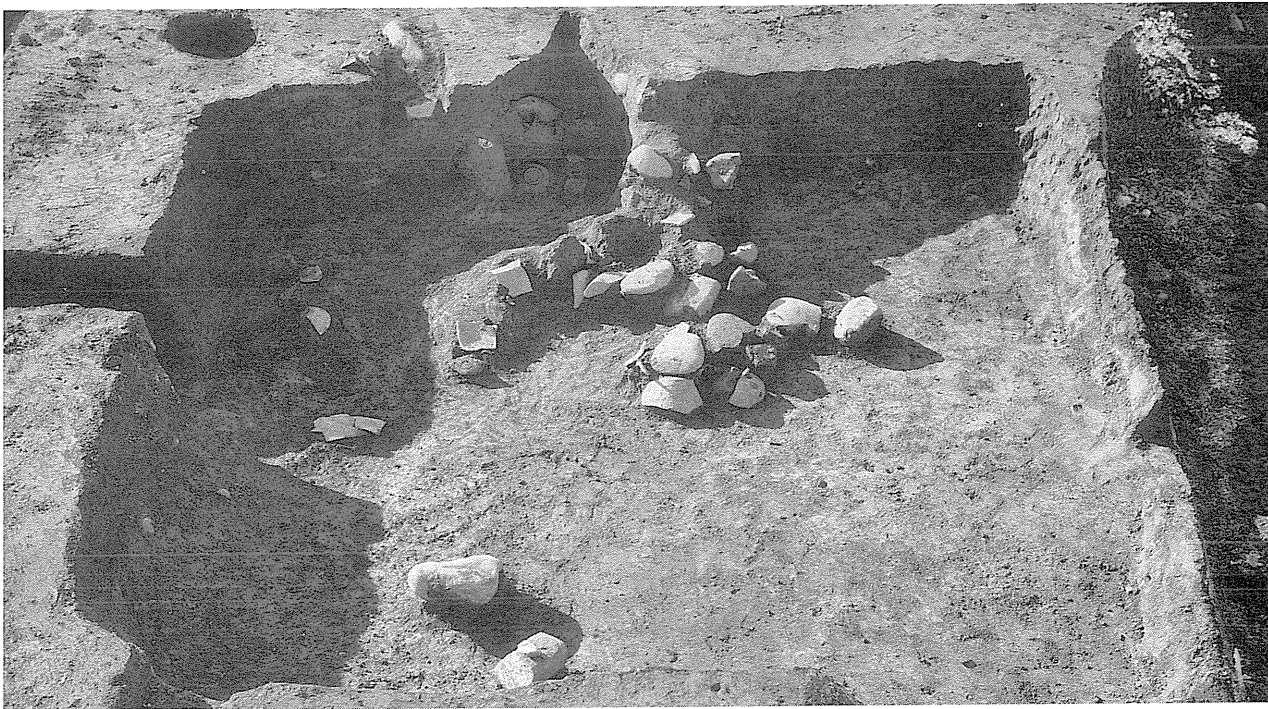

SB264
(東より)



SB266
(東より)



ST201
(東より)



ST204
(南より)



ST206
(南より)

PL.44

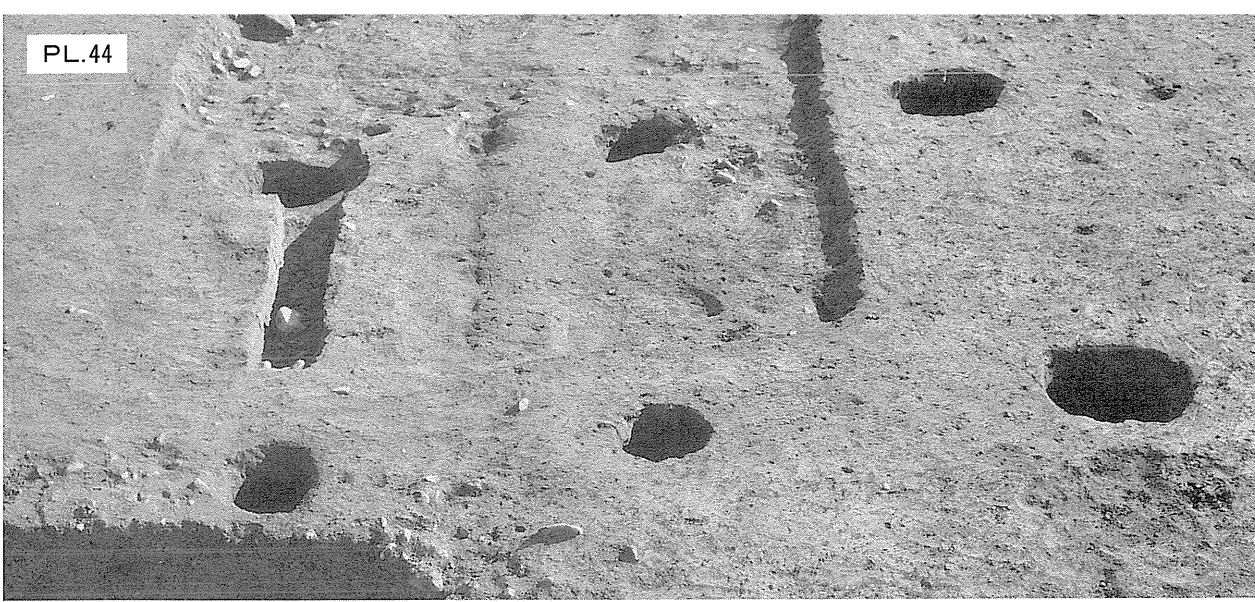

古代遺構 29

ST208
(西より)



O地区北東部
柱穴群
(南より)



ST205
(南より)



SD17
(北より)



SD19-25
(東より)

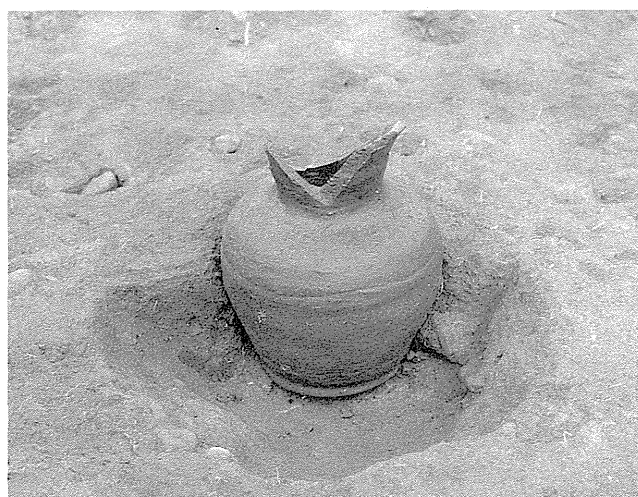

左 SM01
右 SK128



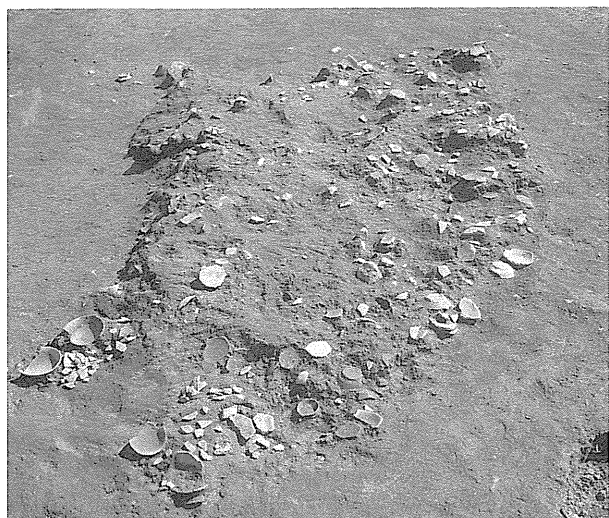

SX21



左 SK21
右 SK42



SK73



左 SK84
右 SK218



ST05
(西より)



SB1121
(東より)



SB1179
(南より)



SD02
(西より)

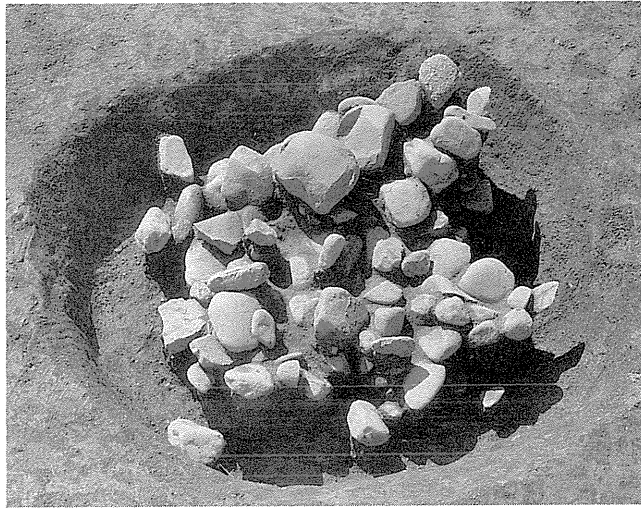
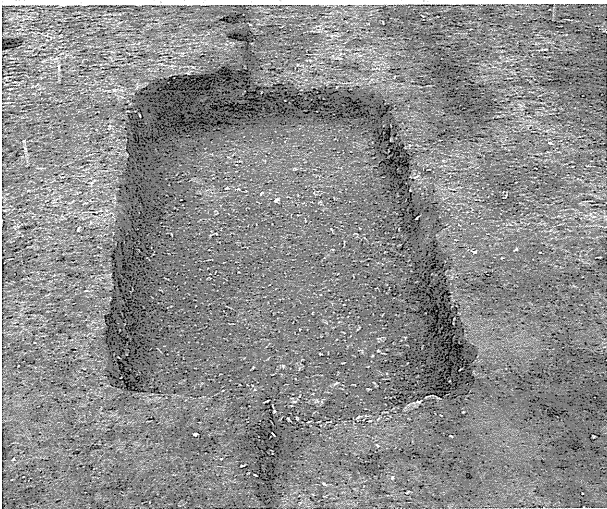

左 ST02内
SX1100
右 SK1133



SK1252



SK1231~
1236



左 SK1141・1142
右 SK1217

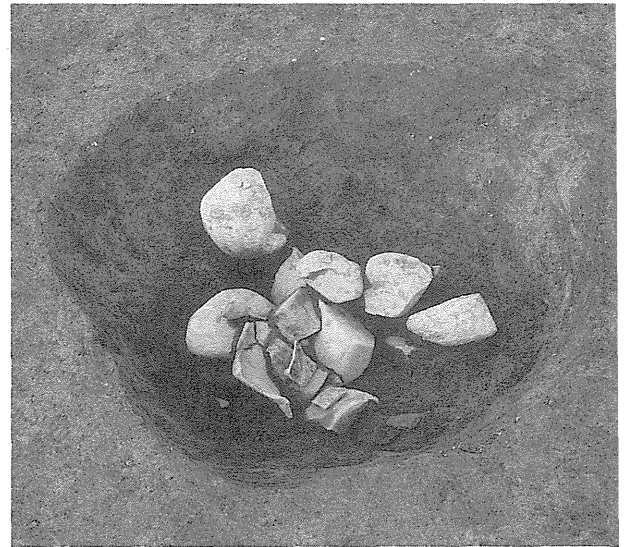

左 SK1221
右 SK1244





整地土層
上面遺構



ST2004

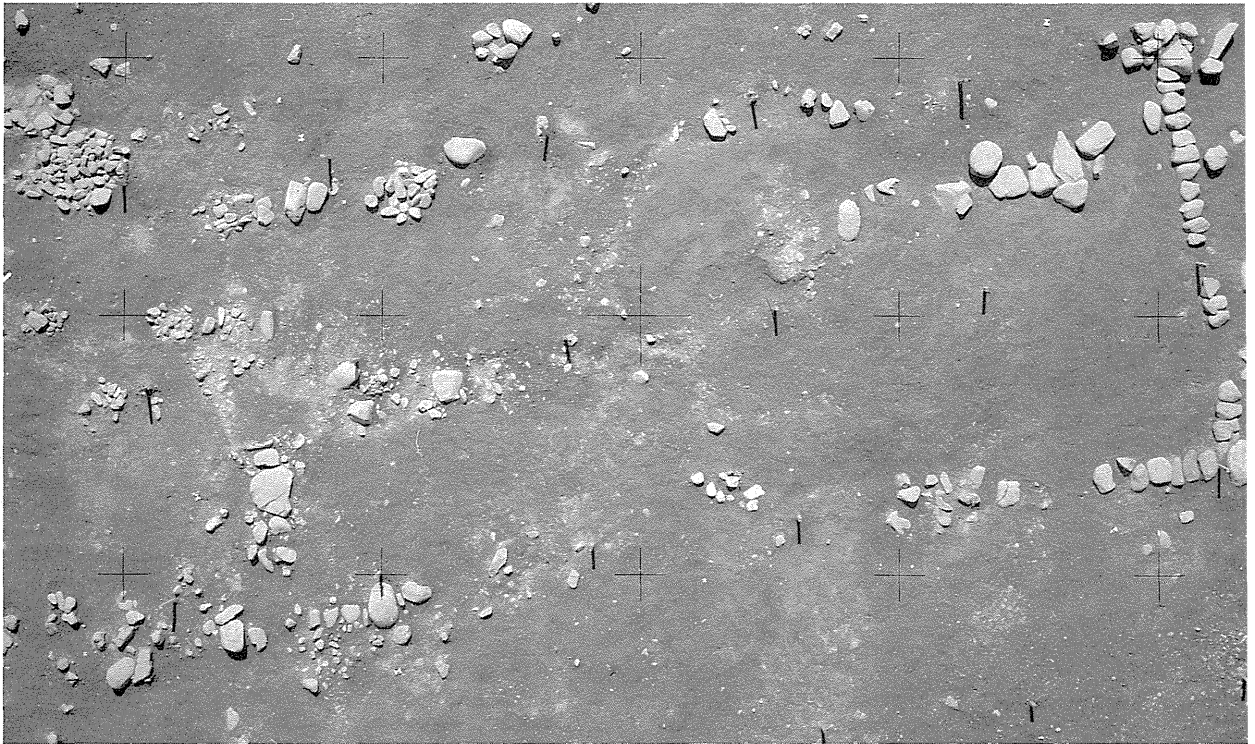

ST2001

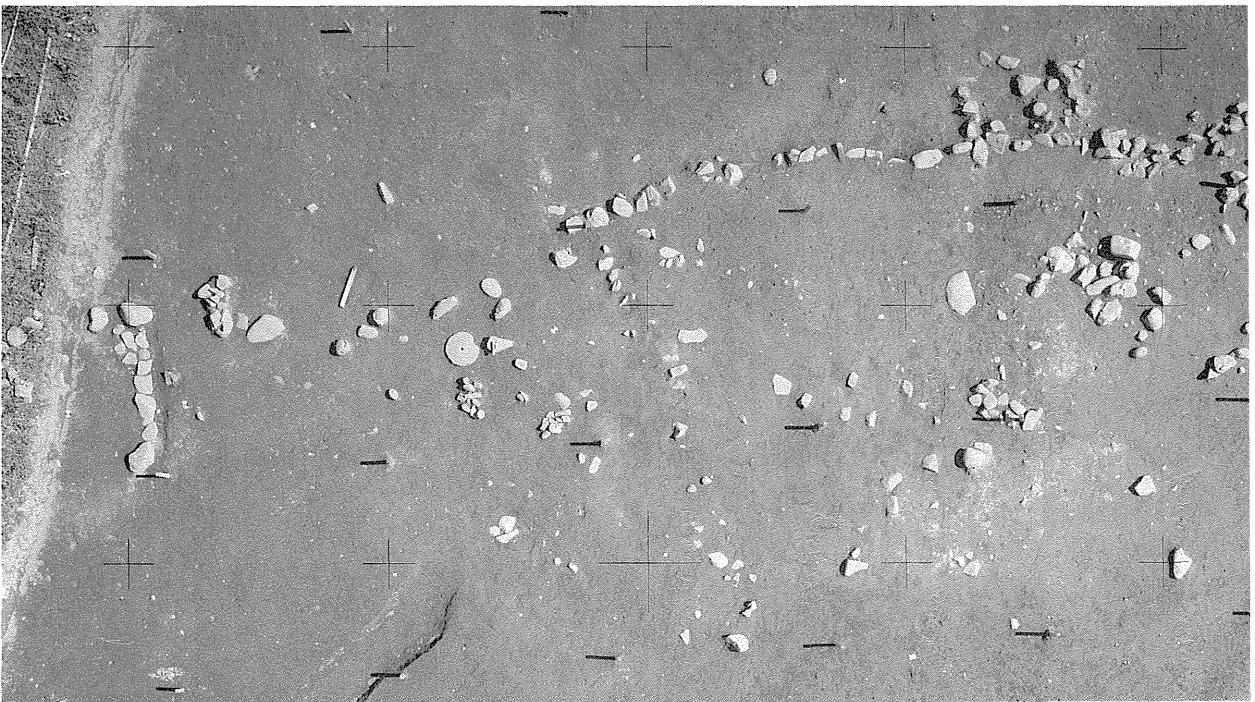

ST2003

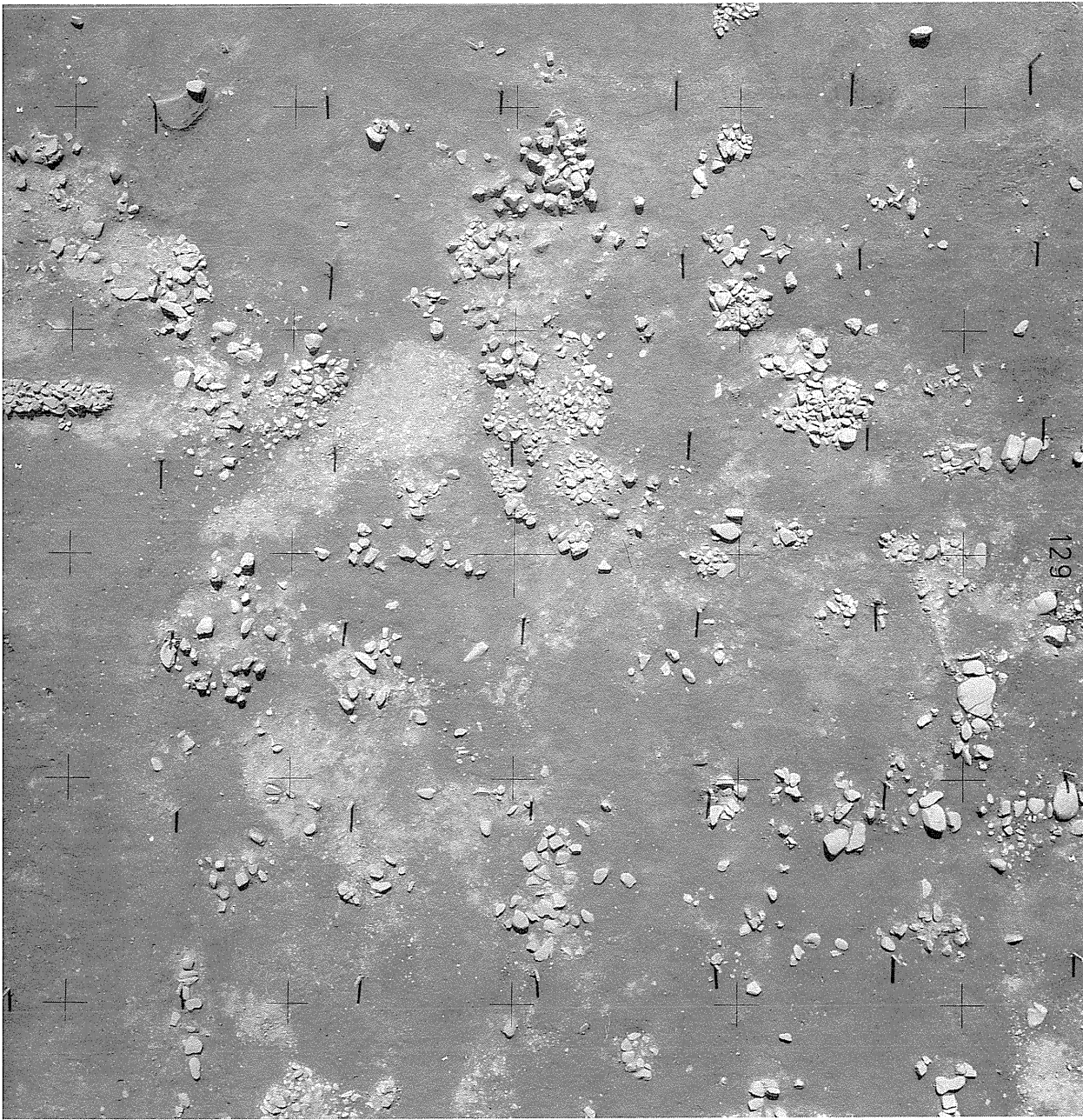

整地土層
上面礫分布



ST2002
断面

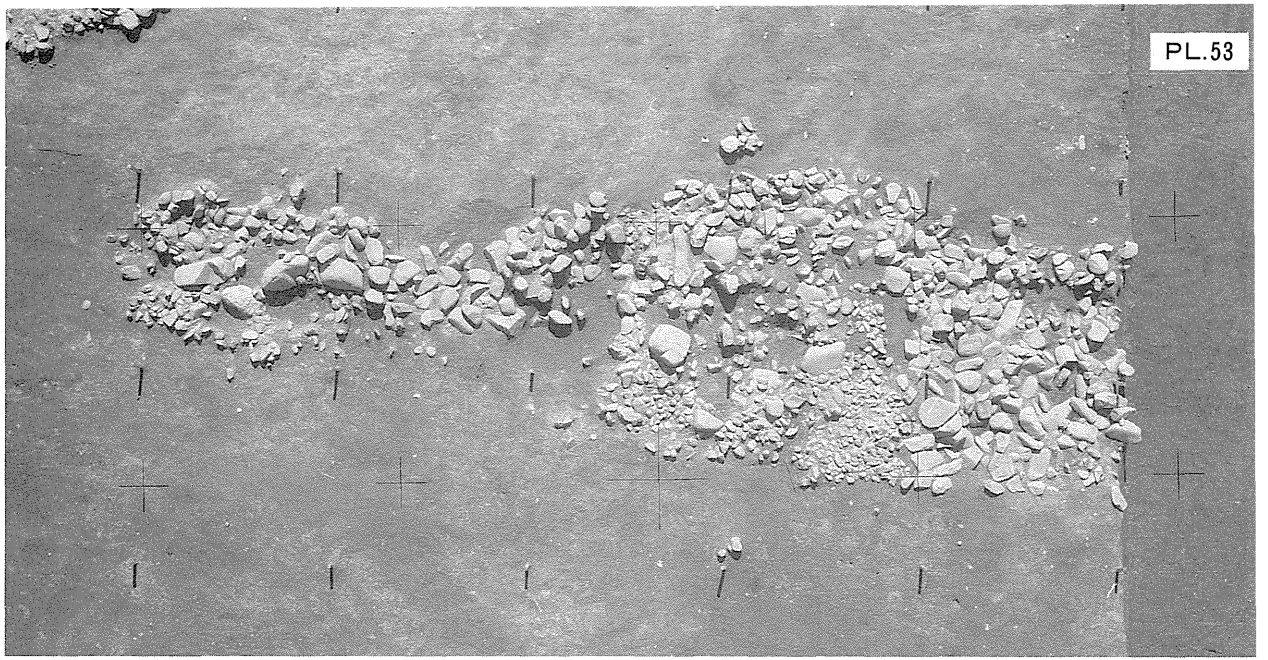

整地土層上面
礫の分布 (東部)

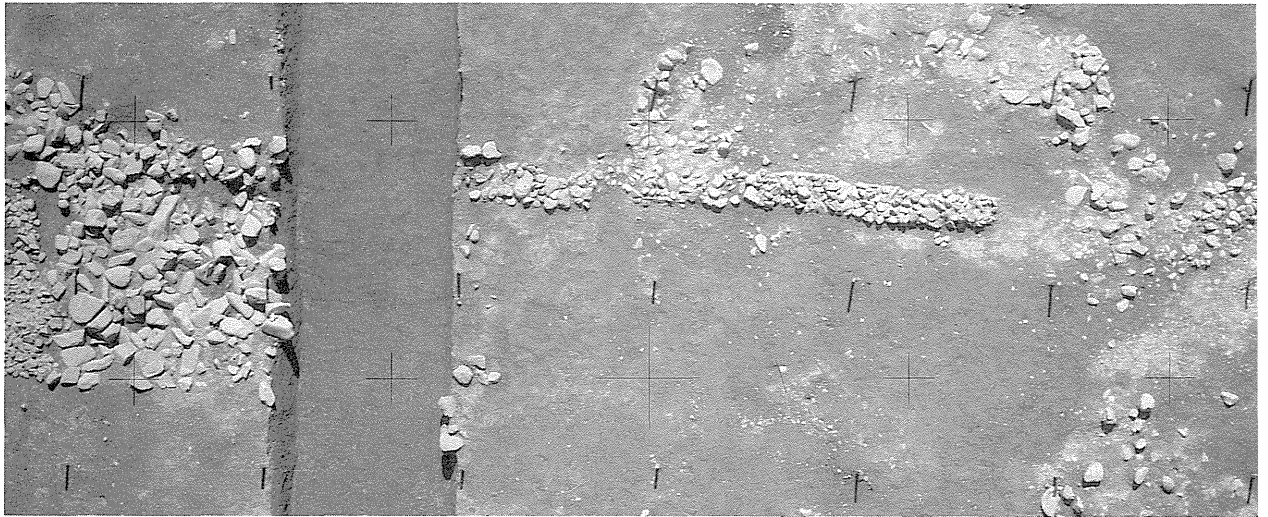

整地土層上面
礫の分布 (西部)

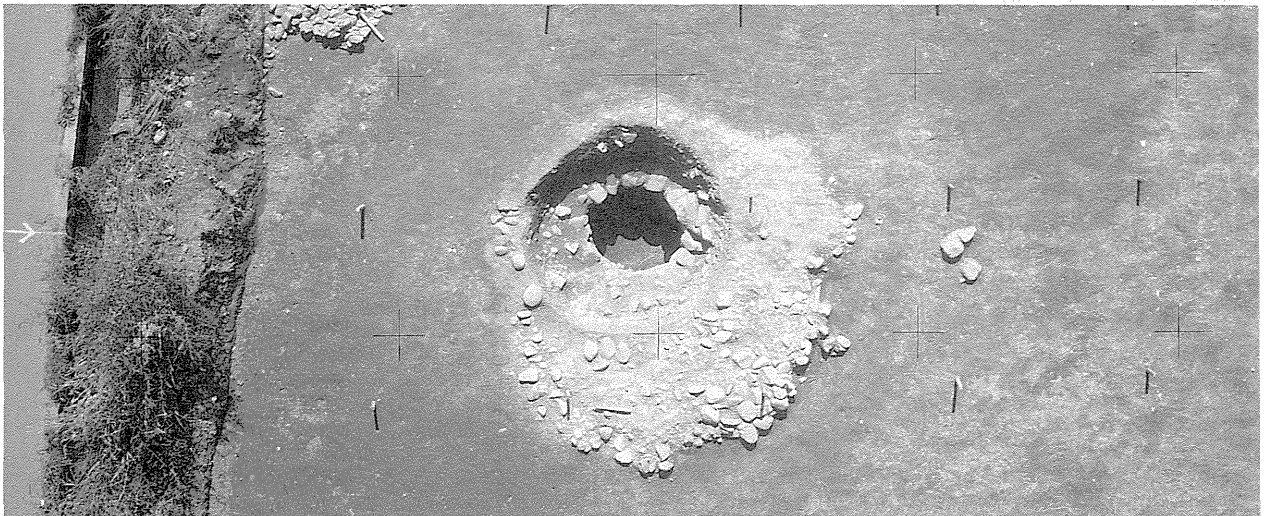

SE01

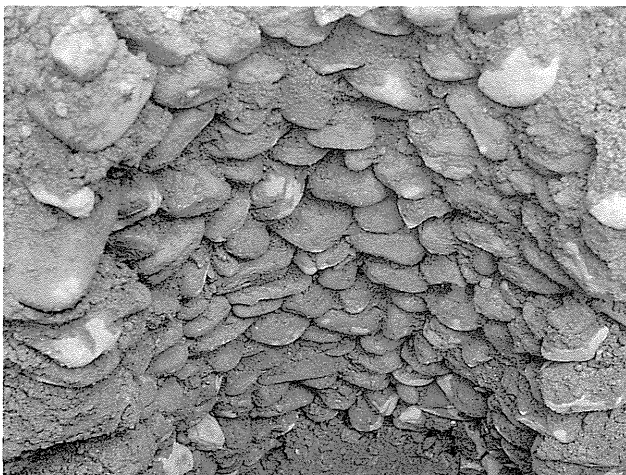

左 SE01
石組の状況

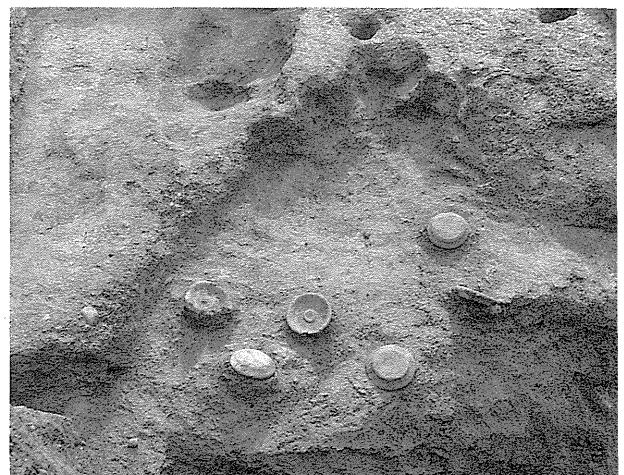

右 SK2013

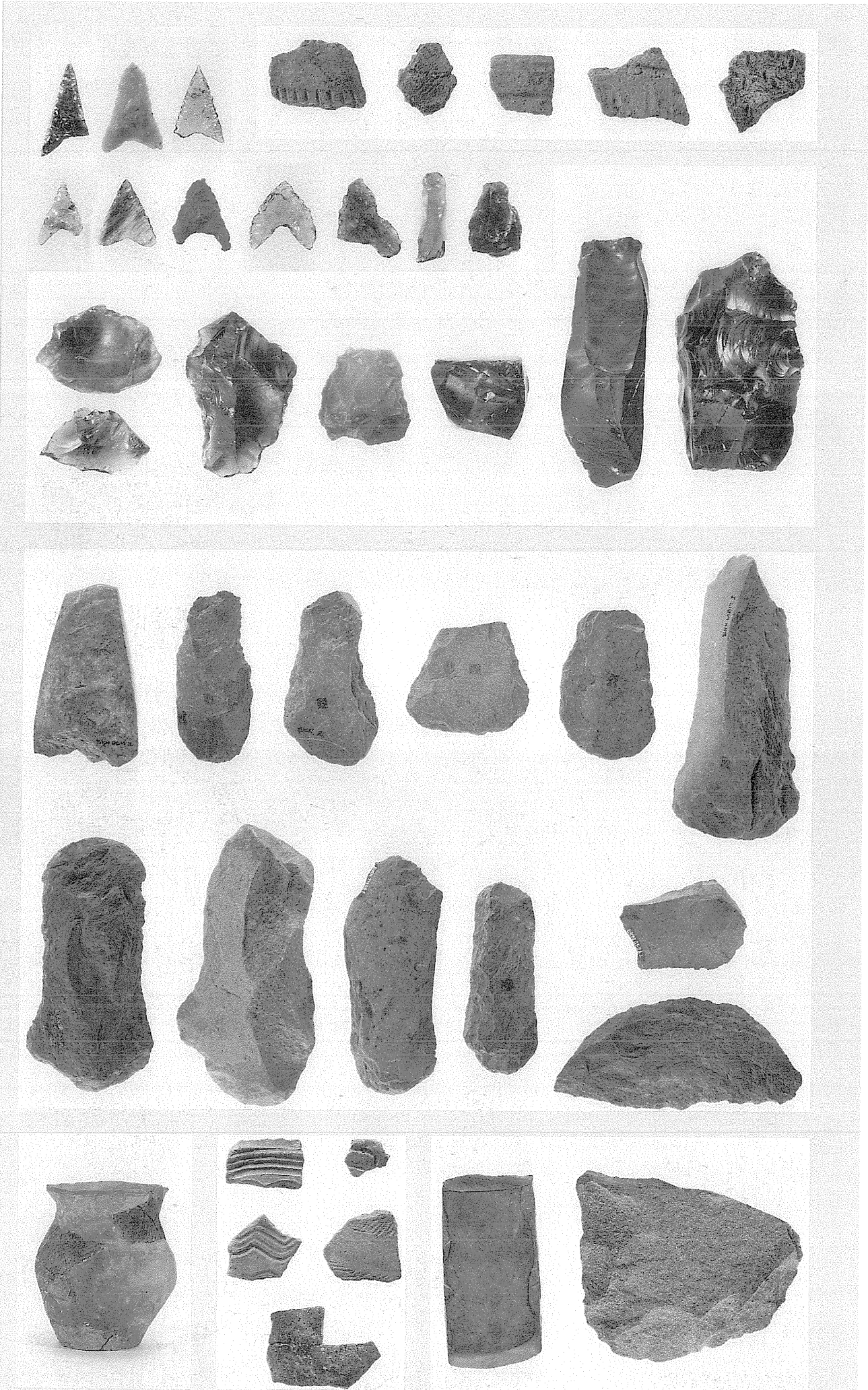

縄文時代

弥生時代



SB01-1

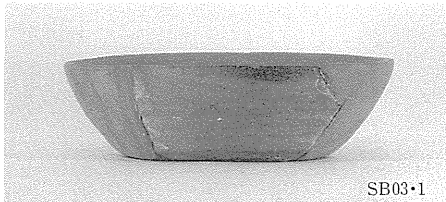

SB03-1

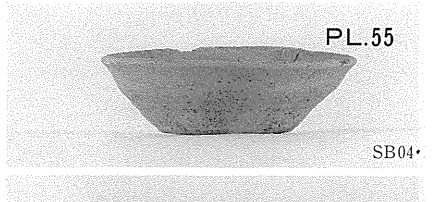

SB04-1



SB01-2

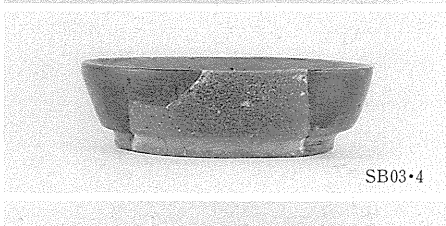

SB03-4

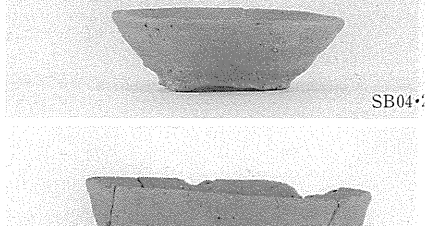

SB04-2



SB01-8

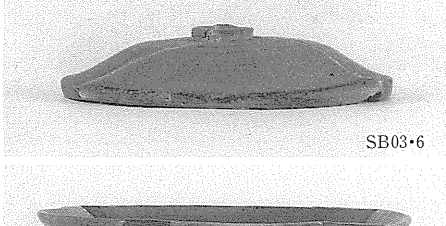

SB03-6

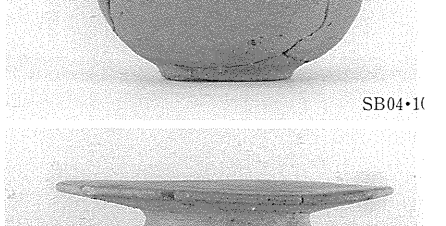

SB04-10

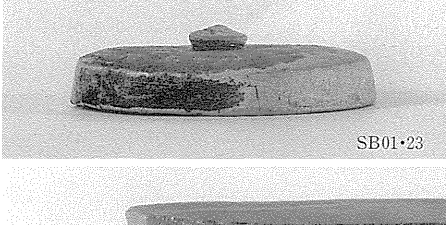

SB01-23



SB03-8

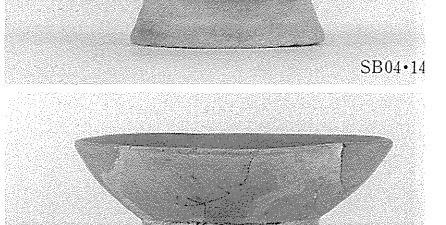

SB04-14

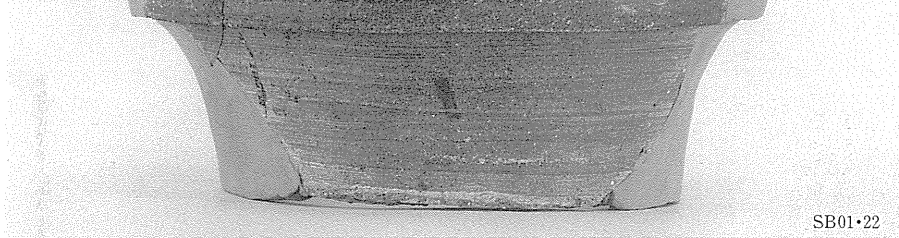

SB01-22

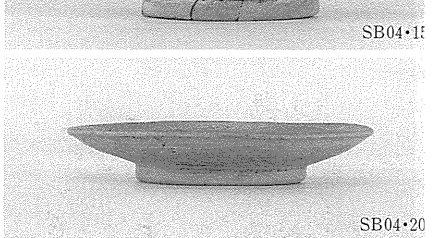

SB04-15

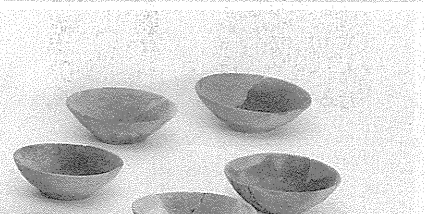

SB04-20

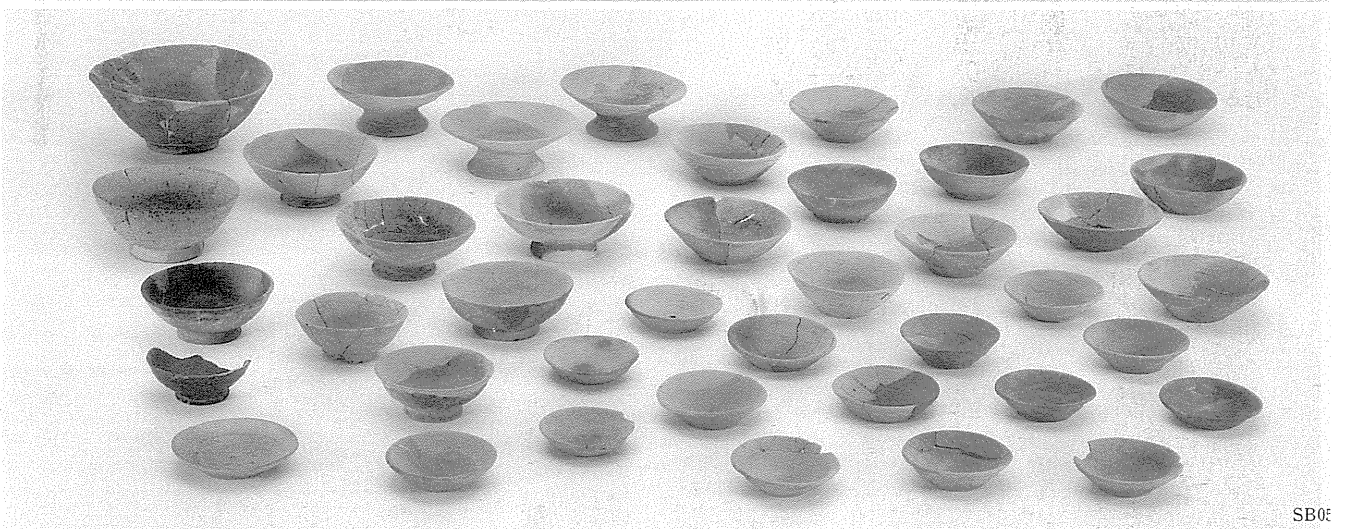

SB05

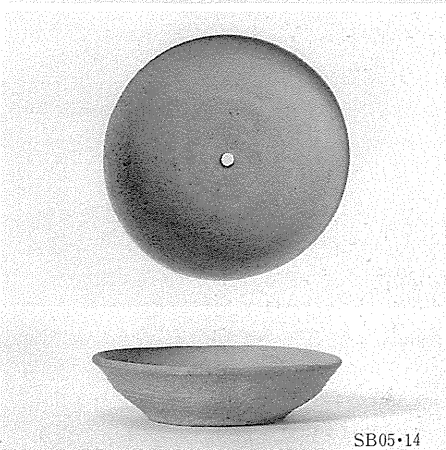

SB05-14



SB05-39



SB05-43



SB05-50

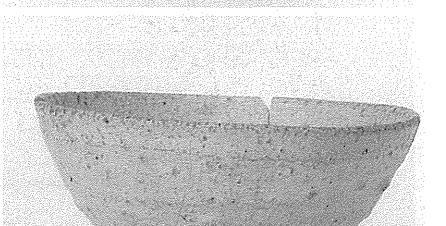

SB05-52



SB05-3

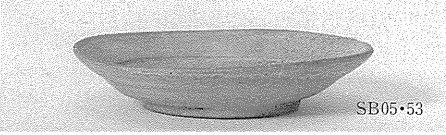

SB05-53

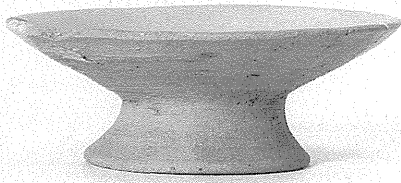

SB05•45



SB05•54



SB06•1



SB06•3

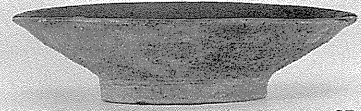

SB06•4



SB06•8



SB06•6



SB07•1

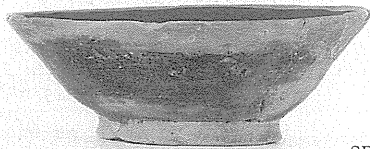

SB07•5

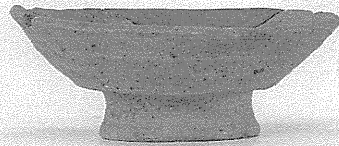

SB10•7



SB10•9



SB10•10



SB10•11

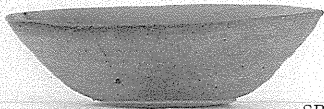

SB11•1

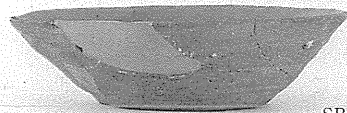

SB11•2



SB11•5

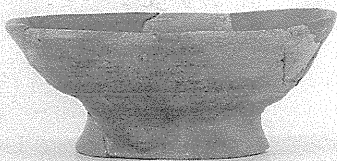

SB13•8



SB13•10

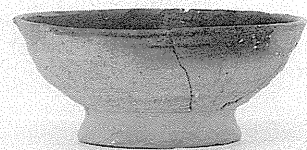

SB13•15

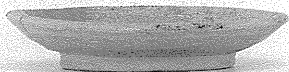

SB13•18

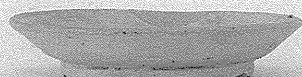

SB13•17

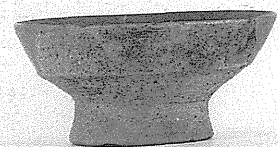

SB16•10



SB11・8

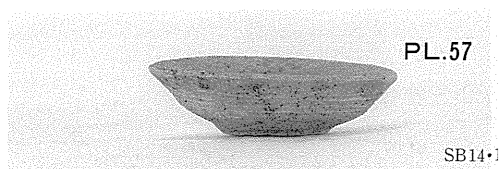

PL.57

SB14・1



SB14・1



SB14・2

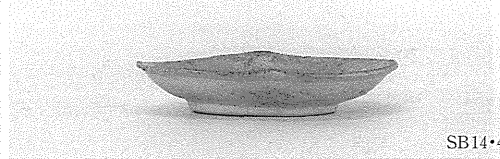

SB14・4

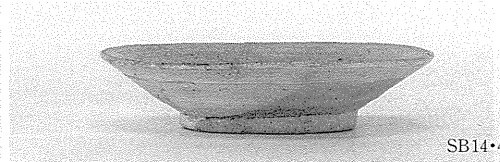

SB14・4

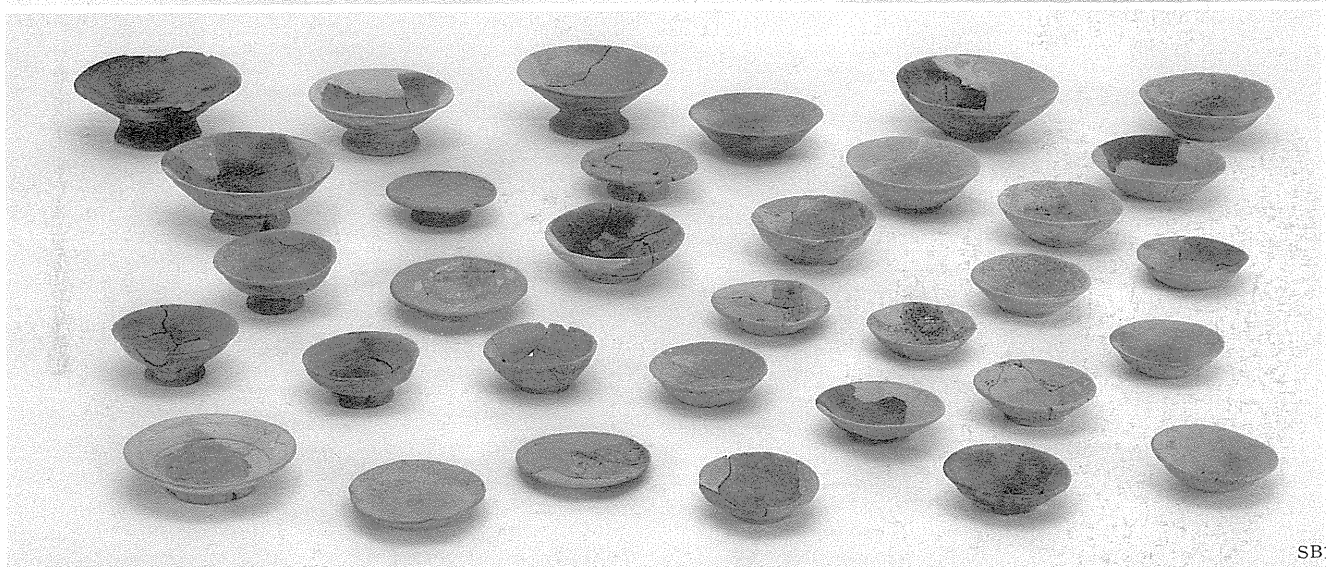

SB14

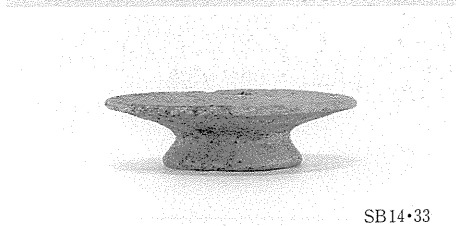

SB14・33



SB14・37

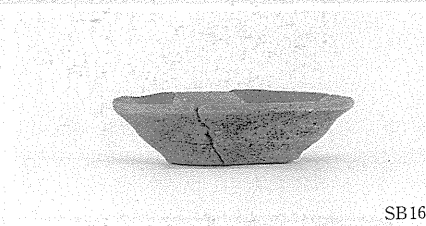

SB16・



SB15・6



SB15・26



SB15・2



SB16・11



SB17・6



SB18・

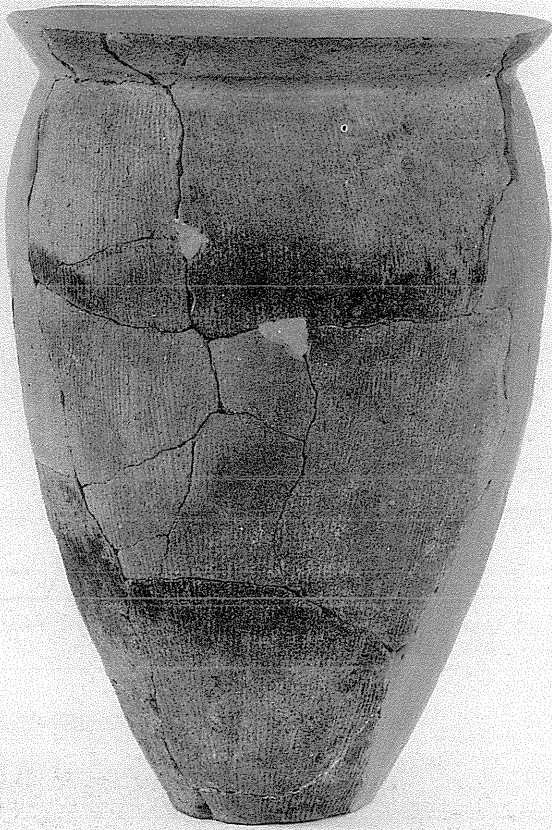

SB17・7



SB18・5



SB18・6

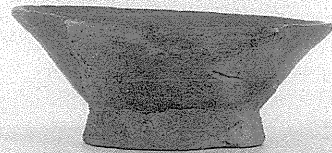

SB19・12

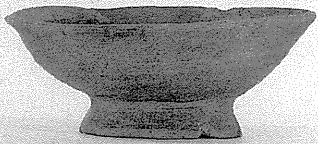

SB19・15



SB19・1



SB19・2

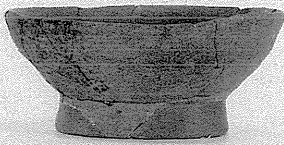

SB19・16

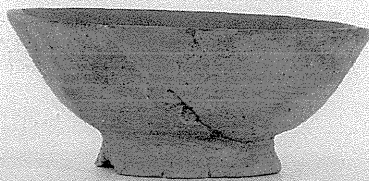

SB19・11

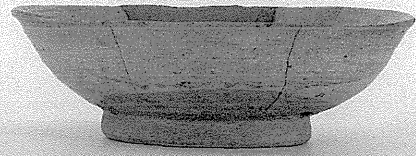

SB19・17



SB21・1



SB21・2



SB21・3

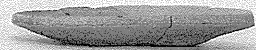

SB21・10



SB21・6



SB21・7



SB21・14

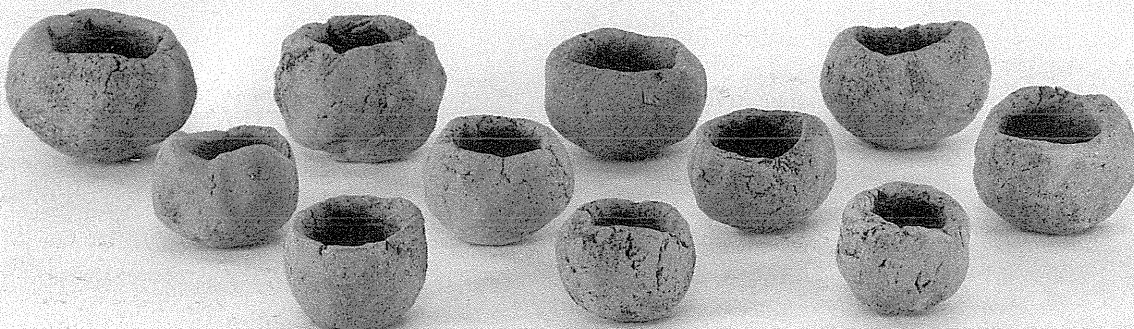

SB22

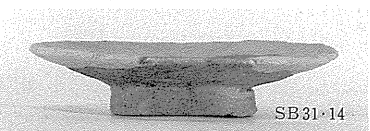
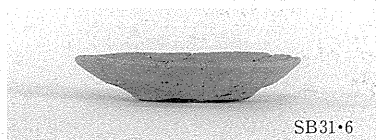
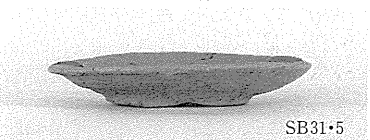
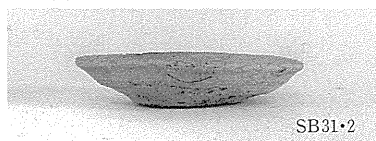
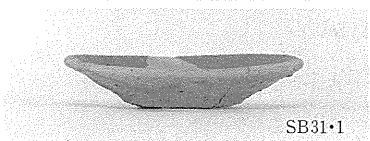
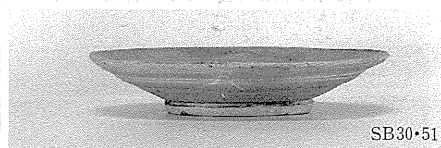
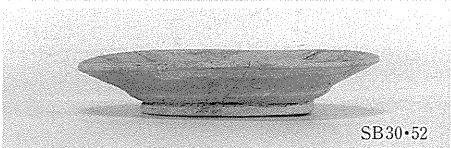
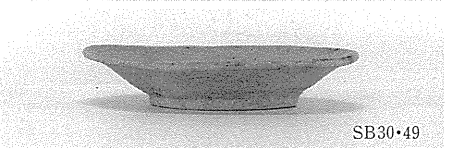
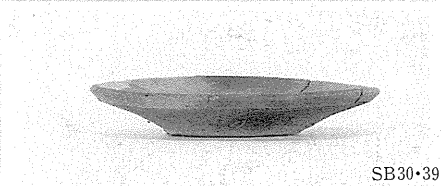
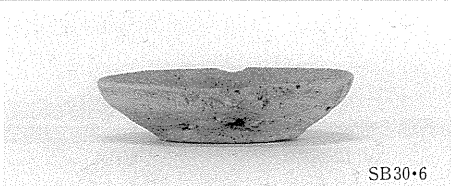
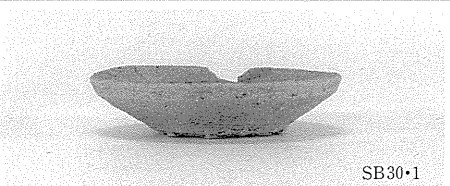
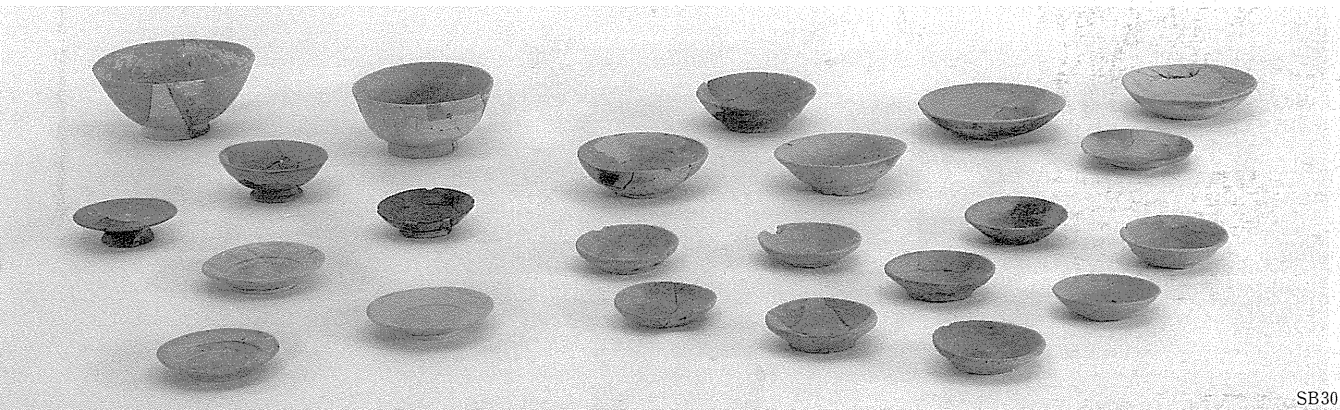
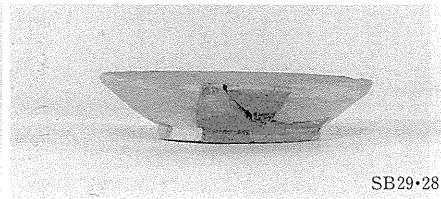
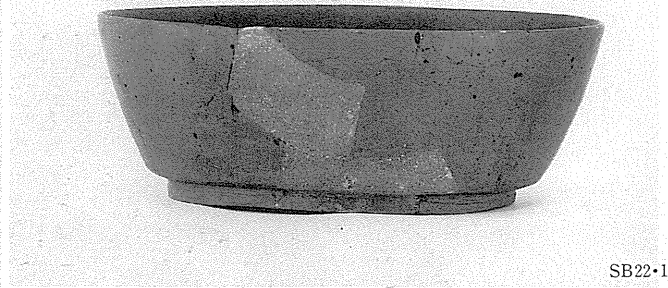
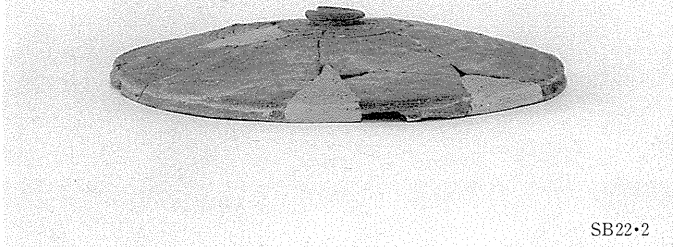

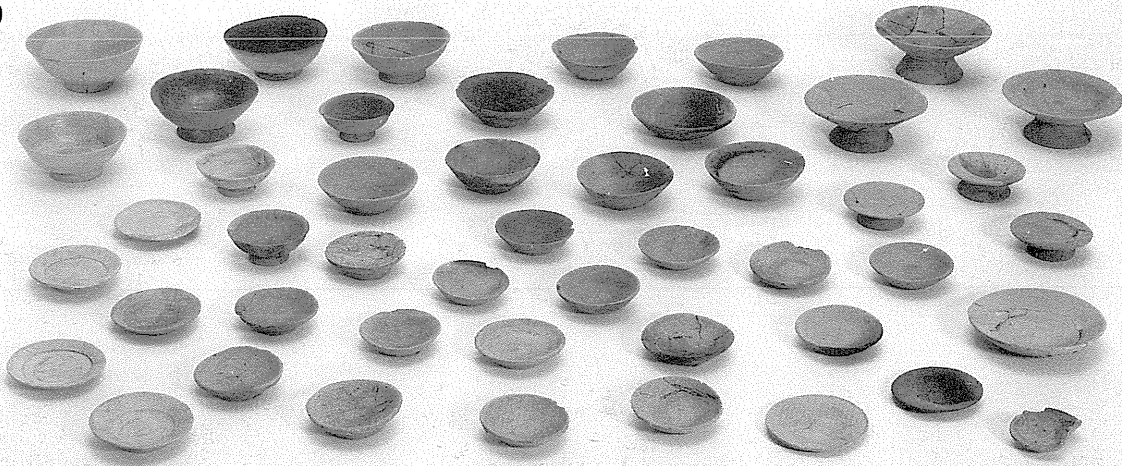

SB 32



SB32・9



SB32・5



SB32・25



SB32・42

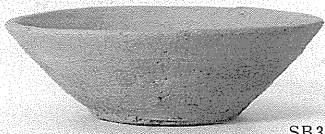

SB32・167



SB32・175



SB32・210

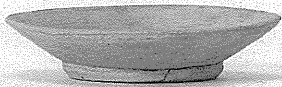

SB32・308



SB32・290



SB32・215

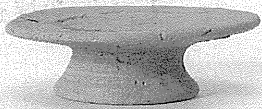

SB32・222

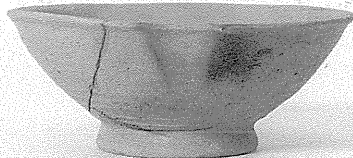

SB32・200



SB32・218



SB32・251

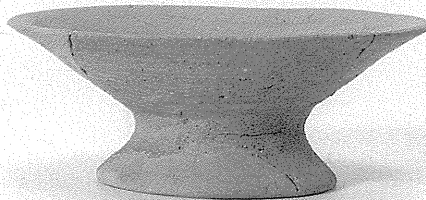

SB32・230



SB32・261



SB33・1

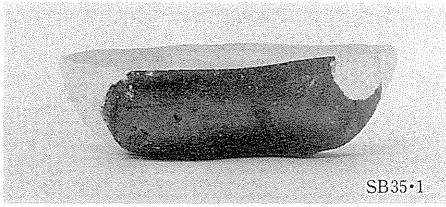

SB35-1



SB37-10

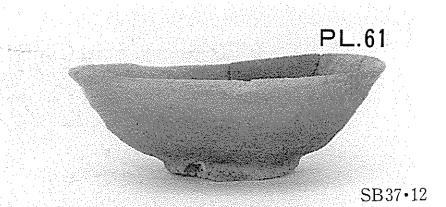

SB37-12



SB37-1



SB37-2



SB37-3



SB37-15



SB37-16



SB37-22

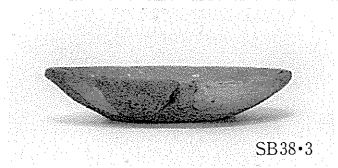

SB38-3



SB38-4

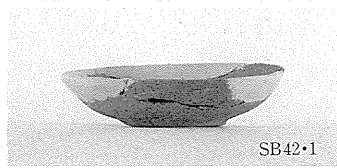

SB42-1

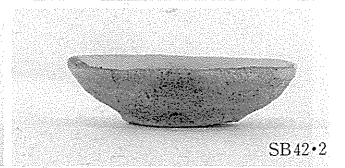

SB42-2



SB38-6



SB42-7



SB43-2



SB43-4



SB43-5

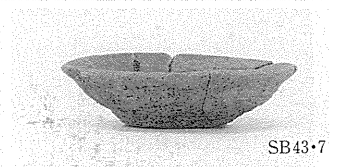

SB43-7



SB43-22



SB43-23



SB43-28



SB43-32



SB43-30

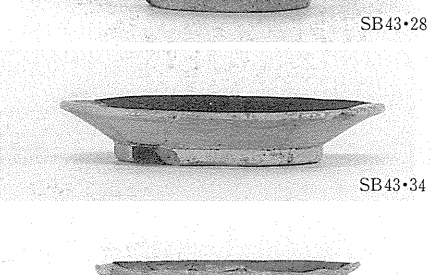

SB43-34

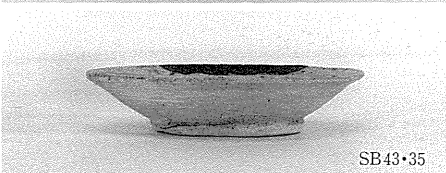

SB43-35



SB44-2

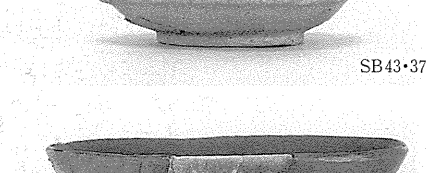

SB43-37



SB43-36

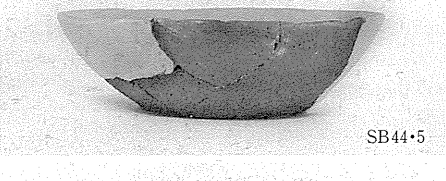

SB44-5



SB44-14



SB45-1



SB45-3



SB45-4



SB45-7



SB45-8

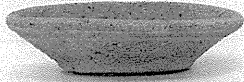

SB47-1

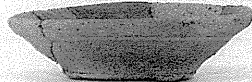

SB47-3



SB47-4



SB47-7



SB47-8

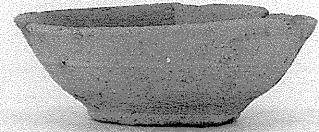

SB47-10

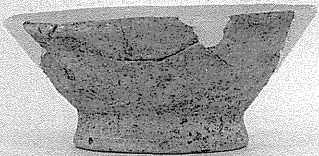

SB48-2

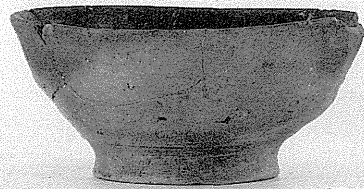

SB48-3

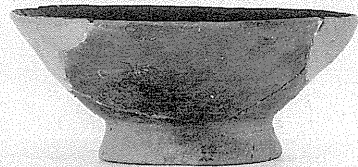

SB48-4



SB48-7



SB48-8

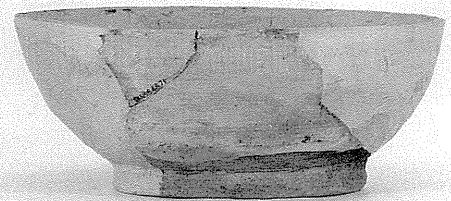

SB48-9



SB48-12



SB48-13



SB48-15

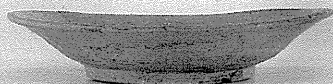

SB48-16



SB49-1



SB48-19

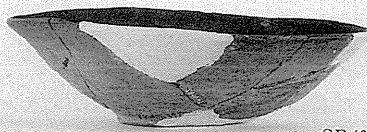

SB49-4



SB49-10



SB49-16



SB49・15



SB50・

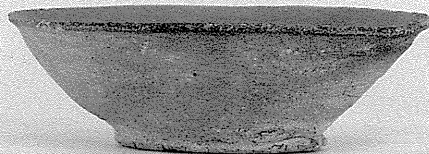

SB51・

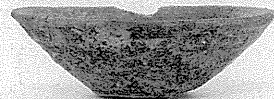

SB52・



SB52・



SB52・15

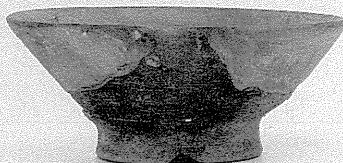

SB52・14

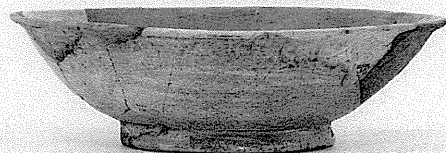

SB55・



SB52・20



SB52・22



SB55・



SB55・6



SB55・5



SB58・



SB58・1



SB58・9



SB58・1

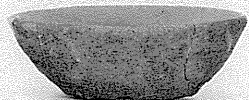

SB58・6



SB58・14



SB58・1



SB58・10



SB58・19



SB59・

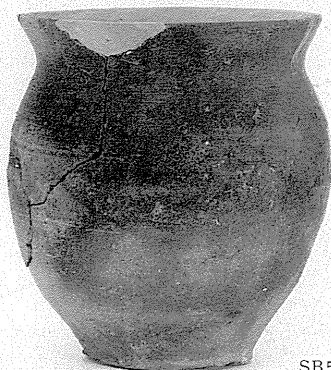

SB58・20



SB59・2



SB59・



SB59・4

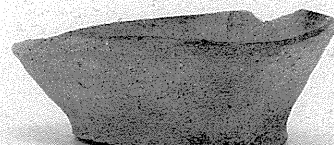

SB59・

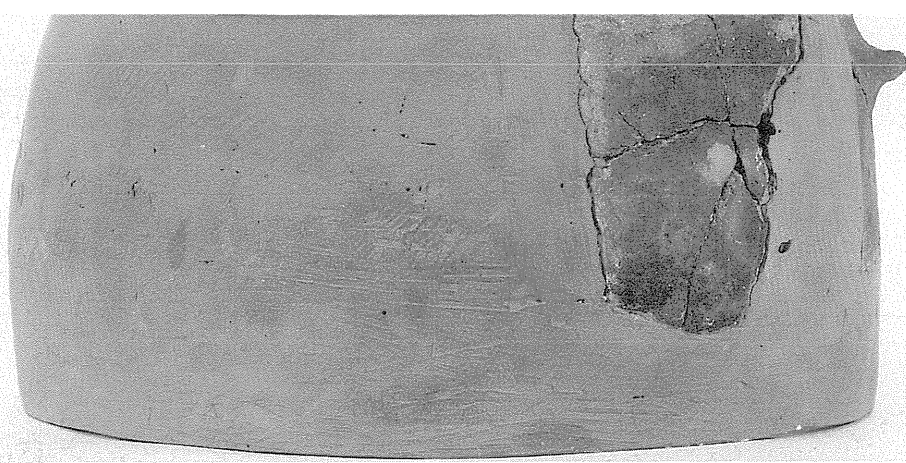

SB59-13

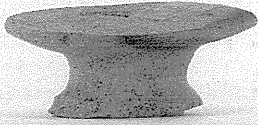

SB59-6

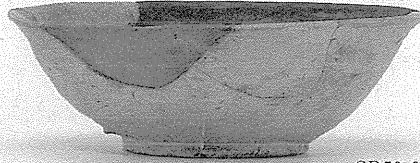

SB59-9

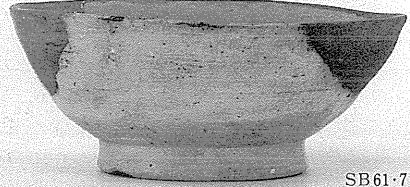

SB61-7



SB61-3



SB61-13

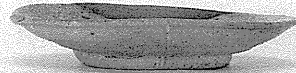

SB61-11

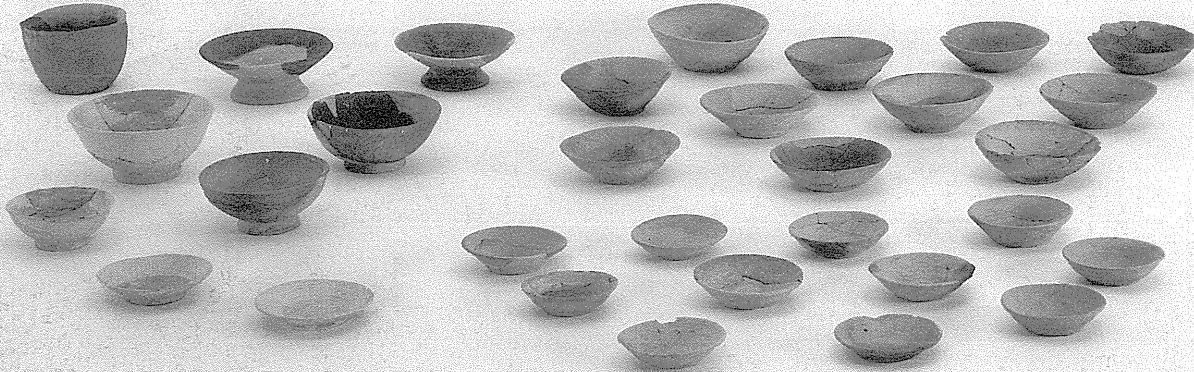

SB63



SB63-11

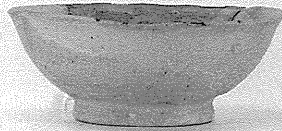

SB63-43



SB63-38



SB63-6



SB63-41



SB63-47

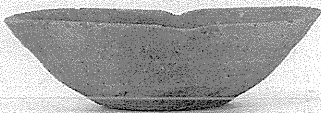

SB63-28



SB63-46



SB63-29



SB66-23



SB66-29



SB64-9



SB66-37

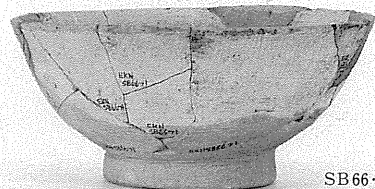

SB66-31

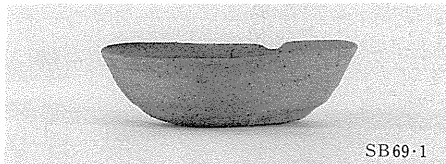

SB69-1

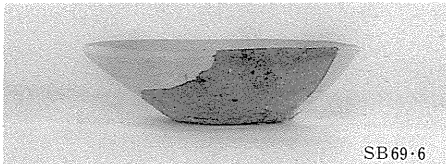

SB69-6

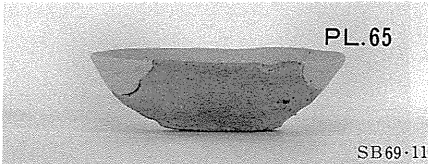

SB69-11

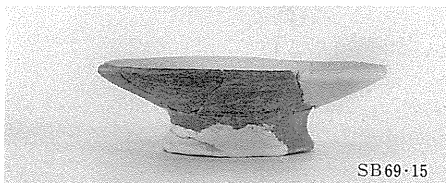

SB69-15



SB69-29



SB69-30

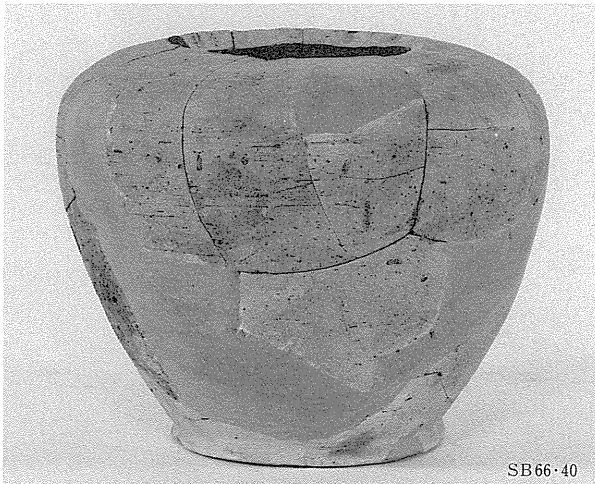

SB66-40

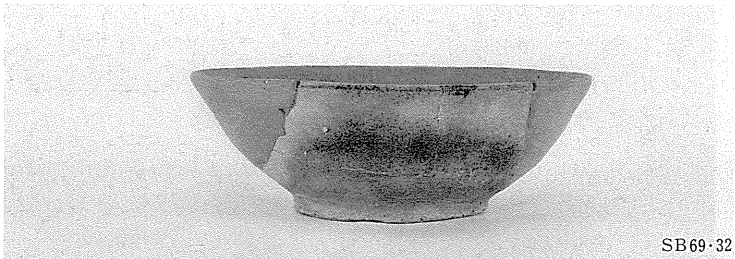

SB69-32



SB71-1



SB71-2



SB66-39

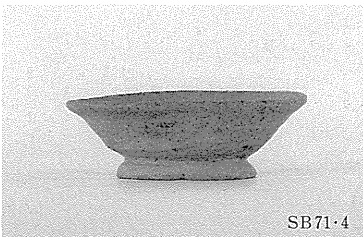

SB71-4



SB71-6



SB72-1



SB72-5



SB72-2



SB72-6



SB72-8

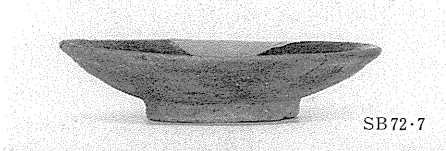

SB72-7



SB72-11



SB73-1



SB73-2

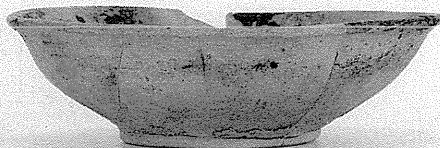

SB73-11



SB73-6

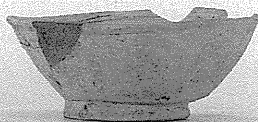

SB73-10

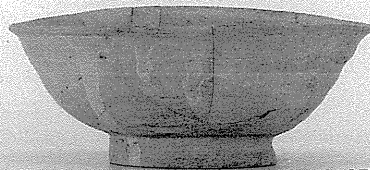

SB73-7



SB74-2



SB74-3



SB74-4



SB74-5



SB74-7



SB74-15



SB74-16



SB74-8



SB74-19



SB74-20



SB74-26



SB74-21



SB74-22



SB74-28

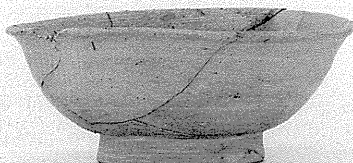

SB74-30



SB74-32



SB74-33

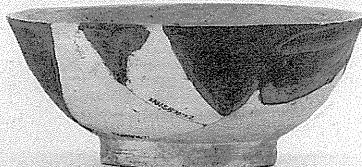

SB74-34



SB74-35



SB74-40



SB74-43



SB76-1



SB74-47



SB75-2



SB76-6



SB75-3



SB76-5



SB76-11



SB77-



SB77-

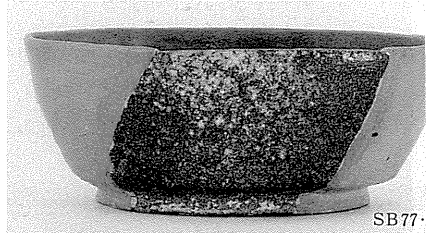

SB77-

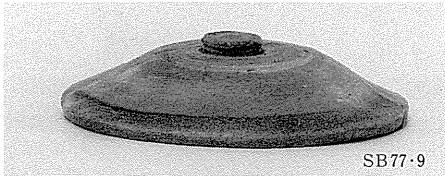

SB77-9

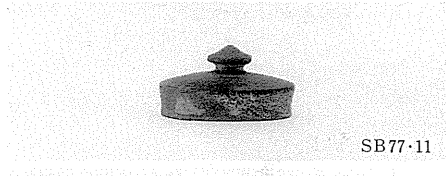

SB77-11



SB77-

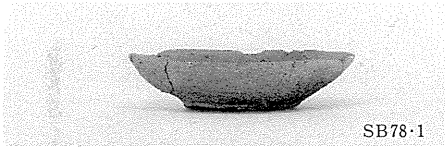

SB78-1

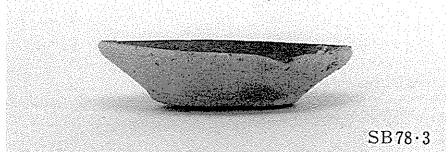

SB78-3

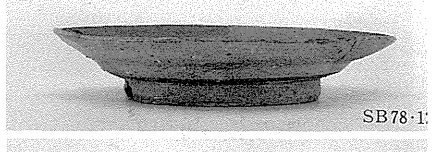

SB78-11

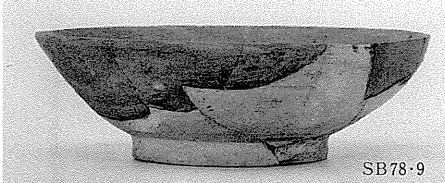

SB78-9



SB78-8



SB79-

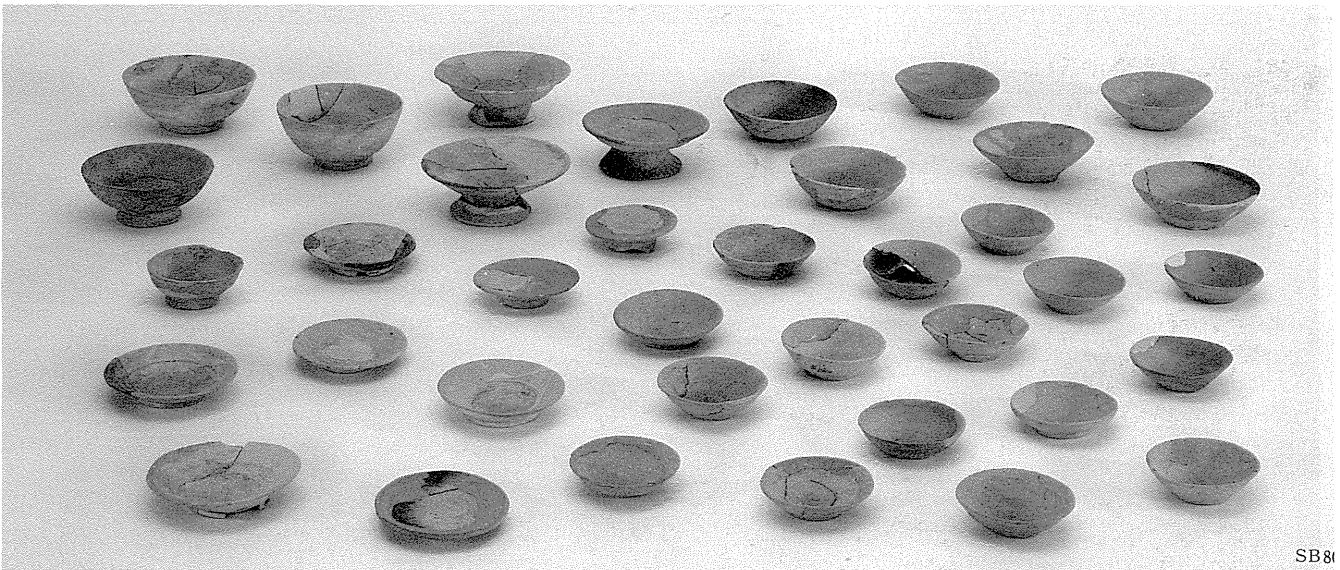

SB80

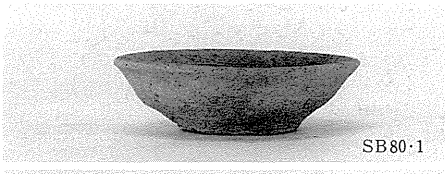

SB80-1

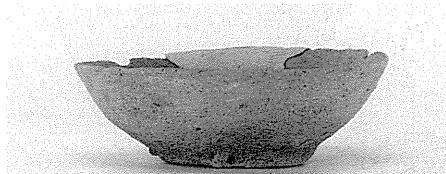

SB80-53

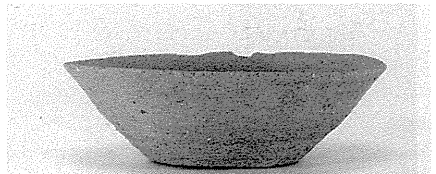

SB80-58

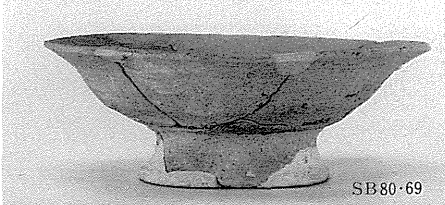

SB80-69



SB80-80



SB80-82



SB81-1



SB81-2



SB81-6



SB81-23



SB81-21



SB81-22

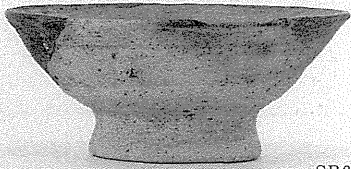

SB81-24

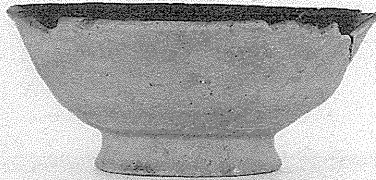

SB81-31



SB81-32



SB83-2



SB83-1

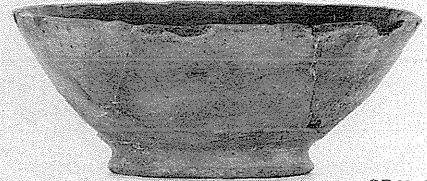

SB83-6



SB83-5

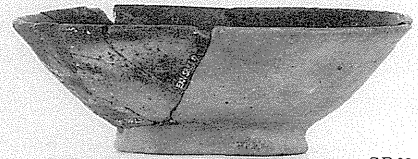

SB83-7



SB83-9

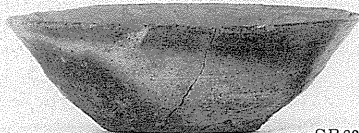

SB83-11



SB83-13

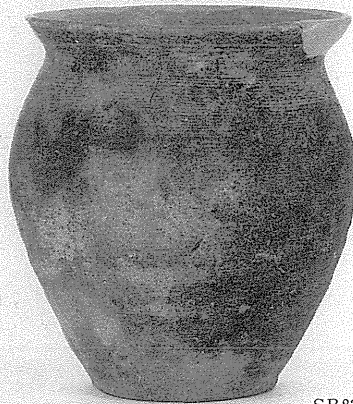

SB83-15



SB83-12



SB84-10

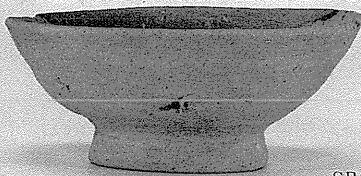

SB84-24



SB84-6



SB84-20

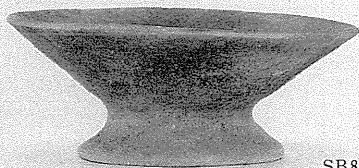

SB84-30

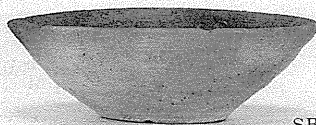

SB84-22



SB84-37



SB84-34

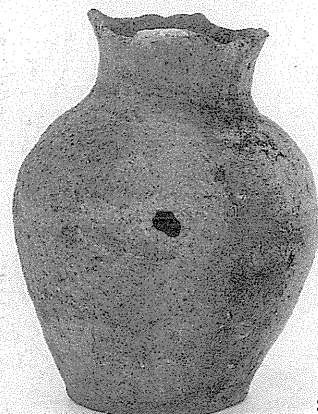

SB84-39

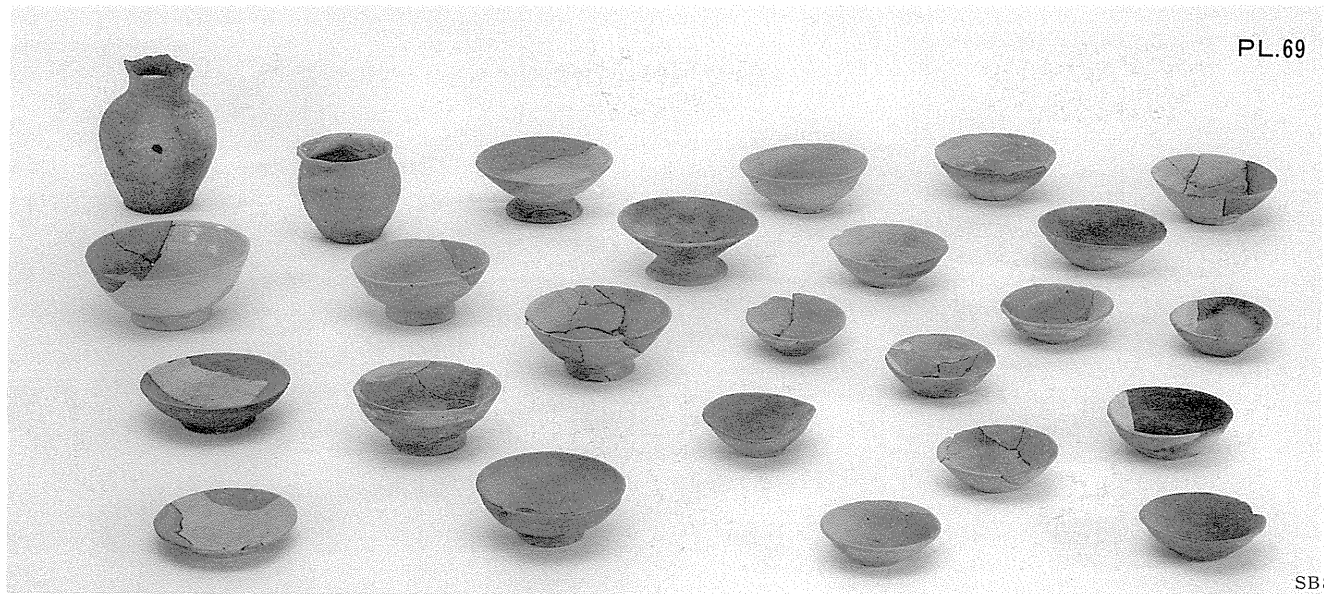

SB8



SB85-1



SB85-2



SB85-3

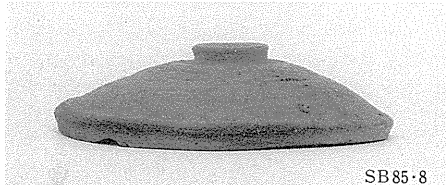

SB85-8

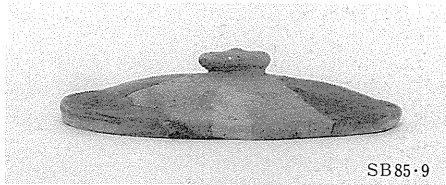

SB85-9

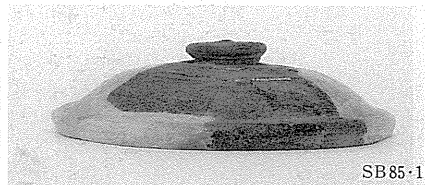

SB85-10



SB86-2



SB86-1



SB86-11



SB87-2

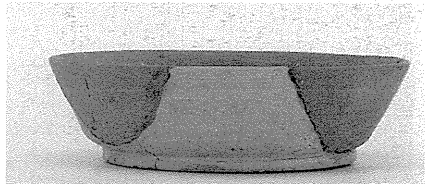

SB87-1



SB86-18

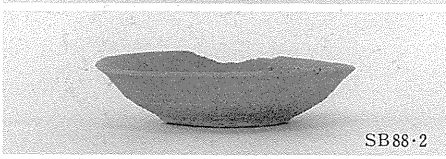

SB88-2



SB88-17

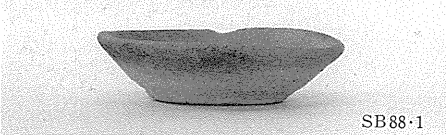

SB88-1



SB88-9

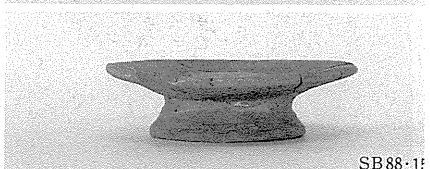

SB88-18



SB88-8



SB88-11



SB88-16



SB88-21



SB88-12



SB88-15

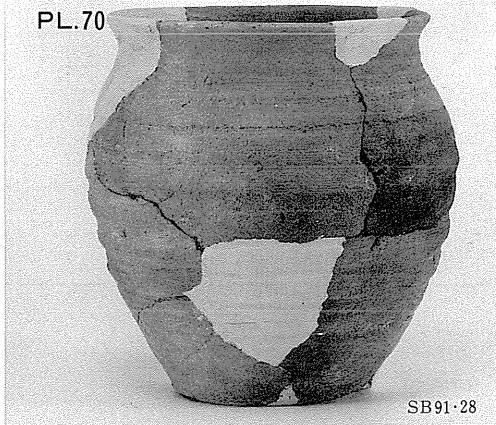

SB91-28

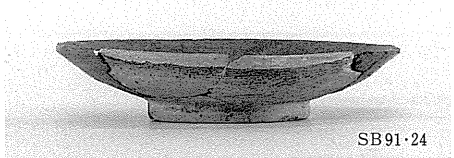

SB91-24

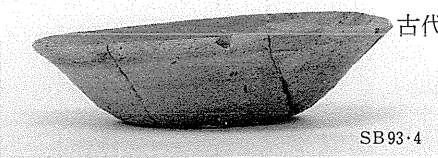

SB93-4

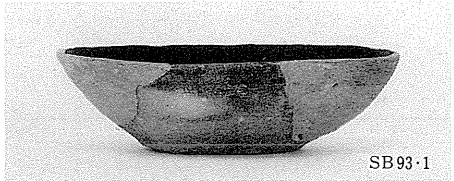

SB93-1



SB93-3



SB94-30

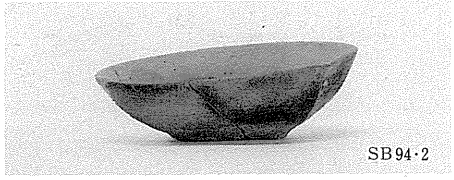

SB94-2



SB94-1



SB94-9



SB94-10



SB94-31



SB94-11



SB94-12



SB94-23

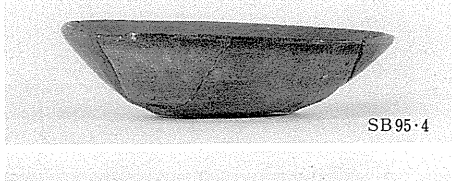

SB95-4



SB95-3

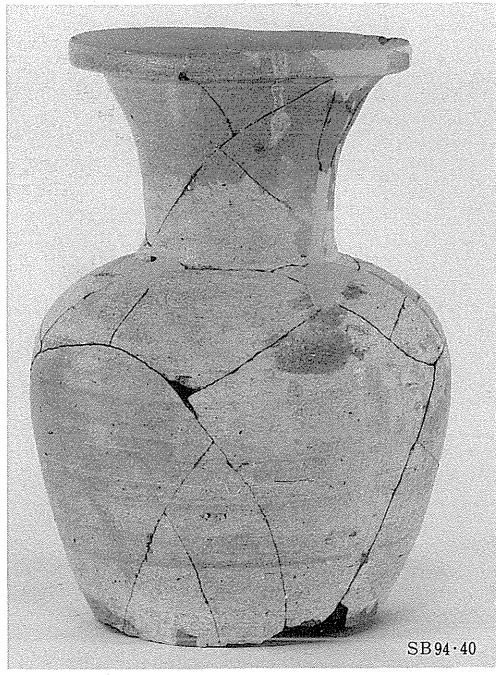

SB94-40

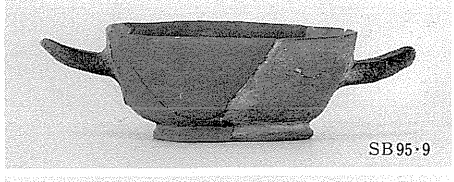

SB95-9



SB100-1

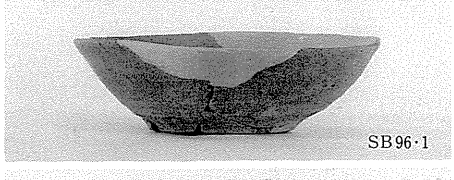

SB96-1

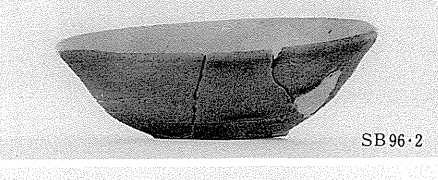

SB96-2



SB96-3



SB97-1

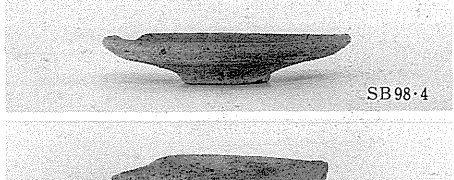

SB98-4



SB98-2

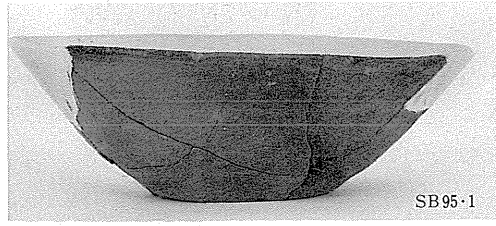

SB95-1



SB99-1



SB99-47

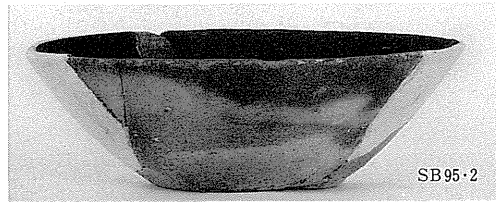

SB95-2



SB99-11



SB99-58



SB99-6

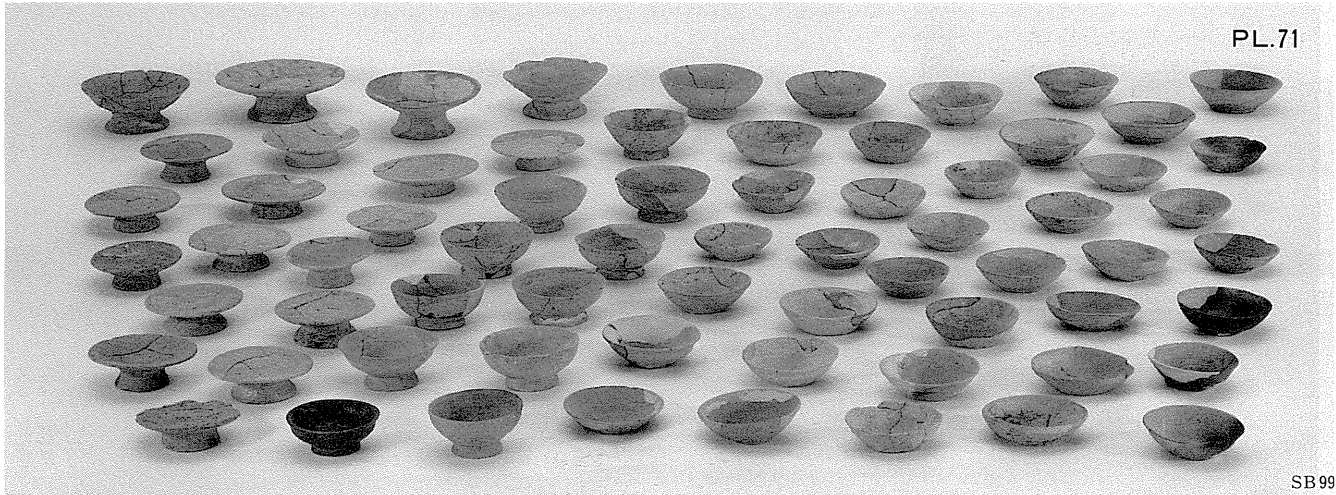

SB99



SB99-63

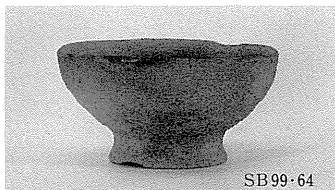

SB99-64



SB99-91



SB99-72



SB99-65



SB99-66



SB99-85

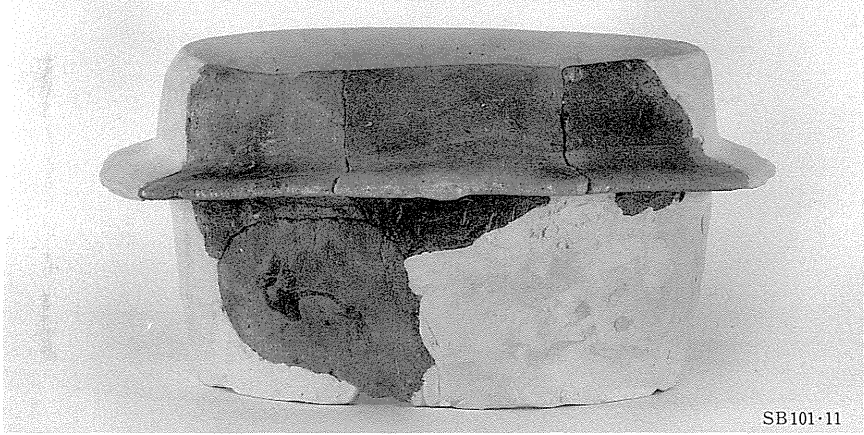

SB101-11

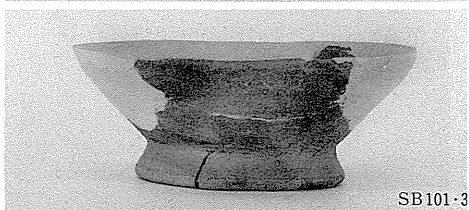

SB101-3



SB102-2



SB101-12

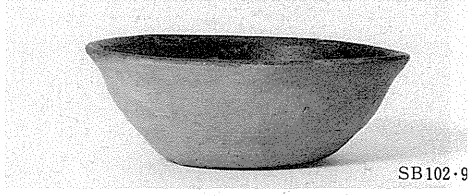

SB102-9

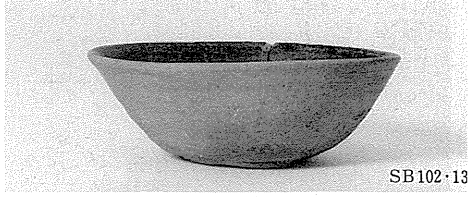

SB102-13

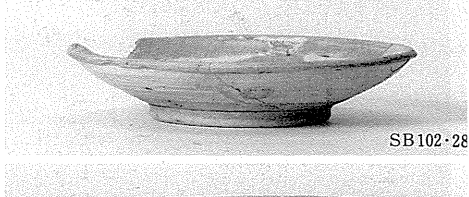

SB102-28

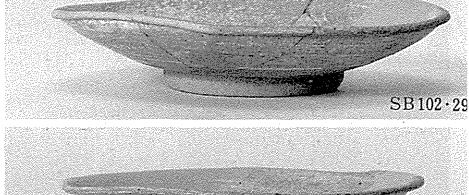

SB102-29

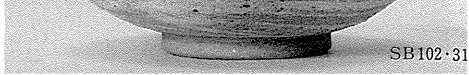

SB102-31



SB103-1



SB103-2



SB103-13



SB103-14



SB103-8

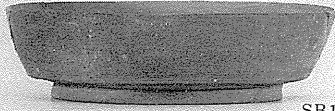

SB105-1



SB105-2



SB103-17



SB107-1



SB108-1



SB108-7



SB108-3



SB108-5



SB108-6

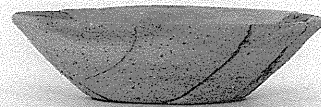

SB109-1



SB109-7

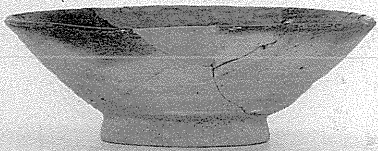

SB110-6

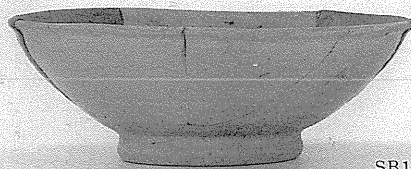

SB110-9



SB109-2



SB110-10

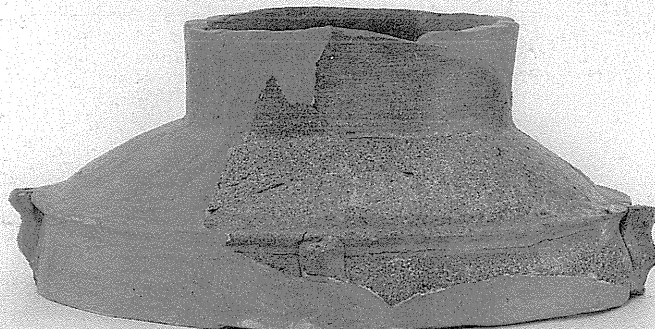

SB114-22



SB111-2



SB111-5



SB111-2



SB111-25



SB111-58



SB111-61



SB111-31



SB111-30



SB111-33



SB111-34



SB111-78

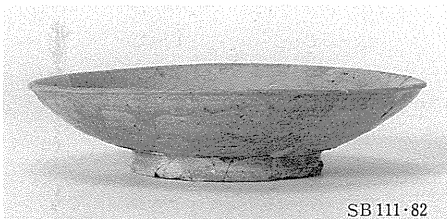

SB111-82



SB111-83



SB111-84



SB114-11



SB114-21

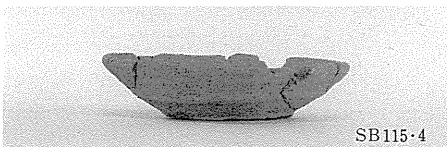

SB115-4

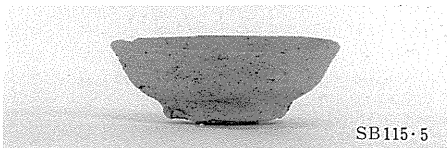

SB115-5

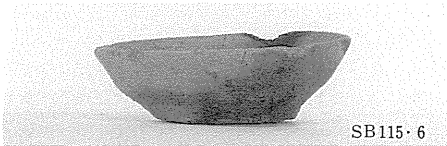

SB115-6



SB115-21

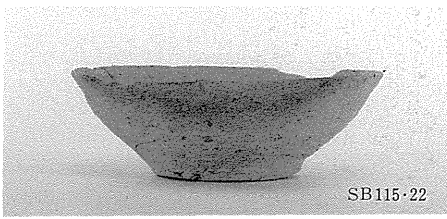

SB115-22



SB116-17



SB115-30

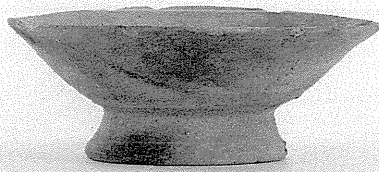

SB115-32

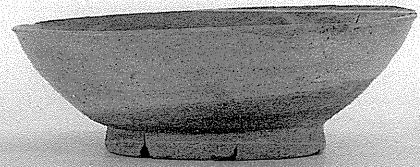

SB116-10

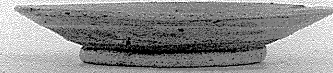

SB115-37



SB115-38



SB116-13



SB116-14



SB118-1



SB118-2



SB118-5



SB118-7

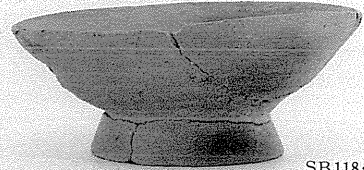

SB118-10



SB118-9



SB118-13



SB120-5



SB118-15



SB120-21



SB122-1



SB122-4



SB124-1



SB124-2



SB124-6



SB124-10

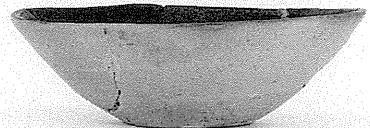

SB125-3



SB124-17

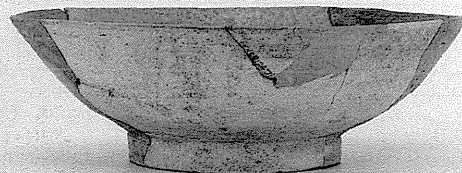

SB124-12

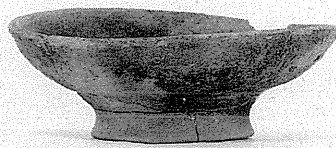

SB125-2

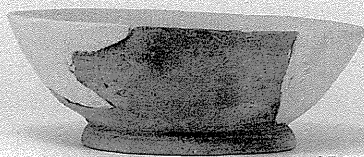

SB127-2



SB127-5



SB128-1



SB128・3



SB129・6

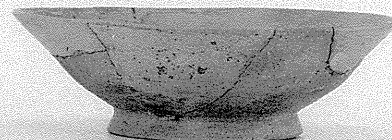

SB129・7

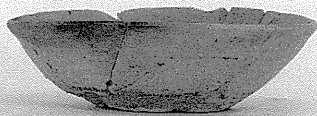

SB129・1

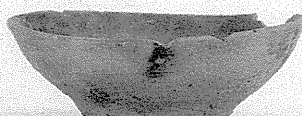

SB129・2

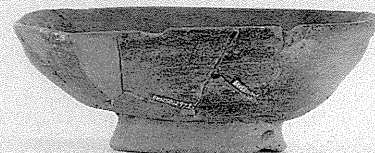

SB129・11



SB132・1



SB132・3



SB132・10



SB132・12

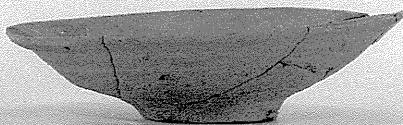

SB132・11



SB134・1

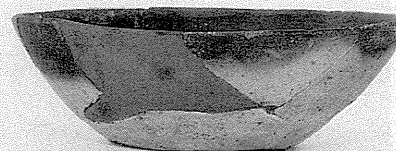

SB135・3



SB137・1



SB135・4



SB135・7



SB137・3



SB139・8

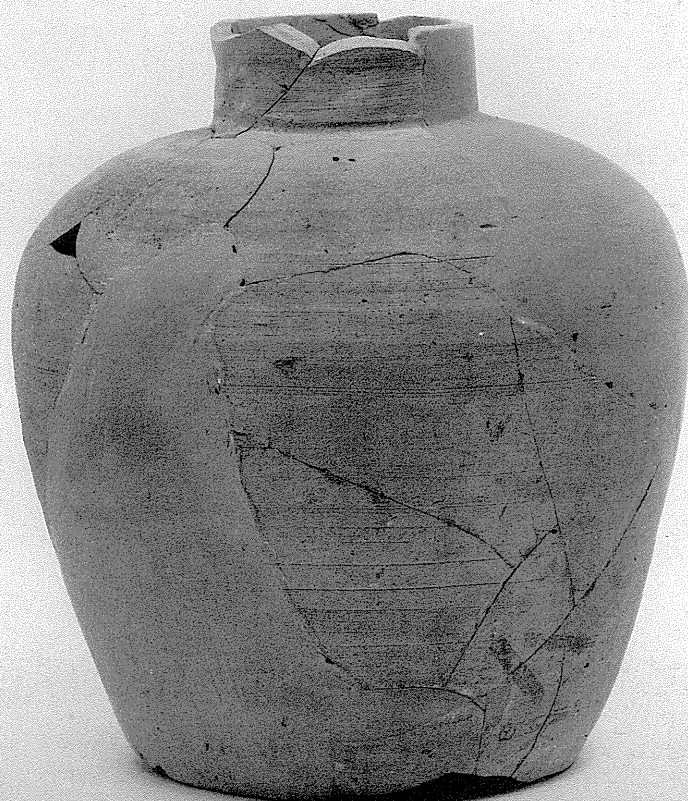

SB140・18



SB139・9



SB140・1



SB140・2



SB140・3



SB140・7



SB141



SB141-10



SB141-17



SB141-18



SB143-31



SB141-24



SB142-1

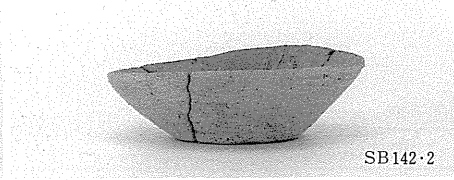

SB142-2



SB141-20



SB142-20



SB142-21



SB144-6



SB144-7



SB144-1



SB144-3

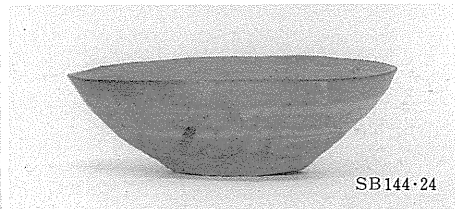

SB144-24

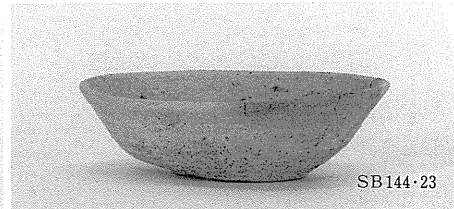

SB144-23

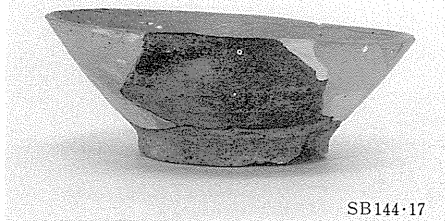

SB144-17



SB144-18



SB144-16



SB145-1

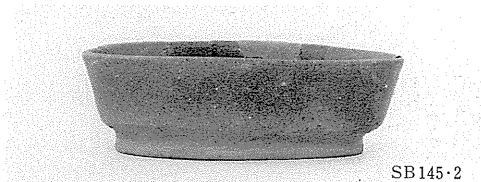

SB145-2



SB150-4



SB156-6

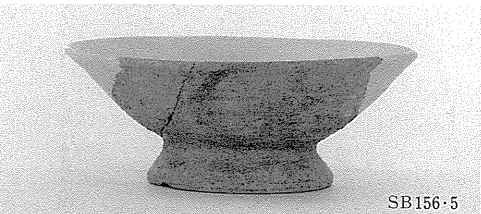

SB156-5



SB144-25



SB150-8



SB150-7

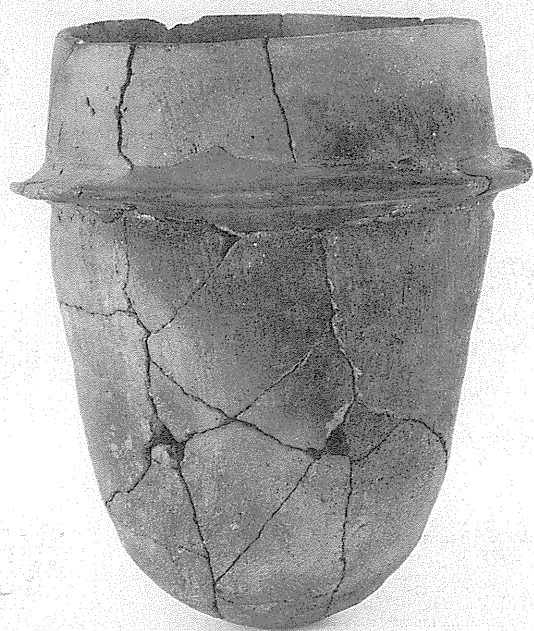

SB156-8



SB154-1

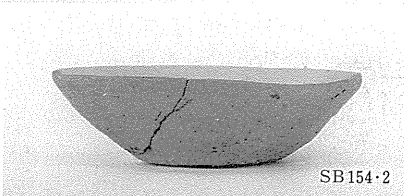

SB154-2

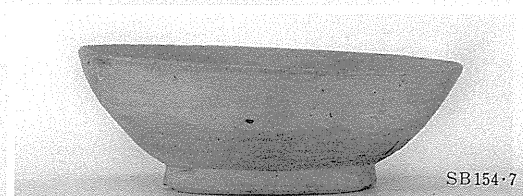

SB154-7

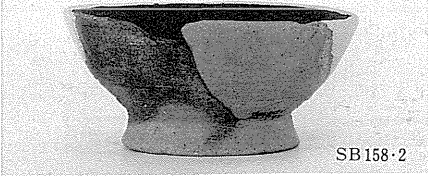

SB158-2

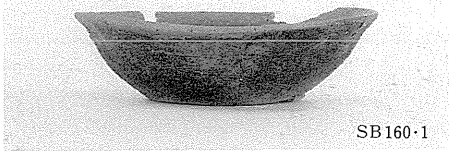

SB160-1



SB160-17



SB160-3

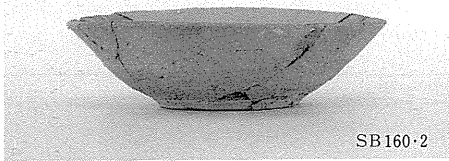

SB160-2



SB161-2

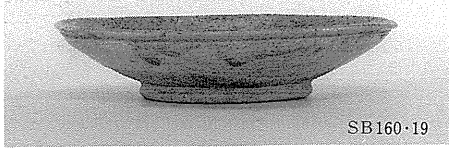

SB160-19

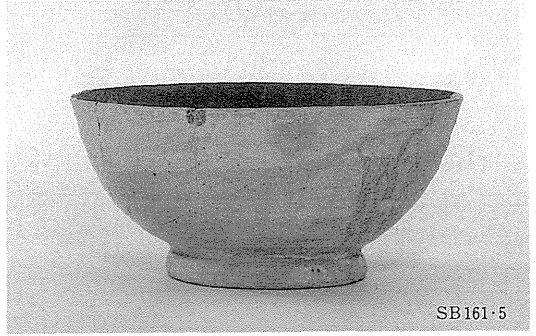

SB161-5

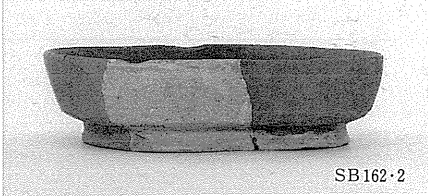

SB162-2



SB162-1

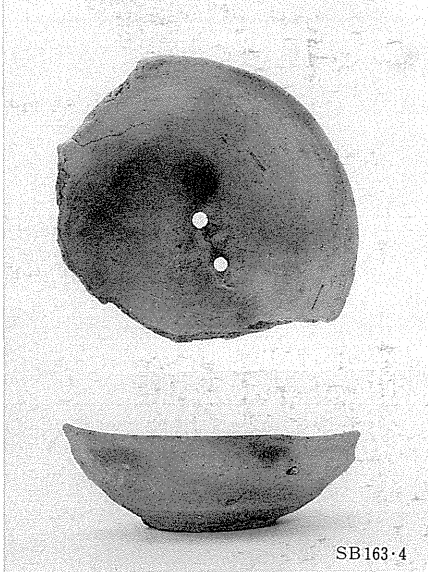

SB163-4

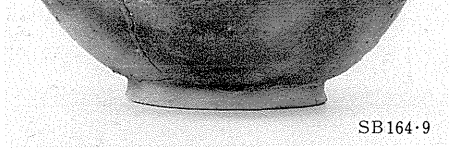

SB164-9



SB164-1



SB166-10

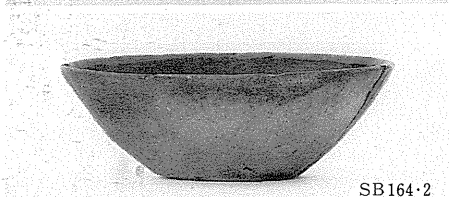

SB164-2

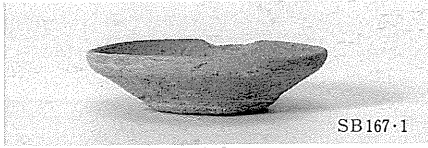

SB167-1

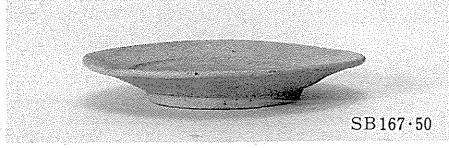

SB167-50

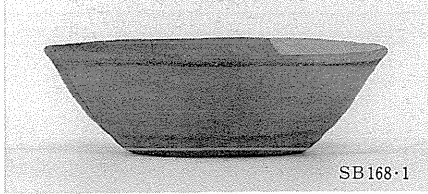

SB168-1

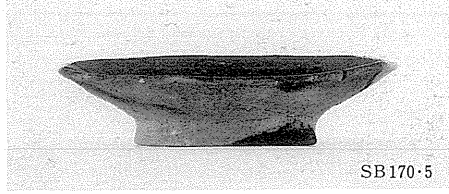

SB170-5



SB172-9



SB172-4

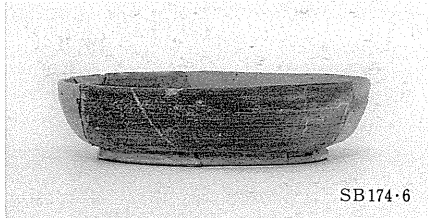

SB174-6

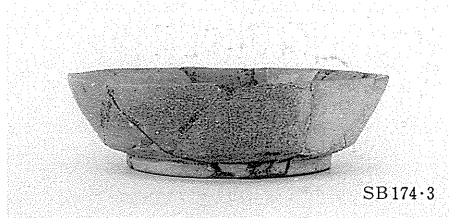

SB174-3



SB170-10

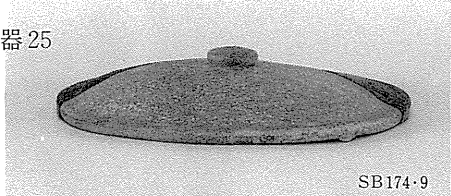

SB174-9



SB174-4

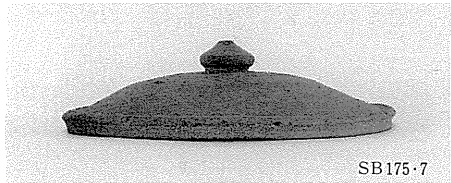

SB175-7



SB178-4

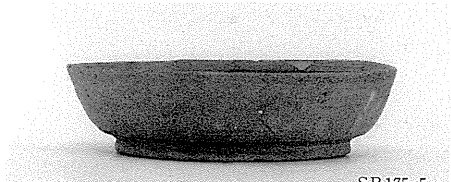

SB175-5

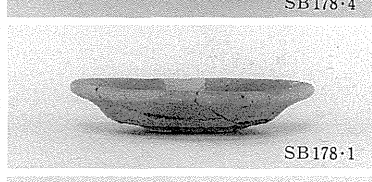

SB178-1



SB175-2

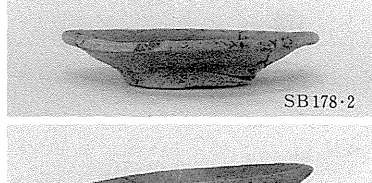

SB178-2

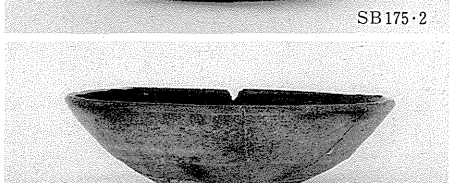

SB181-3

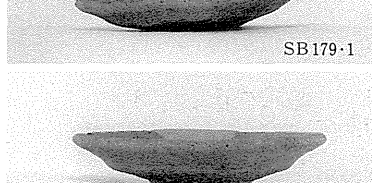

SB179-1



SB183-1

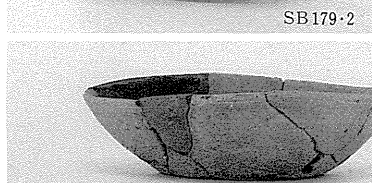

SB179-2

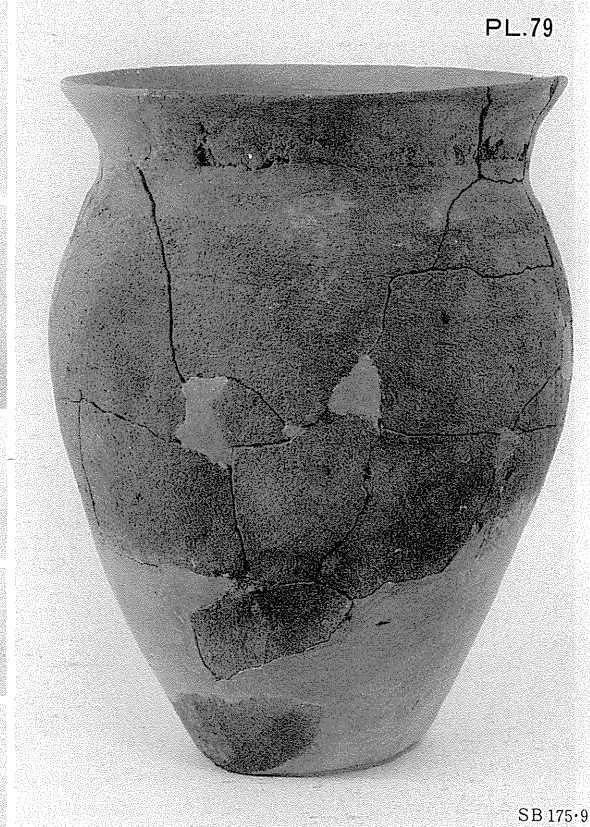

SB175-9



SB179-6



SB183-11



SB183-9



SB183-10

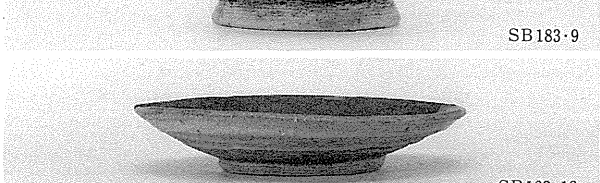

SB183-12



SB184-4



SB184-5

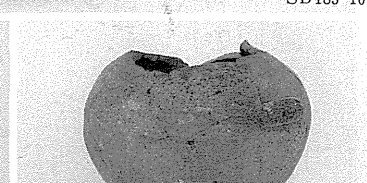

SB184-14



SB185-2



SB185-1



SB186-10

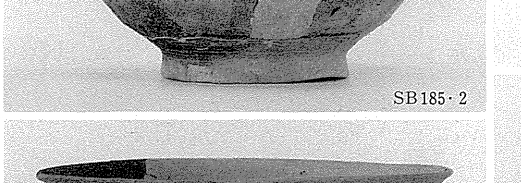

SB186-7

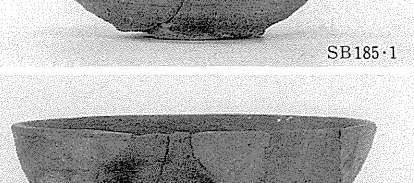

SB186-4



SB186-9



SB184·16



SB184·20



SB187·1

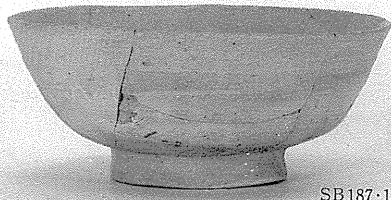

SB187·13

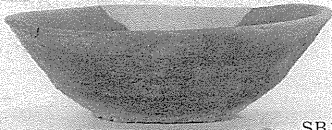

SB187·2



SB187·14

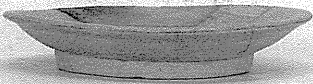

SB187·16

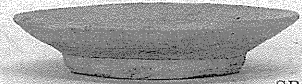

SB187·20



SB187·21

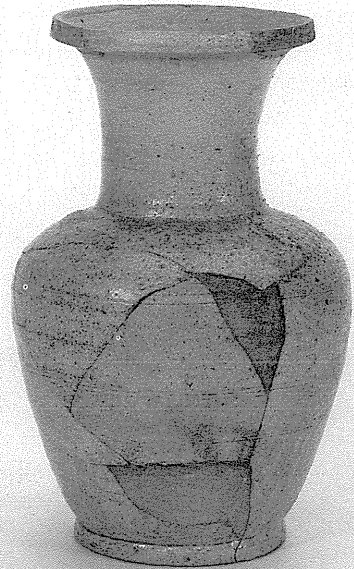

SB187·23



SB187·24

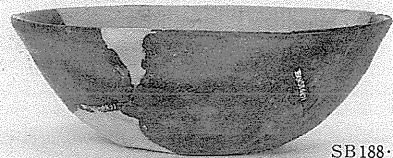

SB188·4

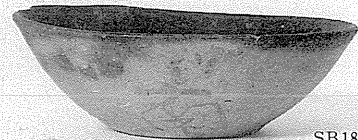

SB188·1

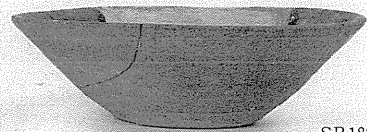

SB188·7



SB188·9

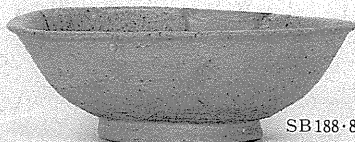

SB188·8

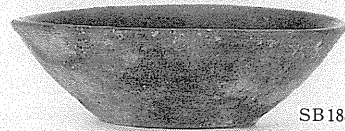

SB188·2



SB189-1



SB189-2



SB189-3

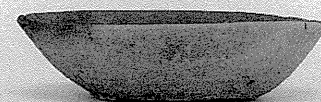

SB191-2



SB188-10



SB191-10



SB191-9



SB192-7



SB191-13

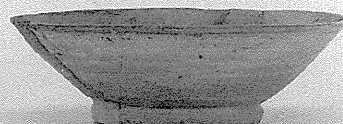

SB191-14



SB193-2



SB192-8



SB194-2

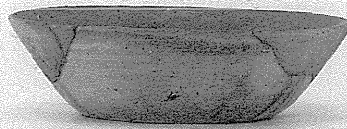

SB199-2

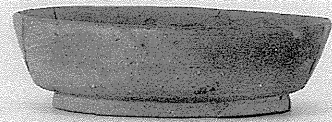

SB199-7



SB196-1

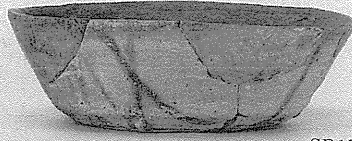

SB199-3



SB199-13

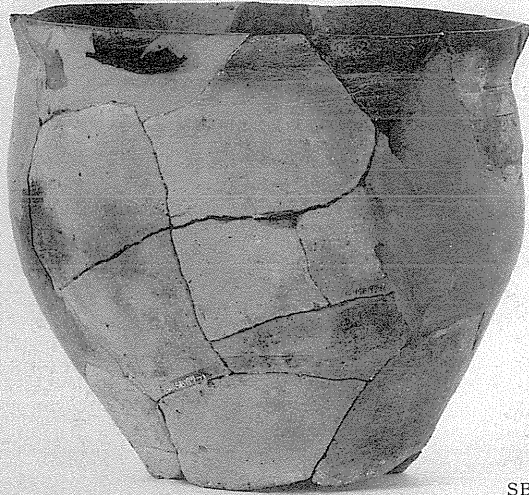

SB197-7

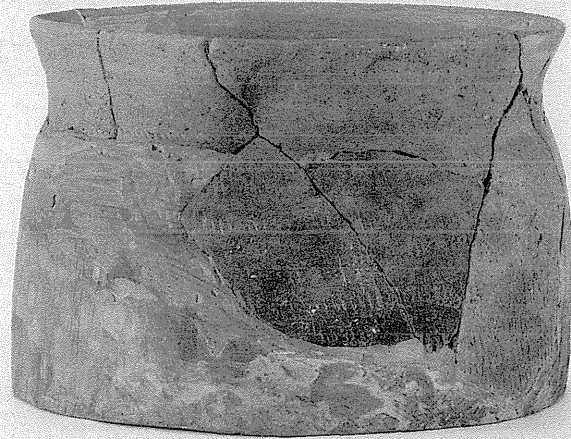

SB197-9



SB199-14



SB199-17



SB200-7

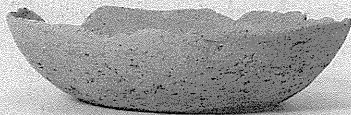

SB201-1

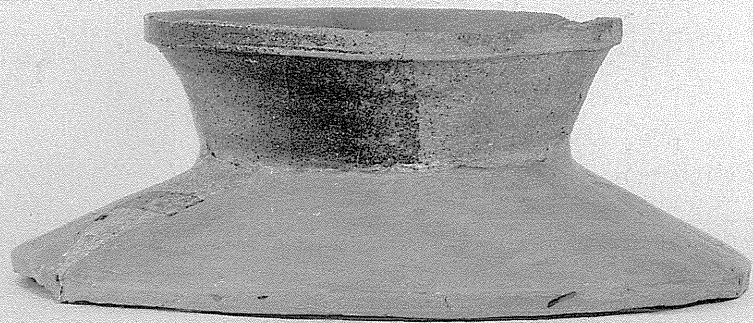

SB200-9



SB202-1



SB202-7

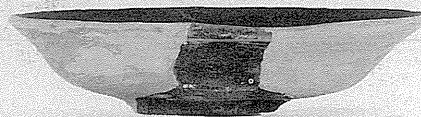

SB202-5



SB203-1



SB207-1



SB207-2

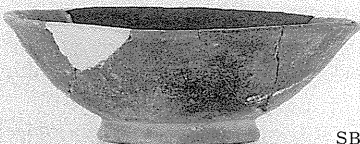

SB203-7

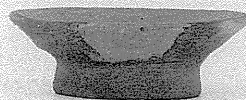

SB207-10



SB207-14



SB209-1



SB210-4

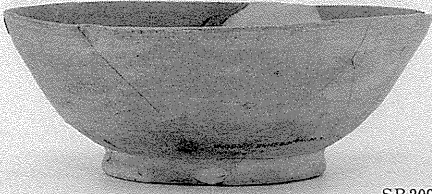

SB209-5



SB210-5

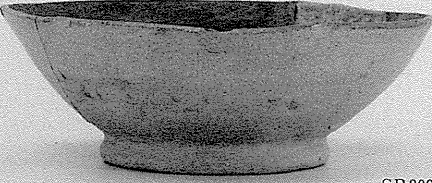

SB209-6

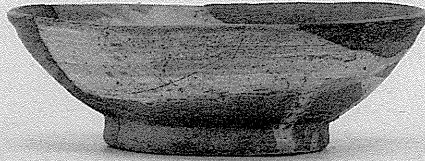

SB210-6

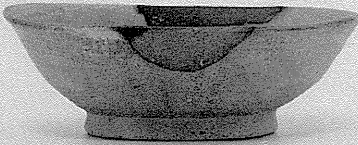

SB209-7



SB211-1

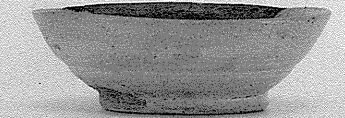

SB211-2



SB211-4

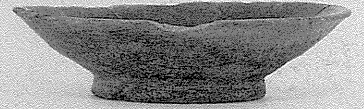

SB212-1



SB214-1



SB213-1



SB213-2

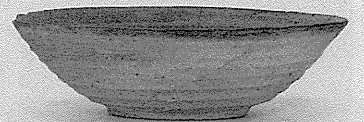

SB213-3



SB215-1

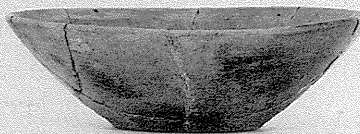

SB215-2



SB216-1



SB219-3



SB216-8

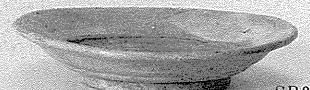

SB216-3



SB226・2

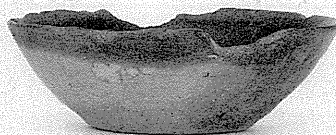

SB226・1

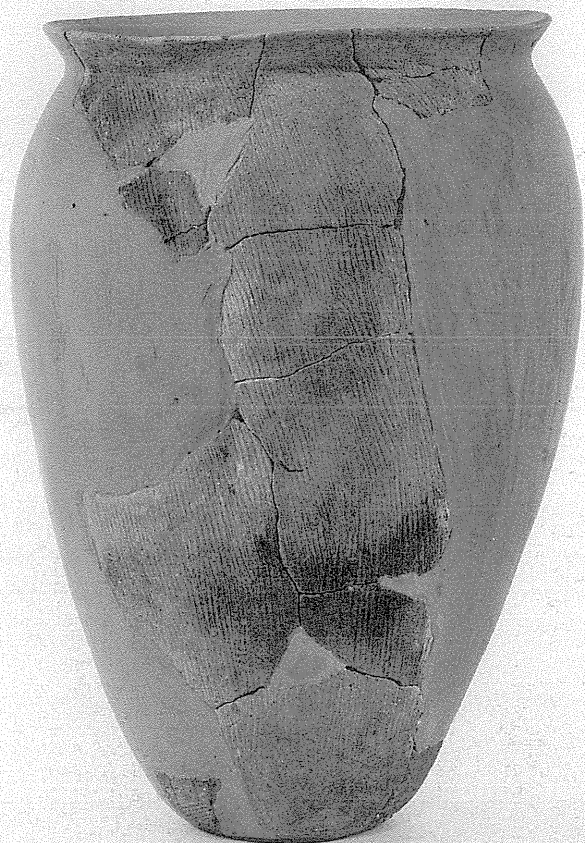

SB226・8

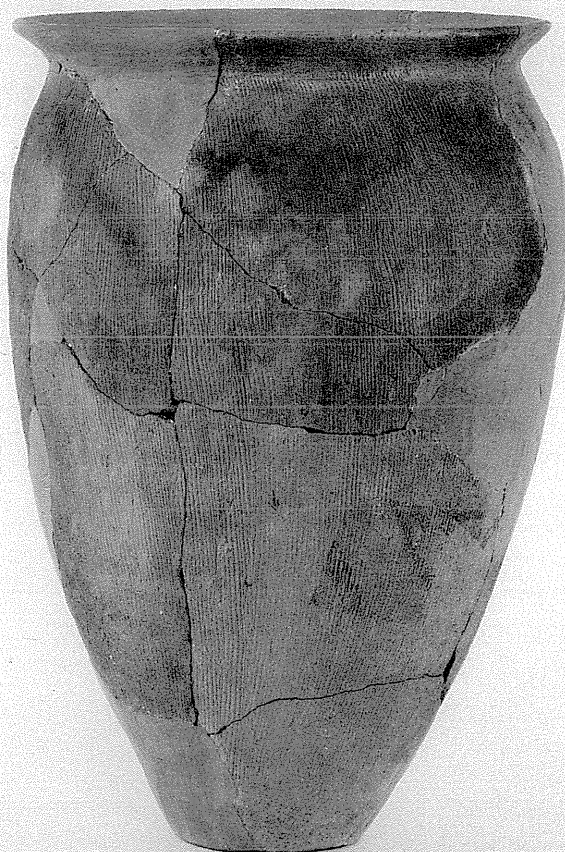

SB226・7

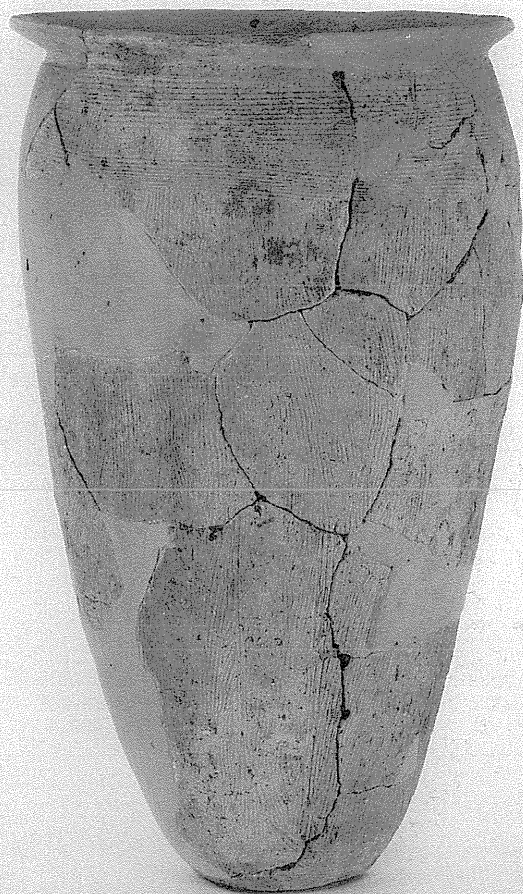

SB227・20



SB226・3



SB226・5



SB227・1

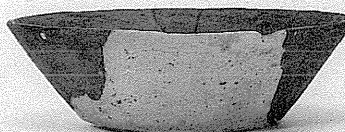

SB227・2



SB227・3

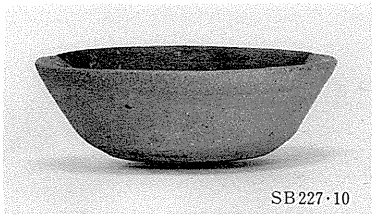

SB227・10

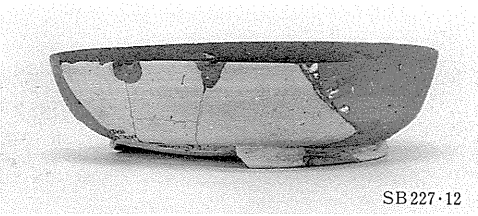

SB227・12

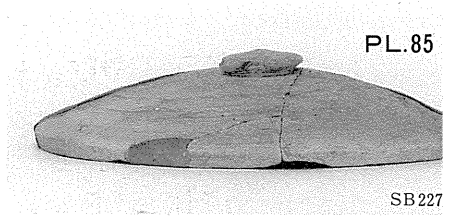

SB227



SB227・16



SB232・2

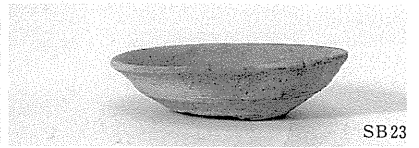

SB232

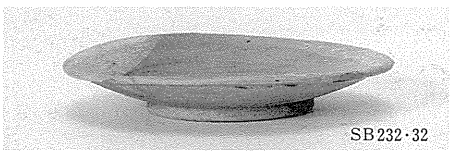

SB232・32

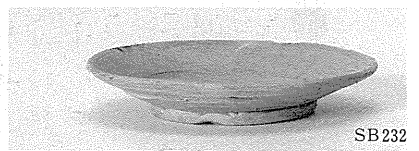

SB232



SB232・15



SB232

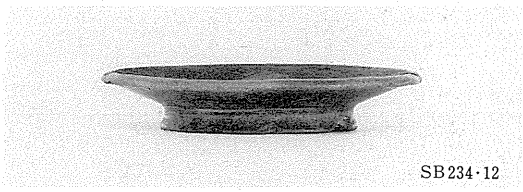

SB234・12



SB235・1



SB235・3



SB235・7



SB234

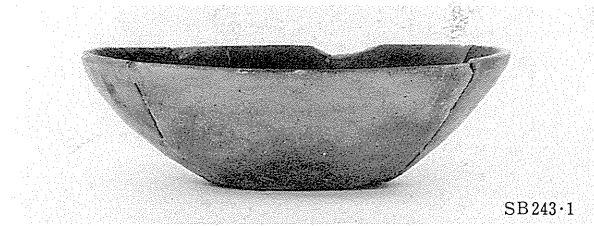

SB243・1



SB246・3



SB237-1



SB242-1



SB243-5

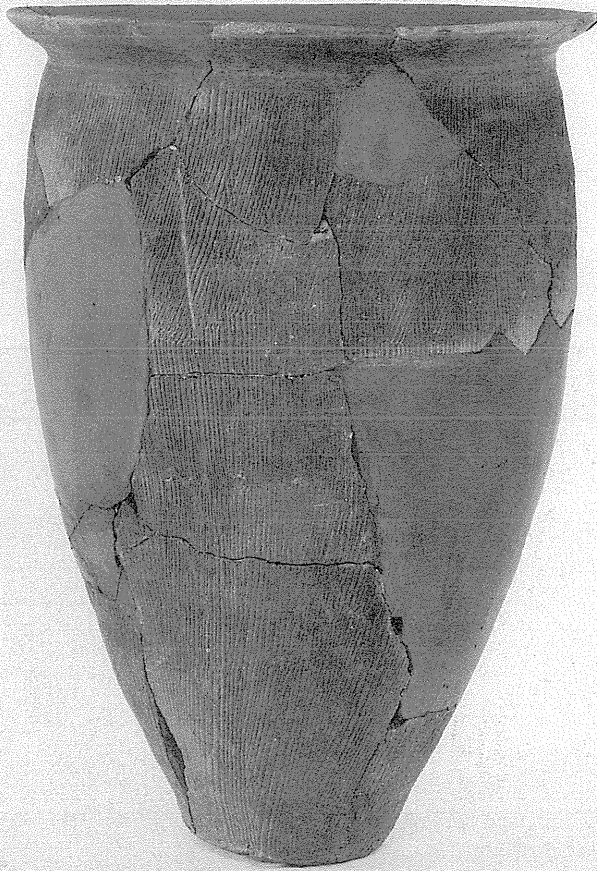

SB246-7



SB246-14



SB247-1

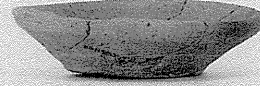

SB247-2



SB247-9



SB247-6



SB247-19

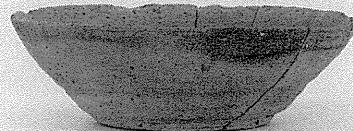

SB248-3



SB248-4



SB248-10



SB248-11



SB248-14

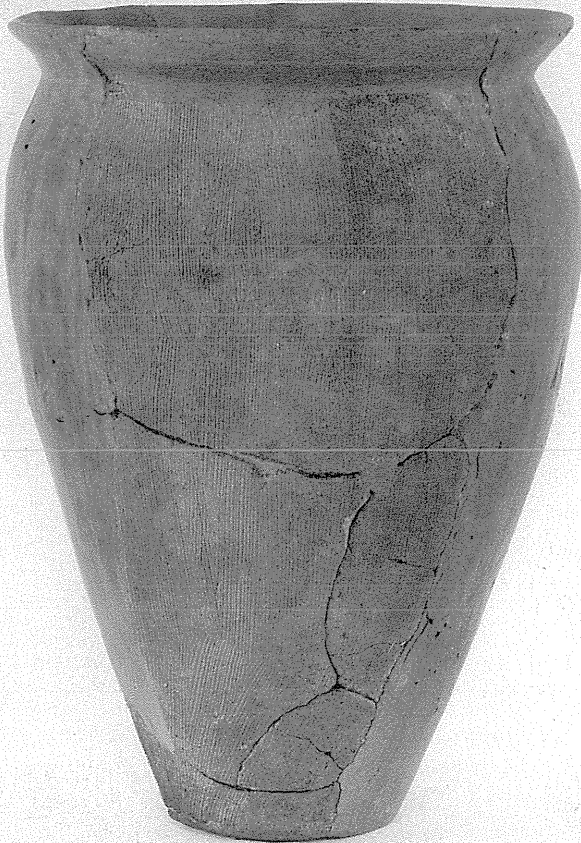

SB246-6



SB247-14

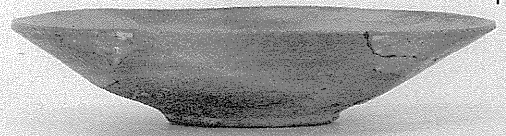

SB247-1



SB248-1

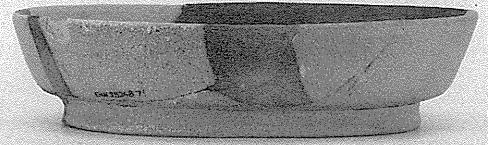

SB248-2



SB251-1



SB256-1



SB256-2



SB256-3

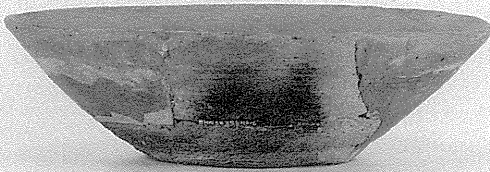

SB256-10



SB256-11

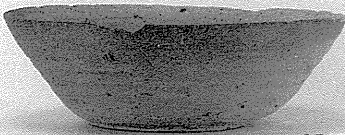

SB258-2



SB258-3

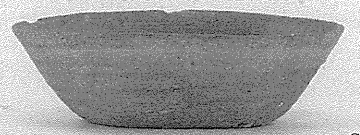

SB258-4



SB260-2

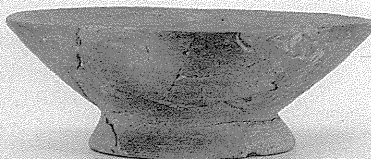

SB260-3

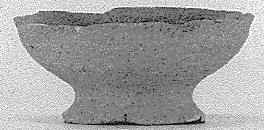

SB263-1



SB263-6



SB263-7

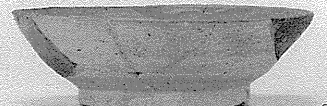

SB263-2



SB264-5



SB264-6



SB263-27



SB267-2

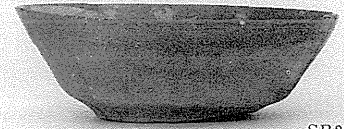

SB268-1



SB264-11

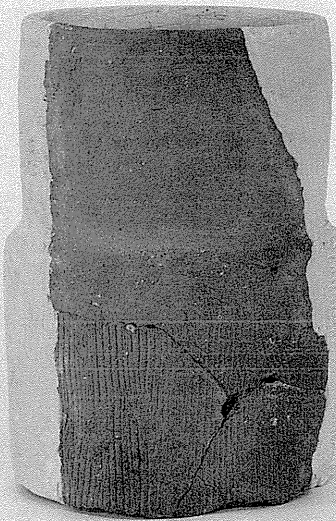

SB264-17

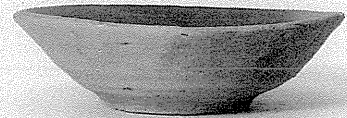

SK128-1

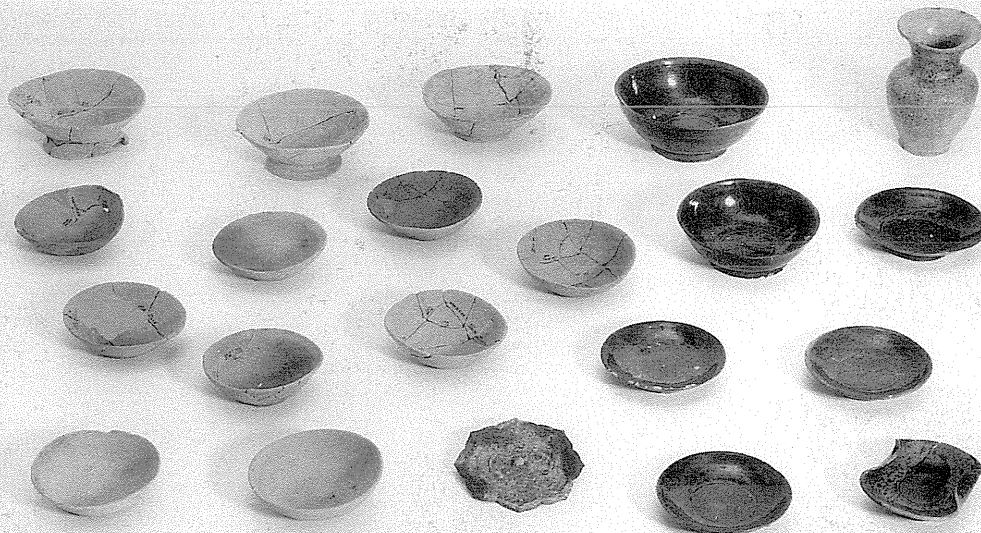

SK128

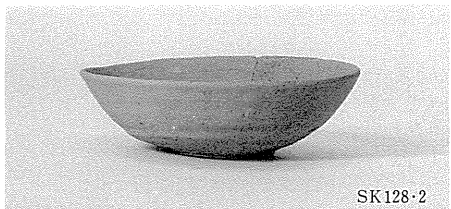

SK128-2



SK128-3



SK128-15



SK128-17

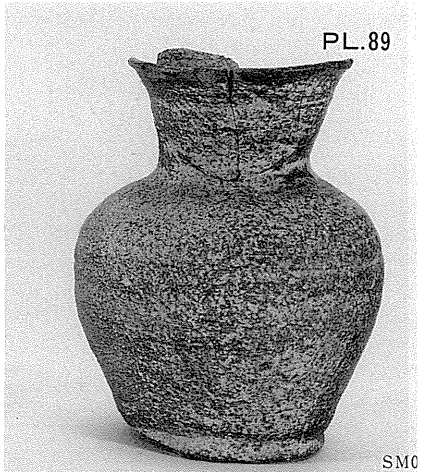

PL.89

SMO



SK34-1

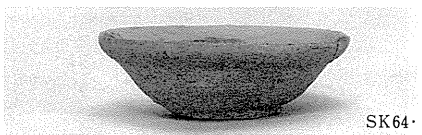

SK64-1



SK64-2



SK84-1

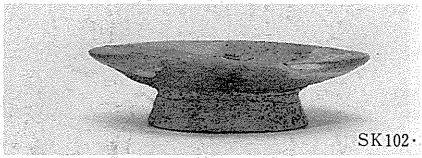

SK102-1



SK102-2



SK101-1



SK107-1



SK107-4



SK107-5



SK112-2



SK103-3

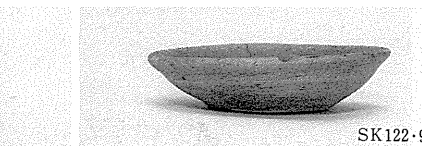

SK122-9



SK122-12



SK122-10

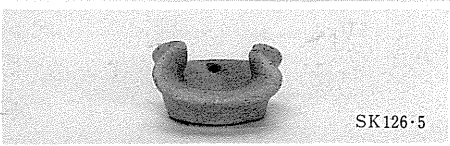

SK126-5



SK122-8

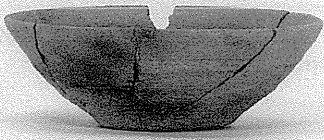

SK122-23



SK122-25

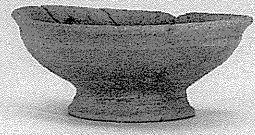

SK122-26

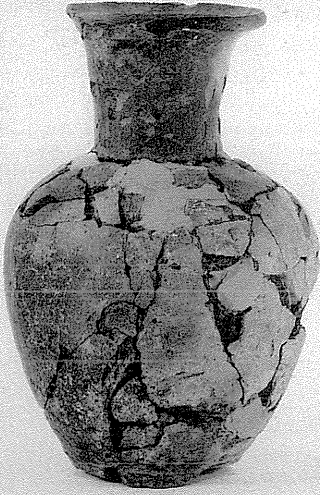

SK203-5



SK126-1



SK211-10

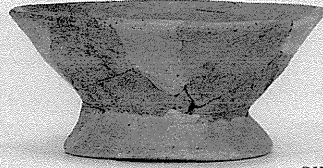

SK129-3



SK218-2



SK218-3



SK218-12



SK218-5



SK218-6



SK218-7

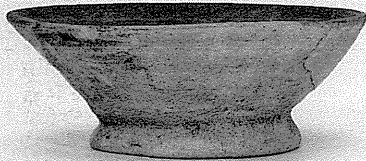

SK218-9



SK218-10



SK259-1



SX21-40



SX21-43

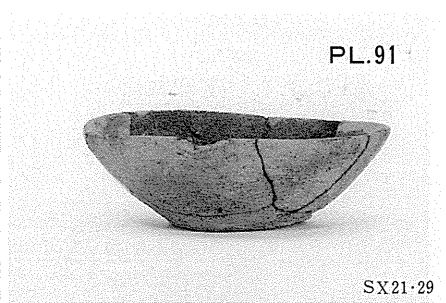

SX21-29



SX21-30



SX21-32

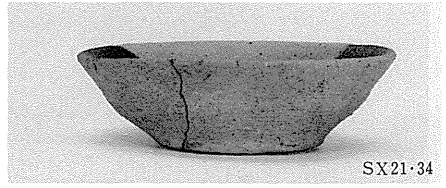

SX21-34

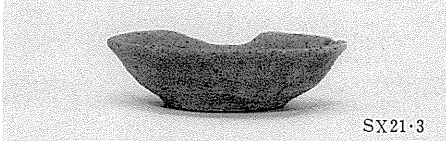

SX21-3



SX21-4



SX21-8



SD17-74

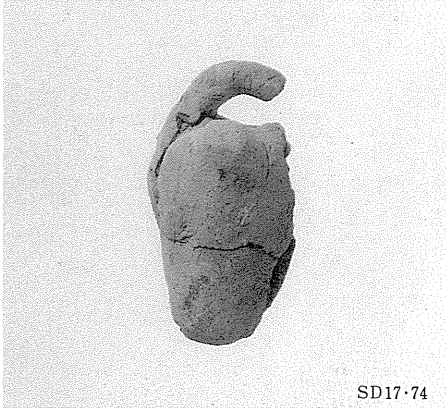

SD17-74

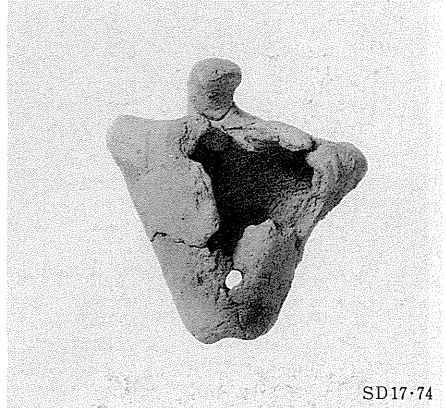

SD17-74



N-79

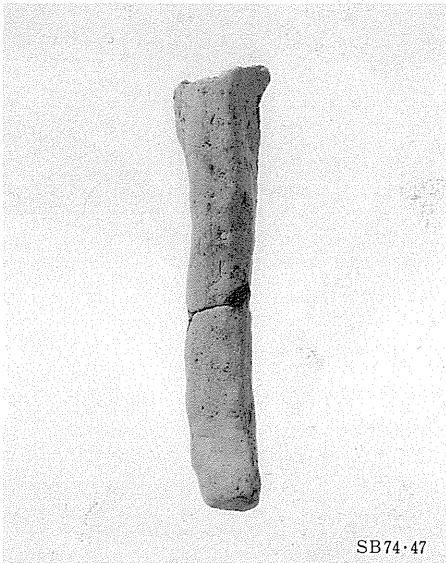

SB74-47



SK26-7

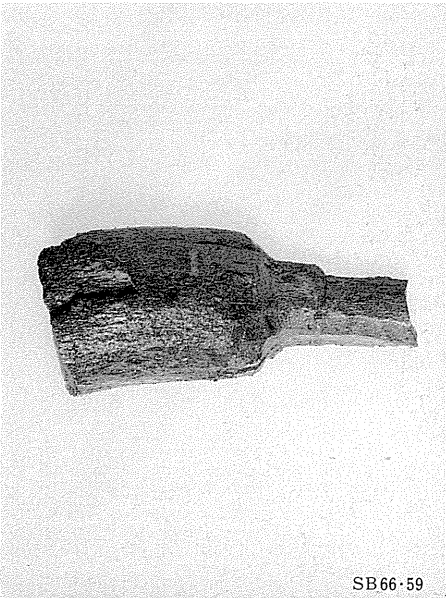

SB66-59



SB66-59

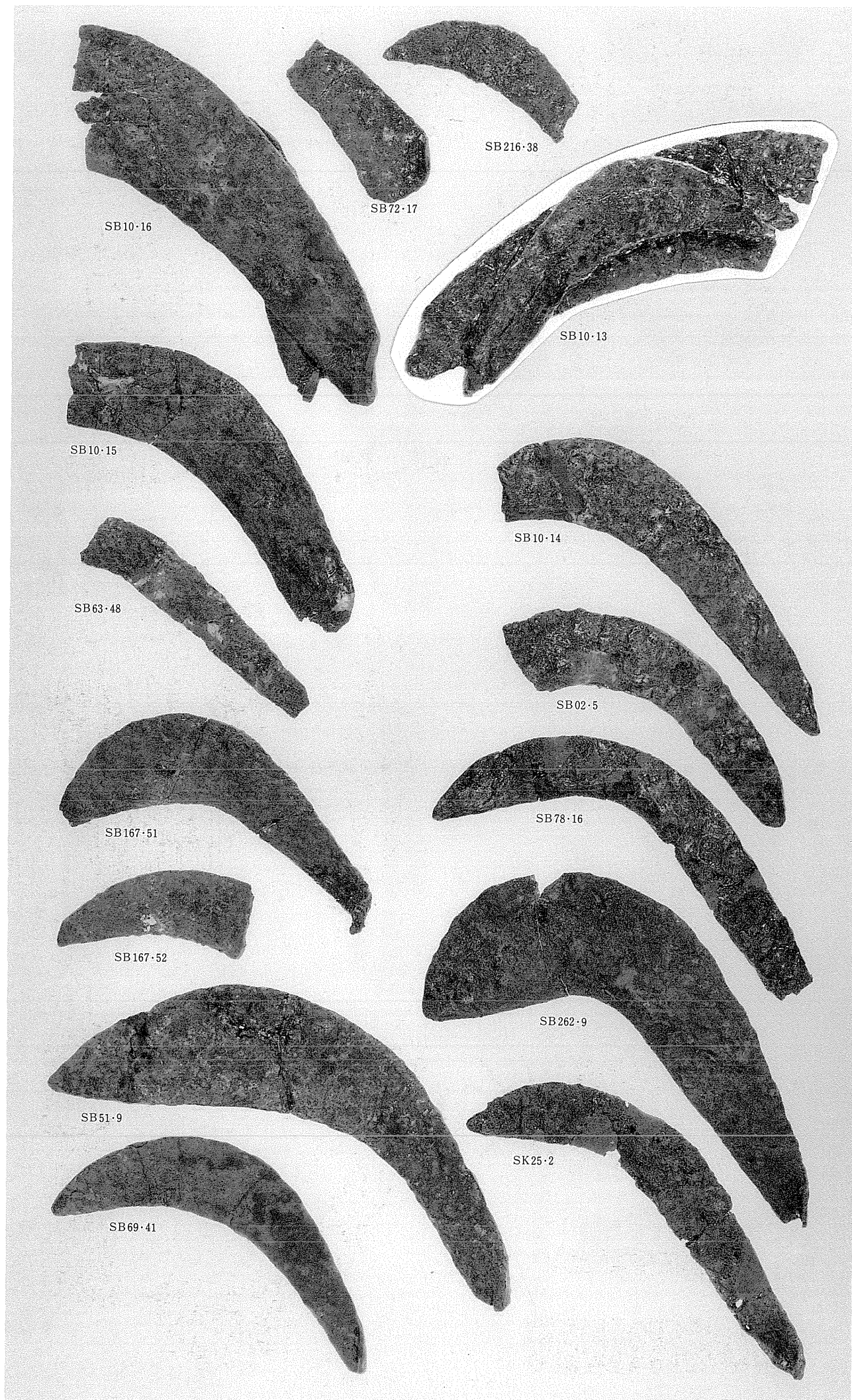

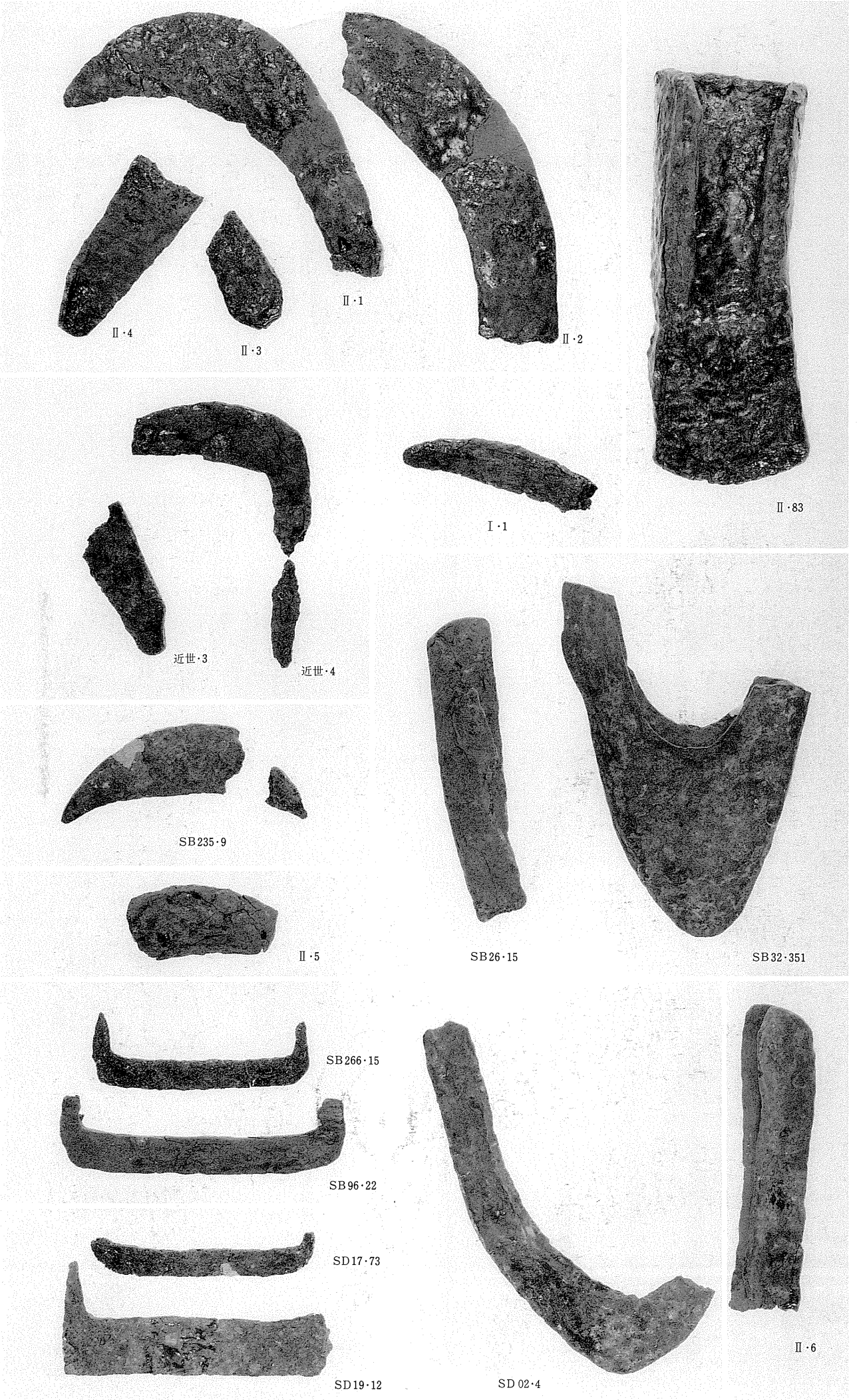

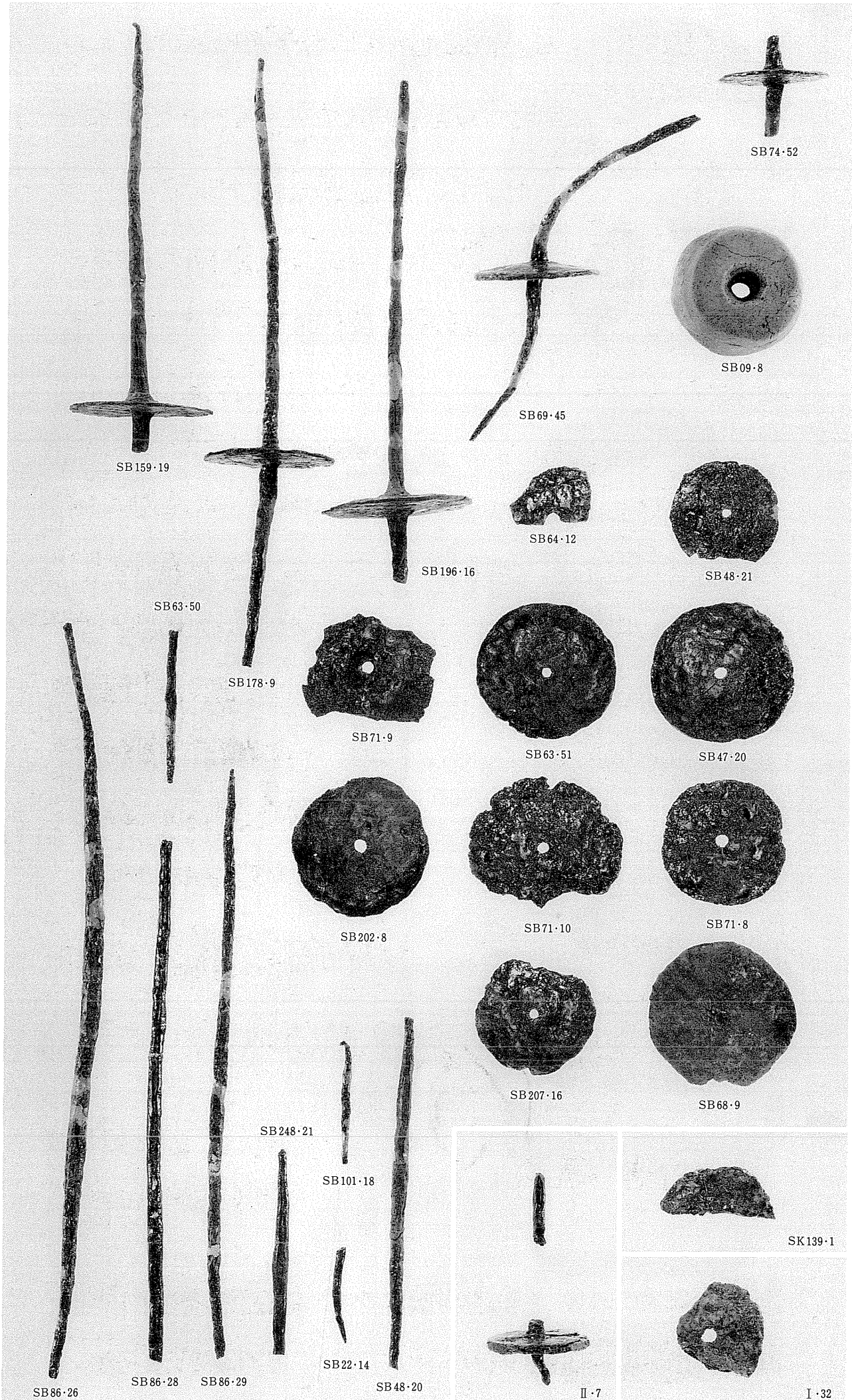

SB86·26

SB86·28

SB86·29

SB22·14

SB48·20

SB248·21

SB101·18

SB63·50

SB178·9

SB196·16

SB71·9

SB202·8

SB69·45

SB64·12

SB63·51

SB71·10

SB207·16

SB74·52

SB09·8

SB48·21

SB47·20

SB71·8

SB68·9

SK139·1

II·7

I·32

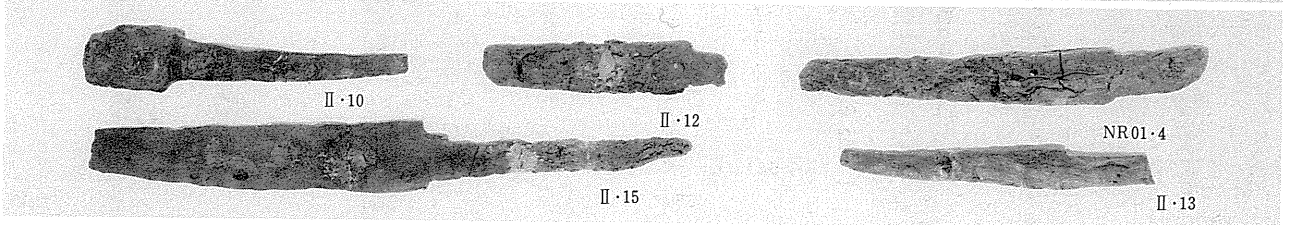
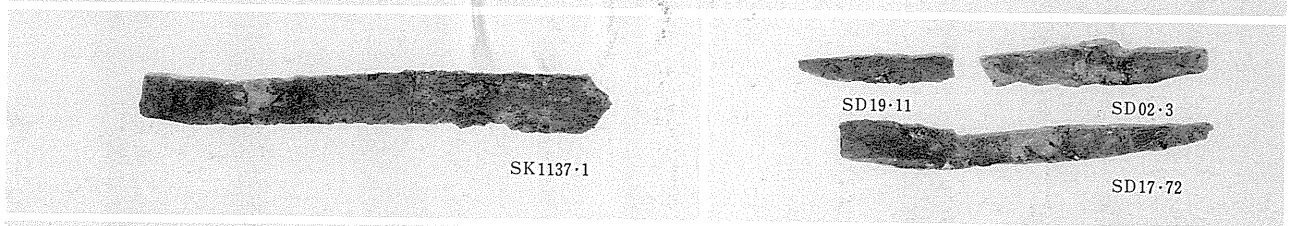
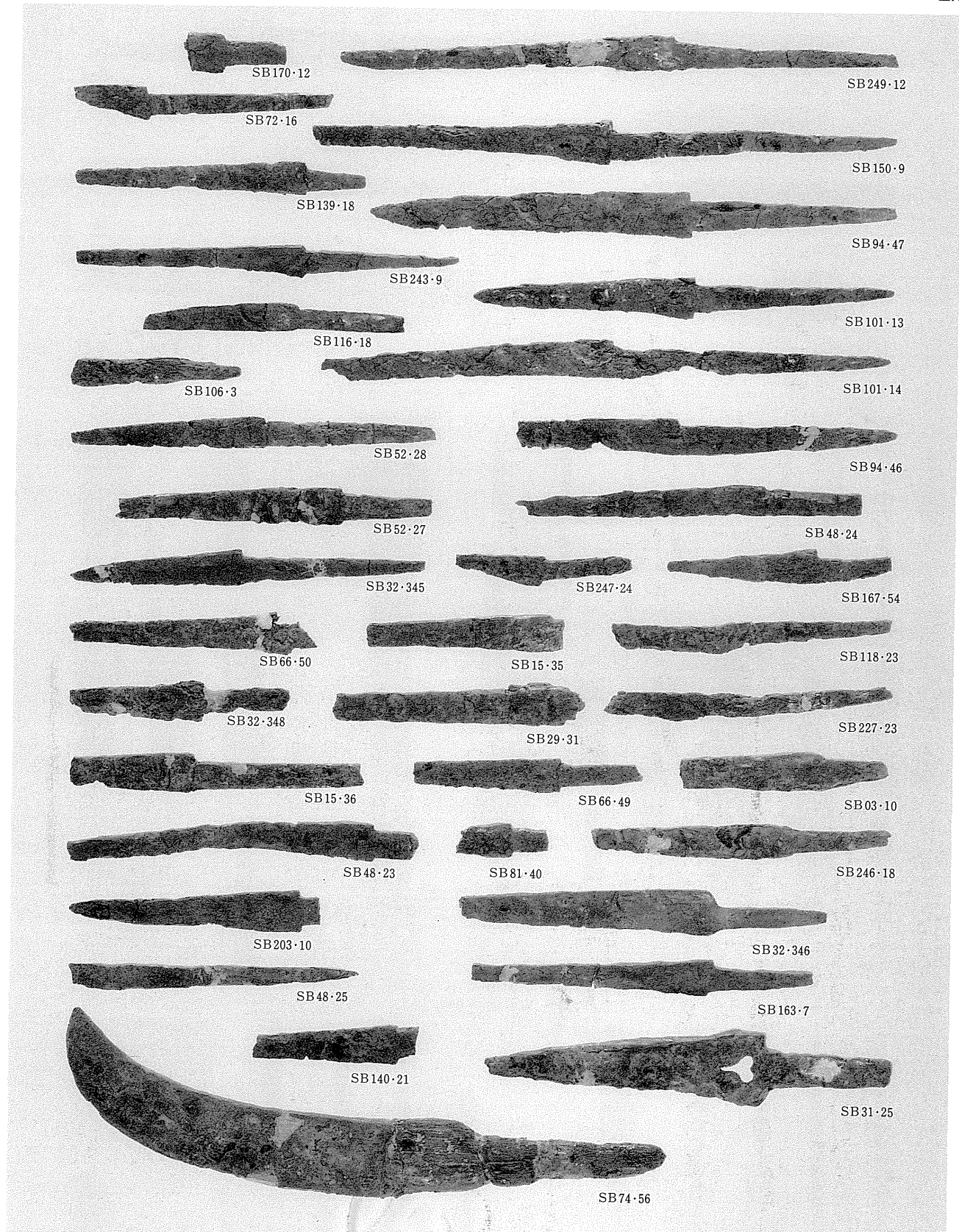

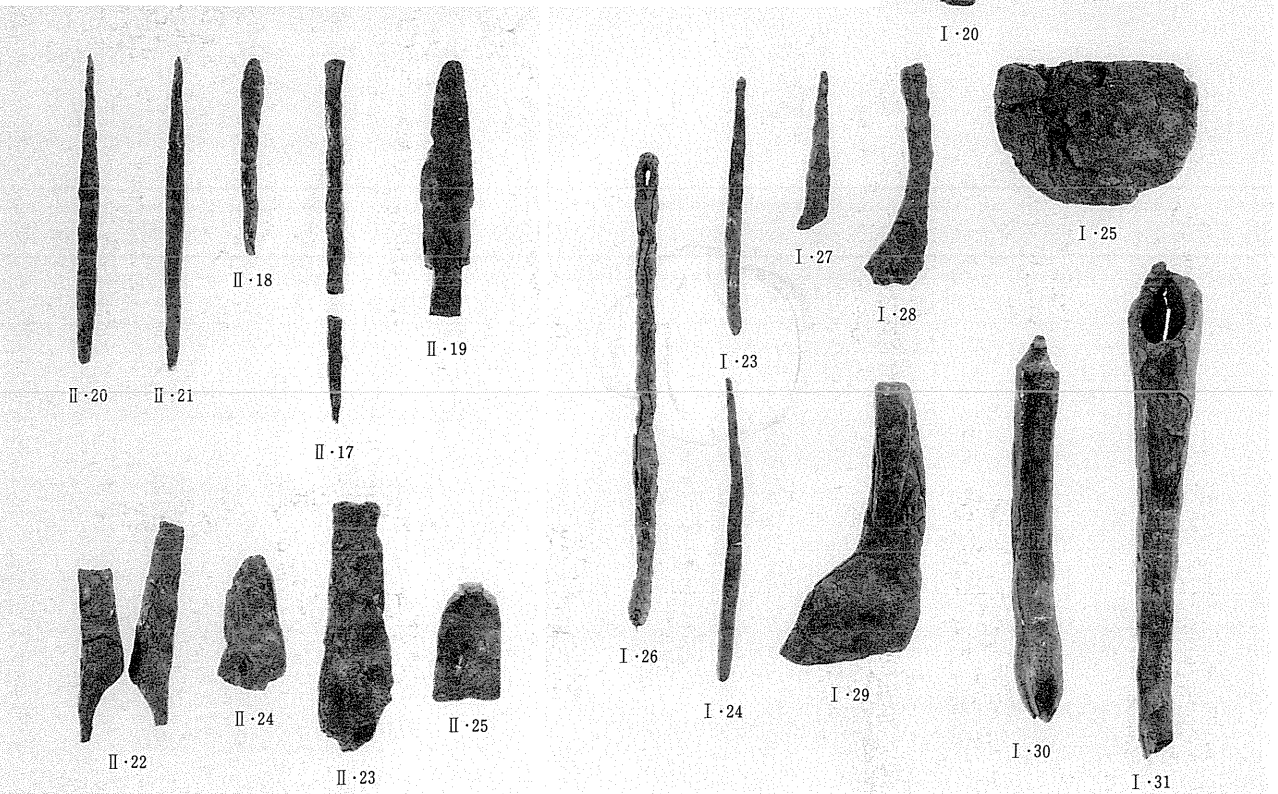
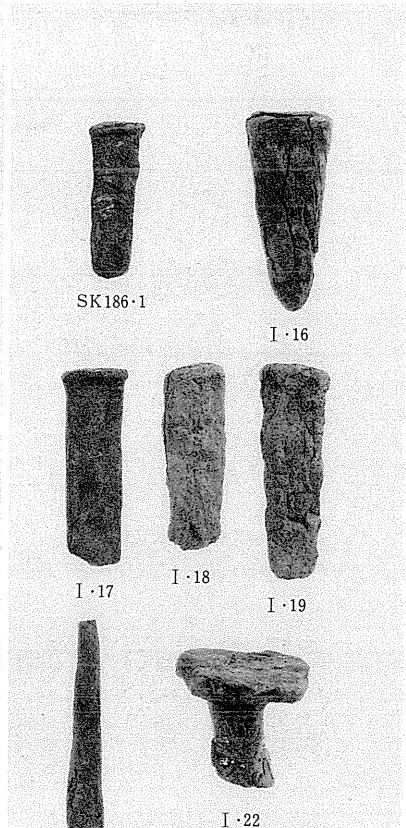
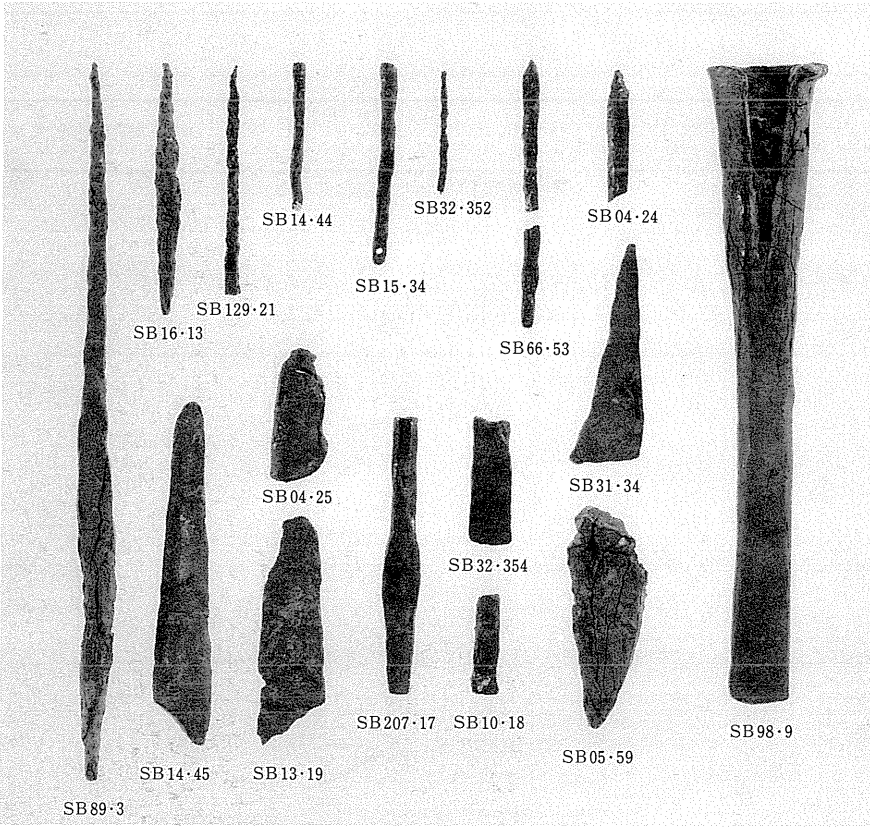
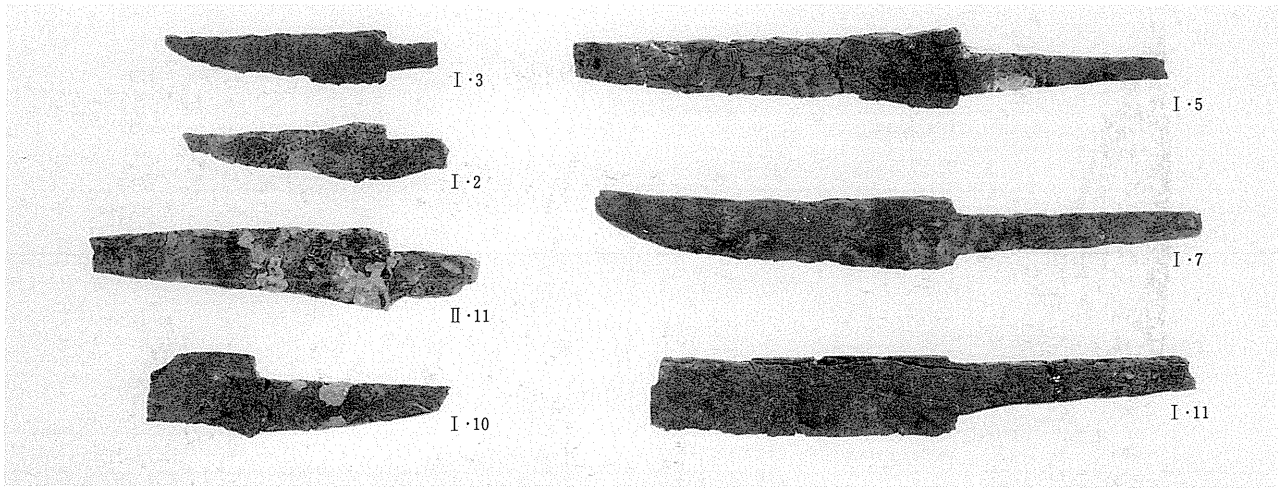

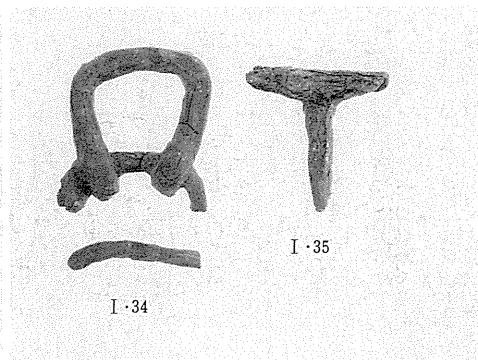
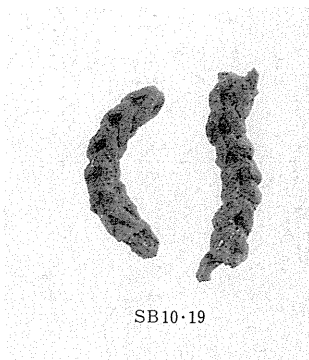
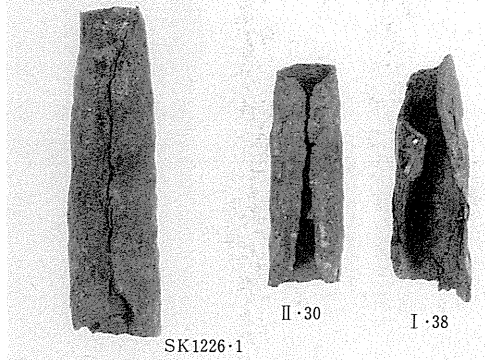
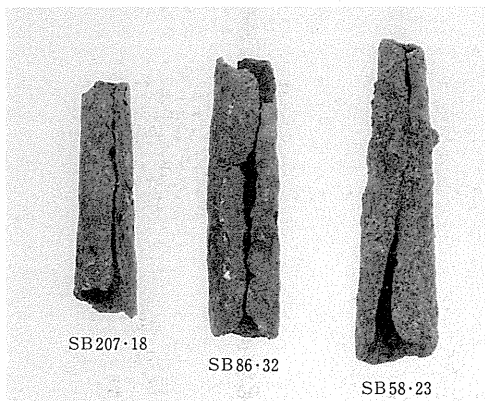
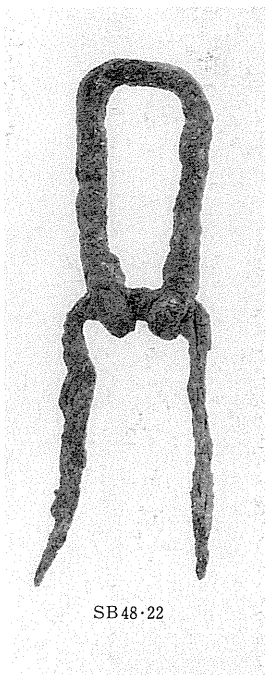
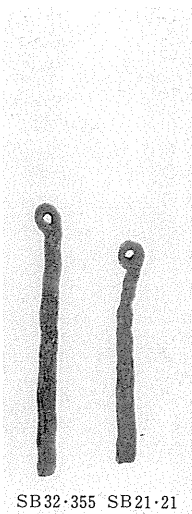
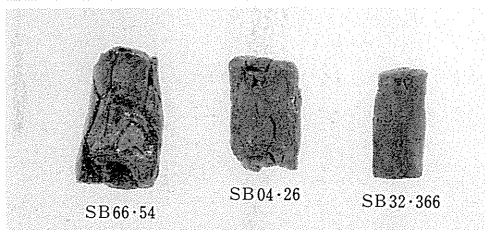
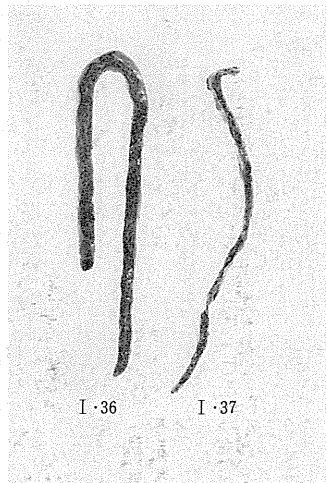
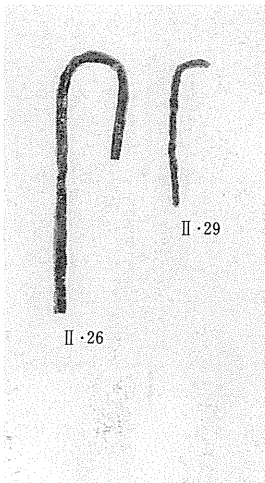
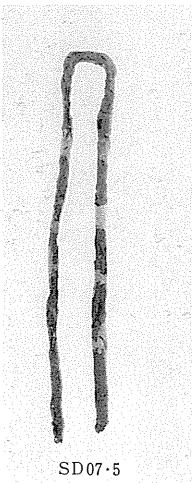
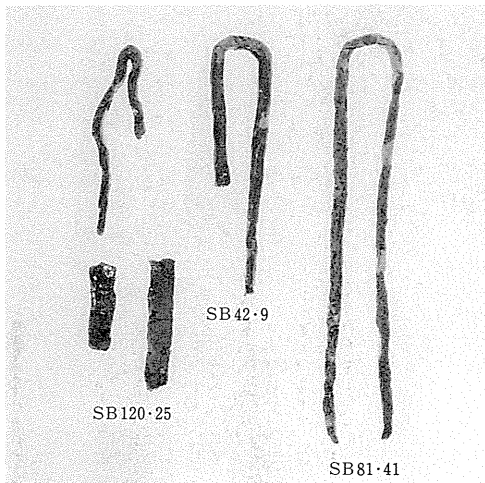
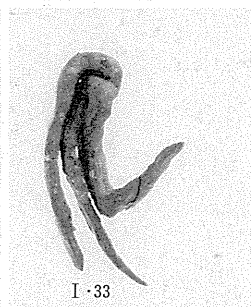
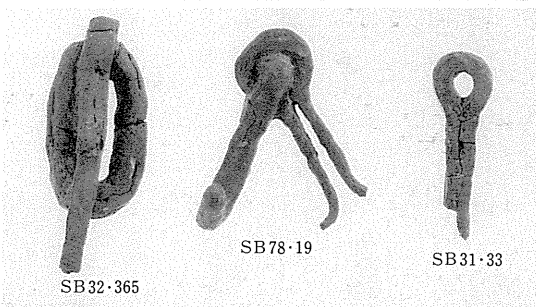
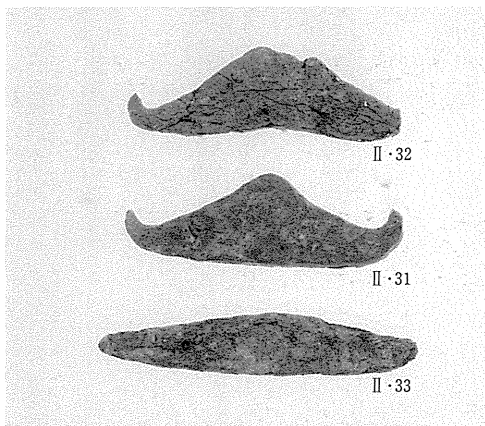
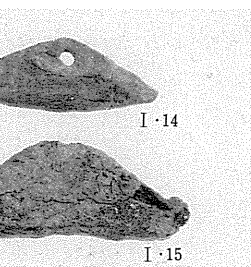
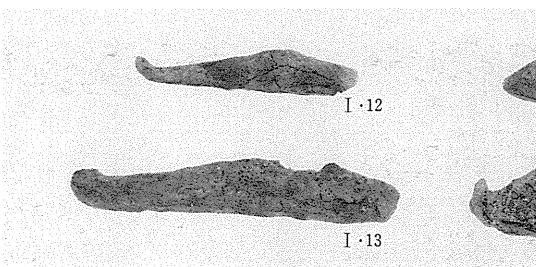

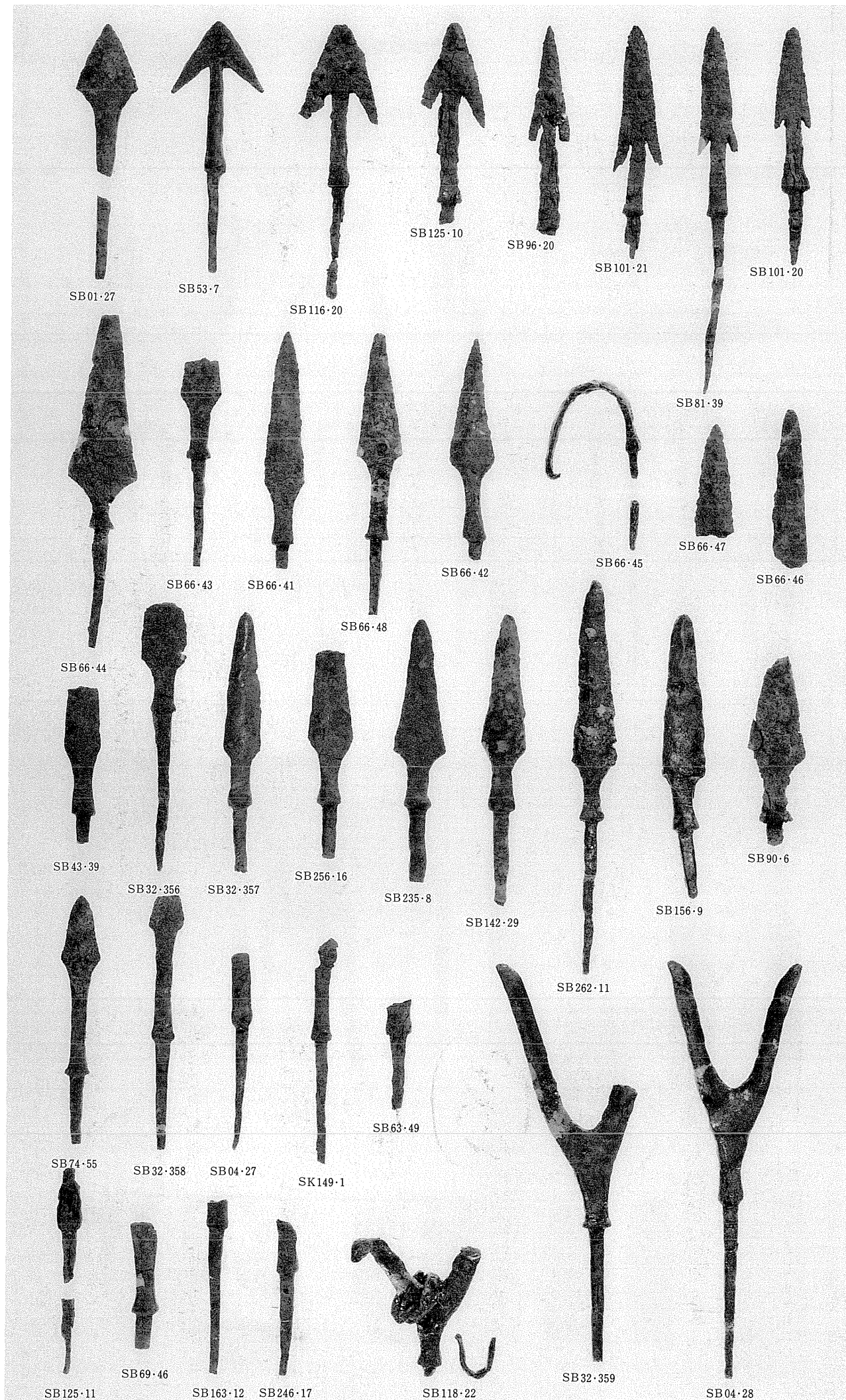

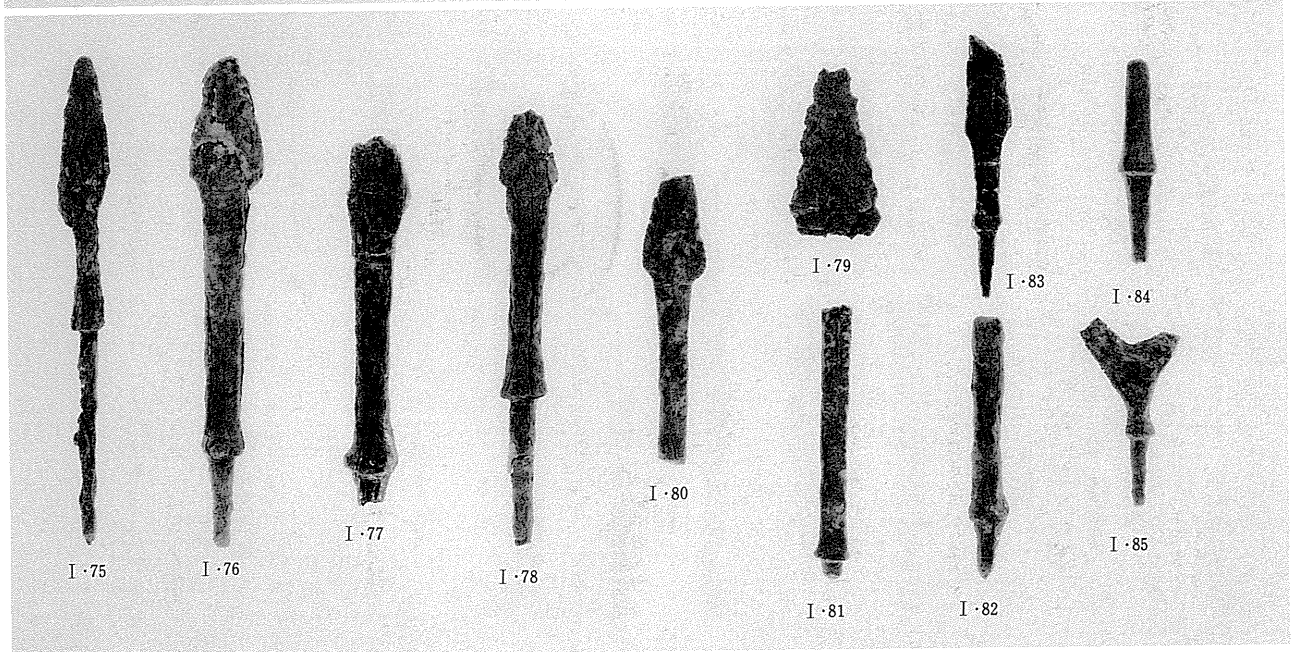
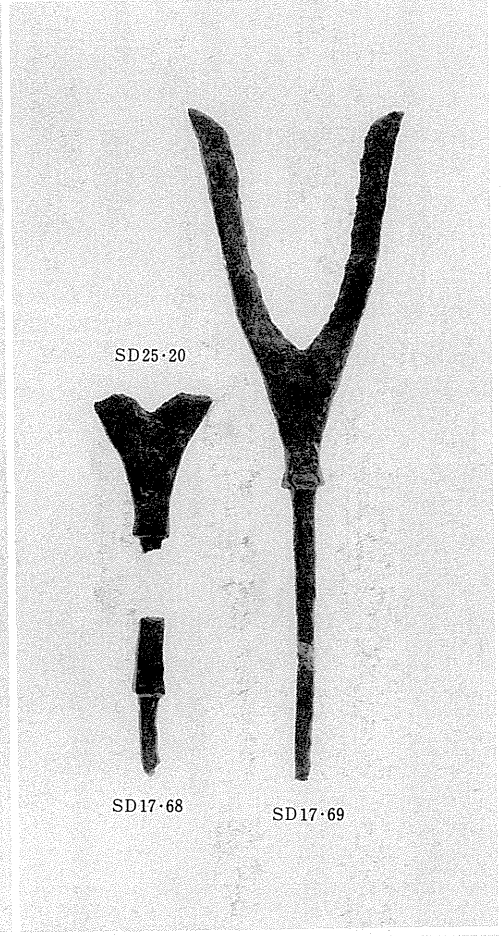
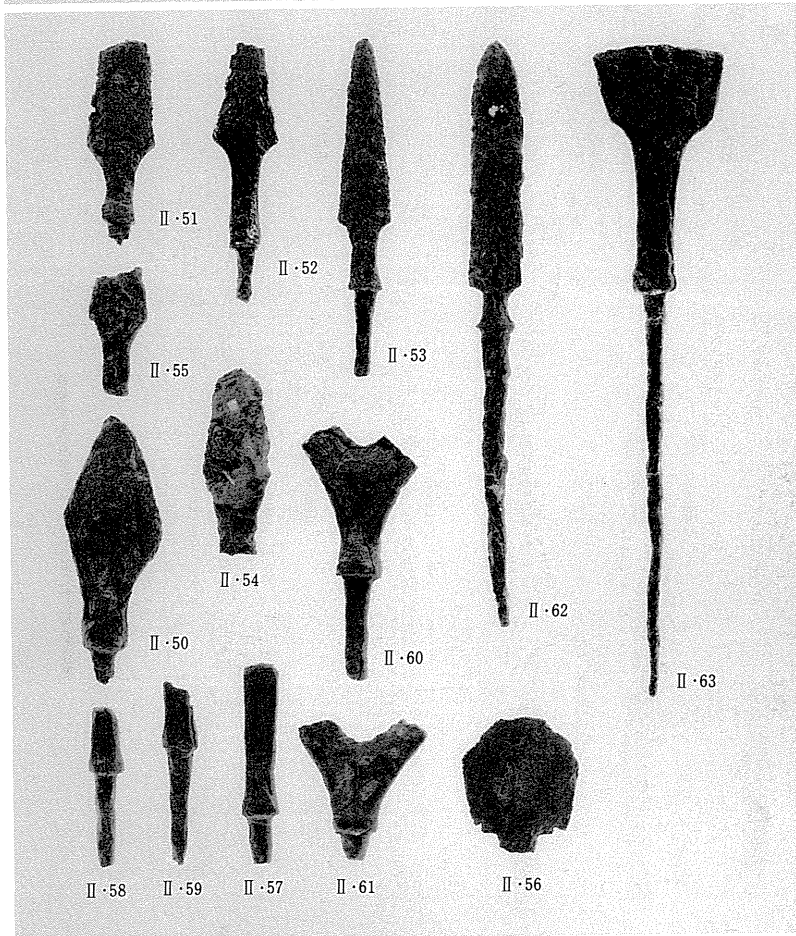
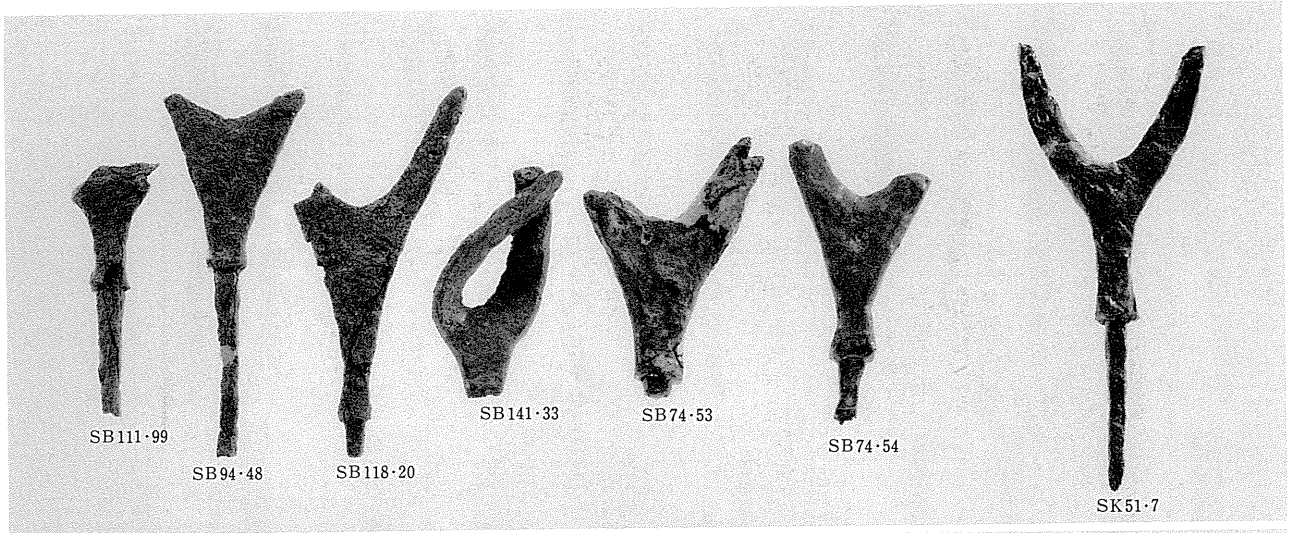

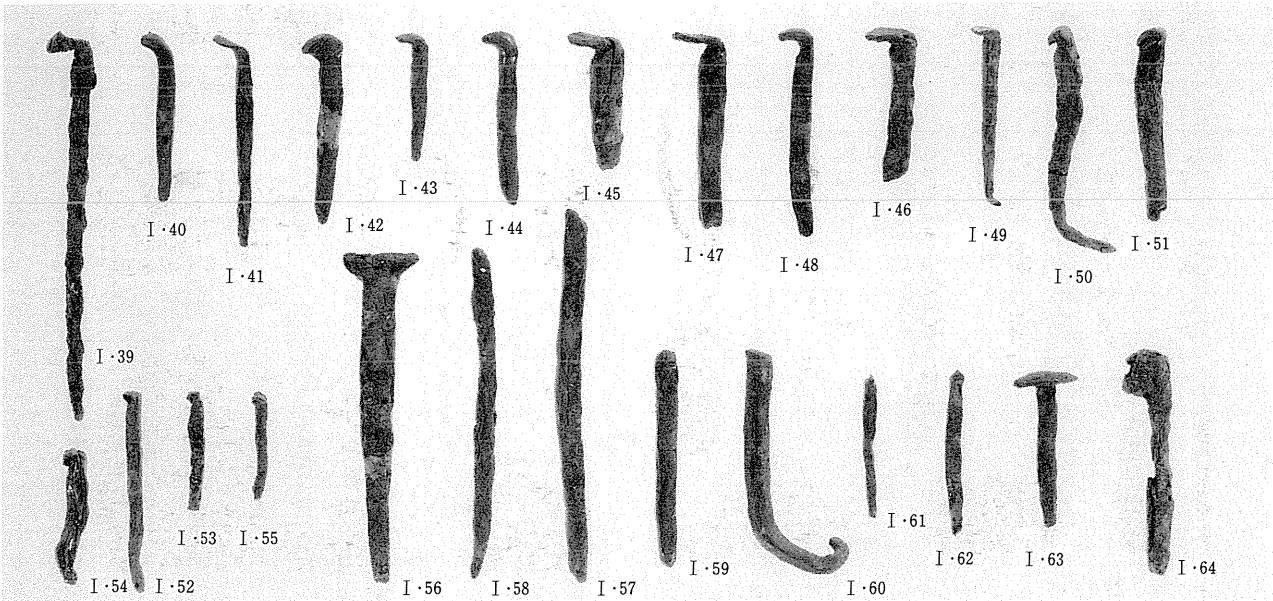
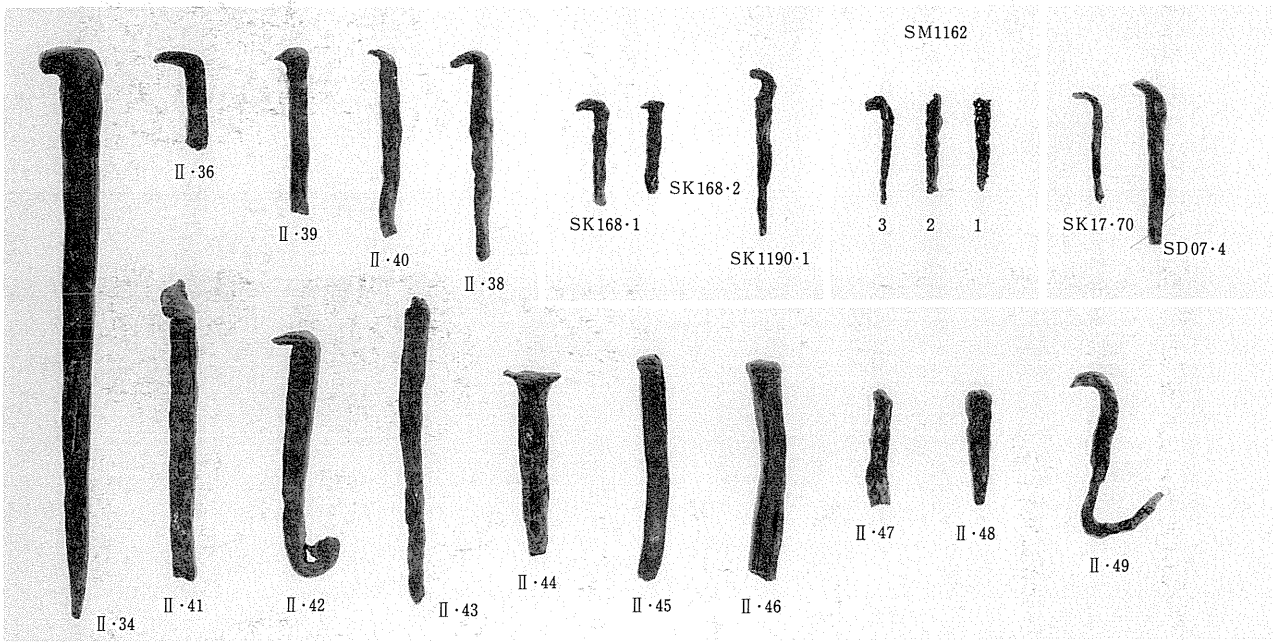
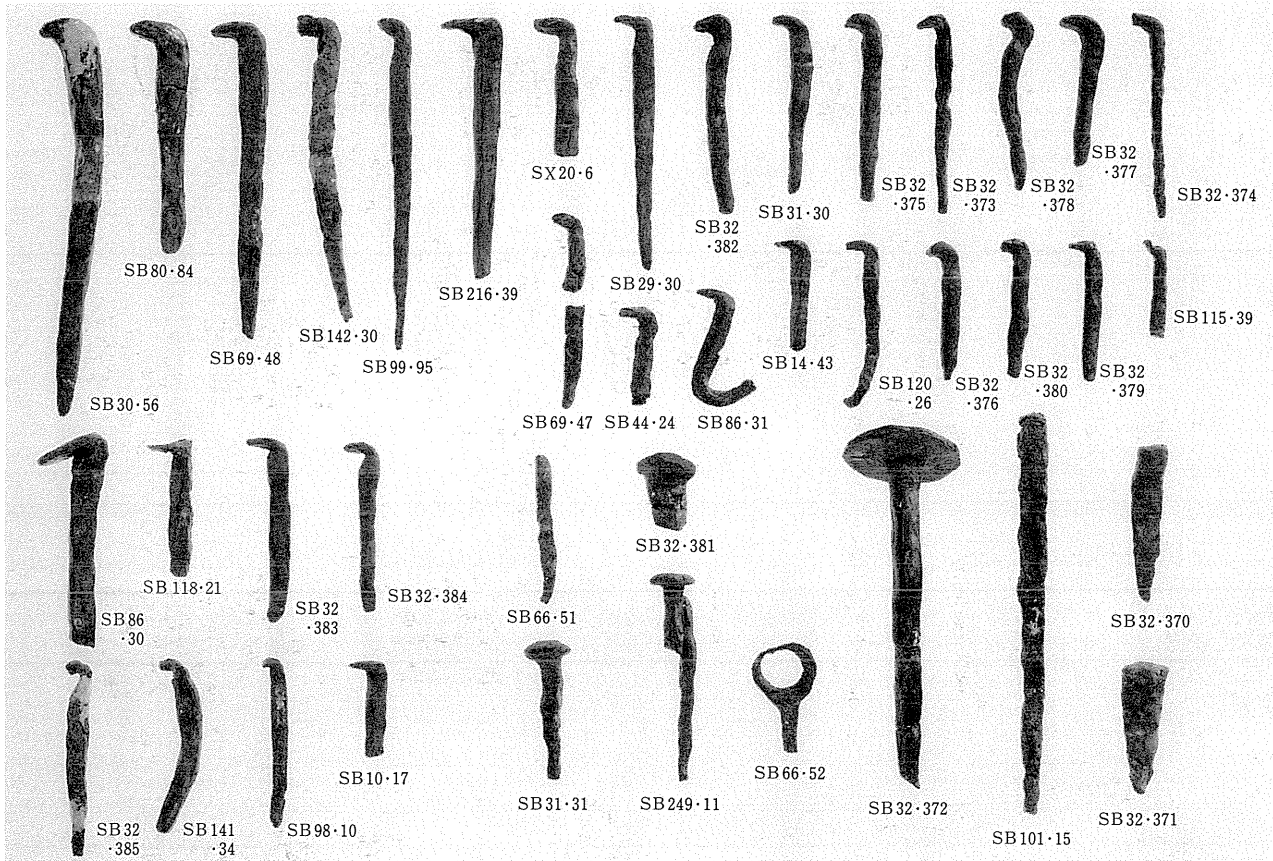

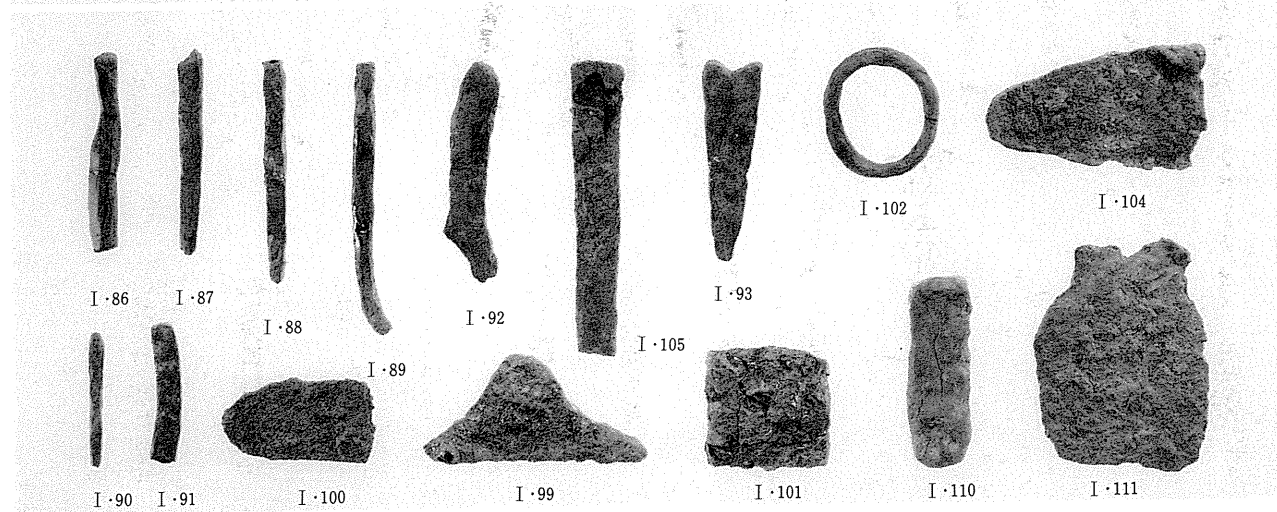
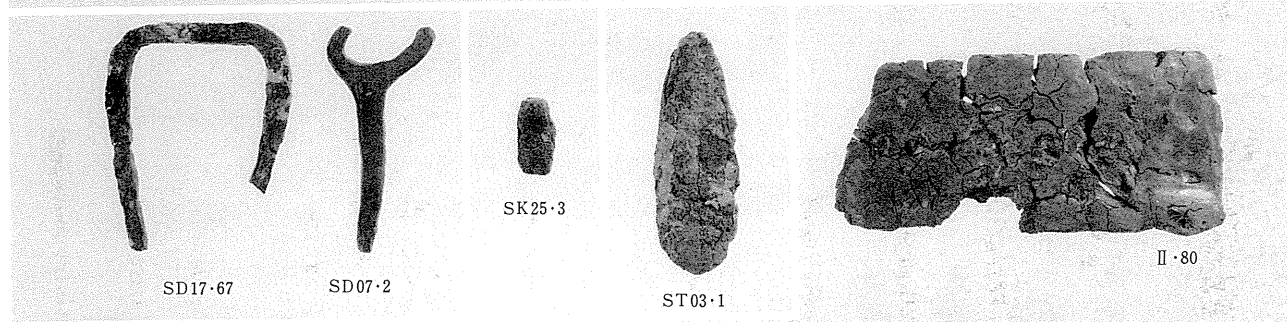
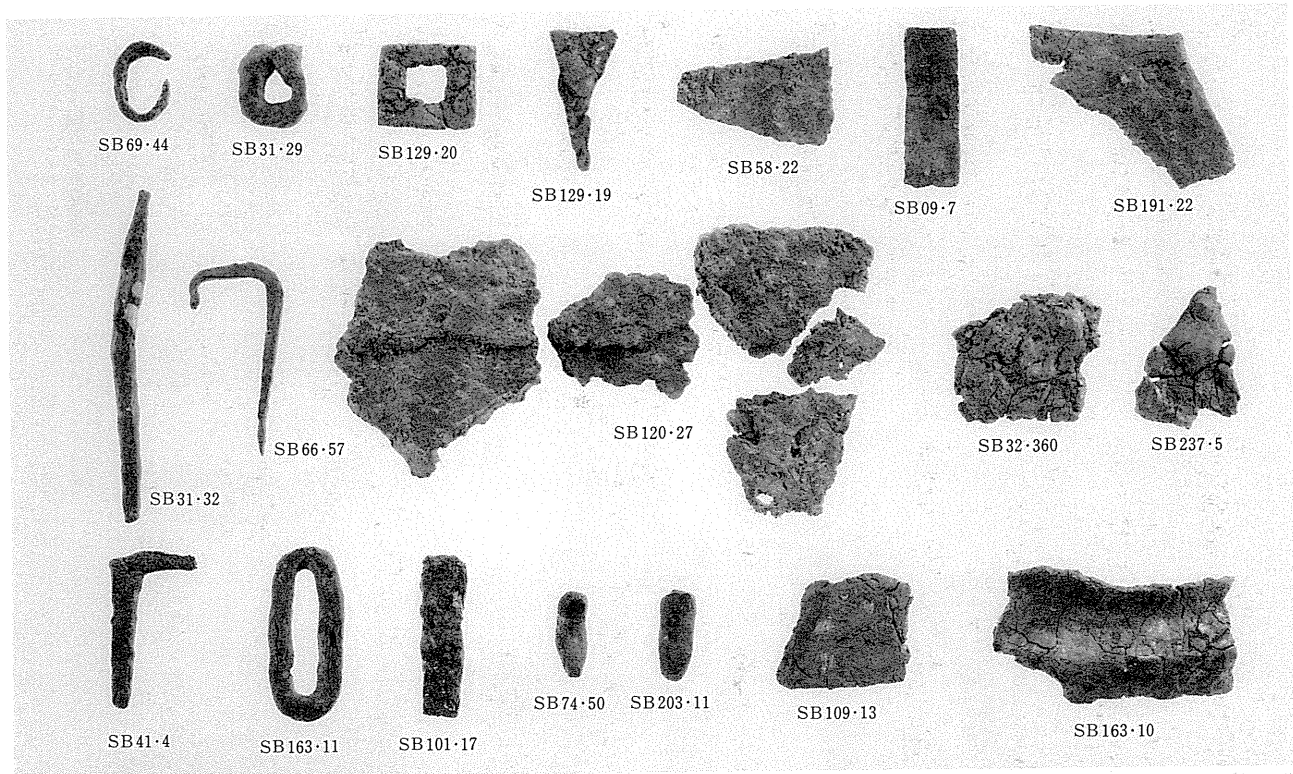

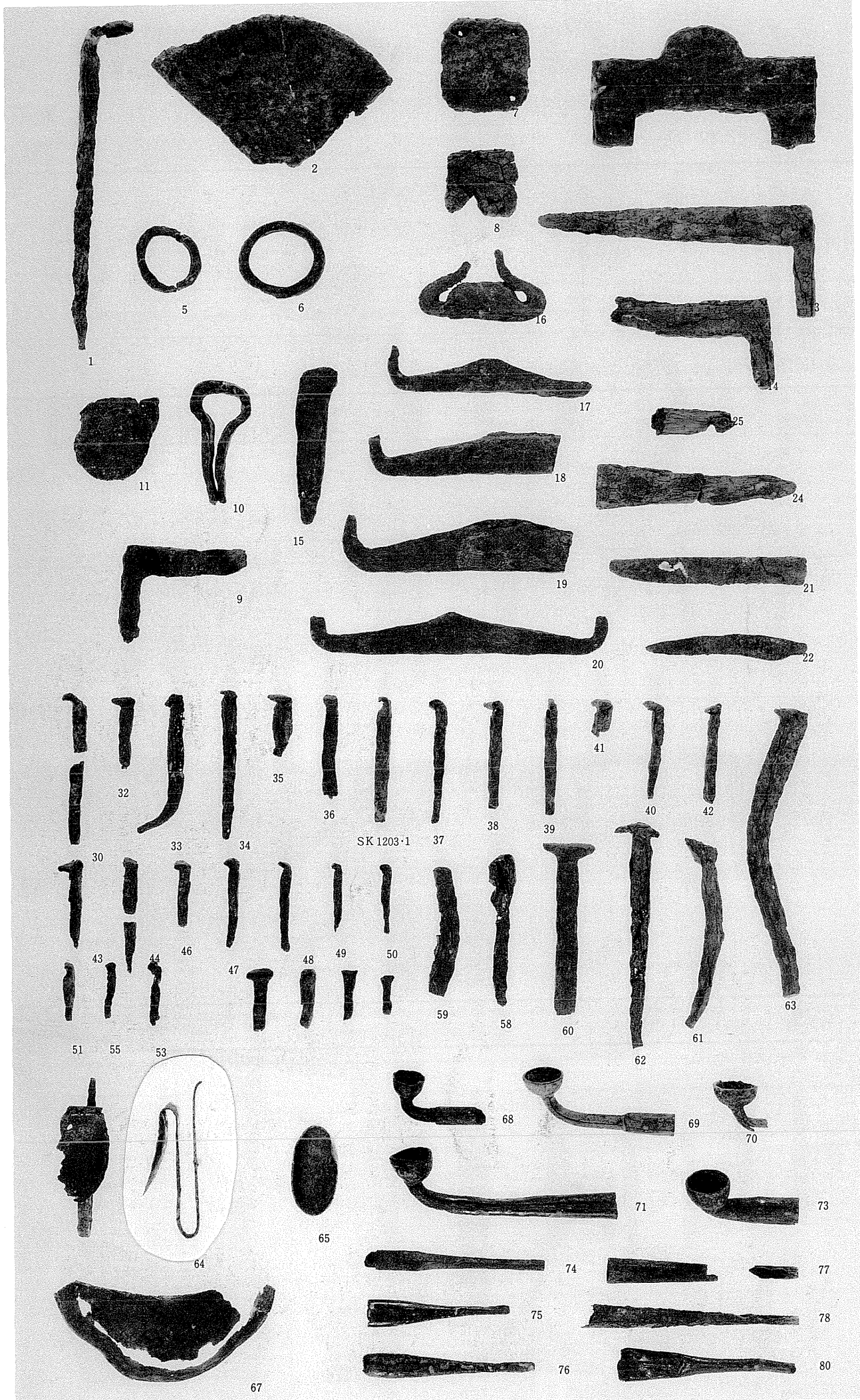

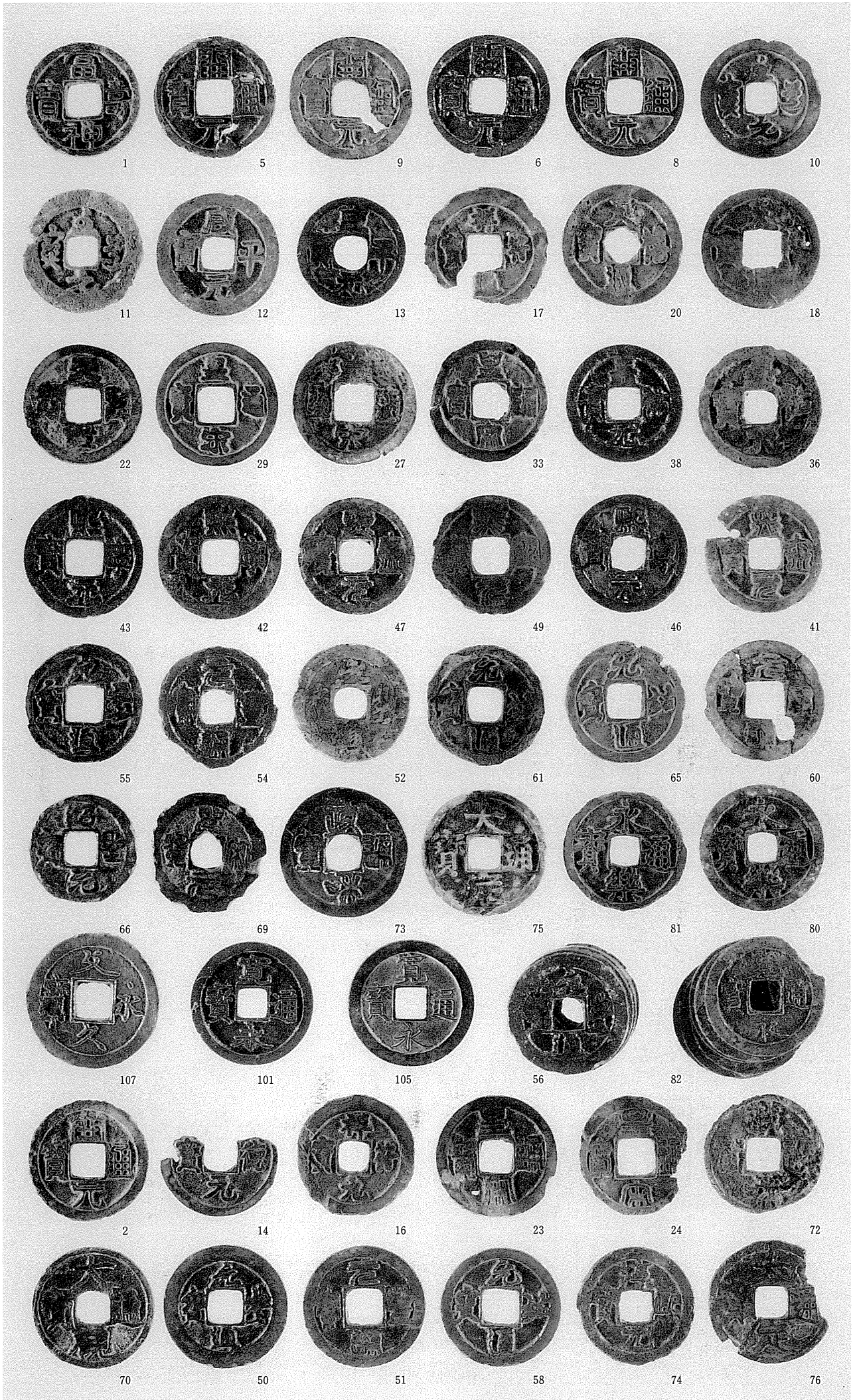

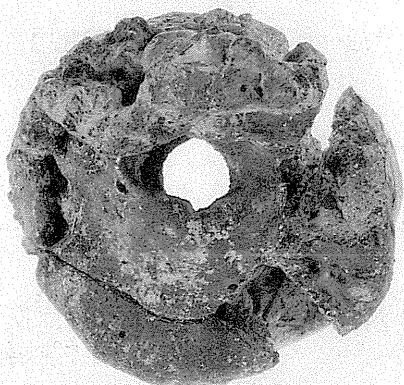

SK73

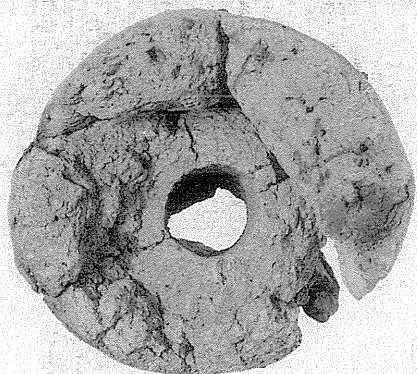
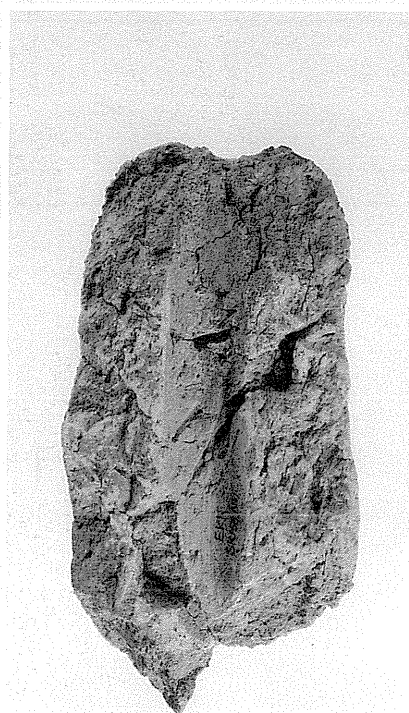
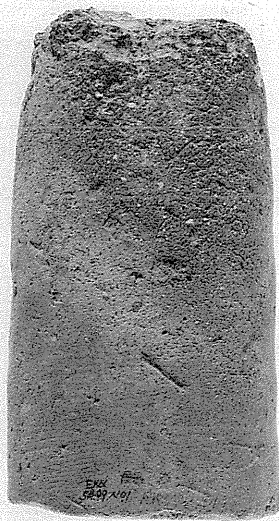

SB47

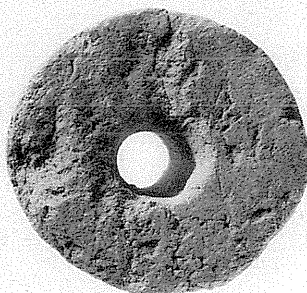

SK73

SK158

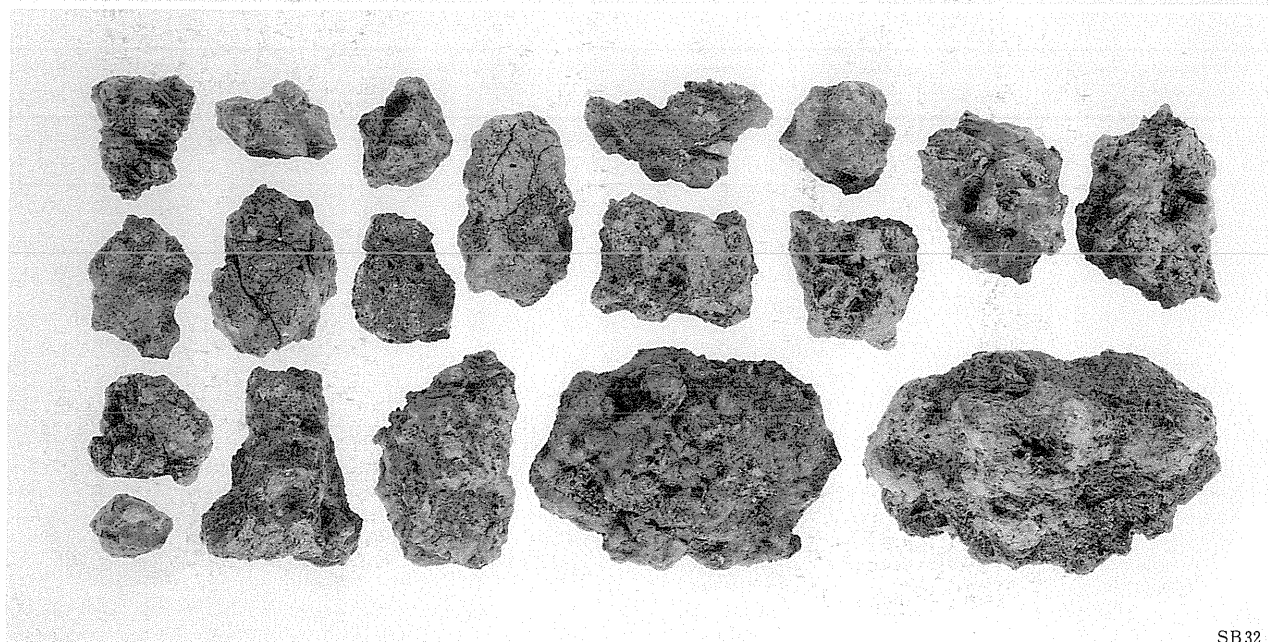

SB32

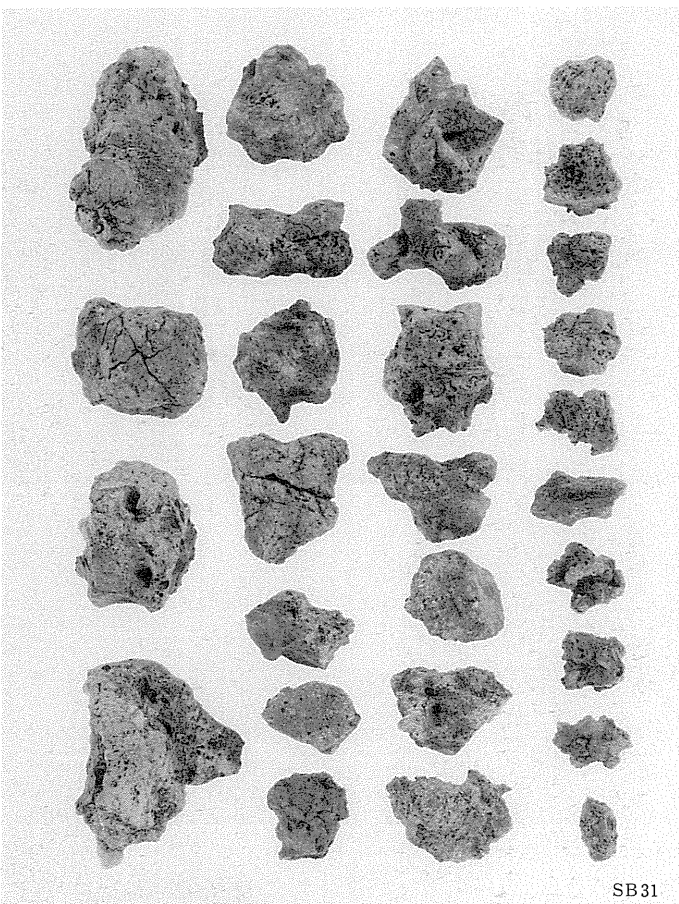

SB31

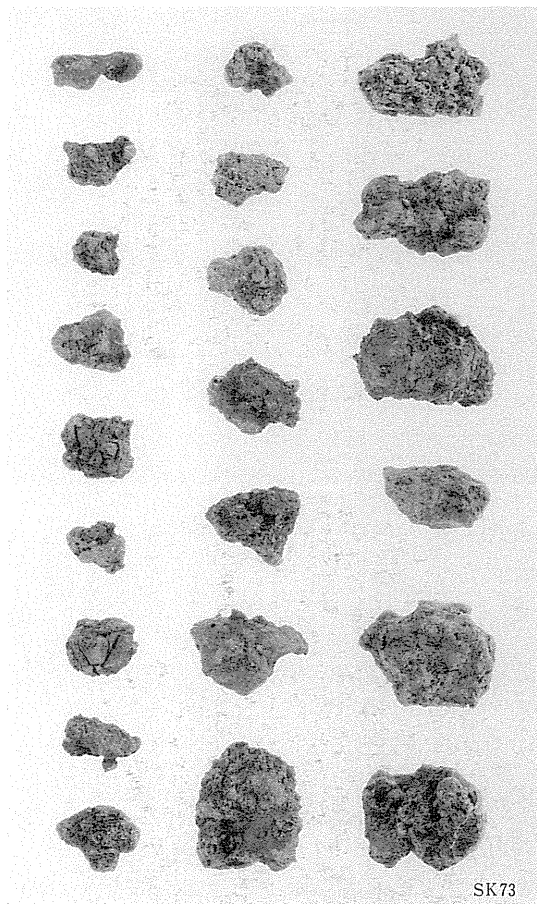

SK73

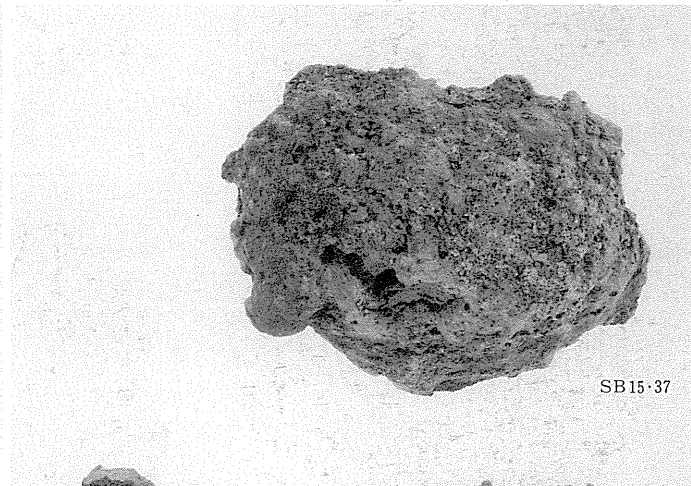
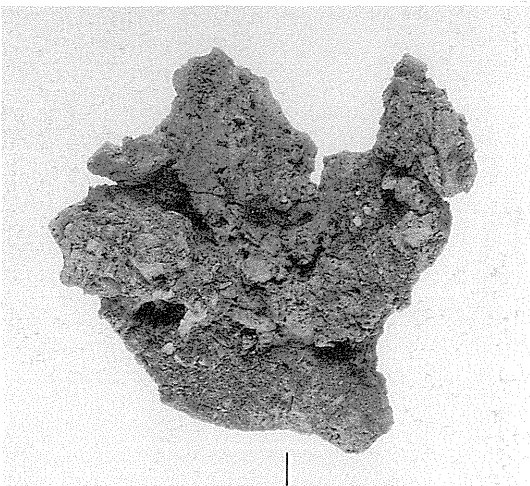

SB15-37

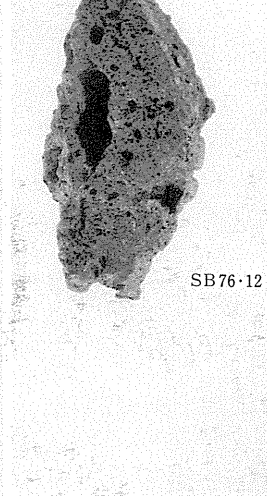
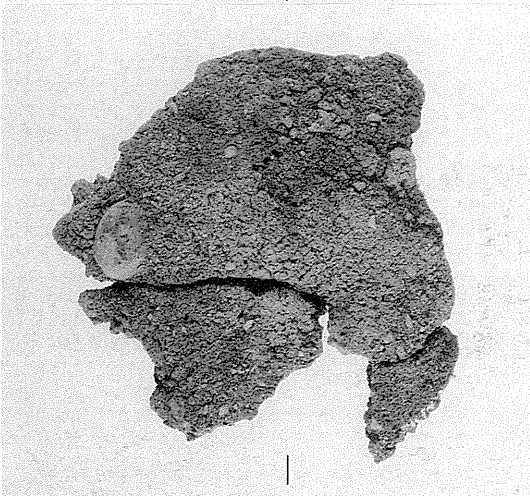

SB76-12

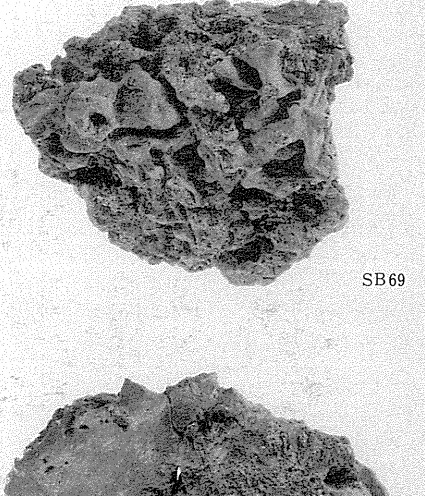

SB69

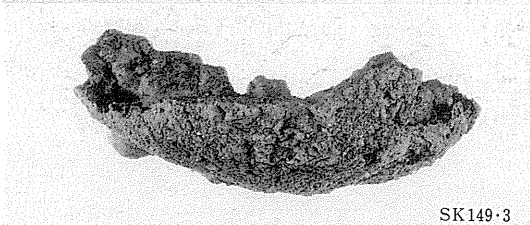

SK149-3

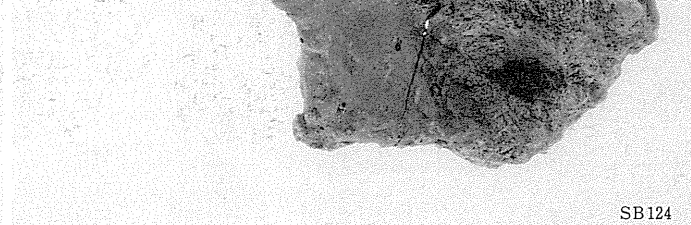

SB124

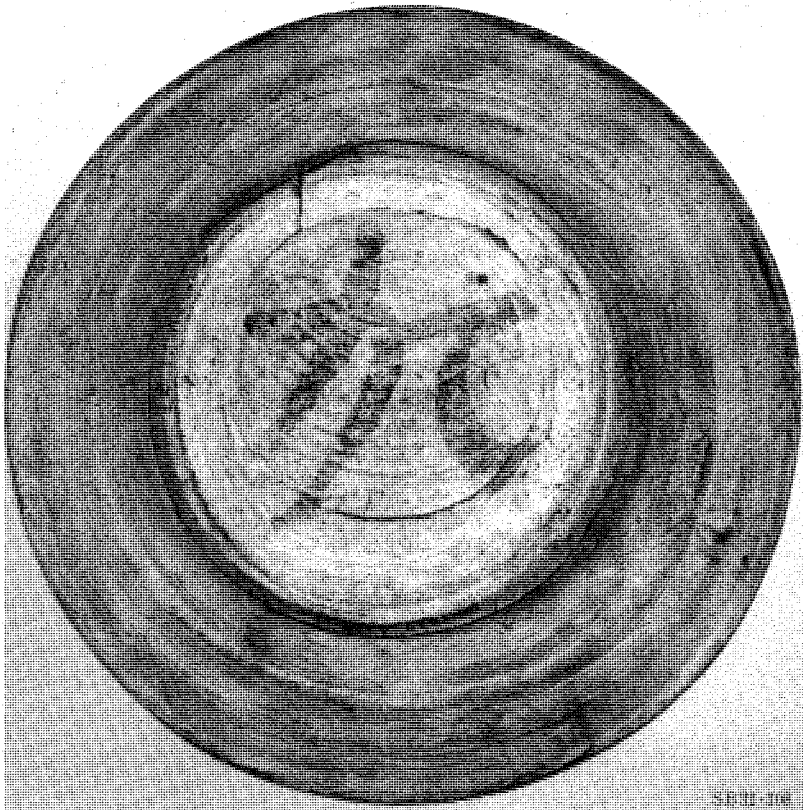
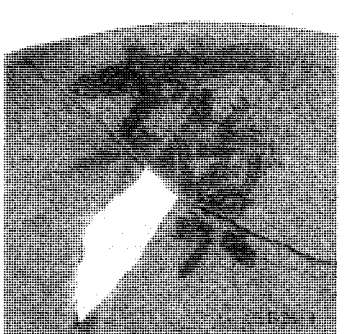
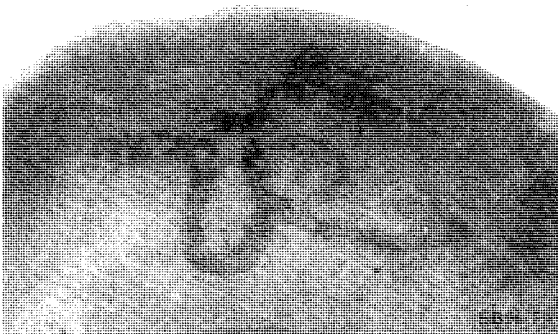
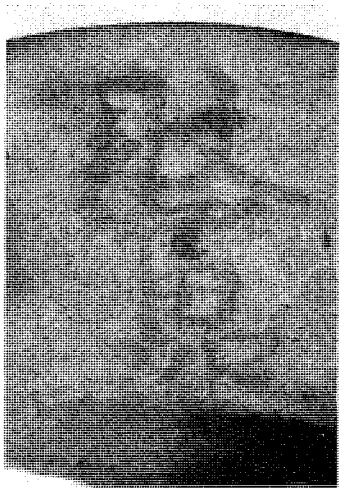
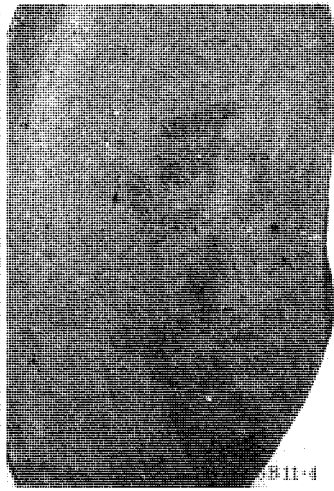

SB94·42



SB94·42

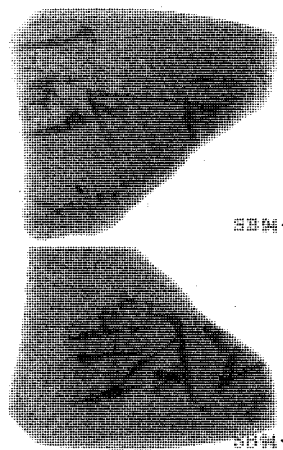
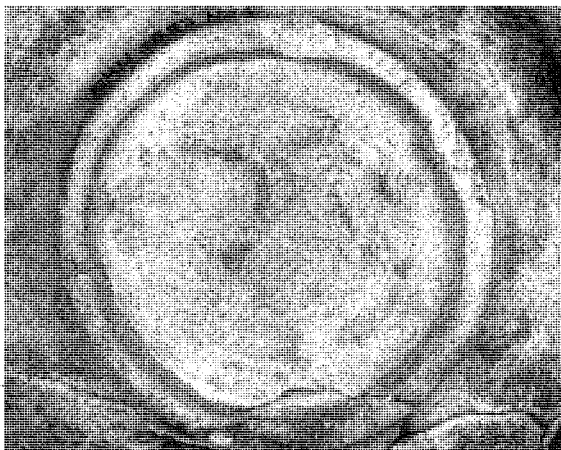
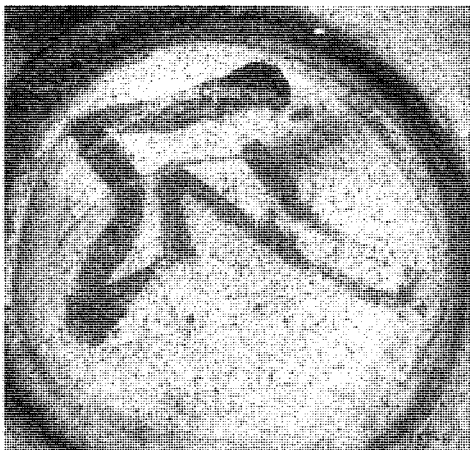

SB94·42

SB94·42

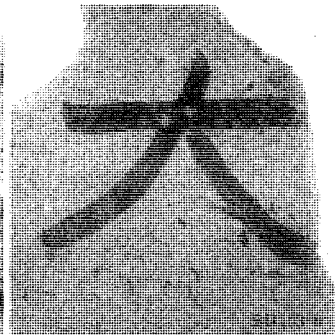
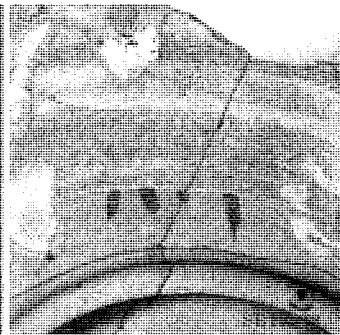
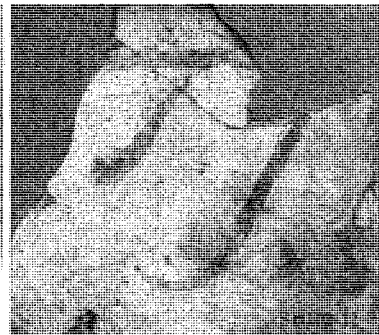
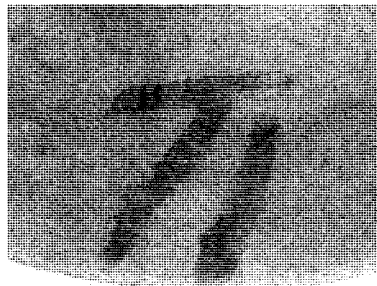

SB102-10

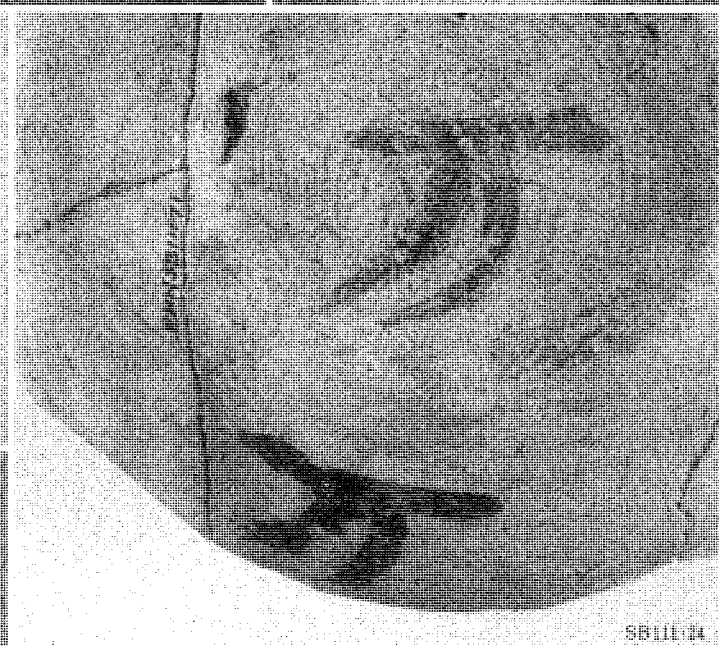
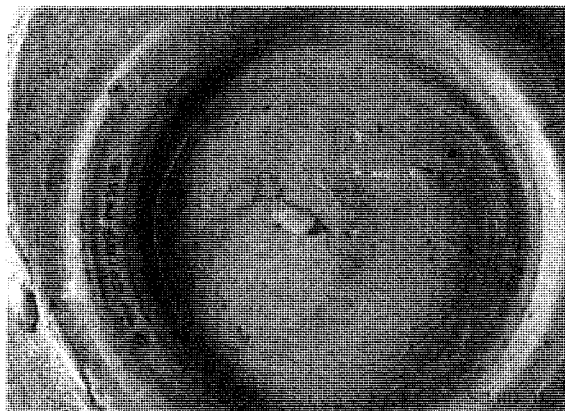

SB111-16

SB111-24

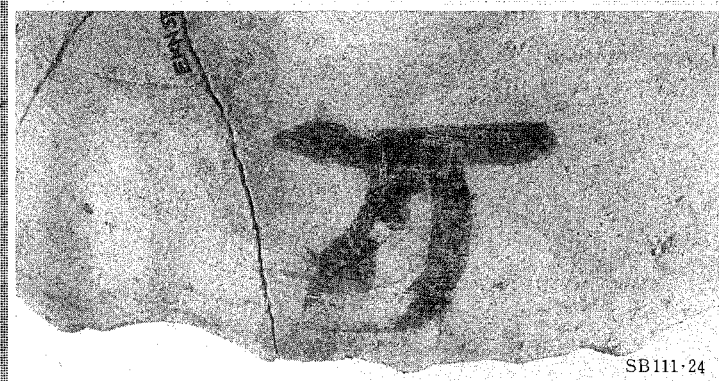
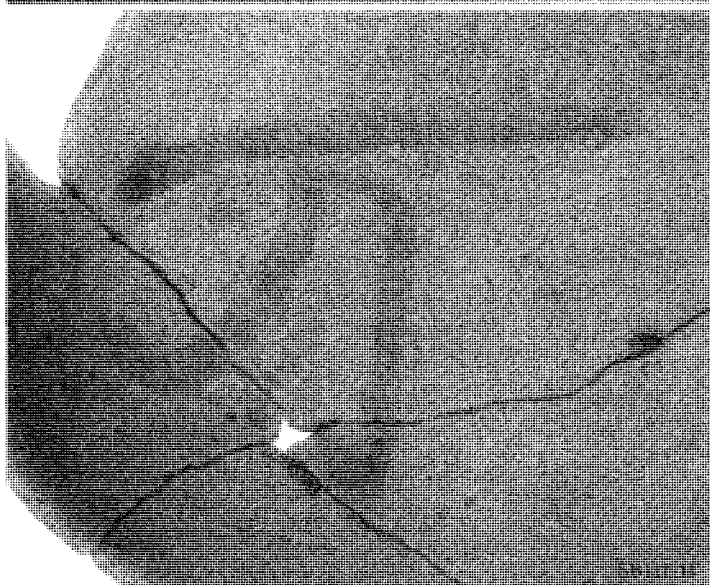

SB111-24

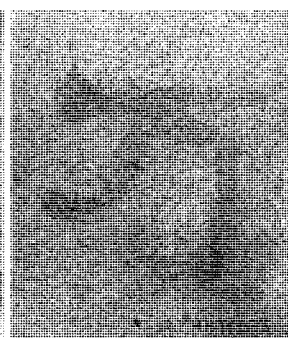
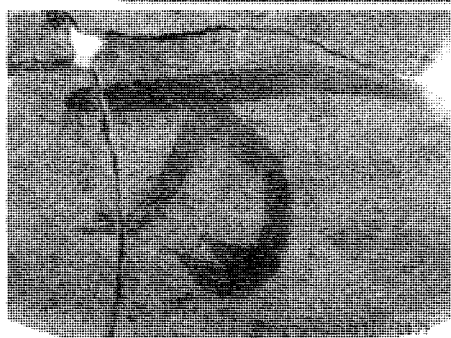

SB111-9

SB111-14

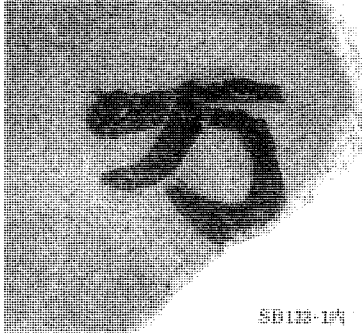
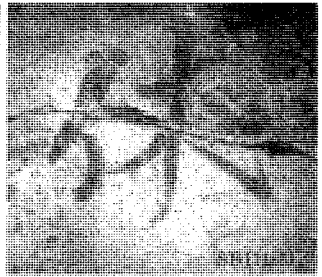
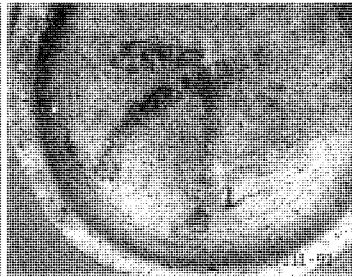
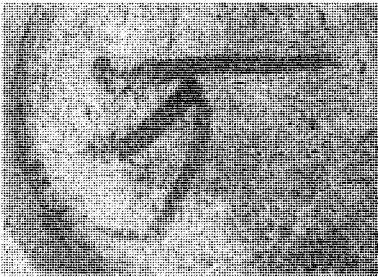
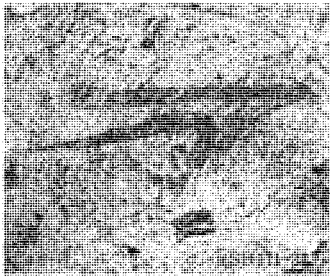

SB138-1內

SB138-2

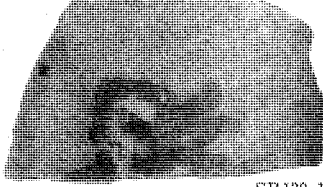

SB139-6

SB139-16

44-5

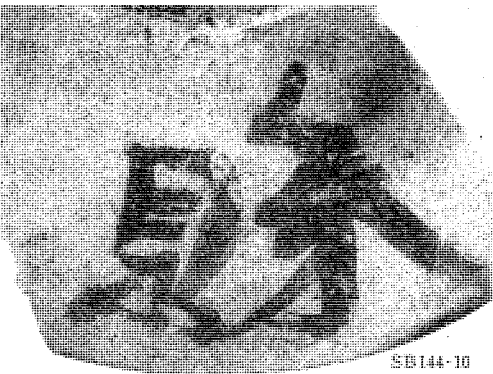
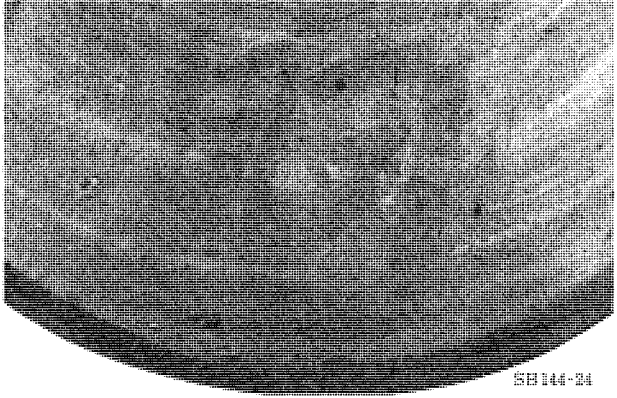

SB144-24

SB144-10

SB144-20

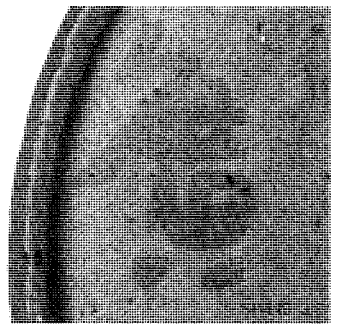
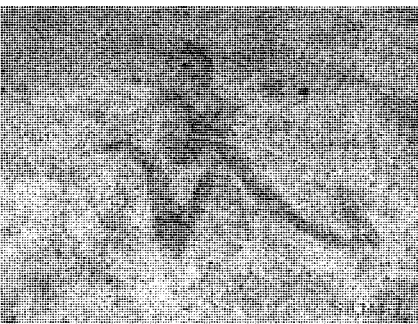
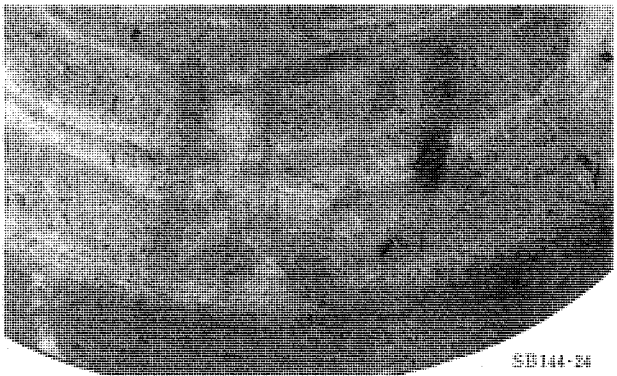

SB144-24

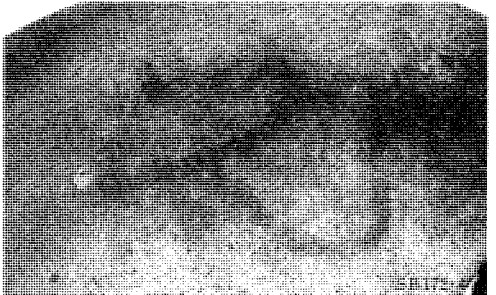
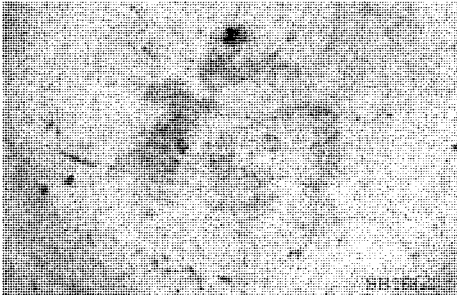
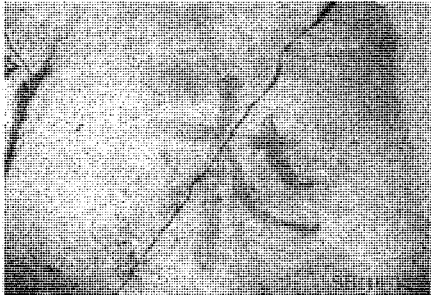

SB144-24

SB144-24

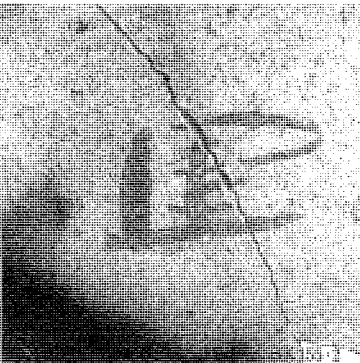
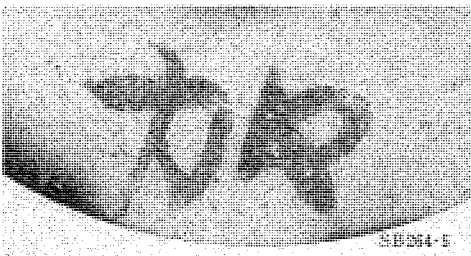
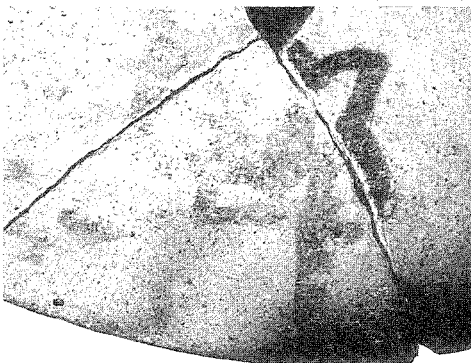
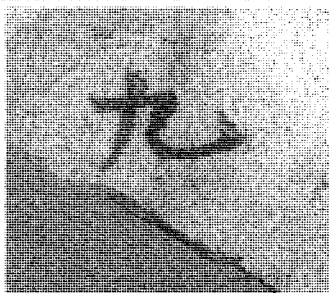
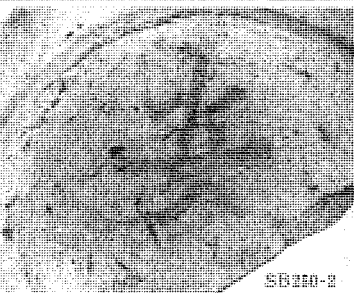
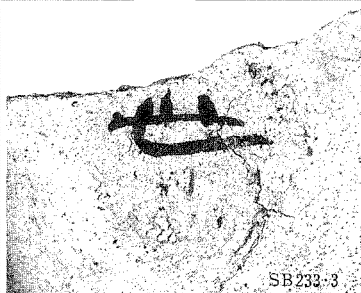
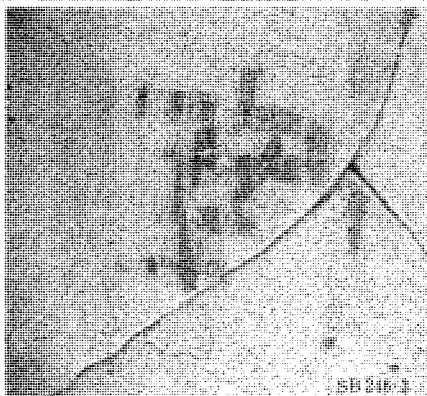
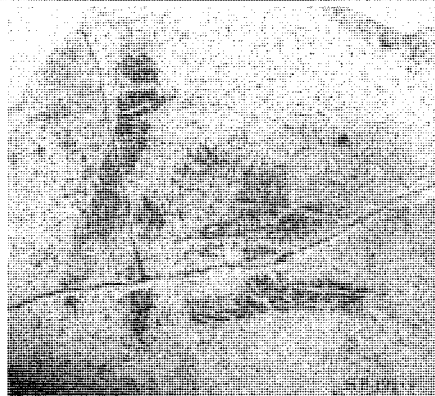
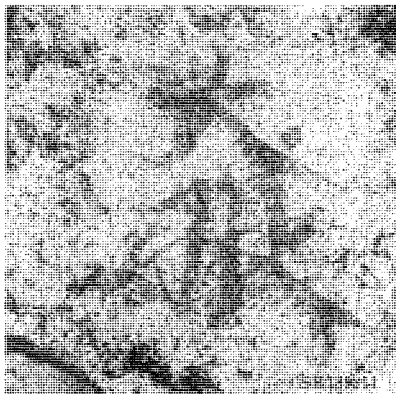
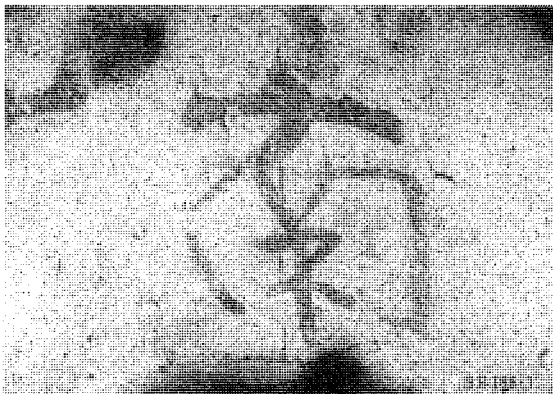

SB155-1

SB155-2

SK155-3

SB233-3

SB233-2

SB259-6

SB258-4

SB264-5

SB267-1



SK155-4



SK202-1

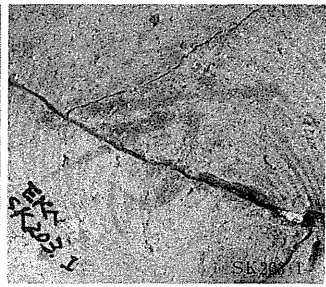

SK202-1

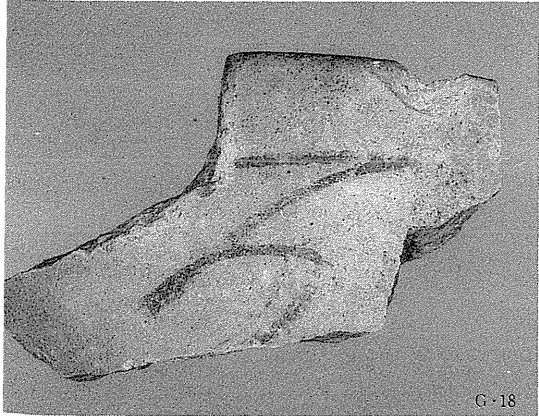

G-18



SK202-3



SK211-6



SK336-1

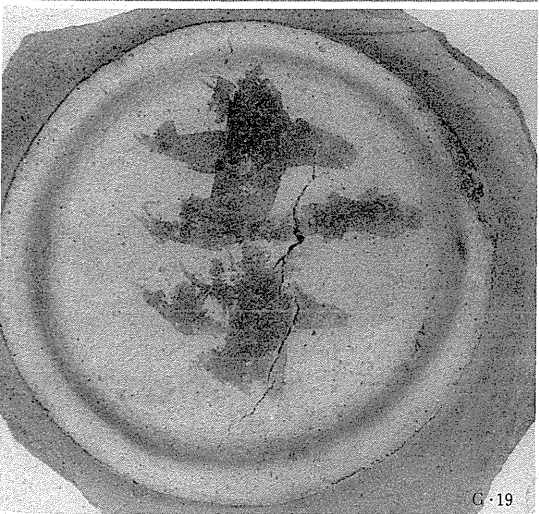

G-19



SK204-9

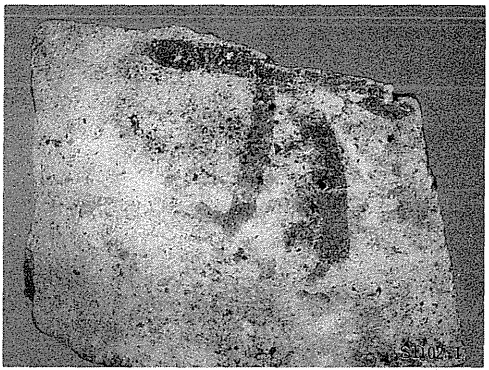

SK204-9

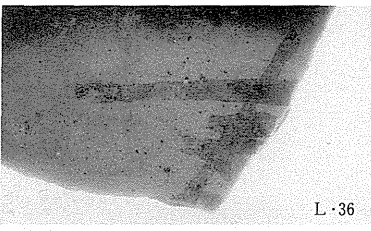

L-36

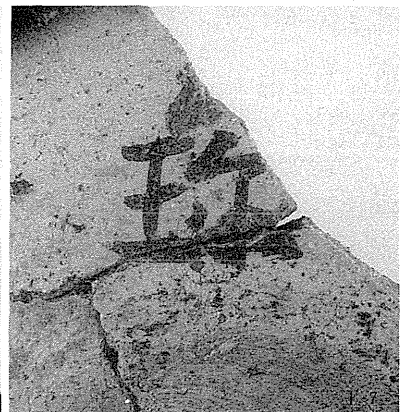

SP03-16



L-34

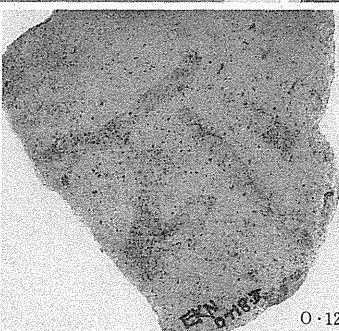

O-129



L-33

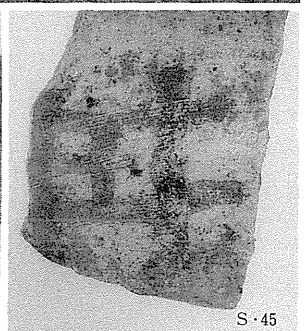

S-45



F-11

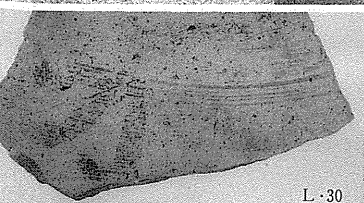

L-30



H-19



Z-21

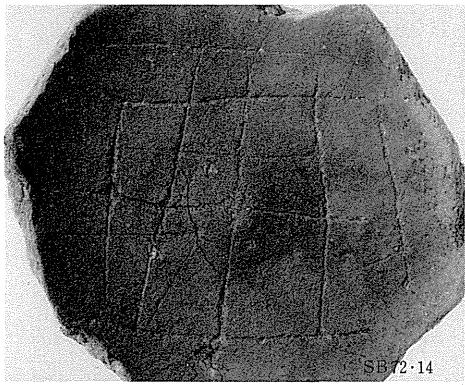

SB72-14

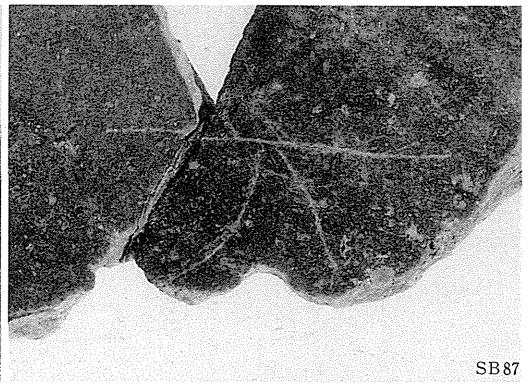
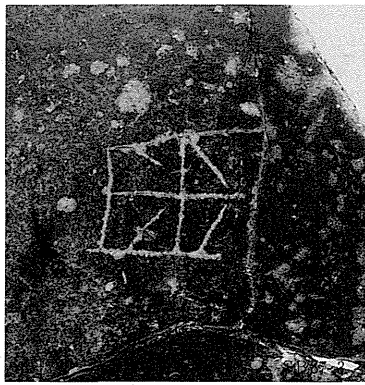

SB87



SB87-11

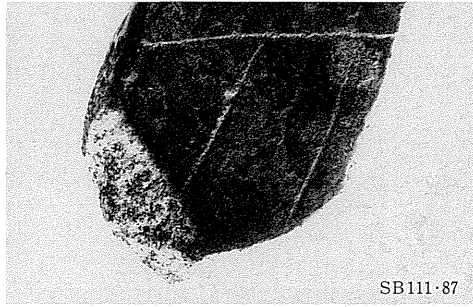
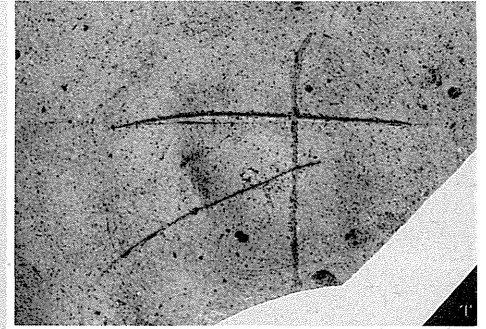
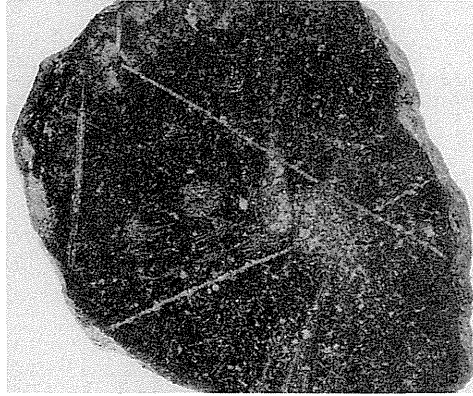

SB111-87

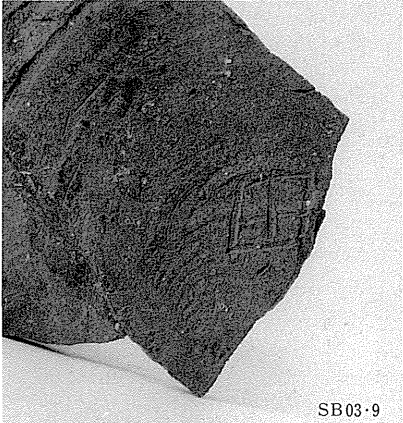
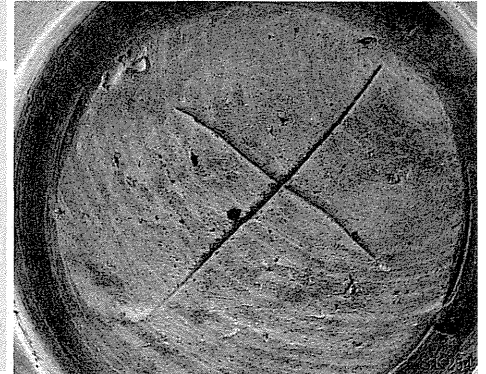

SB03-9

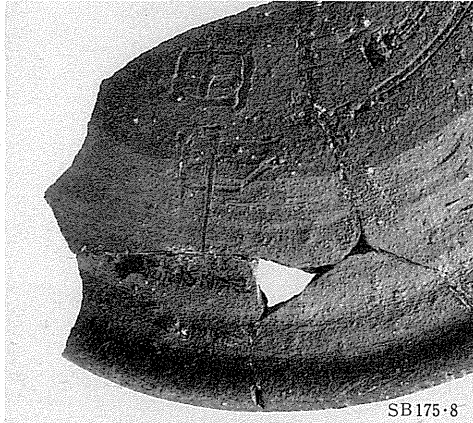

SB175-8



SB199-1

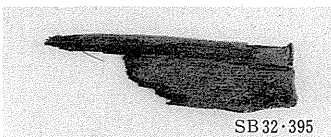

SB32-395

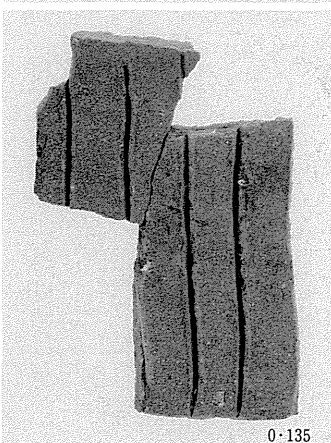

0-135

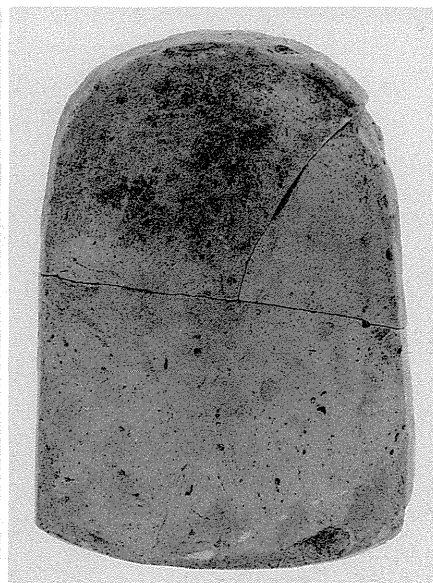

0-13



SX08-1



II-2

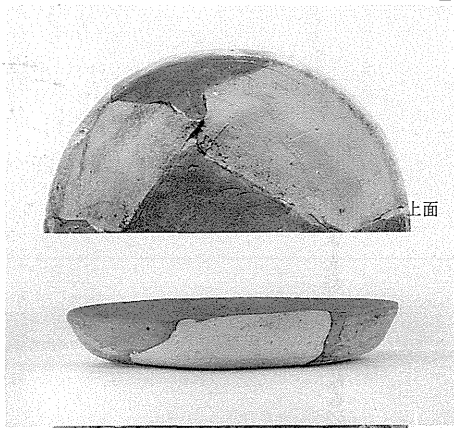

上面



SB255-1



I-5



底面
II-1

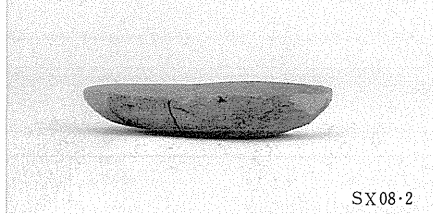

SX08-2



SD21-1

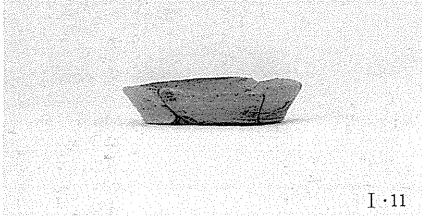

I-11

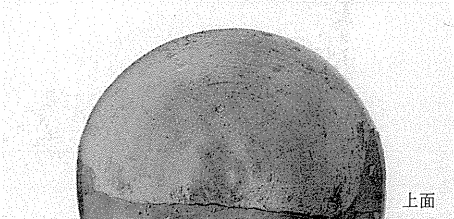

上面



I-3

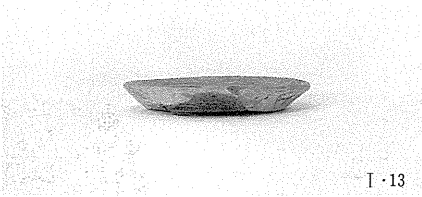

I-13

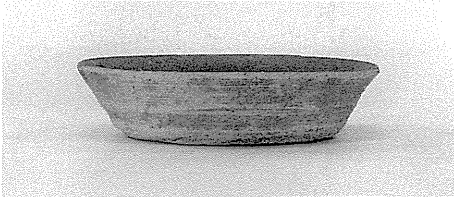

I-17



I-18

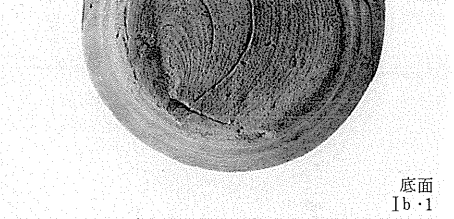

底面
Ib-1

土器皿

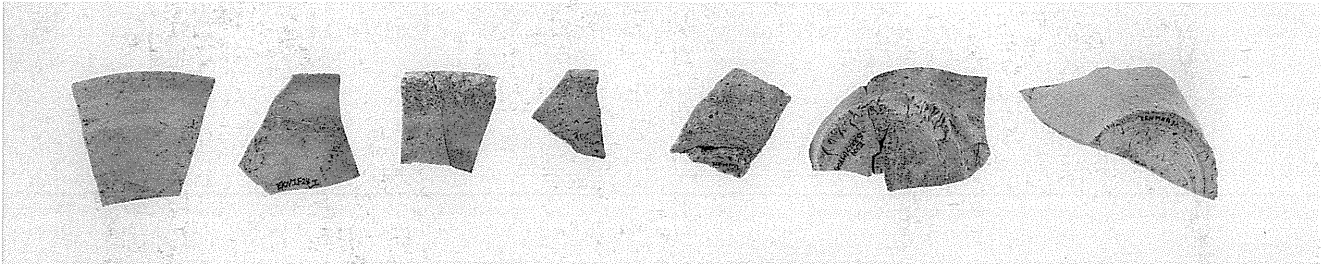

山茶碗

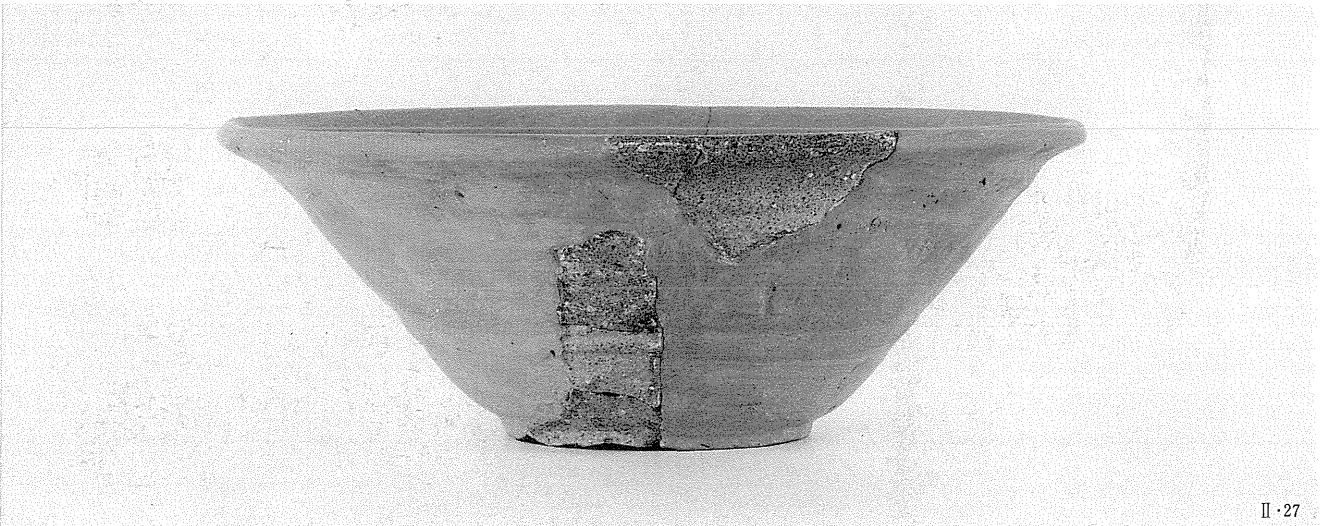

II-27

捏鉢



II・26



捏鉢

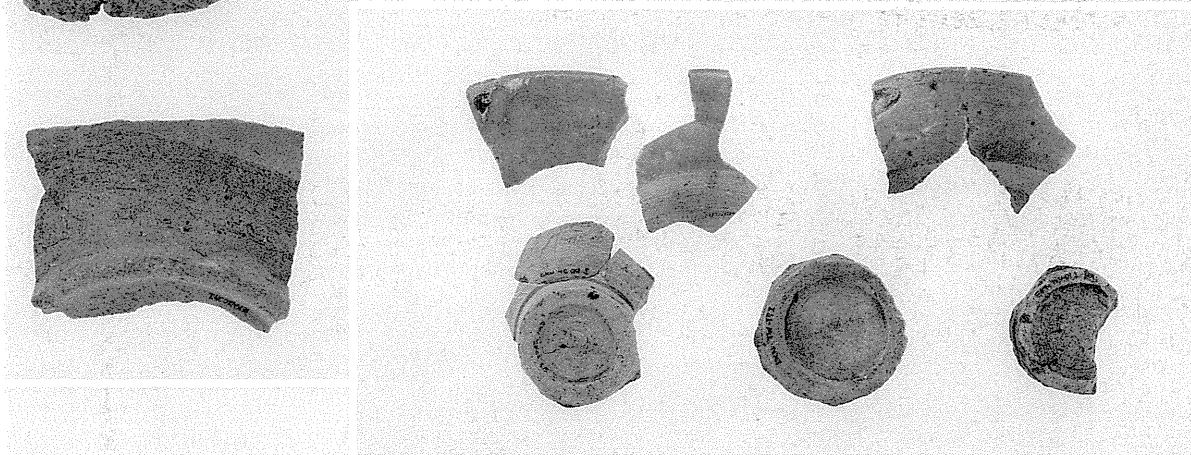

右 古瀬戸系平碗



古瀬戸系天目茶碗

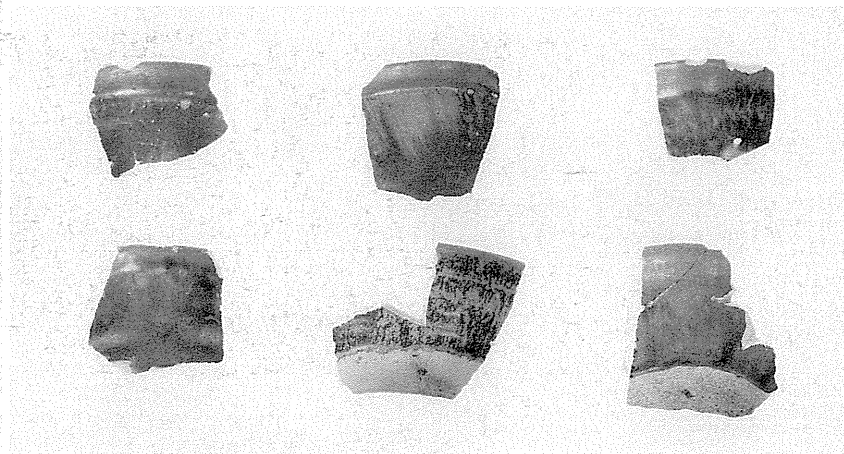

SK1221・1



SB1179-1

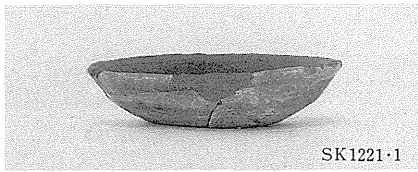

SK1221-1

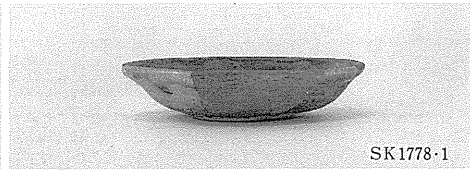

SK1778-1

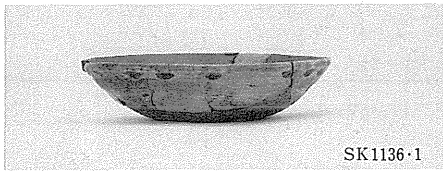

SK1136-1

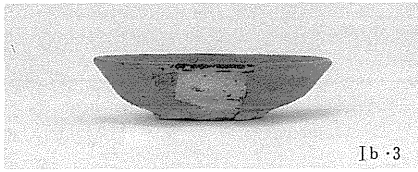

Ib-3

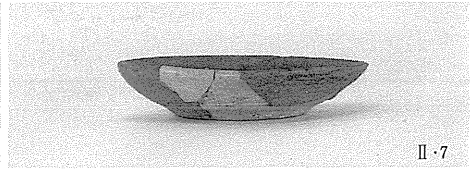

II-7

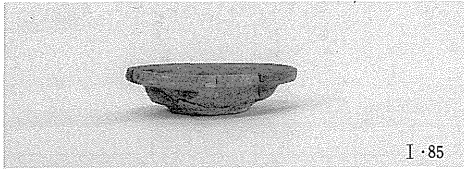

I-85

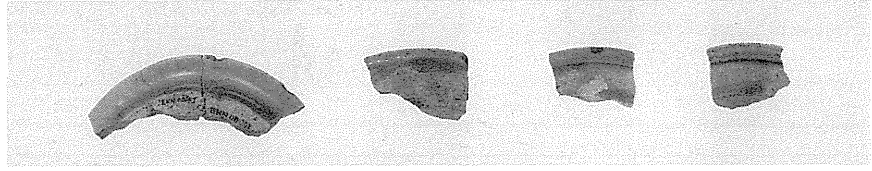

古瀬戸系
小皿

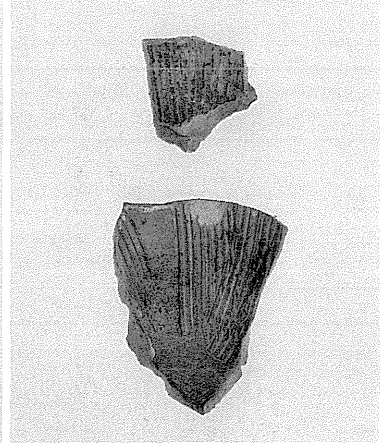
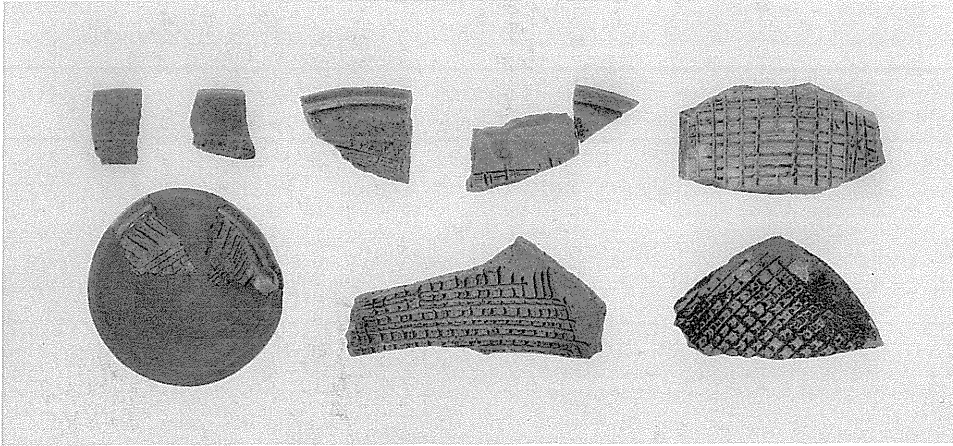

古瀬戸系
おろし皿

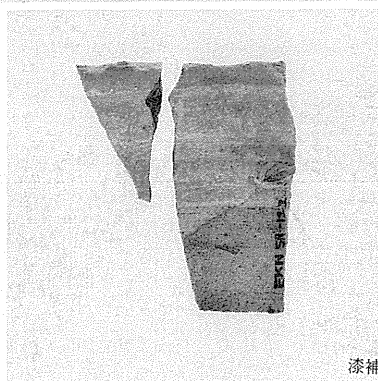
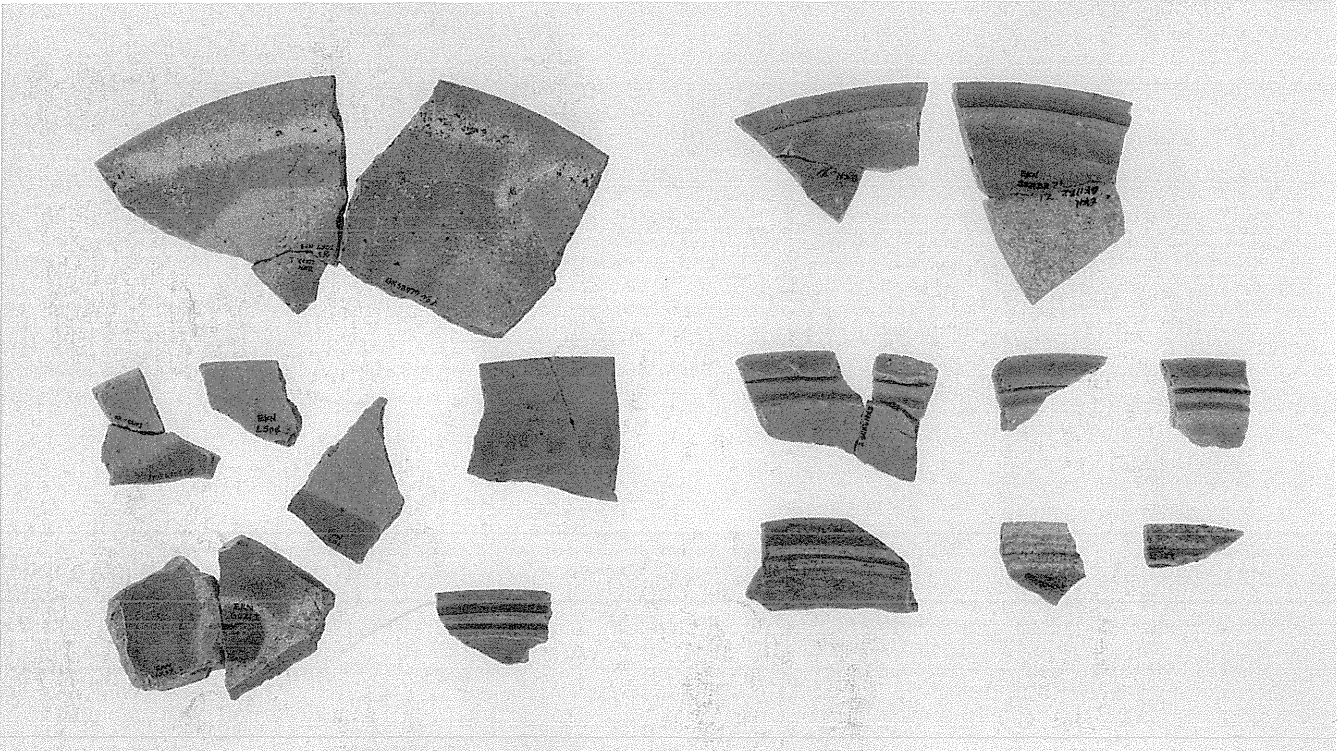

漆補修痕

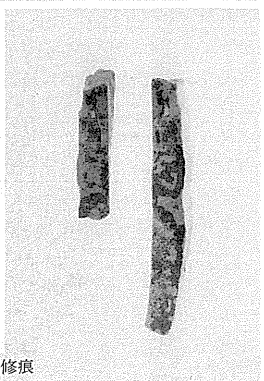

古瀬戸系
折縁深皿

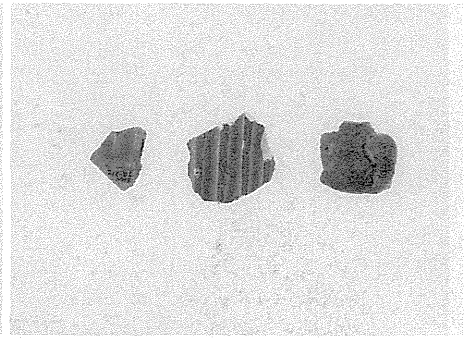
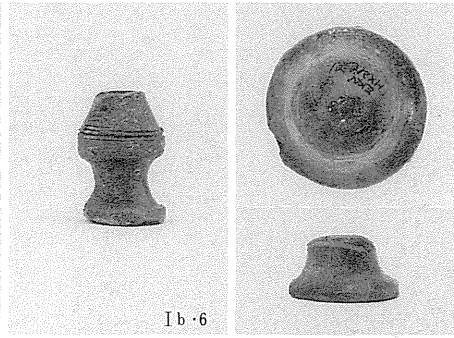
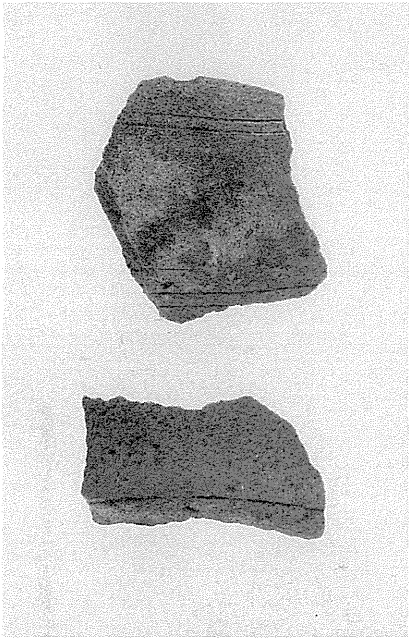
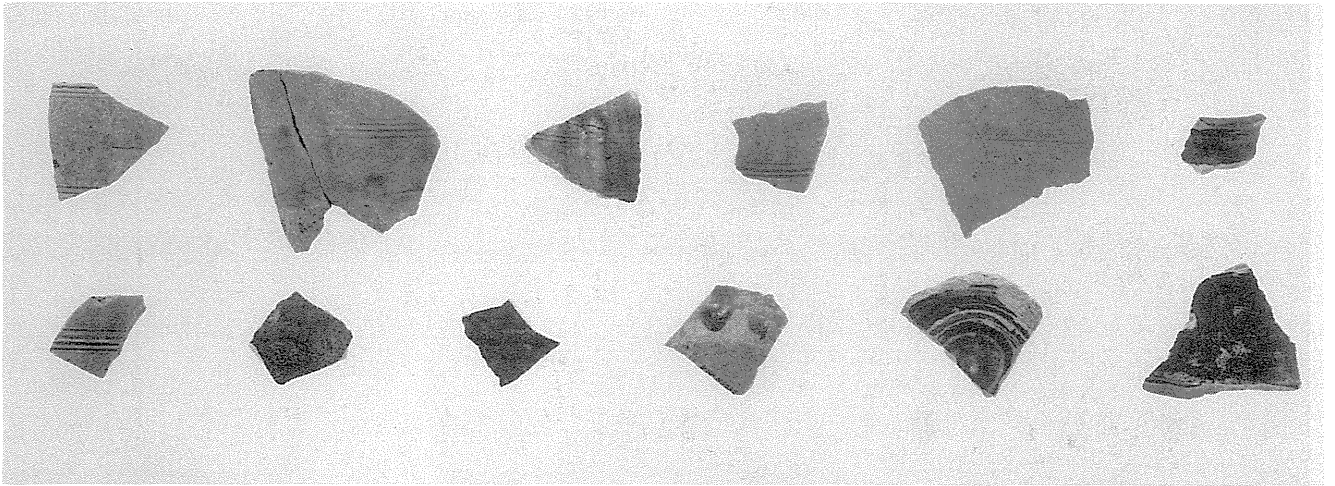

古瀬戸系
壺類

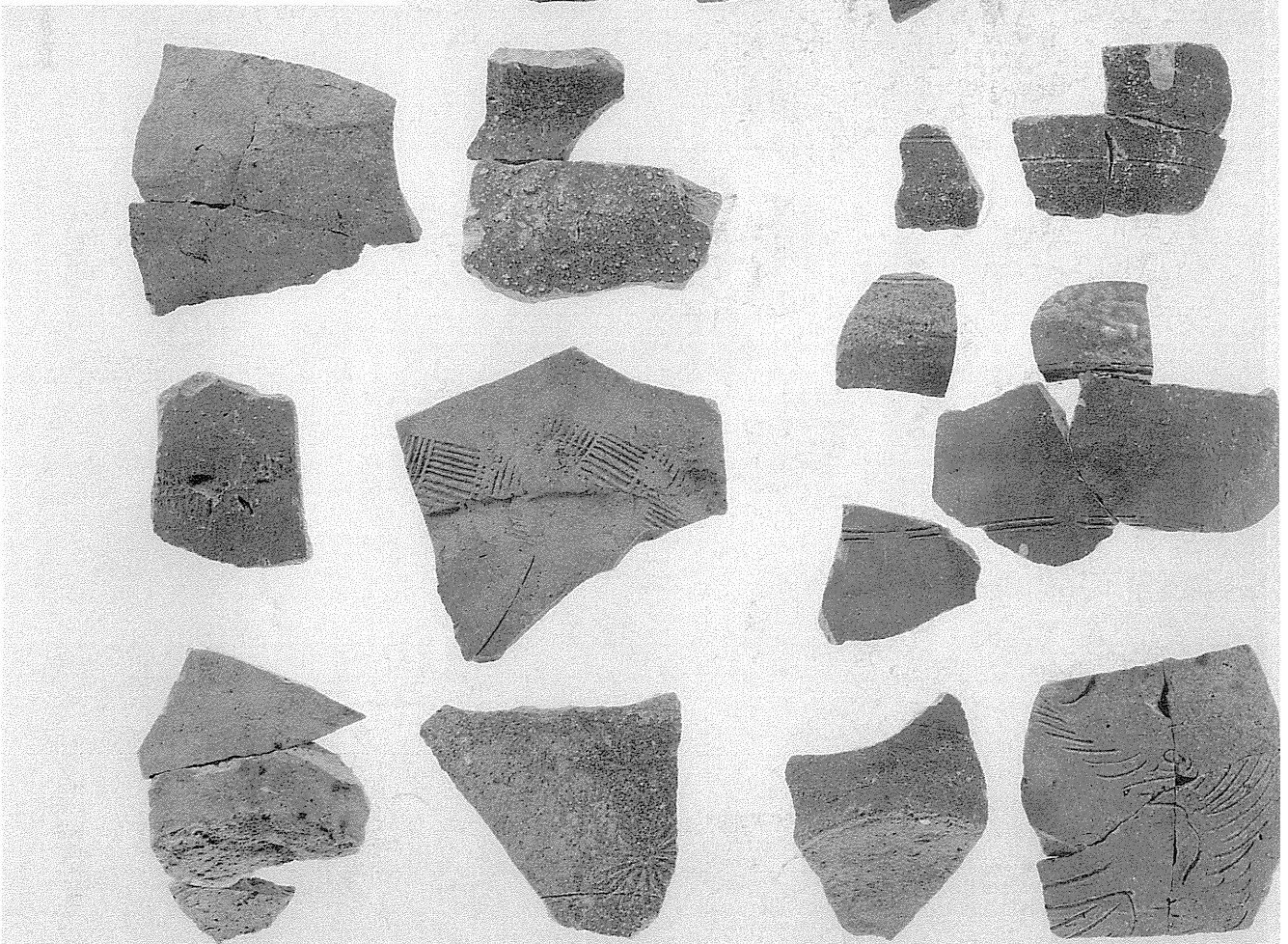
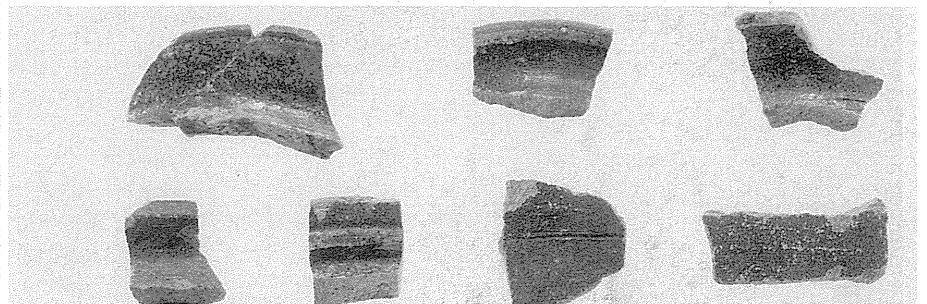

常滑系
壺・甕類

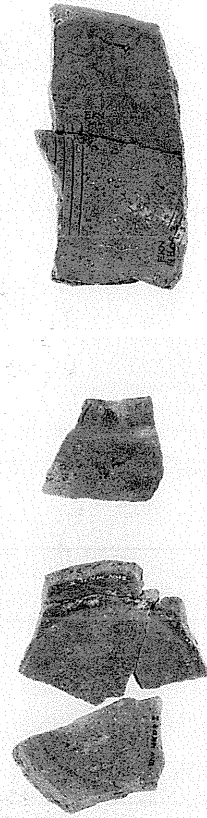

左 須恵器質
摺鉢

II・30

常滑系甕

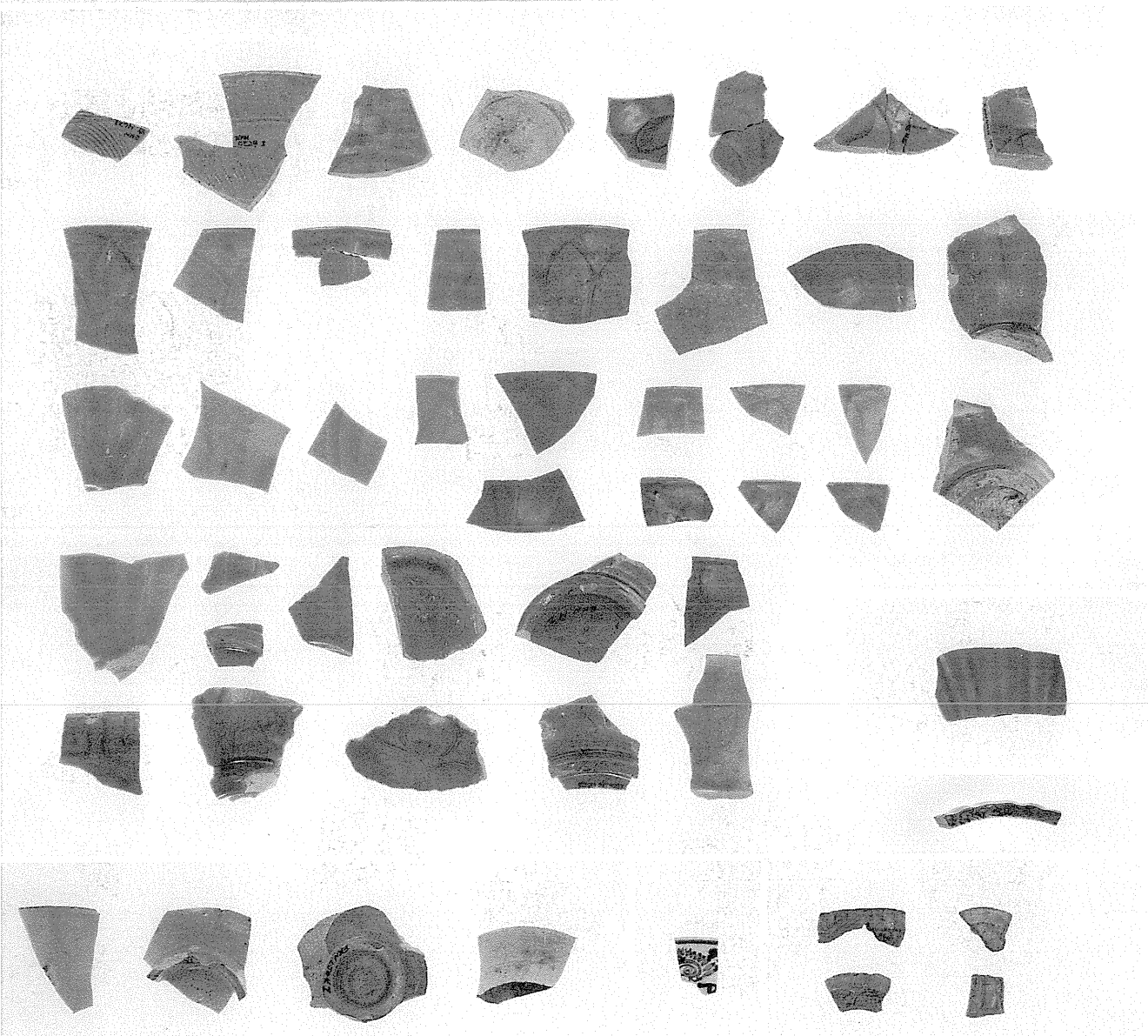

輸入陶磁器

右 銅緑釉
天目茶碗
(大窯)

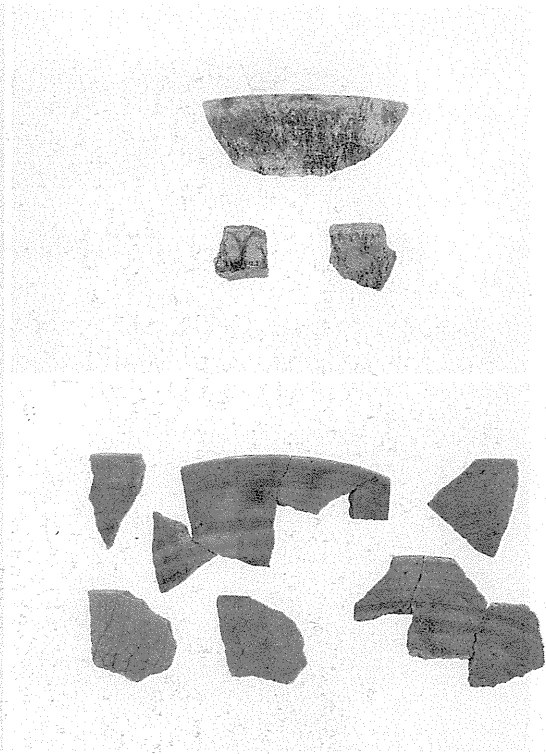
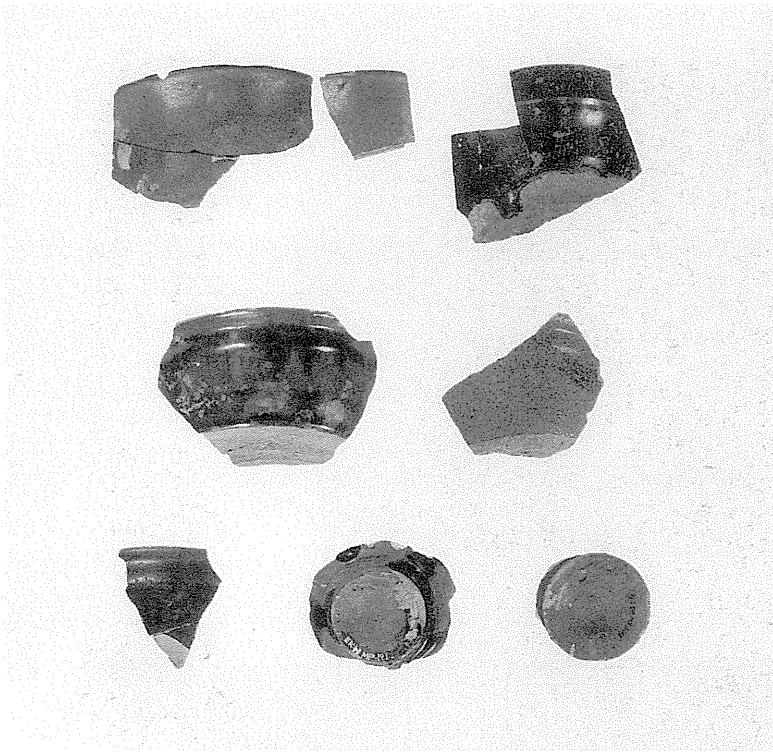

左 天目茶碗
(大窯)

右 平碗
(大窯)



I・147



SK1208-1

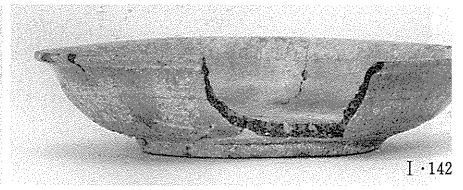

I・142



I・145

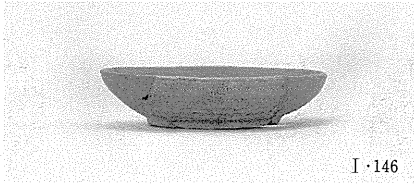

I・146



I・142

皿類
(大窯)

左 香炉
(大窯)

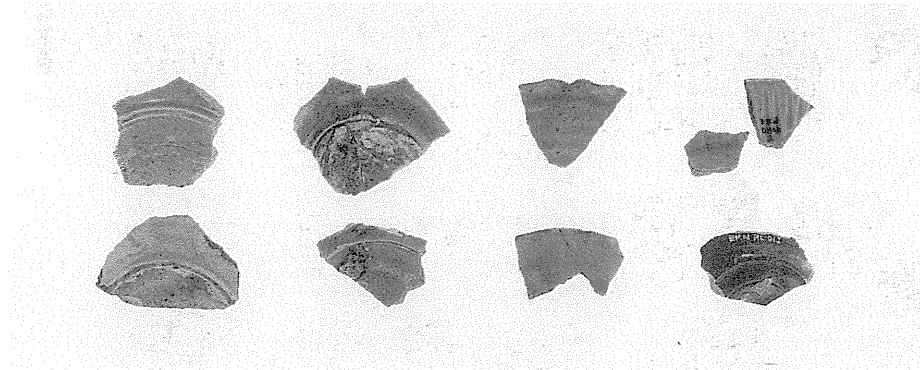

I・157

左 摺鉢
(大窯)

右 香炉
(大窯)

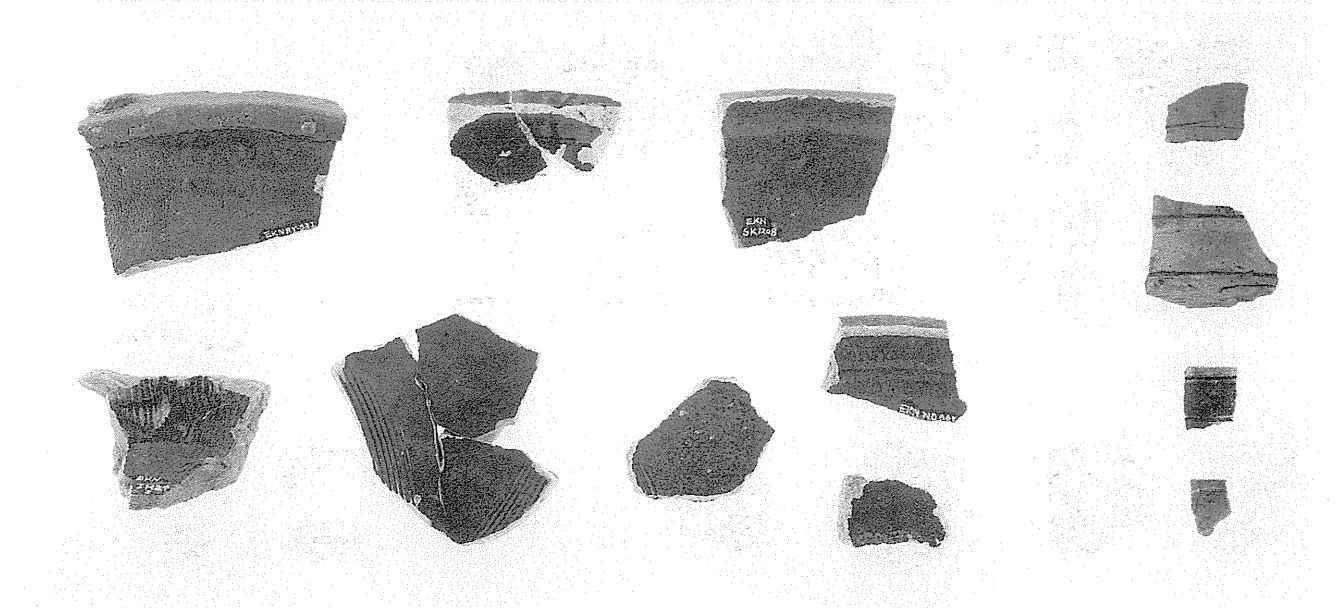

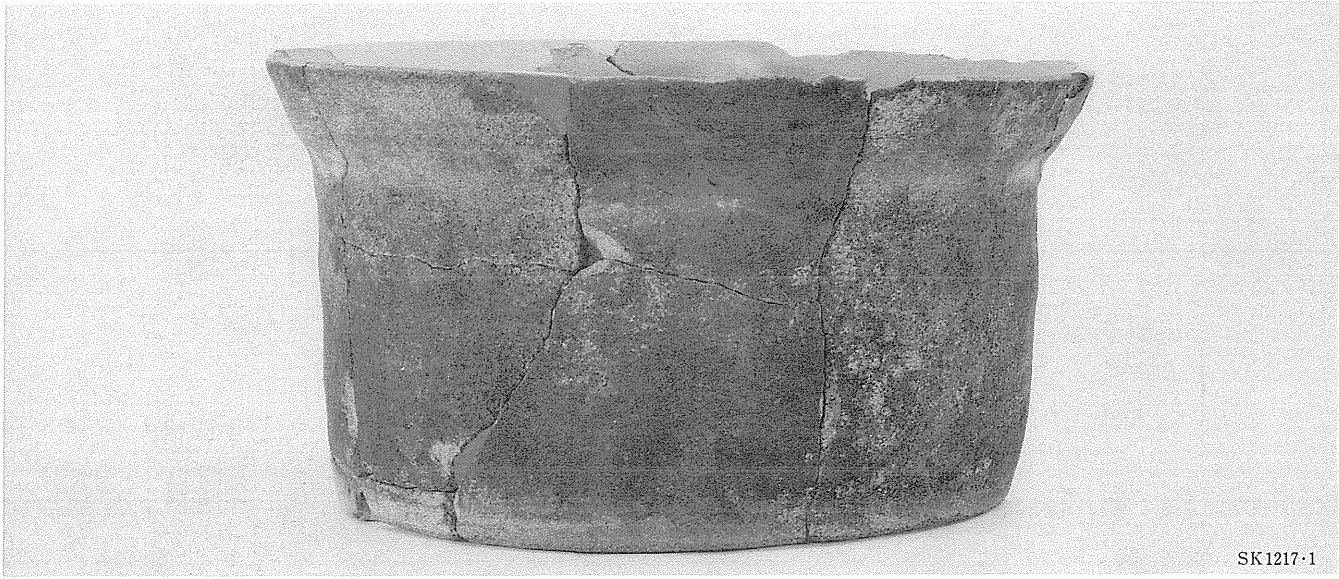

SK1217-1

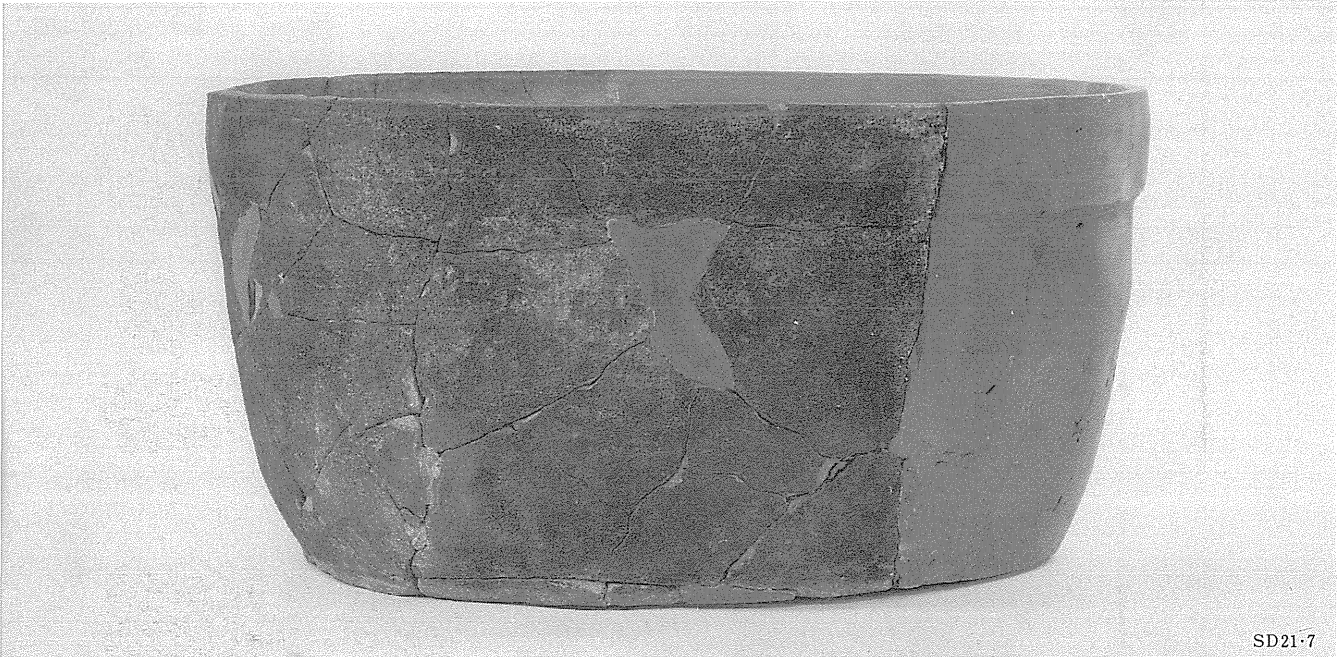

SD21-7



SK1188-1

内耳鍋

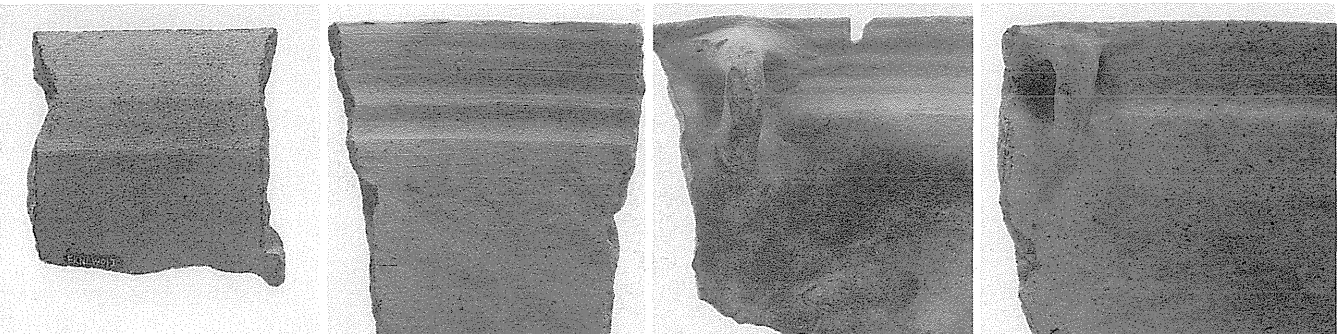

内耳鍋
口縁部内面

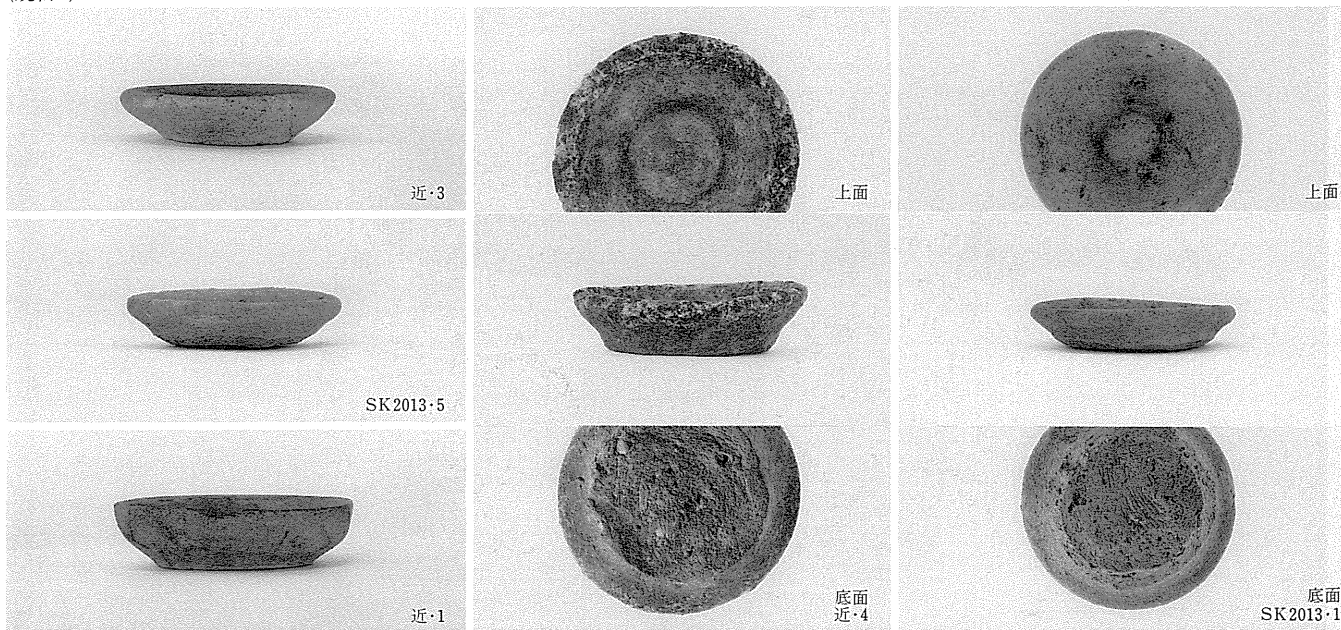

土器皿

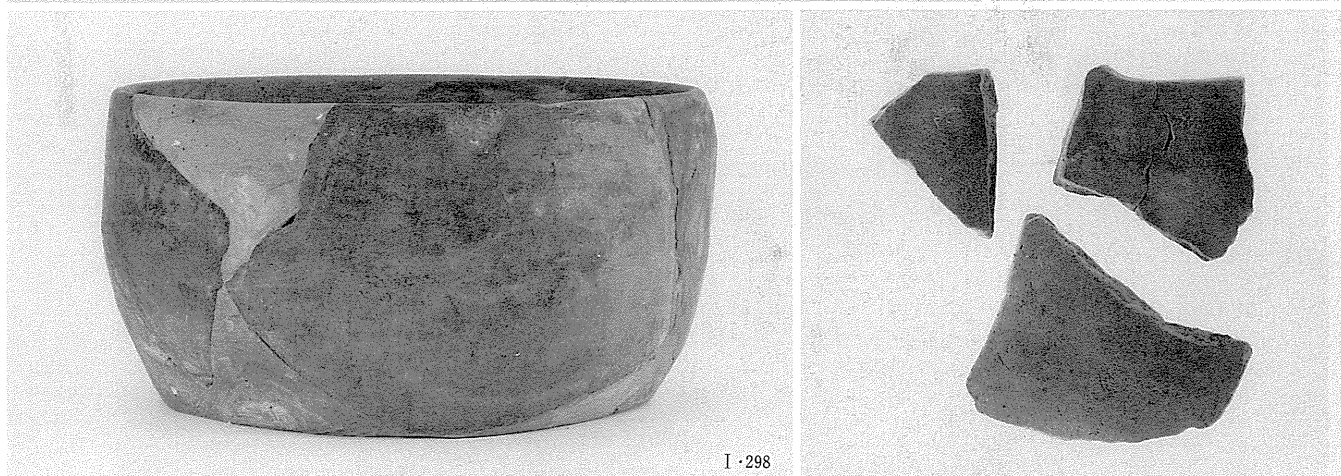

鉢 類

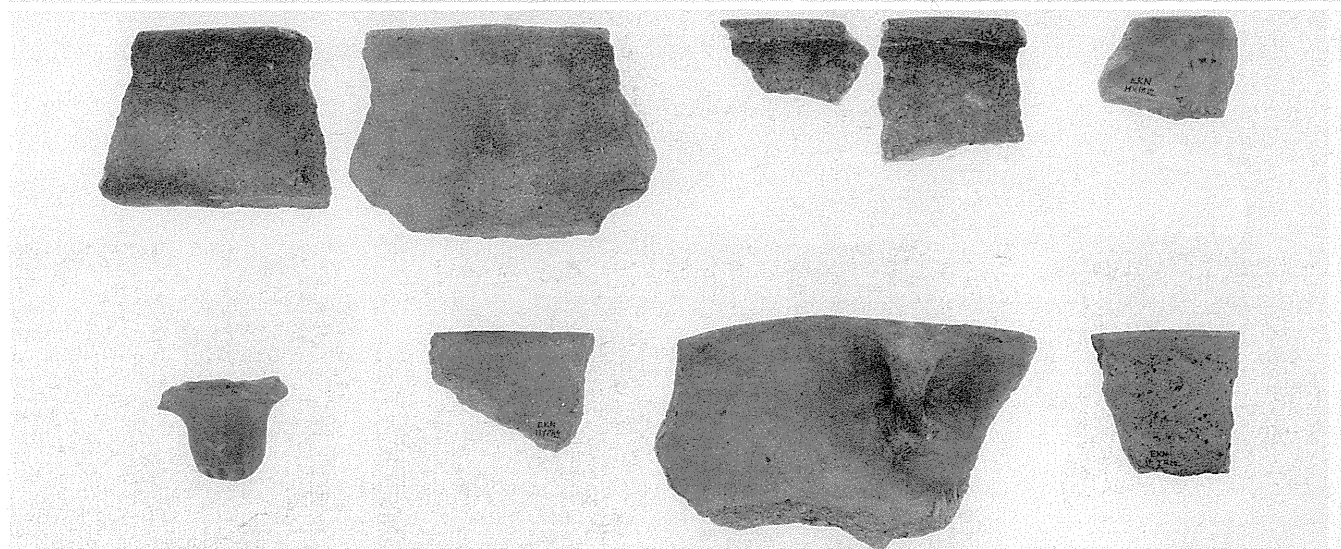

ホウロク



SK2020.2021・1

ホウロク

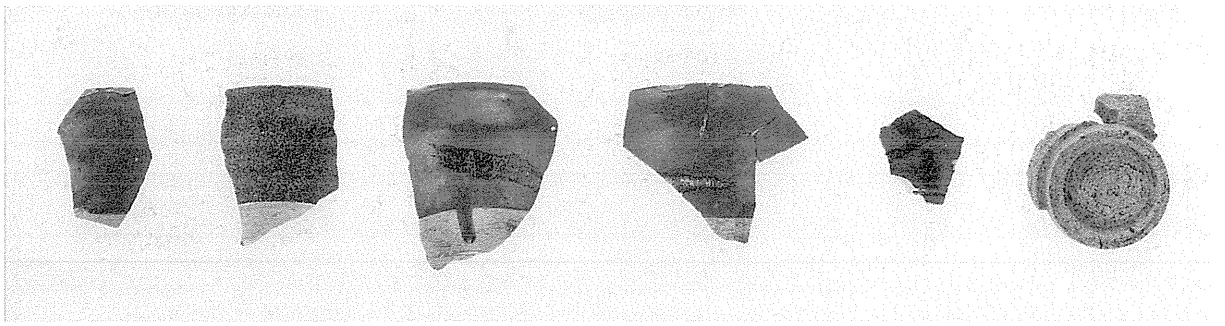

天目茶碗
(近世)

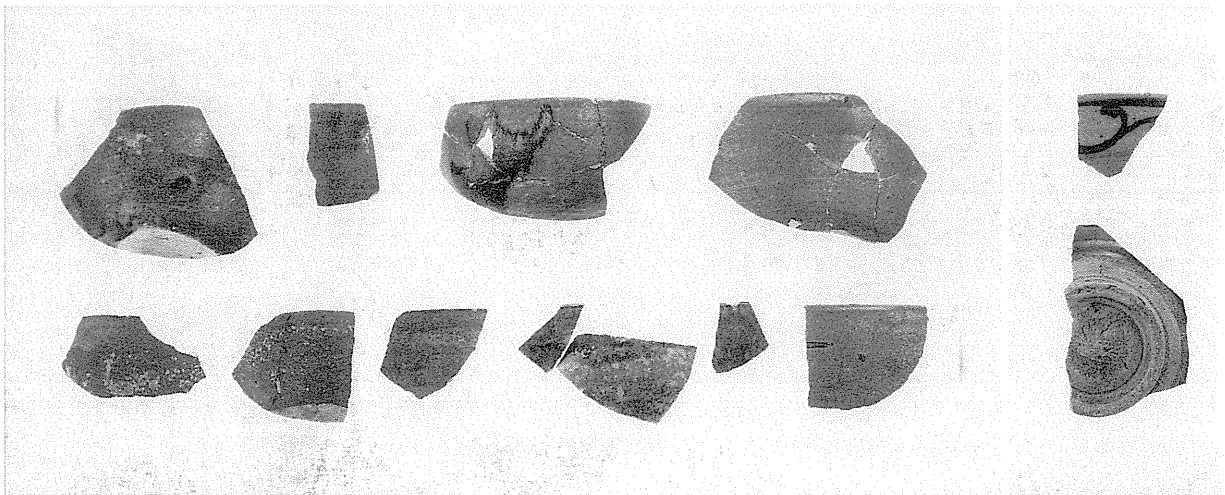

左 鉄釉丸碗
(近世)

右 鉄絵長大釉皿



近・5



SX2023・2



SK2014・1

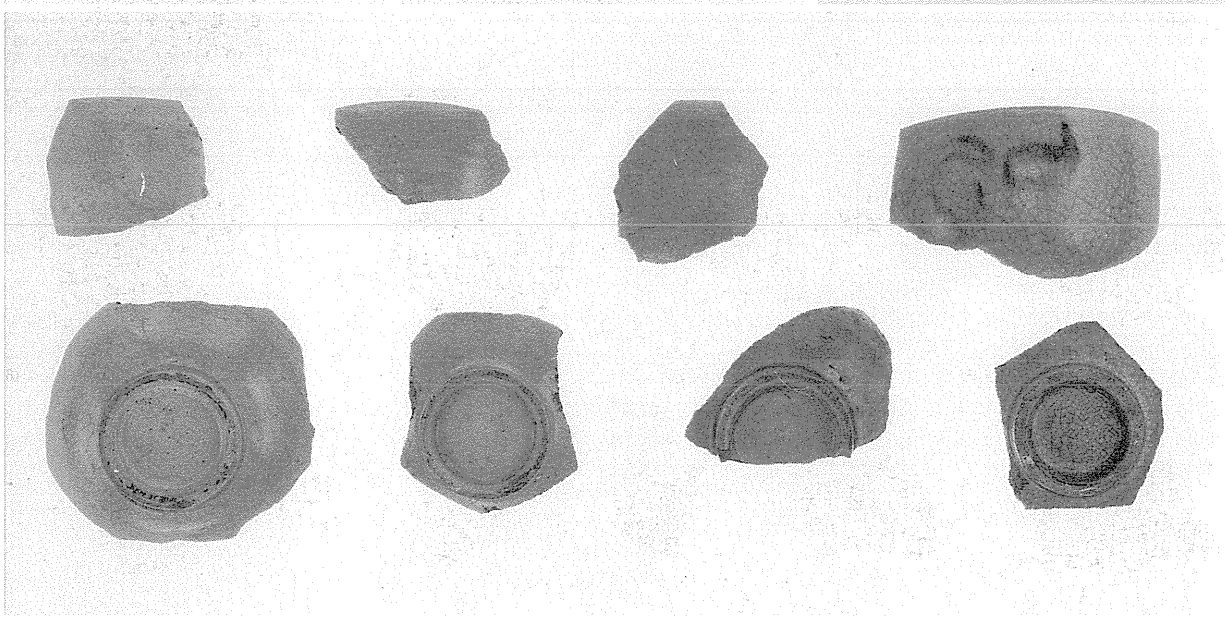

灰釉丸碗
(近世)

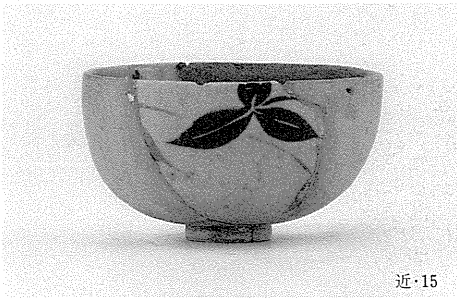

近・15



I・197

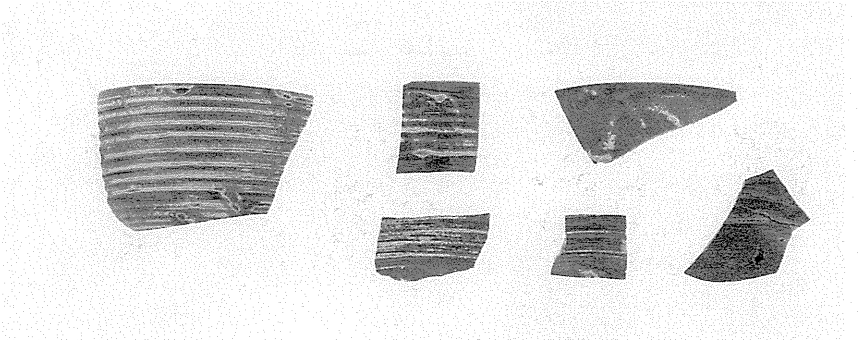

SK2005・1

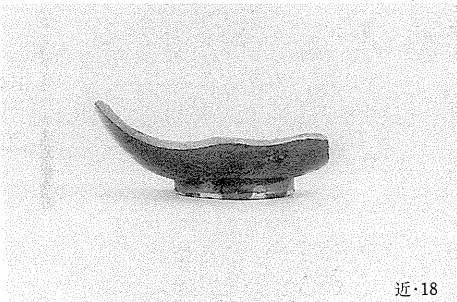
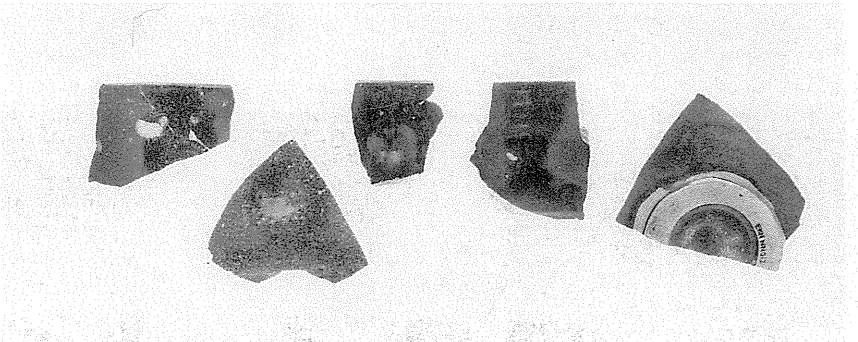

近・18

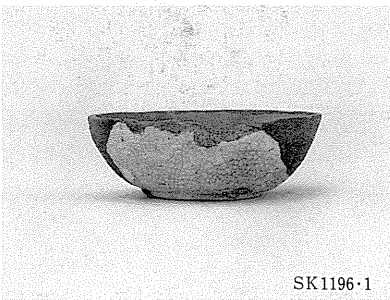
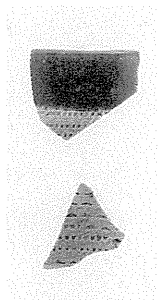
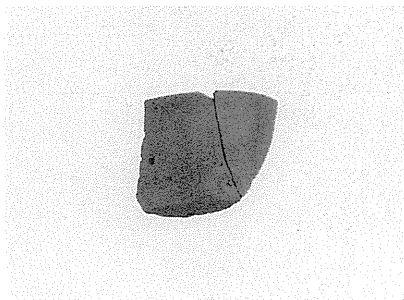
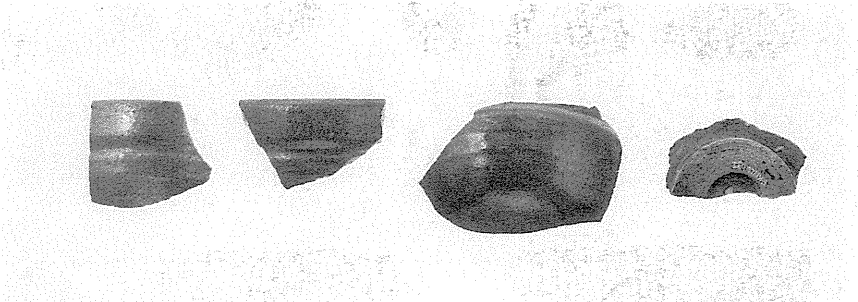

SK1196・1

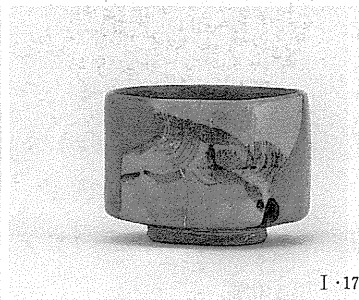

I・177



近・25



I・210



近・26

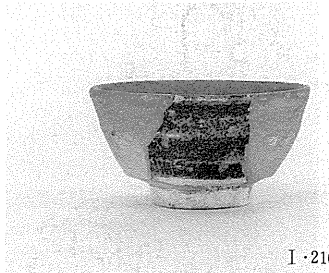

I・216

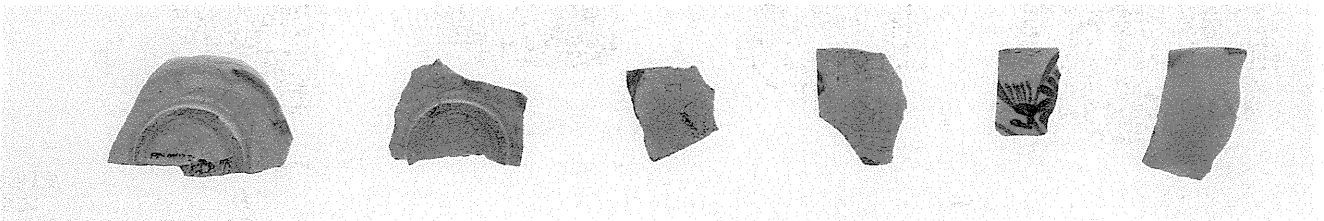

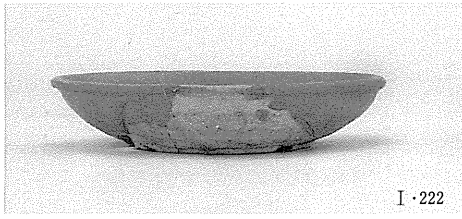

I・222

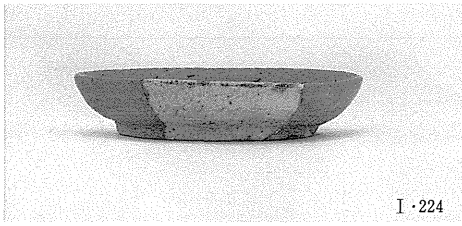

I・224

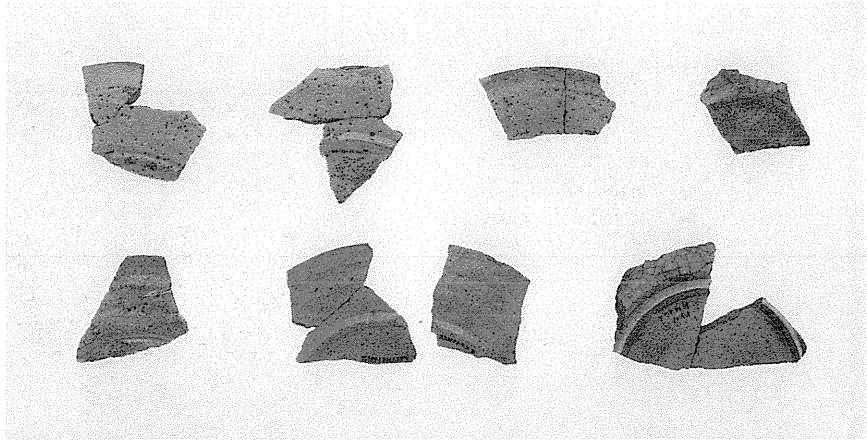

上面



I・232

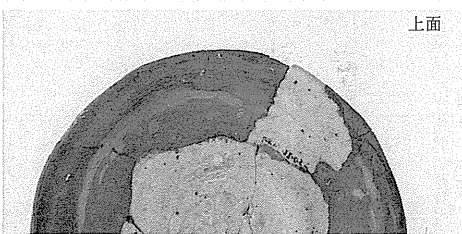
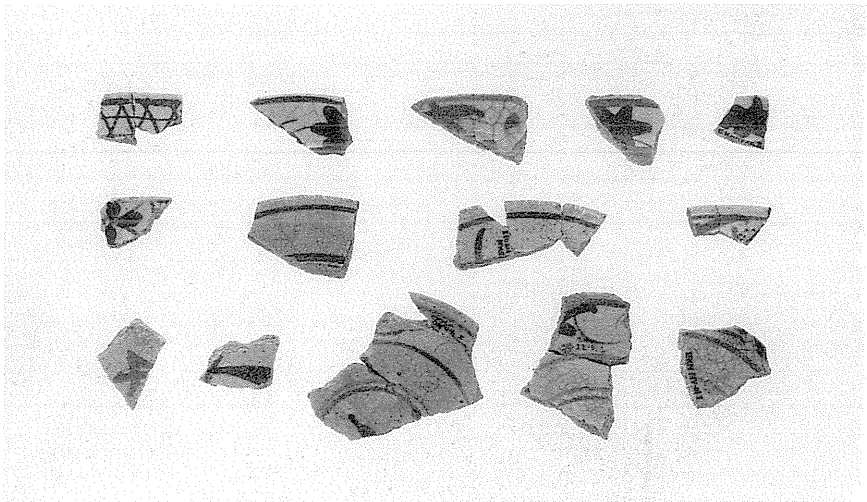

上面

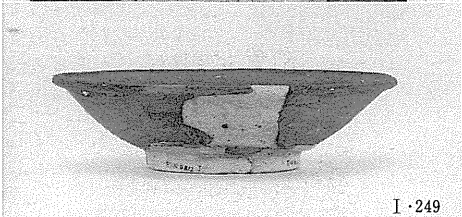

I・249

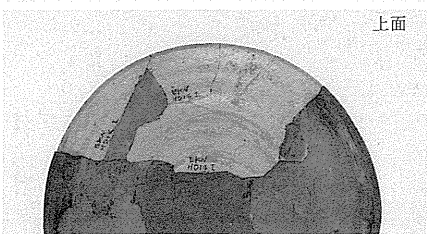

上面



I・237

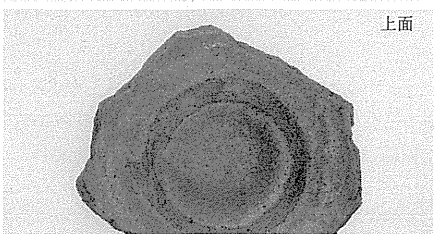

上面



近・41下

長石釉

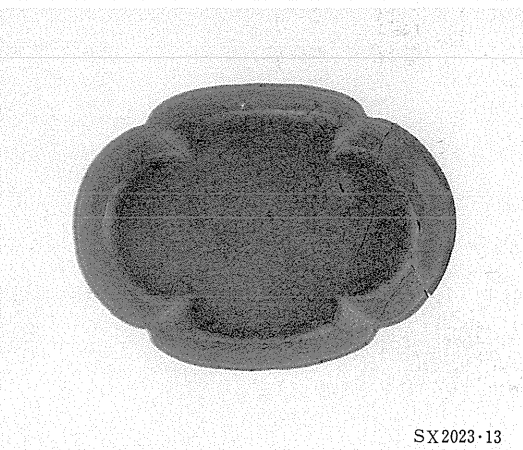
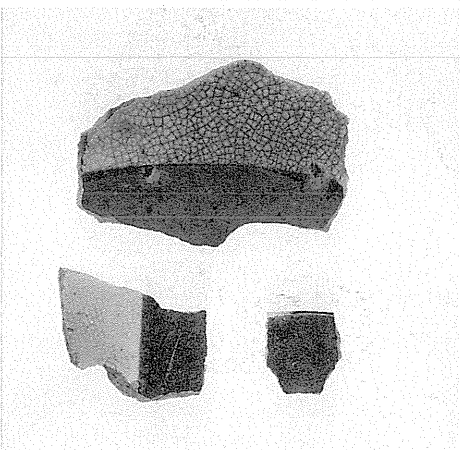
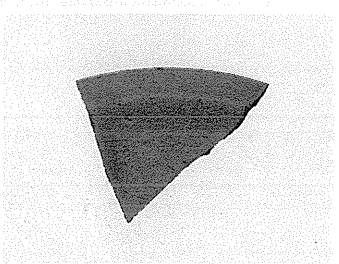

SX2023・13

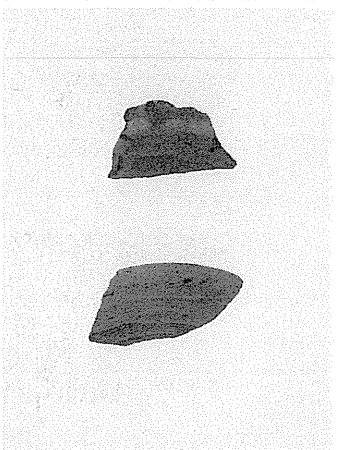

皿
(近世)

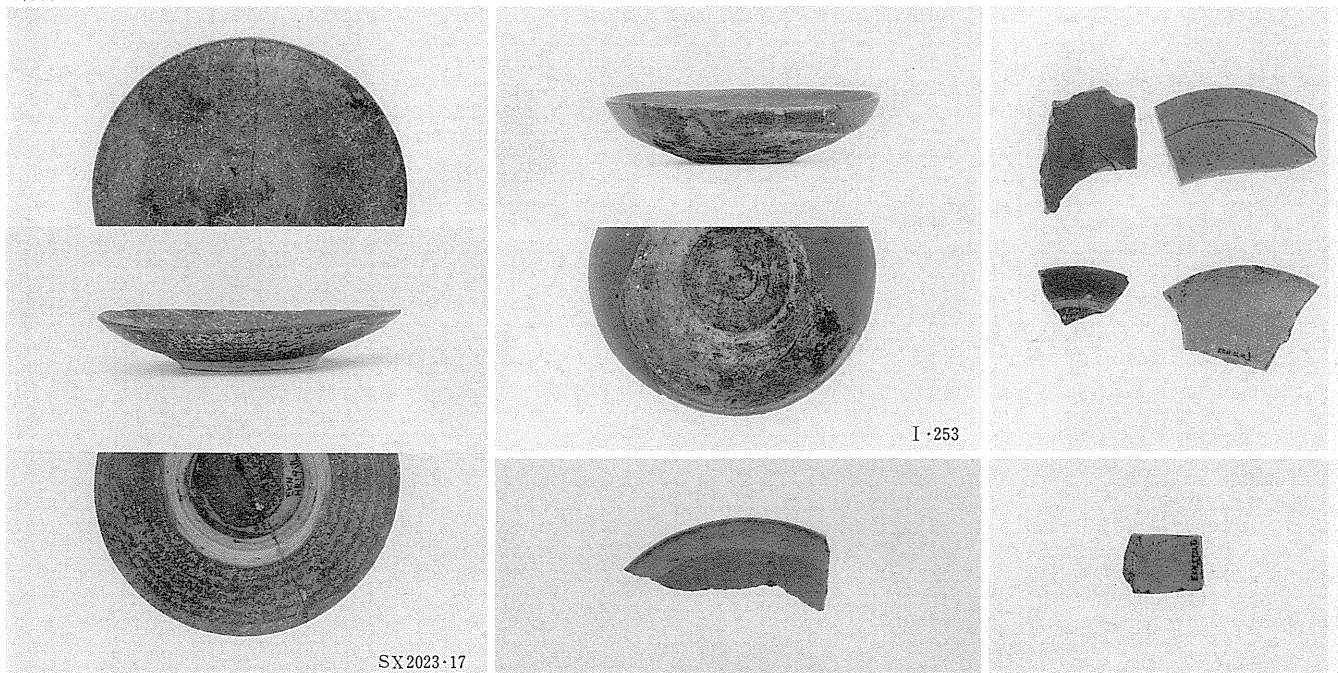

I・253

SX2023・17

皿
(近世)

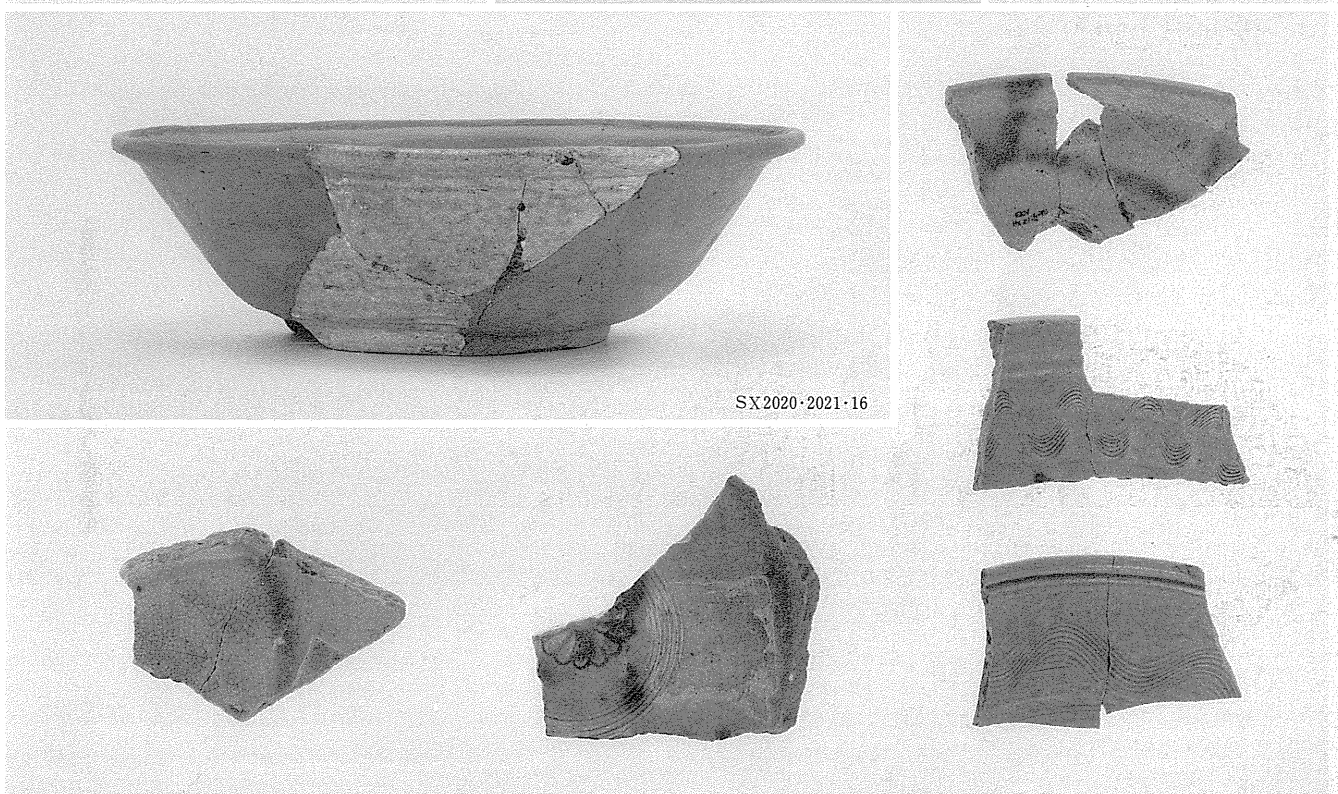

SX2020・2021・16

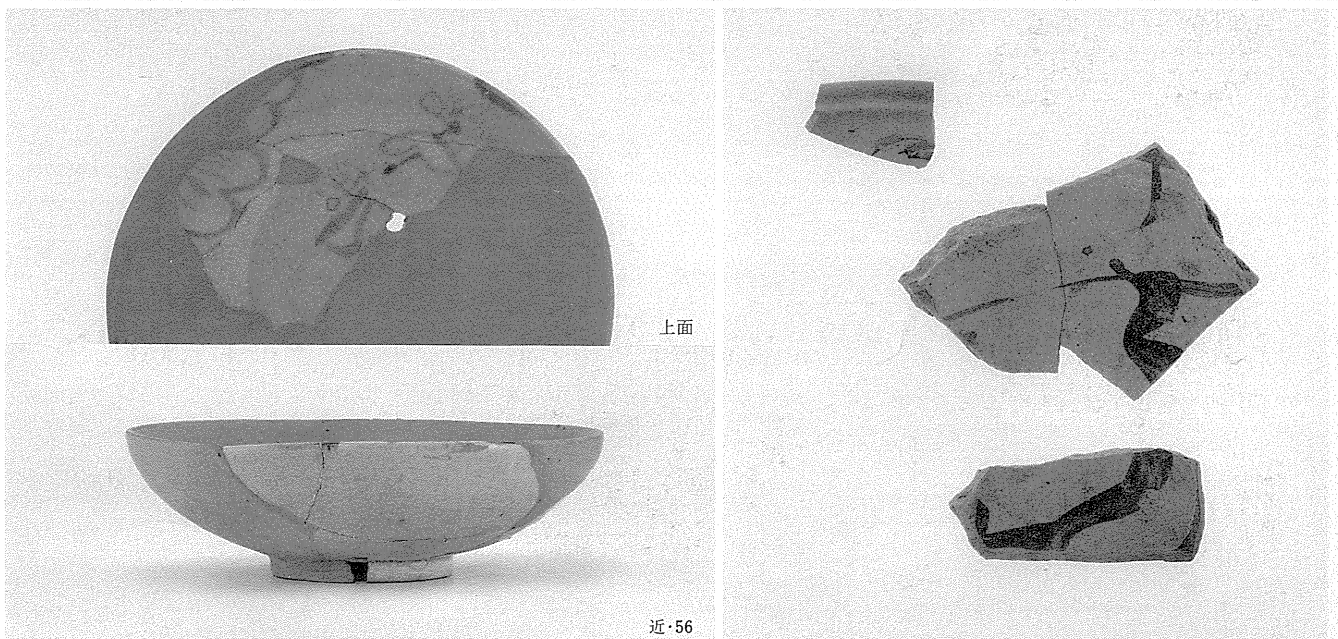

上面

近・56

鉢
(近世)

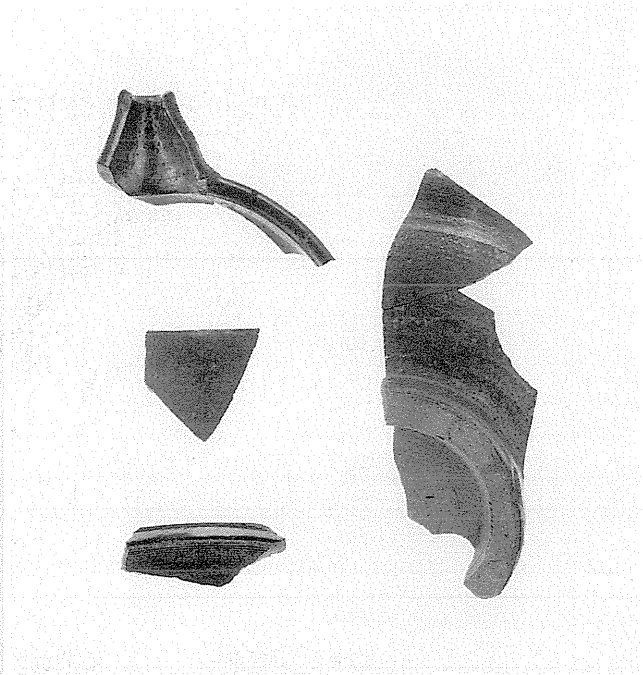
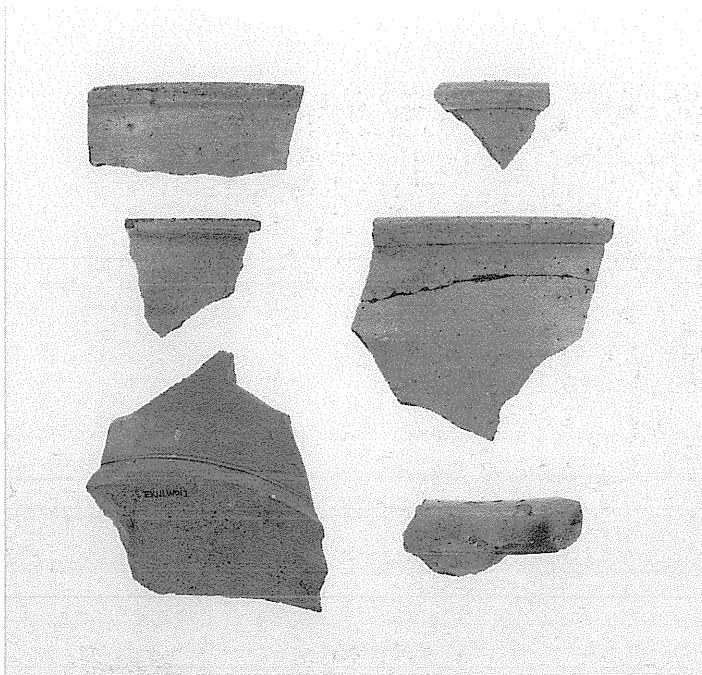

SX2023・23



SX2020・2021・20



SD32・22

鉢
(近世)



SK1190・5

播鉢
(近世)



SX2020.2021・23

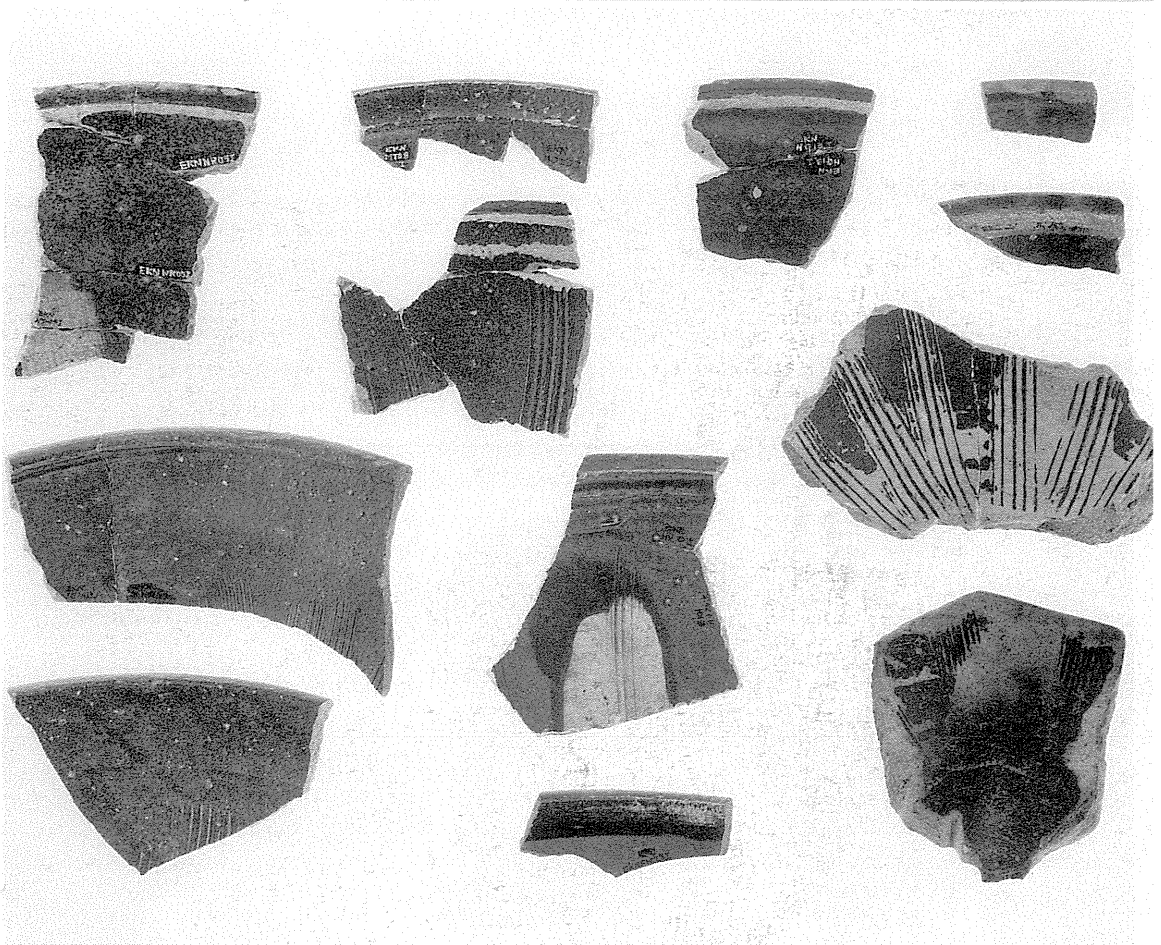

播鉢
(近世)

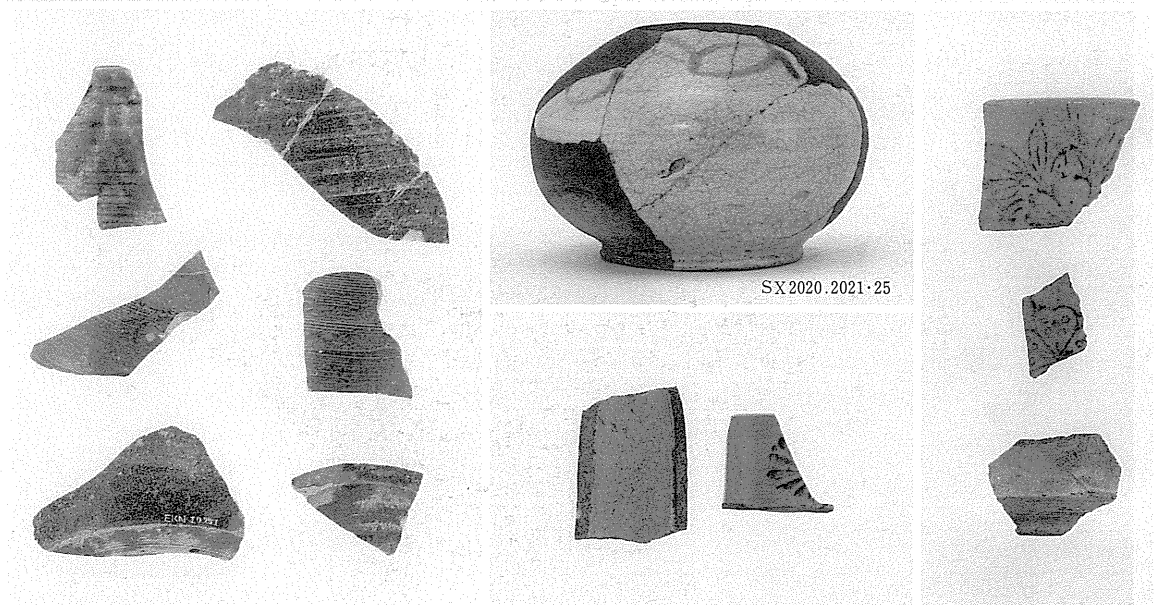

壺類
(近世)

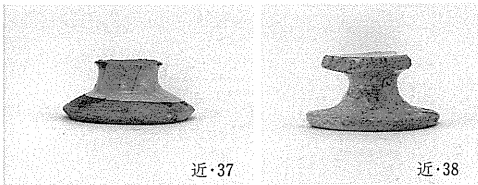

近・37

近・38

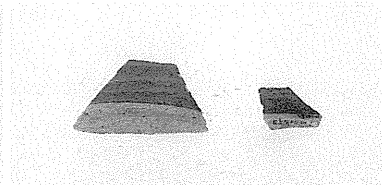

SK2005・8

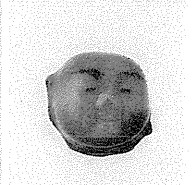

I・300

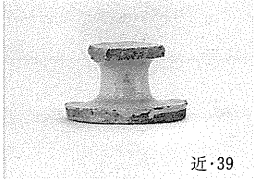

近・39

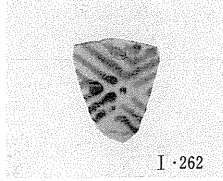

I・262

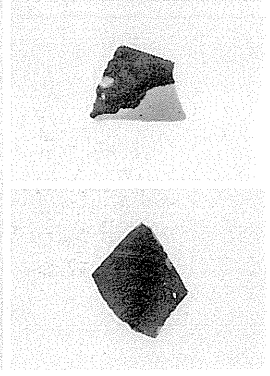
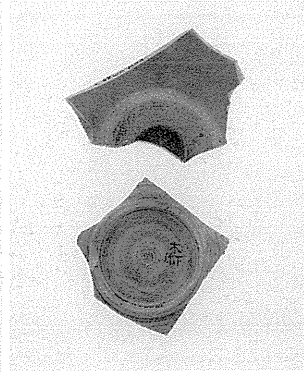
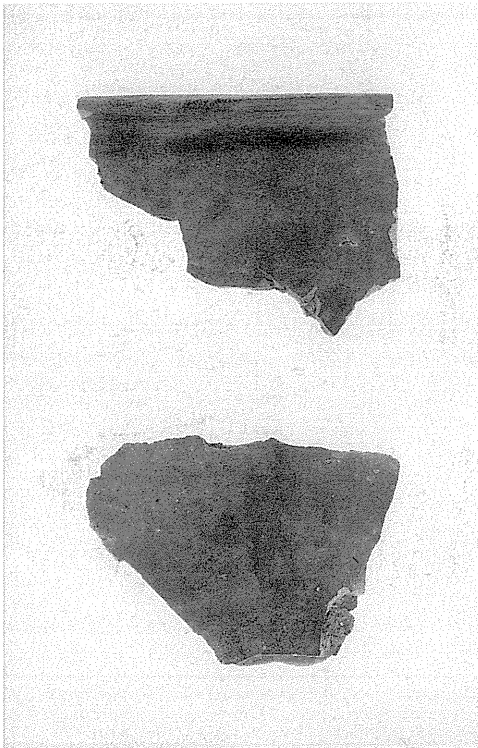
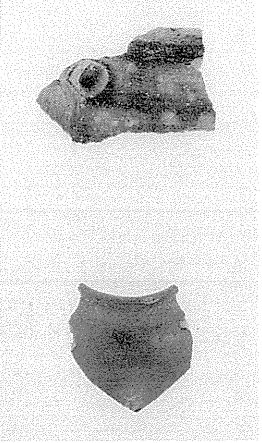
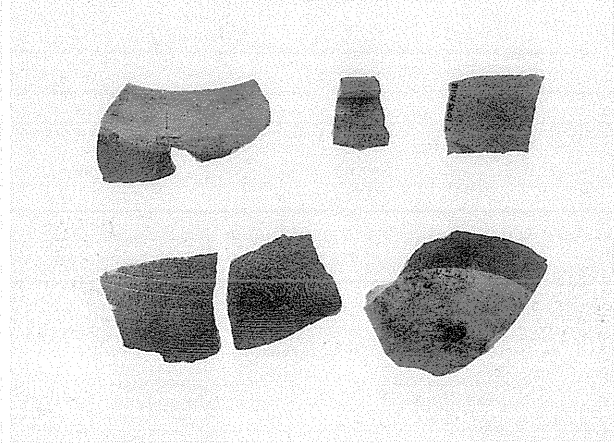
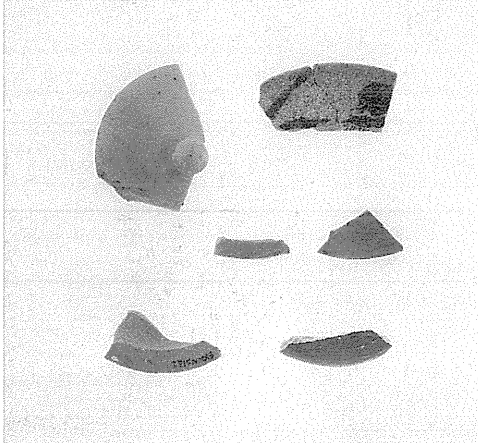
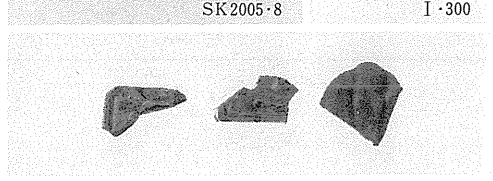
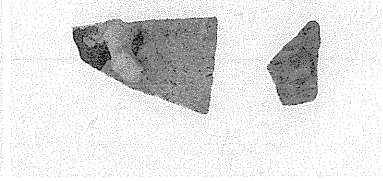

SX2023・3



近・57

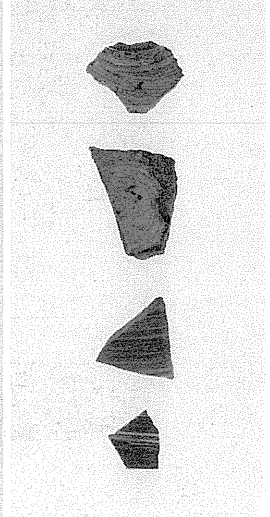

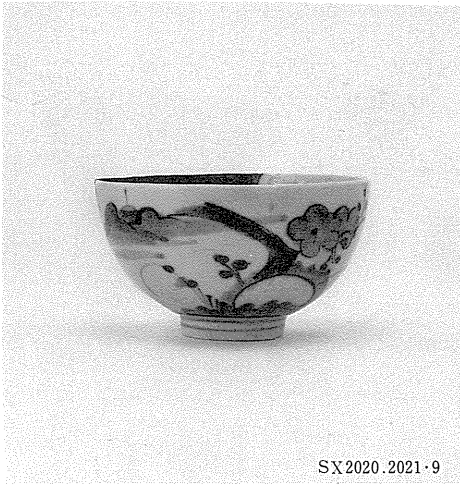

SX2020.2021・9

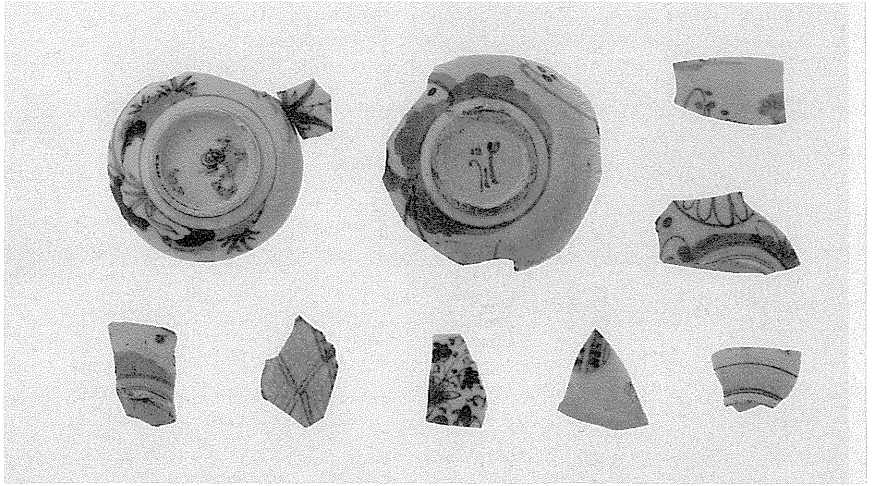

近・23



I・209



SX2023・9

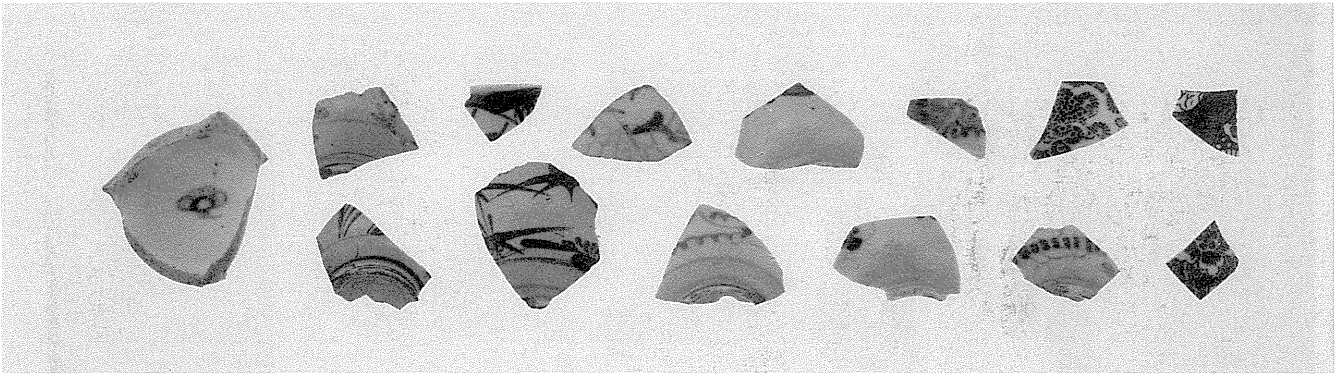

近・32

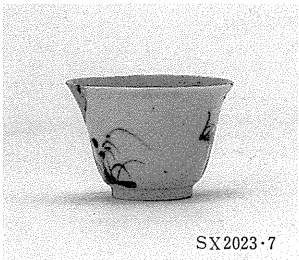

SX2023・7

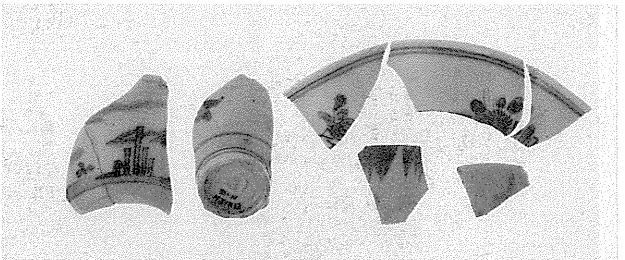

上面

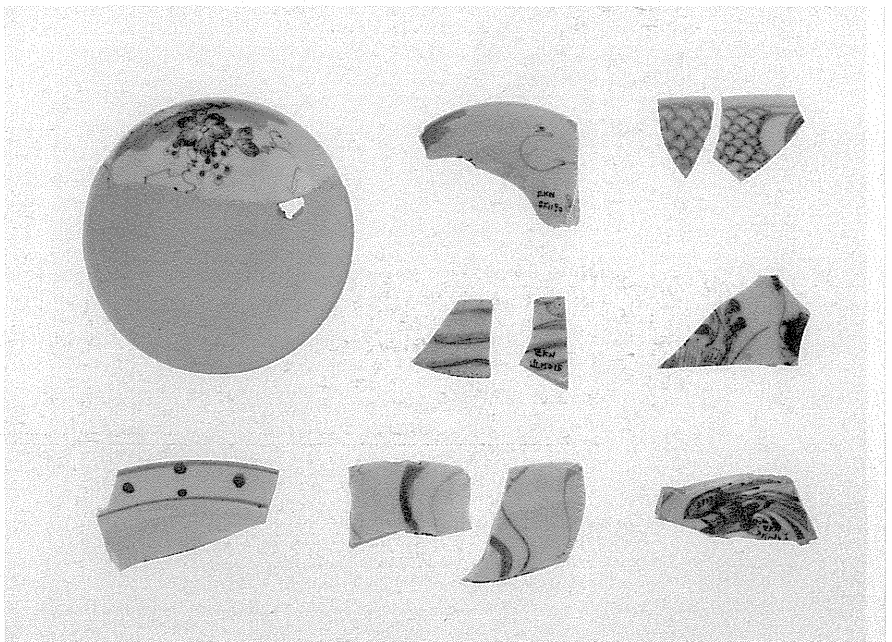

SX2020.2021・14



SX2020.2021-19

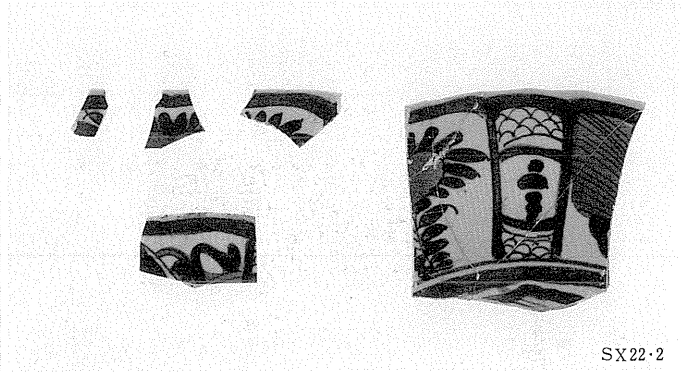

SX22-2

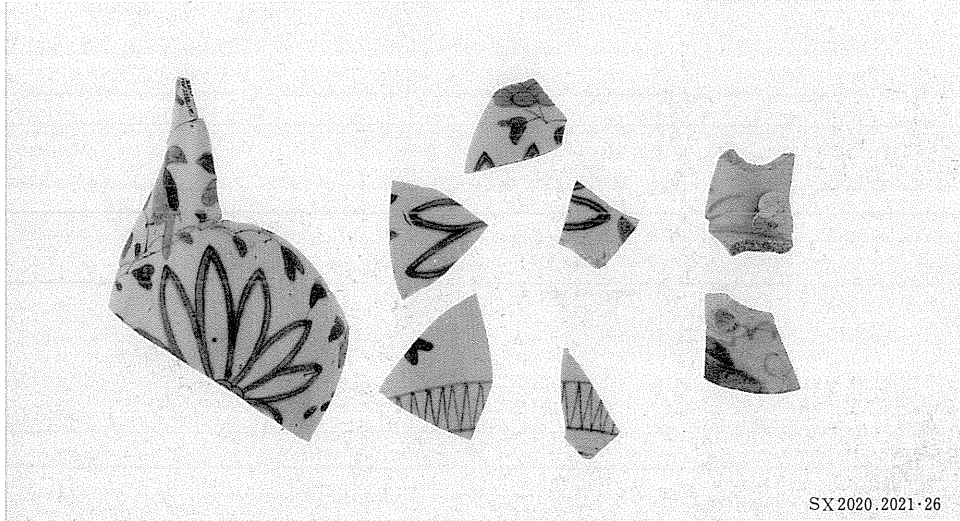

SX2020.2021-26

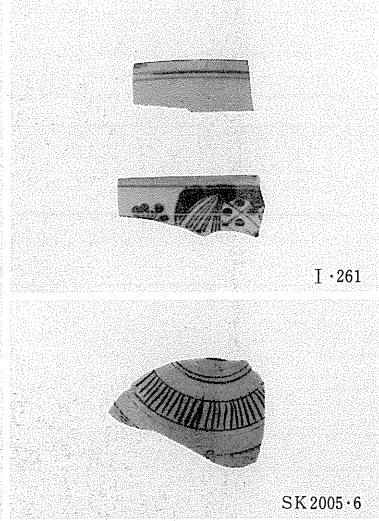

I・261

SK2005-6

染付
鉢・徳利

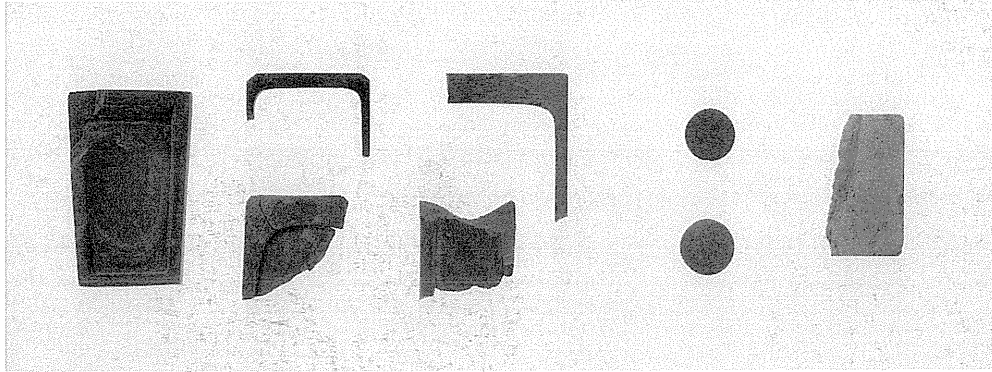

I・4

左 硯

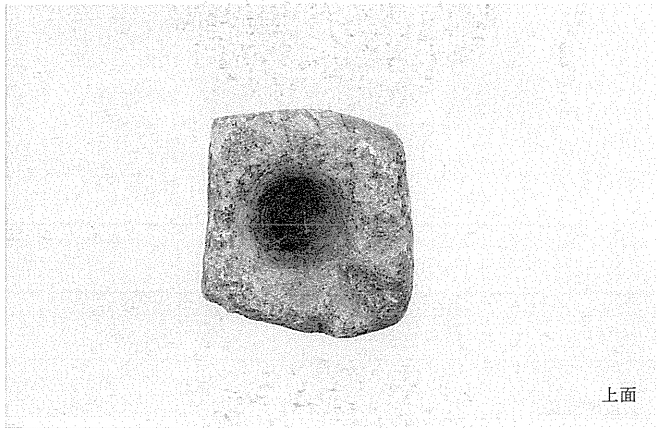

上面

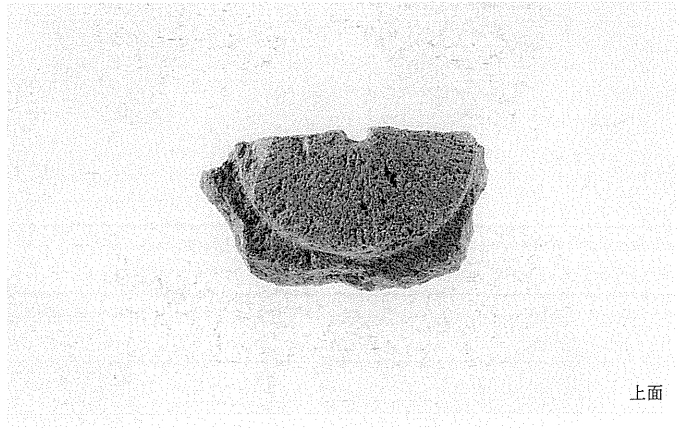

上面



側面
I・22

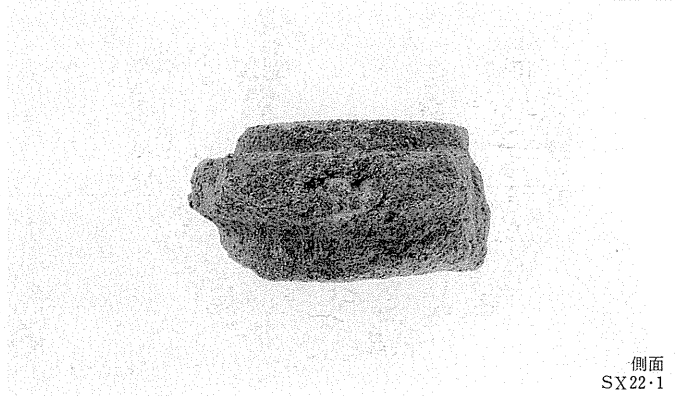

側面
SX22-1

石製品

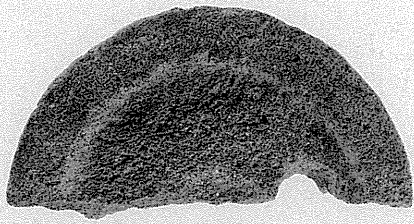

上面



側面

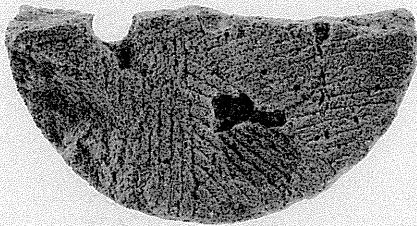

下面
外-6

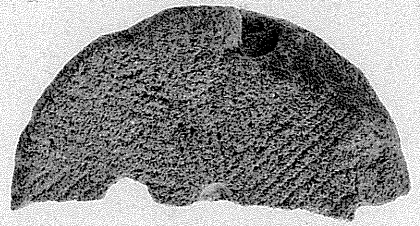

外-3

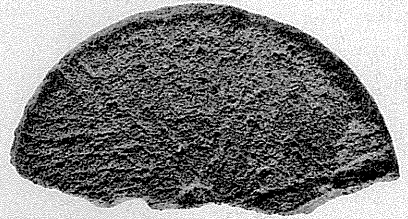

外-2

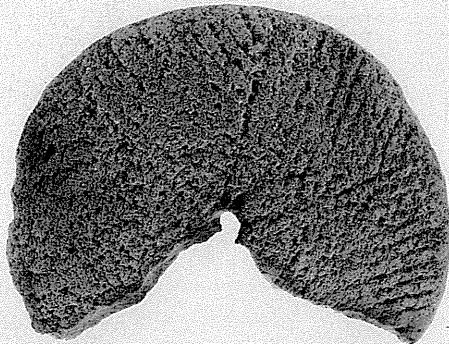

上面



側面

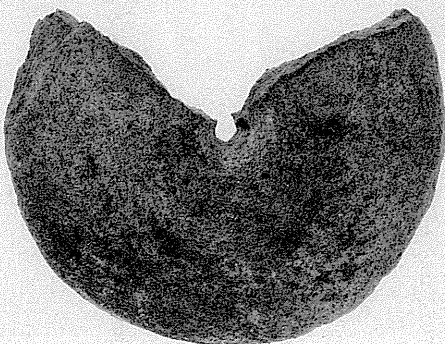

下面
SK1221-1

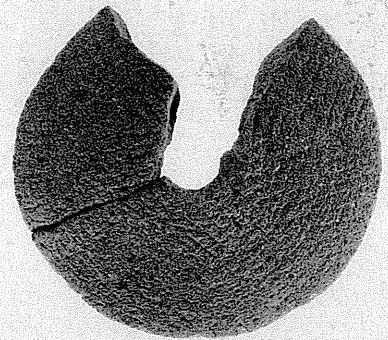

外-13

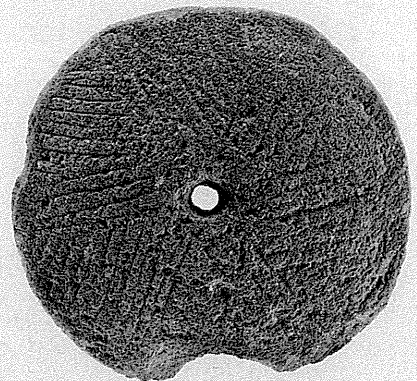

外-12

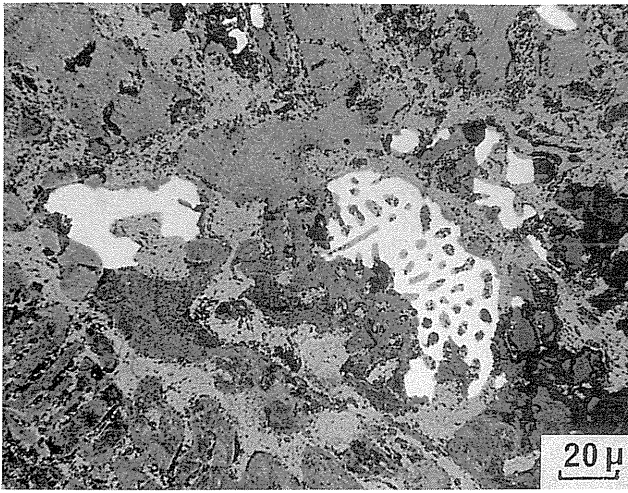

白色部が金属鉄

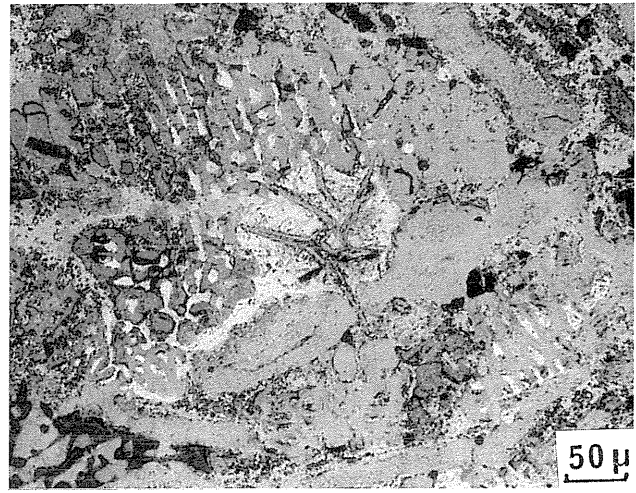

ひも状黒鉛

1 ③試料の組織

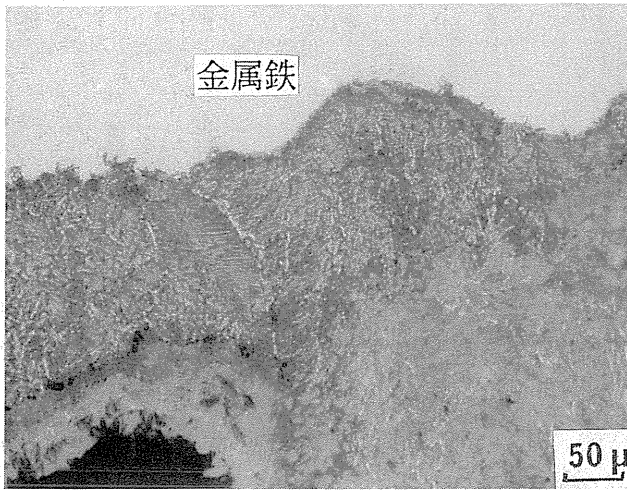

2 ⑥試料の組織

金属鉄周囲が錆化した部分

中央暗灰色部がガラス質珪酸塩、他は錆層

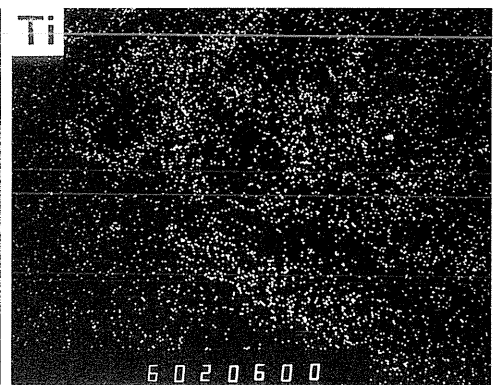
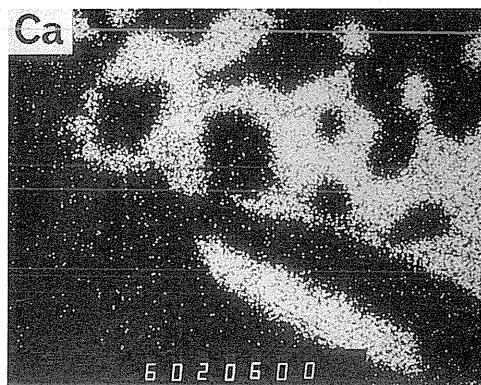
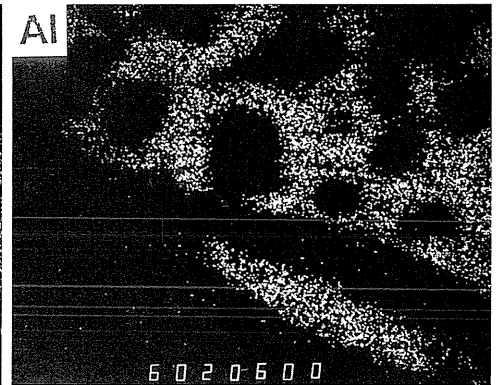
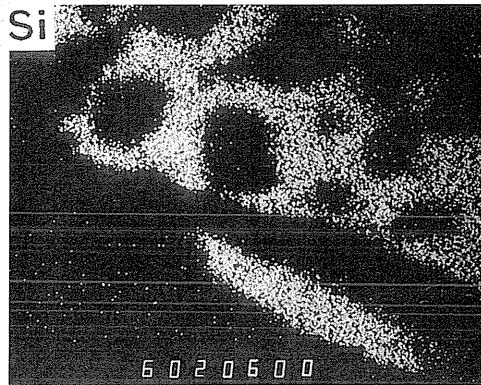
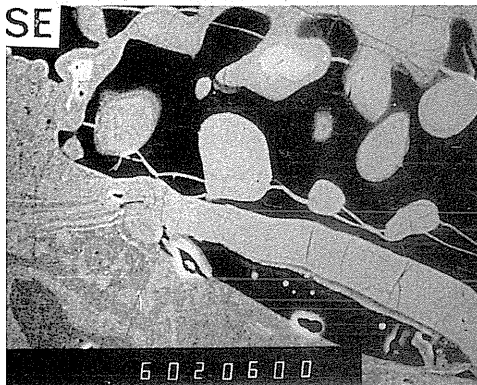

3 ⑥試料中スラグ部分の元素分布 (EPMA)

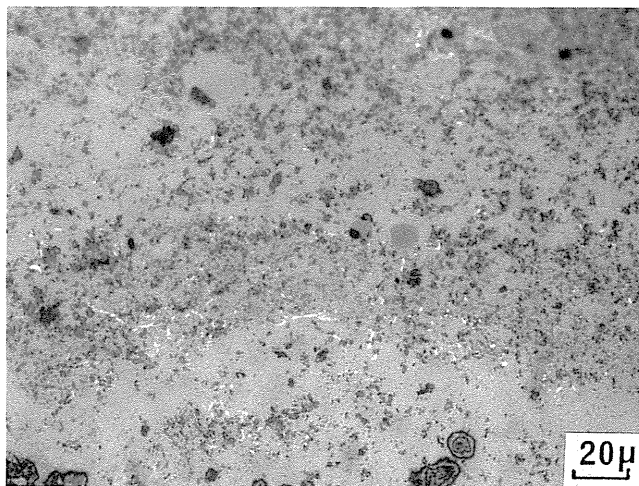
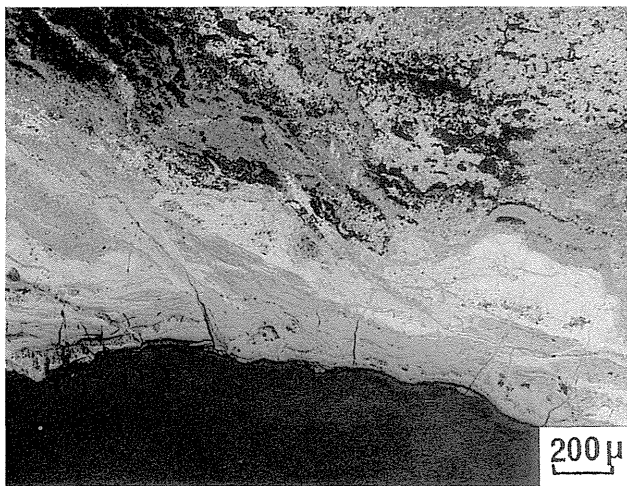

1 ②試料の組織

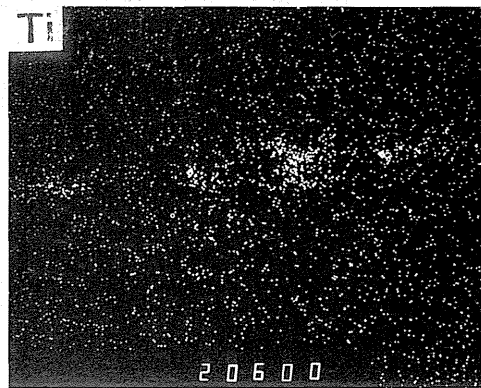
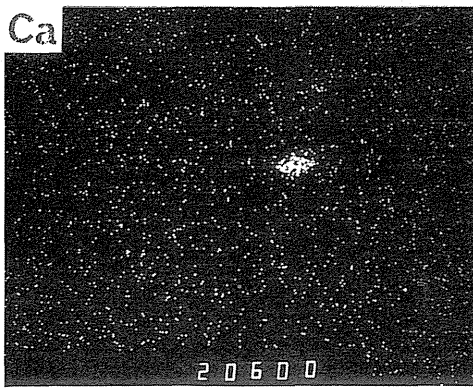
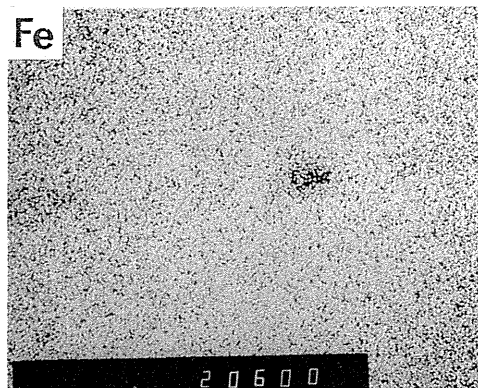
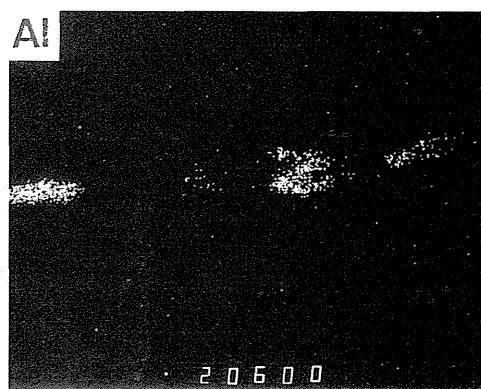
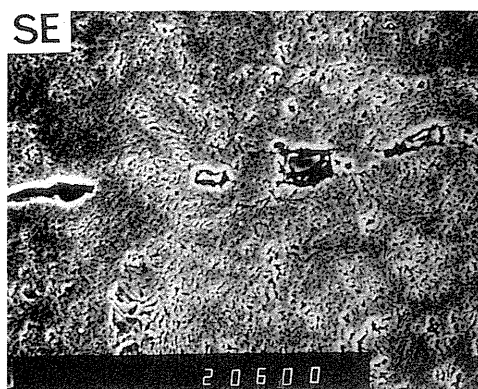

2 ②試料中在物の元素分布 (EPMA)

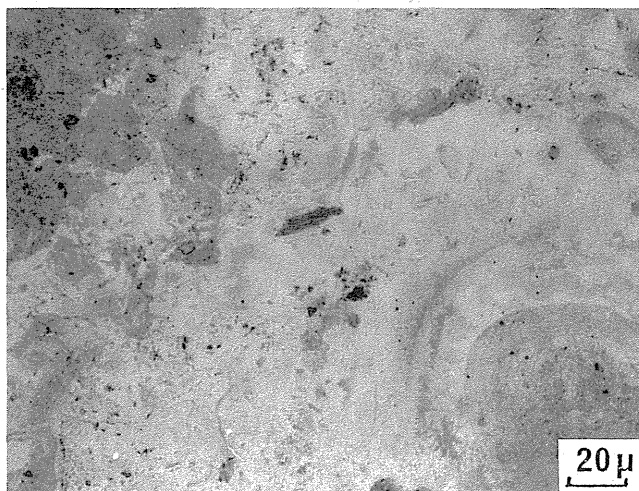
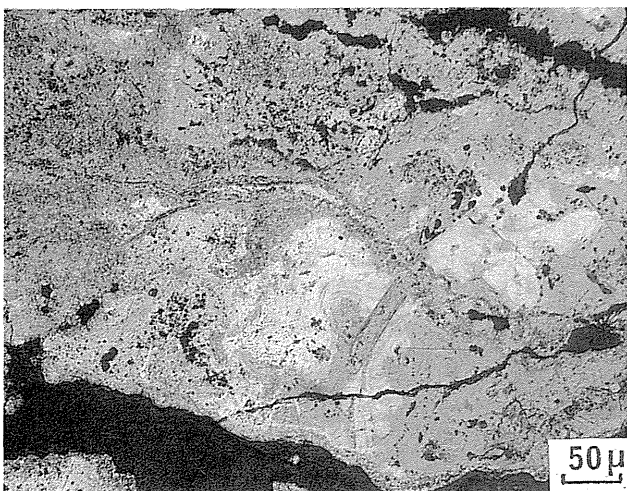

3 ⑩試料の断面組織

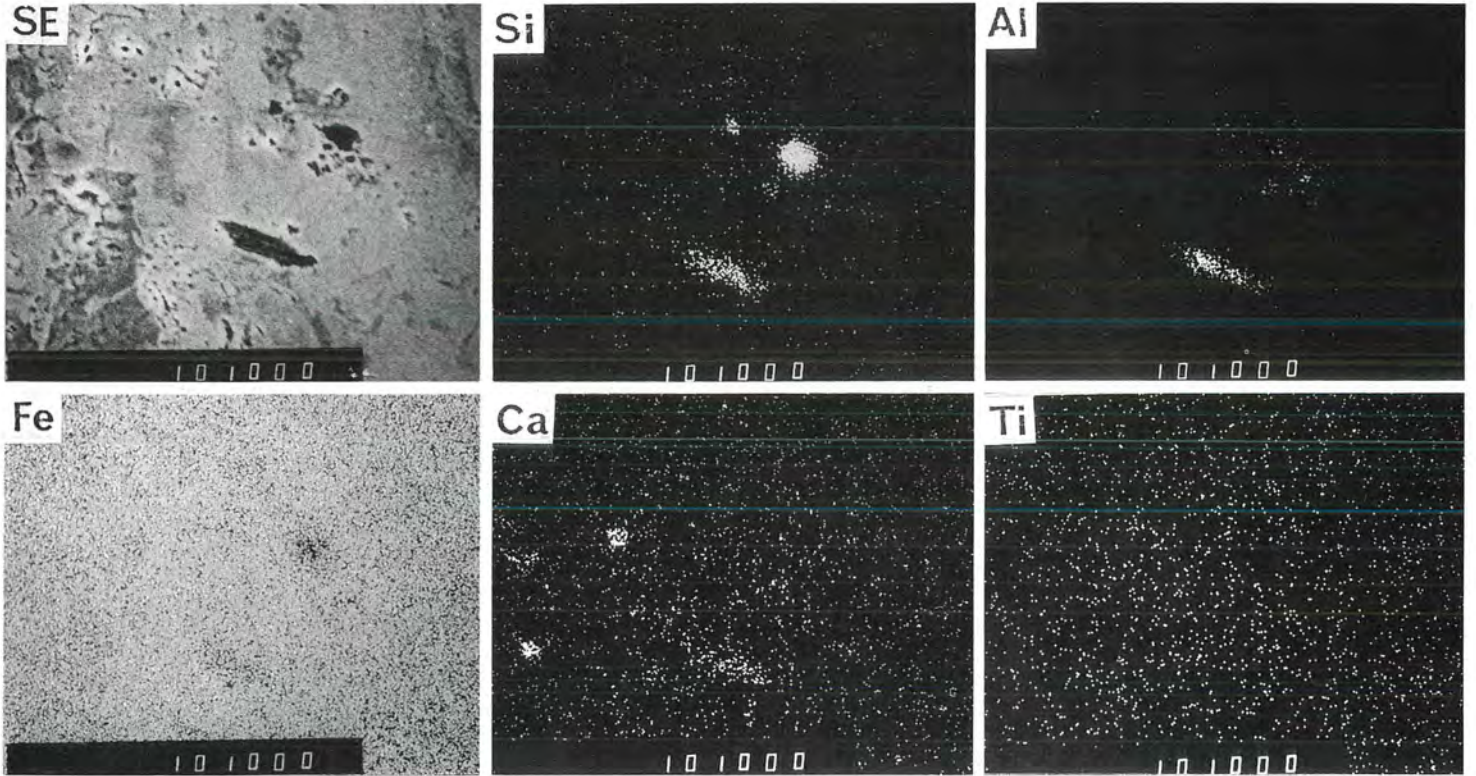

1 ⑩試料中に存在する介在物の元素分布 (EPMA)

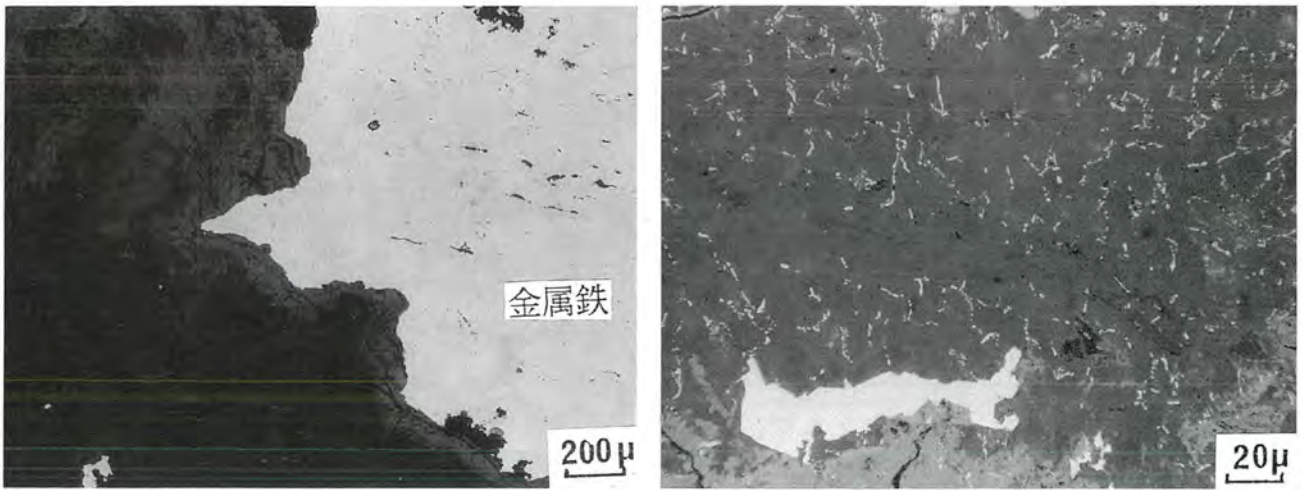

2 ⑬試料の断面組織

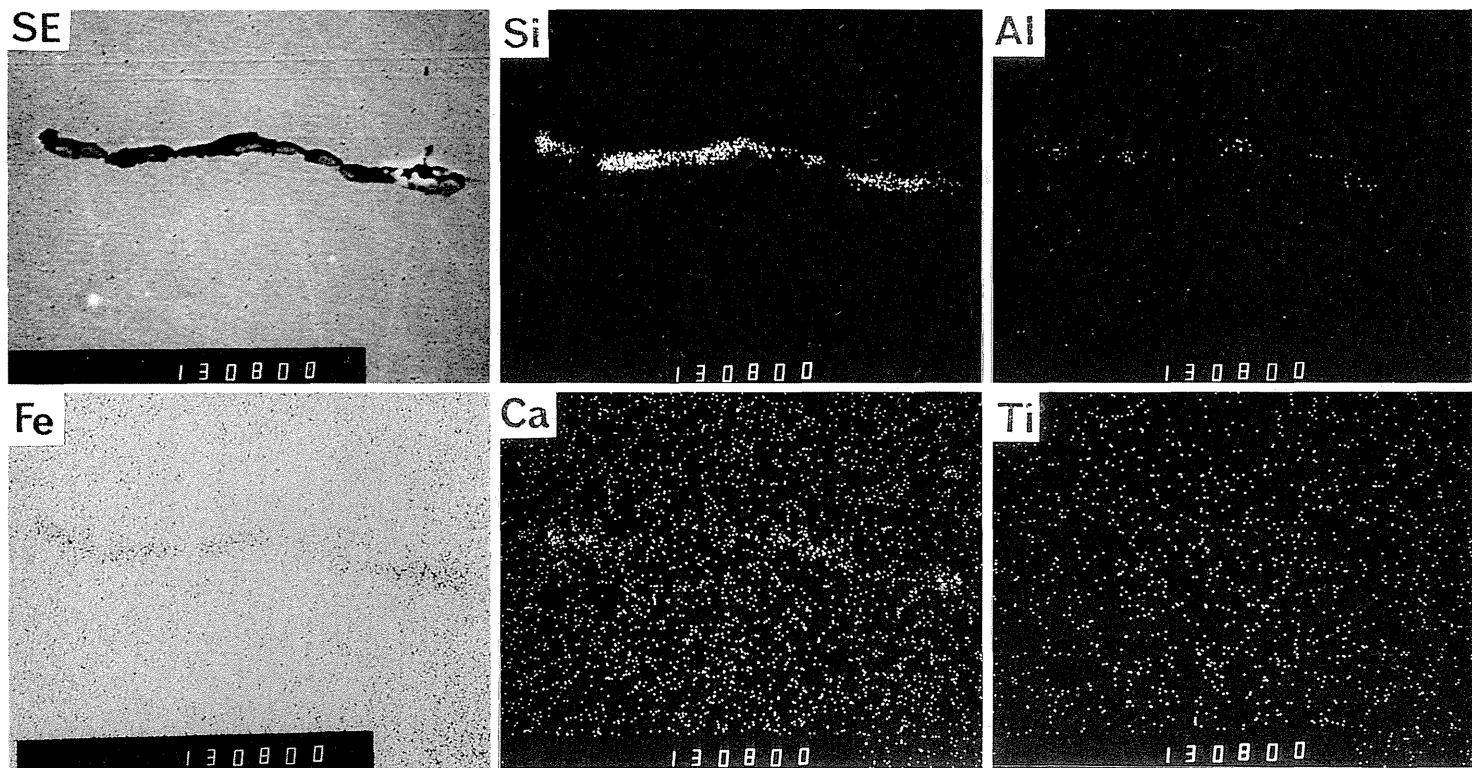

1 ⑬試料に存在する介在物の元素分布 (EPMA)

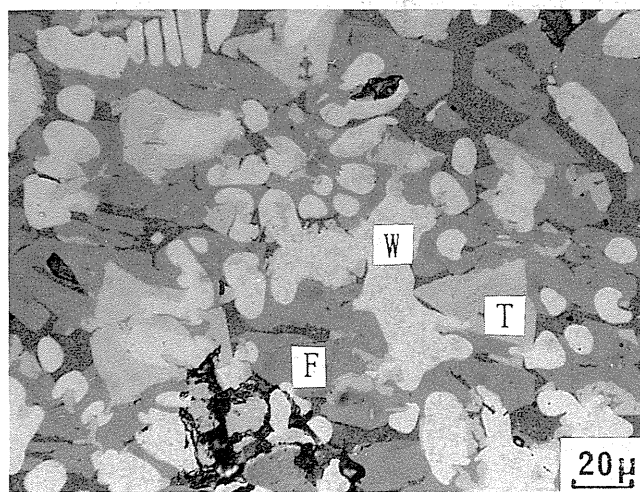
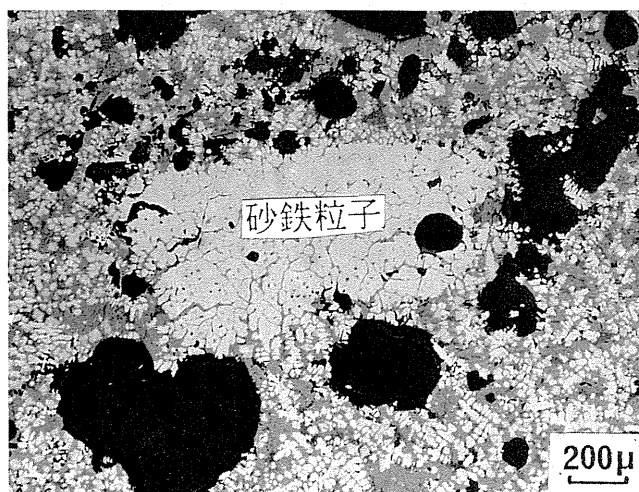

W : ウスタイト (FeO)
 F : ファヤライト ($2\text{FeO}\cdot\text{SiO}_2$)
 T : ウルボスピネル ($2\text{FeO}\cdot\text{TiO}_2$)

2 ⑤鉄滓の組織

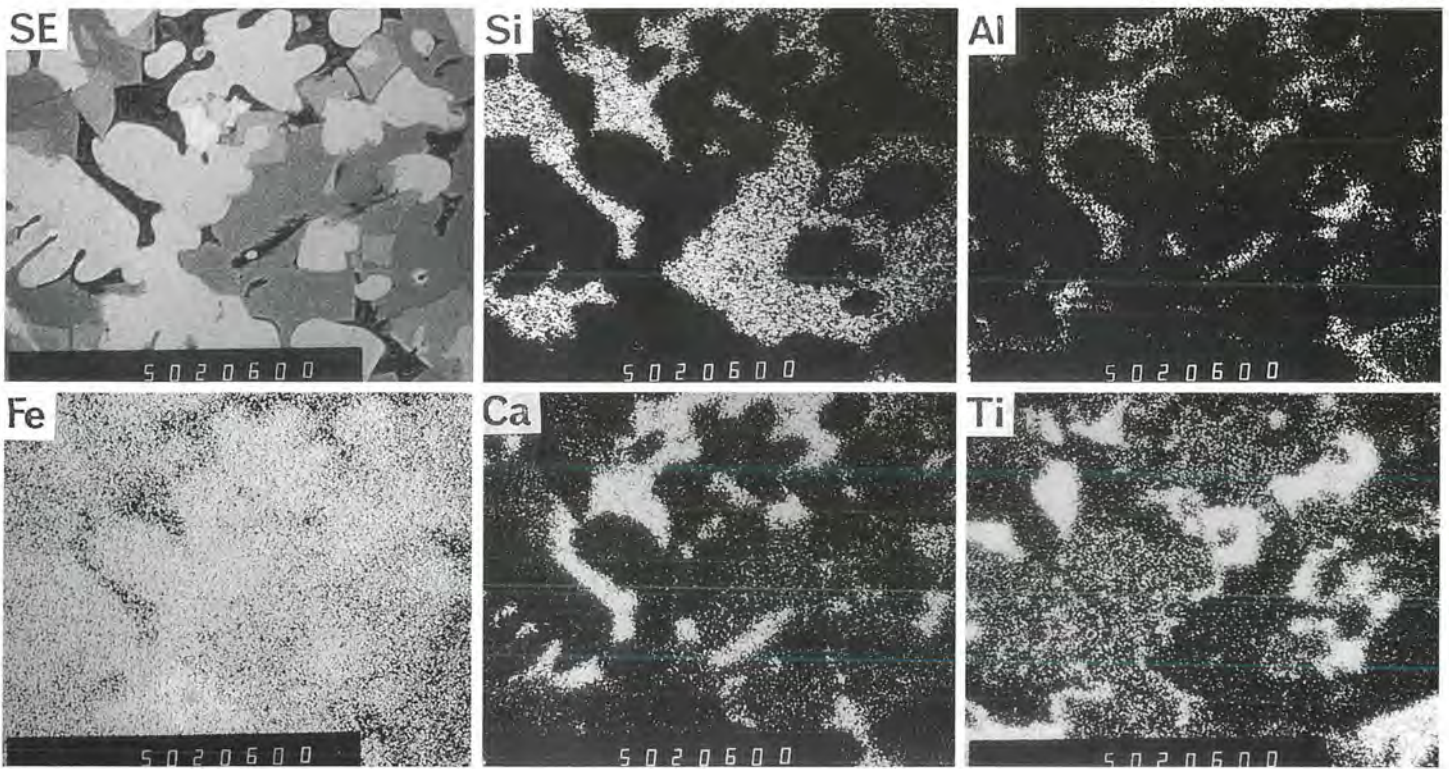

1 ⑤鉄滓の元素分布 (EPMA)

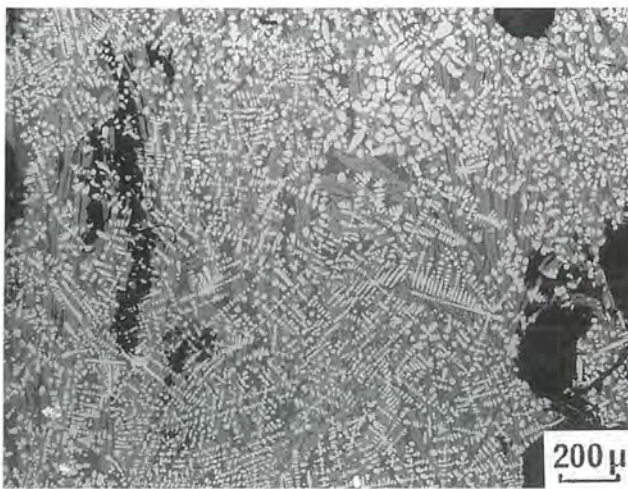

W: ウスタイト (FeO)

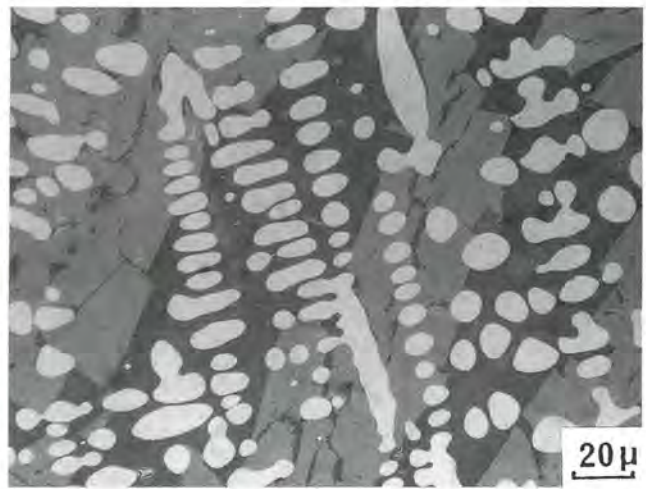

F: ファヤライト (2FeO-SiO_2)

2 ①鉄滓の組織

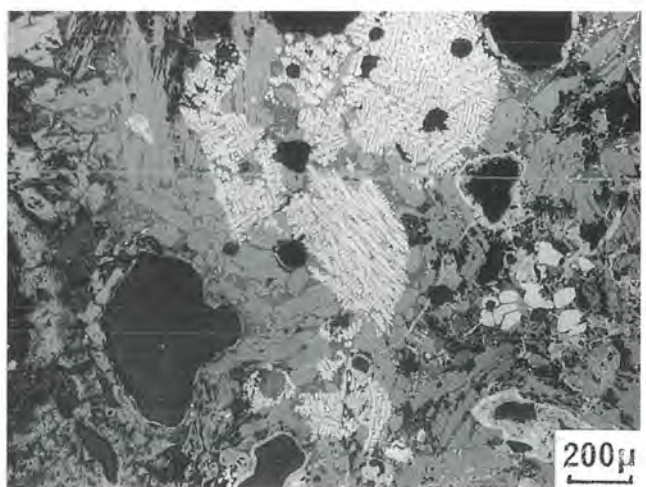
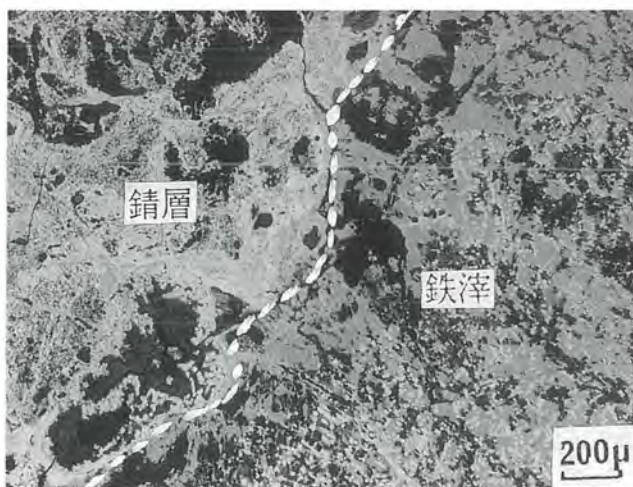

3 ④鉄滓の組織

(財)長野県埋蔵文化財センター発掘調査報告書 3

中央自動車道長野線埋蔵文化財発掘調査報告書 3

— 塩尻市内その2 —

吉田川西遺跡

図 版 編

発 行 平成元年3月31日発行

発行者 日本道路公団名古屋建設局

長野県教育委員会

(財)長野県埋蔵文化財センター

印刷 電算印刷株式会社

