

E②SR1

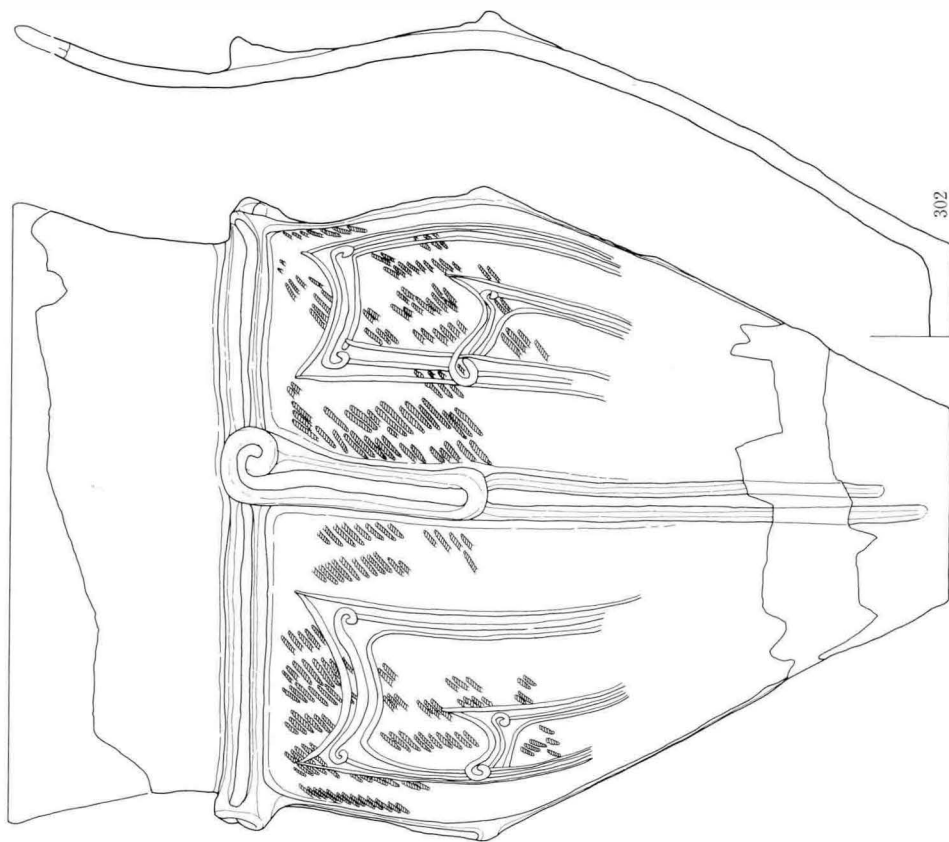

E②SR2

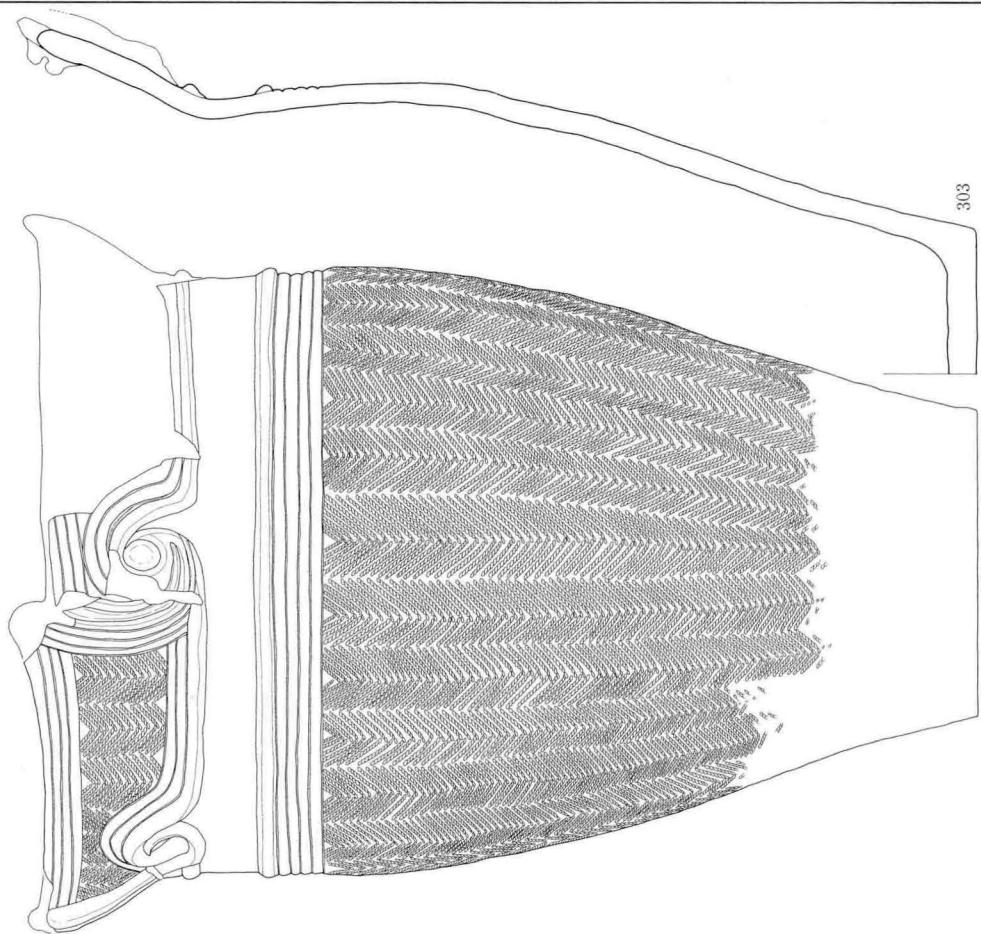

E② SN 1

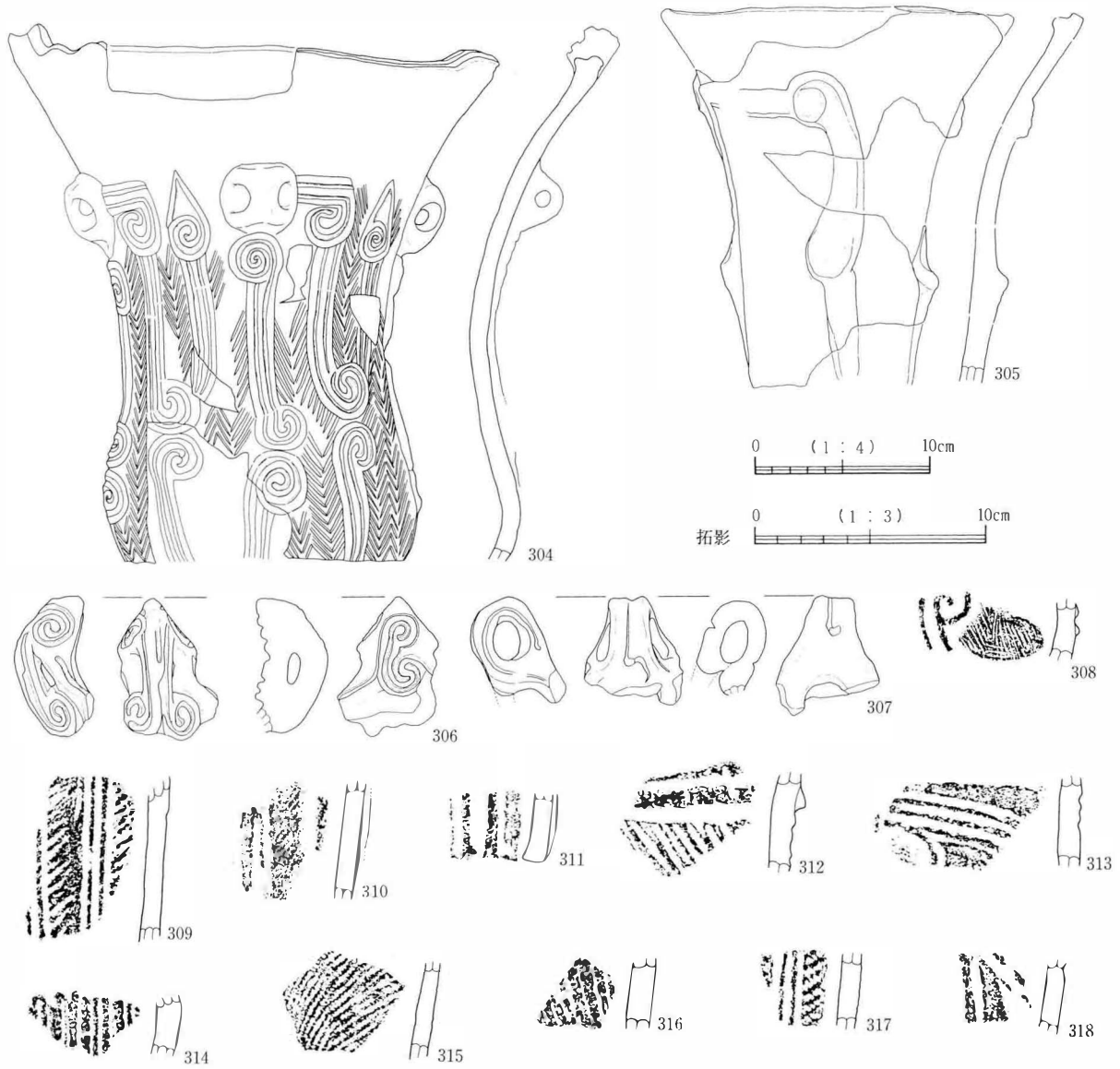

遺構外 (3)

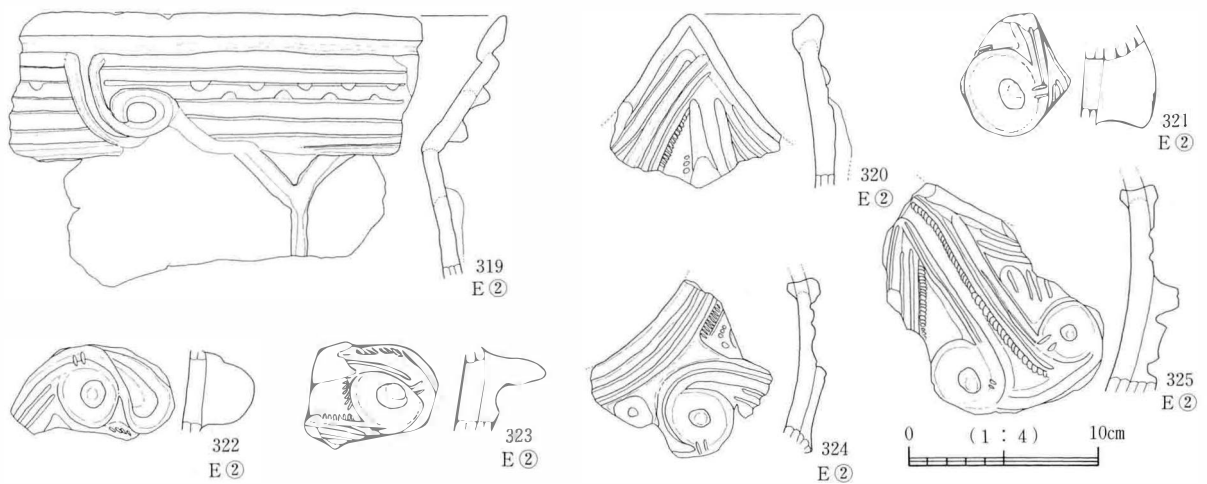

遺構外 (4)

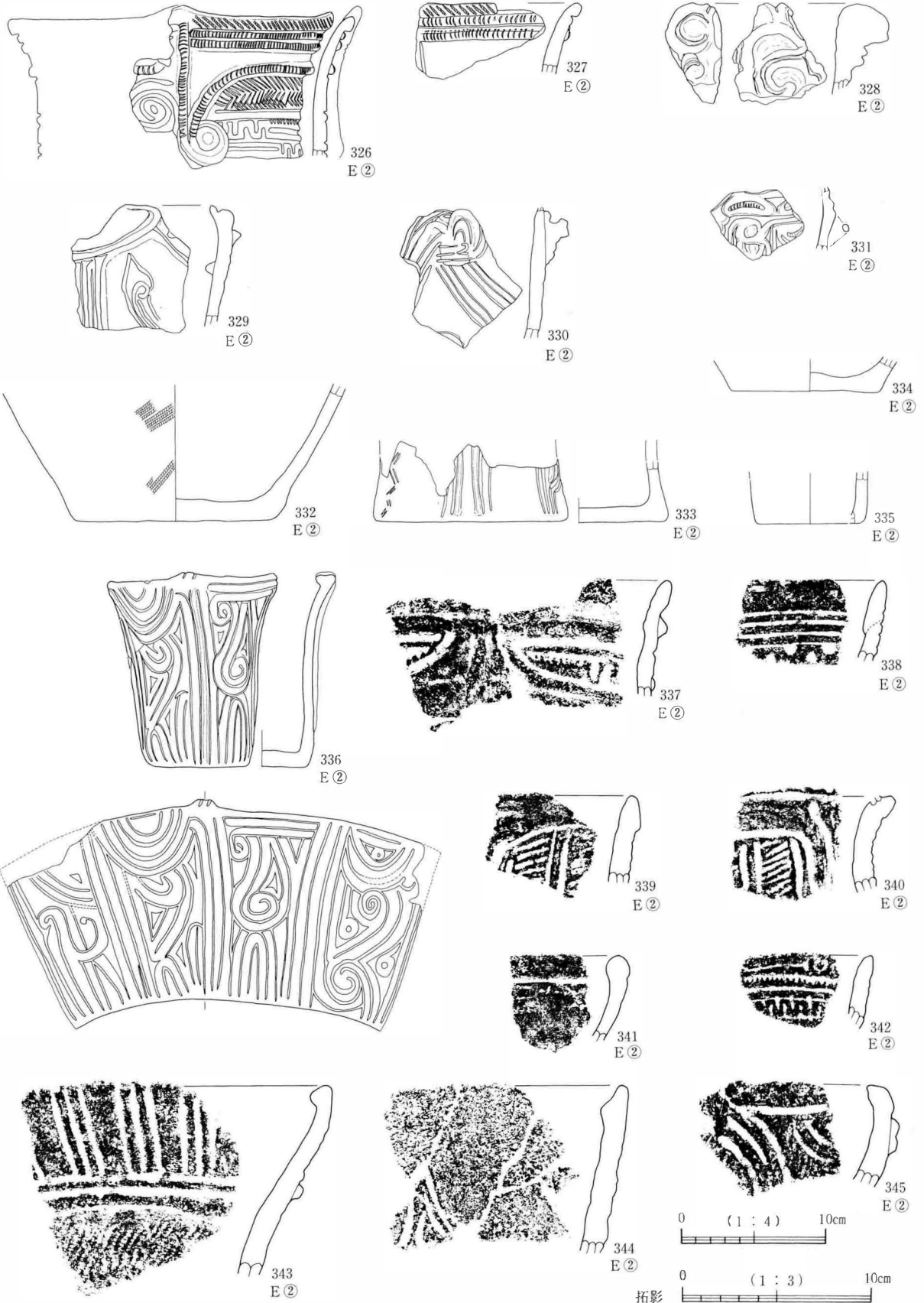

遺構外 (5)

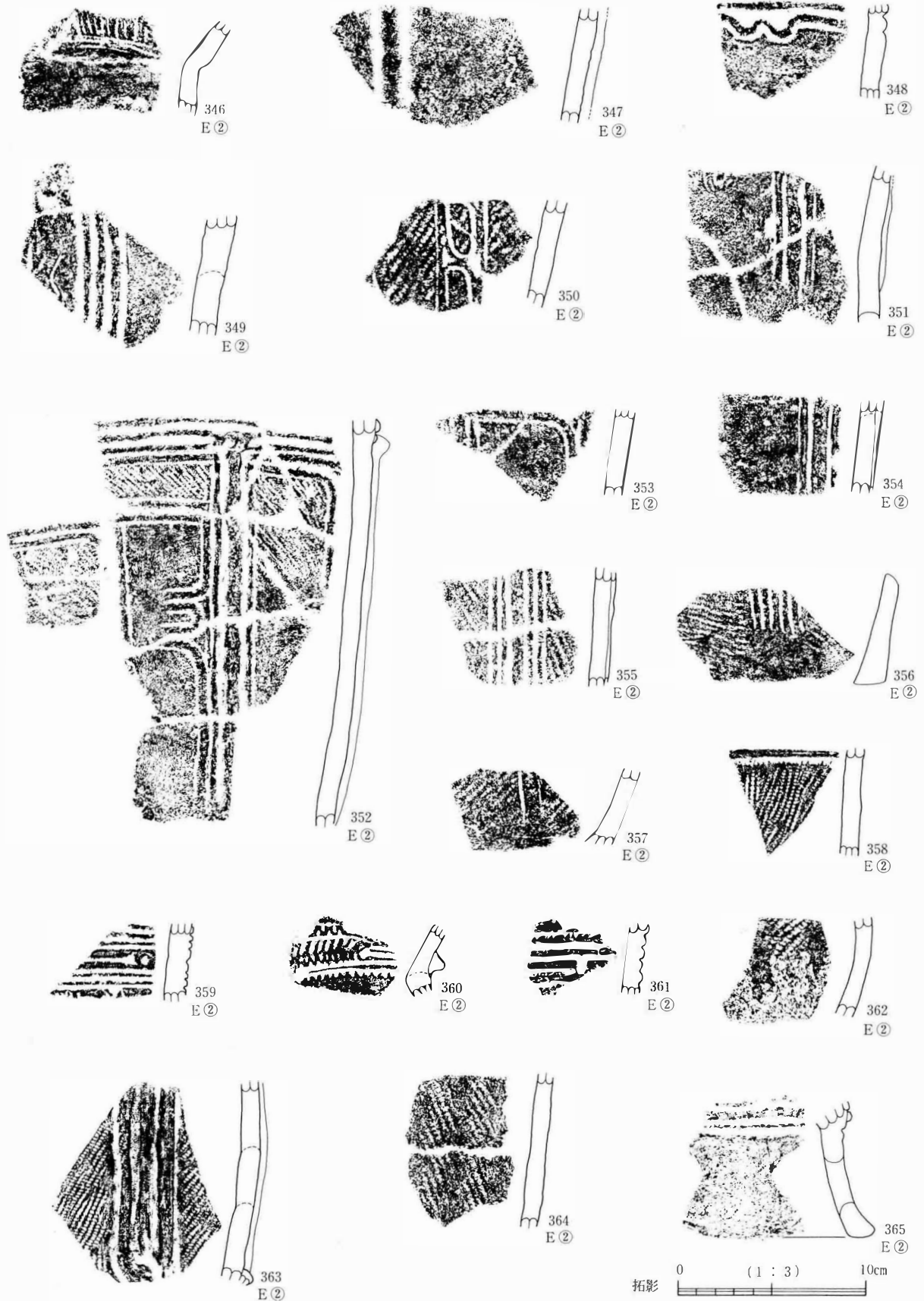

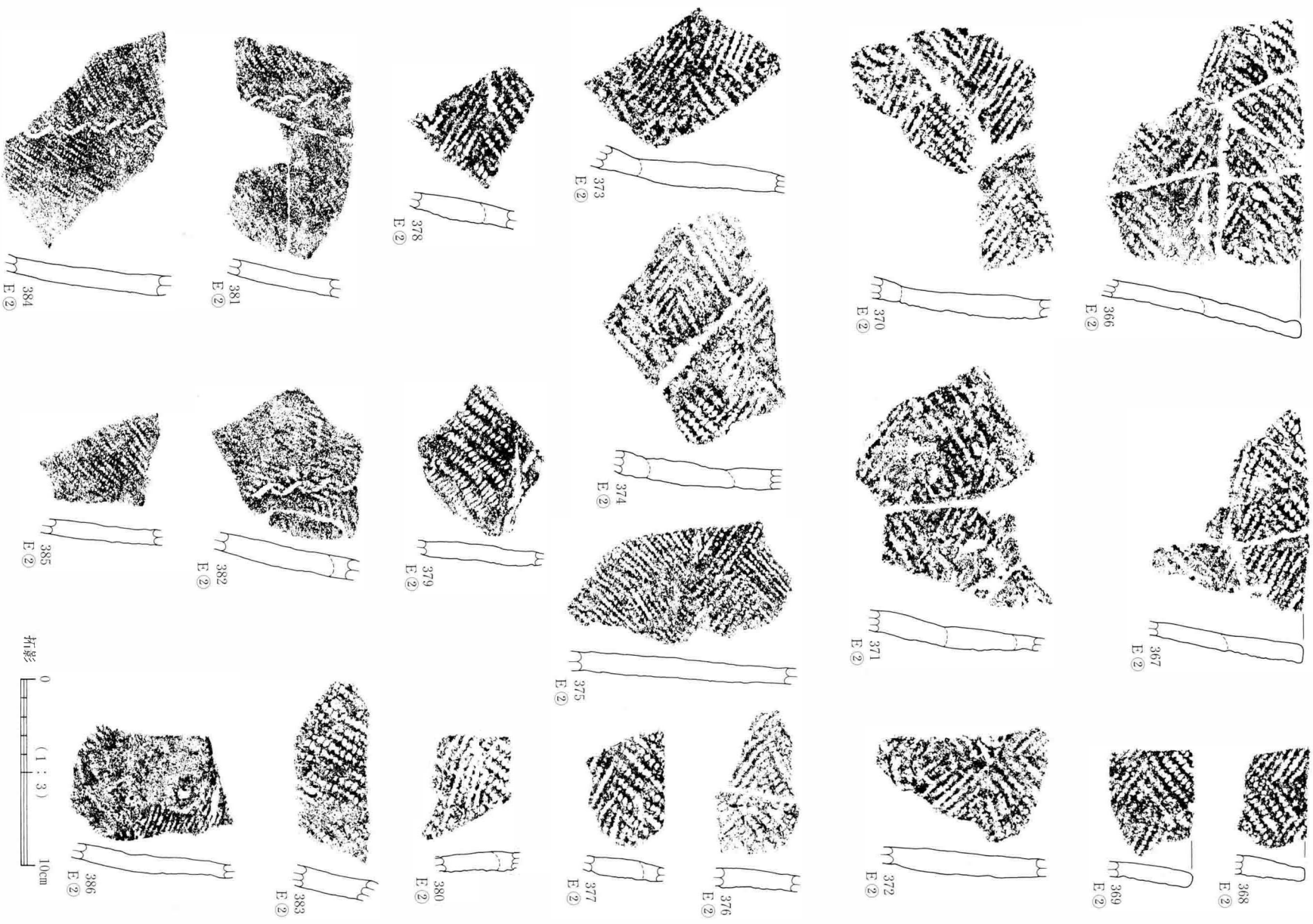

遺構外 (7)

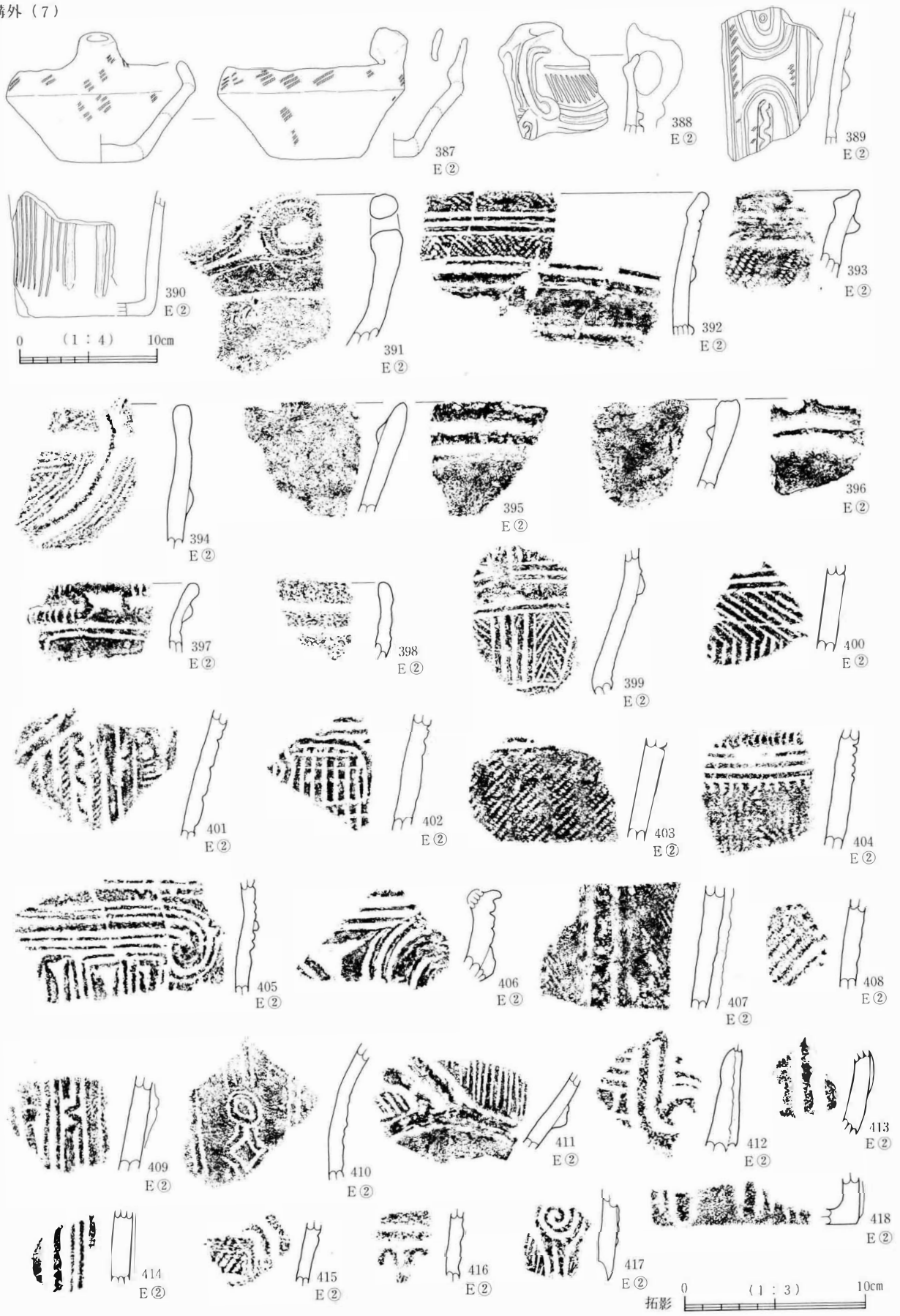

遺構外 (8)

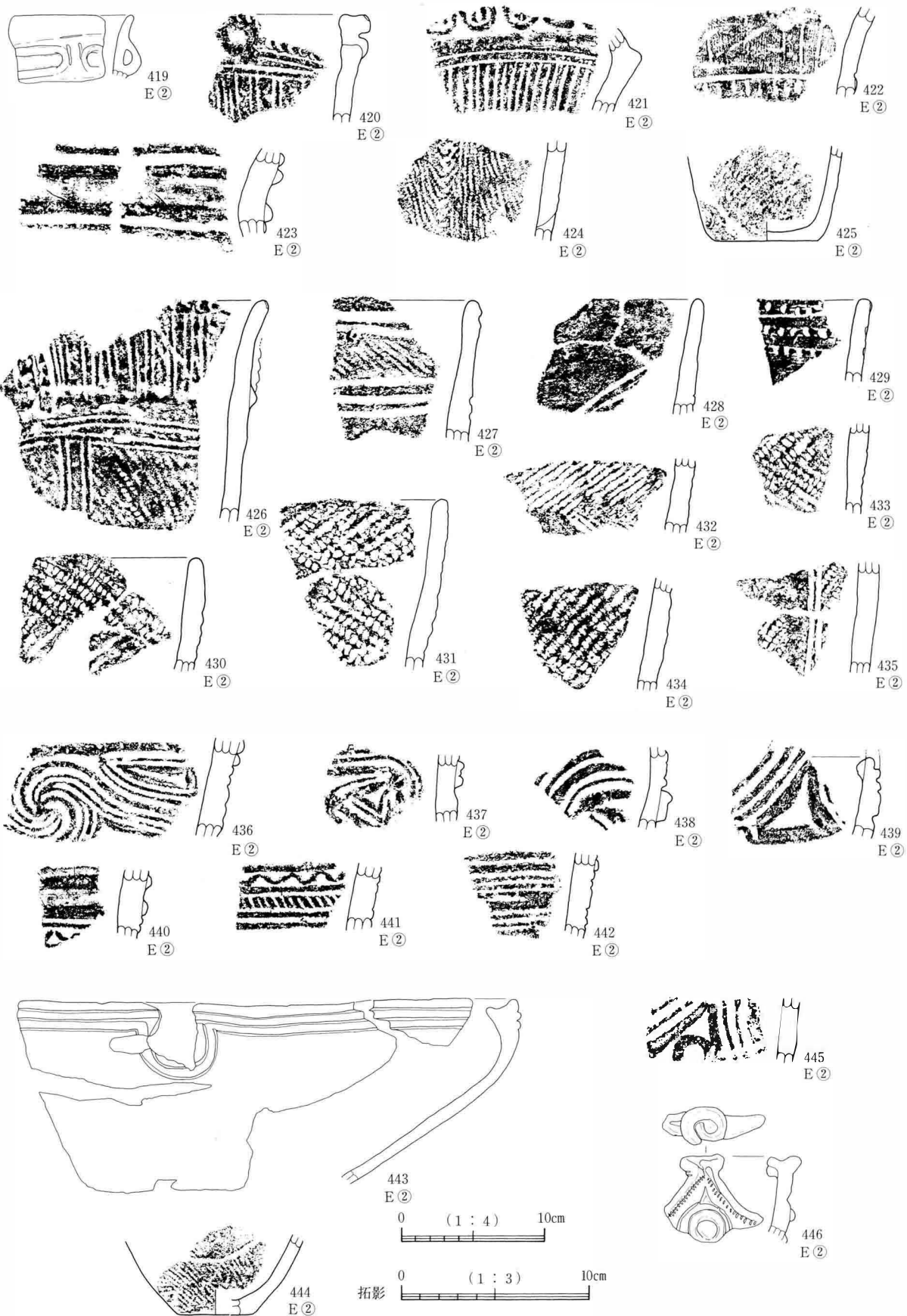

石製品 (1)

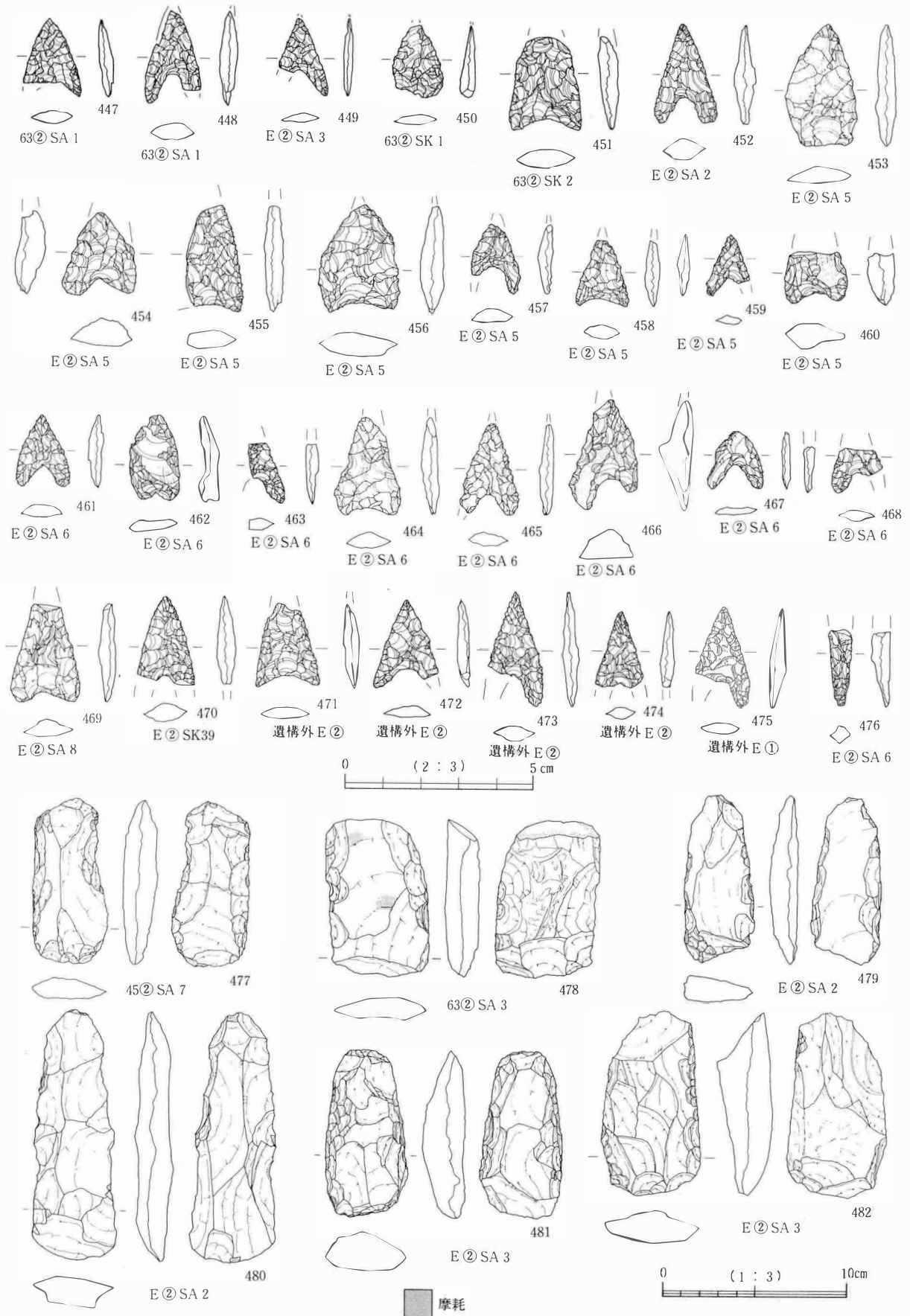

石製品 (2)

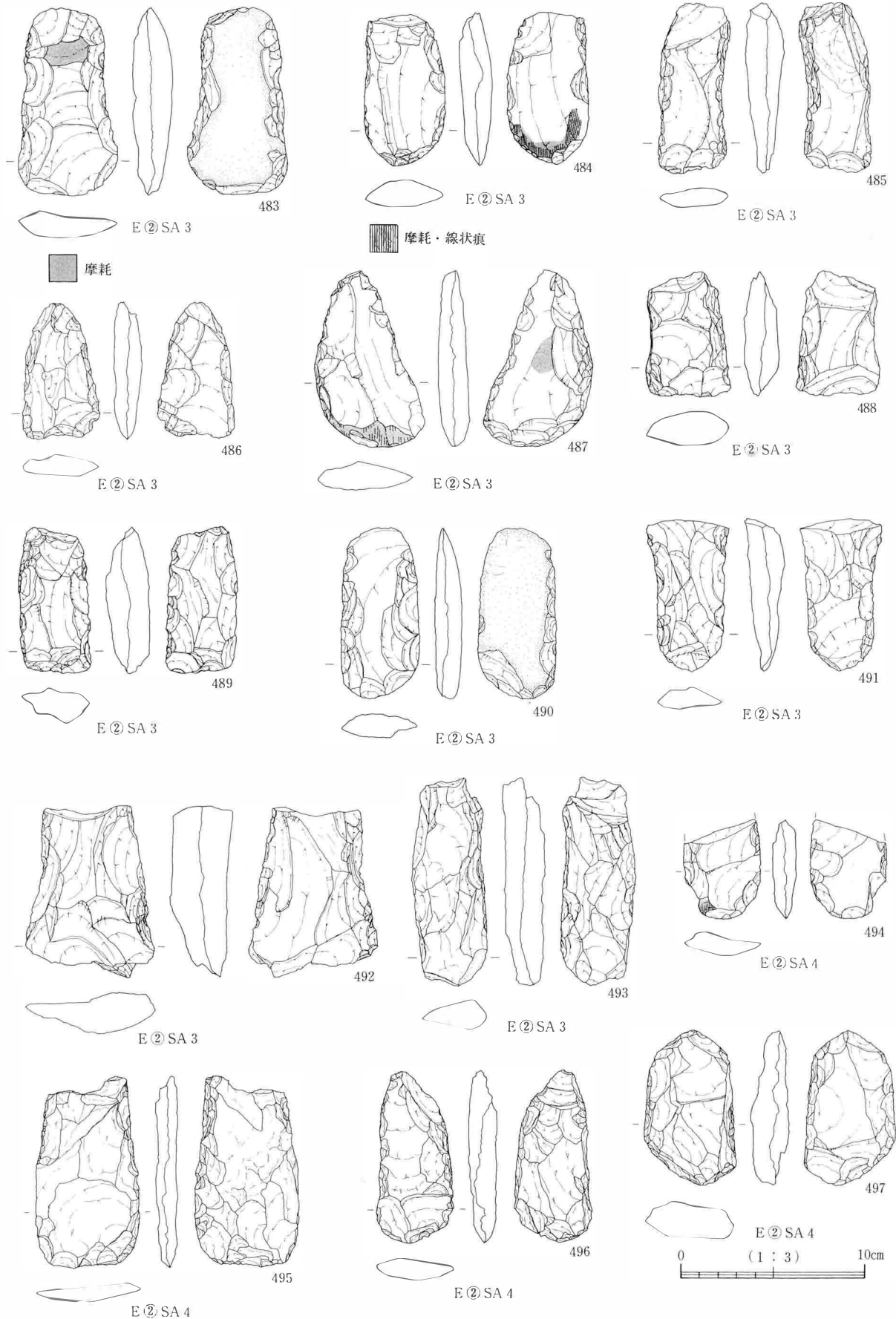

石製品 (3)

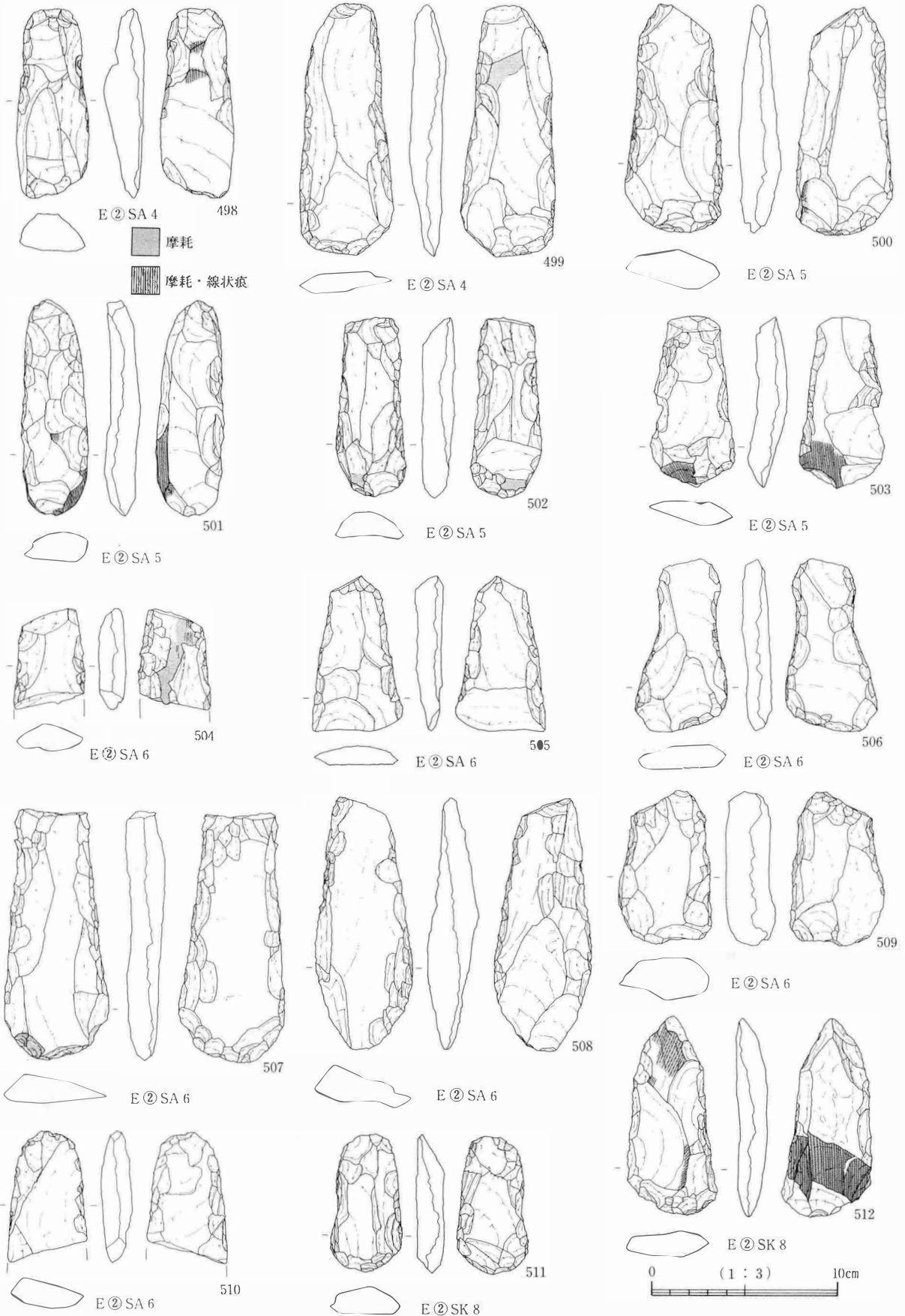

石製品 (4)

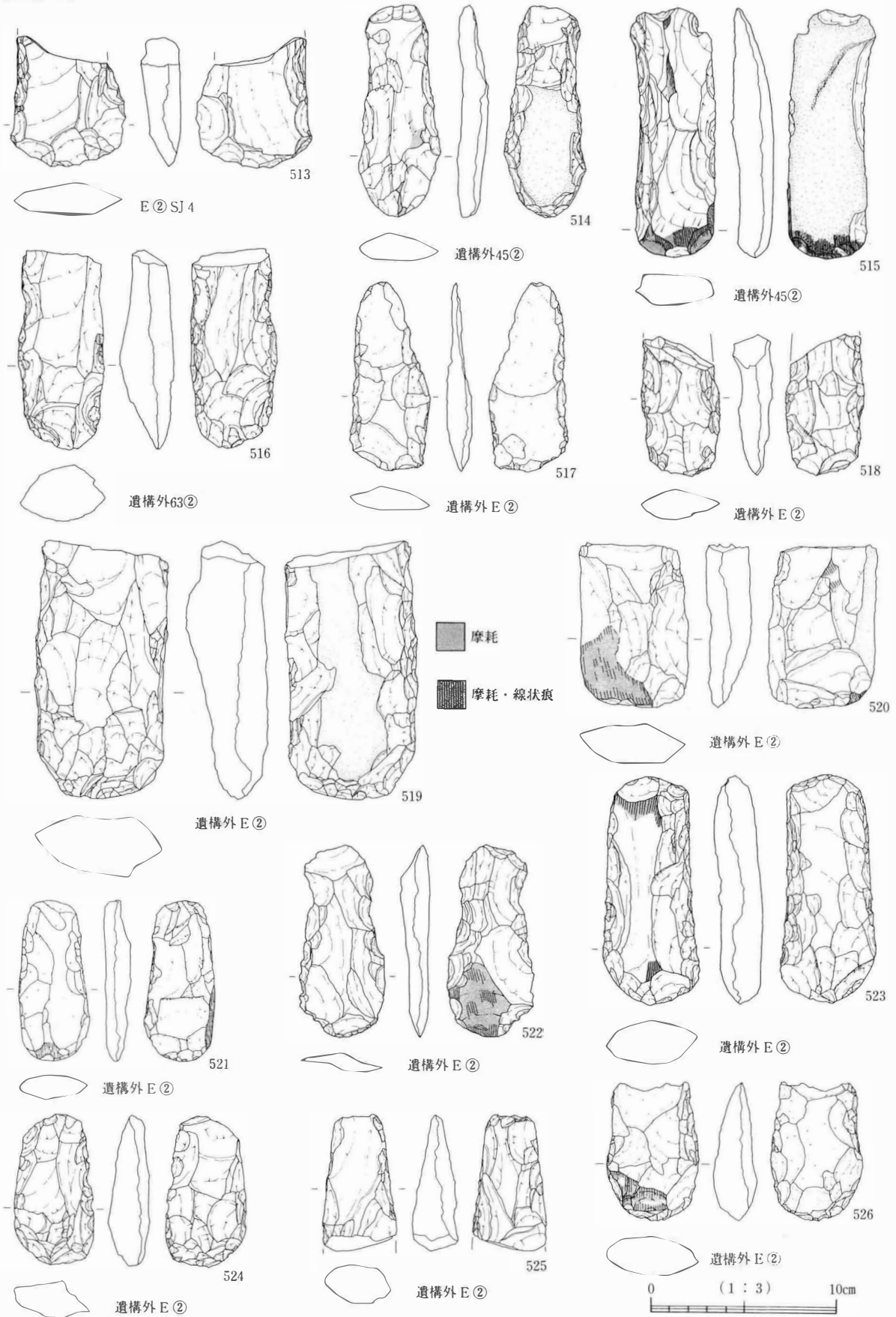

石製品 (5)

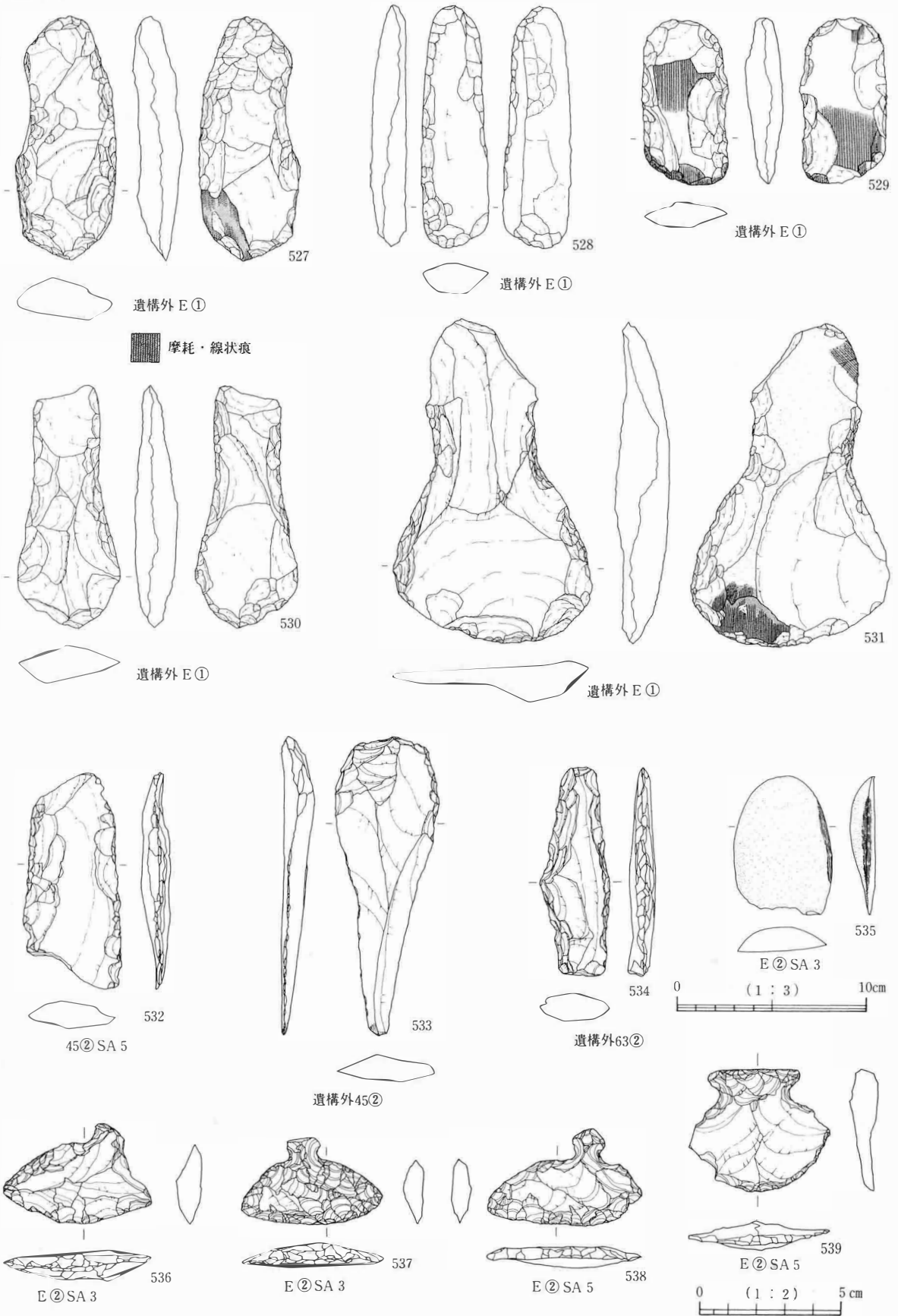

石製品 (6)

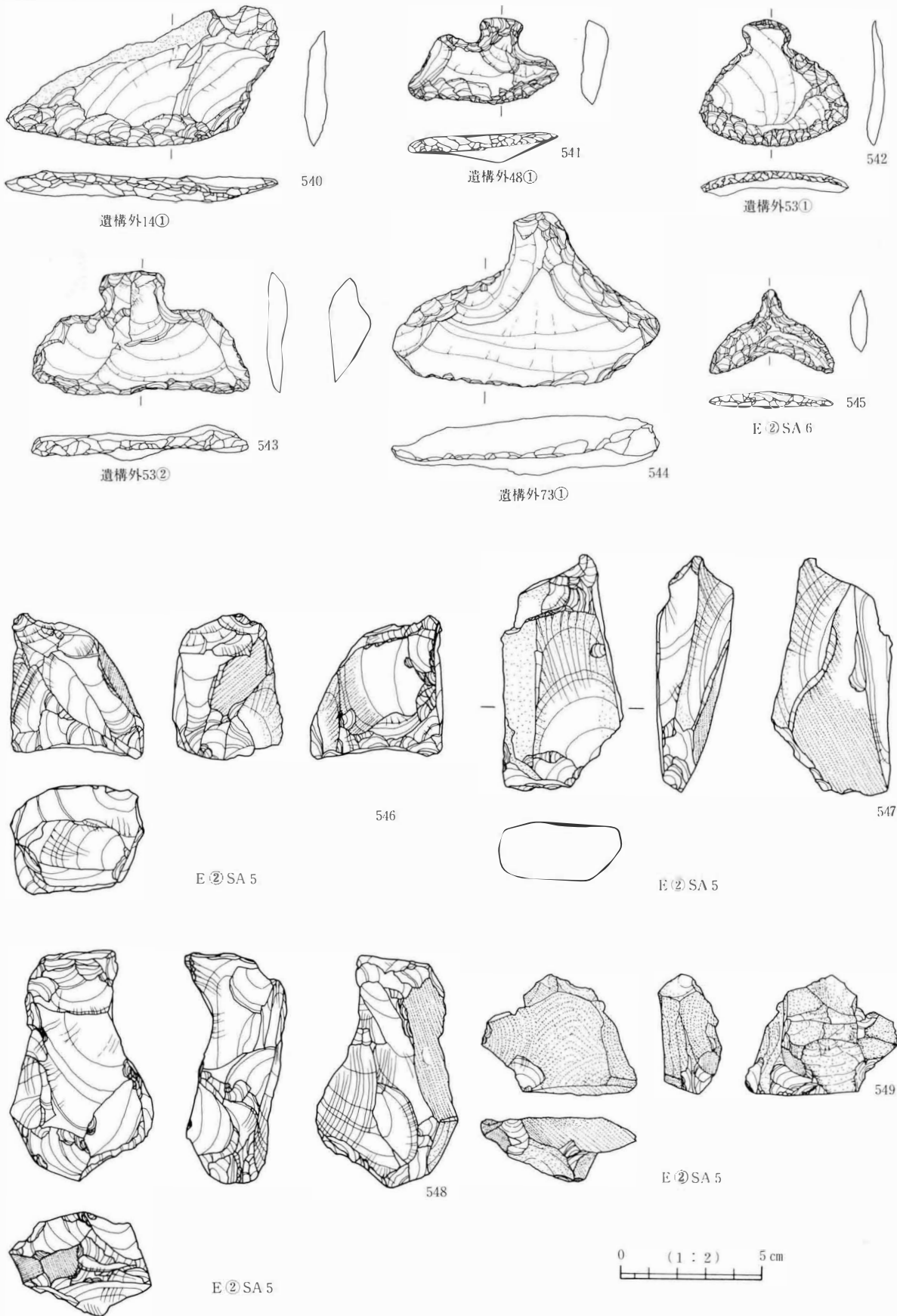

石製品 (7)

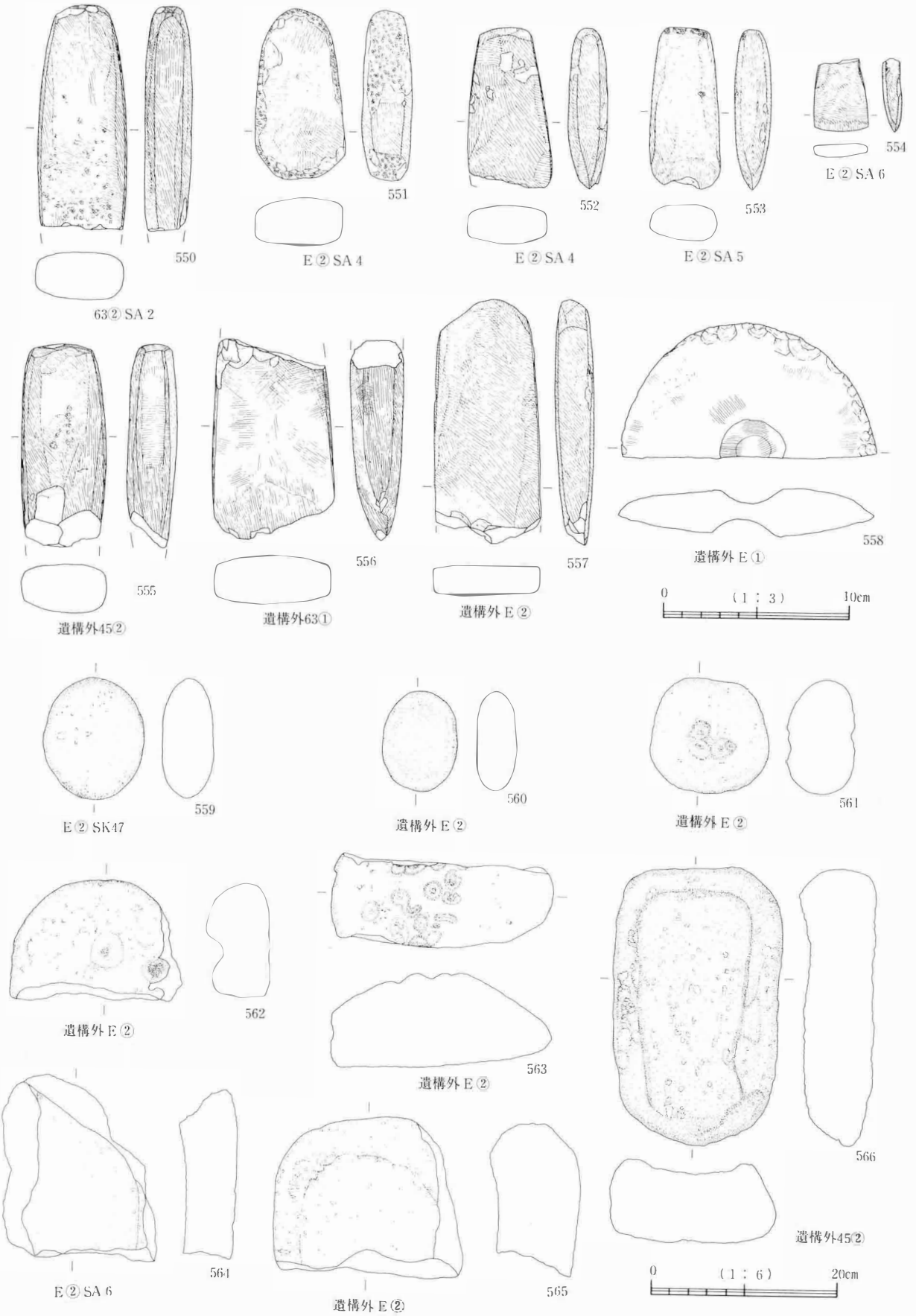

石製品(8)

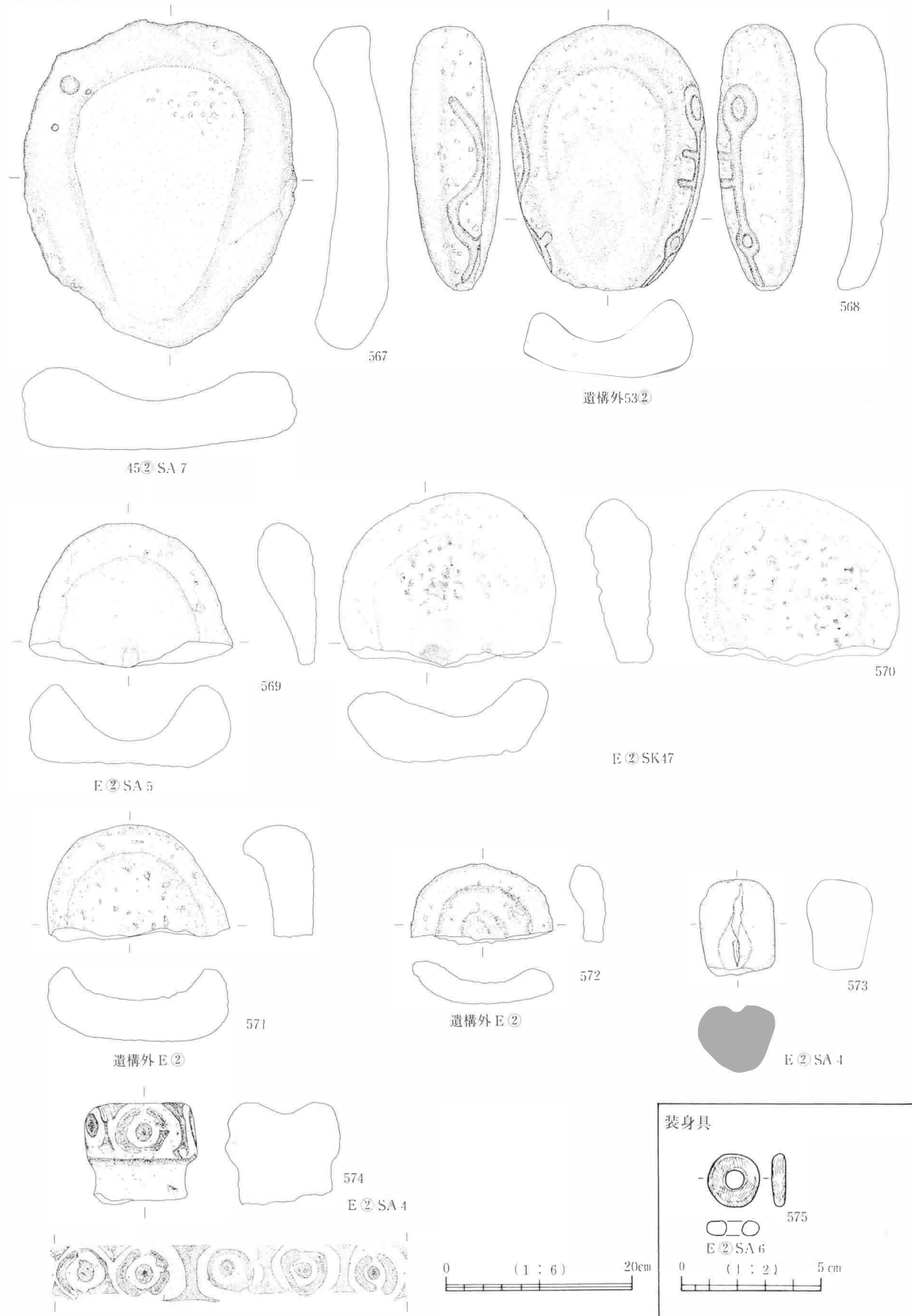

土製品

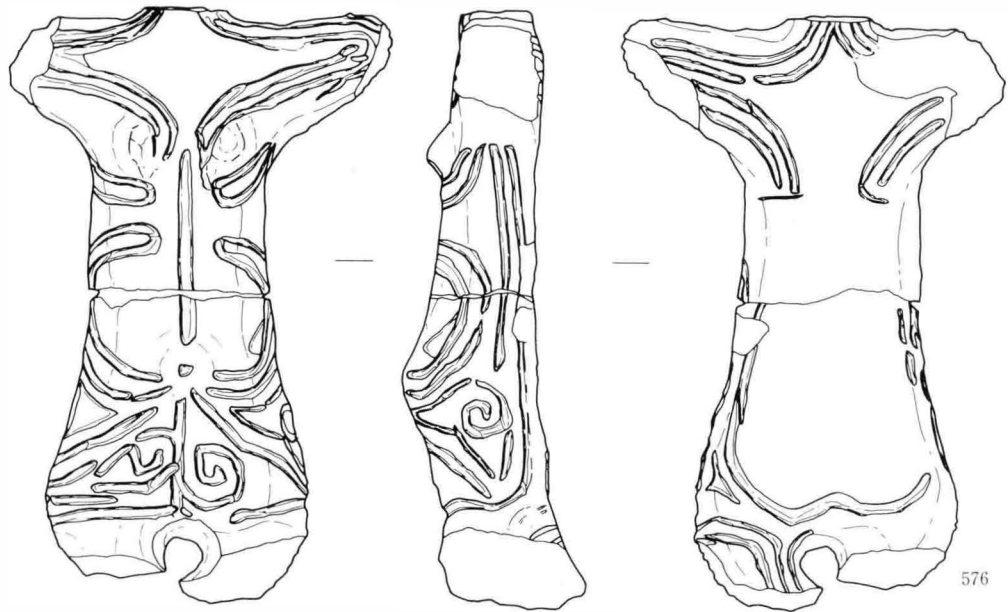

632 SA 1

576

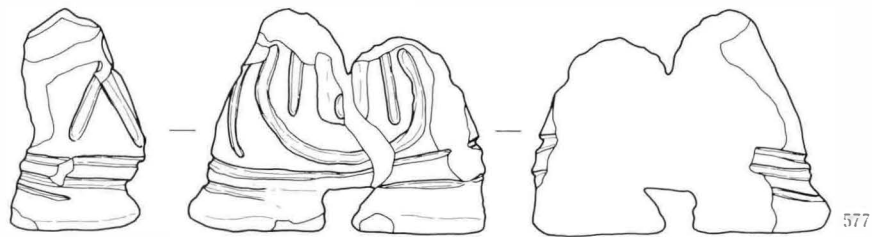

E 2 SA 4

577

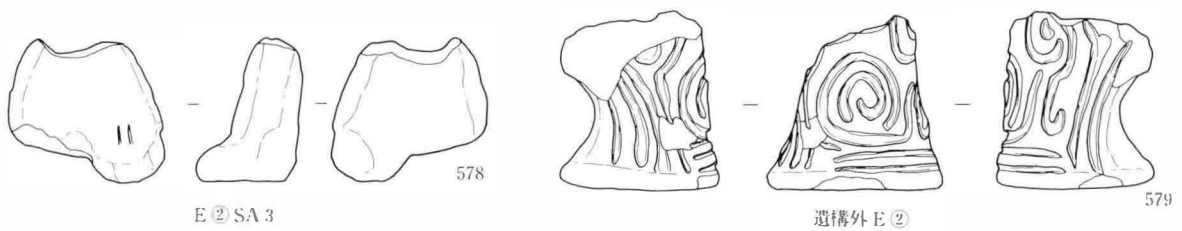

E 2 SA 3

578

遺構外 E 2

579

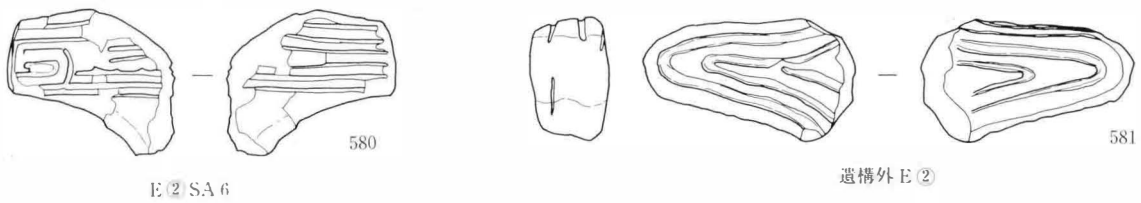

E 2 SA 6

580

遺構外 E 2

581

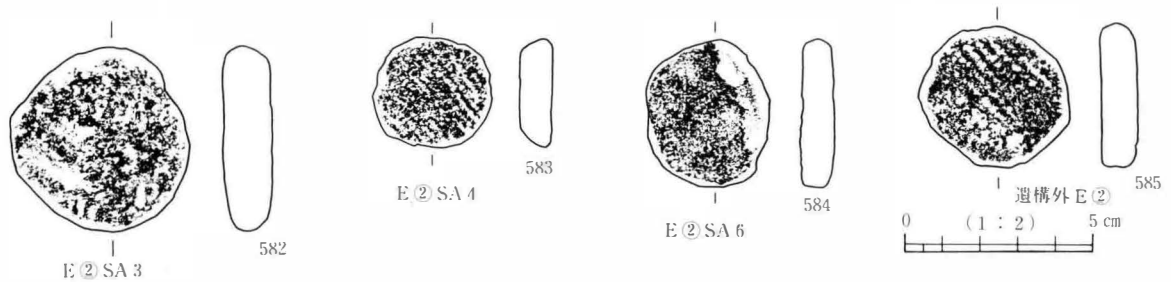

E 2 SA 3

582

E 2 SA 4

583

E 2 SA 6

584

遺構外 E 2

585

0 (1 : 2) 5 cm

3① SA 1

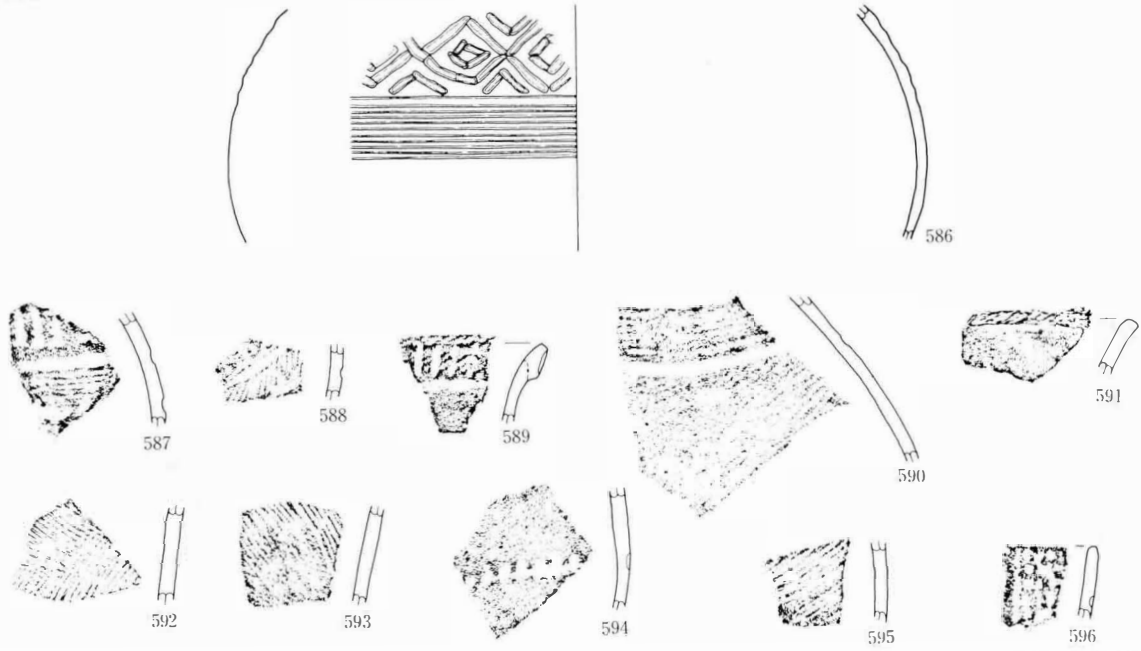

3① SA 2

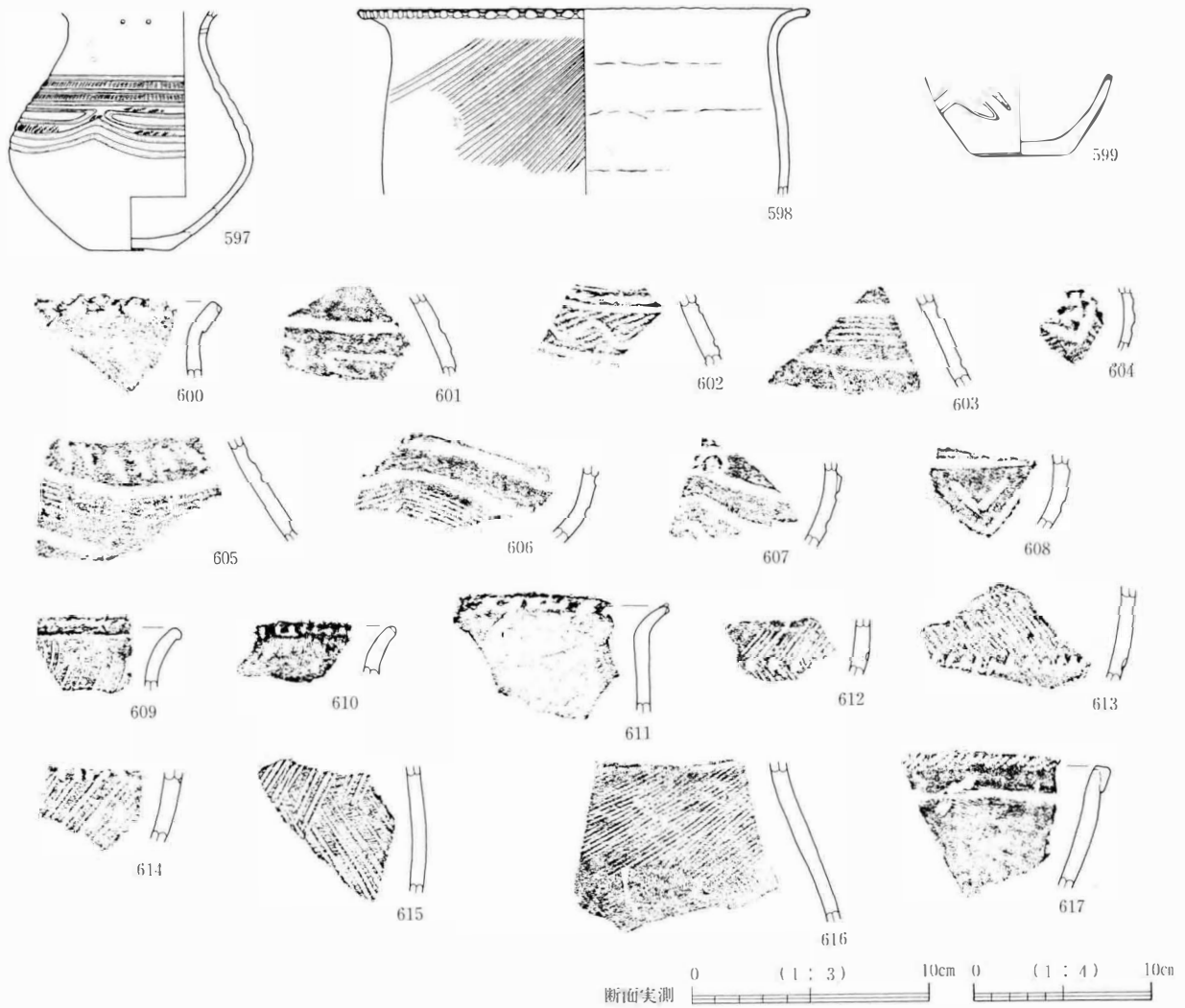

4① SA 1

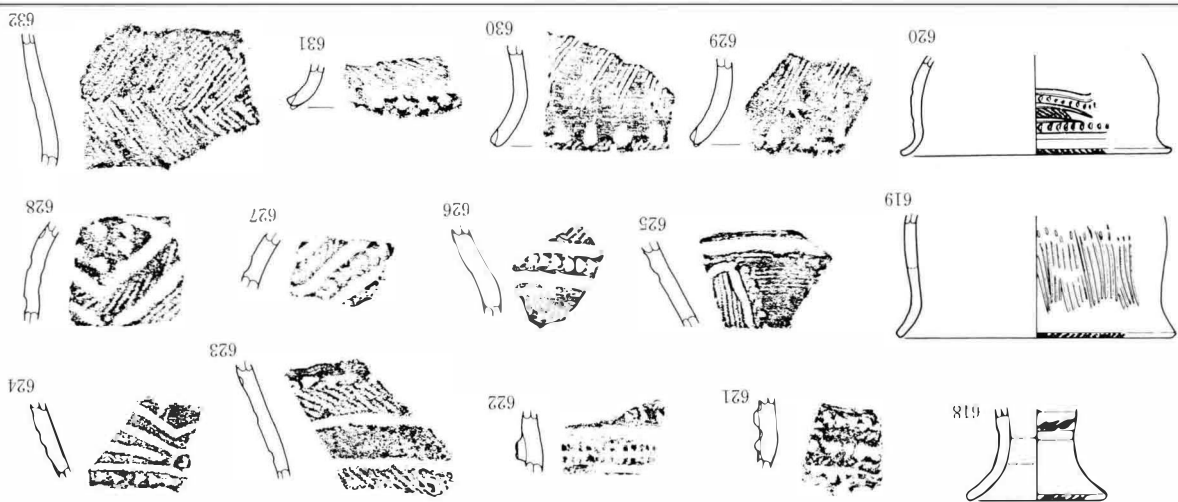

4① SA 2

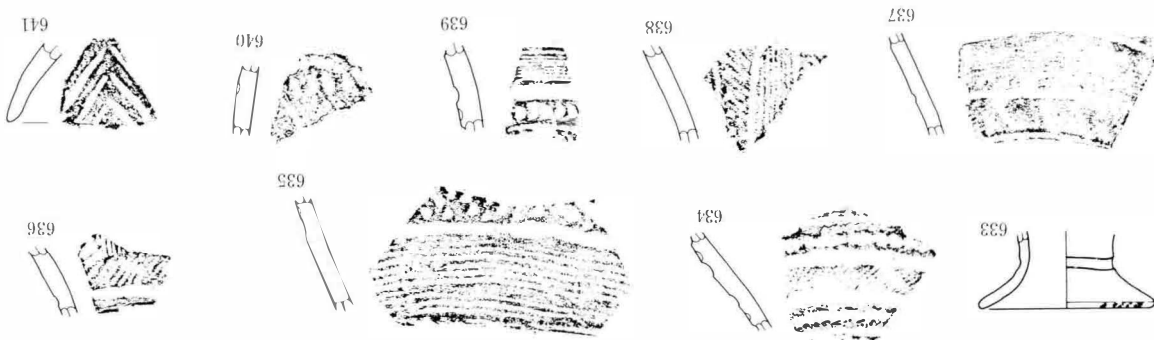

10① SA 1

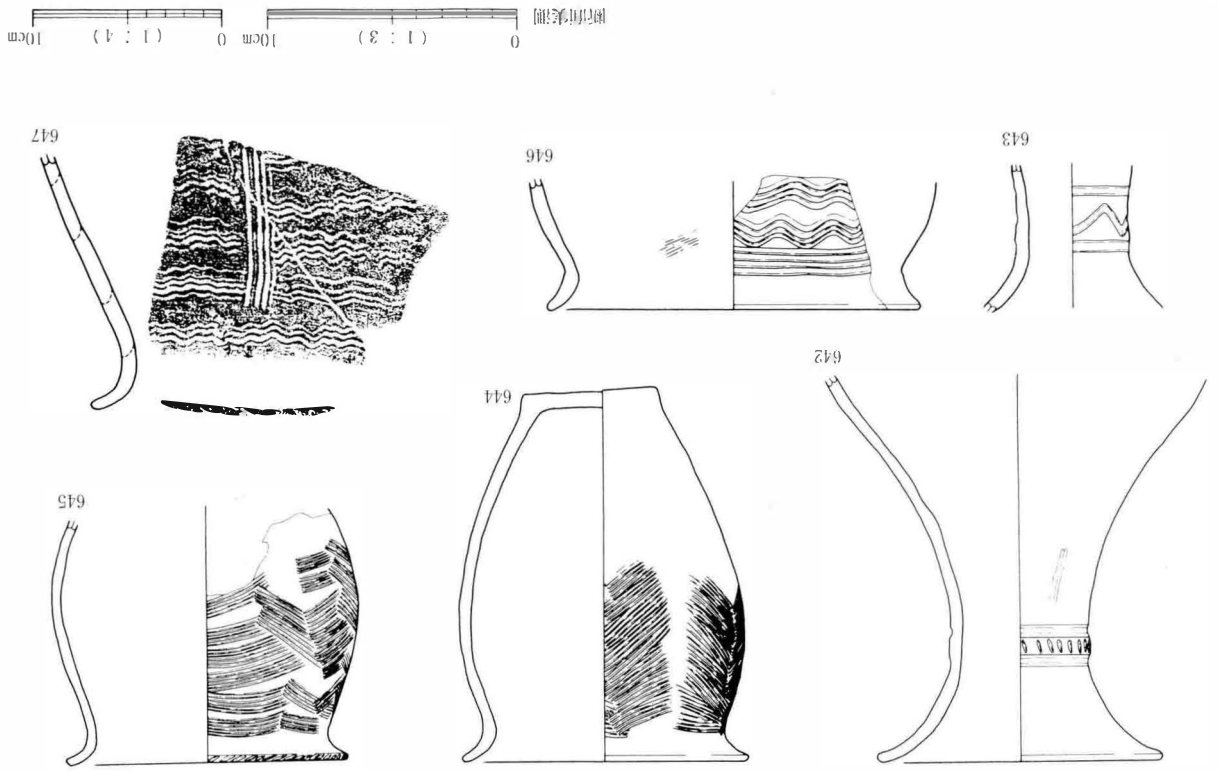

18① SA 1

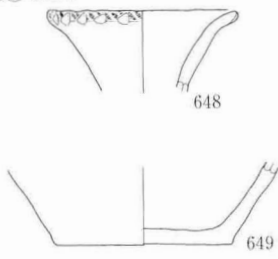

29① SA 1

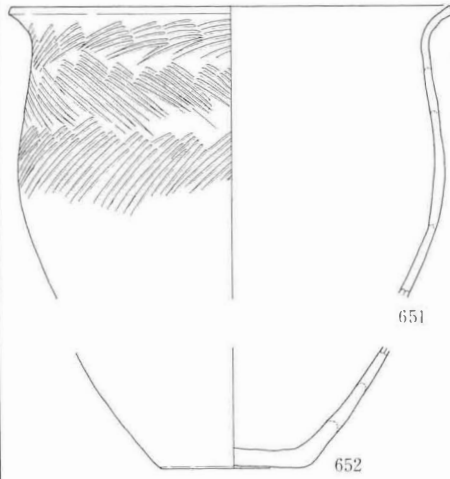

29① SA 2

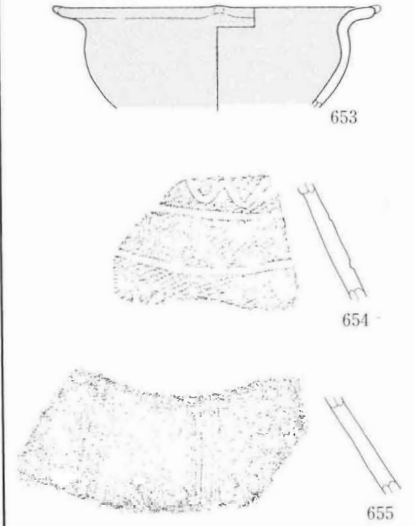

25① SA 1

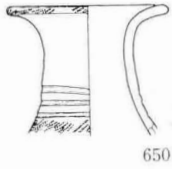

30① SA 1

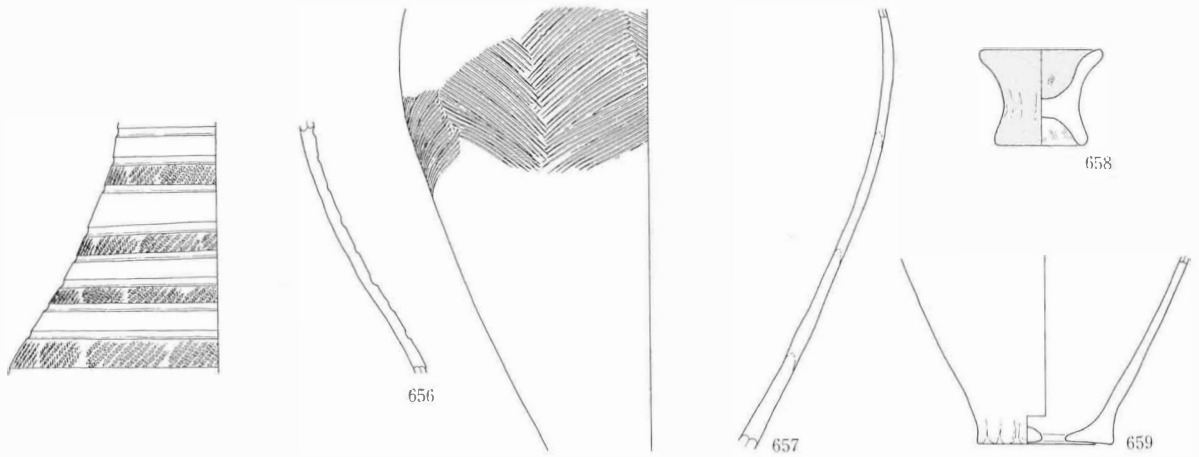

32① SA 1 (1)

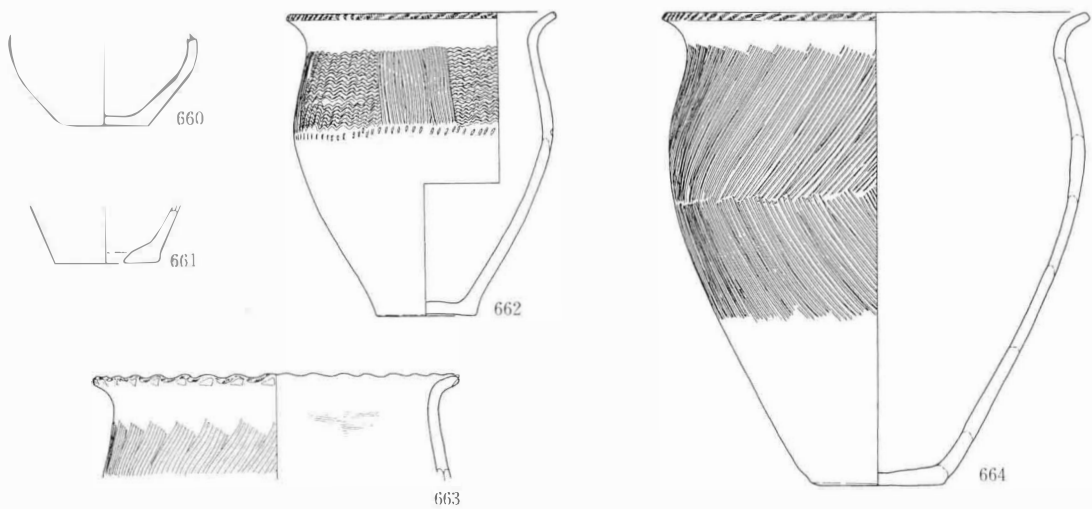

断面実測 0 (1:3) 10cm 0 (1:4) 10cm

32① SA 1 (2)

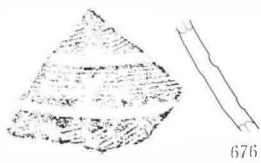
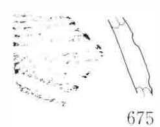
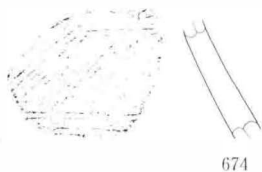
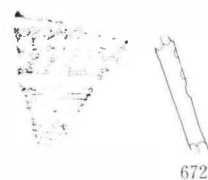
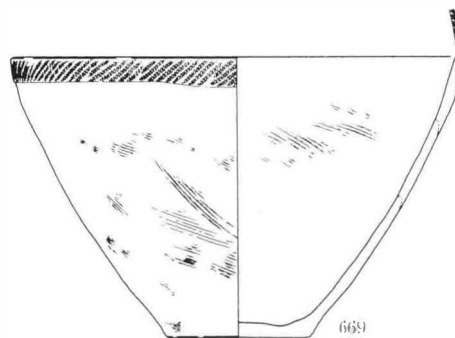
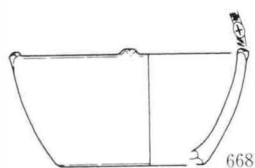
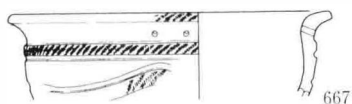
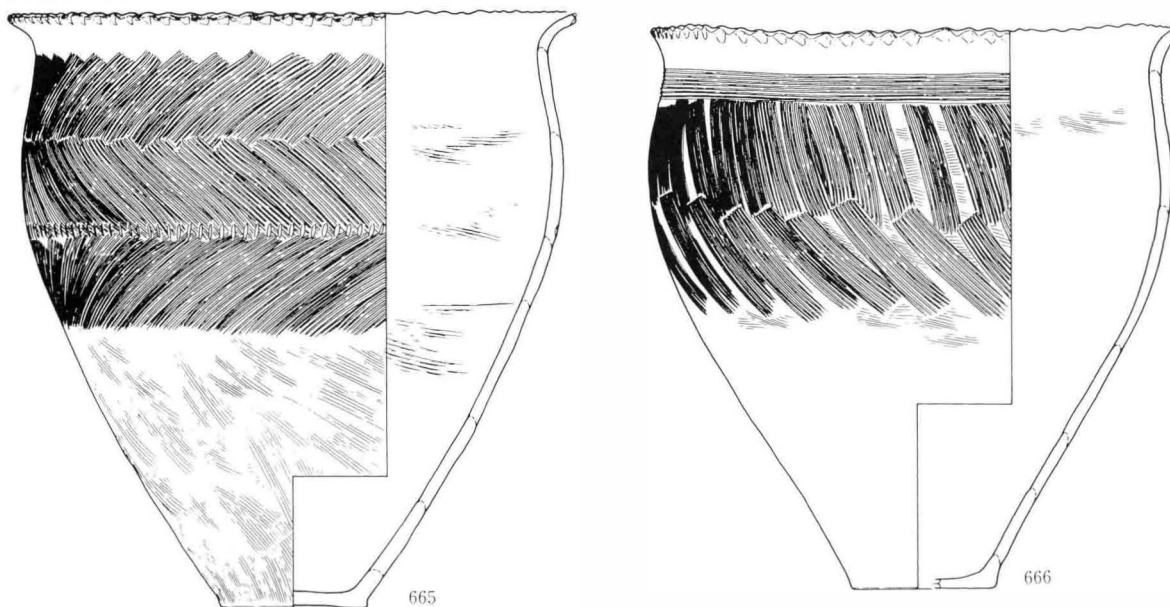

断面実測 0 (1:3) 10cm 0 (1:4) 10cm

図版 126 弥生時代中期の遺物 (5)

34① SA 4

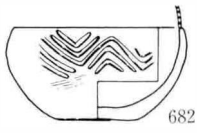

682

43① SA 2

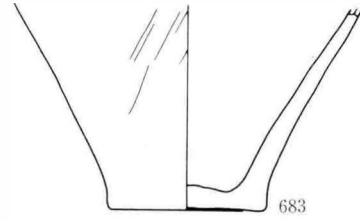

683



684

50① SA 10

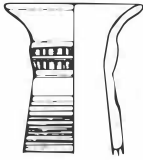

685

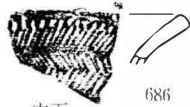

686

内面

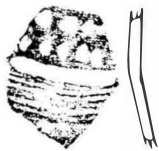

687



688

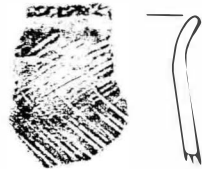

689



690

51① SA 2

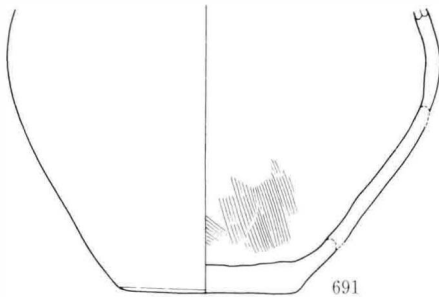

691

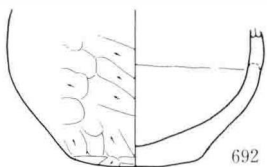

692



693

52② SA 1

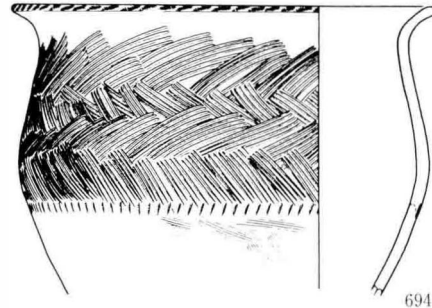

694

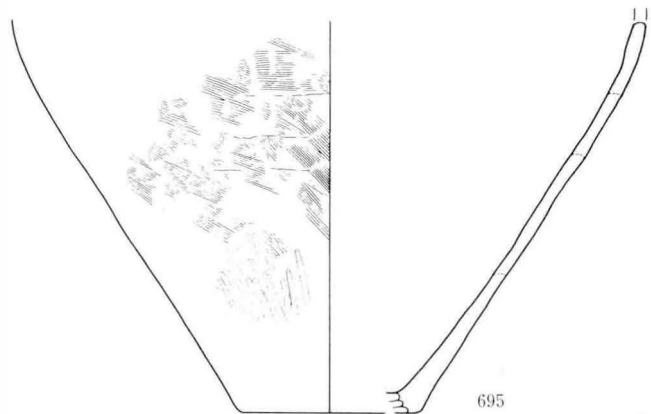

695

断面実測 0 (1:3) 10cm 0 (1:4) 10cm

図版 127 弥生時代中期の遺物 (6)

52② SA 3

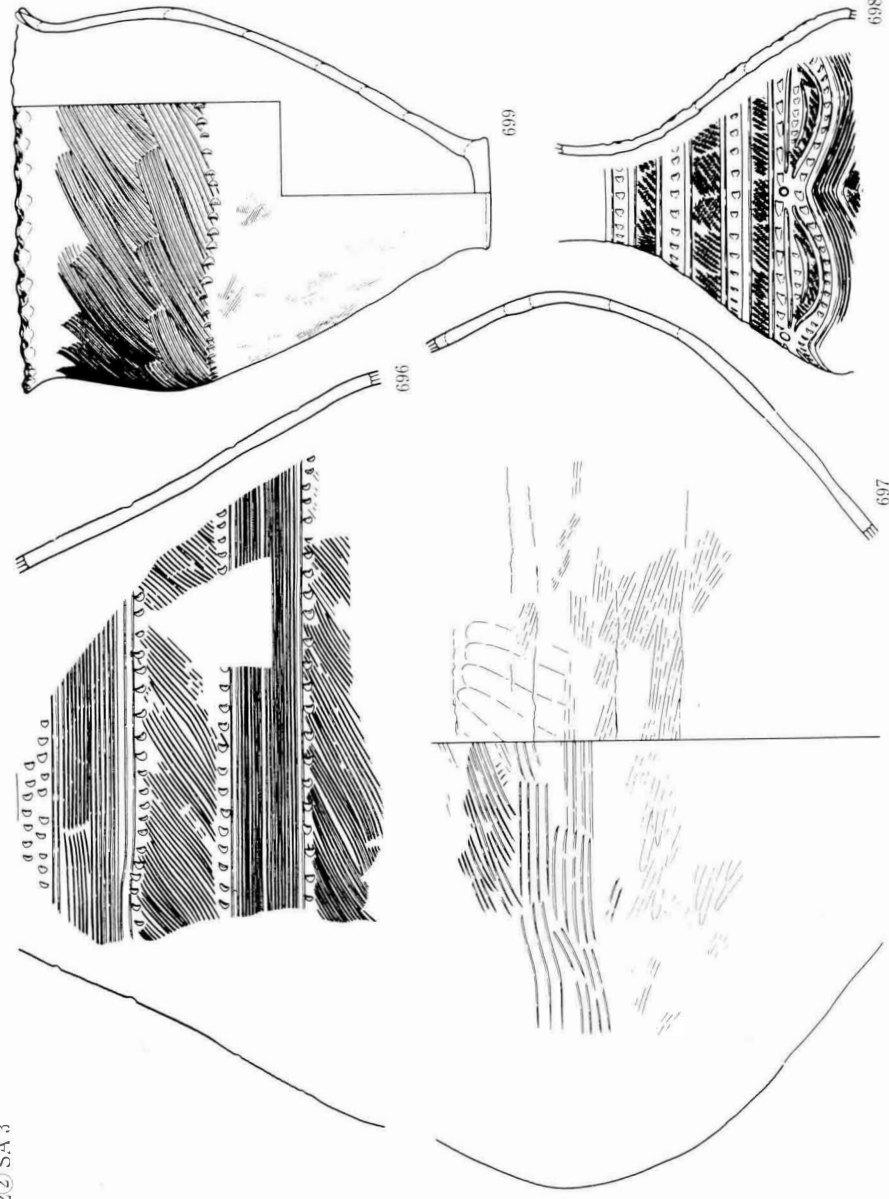

53② SA 3

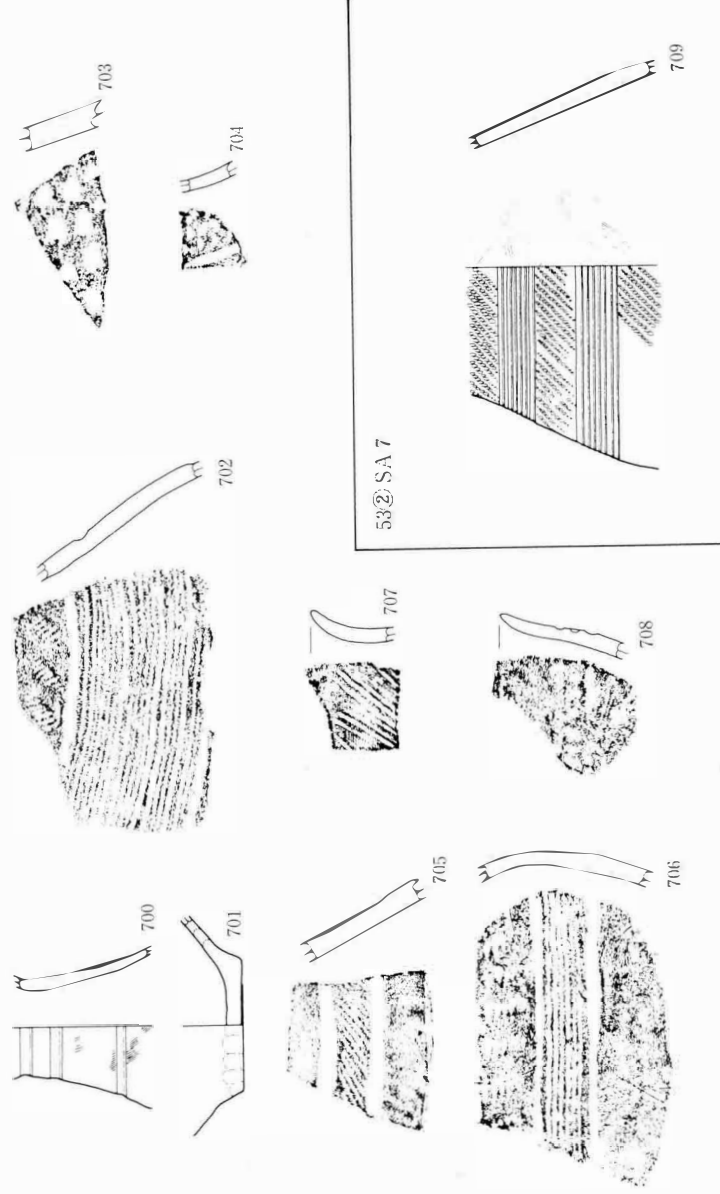

断面実測 0 10cm 0 10cm (1:3) (1:4) 10cm

53② SA11 (1)

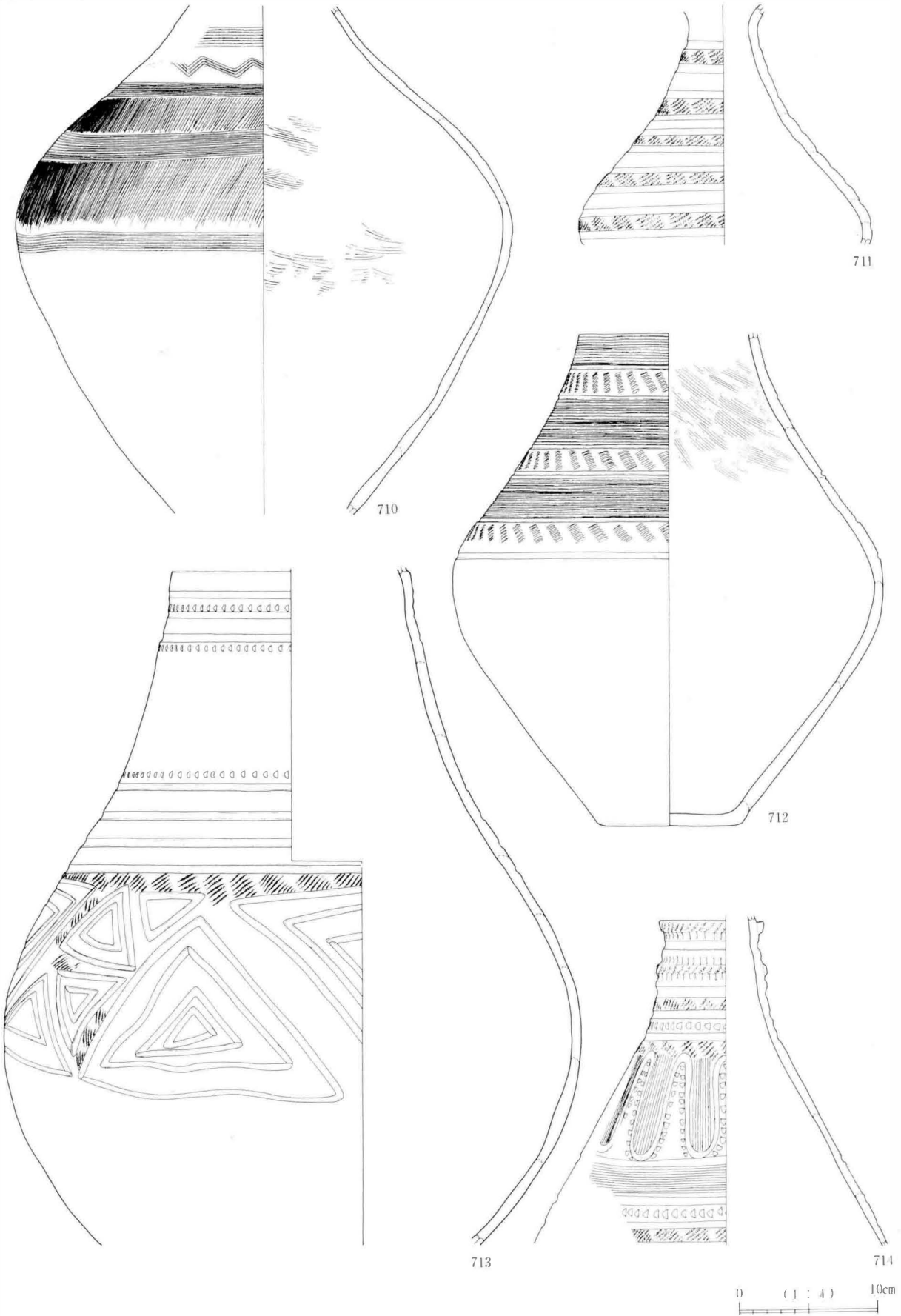

532 SAI (2)

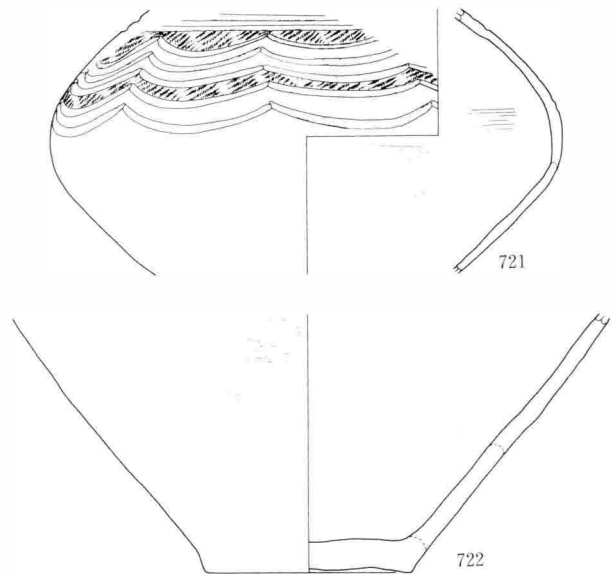
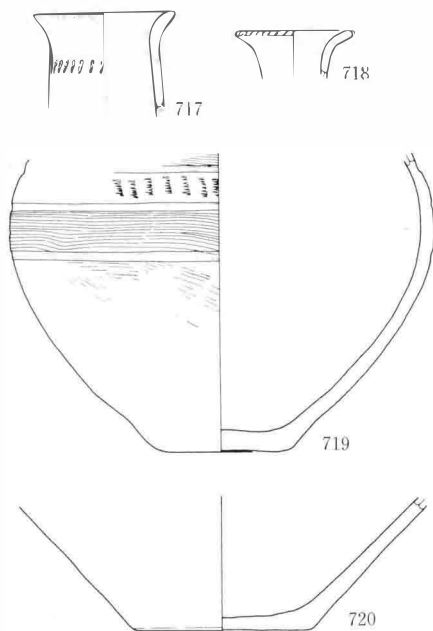
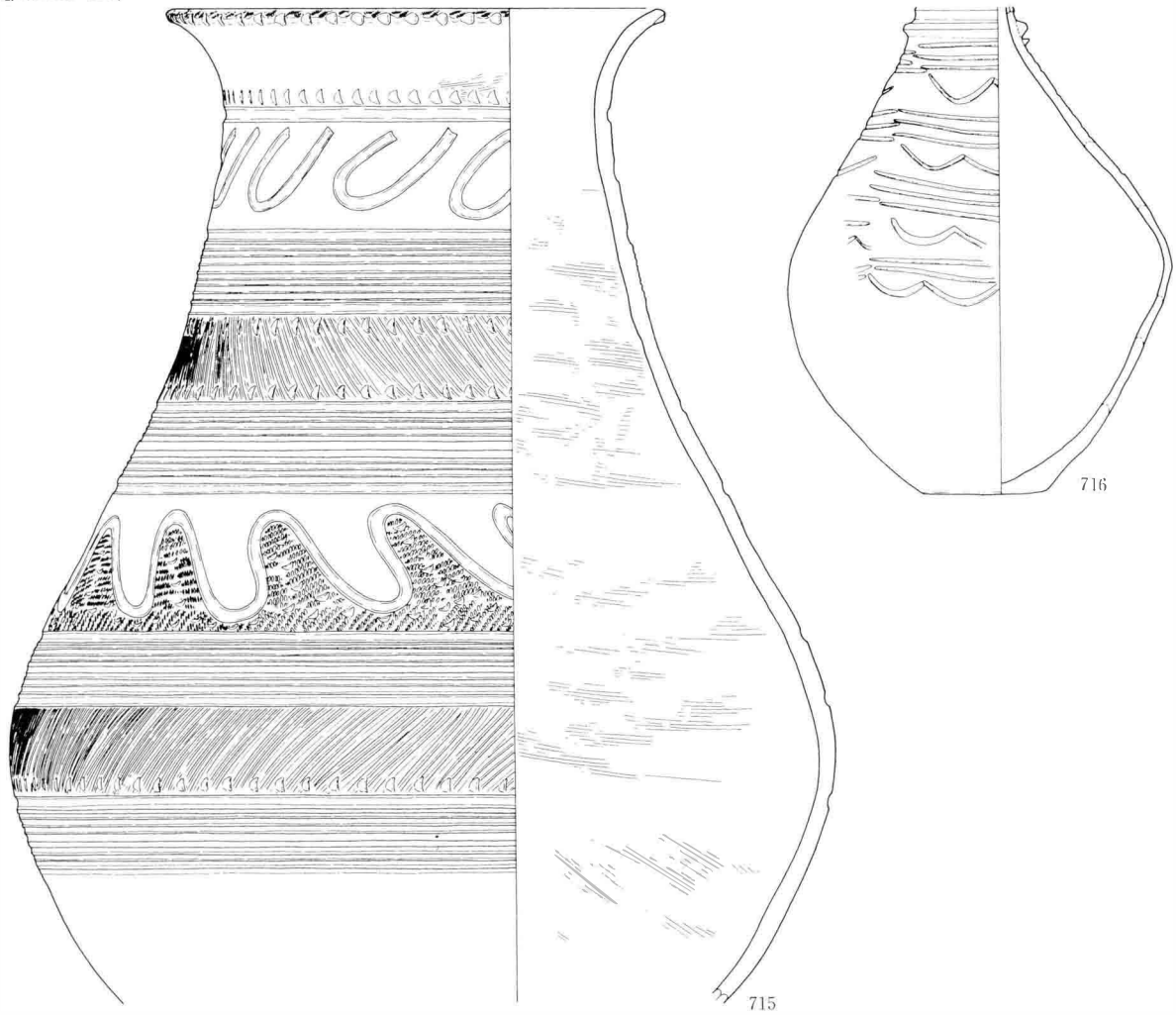

0 (1 : 4) 10cm

53② SA11 (3)

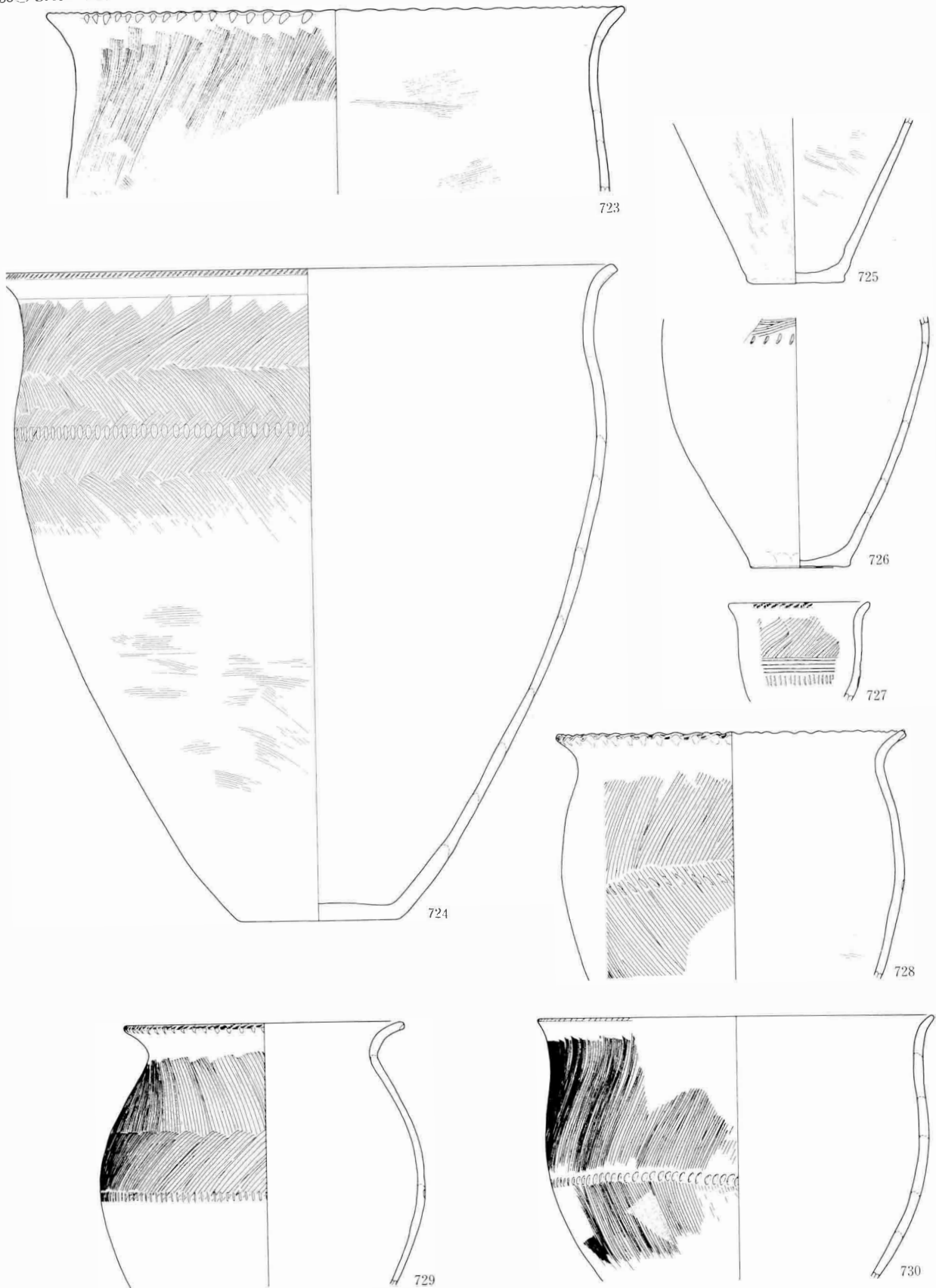

0 (1:4) 10c

53㉔SA11 (4)

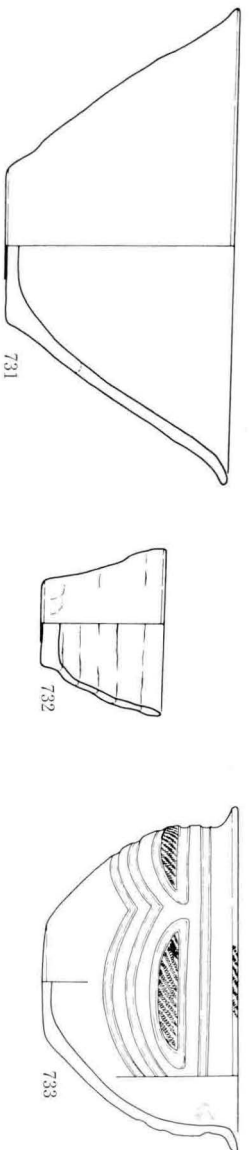

61㉔SA1

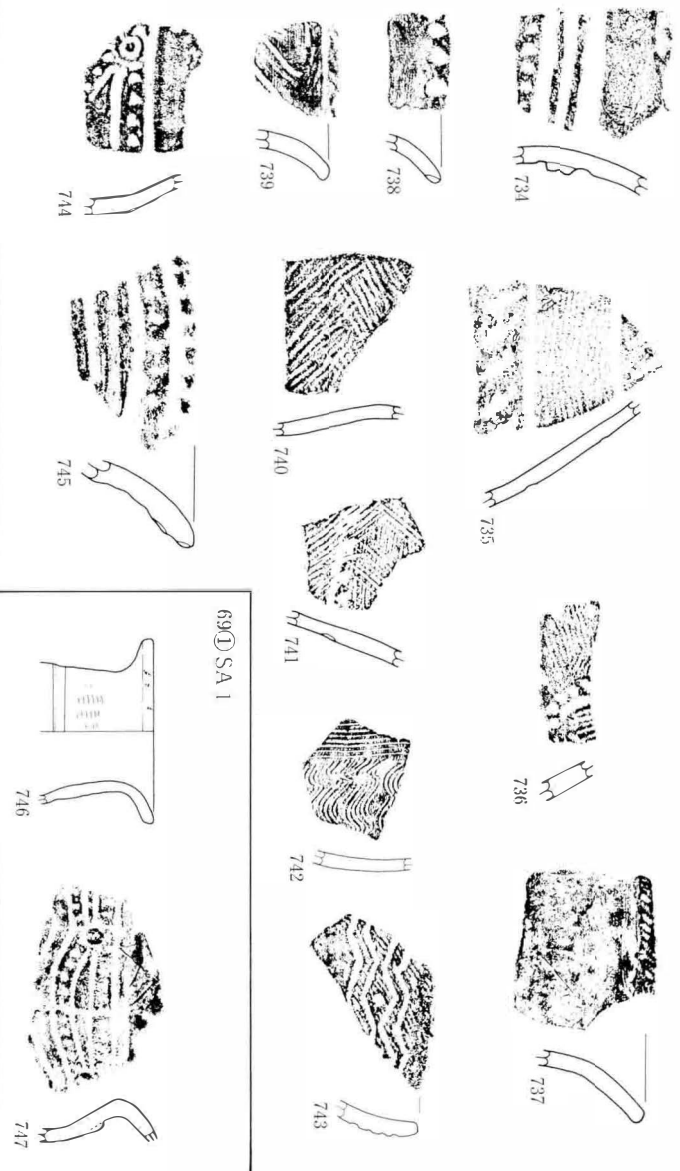

74㉔SA1

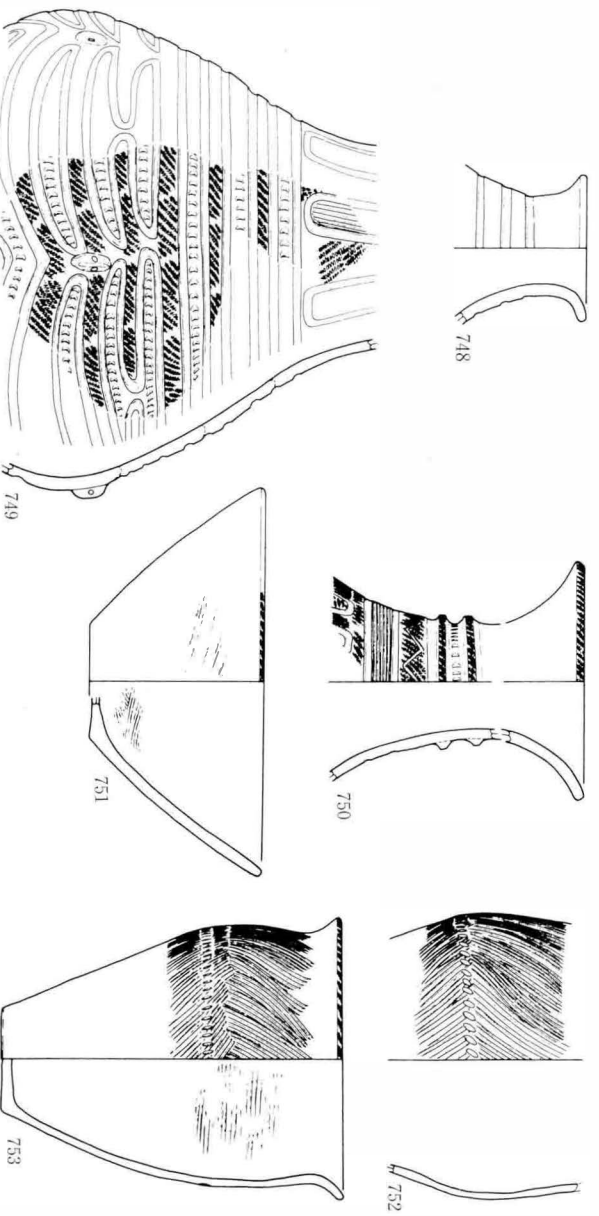

図版 132 弥生時代中期の遺物 (11)

74㉔ SA 2

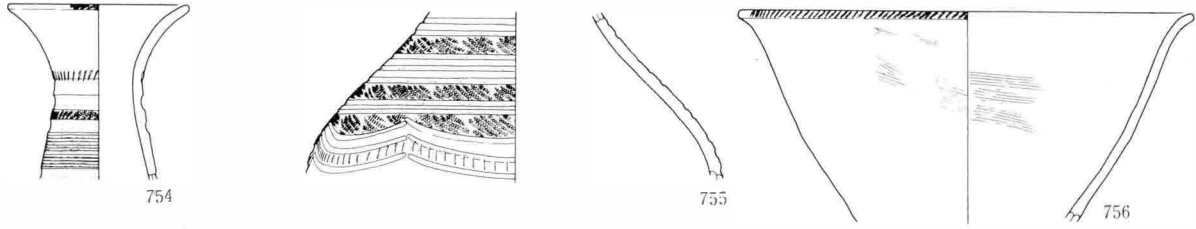

75㉔ SA 1

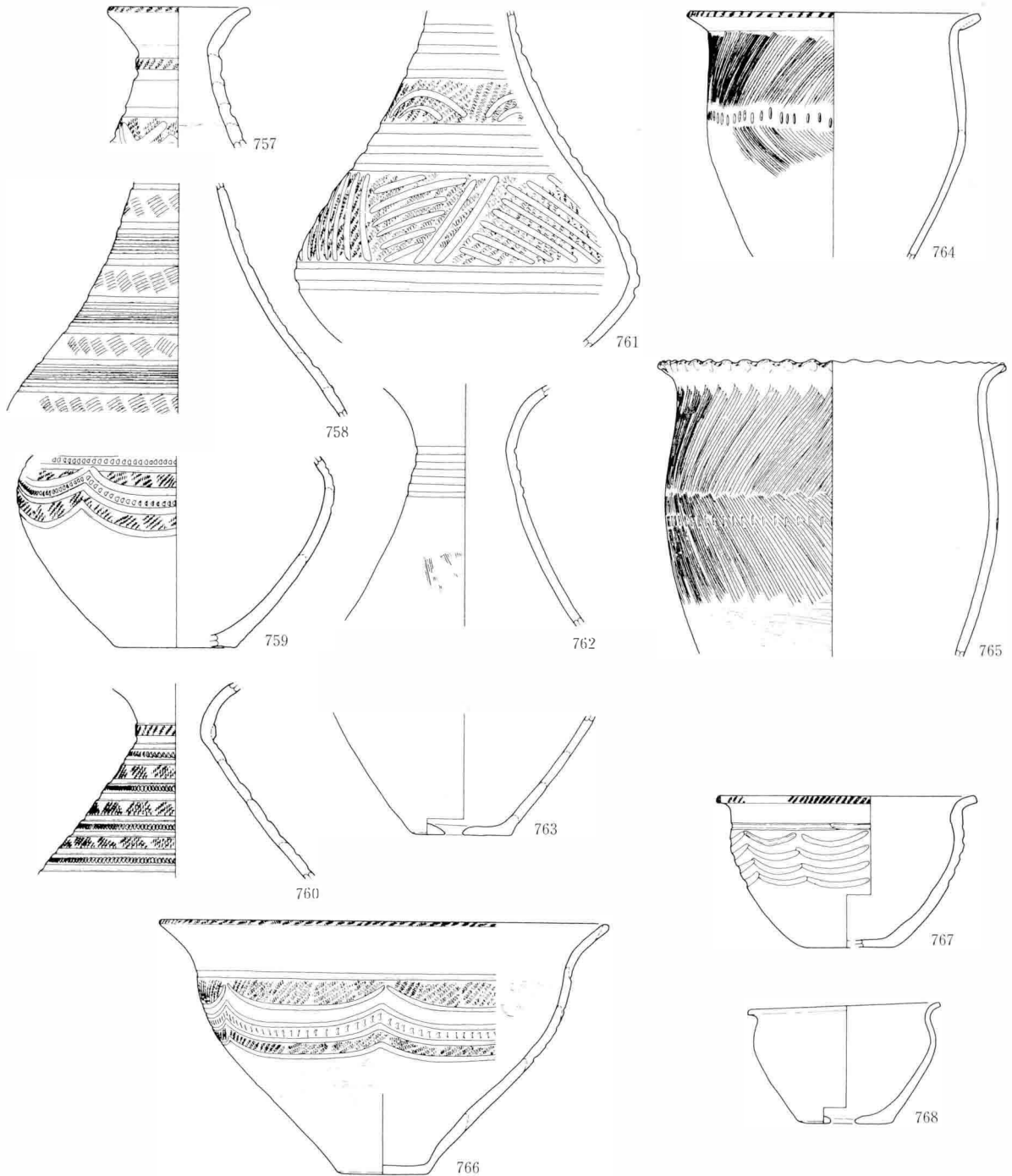

0 (1 : 4) 10cm

図版 133 弥生時代中期の遺物 (12)

B② SA 5

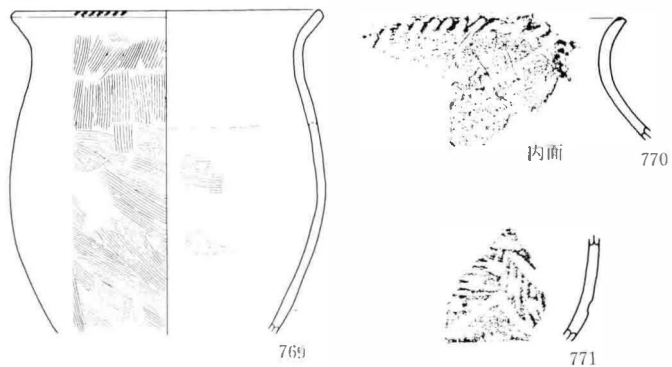

B② SA 6

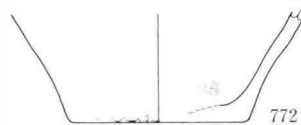

C② SA13

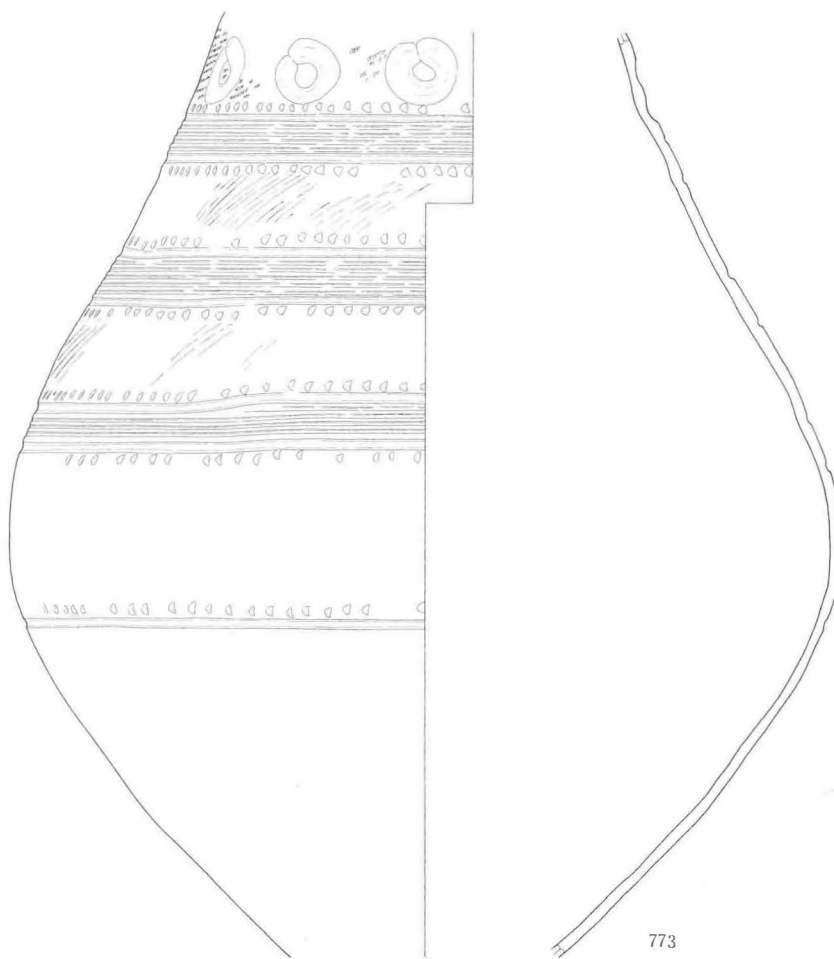

断面実測 0 (1:3) 10cm 0 (1:4) 10cm

図版 134 弥生時代中期の遺物 (13)

C② SA14

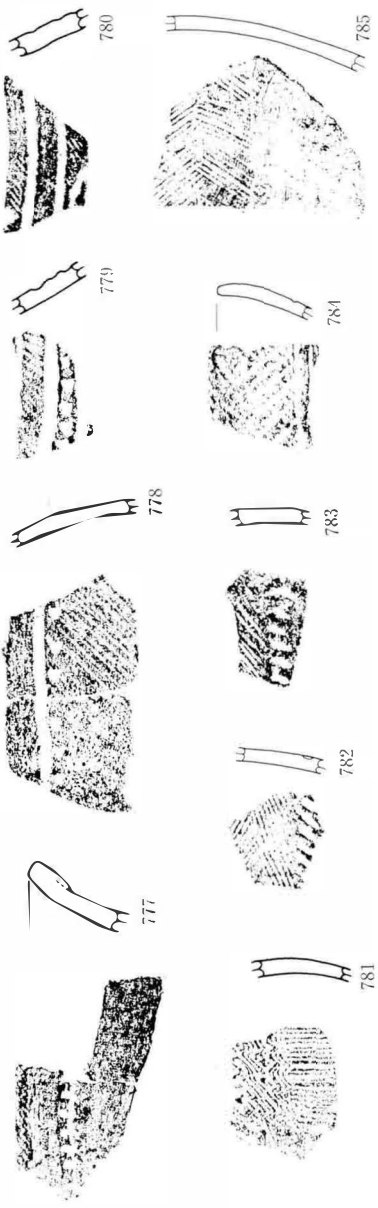

C② SA19

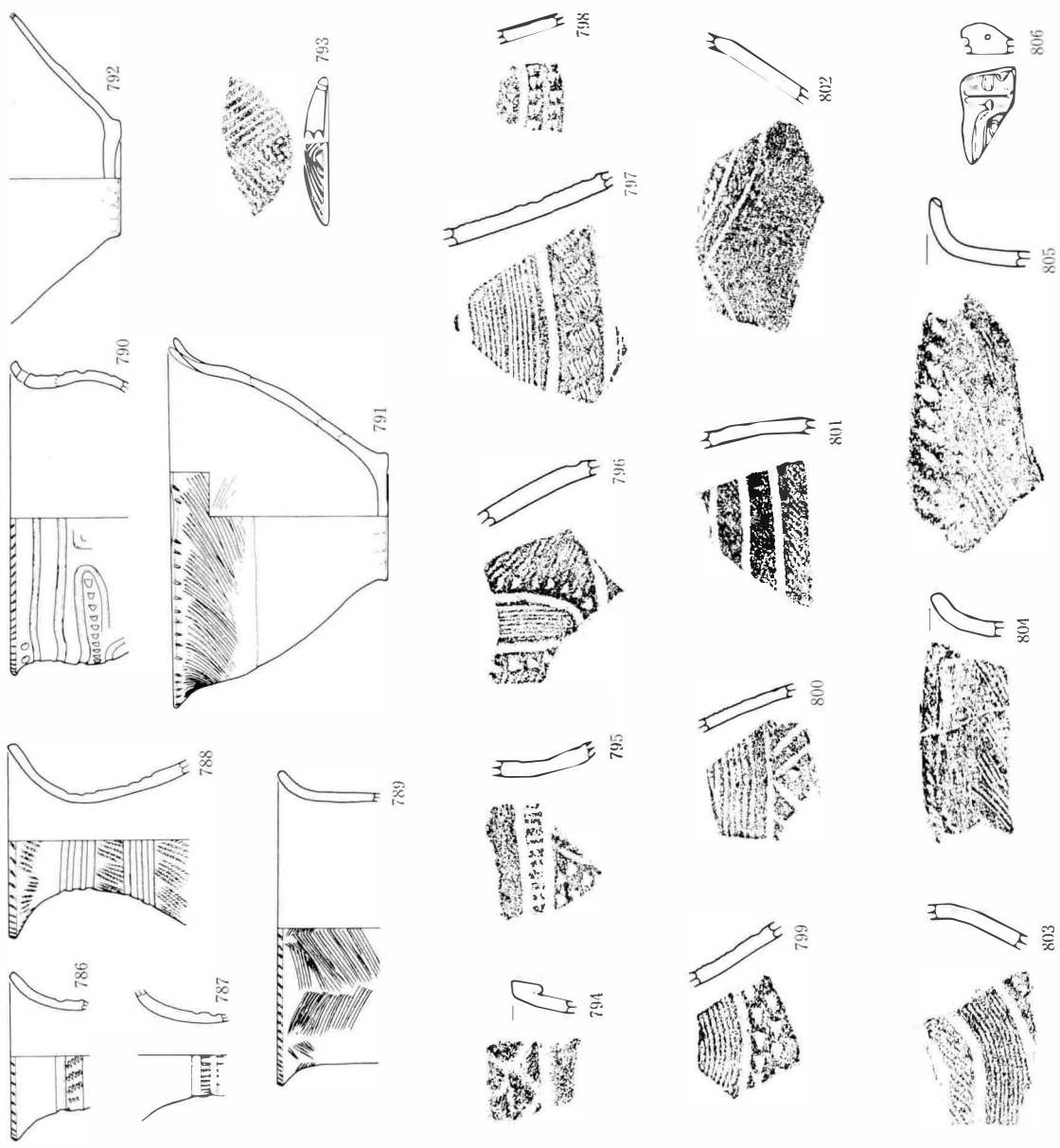

C 2 SA20 (1)

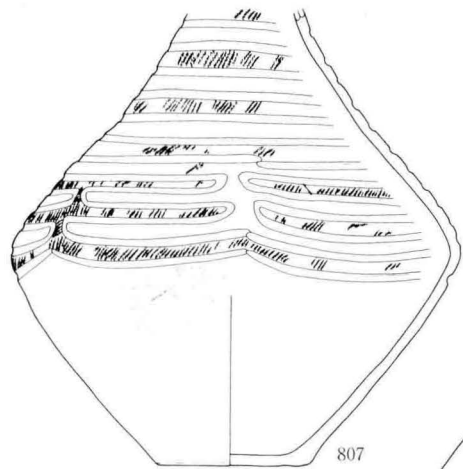

807

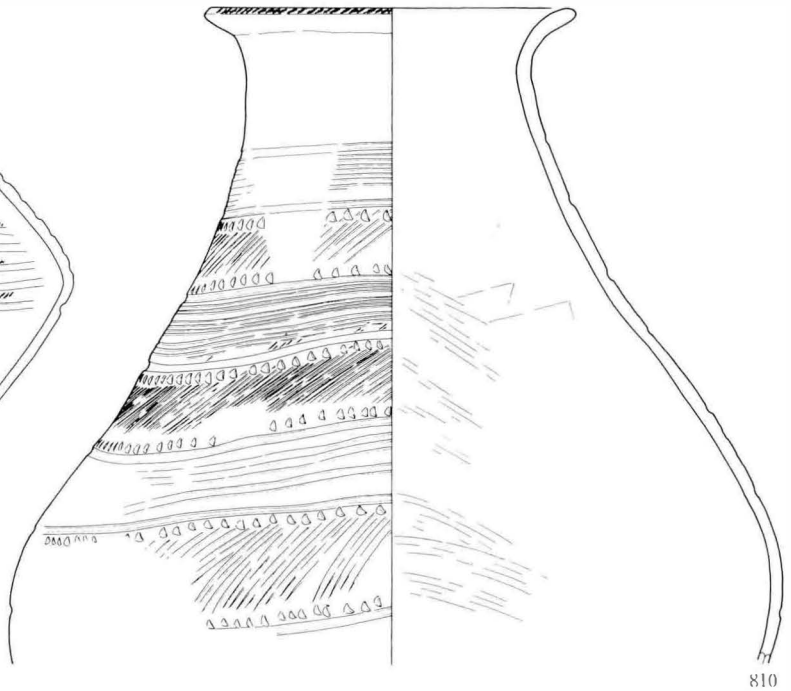

810

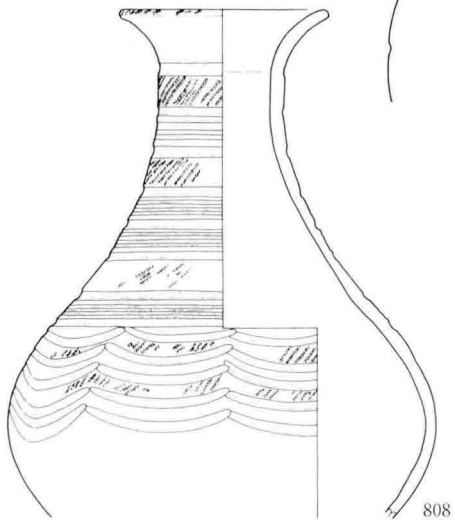

808

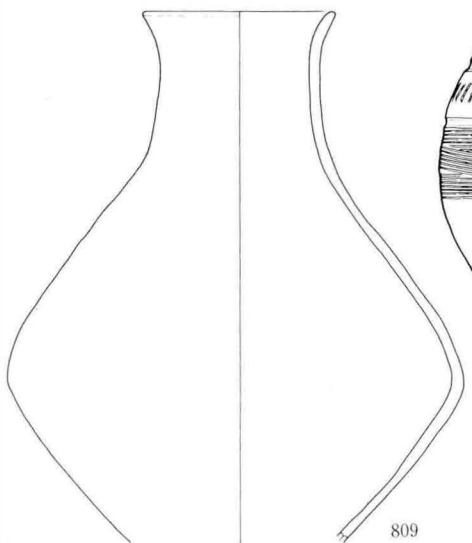

809

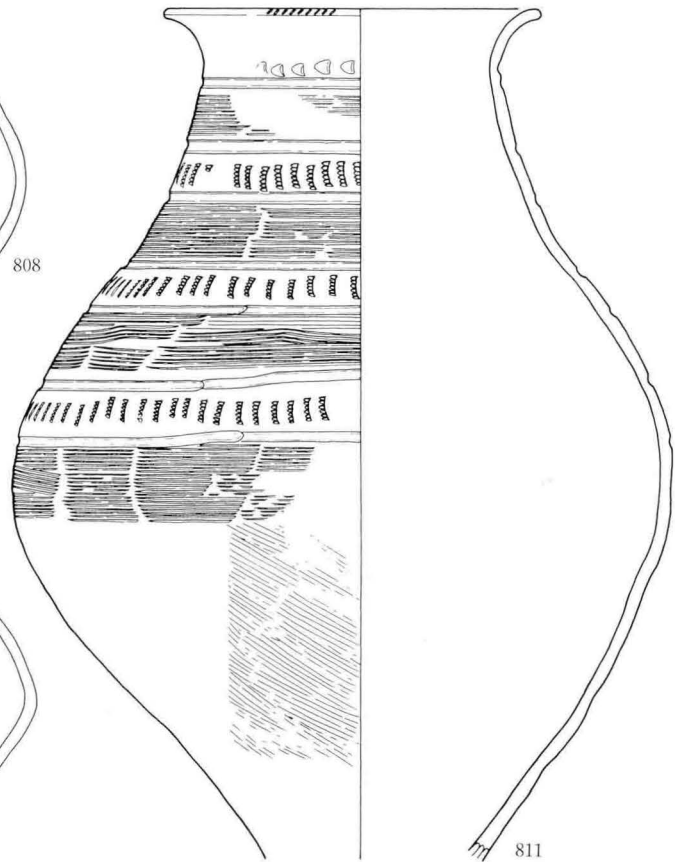

811

0 (1 : 4) 10cm

C② SA20 (2)

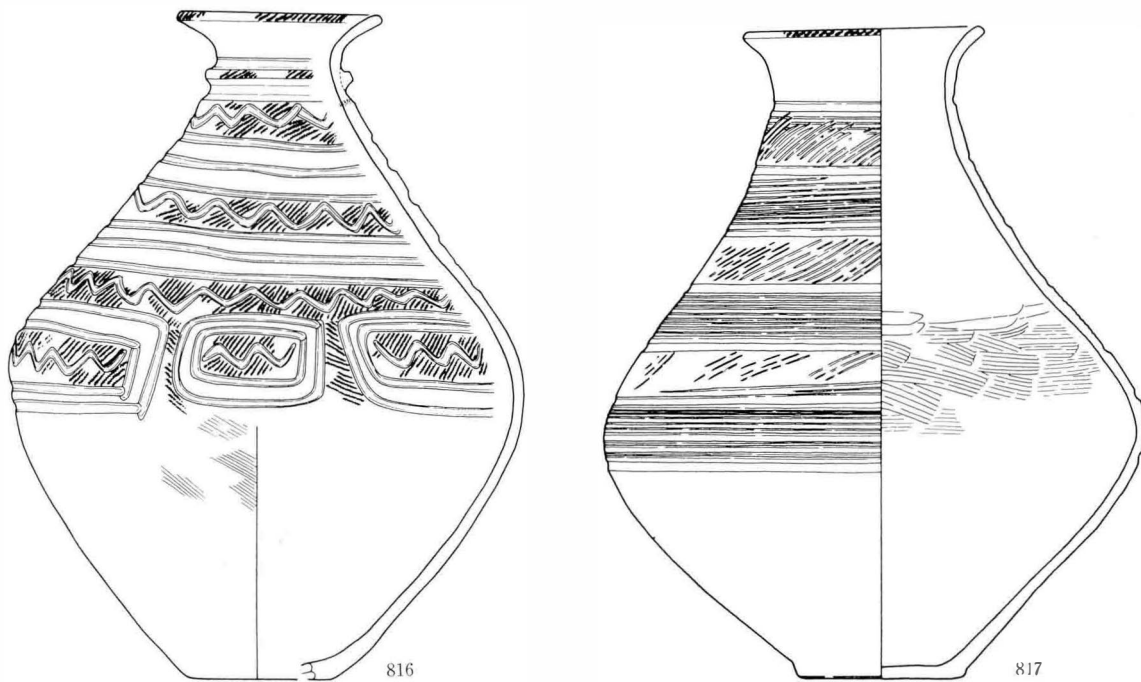
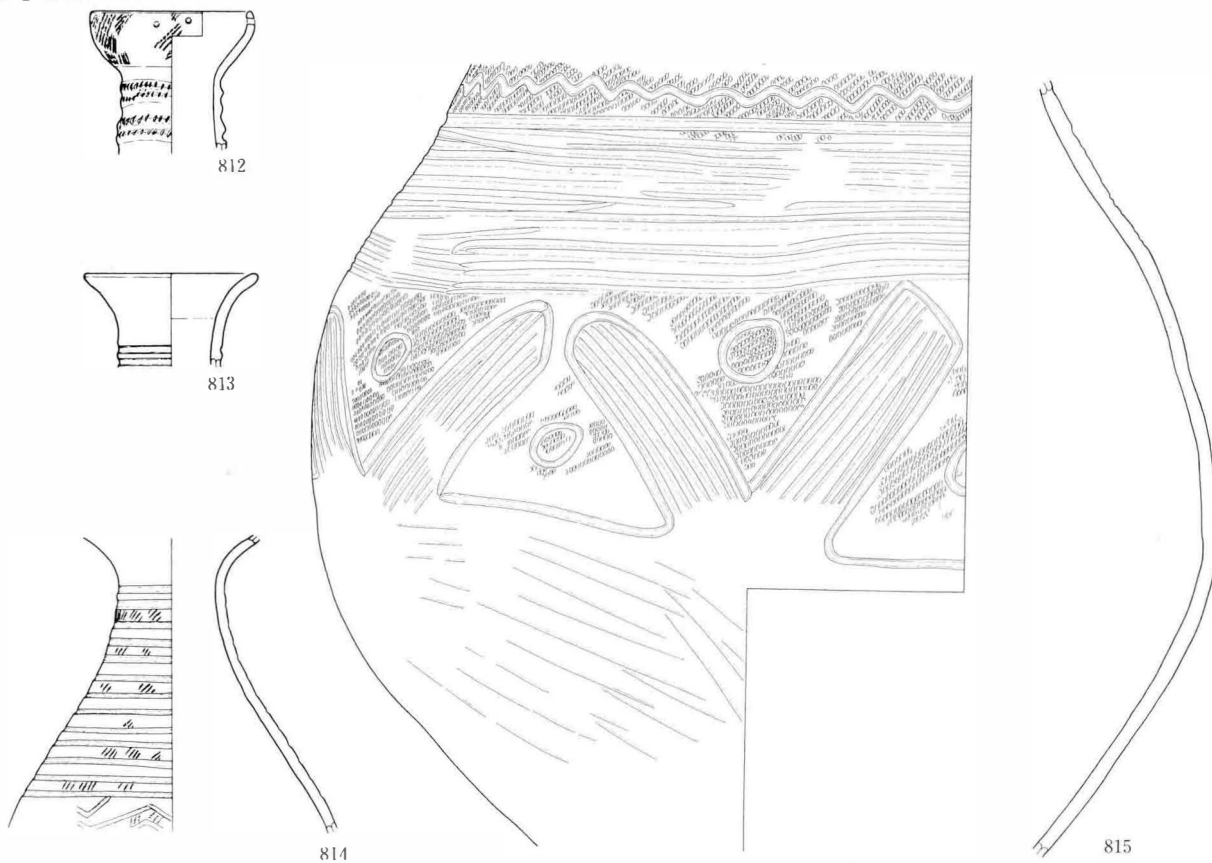

0 (1 : 4) 10cm

図版 137 弥生時代中期の遺物 (16)

C② SA20 (3)

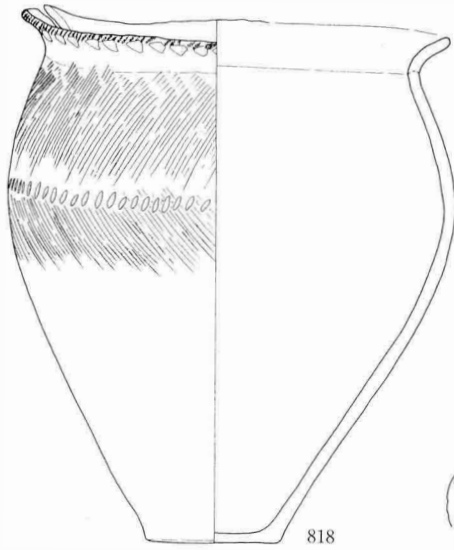

818

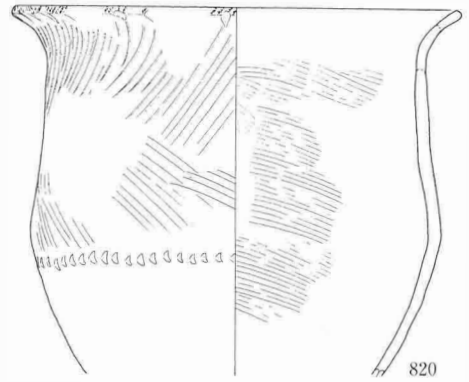

820



821

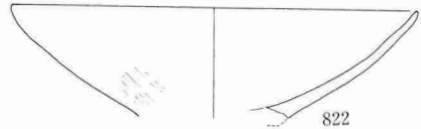

822

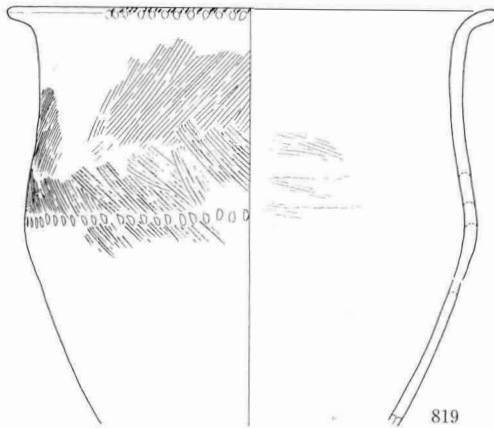

819

C② SA27

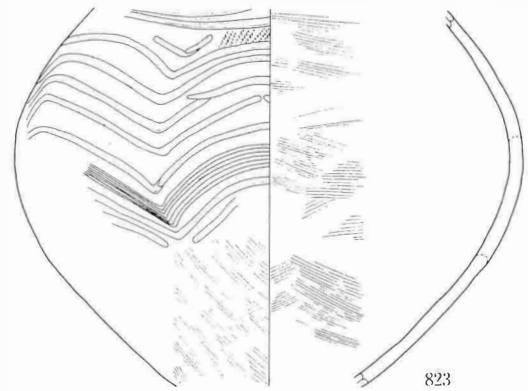

823

E① SA 1

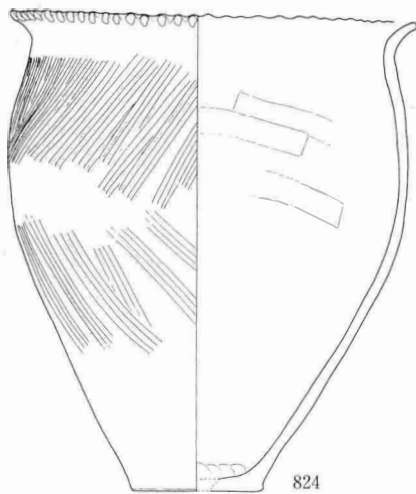

824



825



827

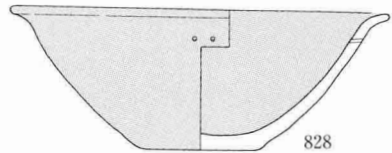

828

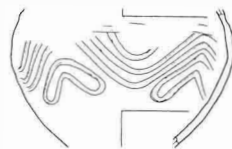

826

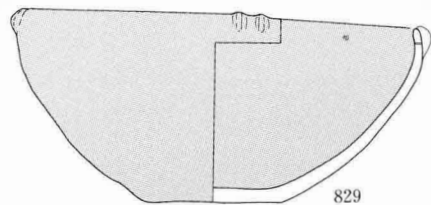

829

0 (1 : 4) 10cm

図版 138 弥生時代中期の遺物 (17)

18① SK 4

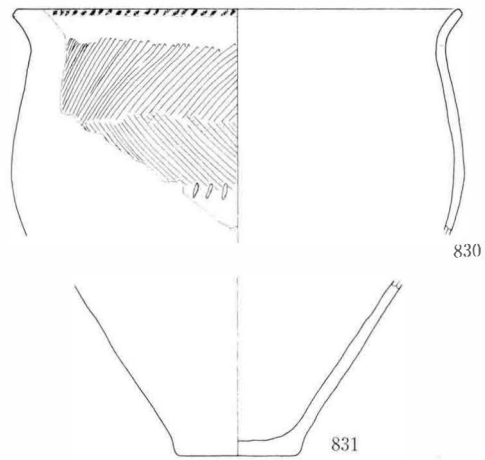

60① SK 3

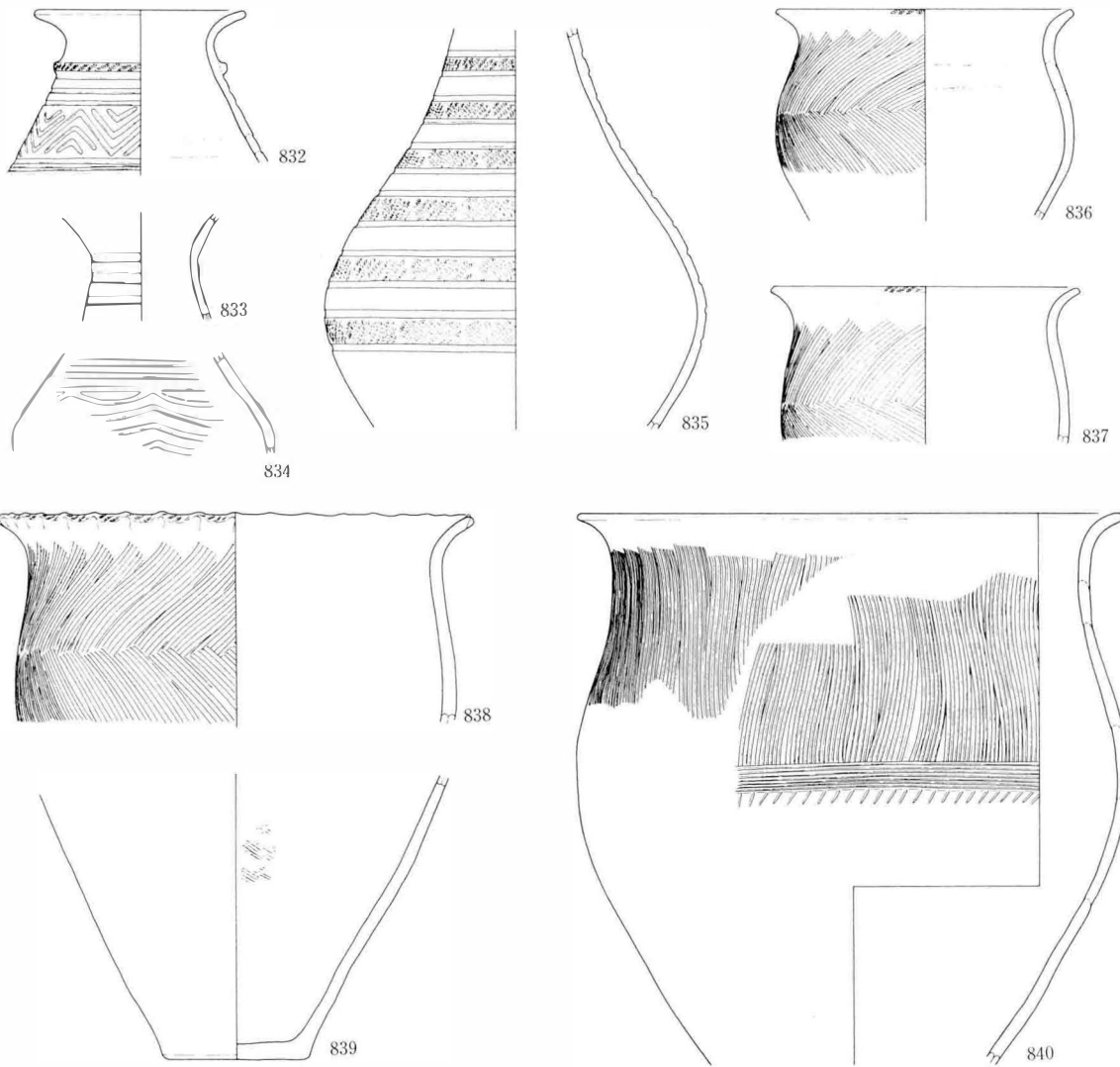

図版 139 弥生時代中期の遺物 (18)

26① SK10

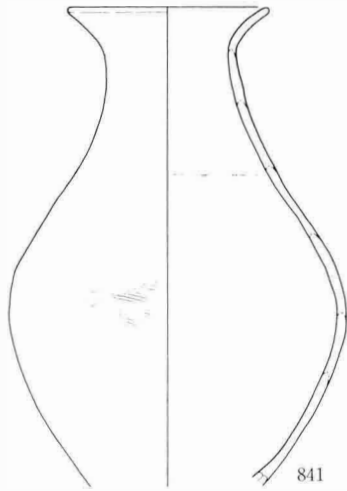

29① SK 2

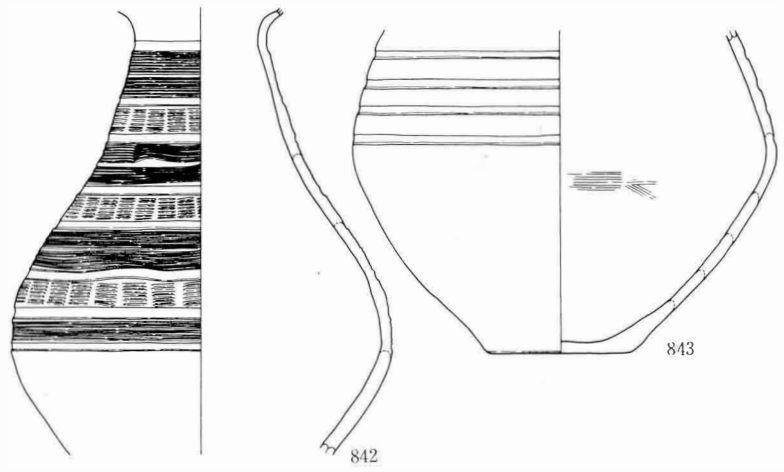

64① SK 1

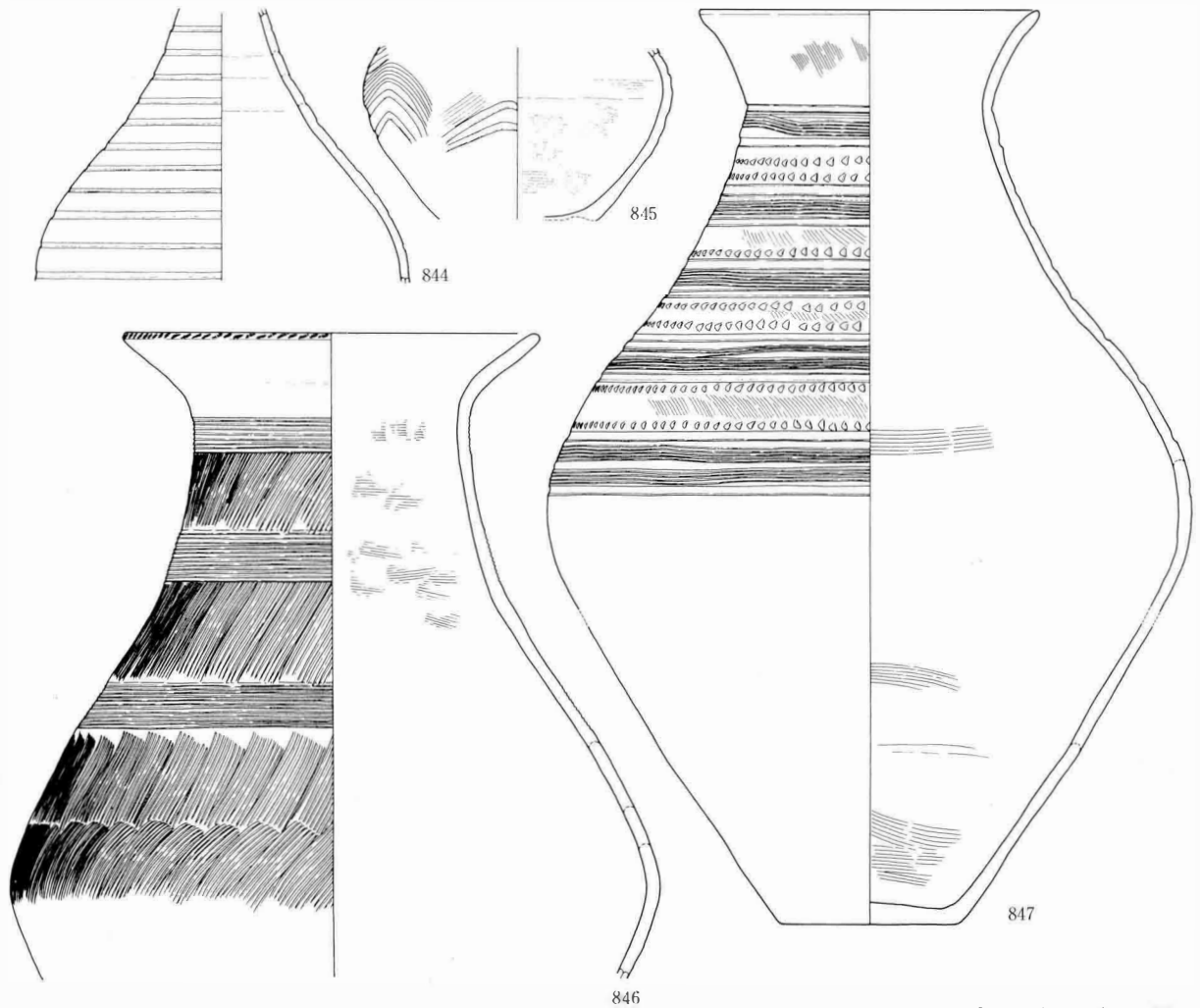

0 (1 : 4) 10cm

C② SK109

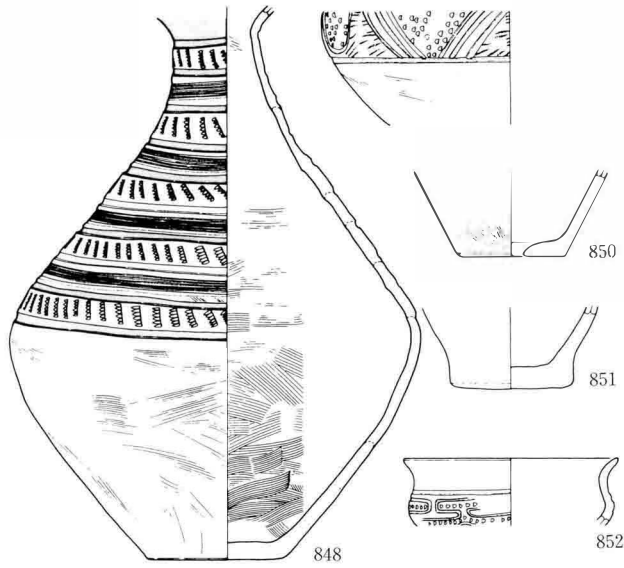

C② SK111

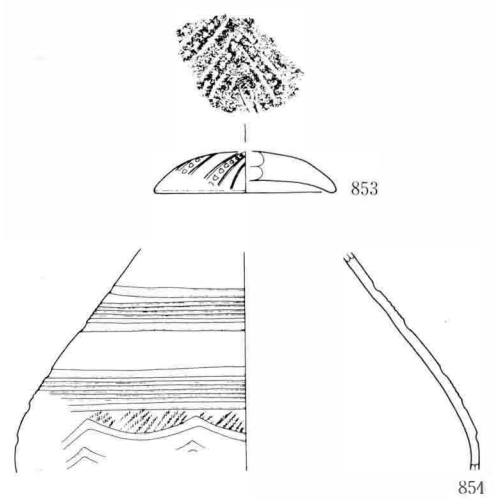

27① SD 1

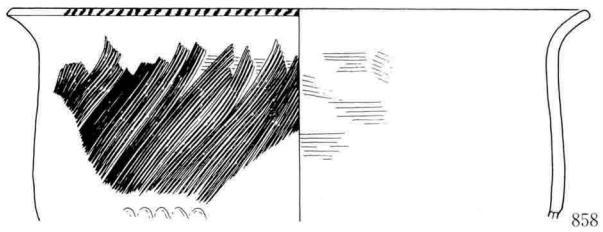
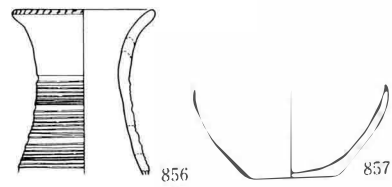
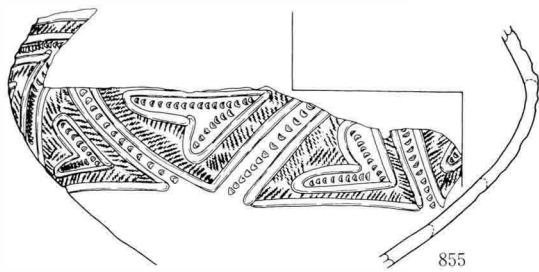

3① SX 1

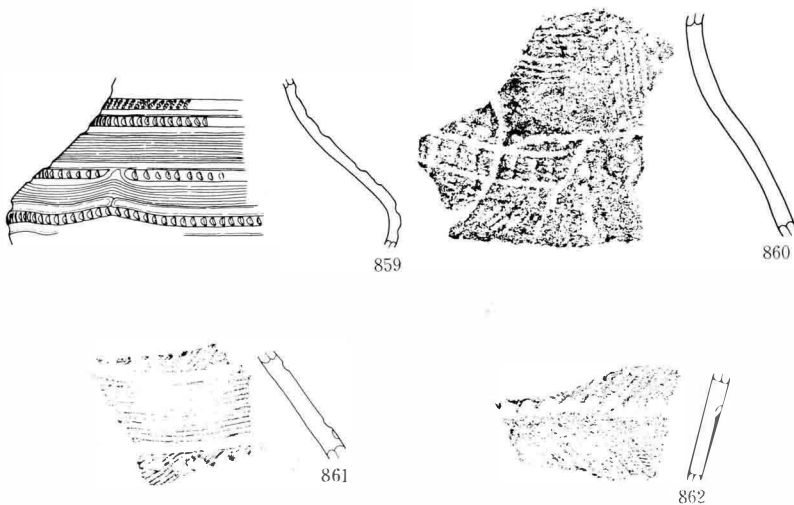

25① SX 1

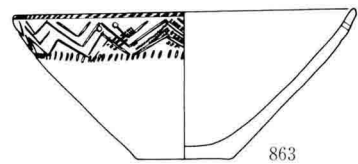

断面実測 0 (1:3) 10cm 0 (1:4) 10cm

図版 141 弥生時代中期の遺物 (20)

石製品 (1)

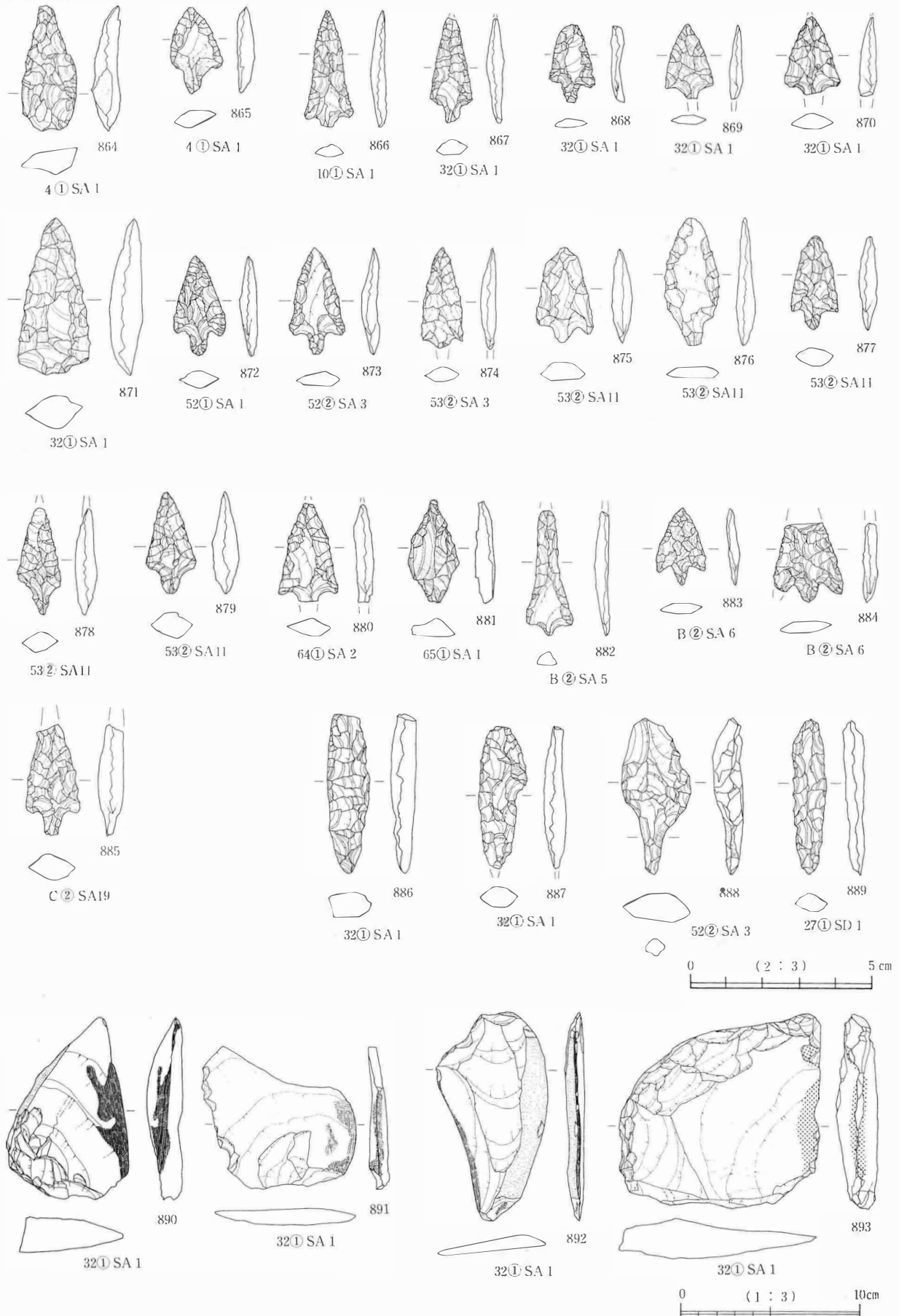

石製品 (2)

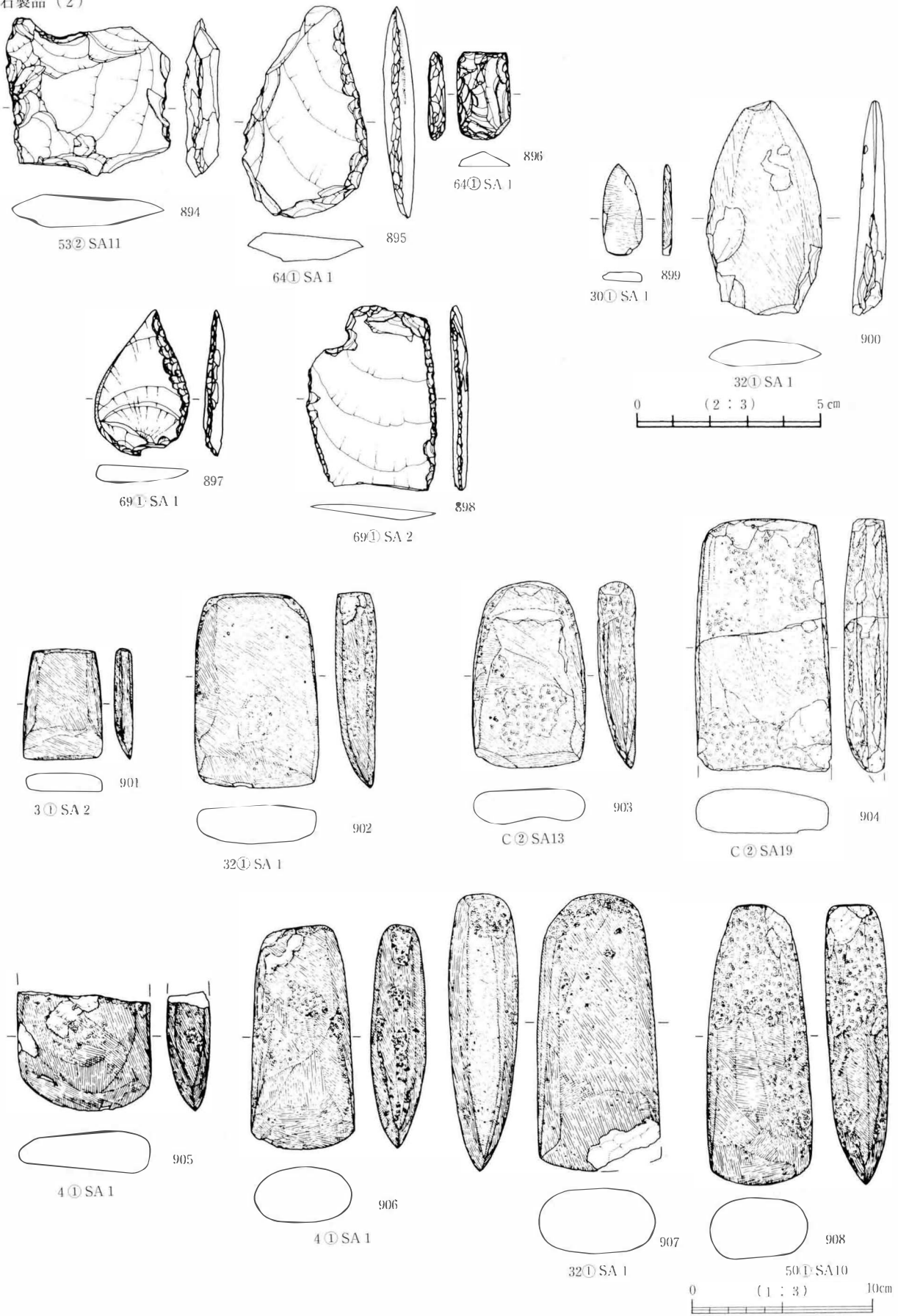

石製品 (3)

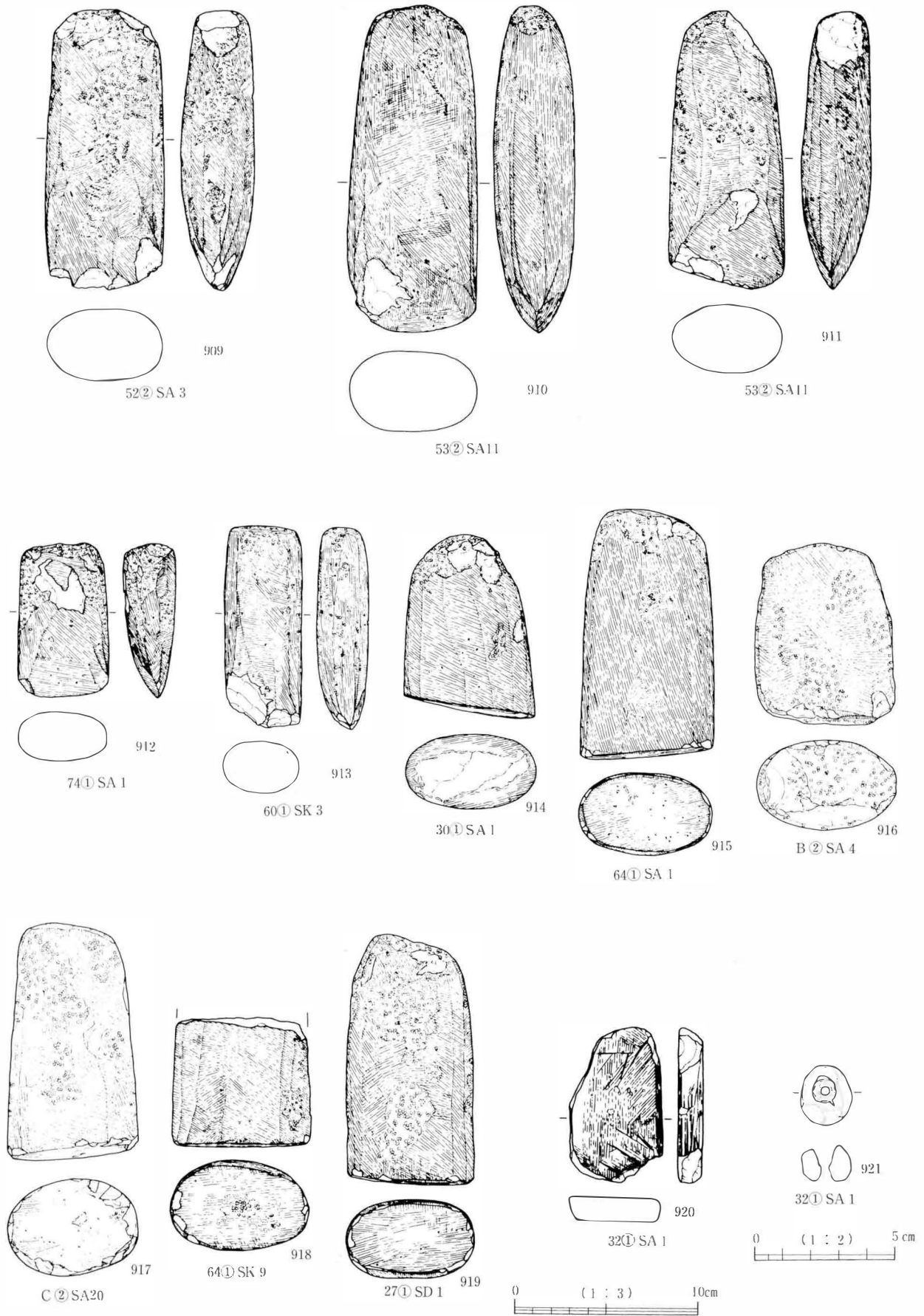

土製品



図版 145 弥生時代中期の遺物 (24)

装身具

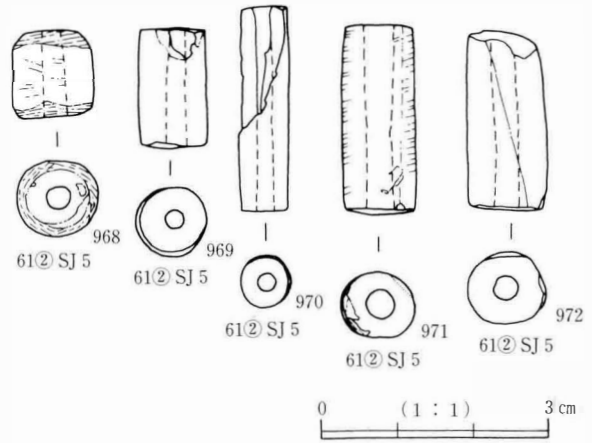
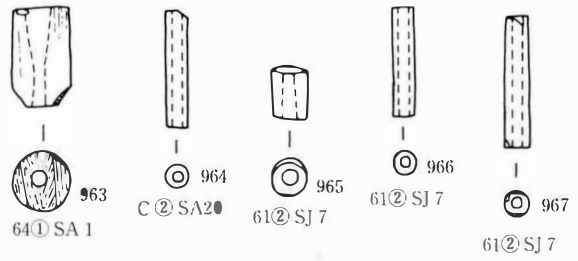
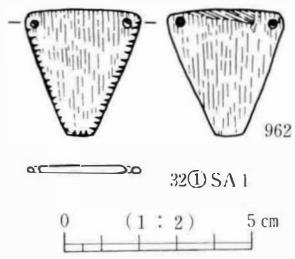

図版 146 弥生時代後期の遺物 (1)

33① SA 2

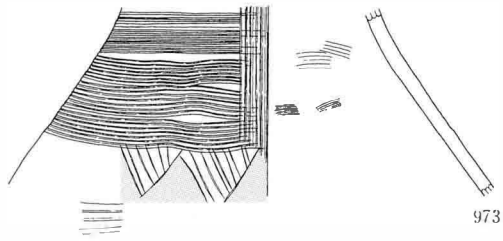

46① SA 1

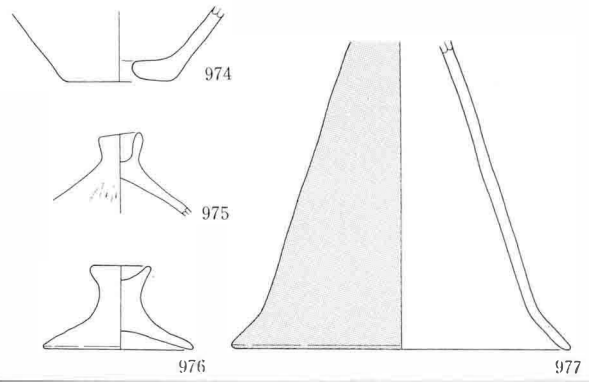

46① SA 2

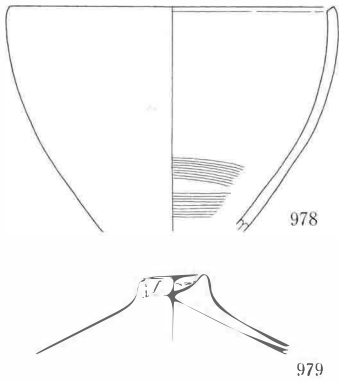

50① SA 7

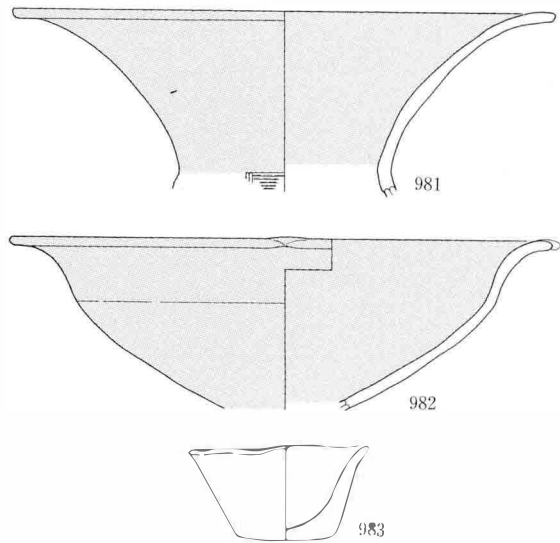

46① SA 3

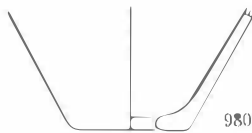

50② SA 1

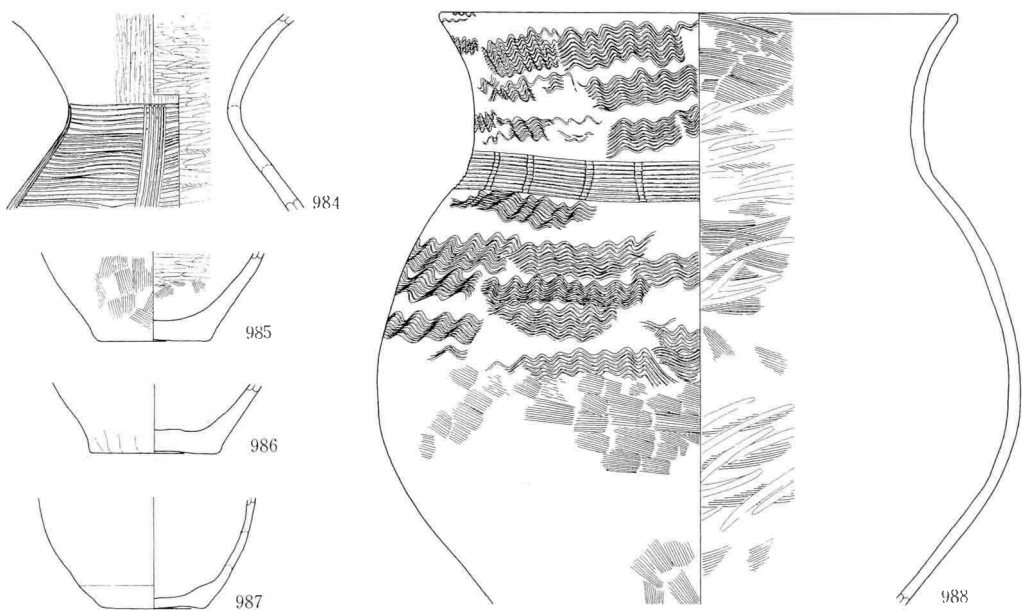

0 (1 : 4) 10cm

図版 147 弥生時代後期の遺物 (2)

50㉔ SA 2

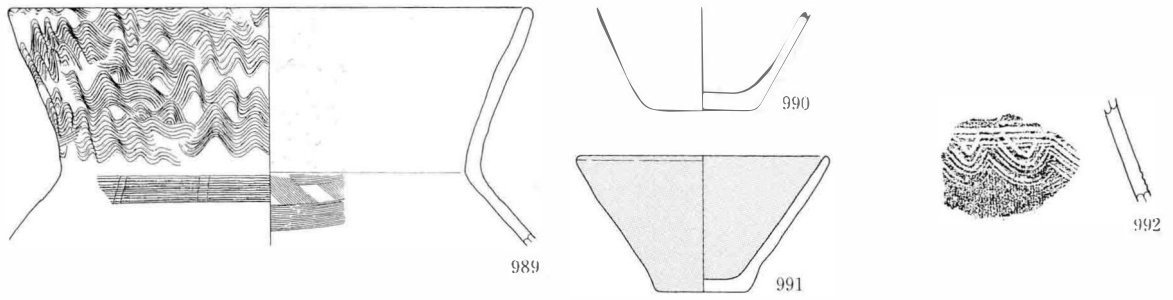

50㉔ SA 3

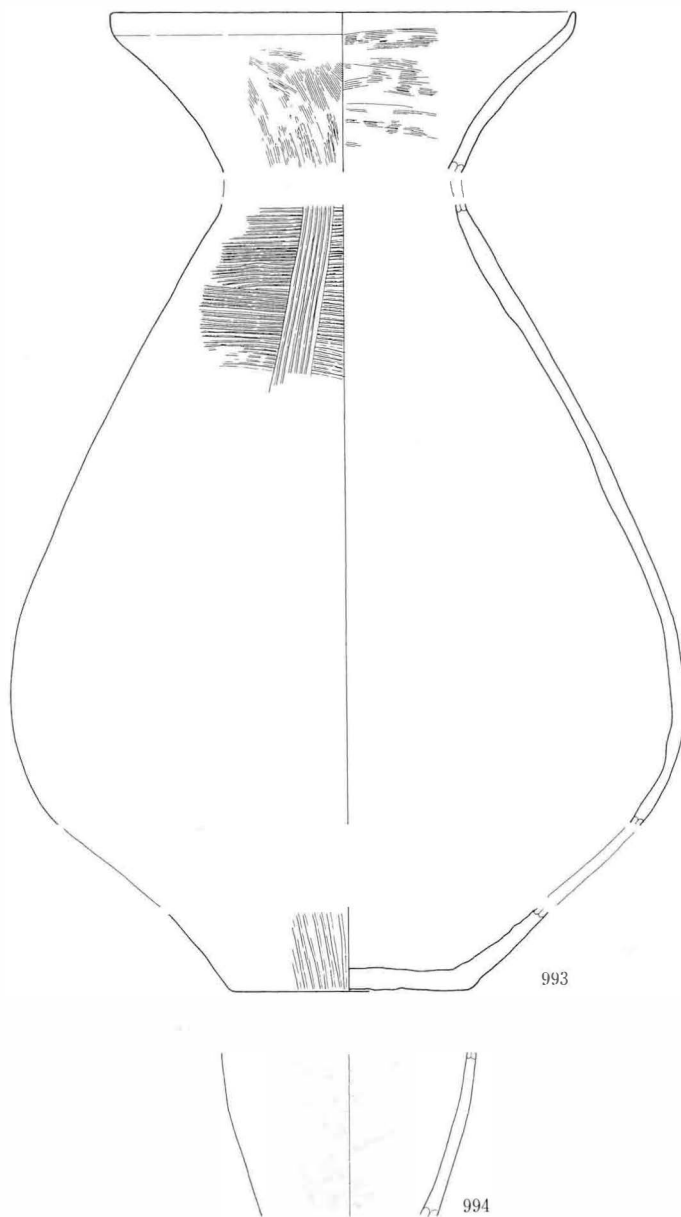

断面実測 0 (1:3) 10cm 0 (1:4) 10cm

図版 148 弥生時代後期の遺物 (3)

50② SA 4

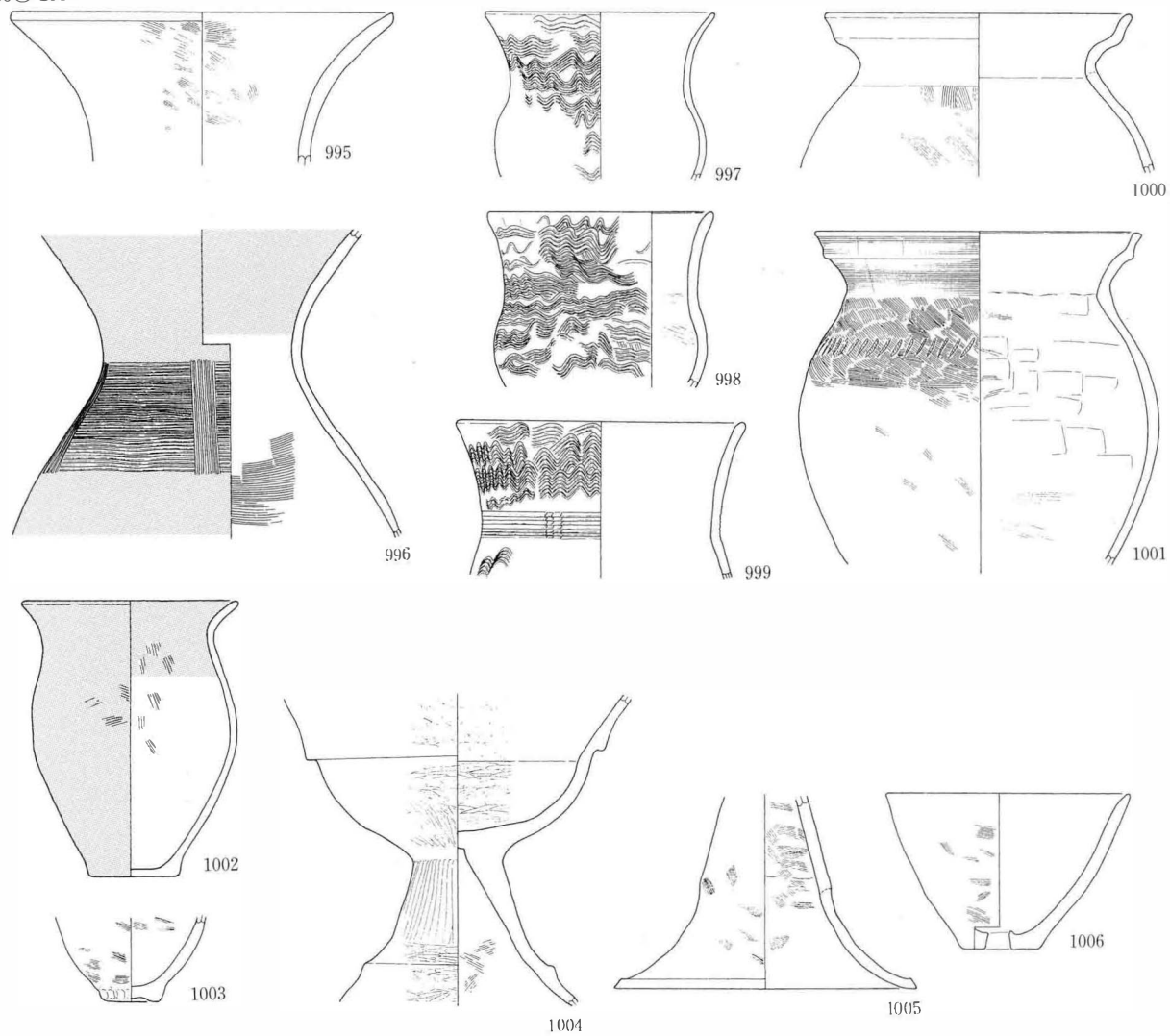

50② SA 6

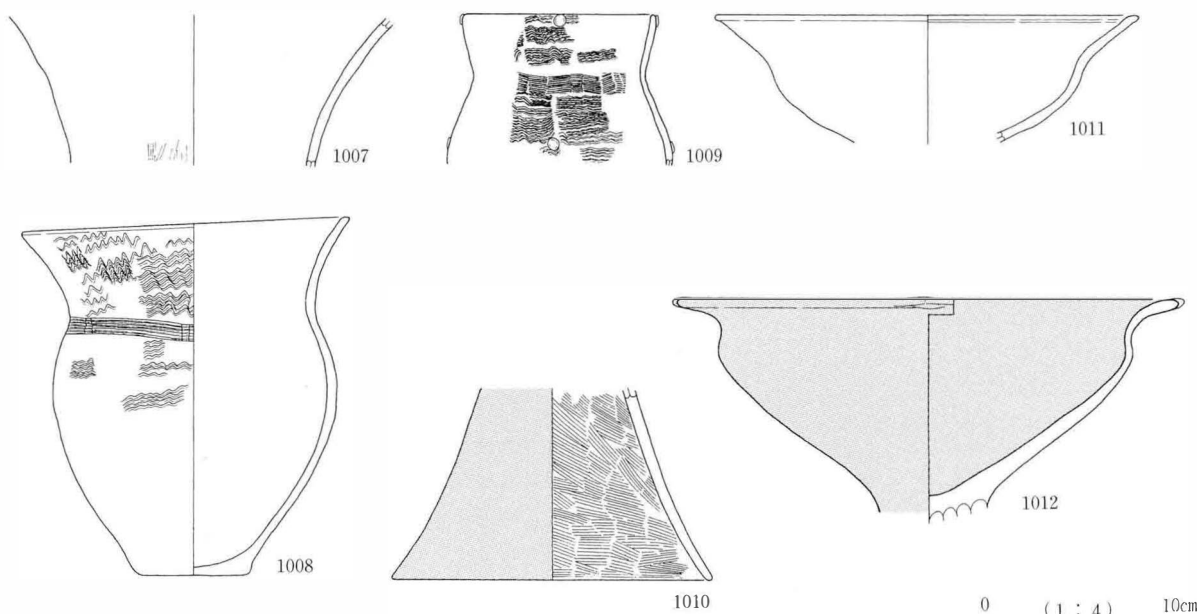

0 (1 : 4) 10cm

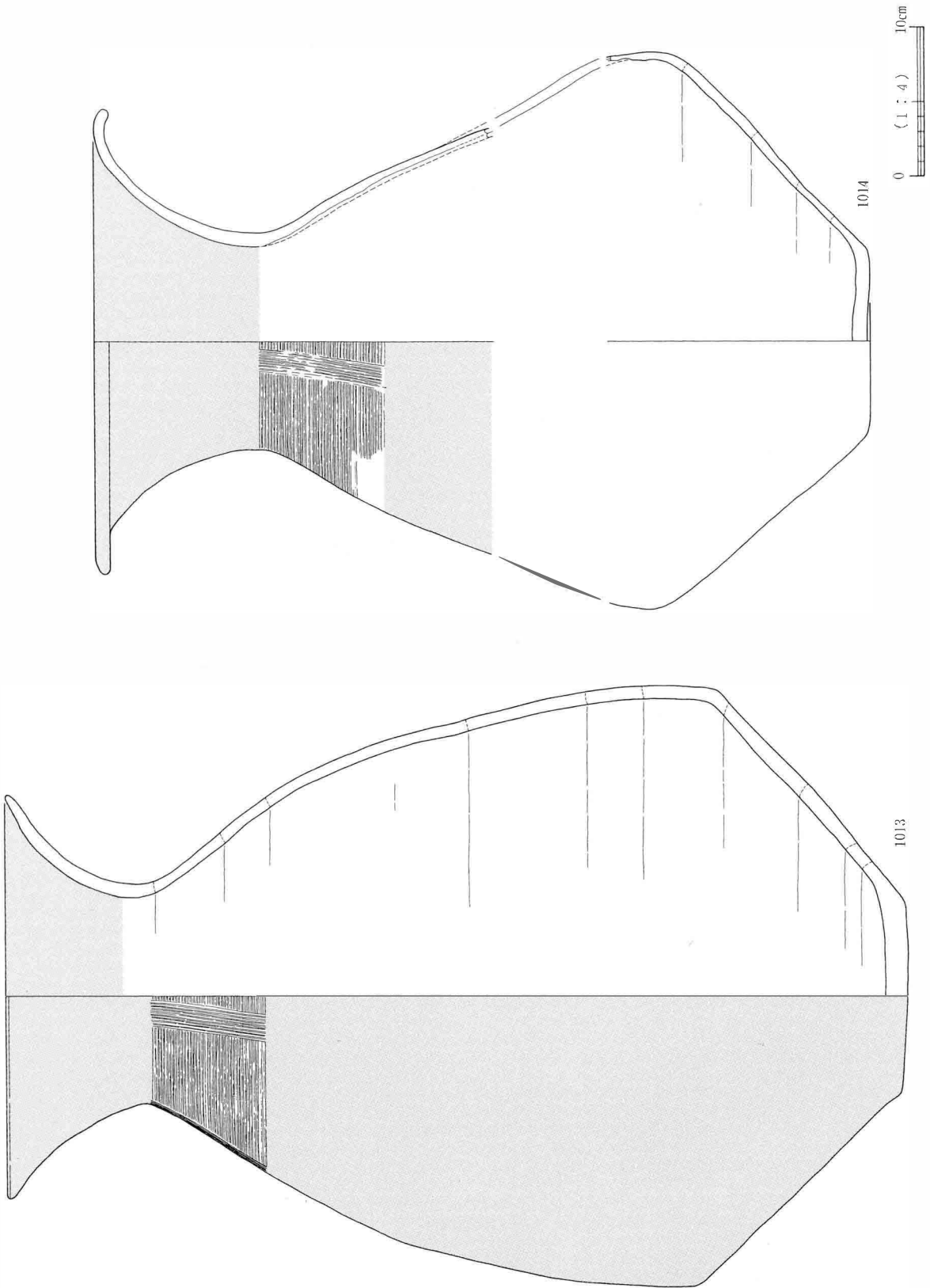

50② SA 7 (1)

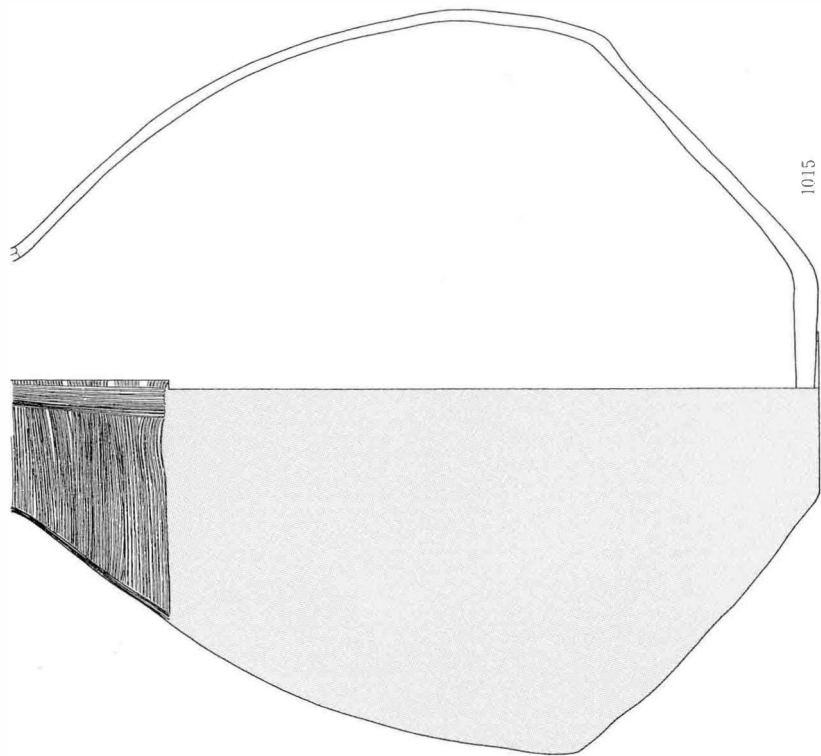
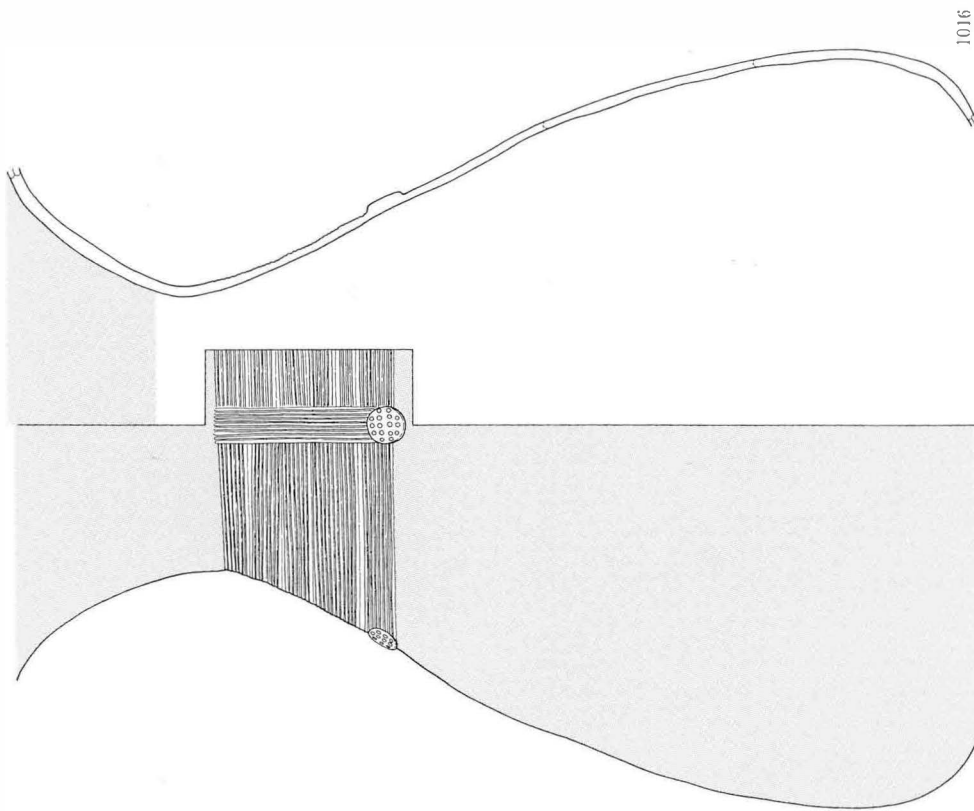

50② SA 7 (2)

50② SA 7 (3)

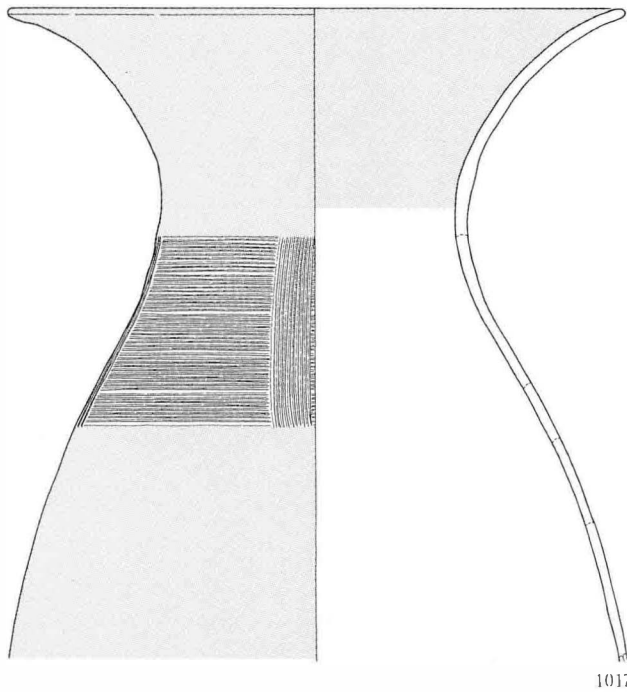

1017

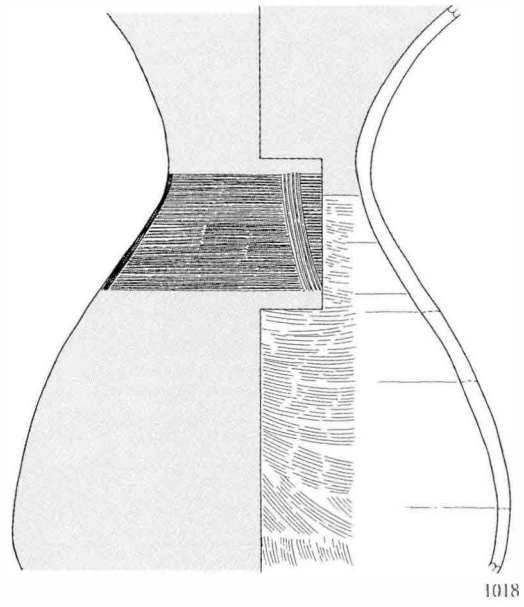

1018

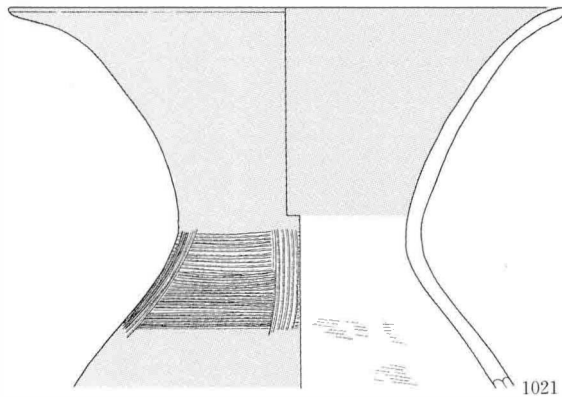

1021

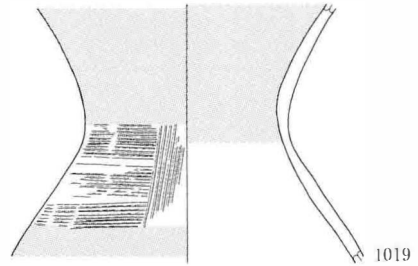

1019

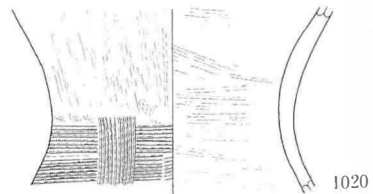

1020

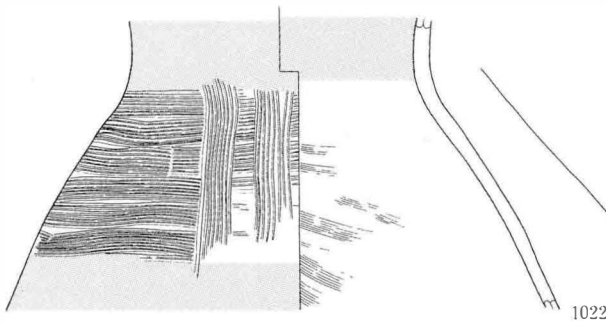

1022

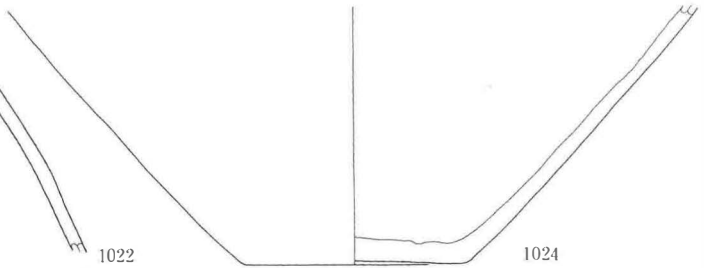

1024

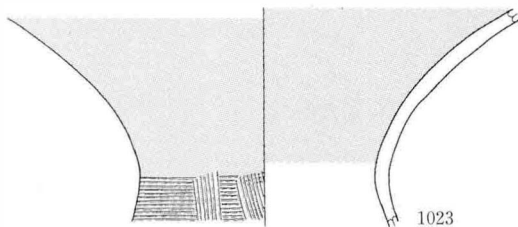

1023

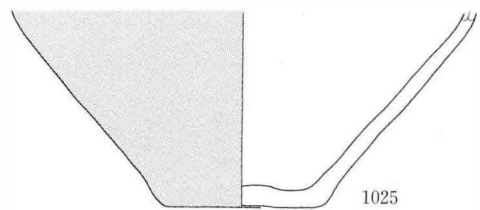

1025

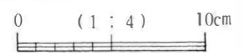

50② SA 7 (4)

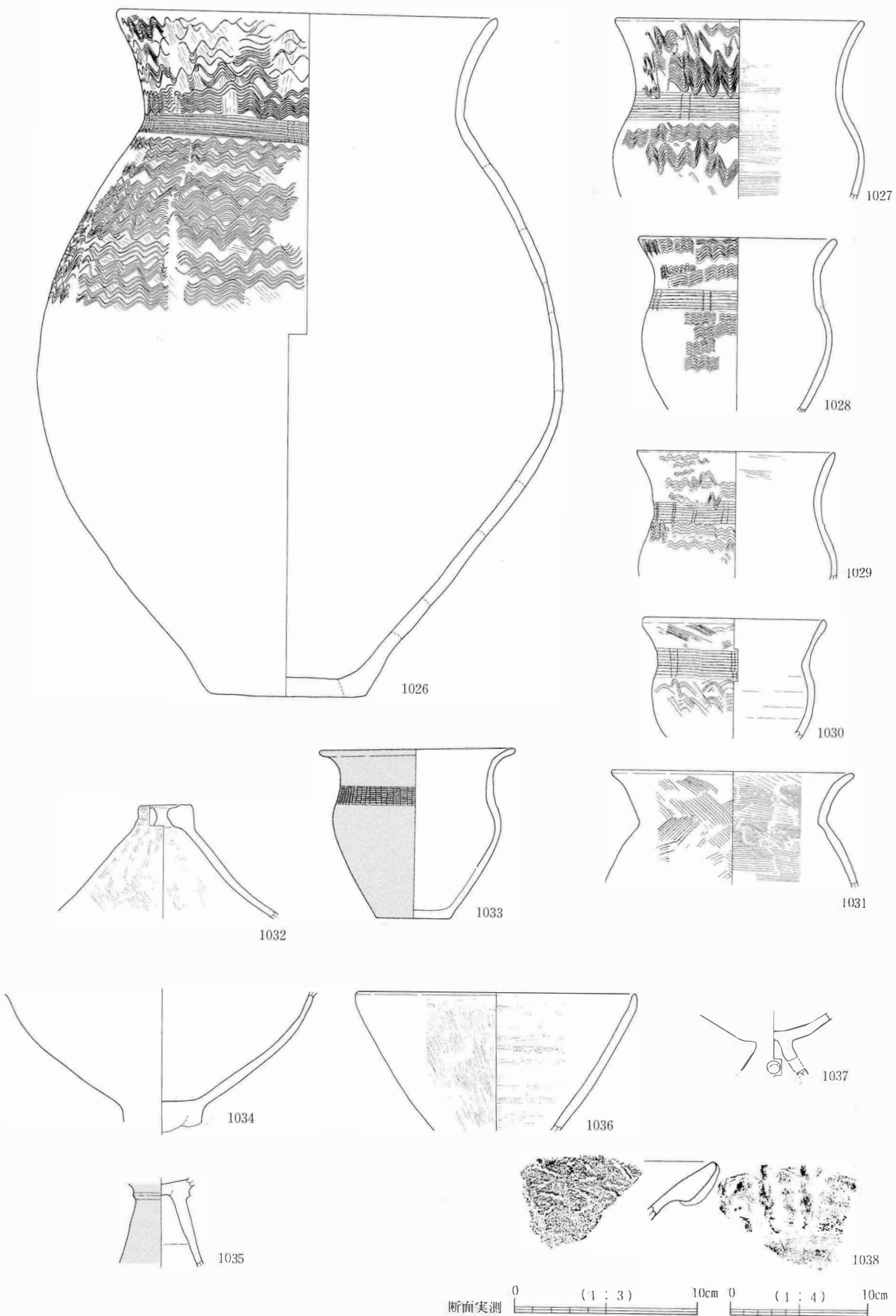

50② SA 8

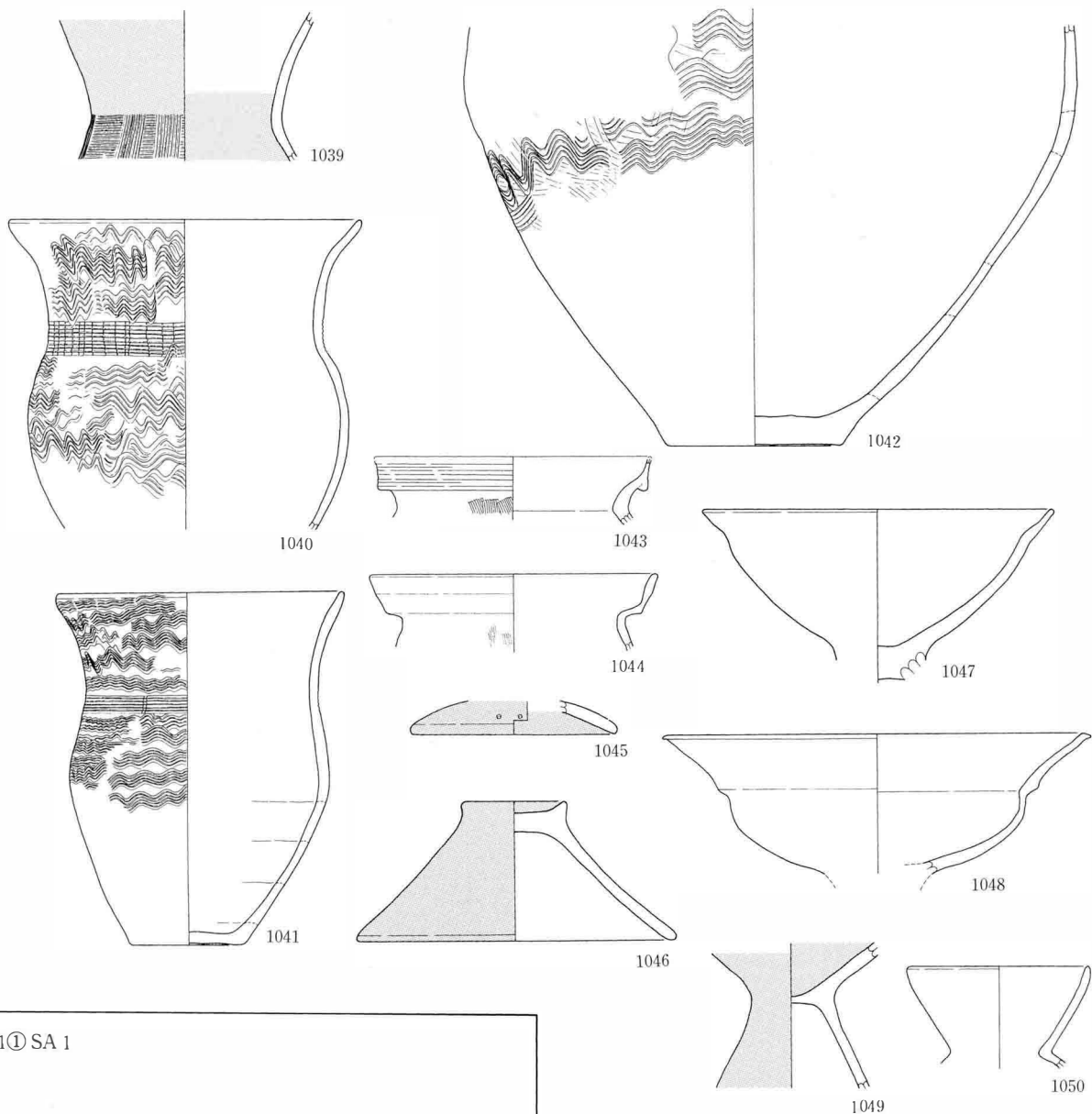

51① SA 1

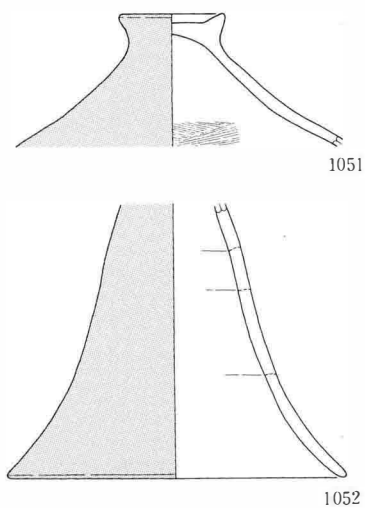

51② SA 1

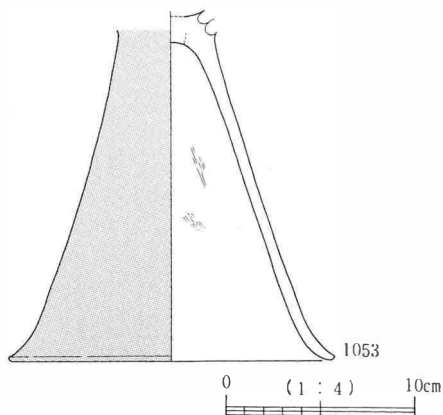

図版 154 弥生時代後期の遺物 (9)

51② SA 2

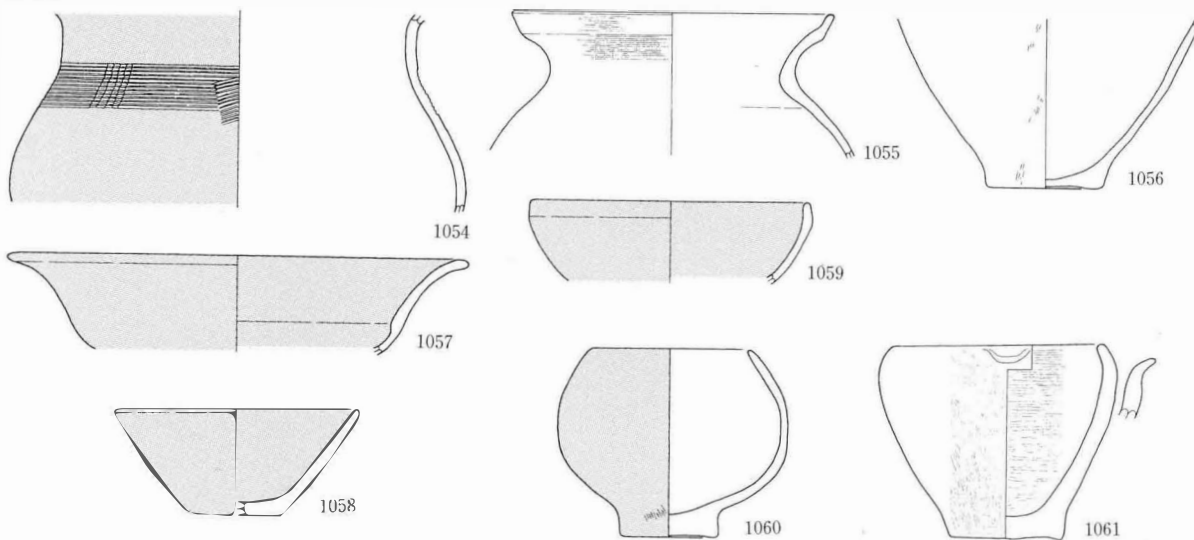

52① SA 5

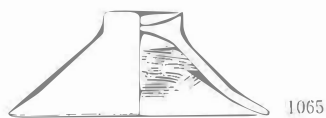
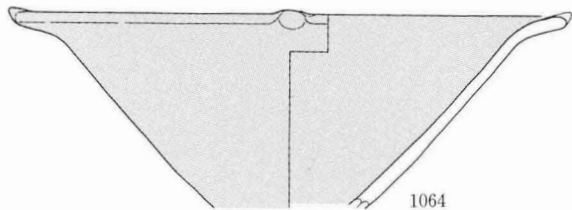
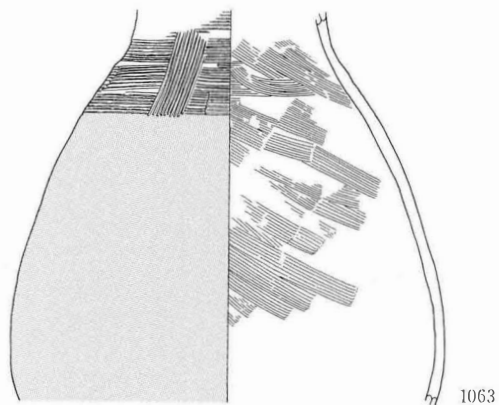
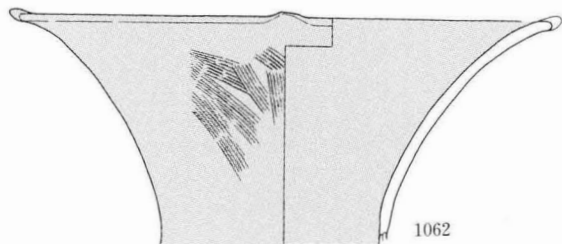

52① SA 7



52② SA 2

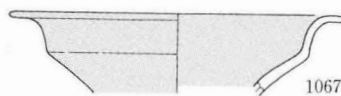

53② SA 1

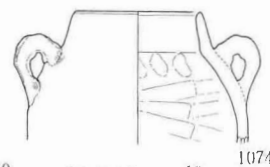
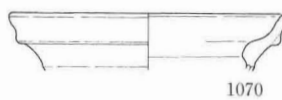
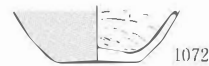
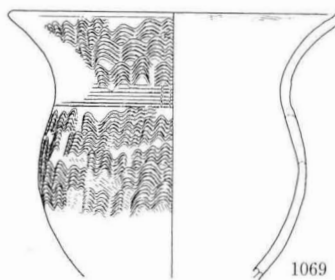
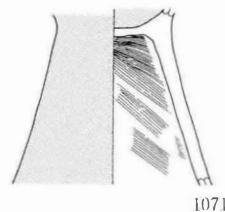
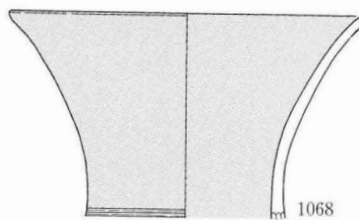

0 (1 : 4) 10cm

53② SA 5

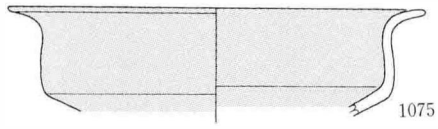

55① SA 3

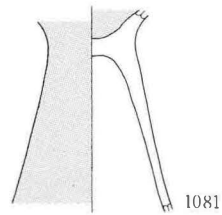
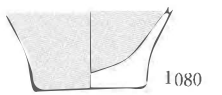
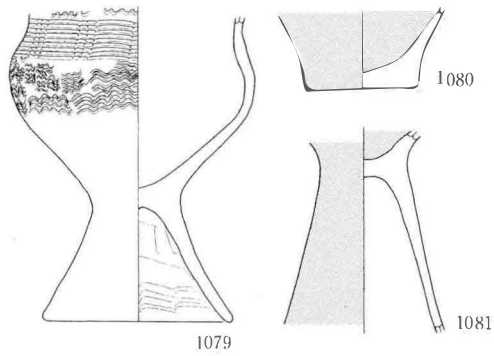
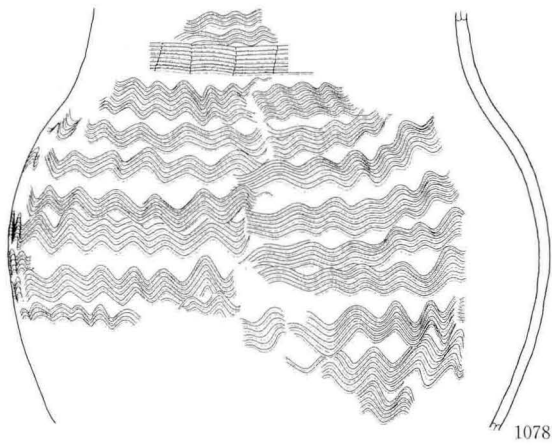
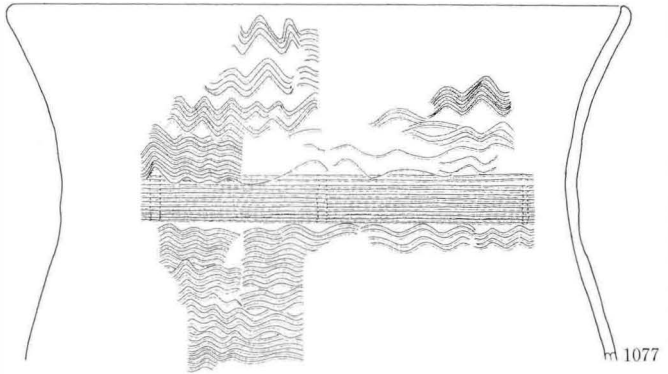

55② SA 1 (1)

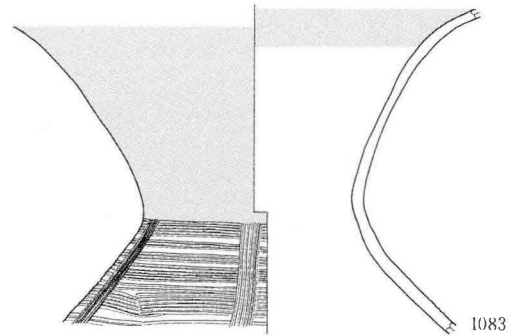
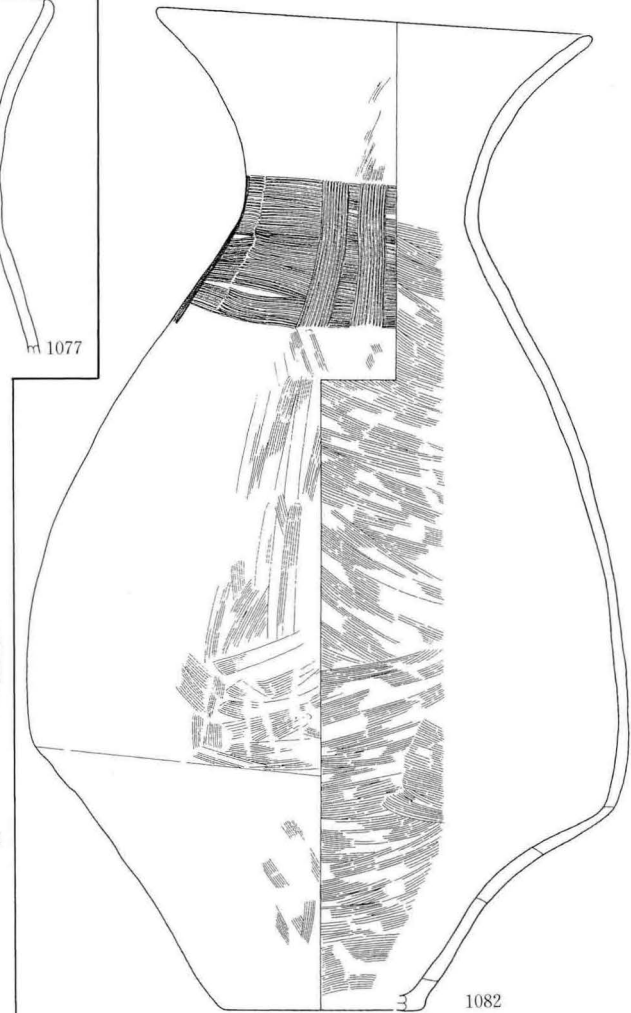

0 (1 : 4) 10cm

図版 156 弥生時代後期の遺物 (11)

55② SA 1 (2)

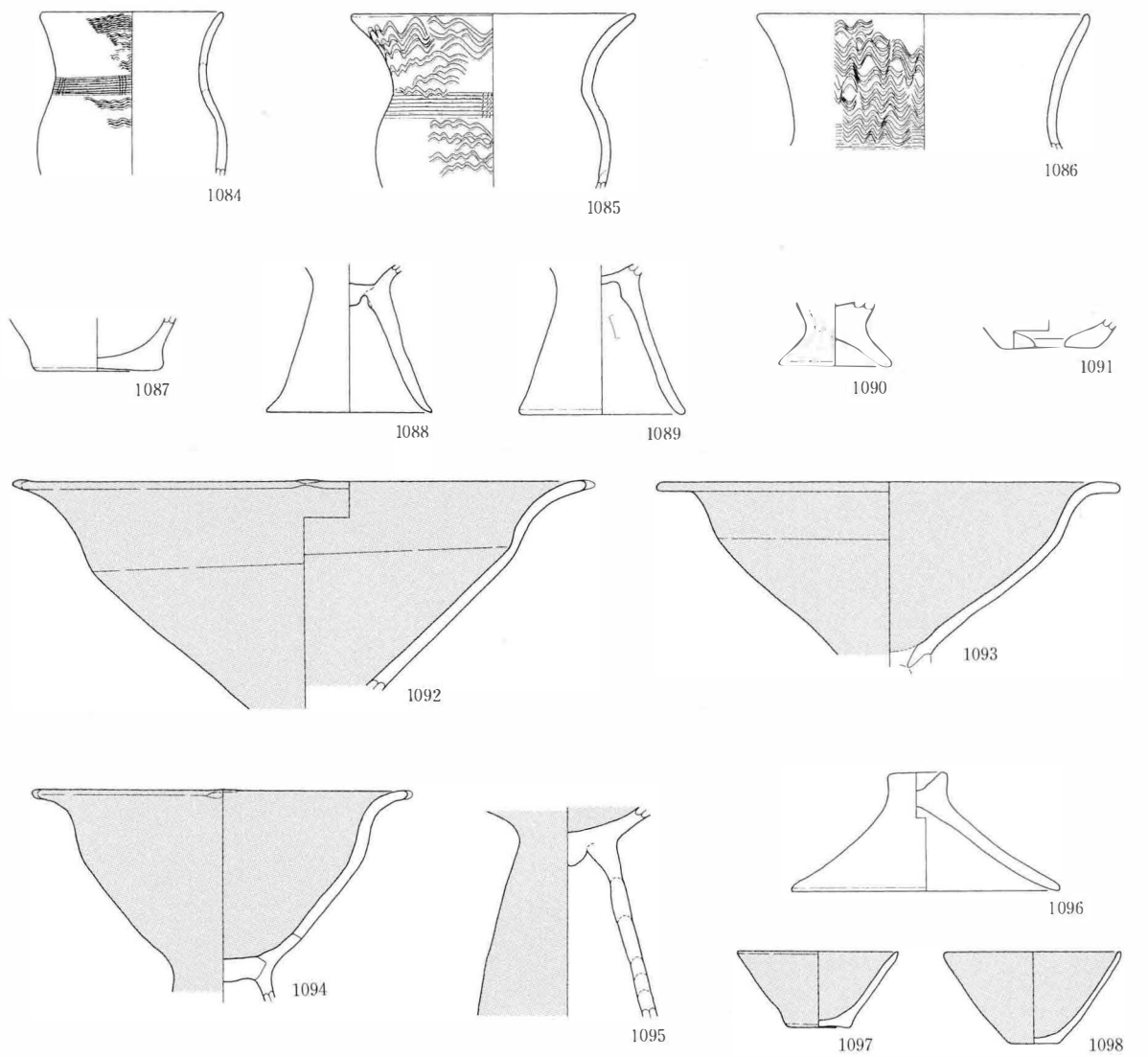

56② SA 1

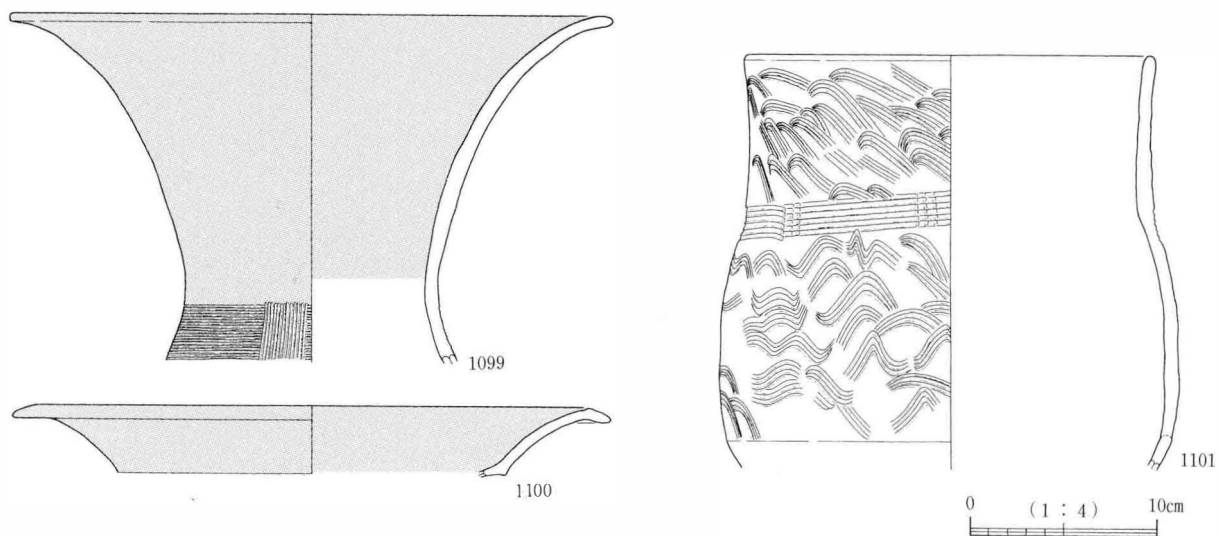

図版 157 弥生時代後期の遺物 (12)

56② SA 3



57② SA 1

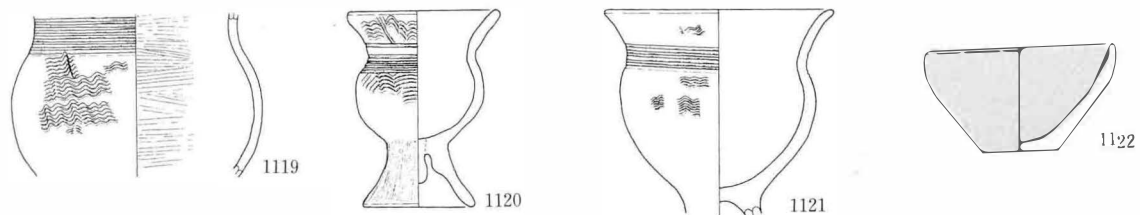

断面実測 0 (1:3) 10cm 0 (1:4) 10cm

57② SA 5 (1)

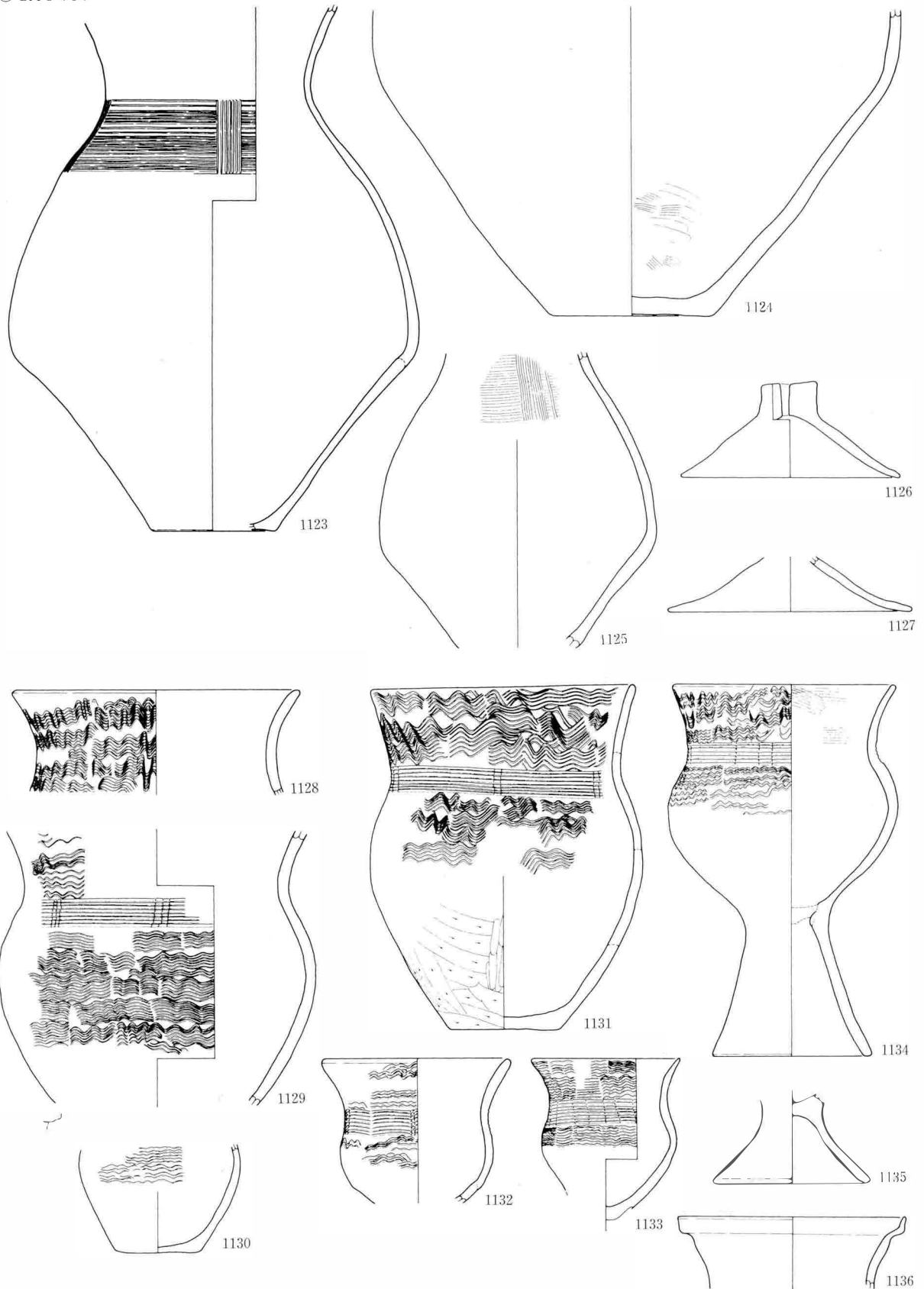

0 (1 : 4) 10cm

57㉔ SA 5 (2)

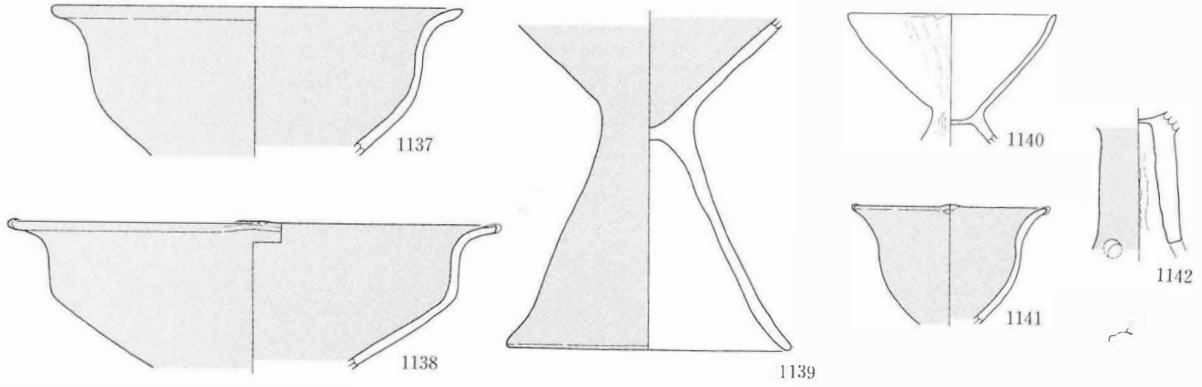

60㉔ SA 2

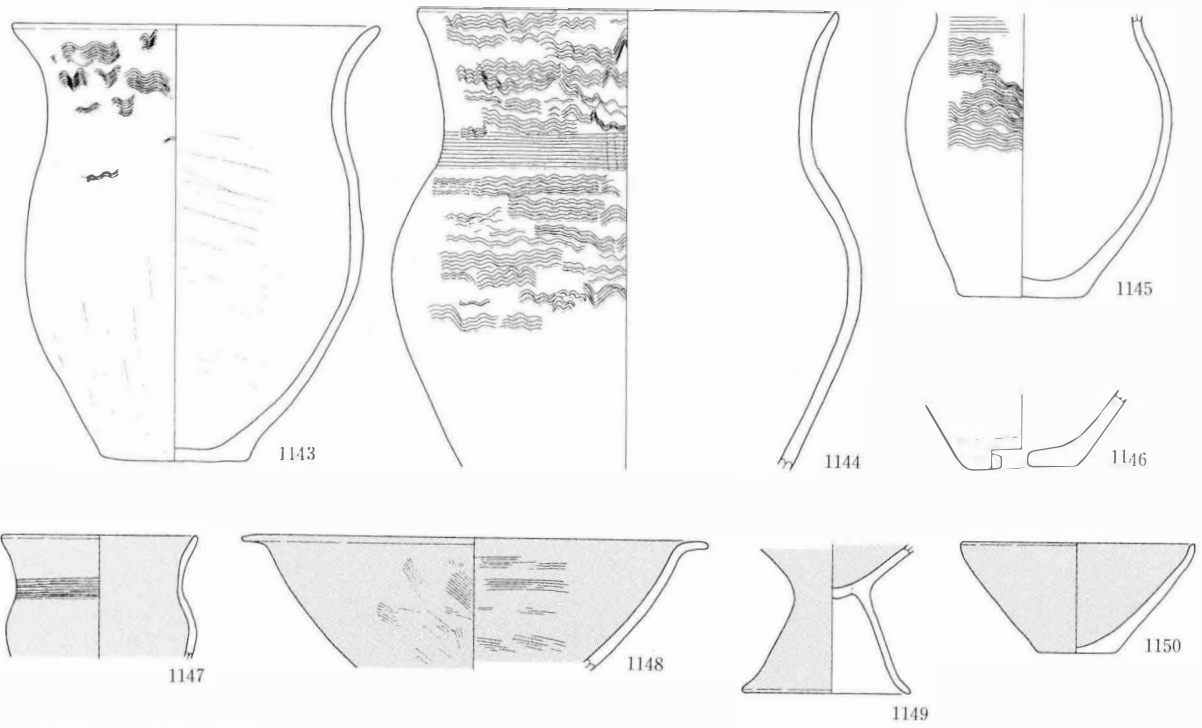

61㉔ SA 6

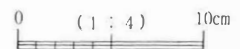
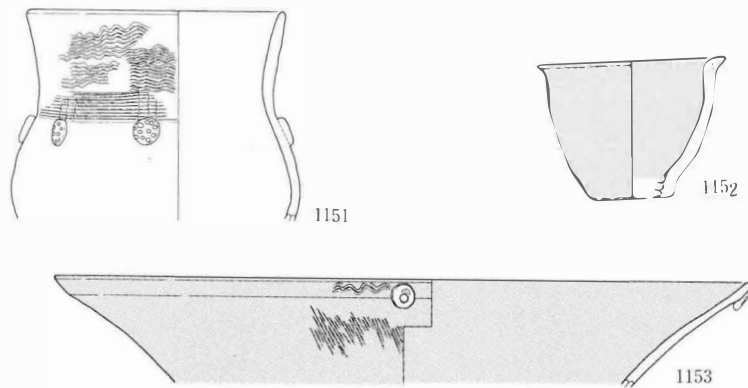

図版 160 弥生時代後期の遺物 (15)

60② SA 4

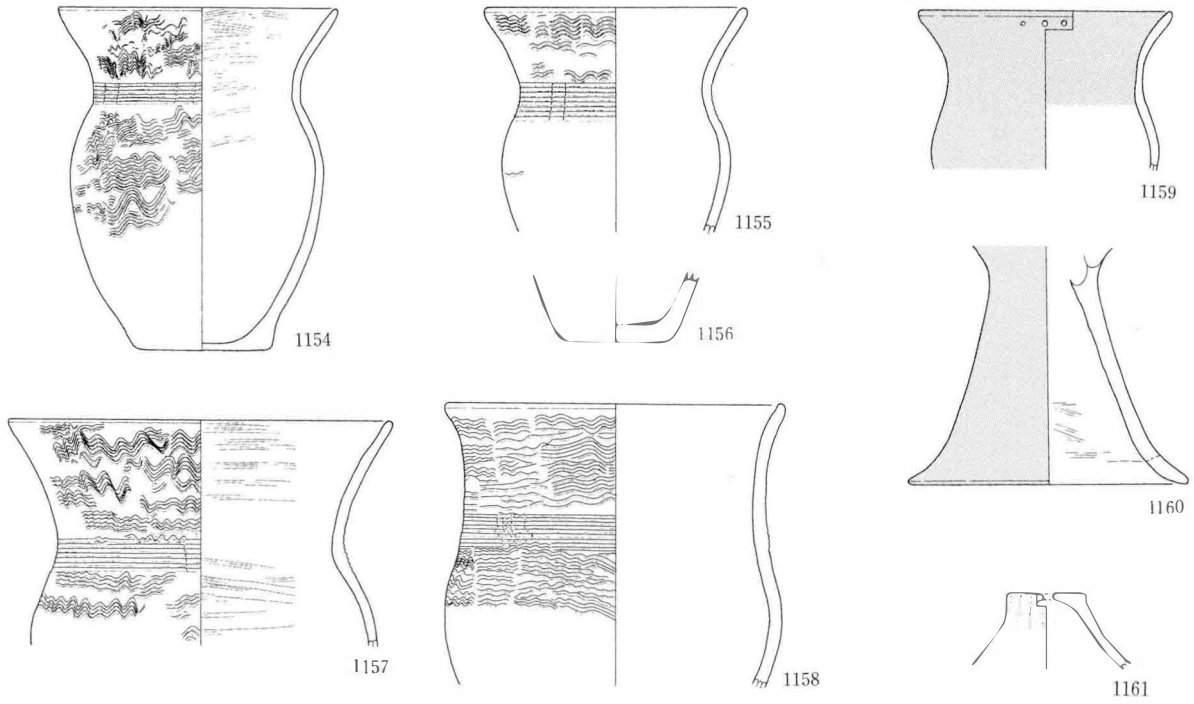

62① SA 1

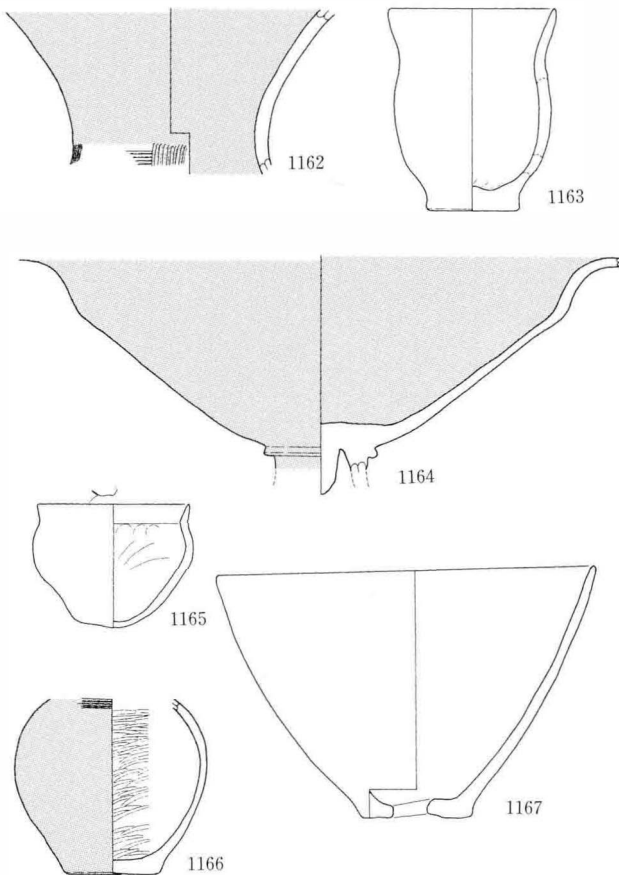

70① SA 1

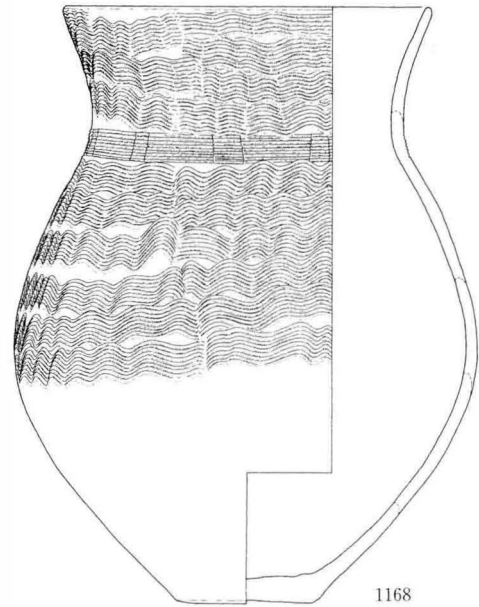

0 (1 : 4) 10cm

78① SA 2

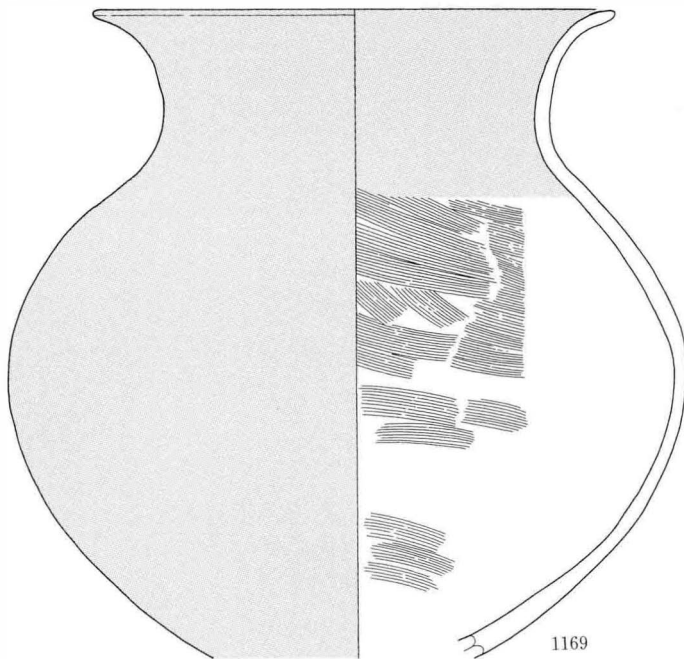

1169

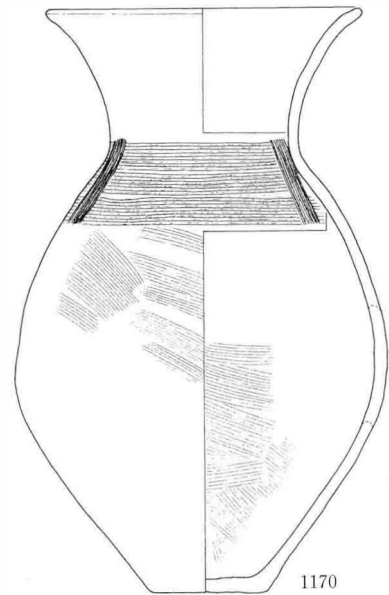

1170

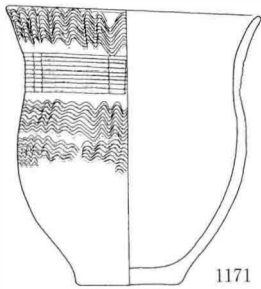

1171

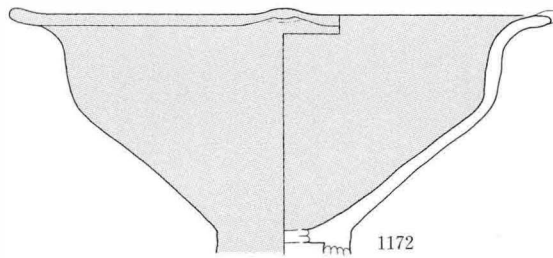

1172

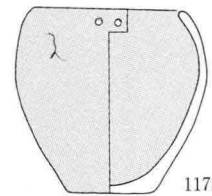

1173

78① SA 6

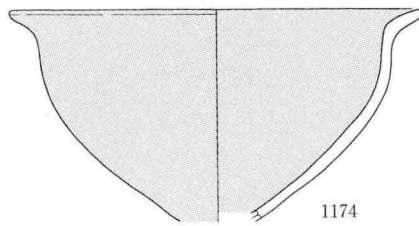

1174

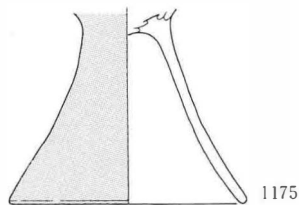

1175

0 (1 : 4) 10cm

図版 162 弥生時代後期の遺物 (17)

79① SA 2

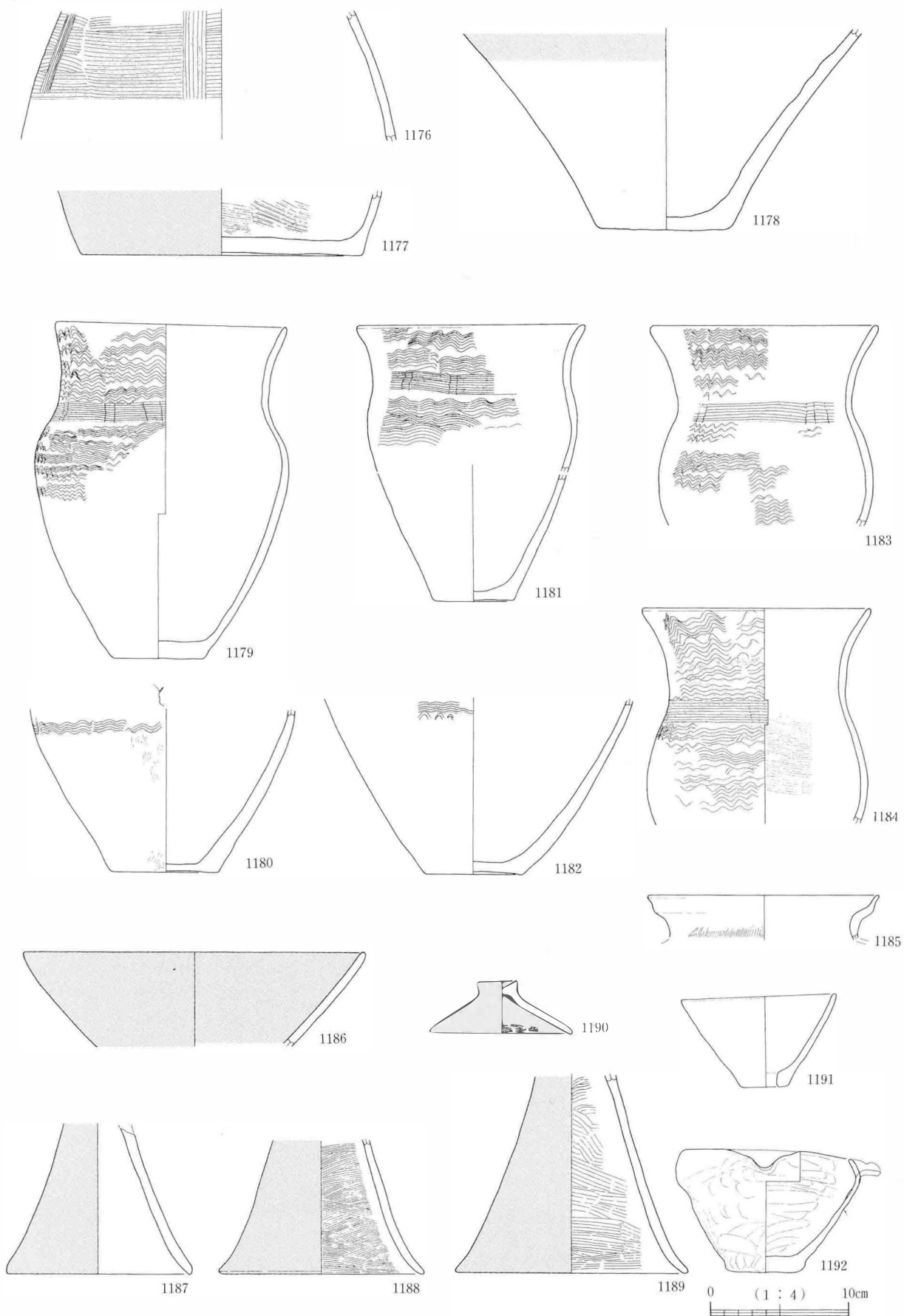

B②SA2(1)

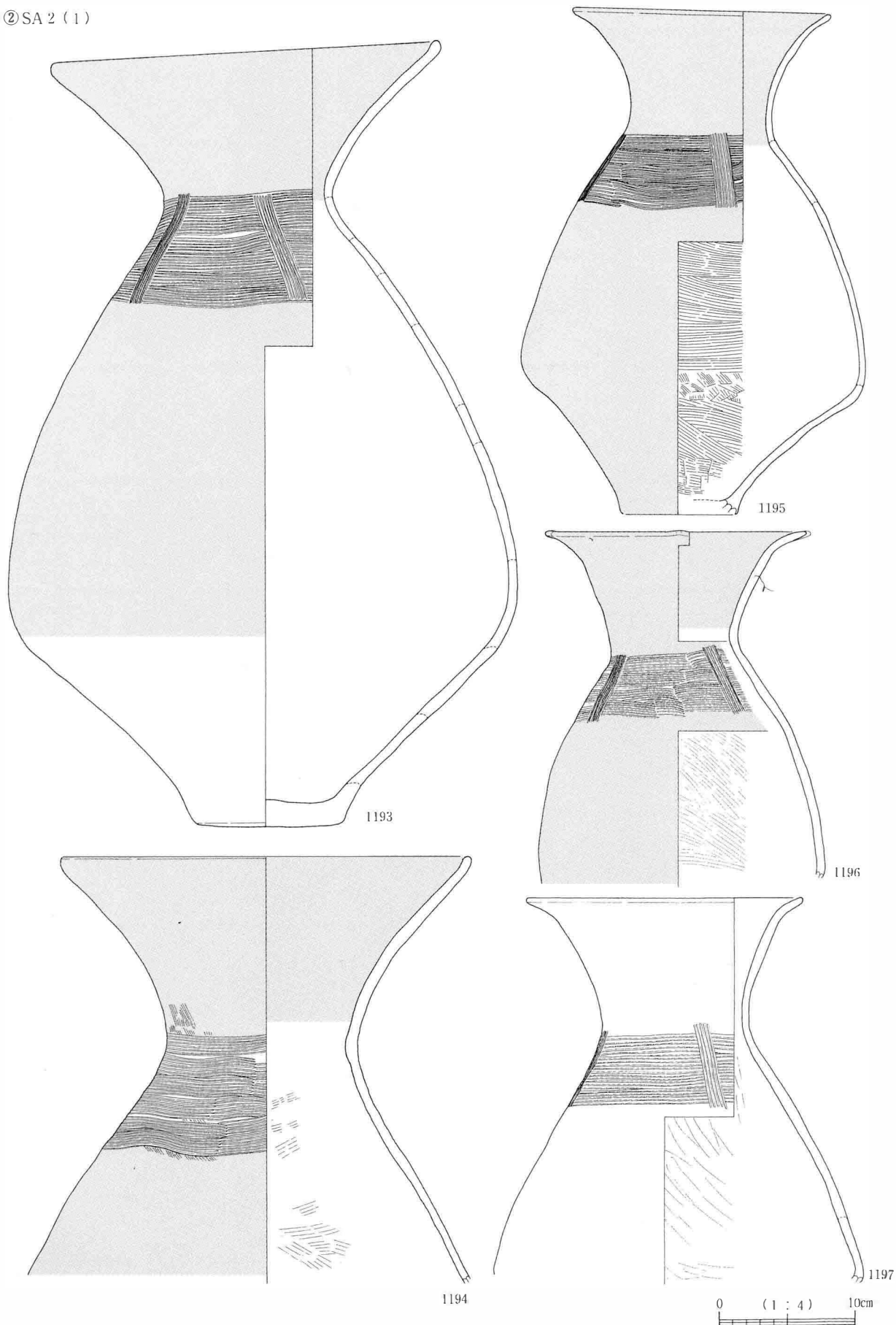

B② SA 2 (2)

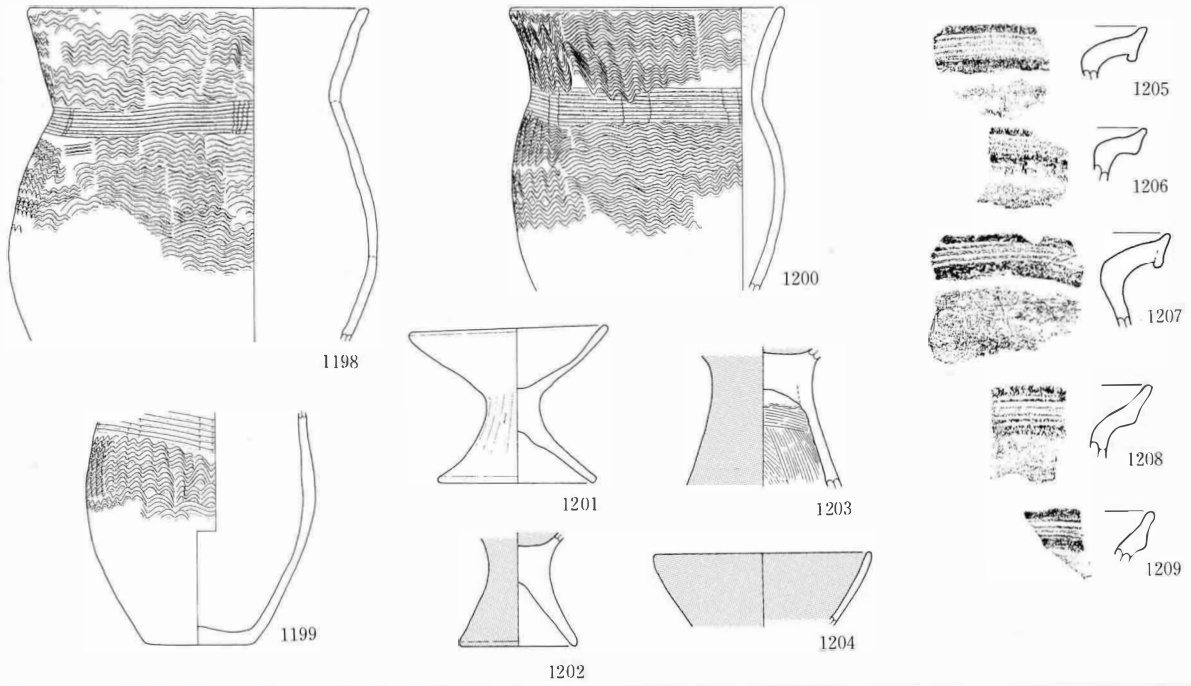

B② SA 3 (1)

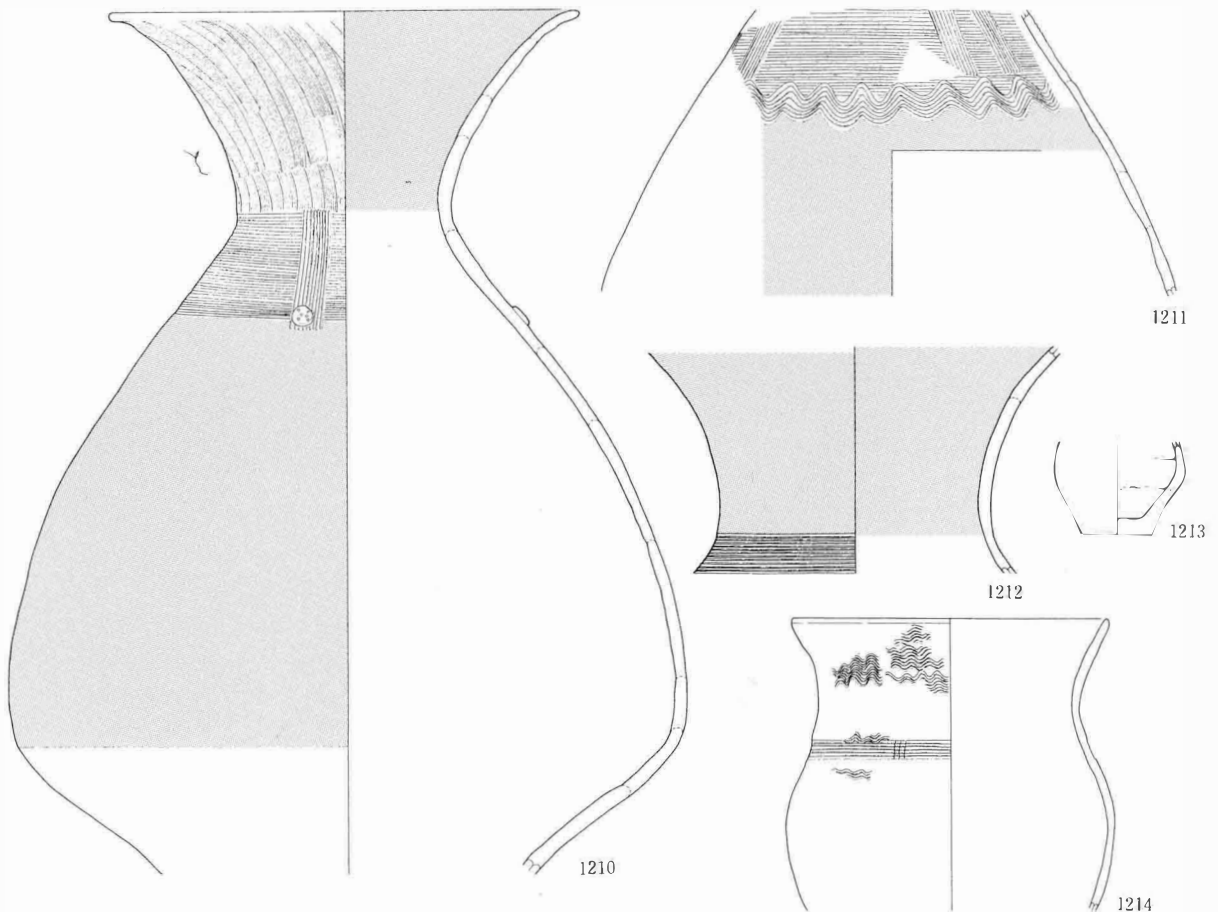

断面実測 0 (1:3) 10cm 0 (1:4) 10cm

B②SA3 (2)

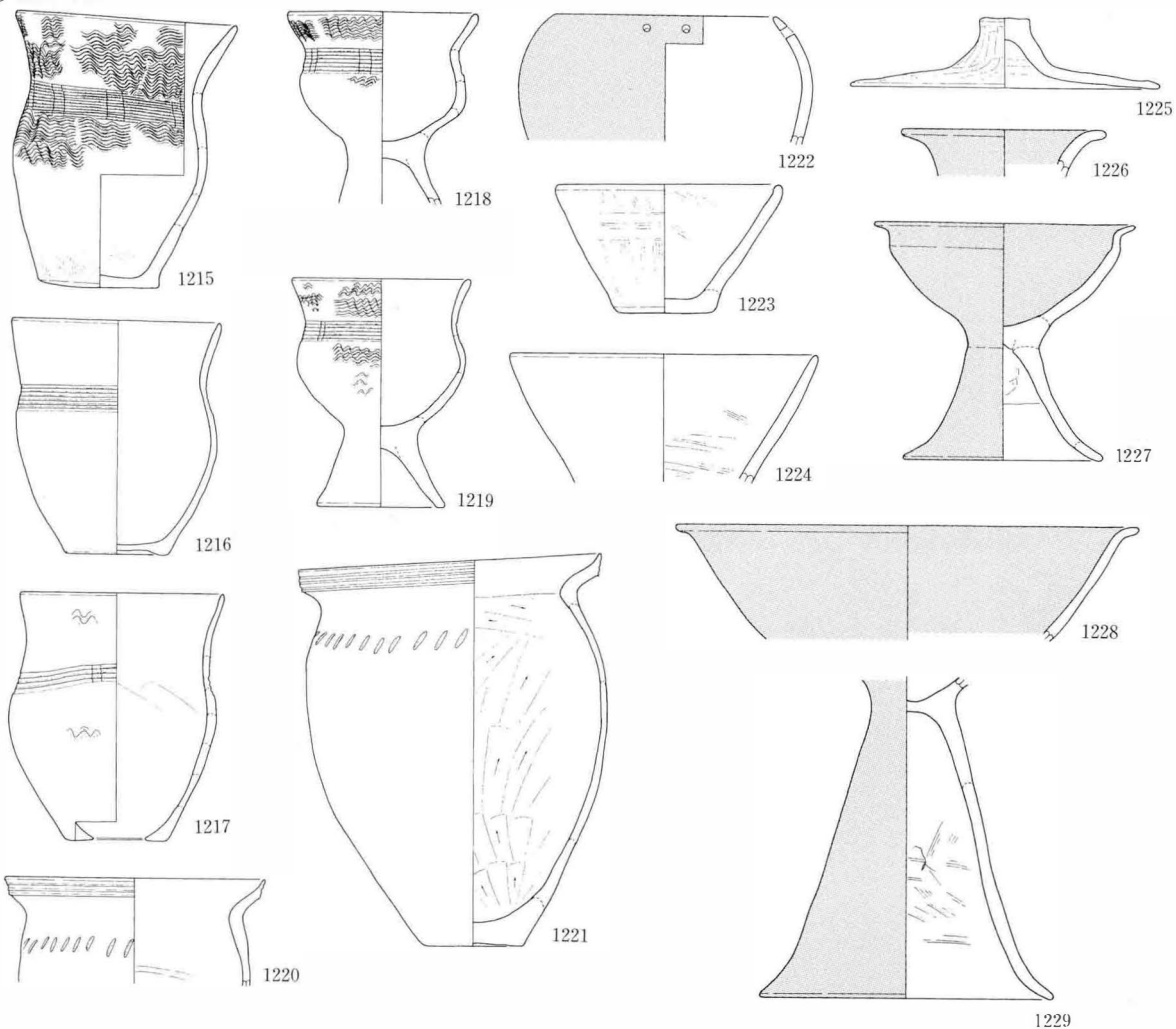

B②SA7 (1)

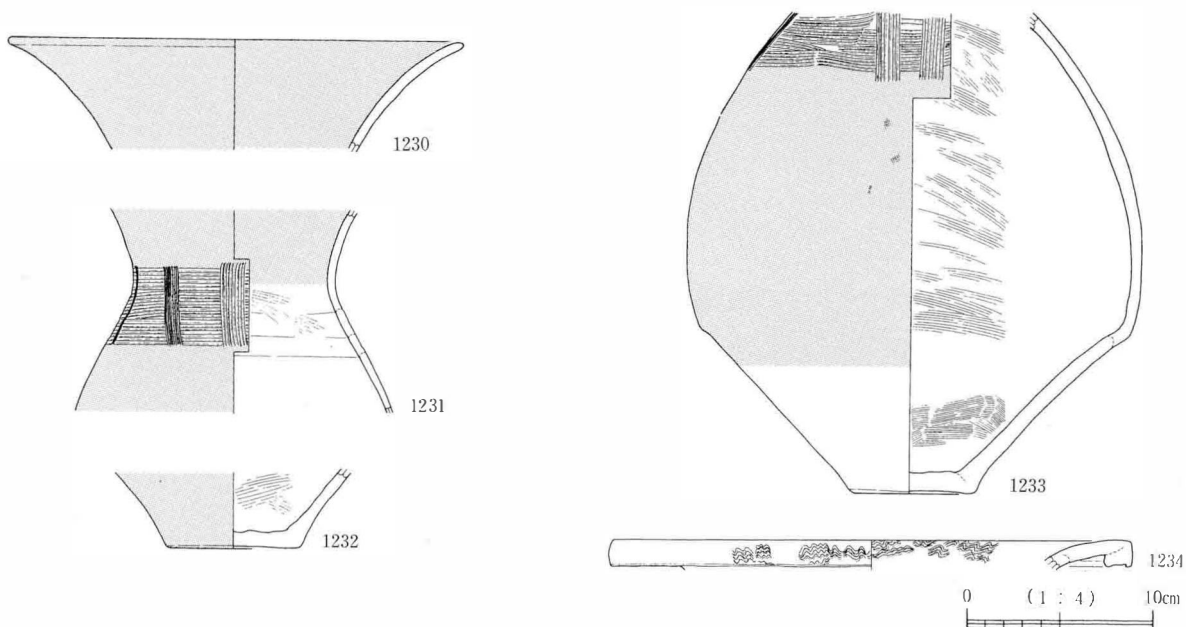

B② SA 7 (2)

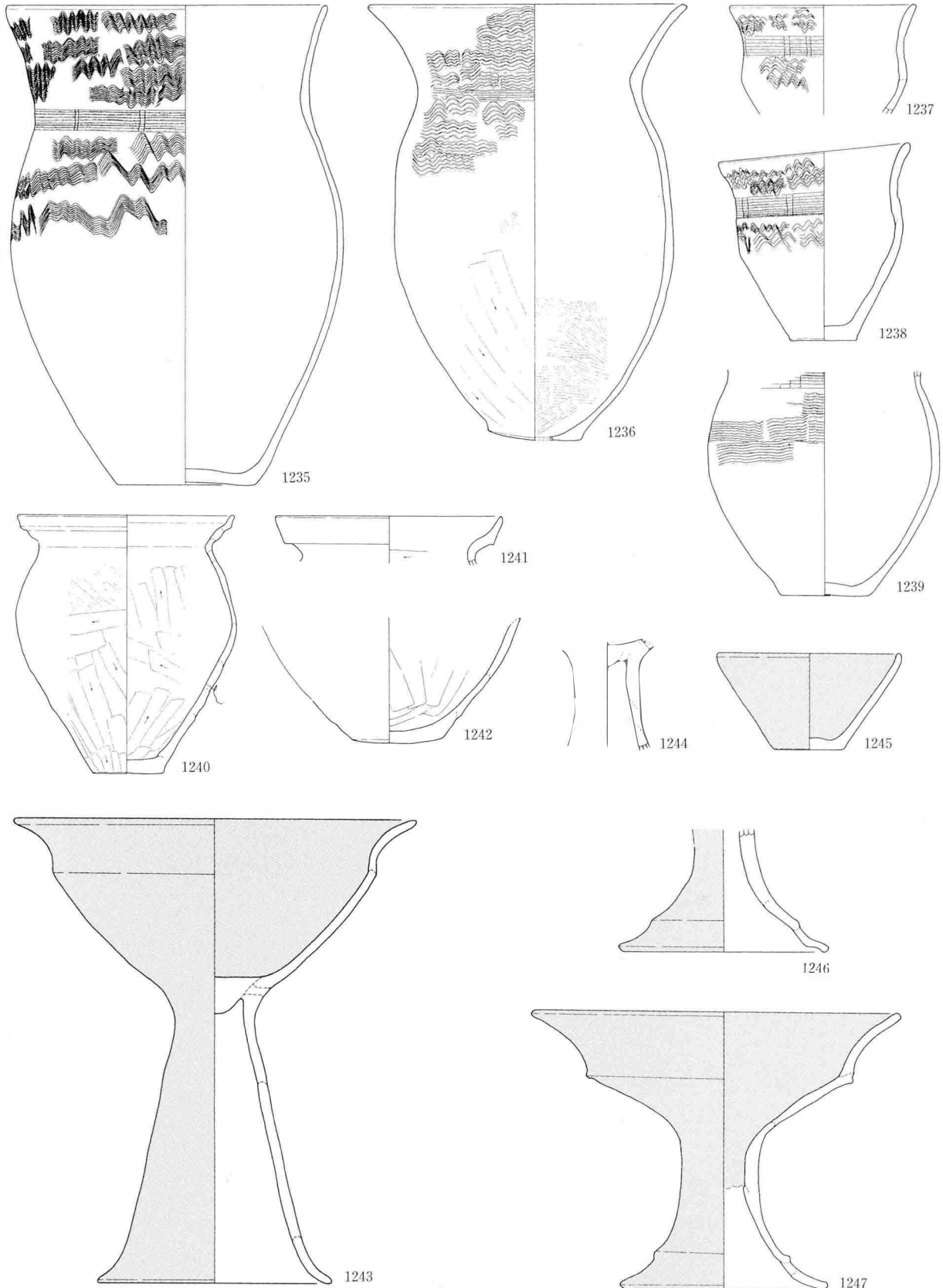

0 (1 : 4) 10cm

B②SA 8

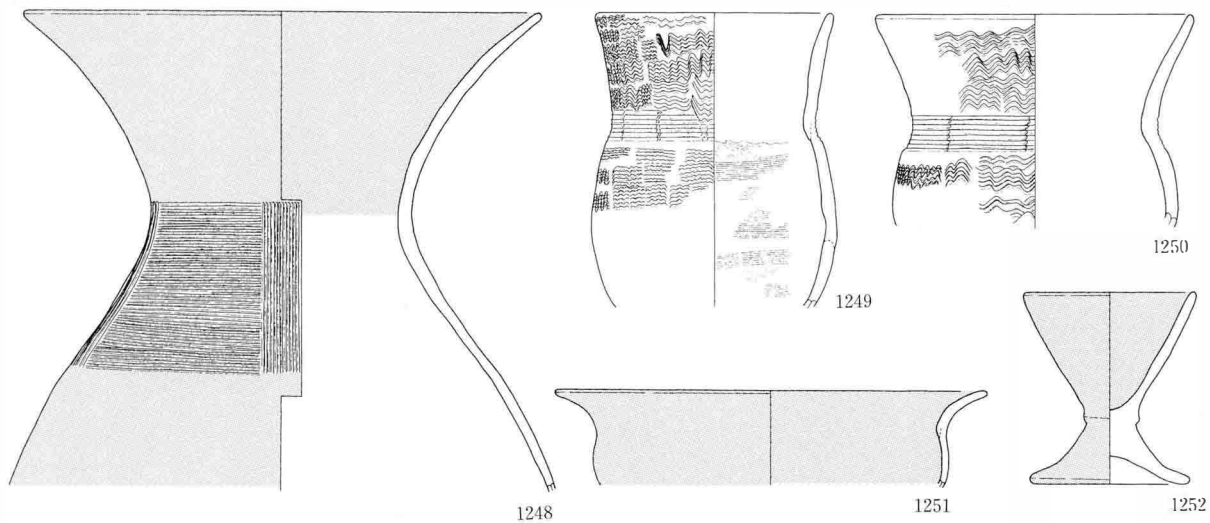

B②SA 9 (1)

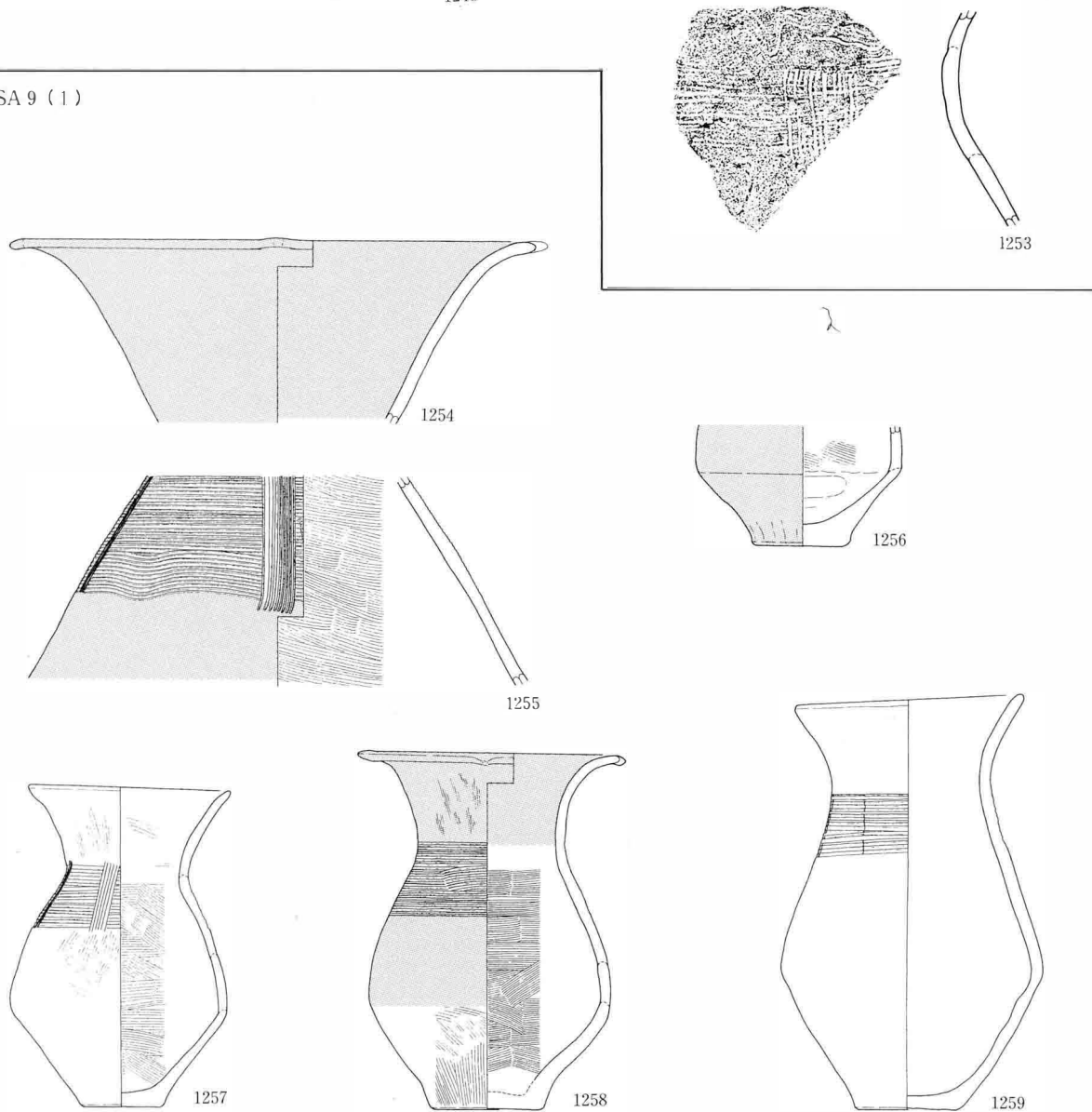

断面実測 0 (1 : 3) 10cm 0 (1 : 4) 10cm

B②SA9(2)

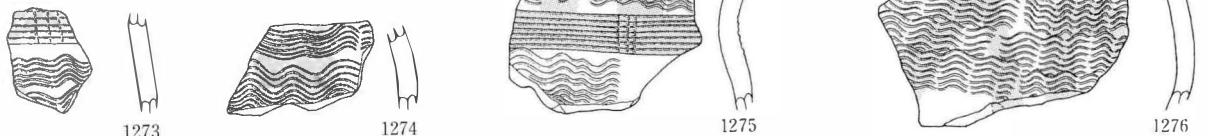
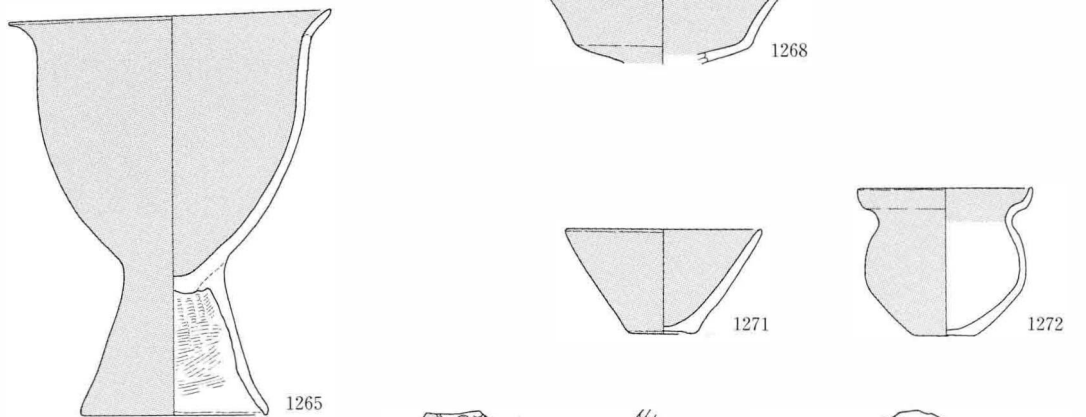
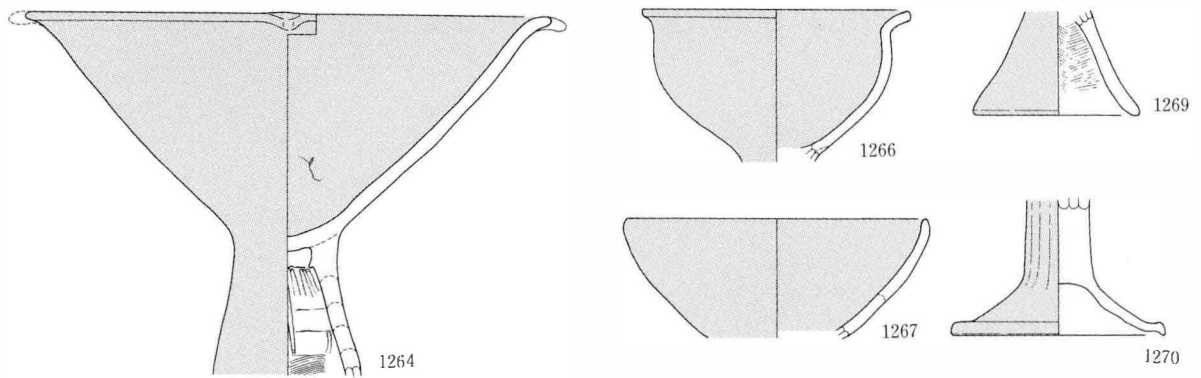
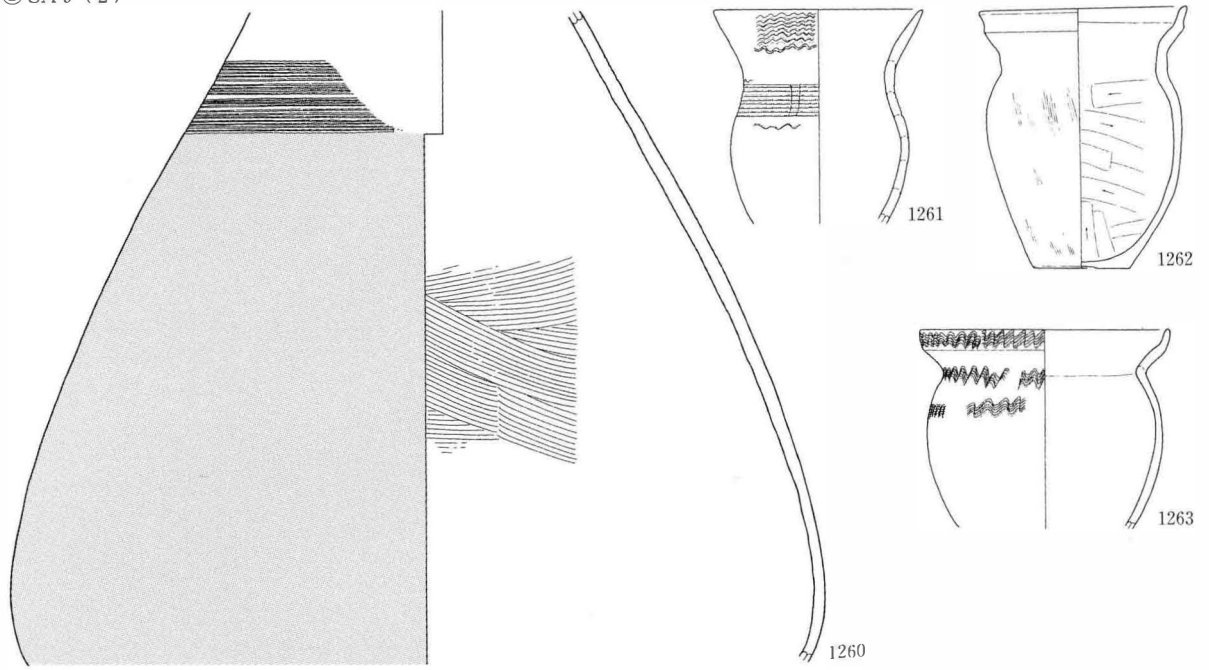

断面実測 0 (1:3) 10cm 0 (1:4) 10cm

B ② SA10

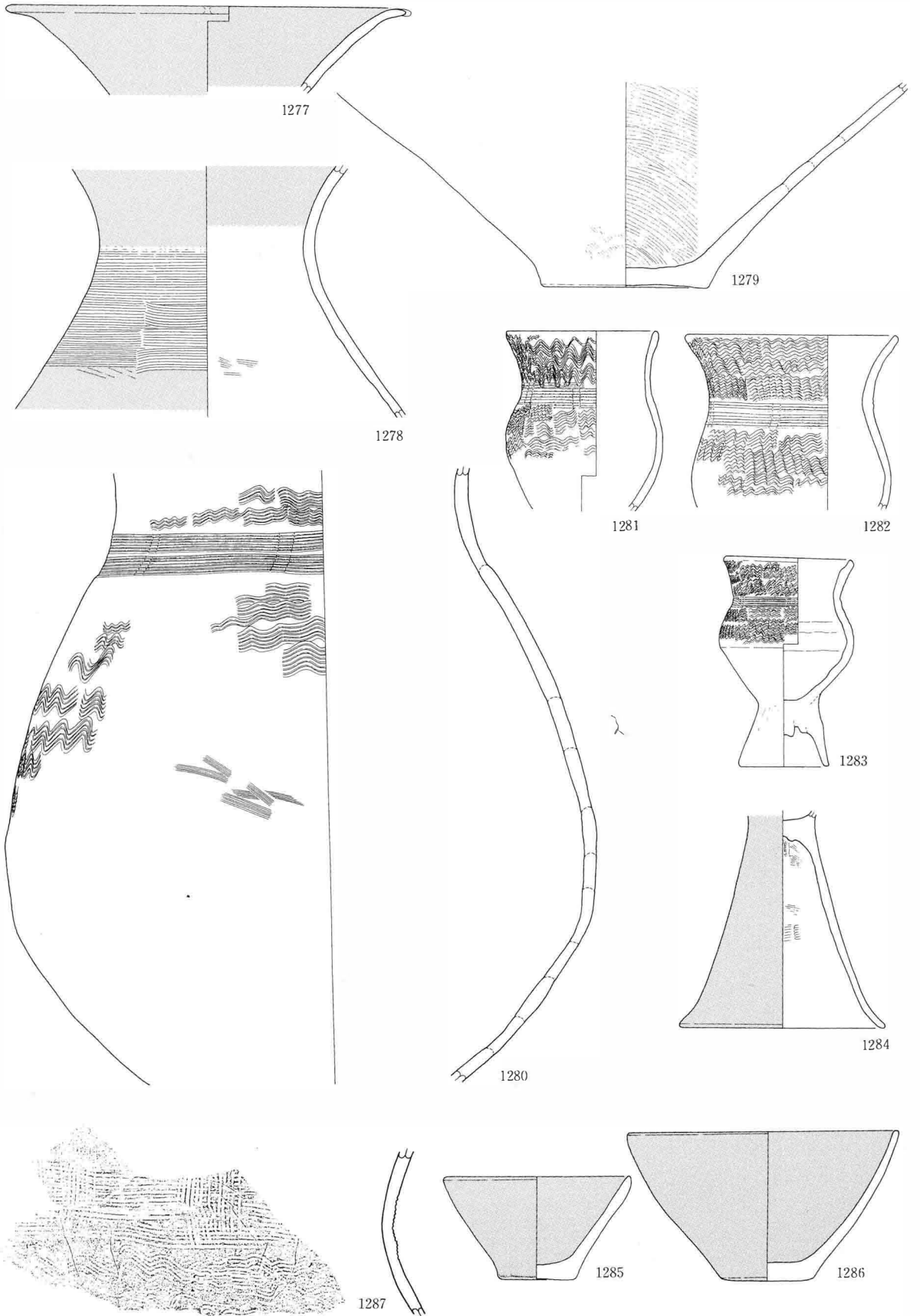

断面実測 0 (1:3) 10cm 0 (1:4) 10cm

図版 170 弥生時代後期の遺物 (25)

B② SA11

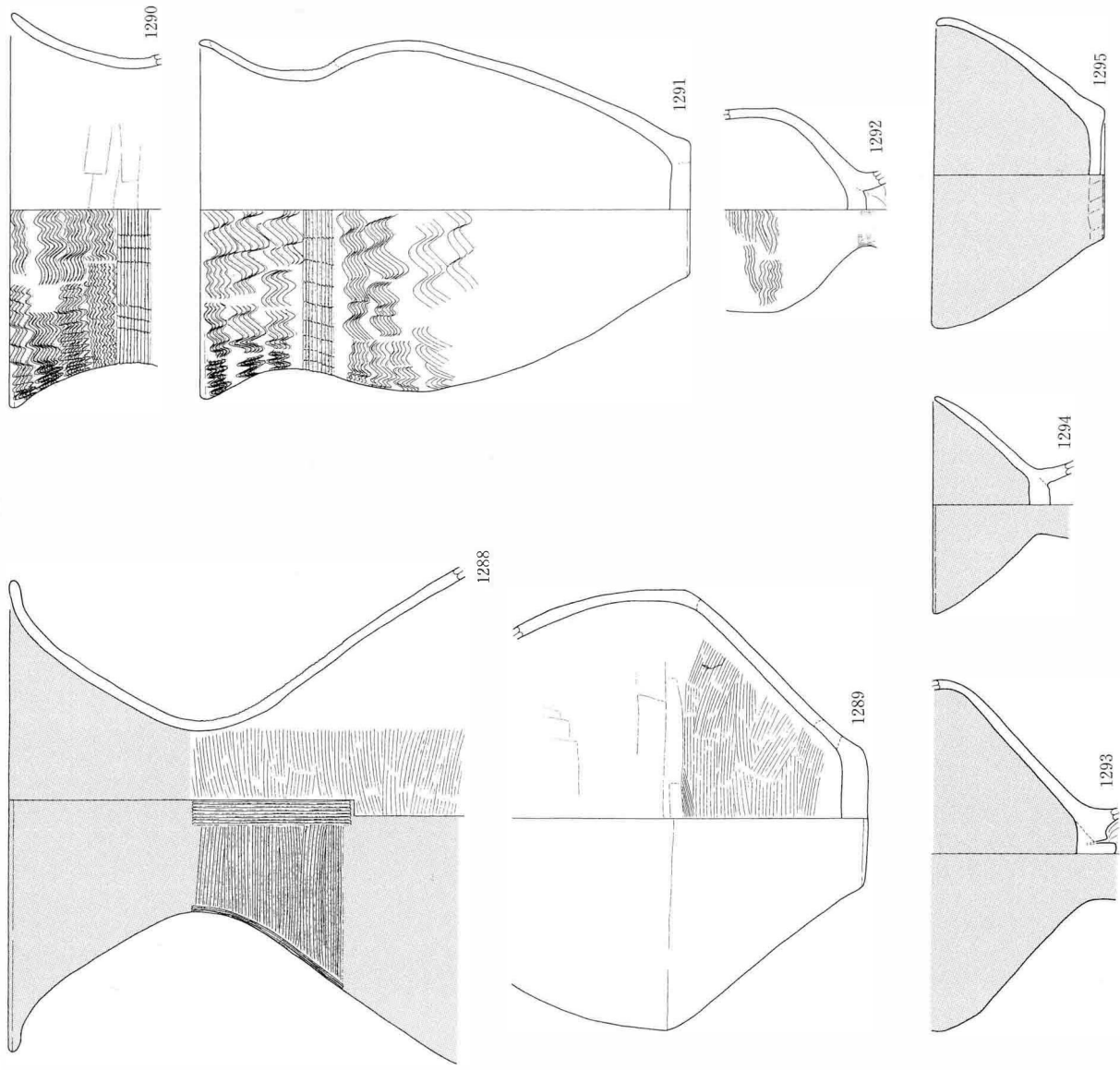

B② SA12

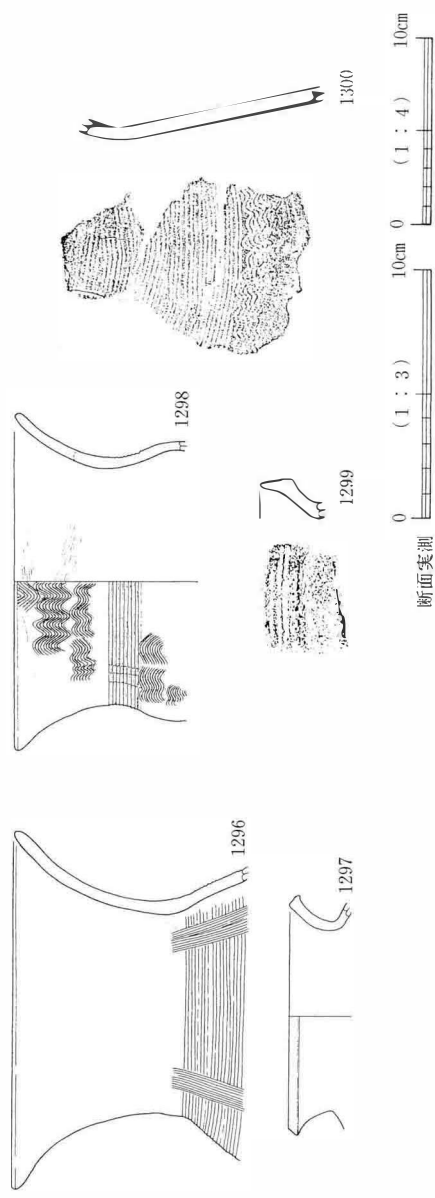

B②SA14

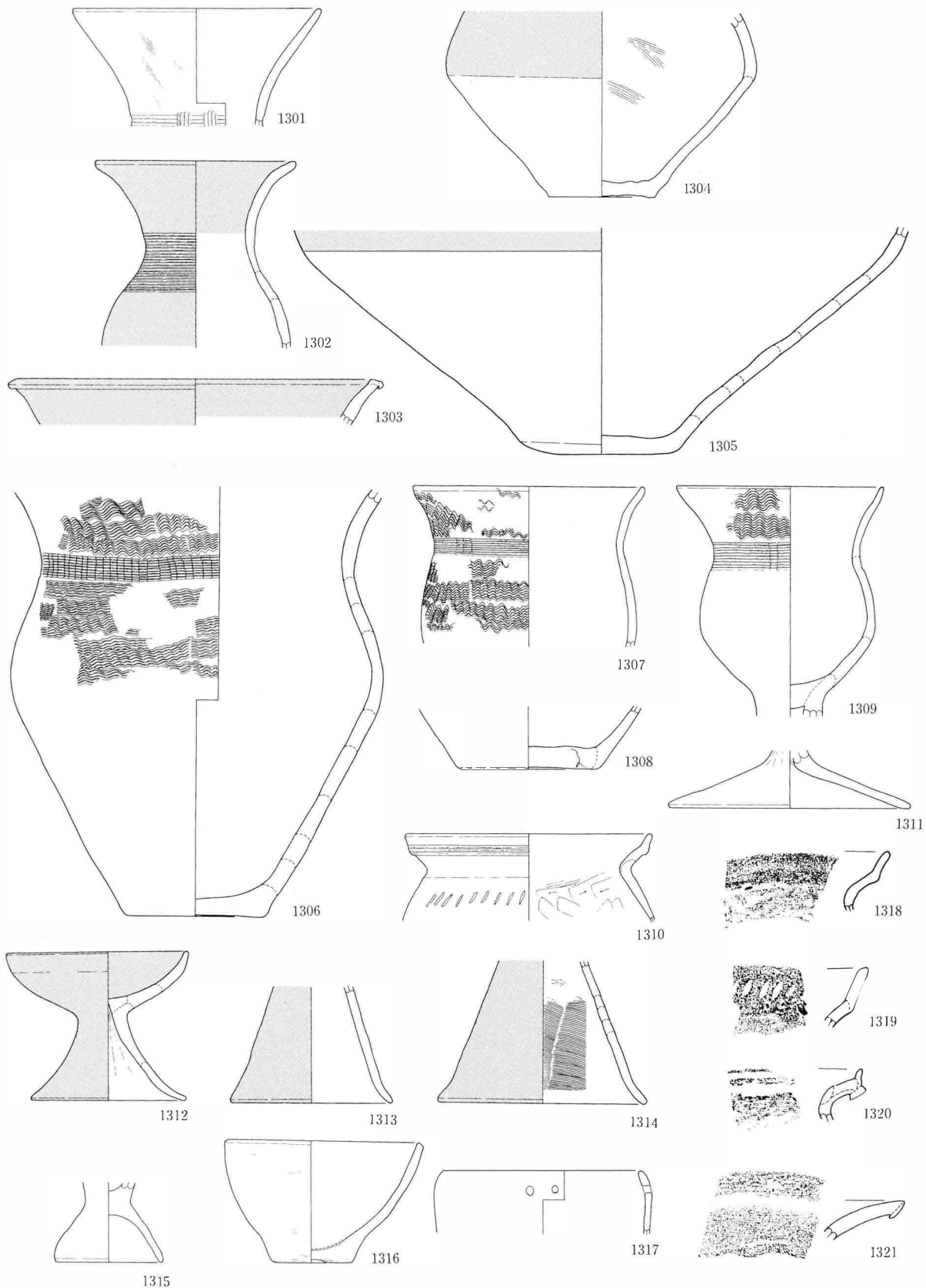

断面実測 0 (1:3) 10cm 0 (1:4) 10cm

B② SA15

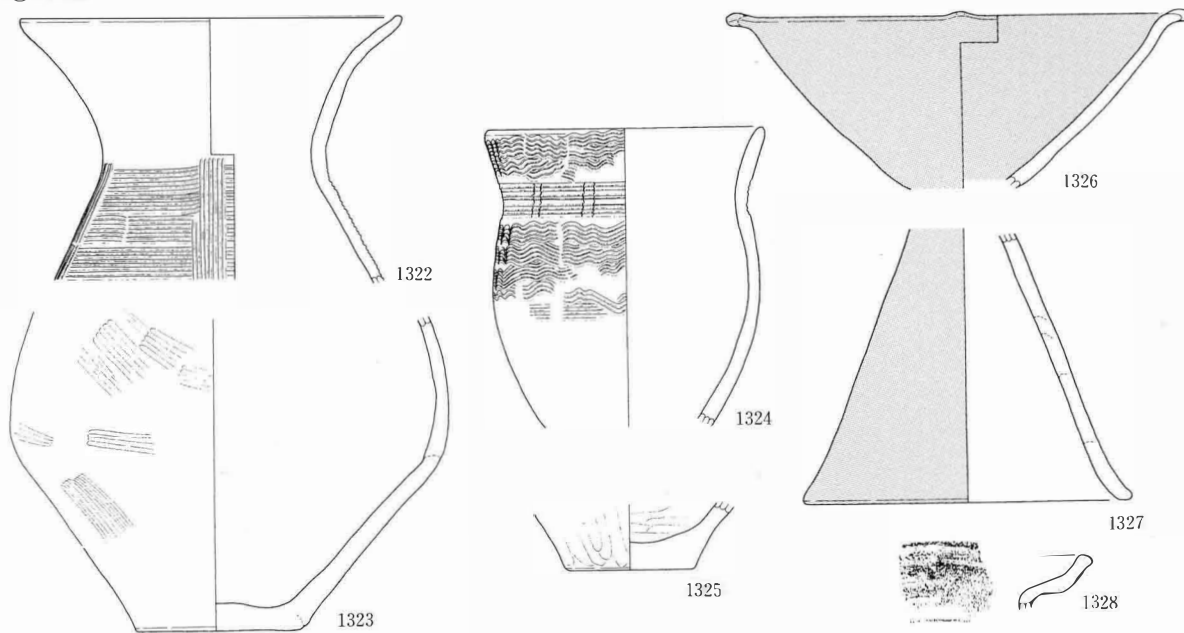

B② SA16

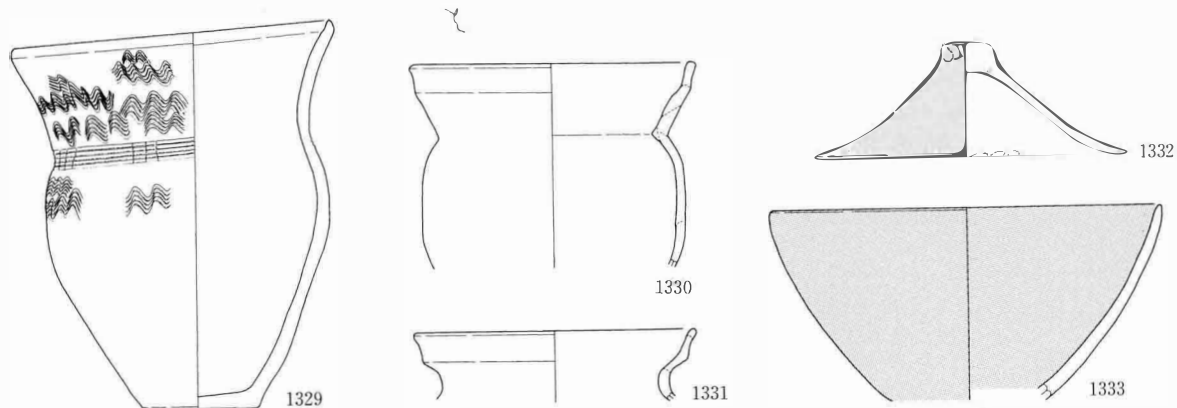

B② SA18

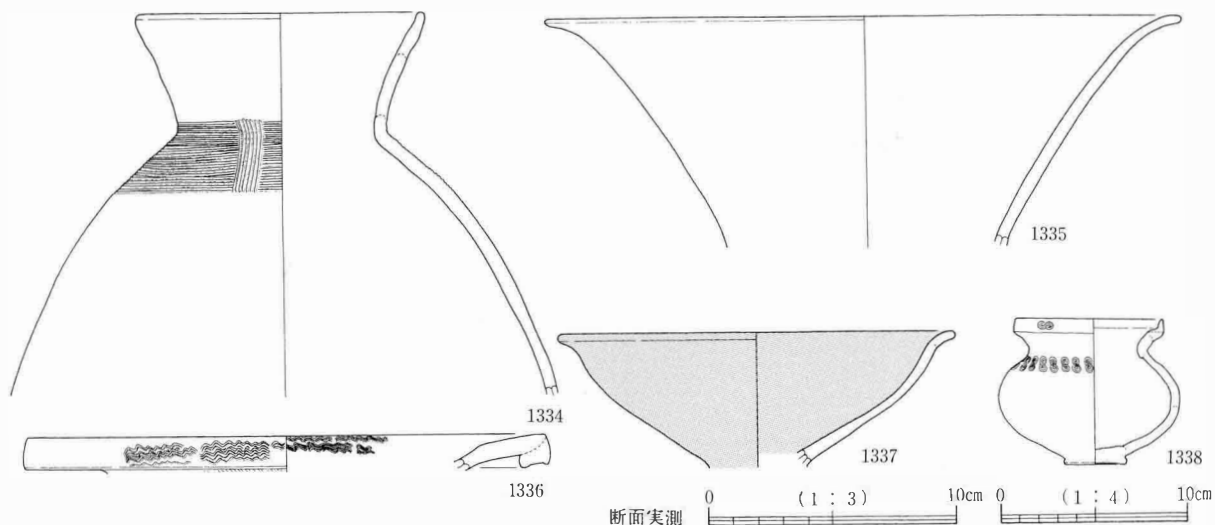

C② SA 1

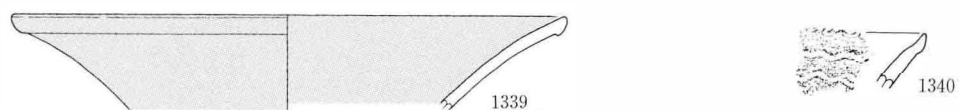

C② SA 2

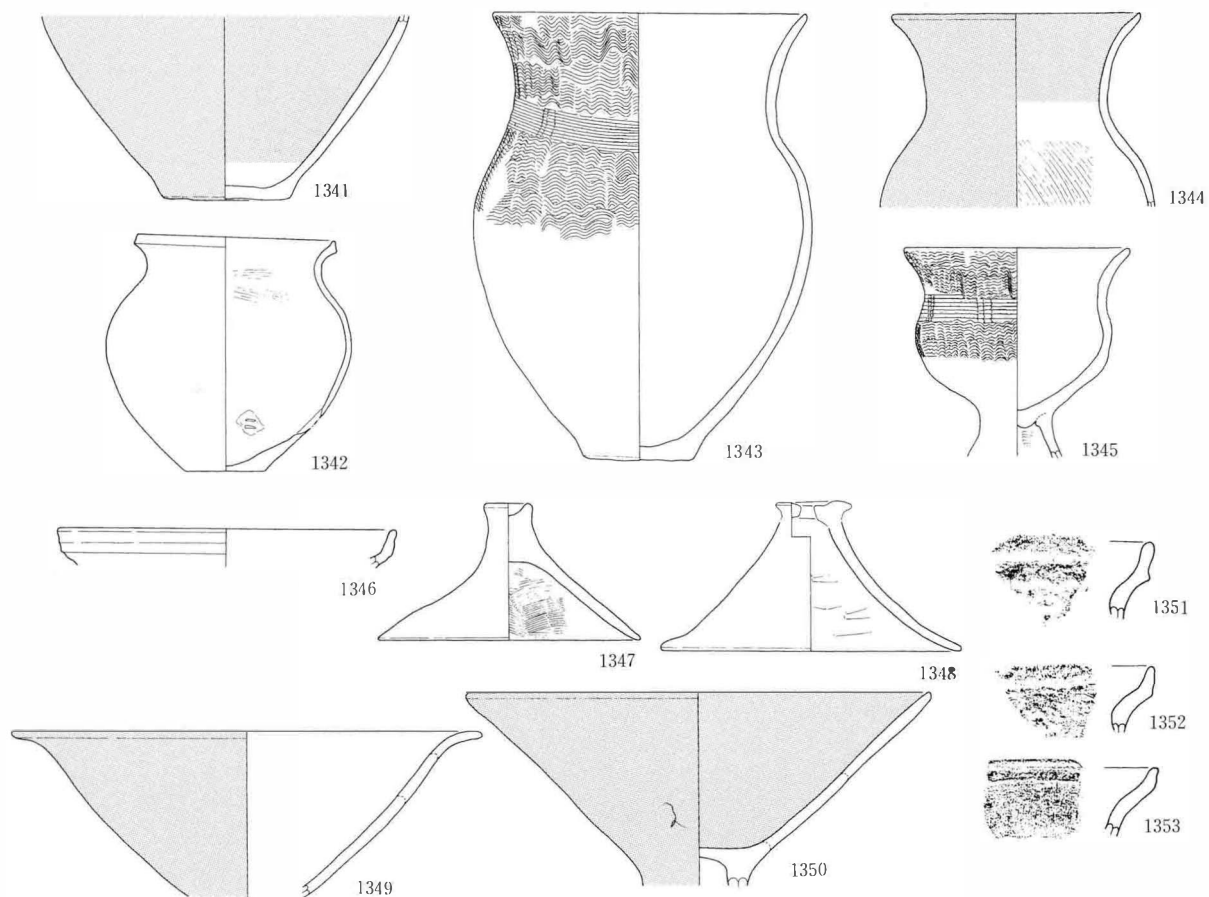

C② SA 4

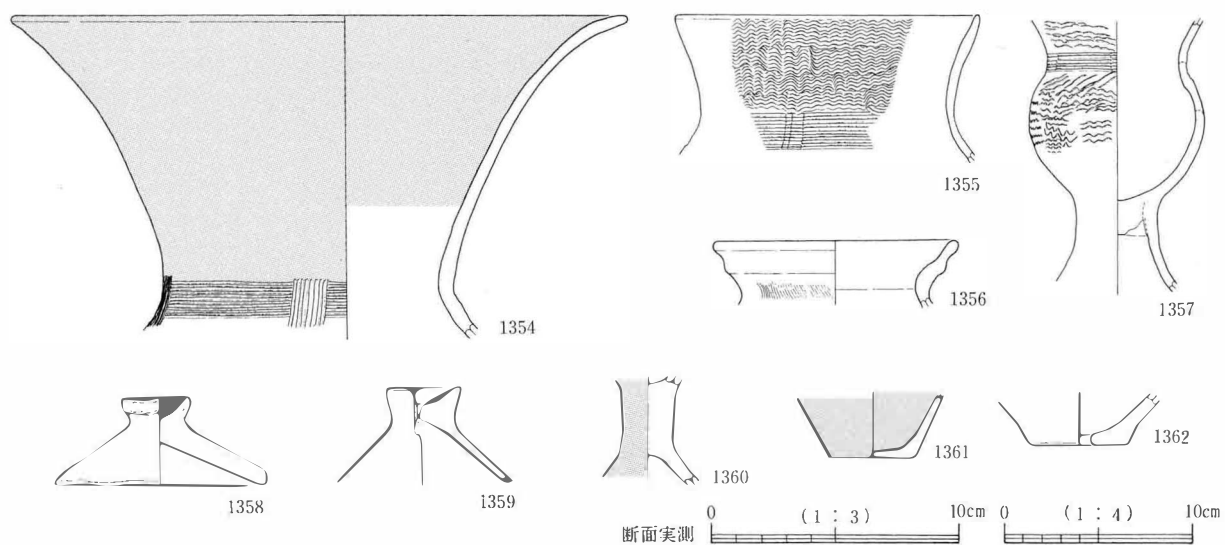

C ② SA 6

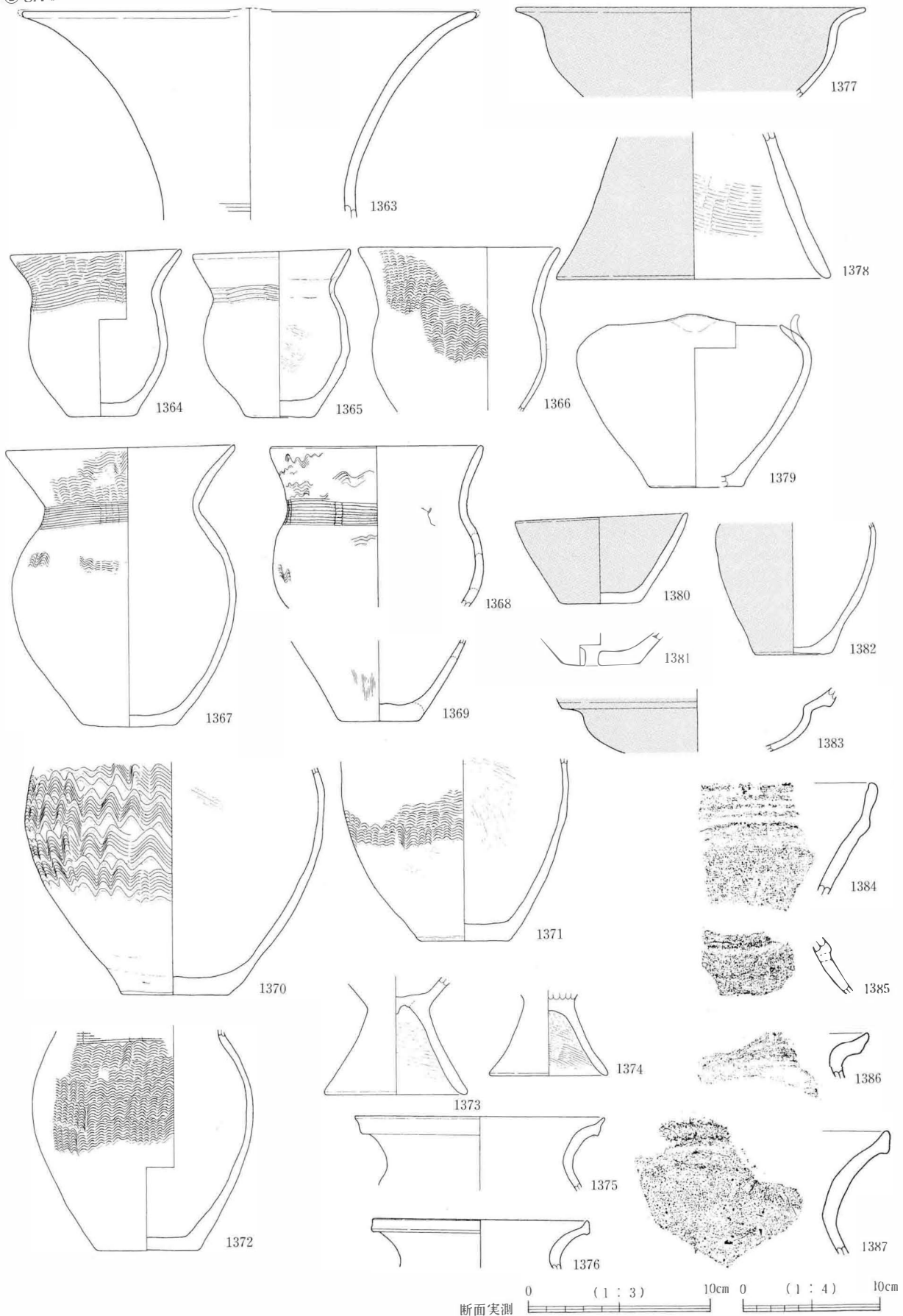

C②SA 7

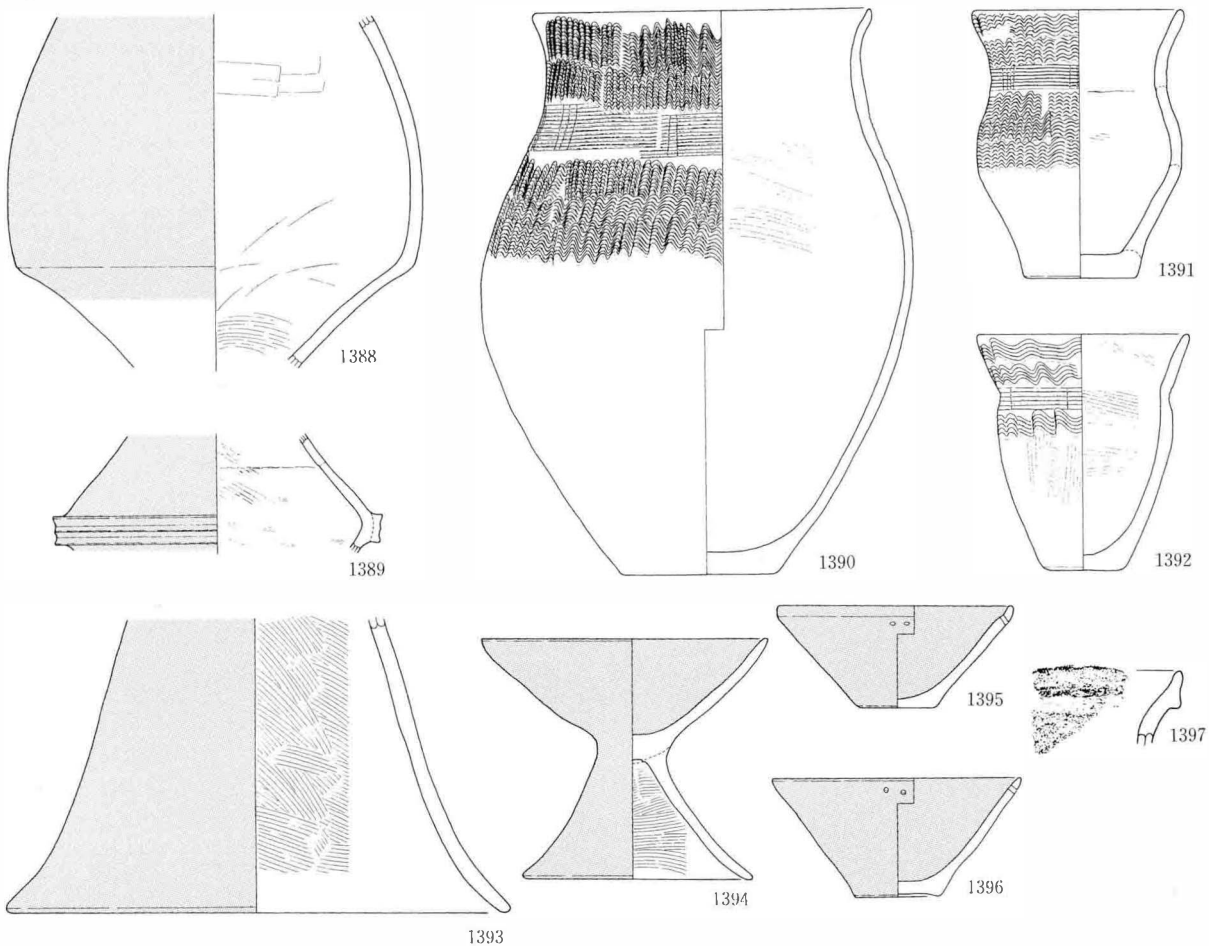

C②SA 8 (1)

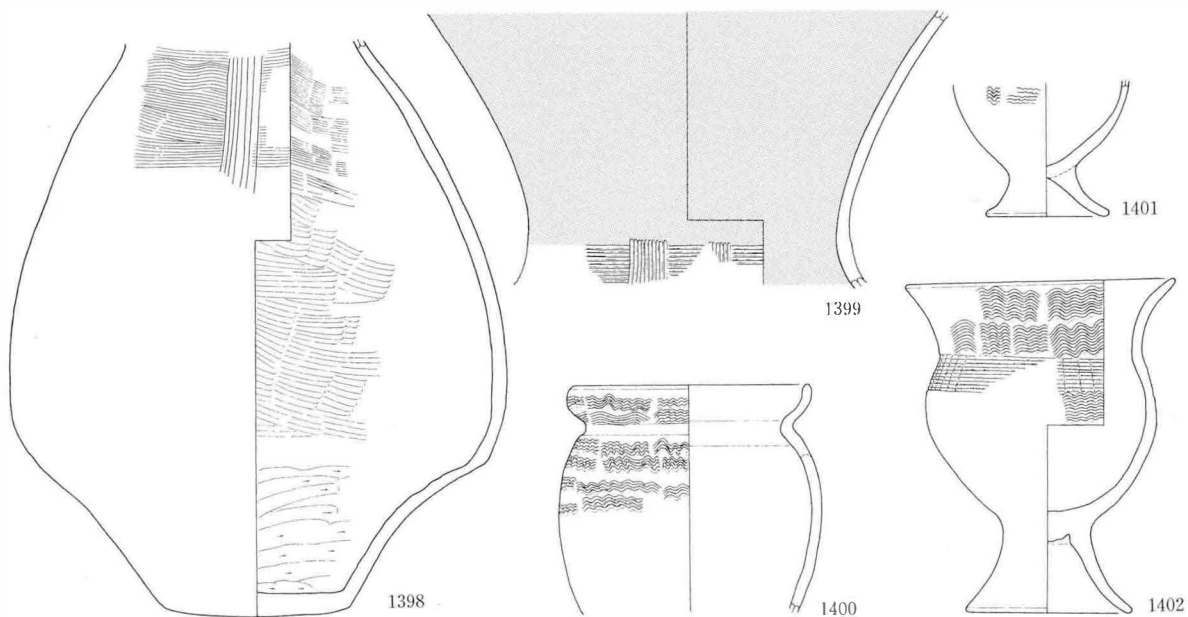

断面実測 0 (1:3) 10cm 0 (1:4) 10cm

C②SA8 (2)

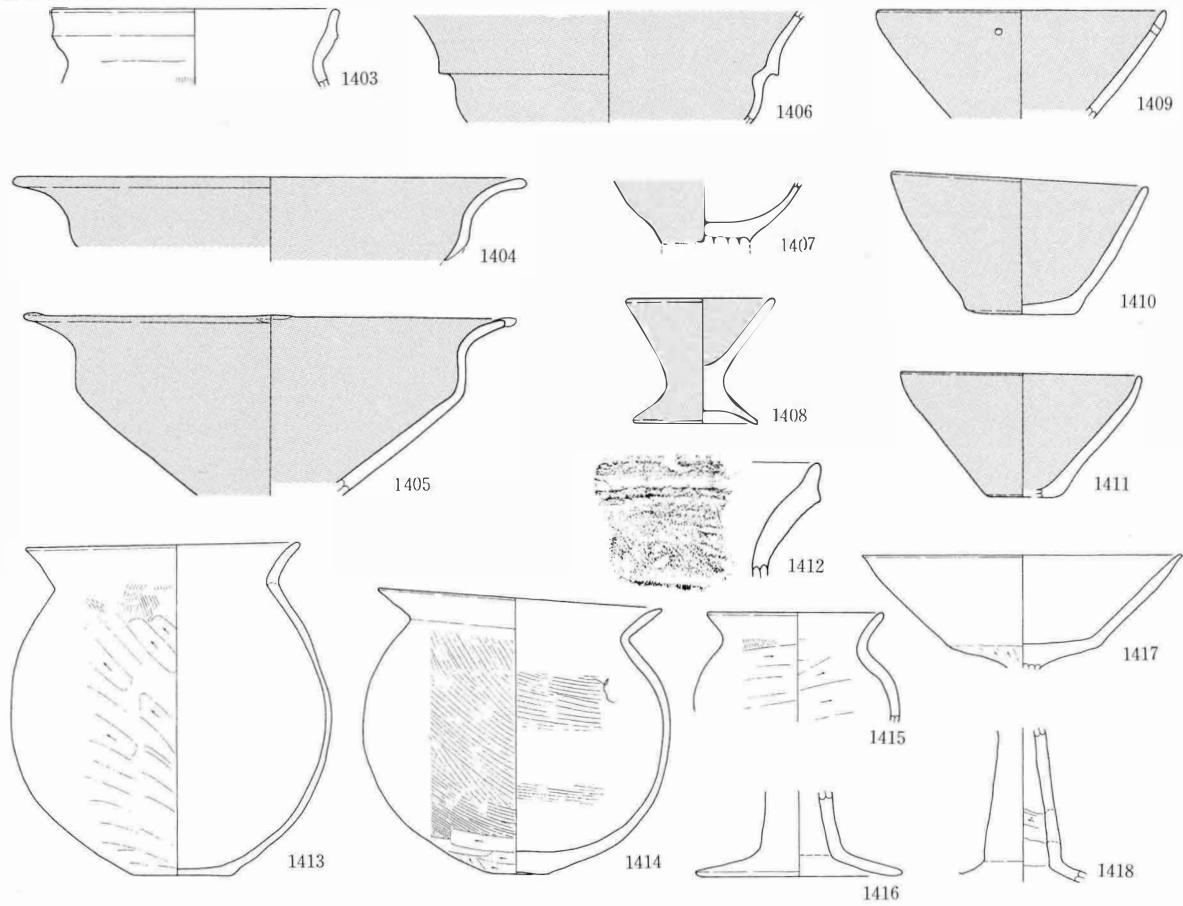

C②SA9

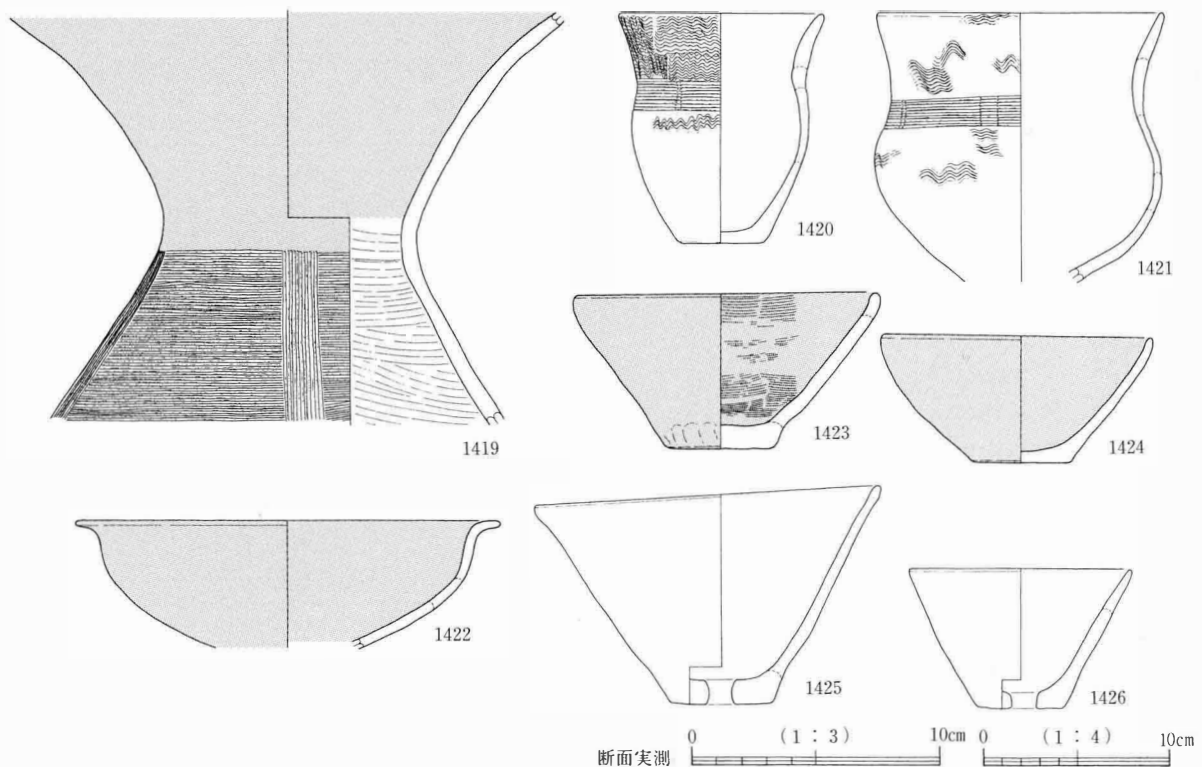

C②SA10(1)

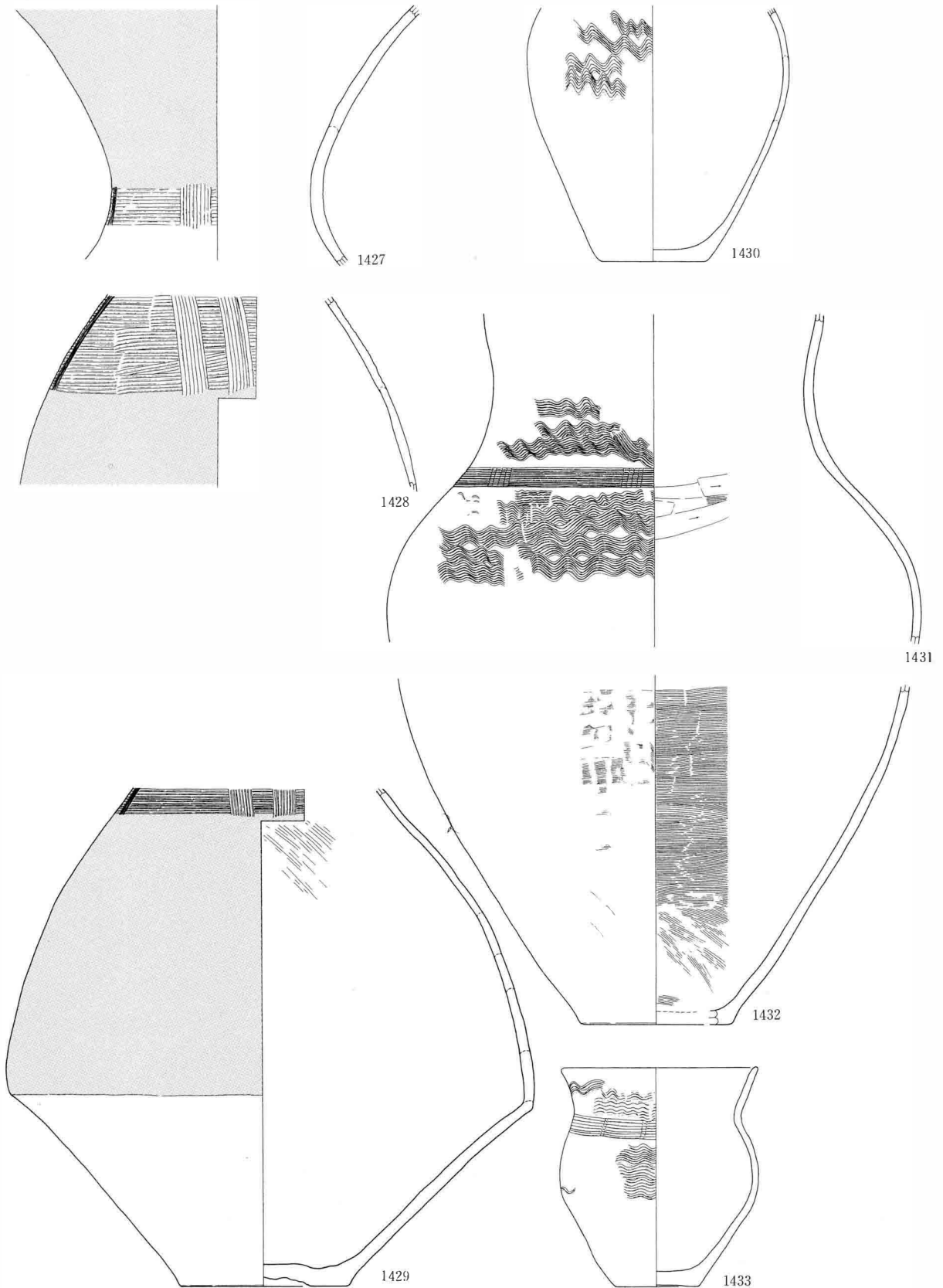

0 (1 : 4) 10cm

C②SA10(2)

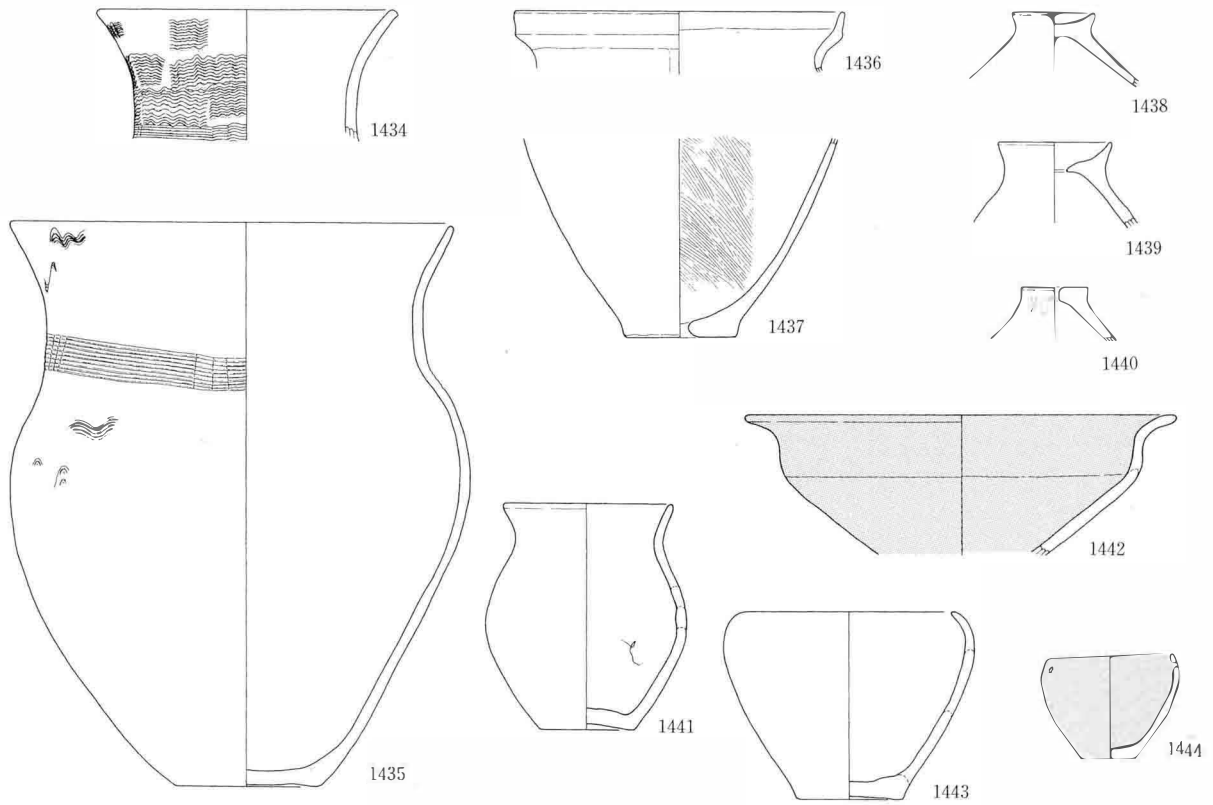

C②SA11

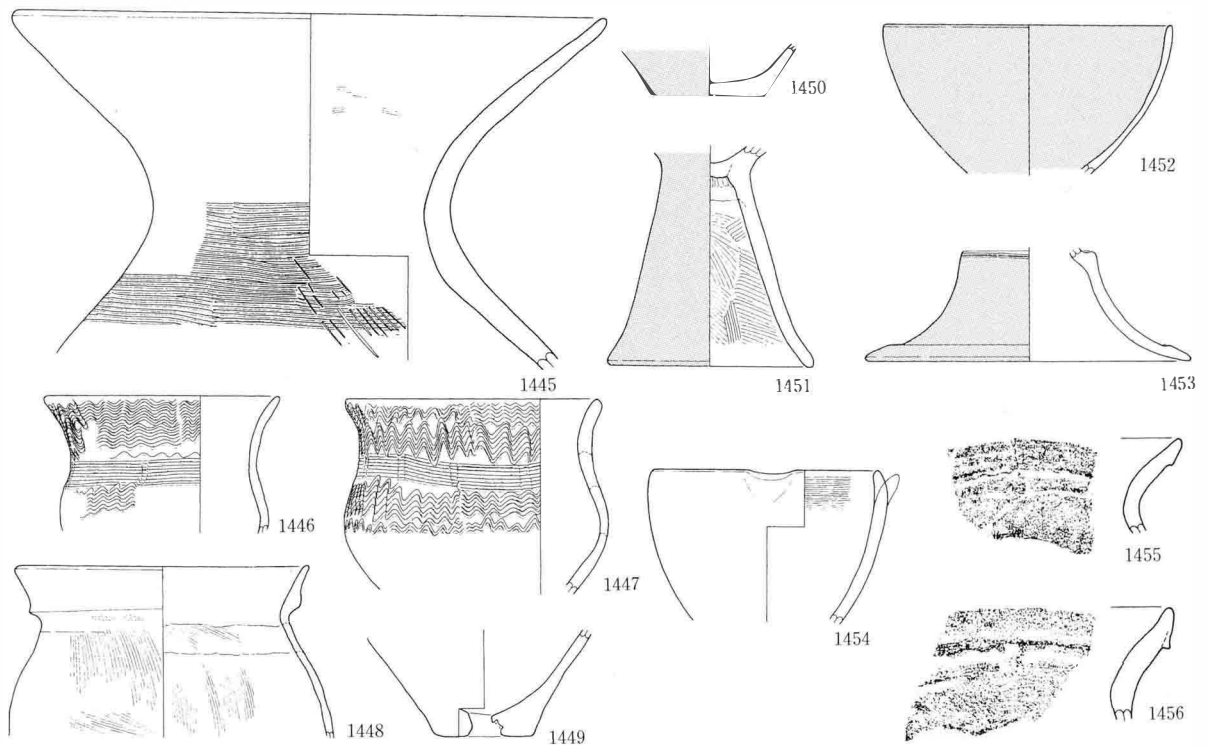

断面実測 0 (1:3) 10cm 0 (1:4) 10cm

C② SA12

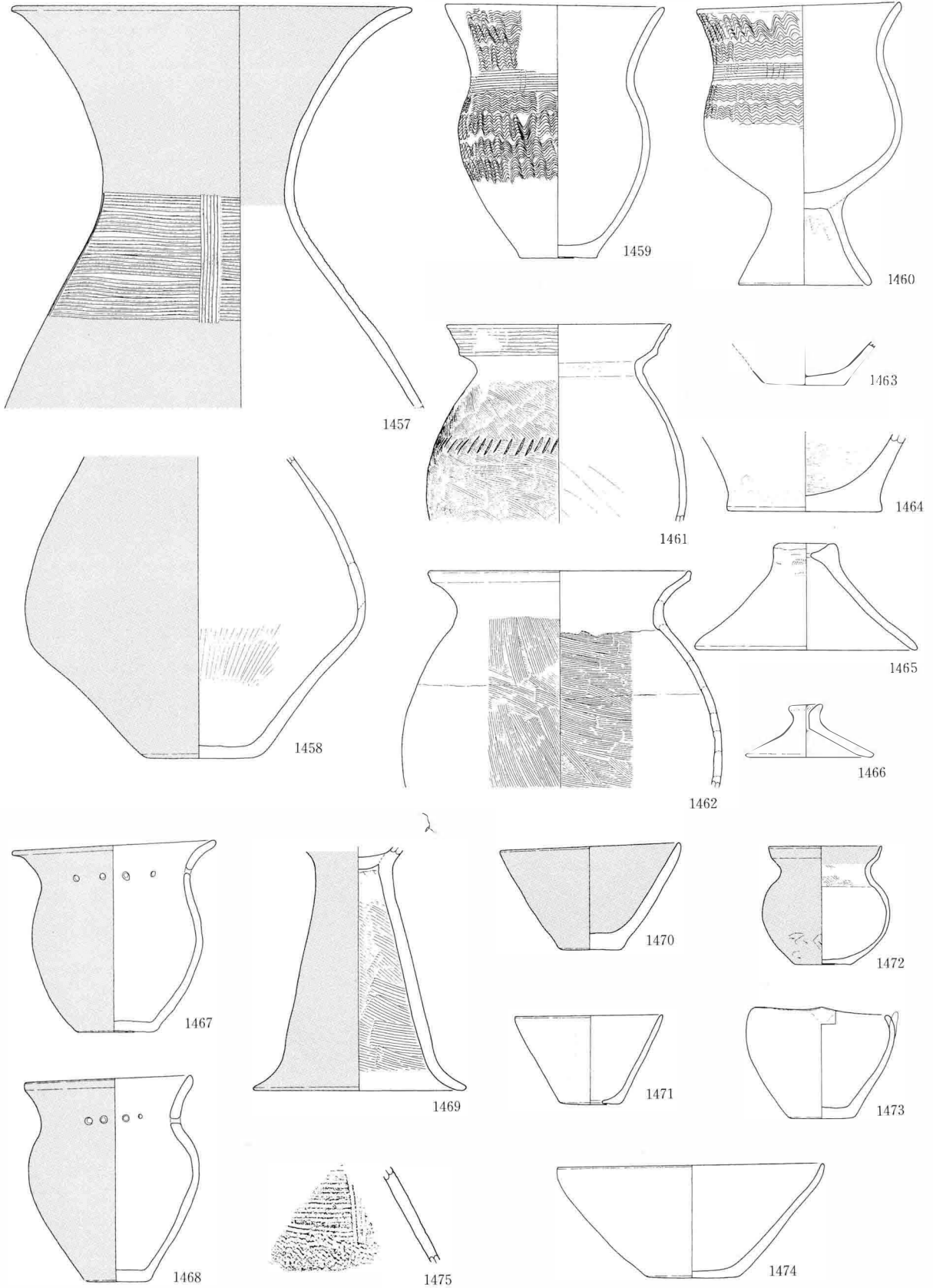

断面実測 0 (1:3) 10cm 0 (1:4) 10cm

C②SA15

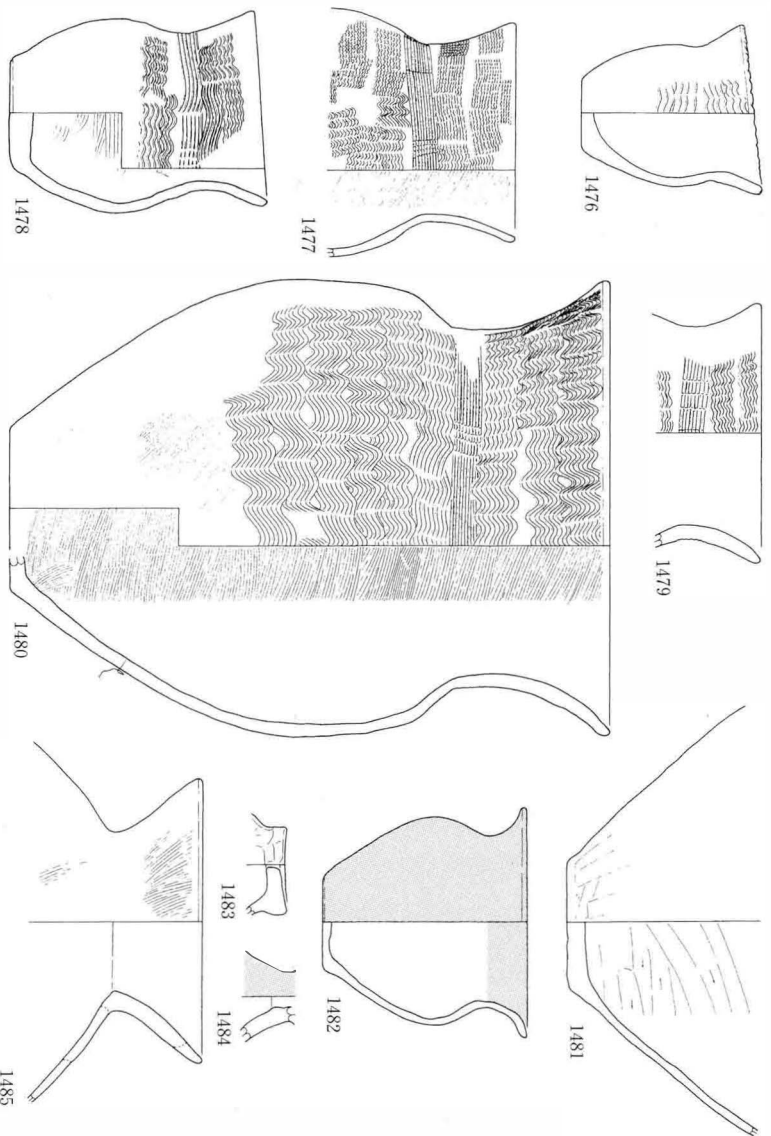

C②SA17



C②SA18

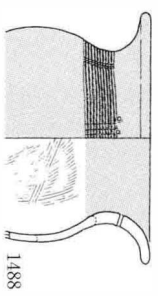

C②SA21

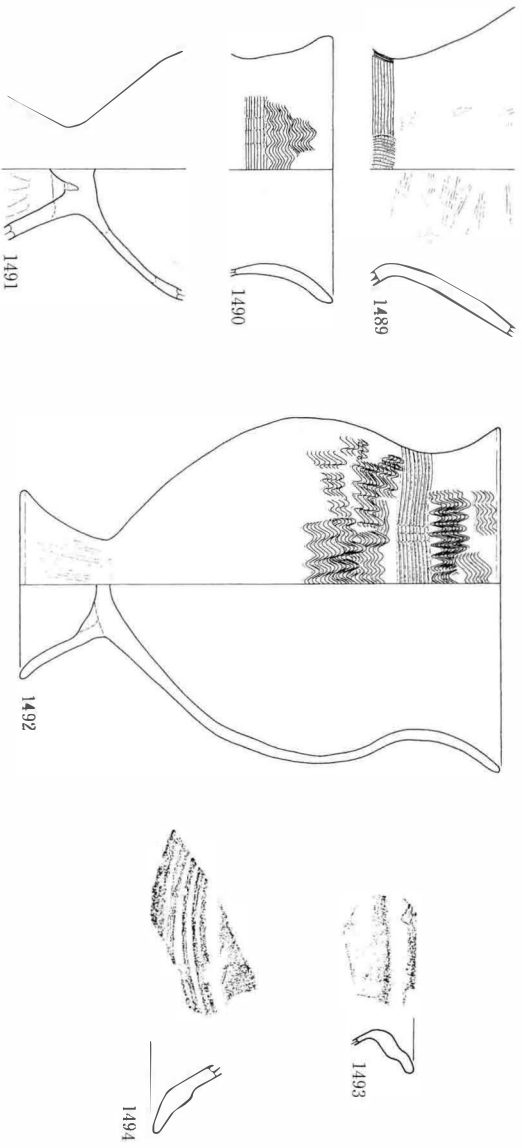

C ② SA22

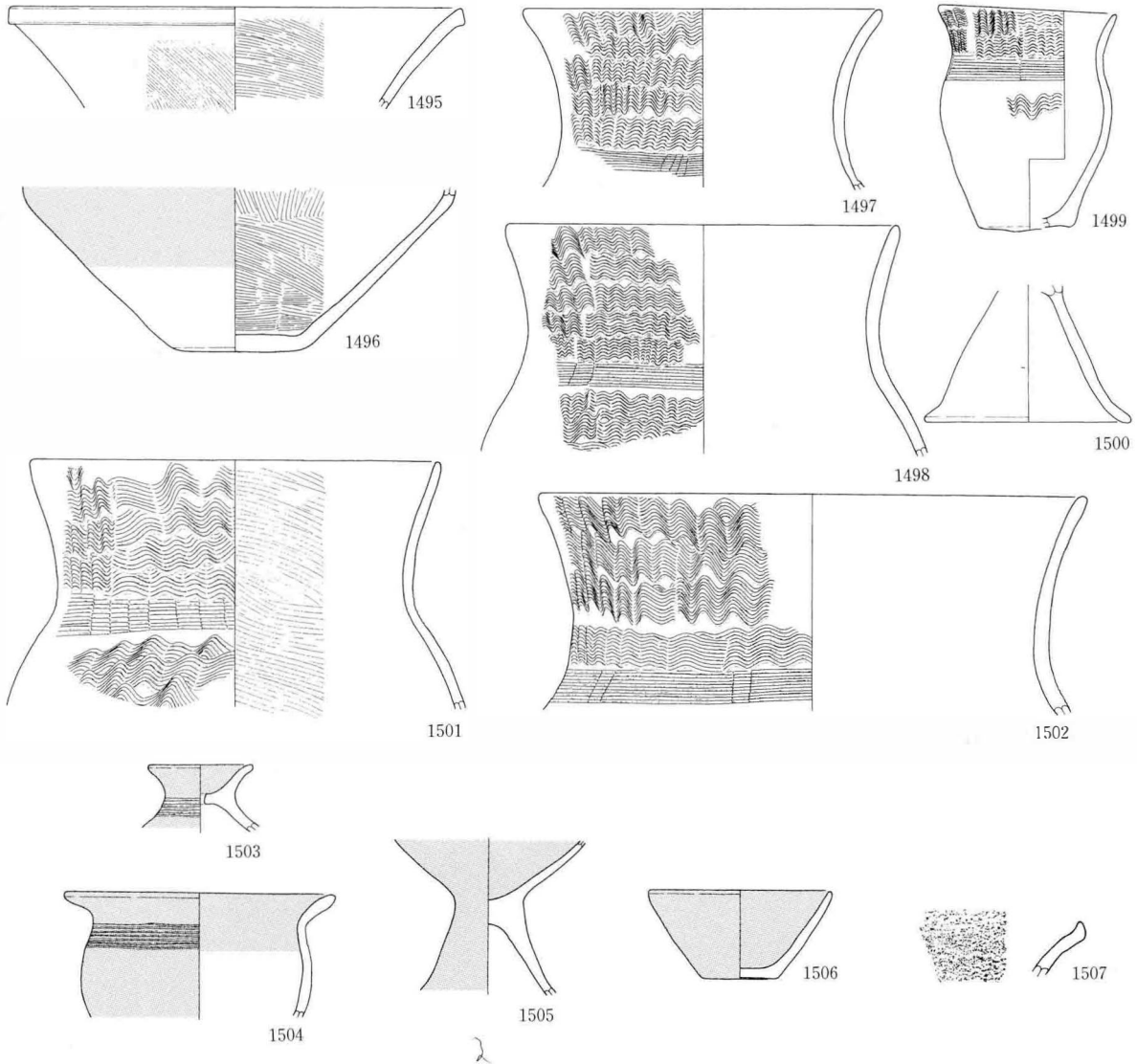

C ② SA25

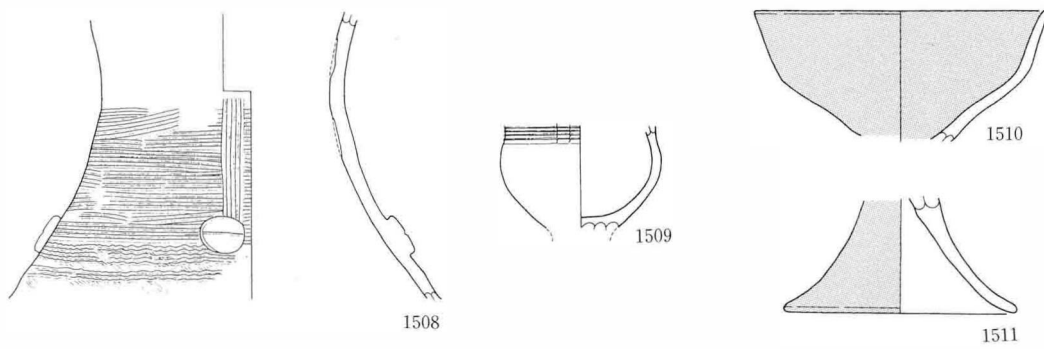

断面実測 0 (1:3) 10cm 0 (1:4) 10cm

48① SJ 7

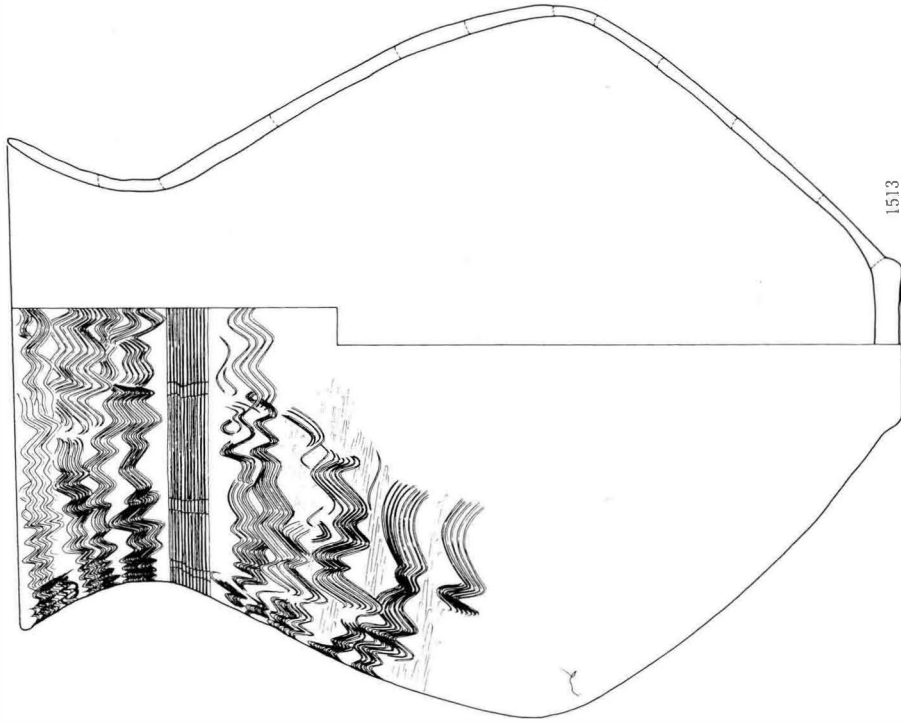

25① SJ 1

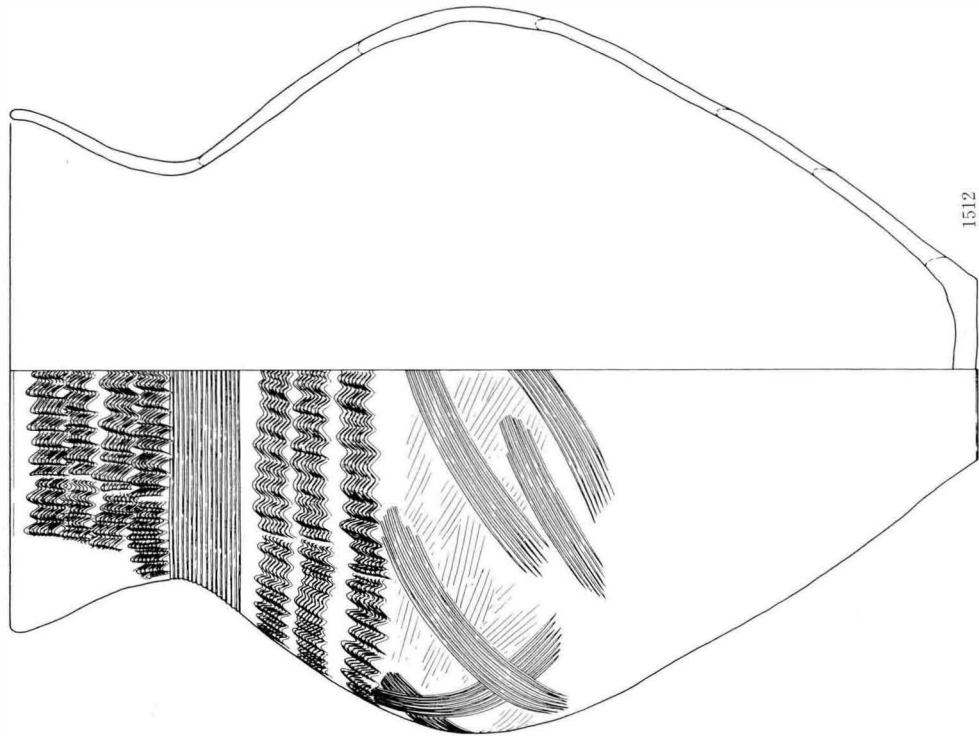

64①SJ 1

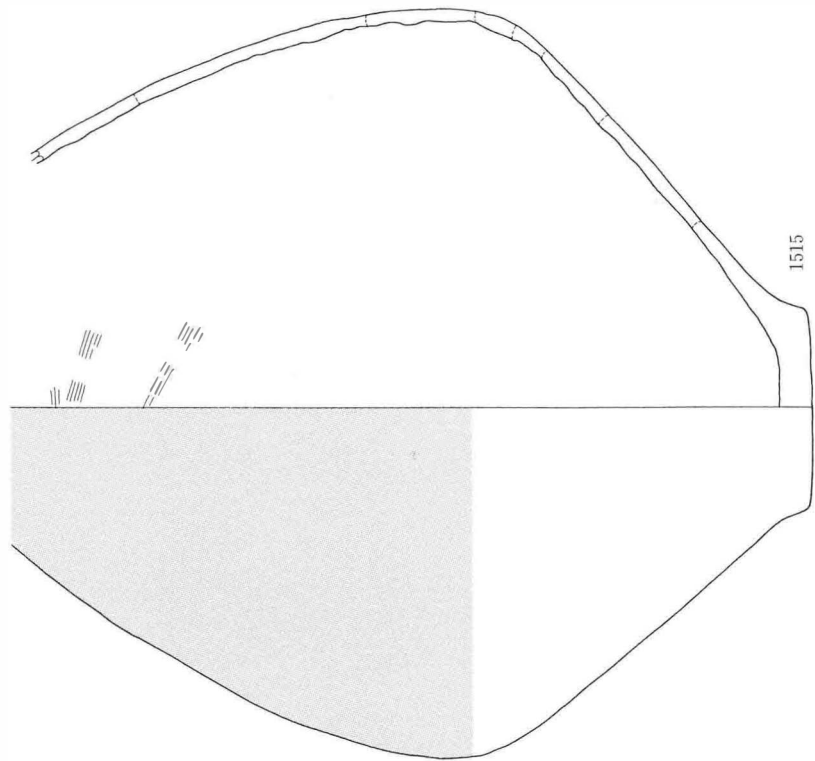
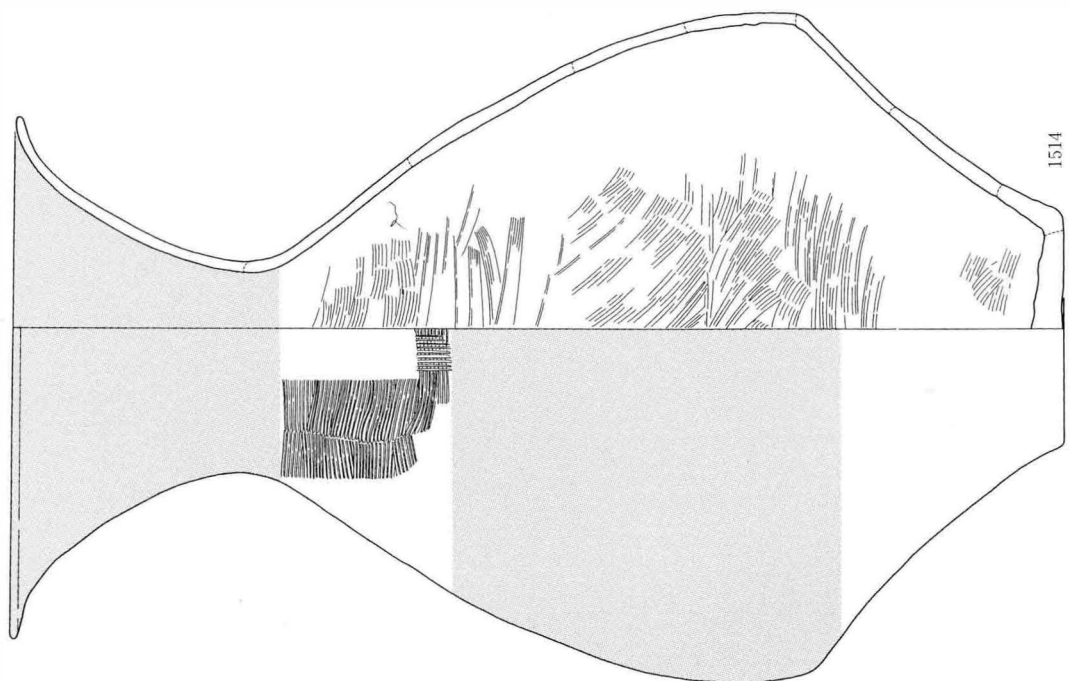

50② SK 4

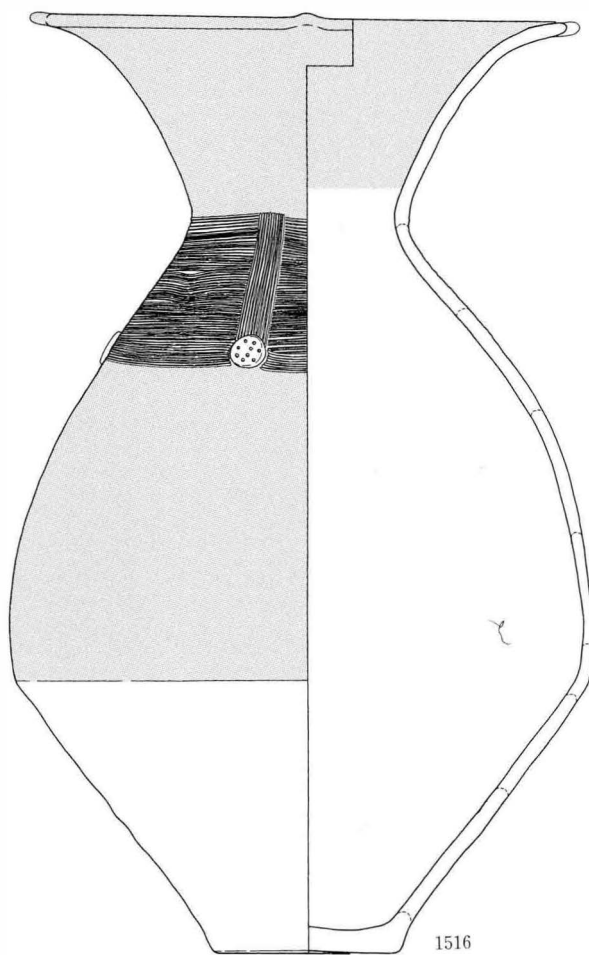

4① SDZ 1

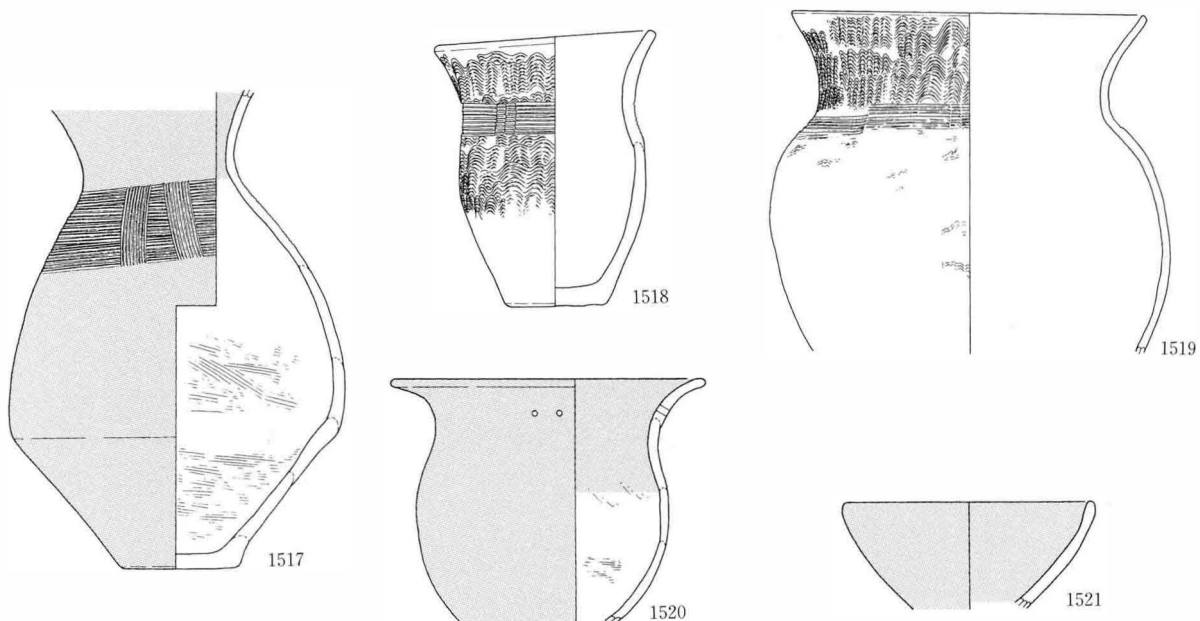

0 (1 : 4) 10cm

19① SDZ 1

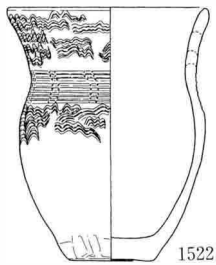

1522

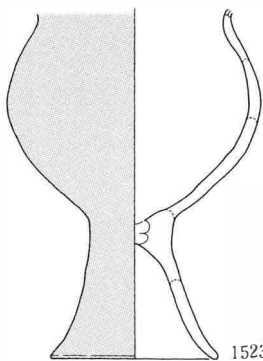

1523

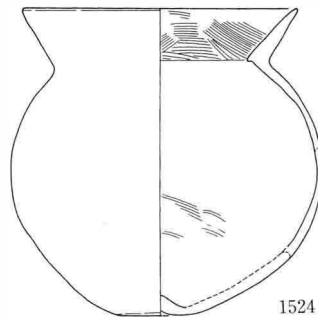

1524

48① SDZ 5

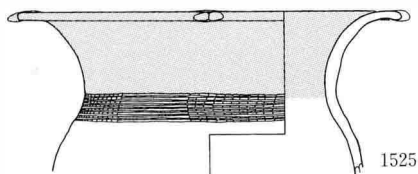

1525

48① SDZ 6

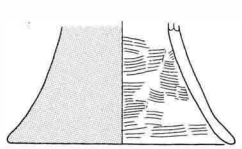

1527

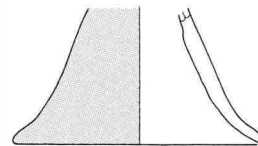

1528

48① SD 1

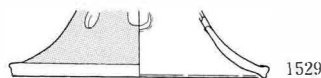

1529

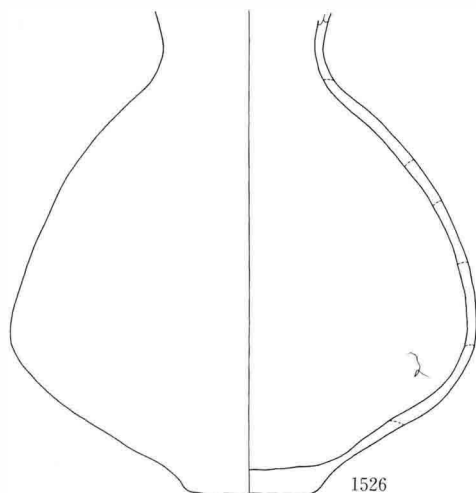

1526

B ② SD 2

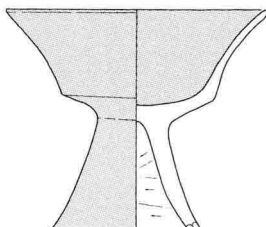

1530

B ② SD 8

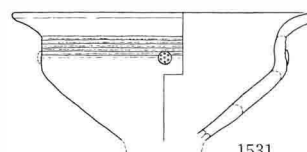

1531

B ② SD 6

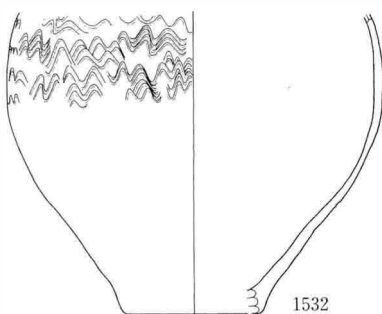

1532

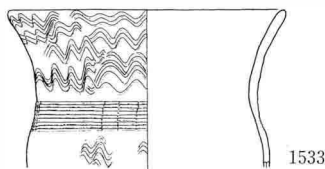

1533

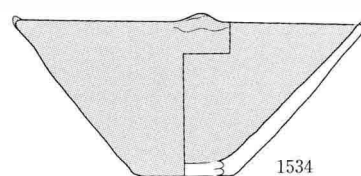

1534



1535



1536



0 1537

(1 : 4)

10cm 1538

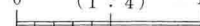

62① SX 4

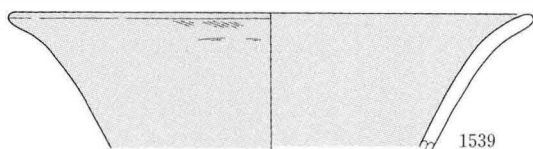

1539

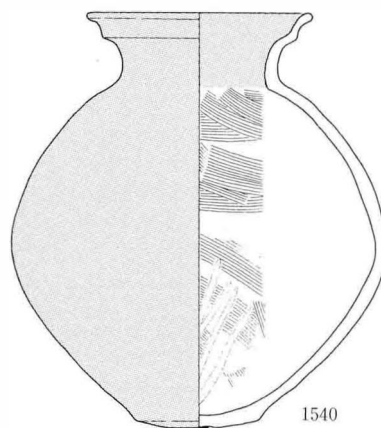

1540

遺構外

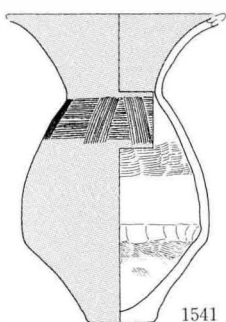

1541
5①

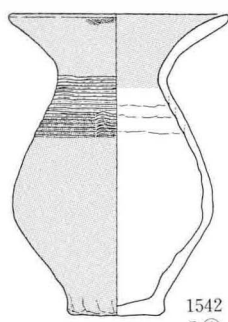

1542
5①

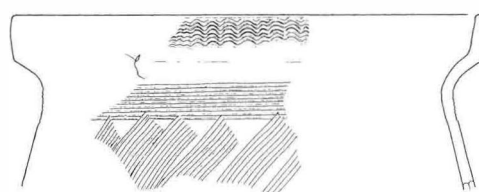

1547
73①



1548
B①

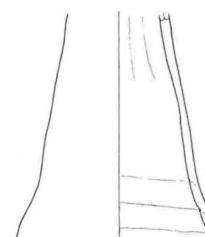

1552
B①

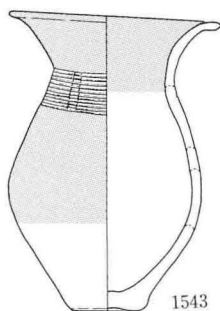

1543
14①

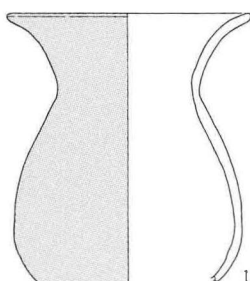

1544
48①

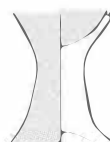

1549
B①



1553
C①

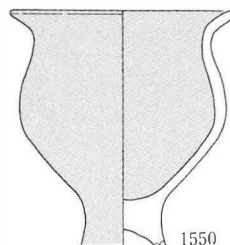

1550
48①

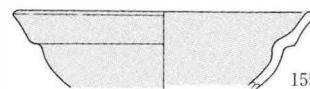

1554
C①

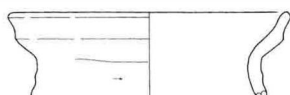

1545
C①

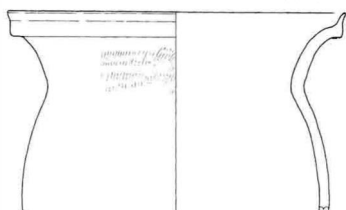

1546
C①



1551
B①

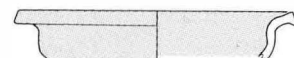

1555
C①

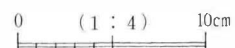

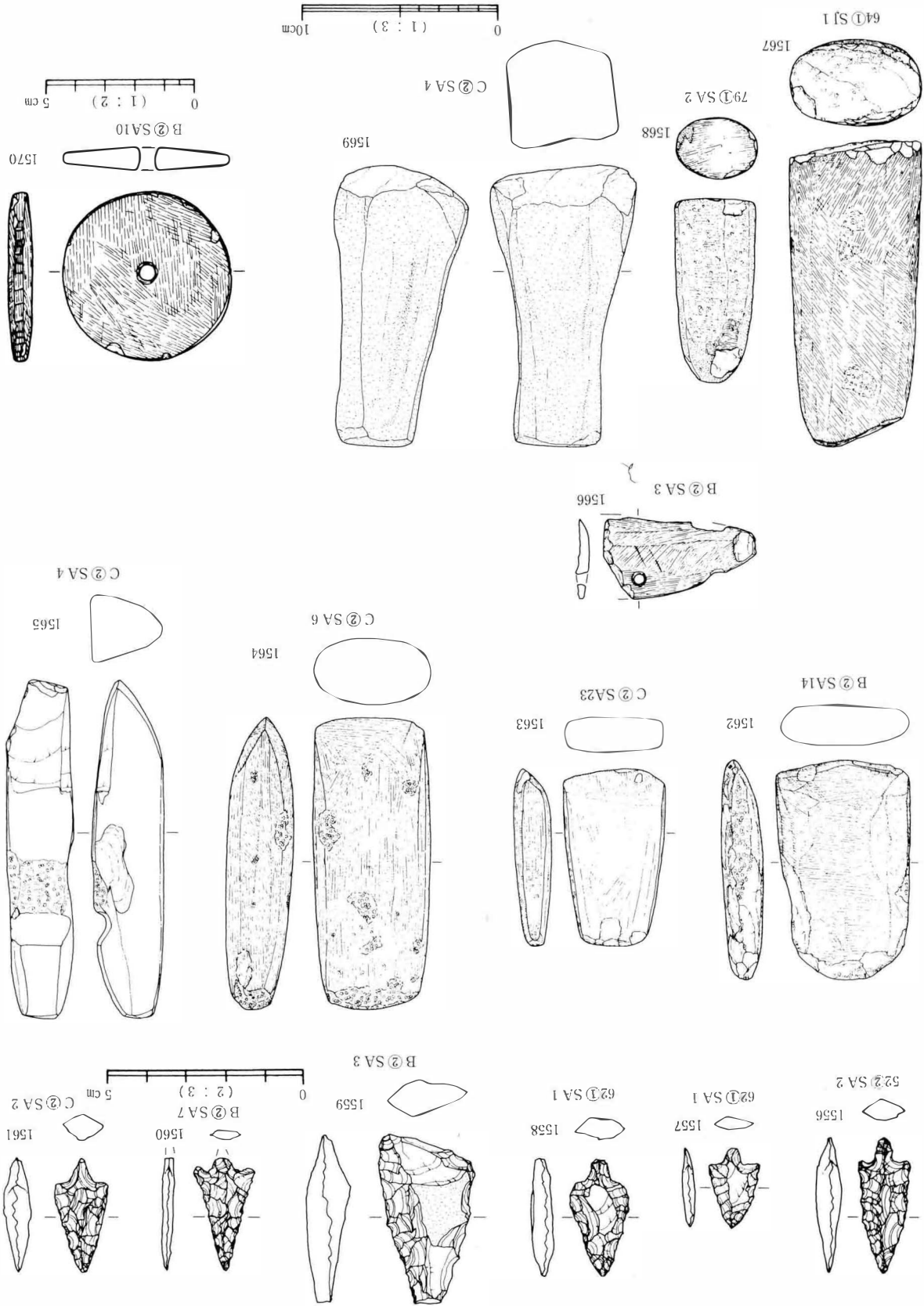

石製品

土製品

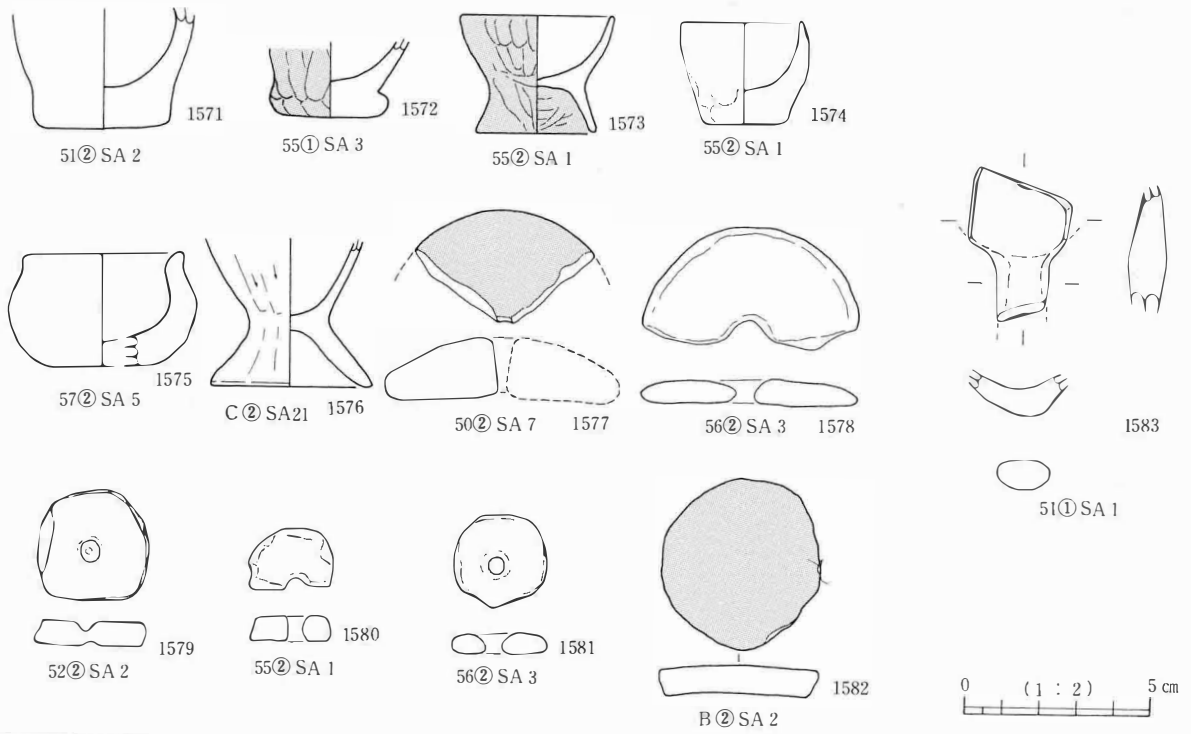

装身具 (1)

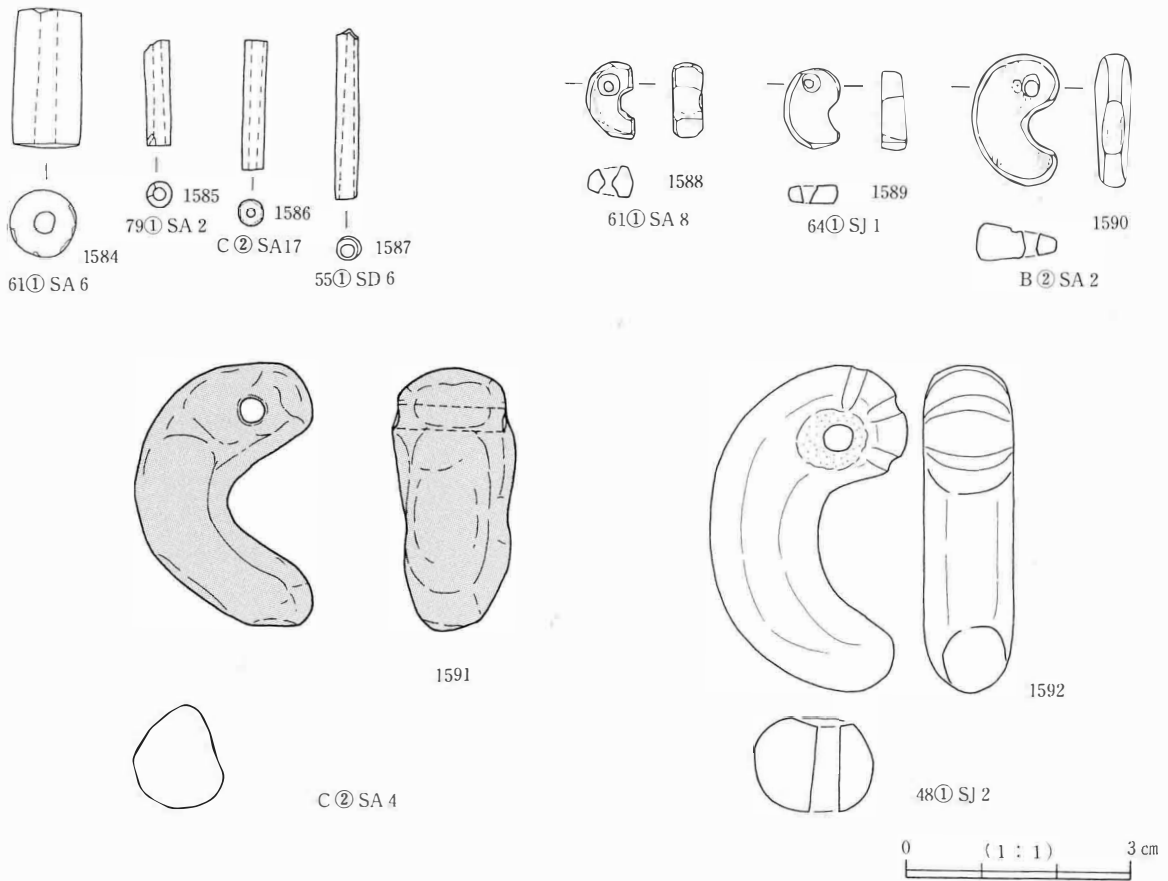

装身具 (2)

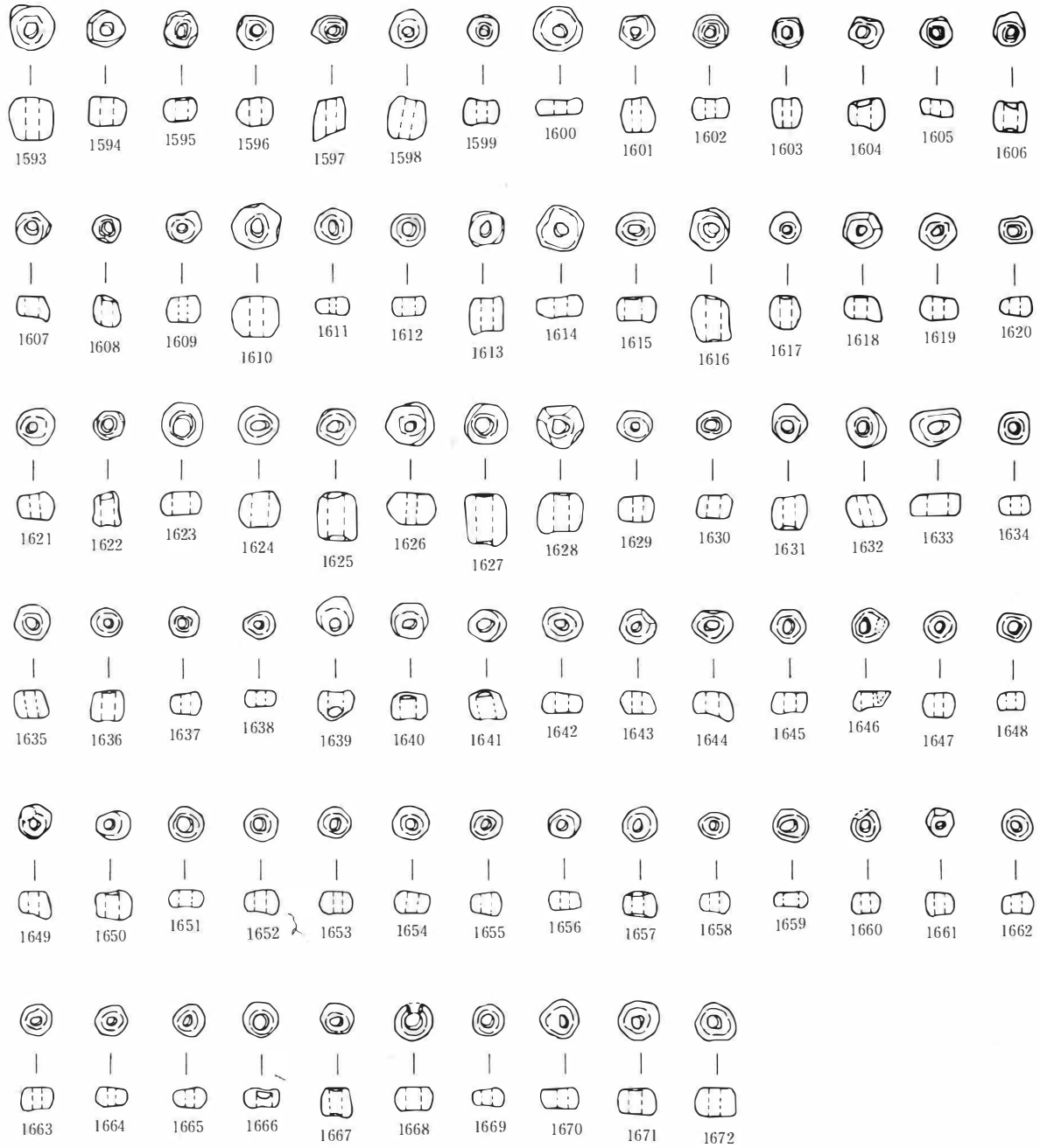

1593~1670
48① SJ 1

1671~1672
48① SJ 2

0 (1 : 1) 3 cm

装身具 (3)

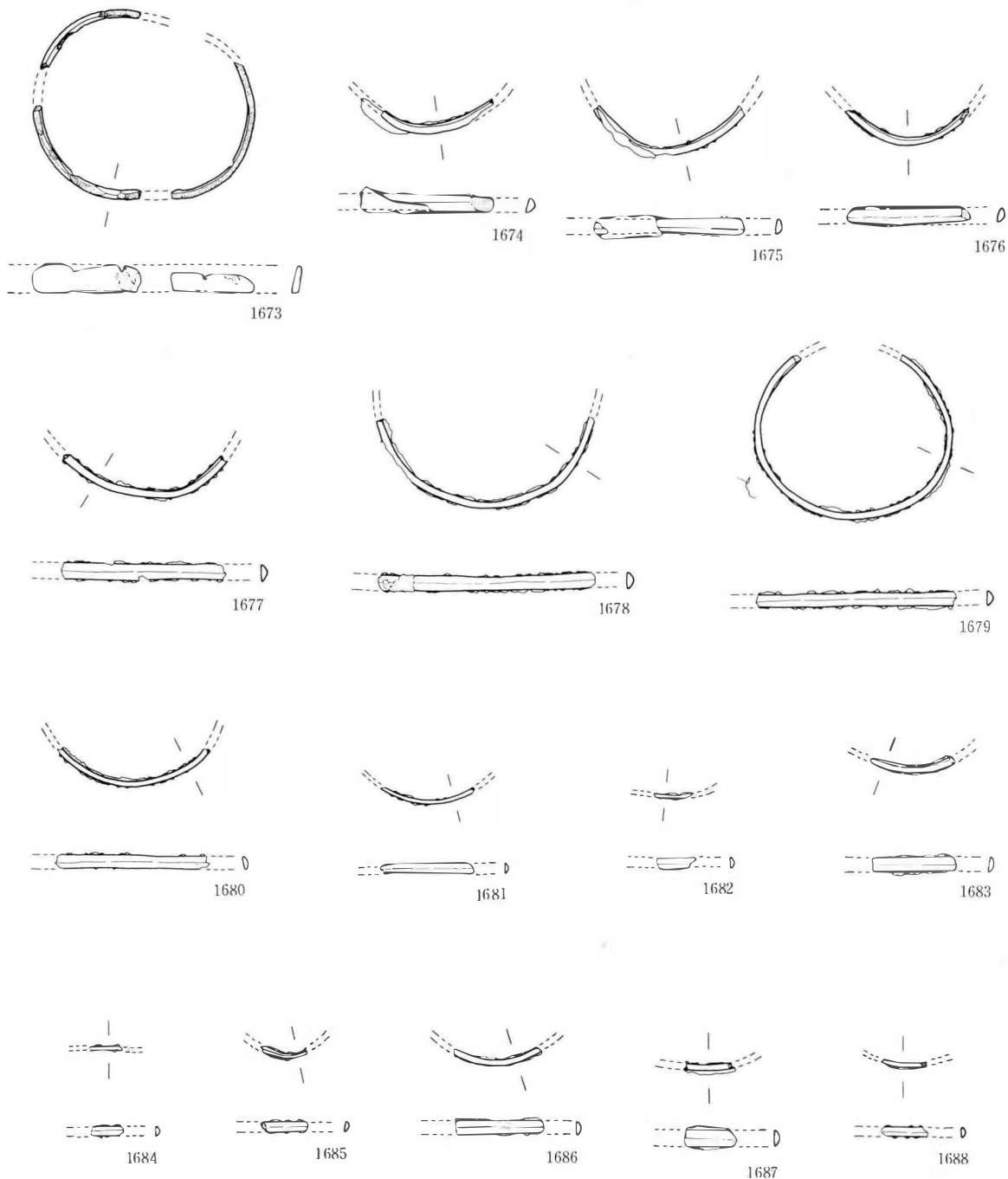

すべて48①SJ1

0 (1 : 2) 5 cm

図版 191 古墳時代前期～中期の遺物 (1)

6① SA 1

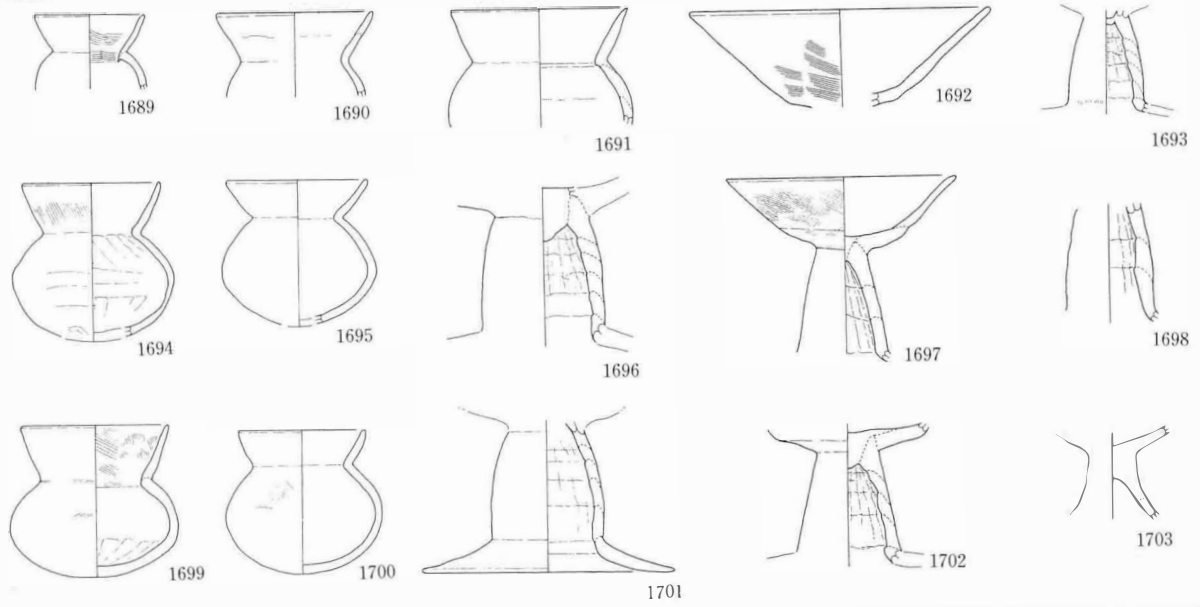

34① SA 3

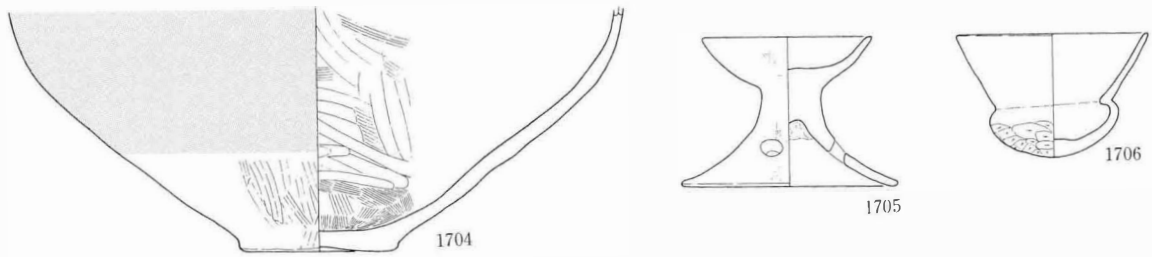

48① SA 1

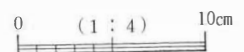
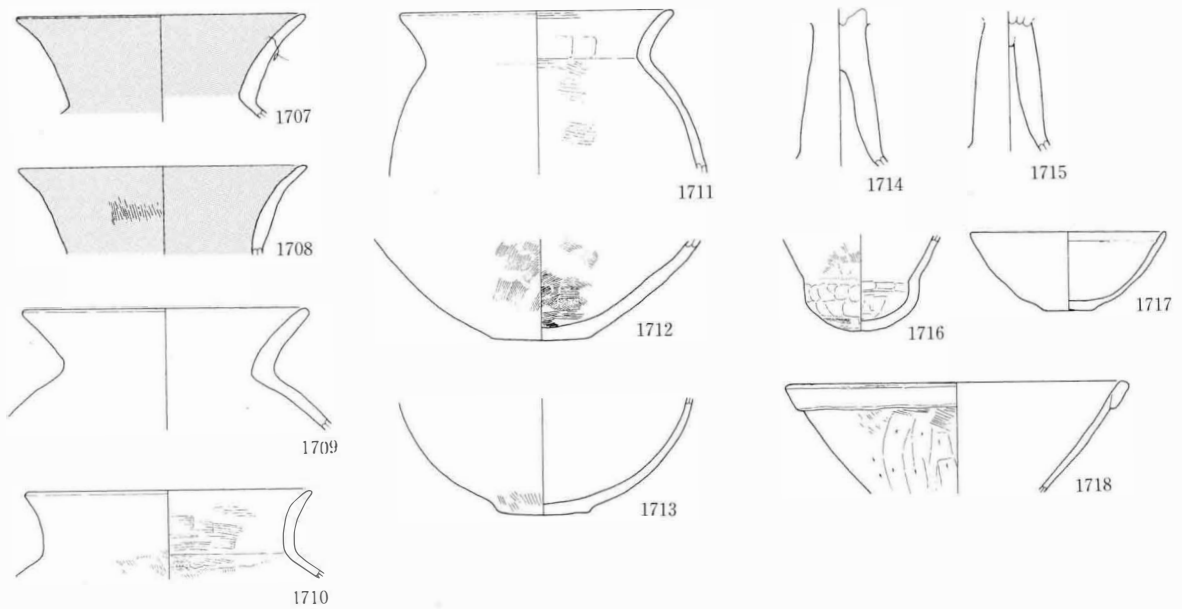

図版 192 古墳時代前期～中期の遺物（2）

48① SA 2

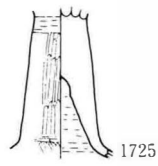
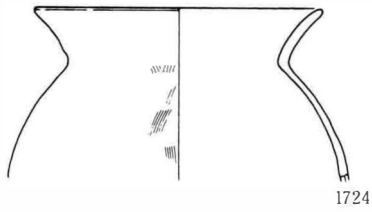
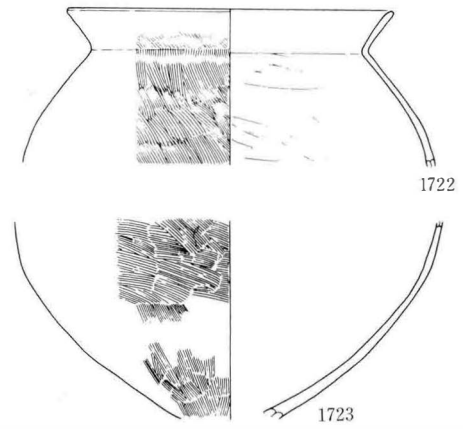
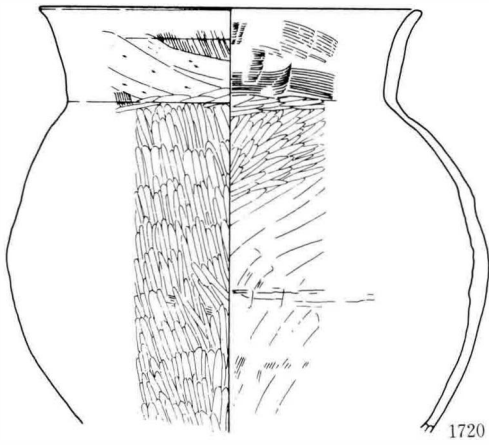
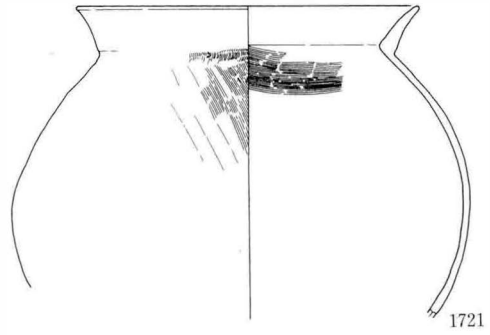
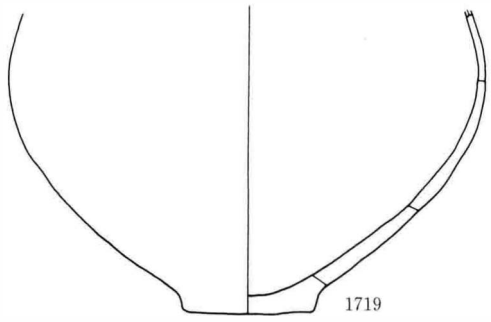

48① SA 3

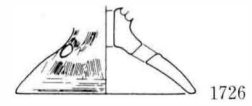

50② SA 5

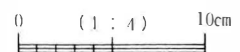
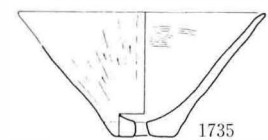
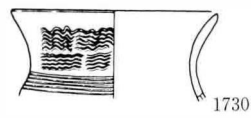
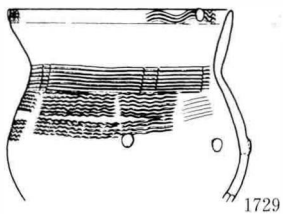
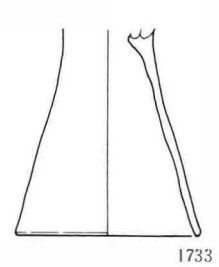
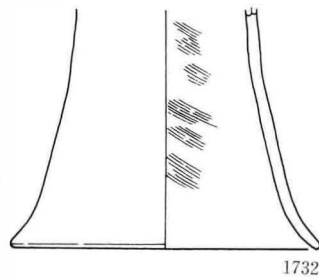
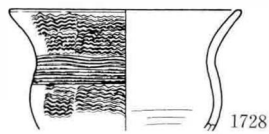
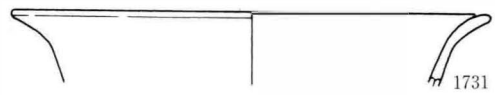
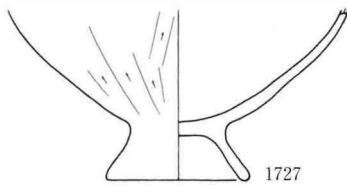

図版 193 古墳時代前期～中期の遺物 (3)

54① SA 1

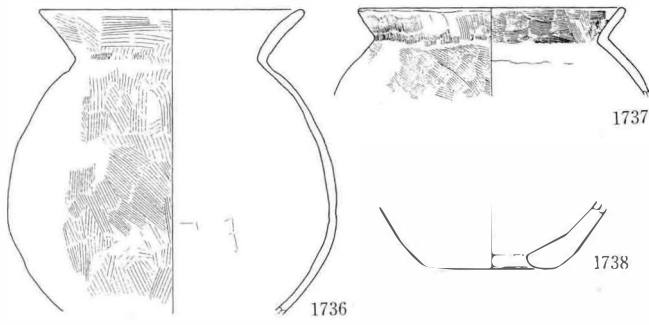

57① SA 3

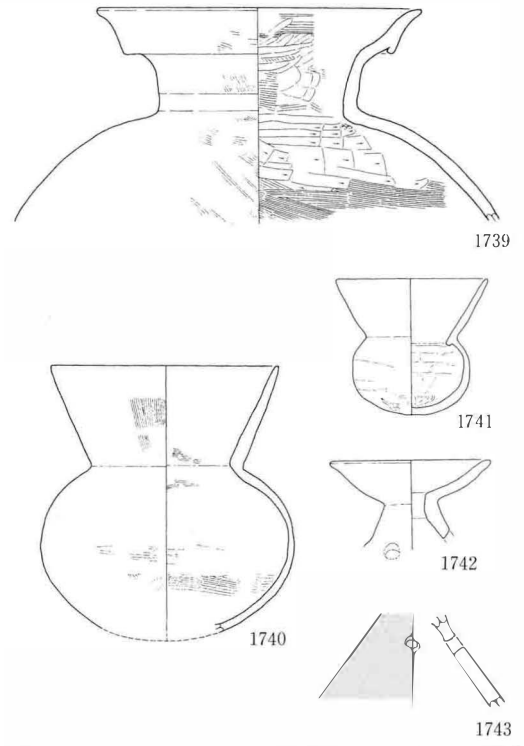

61① SA 9

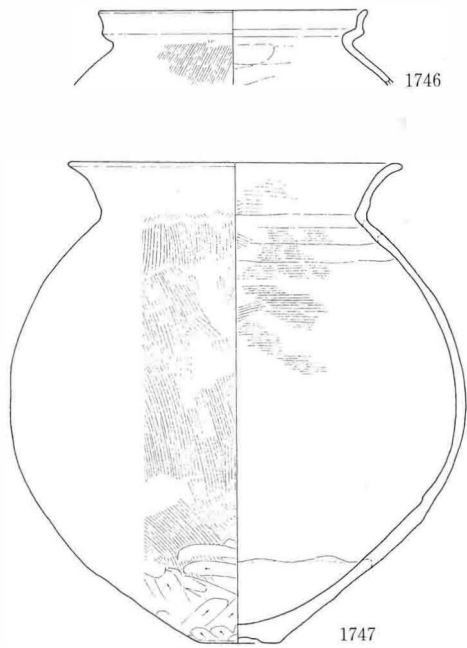

60② SA 3

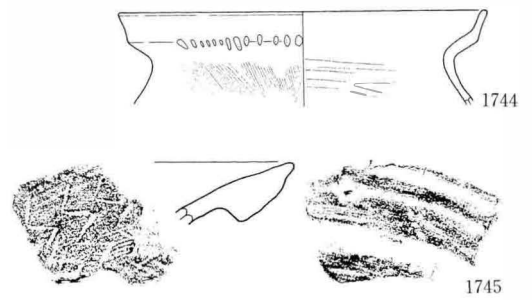

63① SA 1 (1)

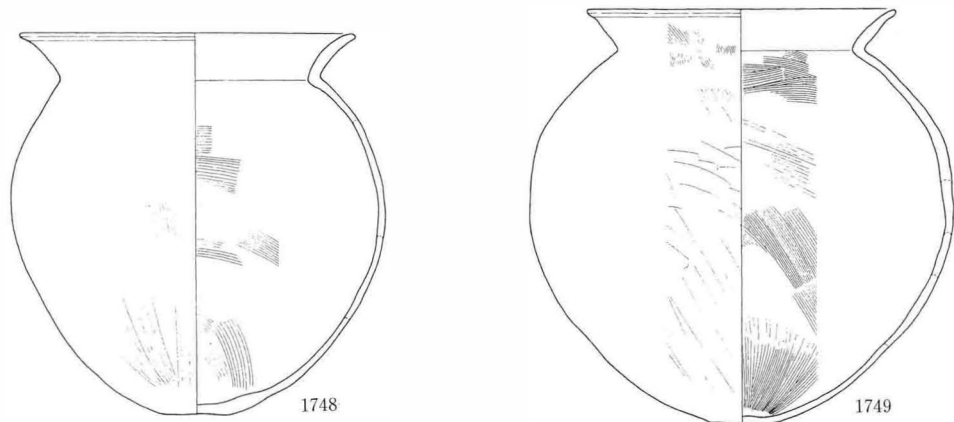

断面実測 0 (1:3) 10cm 0 (1:4) 10cm

図版 194 古墳時代前期～中期の遺物 (4)

63① SA 1 (2)

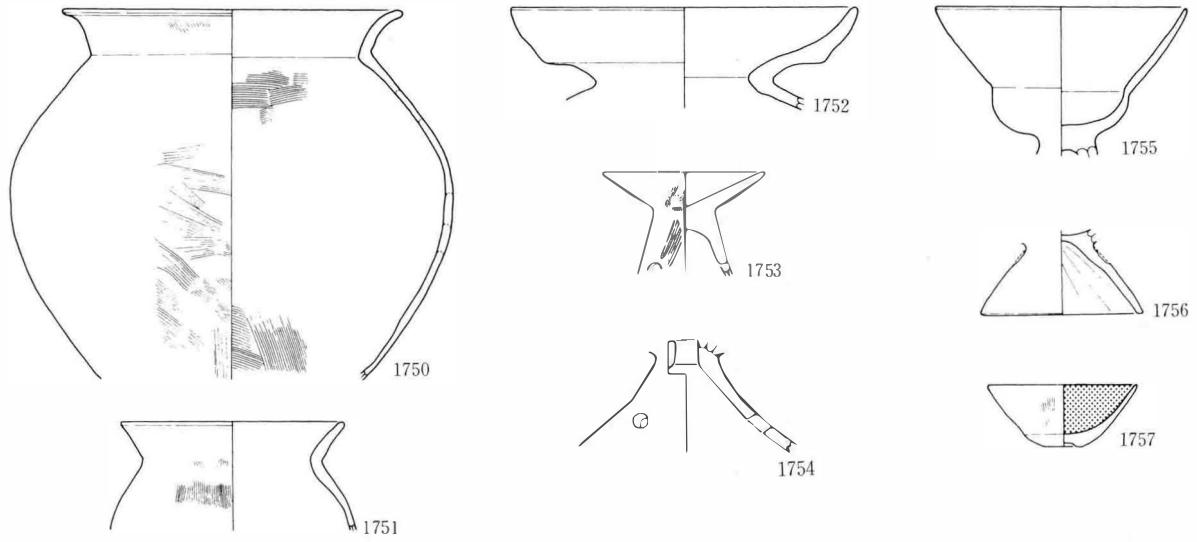

79① SA 5

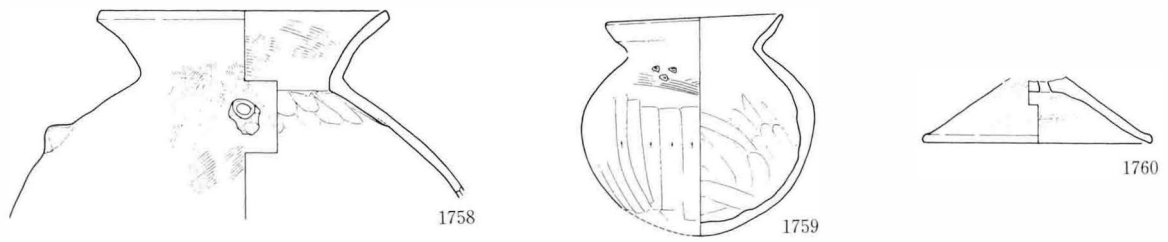

B② SA13

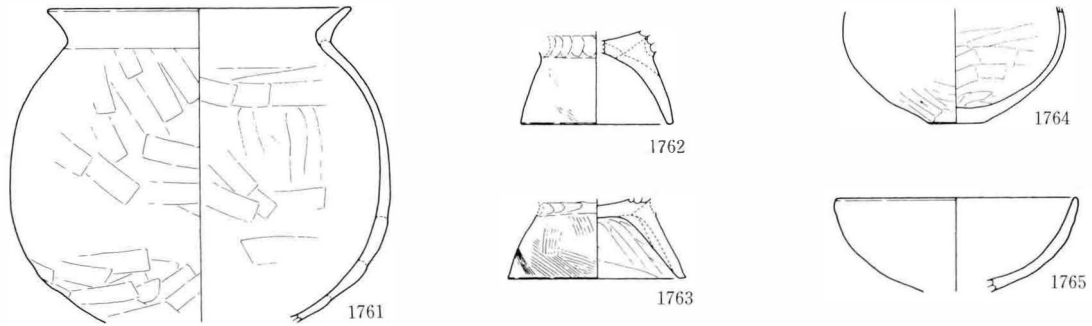

C① SA30 (1)

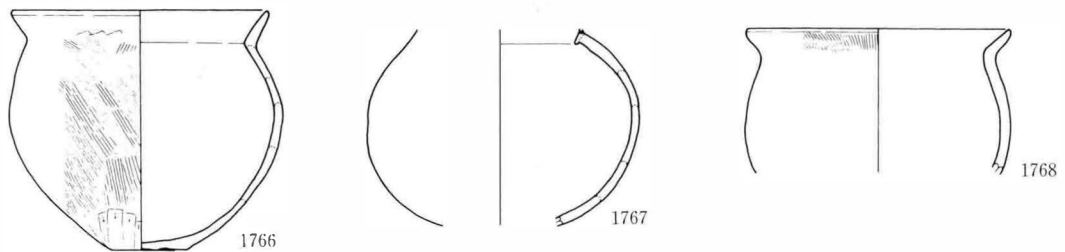

0 (1:4) 10cm

図版 195 古墳時代前期～中期の遺物 (5)

C①SA30(2)

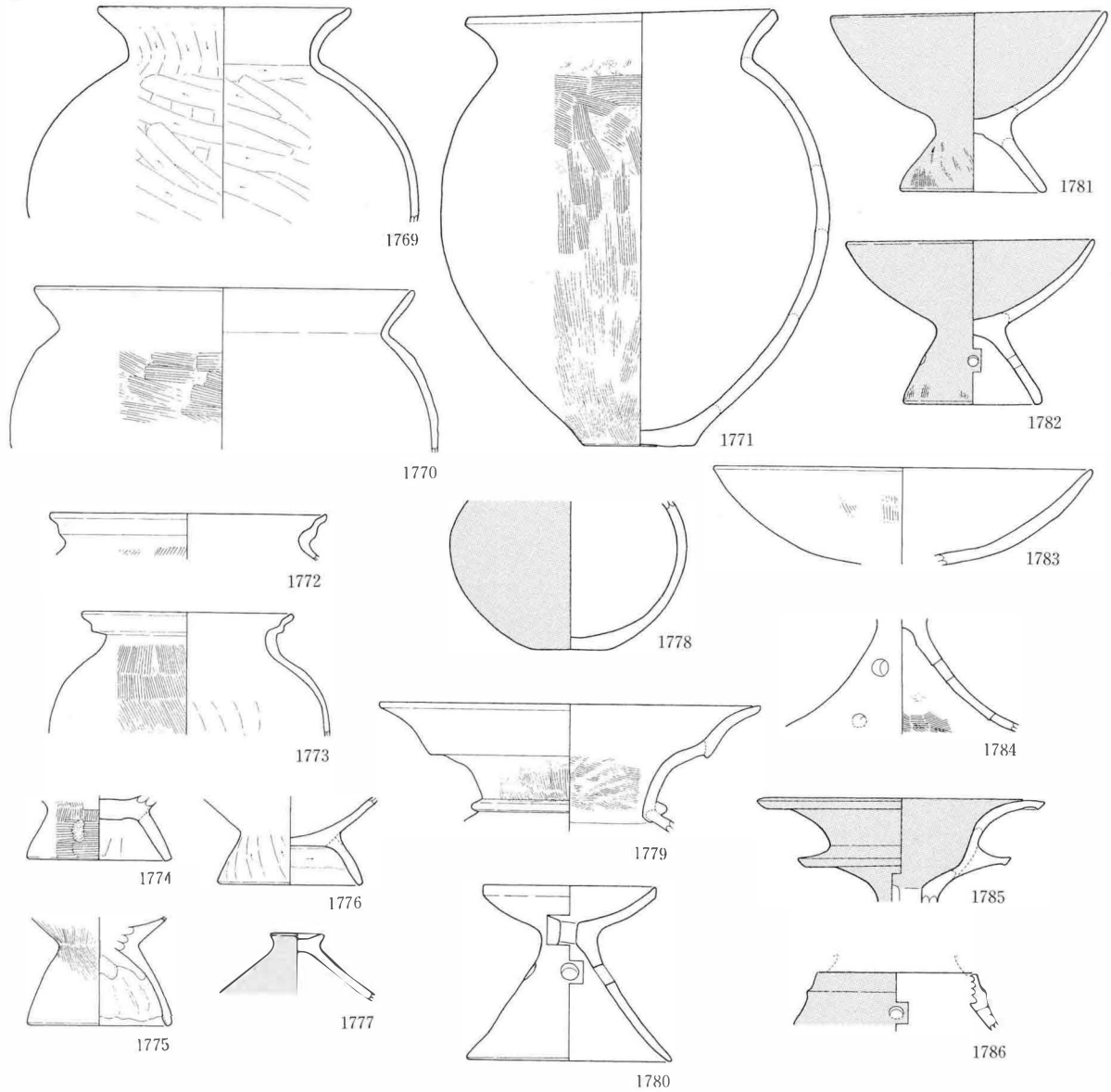

C②SA16

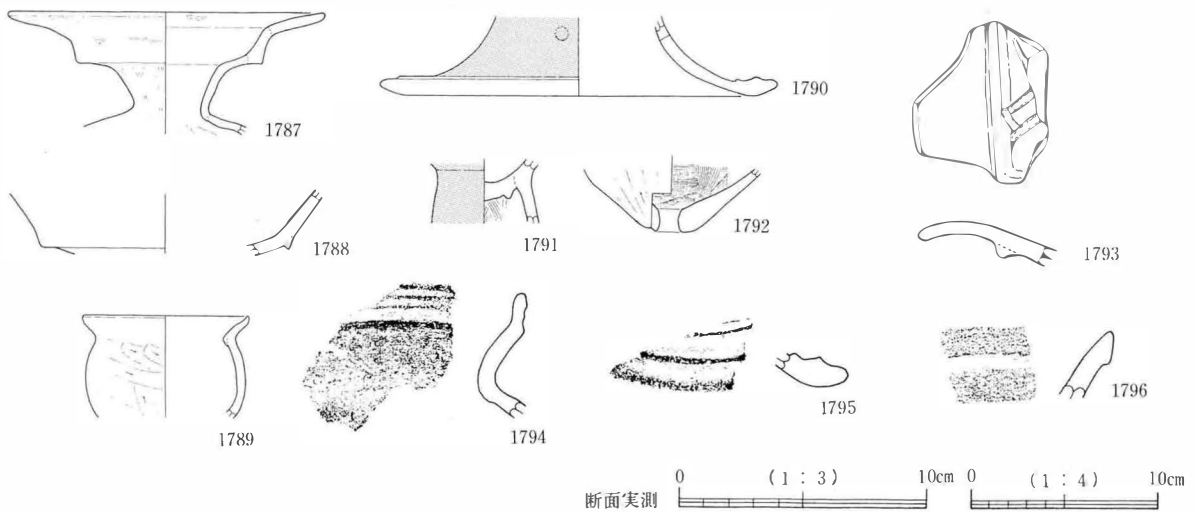

34① SB 1

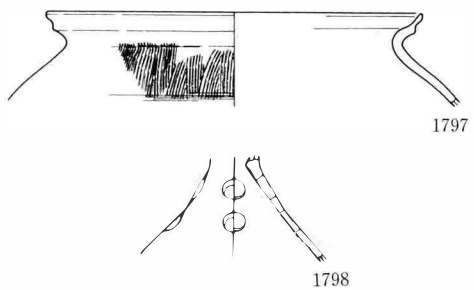

48① SK 3

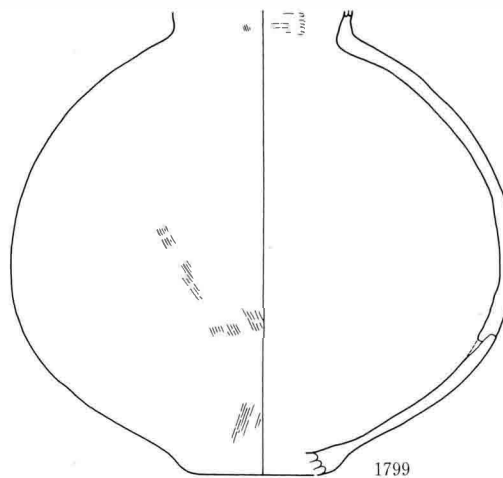

65① SDZ 1

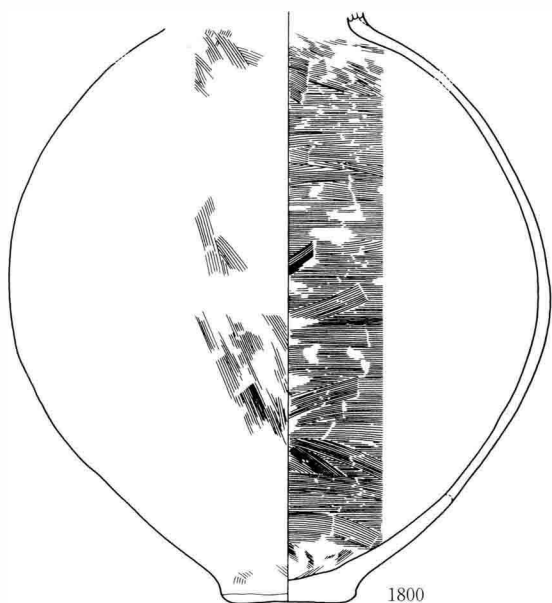

75① SDZ 4

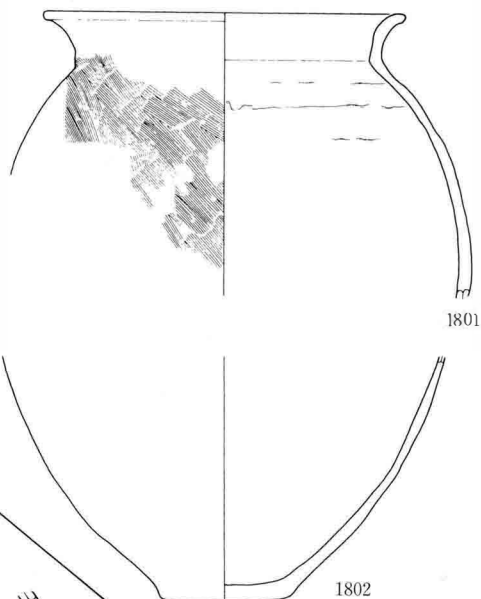

6① SD 1 (1)

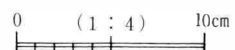
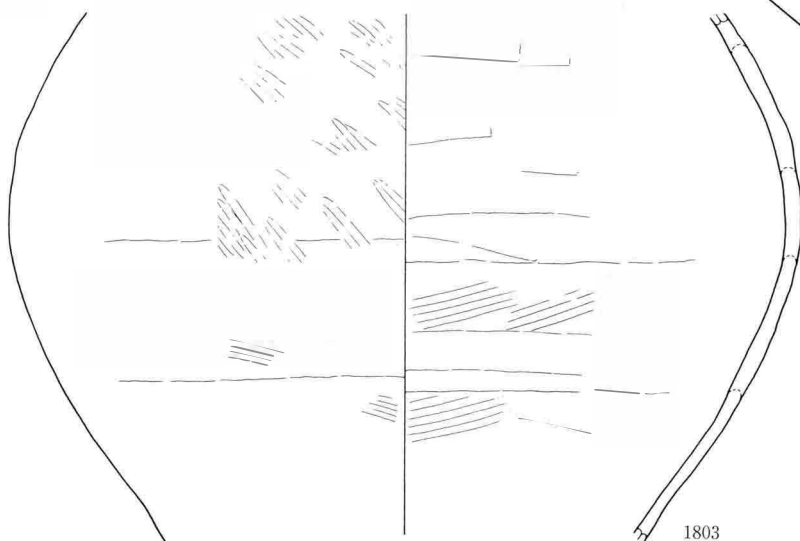

6①SD1(2)

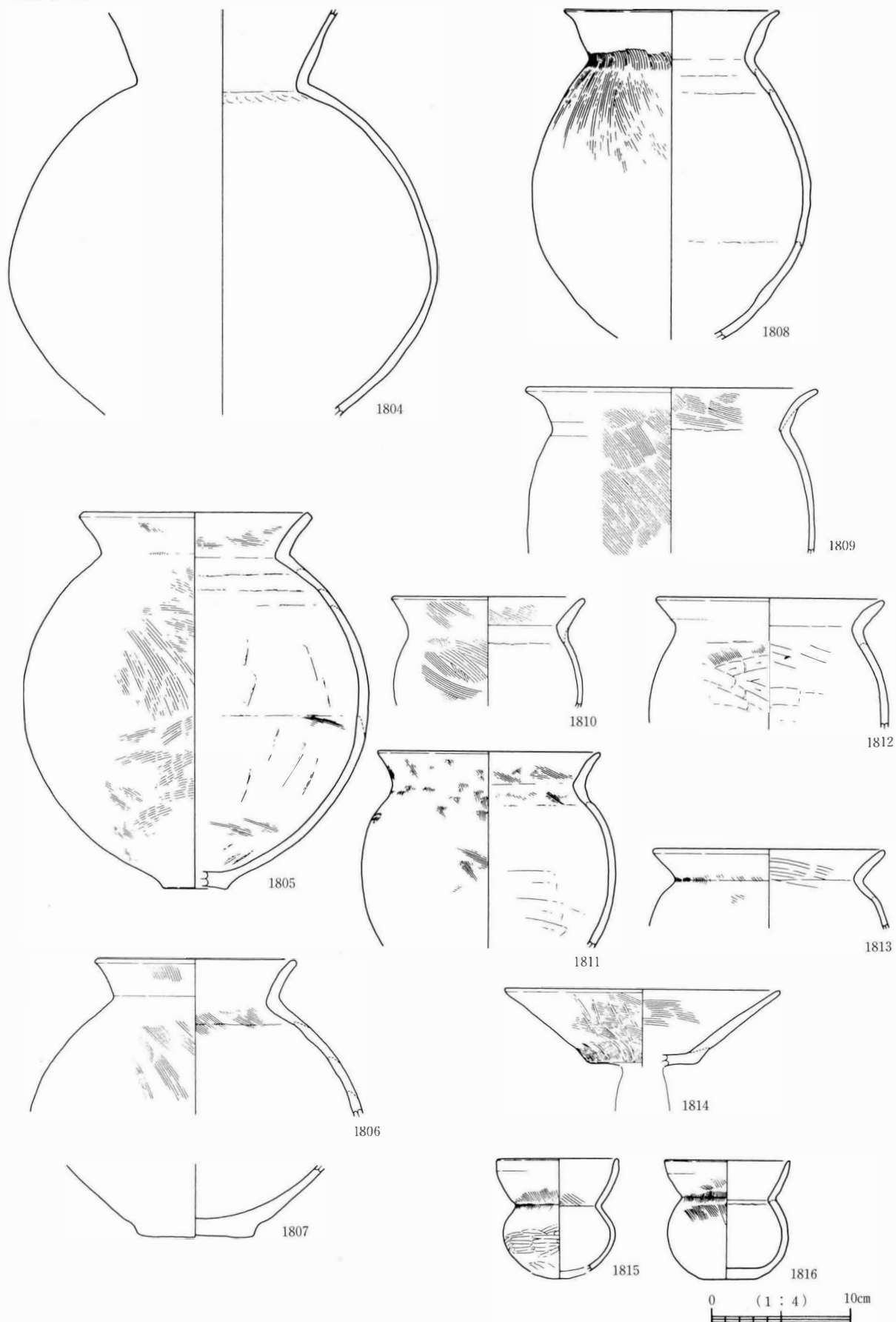

23① SD 5

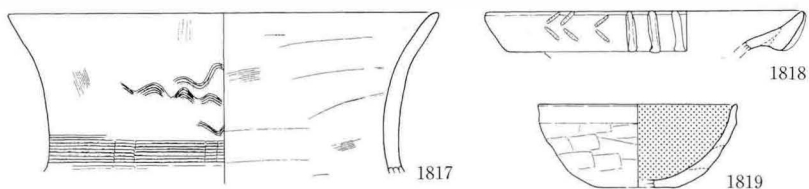

50① SD 2

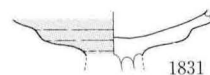

33① SD 7

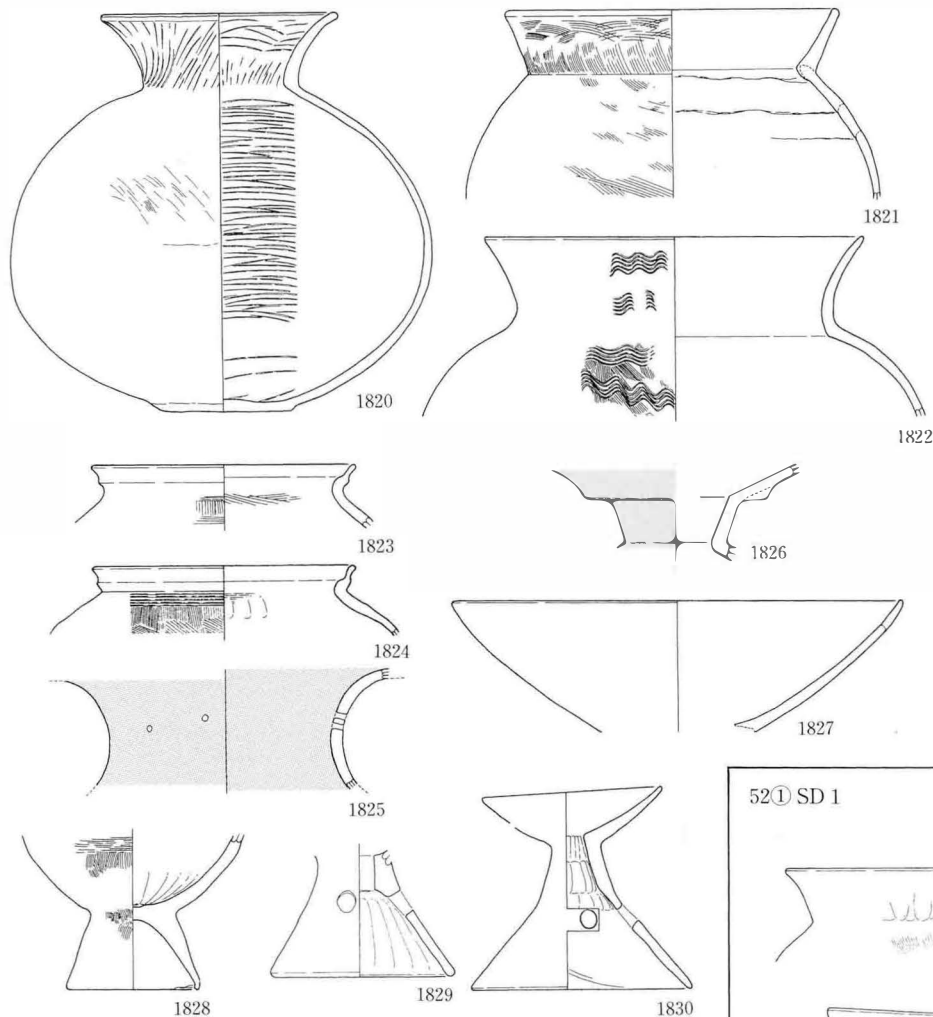

50② SD 3

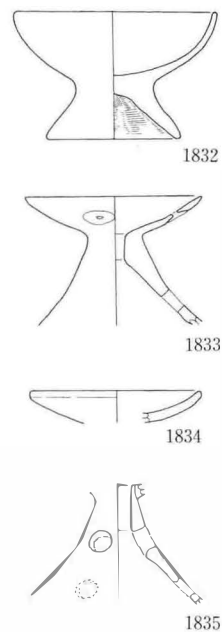

52① SD 1

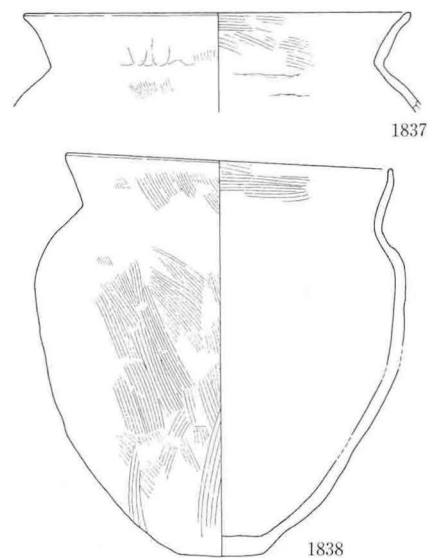

52① SD 4

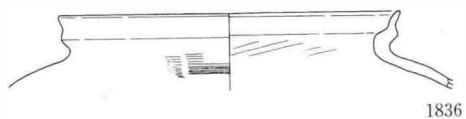

0 (1 : 4) 10cm

34①SD7

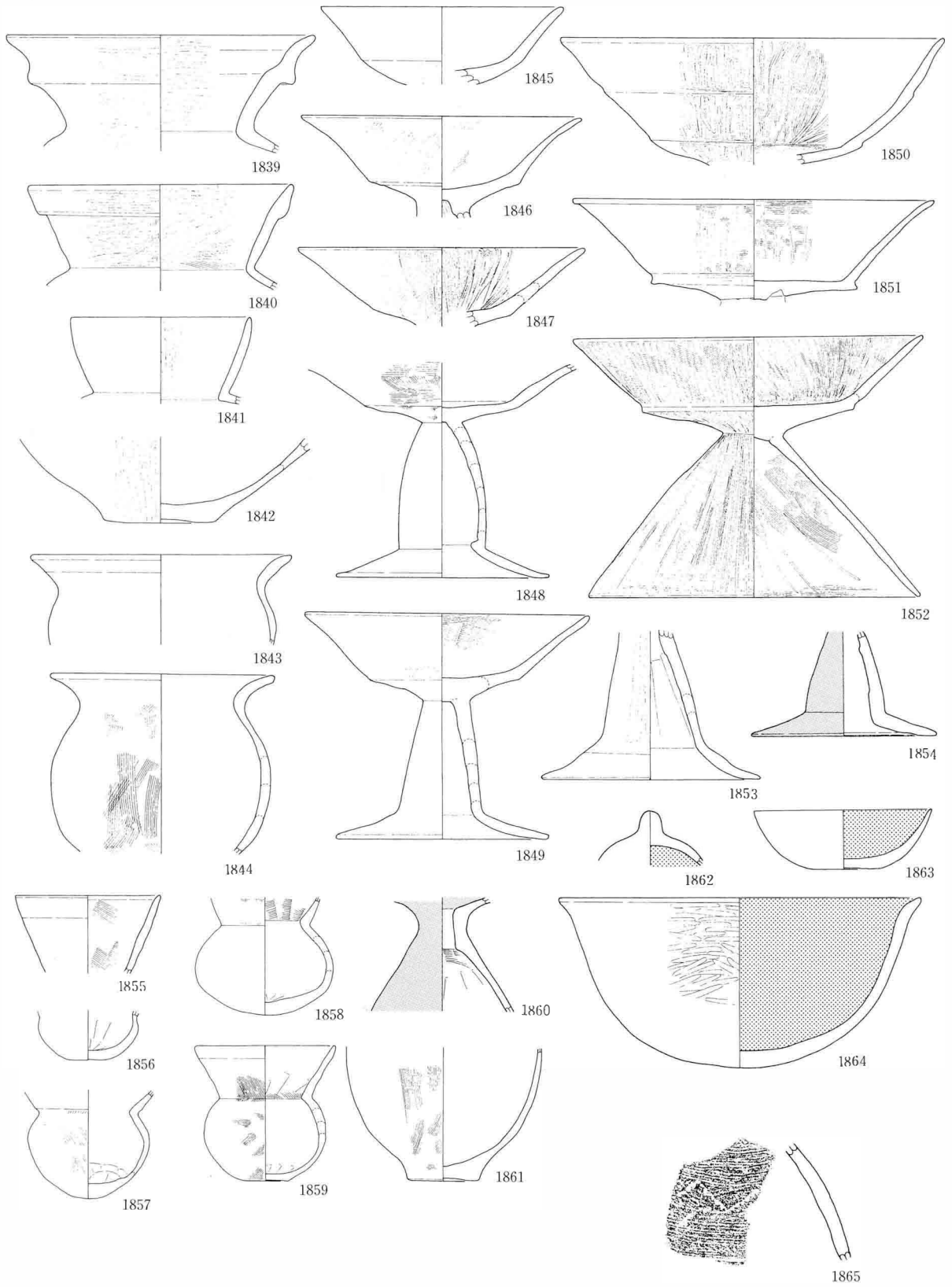

断面実測 0 (1:3) 10cm 0 (1:4) 10cm

62① SD 2

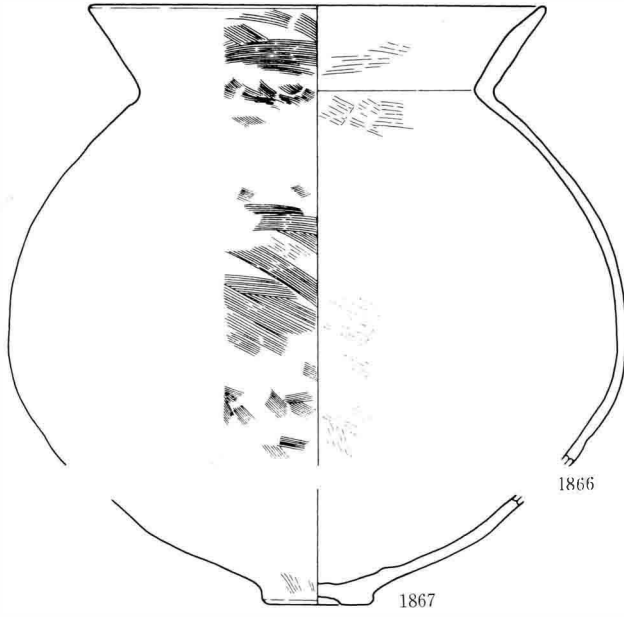

63① SD 2

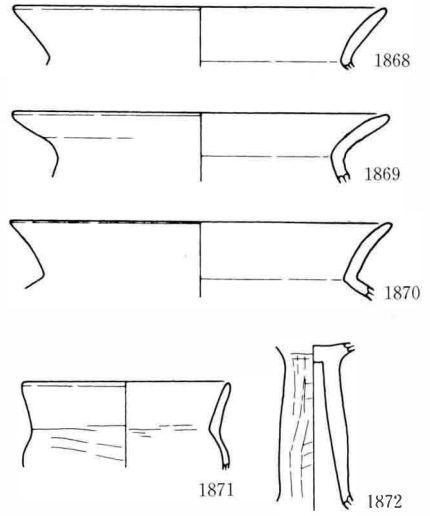

63① SD 6

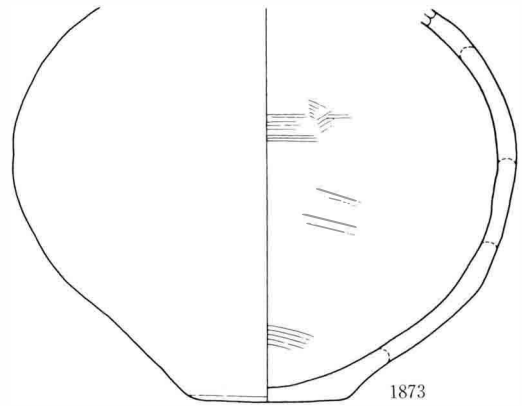
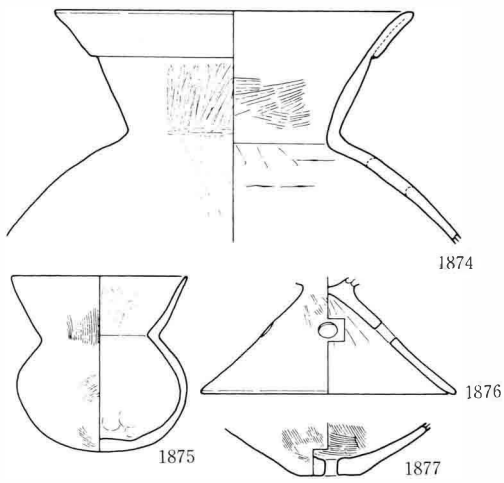

46① SX 1

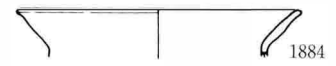

63① SD12

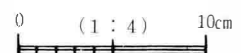
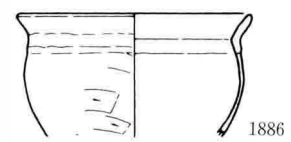
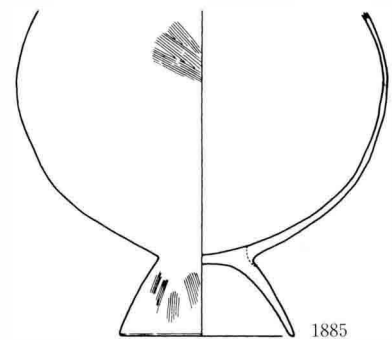
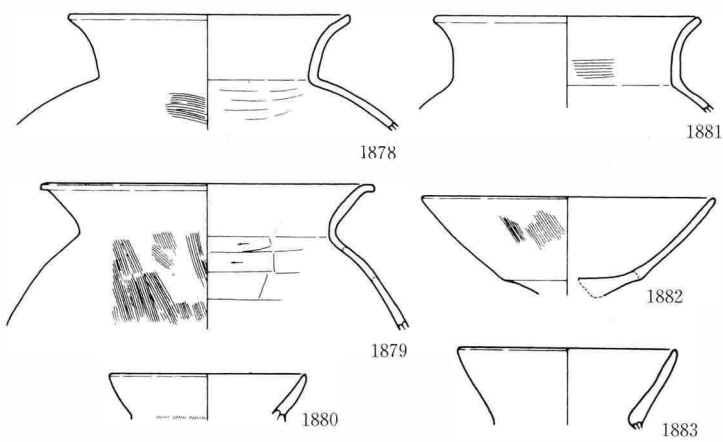

75① SX 1

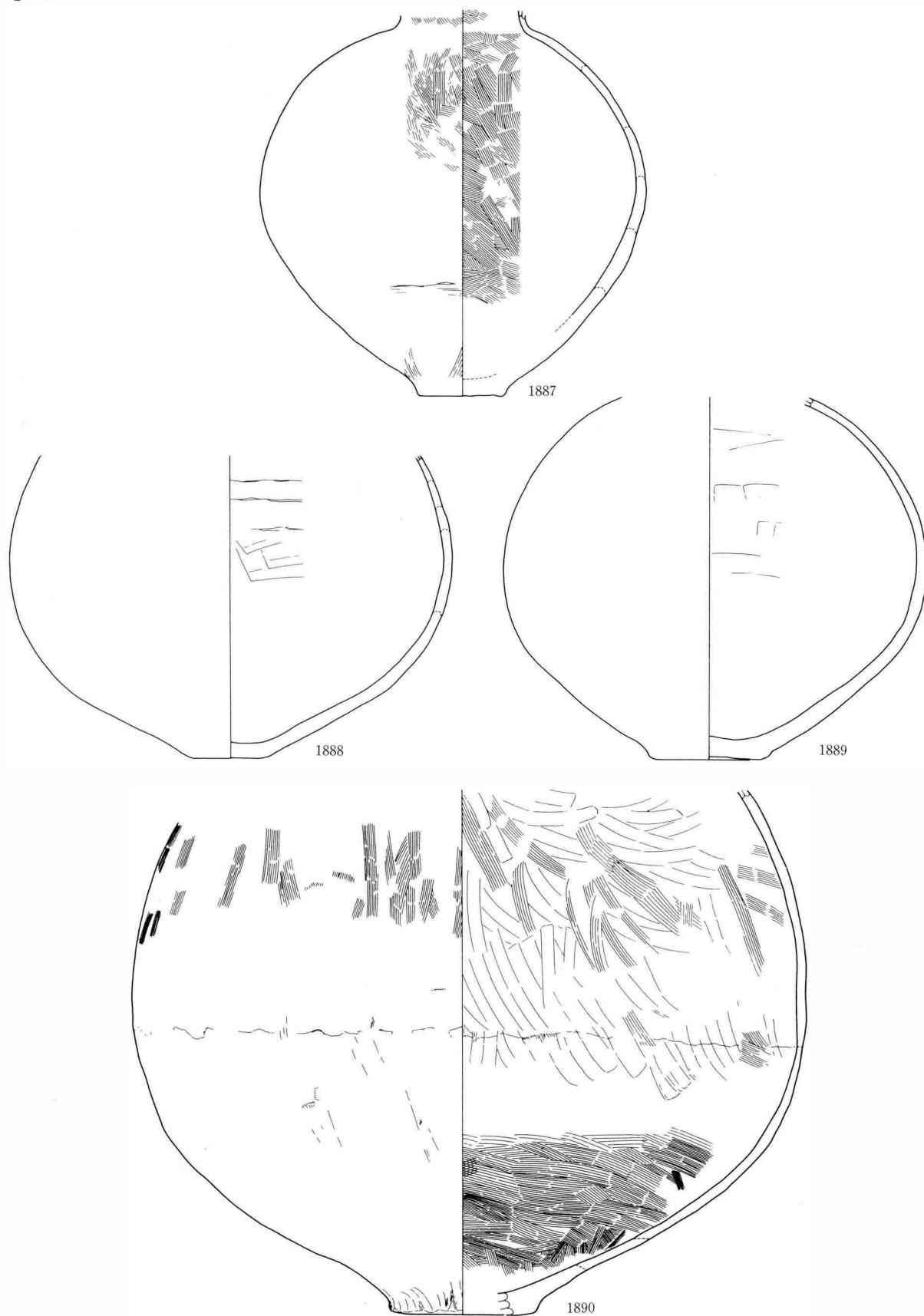

(1 : 4) 10cm

C ① SX 1

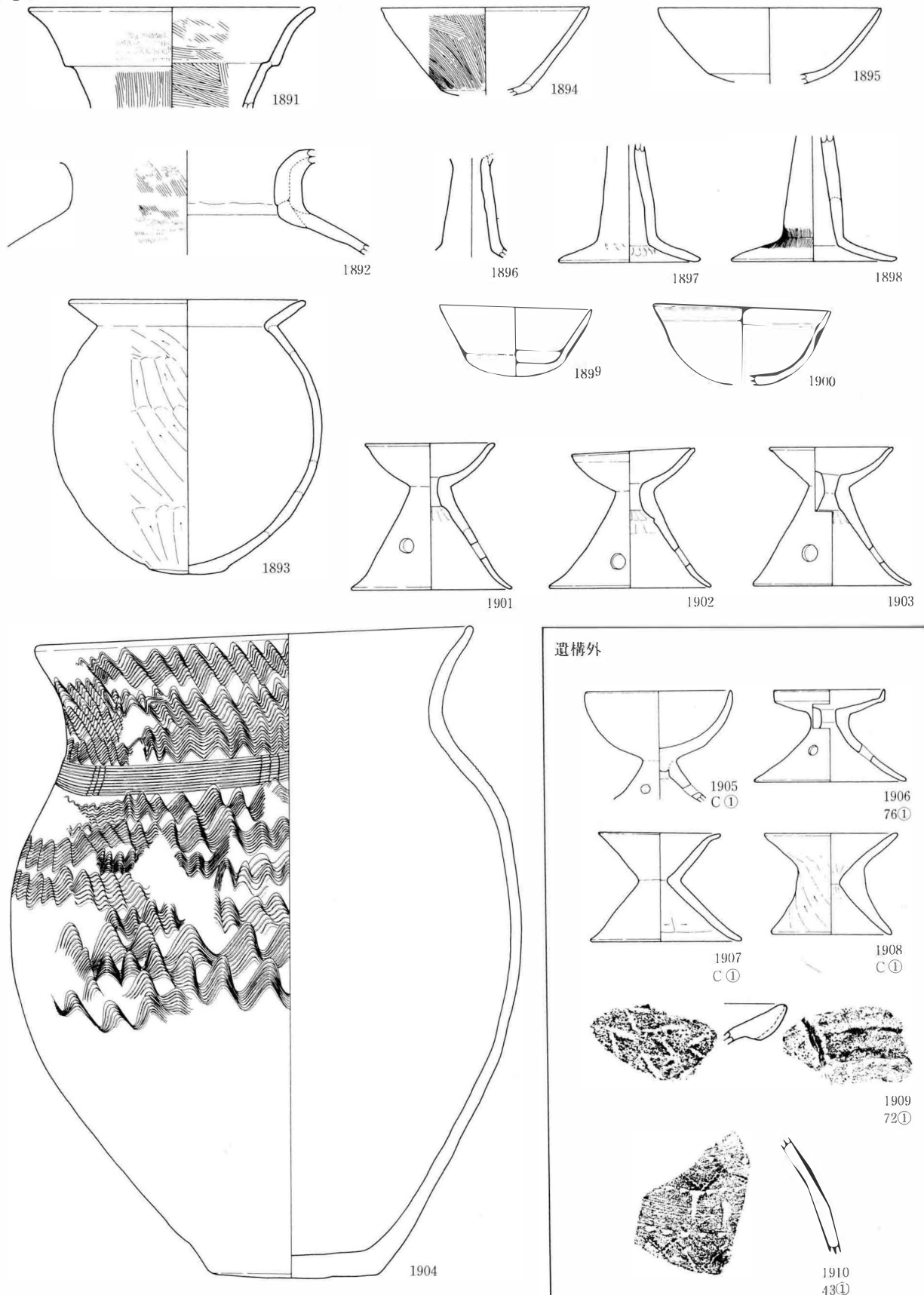

断面実測 0 (1:3) 10cm 0 (1:4) 10cm

図版 203 古墳時代前期～中期の遺物 (13)

土製品

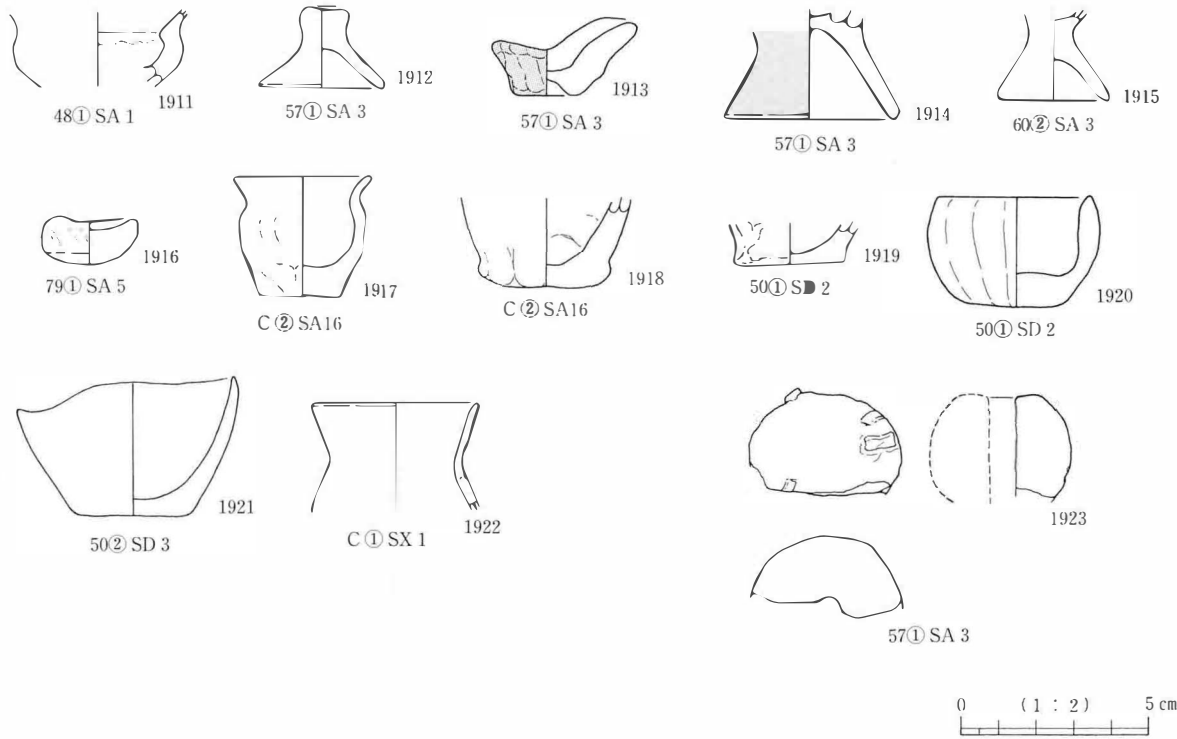

装身具

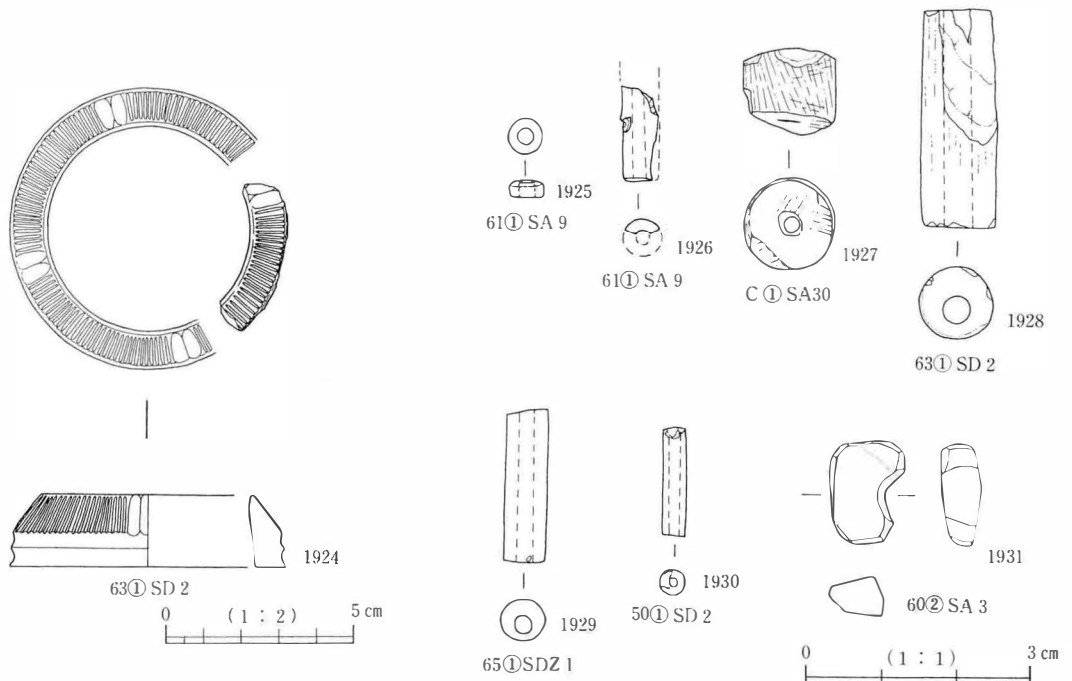

図版 204 古墳時代後期の遺物 (1)

23① SA 1

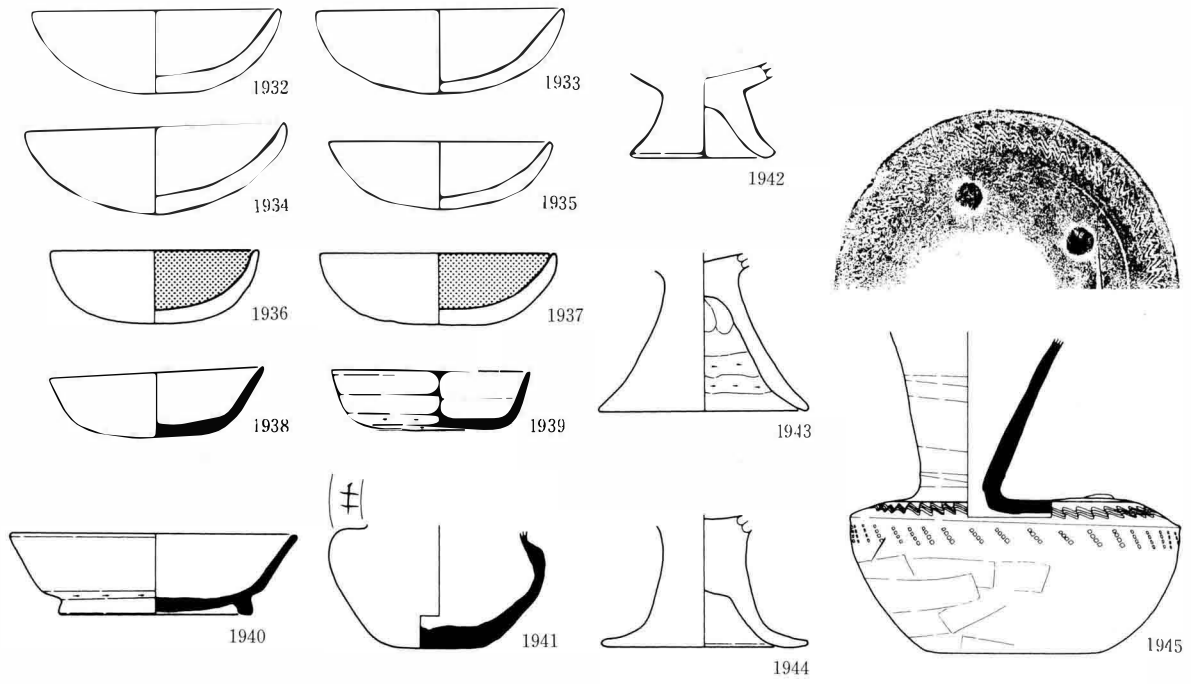

33① SA 1

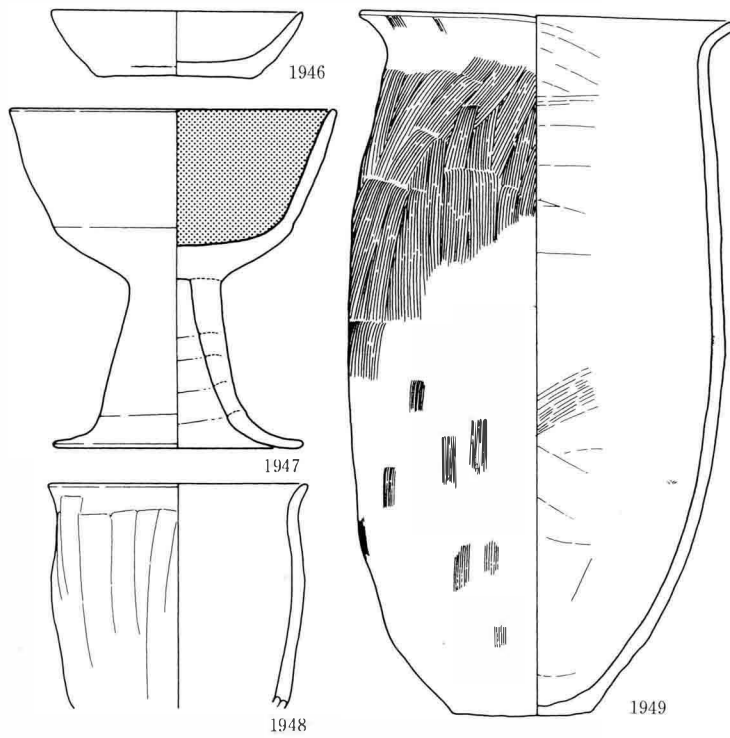

33① SA 5

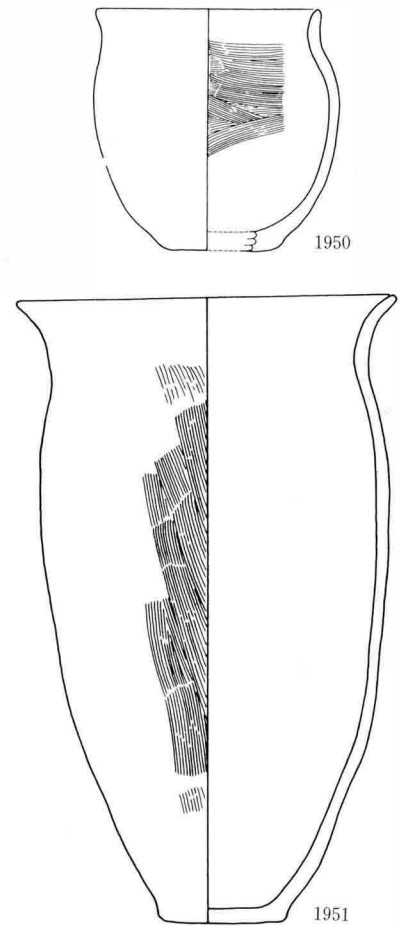

図版 205 古墳時代後期の遺物 (2)

33① SA 4

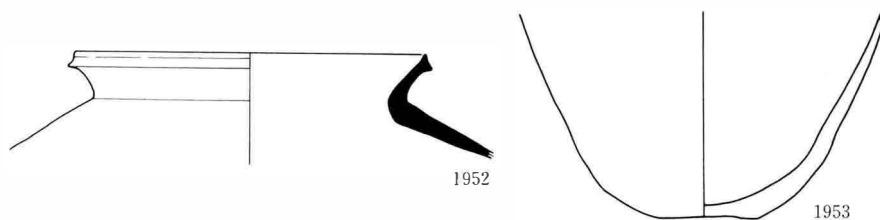

34① SA 1

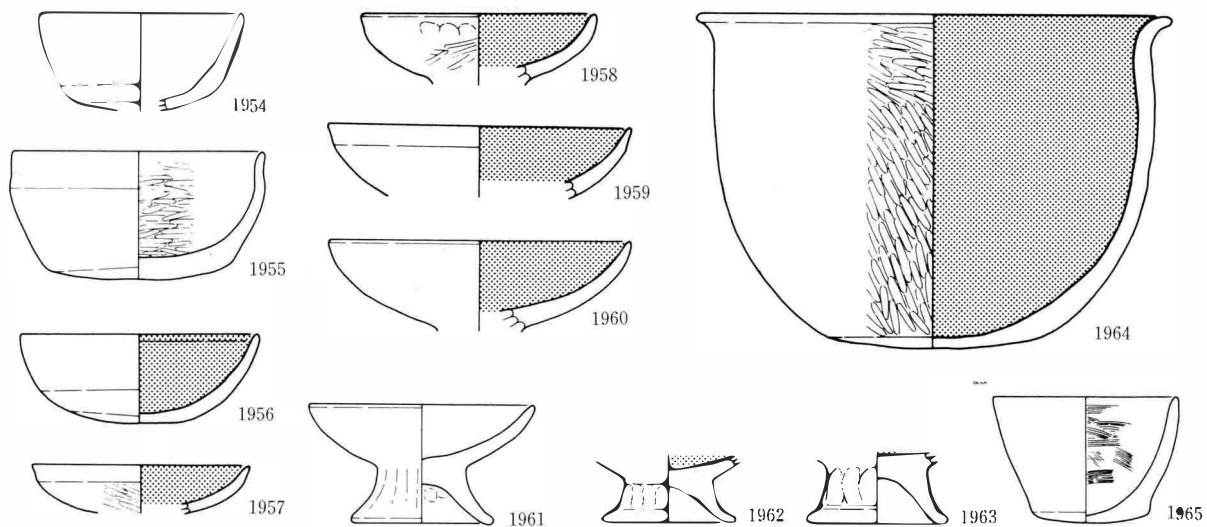

50① SA 1

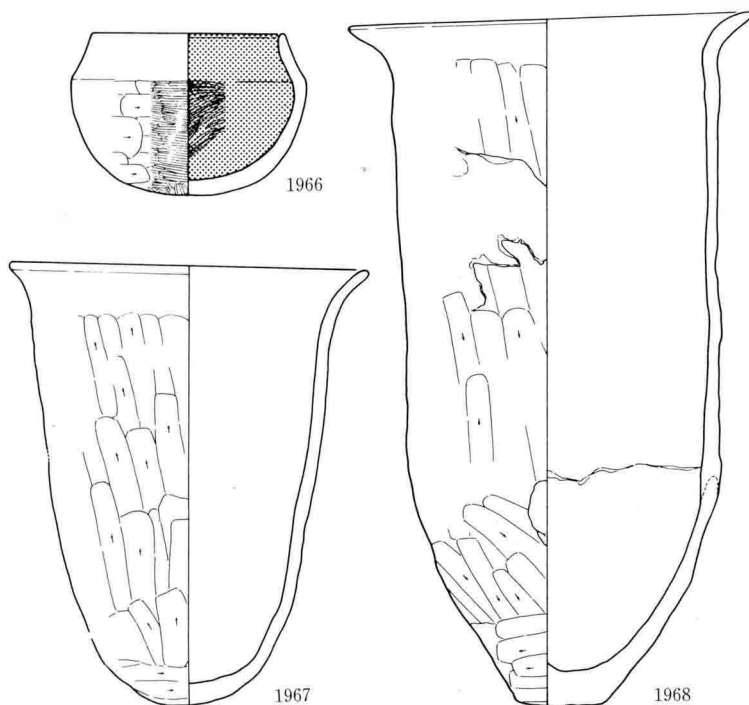

50① SA 4

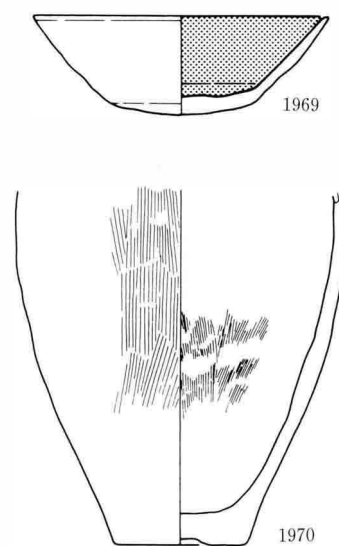

0 (1 : 4) 10cm

48① SA 4

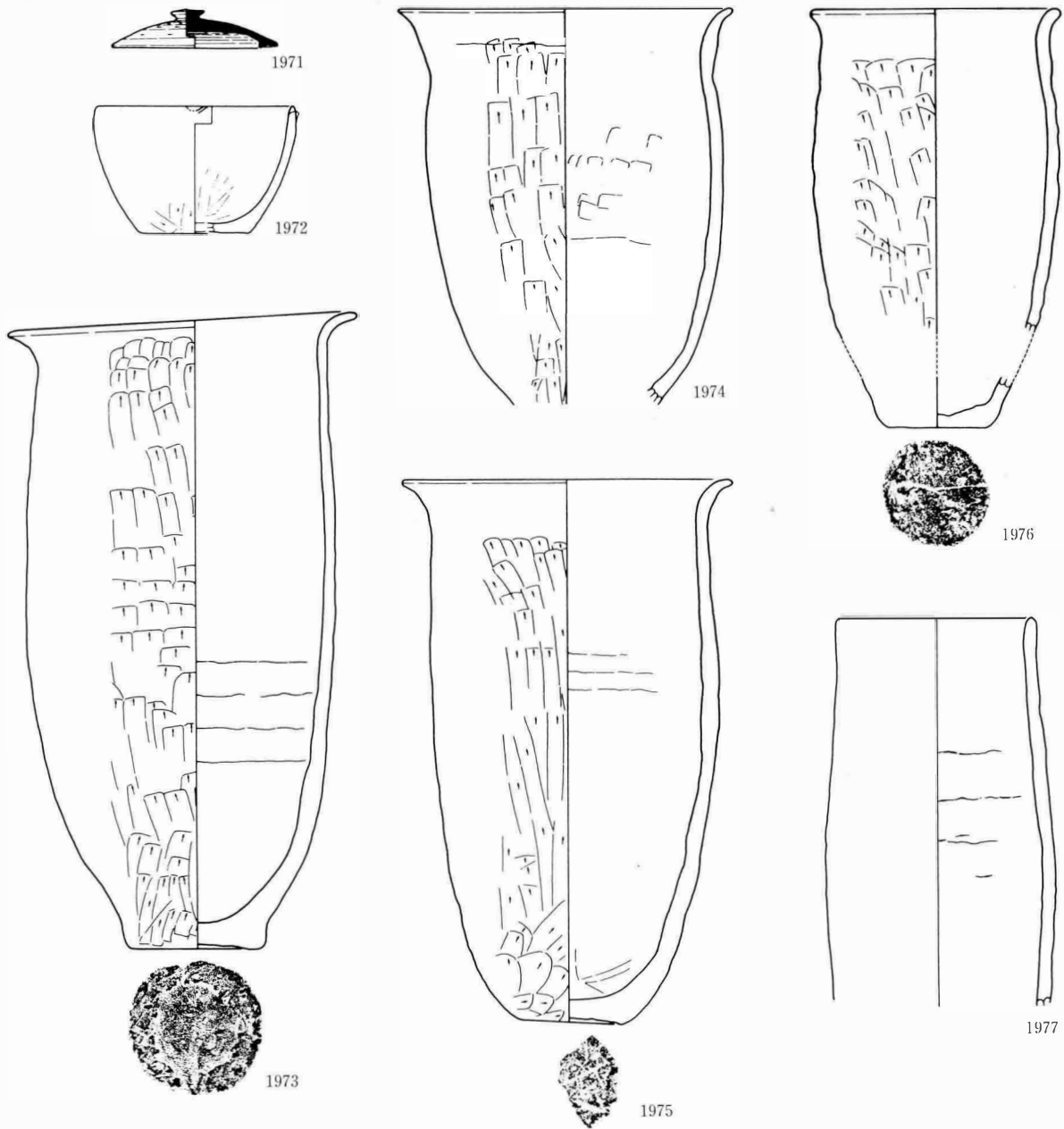

0 (1 : 4) 10cm

50① SA 2

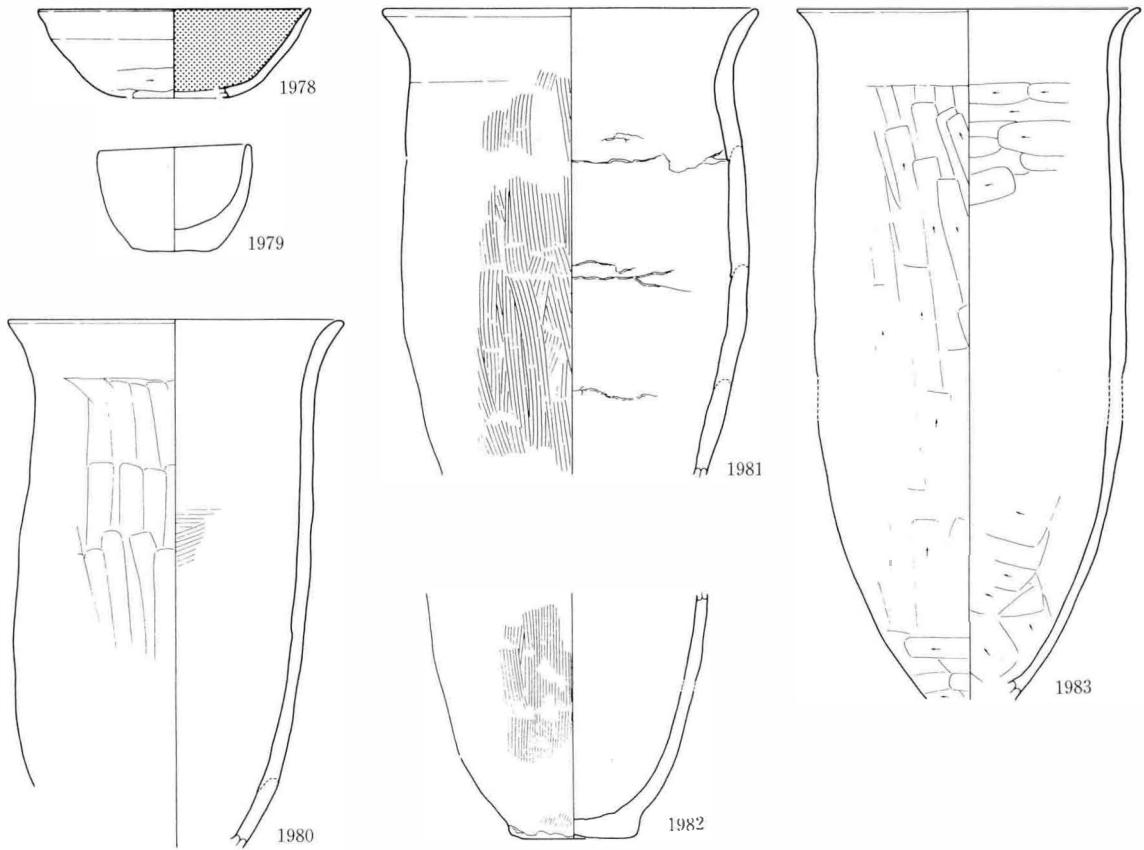

50① SA 3

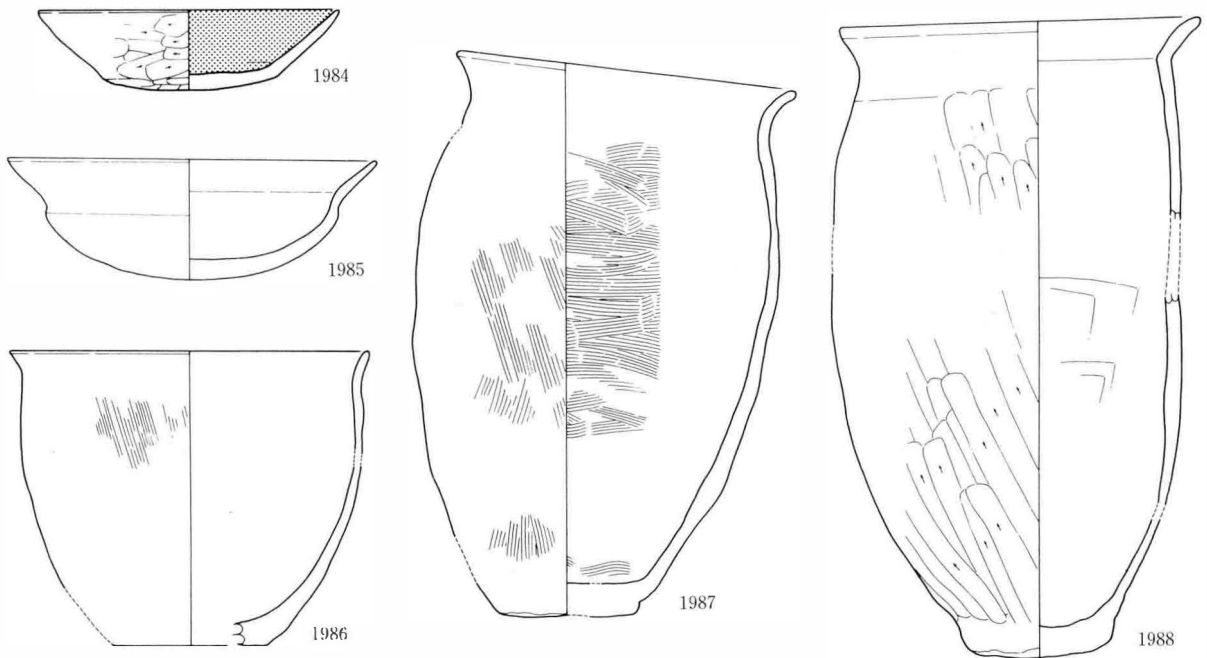

0 (1:4) 10cm

50① SA 6

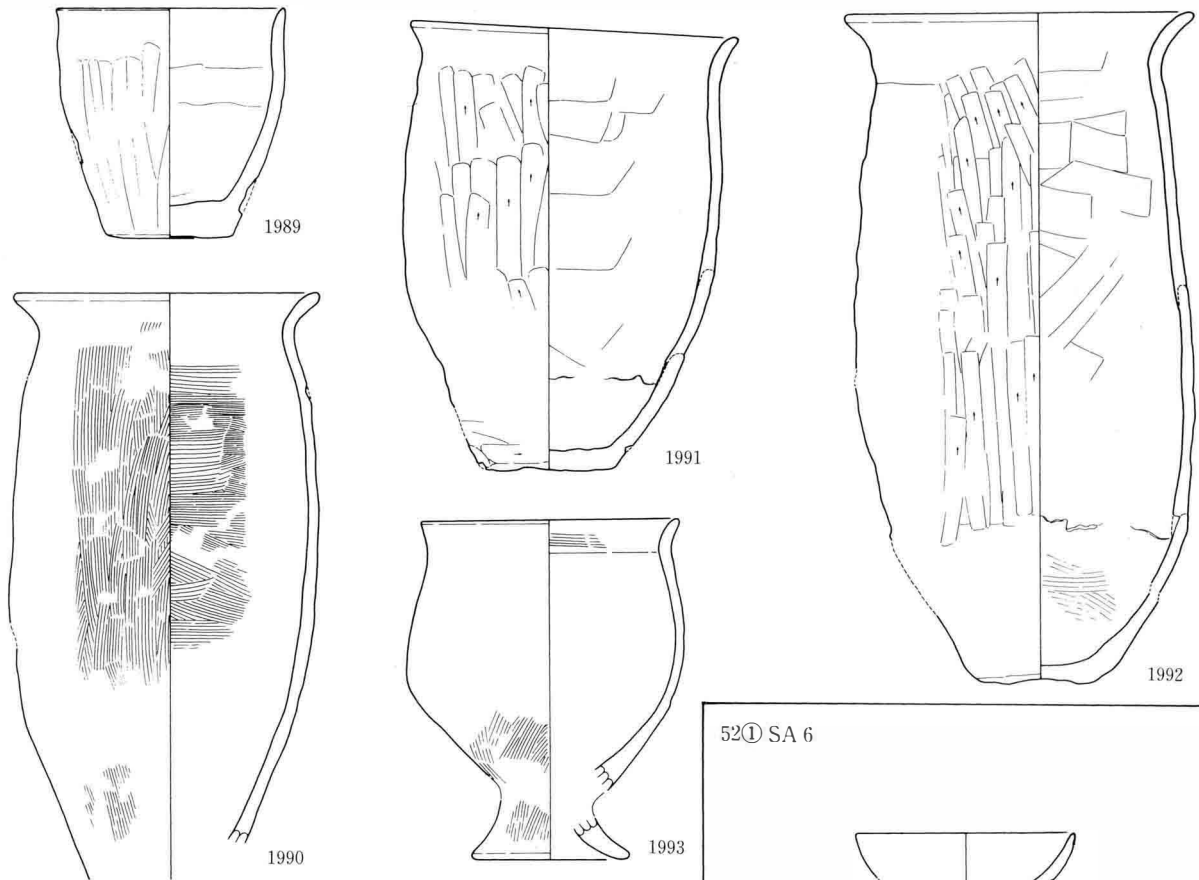

52① SA 6

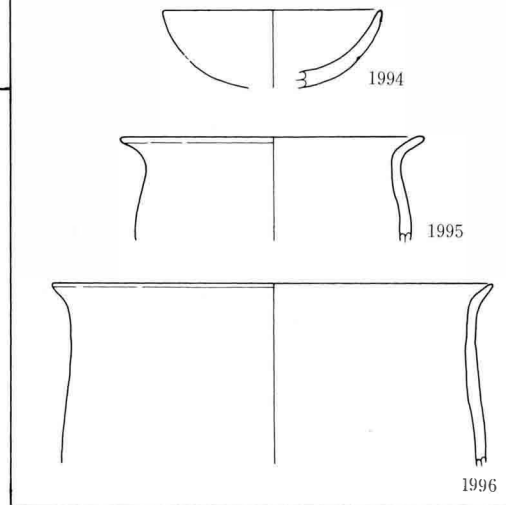

52① SA 2

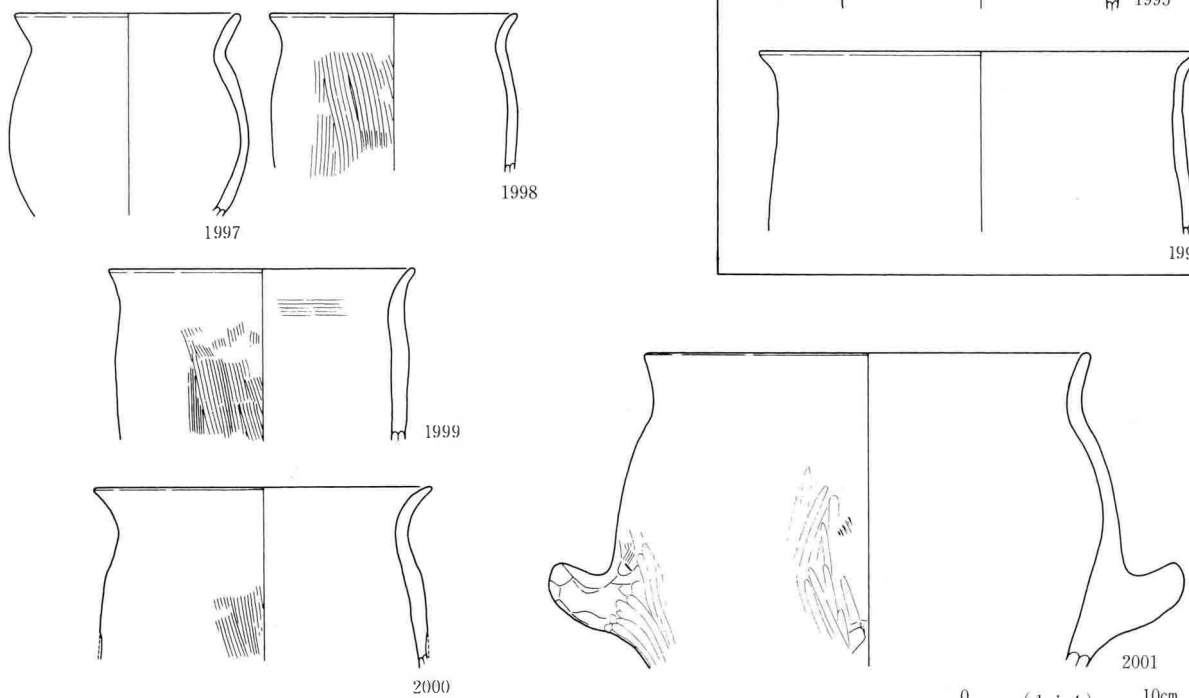

0 (1:4) 10cm