

上信越自動車道

埋蔵文化財発掘調査報告書16

—信濃町内 その2—

せいこうさんそう せいこうさんそう にしおか かのき うえのはら
星光山荘A・星光山荘B・西岡A・貫ノ木・上ノ原
おおくぼみなみ ひがしうら うらのやま はりのき おおだいら
大久保南・東裏・裏ノ山・針ノ木・大平B
ひなたばやし ひなたばやし ななつぐり ふこうだ
日向林A・日向林B・七ツ栗・普光田

縄文時代～近世

図版編

2000

日本道路公団
長野県教育委員会
長野県埋蔵文化財センター

上信越自動車道

埋蔵文化財発掘調査報告書16

—信濃町内 その2—

せいこうさんそう せいこうさんそう にしおか かのき うえのほら
星光山荘A・星光山荘B・西岡A・貫ノ木・上ノ原
おおくぼみなみ ひがしうら うらのやま はりのき おおだいら
大久保南・東裏・裏ノ山・針ノ木・大平B
ひなたばやし ひなたばやし ななつぐり ふこうだ
日向林A・日向林B・七ツ栗・普光田

縄文時代～近世

図版編

2000

日本道路公団
長野県教育委員会
長野県埋蔵文化財センター

凡 例

1 実測図の縮尺は原則として下記の通りで、該当個所のスケールの上に記してある。

(1) 主な遺構実測図

住居址・建物址 1：60 その他 1：40

(2) 主な遺物実測図

土器拓本 1：2または1：3 土器・土師器・須恵器・灰釉陶器 1：4または1：6
金属器 1：2 石器 3：4、1：2または1：3

2 遺物写真の縮尺は下記の通り頁毎に明記した。

土器 1：2、1：3または1：4
石器 2：3、1：2、1：3または1：4

3 分布図中遺物番号は遺物実測図の番号と一致させた。

4 星光山荘B遺跡の縄文時代遺物分布図記号は以下の器種を示す。他の遺跡は本文中または各図中の凡例で示した。

星光山荘B遺跡遺物分布図凡例

略号	記号	器種名	略号	記号	器種名	略号	記号	器種名	略号	記号	器種名
Bo	⊙	舟底形石器	AX	△	石斧	AH	⊕	石鏃	Co	□	石核
Dr	⊙	石錐	ES	★	搔器	GS	⊙	磨石	Ha	*	敲石
Pe	■	楔形石器	Po	◆	槍先形尖頭器	Ps	⊙	凹石	Sc	☆	削器
TP	⊙	有茎尖頭器	Wh	⊙	砥石		△	打製石斧		●	特殊磨石
	○	スタンプ形石器		◇	礫石器		●	剥片類		⊙	原石
	●	土器									

5 遺構図中のスクリーントーンなどは下記のように用いた。これ以外は、本文中または各図中に凡例を示した。

焼土・火床

炭化物層

攪乱



焼土・火床



炭化物層・スス付着



攪乱

6 遺物実測図のスクリーントーンなどは次のように用いた。

- ・縄文土器胎土の繊維混入：断面図のスクリーントーン
- ・縄文時代磨石・特殊磨石・敲石の磨り面：スクリーントーン
- ・縄文時代石器の破損面：黒塗または斜線
- ・平安時代石器断面図
 - 土師器：白抜き
 - 須恵器：黒塗
 - 灰釉陶器：スクリーントーン
 - 黒色処理：内面または両面スクリーントーン

圖版目次

- 圖版 1 星光山莊 A 遺跡 繩文時代遺構圖 1
圖版 2 星光山莊 A 遺跡 繩文時代遺構圖 2
圖版 3 星光山莊 A 遺跡 繩文時代遺構圖 3
圖版 4 星光山莊 A 遺跡 繩文時代土器・石器分布圖
圖版 5 星光山莊 A 遺跡 繩文時代土器 1
圖版 6 星光山莊 A 遺跡 繩文時代土器 2
圖版 7 星光山莊 A 遺跡 繩文時代石器 1
圖版 8 星光山莊 A 遺跡 繩文時代石器 2
圖版 9 星光山莊 A 遺跡 繩文時代石器 3
圖版 10 星光山莊 B 遺跡 繩文時代遺構圖 1
圖版 11 星光山莊 B 遺跡 繩文時代遺構圖 2
圖版 12 星光山莊 B 遺跡 繩文時代遺構圖 3
圖版 13 星光山莊 B 遺跡 繩文時代遺構圖 4
圖版 14 星光山莊 B 遺跡 繩文時代土器・石器分布全体圖
圖版 15 星光山莊 B 遺跡 繩文時代土器・石器分布圖 1
圖版 16 星光山莊 B 遺跡 繩文時代土器・石器分布圖 2
圖版 17 星光山莊 B 遺跡 繩文時代土器・石器分布圖 3
圖版 18 星光山莊 B 遺跡 繩文時代土器・石器分布圖 4
圖版 19 星光山莊 B 遺跡 繩文時代土器・石器分布圖 5
圖版 20 星光山莊 B 遺跡 繩文時代土器・石器分布圖 6
圖版 21 星光山莊 B 遺跡 繩文時代土器・石器分布圖 7
圖版 22 星光山莊 B 遺跡 繩文時代土器・石器分布圖 8
圖版 23 星光山莊 B 遺跡 繩文時代土器 1
圖版 24 星光山莊 B 遺跡 繩文時代土器 2
圖版 25 星光山莊 B 遺跡 繩文時代土器 3
圖版 26 星光山莊 B 遺跡 繩文時代土器 4
圖版 27 星光山莊 B 遺跡 繩文時代土器 5
圖版 28 星光山莊 B 遺跡 繩文時代土器 6
圖版 29 星光山莊 B 遺跡 繩文時代土器 7
圖版 30 星光山莊 B 遺跡 繩文時代土器 8
圖版 31 星光山莊 B 遺跡 繩文時代土器 9
圖版 32 星光山莊 B 遺跡 繩文時代石器 1
圖版 33 星光山莊 B 遺跡 繩文時代石器 2
圖版 34 星光山莊 B 遺跡 繩文時代石器 3
圖版 35 星光山莊 B 遺跡 繩文時代石器 4
圖版 36 星光山莊 B 遺跡 繩文時代石器 5
圖版 37 星光山莊 B 遺跡 繩文時代石器 6
圖版 38 星光山莊 B 遺跡 繩文時代石器 7
圖版 39 星光山莊 B 遺跡 繩文時代石器 8
圖版 40 星光山莊 B 遺跡 繩文時代石器 9
圖版 41 星光山莊 B 遺跡 繩文時代石器 10
圖版 42 星光山莊 B 遺跡 繩文時代石器 11
圖版 43 星光山莊 B 遺跡 繩文時代石器 12
圖版 44 星光山莊 B 遺跡 繩文時代石器 13
圖版 45 星光山莊 B 遺跡 繩文時代石器 14
圖版 46 星光山莊 B 遺跡 繩文時代石器 15
圖版 47 星光山莊 B 遺跡 繩文時代石器 16
圖版 48 星光山莊 B 遺跡 繩文時代石器 17
圖版 49 星光山莊 B 遺跡 繩文時代石器 18
圖版 50 星光山莊 B 遺跡 繩文時代石器 19
圖版 51 星光山莊 B 遺跡 繩文時代石器 20
圖版 52 星光山莊 B 遺跡 繩文時代石器 21
圖版 53 星光山莊 B 遺跡 繩文時代石器 22
圖版 54 星光山莊 B 遺跡 繩文時代石器 23
圖版 55 星光山莊 B 遺跡 繩文時代石器 24
圖版 56 星光山莊 B 遺跡 繩文時代石器 25
圖版 57 星光山莊 B 遺跡 繩文時代石器 26
圖版 58 星光山莊 B 遺跡 平安時代遺構圖
圖版 59 星光山莊 B 遺跡 平安時代遺物圖
圖版 60 貫ノ木遺跡 繩文時代土坑圖 1
圖版 61 貫ノ木遺跡 繩文時代土坑圖 2
圖版 62 貫ノ木遺跡 繩文時代土坑圖 3
圖版 63 貫ノ木遺跡 繩文時代土坑圖 4
圖版 64 貫ノ木遺跡 繩文時代土坑圖 5
圖版 65 貫ノ木遺跡 繩文時代土坑圖 6
圖版 66 貫ノ木遺跡 繩文時代土坑圖 7
圖版 67 貫ノ木遺跡 繩文時代土坑圖 8
圖版 68 貫ノ木遺跡 繩文時代土坑圖 9
圖版 69 貫ノ木遺跡 繩文時代土坑圖 10
圖版 70 貫ノ木遺跡 繩文時代土坑圖 11
圖版 71 貫ノ木遺跡 繩文時代集石圖 1
圖版 72 貫ノ木遺跡 繩文時代集石圖 2
圖版 73 貫ノ木遺跡 繩文時代集石圖 3
圖版 74 貫ノ木遺跡 繩文時代集石圖 4
圖版 75 貫ノ木遺跡 繩文時代土器分布圖
圖版 76 貫ノ木遺跡 繩文時代表裏繩文土器分類別分布圖

図版77	貫ノ木遺跡	縄文時代土器 1	図版118	東裏遺跡	縄文時代土器17
図版78	貫ノ木遺跡	縄文時代土器 2	図版119	東裏遺跡	縄文時代土器18
図版79	貫ノ木遺跡	縄文時代土器 3	図版120	東裏遺跡	縄文時代土器19
図版80	貫ノ木遺跡	縄文時代土器 4	図版121	東裏遺跡	縄文時代土器20
図版81	貫ノ木遺跡	縄文時代土器 5	図版122	東裏遺跡	縄文時代土器21
図版82	貫ノ木遺跡	縄文時代土器 6	図版123	東裏遺跡	縄文時代土器22
図版83	貫ノ木遺跡	縄文時代土器 7	図版124	東裏遺跡	縄文時代土器23
図版84	貫ノ木遺跡	縄文時代土器 8	図版125	東裏遺跡	縄文時代土器24
図版85	貫ノ木遺跡	縄文時代土器 9	図版126	東裏遺跡	縄文時代石器分布図
図版86	貫ノ木遺跡	縄文時代石器分布図	図版127	東裏遺跡	縄文時代石器 1
図版87	貫ノ木遺跡	縄文時代石器 1	図版128	東裏遺跡	縄文時代石器 2
図版88	貫ノ木遺跡	縄文時代石器 2	図版129	東裏遺跡	縄文時代石器 3
図版89	貫ノ木遺跡	縄文時代石器 3	図版130	東裏遺跡	縄文時代石器 4
図版90	貫ノ木遺跡	平安時代遺構図・遺物図、近世遺構図	図版131	東裏遺跡	縄文時代石器 5
図版91	西岡 A 遺跡	縄文時代土坑図 1	図版132	東裏遺跡	縄文時代石器 6
図版92	西岡 A 遺跡	縄文時代土坑図 2	図版133	東裏遺跡	縄文時代石器 7
図版93	西岡 A 遺跡	縄文時代土坑図 3	図版134	東裏遺跡	縄文時代石器 8
図版94	西岡 A 遺跡	縄文時代土坑図 4	図版135	東裏遺跡	縄文時代石器 9
図版95	西岡 A 遺跡	縄文時代土器・石器	図版136	東裏遺跡	縄文時代石器10
図版96	上ノ原遺跡	縄文時代土坑図	図版137	東裏遺跡	縄文時代石器11
図版97	上ノ原遺跡	縄文時代遺物図	図版138	東裏遺跡	縄文時代石器12
図版98	東裏遺跡	縄文時代草創期石器・無文土器分布図	図版139	東裏遺跡	縄文時代石器13
図版99	東裏遺跡	縄文時代草創期石器・無文土器	図版140	東裏遺跡	縄文時代石器14
図版100	東裏遺跡	縄文時代土器分布図	図版141	東裏遺跡	縄文時代石器15
図版101	東裏遺跡	縄文時代表裏縄文土器分類別分布図	図版142	東裏遺跡	縄文時代石器16
図版102	東裏遺跡	縄文時代土器 1	図版143	東裏遺跡	縄文時代石器17
図版103	東裏遺跡	縄文時代土器 2	図版144	東裏遺跡	縄文時代石器18
図版104	東裏遺跡	縄文時代土器 3	図版145	東裏遺跡	縄文時代石器19
図版105	東裏遺跡	縄文時代土器 4	図版146	東裏遺跡	縄文時代石器20
図版106	東裏遺跡	縄文時代土器 5	図版147	東裏遺跡	縄文時代遺構図、平安時代土坑図
図版107	東裏遺跡	縄文時代土器 6	図版148	東裏遺跡	平安時代遺構図 1・遺物図 1
図版108	東裏遺跡	縄文時代土器 7	図版149	東裏遺跡	平安時代遺構図 2
図版109	東裏遺跡	縄文時代土器 8	図版150	東裏遺跡	平安時代遺構図 3
図版110	東裏遺跡	縄文時代土器 9	図版151	東裏遺跡	平安時代遺構図 4
図版111	東裏遺跡	縄文時代土器10	図版152	東裏遺跡	平安時代遺構図 5
図版112	東裏遺跡	縄文時代土器11	図版153	東裏遺跡	平安時代遺物図 2
図版113	東裏遺跡	縄文時代土器12	図版154	東裏遺跡	平安時代遺物図 3
図版114	東裏遺跡	縄文時代土器13	図版155	東裏遺跡	平安時代遺物図 4
図版115	東裏遺跡	縄文時代土器14	図版156	東裏遺跡	平安時代遺構図 6・遺物図 5
図版116	東裏遺跡	縄文時代土器15	図版157	東裏遺跡	平安時代遺構図 7・遺物図 6
図版117	東裏遺跡	縄文時代土器16	図版158	東裏遺跡	平安時代遺構図 8・遺物図 7

- 図版159 東裏遺跡 平安時代遺構図9・遺物図8
- 図版160 東裏遺跡 平安時代遺構図10・遺物図9
- 図版161 東裏遺跡 平安時代金属器
- 図版162 裏ノ山遺跡 縄文時代遺構図・遺物図
- 図版163 針ノ木遺跡 縄文時代石器
- 図版164 針ノ木遺跡 平安時代遺構図1
- 図版165 針ノ木遺跡 平安時代遺構図2
- 図版166 針ノ木遺跡 平安時代遺構図3
- 図版167 針ノ木遺跡 平安時代遺構図4
- 図版168 針ノ木遺跡 平安時代遺物図1
- 図版169 針ノ木遺跡 平安時代遺物図2
- 図版170 針ノ木遺跡 平安時代遺物図3
- 図版171 針ノ木遺跡 平安時代遺物図4
- 図版172 大平B遺跡 縄文時代・弥生時代遺物分布図
- 図版173 大平B遺跡 縄文時代遺物図1
- 図版174 大平B遺跡 縄文時代遺物図2、弥生時代遺物図
- 図版175 日向林A遺跡 縄文時代遺構図
- 図版176 日向林A遺跡 縄文時代集石図1
- 図版177 日向林A遺跡 縄文時代集石図2
- 図版178 日向林A遺跡 縄文時代集石図3
- 図版179 日向林A遺跡 縄文時代集石図4
- 図版180 日向林A遺跡 縄文時代土坑図1
- 図版181 日向林A遺跡 縄文時代土坑図2
- 図版182 日向林A遺跡 縄文時代土坑図3
- 図版183 日向林A遺跡 縄文時代土器分布図
- 図版184 日向林A遺跡 縄文時代表裏縄文土器分類別分布図
- 図版185 日向林A遺跡 縄文時代土器1
- 図版186 日向林A遺跡 縄文時代土器2
- 図版187 日向林A遺跡 縄文時代土器3
- 図版188 日向林A遺跡 縄文時代土器4
- 図版189 日向林A遺跡 縄文時代土器5
- 図版190 日向林A遺跡 縄文時代土器6
- 図版191 日向林A遺跡 縄文時代土器7
- 図版192 日向林A遺跡 縄文時代土器8
- 図版193 日向林A遺跡 縄文時代土器9
- 図版194 日向林A遺跡 縄文時代土器10
- 図版195 日向林A遺跡 縄文時代土器11
- 図版196 日向林A遺跡 縄文時代土器12
- 図版197 日向林A遺跡 縄文時代土器13
- 図版198 日向林A遺跡 縄文時代土器14
- 図版199 日向林A遺跡 縄文時代土器15
- 図版200 日向林A遺跡 縄文時代土器16
- 図版201 日向林A遺跡 縄文時代土器17
- 図版202 日向林A遺跡 縄文時代土器18
- 図版203 日向林A遺跡 縄文時代土器19
- 図版204 日向林A遺跡 縄文時代土器20
- 図版205 日向林A遺跡 縄文時代土器21
- 図版206 日向林A遺跡 縄文時代土器22
- 図版207 日向林A遺跡 縄文時代土器23
- 図版208 日向林A遺跡 縄文時代土器24
- 図版209 日向林A遺跡 縄文時代土器25
- 図版210 日向林A遺跡 縄文時代土器26
- 図版211 日向林A遺跡 縄文時代土器27
- 図版212 日向林A遺跡 縄文時代土器28
- 図版213 日向林A遺跡 縄文時代石器分布図
- 図版214 日向林A遺跡 縄文時代石器1
- 図版215 日向林A遺跡 縄文時代石器2
- 図版216 日向林A遺跡 縄文時代石器3
- 図版217 日向林A遺跡 縄文時代石器4
- 図版218 日向林A遺跡 縄文時代石器5
- 図版219 日向林A遺跡 縄文時代石器6
- 図版220 日向林A遺跡 縄文時代石器7
- 図版221 日向林A遺跡 縄文時代石器8
- 図版222 日向林A遺跡 縄文時代石器9
- 図版223 日向林A遺跡 縄文時代石器10
- 図版224 日向林A遺跡 縄文時代石器11
- 図版225 日向林A遺跡 縄文時代石器12
- 図版226 日向林A遺跡 縄文時代石器13
- 図版227 日向林A遺跡 縄文時代土坑内出土石器
- 図版228 日向林B遺跡 縄文時代草創期石器・無文土器集中部分分布図
- 図版229 日向林B遺跡 縄文時代草創期集中部出土遺物1
- 図版230 日向林B遺跡 縄文時代草創期集中部出土遺物2
- 図版231 七ツ栗遺跡 縄文時代集石図
- 図版232 七ツ栗遺跡 縄文時代土坑図1
- 図版233 七ツ栗遺跡 縄文時代土坑図2
- 図版234 七ツ栗遺跡 縄文時代土坑図3
- 図版235 七ツ栗遺跡 縄文時代土器分布図
- 図版236 七ツ栗遺跡 縄文時代表裏縄文土器分類別分布図
- 図版237 七ツ栗遺跡 縄文時代土器1
- 図版238 七ツ栗遺跡 縄文時代土器2
- 図版239 七ツ栗遺跡 縄文時代土器3
- 図版240 七ツ栗遺跡 縄文時代土器4

図版241	七ツ栗遺跡	縄文時代土器 5	図版253	七ツ栗遺跡	縄文時代石器 3
図版242	七ツ栗遺跡	縄文時代土器 6	図版254	七ツ栗遺跡	縄文時代石器 4
図版243	七ツ栗遺跡	縄文時代土器 7	図版255	七ツ栗遺跡	縄文時代石器 5
図版244	七ツ栗遺跡	縄文時代土器 8	図版256	七ツ栗遺跡	縄文時代石器 6
図版245	七ツ栗遺跡	縄文時代土器 9	図版257	七ツ栗遺跡	平安時代遺構図 1
図版246	七ツ栗遺跡	縄文時代土器 10	図版258	七ツ栗遺跡	平安時代遺構図 2
図版247	七ツ栗遺跡	縄文時代土器 11	図版259	七ツ栗遺跡	平安時代遺構図 3
図版248	七ツ栗遺跡	縄文時代土器 12	図版260	七ツ栗遺跡	平安時代遺構図 4
図版249	七ツ栗遺跡	縄文時代土器 13	図版261	七ツ栗遺跡	平安時代遺構図 5・近世遺構図
図版250	七ツ栗遺跡	縄文時代石器分布図	図版262	七ツ栗遺跡	平安時代遺物図 1
図版251	七ツ栗遺跡	縄文時代石器 1	図版263	七ツ栗遺跡	平安時代遺物図 2
図版252	七ツ栗遺跡	縄文時代石器 2	図版264	七ツ栗遺跡	平安時代遺物図 3

写真図版目次

P L 1	星光山荘 A 遺跡	調査状況	P L 24	西岡 A 遺跡	調査状況
P L 2	星光山荘 A 遺跡	縄文時代土器・石器	P L 25	西岡 A 遺跡	遺構・遺構の土層
P L 3	星光山荘 A 遺跡	縄文時代石器	P L 26	西岡 A 遺跡	遺構・縄文時代出土土器
P L 4	星光山荘 B 遺跡	調査状況	P L 27	上ノ原遺跡	調査状況
P L 5	星光山荘 B 遺跡	調査状況	P L 28	上ノ原遺跡	縄文時代土器
P L 6	星光山荘 B 遺跡	調査状況	P L 29	大久保南遺跡	調査状況
P L 7	星光山荘 B 遺跡	縄文時代草創期土器 (1)	P L 30	東裏遺跡	調査状況
P L 8	星光山荘 B 遺跡	縄文時代草創期土器 (2)	P L 31	東裏遺跡	1区～3区調査区・平安時代住居
P L 9	星光山荘 B 遺跡	縄文時代早期・前期・晩期土器	P L 32	東裏遺跡	平安時代住居
P L 10	星光山荘 B 遺跡	縄文時代草創期石器 (1)	P L 33	東裏遺跡	調査状況
P L 11	星光山荘 B 遺跡	縄文時代草創期石器 (2)	P L 34	東裏遺跡	縄文時代草創期土器・石器
P L 12	星光山荘 B 遺跡	縄文時代草創期石器 (3)	P L 35	東裏遺跡	縄文時代土器 (1)
P L 13	星光山荘 B 遺跡	縄文時代草創期石器 (4)	P L 36	東裏遺跡	縄文時代土器 (2)
P L 14	貫ノ木遺跡	調査状況	P L 37	東裏遺跡	縄文時代土器 (3)
P L 15	貫ノ木遺跡	縄文時代遺構 (1)	P L 38	東裏遺跡	縄文時代土器 (4)
P L 16	貫ノ木遺跡	縄文時代遺構 (2)	P L 39	東裏遺跡	縄文時代土器 (5)
P L 17	貫ノ木遺跡	縄文時代遺構 (3)・近世遺構	P L 40	東裏遺跡	縄文時代土器 (6)
P L 18	貫ノ木遺跡	縄文時代土器 (1)	P L 41	東裏遺跡	縄文時代土器 (7)
P L 19	貫ノ木遺跡	縄文時代土器 (2)	P L 42	東裏遺跡	縄文時代土器 (8)
P L 20	貫ノ木遺跡	縄文時代土器 (3)	P L 43	東裏遺跡	縄文時代土器 (9)
P L 21	貫ノ木遺跡	縄文時代土器 (4)	P L 44	東裏遺跡	縄文時代土器 (10)
P L 22	貫ノ木遺跡	縄文時代石器 (1)	P L 45	東裏遺跡	縄文時代土器 (11)
P L 23	貫ノ木遺跡	縄文時代石器 (2)	P L 46	東裏遺跡	縄文時代土器 (12)

- P L 47 東裏遺跡 縄文時代石器 (1)
- P L 48 東裏遺跡 縄文時代石器 (2)
- P L 49 東裏遺跡 縄文時代石器 (3)
- P L 50 東裏遺跡 縄文時代石器 (4)
- P L 51 東裏遺跡 縄文時代石器 (5)
- P L 52 東裏遺跡 縄文時代石器 (6)
- P L 53 東裏遺跡 縄文時代石器 (7)
- P L 54 東裏遺跡 平安時代遺物 (1)
- P L 55 東裏遺跡 平安時代遺物 (2)
- P L 56 裏ノ山遺跡 全景・出土状況・縄文時代遺物
- P L 57 針ノ木遺跡 全景・遺構・縄文時代遺物
- P L 58 針ノ木遺跡 平安時代土器 (1)
- P L 59 針ノ木遺跡 平安時代土器 (2)
- P L 60 大平B遺跡 調査状況
- P L 61 大平B遺跡 縄文・弥生時代土器
- P L 62 日向林A・B遺跡 調査状況
- P L 63 日向林A遺跡 調査状況
- P L 64 日向林A遺跡 遺構
- P L 65 日向林A遺跡 縄文時代土器 (1)
- P L 66 日向林A遺跡 縄文時代土器 (2)
- P L 67 日向林A遺跡 縄文時代土器 (3)
- P L 68 日向林A遺跡 縄文時代土器 (4)
- P L 69 日向林A遺跡 縄文時代土器 (5)
- P L 70 日向林A遺跡 縄文時代土器 (6)
- P L 71 日向林A遺跡 縄文時代土器 (7)
- P L 72 日向林A遺跡 縄文時代土器 (8)
- P L 73 日向林A遺跡 縄文時代土器 (9)
- P L 74 日向林A遺跡 縄文時代土器 (10)
- P L 75 日向林A遺跡 縄文時代土器 (11)
- P L 76 日向林A遺跡 縄文時代土器 (12)
- P L 77 日向林A遺跡 縄文時代石器 (1)
- P L 78 日向林A遺跡 縄文時代石器 (2)
- P L 79 日向林A遺跡 縄文時代石器 (3)
- P L 80 日向林A遺跡 縄文時代石器 (4)
- P L 81 日向林A遺跡 縄文時代石器 (5)
- P L 82 七ツ栗遺跡 調査状況
- P L 83 七ツ栗遺跡 遺構
- P L 84 七ツ栗遺跡 縄文時代土器 (1)
- P L 85 七ツ栗遺跡 縄文時代土器 (2)
- P L 86 七ツ栗遺跡 縄文時代土器 (3)
- P L 87 七ツ栗遺跡 縄文時代土器 (4)
- P L 88 七ツ栗遺跡 縄文時代土器 (5)
- P L 89 七ツ栗遺跡 縄文時代土器 (6)
- P L 90 七ツ栗遺跡 縄文時代土器 (7)
- P L 91 七ツ栗遺跡 縄文時代土器 (8)
- P L 92 七ツ栗遺跡 縄文時代石器 (1)
- P L 93 七ツ栗遺跡 縄文時代石器 (2)
- P L 94 七ツ栗遺跡 平安時代遺物(1)
- P L 95 七ツ栗遺跡 平安時代遺物(2)
- P L 96 普光田遺跡 調査状況・縄文時代遺物

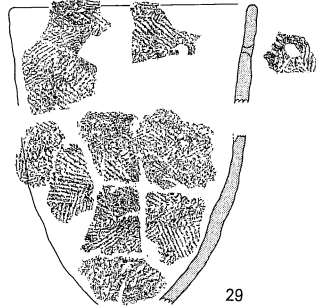
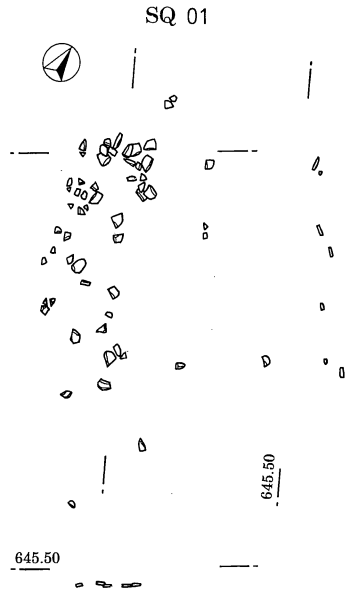

(1:6)

土器集中部出土土器

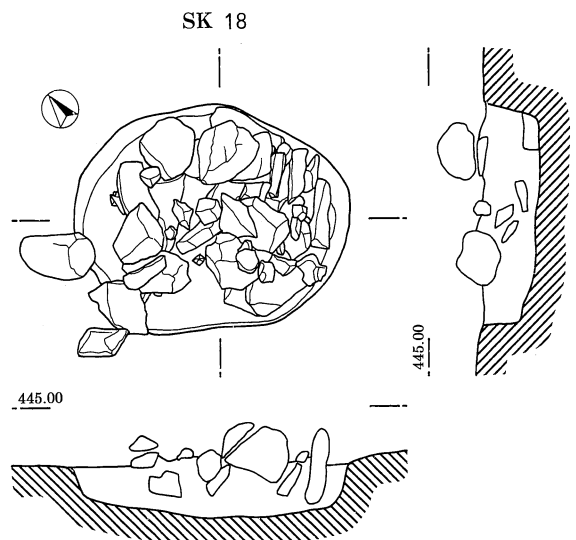
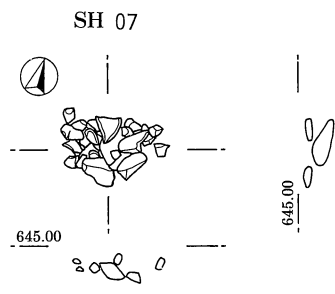
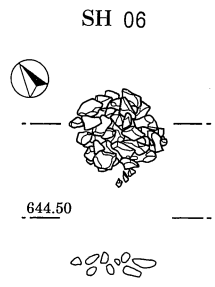
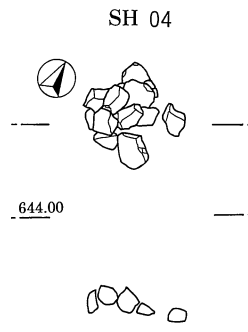
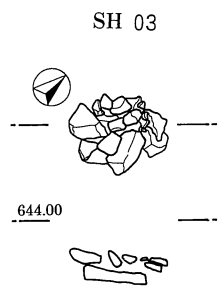
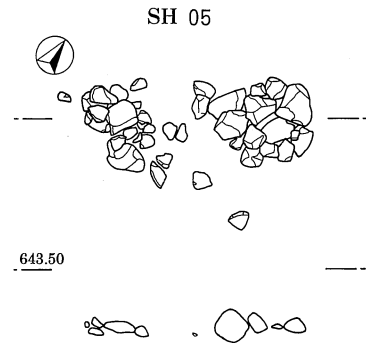
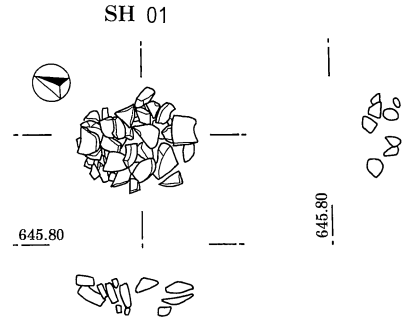

SK18 黒色土

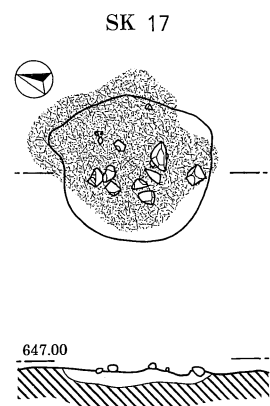

SK17 黒色土 表面に炭化物が集中して含有

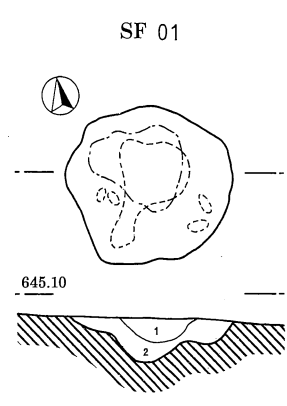

SF01
 1 赤褐色土 焼土
 2 にぶい黄褐色土

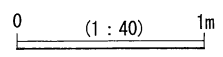

縄文時代遺構図 1

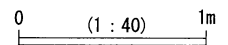
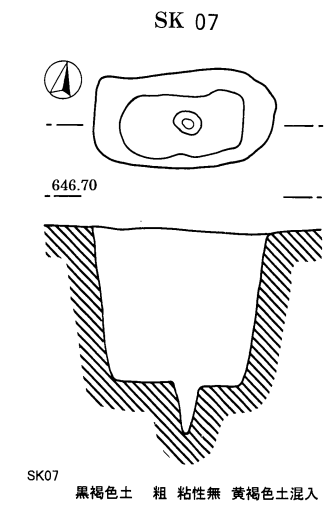
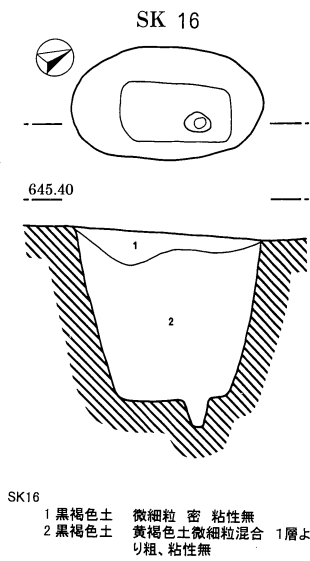
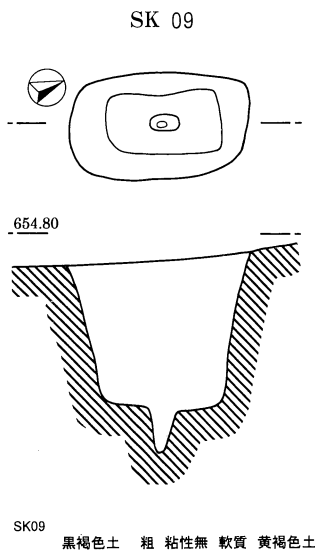
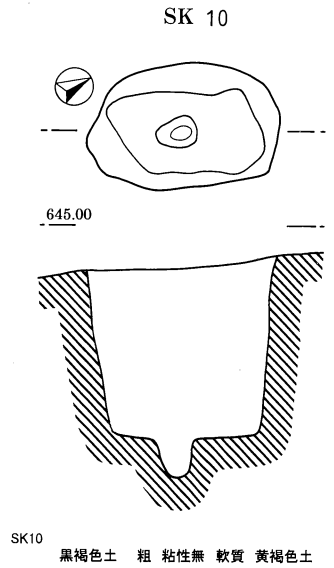
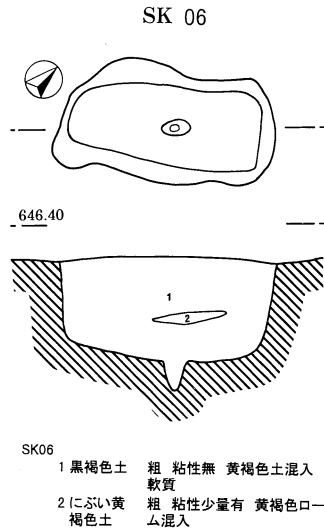
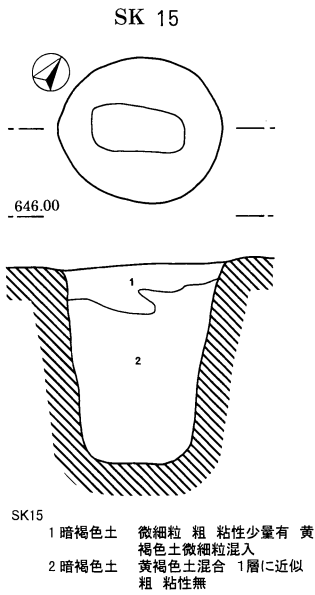
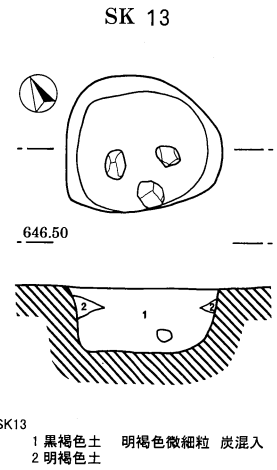
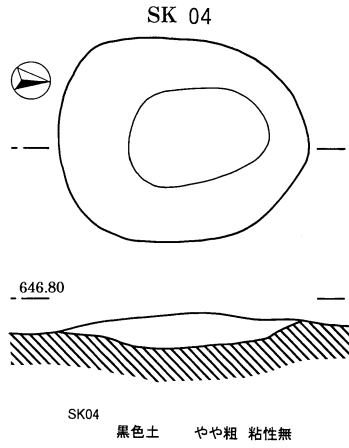
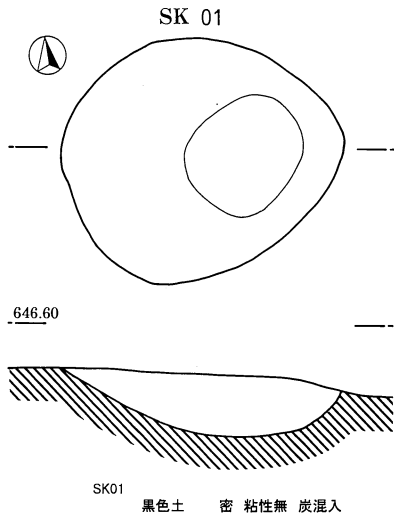

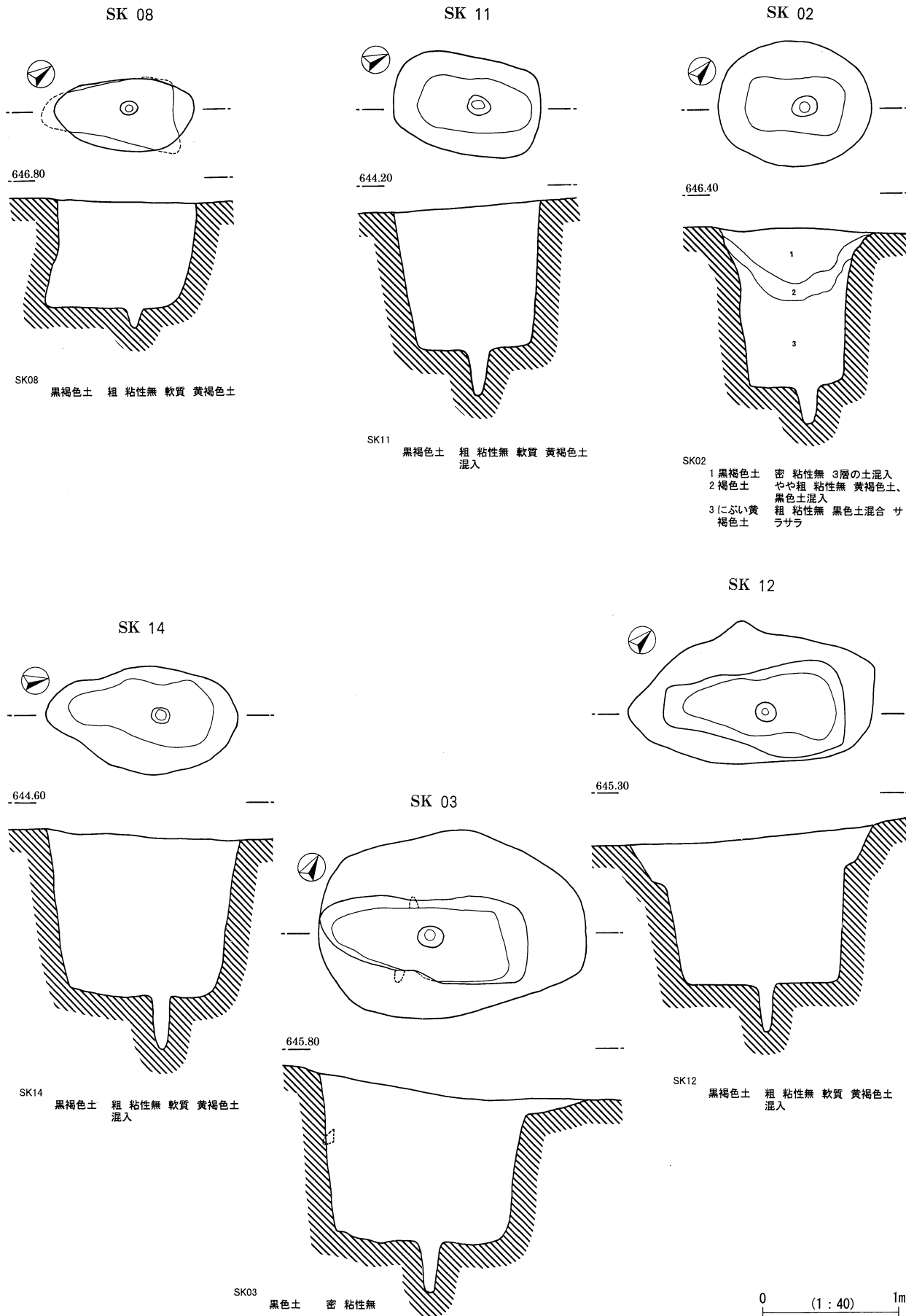

縄文時代遺構図 3

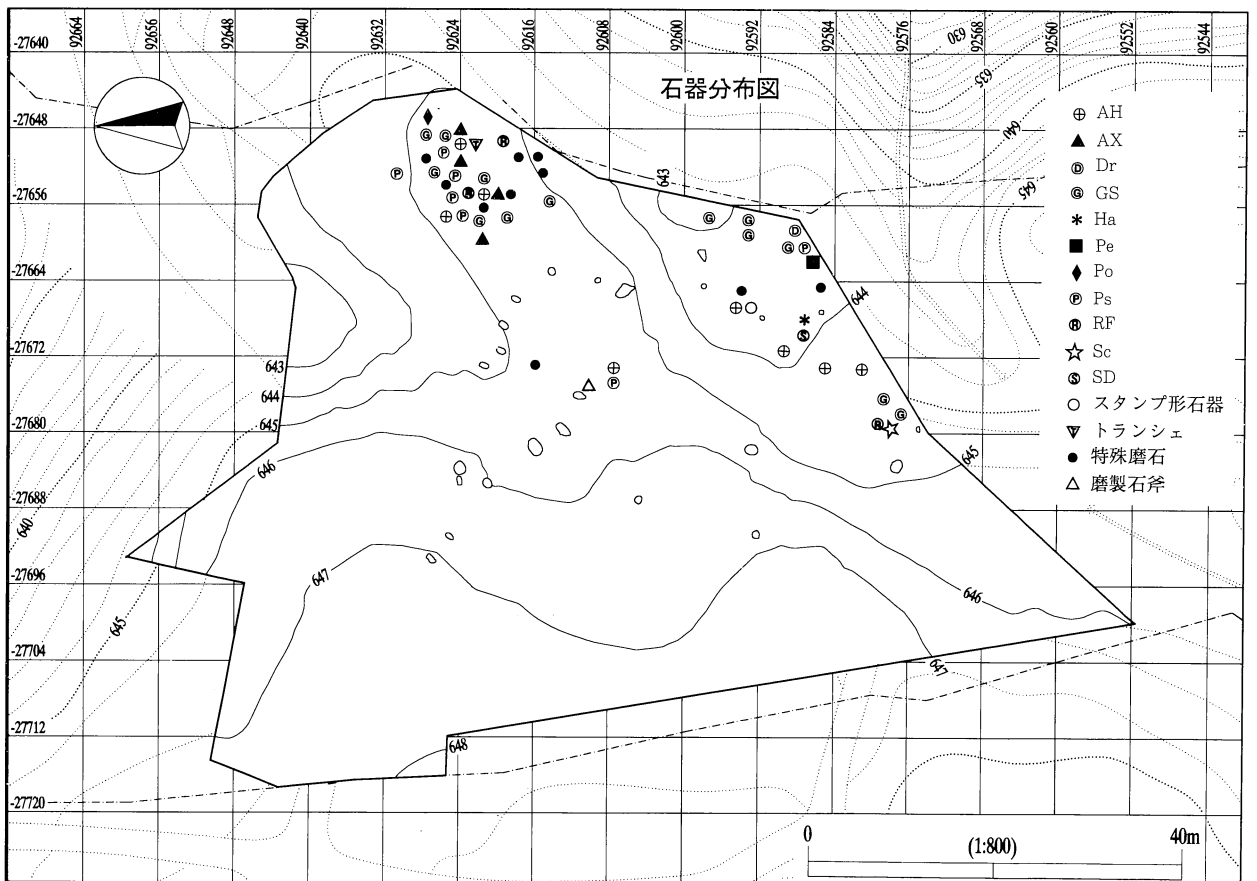
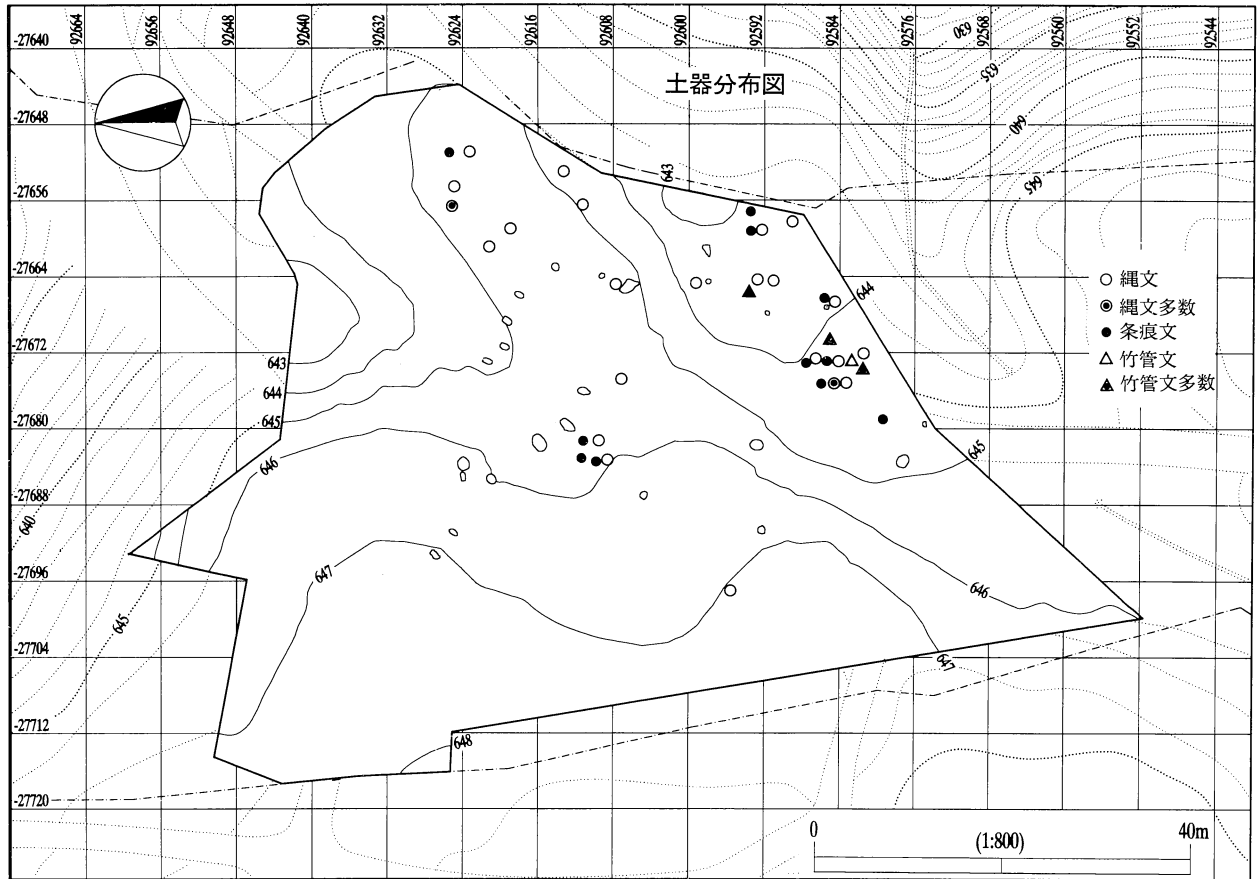

縄文時代土器・石器分布図

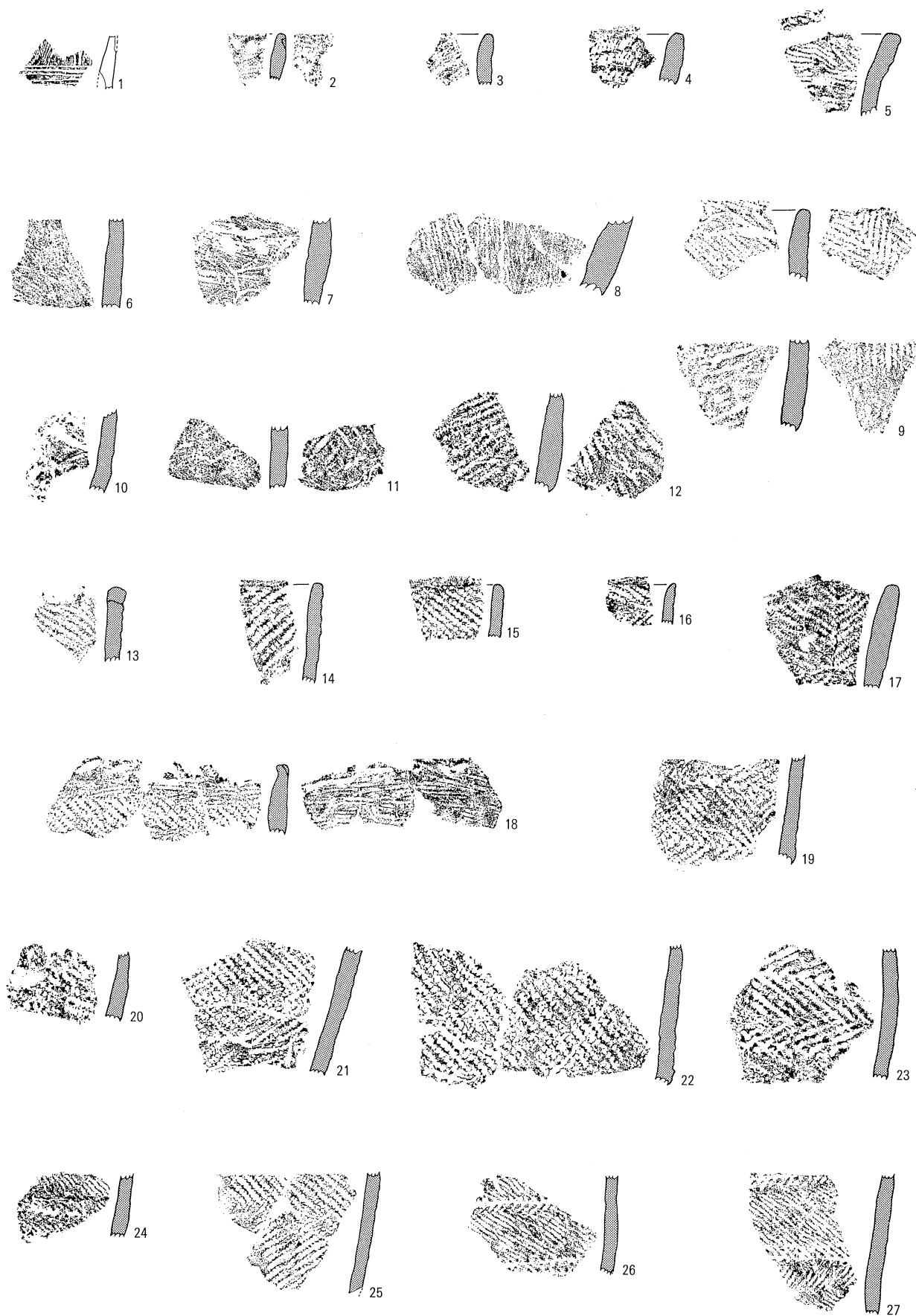

0 (1:3) 10cm

繩文時代土器 1

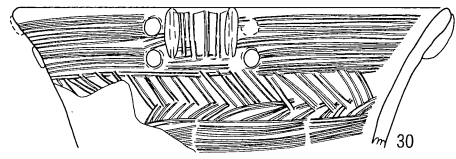
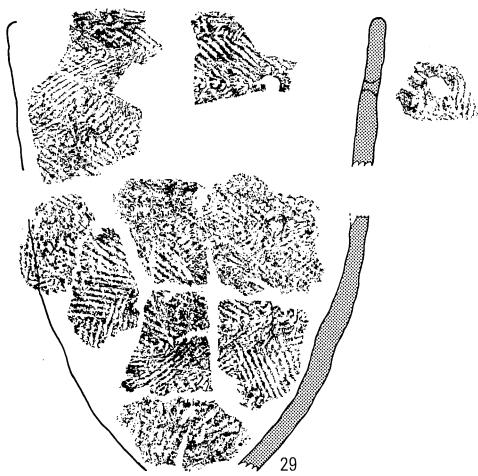
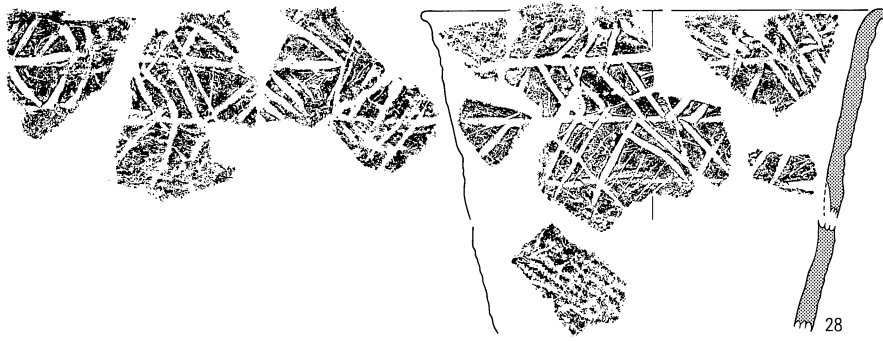

0 (1 : 4) 10cm

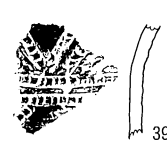
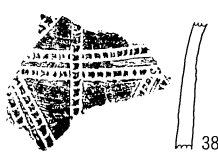
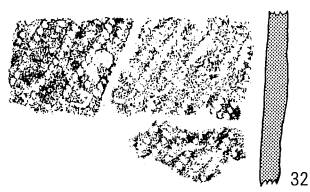
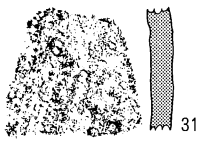

0 (1 : 3) 10cm

縄文時代土器 2

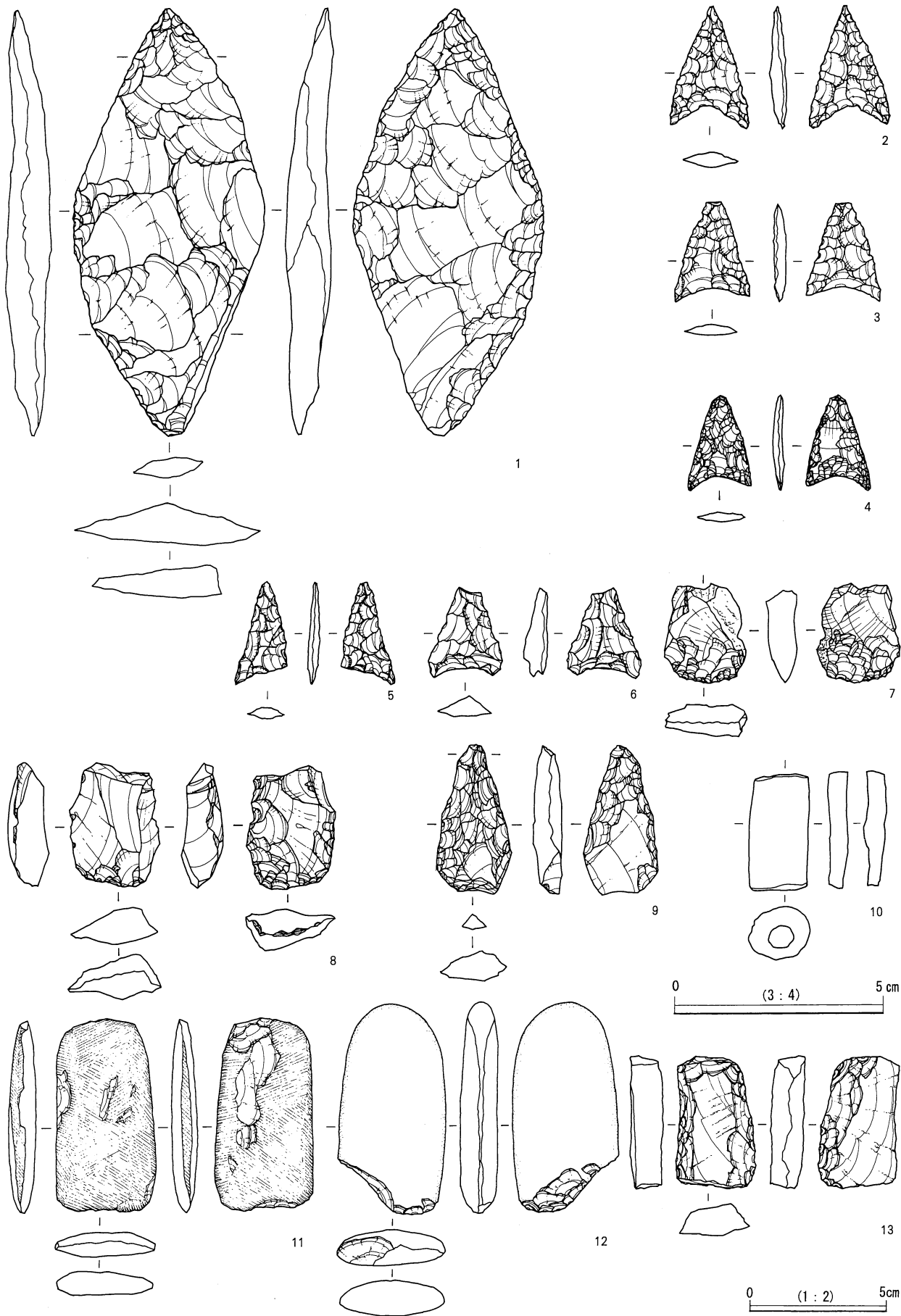

繩文時代石器 1

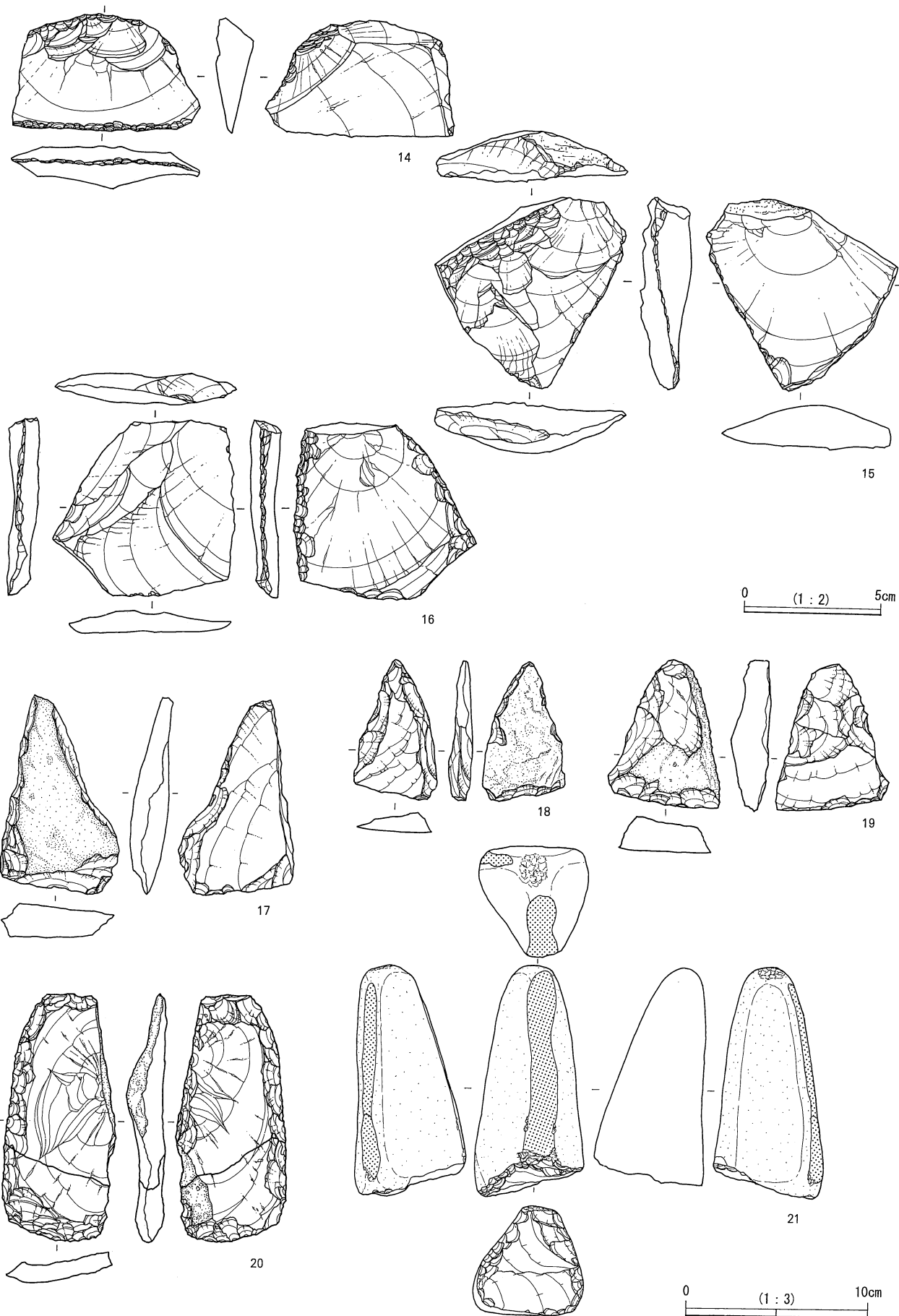

縄文時代石器 2

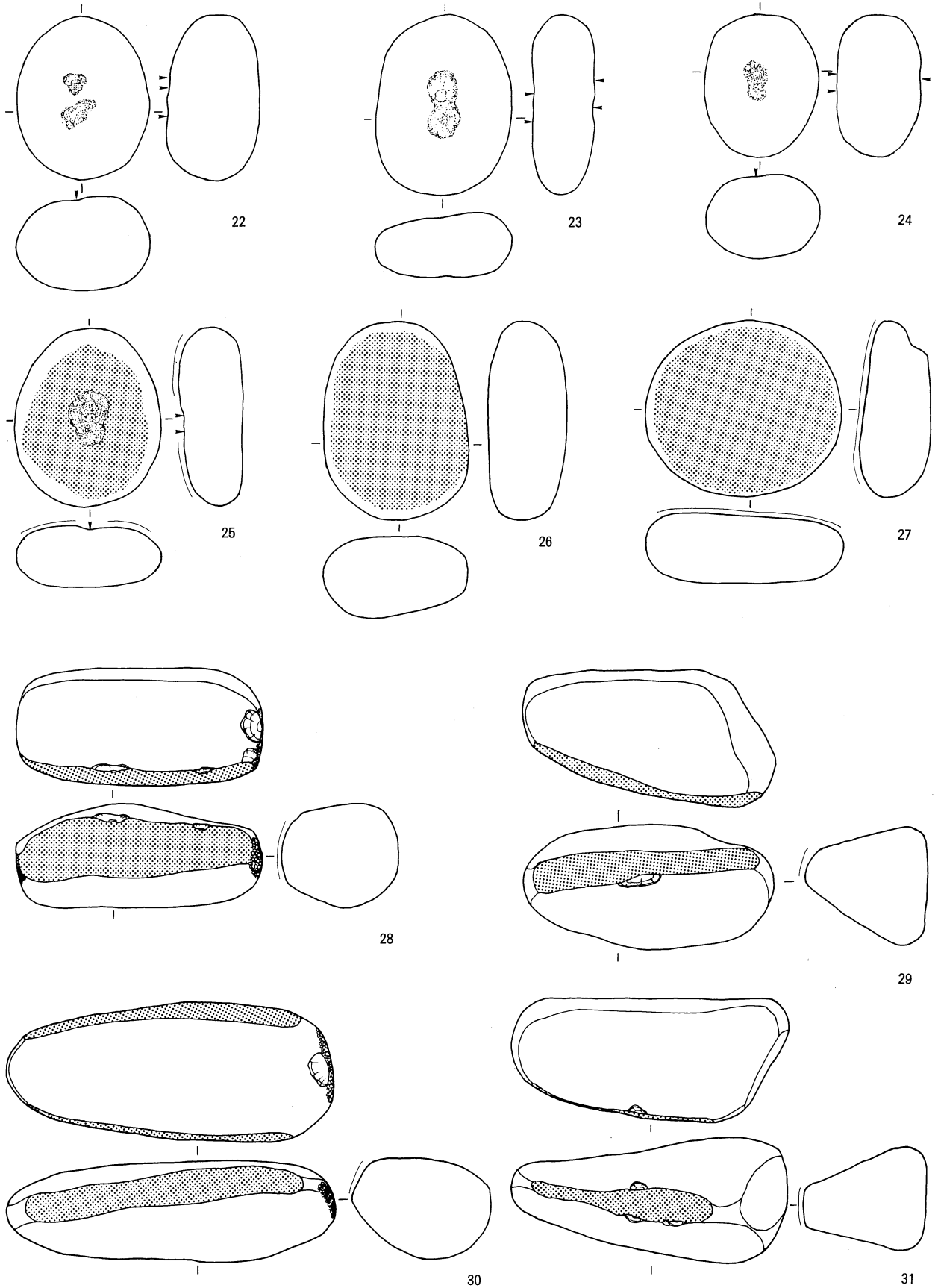

0 (1 : 3) 10cm

繩文時代石器 3

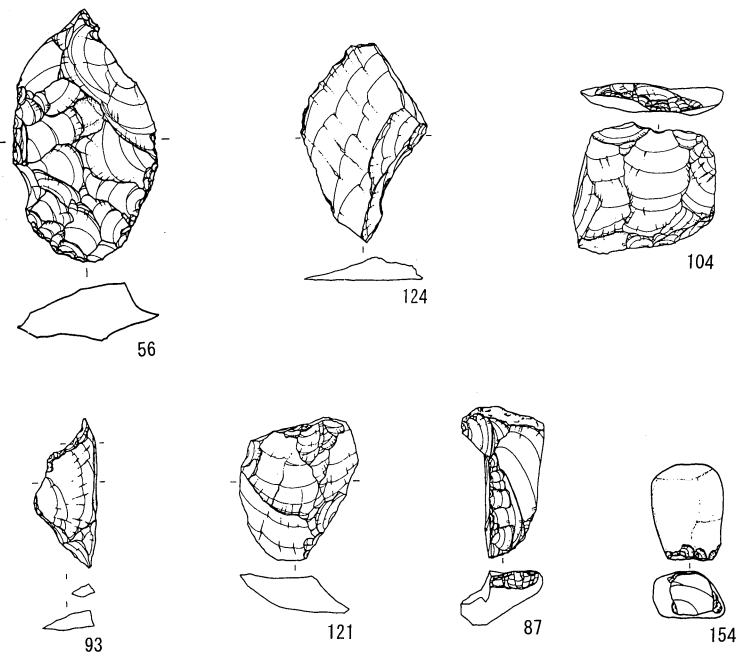
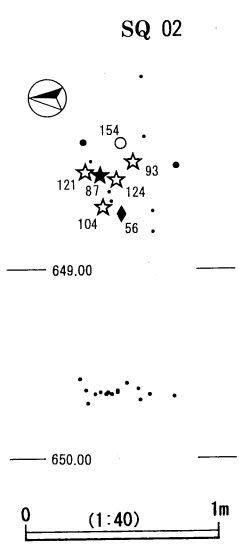
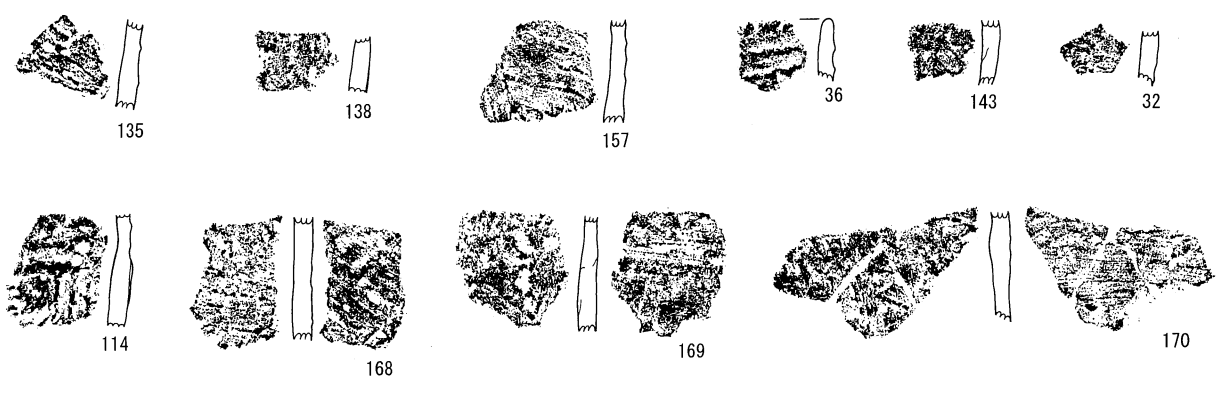
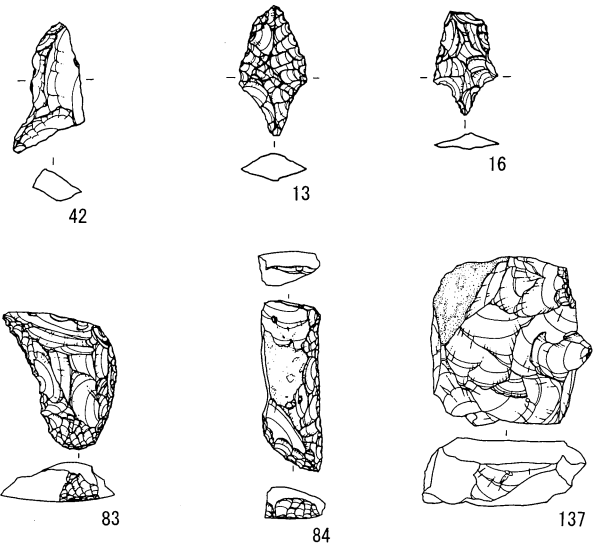
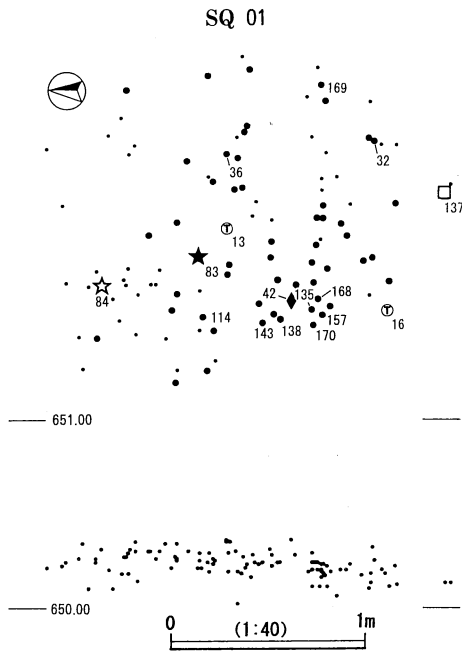

繩文時代遺構圖 1

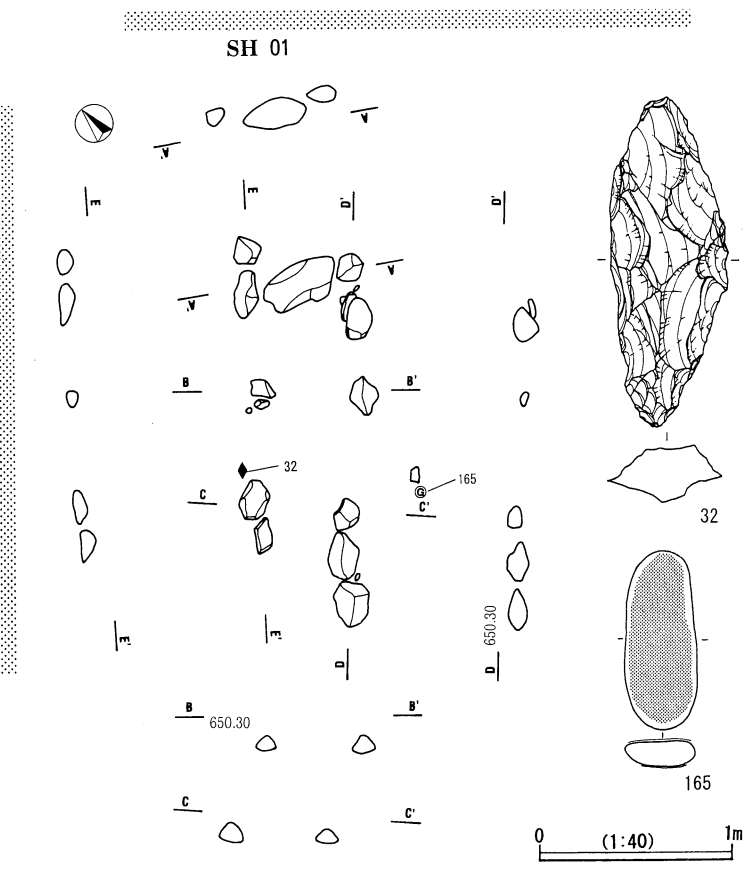
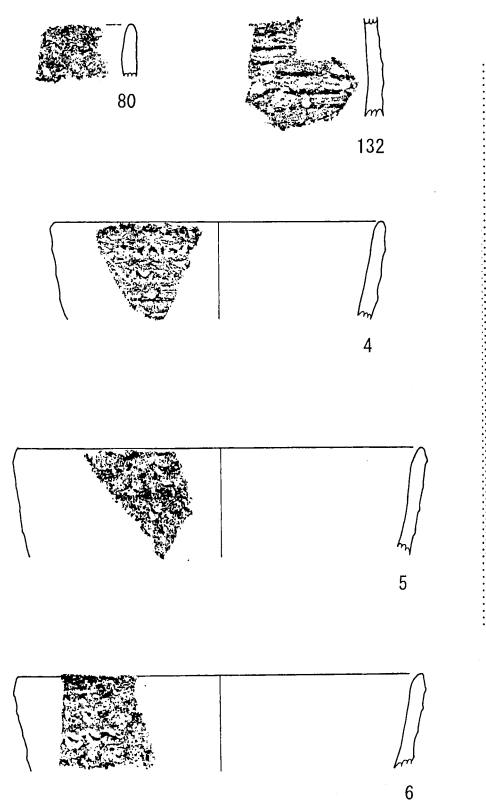
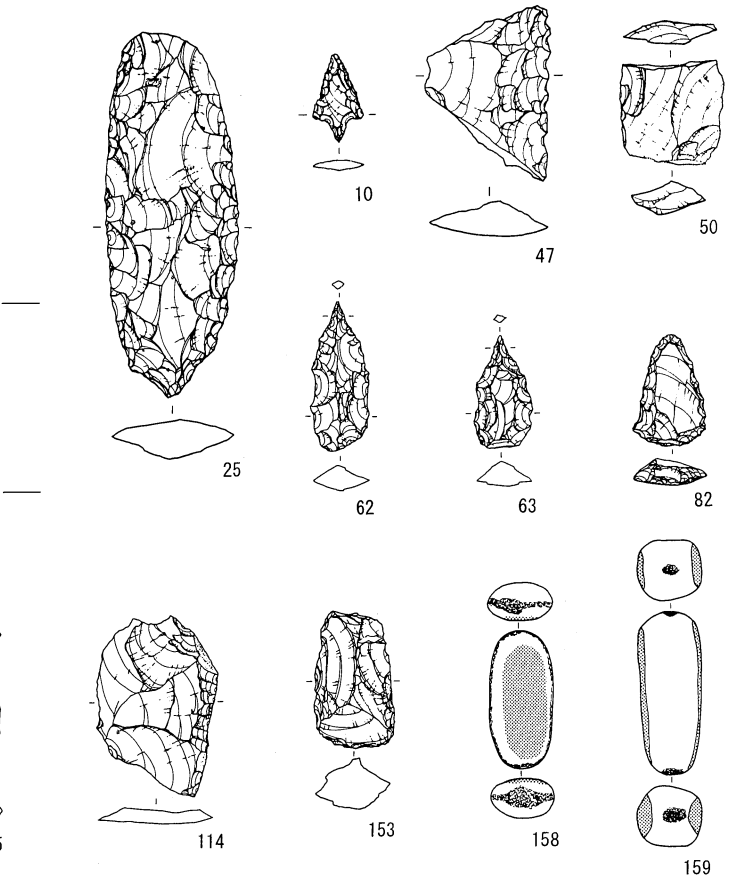
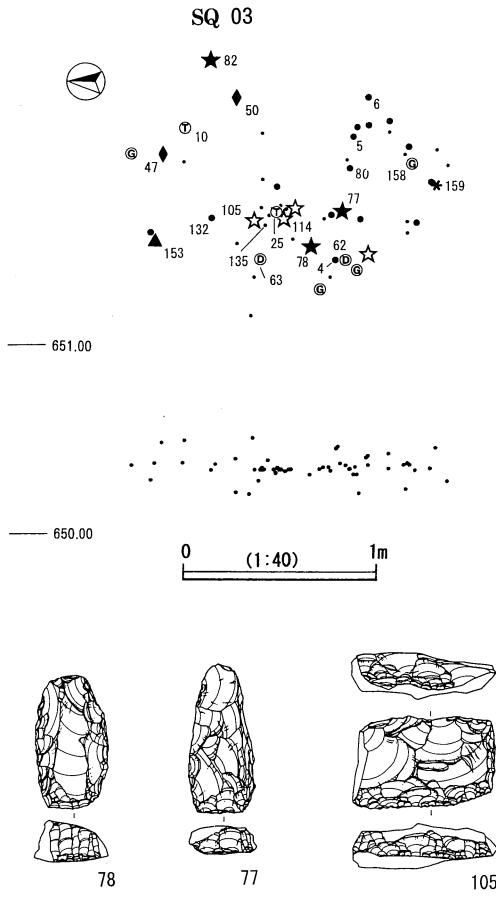

繩文時代遺構圖 2

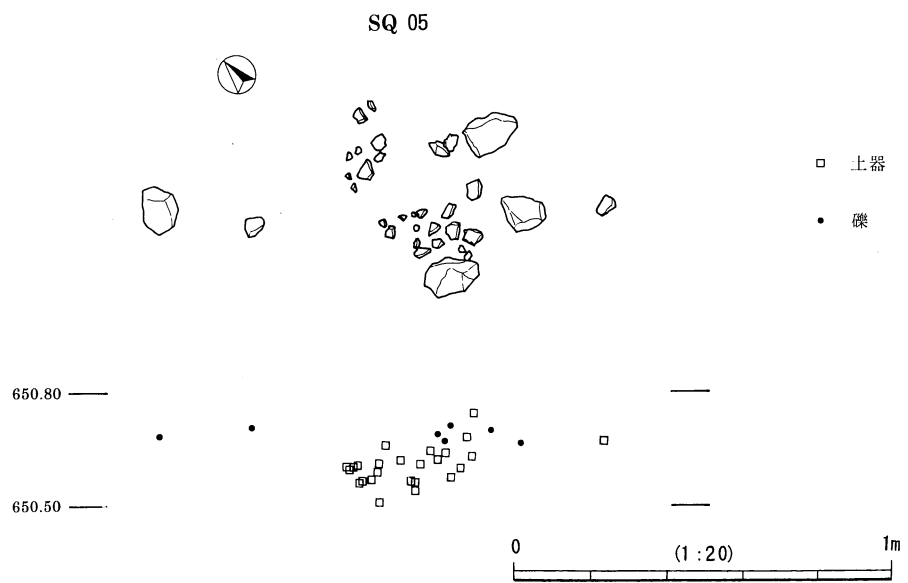
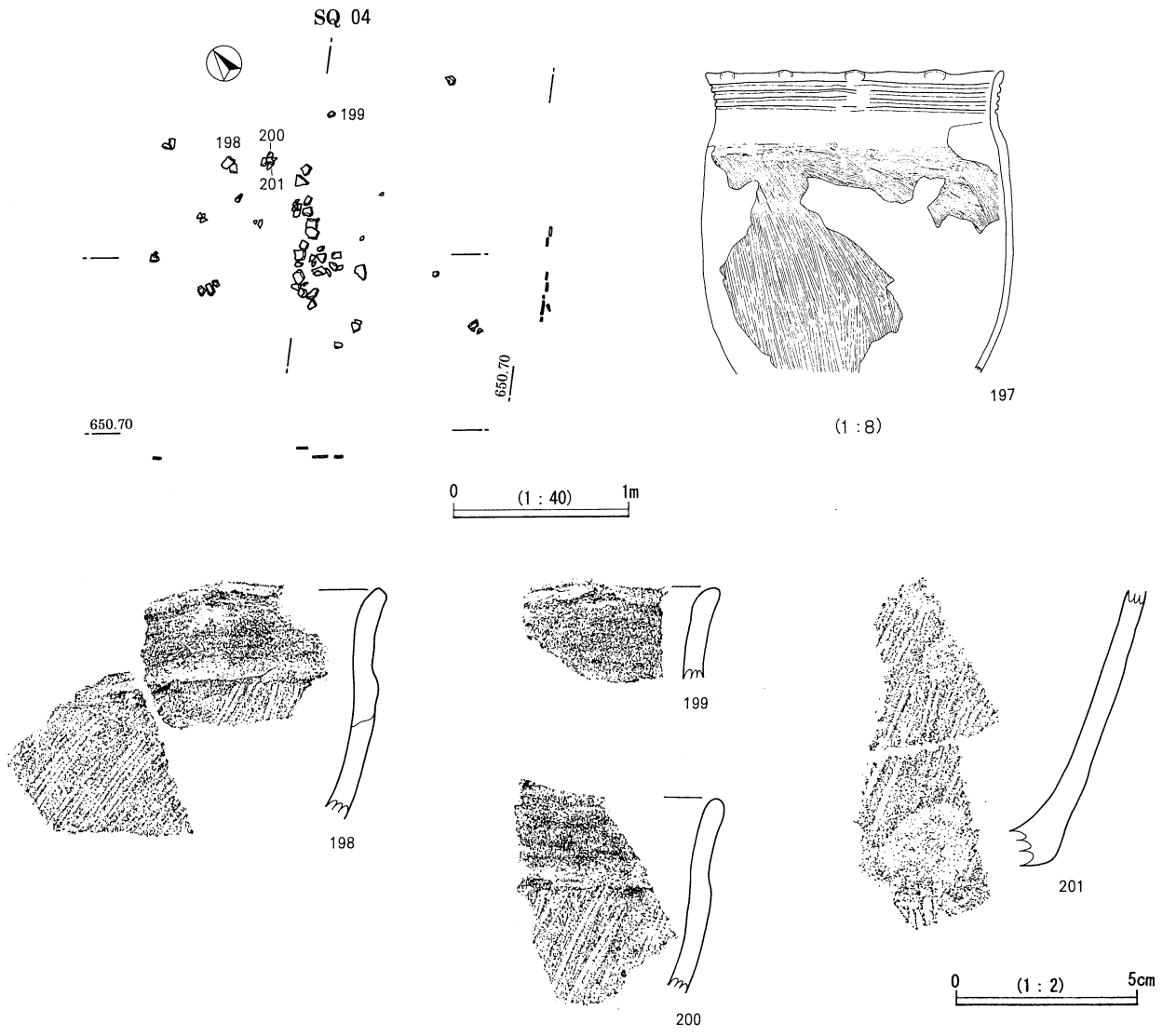

繩文時代遺構圖 3

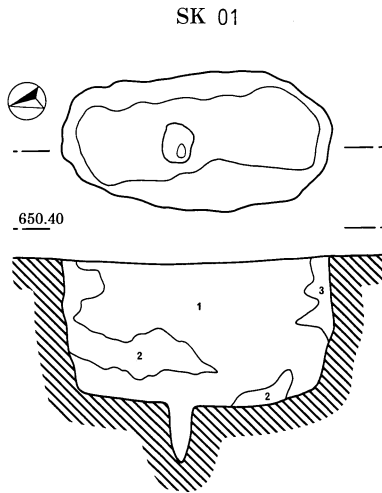

- SK01
- | | | |
|--------|-------------|-----|
| 1 黒褐色土 | 2層下部に黄褐色粒混入 | 粘性有 |
| 2 褐色土 | 黄褐色土と黒色土の混合 | 堆積粗 |
| 3 黄褐色土 | | |

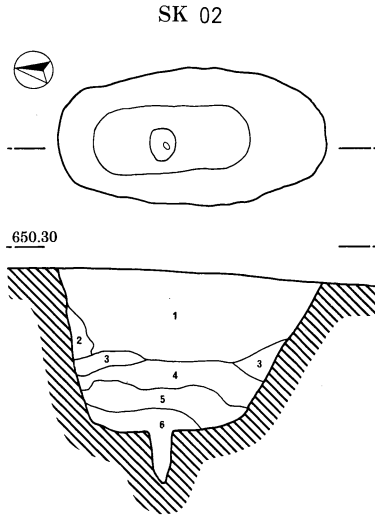

- SK02
- | | |
|--------|------------|
| 1 黒褐色土 | 軟質 堆積粗 |
| 2 褐色土 | 黒色土に明褐色土混入 |
| 3 褐色土 | 2層より黒色強 |
| 4 黒褐色土 | 1層より黒い |
| 5 黄褐色土 | |
| 6 黒褐色土 | 硬質 密 |

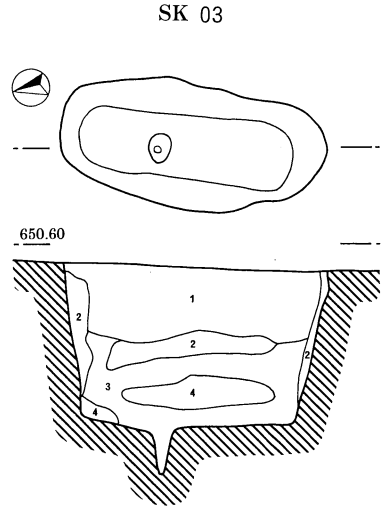

- SK03
- | | |
|-----------|------------------|
| 1 極暗褐色土 | 粘性少量有 |
| 2 暗褐色土 | 明褐色土微細粒多量 |
| 3 黒色土 | 暗褐色土の混合 明褐色微細粒含有 |
| 4 にぶい黄褐色土 | 粘性少量有 堆積粗 |

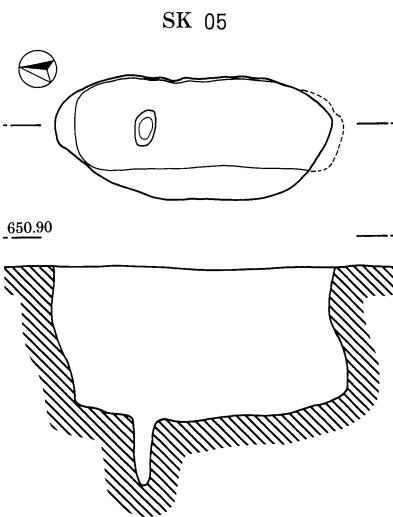

- SK05
- | | |
|--------|-------|
| 1 黒褐色土 | 粘性無 粗 |
|--------|-------|

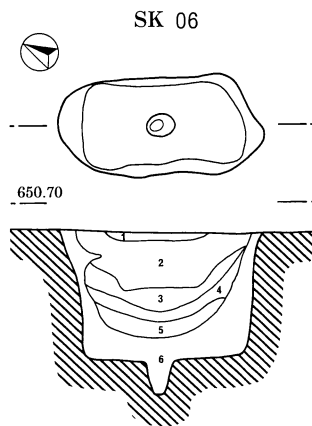

- SK06
- | | |
|--------|--------------|
| 1 黒色土 | |
| 2 黒褐色土 | 黄橙色土粒混入 |
| 3 灰褐色土 | 灰か粘土のような塊 |
| 4 黒色土 | |
| 5 暗褐色土 | 黄橙色土粒少量 |
| 6 暗褐色土 | 2層より、黄橙色土粒多量 |

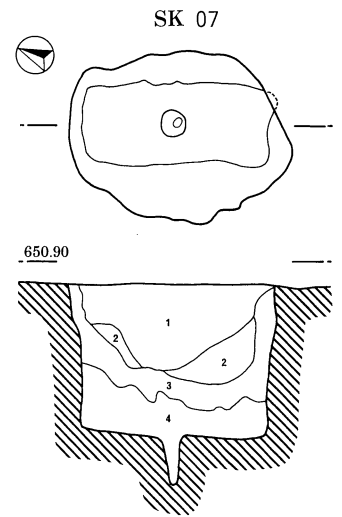

- SK07
- | | |
|---------|-----------------|
| 1 黒色土 | 黄橙色土粒含有 |
| 2 黒褐色土 | 灰褐色の粘土か灰のような塊含有 |
| 3 明黄褐色土 | 褐色土のモヤ層混入 |
| 4 黒褐色土 | |

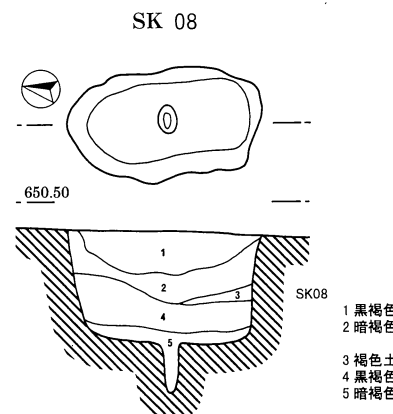

- SK08
- | | |
|--------|-------------------|
| 1 黒褐色土 | II層の土 |
| 2 暗褐色土 | 黄褐色土粒混入 灰 |
| 3 褐色土 | 褐色土大粒混入 |
| 4 黒褐色土 | 黒色土粒混入 |
| 5 暗褐色土 | 下部ほど褐色強 堆積少量有 堆積密 |

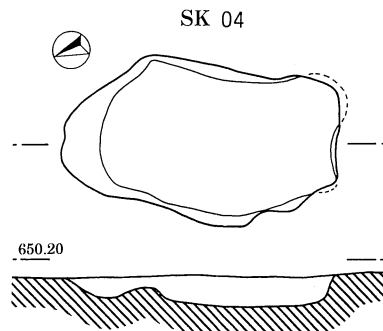

- SK04
- | | |
|-------|------------|
| 1 黒色土 | 粘性無 粗 サラサラ |
|-------|------------|

0 (1:40) 1m

縄文時代遺構図 4

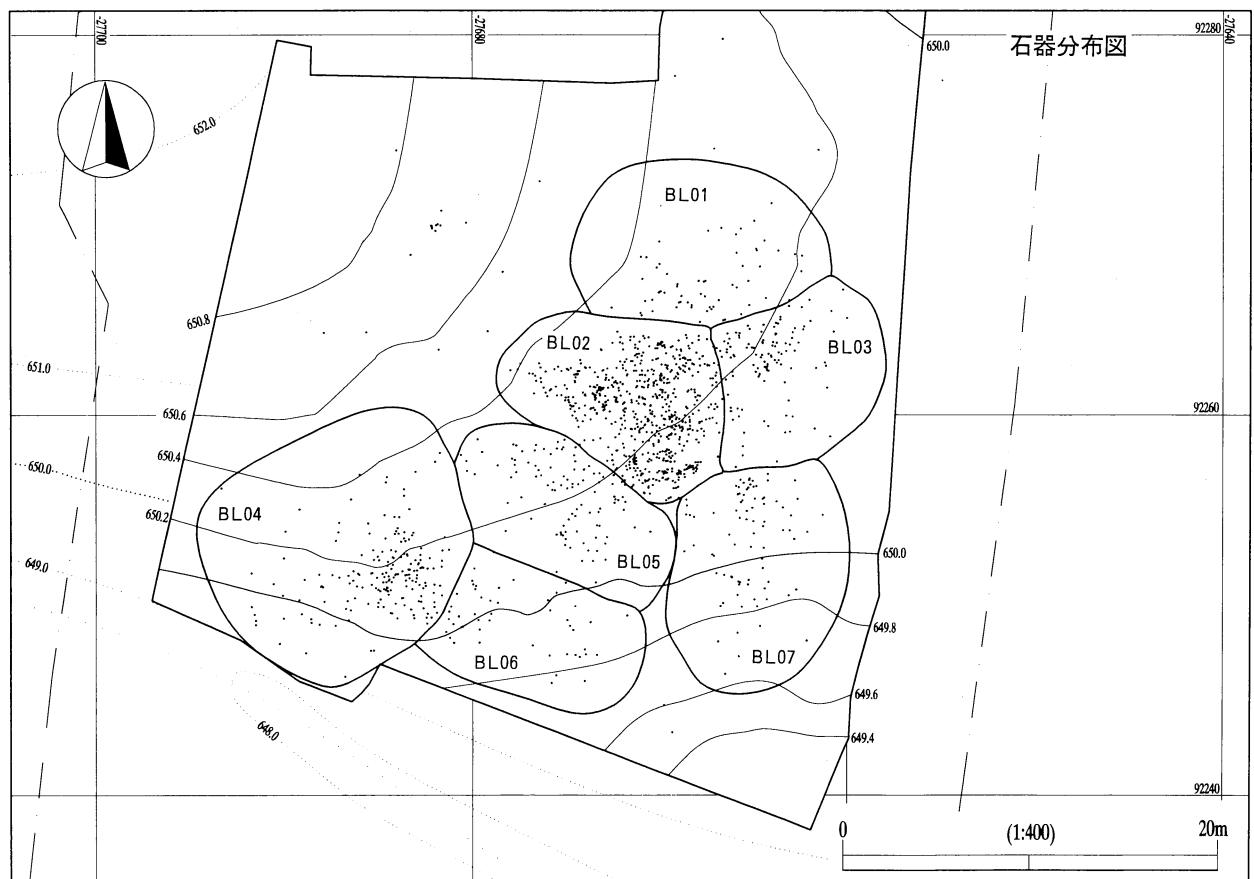
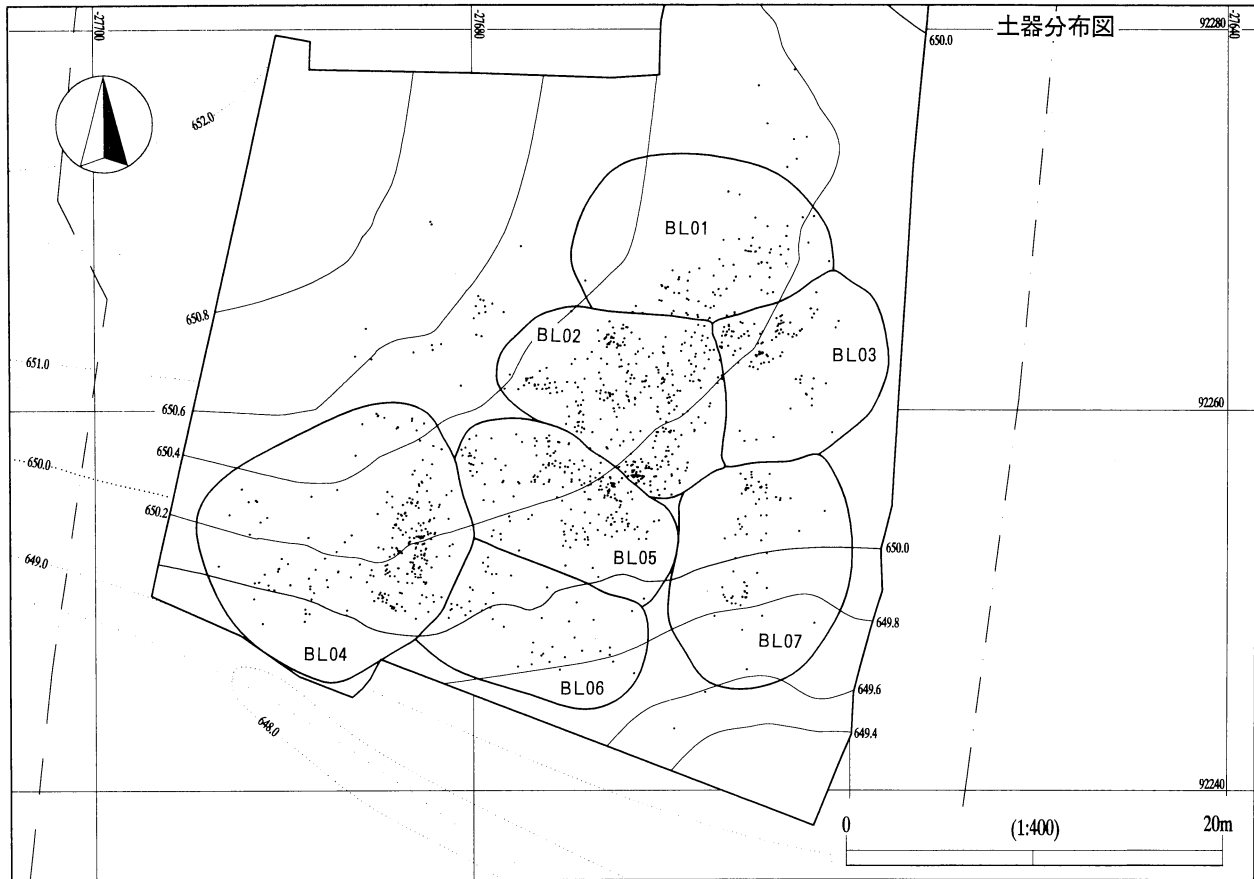

縄文時代土器・石器分布全体図

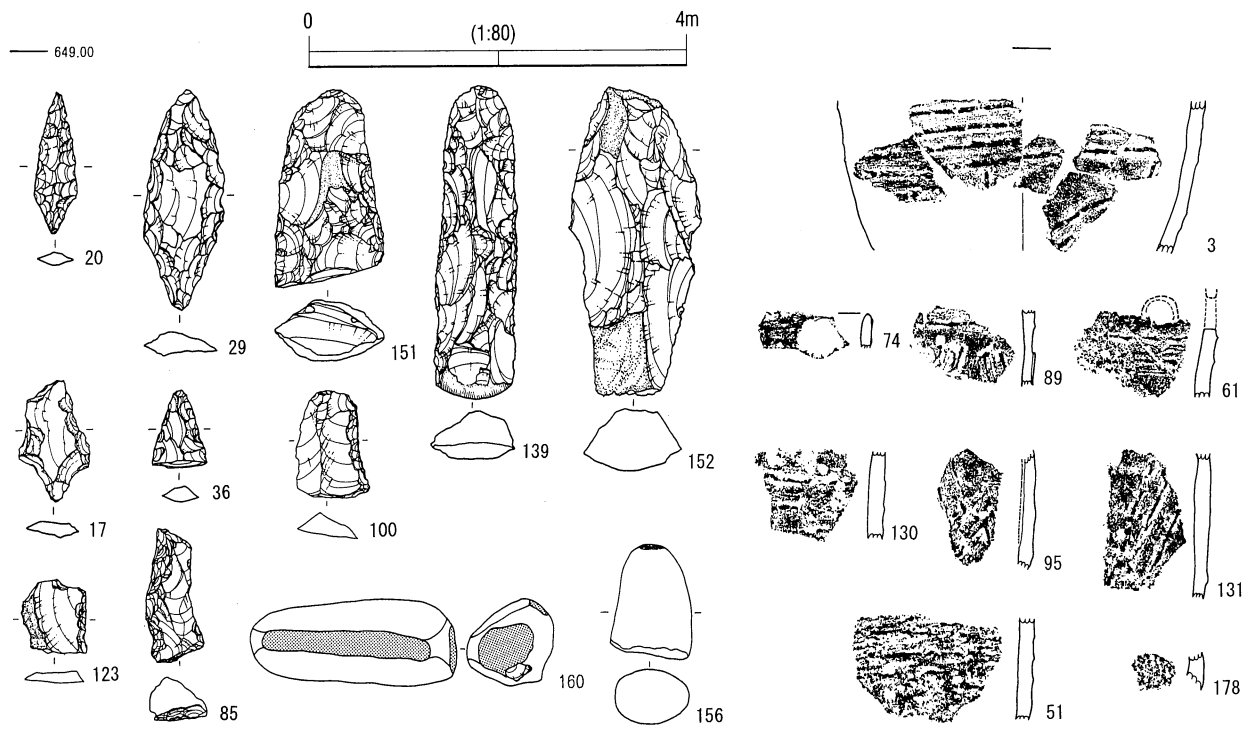
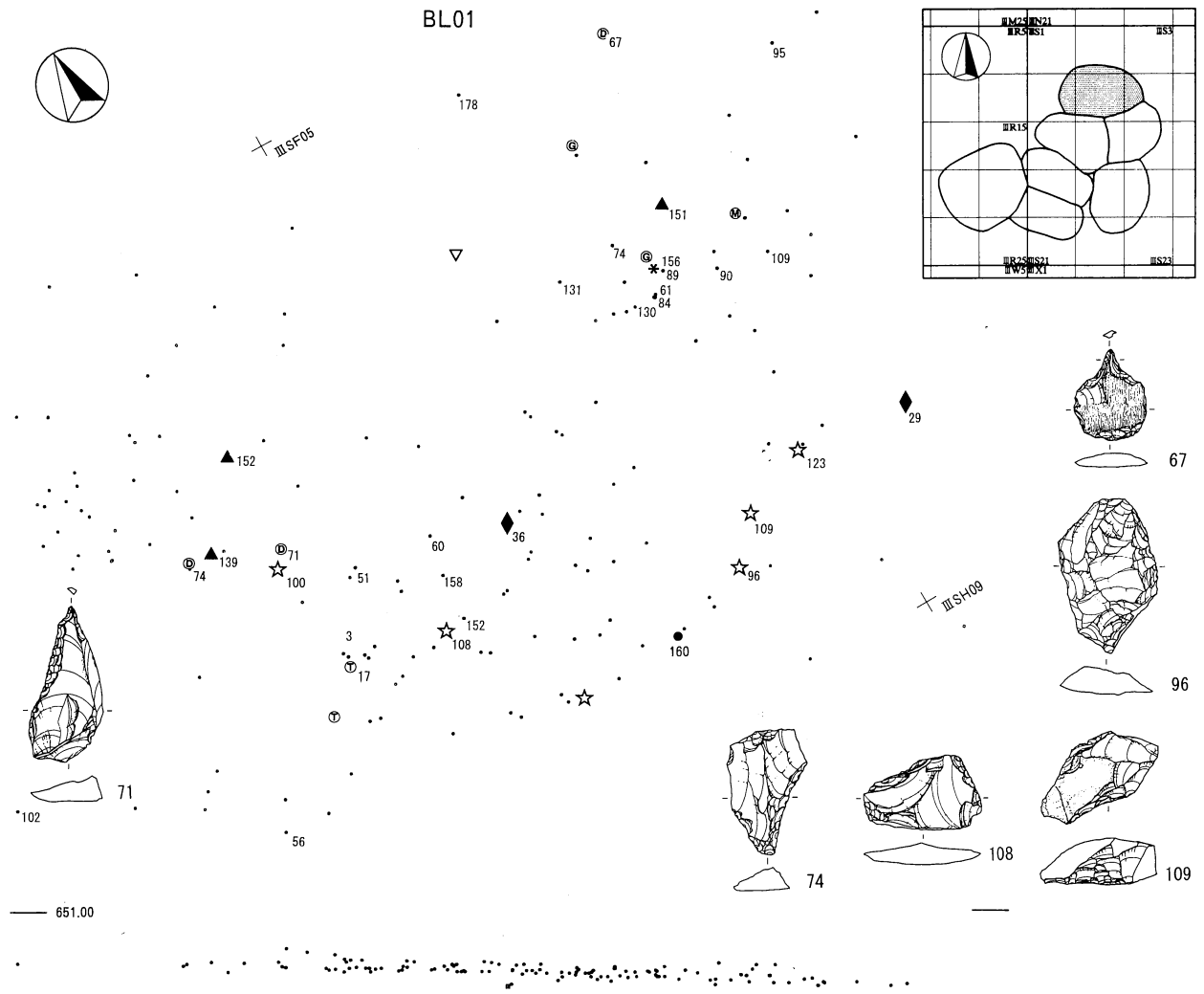

繩文時代土器・石器分布圖 1

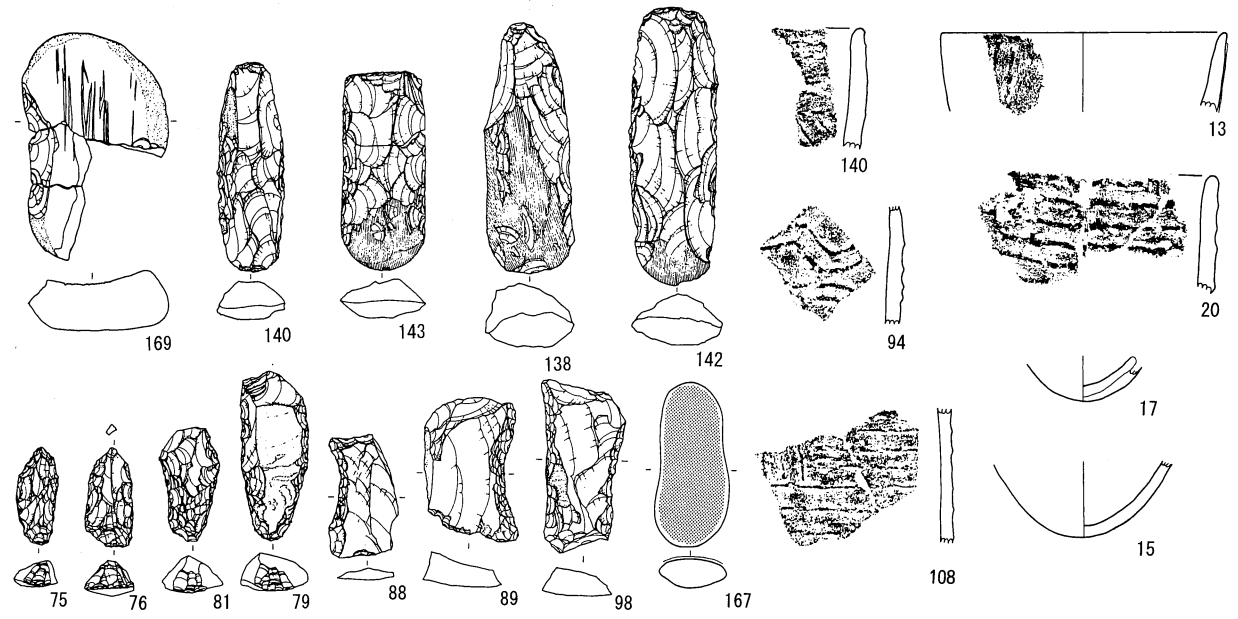
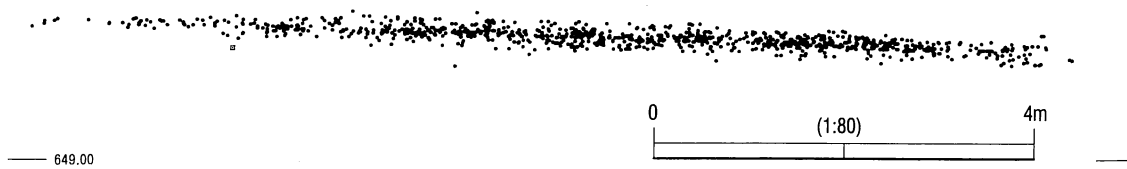
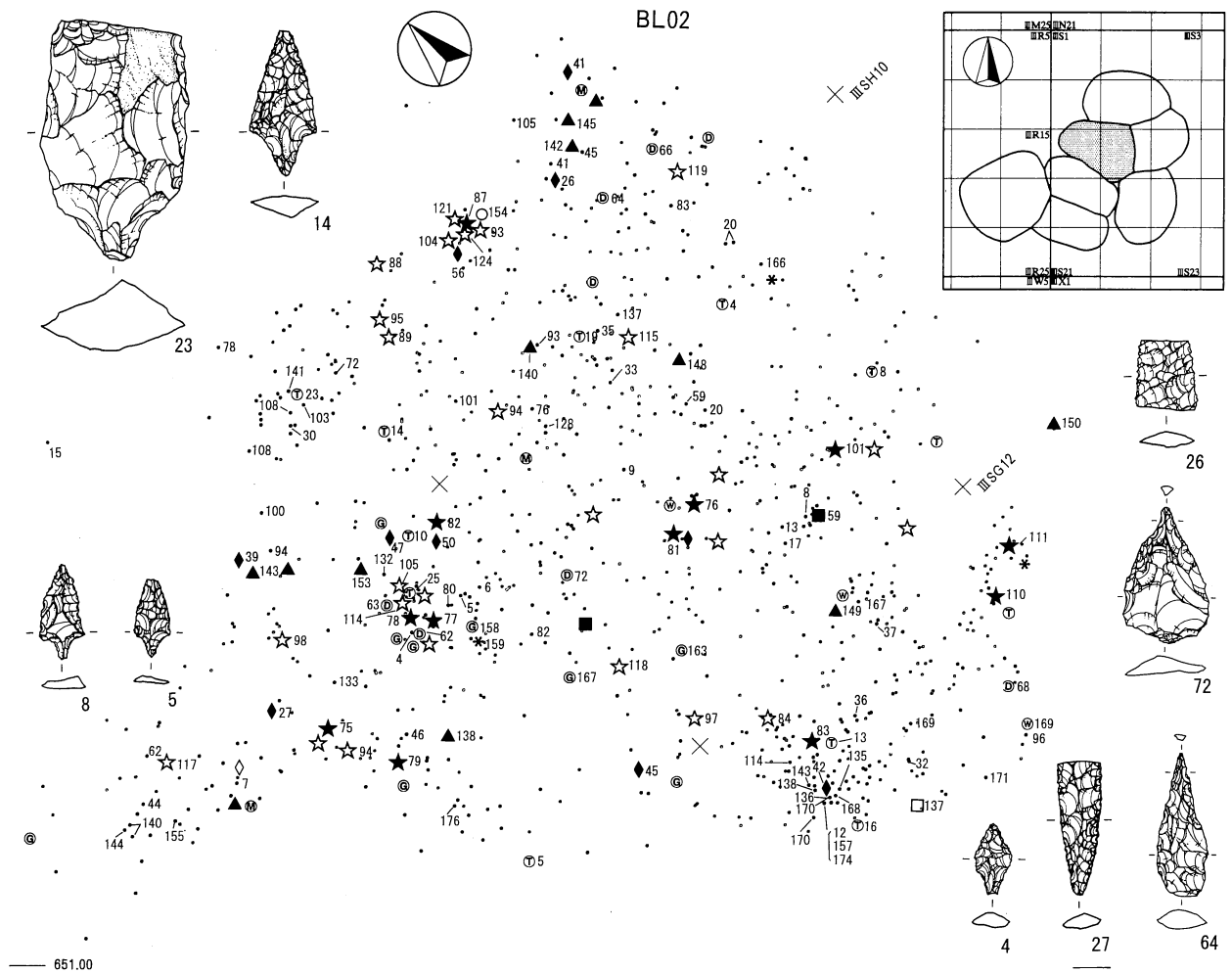

縄文時代土器・石器分布図 2

BL03

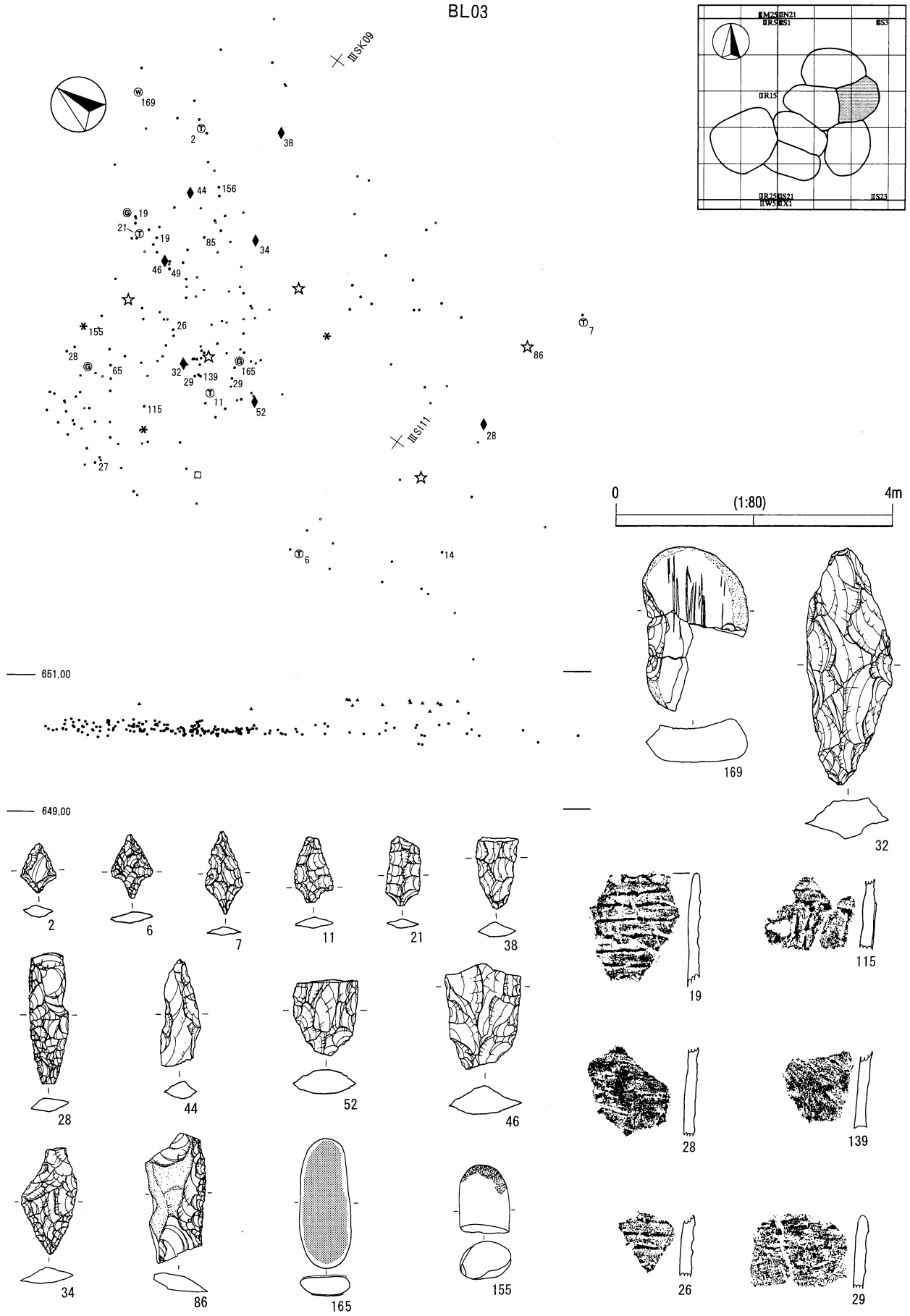

繩文時代土器・石器分布図 3

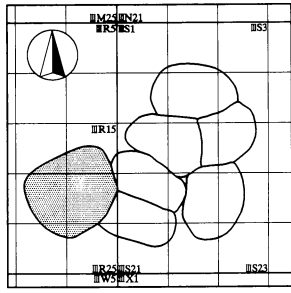

BL04

55
68

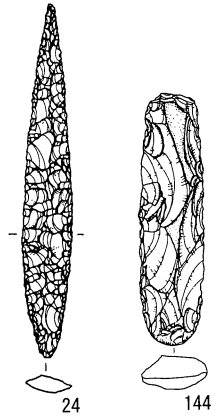

24

144

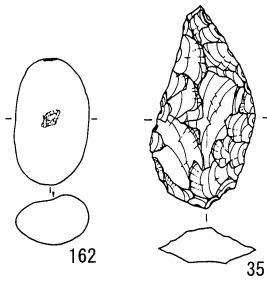

162

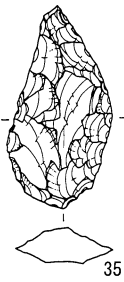

35

III RQ13



3

3



1

123

21

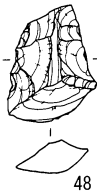

48

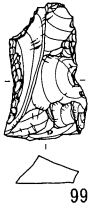

99



70



58

18

124

112

134

48

106

16

III RQ17

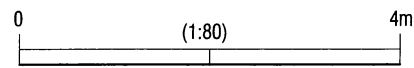

0

(1:80)

4m

650.00

649.00

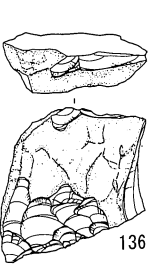

136



65



106



21

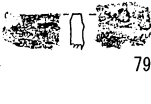

79



145



23



1



68



110



148



16

縄文時代土器・石器分布図 4

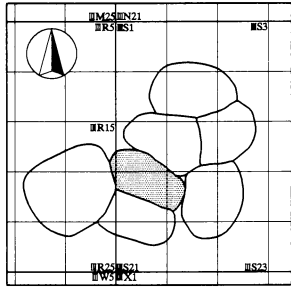

BL05

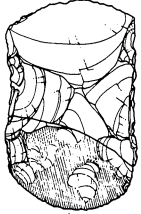

146

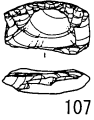

107

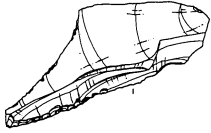

103

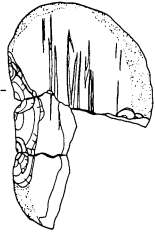

169



80

651.00

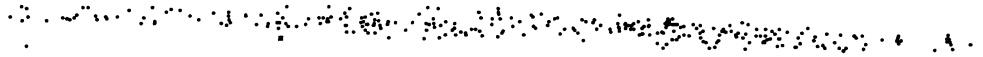

649.00

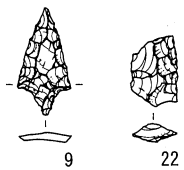

9

22

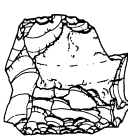

60

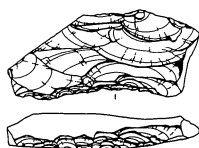

102

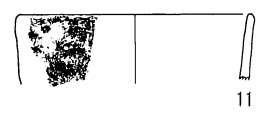

11



164



31

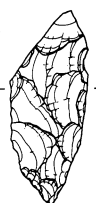

33

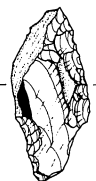

43



30

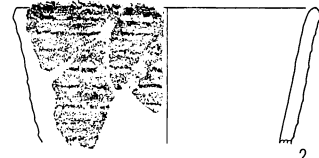

2



91

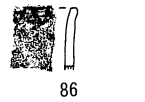

86



52



117



151



92

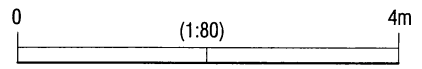

縄文時代土器・石器分布図 5

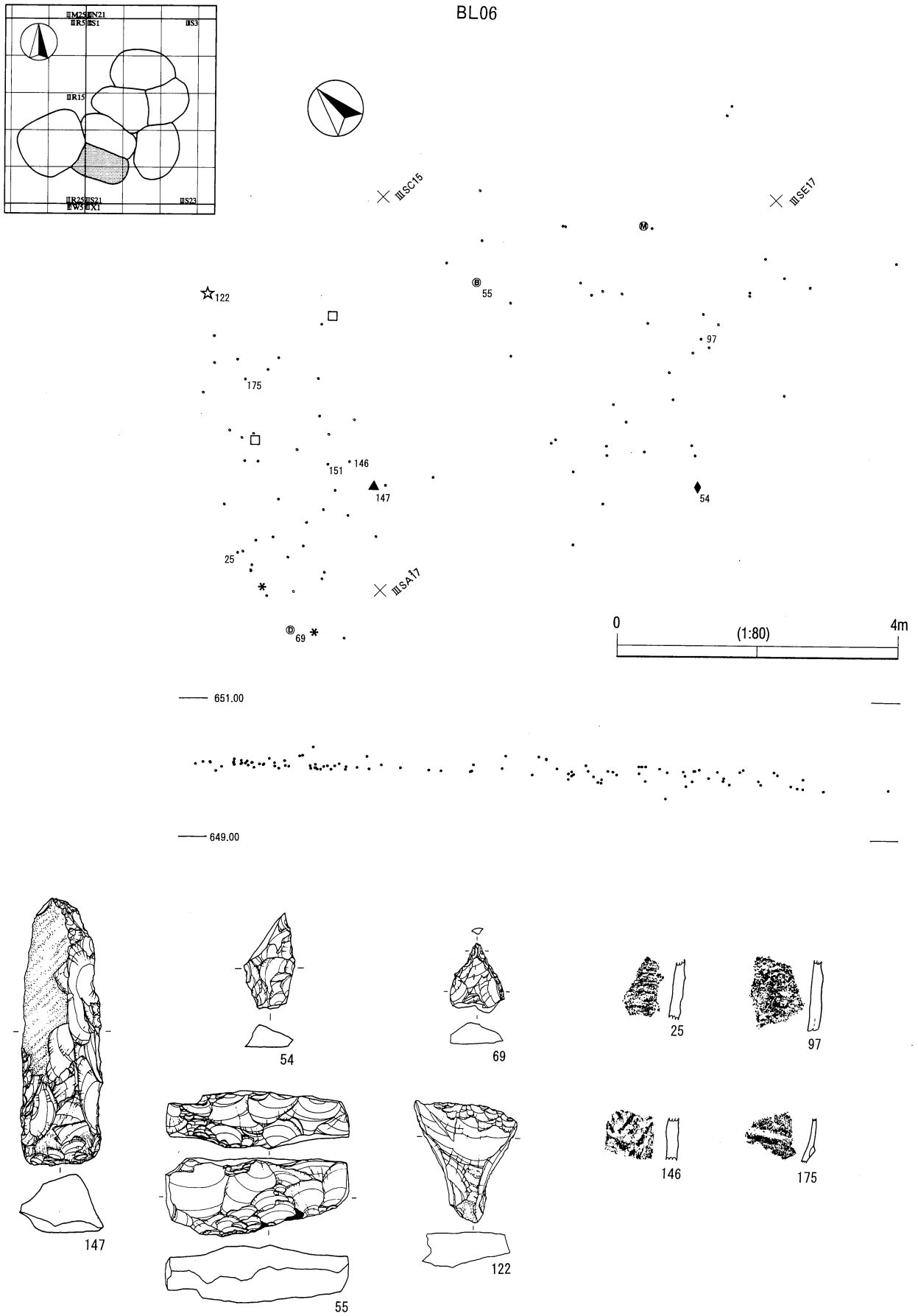

縄文時代土器・石器分布図 6

BL07

III SK16

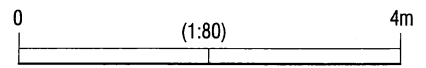
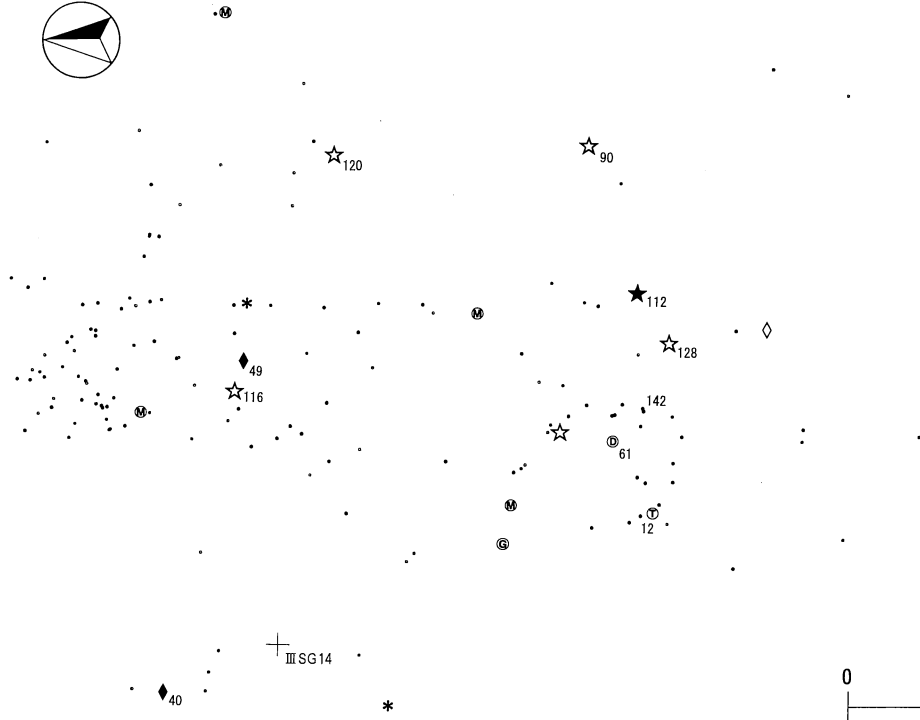
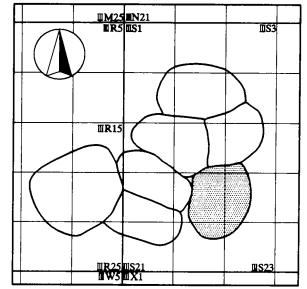

651.00

649.00

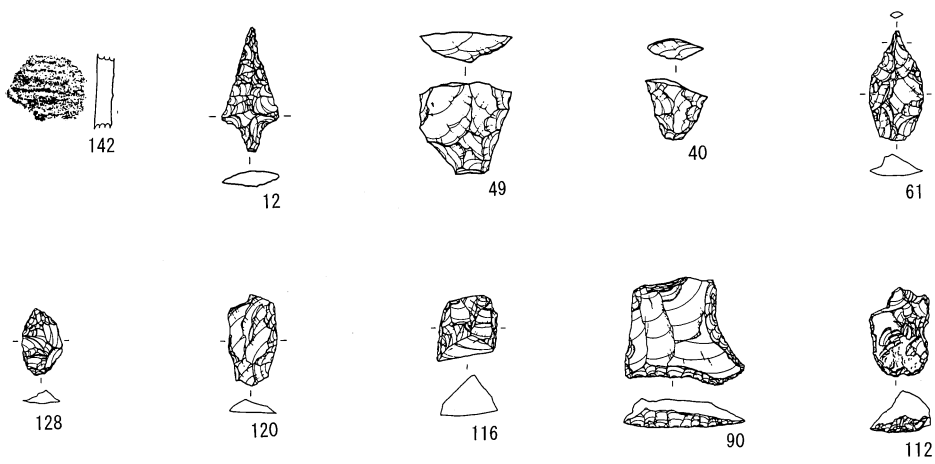

縄文時代土器・石器分布図 7

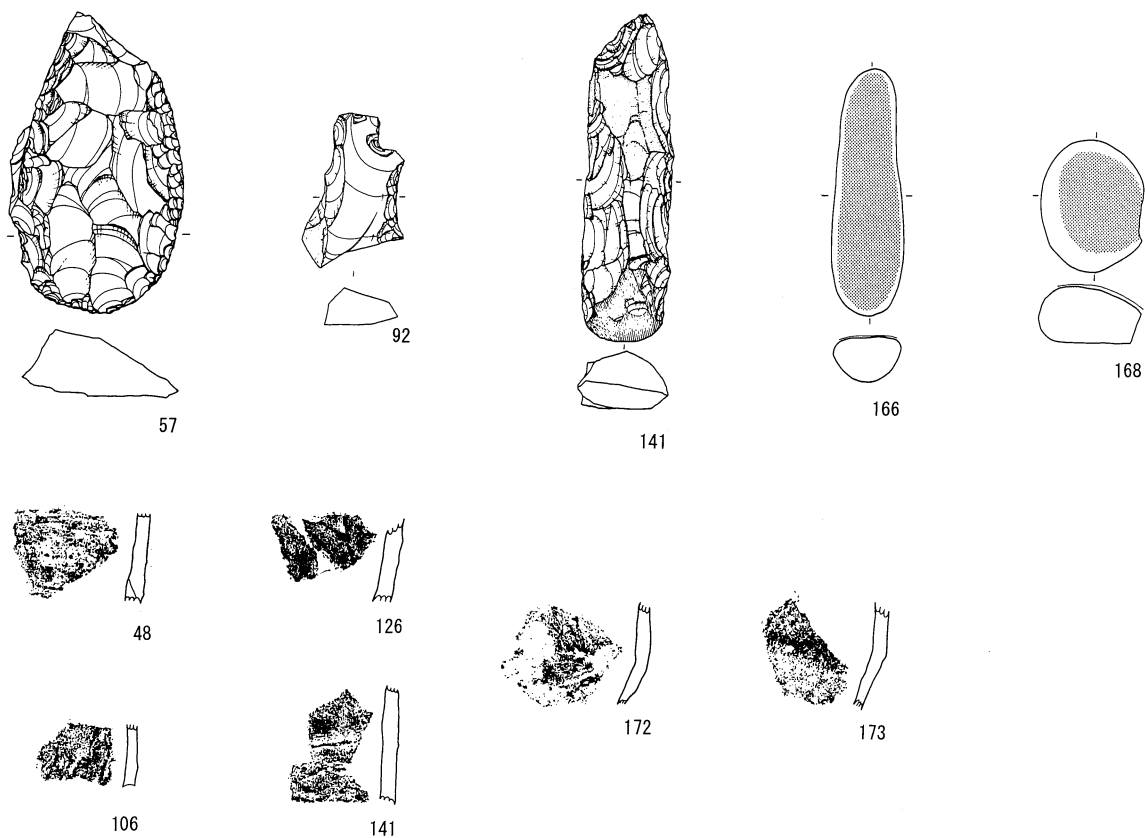
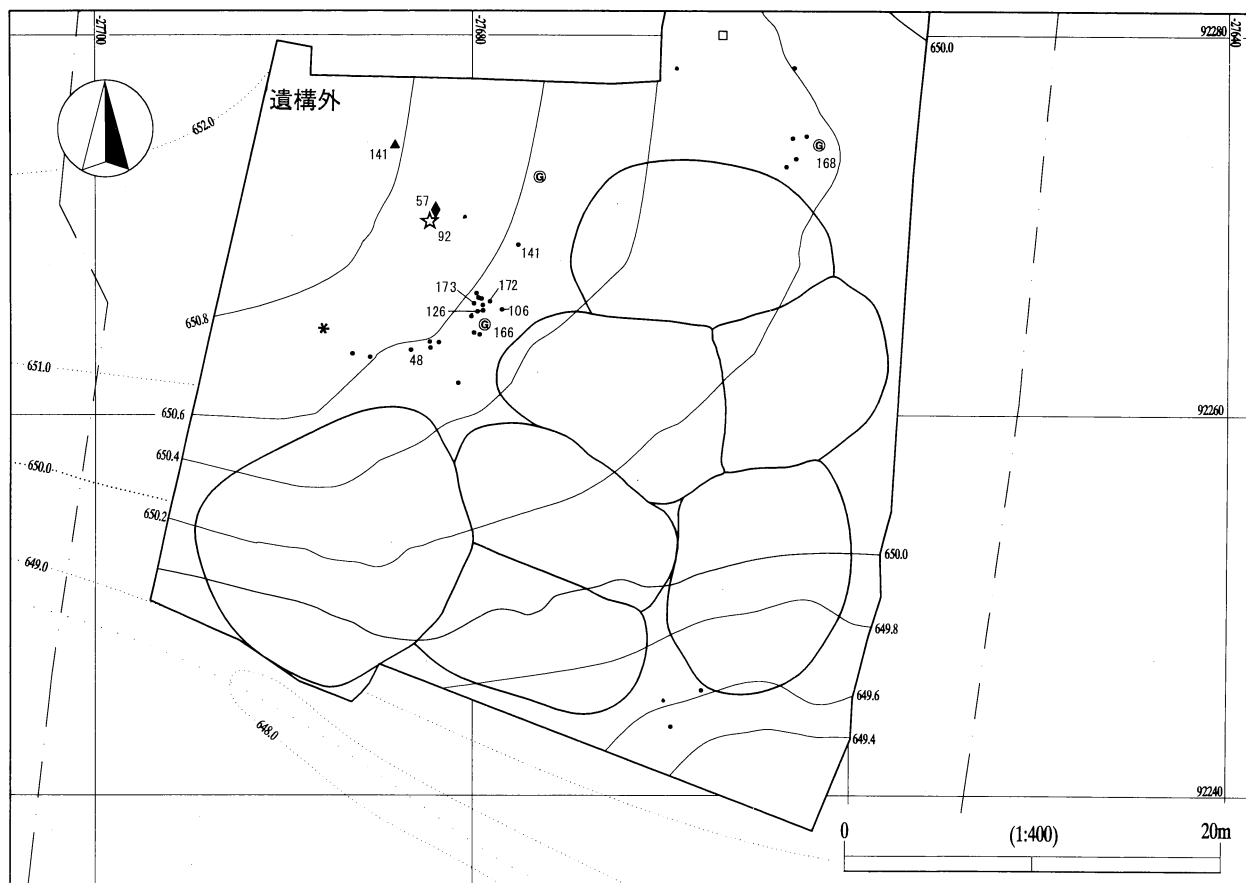

縄文時代土器・石器分布図 8

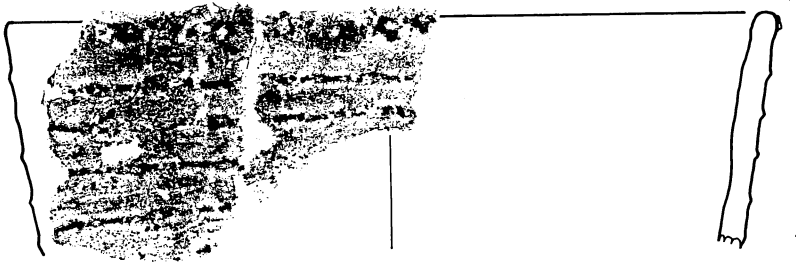

1

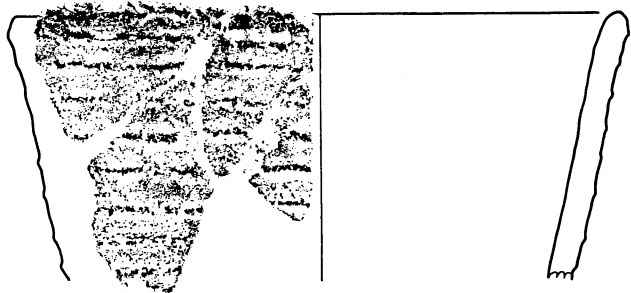

2

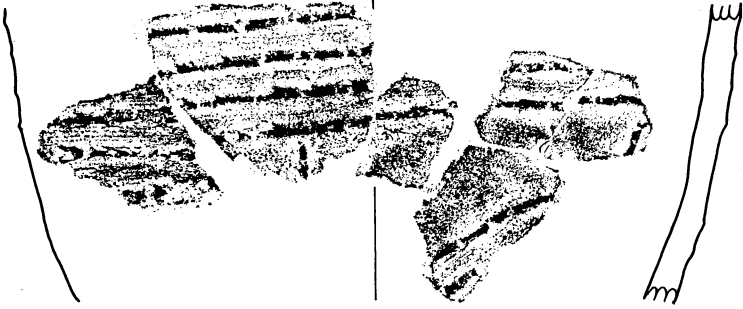

3

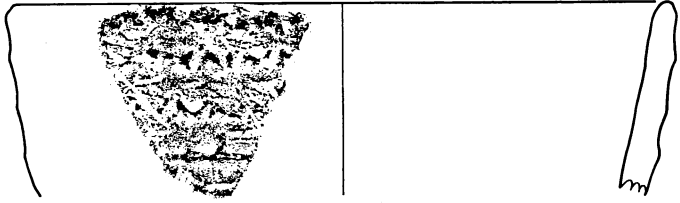

4

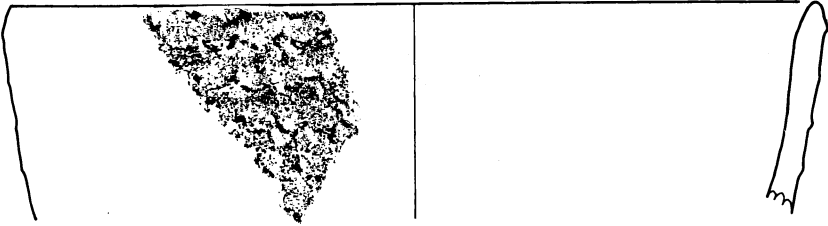

5

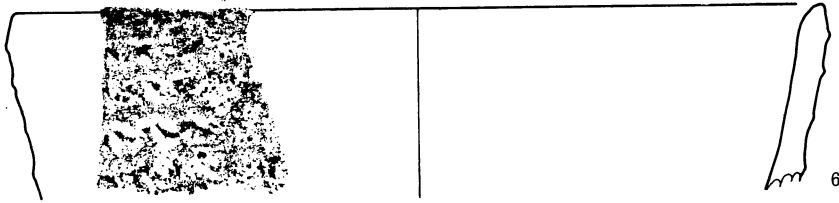

6

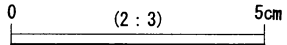

繩文時代土器 1

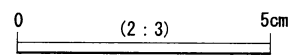
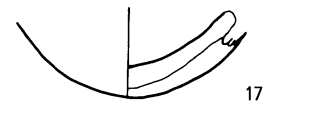
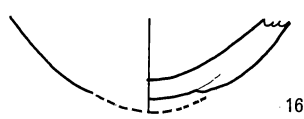
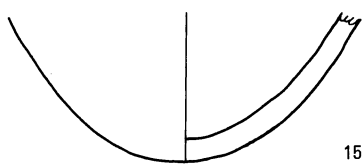
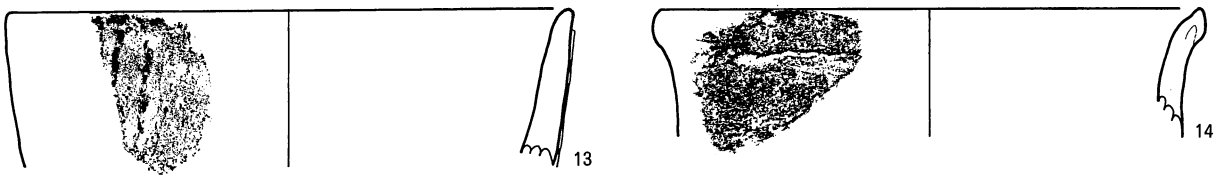
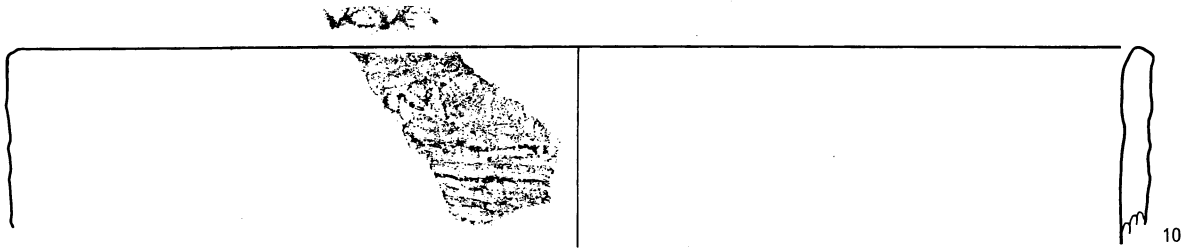
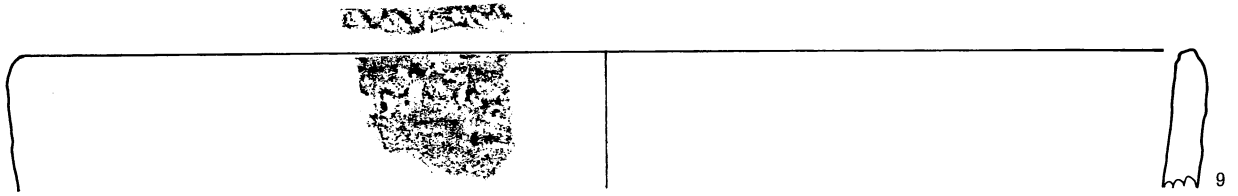
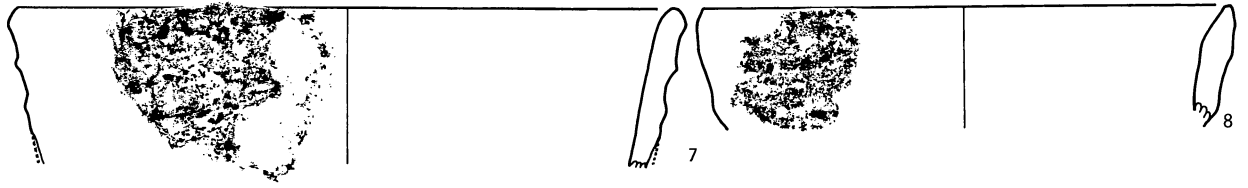

繩文時代土器 2

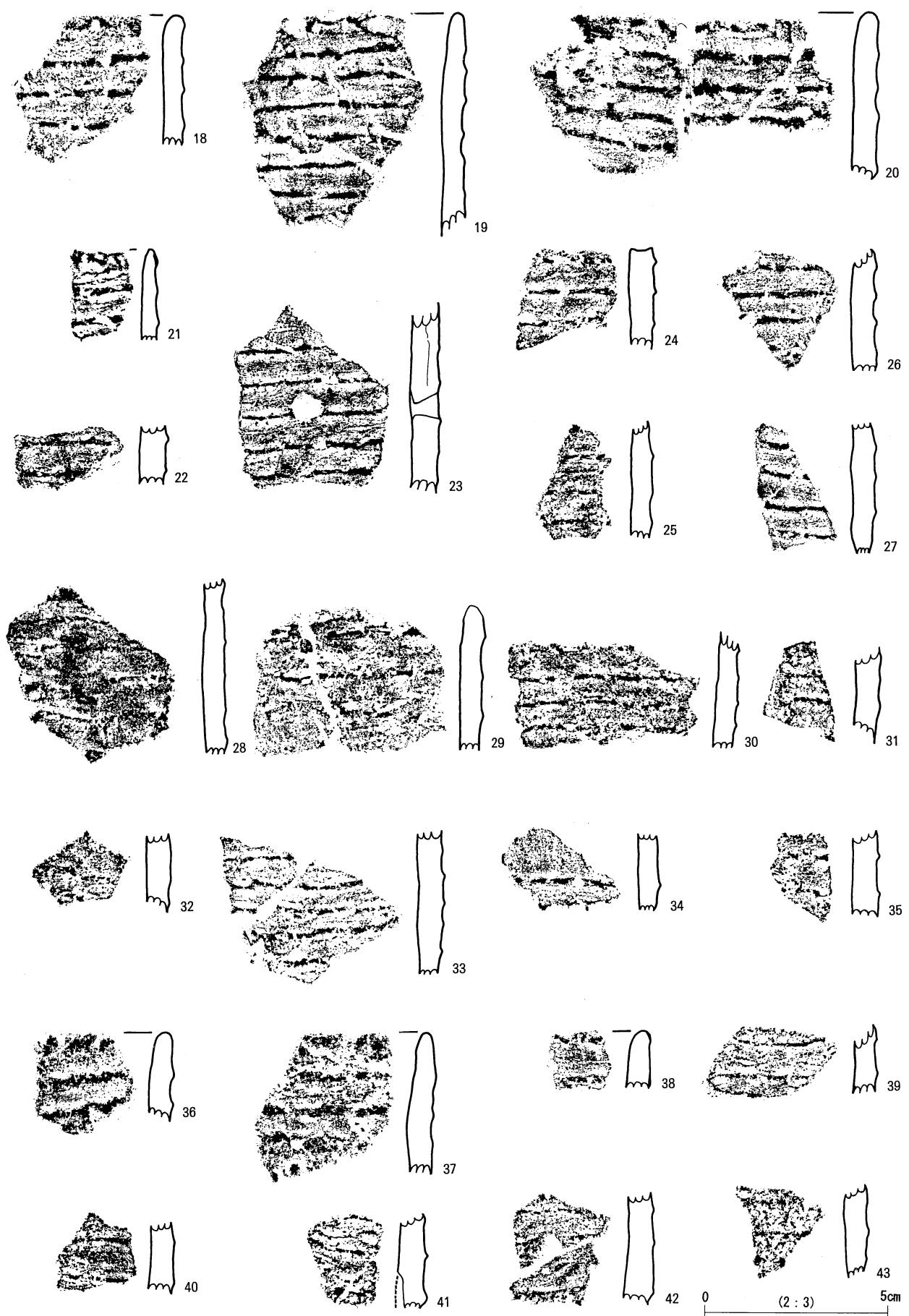

繩文時代土器 3

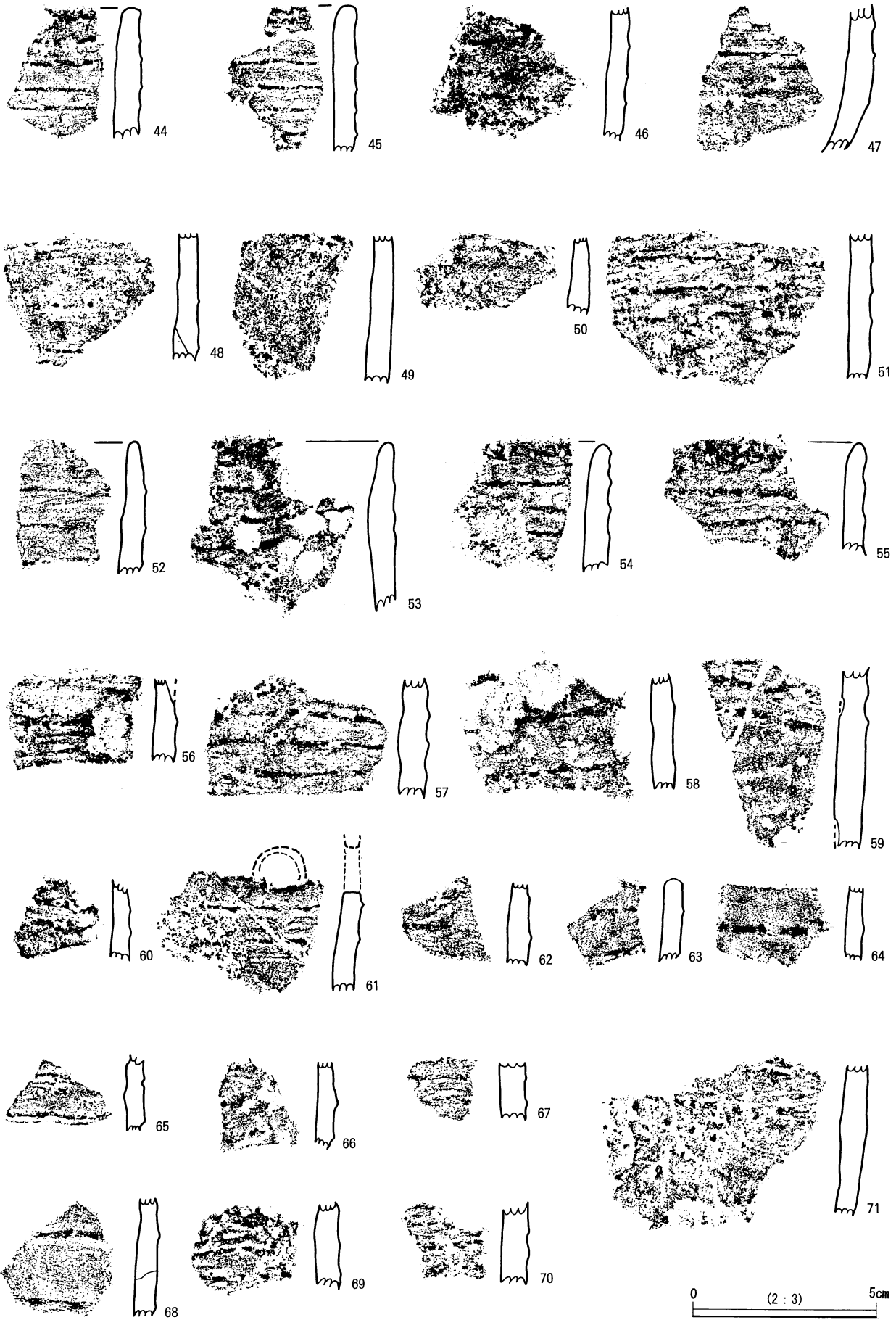

繩文時代土器 4

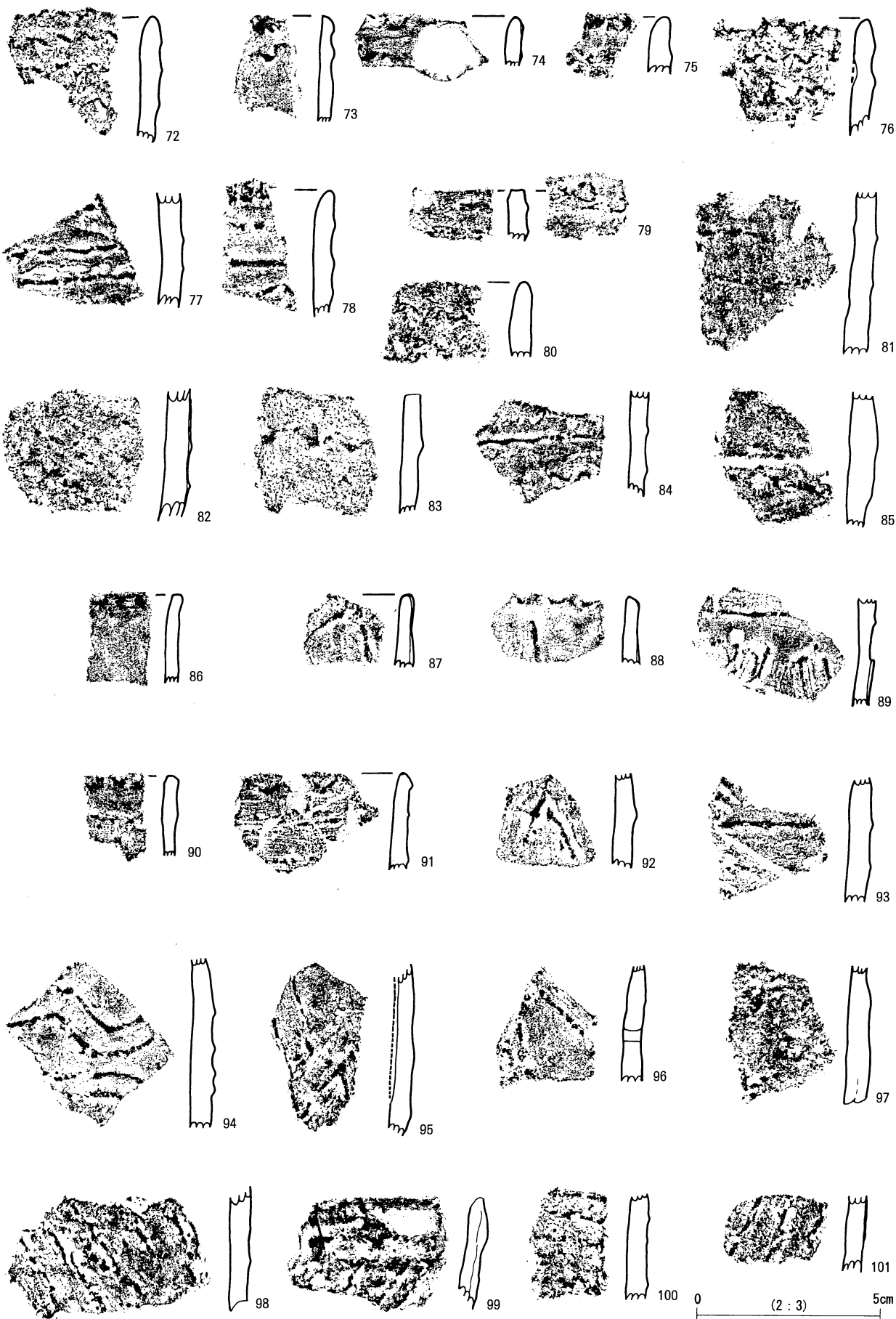

繩文時代土器 5

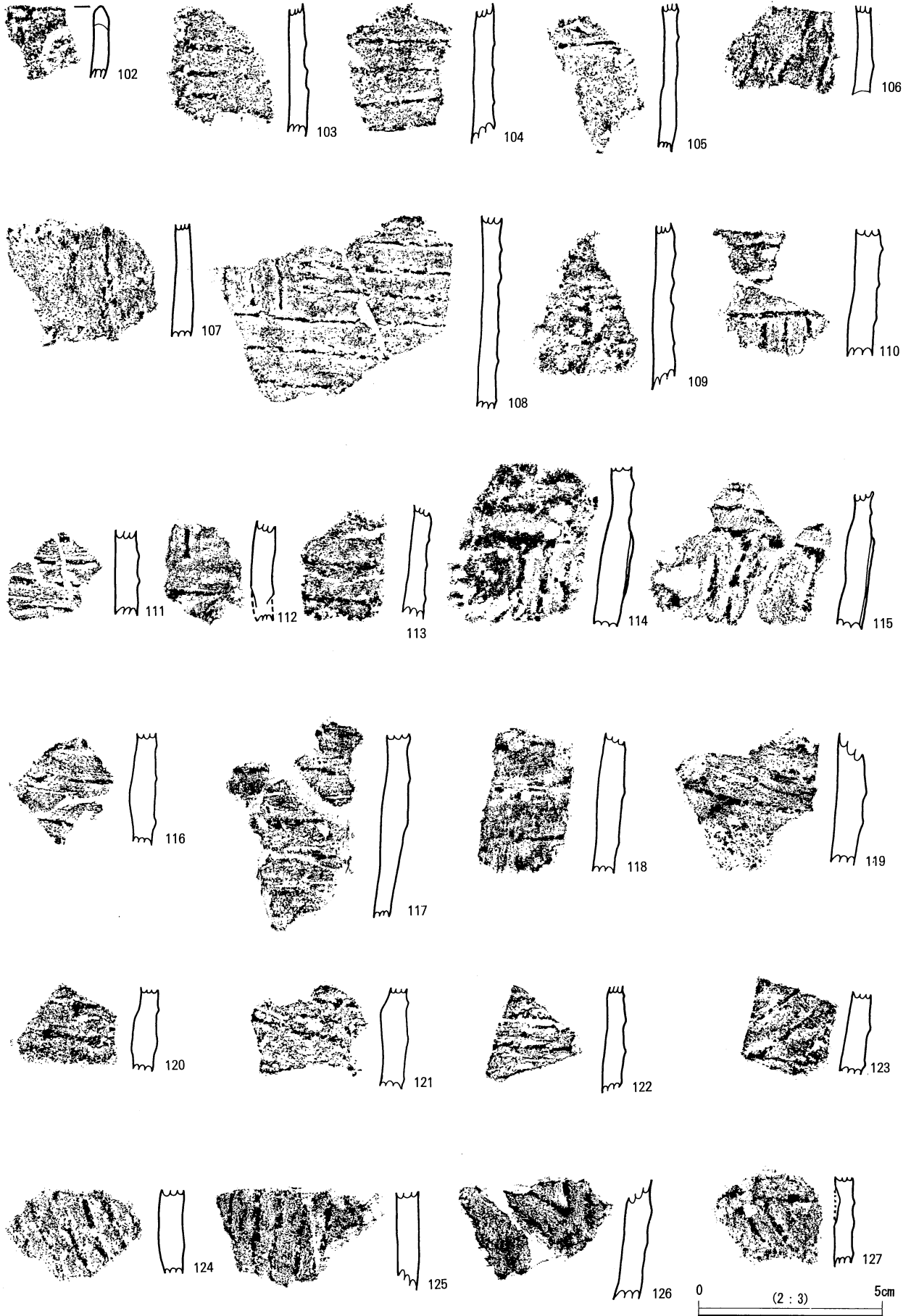

繩文時代土器 6

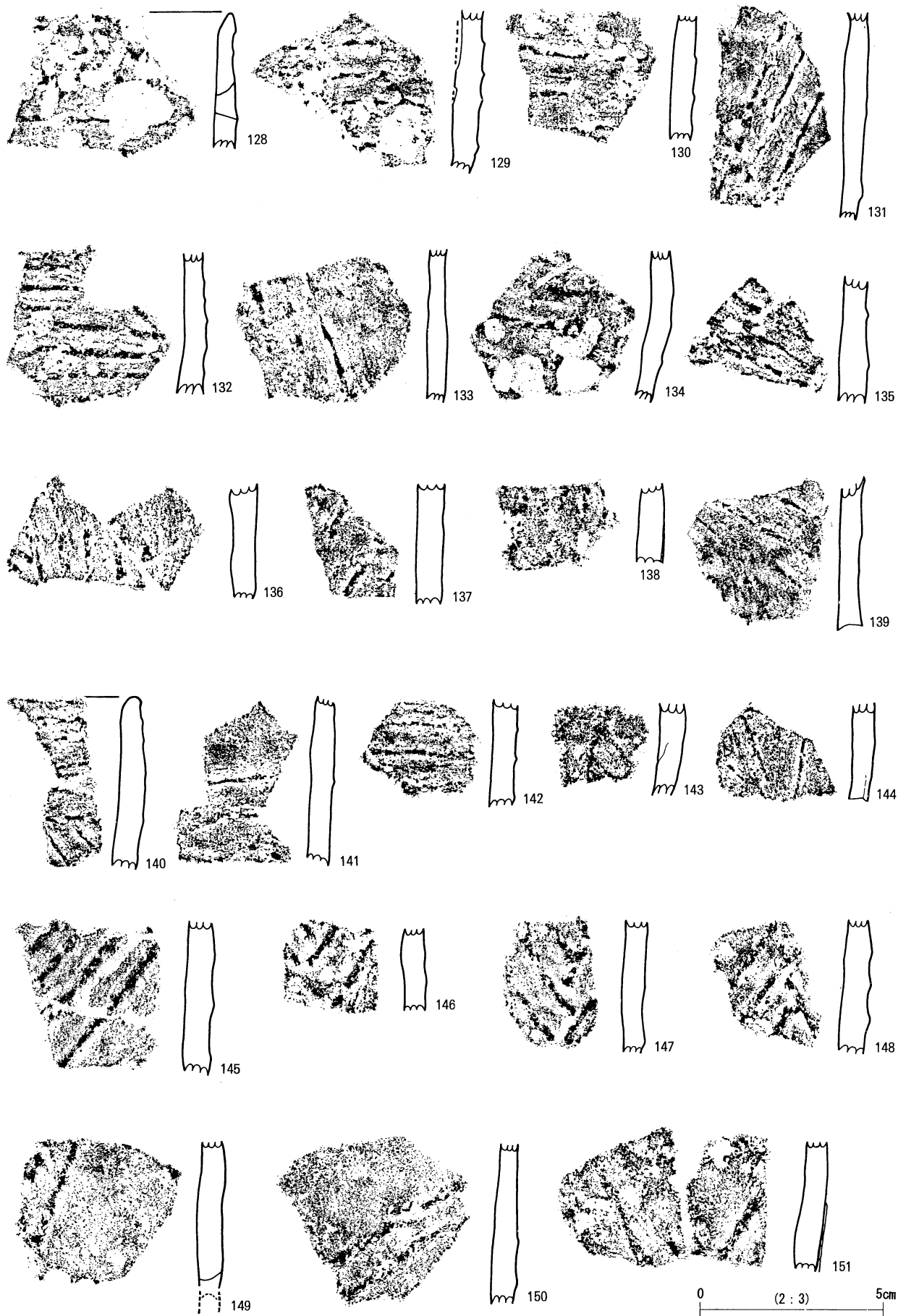

繩文時代土器 7

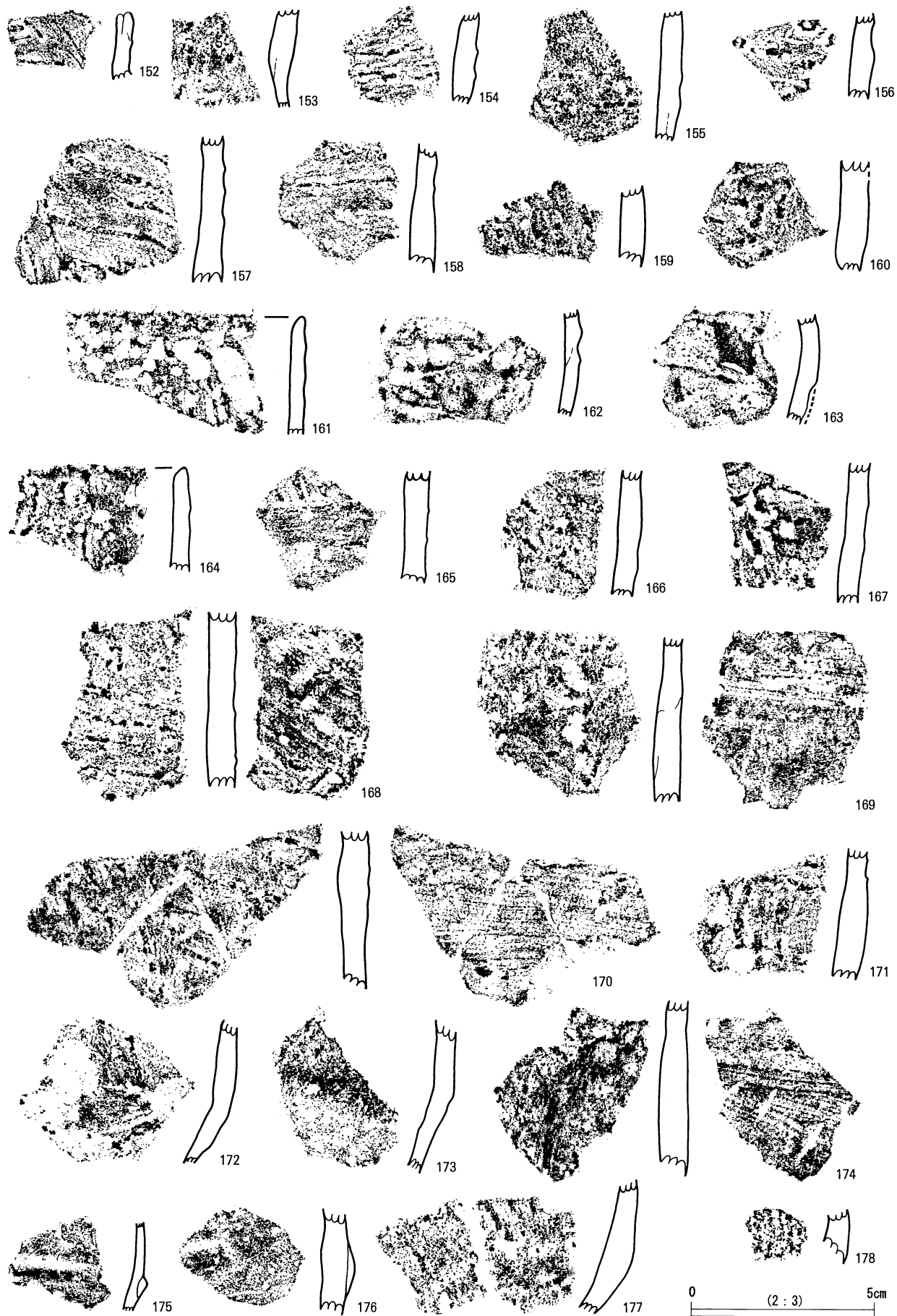

繩文時代土器 8

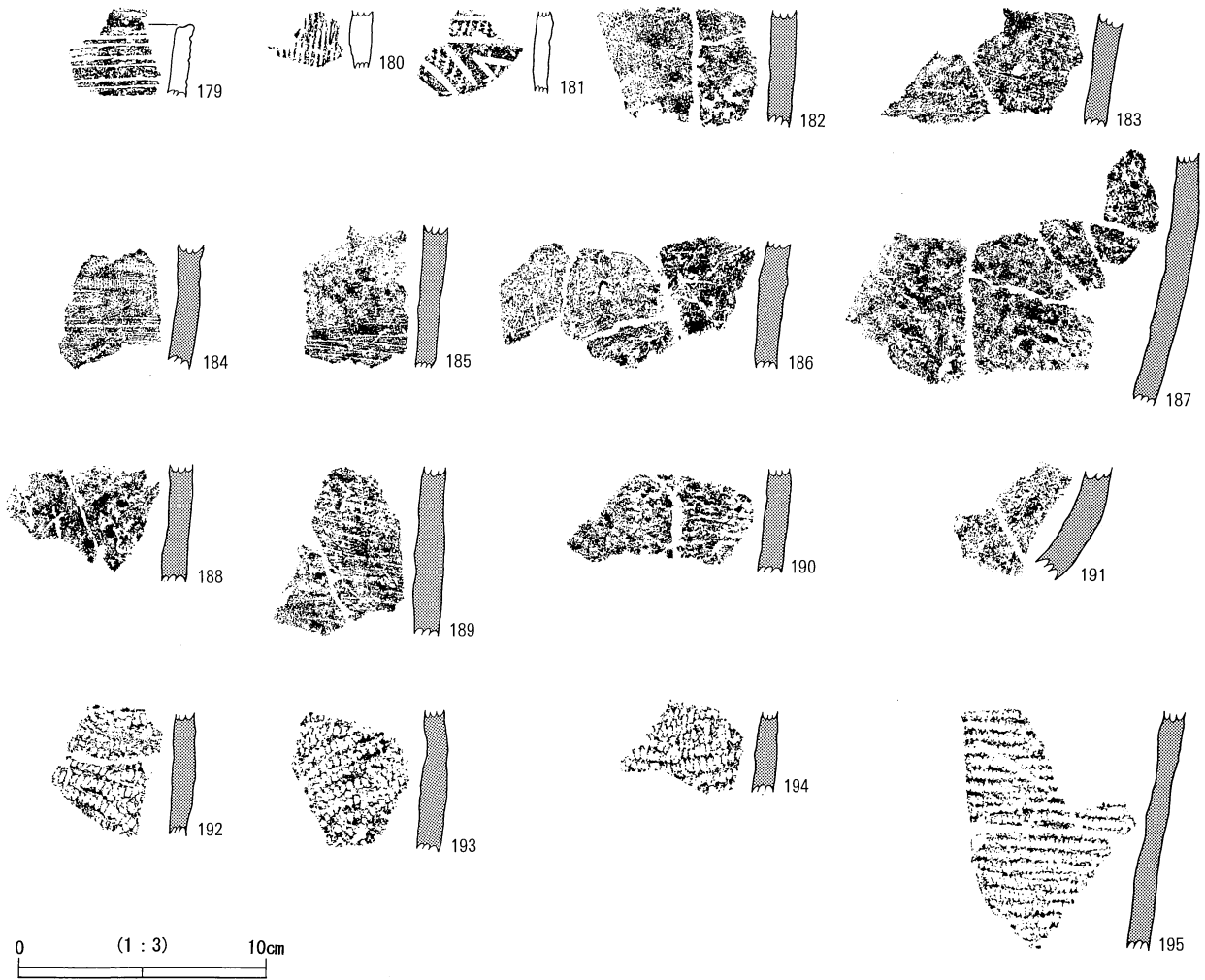

0 (1 : 3) 10cm

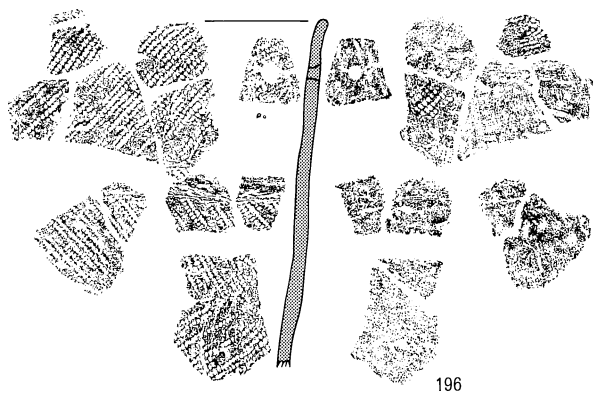

0 (1 : 4) 10cm

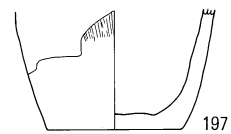
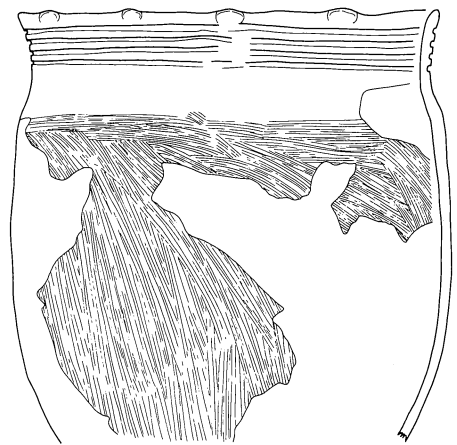

0 (1 : 6) 20cm

繩文時代土器 9

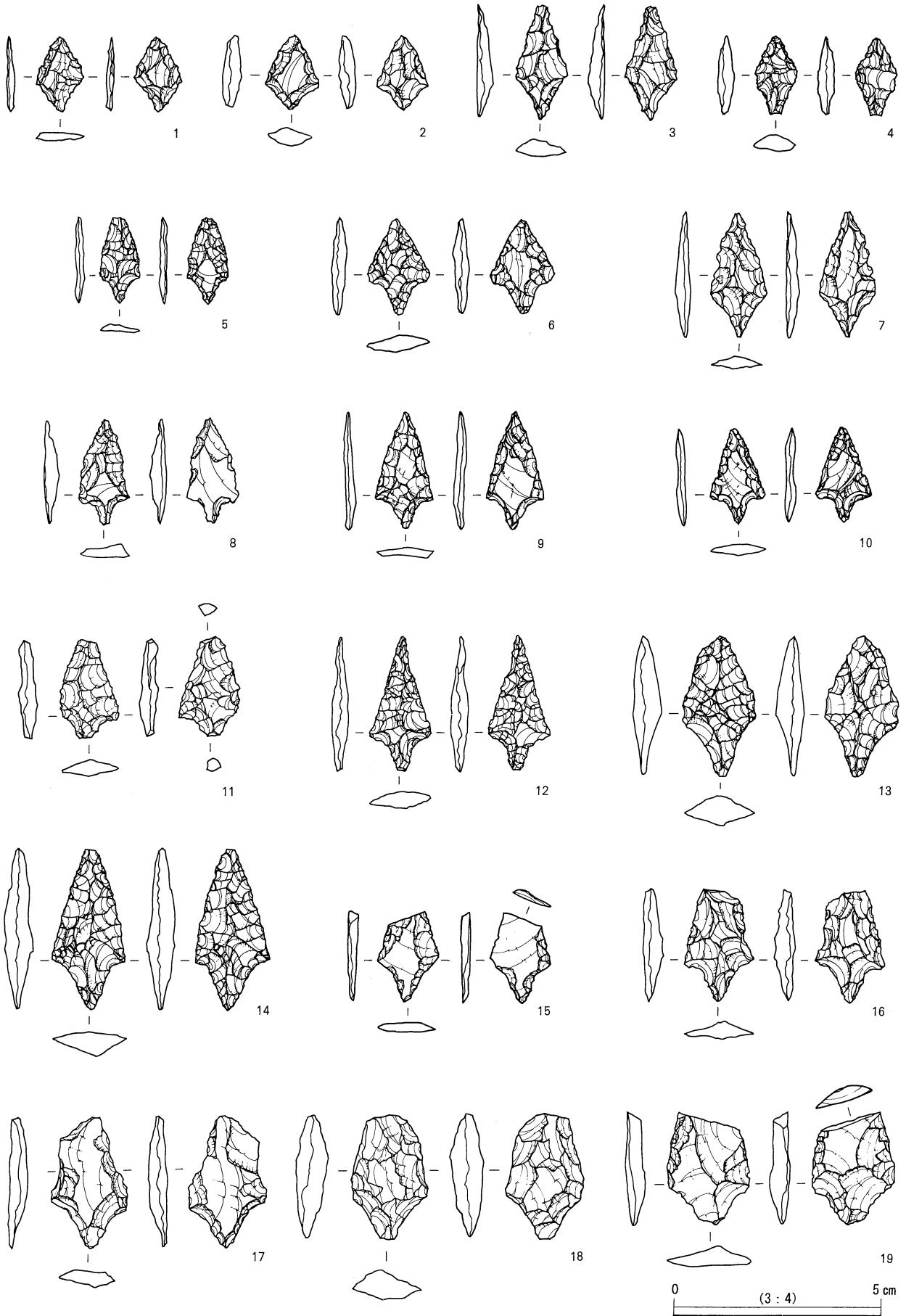

繩文時代石器 1

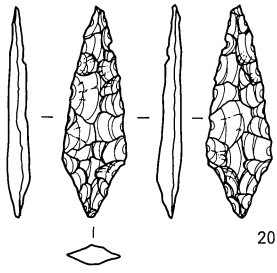

20

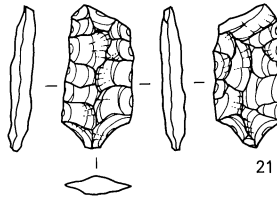

21

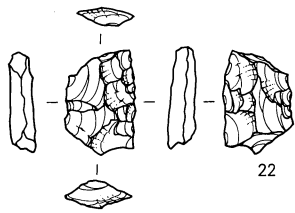

22

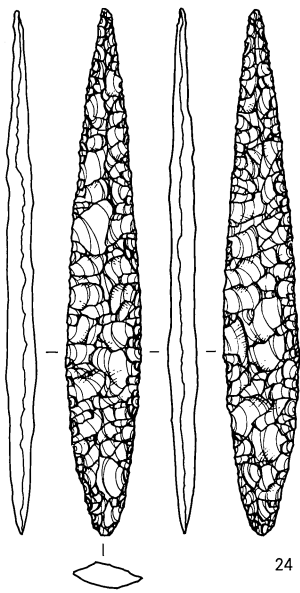

24

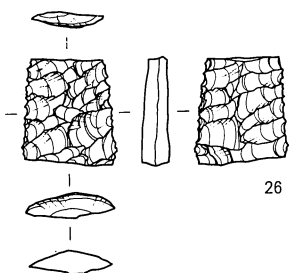

26

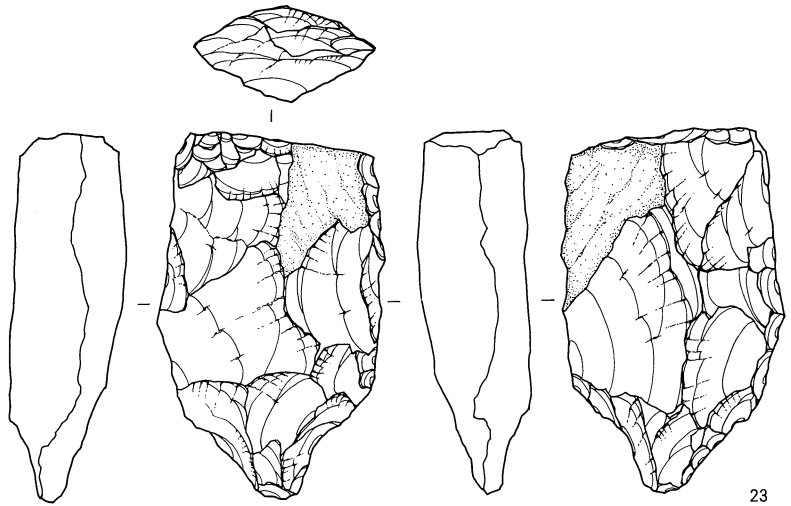

23

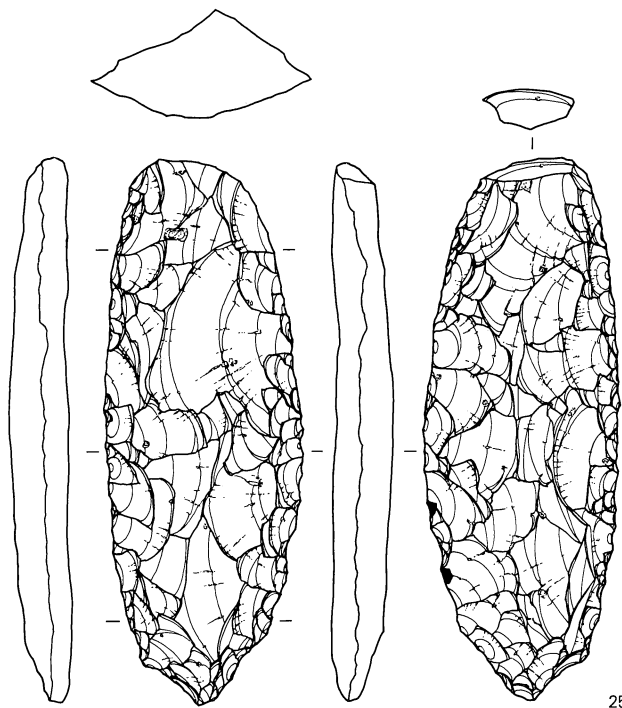

25

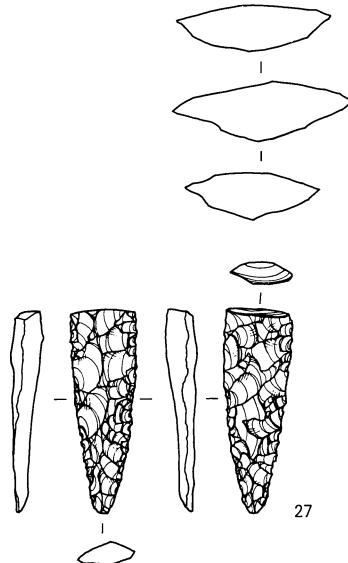

27

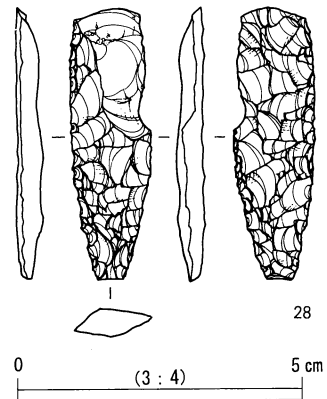

28

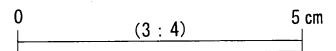

繩文時代石器 2

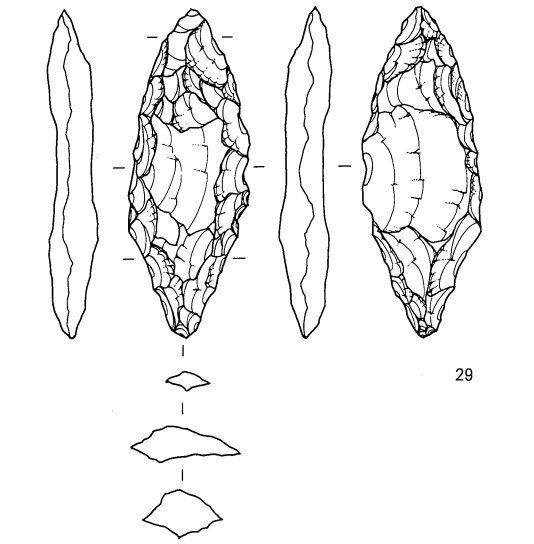

29

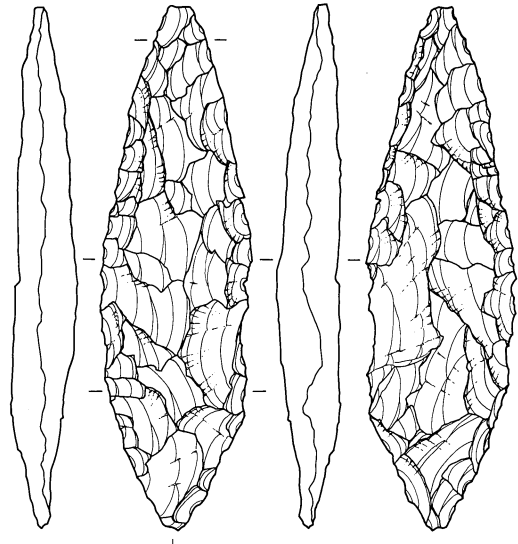

30

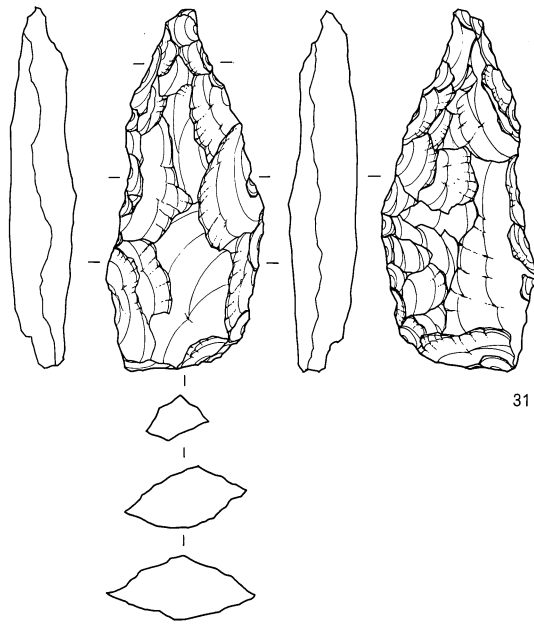

31

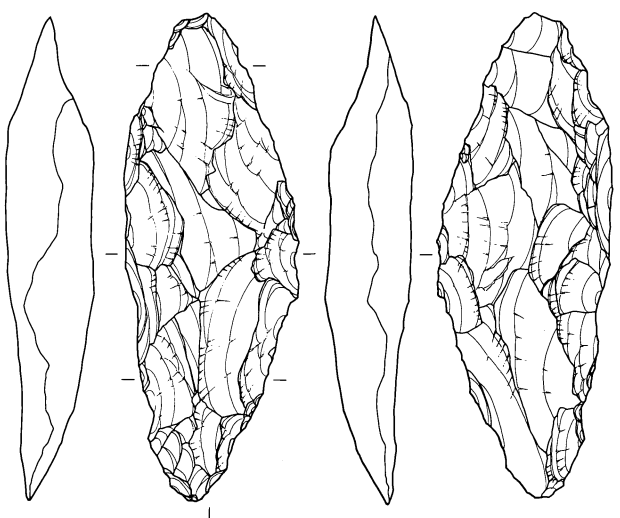

32

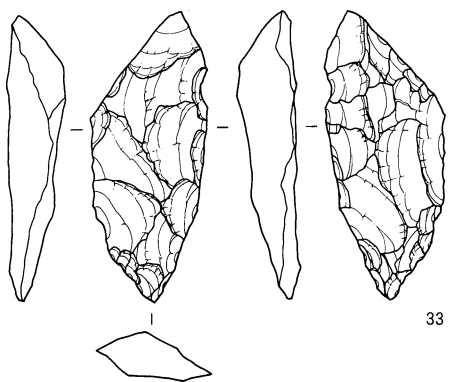

33

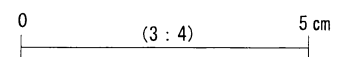



繩文時代石器 4

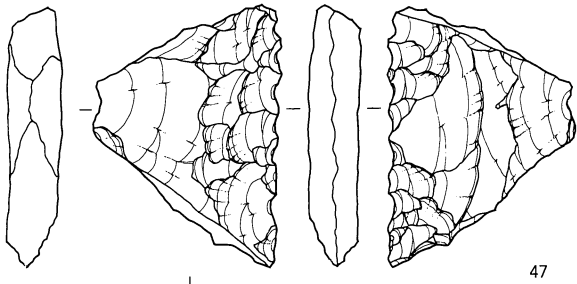

47

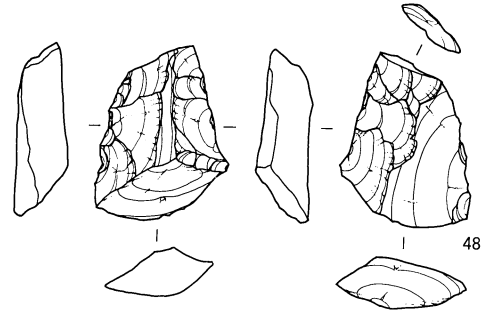

48

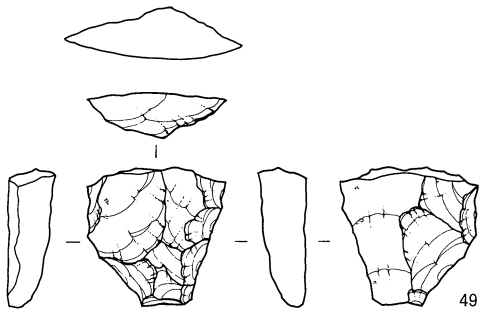

49

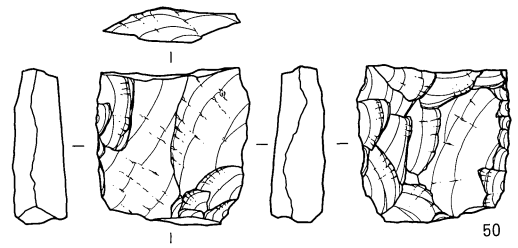

50

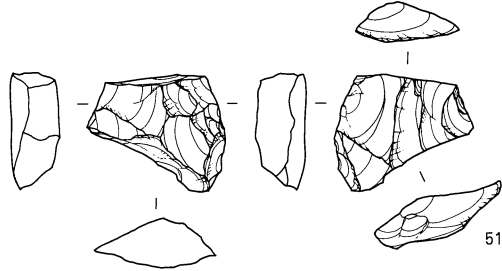

51

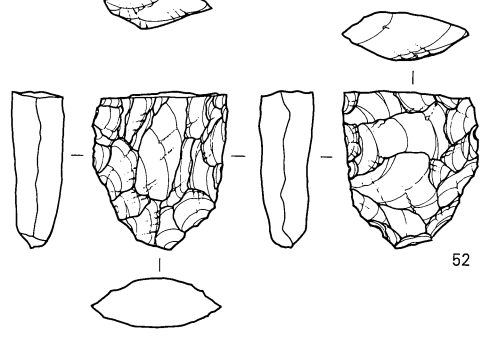

52

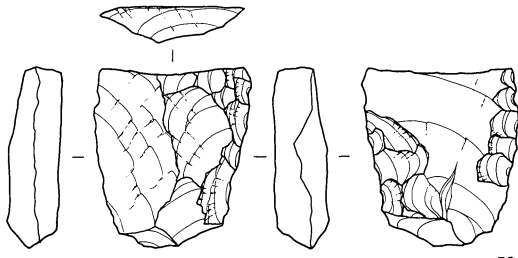

53

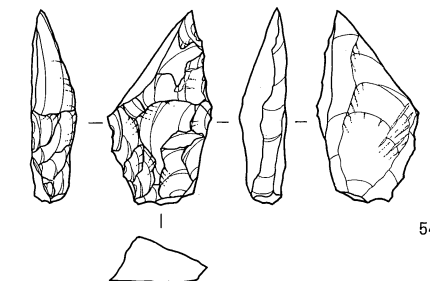

54

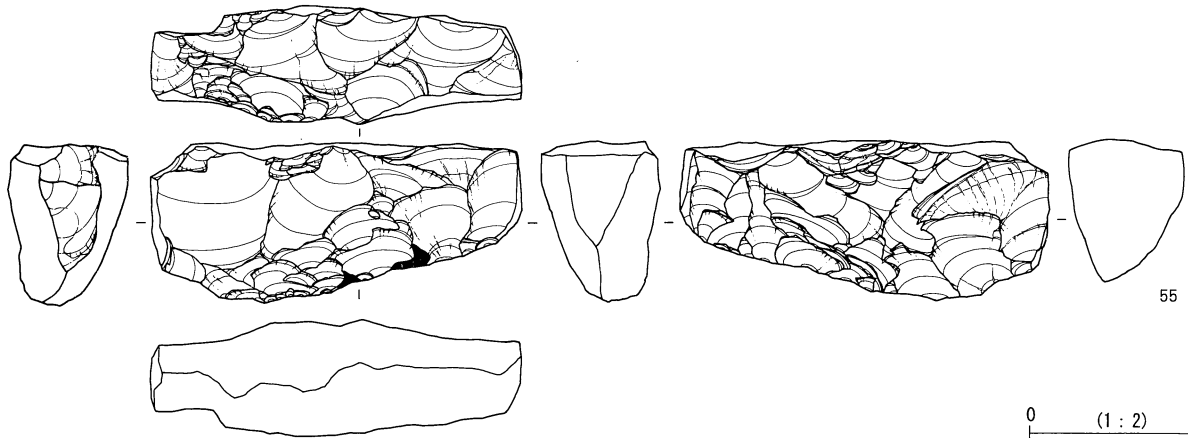
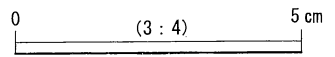

55

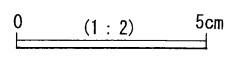

繩文時代石器 5

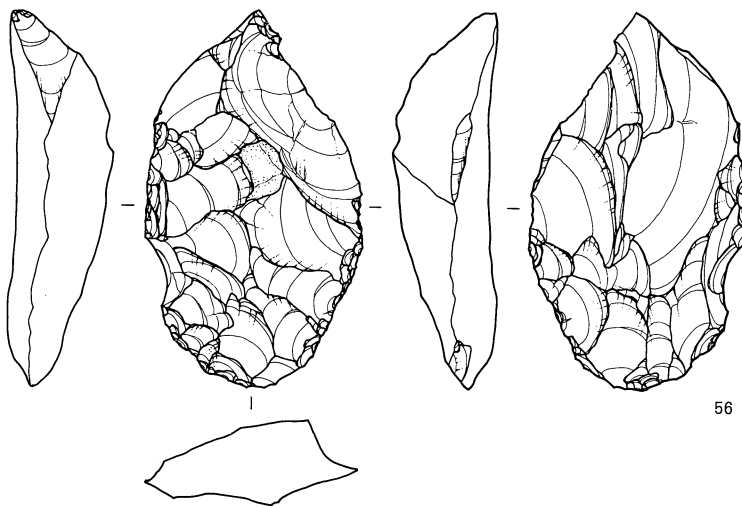

56

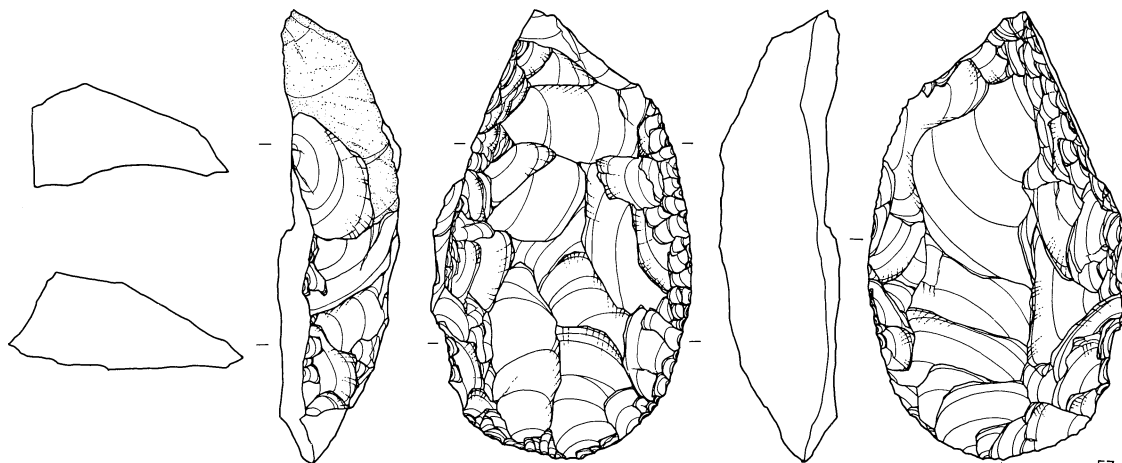

57

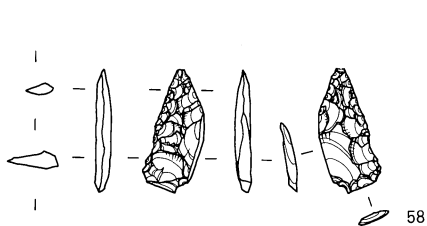

58

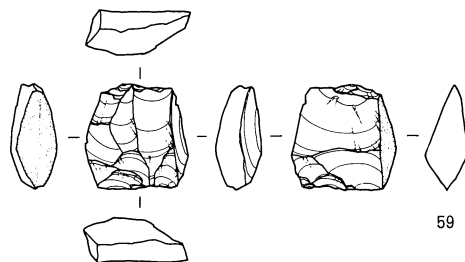

59

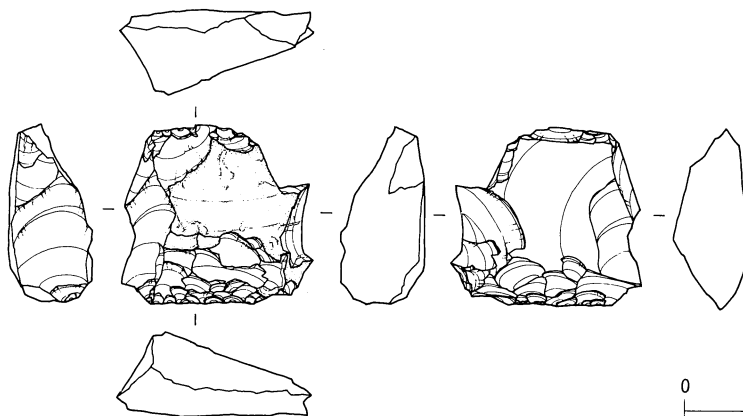

60

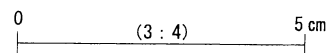

繩文時代石器 6

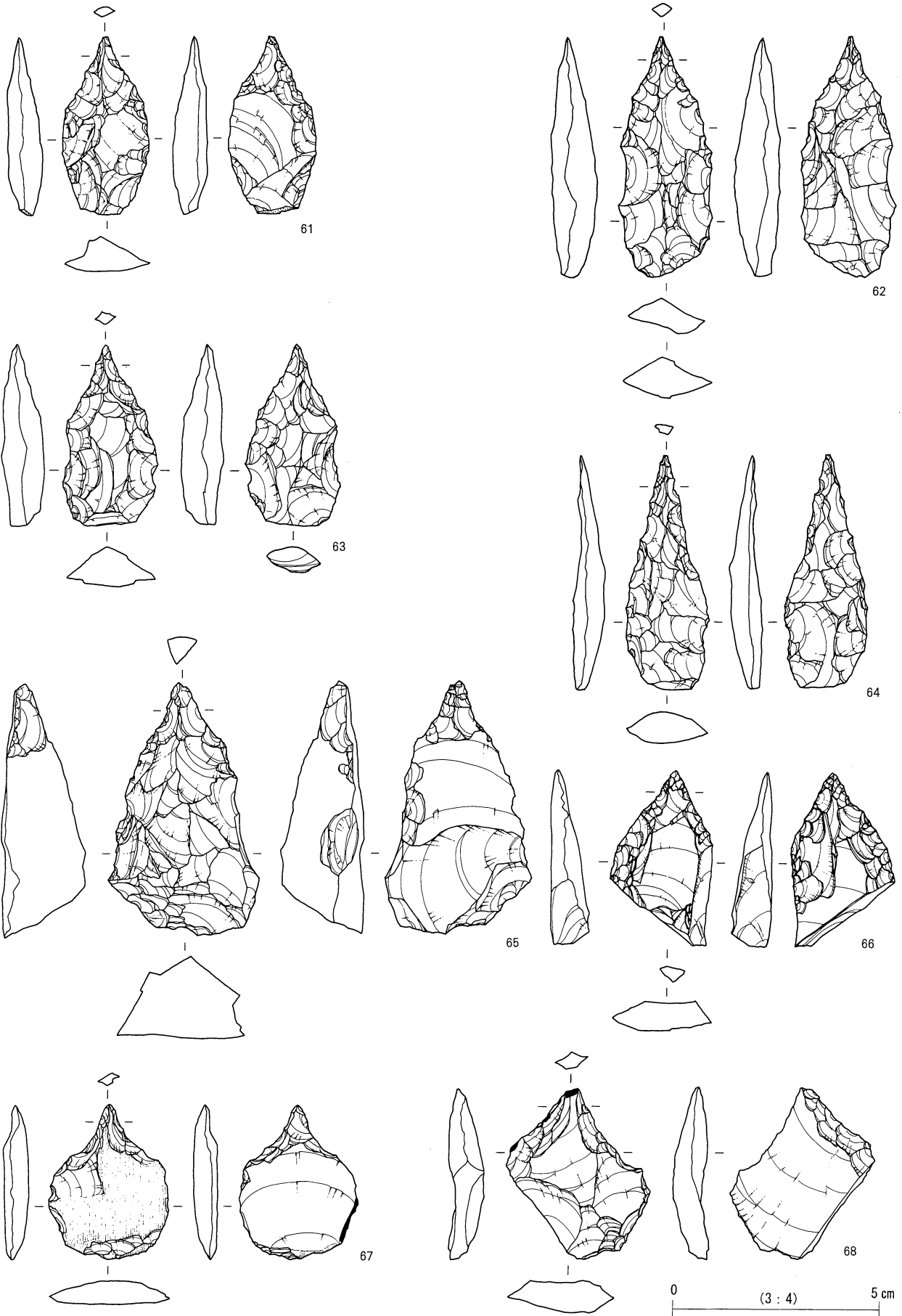

繩文時代石器 7

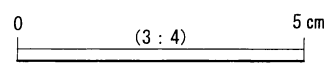
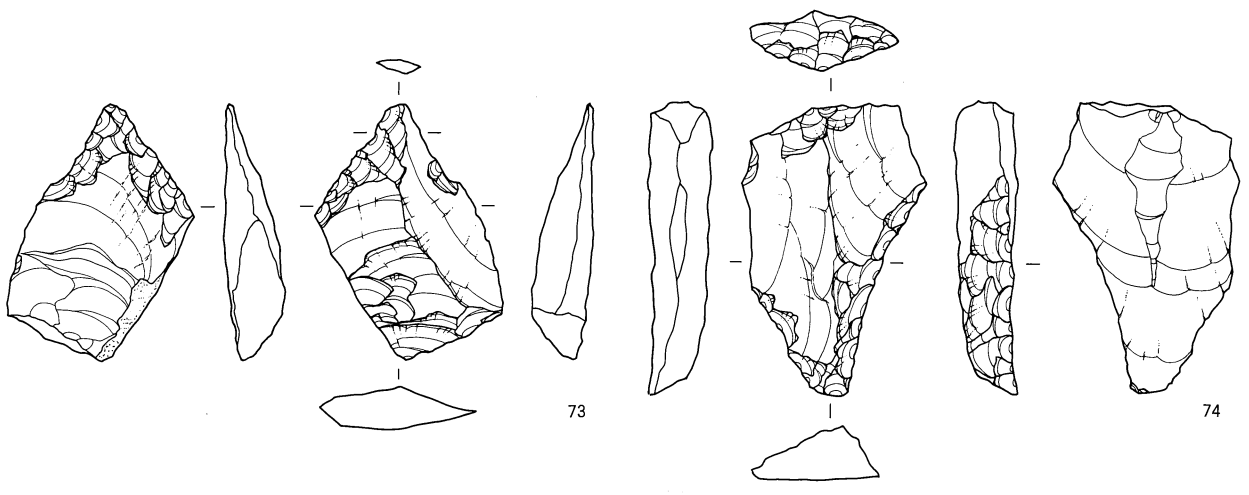
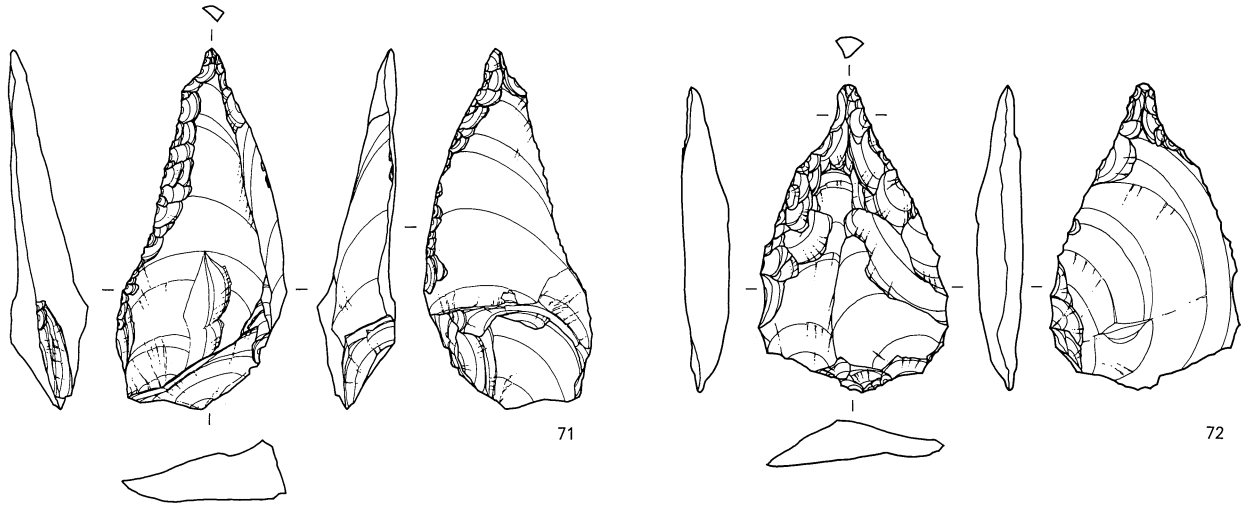
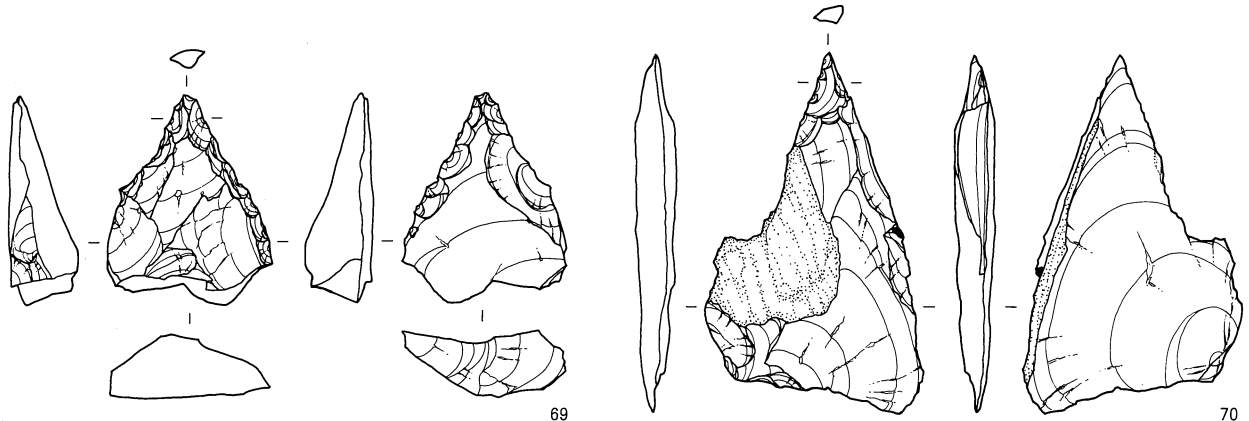



繩文時代石器 9



繩文時代石器 10



縄文時代石器 11



繩文時代石器 12

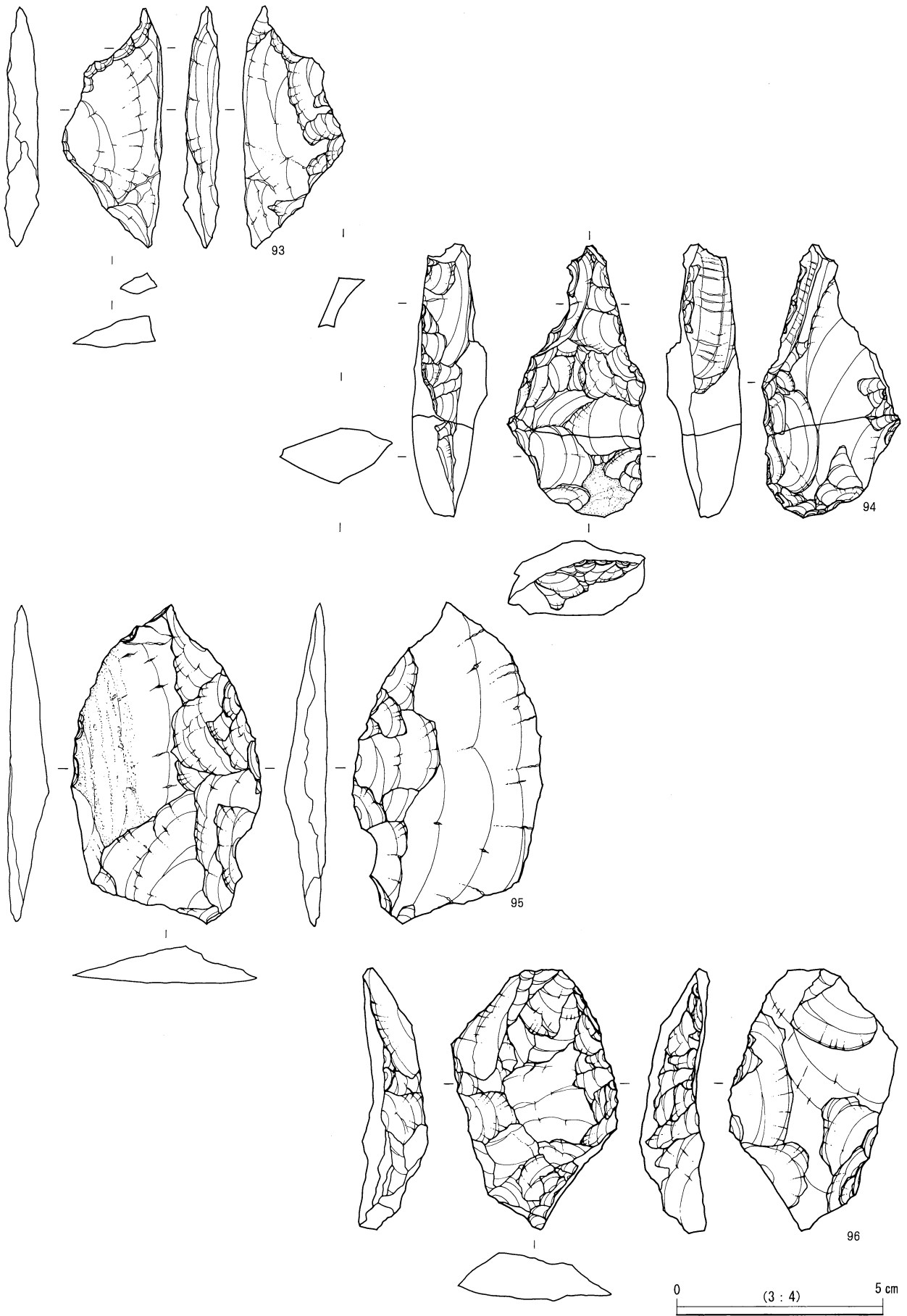

繩文時代石器 13

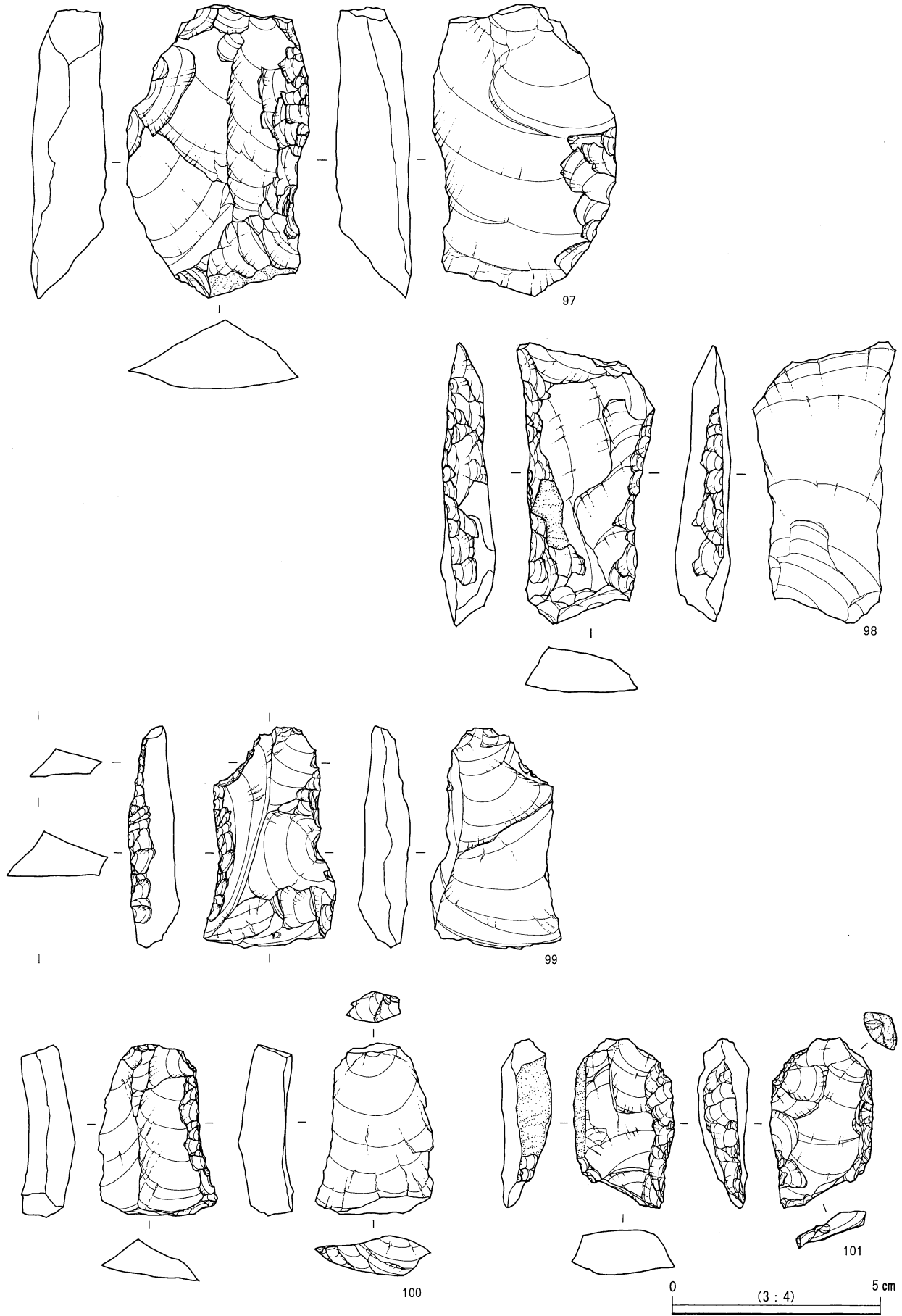

繩文時代石器 14

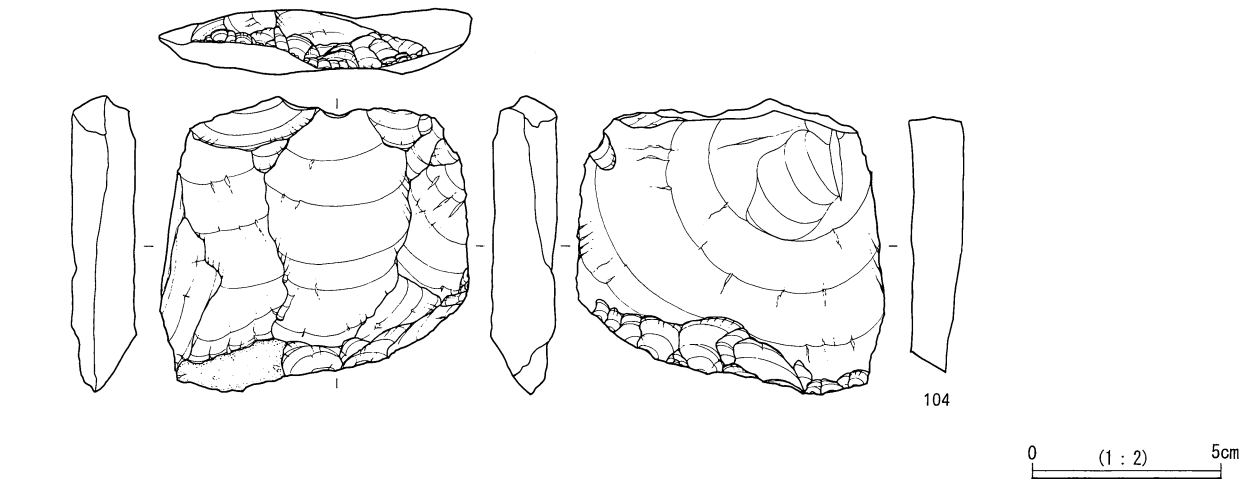
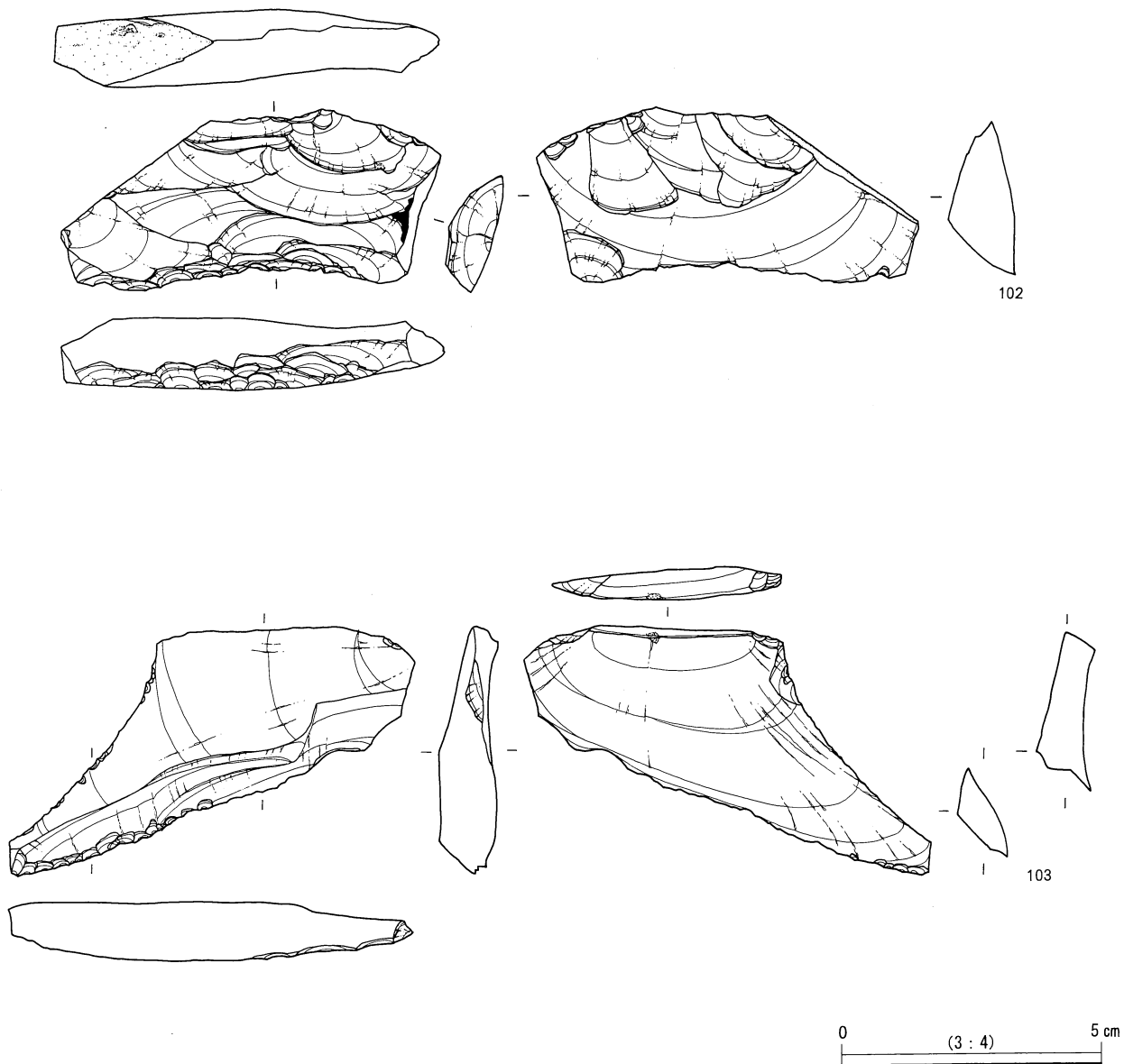

繩文時代石器 15

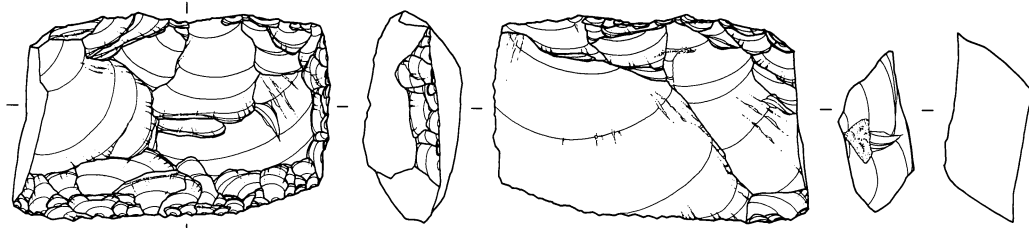

105

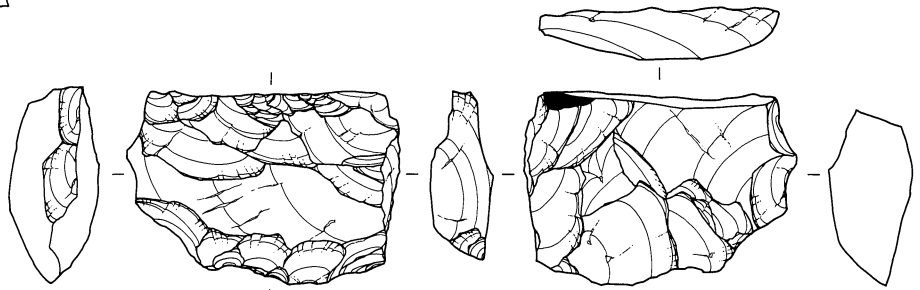

106

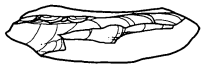
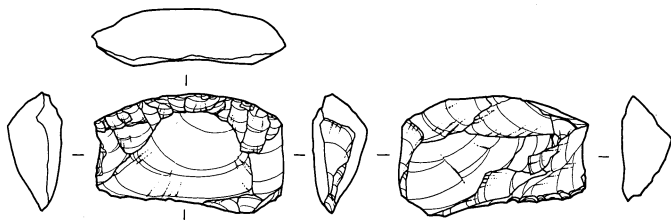

107

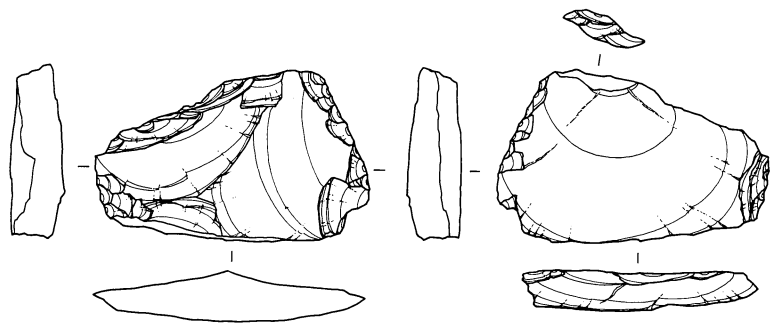

108

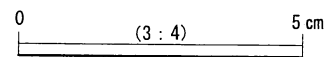

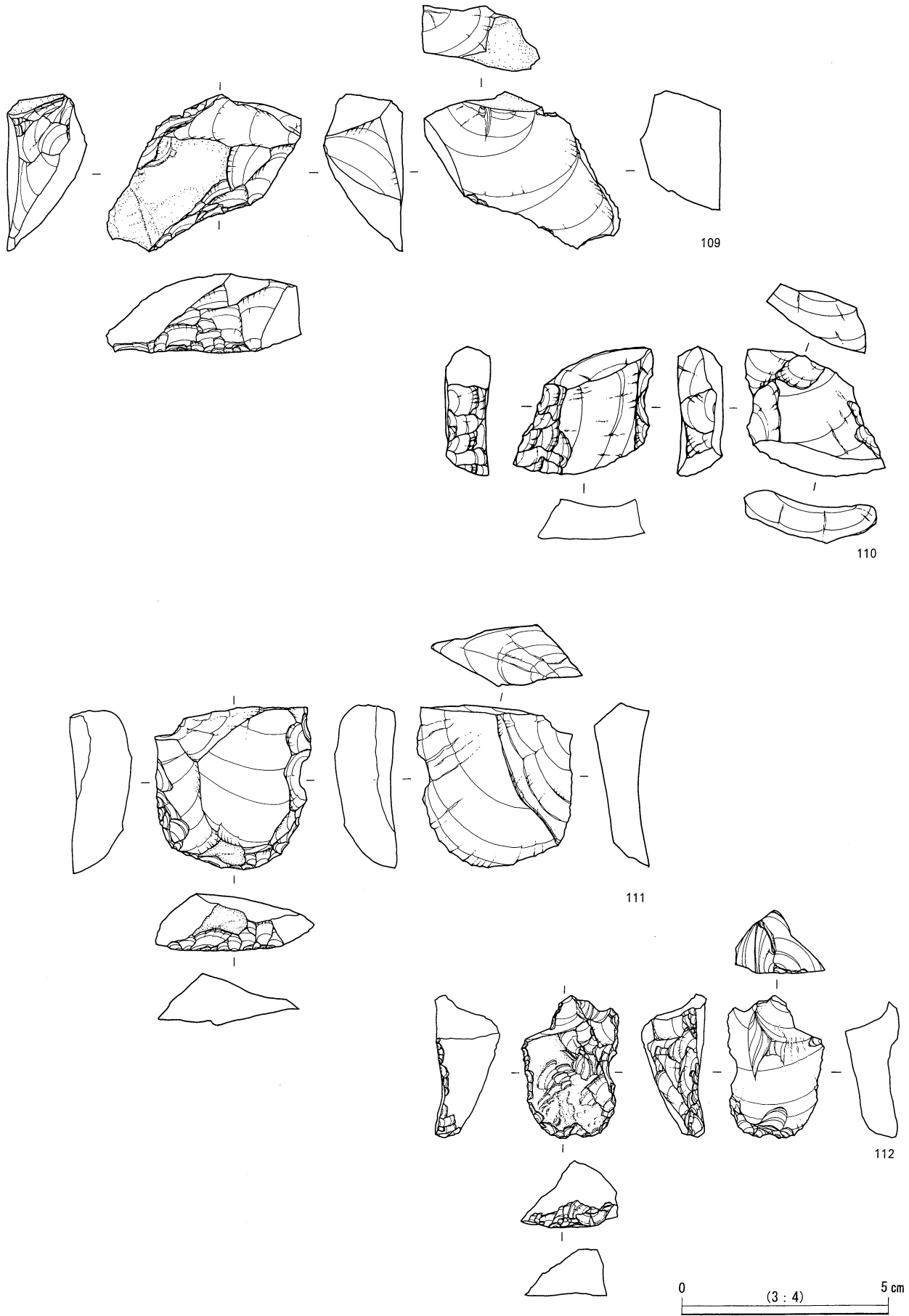

繩文時代石器 17

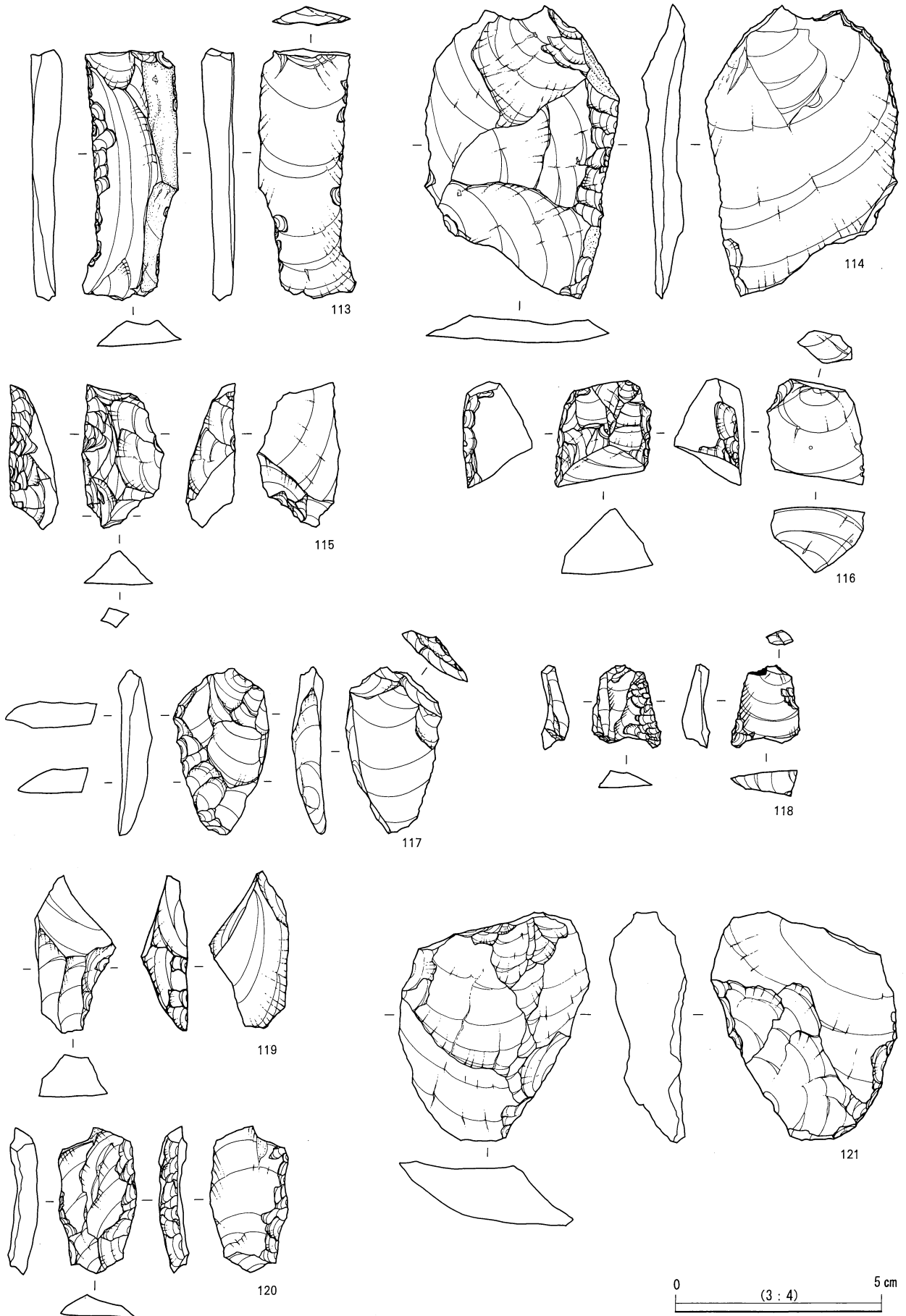

繩文時代石器 18

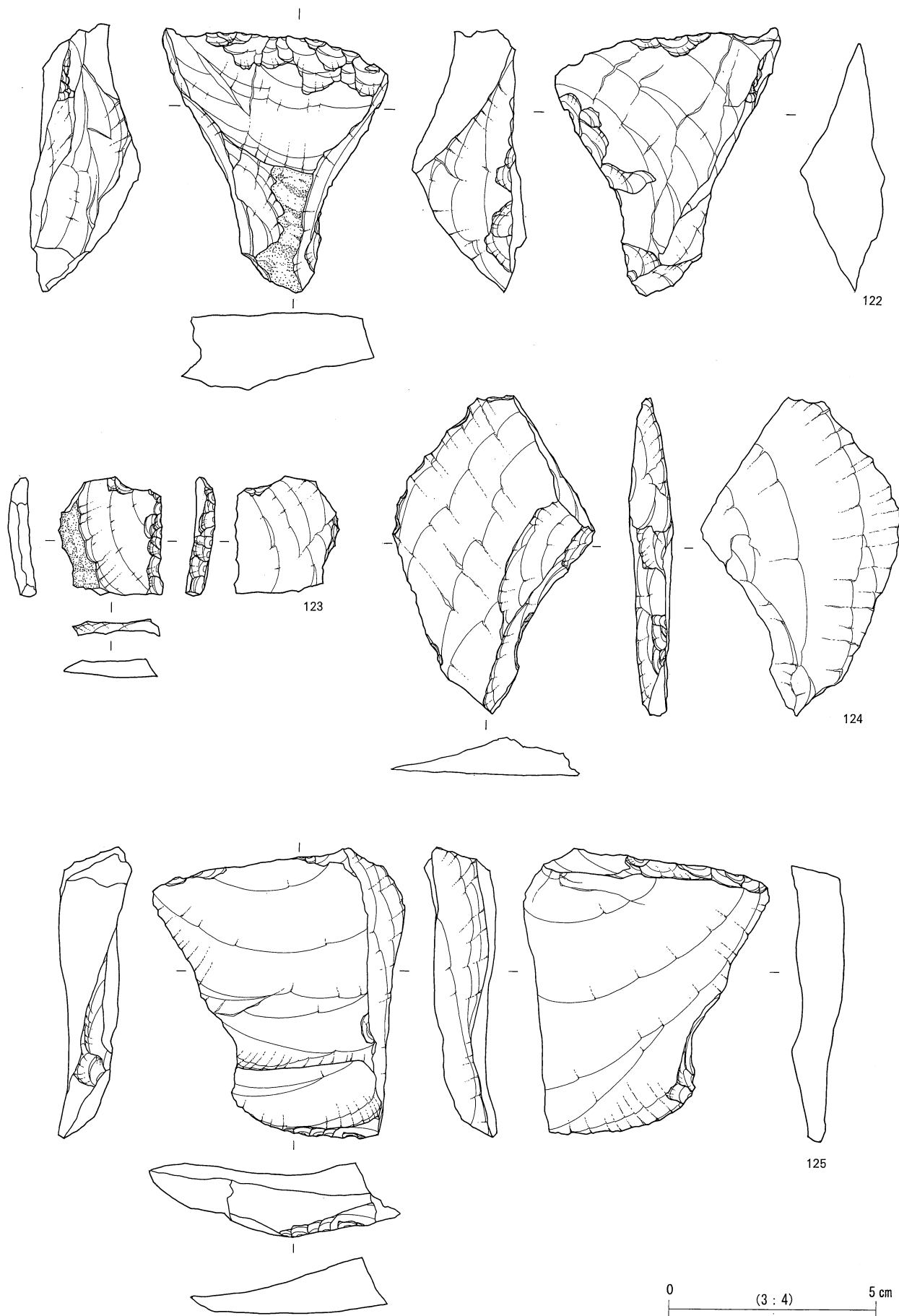

縄文時代石器 19

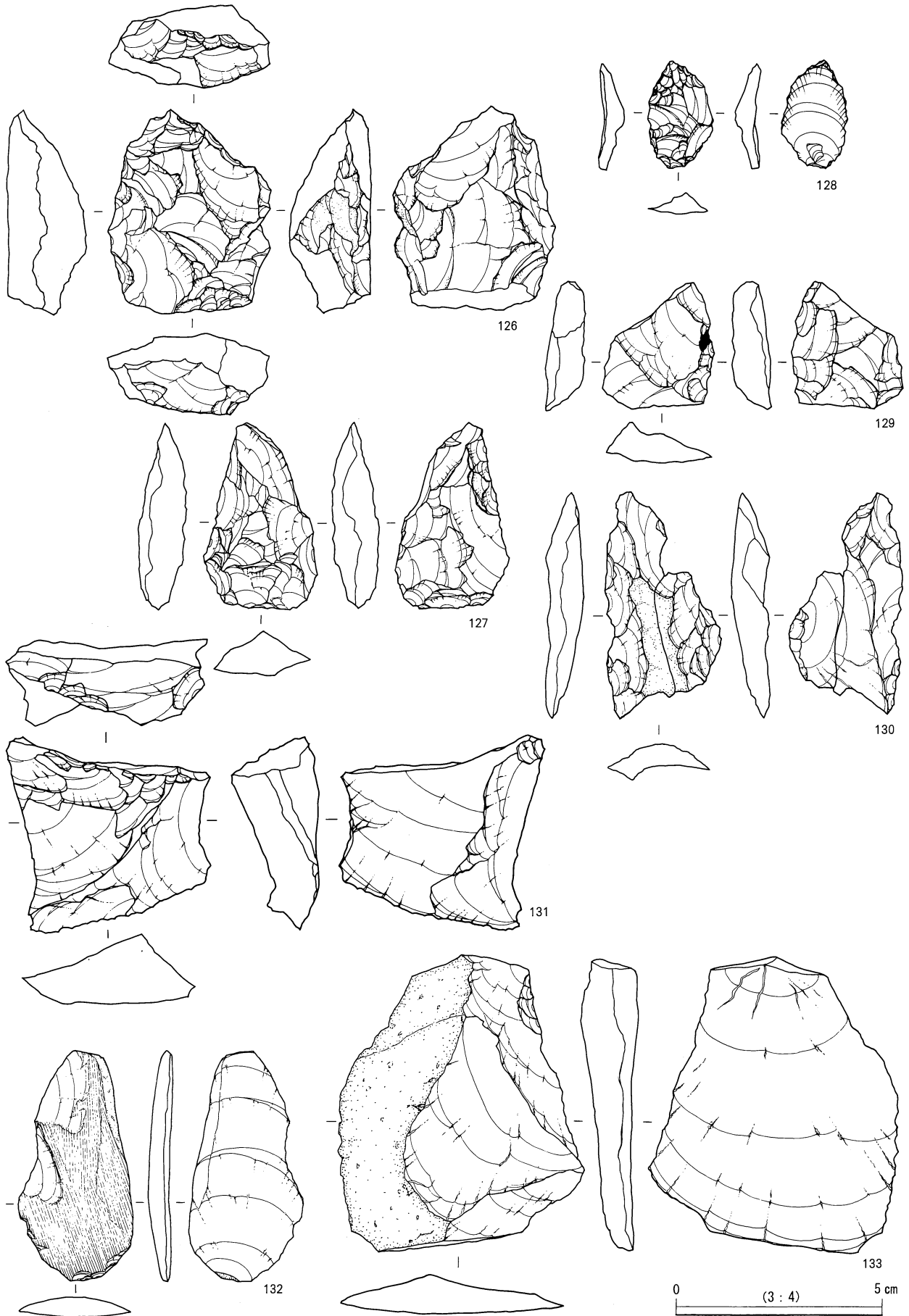

繩文時代石器 20

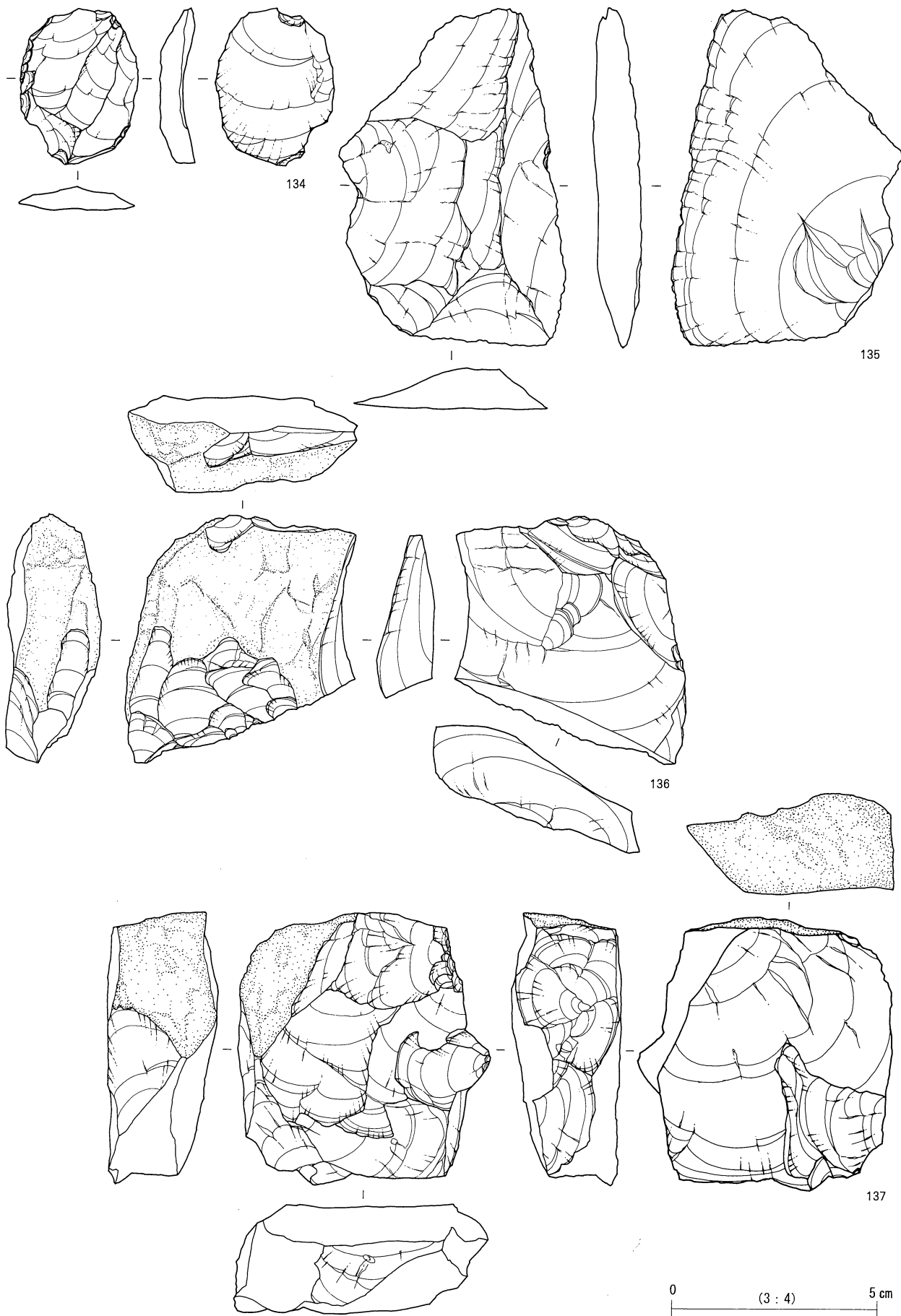

繩文時代石器 21

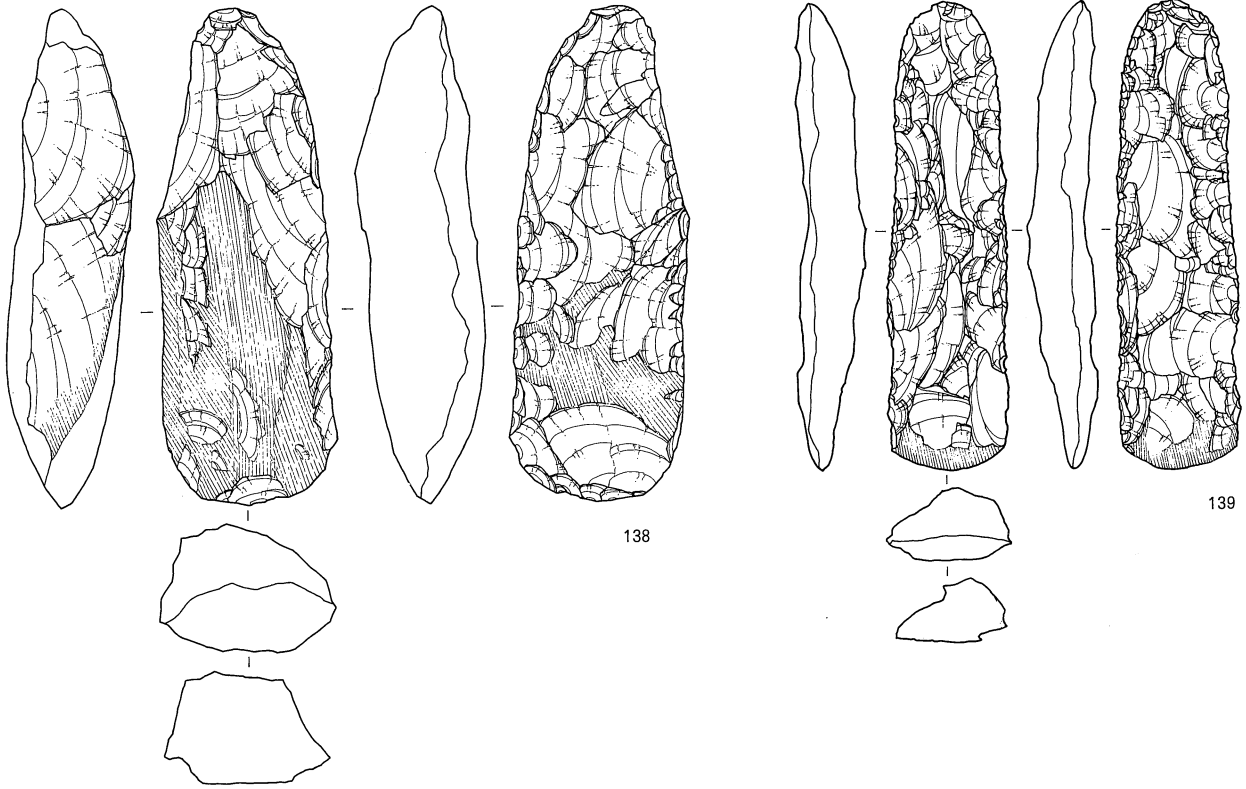

138

139

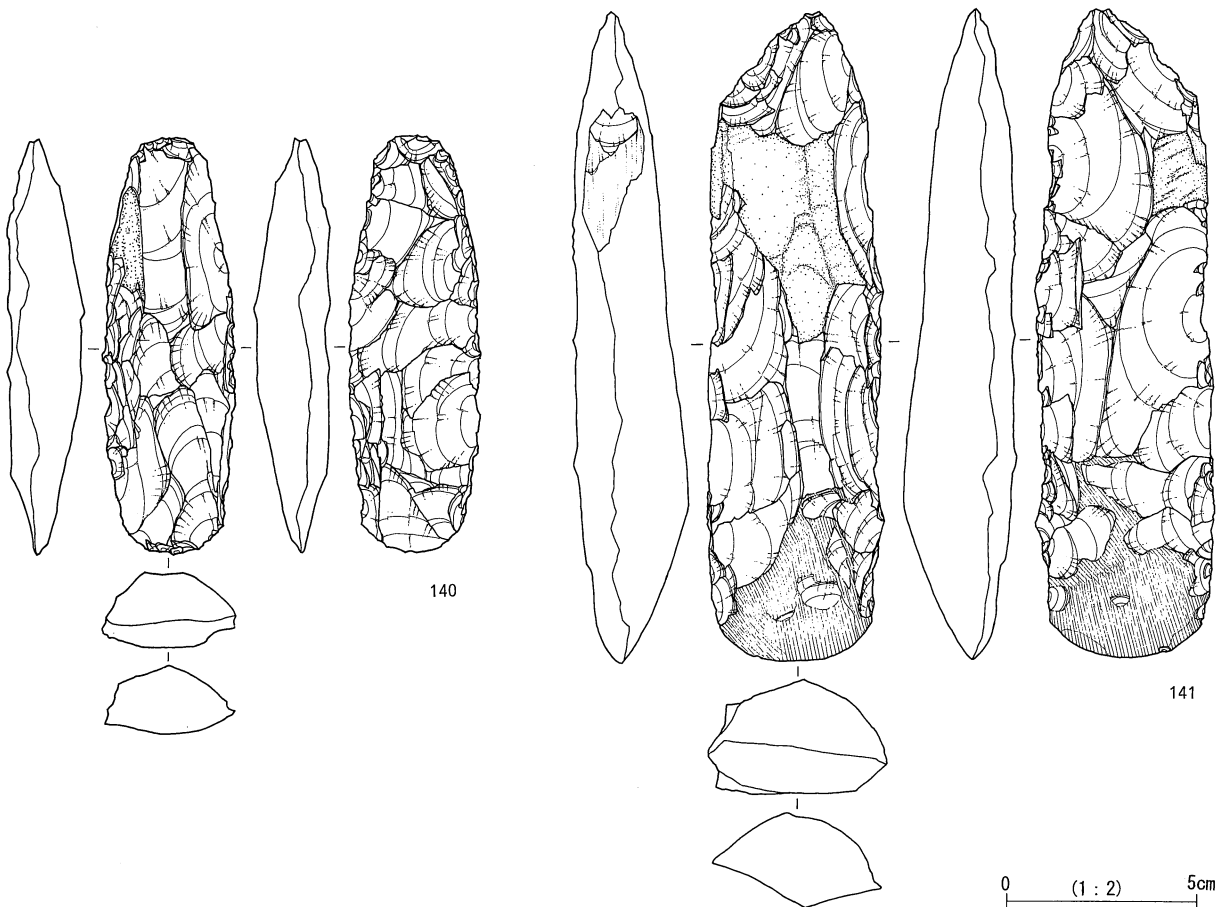

140

141

0 (1 : 2) 5cm

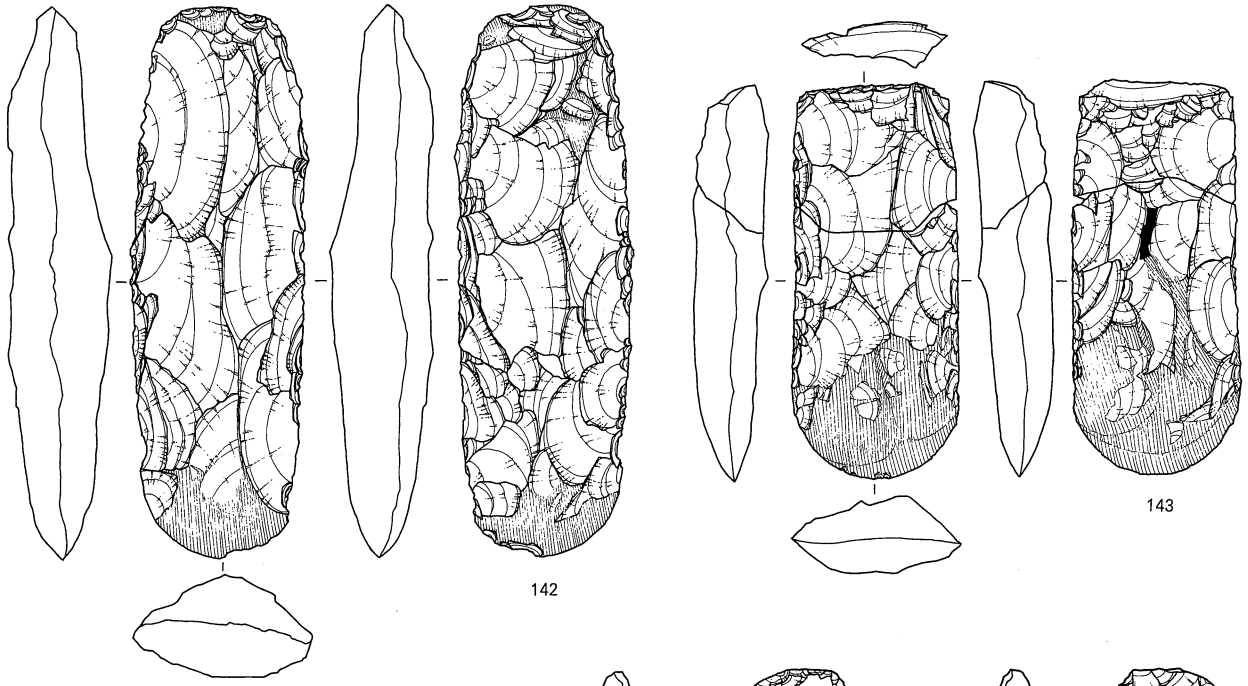

142

143

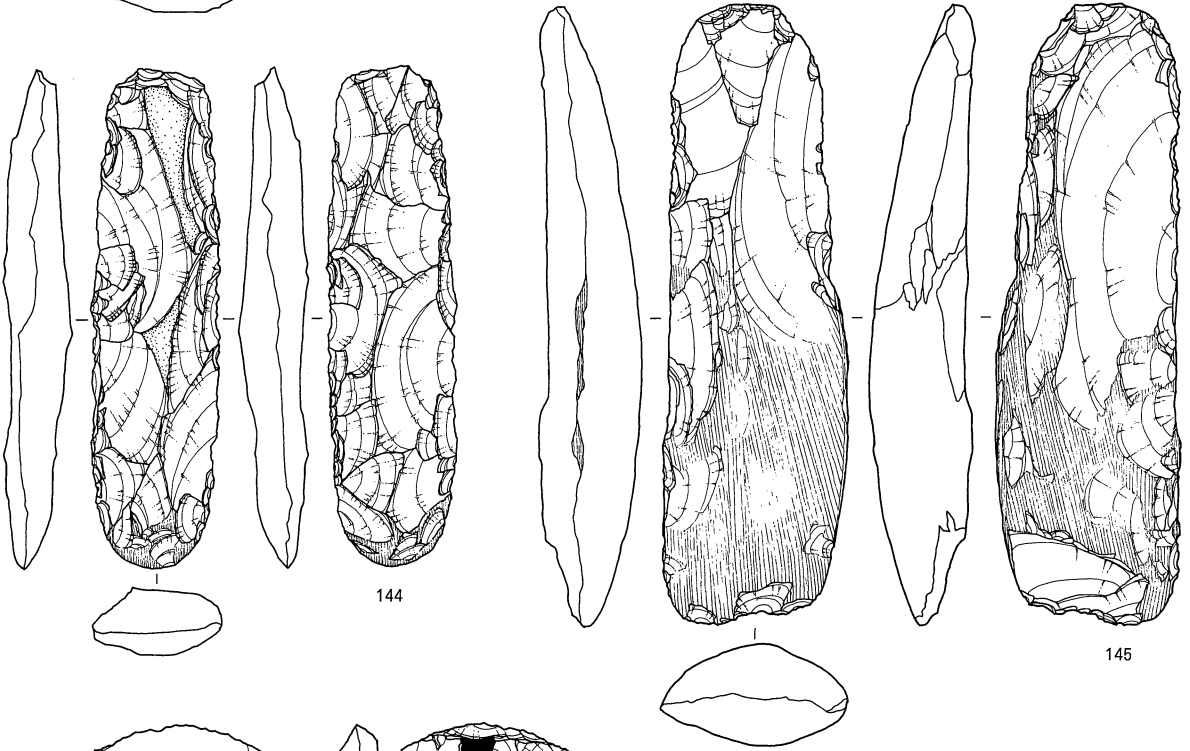

144

145

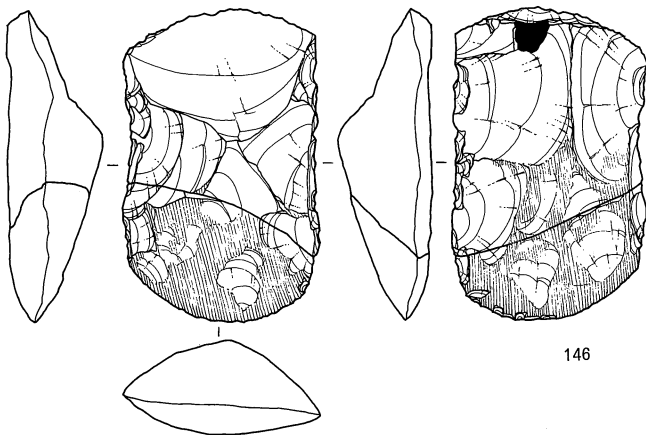

146

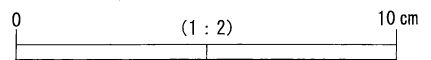

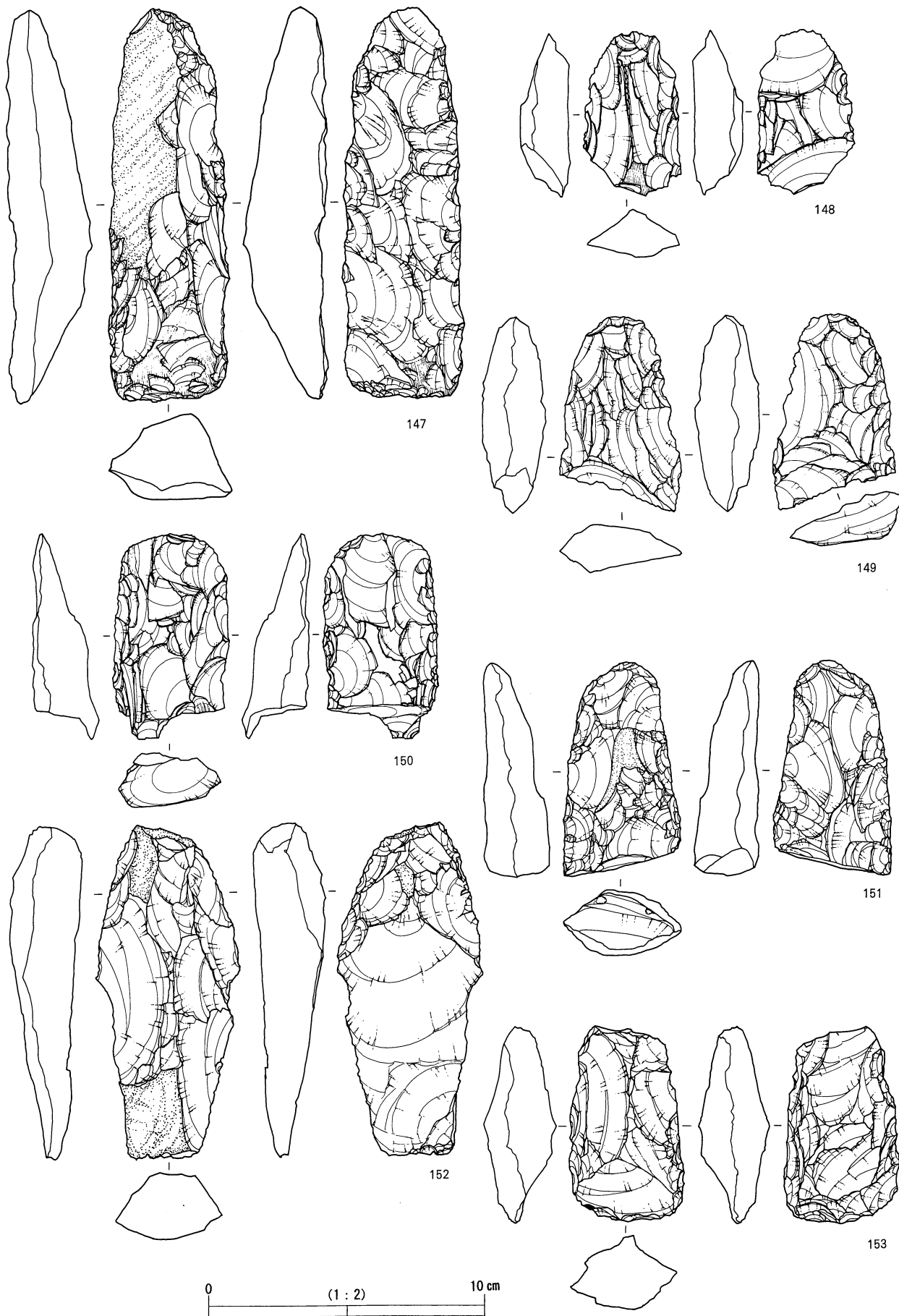

繩文時代石器 24

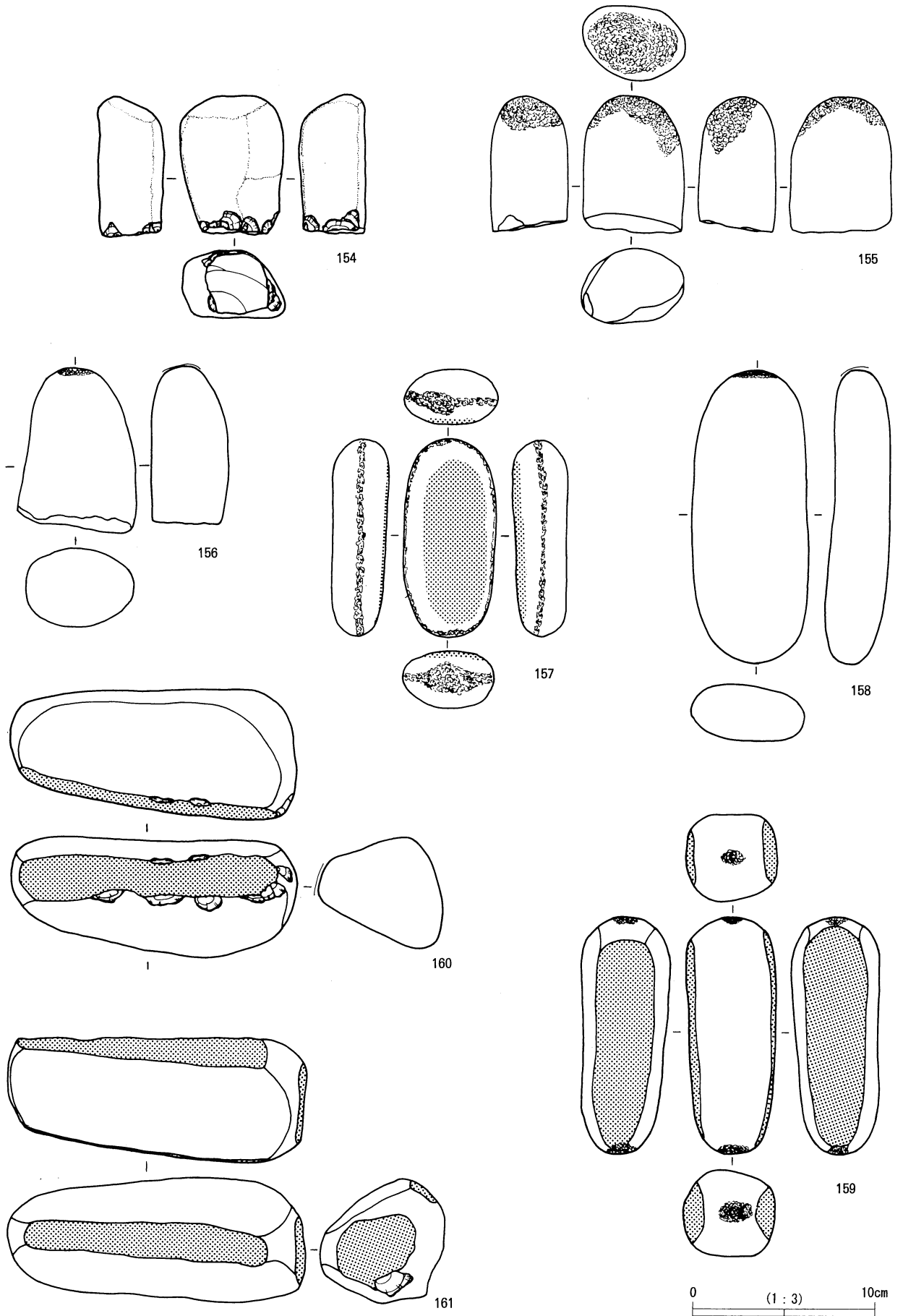

繩文時代石器 25

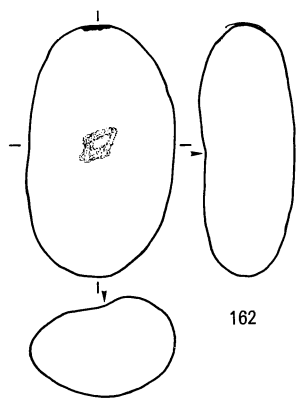

162

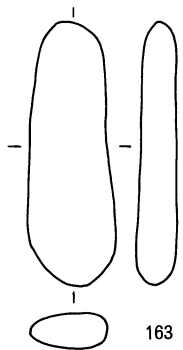

163

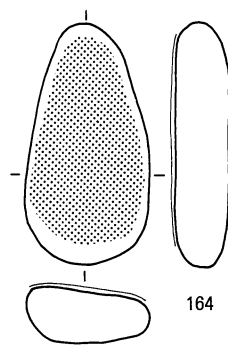

164

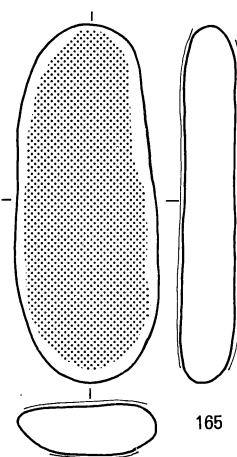

165

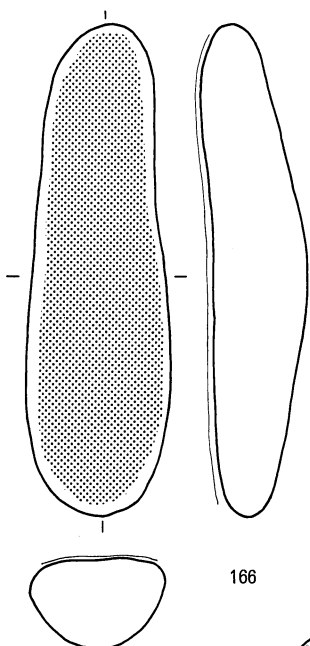

166

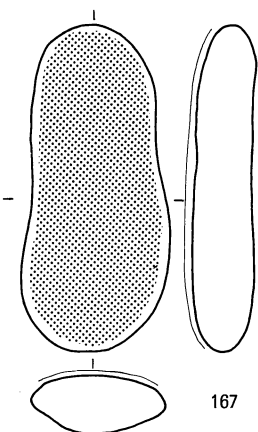

167

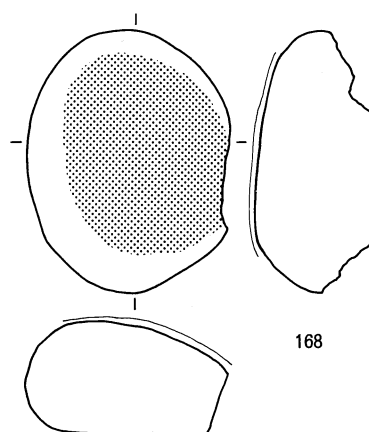

168

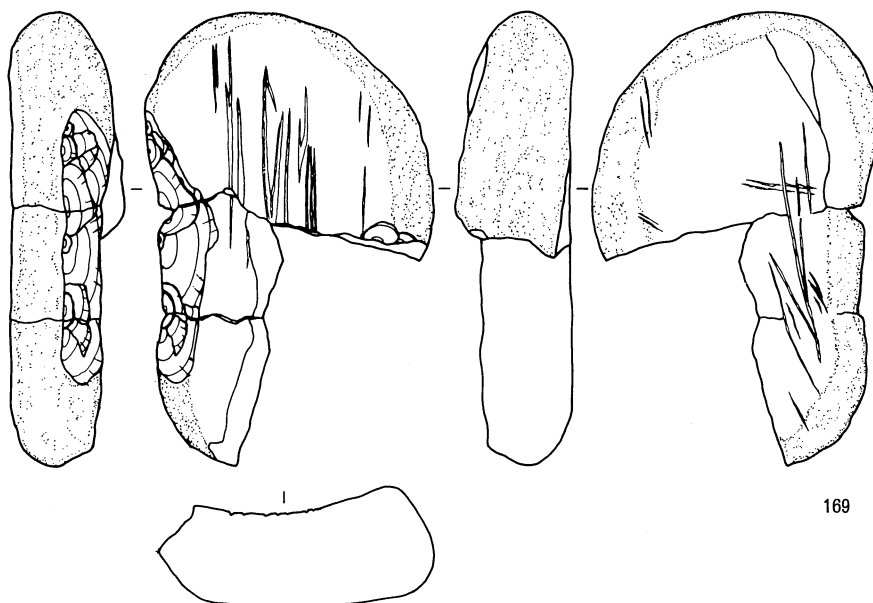

169

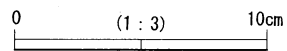

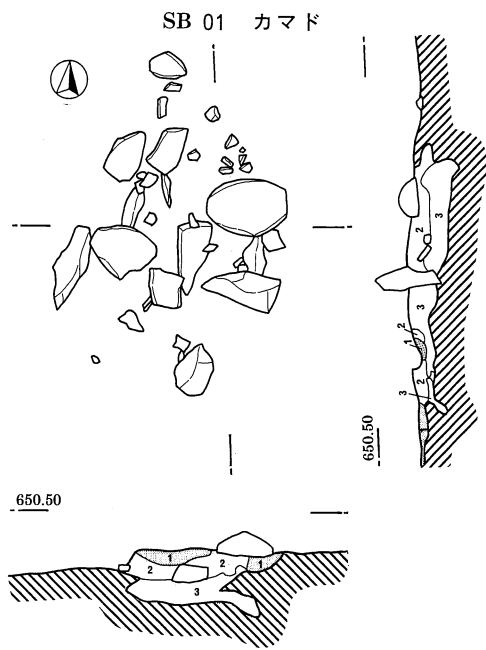
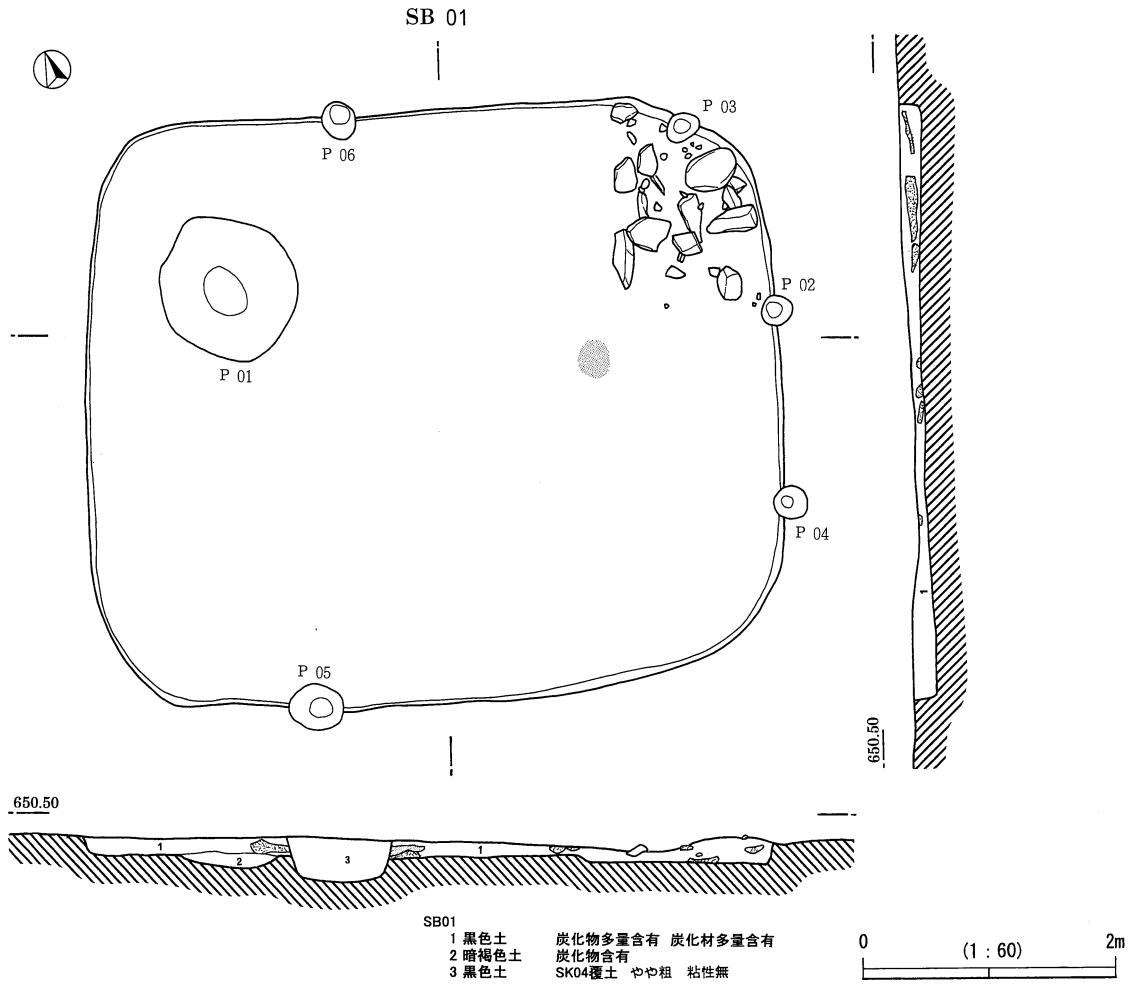

SB01カマド

1 明褐色土	焼土 橙色粒含有
2 にぶい褐色土	灰色粒多量含有
3 にぶい赤褐色土	

0 (1 : 40) 1m

SB 01 炭化材出土状況

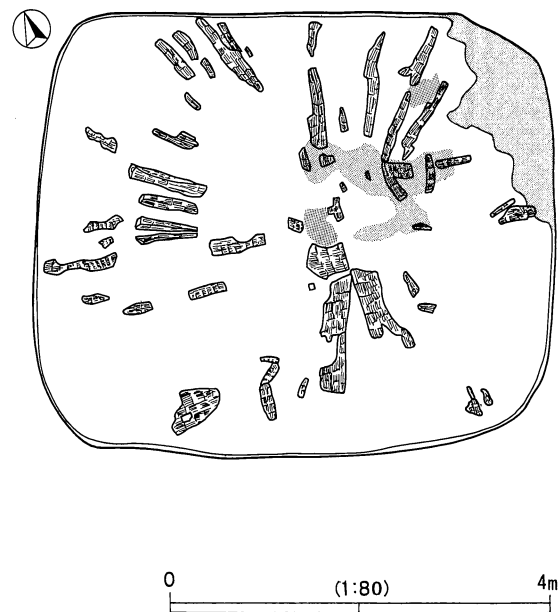

平安時代遺構図

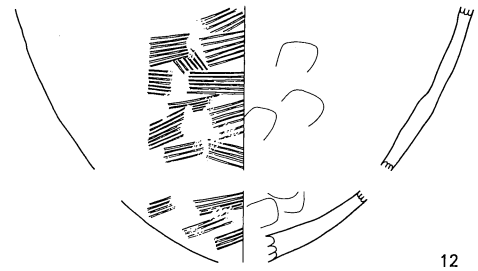
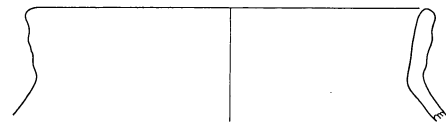
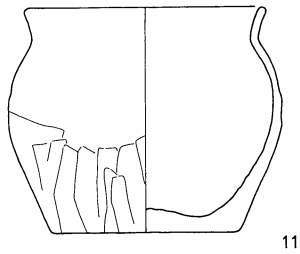
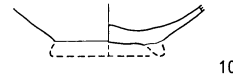
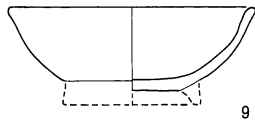
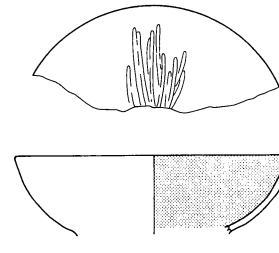
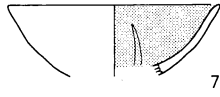
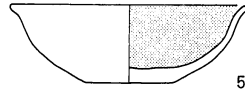
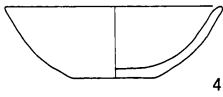
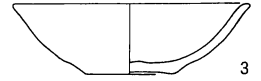
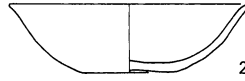
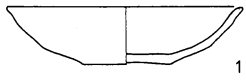

0 (1:4) 10cm

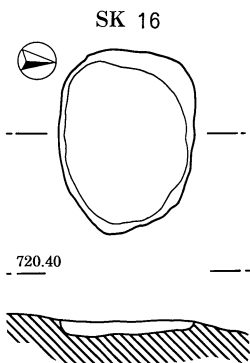

SK16
黒色土 堆積粗 IV層ブロック

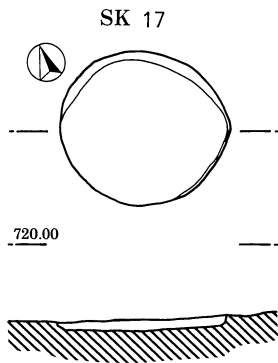

SK17
黒色土 堆積粗

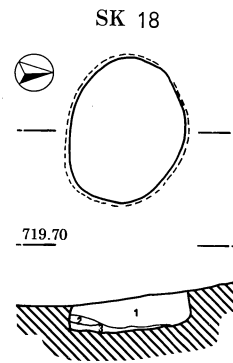

SK18
1 黒色土
2 黒色土 褐色土含有
3 褐色土 黒色土混入

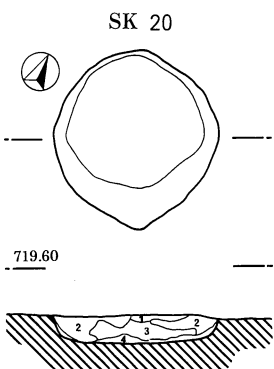

SK20
1 黒褐色土 モヤ上部層に類似
2 にぶい黄褐色土 モヤ下部層に近似
3 黒褐色土 1層より、やや明るい
4 黄褐色土

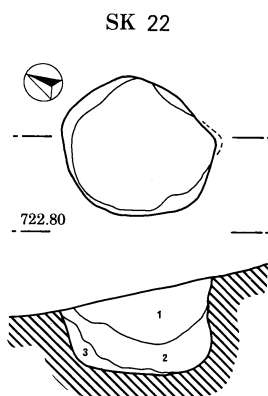

SK22
1 黒褐色土 軟質 粘性無 サラサラ
2 明暗褐色土 1層より軟質 粘性有 IV層の細粒混入
3 黄橙色土 1・2層より硬質 粘性有

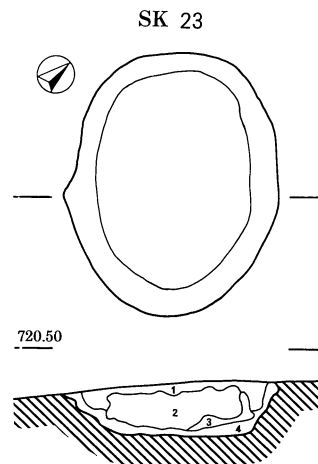

SK23
1 黒色土 明褐色土のブロックを含有 堆積粗 粘性少
2 黒色土 黄褐色ローム粒を若干含有 堆積粗
3 黒色土 黄褐色ローム粒を多量に含有 堆積粗 粘性少
4 暗褐色土 黄褐色ロームブロックを含む 堆積やや密 粘性有

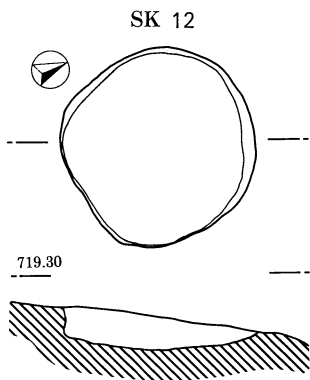

SK12
黒褐色土 モヤ層上部に近似

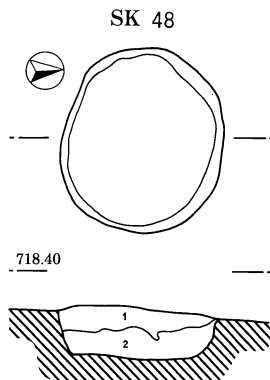

SK48
1 黒褐色土
2 黄褐色土
モヤ層上部の色調と類似

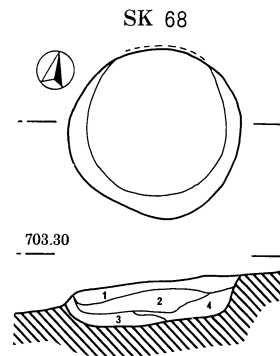

SK68
1 黒褐色土 粘性有 炭化物含有
2 暗褐色土 褐色ブロック含有
3 褐色土 2層より、やや粘性強
4 黒褐色土 2層より、やや軟質 粘性有

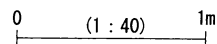

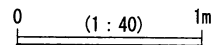
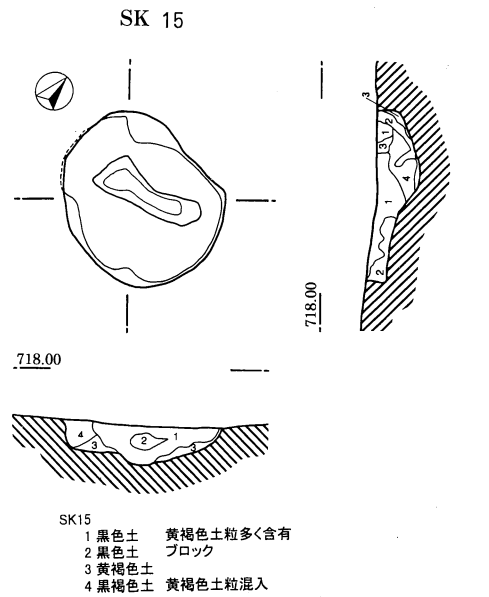
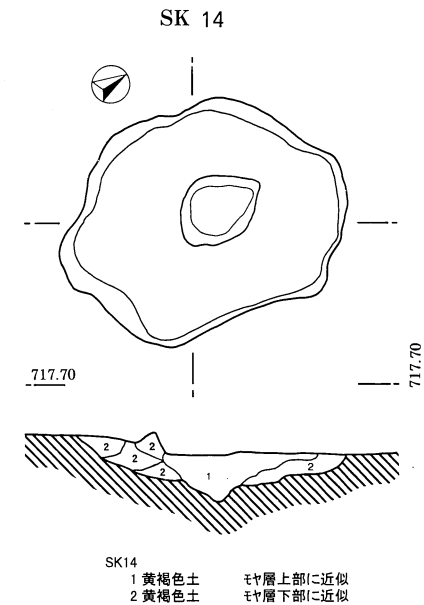
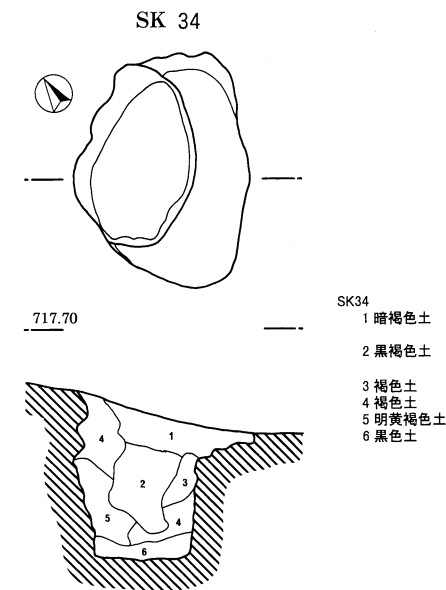
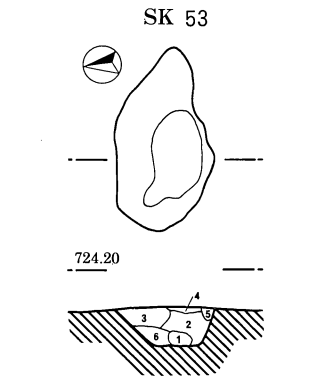
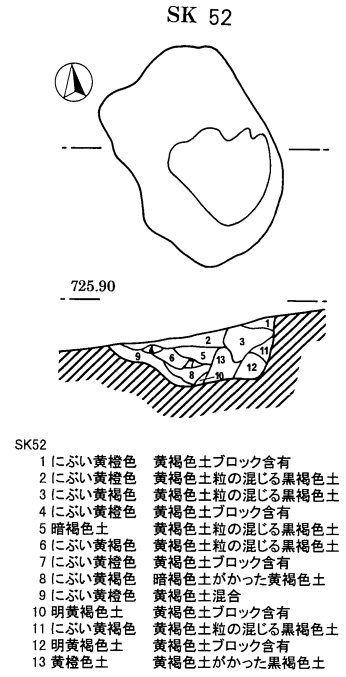
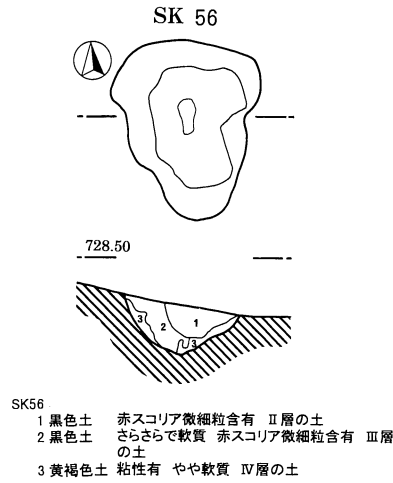
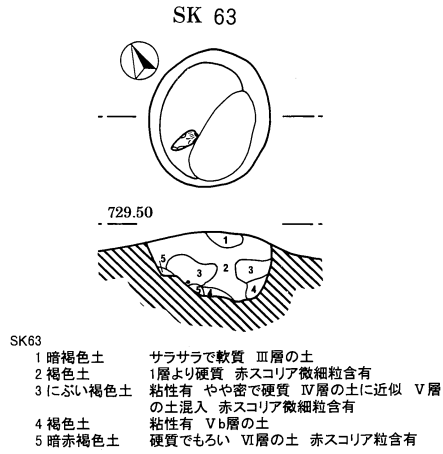

縄文時代土坑図 2

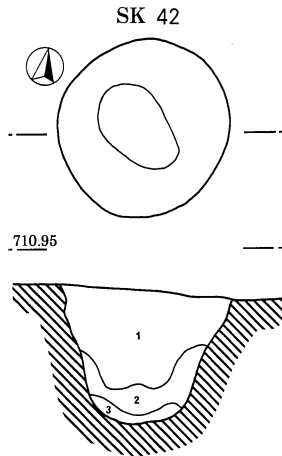

- SK42
- 1 黒色土 橙色のスコリア大粒含有
 - 2 黒褐色土 黄橙土含有
 - 3 黒褐色土 黄褐色土と混合 赤褐色のスコリア含有

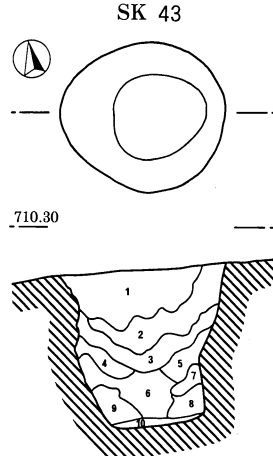

- SK43
- 1 黒色土 黒褐色土と混合 明暗褐色のスコリア含有 粘性有
 - 2 暗褐色土 明黄褐色と赤褐色のスコリア含有 粘性有
 - 3 黒褐色土 黒色土混合 明黄褐色と赤褐色のスコリア含有 堆積粗
 - 4 極暗褐色土 堆積粗
 - 5 褐色土 黄色土含有 堆積粗
 - 6 黒褐色土 赤褐色のスコリア含有 堆積粗
 - 7 黄褐色土 黒色土混合 赤褐色のスコリア大粒含有 堆積粗
 - 8 明褐色土 明黄褐色のスコリア含有 堆積粗
 - 9 黒褐色土 赤褐色のスコリア含有 堆積粗
 - 10 明黄褐色土 灰緑色と黄橙色のスコリアブロック含有 堆積粗 水分含有

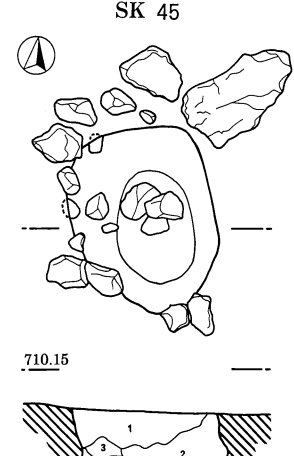

- SK45
- 1 黒色土 明黒色土混合 オリーブ色と赤褐色のスコリア微細粒含有 水分多量含有 粘性有
 - 2 暗褐色土 黄褐色のスコリア含有 オリーブ色と赤褐色のスコリア多量含有 水分含有
 - 3 暗褐色土 明黄褐色土混合 明黄褐色のスコリア含有 水分含有
 - 4 黒褐色土 黄褐色のスコリア含有 水分含有
 - 5 黒褐色土 赤褐色のスコリア微細粒含有 赤褐色と黄褐色のスコリア含有 黄褐色土混合 水分含有
 - 6 明黄褐色土 黒色土混合 赤褐色のスコリア含有 水分含有
 - 7 黒褐色土 赤褐色のスコリア大粒含有 水分含有
 - 8 黄褐色土 暗緑灰色と暗赤褐色のスコリア含有 水分含有

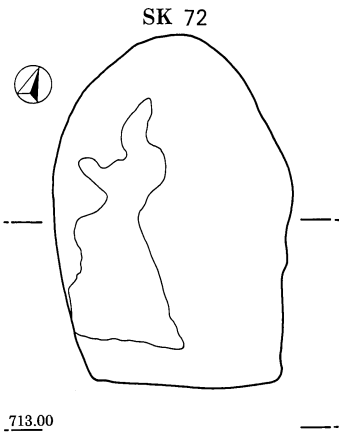

- SK72
- 1 黒色土 II層の土 細粒で粘性無 サラサラの黒色土
 - 2 褐色土 IV層にIII層が混入 細粒でやや粘性有
 - 3 明褐色土 I・2層より少し大粒混入 粘性有 IV層の土に近似

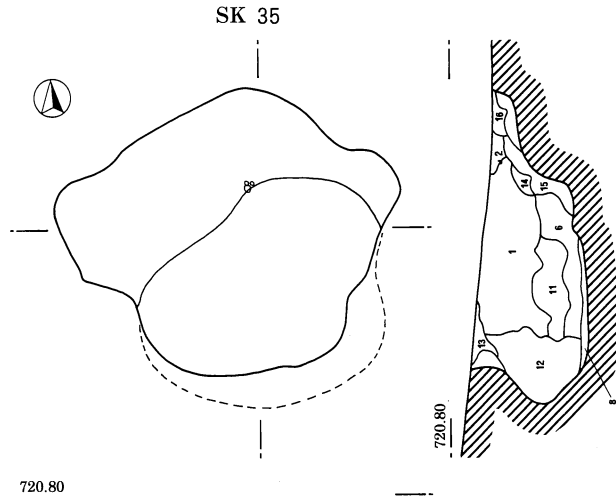

- SK35
- 1 黒色土 黄褐色土含有 堆積粗
 - 2 暗褐色土 堆積粗
 - 3 褐色土 明黄褐色のブロック含有
 - 4 暗褐色土 堆積粗
 - 5 黄褐色土 暗褐色土含有 堆積粗
 - 6 褐色土 堆積粗
 - 7 黄褐色土 暗褐色土含有 堆積粗
 - 8 黄褐色土 堆積粗
 - 9 黄褐色土 褐色土含有 堆積粗
 - 10 黄褐色土 暗褐色土のブロック含有 堆積粗
 - 11 暗褐色土 黒褐色土含有 黄褐色土のブロック粒含有 炭化物含有 堆積粗
 - 12 暗褐色土 炭化物含有 黄褐色土含有 堆積粗
 - 13 黄褐色土 炭化物含有 堆積粗
 - 14 黄褐色土 黒褐色土含有 堆積粗
 - 15 明黄褐色土 堆積粗
 - 16 褐色土 黒褐色土と黄褐色土混合 黒色土の堆積 黄褐色土、黒褐色土の攪乱

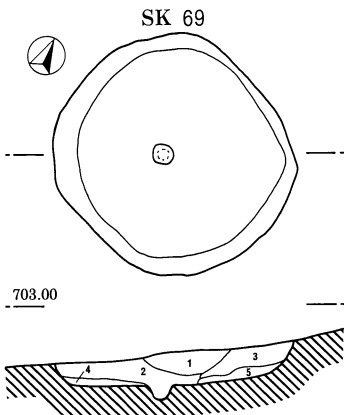

- SK69
- 1 黒褐色土 軟質 粘性有
 - 2 暗褐色土 粘性有 堆積粗 黒褐色土と黄色土の混合 黄色土ブロック含有
 - 3 黒褐色土 炭化物含有 堆積粗 黒褐色土と黄色土の混合
 - 4 黄褐色土 2層より水分少量で硬質
 - 5 黒褐色土 炭化物含有 3層よりかなり硬質

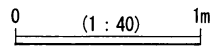

縄文時代土坑図 3

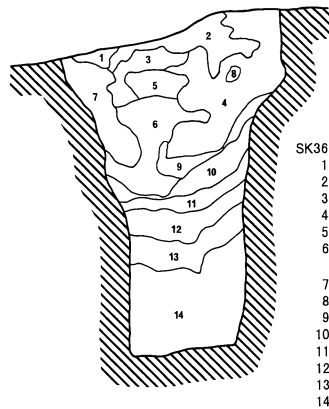
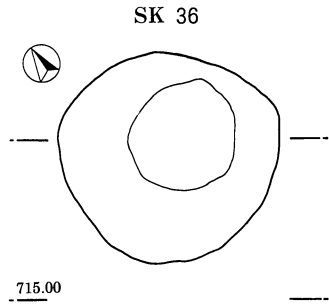

- SK36
- | | |
|-----------|---------------------|
| 1 黒褐色土 | 黄ブロック土粒含有 粘性無 |
| 2 暗褐色土 | 土質は1層と同類 |
| 3 黒褐色土 | 褐色のモヤ層と赤スコリア粒含有 やや密 |
| 4 褐色土 | 7層よりやや暗い 密度低い |
| 5 黒褐色土 | 3層より最小、密度高い |
| 6 にぶい黄褐色土 | 4層よりやや暗い 部分的混合 |
| 7 褐色土 | やや黄色 密度低い ポロポロ |
| 8 暗褐色土 | 4層の褐色土中、ブロック状で分布 |
| 9 暗褐色土 | やや密 帯状に堆積 |
| 10 黄褐色土 | 粗 明るい土が帯状 |
| 11 暗褐色土 | やや密 |
| 12 黄褐色土 | やや密 |
| 13 褐色土 | やや粗 |
| 14 黄褐色土 | やや密 |

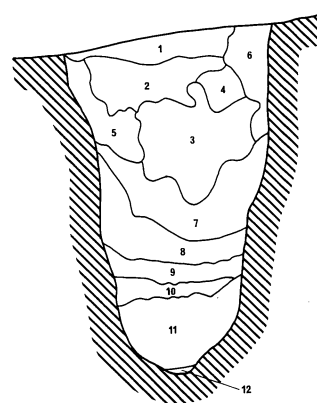
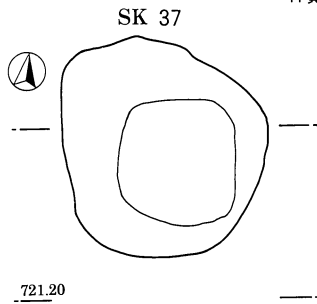

- SK37
- | | |
|------------|--|
| 1 暗褐色土 | 炭化物微細粒含有 |
| 2 黒色土 | 黄褐色土、明黄褐色土含有 明褐色土のスコリア含有 |
| 3 黒色土 | 黄褐色土、にぶい黄褐色土との攪乱 明褐色と灰緑色のスコリア含有 炭化物含有 最下部、水分含有 |
| 4 黄褐色土 | 黒褐色土との攪乱 灰緑色のスコリアと明褐色のスコリア含有 炭化物含有 |
| 5 黒色土 | 褐灰色土、黄褐色土との攪乱 明褐色のスコリア大粒含有 灰緑色のスコリア含有 |
| 6 明黄褐色土 | 褐色土との攪乱 褐色、明褐色、灰緑色のスコリア含有 炭化物含有 |
| 7 黒褐色土 | 赤褐色のスコリア含有 炭化物含有 |
| 8 黄褐色土 | 赤褐色のスコリア含有 炭化物含有 |
| 9 暗オリーブ褐色土 | 黒色土のブロック点在 炭化物含有 赤褐色のスコリア含有 |
| 10 黄褐色土 | 赤褐色のスコリア含有 緑灰色ブロック点在 |
| 11 黒褐色土 | 赤褐色と灰緑色のスコリア含有 |
| 12 黒色土 | 炭化物の層 植物の炭化物有 |

- SK39
- | | |
|---------|--------------------------------------|
| 1 黒褐色土 | 明褐色のスコリア含有 スコリアブロック含有 堆積粗 |
| 2 黒褐色土 | 明褐色のスコリア含有 黒色土と明黄褐色土のしみ含有 堆積粗 |
| 3 黄褐色土 | 明褐色のスコリア含有 炭化物粒含有 黒色土と明黄褐色土のしみ含有 堆積粗 |
| 4 明黄褐色土 | 褐色のスコリア含有 緑灰色のスコリア含有 黒色のしみ含有 堆積粗 |
| 5 黄褐色土 | 黒色土含有 褐色のスコリア含有 スコリアブロック含有 堆積粗 |
| 6 黄褐色土 | 灰緑色、赤褐色、黄色のスコリア含有 炭化物含有(V層のブロック含有) |
| 7 黒色土 | 灰緑色と赤褐色のスコリア含有 黄色土多量 |
| 8 褐色土 | 明褐色と灰緑色のスコリア含有 灰緑色ブロック含有 |
| 9 暗褐色土 | 明赤褐色と灰緑色のブロック含有 明赤褐色と灰緑色のスコリア含有 |
| 10 黒色土 | 明褐色のブロック含有 炭化物含有 |

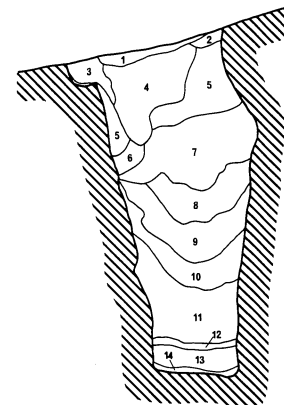
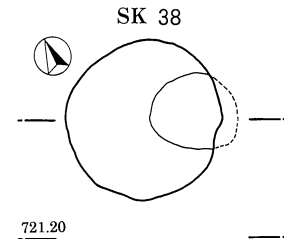
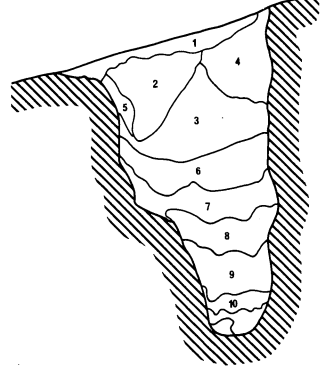
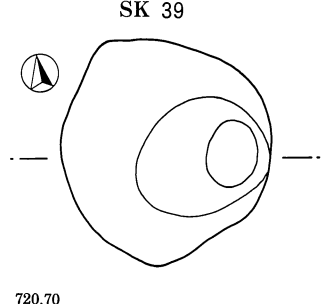

- SK38
- | | |
|---------|---------------------------------|
| 1 褐色土 | 堆積粗 |
| 2 黄褐色土 | |
| 3 黄褐色土 | スコリア大粒含有 |
| 4 暗褐色土 | スコリア含有、色は3層と同類 |
| 5 暗褐色土 | 明褐色のスコリア含有 オリーブ黒色のスコリア大粒含有 |
| 6 黄褐色土 | 明褐色のスコリア含有 |
| 7 褐色土 | 明黄褐色のスコリア含有 |
| 8 明褐色土 | 褐色土含有 赤褐色のスコリアブロック含有 灰緑色のスコリア含有 |
| 9 黒褐色土 | 赤褐色のスコリアブロック含有 黄褐色土含有 |
| 10 黒褐色土 | 赤褐色のスコリア含有 |
| 11 暗褐色土 | 泥炭層 黄褐色土含有 赤褐色のスコリア含有 |
| 12 黒色土 | 泥炭層 |
| 13 褐色土 | 赤褐色のスコリア含有 |
| 14 黒色土 | 泥炭層 |

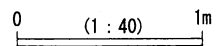
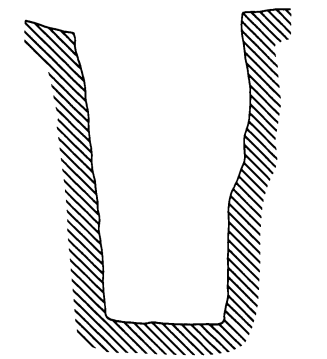
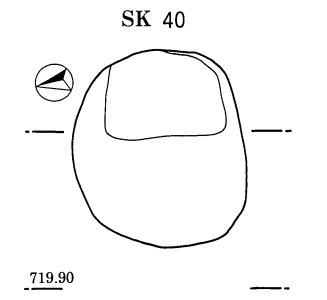

縄文時代土坑図 4

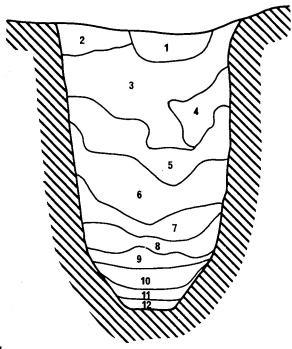
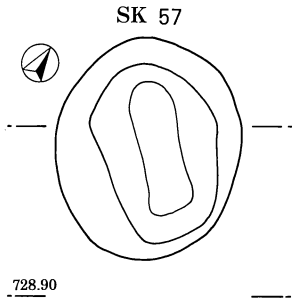

- SK57
- | | |
|-----------|--------------------------------|
| 1 暗褐色土 | やや粗粒 黄褐色土含有 |
| 2 褐色土 | やや粗粒 黒色ローム微量含有 |
| 3 にぶい黄褐色 | やや粗粒 黄色土含有 |
| 4 黄褐色土 | やや粗粒 粘性有 |
| 5 黒褐色土 | やや粗粒 黄色塊少量含有 スコリア粒含有 |
| 6 褐色土 | 粗粒 黒色土混合 スコリア粒含有 |
| 7 黒色土 | 粗粒 スコリア微細粒含有 |
| 8 明褐色土 | 粗粒 スコリア微細粒多量含有 |
| 9 黄褐色土 | 赤スコリア、青スコリア混合 ブロック状で硬質 暗褐色で堆積粗 |
| 10 黄褐色土 | 9層と同類 暗褐色弱い |
| 11 黒色有機質土 | 纖維状物質混入 堆積密 |
| 12 暗黄褐色土 | 白・赤・青スコリア、ローム粒多量含有 堆積粗 |

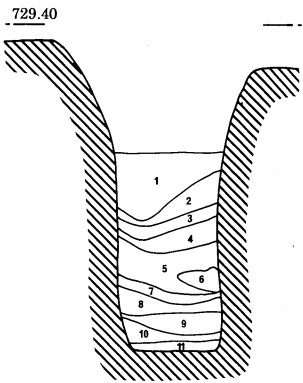
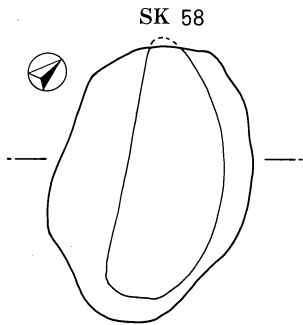

- SK58
- | | |
|----------|------------------|
| 1 黒色土 | 攪乱 |
| 2 黄褐色土 | やや細粒 粘性有 |
| 3 暗褐色土 | 黒色土粒と黄色土粒混合 粗粒 |
| 4 黒褐色土 | 粗粒 黄色土少量含有 |
| 5 褐色土 | 粗粒 黒色土混合 スコリア粒含有 |
| 6 黄褐色土 | 粗粒 粘性有 |
| 7 黒色土 | 粗粒 スコリア微細粒含有 |
| 8 明褐色土 | 粗粒 スコリア微細粒多量含有 |
| 9 黄褐色土 | 赤スコリア多量含有 |
| 10 黒有機質土 | SK57の10層と同類 |
| 11 暗黄褐色土 | SK57の11層と同類 |

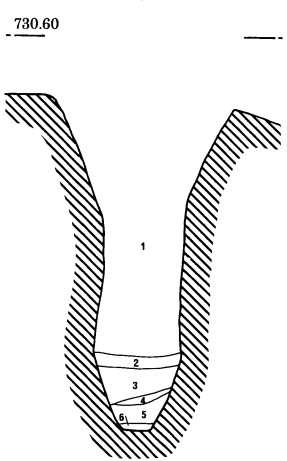
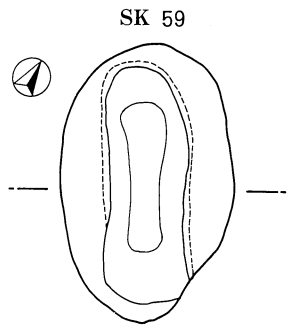

- SK59
- | | |
|--------|-----------|
| 1 | 不明 |
| 2 黄褐色土 | |
| 3 | 安山岩の礫多量含有 |
| 4 暗褐色土 | やや有機質 |
| 5 | 硬質 |
| 6 黒色土 | 有機質土 |

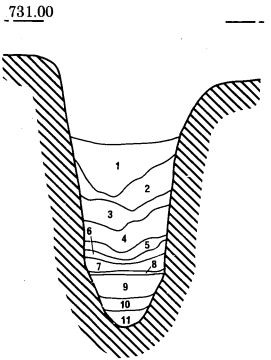
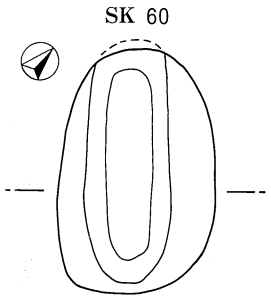

- SK60
- | | |
|----------|-----------------------|
| 1 褐色土 | 粗粒 スコリア微細粒少量含有 |
| 2 黄褐色土 | やや粗粒 粘性有 スコリア微細粒少量含有 |
| 3 黒褐色土 | 粗粒 黒色土と黄色土の混合 スコリア粒含有 |
| 4 にぶい黄褐色 | やや粗粒 粘性有 スコリア微細粒少量含有 |
| 5 黒色土 | やや粗粒 粘性有 光沢有 |
| 6 明褐色土 | 細粒 粘性有 スコリア粒含有 |
| 7 | |
| 8 | |
| 9 | プレッチャーゾーン多量含有 赤スコリア含有 |
| 10 黄褐色土 | ローム、赤スコリア含有 |
| 11 暗褐色土 | ローム粒含有 |

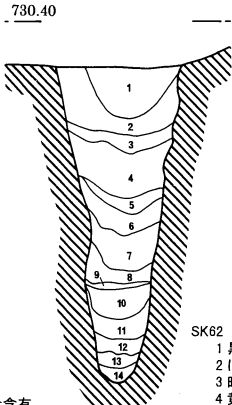
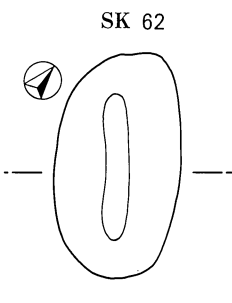

- SK62
- | | |
|----------|----------------------|
| 1 黒褐色土 | やや粗粒 |
| 2 にぶい黄褐色 | やや粗粒 スコリア微細粒含有 |
| 3 暗褐色土 | やや細粒 黄色土少量含有 |
| 4 黄褐色土 | |
| 5 暗褐色土 | ロームブロック含有 |
| 6 暗黄褐色土 | |
| 7 暗褐色土 | ロームブロック含有 |
| 8 黄褐色土 | |
| 9 暗褐色土 | 6・7層と同類 |
| 10 黄褐色土 | プレッチャーゾーンのブロック含有 堆積粗 |
| 11 黒褐色土 | 有機質多量含有 |
| 12 黄褐色土 | 赤スコリア含有 |
| 13 暗褐色土 | ローム粒含有 |
| 14 黄褐色土 | 硬質 |

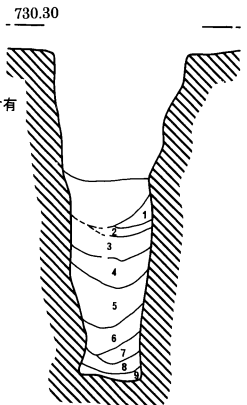
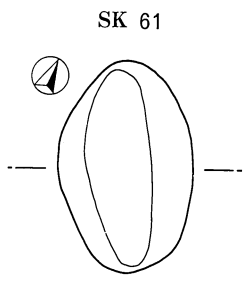

- SK61
- | | |
|---------|-----------|
| 1 暗褐色土 | |
| 2 明黄褐色土 | |
| 3 暗褐色土 | |
| 4 黒色土 | |
| 5 黄褐色土 | ロームブロック含有 |
| 6 暗黄褐色土 | |
| 7 明黄褐色土 | |
| 8 黄褐色土 | |
| 9 黒色土 | |

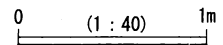

縄文時代土坑図 5

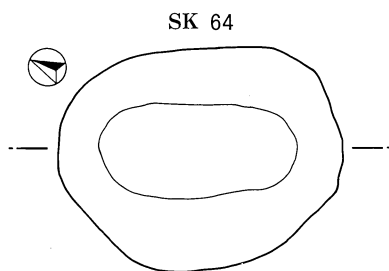

730.60

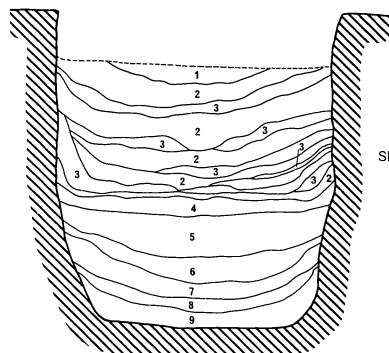

SK64

- 1 極暗褐色土
 - 2 暗褐色土
 - 3 黄褐色土
 - 4 黒色土
 - 5 黄褐色土
 - 6 暗黄褐色土
 - 7 黄褐色土
 - 8 黒色土
 - 9 黄褐色土
- ローム粒、赤スコリア含有 ロームブロック多量含有
有機質土層 繊維混入
硬質のロームブロック、赤スコリア含有
混合物多量の土層
赤スコリア、プレッシャーゾーンブロック、暗褐色ロームブロック含有
有機質土層
赤スコリア、ロームブロック含有

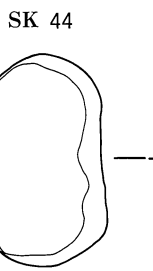

710.40

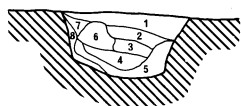

SK44

- 1 黒褐色土
 - 2 明黄褐色土
 - 3 黒色土
 - 4 黒褐色土
 - 5 黒褐色土
 - 6 黒褐色土
 - 7 灰黄褐色土
 - 8 にぶい黄褐色土
- 黒色土混合 堆積粗
堆積粗
堆積密
堆積密
堆積粗
堆積密
堆積密
土

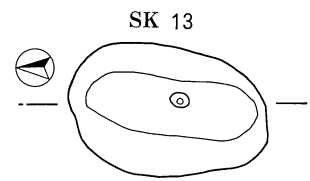

718.50

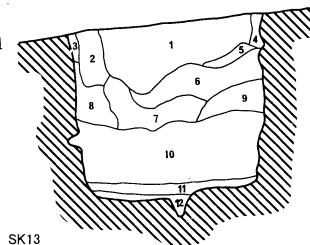

SK13

- 1 黒色土
 - 2 黒褐色土
 - 3 黒褐色土
 - 4 黒褐色土
 - 5 黄褐色土
 - 6 黒褐色土
 - 7 黒褐色土
 - 8 黒褐色土
 - 9 黒褐色土
 - 10 黒褐色土
 - 11 黒色土
 - 12 黒褐色土
- ロームブロック
黄褐色モヤがかかる
モヤ層下部のような土
6層と同類
6層に近似
前層より暗い色調でほぼ均質
黒色火山灰(II層)に近い色調
7層に近似

SK 70

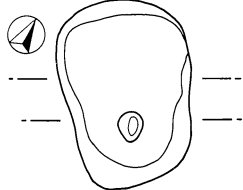

703.70

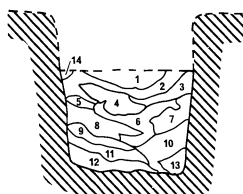

703.70

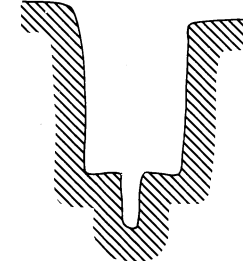

SK70

- 1 黒色土
 - 2 にぶい黄色土
 - 3 褐色土
 - 4
 - 5 暗褐色土
 - 6 黒褐色土
 - 7 褐色土
 - 8 黒褐色土
 - 9 黒褐色土
 - 10 黒褐色土
 - 11 暗褐色土
 - 12 黒褐色土
 - 13 暗褐色土
 - 14
- 粗粒 粘性有 明黄褐色土の混合
緑灰色スコリア含有 黄色土ブロック含有 硬さは1層と同類
緑灰色スコリア含有 砂状帯 硬さは1・2層より硬質
軟質 粘性有
黒色土と黄色土の混合 1・2層より軟質、粘性有 下部、黒色土強
軟質 粘性有 水分含有 炭化物含有
6層と同類 黒色が、より強い
黄色土混合 軟質で粘性有
土質は9層と同類 軟質で増
10層より硬質で密 黄褐色土と灰黄褐色土との混合 赤褐色スコリア大粒含有
黄色土の大粒ブロック含有
10層よりやや硬質
V層の土

SK 95

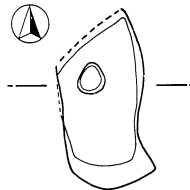

707.10

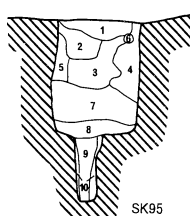

SK95

- 1 黒褐色土
 - 2 黒色土
 - 3 黒褐色土
 - 4 暗褐色土
 - 5 にぶい黄褐色土
 - 6 黒色土
 - 7 黒褐色土
 - 8 黒褐色土
 - 9 褐色土
 - 10 黄褐色土
- 細粒 密 硬質
粗粒 粗 軟質
1層と類似 やや粗 上部は硬質、下部は軟質
粗粒 黒色土と黄色土の混合 粗 軟質
4層と同類 4層より黄色は強
粗粒 粗 軟質
やや粗粒 粗 1・3層より黒色は強い
やや粗粒 密 東側ほど黄色は強い
粗粒 粗 軟質 黒色土と黄色土の混合 粘性有
やや粗粒 9層より密で硬質 黄色土に黒色土混入 粘性有

SK 73

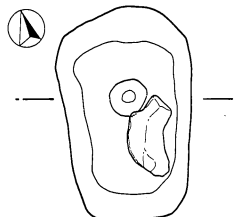

703.50

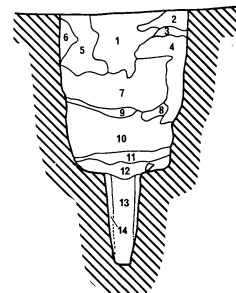

SK73

- 1 黒色土
 - 2 明黄褐色土
 - 3 オリーブ褐色土
 - 4 オリーブ褐色土
 - 5 オリーブ褐色土
 - 6 明黄褐色土
 - 7 暗灰黄色土
 - 8 黄褐色土
 - 9 暗褐色土
 - 10
 - 11 黄褐色土
 - 12 黒色土
 - 13 暗褐色土
 - 14 暗褐色土
- ローム粒・焼土粒含有 粘性無 軟質
オリーブ褐色土混入 ローム粒含有 粘性無 軟質
ローム粒多量含有 粘性無 1・2層よりやや硬
ローム粒、黄褐色スコリア含有 粘性無 軟質
3層と同類
黄褐色スコリア、ロームブロック多量含有 粘性無 堆積粗
ローム粒、ロームブロック含有 粘性無 軟質
ロームブロック含有
焼土粒の塊 ロームブロック含有 粘性無 軟
7層と4層の互層
黄褐色ローム塊、VII層の硬質層の塊含有 マトリックス土層はやや粗
炭化物多量含有 ローム粒含有
黄褐色ローム粒、赤・橙色スコリア含有 硬質で密
黄褐色ローム粒、黒褐色土粒、赤スコリアブロック含有 硬質で密

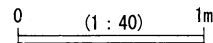

縄文時代土坑図 6

SK 71

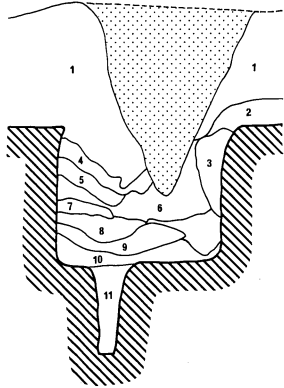
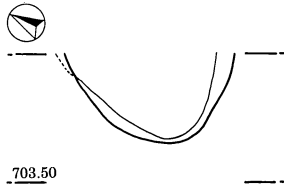

- SK71
- 1 黒色土 やや細粒 粘性少量 黄色土塊含有 土坑壁不明
 - 2 褐色土 やや細粒 粘性有 堆積密 黒色土混入 III層モヤ層
 - 3 明黄褐色土 やや細粒 粘性有 堆積密 黒色土混入 IV層
 - 4 黒褐色土 やや粗粒 粘性弱 やや粗
 - 5 黒色土 やや粗粒 粘性無
 - 6 にぶい黄褐色土 黒色土と黄色土の混合 やや粗粒 粘性無 黄色ローム塊含有
 - 7 黒色土 粗粒 粘性無
 - 8 黒褐色土 黒色土と黄色土の混合 粘性無 やや粗 黒色ローム塊含有
 - 9 明褐色土 焼土層 密
 - 10 黒色土 やや粗粒 密 粘性有
 - 11 暗褐色土 やや粗粒 粘性少量 粗 黄・黒色ローム塊含有

SK 51

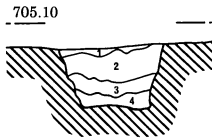
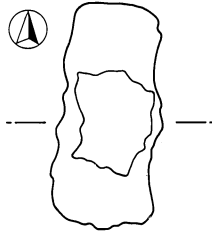

- SK51
- 1 黒色土 縄文期の土器片出土
 - 2 薄い黒色土 サラサラ
 - 3 黒色土 1層と同色 粘性有
 - 4 薄い黒色土 2層より硬質 赤スコリア混入

SK 54

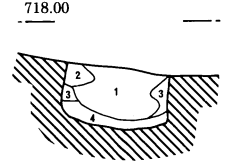
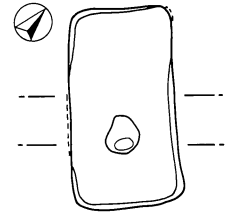

718.00

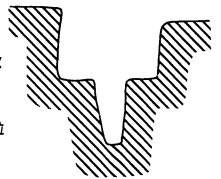

- SK54
- 1 黒色土 黄褐色ローム粒含有 ブロック状 やや粗 軟質
 - 2 黒色土 色調は1層と同類 ロームブロック多量含有
 - 3 暗褐色土 1層と類似 ローム粒多量
 - 4 暗褐色土 ローム粒多量 ロームブロック含有 炭化物粒多量含有 密
 - 5 黄褐色土 ブロック状でローム質土、粗 赤スコリア、白色粒多量含有

718.00

SK 28

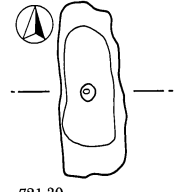

721.30

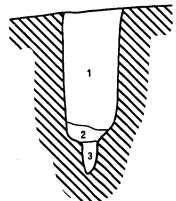

- SK28
- 1 黄褐色土
 - 2 褐色土 軟質粘性有
 - 3 にぶい褐色土 堆積粗

SK 27

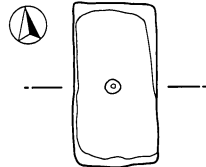

721.50

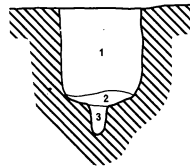

- SK27
- 1 黄褐色土
 - 2 褐色土 軟質粘性有
 - 3 にぶい褐色土 堆積粗

SK 32

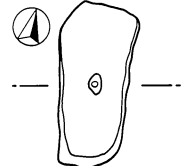

720.70

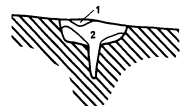

- SK32
- 1 黒色土 軟質さらさら 粘性無 V層の細粒と炭化物混入
 - 2 黒色土 炭化物粒混入 粘性無 さらさら 堆積粗 にぶい褐色

SK 30

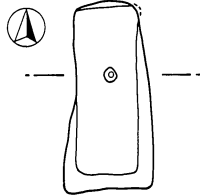

721.00

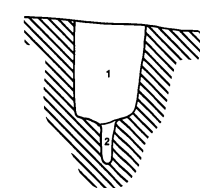

- SK30
- 1 黒色土 II層にIV層粒が混入
 - 2 にぶい褐色土 堆積粗

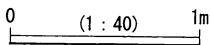

縄文時代土坑図 7

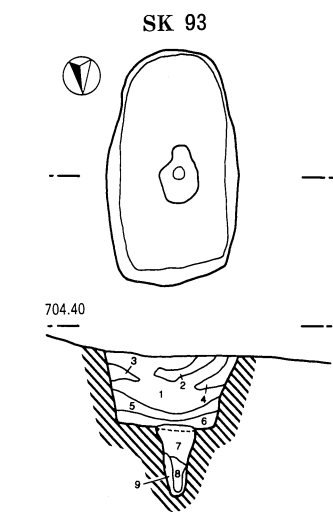

- SK93
- 1 黒色土 黄褐色粒子をわずかに含む、粘性ない
 - 2 黒褐色土 黄褐色粒子を含む、堆積やや密、粘性あり
 - 3 暗褐色土 黒色、黄褐色の混合土
 - 4 黒褐色土 土坑壁近くが明るく、中央部が暗い
 - 5 にぶい黄褐色土 V層のブロック、土坑壁の崩れか
 - 6 黒色土 堆積疎
 - 7 黒褐色土 黄褐色ブロックが下部になるに従い多くなる
 - 8 黄褐色土 黒色土粒子、赤色、青色スコリアを含む
 - 9 黄褐色土 8層より明るい、堆積やや密

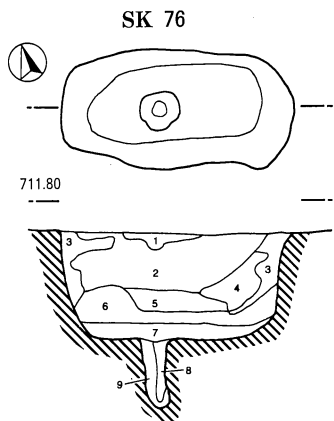

- SK76
- 1 黒色土 堆積疎で、しまりなく、崩れやすい
 - 2 暗褐色土 堆積疎、粘性なく軟らかい
 - 3 褐色土 堆積疎
 - 4 黒褐色土 黒色土が右上から左下方向に縞状に走る。堆積疎
 - 5 黒褐色土 軟弱
 - 6 黒色土 粘性なく、軟らかい
 - 7 暗褐色土 しまりのある褐色土と黒色土がブロック状に入る
 - 8 暗褐色土 堆積疎、粘性なく軟らかい
 - 9 褐色土 堆積疎、軟らかい

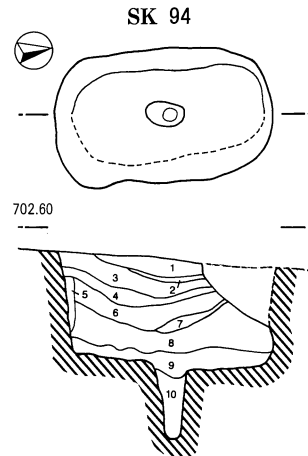

- SK94
- 1 黒褐色土 明黄褐色粒子よく含む、キビダンゴⅡに対比されようか、粘性なし
 - 2 黒色土 粒子を含まない、Ⅱ層に相当する。
 - 3 黒褐色土 1層とほぼ同じ
 - 4 黒色土 2層とほぼ同じ
 - 5 黒褐色土 堆積疎
 - 6 黒褐色土 1層とほぼ同じ
 - 7 黒褐色土 明褐色土のブロックをよく含む、Ⅱb層に相当すると思われる
 - 8 黒褐色土 1層とほぼ同じ
 - 9 黒色土 堆積疎、明褐色ロームブロックをよく含む
 - 10 暗黄褐色土 ローム粒子、ブロックを多量にふくむ

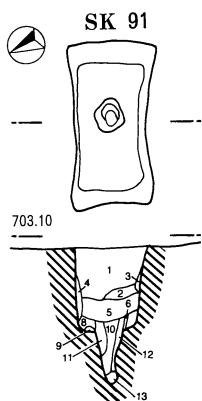

- SK91
- 1 黒褐色土 明黄褐色粒子を含む
 - 2 黒褐色土 明黄褐色粒子を若干含む
 - 3 黒褐色土 黄褐色と黒褐色土の混合土
 - 4 黒褐色土 黄褐色と黒褐色土の混合土
 - 5 黒褐色土 堆積疎で軟弱
 - 6 黒褐色土 堆積疎で軟弱
 - 7 黒褐色土 黄褐色ロームをよく含む、粘性あり硬
 - 8 黄褐色土 黄褐色ロームをよく含む、粘性あり硬
 - 9 黒色土 ロームブロック
 - 10 黒褐色土 黄褐色粒子をよく含む、軟からい
 - 11 黒褐色土 黒褐色と黄褐色土の混合土
 - 12 黒褐色土 粘性あり
 - 13 褐色土 粘性あり硬い

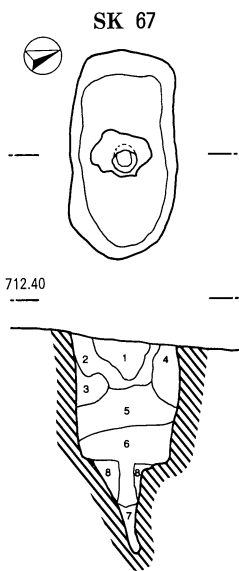

- SK67
- 1 黒色土 堆積疎
 - 2 黒褐色土 堆積やや密
 - 3 暗褐色土 堆積疎、壁の崩れか
 - 4 褐色土 堆積やや密、壁の崩れか
 - 5 暗褐色土 堆積やや密
 - 6 黒色土 堆積疎
 - 7 暗褐色土 堆積疎
 - 8 褐色土 赤色、緑色スコリアを含み、堆積密

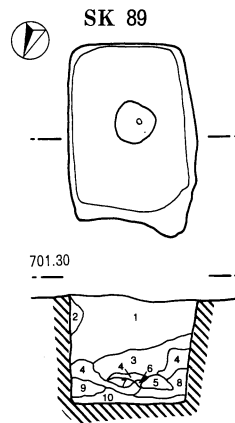

- SK89
- 1 黒色土 縞状に黄褐色粒子が多いところがある
 - 2 暗褐色土 黄褐色と黒色土の混ざり
 - 3 黒色土 1層に比べ、黄褐色粒子が増える、大粒の炭化物を含む
 - 4 黒褐色土 堆積密、粘性あり、黄褐色粒子含む
 - 5 黒褐色土 黄褐色と黒褐色土の混ざり
 - 6 黒褐色土 軟弱
 - 7 暗褐色土 4層と5層の中間の硬さ
 - 8 黒褐色土 黄褐色と黒褐色土の混ざり、黄褐色ロームブロックをよく含む
 - 9 黒褐色土 黄褐色と黒褐色土の混ざりだが、黒色粒子をよく含む
 - 10 黒褐色土 大粒の赤色スコリアを含む

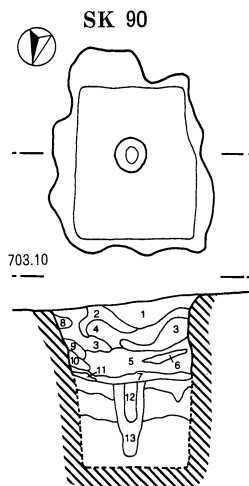

- SK90
- 1 黒色土 黄褐色粒子を若干含む、粘性あり、軟らか
 - 2 黒色土 黄褐色粒子、黄褐色ブロックを若干含む
 - 3 黒褐色土 堆積やや密、硬くなる
 - 4 黒褐色土 炭化物と黒色土のブロック、軟らかい
 - 5 黒褐色土 下部ほど黄褐色粒子を多く含む
 - 6 黒褐色土 炭化物層
 - 7 黒褐色土 黄褐色と黒色土の混ざり、ブロック状に硬い部分がある
 - 8 黒褐色土 黄褐色と黒色土の混ざり
 - 9 黄褐色土 ロームブロック
 - 10 暗褐色土 ロームブロックと黒色土の混ざり
 - 11 黄褐色土 ロームブロック
 - 12 黒色土 黄褐色粒子を若干含む、軟らかい
 - 13 暗褐色土 黄褐色と黒色土の混ざり

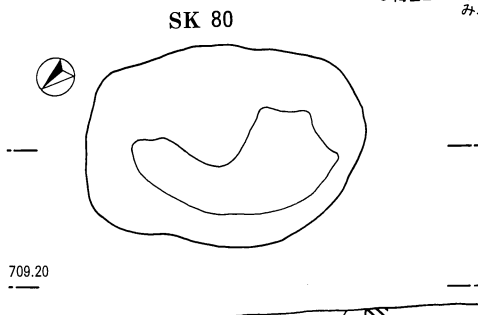

- SK80
- 1 黒色土 Ⅱ層に相当
 - 2 黒褐色土 堆積疎、軟らかい
 - 3 褐色土 粘性あり、軟らかい

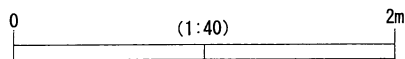
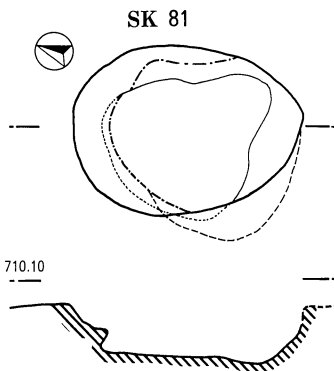

縄文時代土坑図 8

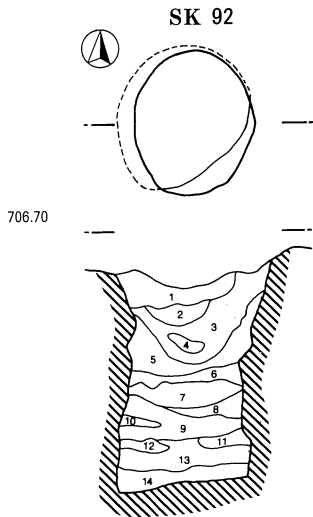

- SK92
- 1 黒褐色土 堆積密で硬い、粘性あり、細粒
 - 2 黒褐色土 軟弱、粘性なし、やや粗粒
 - 3 黒褐色土 堆積疎で軟らかい。粘性ややあり、粗粒
 - 4 にぶい黄褐色土 黄色粒子と黒色粒子の混合土、粘性あり、粗粒
 - 5 褐色土 4層と同じ
 - 6 黒褐色土 やや粗粒、5層よりは硬い、壁際で黄色粒子が多くなる
 - 7 黒褐色土 堆積密、粘性若干あり、やや細粒
 - 8 にぶい黄褐色土 黄色ローム粒子をよく含む、粘性あり、やや粗粒
 - 9 黒褐色土 6層とほぼ同じ、若干硬い
 - 10 にぶい黄褐色土 8層と同じ
 - 11 にぶい黄褐色土 8層と同じ
 - 12 にぶい黄褐色土 8層と同じ
 - 13 暗褐色土 黒色粒子多く、黄色粒子を若干含む、粘性ややあり、粗粒
 - 14 にぶい黄褐色土 13層に比べ黄色味を帯びる

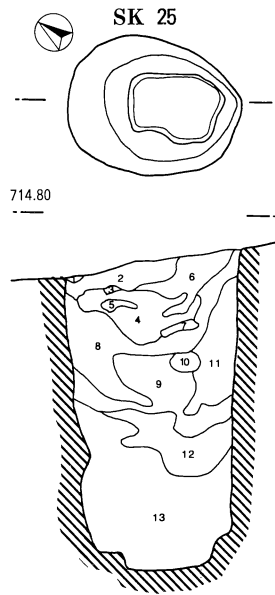

- SK25
- 1 褐色土 堆積疎
 - 2 黒褐色土 堆積密、赤色、青色スコリアを含む
 - 3 褐色土 ロームブロック
 - 4 黒褐色土 2層よりも黒く、硬い
 - 5 褐色土 ロームブロック
 - 6 褐色土 堆積疎
 - 7 褐色土 堆積疎
 - 8 褐色土 ロームブロック
 - 9 褐色土 堆積疎
 - 10 暗褐色土 堆積疎、ブロック状
 - 11 にぶい黄褐色土 堆積疎
 - 12 黄褐色土 堆積やや密
 - 13 褐色土 堆積疎

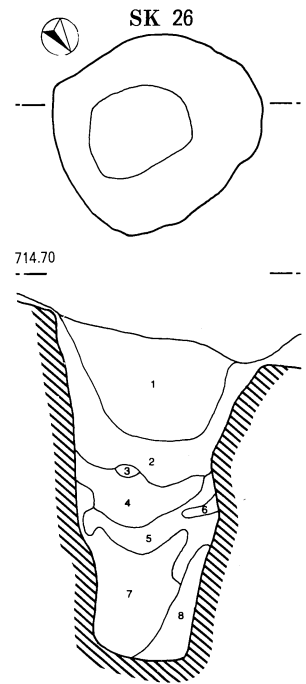

- SK26
- 1 暗褐色土 III層の黄マヤに似る
 - 2 黄褐色土 I層より黄色味を増す
 - 3 明褐色土 ブロック
 - 4 褐色土 暗褐色土を含む、軟弱
 - 5 黄褐色土 明褐色土を含む、軟弱
 - 6 暗褐色土 黄褐色土を含む、軟弱
 - 7 暗褐色土 暗褐色と褐色の混合土、堆積密
 - 8 暗褐色土 7層より色調が暗い

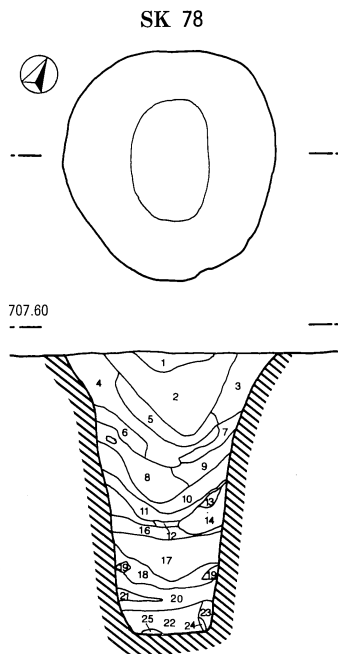

- SK78
- 1 黒色土 黄褐色粒子、赤色スコリアを含む
 - 2 黒色土 黄褐色粒子、赤色スコリアともに1層に比べ、多く
 - 3 暗褐色土 黄褐色土と褐色土の混
 - 4 黒褐色土 堆積疎で軟弱
 - 5 暗褐色土 黄褐色土と黒色土の混
 - 6 暗褐色土 赤色スコリアを若干含む
 - 7 褐色土 黒色土に黄色土が混ざる、粘性あり
 - 8 黒褐色土 黄色土に黒色土が混ざる、堆積疎
 - 9 暗褐色土 粘性強くなる
 - 10 黄褐色土 黒色土が混じる、粘性増
 - 11 黒褐色土 黄褐色粒子、赤色スコリアを含む
 - 12 暗褐色土 黄褐色土と黒色土の混
 - 13 暗褐色土 黄褐色流下多量に含む、堆積密
 - 14 褐色土 黒色土のブロックを含む
 - 15 褐色土 黄褐色土と黒色土の混ざり、Vb層のブロック
 - 16 黒色土 黄褐色粒子を含む、堆積
 - 17 黒色土 黄褐色粒子を多く含む、堆積やや密
 - 18 褐色土 黄褐色土と黒色土の混
 - 19 明褐色土 赤色、青色スコリアを多量に含む
 - 20 暗褐色土 粘性あり、軟らかく、細粒
 - 21 明黄褐色土 20層に似る
 - 22 褐色土 硬い黄褐色土と軟らかい黒色土の混ざり、赤色スコリアを若干含む
 - 23 黄褐色土 非常に硬い、緑灰色スコリアを含む
 - 24 褐色土 黄褐色土と黒色土の混
 - 25 黒色土 粘性あり

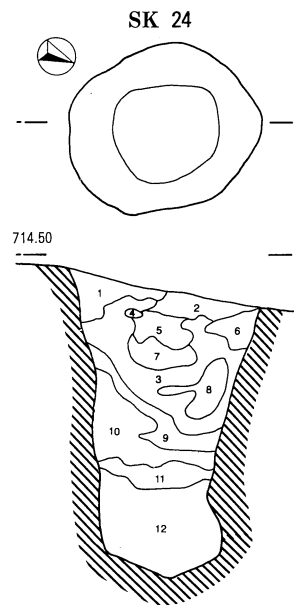

- SK24
- 1 褐色土 やや軟弱
 - 2 暗褐色土 堆積密
 - 3 暗褐色土 2層よりやや明るい
 - 4 褐色土 ブロック
 - 5 黒褐色土 他の覆土と比べ最も黒い、褐色土をブロック状に含む
 - 6 褐色土 やや軟弱
 - 7 褐色土 やや軟弱
 - 8 褐色土 ブロック状
 - 9 黄褐色土 軟弱
 - 10 暗褐色土 軟弱
 - 11 黄褐色土 堆積疎で軟弱
 - 12 黒褐色土 最下底にかなり黒い団粒状の土がある

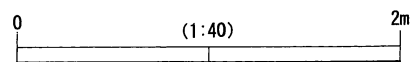

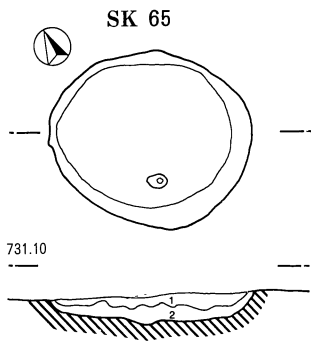

- SK65
- 1 黒色土 粘性なく、軟らかい
 - 2 褐色土 ロームブロックを含む。粘性あり、堆積密

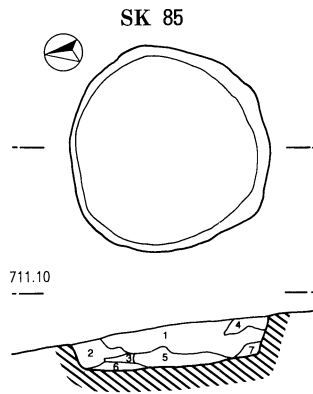

- SK85
- 1 黒褐色土 III層に似るが、粘性なく軟らかい
 - 2 にぶい黄褐色土 やや粗粒、堆積密
 - 3 黒色土 1層に比べやや暗い
 - 4 褐色土 堆積やや疎
 - 5 にぶい黄褐色土 堆積密、粘性あり
 - 6 褐色土 堆積密で粘性あり
 - 7 黄褐色土 堆積やや疎、粘性はある

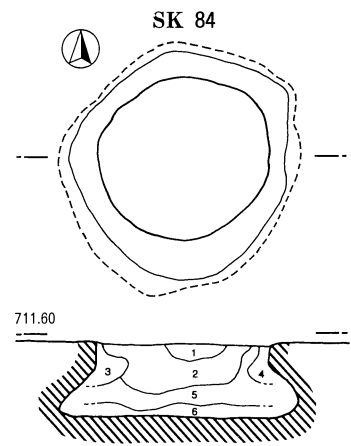

- SK84
- 1 黄褐色土 堆積疎、粗粒、暗褐色土のブロックを含む
 - 2 暗褐色土 黄褐色粒子を若干含む、粘性少なく、粗粒で堆積疎
 - 3 黄褐色土 黒色土がモヤ状に入る、粗粒
 - 4 黄褐色土 3層と同じ
 - 5 暗褐色土 やや粗粒、粘性少しあり、堆積密
 - 6 褐色土 スコリア粒子を若干含む、堆積密

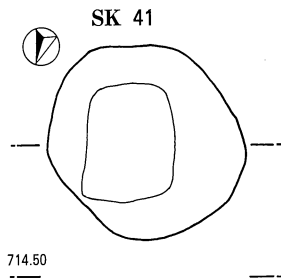

- SK41
- 1 暗褐色土 堆積密
 - 2 褐色土 堆積疎、赤色スコリアを若干含む
 - 3 暗褐色土 堆積疎、赤色スコリアを若干含む
 - 4 褐色土 堆積密
 - 5 明黄褐色土 堆積密
 - 6 褐色土 堆積疎、赤色スコリアを若干含む
 - 7 黒褐色土 軟弱
 - 8 褐色土 堆積疎、赤色スコリアを若干含む
 - 9 極暗褐色土 炭化物を含む、赤色スコリアも若干含む
 - 10 黄褐色土 暗褐色土が帯状に入る
 - 11 暗褐色土 堆積疎、粘性なし
 - 12 褐色土 堆積密、赤色、青色スコリアを含む、粘性あり
 - 13 黒褐色土 堆積密、赤色スコリアを含む、粘性なし、白色粒子を最下底に含む

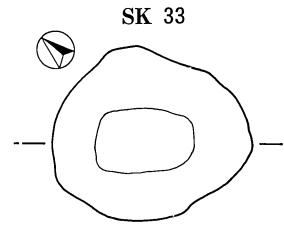

- SK33
- 1 暗褐色土 堆積やや密
 - 2 褐色土 軟弱、茶褐色スコリア若干含む
 - 3 暗褐色土 2層に比べ暗い
 - 4 褐色土 2層に比べ明るい
 - 5 褐色土 軟弱
 - 6 黄褐色土 堆積やや密
 - 7 黒褐色土 堆積疎、ブロック状
 - 8 褐色土 堆積やや密

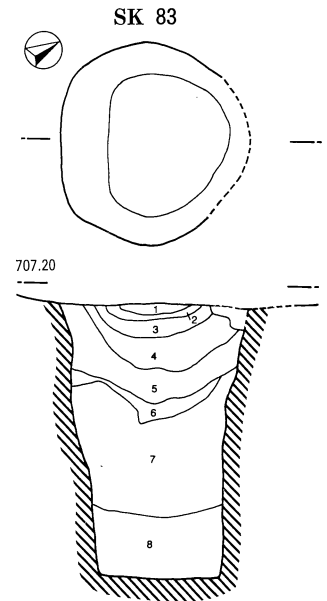

- SK83
- 1 黒褐色土 堆積密で硬い
 - 2 暗褐色土 堆積は密だが1層よりやや軟らかい
 - 3 黒褐色土 堆積疎で、軟弱
 - 4 黒褐色土 砂質土、スコリア粒子を含み軟らかい
 - 5 黒褐色土 粘性はややあるが、軟らかい
 - 6 黒色土 砂質土
 - 7 暗褐色土 黄褐色と黒褐色土の混ざり
 - 8 黒褐色土 底部に団粒状の軟らかい土が堆積

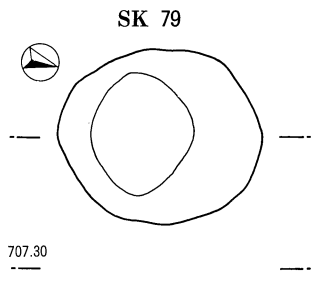

- SK79
- 1 黒色土 堆積疎で軟弱
 - 2 黒褐色土 赤色スコリアを含む
 - 3 暗褐色土 黄褐色粒子、ブロックを含む
 - 4 暗褐色土 ロームブロックをよく含む
 - 5 黒褐色土 硬い黄褐色土(VIII層相当)を含む
 - 6 暗褐色土 黒色土、黄褐色土の混ざり
 - 7 黄褐色土 Vb層のブロックを含む
 - 8 褐色土 黄褐色土と黒色土の混ざり
 - 9 褐色土 黄褐色土と黒色土の混ざり、赤色スコリアを含む、軟らかい
 - 10 黒褐色土 Vb層のブロックを含む
 - 11 暗褐色土 黒色土、黄褐色土の混ざり
 - 12 褐色土 黒色土、黄褐色土の混ざり、堆積密で硬い
 - 13 黒褐色土 下部に炭化物の層あり
 - 14 黄褐色土 赤色スコリアを若干含む、硬い
 - 15 黒褐色土 黄褐色、黒色土の混ざり、黒色土の部は軟らかい

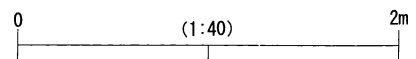

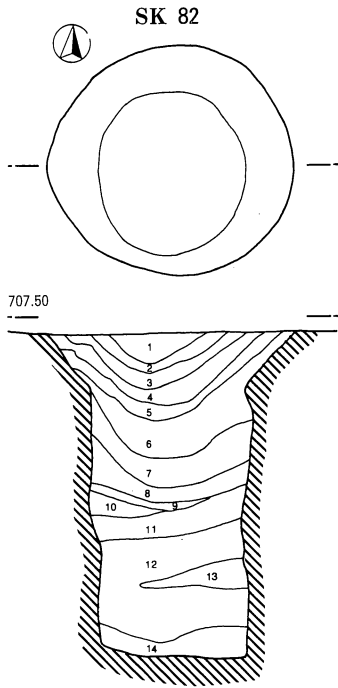

- SK82
- 1 黒色土 砂質土
 - 2 黒褐色土 砂質土、赤色スコリアを含む
 - 3 黒色土 砂質土、1層に比べ黒い
 - 4 黒褐色土 砂質土、2層に比べやや大粒の赤色スコリアを含む
 - 5 黒色土 砂質土、黒味が強い
 - 6 暗褐色土 砂質の黒色土と褐色土の混ざり
 - 7 黄褐色土 粗粒で粘性ややあり、やや硬い
 - 8 褐色土 粘性なく軟弱
 - 9 黒色土 砂質土
 - 10 褐色土 堆積疎で軟らかい
 - 11 黒褐色土 堆積疎で軟らかい、粘性ややあり
 - 12 黒褐色土 黒色土が縞状に走る
 - 13 黄褐色土 粘性あり、堆積やや密
 - 14 暗赤褐色土 粘性の強い、硬い層

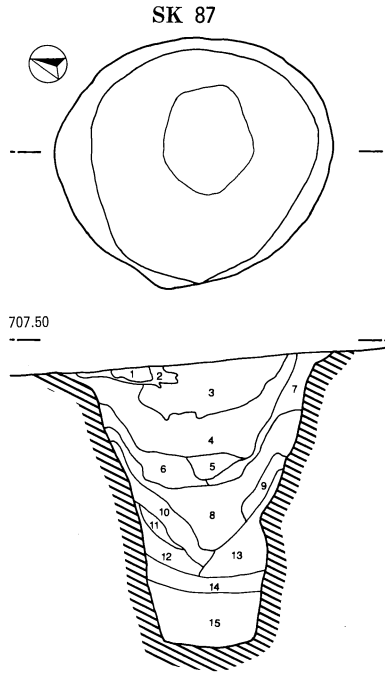

- SK87
- 1 褐色土 IIb層に相当
 - 2 黒褐色土 赤色スコリアを若干含む
 - 3 黒褐色土 赤色スコリアを若干含む、粘性なく軟
 - 4 黒褐色土 赤色スコリアを含む
 - 5 黒褐色土 堆積疎、赤色、青色スコリア、炭化物を含む
 - 6 暗褐色土 黒色と黄褐色土の混ざり
 - 7 暗褐色土 6層に似るが、黄褐色土が多くなる
 - 8 黒褐色土 黒色と黄褐色土の混ざり、軟らかい
 - 9 黒褐色土 明褐色の粒子をよく含む
 - 10 暗褐色土 炭化物を含む
 - 11 黄褐色土 10層に似るが、より粘性が強くなる
 - 12 暗褐色土 黒色と黄褐色土の混ざり
 - 13 暗褐色土 炭化物を比較的好く含む
 - 14 黒褐色土 炭化物を若干含む、粘性強いが軟弱
 - 15 黒褐色土 団粒状、黄褐色粒子、炭化物を含む

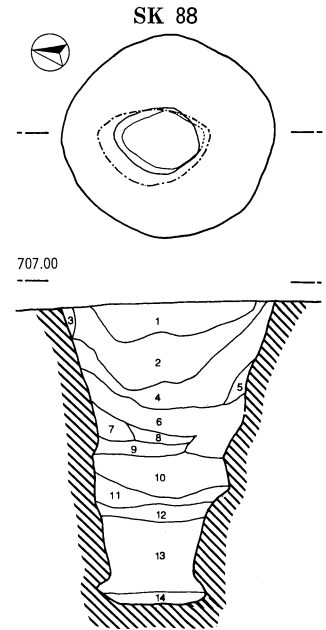

- SK88
- 1 黒色土 堆積密で硬い、細粒で粘性なし
 - 2 黒褐色土 堆積疎で軟らかく、粗粒で粘性なし
 - 3 にぶい黄褐色土 黄色と黒色土の混合土、堆積やや密、粘性あり粗粒
 - 4 にぶい黄褐色土 黄色と黒色土の混合土、堆積疎、粘性なく粗粒
 - 5 黄褐色土 黄色と黒色土の混合土、堆積やや密、粘性なく粗粒
 - 6 黒褐色土 黄色ローム粒子を若干含む、やや粗
 - 7 黄褐色土 黄色ロームブロックを含む、やや粗
 - 8 褐色土 黄色ロームと黒色土の混合土、軟弱
 - 9 黒褐色土 黄色粒子を若干含む、粗粒
 - 10 にぶい黄褐色土 黒色土と黄色土が互層になる
 - 11 黒褐色土 粘性あるが、やや粗粒
 - 12 黄褐色土 細粒、粘性強、ロームブロックを含む
 - 13 黒褐色土 粗粒、粘性強、ロームブロックをよく含む
 - 14 黒褐色土 堆積密、細粒で粘性あり

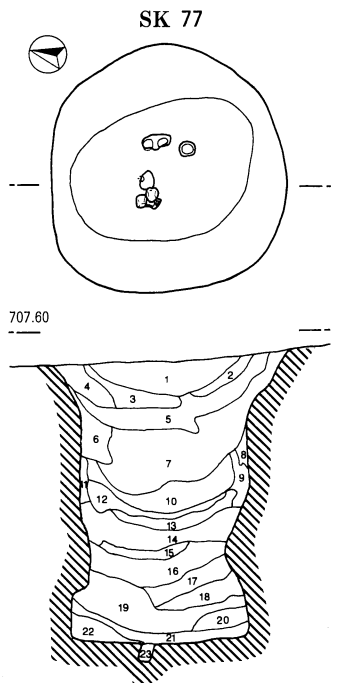

- SK77
- 1 黒色土 粘性あり、黄褐色粒子、青灰色スコリア、炭化物粒子を若干含む
 - 2 黒褐色土 黄褐色粒子を含む、粘性あり
 - 3 黒褐色土 黄褐色粒子、赤色、青灰色スコリアを含む、粘性あり
 - 4 暗褐色土 粘性なし、青灰色、赤褐色スコリアを含む
 - 5 黒色土 粘性あり、赤褐色スコリアを含む
 - 6 暗褐色土 粘性あり、青灰色、赤褐色スコリアを含む
 - 7 暗褐色土 黒色土ブロック、黄褐色粒子を含む
 - 8 黄褐色土 堆積疎
 - 9 暗褐色土 堆積疎
 - 10 黄褐色土 堆積やや密、粘性あり、黒色土が混ざる
 - 11 暗褐色土 9層と同じ
 - 12 黒褐色土 堆積疎で軟らかい
 - 13 黄褐色土 10層に比べ堆積疎で黒色土の混じりが多い
 - 14 黒褐色土 赤褐色、青灰色スコリア、黄褐色土のブロックを含む
 - 15 褐色土 黒色土がシミ状に入る
 - 16 黒色土 黄褐色ロームブロックをよく含む
 - 17 暗褐色土 黒色と黄褐色土の混ざり
 - 18 褐色土 黄褐色ロームに黒色土ブロックが混じる
 - 19 黒褐色土 堆積疎、黄褐色ロームブロックをよく含む
 - 20 褐色土 硬い黄褐色土と軟らかい黒色土の混ざり
 - 21 黒褐色土 堆積疎で軟らかい
 - 22 黒褐色土 硬い黄褐色土と軟らかい黒色土の混ざり
 - 23 褐色土 赤色、青色スコリアを含む

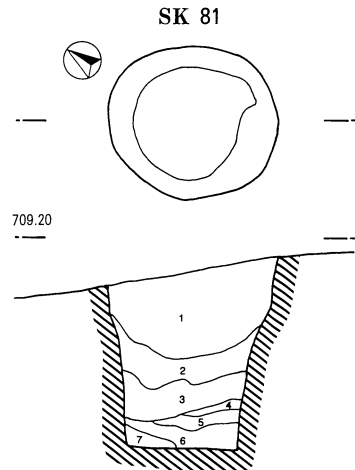

- SK81
- 1 黒色土 堆積疎で粘性ない、赤色スコリアを含む
 - 2 黒褐色土 堆積疎で粘性ない、赤色スコリアを含む、軟らかい
 - 3 黒色土 堆積疎で粘性ない、赤色スコリアを含む、2層よりさらに軟らかい
 - 4 褐色土 黒色と褐色土の混ざり
 - 5 黒色土 堆積疎、粘性なし、軟弱
 - 6 暗褐色土 赤色スコリアを若干含む、粘性なし
 - 7 黒褐色土 堆積密で硬い

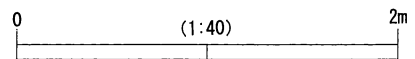

縄文時代土坑図11



縄文時代集石図 1



縄文時代集石図 2

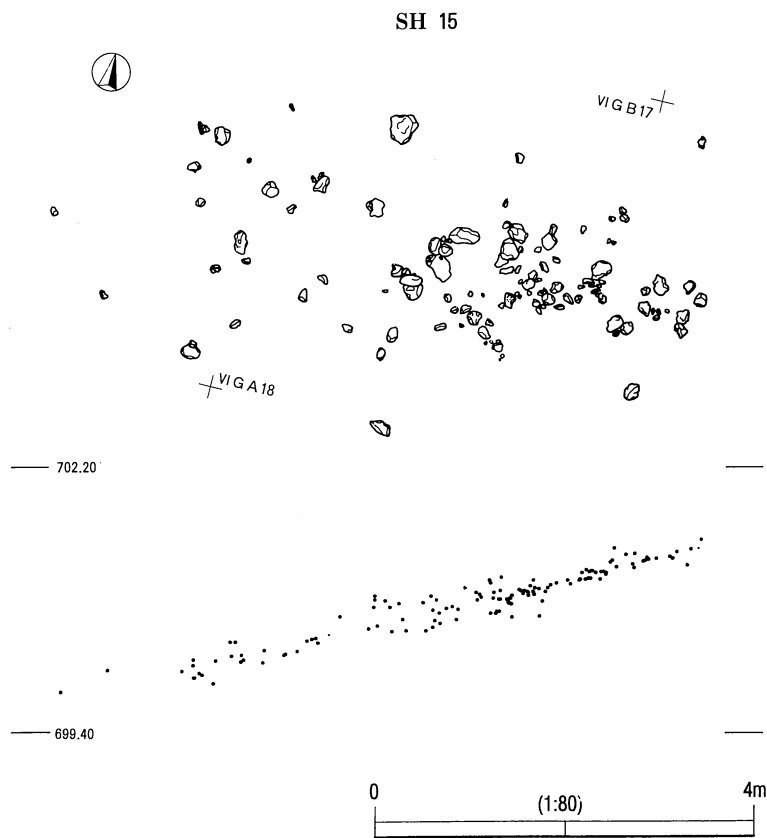
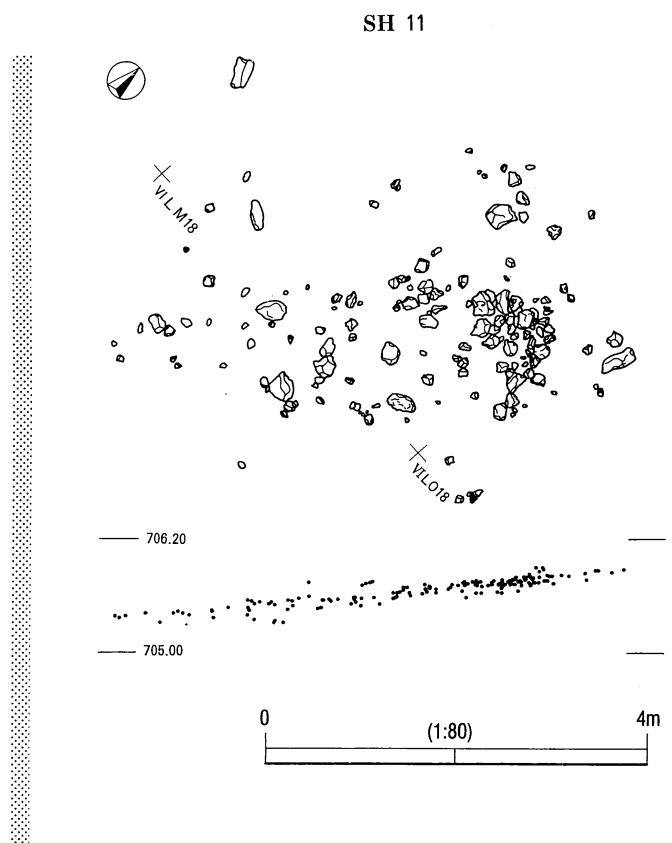
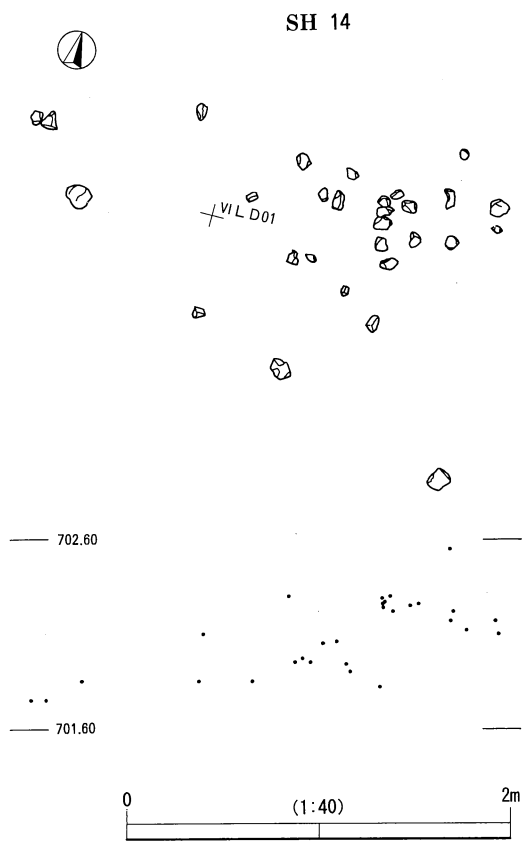

縄文時代集石図 3

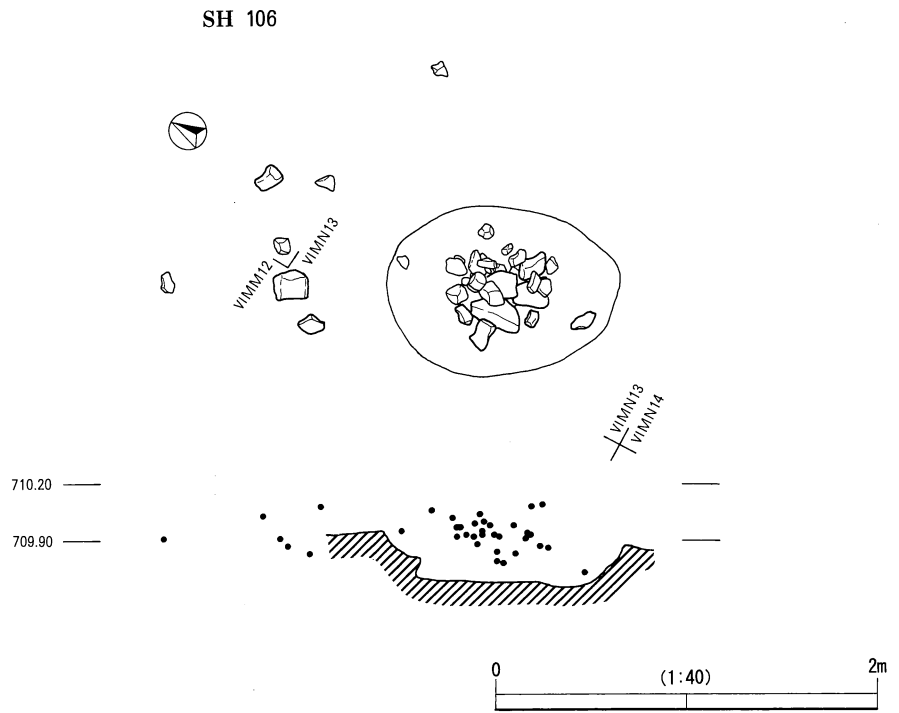
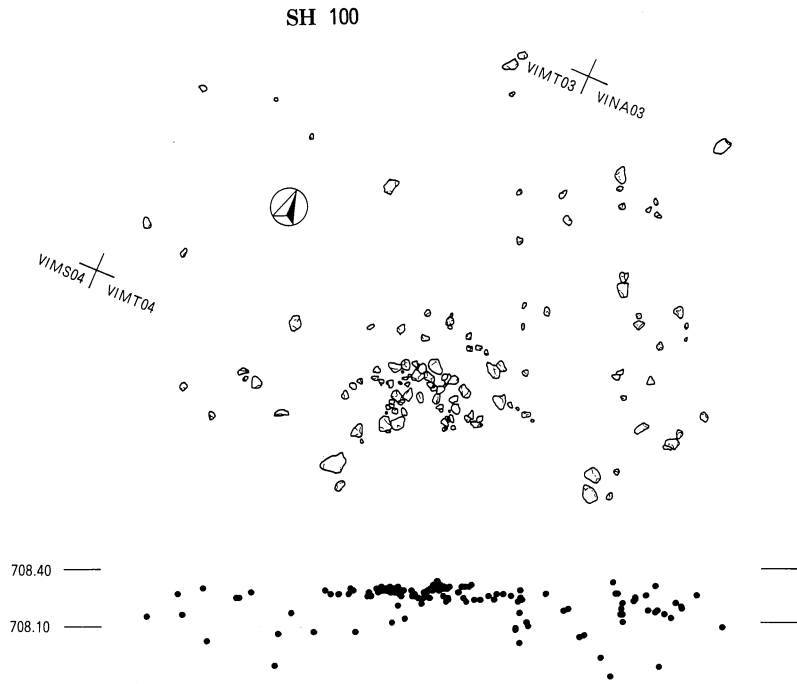

縄文時代集石図 4

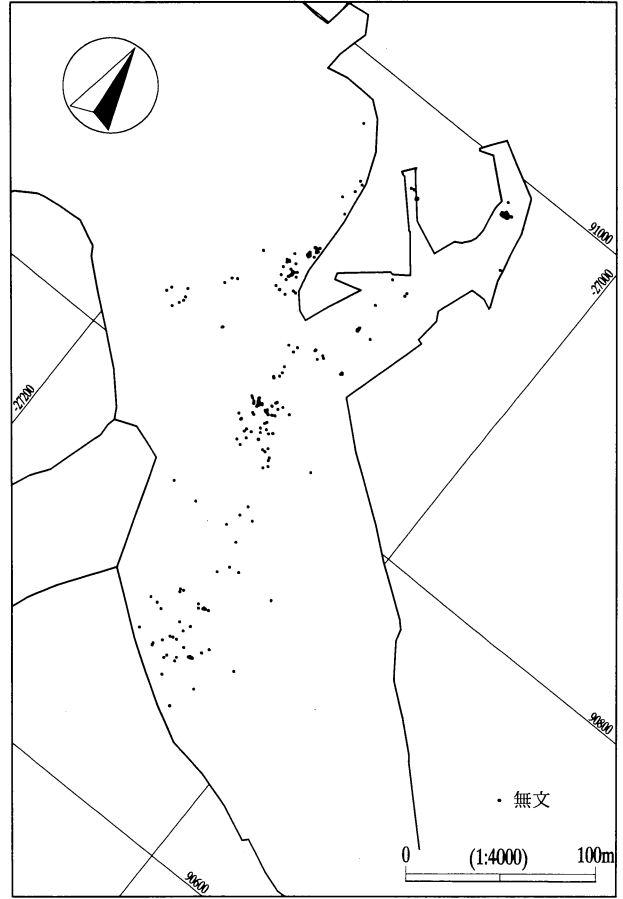

縄文時代土器分布図

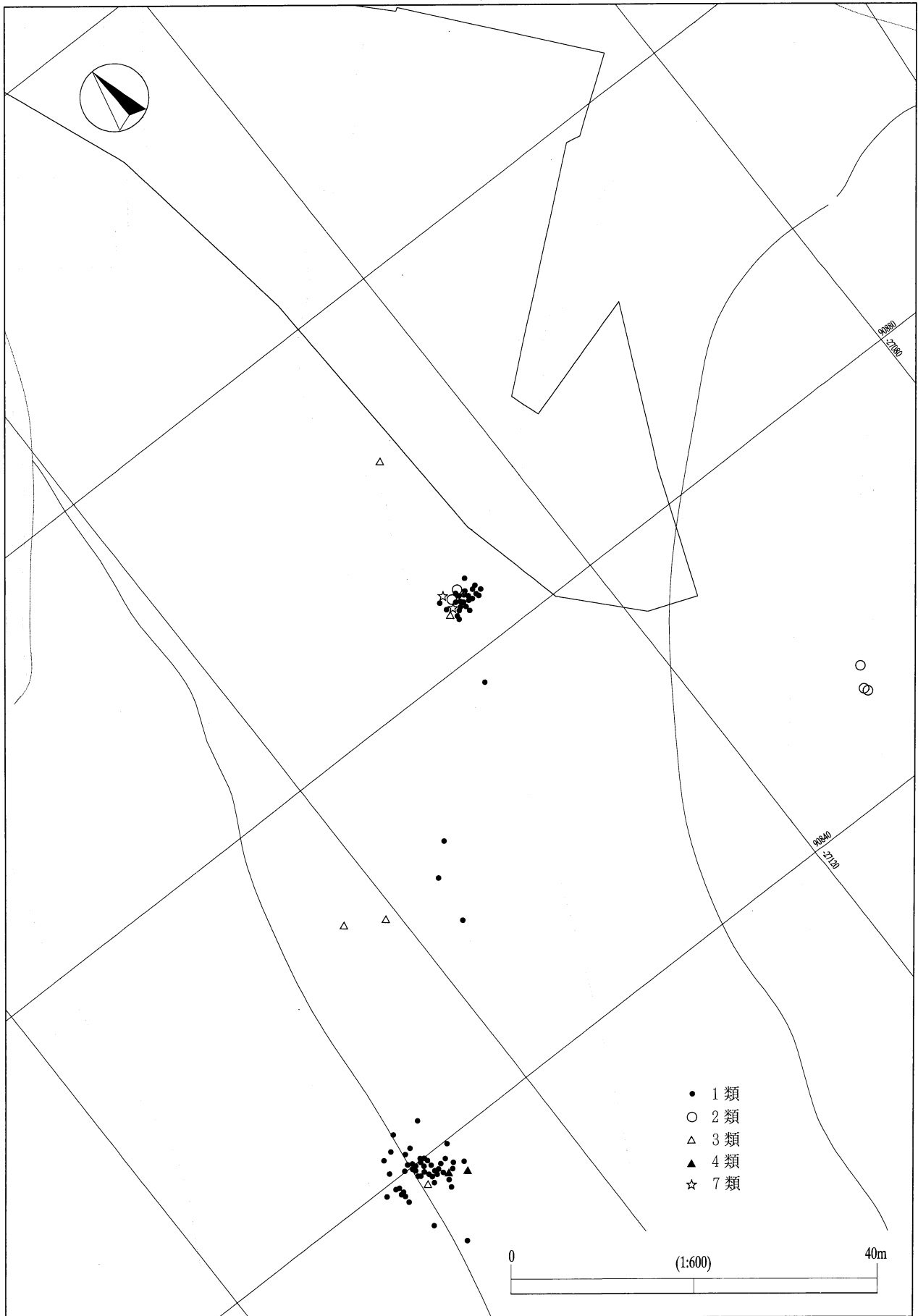

縄文時代表裏縄文土器分類別分布図

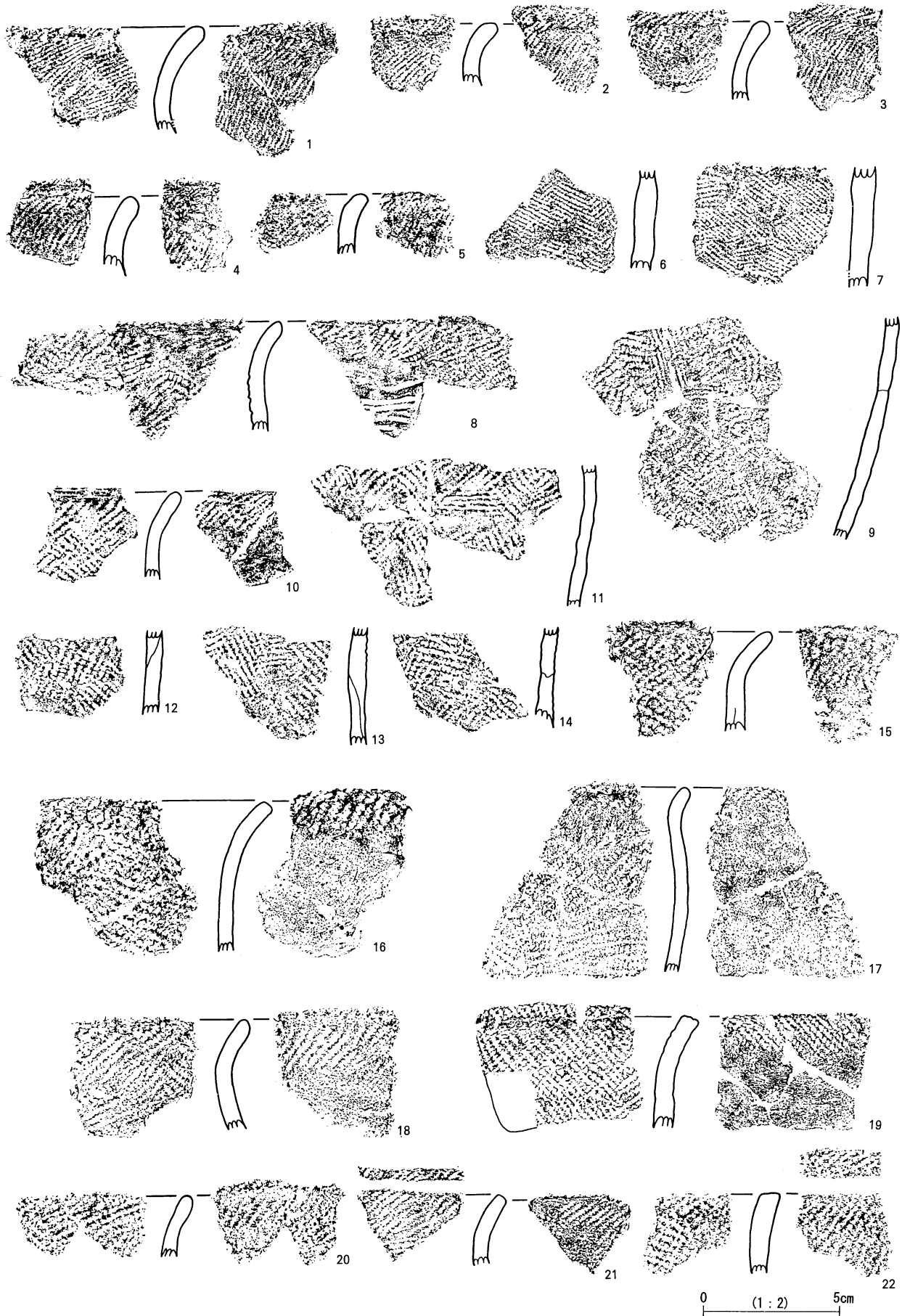

縄文時代土器 1

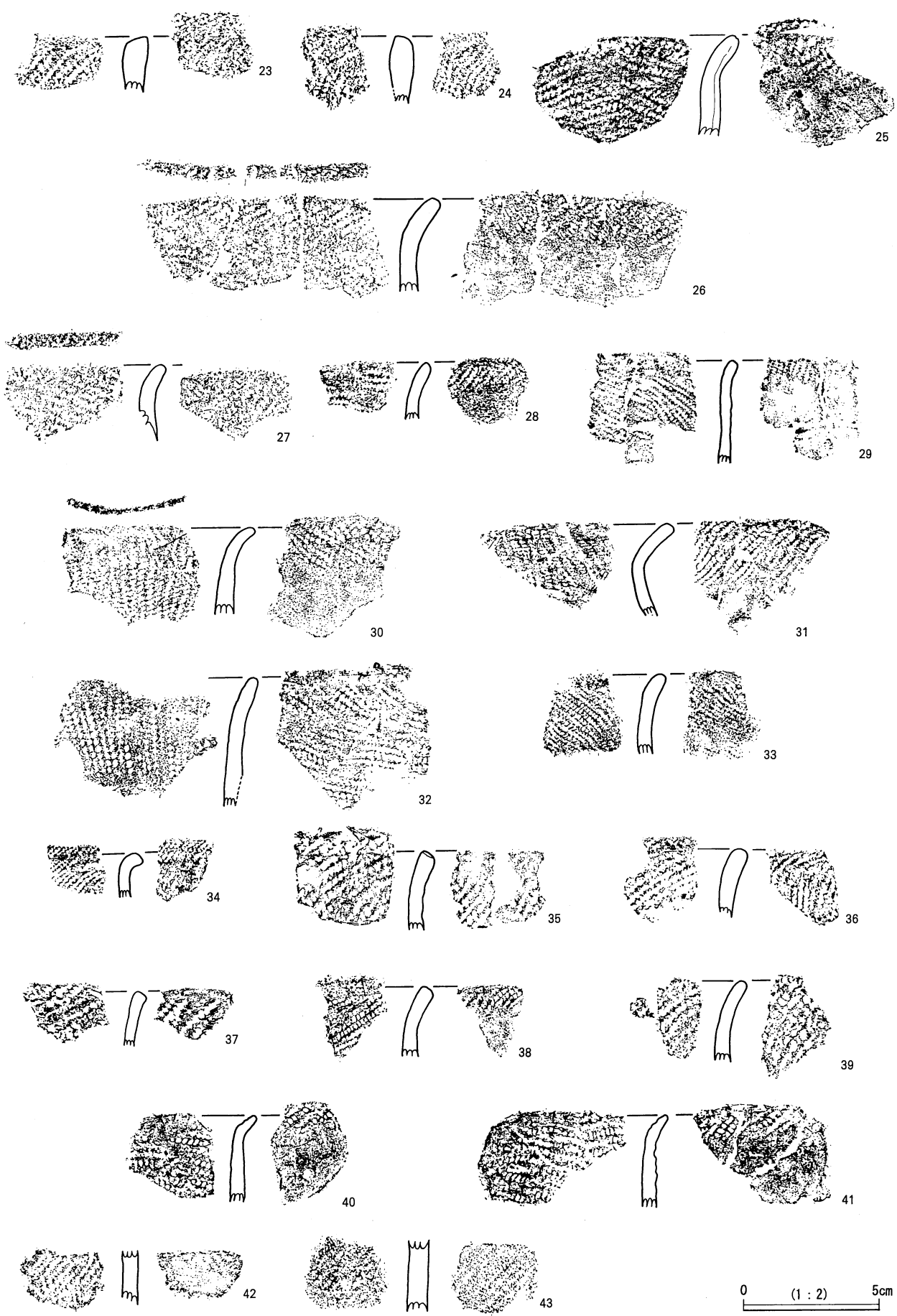

縄文時代土器 2

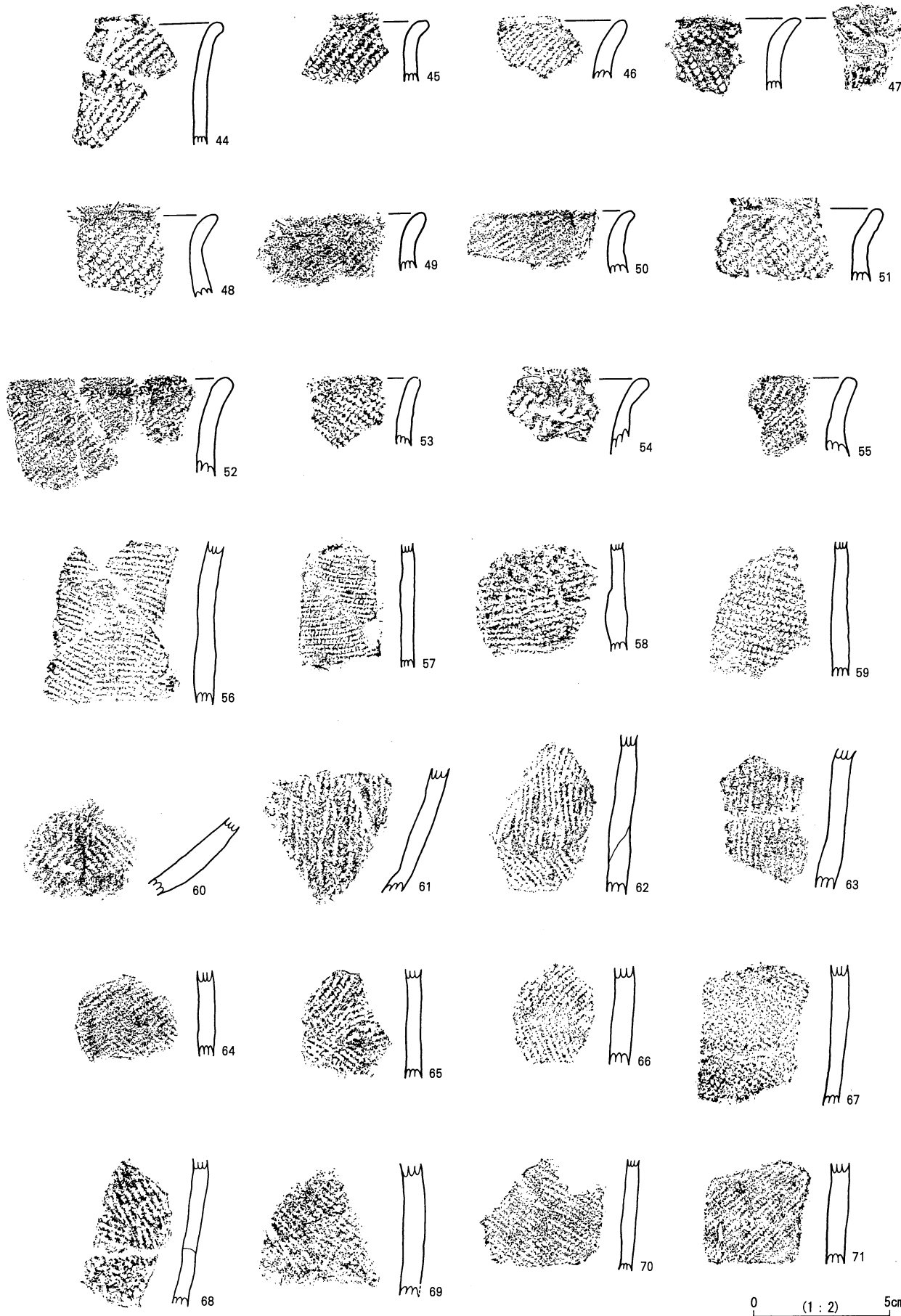

縄文時代土器 3

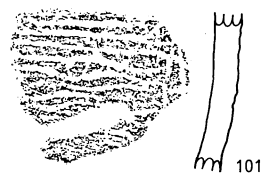
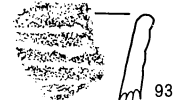
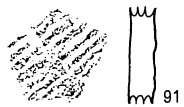
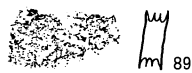
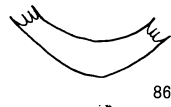
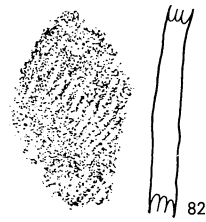
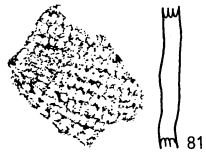
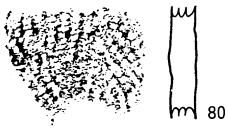
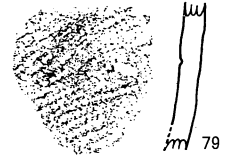
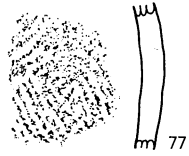

0 (1 : 2) 5cm

縄文時代土器 4

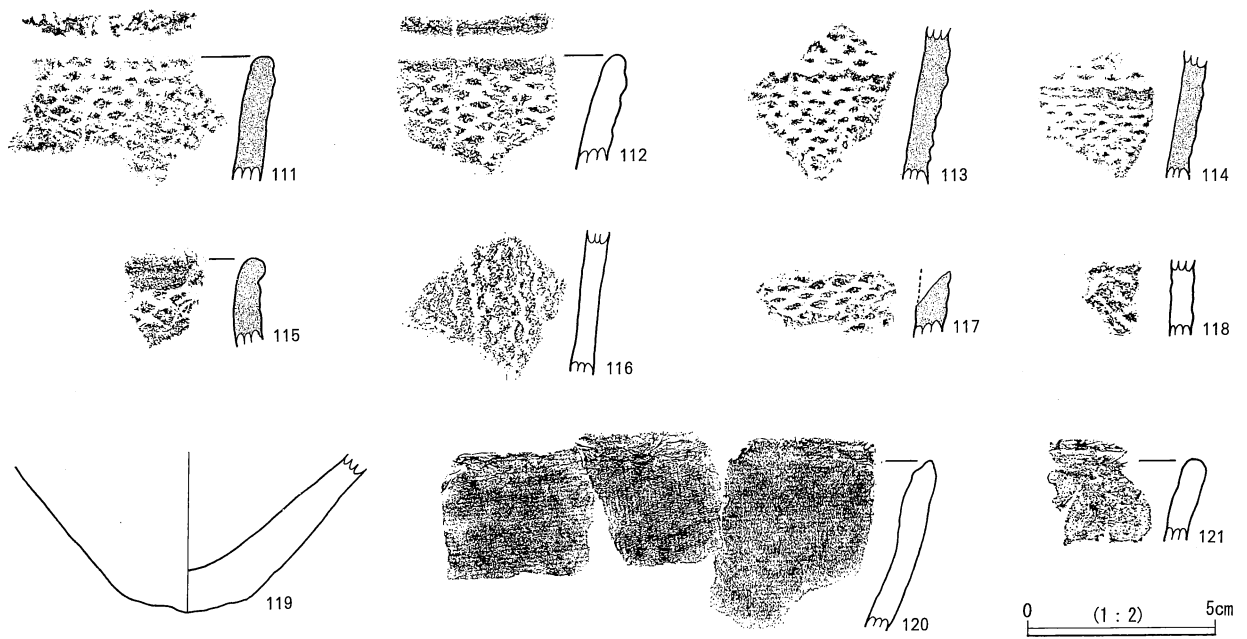
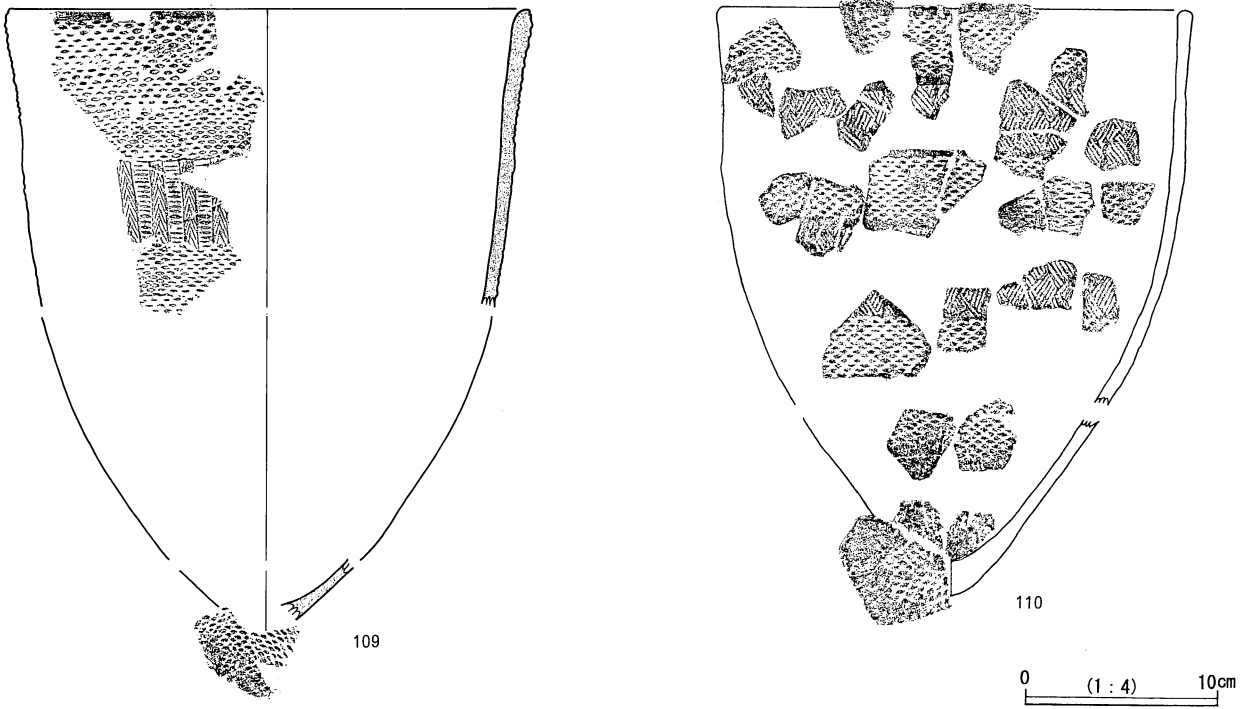
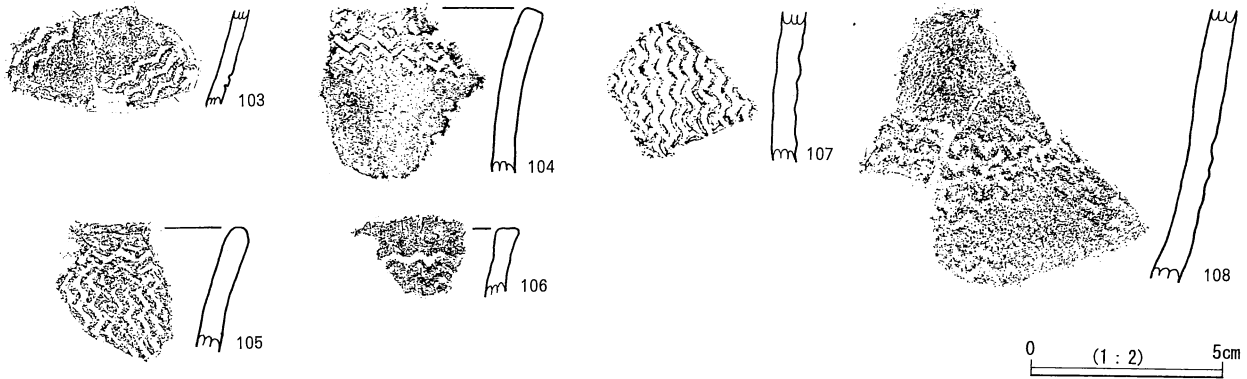

縄文時代土器 5

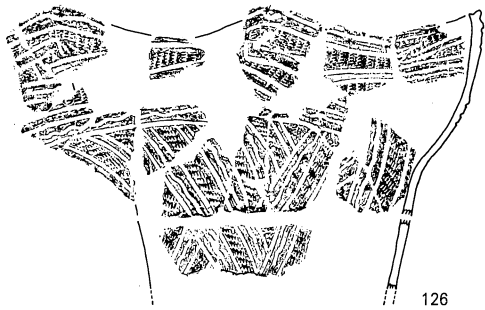
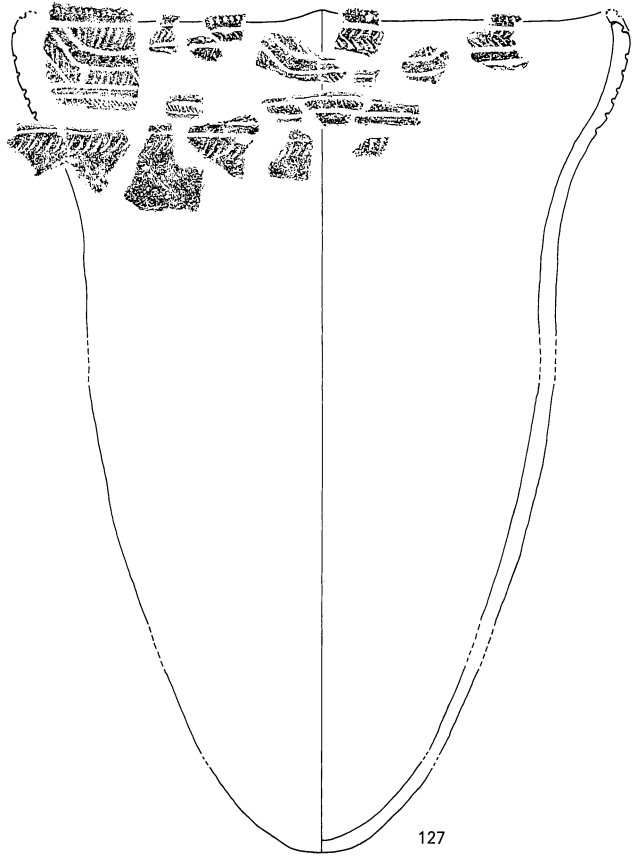
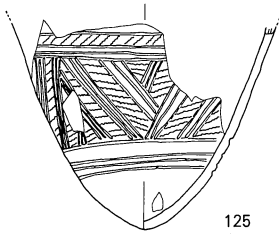
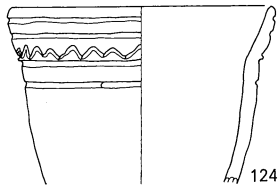
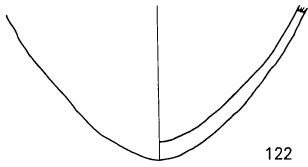
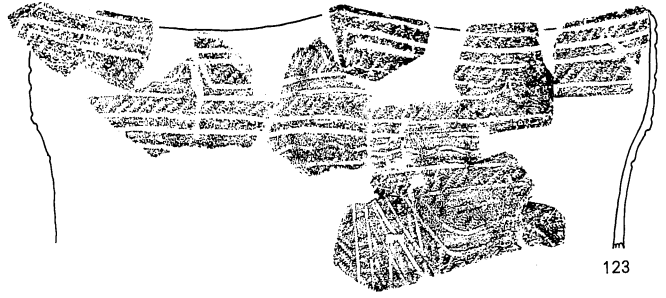

0 (1 : 4) 10cm

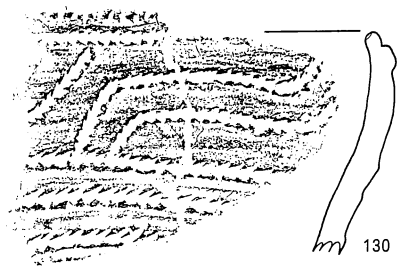
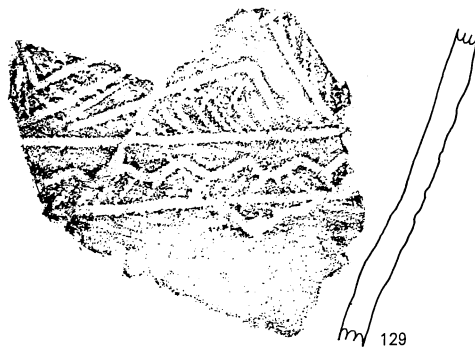
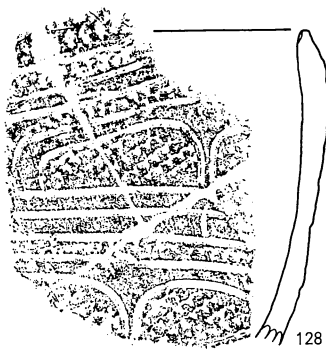

0 (1 : 2) 5cm

縄文時代土器 6

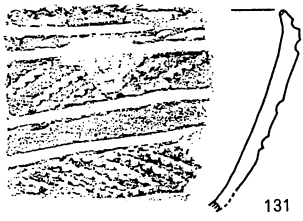

131

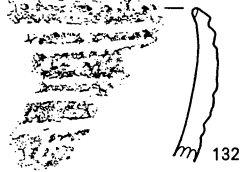

132



133

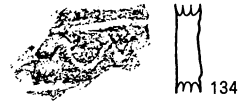

134

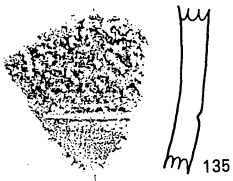

135



136



137

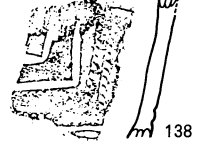

138

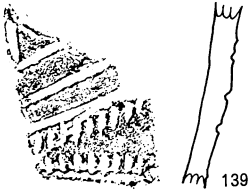

139

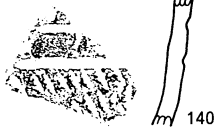

140

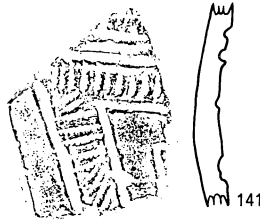

141



142



143

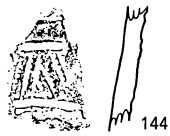

144



145



146



147

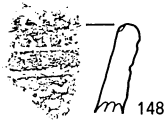

148



149



150



151



152



153



154



155



156

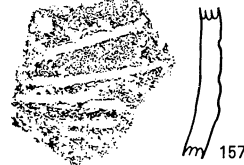

157



158

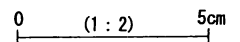

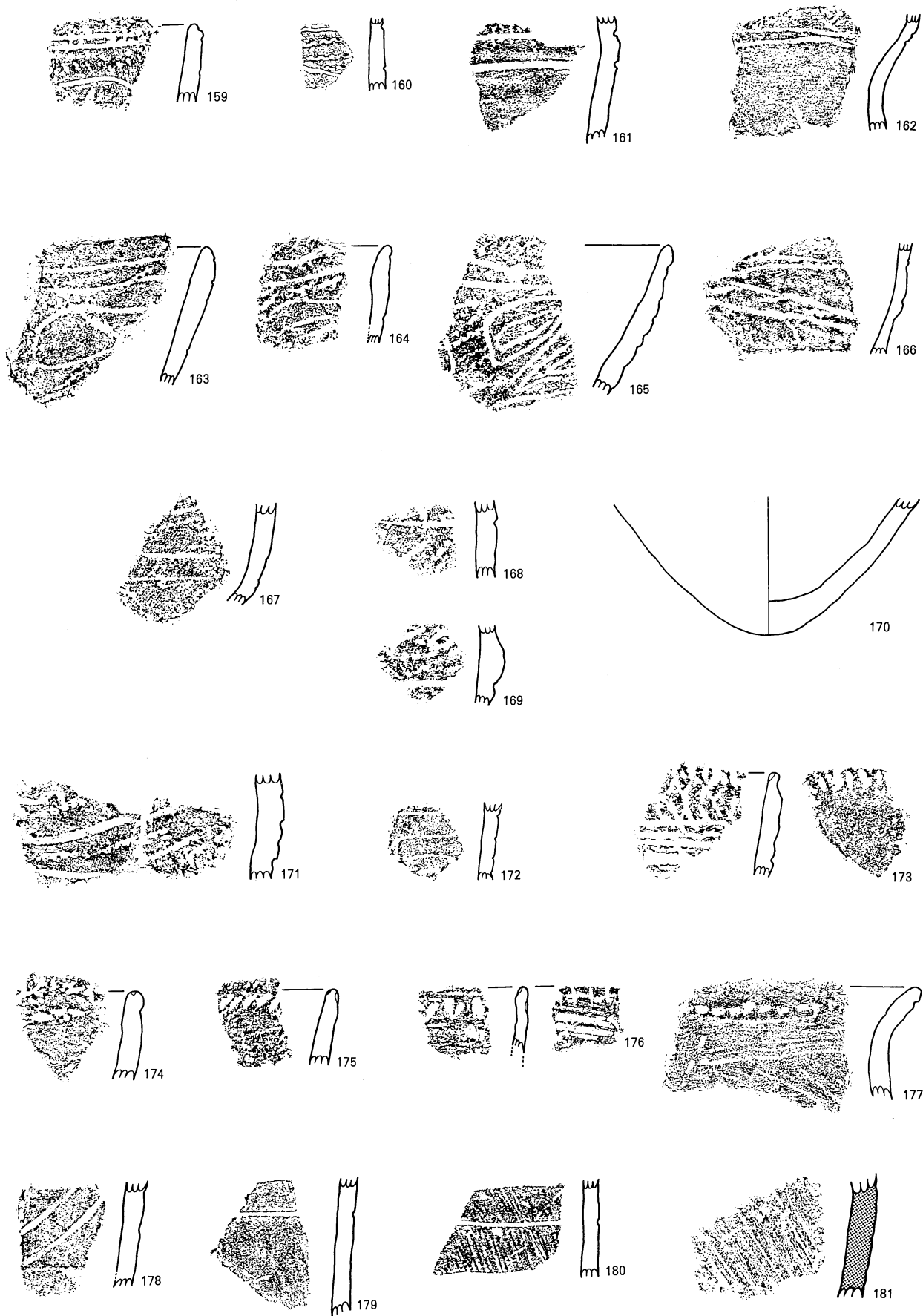

0 (1:2) 5cm

縄文時代土器 8

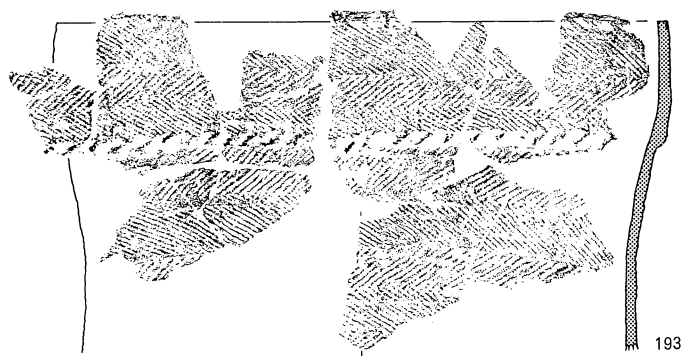
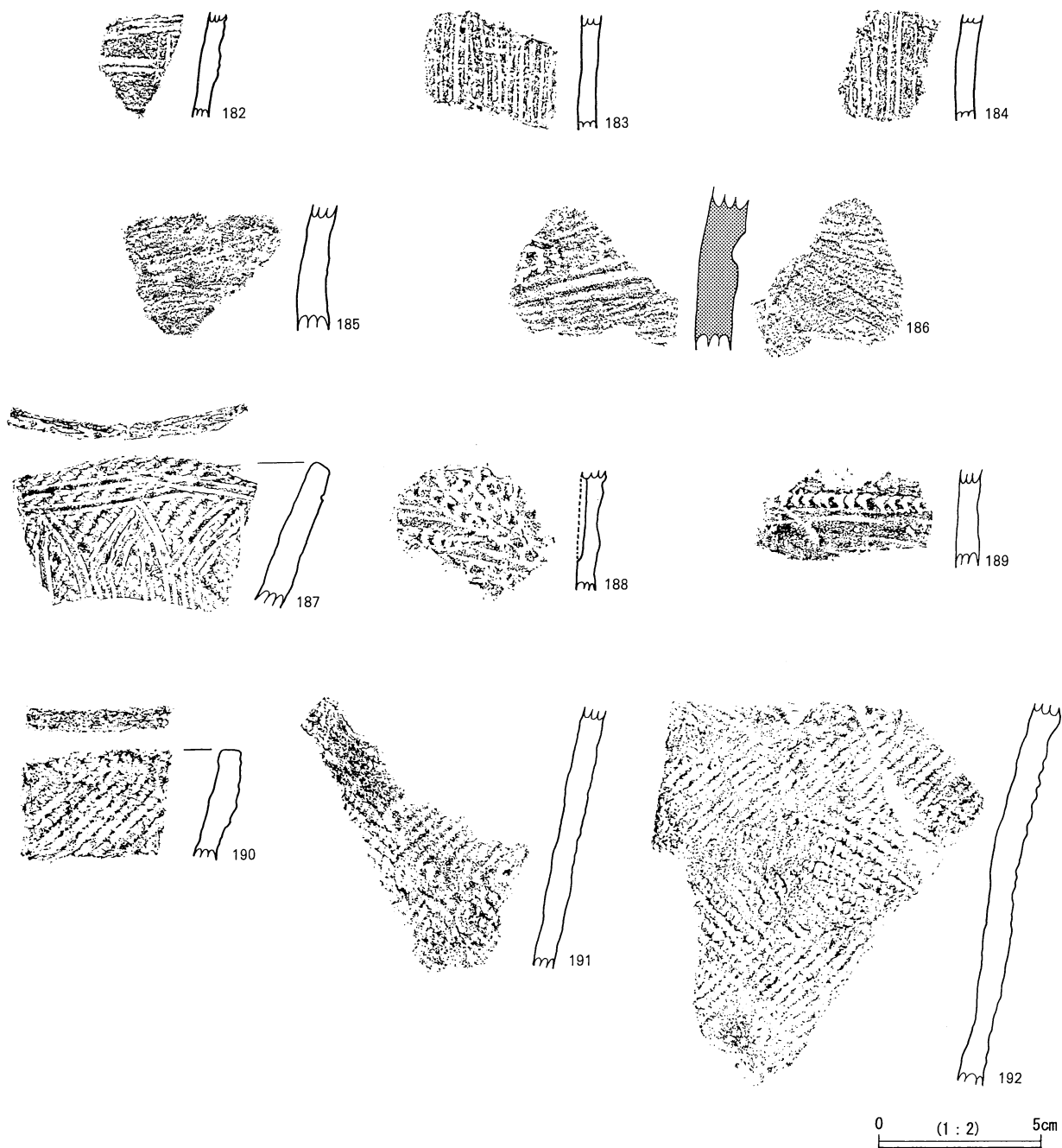

縄文時代土器 9

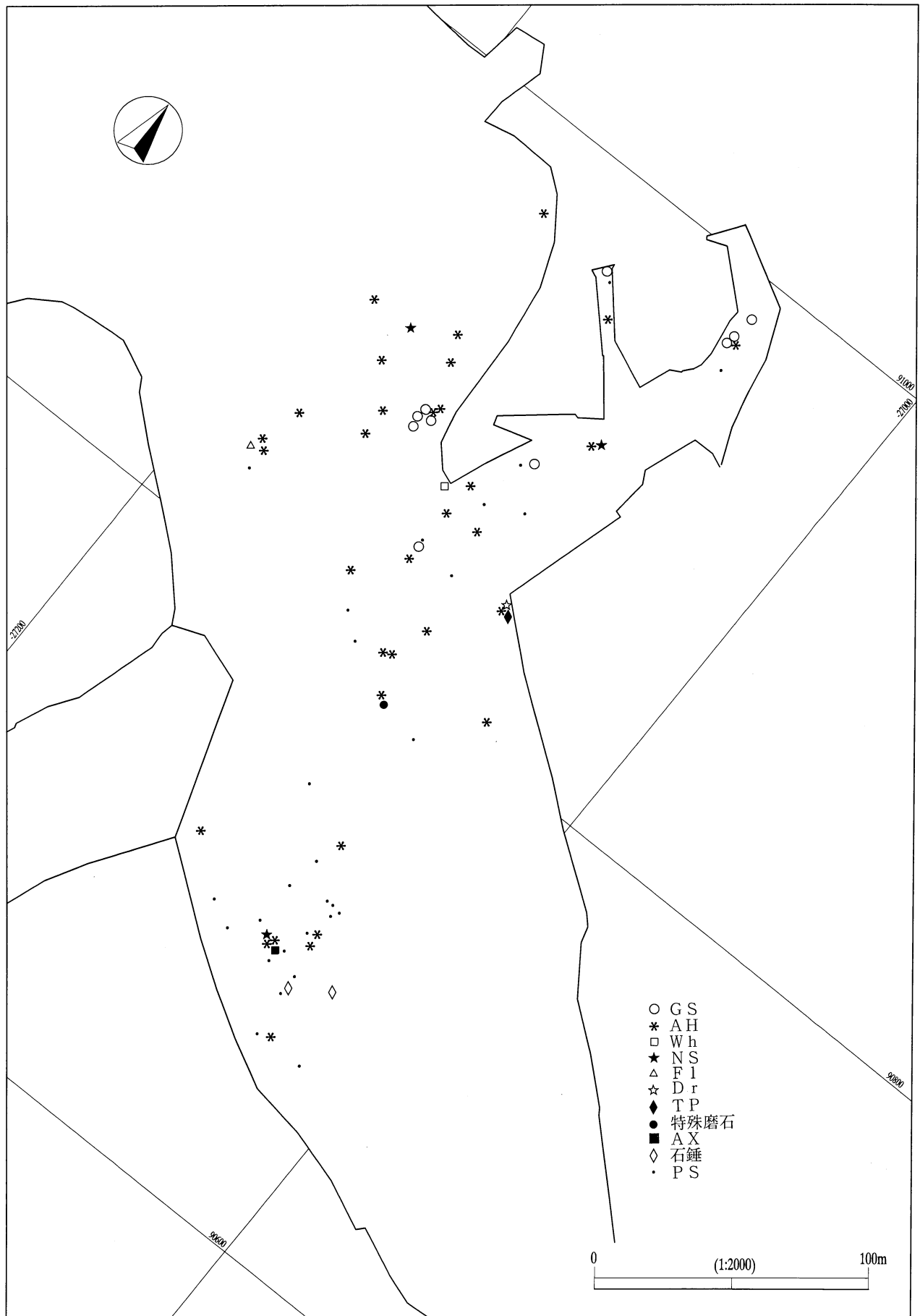

縄文時代石器分布図

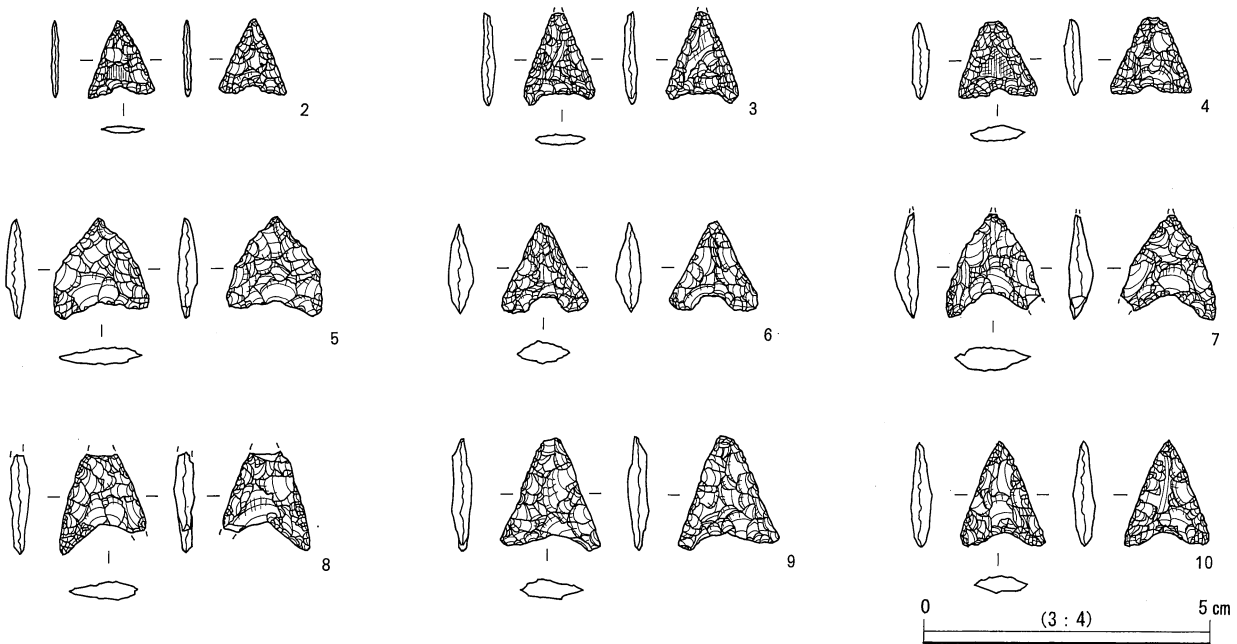
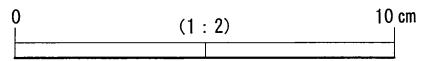
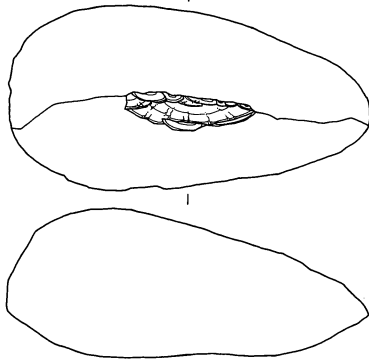
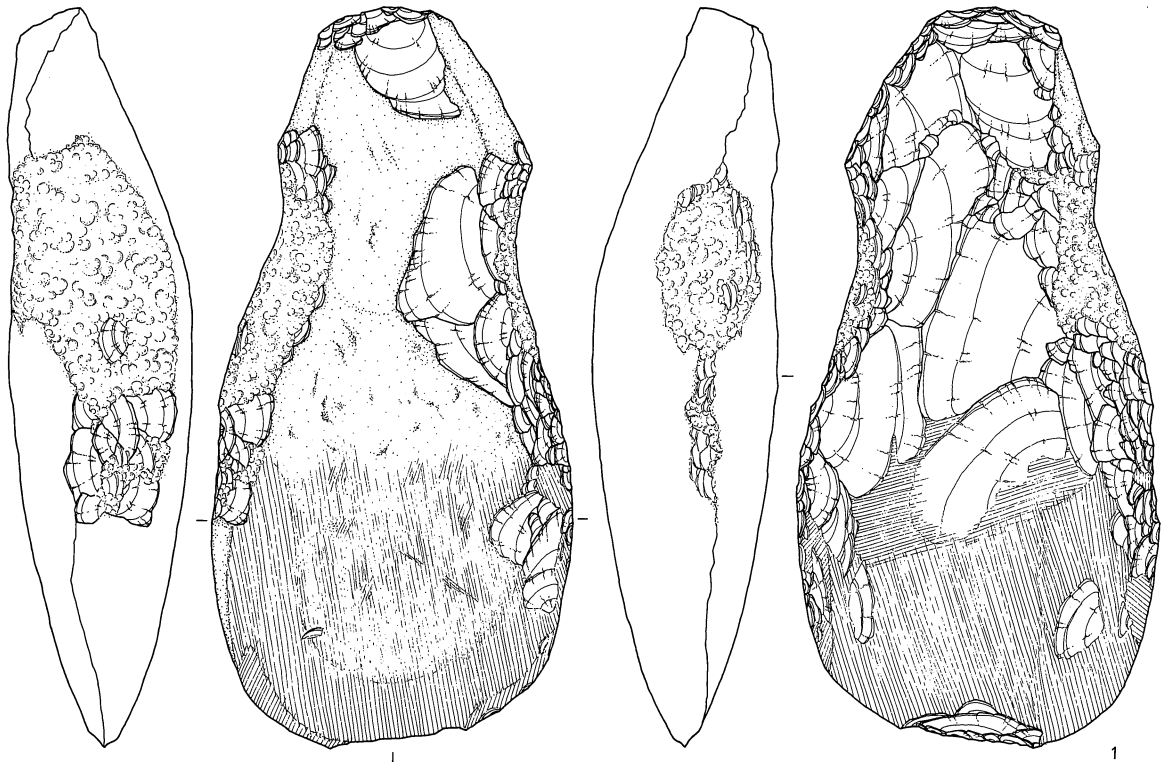

縄文時代石器 1

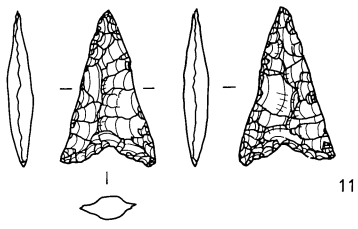

11

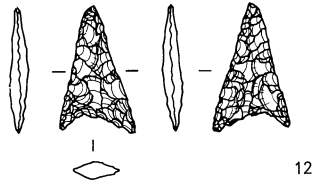

12

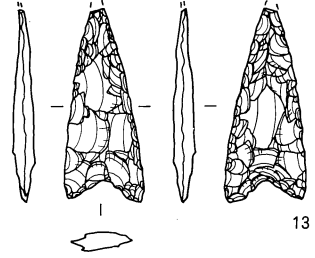

13

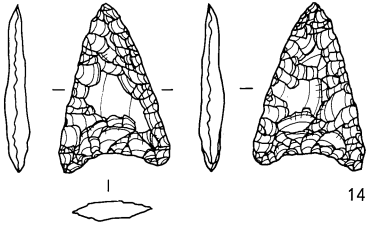

14

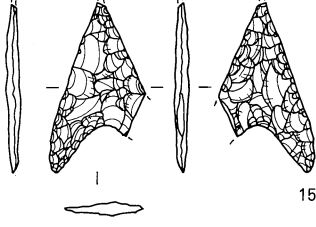

15

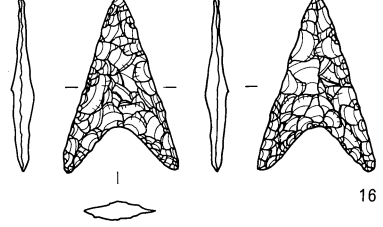

16

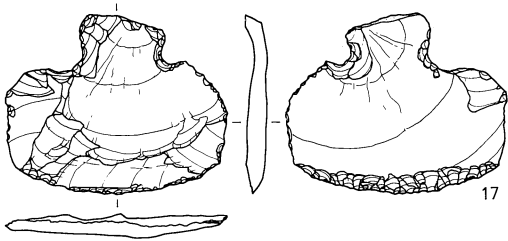
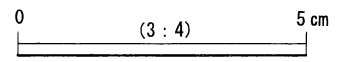

17

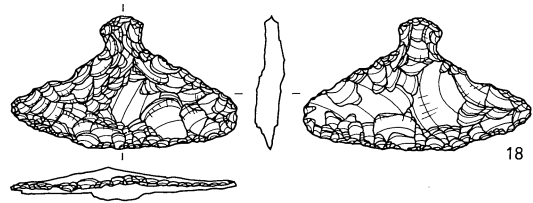

18

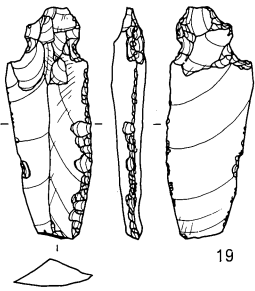

19

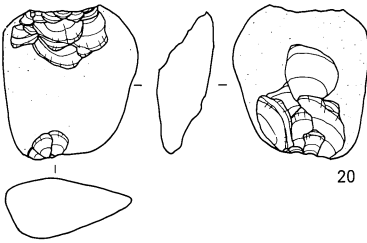

20

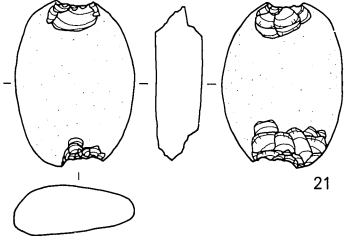

21

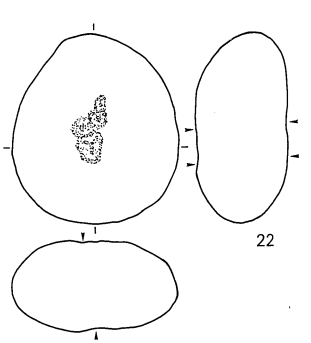
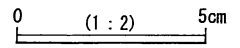

22

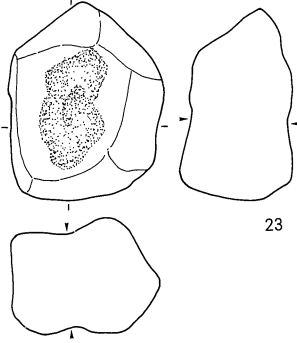

23

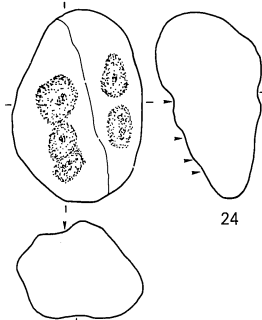

24

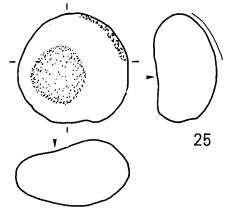

25

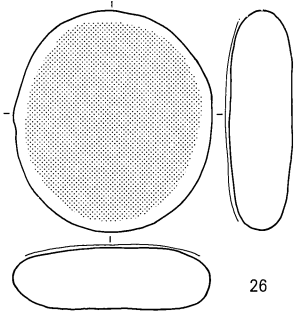

26

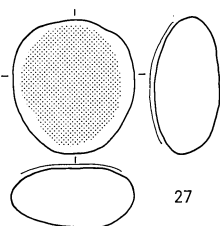

27

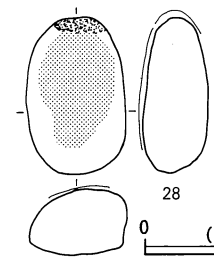

28

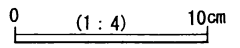

縄文時代石器 2

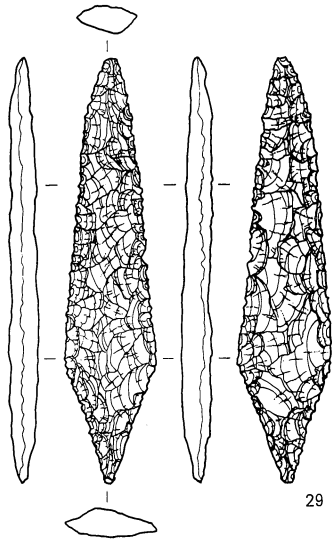

29

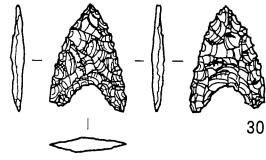

30

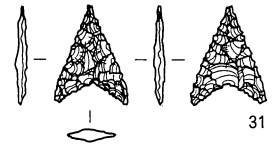

31

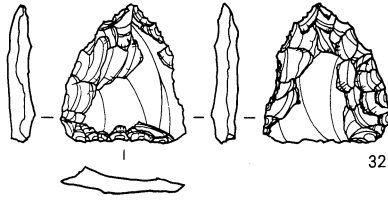

32

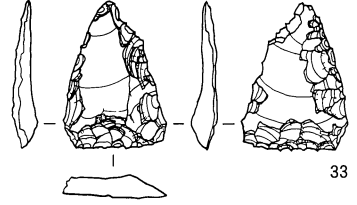

33

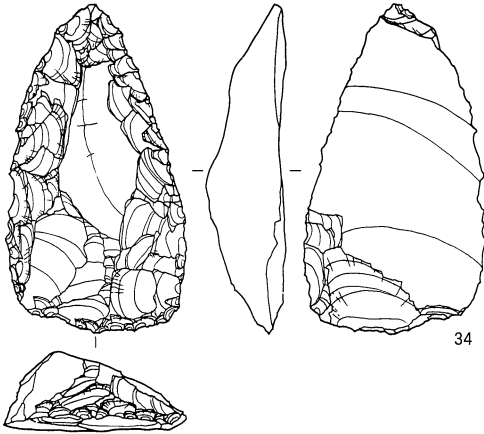
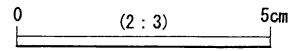

34

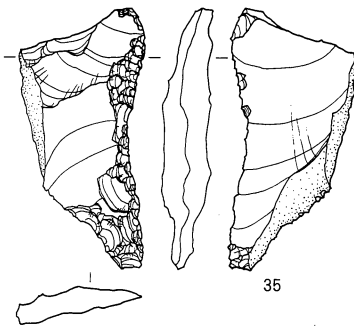

35

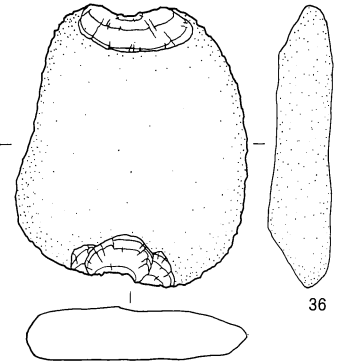

36

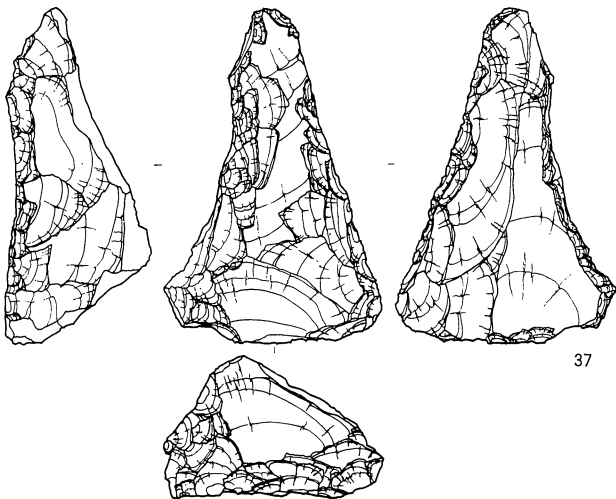
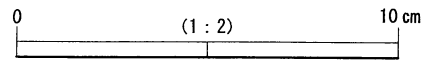

37

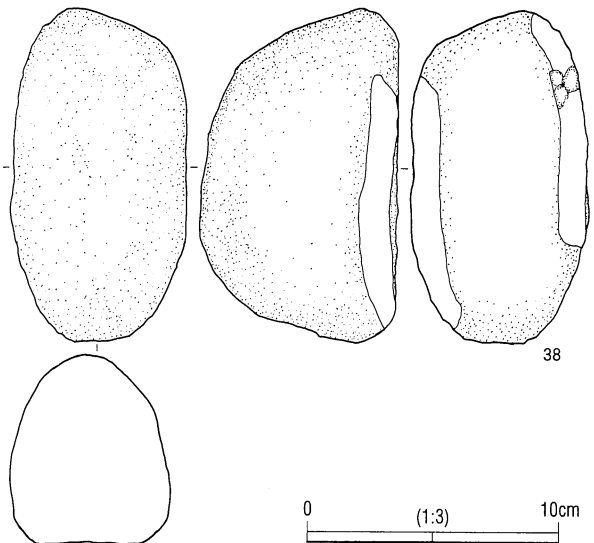

38

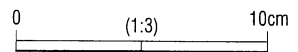

縄文時代石器 3

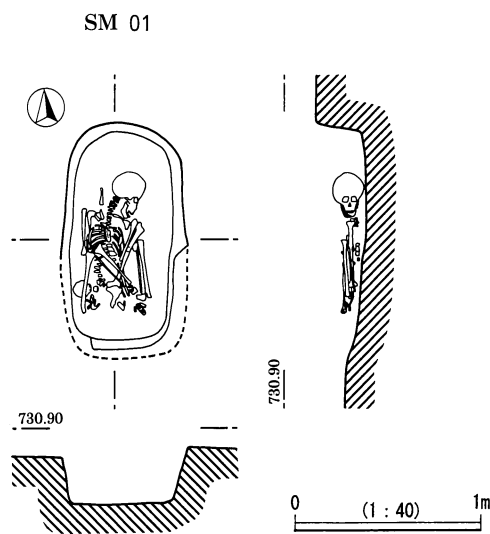
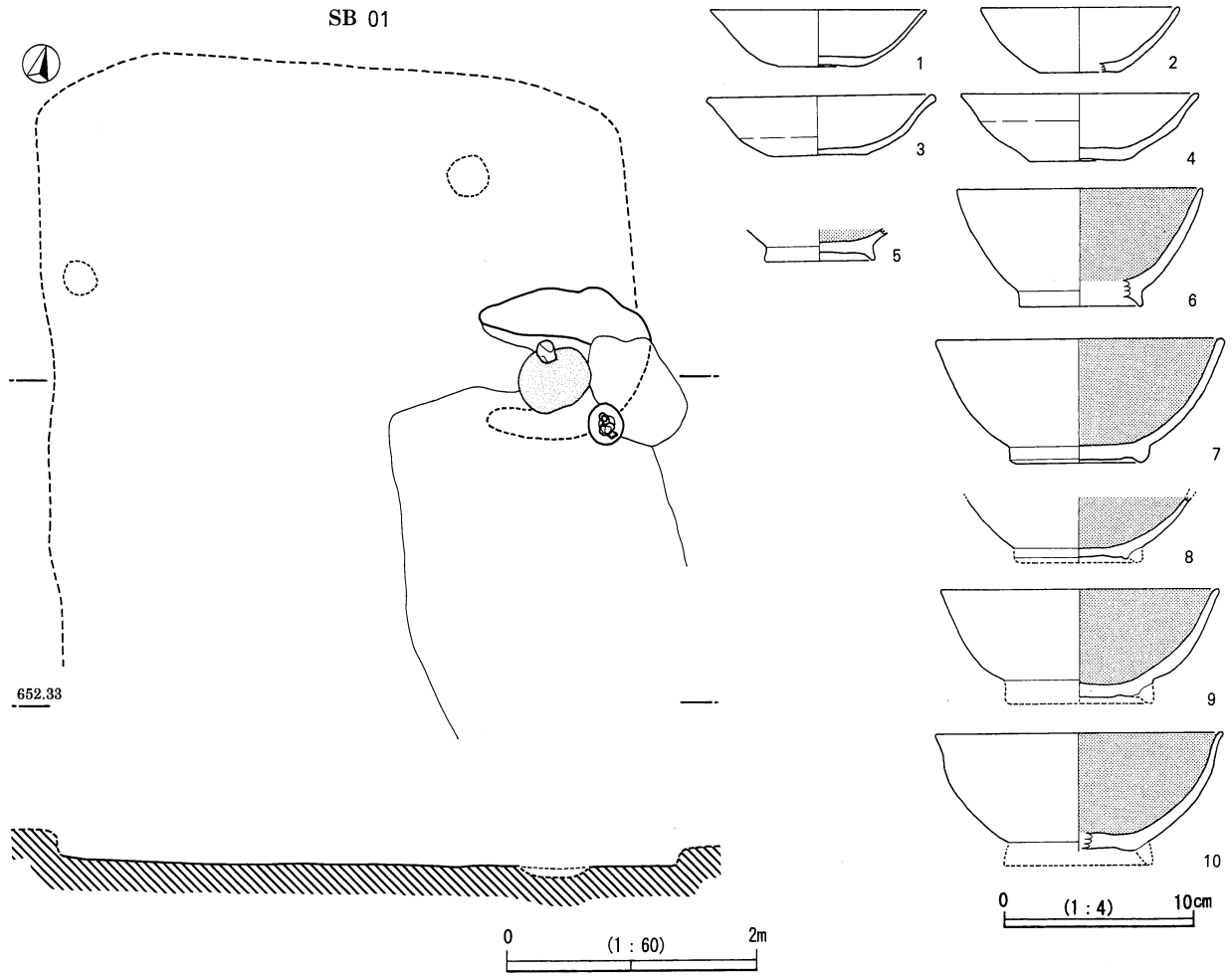

平安時代遺構図・遺物図、近世遺構図

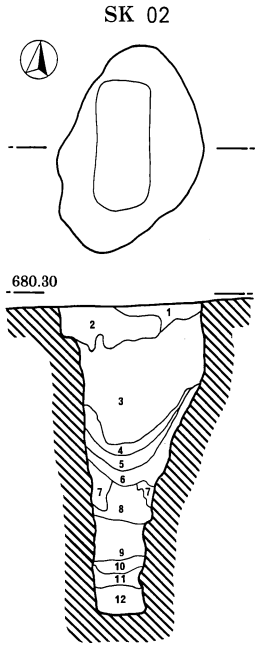

- SK02
- 1 暗褐色土
 - 2 褐色土
 - 3 暗褐色土
 - 4 黄褐色土
 - 5 黄褐色土
 - 6 暗褐色土
 - 7 明黄褐色
 - 8 黄褐色土
 - 9 暗褐色土
 - 10 黒褐色土
 - 11 明黄褐色
 - 12 褐色土
- 黄褐色土混合
 - 黒褐色土混合
 - 密 粘性有 微細粒
 - 暗褐色土混合 粘性少量有 ポロポロ 微細粒
 - 黄褐色土混合 粘性少量有
 - 細粒 粘性少量有
 - 褐色土混合 粘性少量有 微細粒
 - 黄褐色土混合 粘性少量有 微細粒
 - 微細粒 粗 軟質 粘性有
 - スコリア細粒混入 粗 粘性少量有
 - 黄褐色土混合 粗 粘性少量有

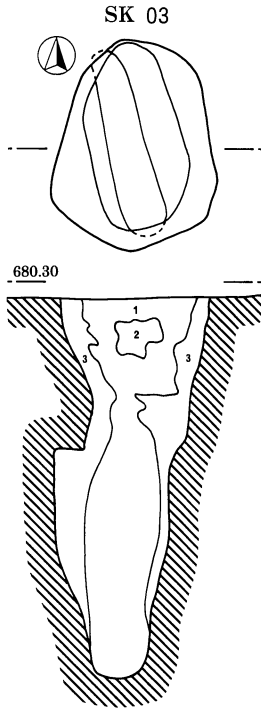

- SK03
- 1 暗褐色土
 - 2 黒褐色土
 - 3 黄褐色土
- II層の土 微細粒 粘性有 赤褐色 微細粒含有
 - 微細粒 粘性有
 - IV層の土 微細粒 粘性有

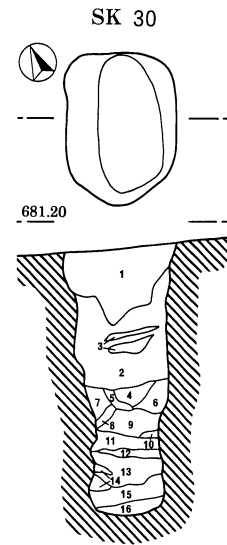

- SK30
- 1 暗褐色土
 - 2 にぶい黄褐色土
 - 3 褐色土
 - 4 褐色土
 - 5 褐色土
 - 6 黄褐色土
 - 7 黄褐色土
 - 8
 - 9 褐色土
 - 10 黄褐色土
 - 11 暗褐色土
 - 12 にぶい黄褐色土
 - 13 暗褐色土
 - 14 黄褐色土
 - 15 褐色土
 - 16 黒褐色土
- 微細粒 密 粘性有 褐色土粒混入
 - 微細粒 密 粘性有
 - にぶい黄褐色土混入 微細粒 粗 粘性少量有
 - 暗褐色土粒混合、粗、粘性無 灰白色微細粒混入
 - 粗、粘性無 灰白色微細粒混入
 - 微細粒 粗、粘性無 ポロポロ
 - 褐色土混合 6層と同類
 - スコリア
 - 粗 スコリア微細粒、灰白色粒混入 6層と同類
 - 褐色土粒混合 粗 Vb層の粘土粒混入
 - 微細粒 粗 黄褐色土粒とスコリア 細粒少量混入
 - 微細粒 粗、粘性無 ポロポロ
 - 6層と同類 スコリア粒混入
 - 微細粒 粗 黄褐色土粒混入
 - 微細粒 粗 粘性有 スコリア細粒混入

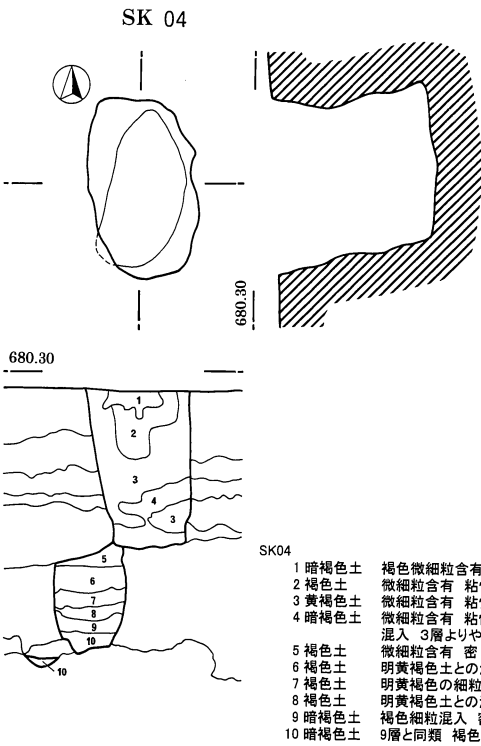

- SK04
- 1 暗褐色土
 - 2 褐色土
 - 3 黄褐色土
 - 4 暗褐色土
 - 5 褐色土
 - 6 褐色土
 - 7 褐色土
 - 8 褐色土
 - 9 暗褐色土
 - 10 暗褐色土
- 褐色微細粒含有 粘性少量有
 - 微細粒含有 粘性有
 - 微細粒含有 粘性有 IV層の土
 - 微細粒含有 粘性有 黒色ブロック 混入 3層よりやや黒色
 - 微細粒含有 密 粘性少量有
 - 明黄褐色土との混合 粗
 - 明黄褐色土の細粒混入
 - 明黄褐色土との混合 粗
 - 褐色細粒混入 密
 - 9層と同類 褐色細粒やや多く混入

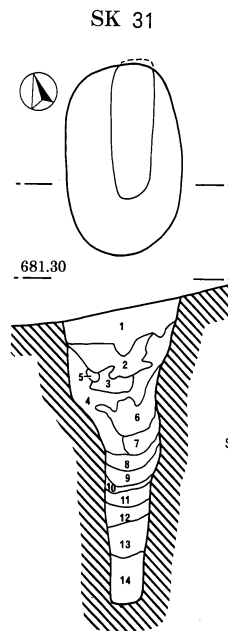

- SK31
- 1 にぶい黄褐色土
 - 2 にぶい黄褐色土
 - 3 暗褐色土
 - 4 黄褐色土
 - 5 明黄褐色
 - 6 黒褐色土
 - 7 褐色土
 - 8 暗褐色土
 - 9 黄褐色土
 - 10 黄褐色土
 - 11 褐色土
 - 12 黄褐色土
 - 13 黒褐色土
- 黄褐色土微細粒混合 粘性少量有
 - 微細粒 粗 粘性有
 - 微細粒 密 粘性有
 - 微細粒 密 粘性有
 - 微細粒 粗 粘性少量有
 - 微細粒 サラサラ 粗 粘性少量有
 - 微細粒 密 粘性有 Vb層の粘土 大粒混入
 - 微細粒 粘性有 スコリア粒混入
 - 褐色土混合 粗 粘性少量有
 - 褐色土混合、黒色土微細粒混合 9層と同類
 - 4層の細粒混入
 - 褐色土粒混入 粗、ポロポロ
 - ブロック状の覆土 粗、ポロポロ 黄褐色粒混入

0 (1:40) 1m

縄文時代土坑図 1

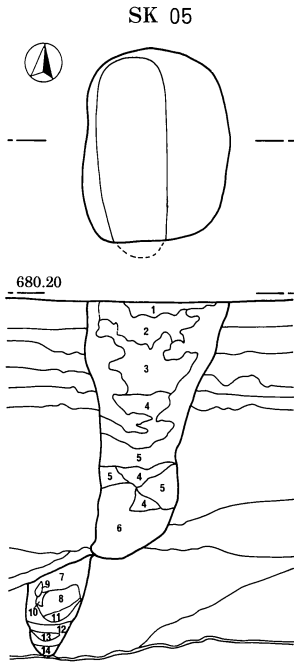

- SK05
- 1 暗褐色土 III層の土 微細粒 粘性少量有
 - 2 黒褐色土 1層と同類 1層の細粒含有
 - 3 褐色土 暗褐色のブロック粒含有 微細粒 粘性少量有
 - 4 暗褐色土 III層の土 暗褐色土と褐色土微細粒混入
 - 5 褐色土 IV層に近似 微細粒 粘性有
 - 6 黒褐色土 微細粒 ザラザラ やや粗 粘性有 褐色土微細粒混入
 - 7 暗褐色土 黄褐色微細粒混入 粗
 - 8 暗褐色土 黄褐色土混合 粗
 - 9 黒色土 黄褐色土混合 粗
 - 10 黄褐色土 暗褐色の小ブロック微量混入 粗 粘性少量有
 - 11 黒色土 微細粒 粗 粘性有 軟質
 - 12 褐色土 黒色土混入 粗
 - 13 黒色土 褐色土混入 粗
 - 14 にぶい黄褐色土 赤色スコリア粒混入

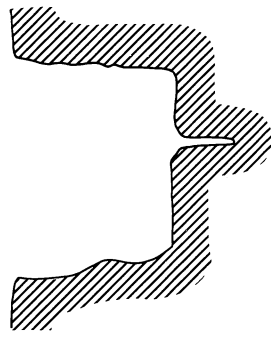
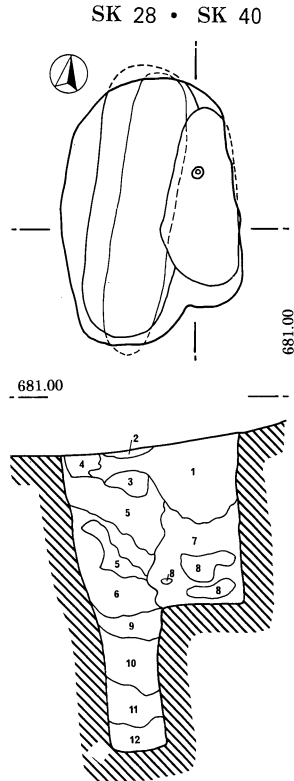

- SK28・40
- 1 黒褐色土 微細粒 密 粘性有
 - 2 にぶい黄褐色土 微細粒 密 粘性少量有
 - 3 オリーブ褐色土 微細粒 粘性有 褐色土粒混入
 - 4 オリーブ褐色土 3層より明るい 微細粒 粘性有
 - 5 褐色土 微細粒 密 粘性少量有
 - 6 黄褐色土 微細粒 密 粘性少量有 IV層の土
 - 7 黒褐色土 微細粒 密 粘性少量有 ポロポロ
 - 8 黒色土 微細粒 粗 粘性少量有 水分多量含有
 - 9 暗褐色土 明黄褐色土との混合 赤褐色のスコリア粒混入 粗 水分含有
 - 10 暗褐色土 黒色粒、灰白色粒、明褐色スコリア混入 9層と類似
 - 11 黒褐色土 暗褐色土と混合 明黄褐色粒、灰白色微細粒混入 9層と類似
 - 12 暗褐色土 褐色土と混合 黒色粒、明黄褐色大粒、赤褐色スコリア微細粒混入 9層と類似 粘性有 水分含有

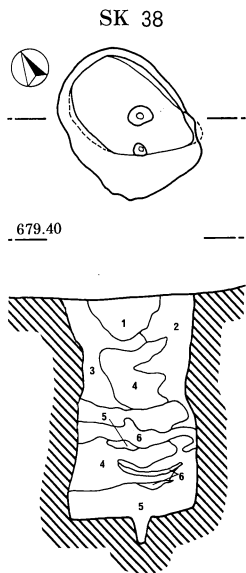

- SK38
- 1 暗褐色土 微細粒 密 粘性少量有 ポロポロ
 - 2 褐色土 黄褐色土混合 粗 粘性少量有 もろい
 - 3 褐色土 黄褐色土混合 2層と類似
 - 4 黒褐色土 黄褐色土微細粒混入 2・3層より
 - 5 褐色土 黄褐色土混合 2・3層と類似
 - 6 褐色土 黒色土混合(炭化物混入) 黄褐色土混入 2・3層と同類

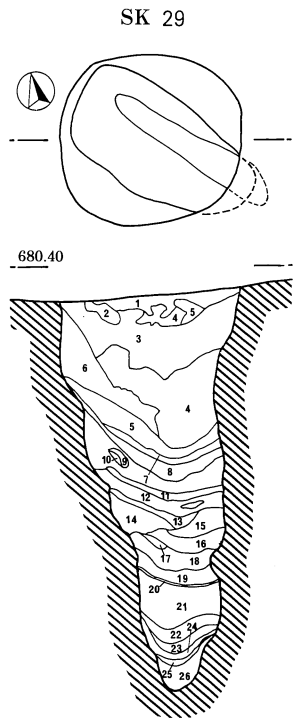

- SK29
- 1 暗褐色土 微細粒 粘性有
 - 2 黒褐色土 粗 粘性少量有
 - 3 にぶい黄褐色土 覆土 粘性有
 - 4 黒褐色土 微細粒 粘性有
 - 5 褐色土 微細粒 粘性有
 - 6 黄褐色土 微細粒 粘性有
 - 7 黄褐色土 褐色土粒混入 6層と同類
 - 8 暗褐色土 黄褐色土粒混入
 - 9 褐色土 Vb層の土 ブロック状 密、硬質 粘性無
 - 10 黄褐色土 微細粒 ザラザラ 粘性無 褐色土粒混入
 - 11 黒褐色土 微細粒 粗 粘性無 黄褐色土粒混入
 - 12 黄褐色土 7層と同類 Vb層や多量
 - 13 褐色土 微細粒 粗 粘性無 黄褐色土粒混入
 - 14 スコリア
 - 15 にぶい黄褐色土 微細粒 粗 粘性無 褐色土粒混入
 - 16 黄褐色土 褐色土粒混合 黒色土混入 粗 粘性無
 - 17 褐色土 黒色土混合 黄褐色土混入 粗 粘性無
 - 18 黄褐色土 10層と同類
 - 19 暗褐色土 粗 粘性無
 - 20 黒褐色土 褐色土混合 微細粒 水分含有 粘性少量有 ポロポロ 黄褐色土混入
 - 21 褐色土 13層と同類
 - 22 黄褐色土 褐色土混合 微細粒 粗 粘性無
 - 23 暗褐色土 微細粒 粗 粘性無 水分含有
 - 24 黄褐色土 暗褐色土混入 23層と同類 粗
 - 25 黒褐色土 微細粒 23・24層より粗粒 水分含有
 - 26 褐色土 微細粒 密 粘性有

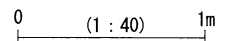

縄文時代土坑図 2

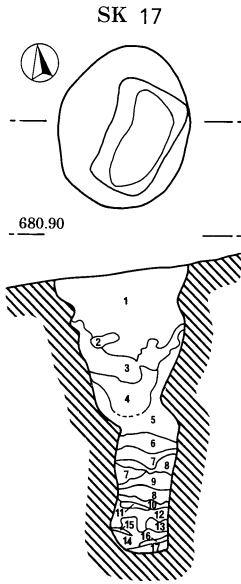

- SK17
- 1 暗褐色土 微細粒 粘性少量有 褐色土粒混入
 - 2 黒褐色土 黄褐色土、にぶい黄褐色土微細粒との混合 やや粗 粘性少量有 ポロポロ
 - 3 黒褐色土 密 粘性有 黄褐色土粒少量混入
 - 4 暗褐色土 微細粒 粘性有 やや軟質
 - 5 にぶい黄褐色土 微細粒 4層より粘性無 粗
 - 6 黄褐色土 微細粒 密 粘性少量有 褐色土粒混入
 - 7 暗褐色土 微細粒 粗 粘性無 褐色土粒混入
 - 8 黄褐色土 黒褐色土混入 粗 粘性少量有
 - 9 暗褐色土 黒色土混入 粗 粘性少量有
 - 10 暗褐色土 9層と同類 褐色土粒、灰白色土微細粒含有
 - 11 黒褐色土 暗褐色土混合 9層と同類
 - 12 暗褐色土 明黄褐色土混入 大粒、粗、粘性少量有
 - 13 暗褐色土 褐色土混入 大粒、密、粘性無でポロポロ
 - 14 黒褐色土 9層と同類
 - 15 黒色土 9層と同類
 - 16 黒褐色土 浅黄橙色土粒混入 9層と同類
 - 17 にぶい黄褐色土 密 粘性有

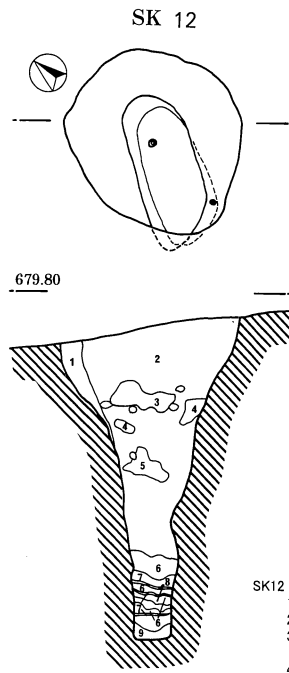

- SK12
- 1 Vb層
 - 2 暗褐色土 微細粒 粘性少量有 黄褐色粒混入
 - 3 暗褐色土 微細粒 粗 粘性少量有 黄褐色微細粒混入
 - 4 黄褐色土 褐色土との混合 粗 粘性少量有 ポロポロ
 - 5 黒褐色土 粗 粘性少量有 ポロポロ
 - 6 暗褐色土 粗 粘性少量有 ザラザラ 黄褐色粒混入
 - 7 黒色土 粗 粘性無 ザラザラ 黄褐色粒混入 炭化物混入
 - 8 暗褐色土 粗 粘性少量有 黄褐色土混入
 - 9 黄褐色土 粗 粘性無 ポロポロ

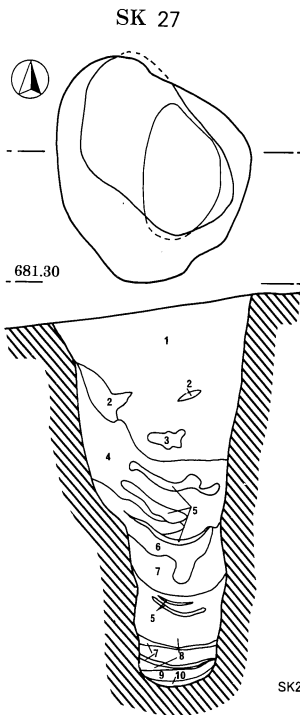

- SK27
- 1 暗褐色土 褐色土粒混入 微細粒 粘性少量有
 - 2 黄褐色土 褐色土混入 微細粒 密 粘性有
 - 3 暗褐色土 粗粒でポロポロ 粗 粘性少量有
 - 4 黄褐色土 微細粒 粗、ポロポロ 粘性少量有 褐色土粒の塊混入 Va層の土
 - 5 黒色土 黒褐色土、褐色土混入 微細粒、粗、粘性少量有 炭化物多量含有 Vbの土 黄褐色土粒混入
 - 7 にぶい黄褐色土 明黄褐色土混入 赤スコリアブロック混入 粗 粘性無 炭化物多量
 - 8 暗褐色土 微細粒 密 粘性有 にぶい黄褐色土混入
 - 9 暗褐色土 黒色土混入 微細粒 粗 粘性無 炭化物混入
 - 10 褐色土 微細粒 粘性有 密

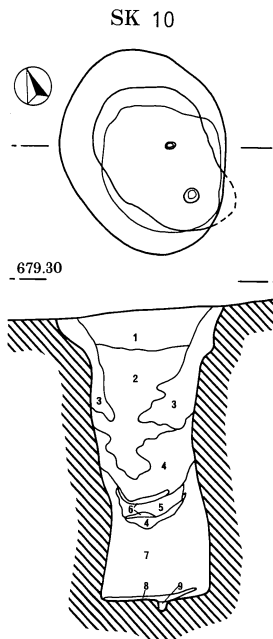

- SK10
- 1 褐色土 微細粒 粘性少量有
 - 2 暗褐色土 微細粒 粘性少量有 ポロポロ
 - 3 明黄褐色土 2層と同類
 - 4 にぶい黄褐色土 黄褐色土混入 2層と同類
 - 5 黒色土 微細粒 粗 粘性無
 - 6 褐色土 黄褐色土混合 粗 粘性無 ポロポロ
 - 7 黄褐色土 微細粒 密 粘性有
 - 8 黄褐色土 黒色土粒混入 水分含有 密 粘性有
 - 9 褐色土 覆土

0 (1:40) 1m

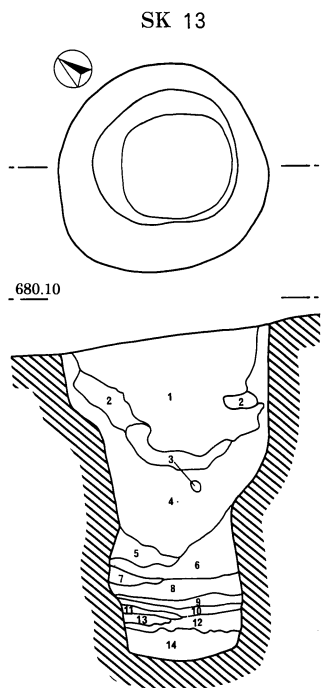

- SK13
- 1 暗褐色土 微細粒 粘性少量有 にぶい黄褐色土混入
 - 2 暗褐色土 微細粒 粗 粘性少量有 ポロポロ
 - 3 黒色土 2層と類似 水分多量含有
 - 4 黄褐色土 2層と類似 褐色土混合
 - 5 黄褐色土 V層の褐色土の粘土状大粒混入 明黄褐色土粒混入、粗、粘性無
 - 6 褐色土 暗褐色土混合 5層と類似
 - 7 褐色土 明黄褐色土混合 5層と類似
 - 8 褐色土 灰黄褐色土混合 明黄褐色土粒混入
 - 9 黒褐色土 粗 粘性少量有 褐色土粒混入
 - 10 褐色土 粗 粘性無 黄褐色土粒混入
 - 11 黒褐色土 5層と類似
 - 12 黒褐色土 5層と類似 黄褐色土粒混入
 - 13 明黄褐色土 細粒、硬質、密でザラザラ スコリア細粒含有
 - 14 黄褐色土 微細粒、硬質、密 スコリア細粒含

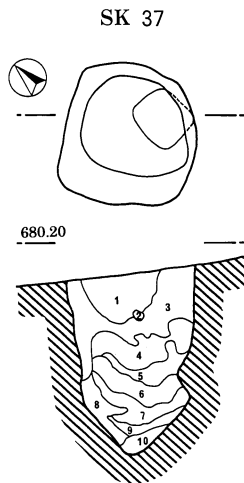

- SK37
- 1 暗褐色土 微細粒 密、硬質 粘性無
 - 2 黒褐色土 微細粒 やや密 粘性無 軟質
 - 3 暗褐色土 2層と同類 明褐色スコリア粒混入
 - 4 黒色土 2層と同類 黄褐色土微細粒混入
 - 5 暗褐色土 2層と同類 黄褐色ブロック、赤スコリア粒混入
 - 6 黄褐色土 2層と同類 粘土状粒混入
 - 7 黄褐色土 褐色土混合 微細粒 粗 粘性無 ポロポロ
 - 8 黄褐色土 赤スコリア粒混入 7層と類似
 - 9 褐色土 黄褐色土混入 7層と類似
 - 10 黒褐色土 黄褐色土混入 微細粒 やや密 粘性有

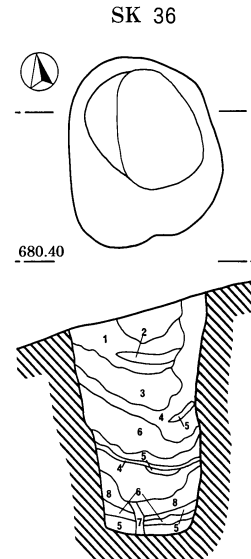

- SK36
- 1 にぶい黄褐色土 微細粒 密 硬質 粘性少量有
 - 2 黒褐色土 微細粒 密 粘性有
 - 3 褐色土 微細粒 粗、ポロポロ 粘性少量有
 - 4 黄褐色土 微細粒 やや粗 粘性少量有
 - 5 黒色土 微細粒 粗 粘性無 炭化物混入 黄褐色土混入
 - 6 褐色土 黄褐色土混入 細粒 やや粗 粘性少量有
 - 7 黒褐色土 黒色土混入、にぶい黄褐色土混入 微細粒 粗 粘性少量有
 - 8 黄褐色土 褐色土混合 微細粒 粗 粘性少量有

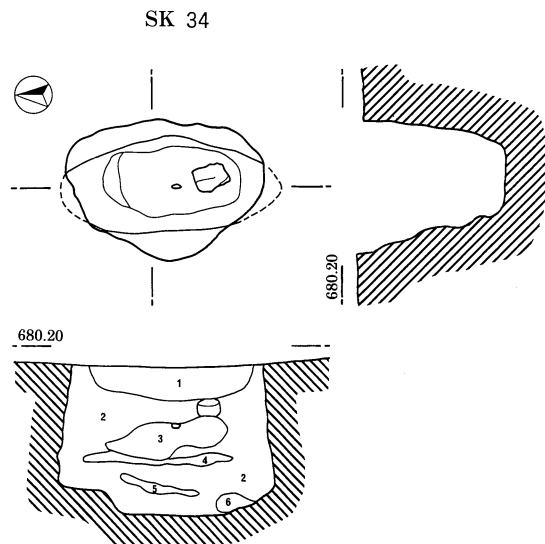

- SK34
- 1 褐色土 黄褐色土との混合 微細粒 粘性有
 - 2 褐色土 微細粒 粗 粘性少量有
 - 3 明黄褐色土 微細粒 粗 粘性有 暗褐色土粒混入
 - 4 黒褐色土 微細粒 粘性有
 - 5 黒色土 微細粒 粗 粘性有
 - 6 明黄褐色土 微細粒 粗 粘性少量有 スコリア細粒混入

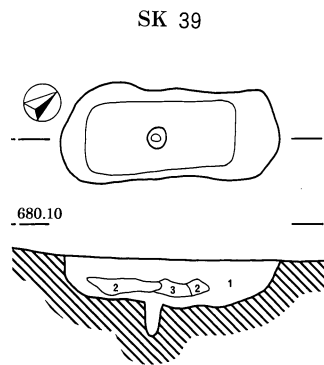

- SK39
- 1 褐色土 微細粒 密 硬質 粘性無 暗褐色土粒混入
 - 2 暗褐色土 褐色土混入 密 粘性無
 - 3 黄褐色土 微細粒 密 粘性少量有 サラサラ

0 (1 : 40) 1m

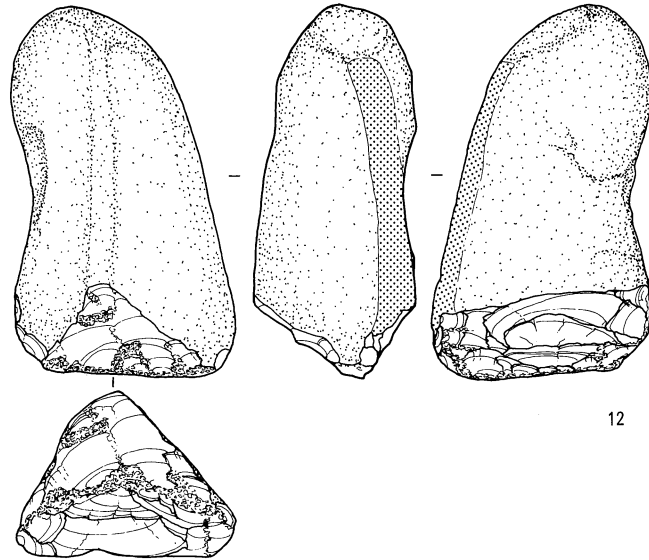
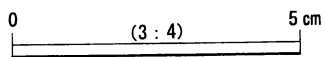
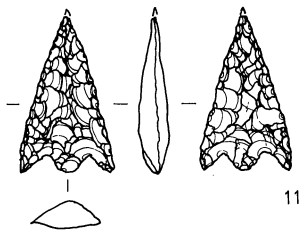
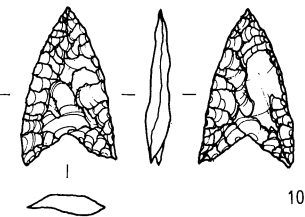
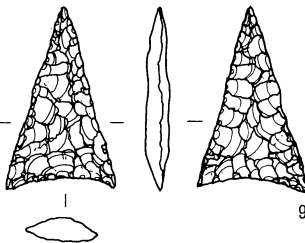
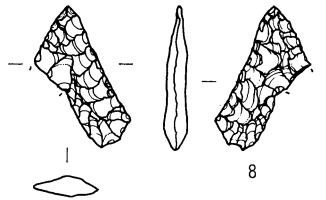
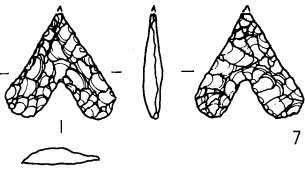
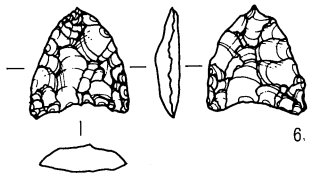
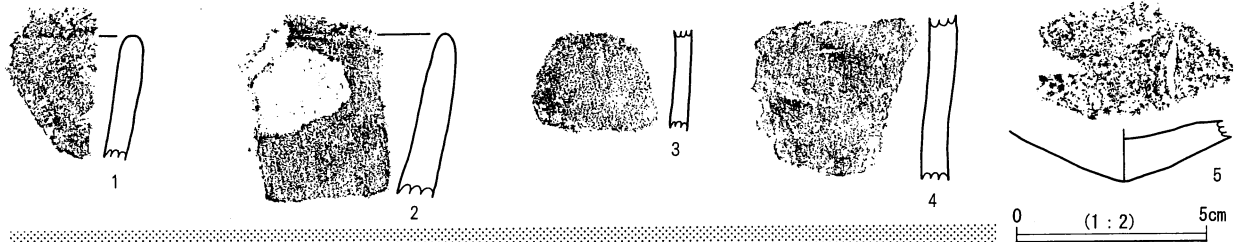

12

13

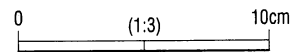

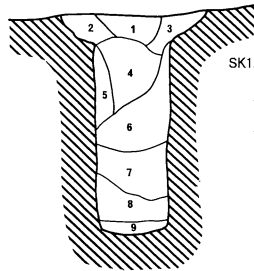
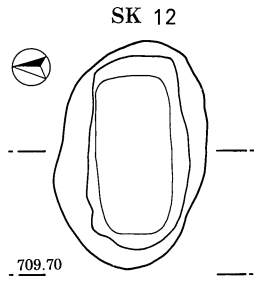

- SK12
- 1 黒褐色土 粘性有 やや密
 - 2 暗褐色土 黒褐色土混入 粘性有 密
 - 3 暗褐色土 2層と同類
 - 4 黒褐色土 粘性有 密
 - 5 黒褐色土 にふい黄褐色土粒混合 粘性有 やや密
 - 6 暗褐色土 黒褐色土が褐色土微細粒に混入 粘性有 やや密
 - 7 暗褐色土 黒色土が褐色土微細粒に混入 橋円状ブロック混入 粘性有 やや密
 - 8 黒色土 暗赤褐色土微細粒に暗褐色土混入 粘性有 密
 - 9 暗褐色土 明黄褐色土微細粒混入 礫含有 粘性有 密

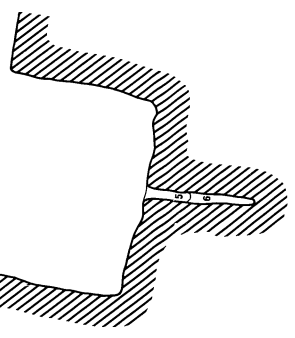
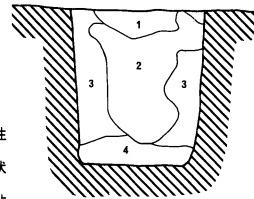
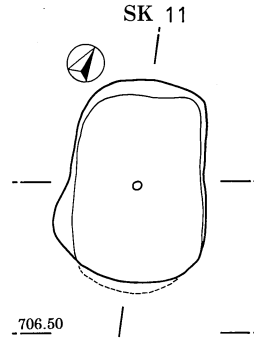

- SK11
- 1 黒褐色土
 - 2 黒色土
 - 3 暗褐色土
 - 4 黒色土
 - 5 灰褐色土 赤スコリア細粒混入
 - 6 褐色土

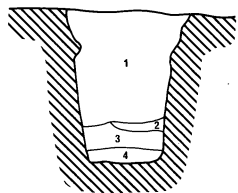
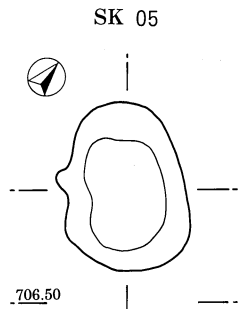

- SK05
- 1 黒色土
 - 2 暗褐色土
 - 3 暗褐色土
 - 4 黒色土

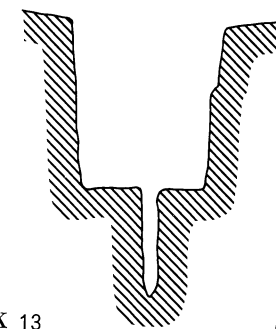
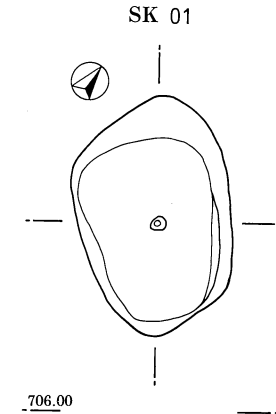

- SK01
- 1 黒色土
 - 2 暗褐色土
 - 3 黒色土 黄褐色土混入
 - 4 黒色土 黄褐色土混入
 - 5 黒色土 黄褐色土ブロック状に混入
 - 6 黒色土 5層より黒色 黄褐色土含まない
 - 7 暗褐色土 2層に類似
 - 8 暗褐色土
 - 9 黄褐色土
 - 10 暗褐色土 他層より硬質 密
 - 11 暗褐色土 10層より、やや粗 黄褐色土ブロック状混入

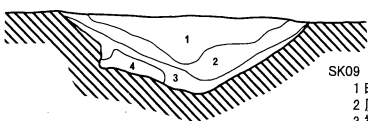
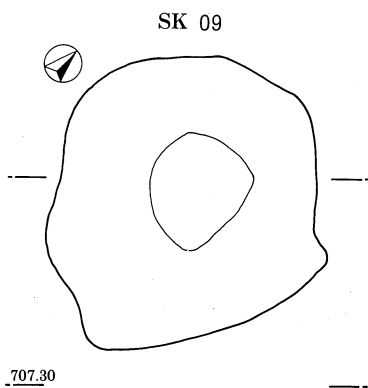

- SK09
- 1 暗褐色土
 - 2 灰褐色土
 - 3 褐色土
 - 4 褐色土

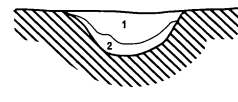
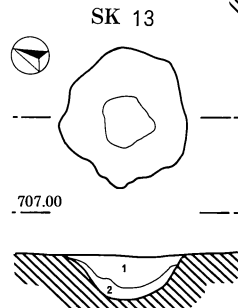

- SK13
- 1 黒色土 褐色土混入 炭化物含有 粘性少量有 やや密
 - 2 暗褐色土 黒褐色土、黄褐色土混入 粘性少量有 やや密

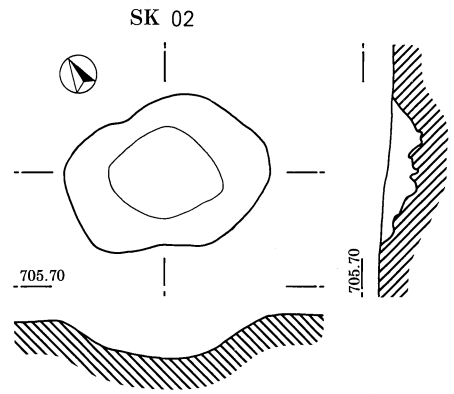

- SK02
- 1 黄褐色土 褐色土と黒褐色土混入 粘性有 密

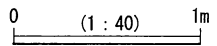

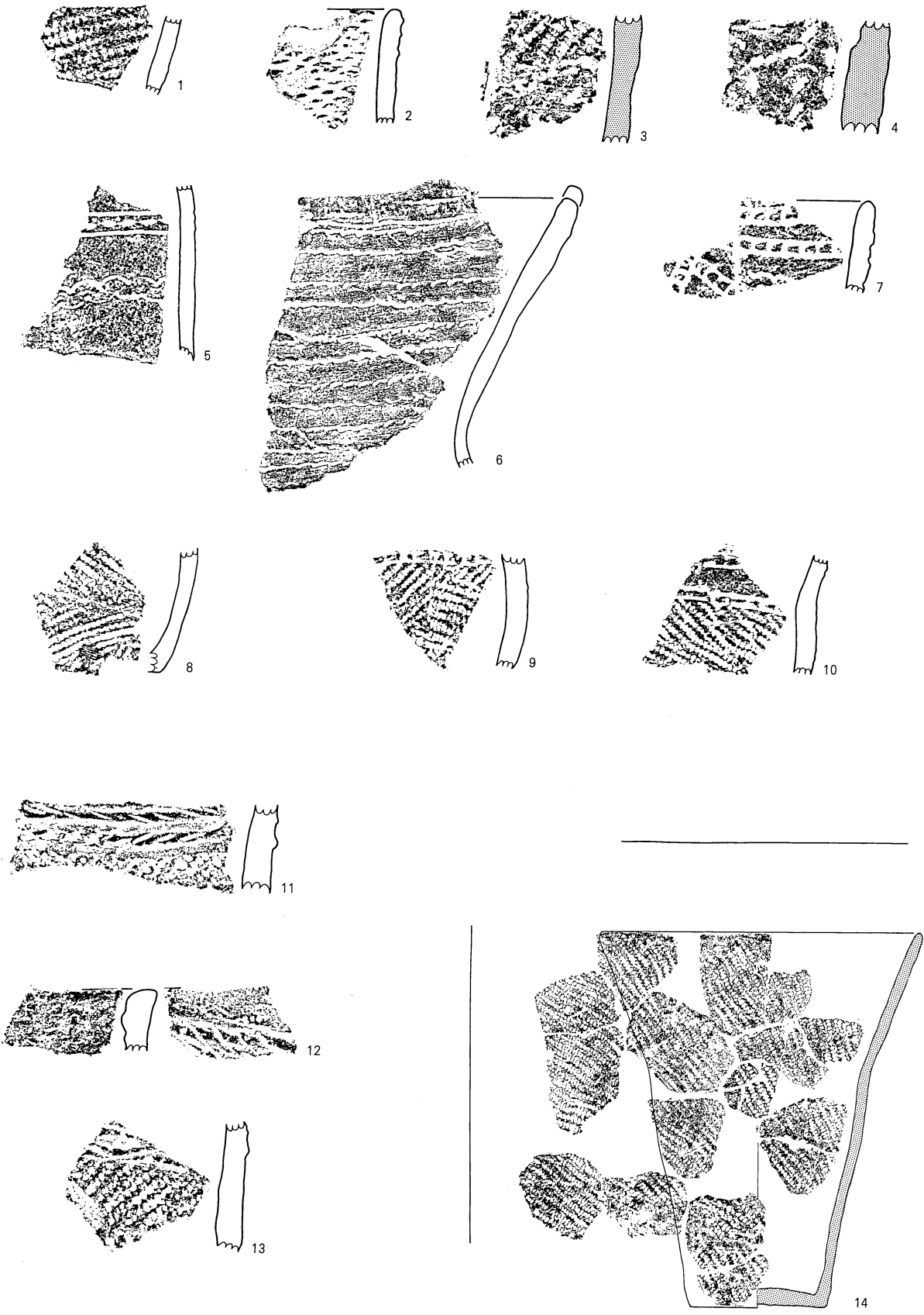

0 (1:2) 5cm

0 (1:4) 10cm

縄文時代遺物図

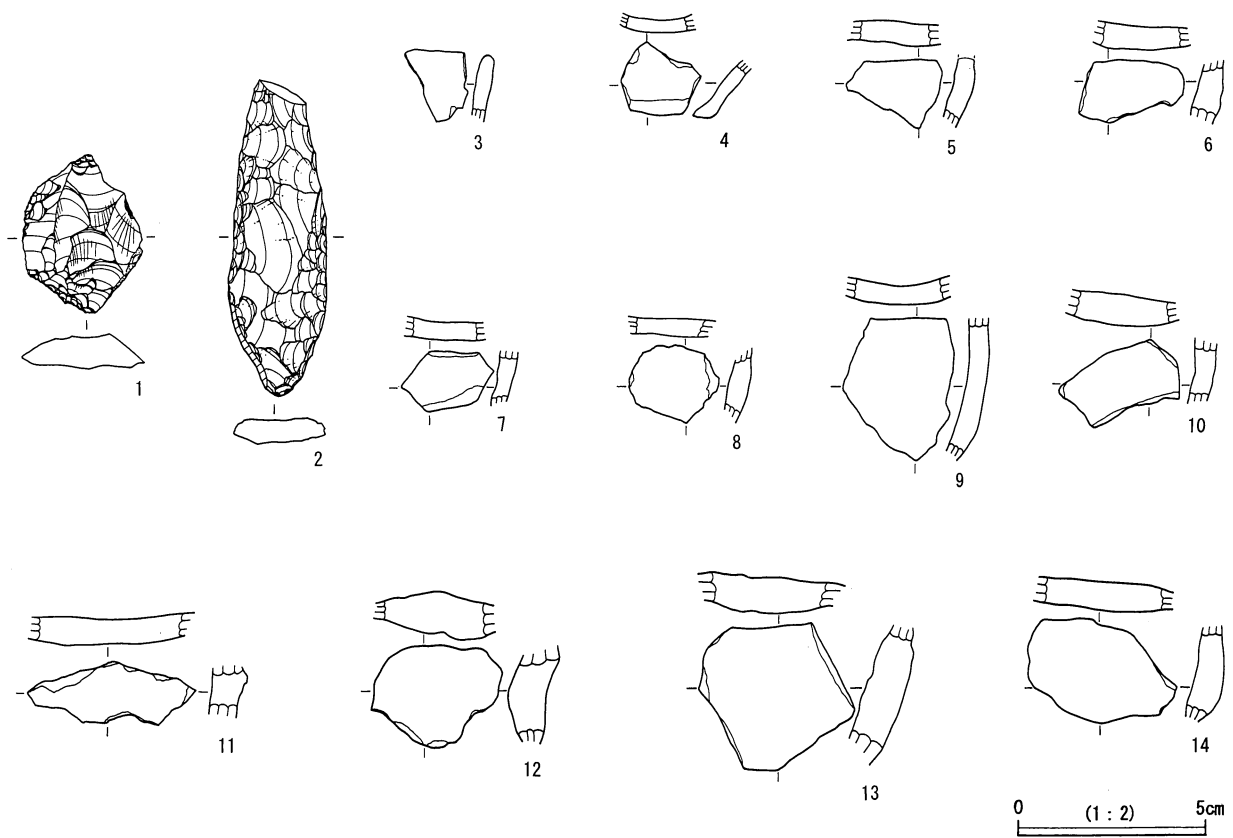
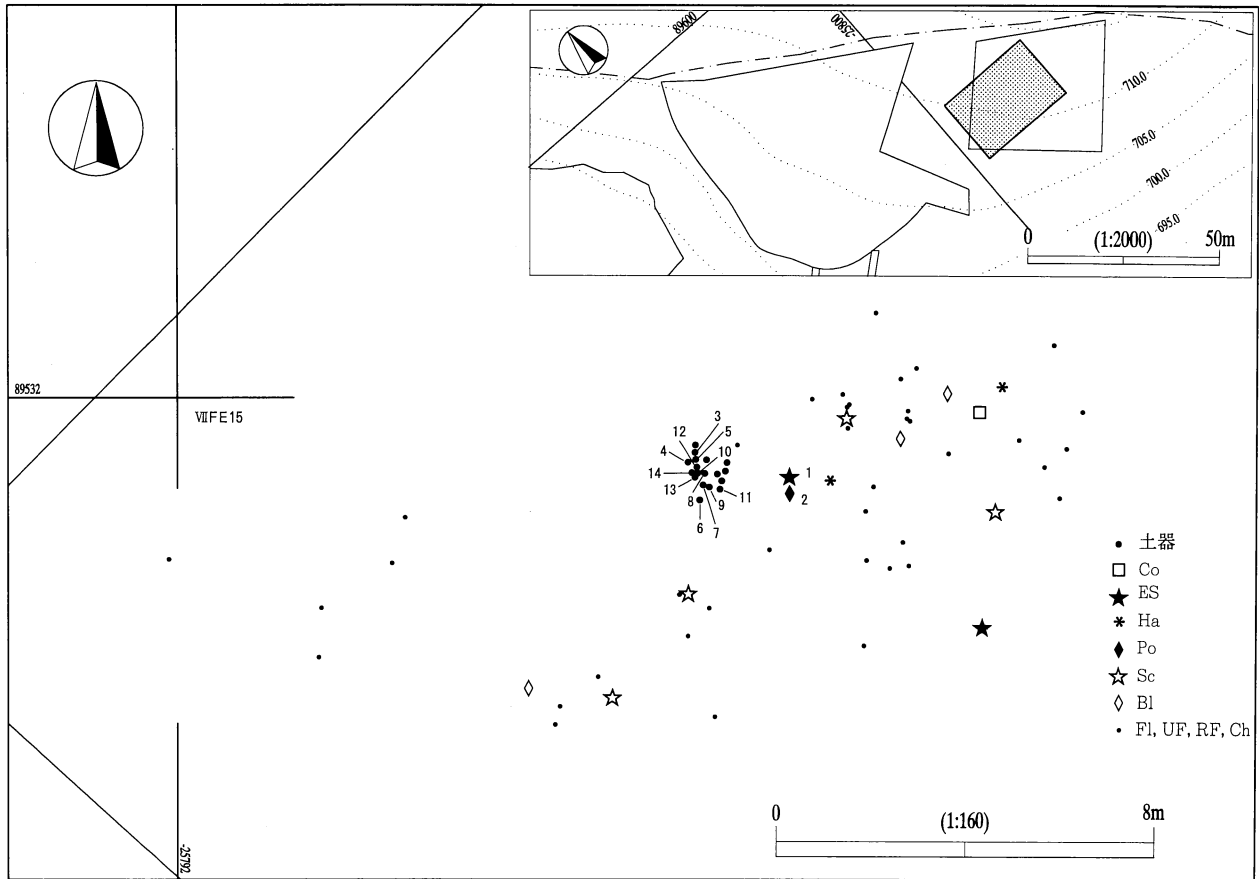

縄文時代草創期石器・無文土器分布図

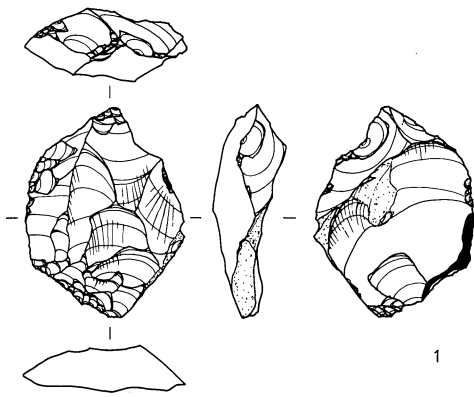

1

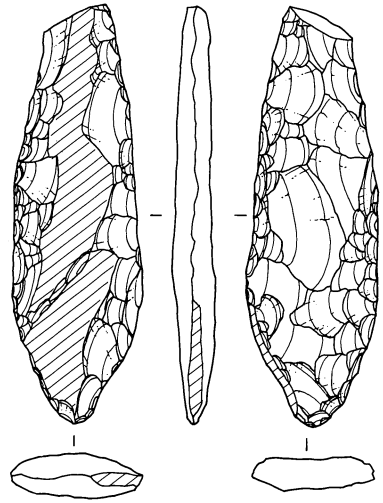

2

剥落部分

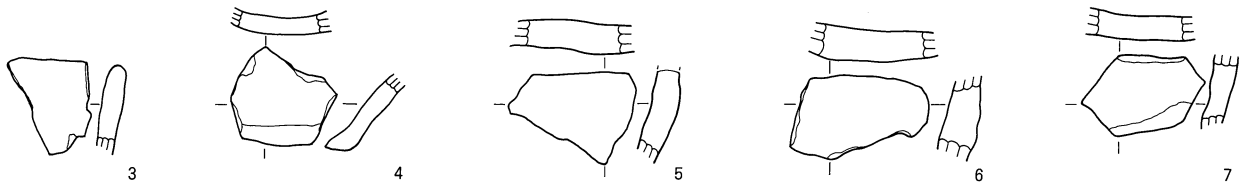
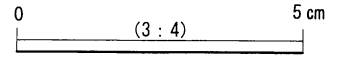

3

4

5

6

7

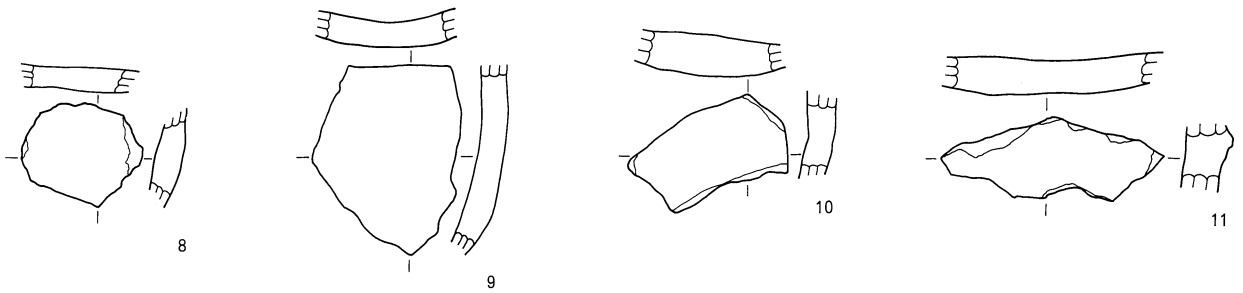

8

9

10

11

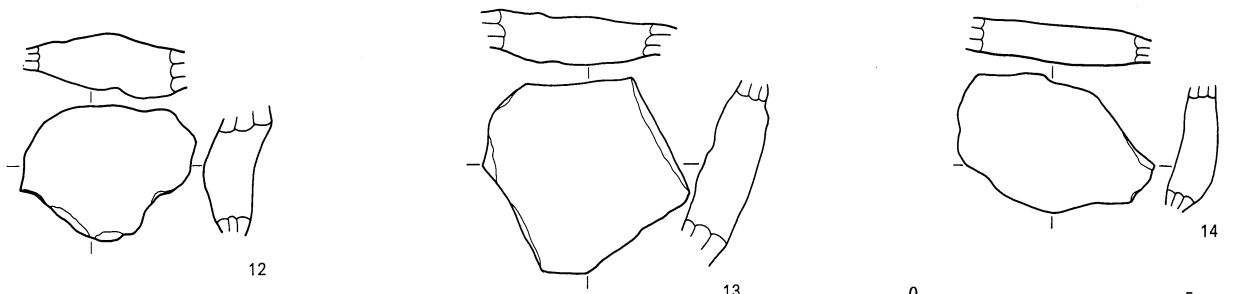

12

13

14

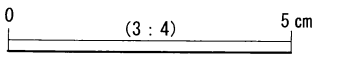

縄文時代草創期石器・無文土器

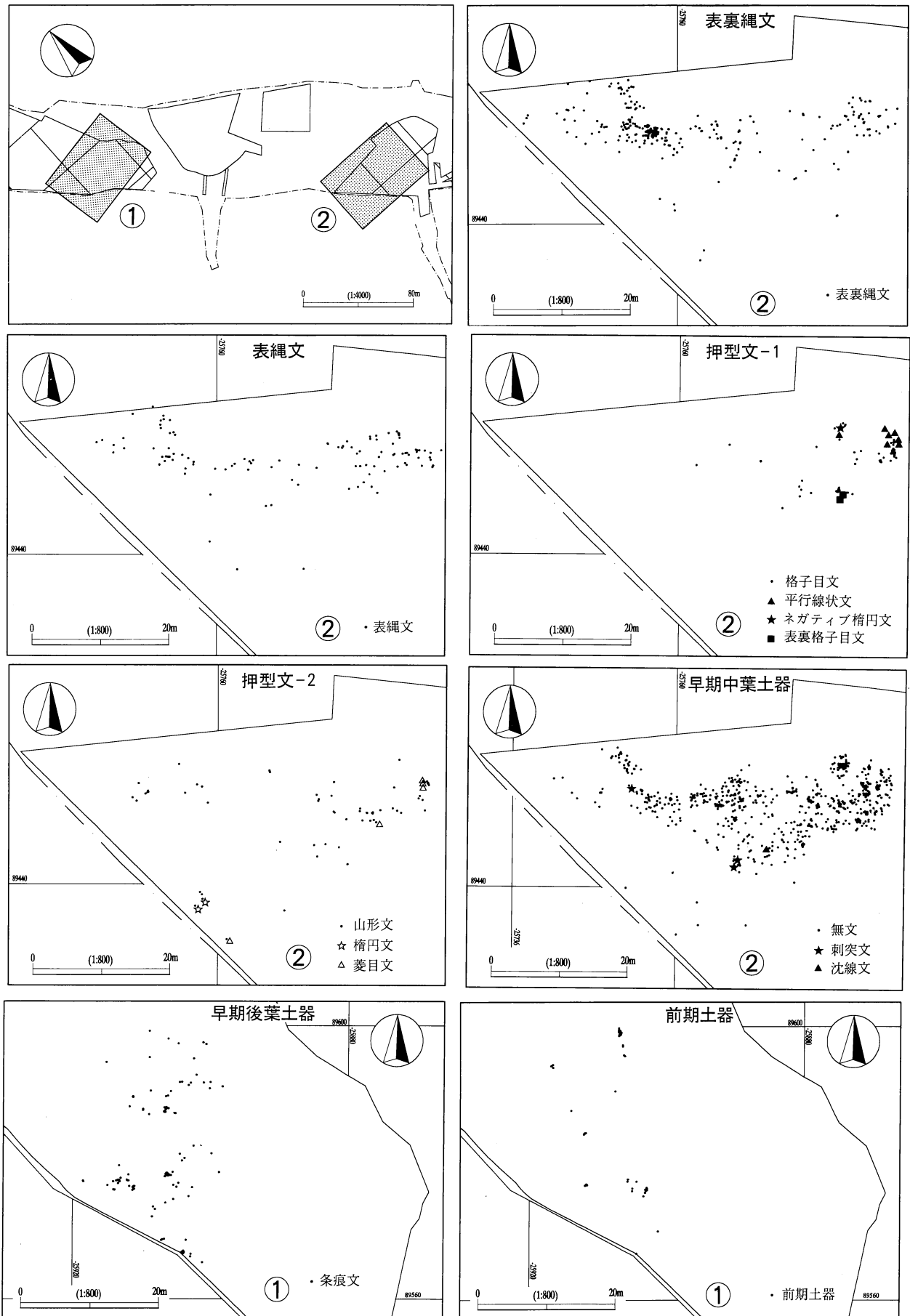

縄文時代土器分布図

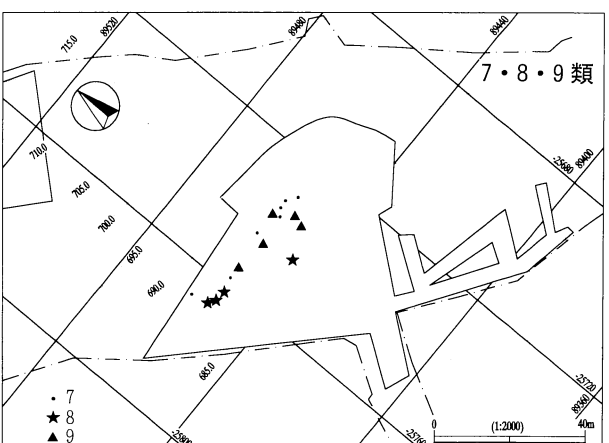
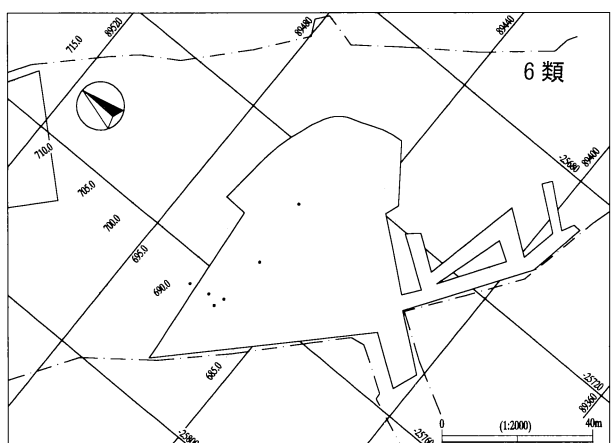
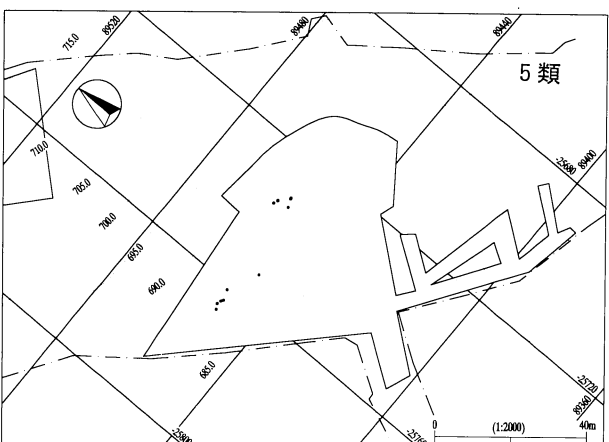
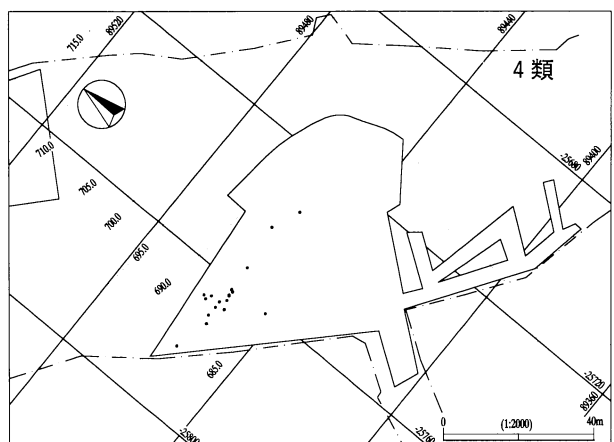
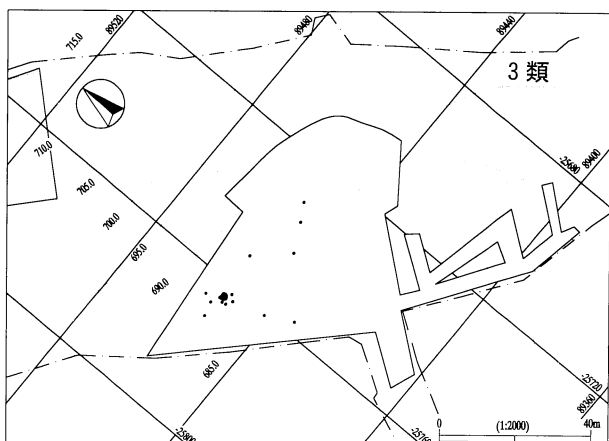
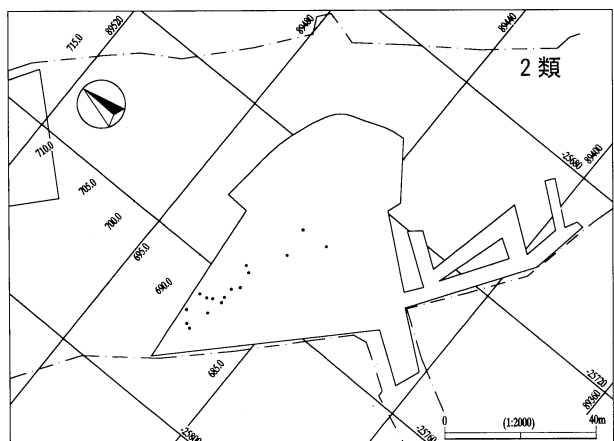
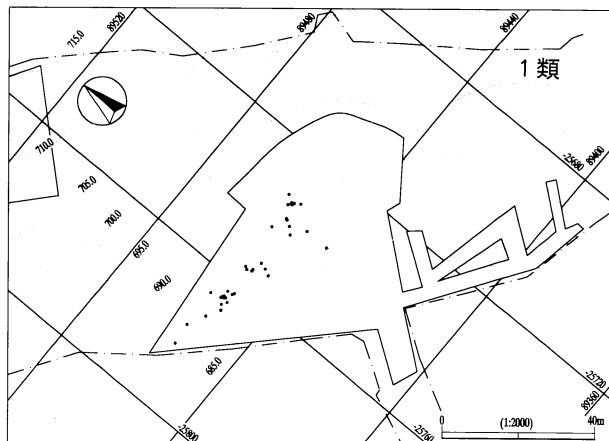
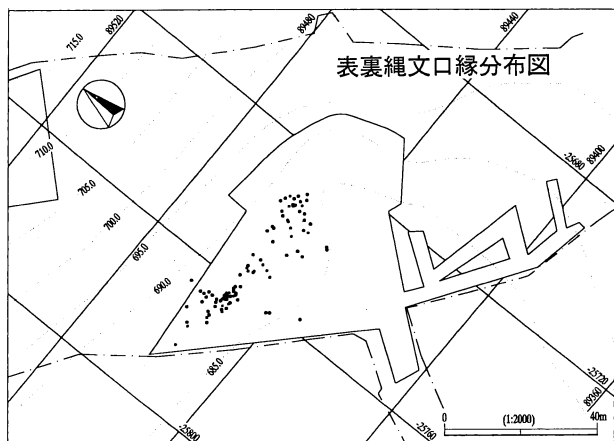

縄文時代表裏縄文土器分類別分布図

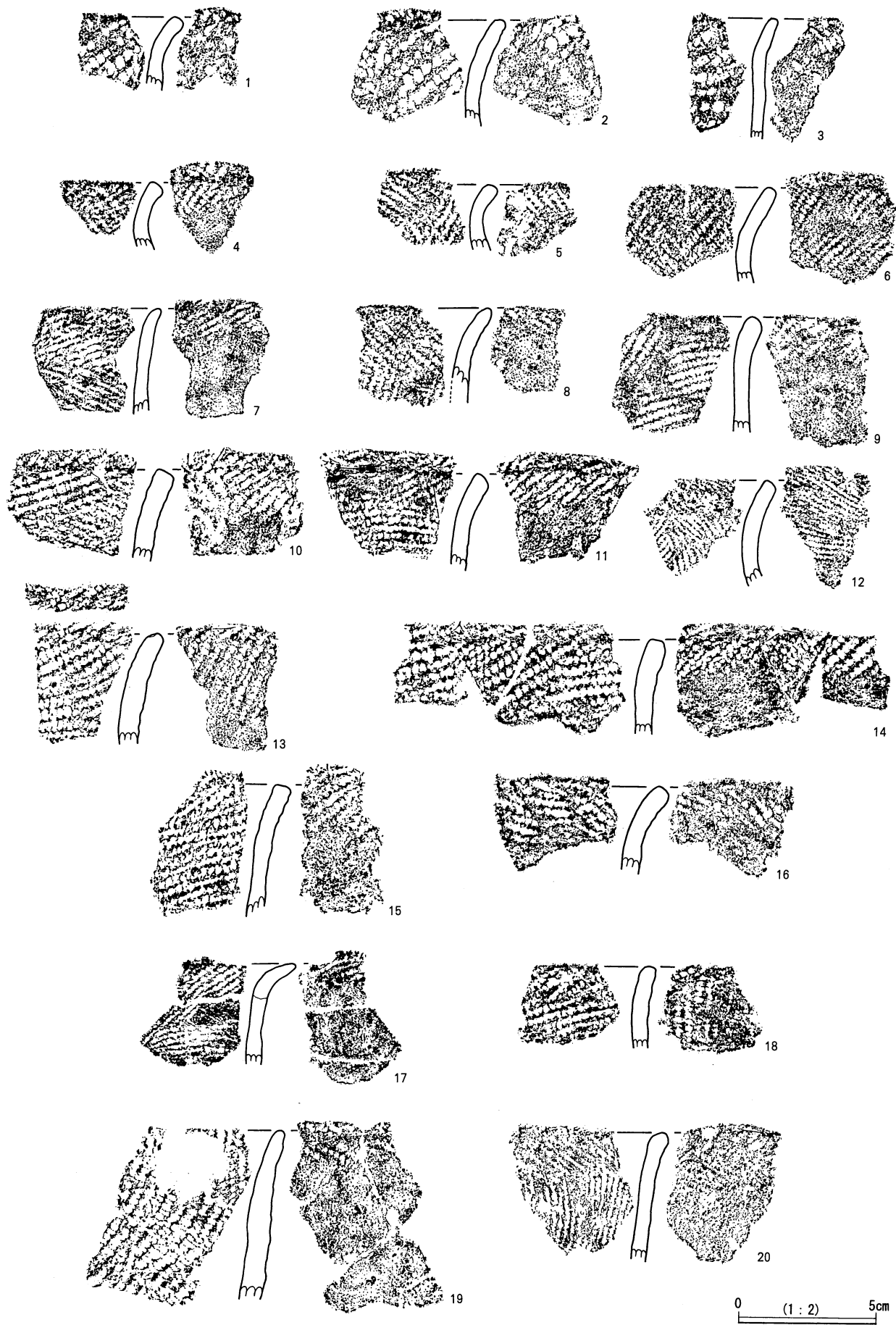

0 (1:2) 5cm

縄文時代土器 1

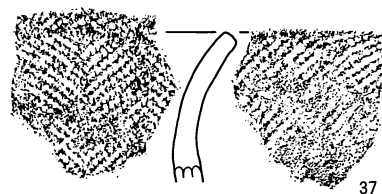
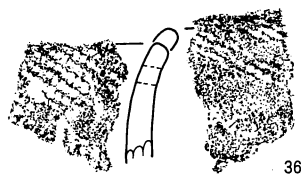
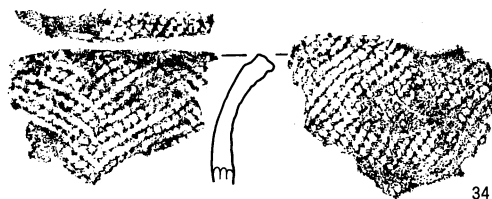
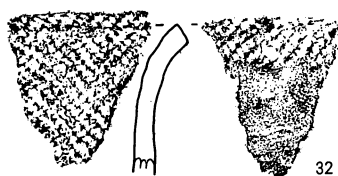
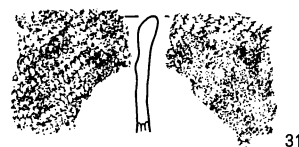
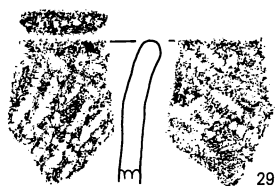
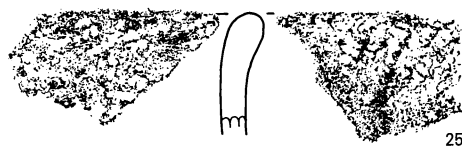
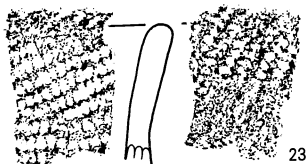
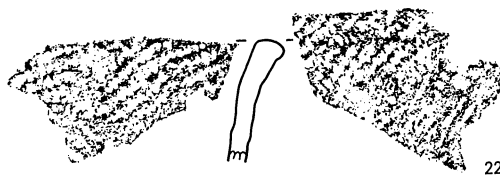

0 (1:2) 5cm

縄文時代土器 2

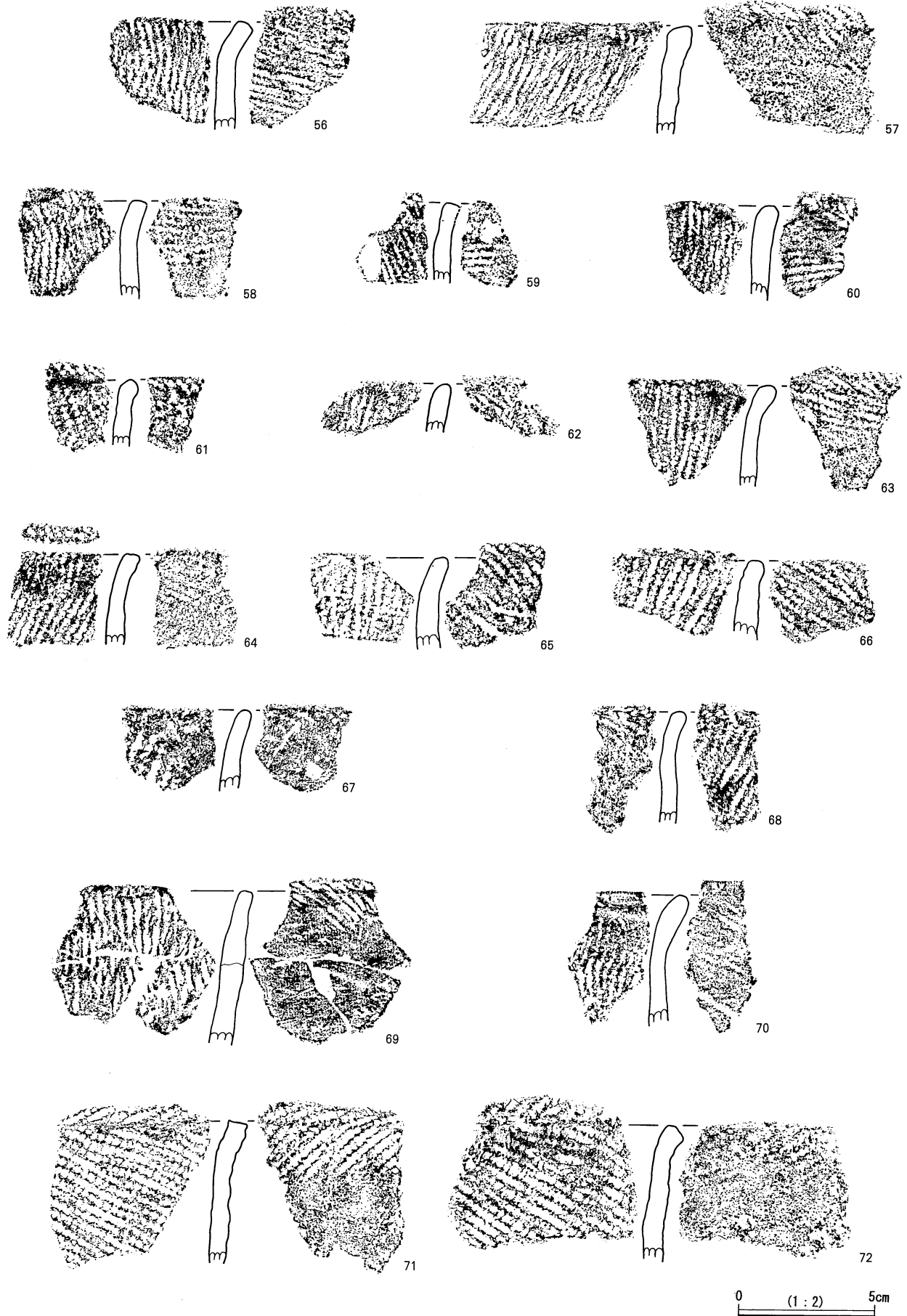

縄文時代土器 4

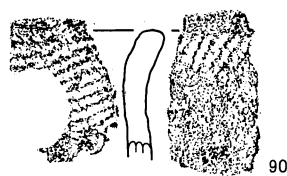
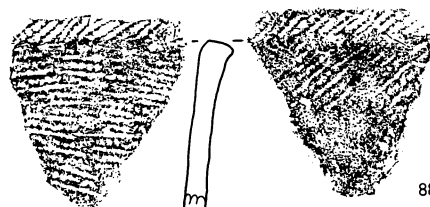
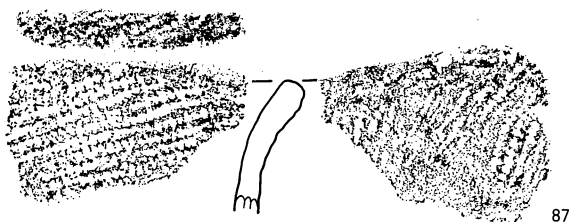
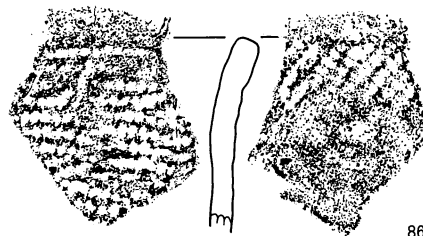
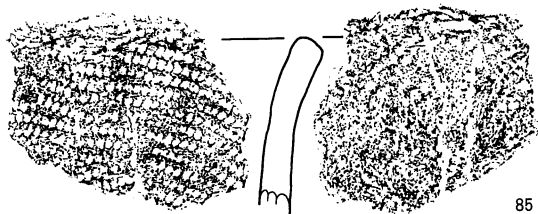
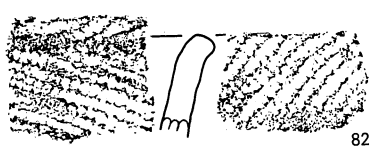
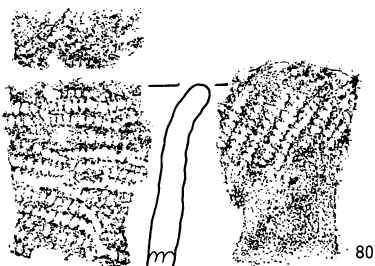
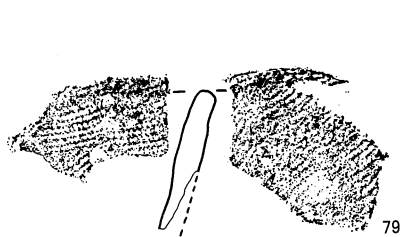
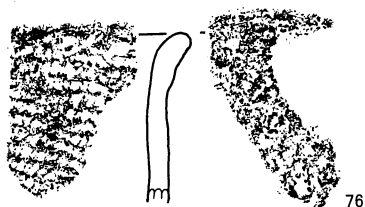
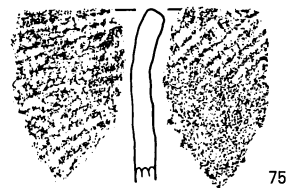
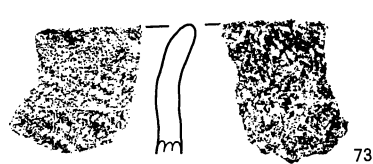

0 (1:2) 5cm

縄文時代土器 5

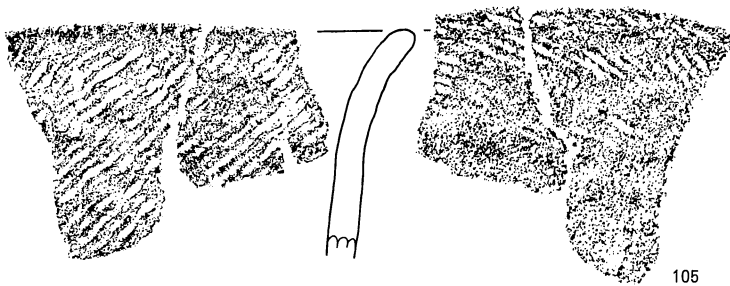
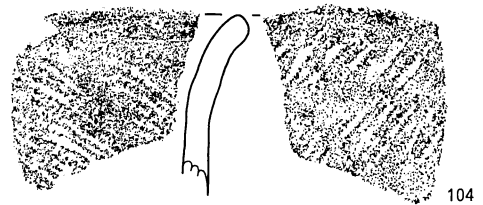
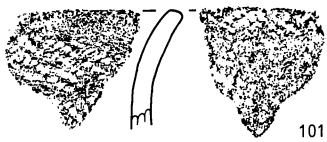
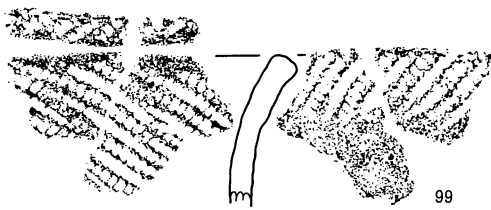
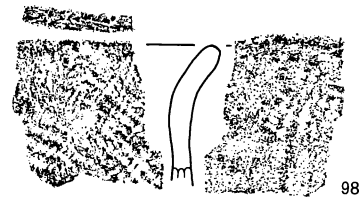
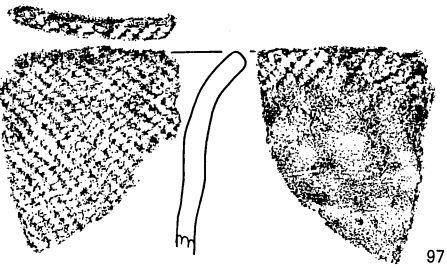
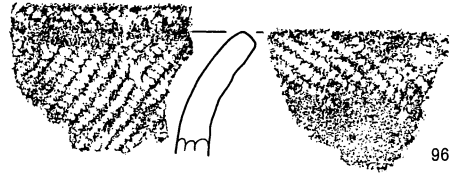
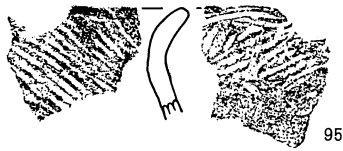
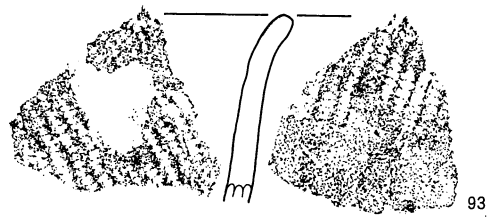
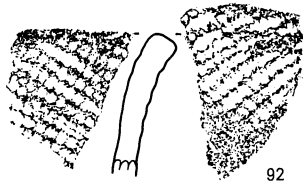
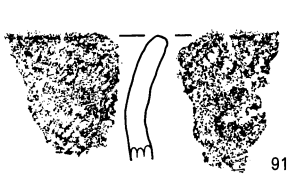

0 (1:2) 5cm

縄文時代土器 6

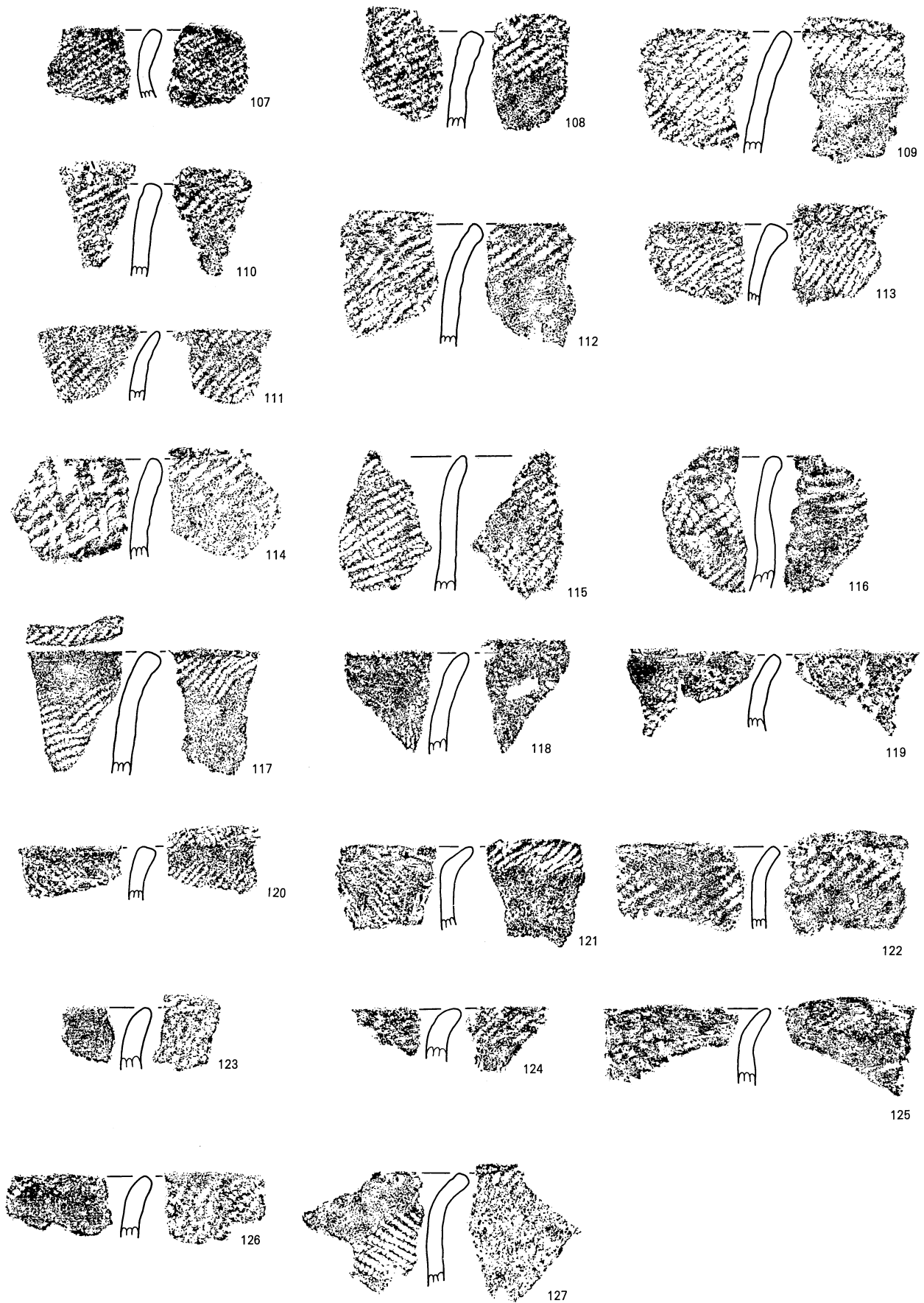

0 (1:2) 5cm

縄文時代土器 7

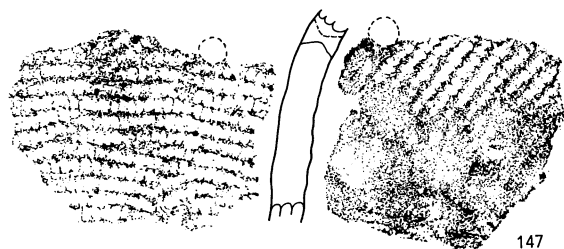
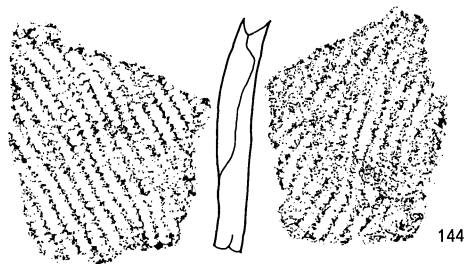
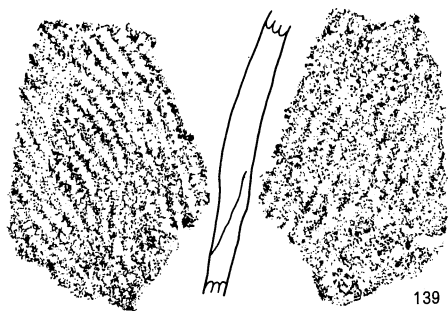
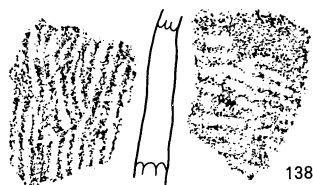
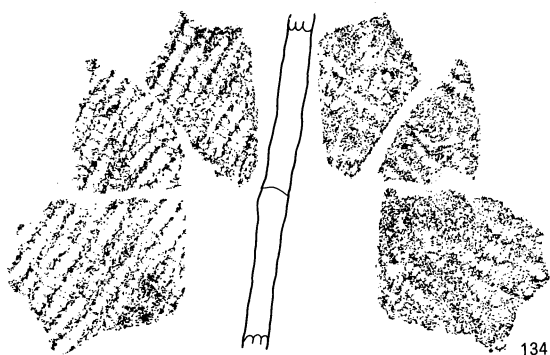
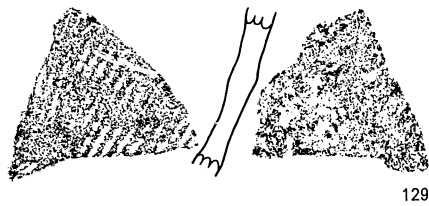
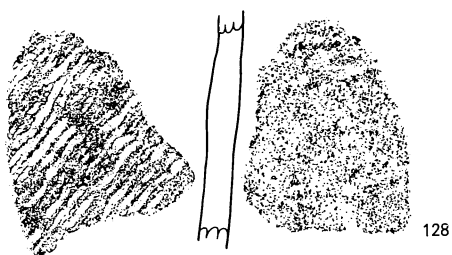

0 (1:2) 5cm

縄文時代土器 8

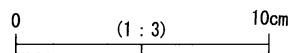
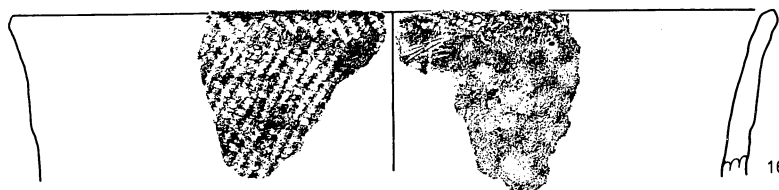
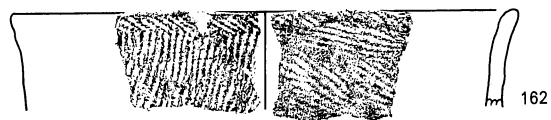
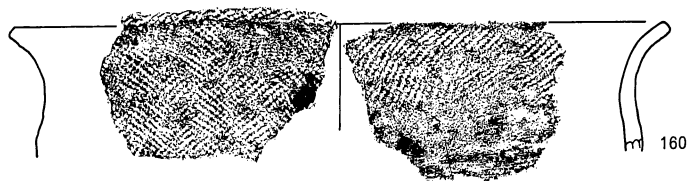
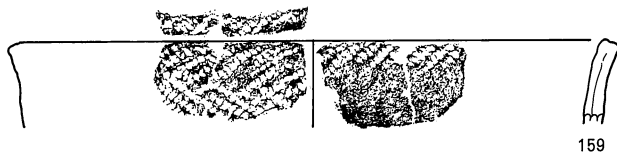
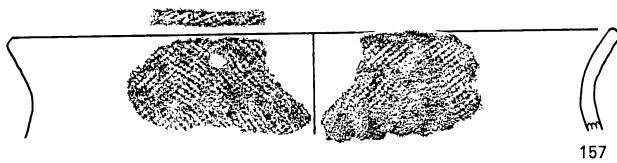

縄文時代土器 9

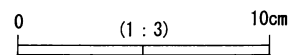
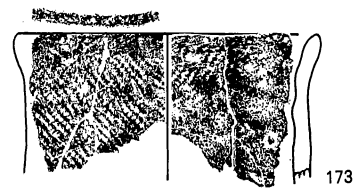
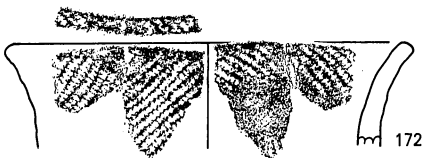
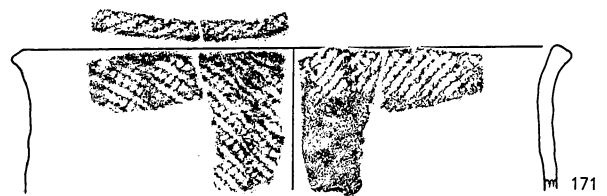

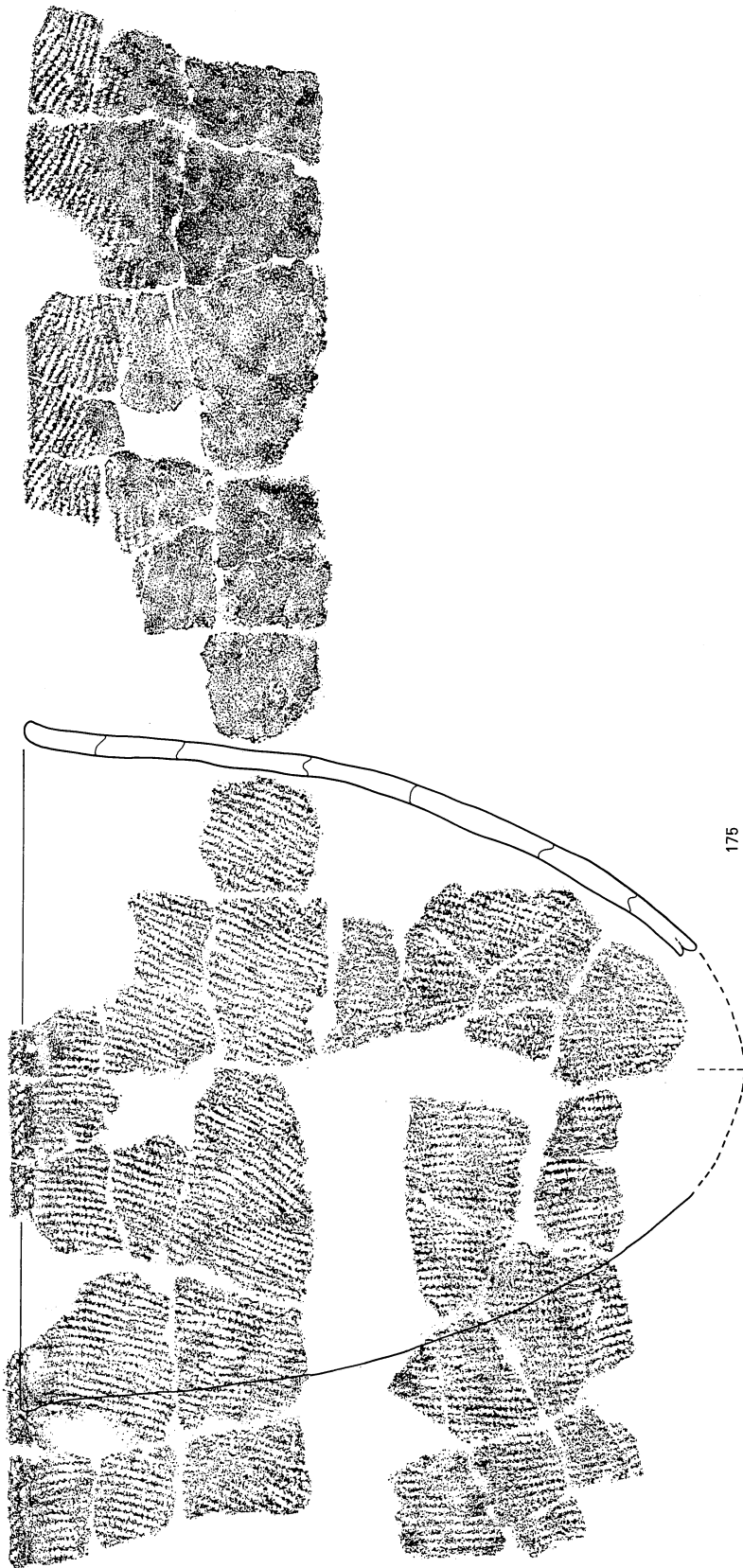

縄文時代土器 11

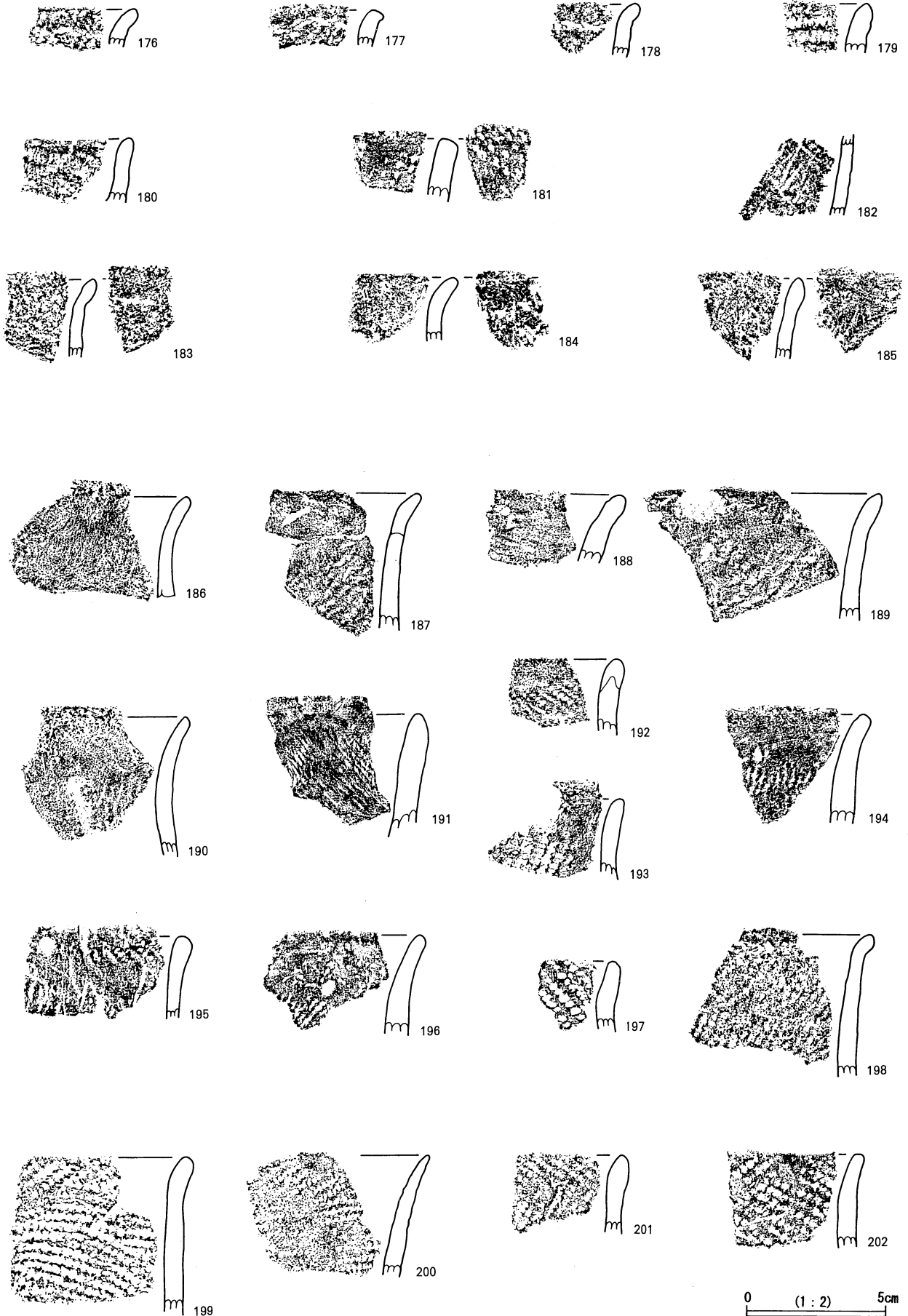

縄文時代土器 12

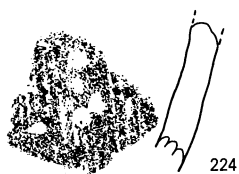
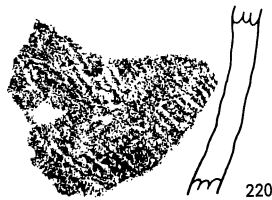
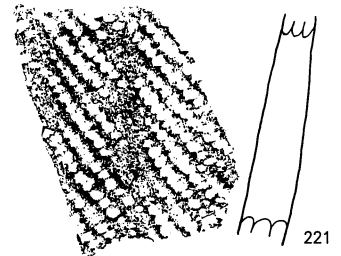
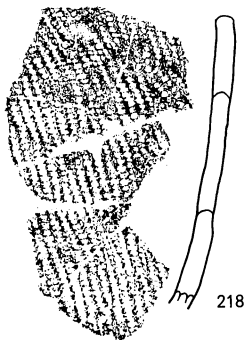
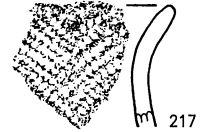
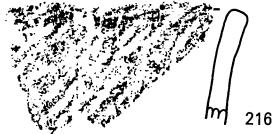
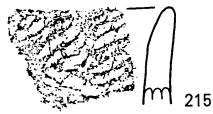
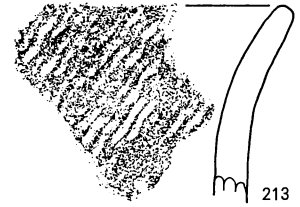
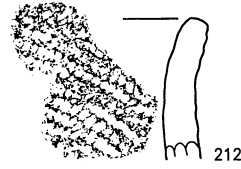
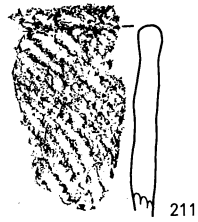
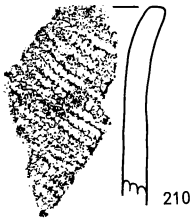
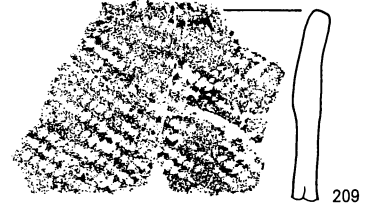
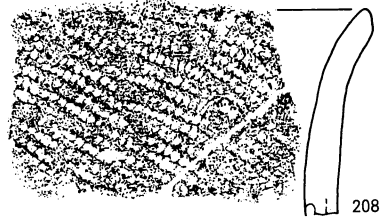
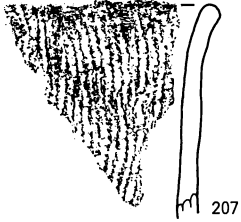
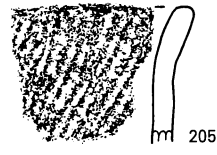
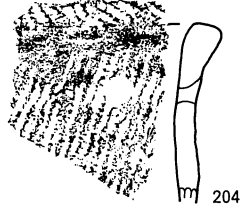
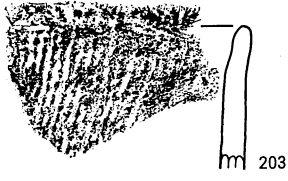

0 (1:2) 5cm

縄文時代土器 13

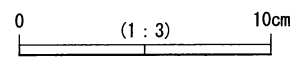
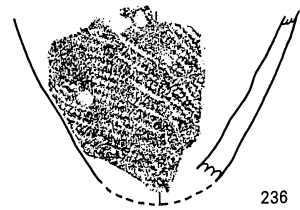
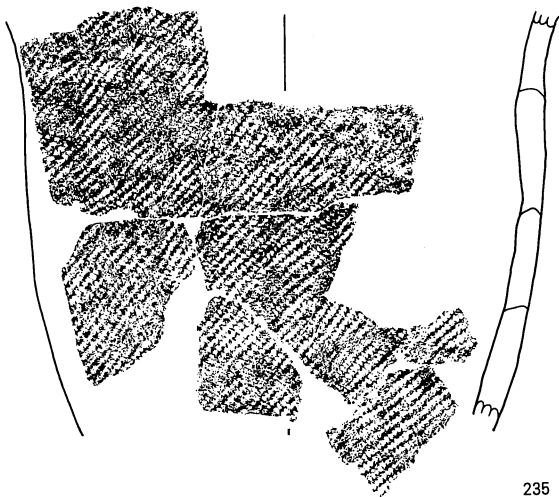
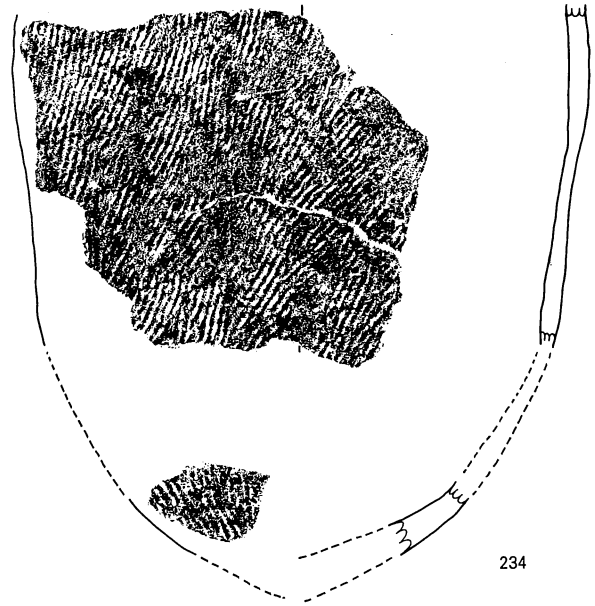
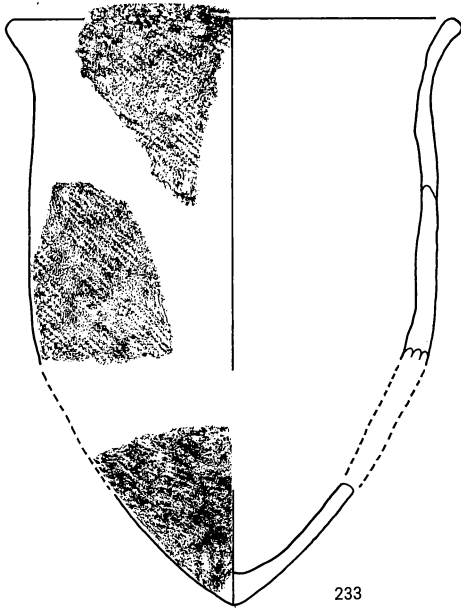
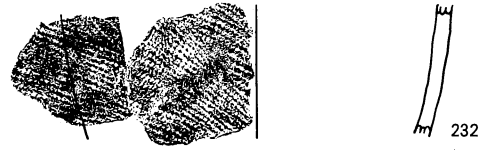
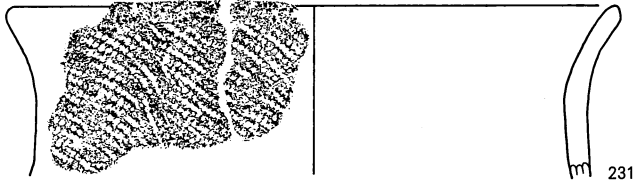
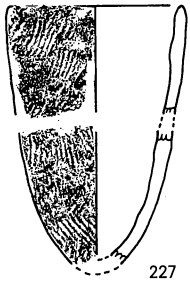

縄文時代土器 14

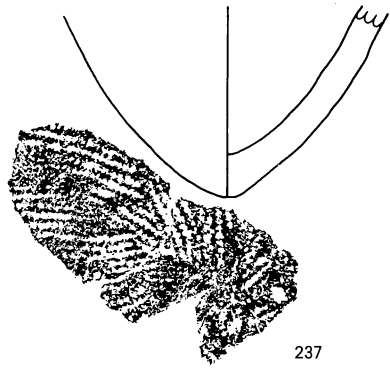

237

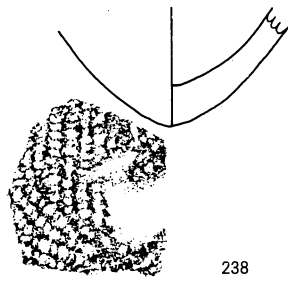

238

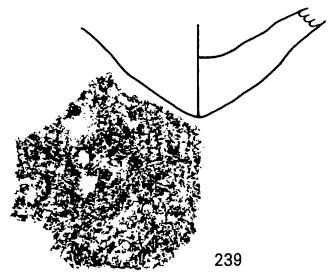

239



240

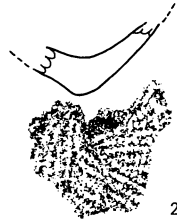

241

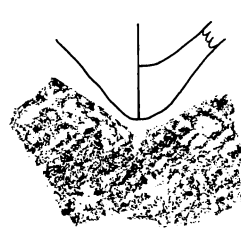

242

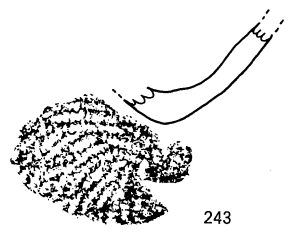

243



244

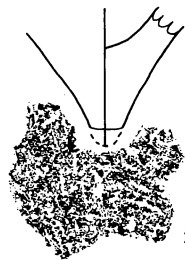

245

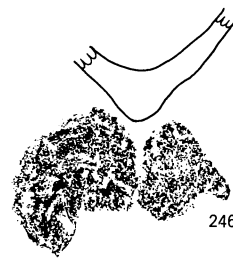

246



247

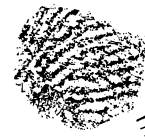

248

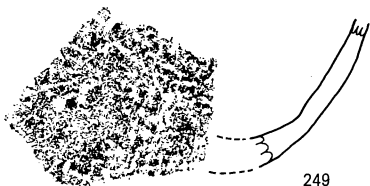

249



250



251

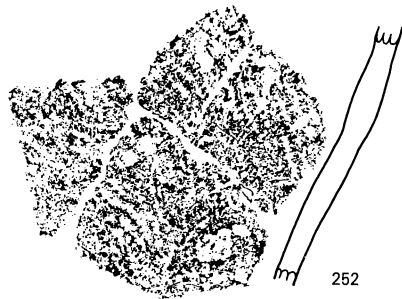

252

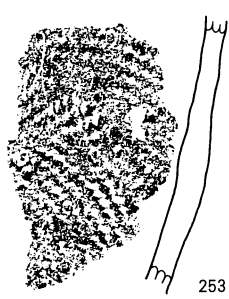

253

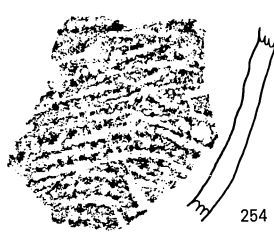

254



255



256



257

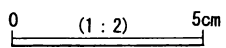

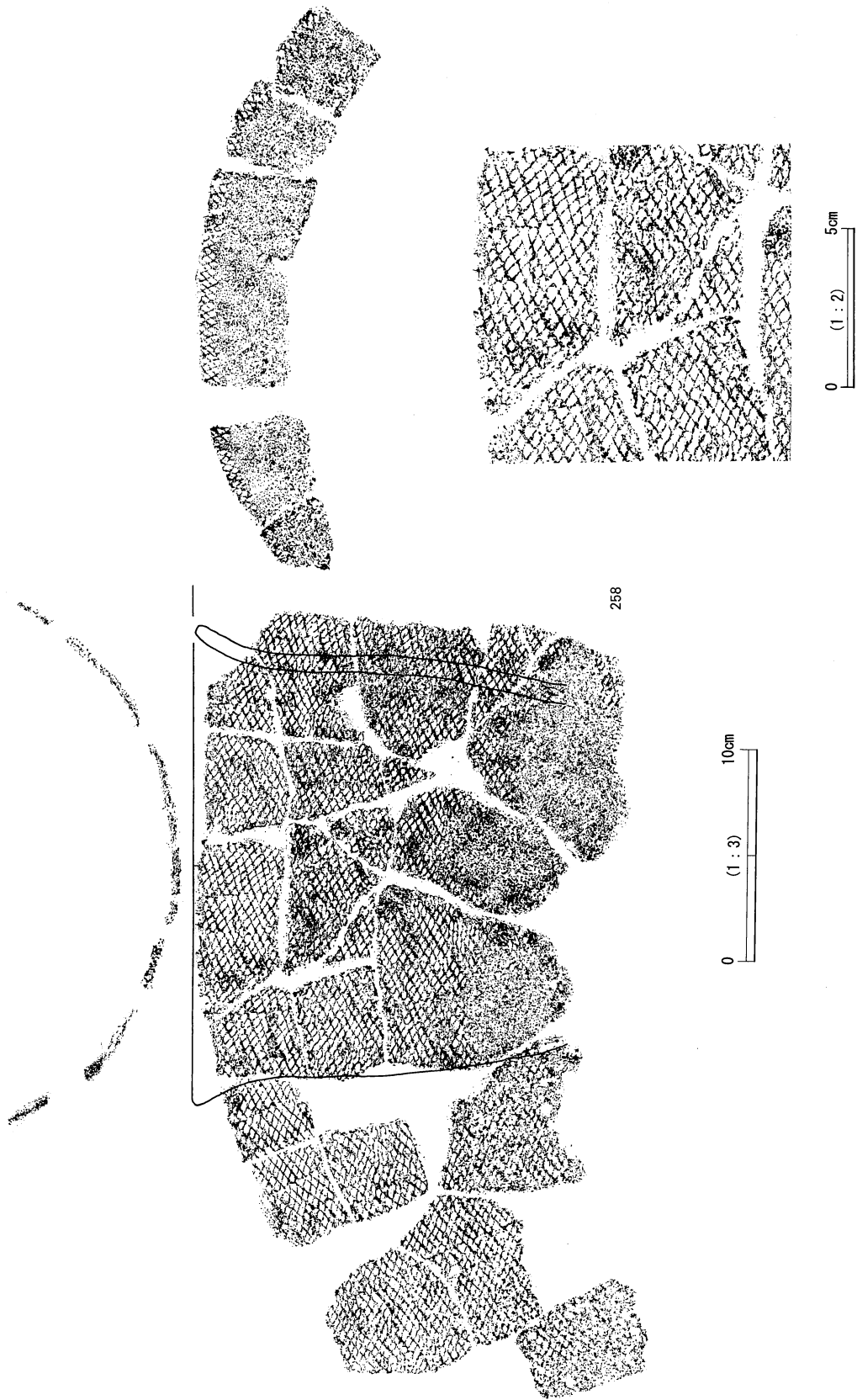

縄文時代土器 16

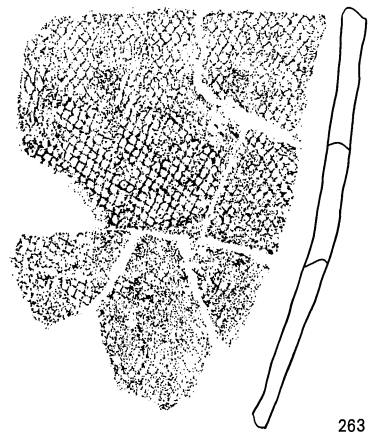
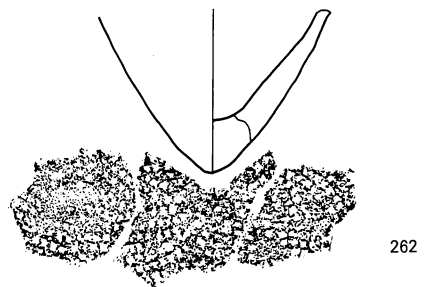
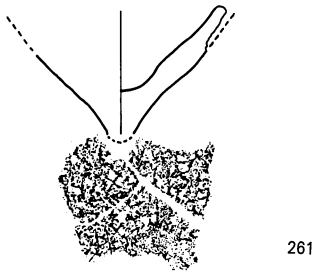
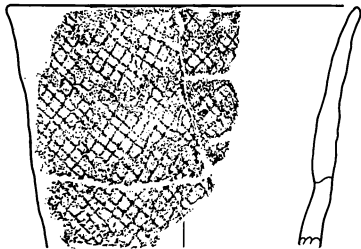
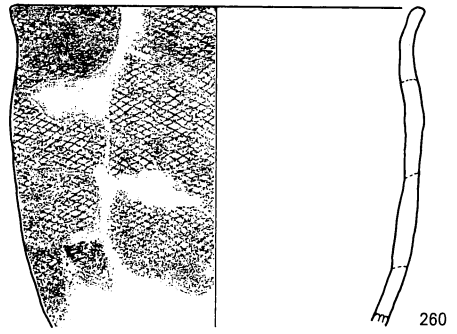
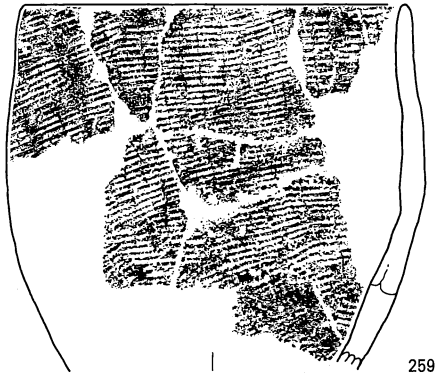

0 (1 : 3) 10cm

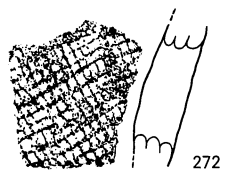
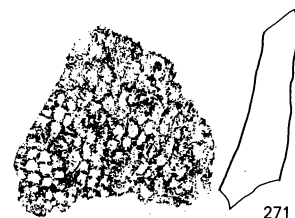
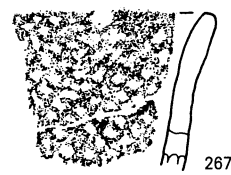
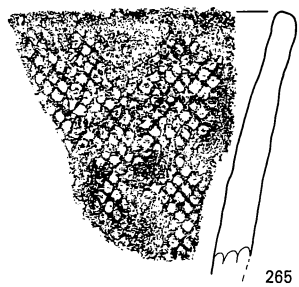
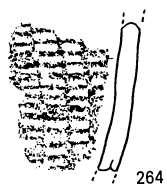

0 (1 : 2) 5cm

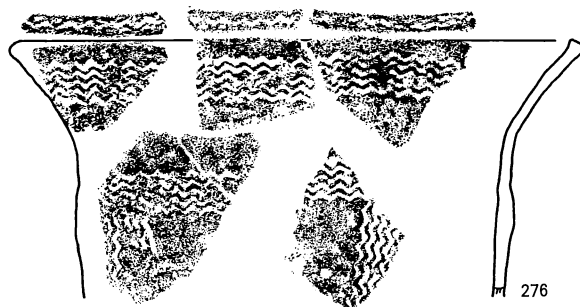
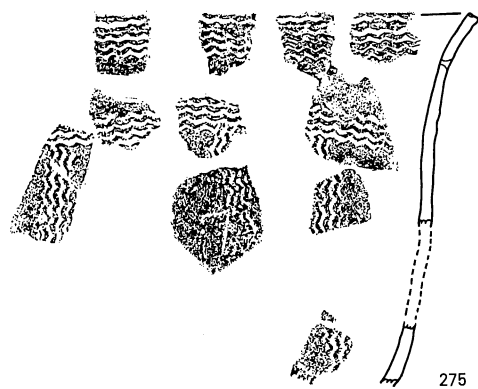

0 (1 : 3) 10cm

縄文時代土器 18

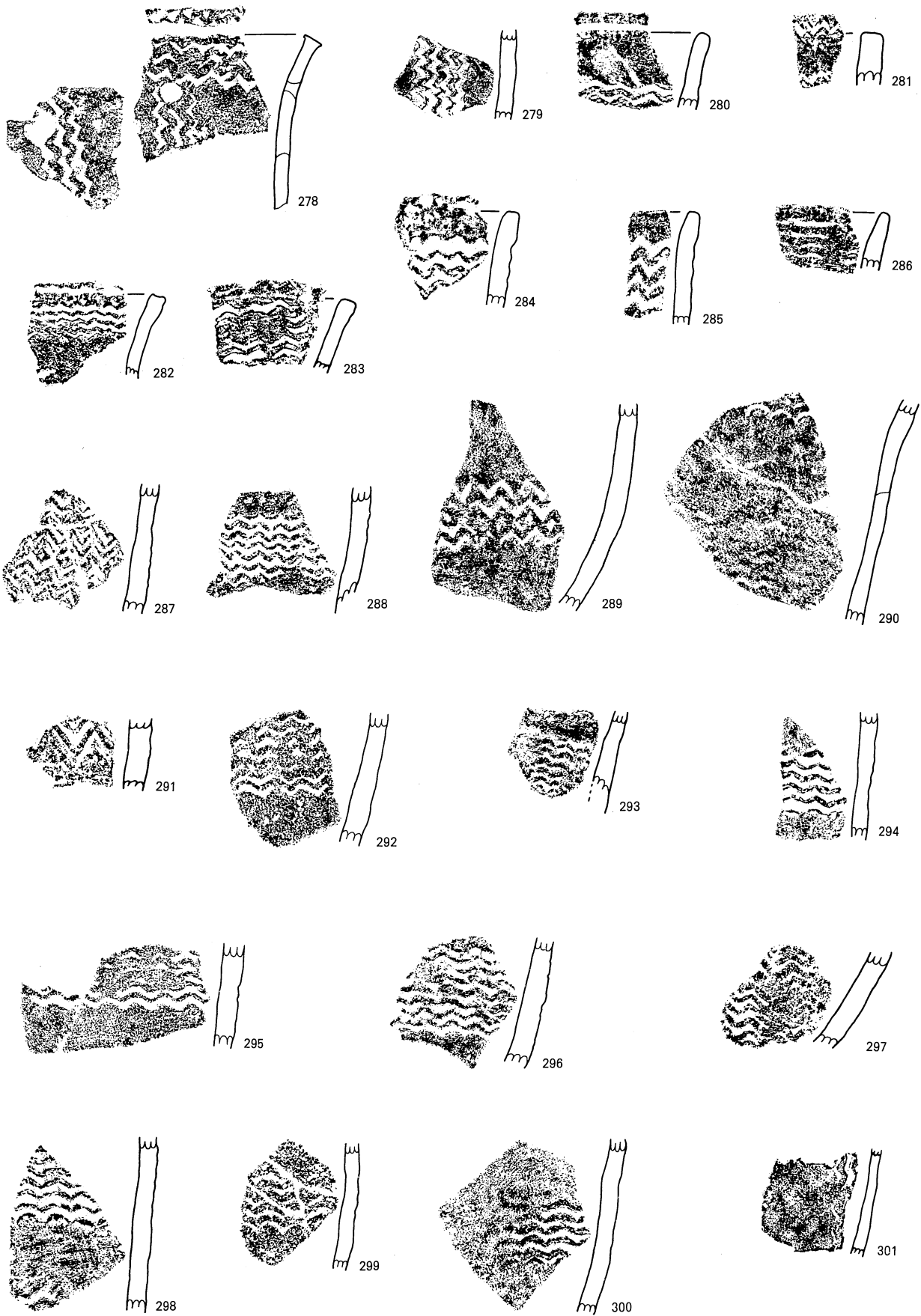

0 (1 : 2) 5cm

縄文時代土器 19

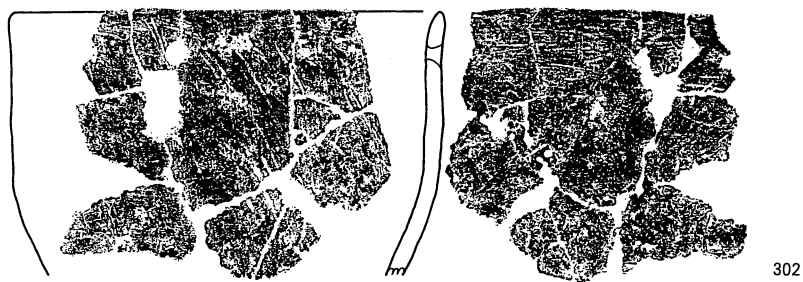

302



303

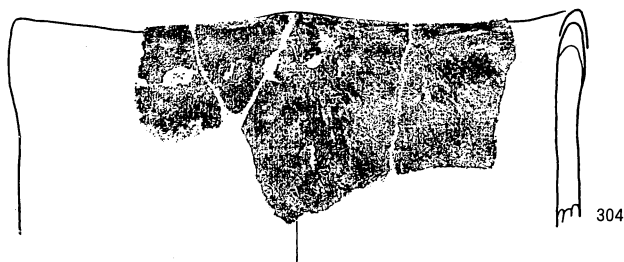

304



305

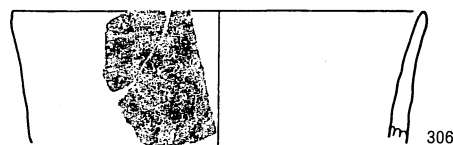

306



307



308

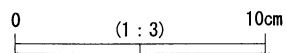

縄文時代土器 20

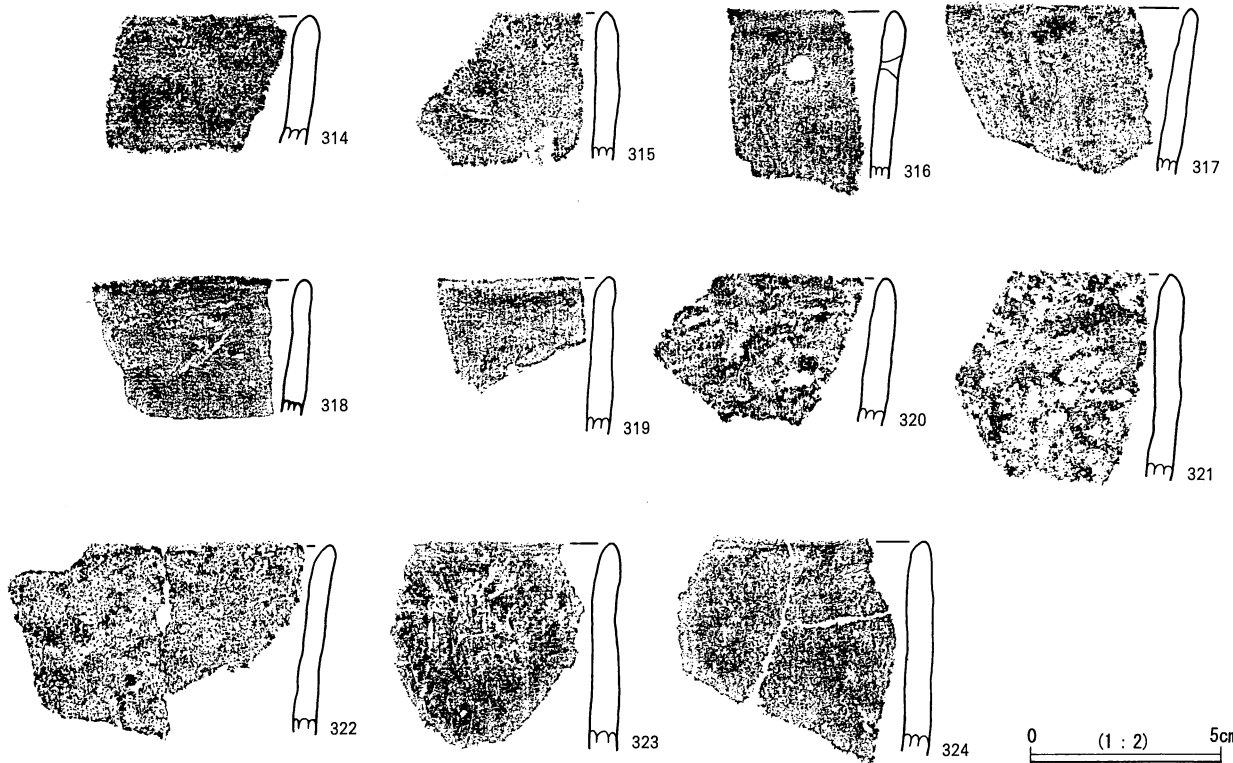
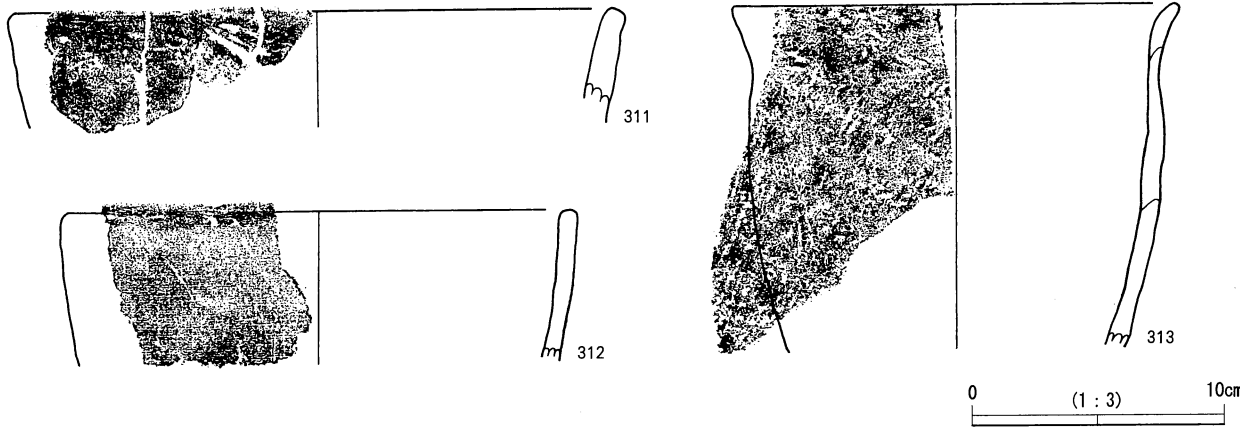

縄文時代土器 21

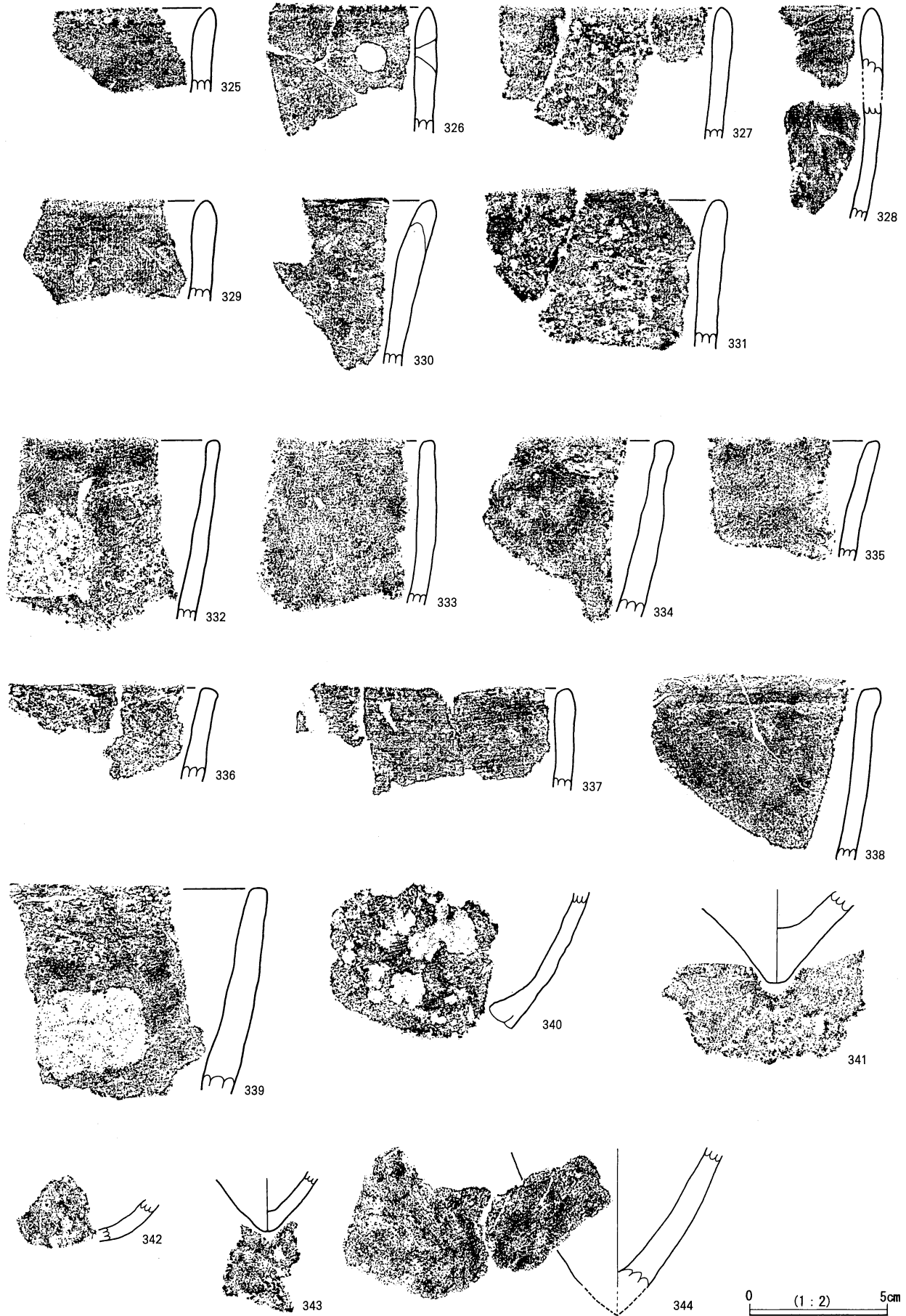

縄文時代土器 22

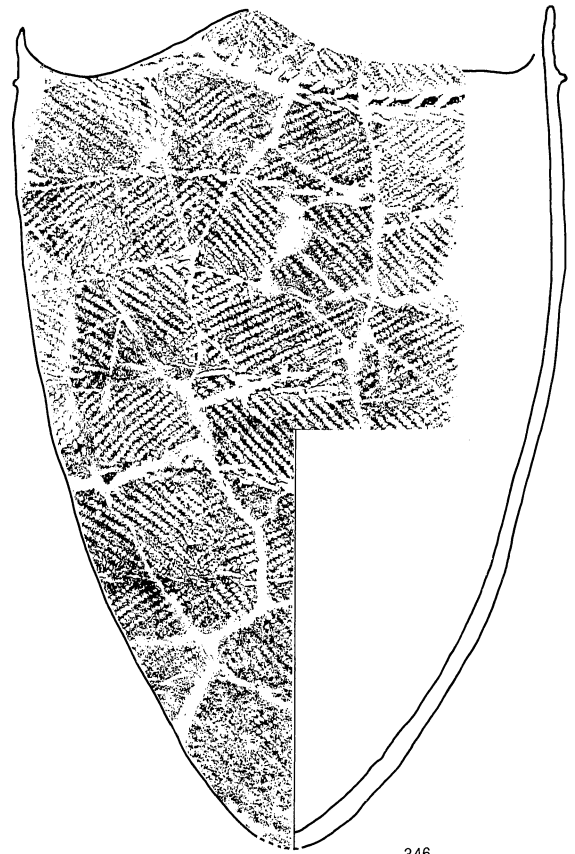
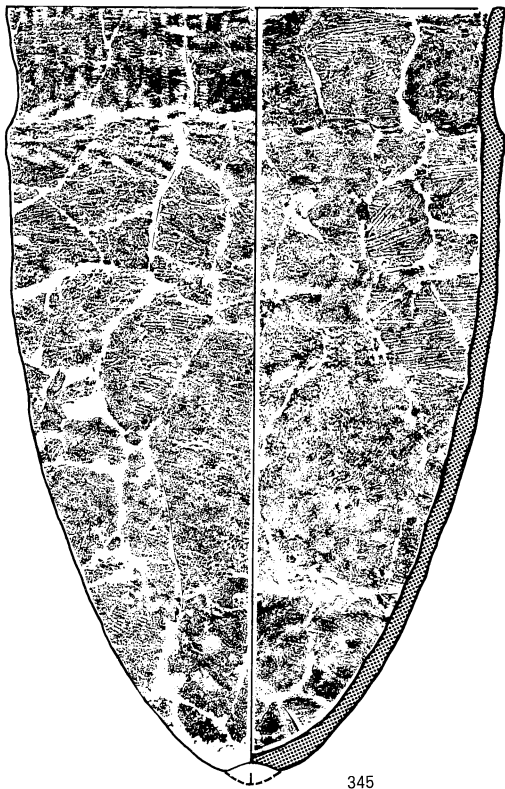
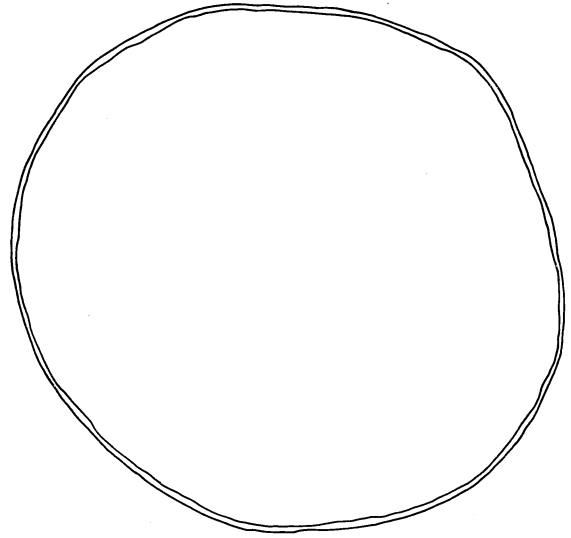
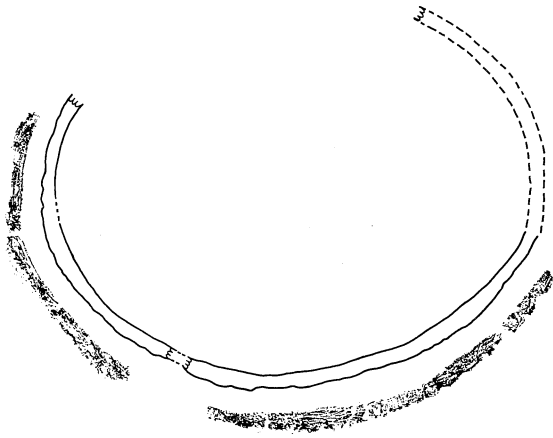

0 (1 : 4) 10cm



0 (1:4) 10cm



349

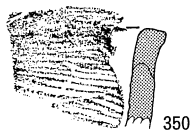

350

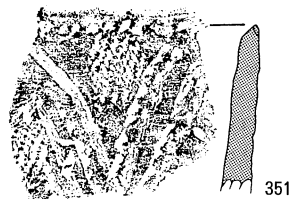

351



352

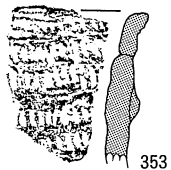

353



354



355



356



357

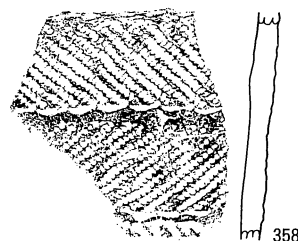

358



359

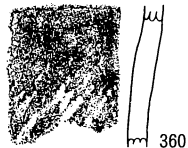

360

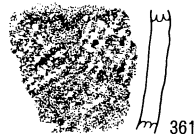

361



362



363

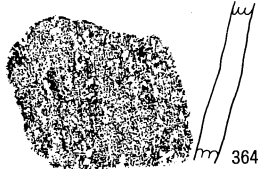

364

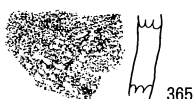

365



366



367



368

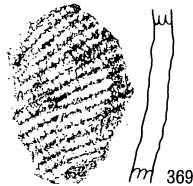

369

0 (1:3) 10cm

縄文時代土器 24

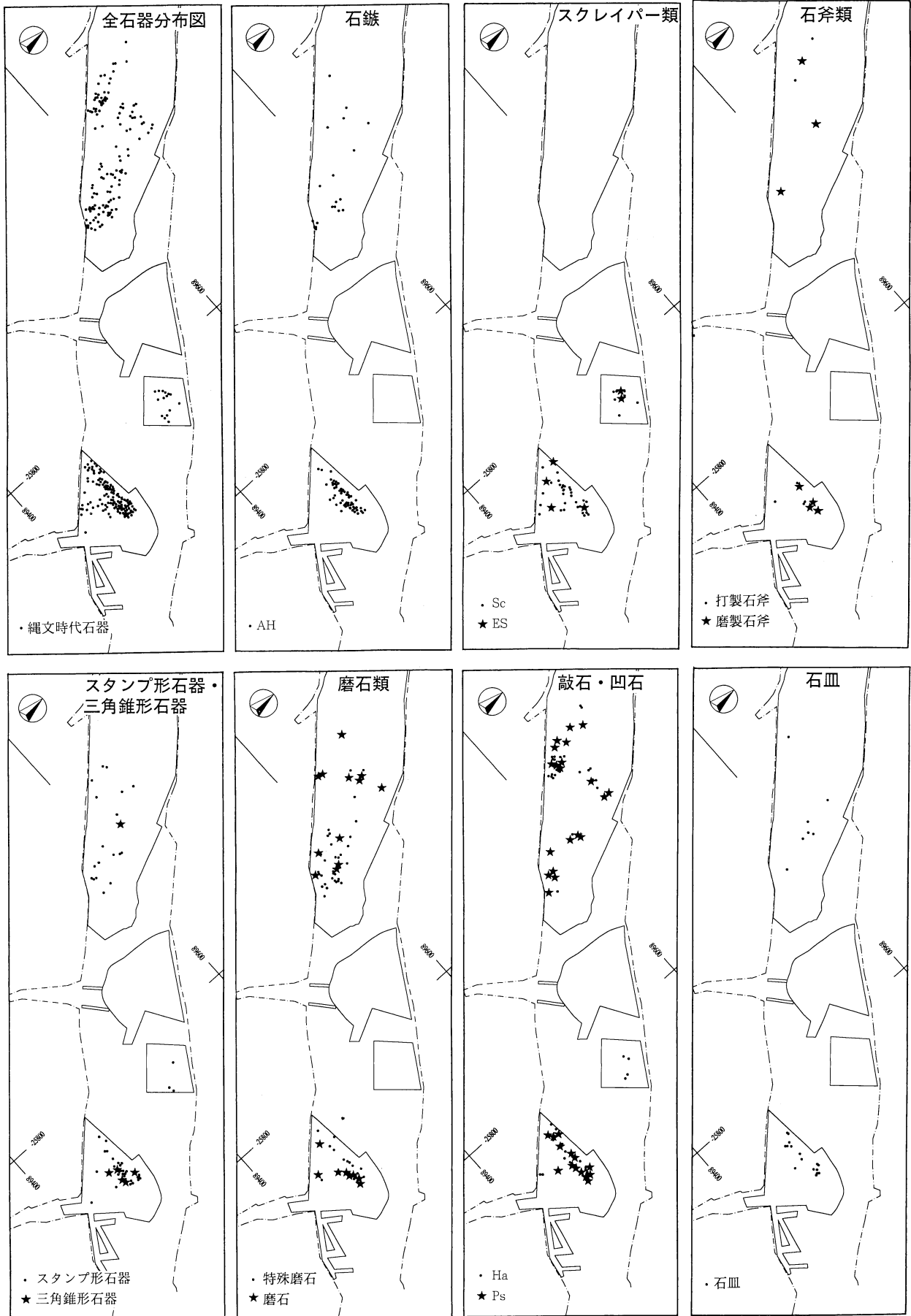

縄文時代石器分布図

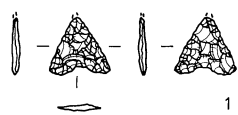

1

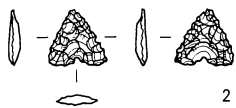

2

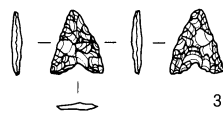

3



4

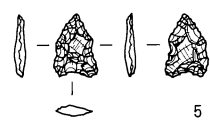

5

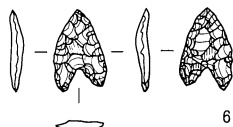

6

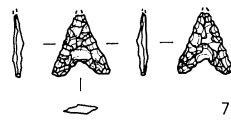

7

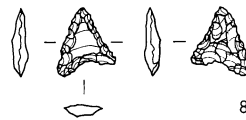

8

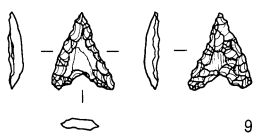

9

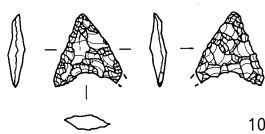

10

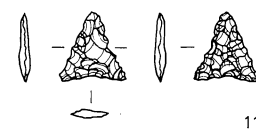

11

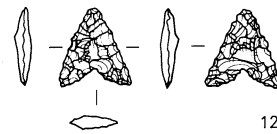

12

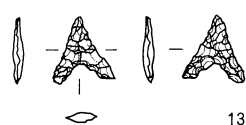

13



14

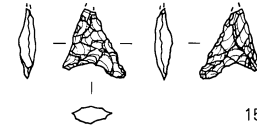

15

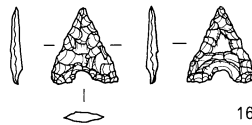

16

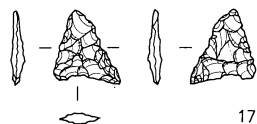

17

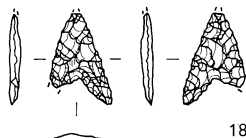

18

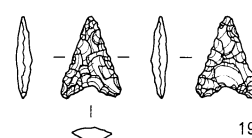

19

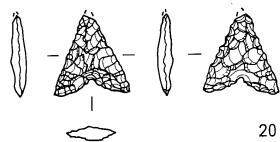

20

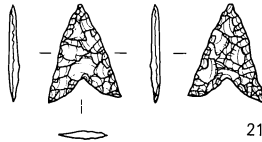

21

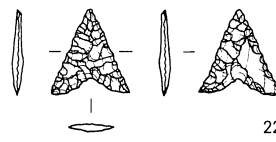

22

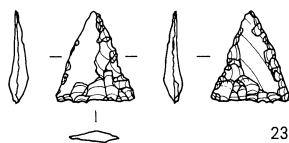

23

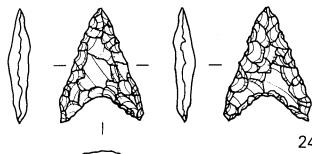

24

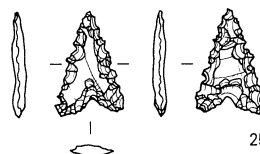

25

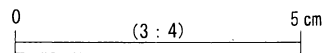

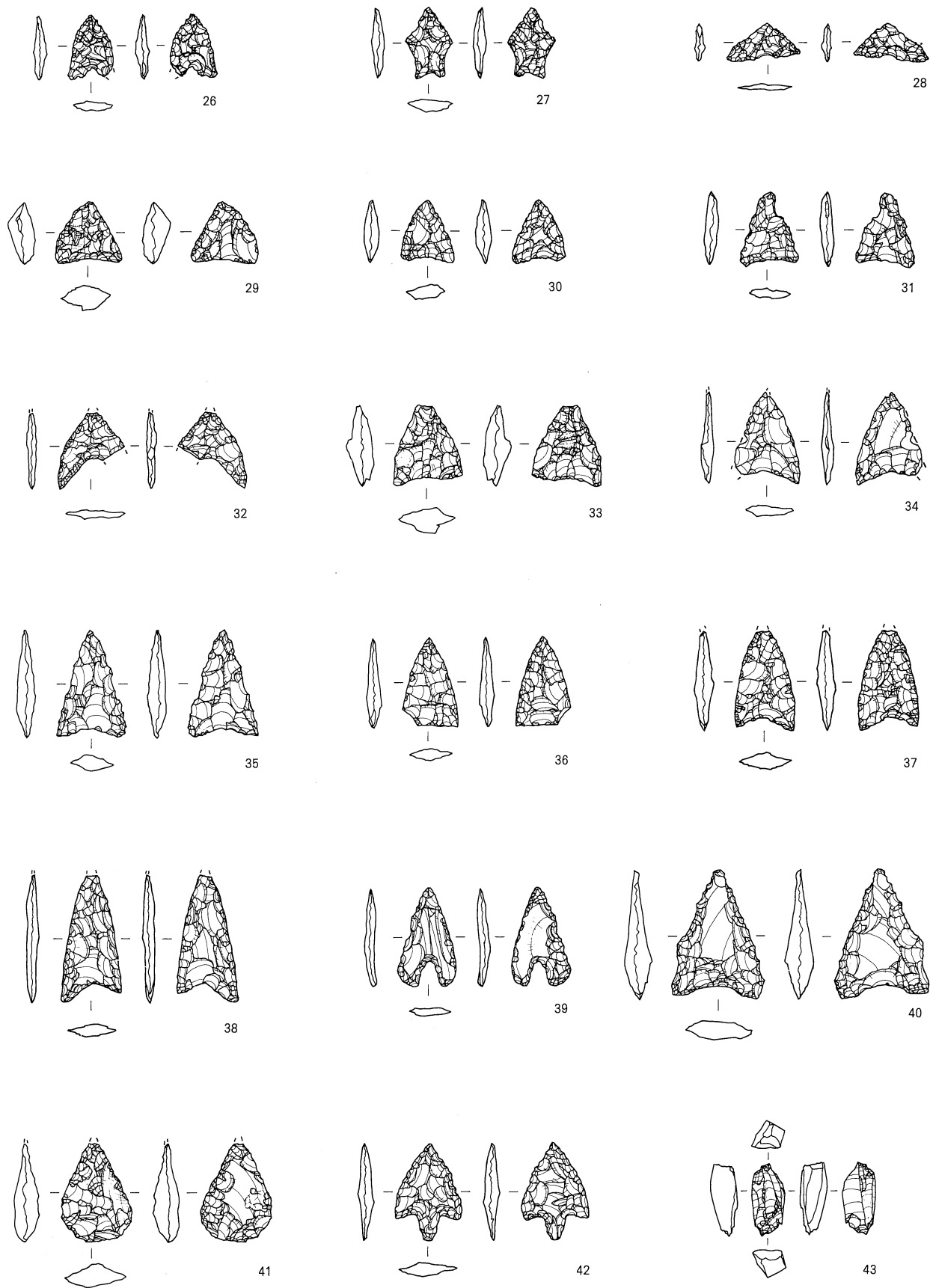

0 (3 : 4) 5 cm

縄文時代石器 2

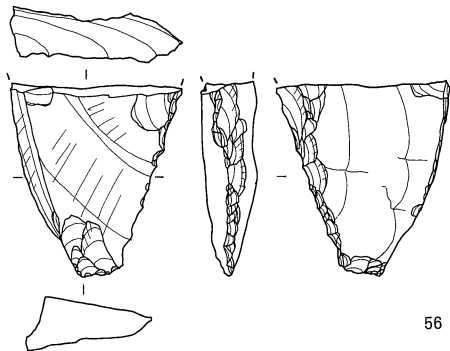
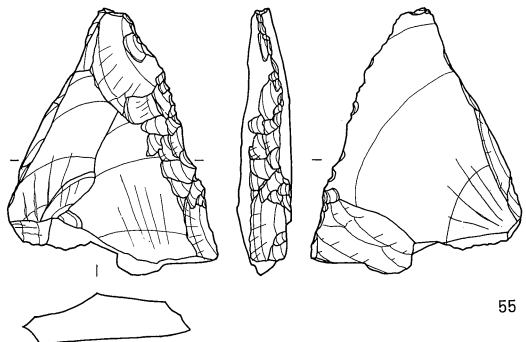
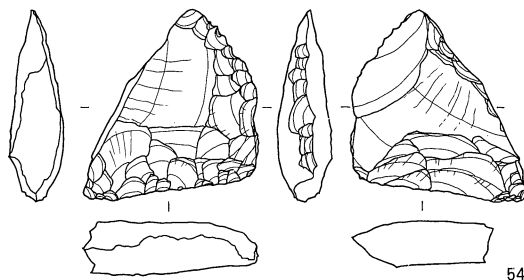
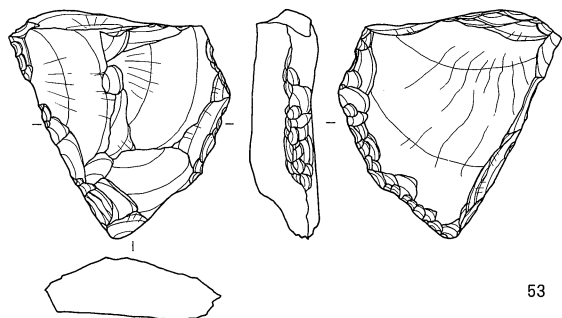
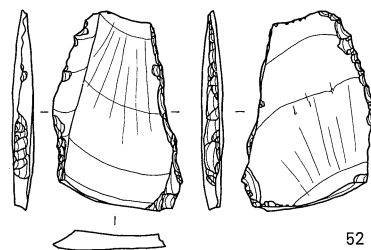
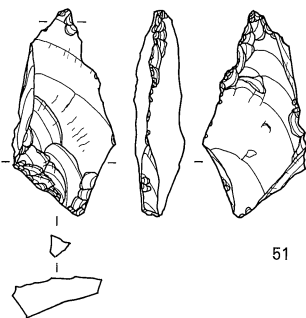
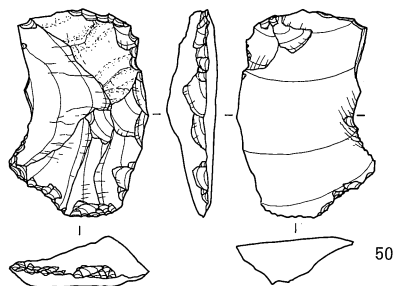
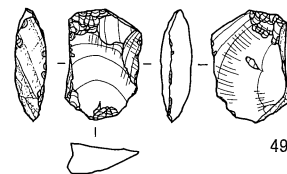
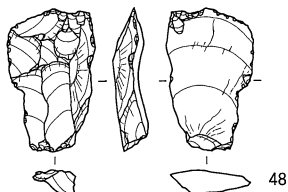
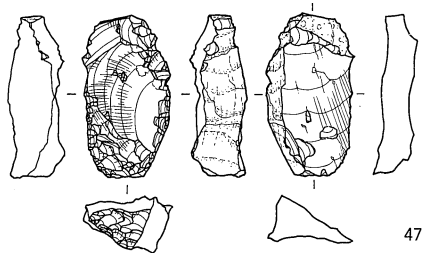
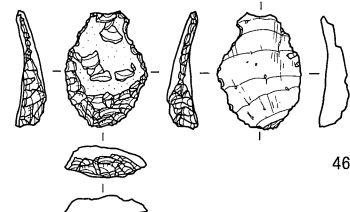
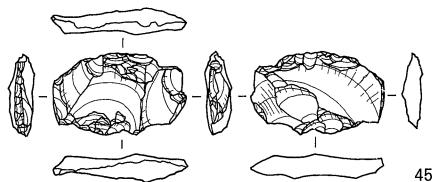
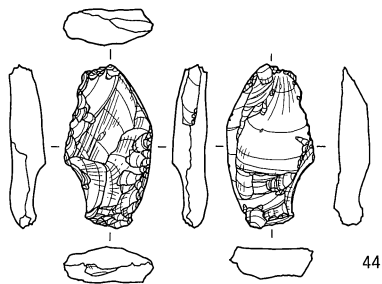

0 (1 : 2) 5cm

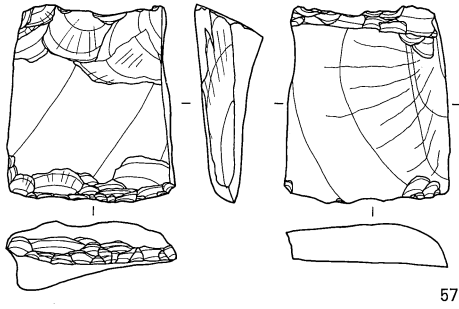

57

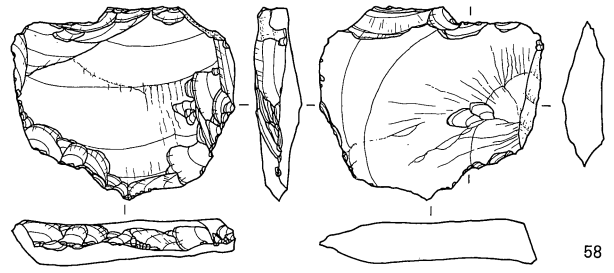

58

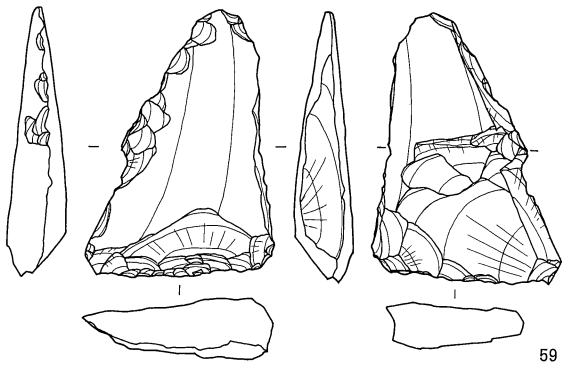

59

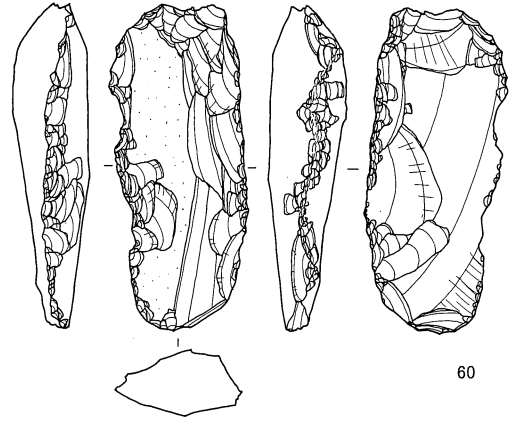

60

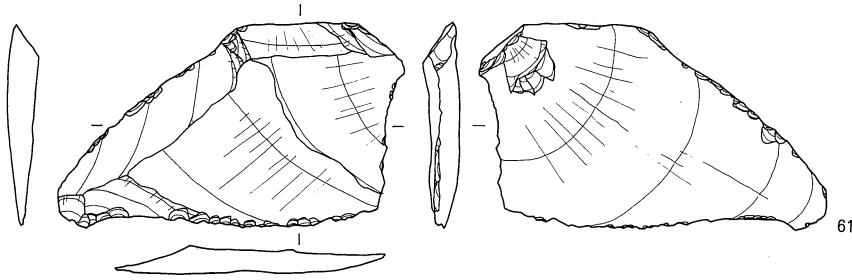

61

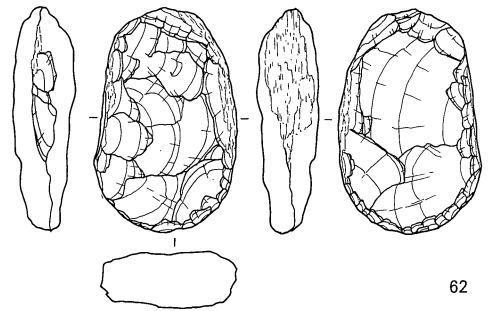

62

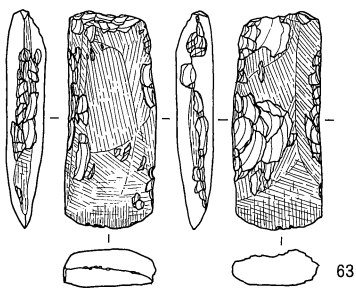

63

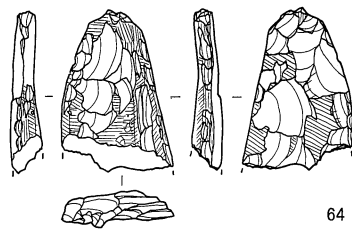

64

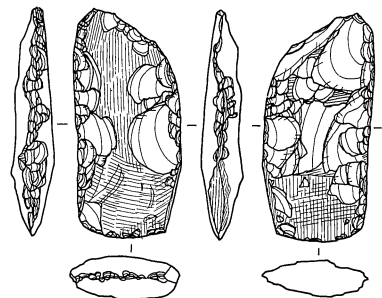

65

0 (1:2) 5cm

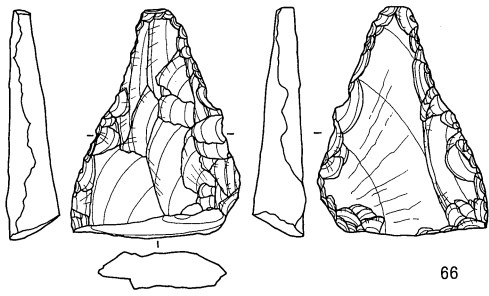

66

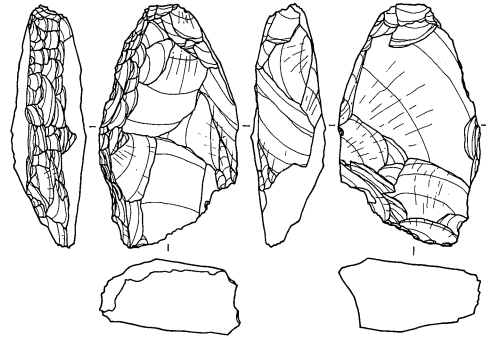

67

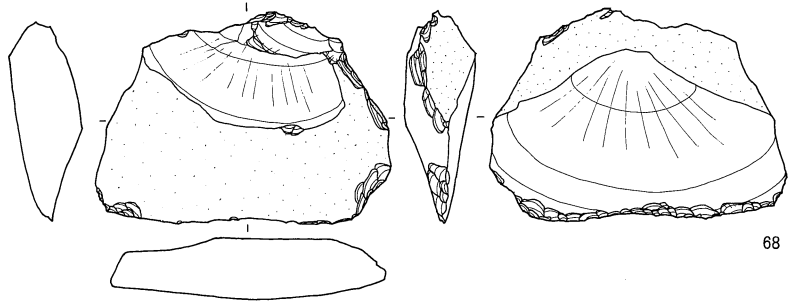

68

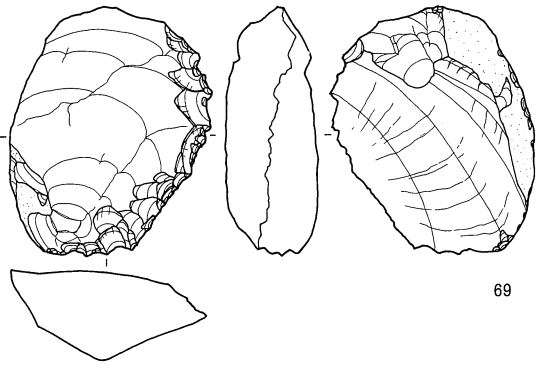

69

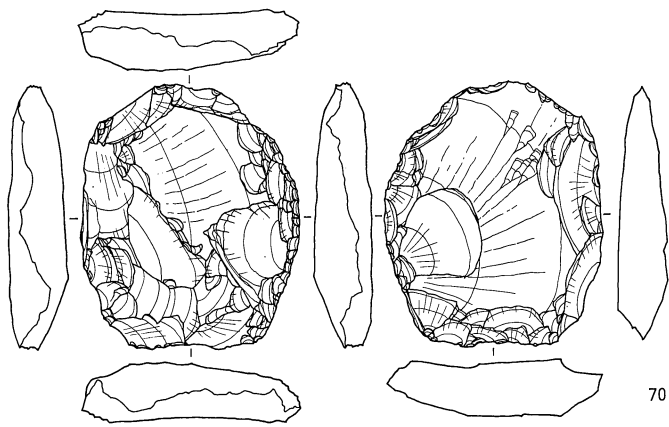

70

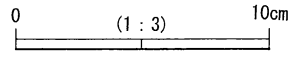

縄文時代石器 5

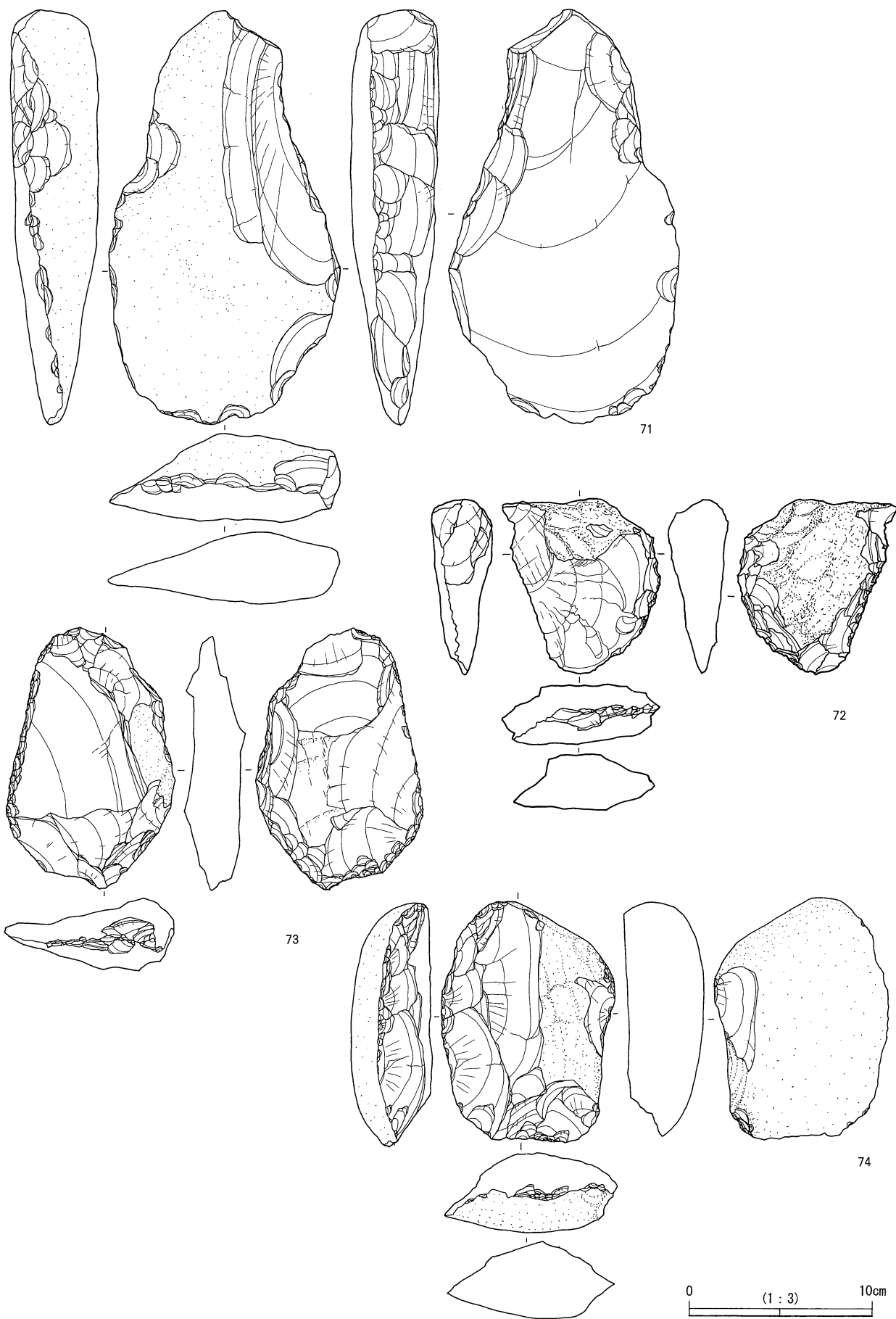

縄文時代石器 6

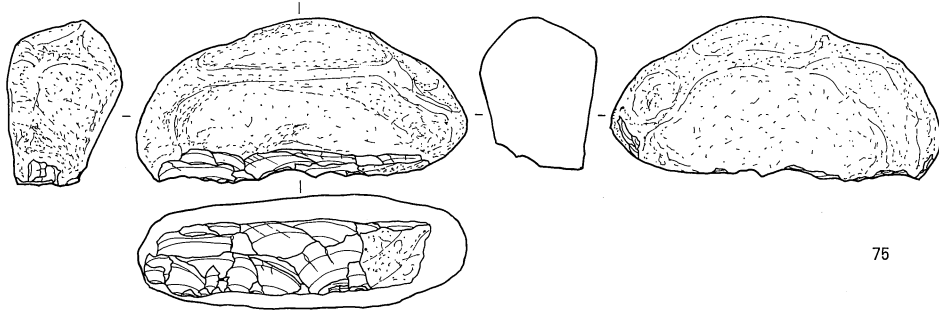

75

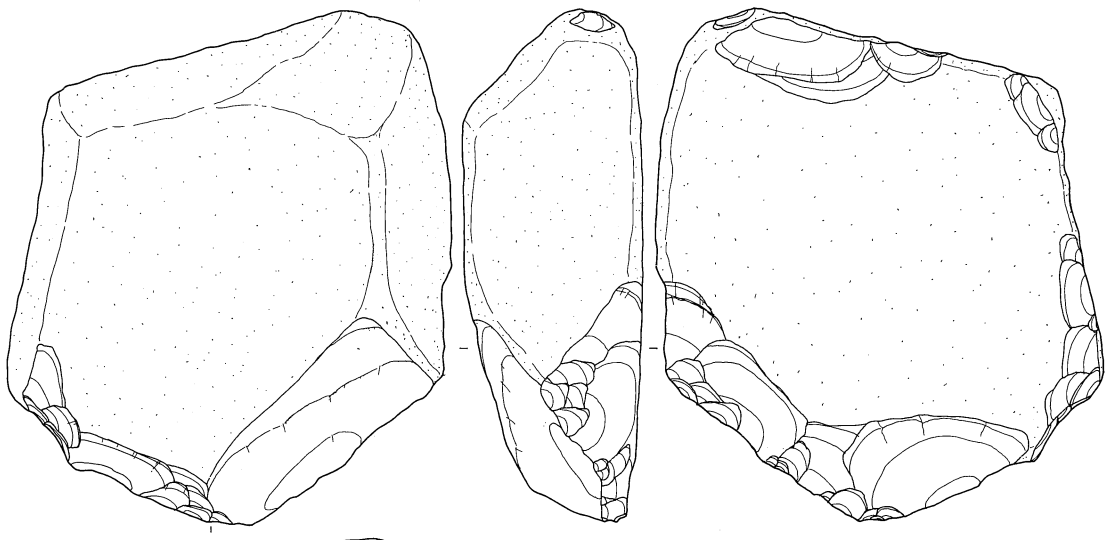

76

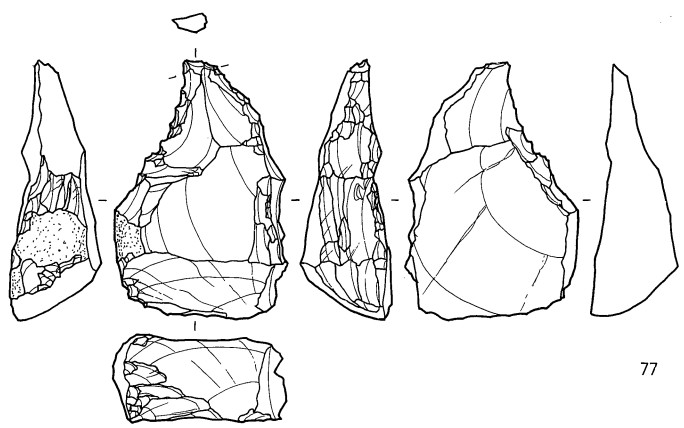
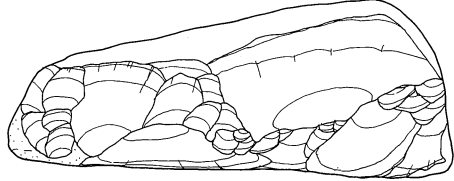

77

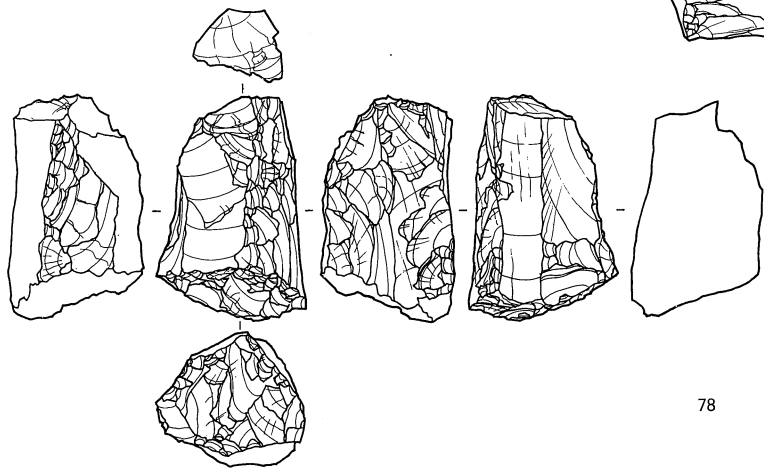

78

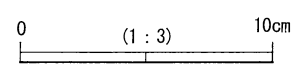

縄文時代石器 7

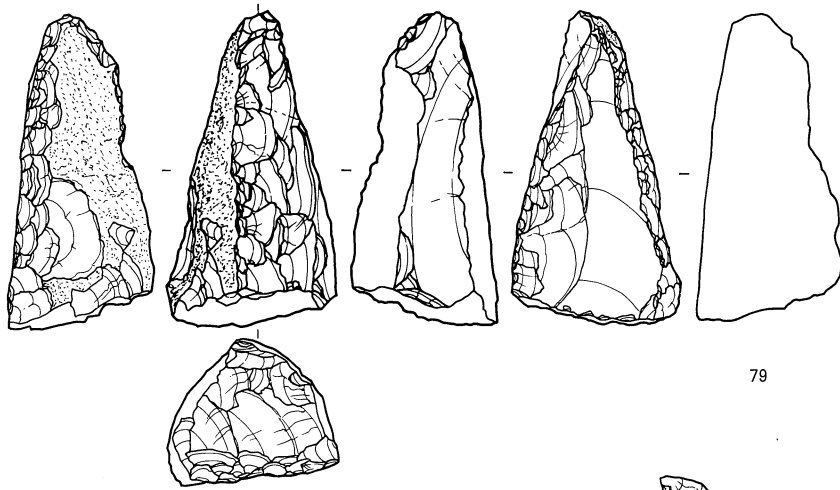

79

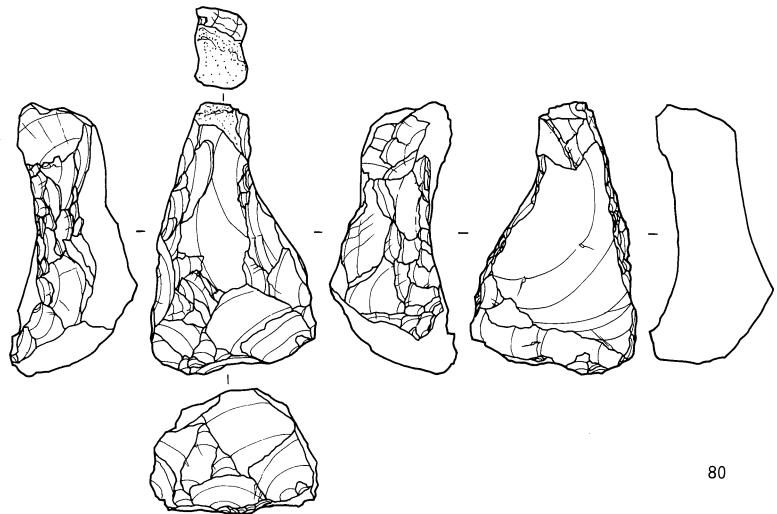

80

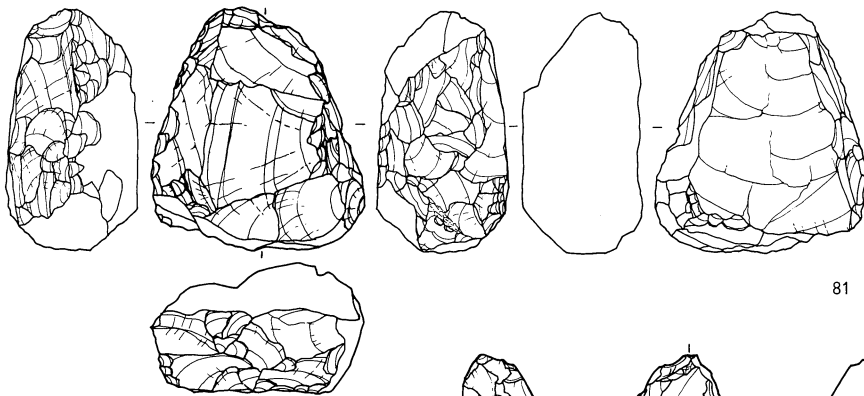

81

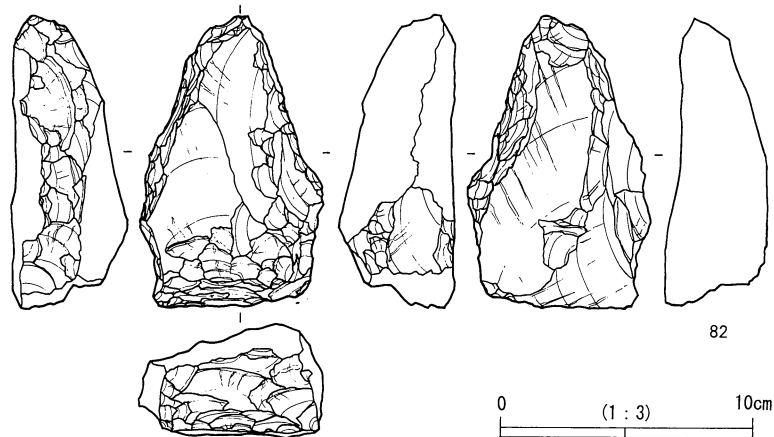

82

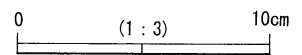

縄文時代石器 8

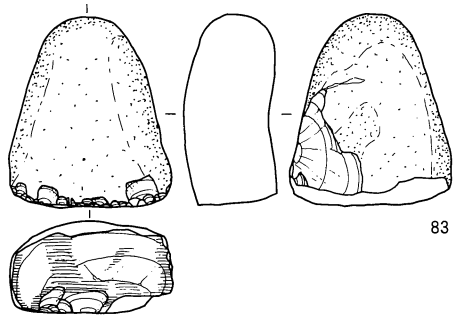

83

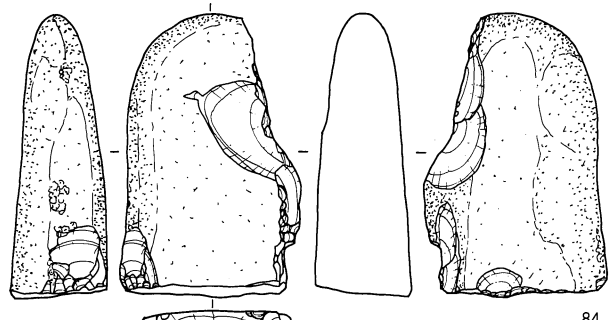

84

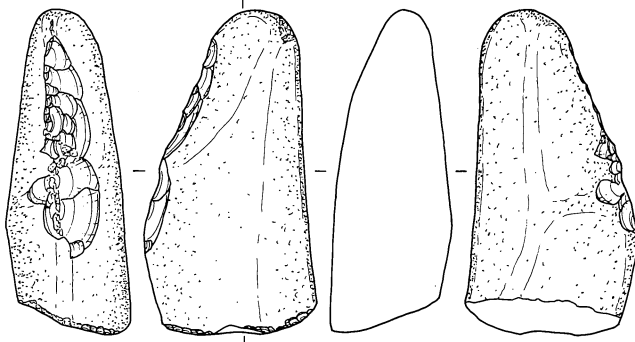

85

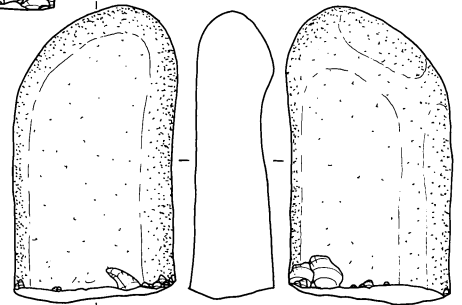

86

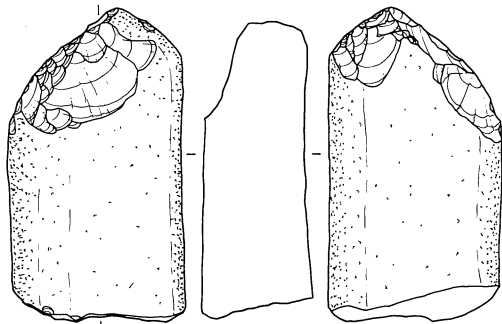
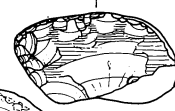
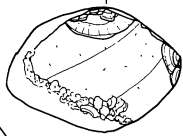
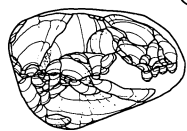

87

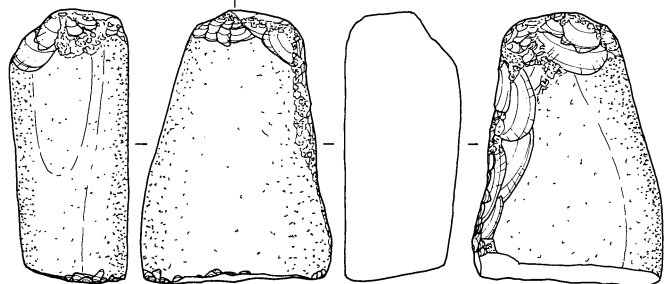

88

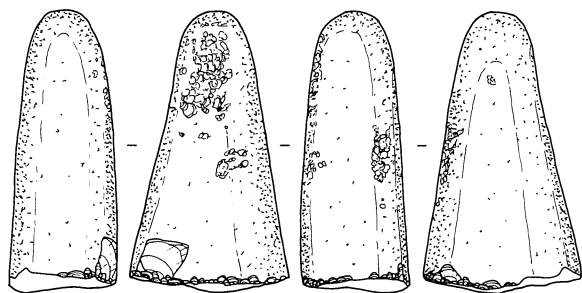
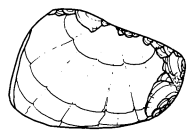

89

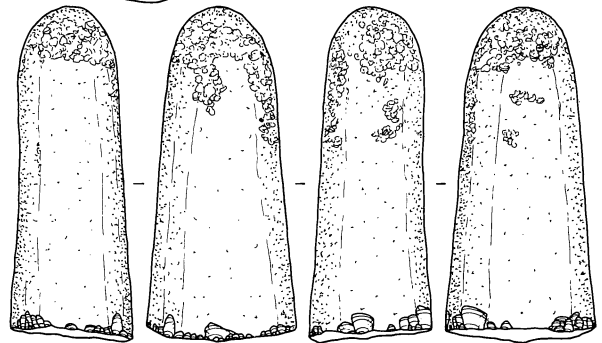

90

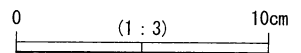
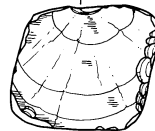
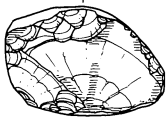

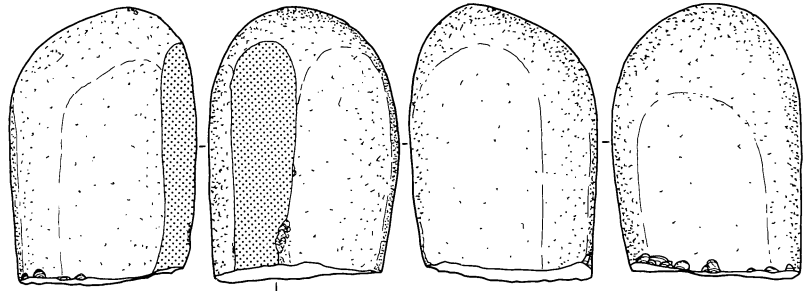

91

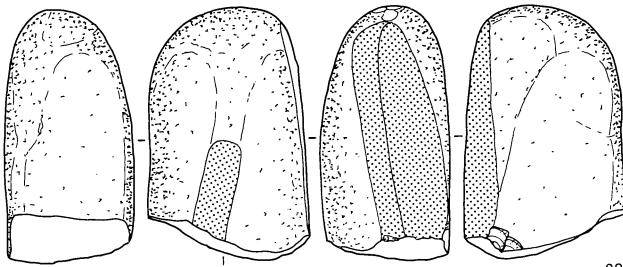
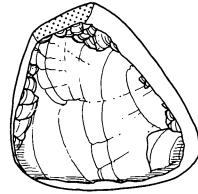

92

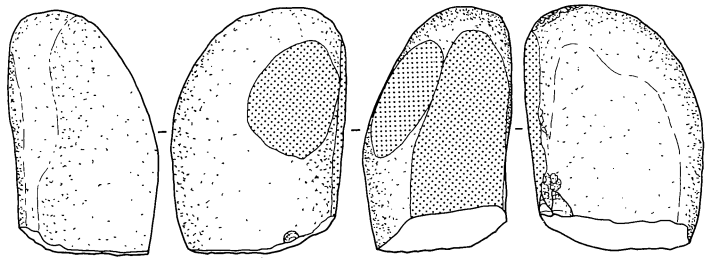
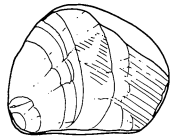

93

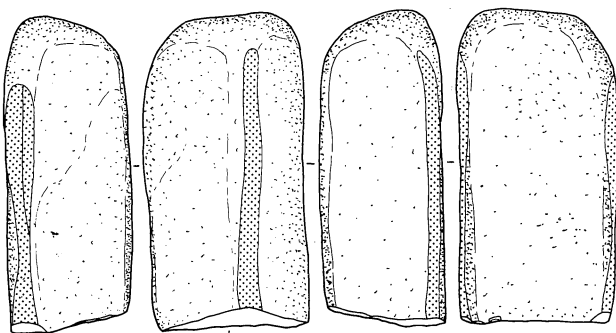
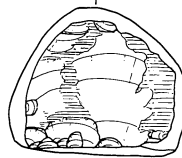

94

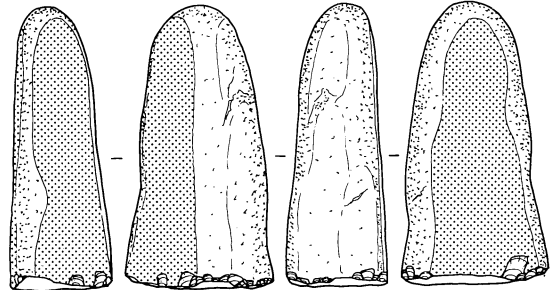

95

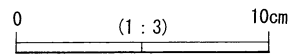
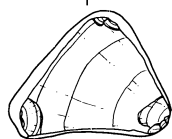

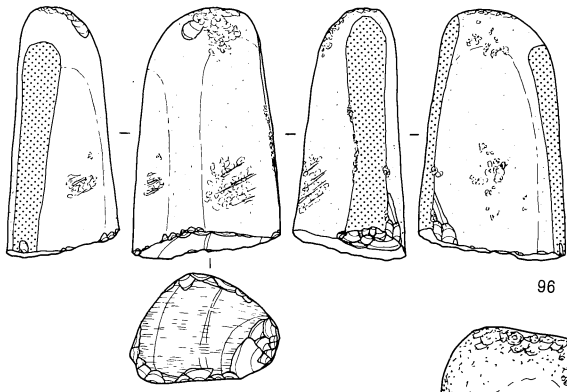

96

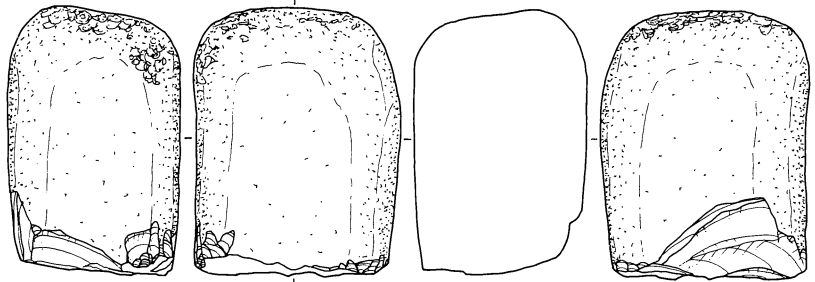
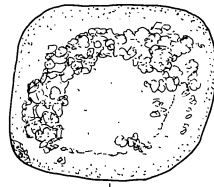

97

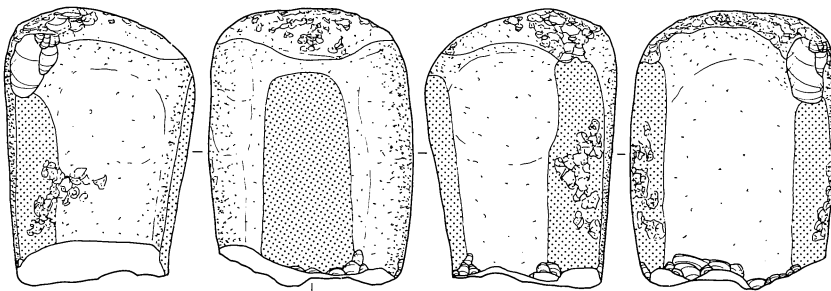
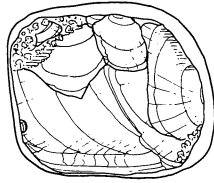

98

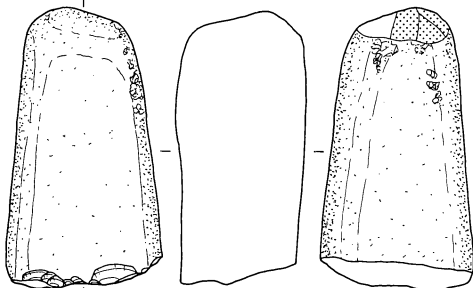
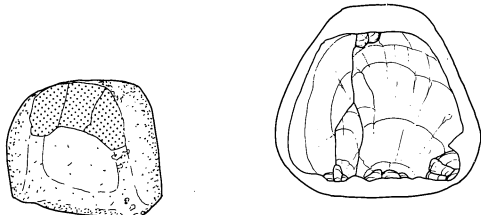

99

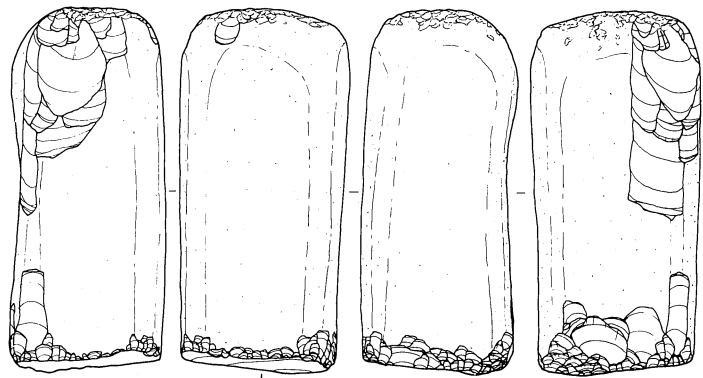

100

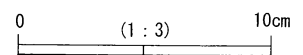
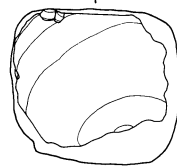
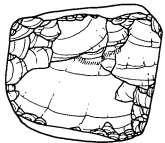

縄文時代石器 11

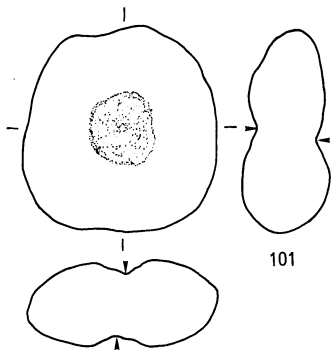

101

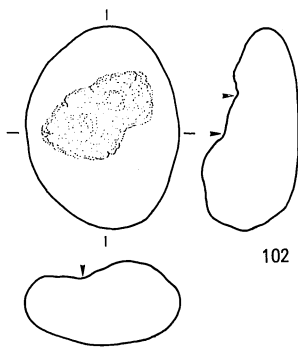

102

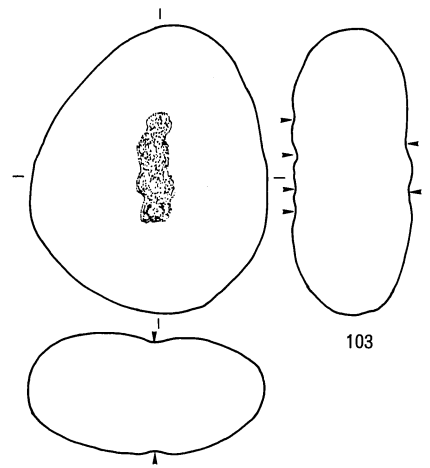

103

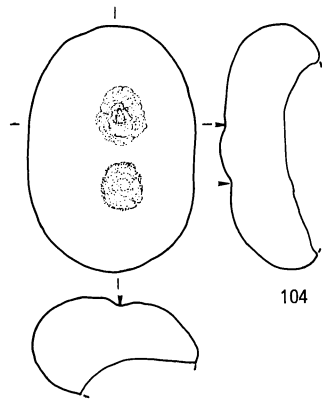

104

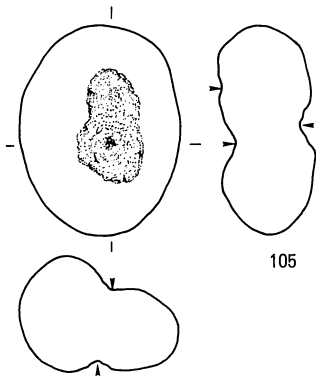

105

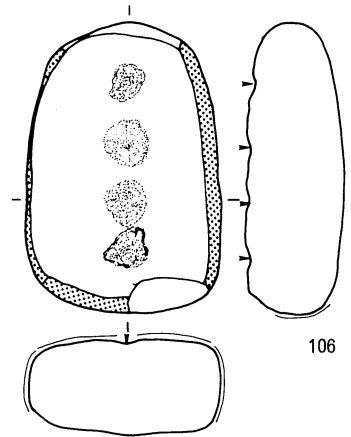

106

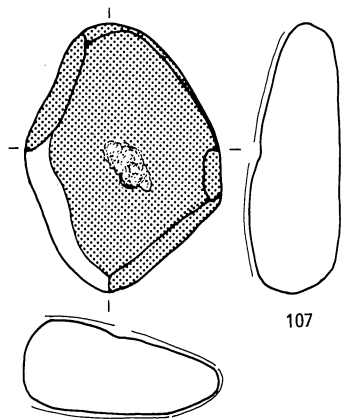

107

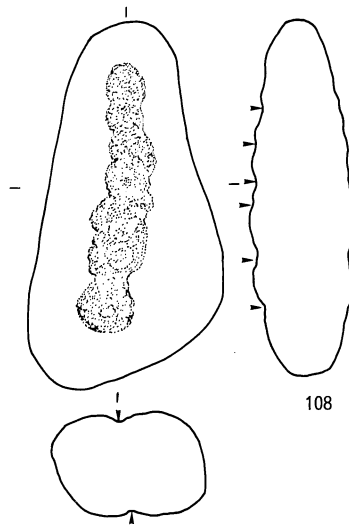

108

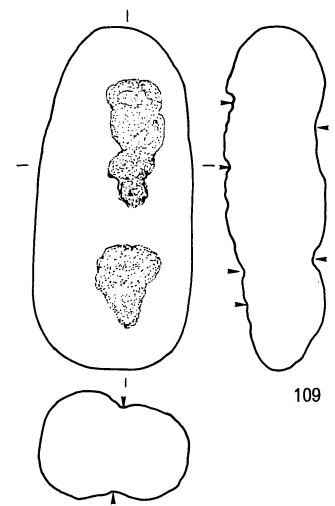

109

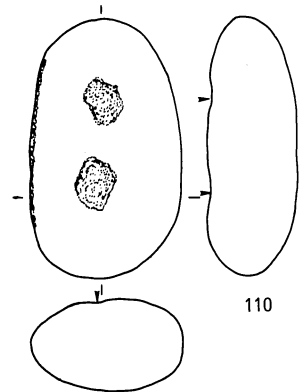

110

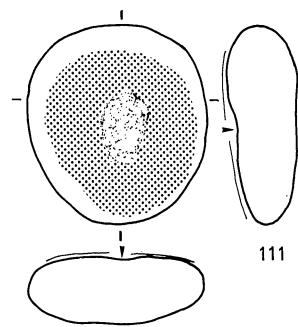

111

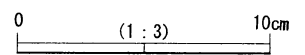

縄文時代石器 12

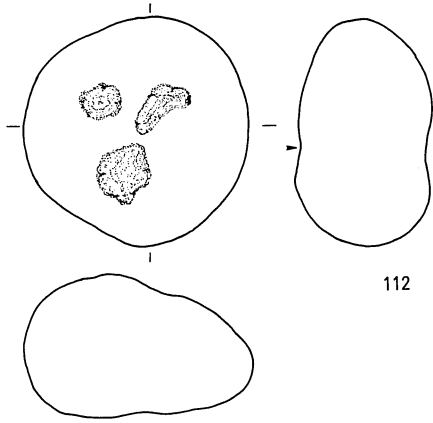

112

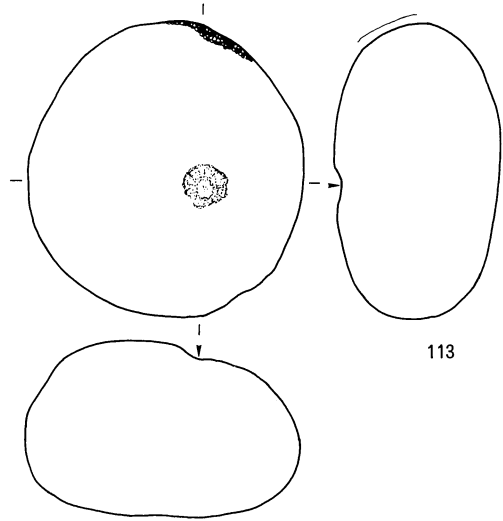

113

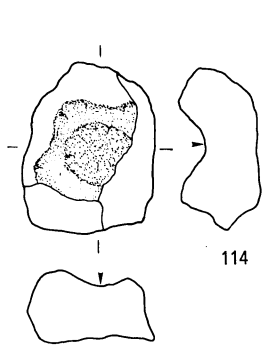

114

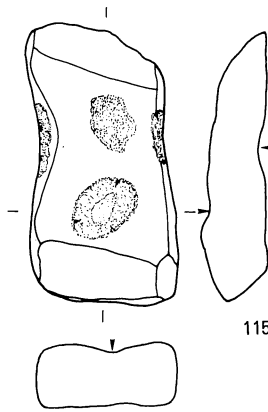

115

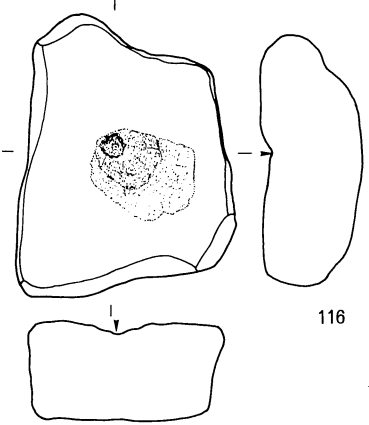

116

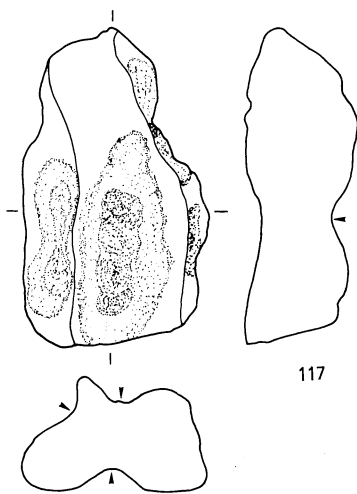

117

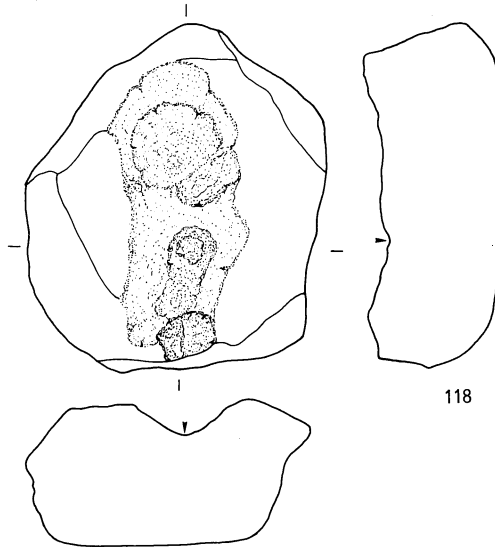

118

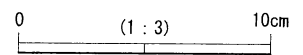

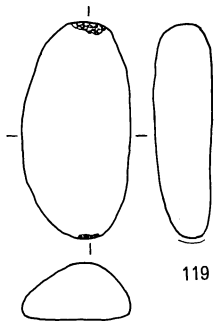

119

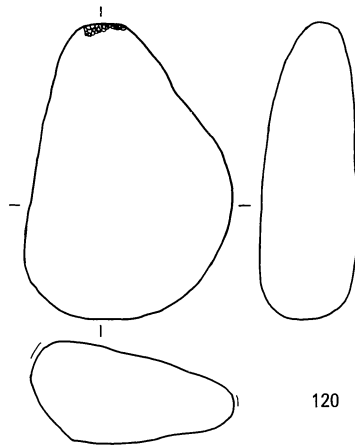

120

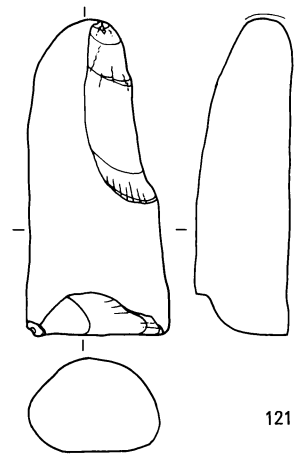

121

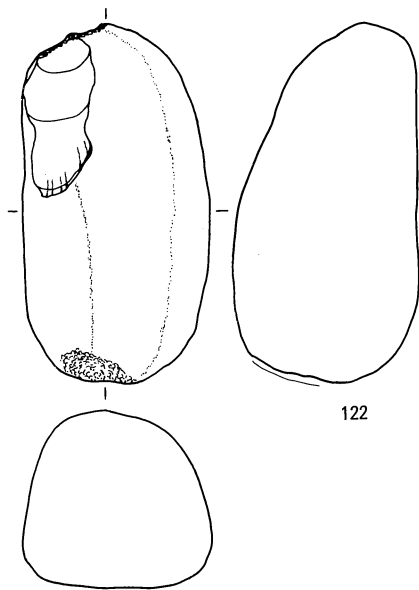

122

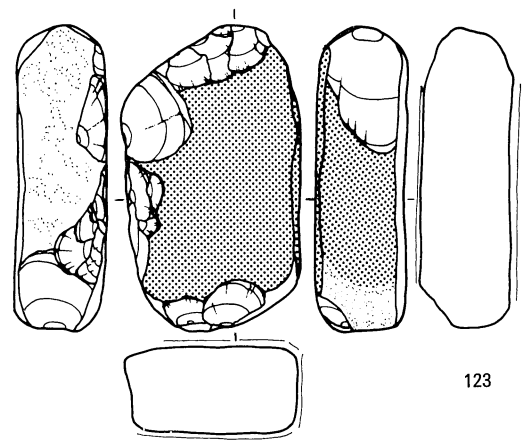

123

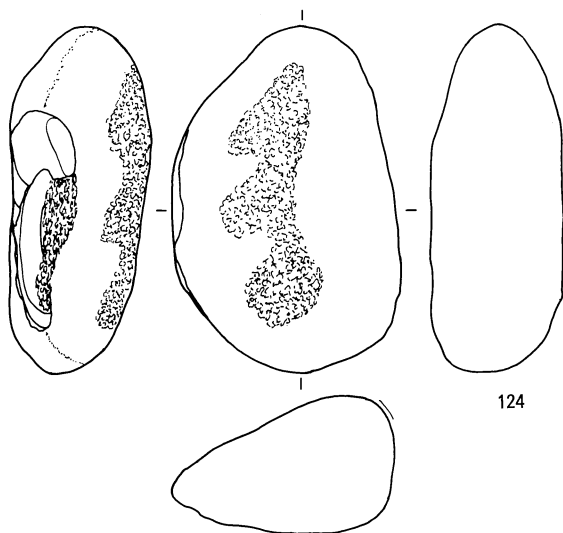

124

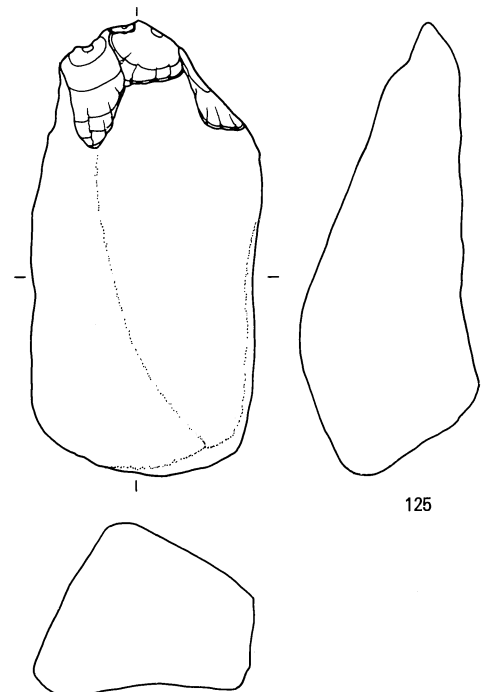

125

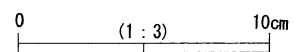

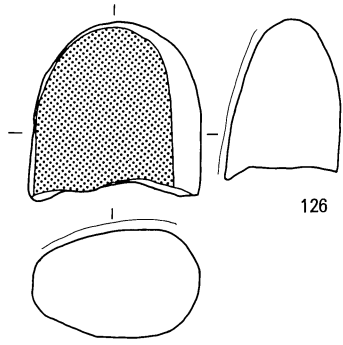

126

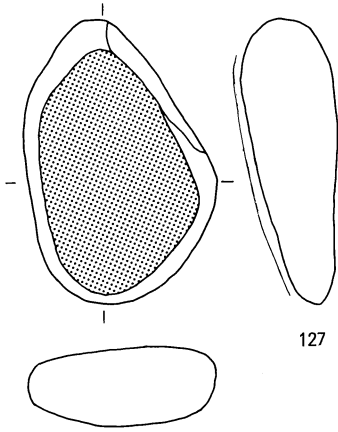

127

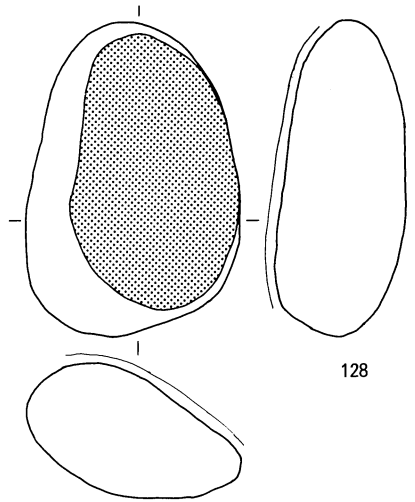

128

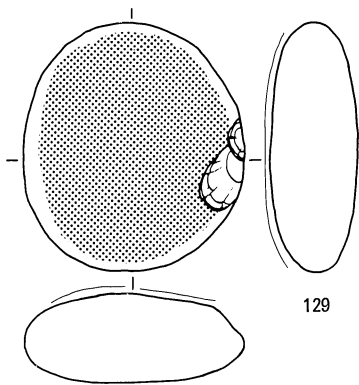

129

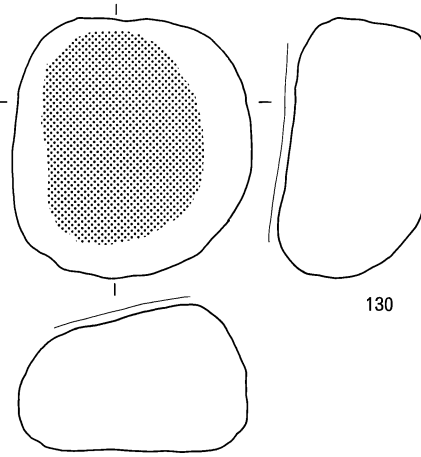

130

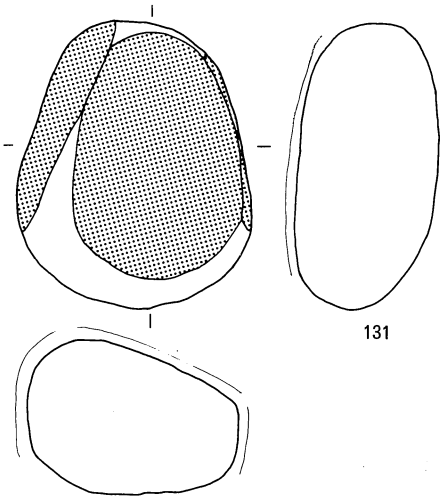

131

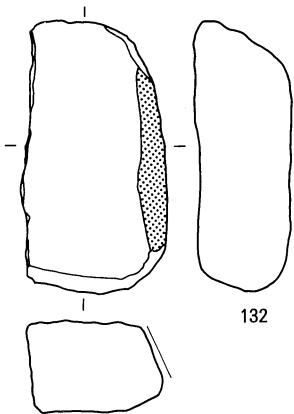

132

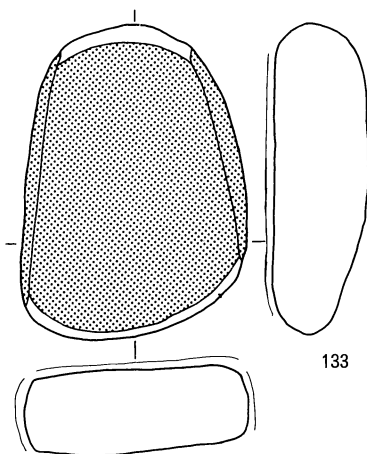

133

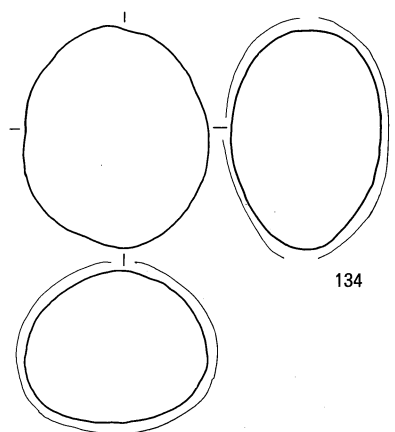

134

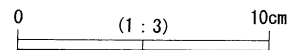

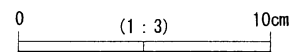
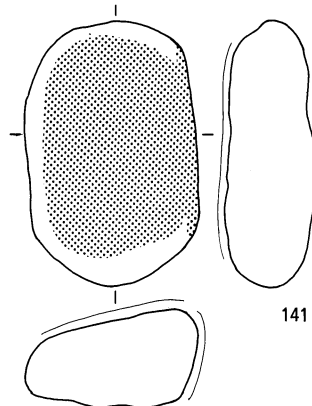
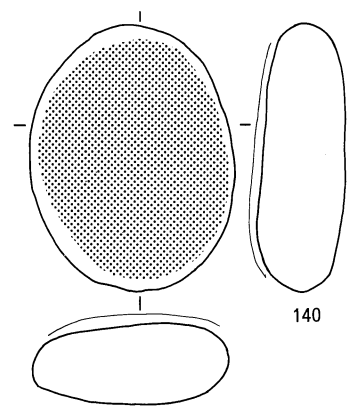
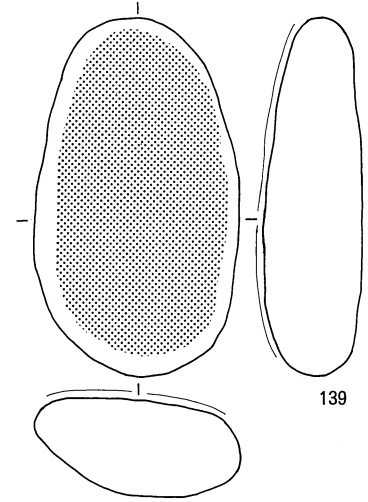
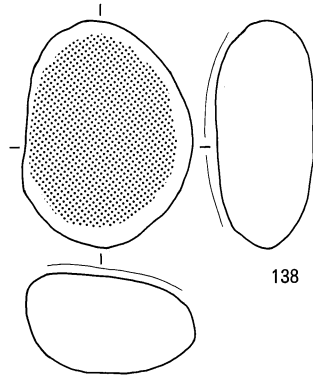
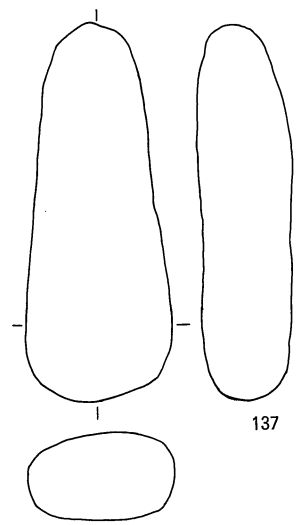
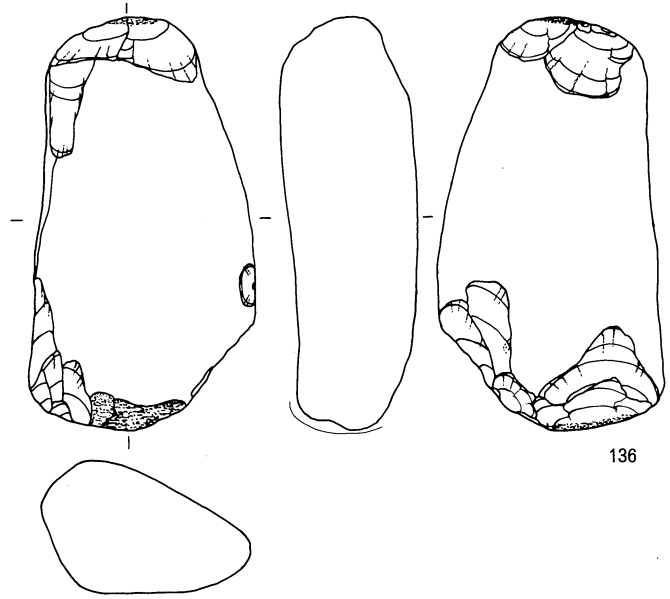
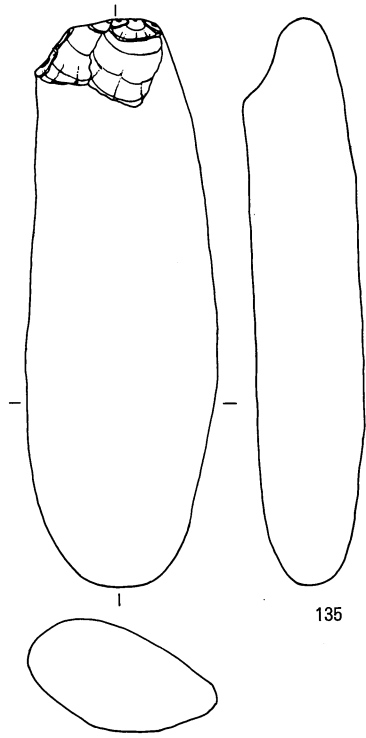

縄文時代石器 16

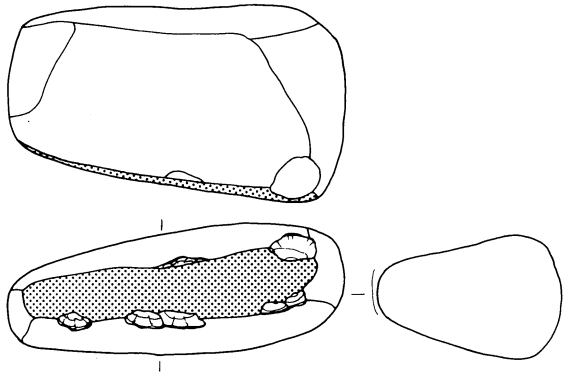

142

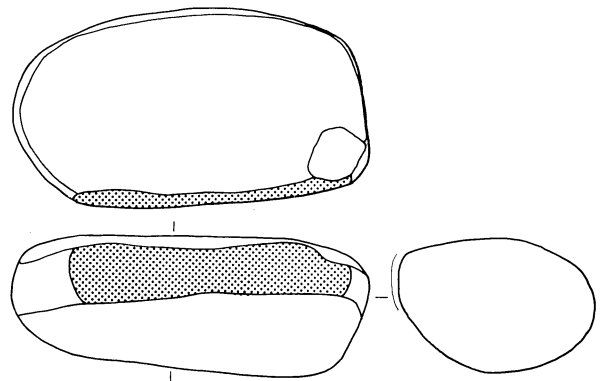

143

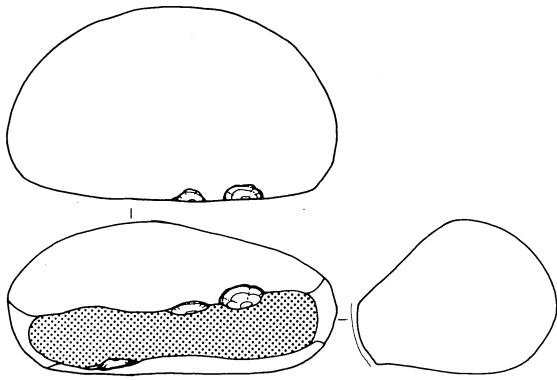

144

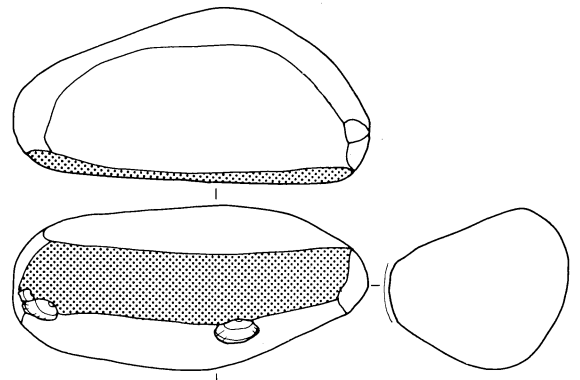

145

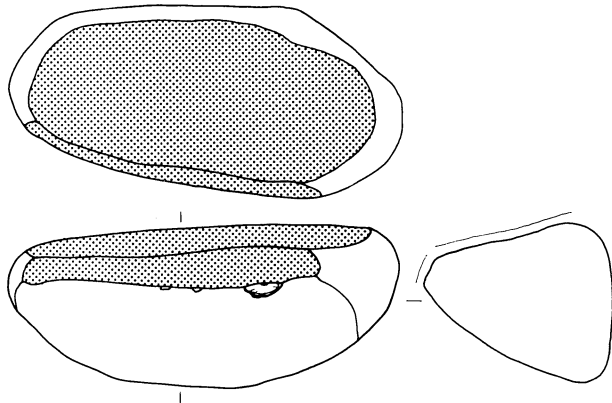

146

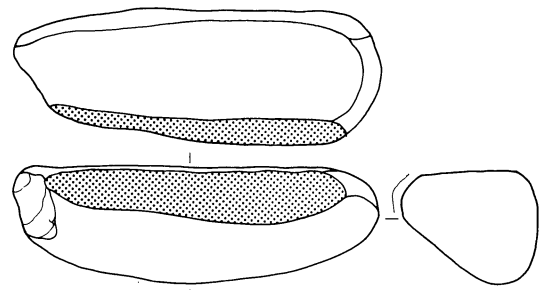

147

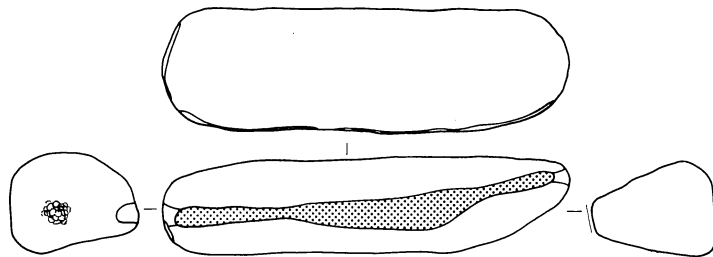

148

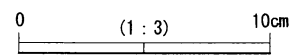

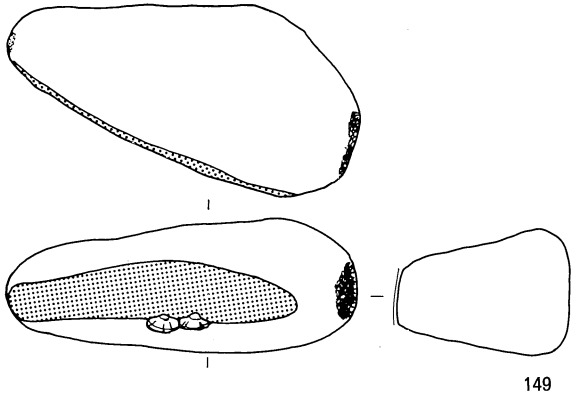

149

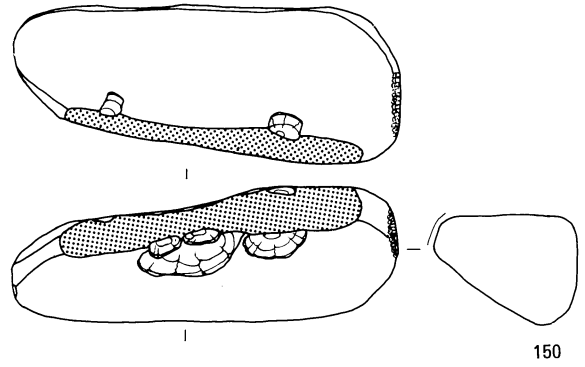

150

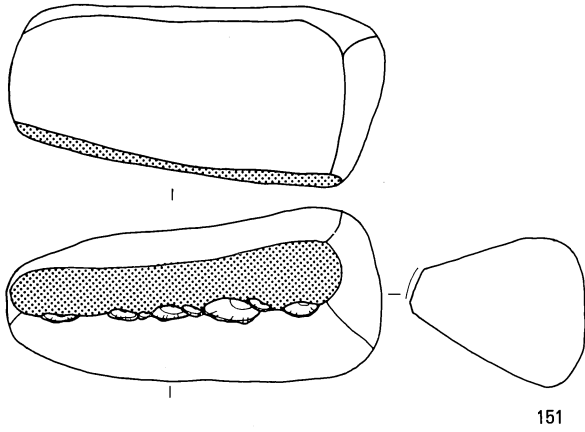

151

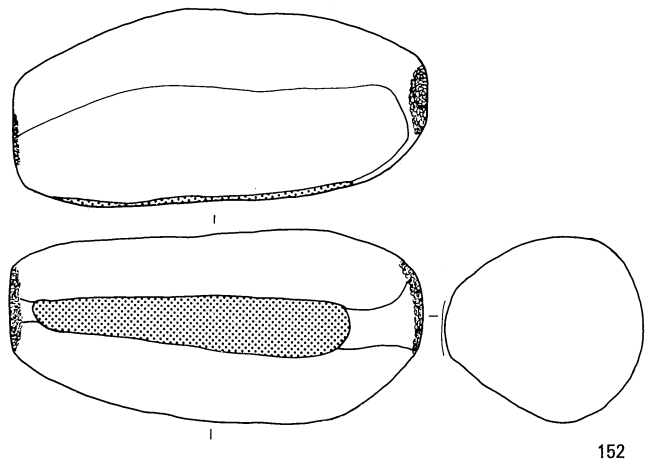

152

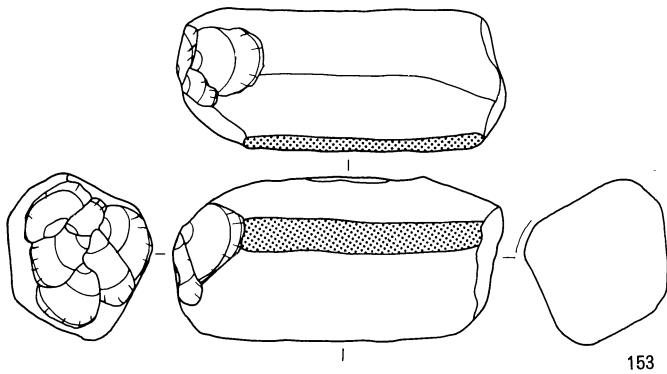

153

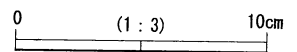

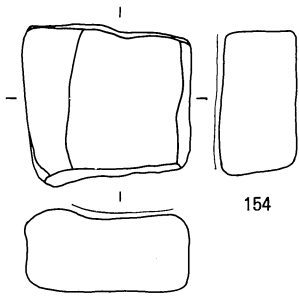

154

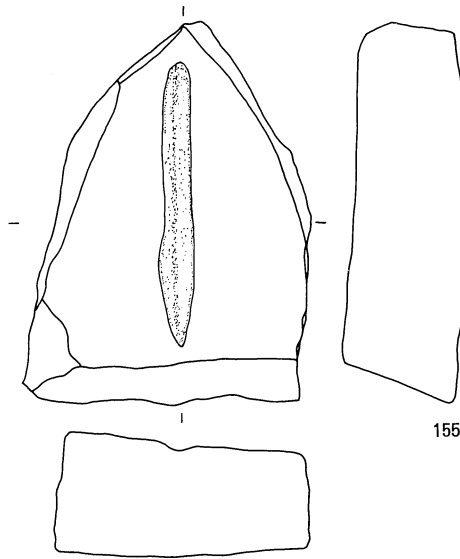

155

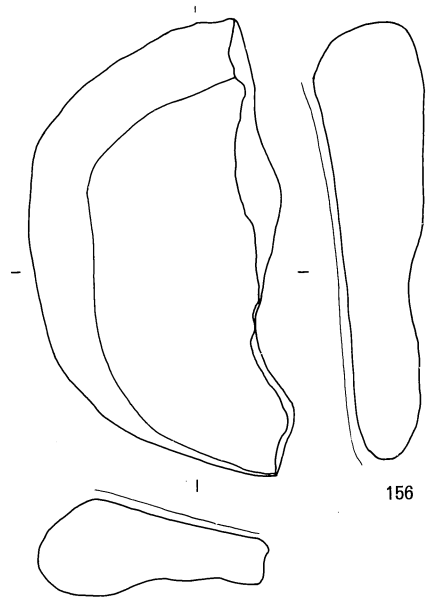

156

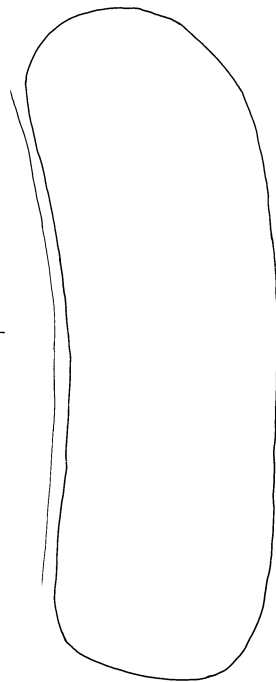
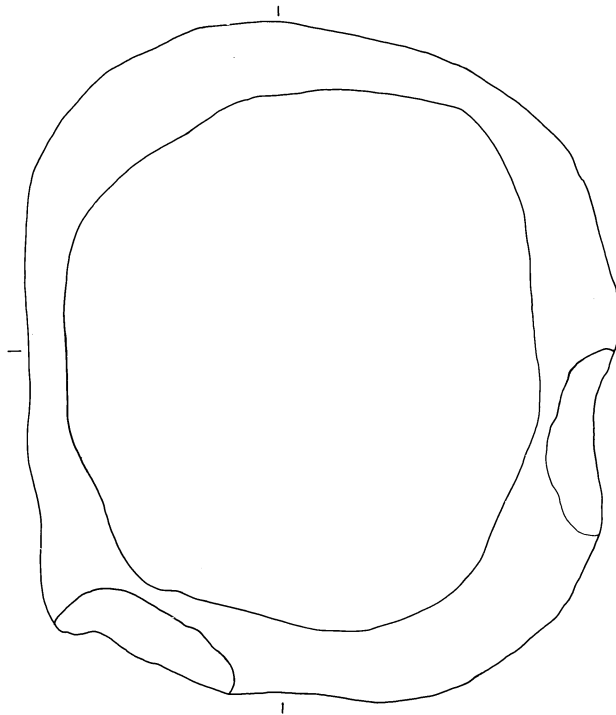

157

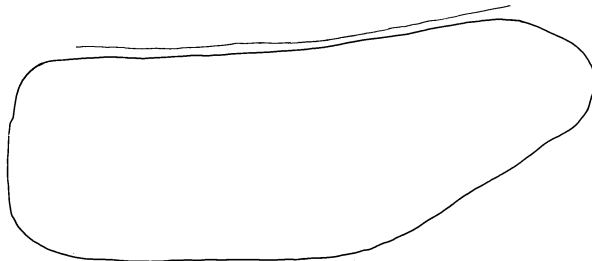

0 (1:4) 10cm

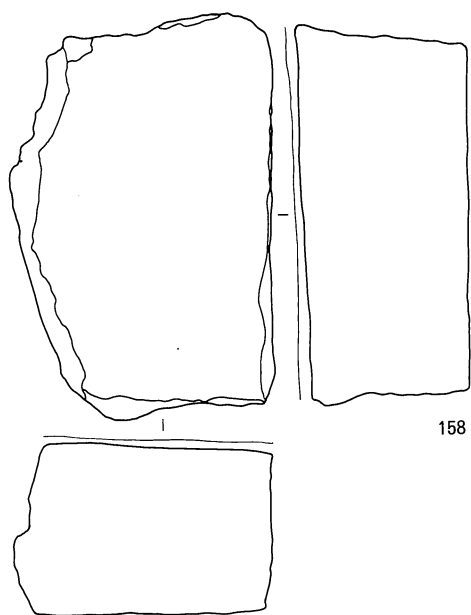

158

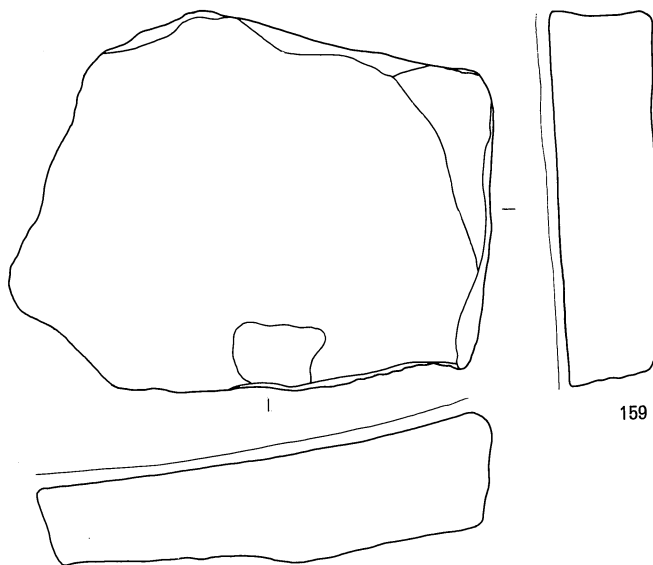

159

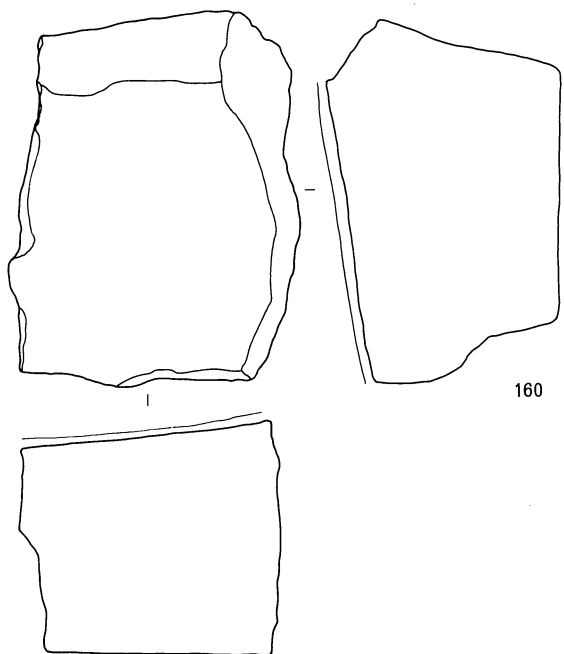

160

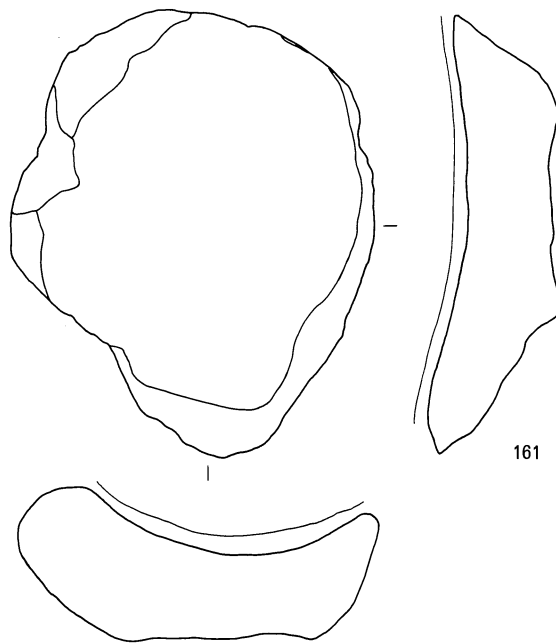

161

0 (1:4) 10cm

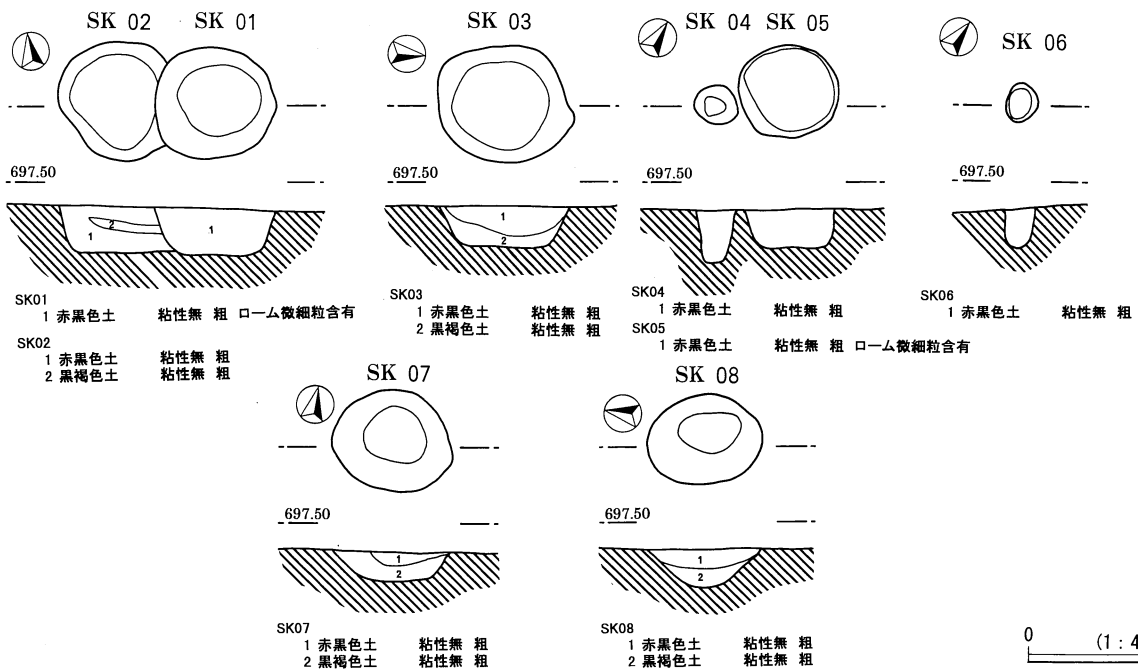
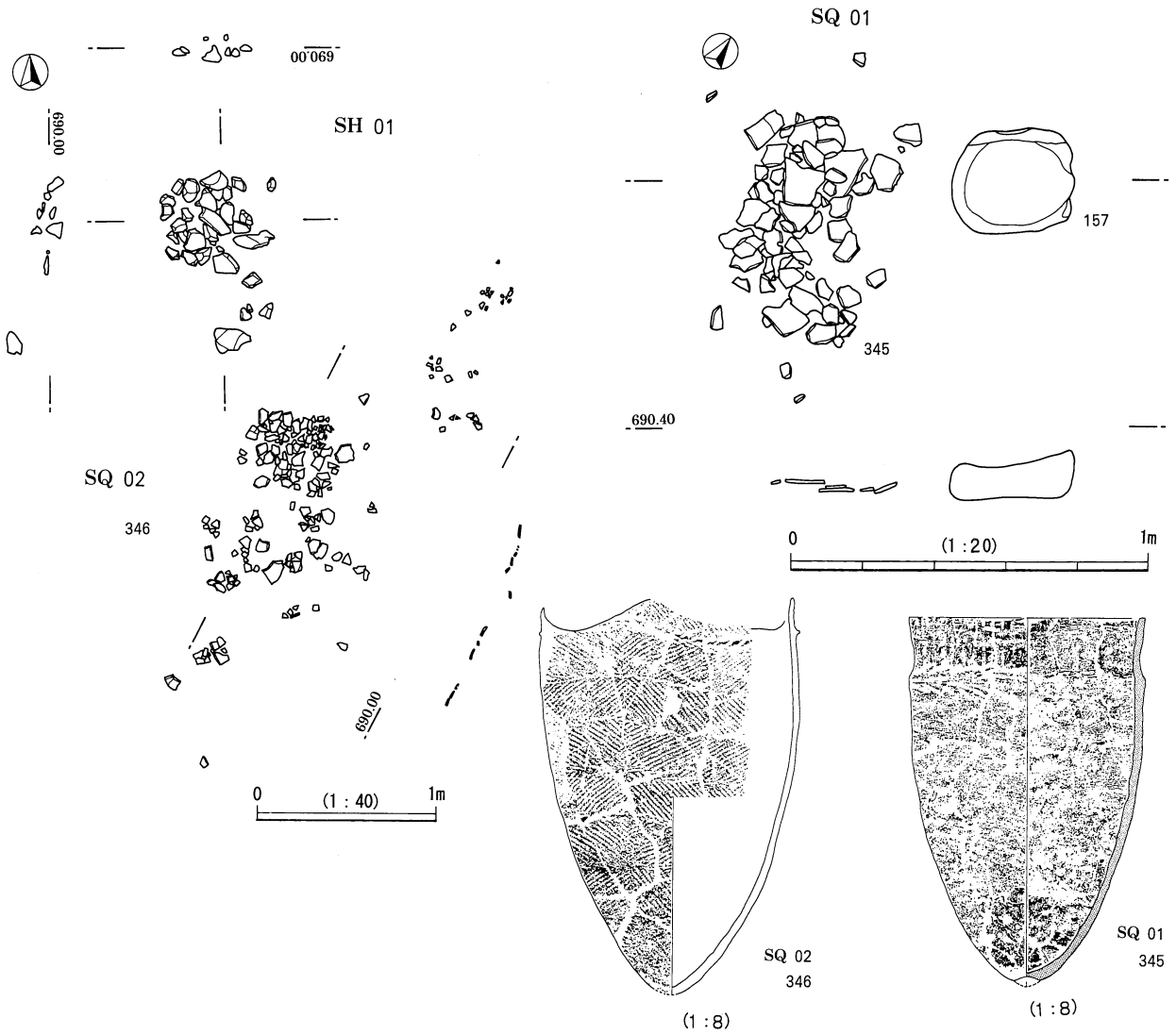

縄文時代遺構図、平安時代土坑図

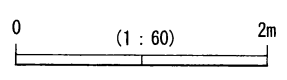
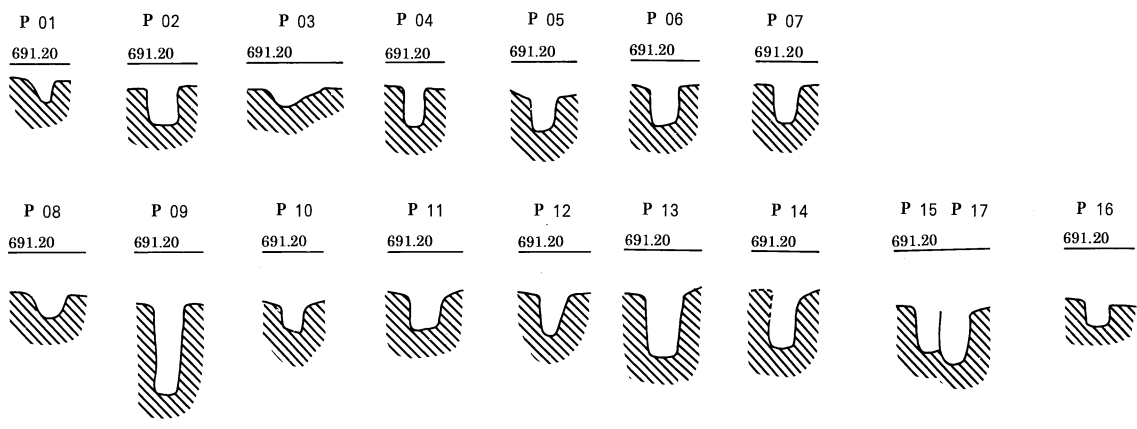
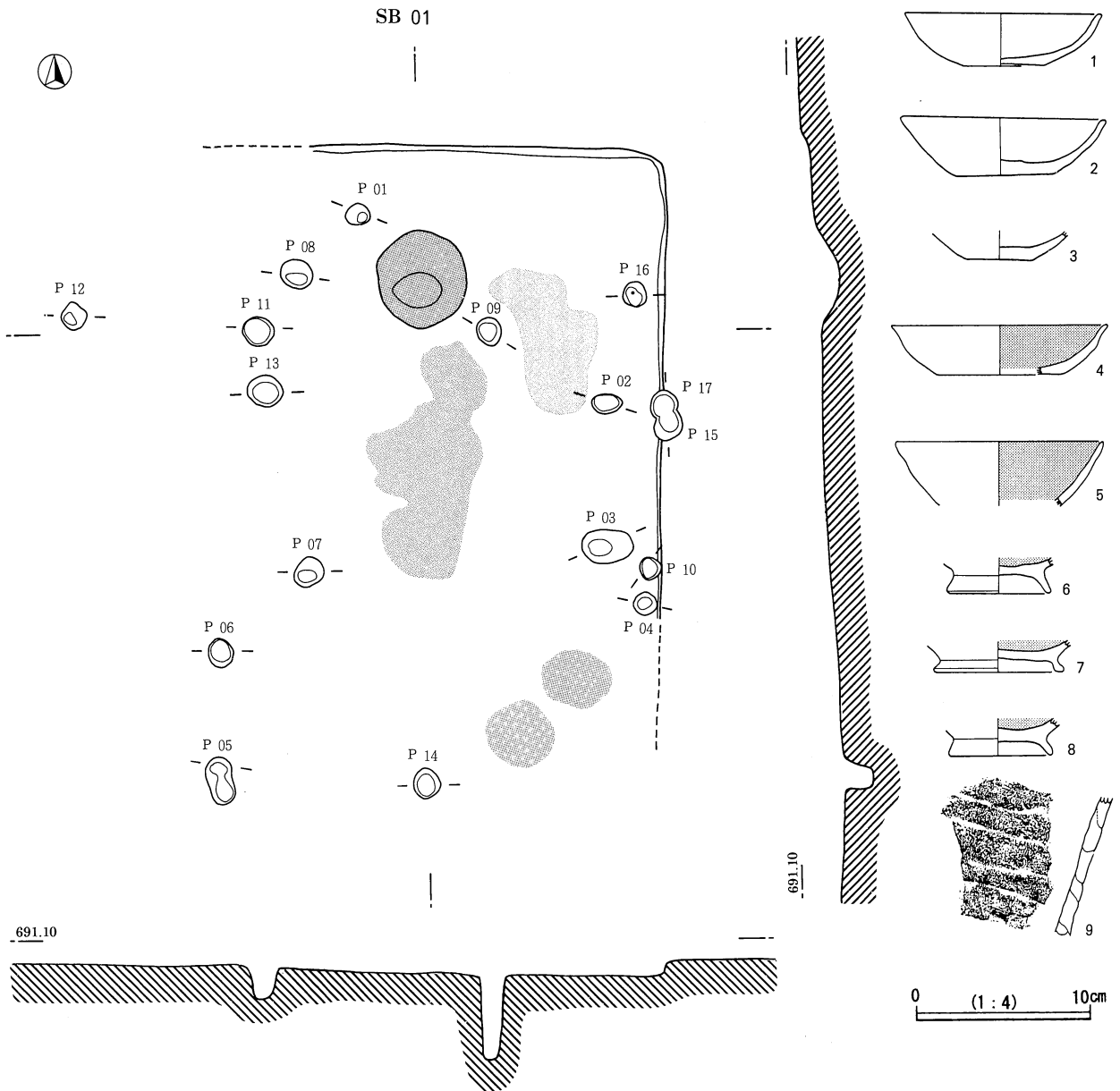

平安時代遺構図1・遺物図1

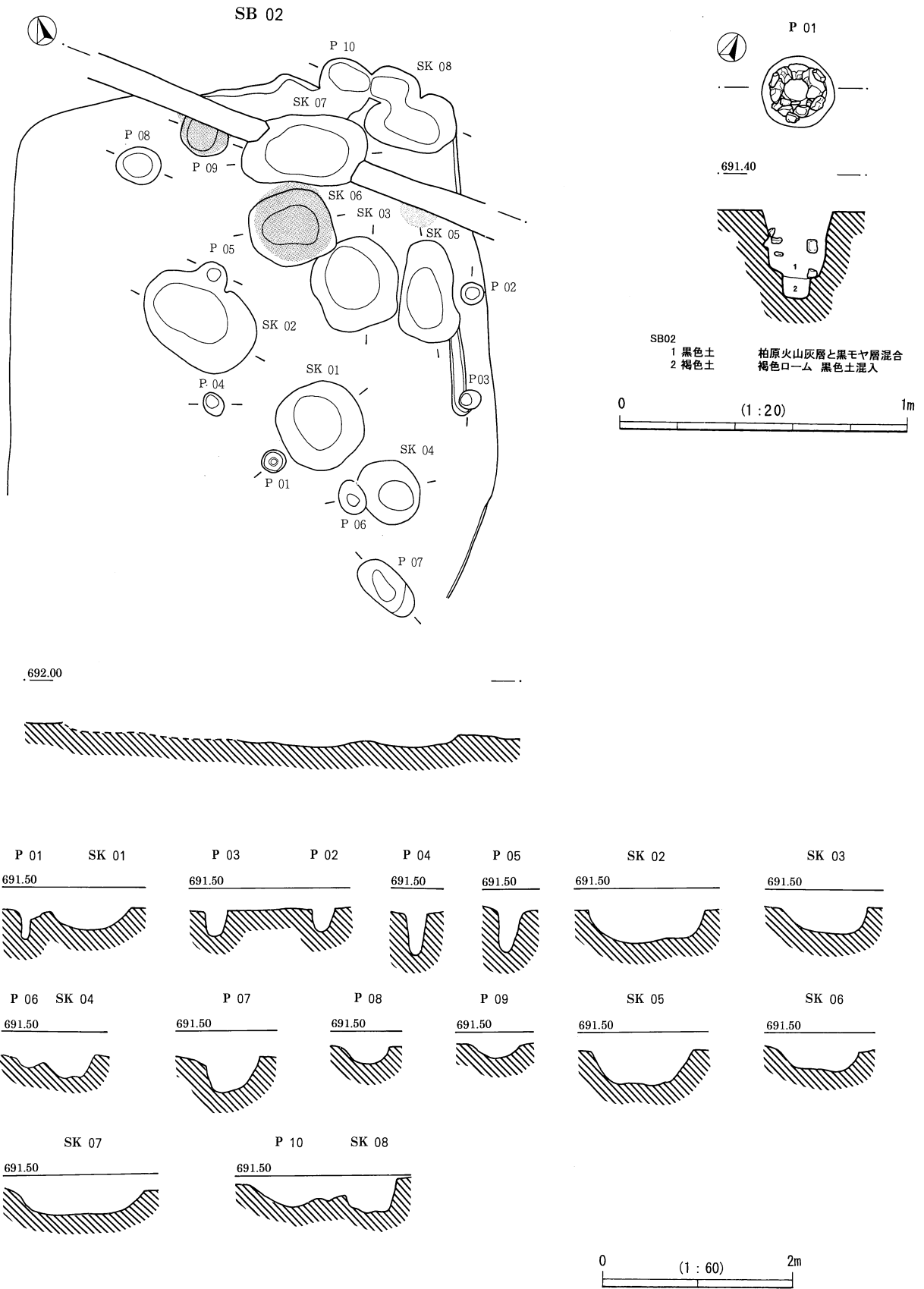

平安時代遺構図 2

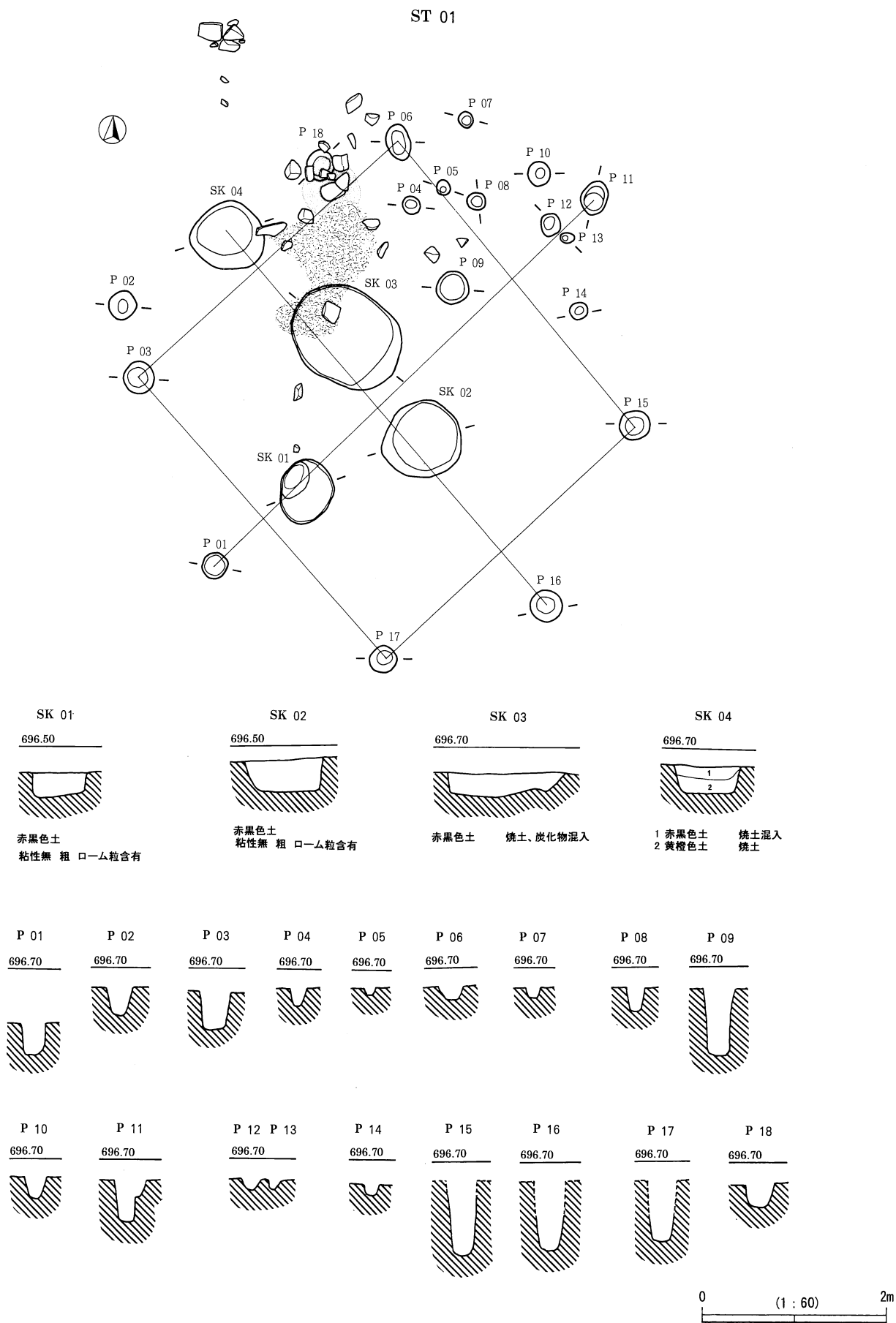

平安時代遺構図 3

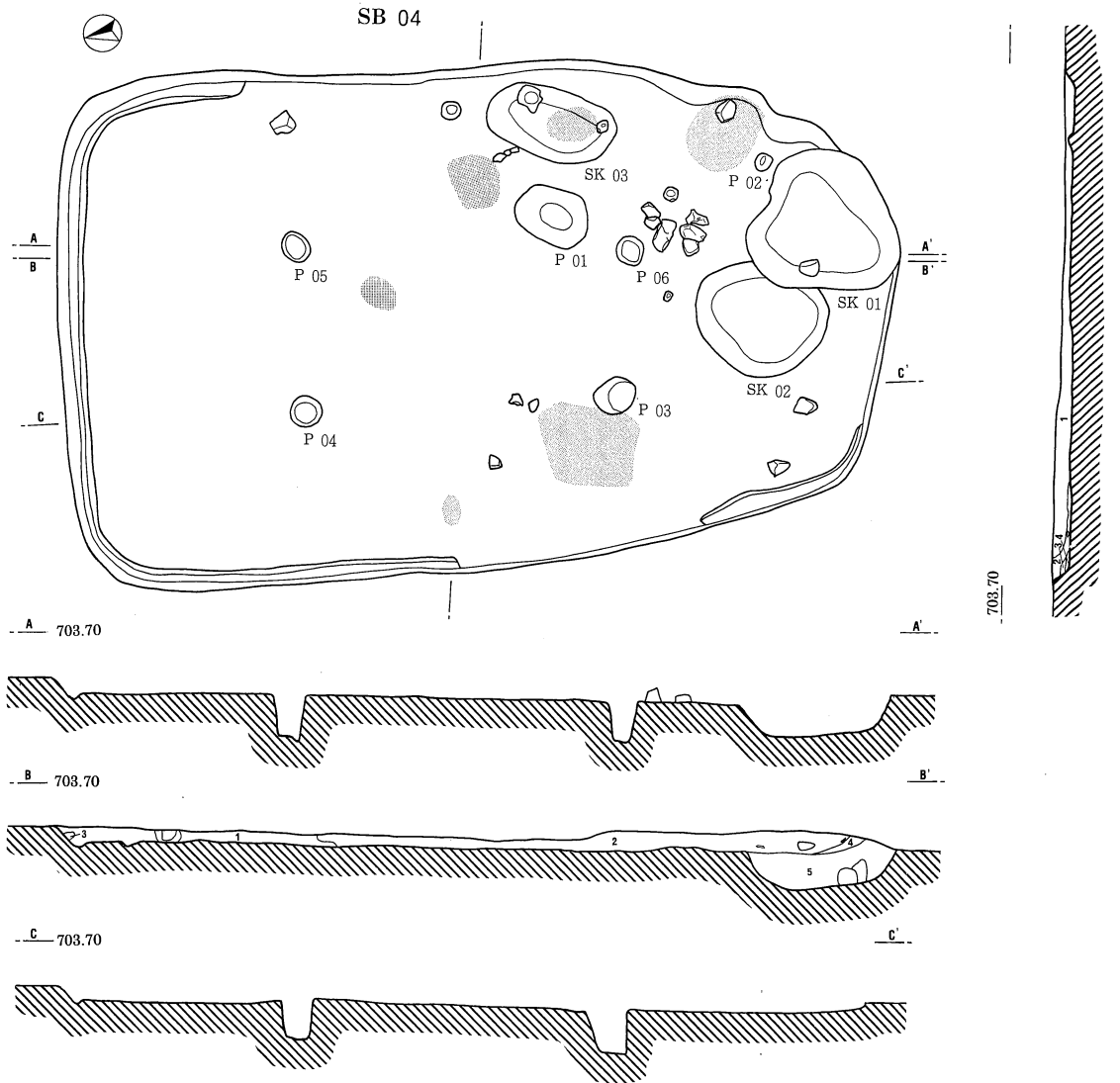

- SB04
- | | |
|---------|--------------------------------|
| 1 黒色土 | 黄色ローム微細粒混入 炭多量含有 焼土粒少量混入 |
| 2 黒色土 | 密 粘性有 |
| 3 明黄褐色土 | 黄色のローム層 |
| 4 黒褐色土 | 黒色土に黄色土混入 |
| 5 | 黄色土と黒色土の混合 黒色土ブロックとロームブロックから構成 |

0 (1:60) 2m

SB 04 カマド

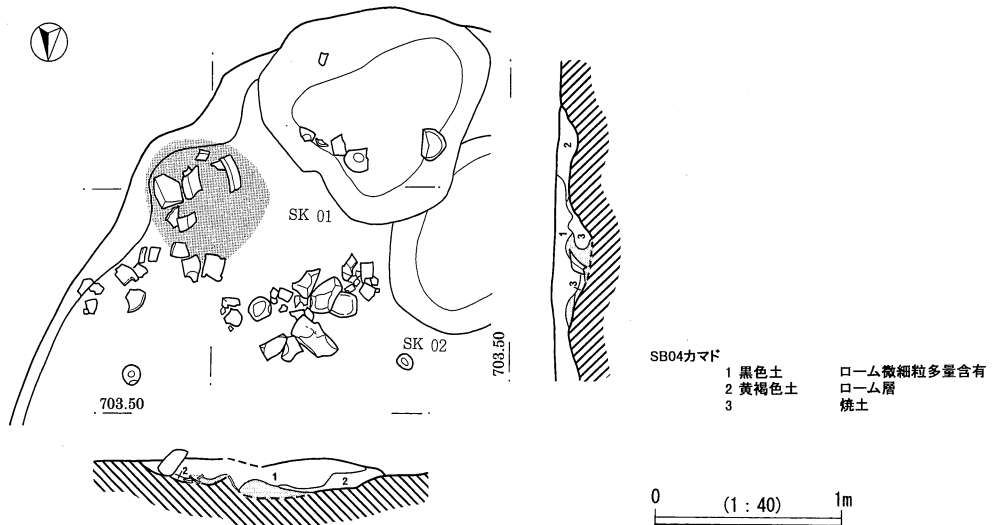

- SB04カマド
- | | |
|--------|------------|
| 1 黒色土 | ローム微細粒多量含有 |
| 2 黄褐色土 | ローム層 |
| 3 | 焼土 |

0 (1:40) 1m

平安時代遺構図 4

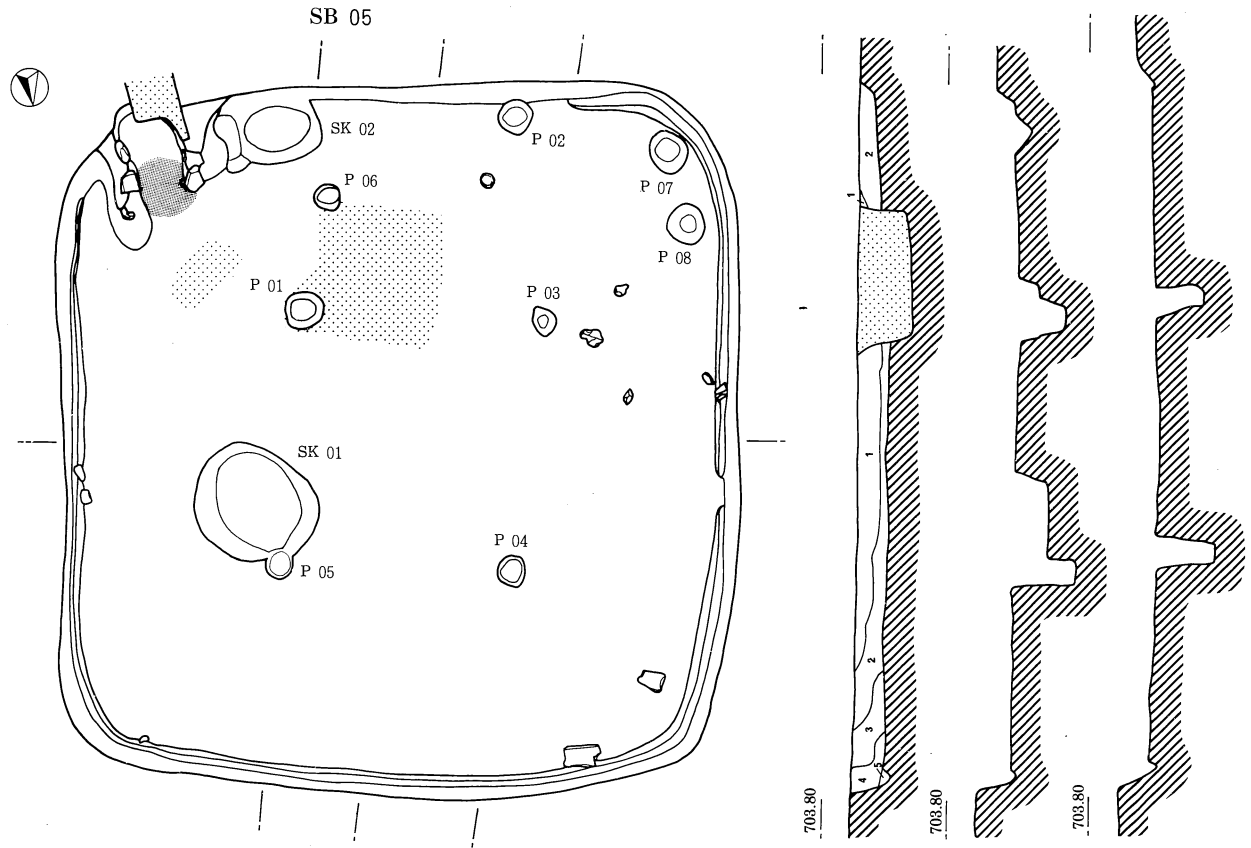

703.80

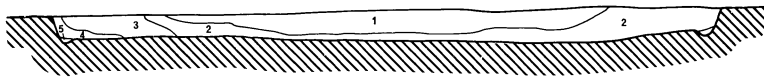

SB05

- 1 黒色土 細粒 密
- 2 暗褐色土 粘性有 細粒 ローム粒含有
- 3 暗褐色土 粗粒 ロームブロック、ローム粒多量含有
- 4 黒色土 暗褐色土ブロック含有 1層より粗
- 5 明黄褐色土 粘性有 細粒 ロームブロックが主で黒色ブロック

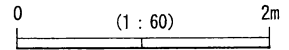

SB 05 カマド

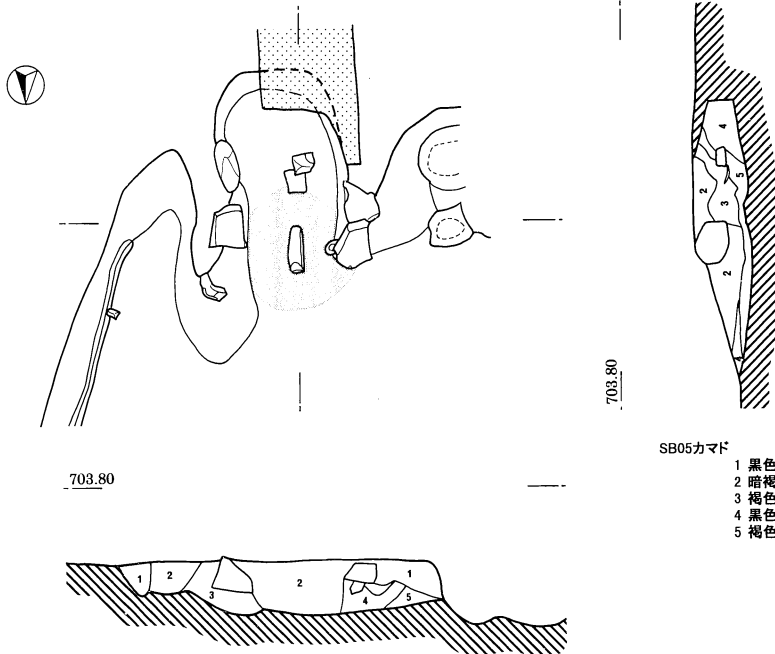

703.80

SB05カマド

- 1 黒色土 細粒 密
- 2 暗褐色土 やや粗粒 ロームブロック、ローム粒含有
- 3 褐色土 炭、ローム粒多量含有
- 4 黒色土 1層より粗粒 ローム粒含有
- 5 褐色土 ローム層に黒色土混入 細粒 粘性有

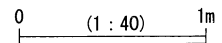

平安時代遺構図 5

SB 02

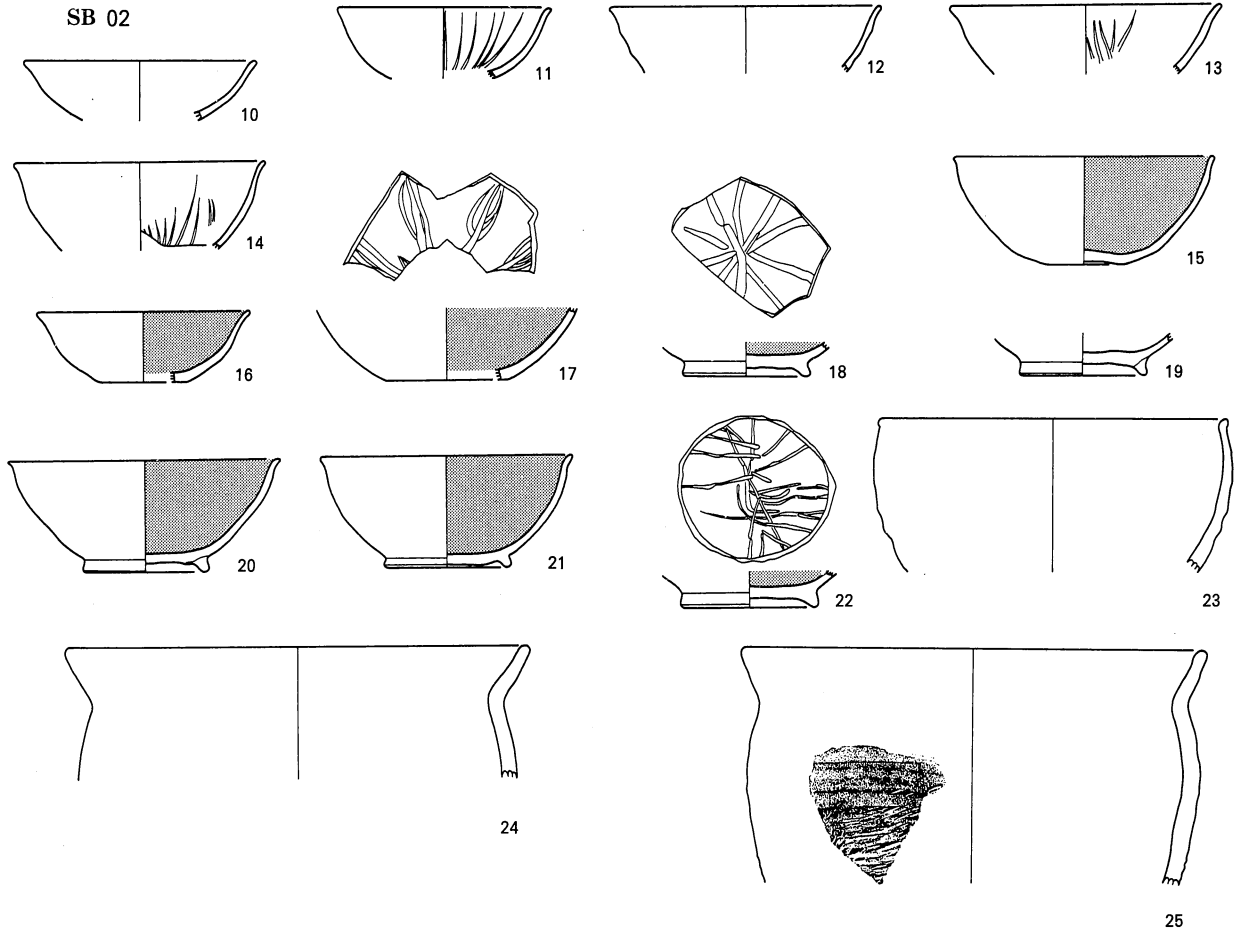

ST 01

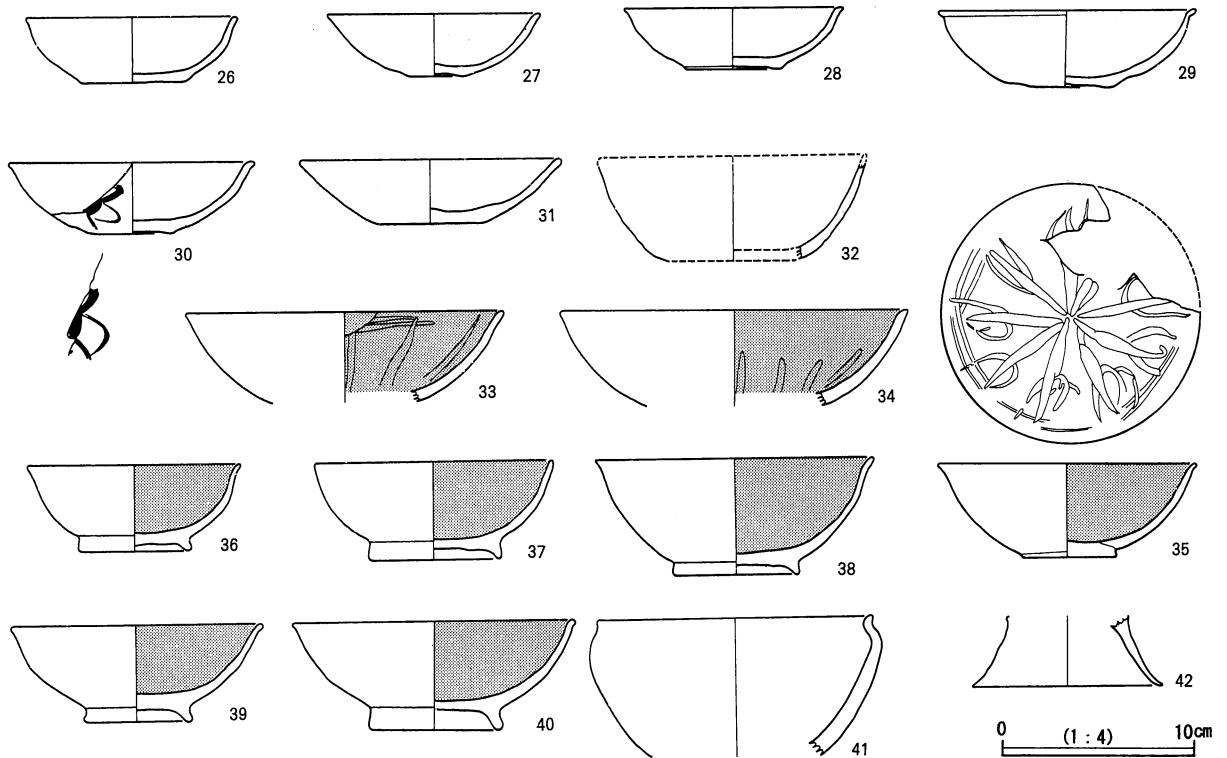

平安時代遺物図 2

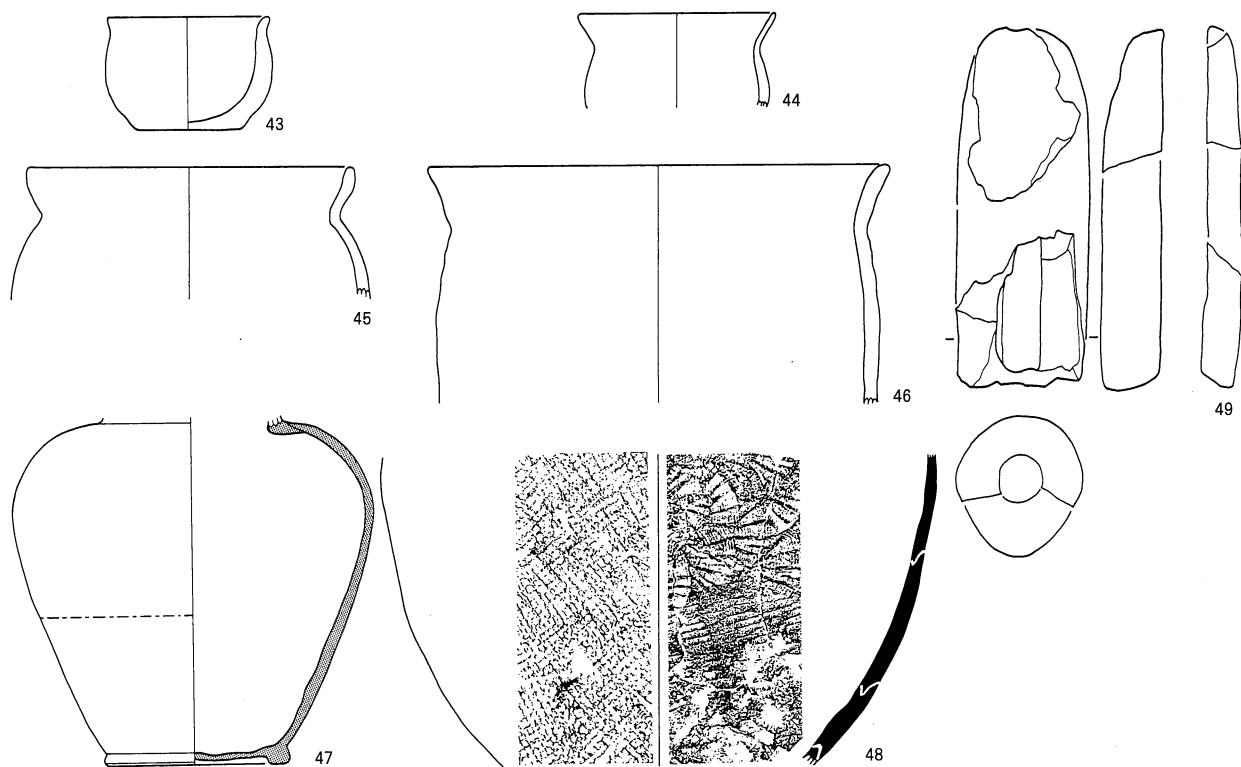

SB 04

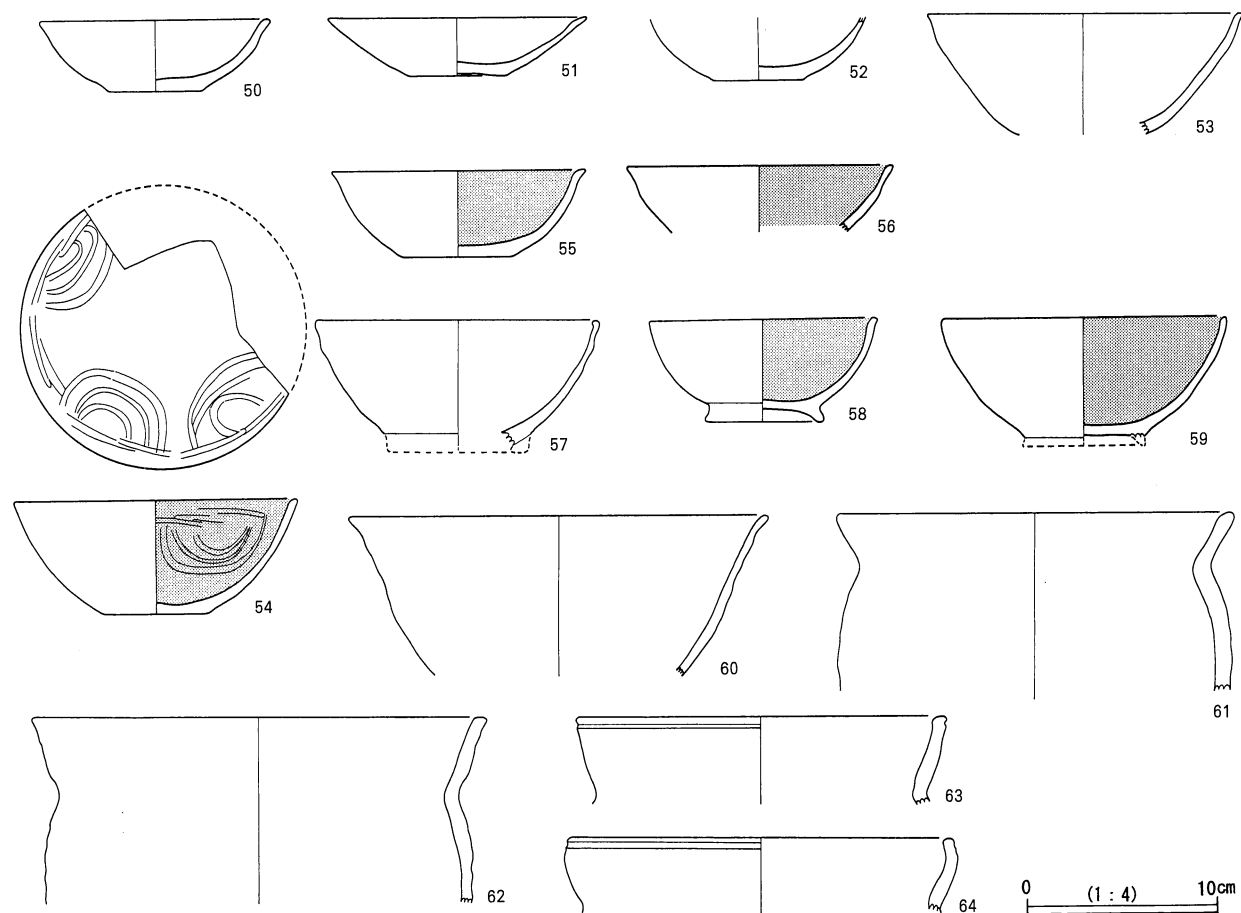

平安時代遺物図 3

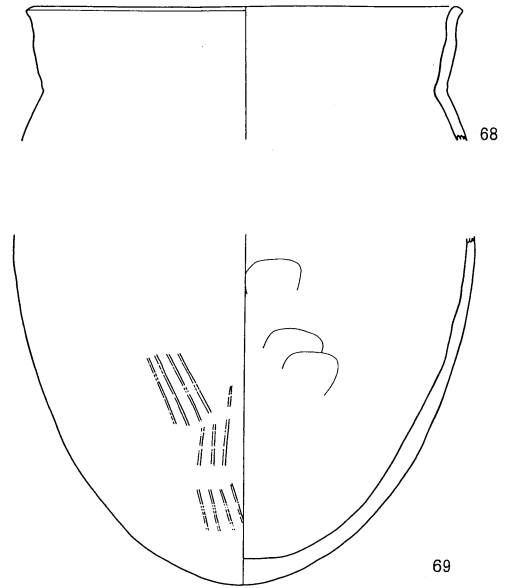
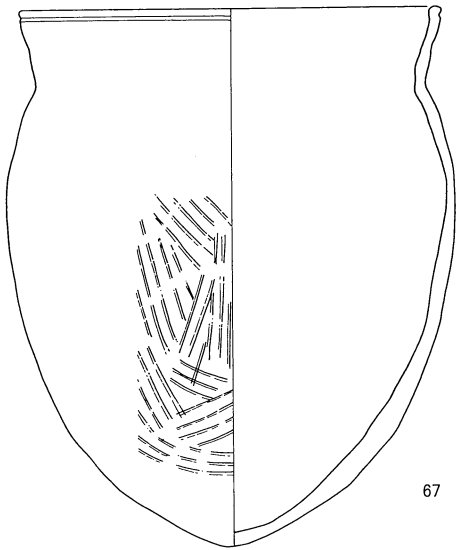
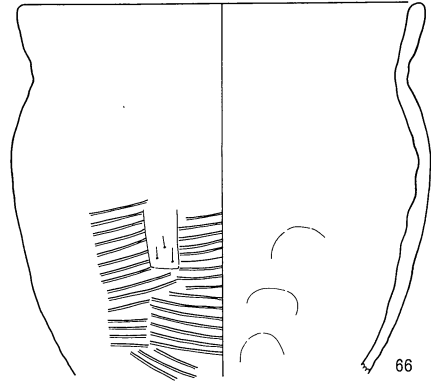
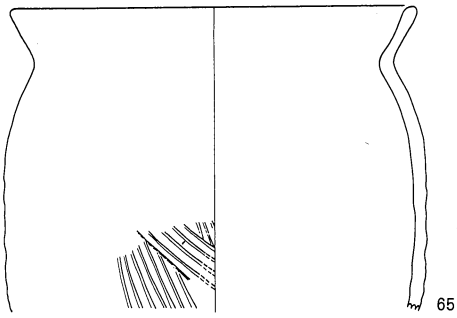

SB 05

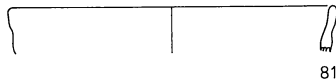
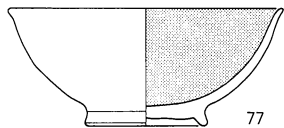
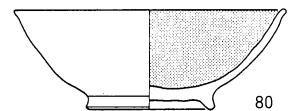
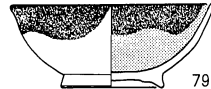
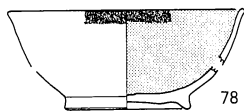
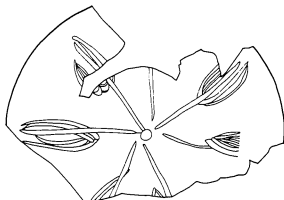
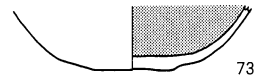
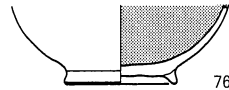
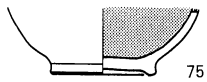
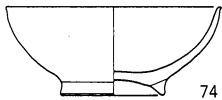
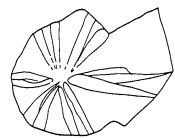
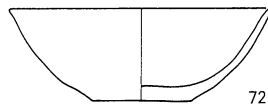
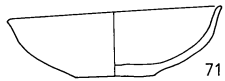
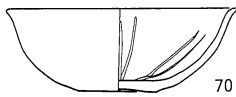

漆付着

0 (1:4) 10cm

平安時代遺物図 4

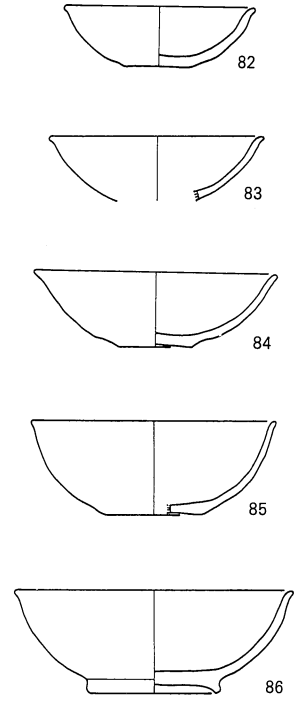
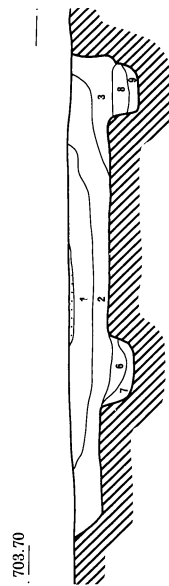
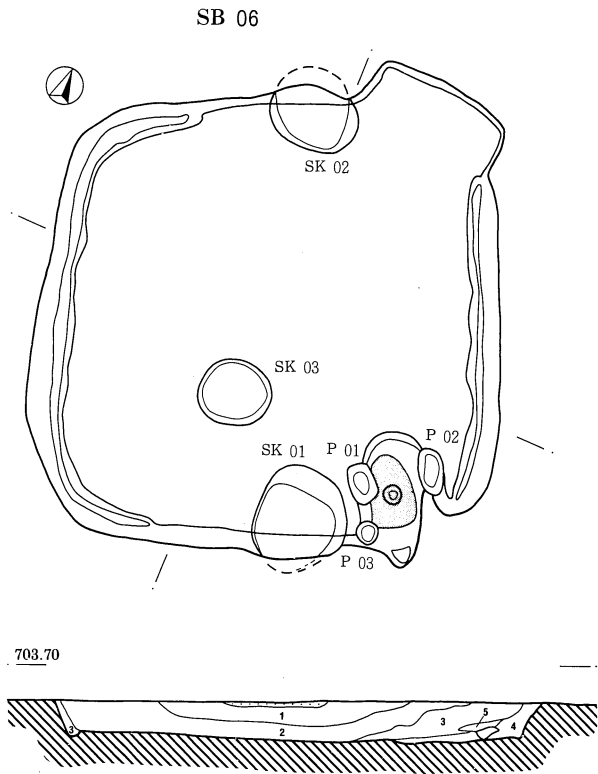

SB06

- 1 黒色土 ローム微細粒、砂粒混入 漸移層のブロックから成
- 2 黒褐色土 黒色土にローム混入 ローム微細粒、炭少量含有
- 3 暗褐色土 2層と類似 褐色のローム流入多い ローム粒2層よ
- 4 黒褐色土 1と2層の中間的層 ローム微量混入
- 5 4層の崩落土
- 6 ロームブロックと焼土ブロックから成る
- 7 ロームブロックに黒色土微量混入
- 8 黒色土 ロームブロック(焼土、炭含有)黒色土ブロック (ローム粒含有)
- 9 ロームブロックに黒色土微量混入

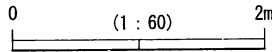

SB 06 カマド

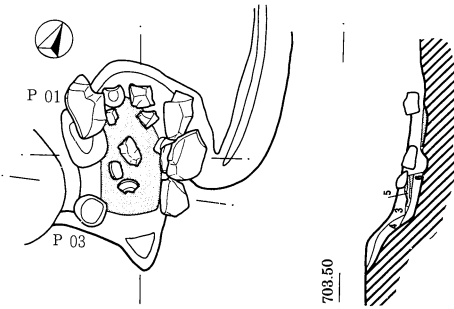

703.40

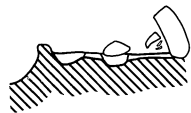

703.50

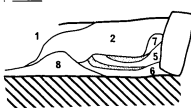

SB06カマド

- 1 住2層土
- 2 住3層土
- 3 ロームブロックと黒色土ブロック混入 焼土、炭含
- 4 黒色土ブロック、焼土ブロック、ローム粒混入
- 5 黒色土 粘土ブロック、炭含有
- 6 焼土
- 7 ロームブロック
- 8 粘土ブロック

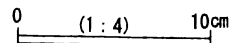
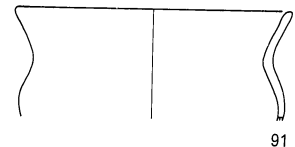
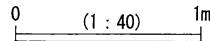

平安時代遺構図6・遺物図5

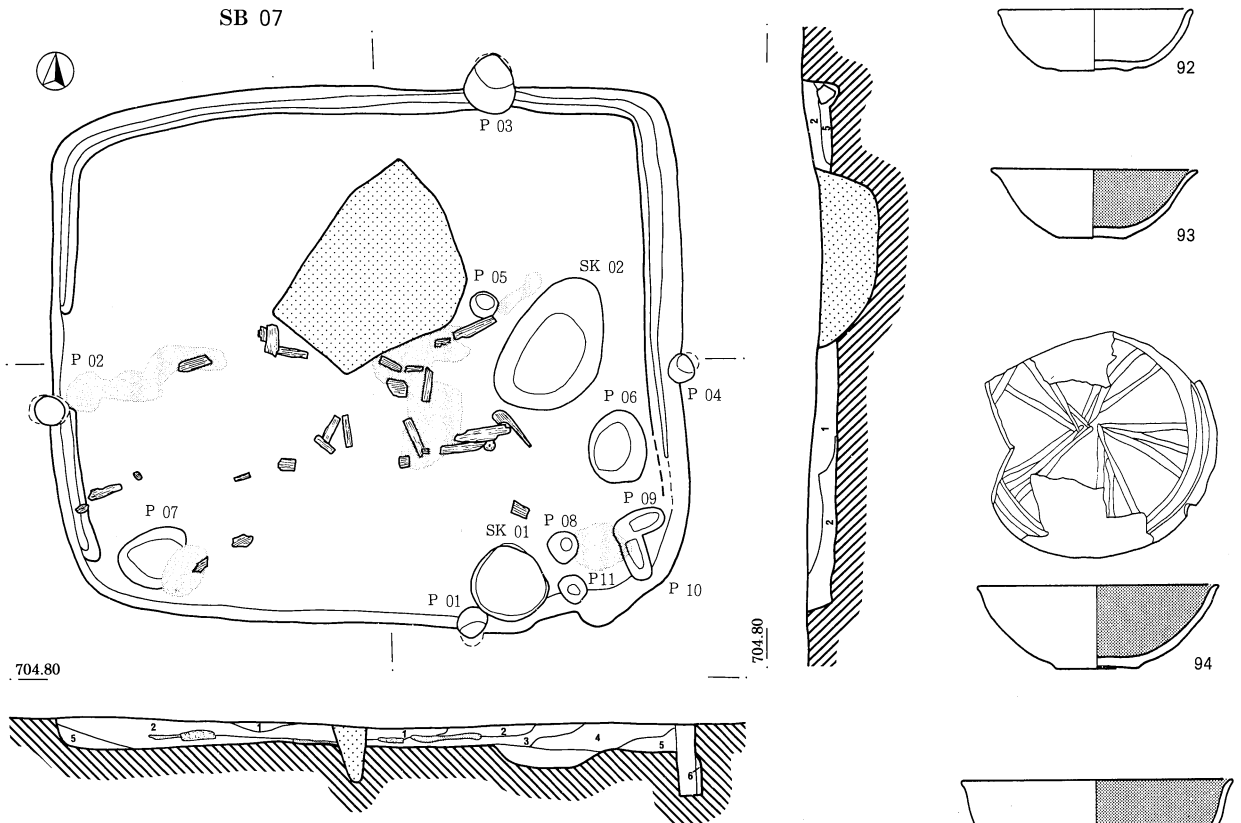

- SB07
- | | |
|-------|-------------------------|
| 1 黒色土 | ローム粒混合 |
| 2 黒色土 | ローム、黒色土ブロック混入 |
| 3 黒色土 | ロームブロック、ローム粒多量含有 焼土、炭含有 |
| 4 褐色土 | 3層と類似 ローム多量混入 褐色強 |
| 5 黒色土 | ロームブロック少量含有 |
| 6 黒色土 | ロームに黒色土混入 密 |
| 7 黒色土 | ローム混合 4層に近似 粗 軟質 |

0 (1:60) 2m

SB 07 カマド

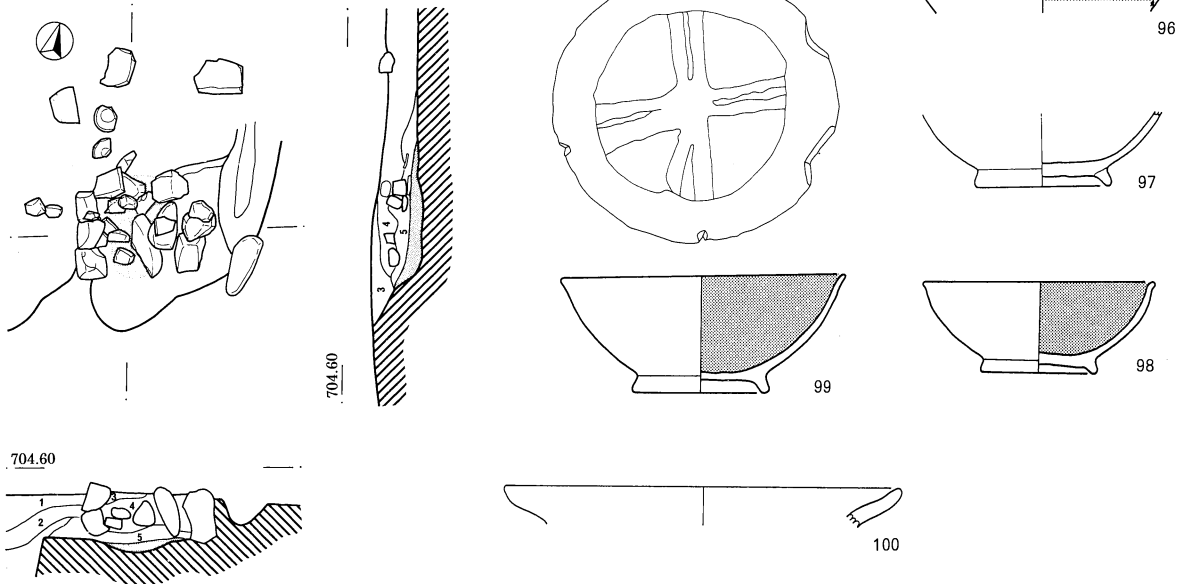

- SB07カマド
- | | |
|--------|----------------------|
| 1 黒褐色土 | ローム粒含有 |
| 2 黒褐色土 | ロームに黒褐色土混入 |
| 3 黒色土 | 焼土粒少量含有 |
| 4 黒褐色土 | 焼土ブロック、ロームブロック含有 炭含有 |
| 5 黒褐色土 | 黒色土、ローム混合 焼土ブロック混入 |

0 (1:40) 1m

0 (1:4) 10cm

平安時代遺構図7・遺物図6

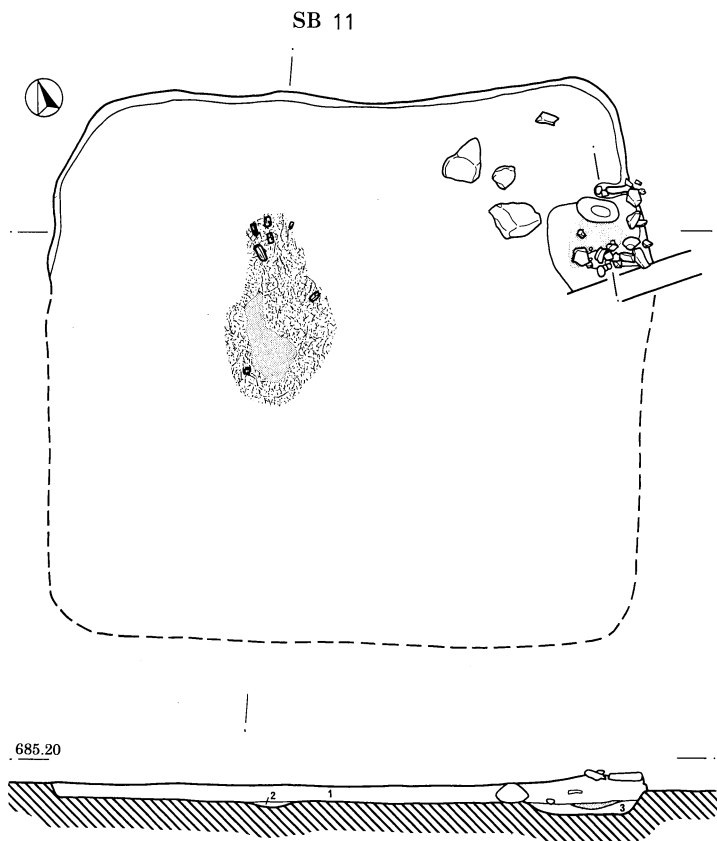

- SB11
 1 黒色土 SB13と同類
 2 黒色土 炭材、粒含有
 3 黒色土 焼土粒、炭粒混入 褐黒色土

0 (1 : 60) 2m

SB 11 カマド

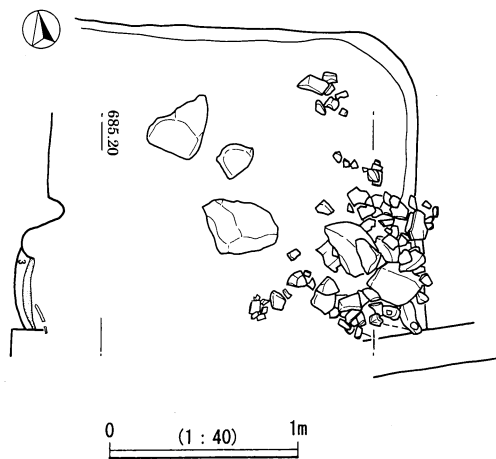

0 (1 : 40) 1m

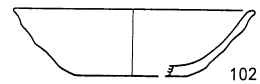

102

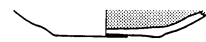

103

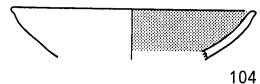

104

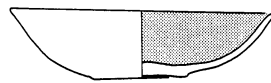

105

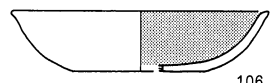

106

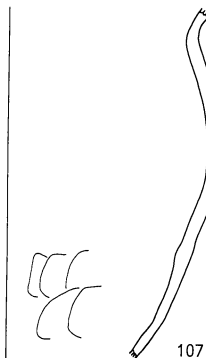

107

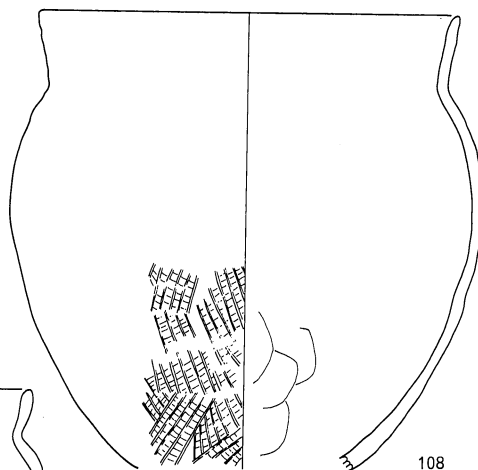

108

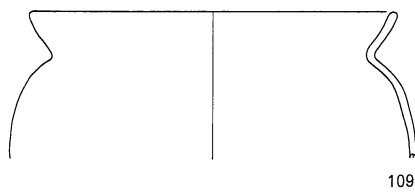

109

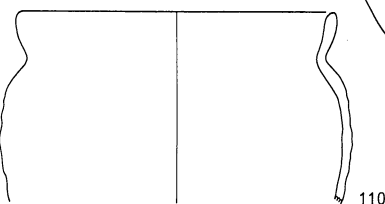

110

0 (1 : 4) 10cm

平安時代遺構図8・遺物図7

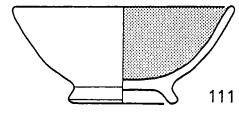
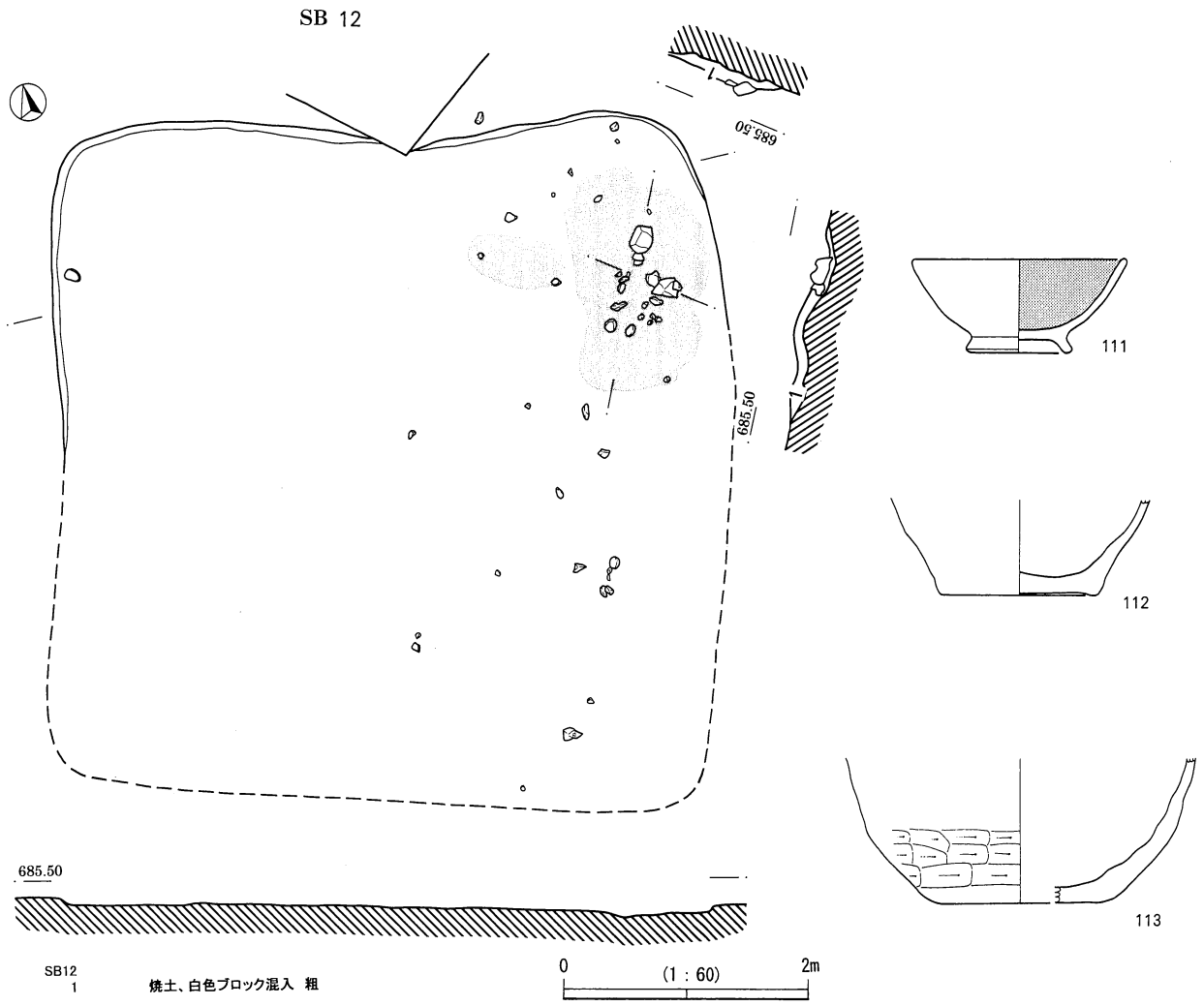

111

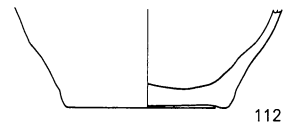

112

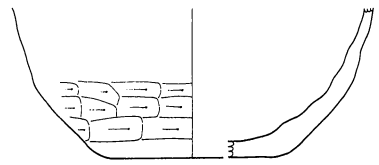

113

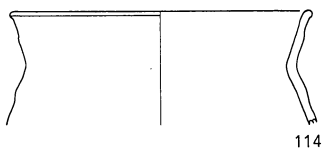

114

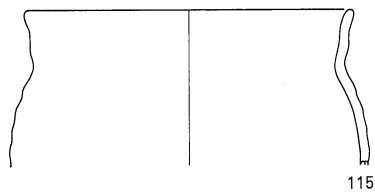

115

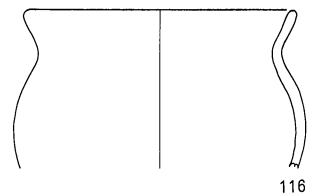

116

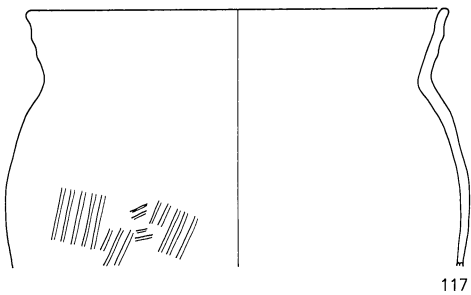

117

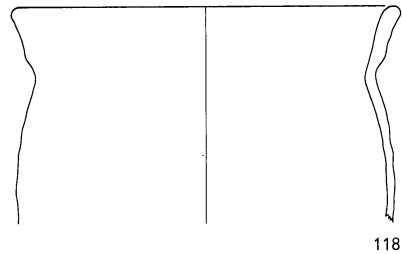

118

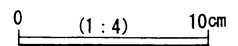

平安時代遺構図9・遺物図8

SB 13

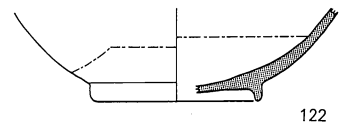
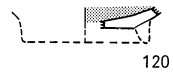
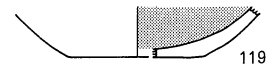
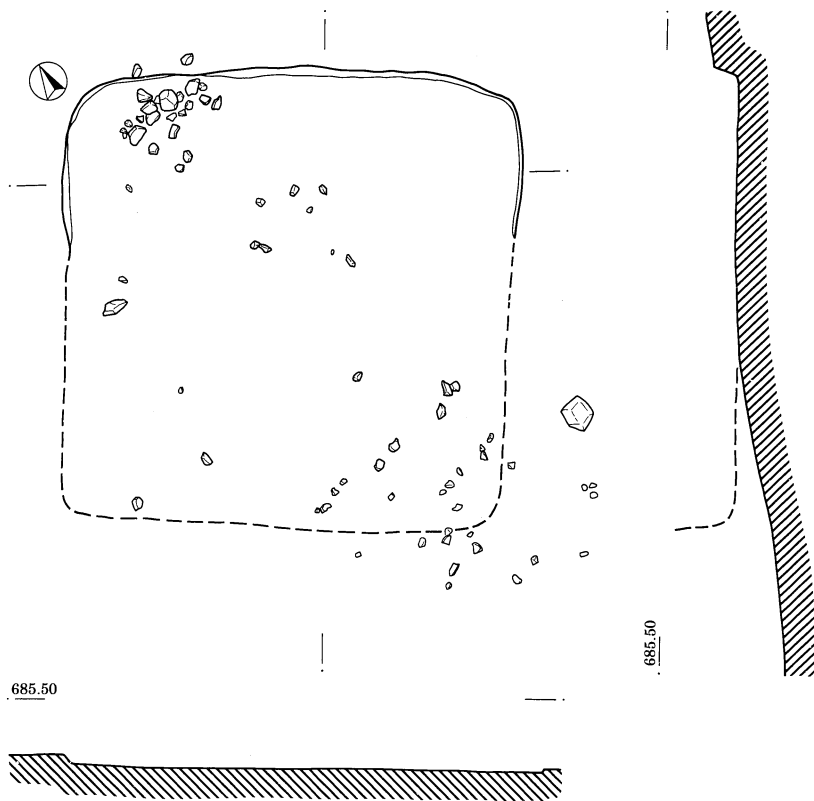

0 (1 : 60) 2m

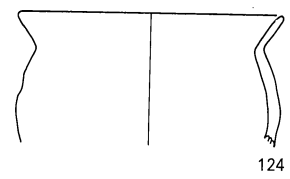
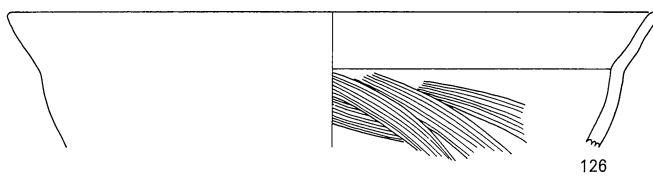
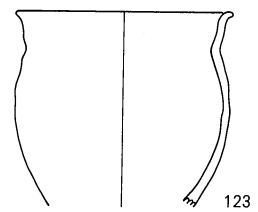
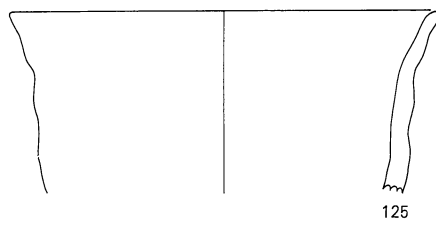

0 (1 : 4) 10cm

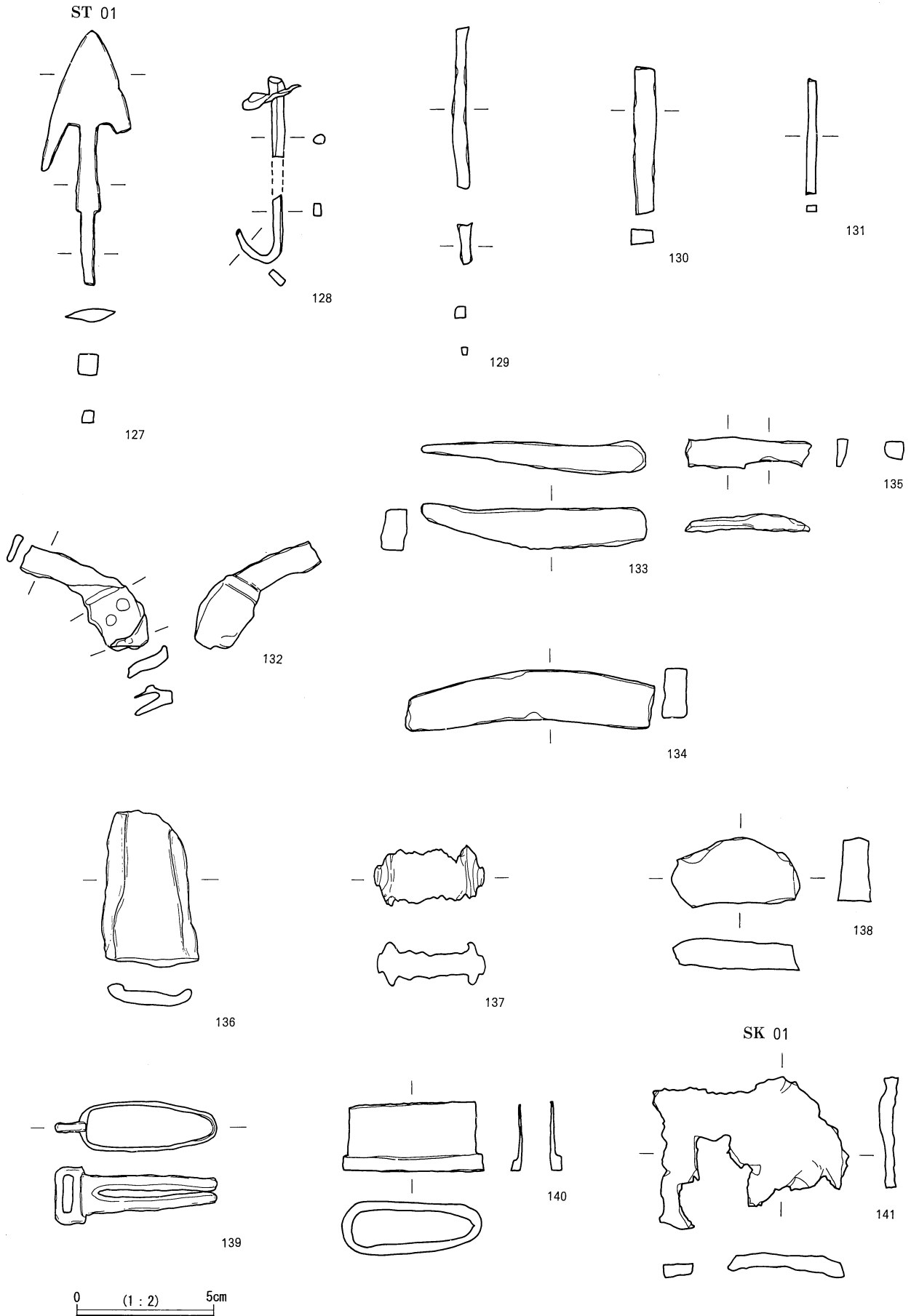

平安時代金属器

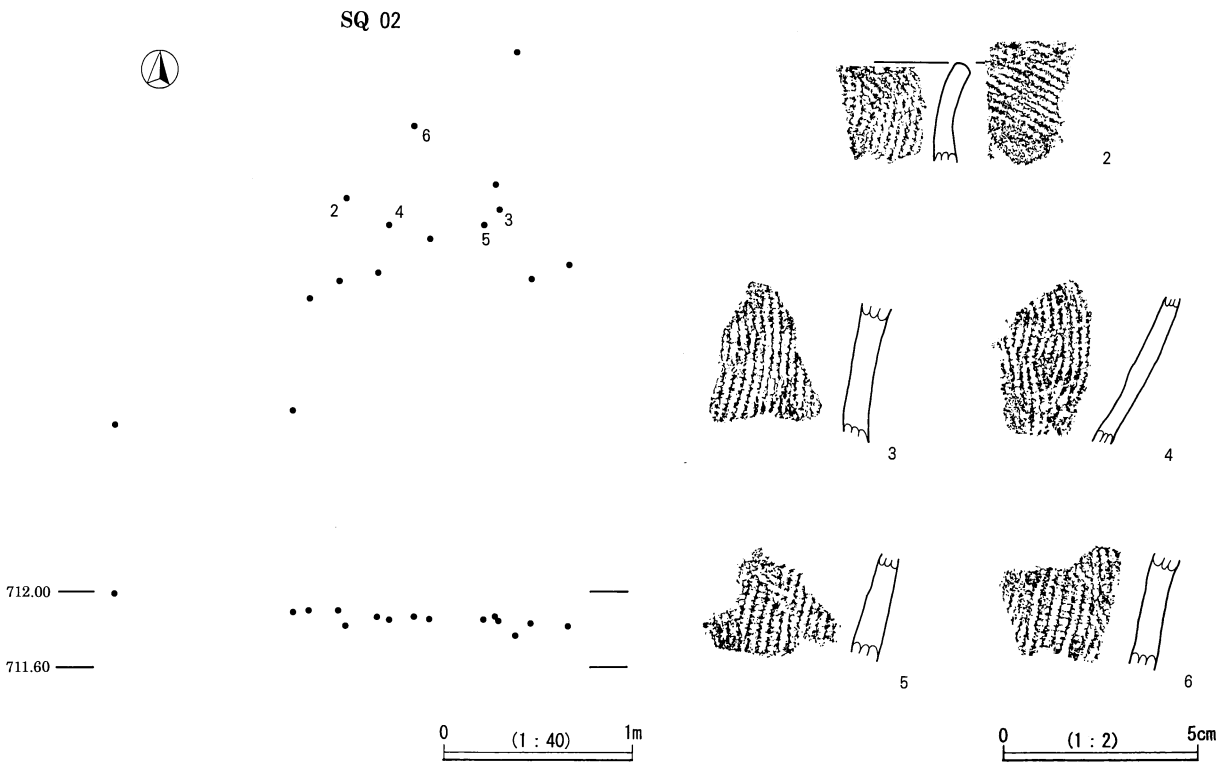
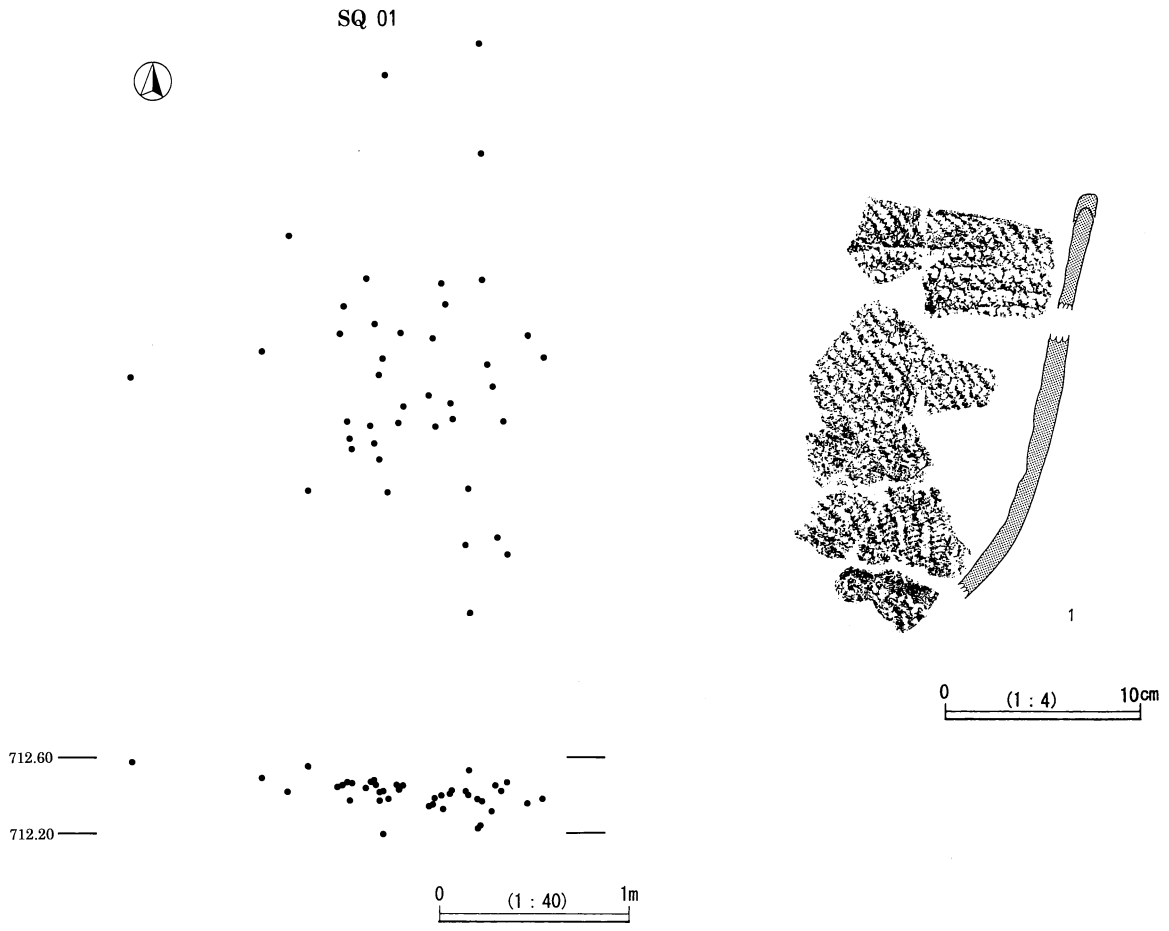

縄文時代遺構図・遺物図

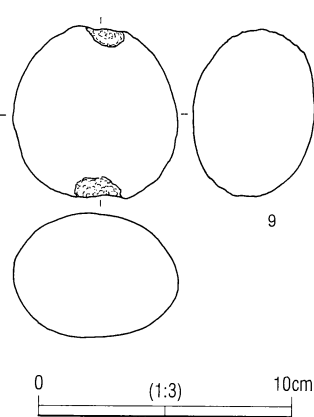
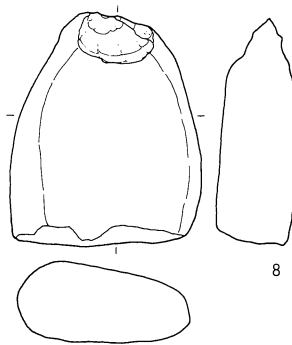
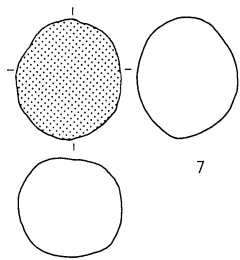
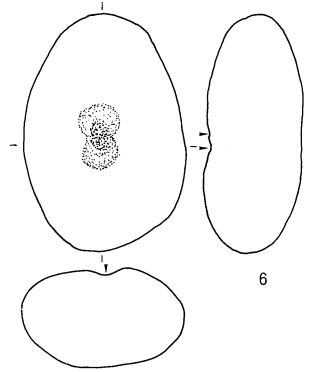
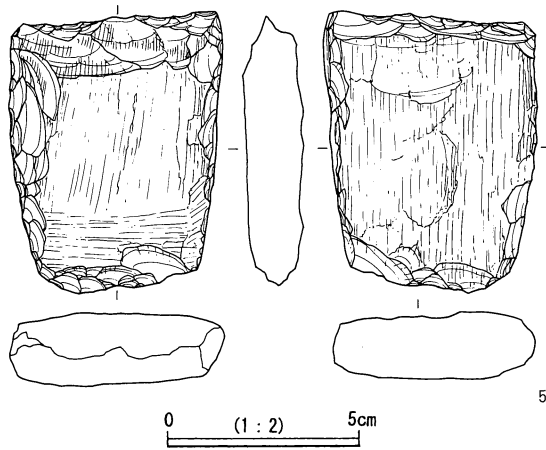
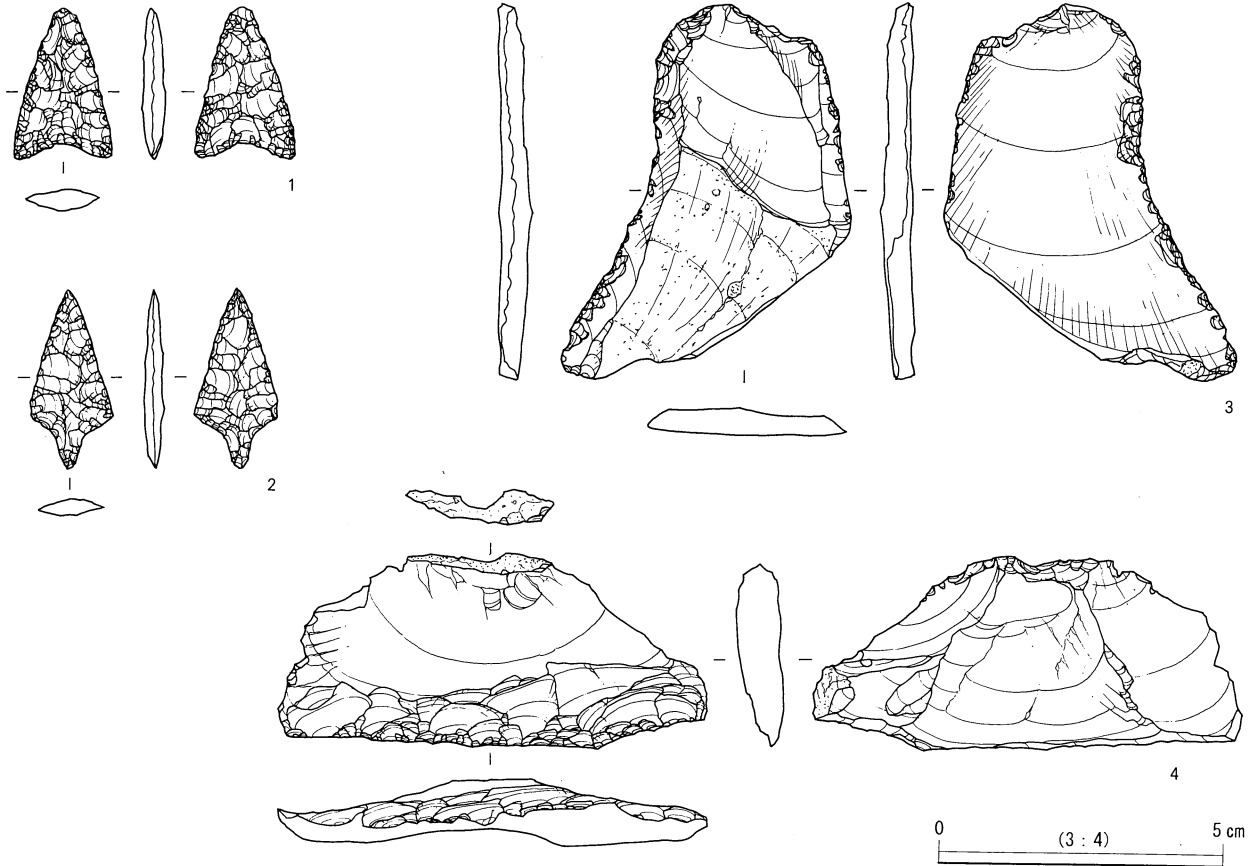

縄文時代石器

SB 01

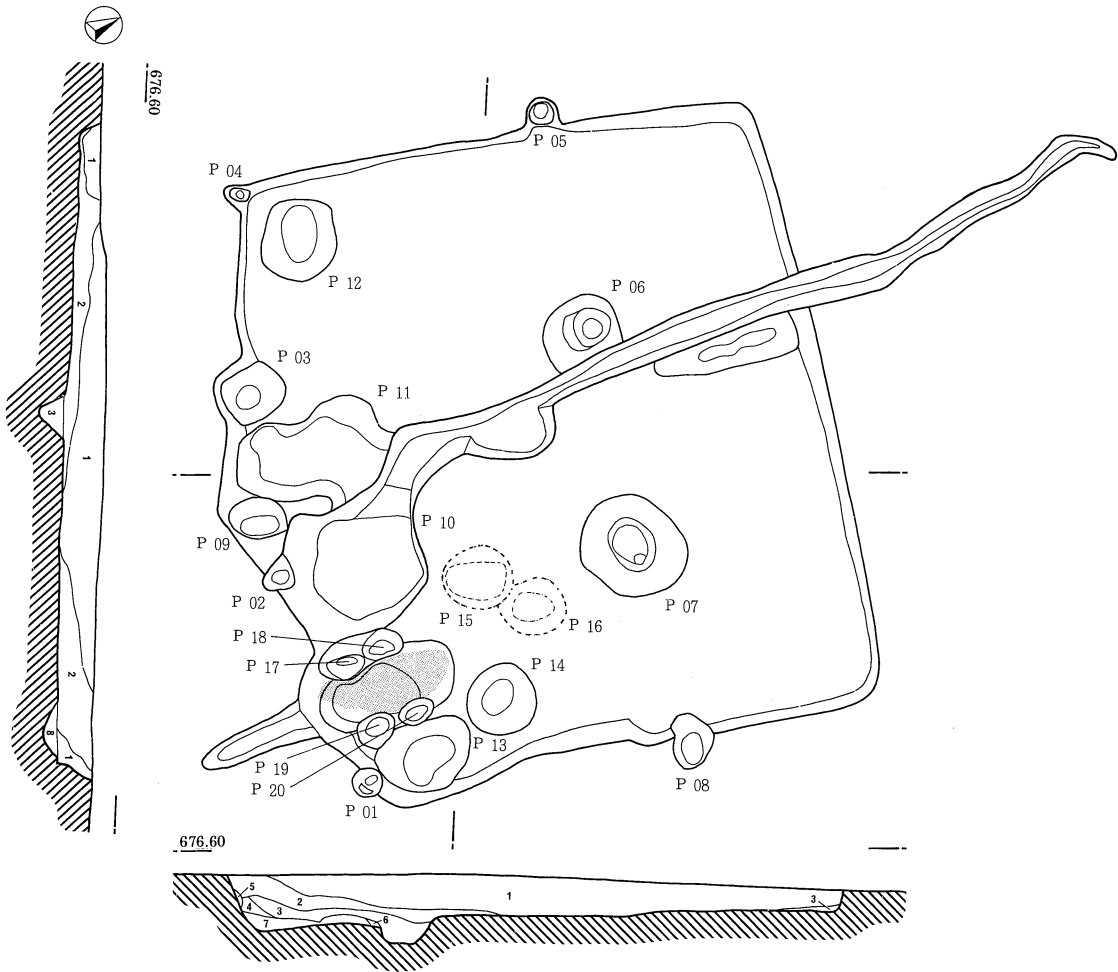

SB01

- | | |
|--------|--------------|
| 1 黒色土 | 黒色土に焼土、炭化物含有 |
| 2 黒色土 | 黄褐色土混入 |
| 3 黒色土 | 2層より黄褐色土多量混入 |
| 4 黒色土 | 黄褐色土粒混入 |
| 5 黄褐色土 | 黒色土混入 微細粒 |
| 6 黄褐色土 | 黒色土混入 フロック状 |
| 7 黒色土 | 黄褐色土混入 |
| 8 黒色土 | 赤色ローム粒少量含有 |

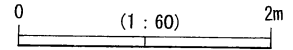

SB 01 カマド

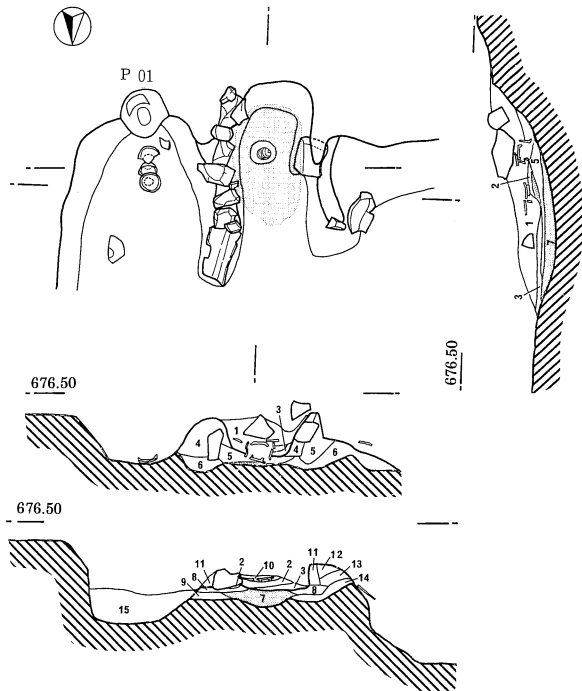

SB01カマド

- | | |
|---------|------------------------|
| 1 黒色土 | 柏原黒色火山灰層 |
| 2 黒色土 | 炭 |
| 3 | 焼土・黒色土ブロック |
| 4 黒褐色土 | 黒色土ブロックにローム、焼土ブロック含有 |
| 5 黄褐色土 | 焼土、ロームブロックに黒色土ブロック少量含有 |
| 6 黒色土 | 焼土ブロック少量含有 |
| 7 赤褐色 | 焼土 |
| 8 黒褐色土 | 黒色強 黒色土、ローム、焼土、炭ブロック含有 |
| 9 黒褐色土 | 8層より黒色薄い |
| 10 赤褐色 | 焼土ブロック |
| 11 暗褐色土 | 黒色土とロームブロックに焼土、炭粒含有 |
| 12 黄褐色土 | ロームブロック |
| 13 黄褐色土 | 5層に類似 |
| 14 黒色土 | |
| 15 黒色土 | 赤色ローム粒少量含有 |

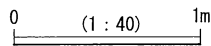

平安時代遺構図 1

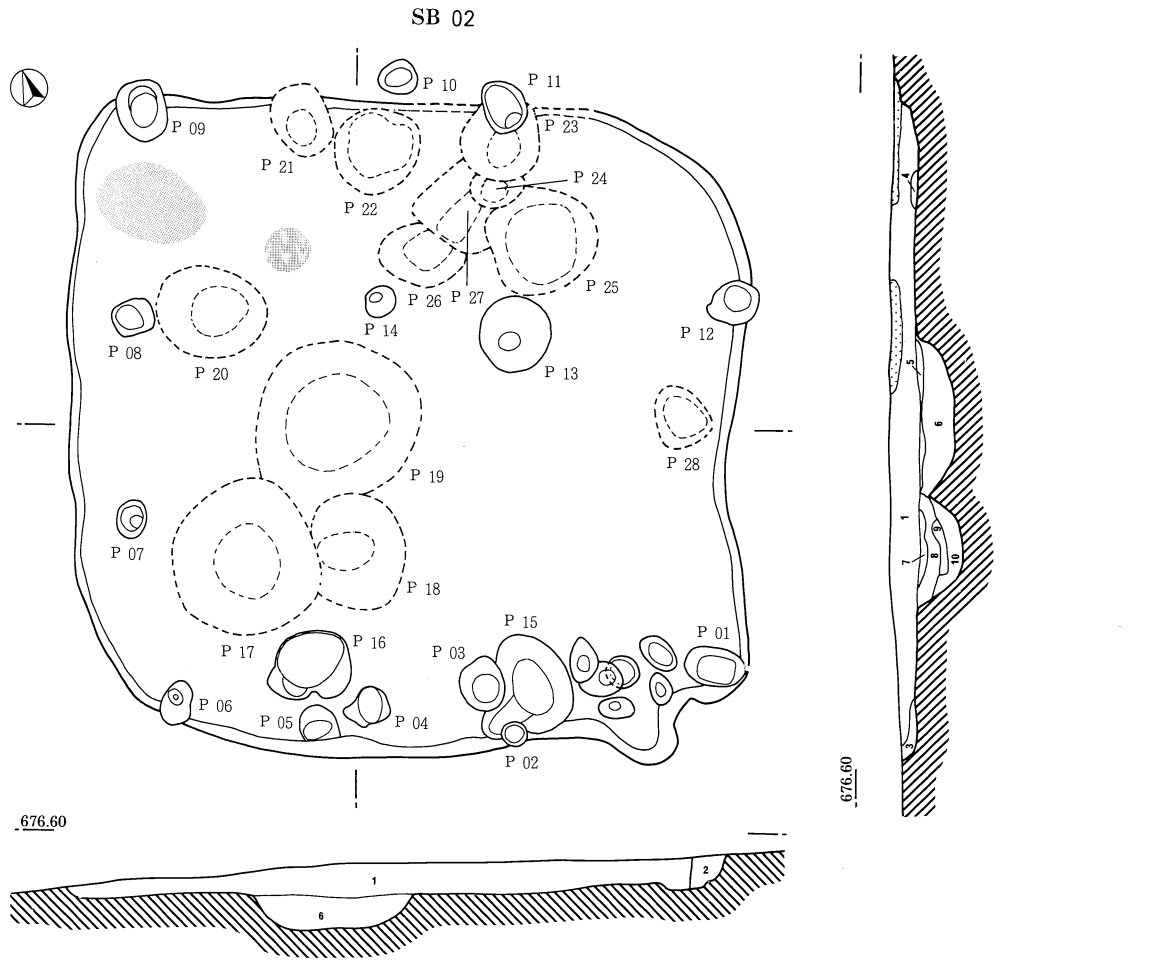

- SB02
- | | |
|---------|----------------------------|
| 1 黒色土 | 焼土、ローム粒、炭粒含有 |
| 2 黒色土 | 1層より焼土、ローム粒、炭粒多量 |
| 3 黒色土 | 壁の崩落か？ |
| 4 黒褐色土 | 黒色土とローム間の漸移層 |
| 5 黒色土 | ロームブロック含有 密 |
| 6 黒色土 | 粗 |
| 7 黒褐色土 | 焼土、炭粒含まない |
| 8 暗褐色土 | 焼土、ロームブロックに黒色土ブロック含有 |
| 9 褐色土 | 焼土ブロック |
| 10 黒褐色土 | 焼土、炭ブロック含有 黒色土にロームブロック少量含有 |

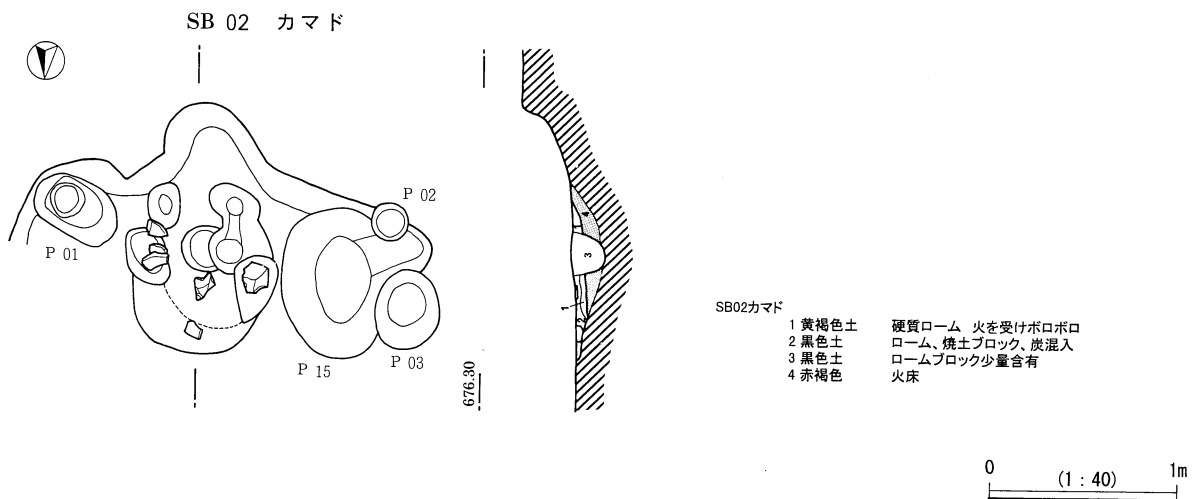
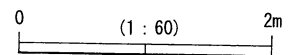

- SB02カマド
- | | |
|--------|----------------|
| 1 黄褐色土 | 硬質ローム 火を受けボロボロ |
| 2 黒色土 | ローム、焼土ブロック、炭混入 |
| 3 黒色土 | ロームブロック少量含有 |
| 4 赤褐色 | 火床 |

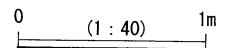

平安時代遺構図 2

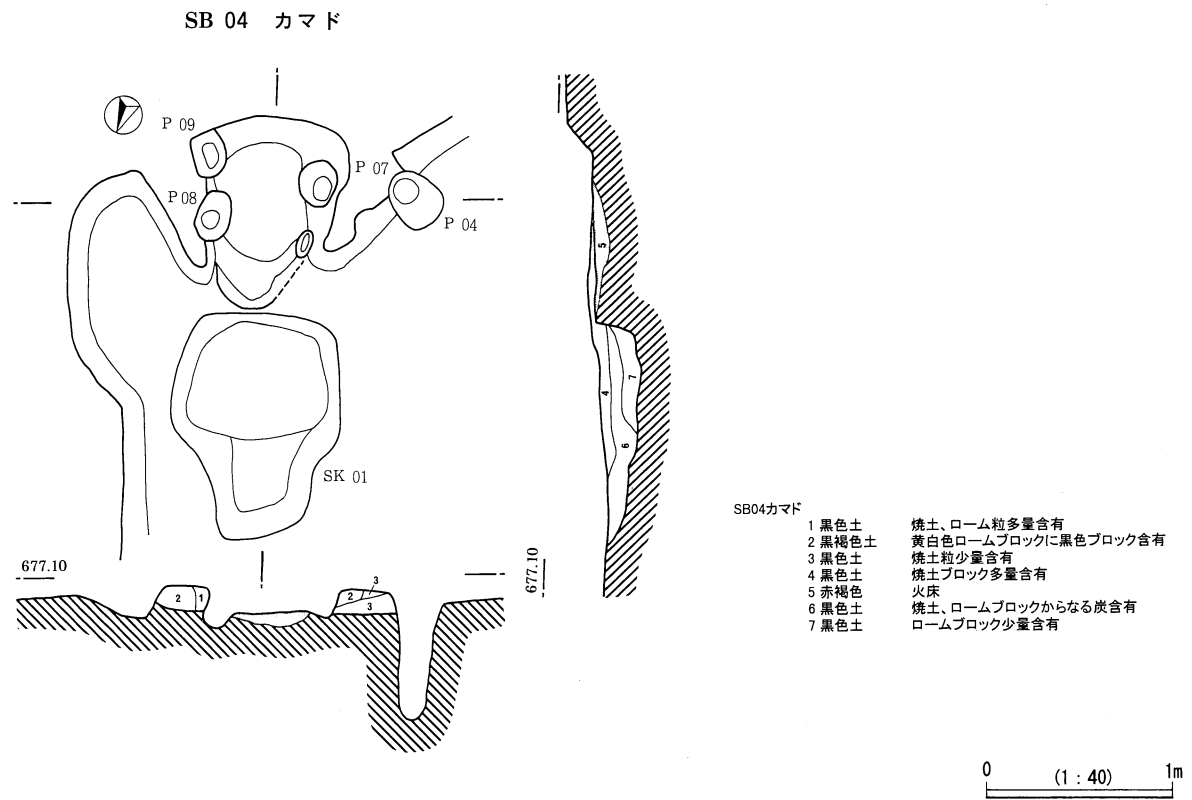
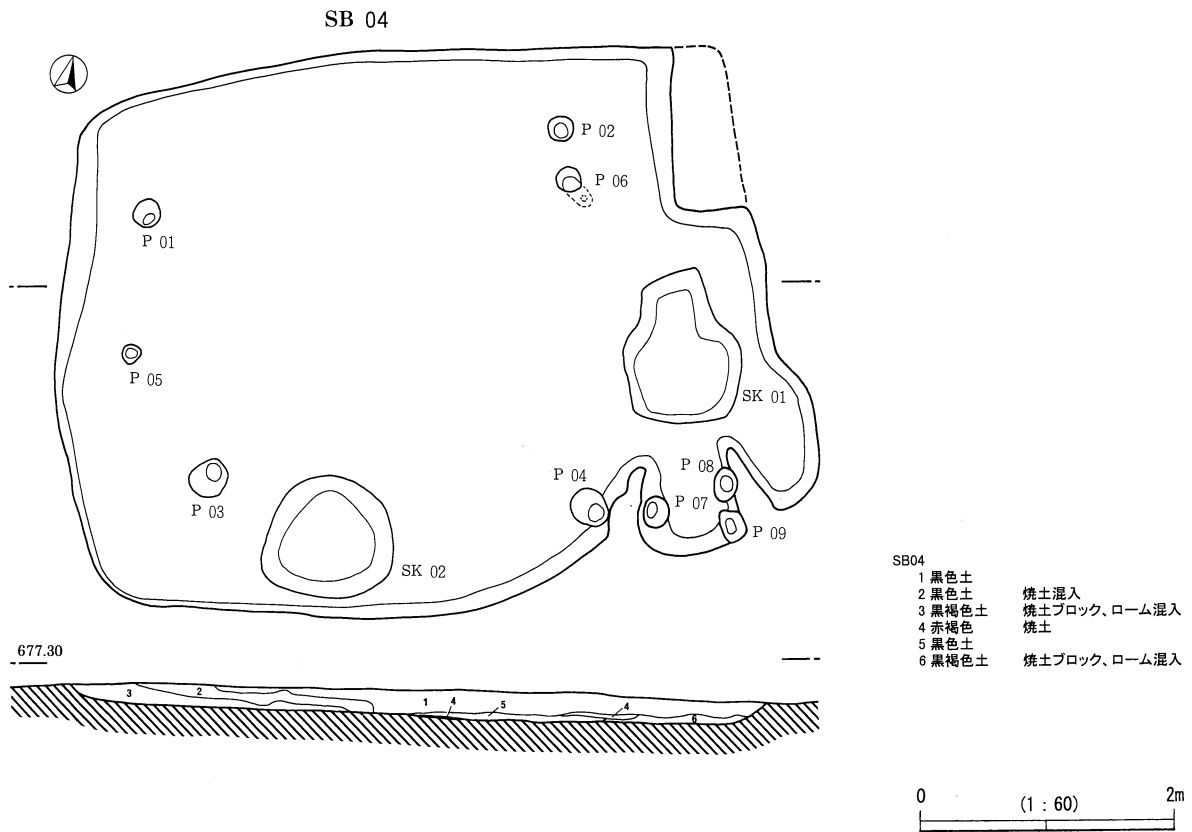

平安時代遺構図 3

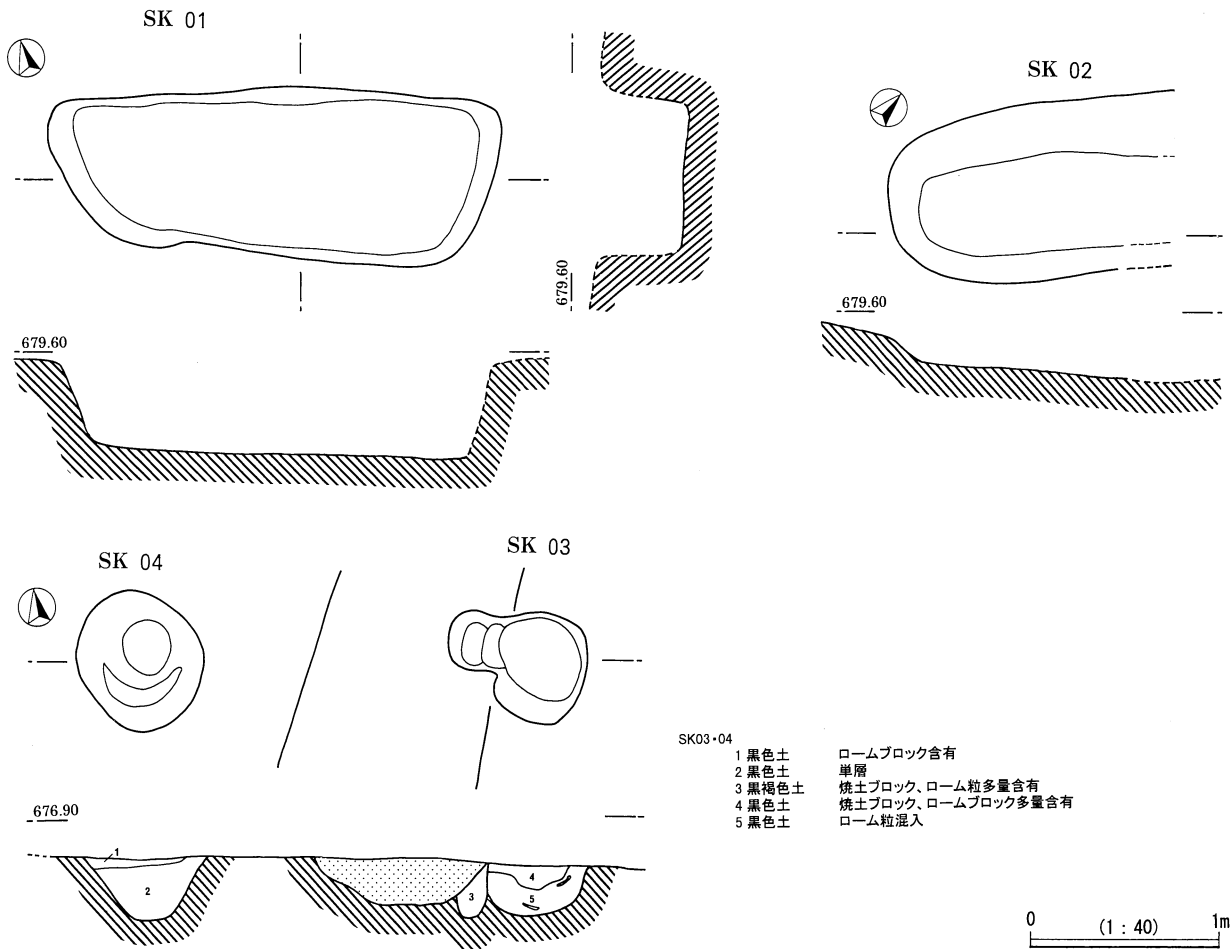
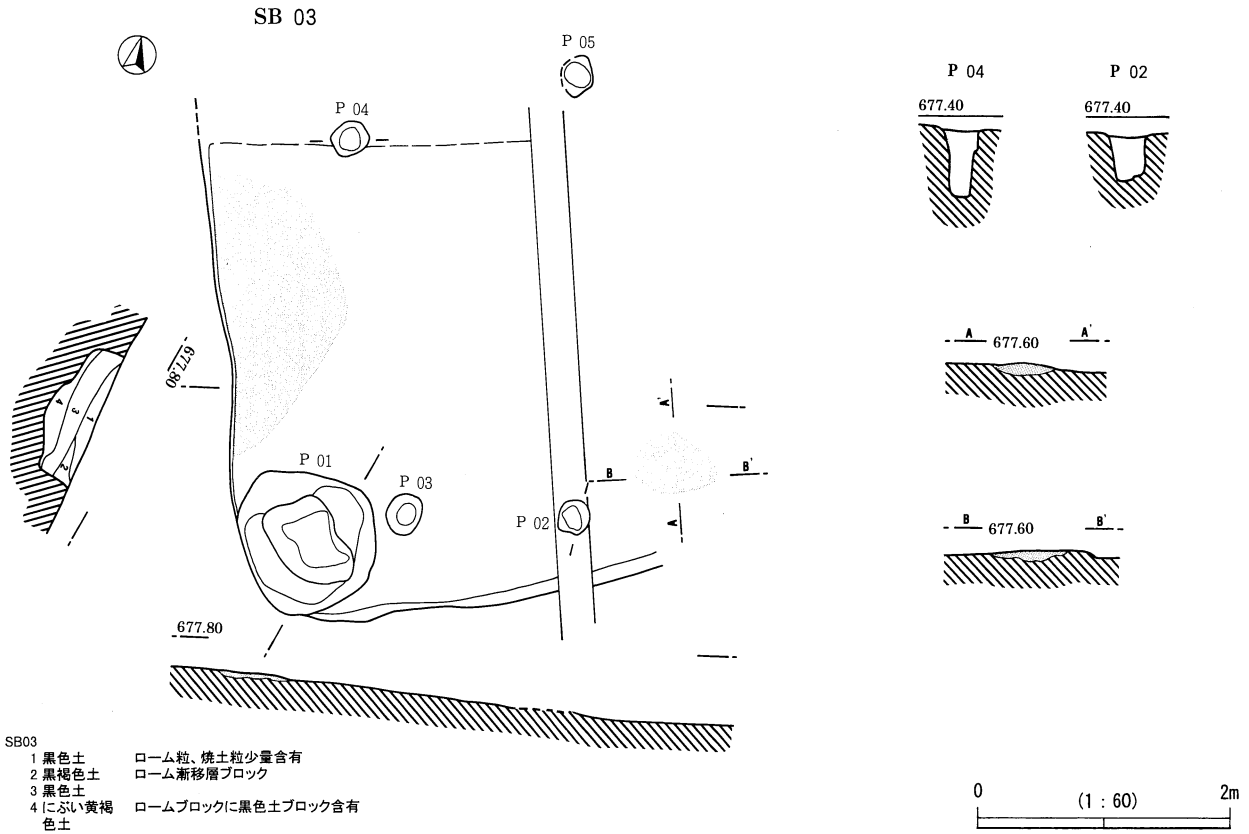

平安時代遺構図 4

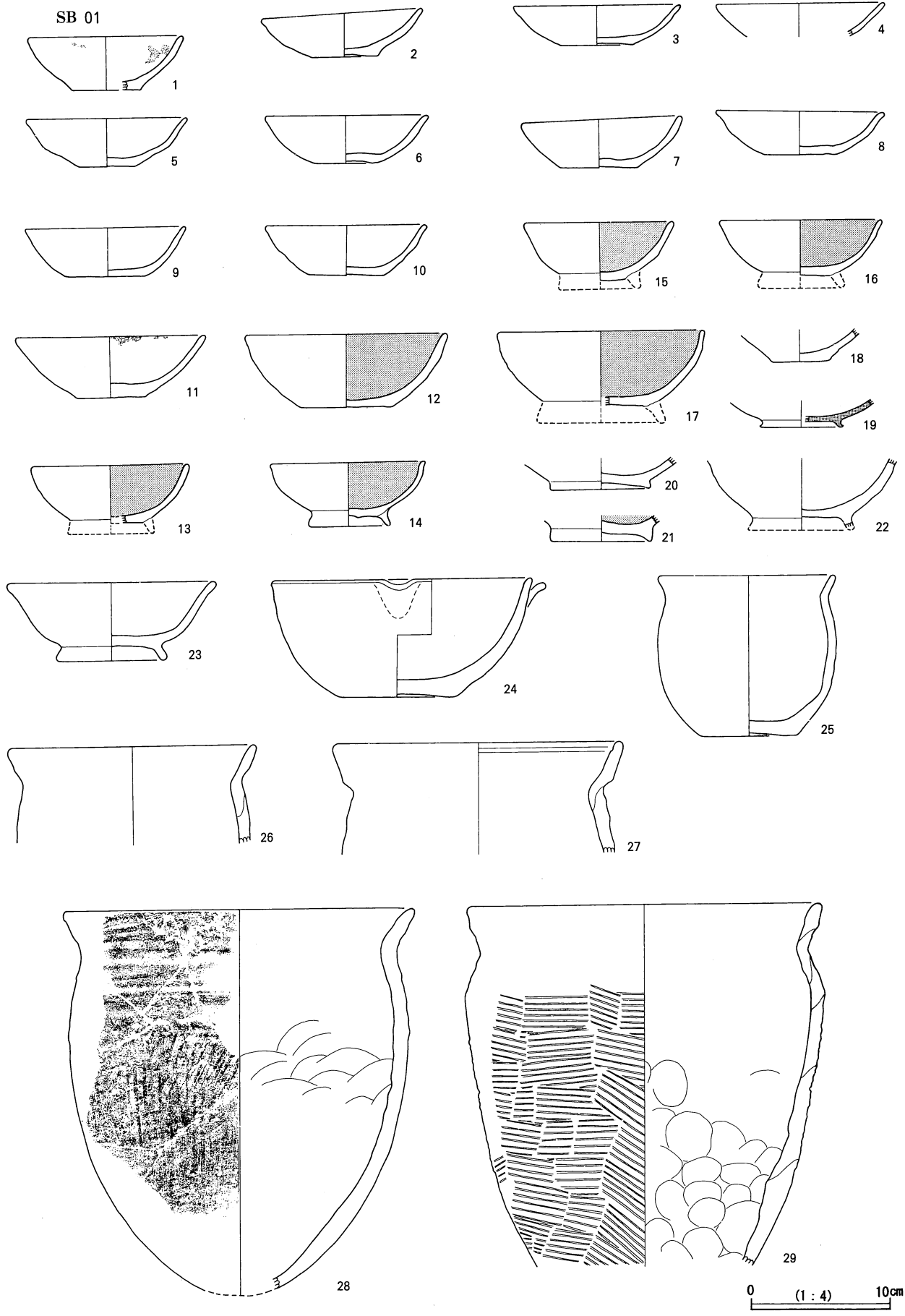

平安時代遺物図 1

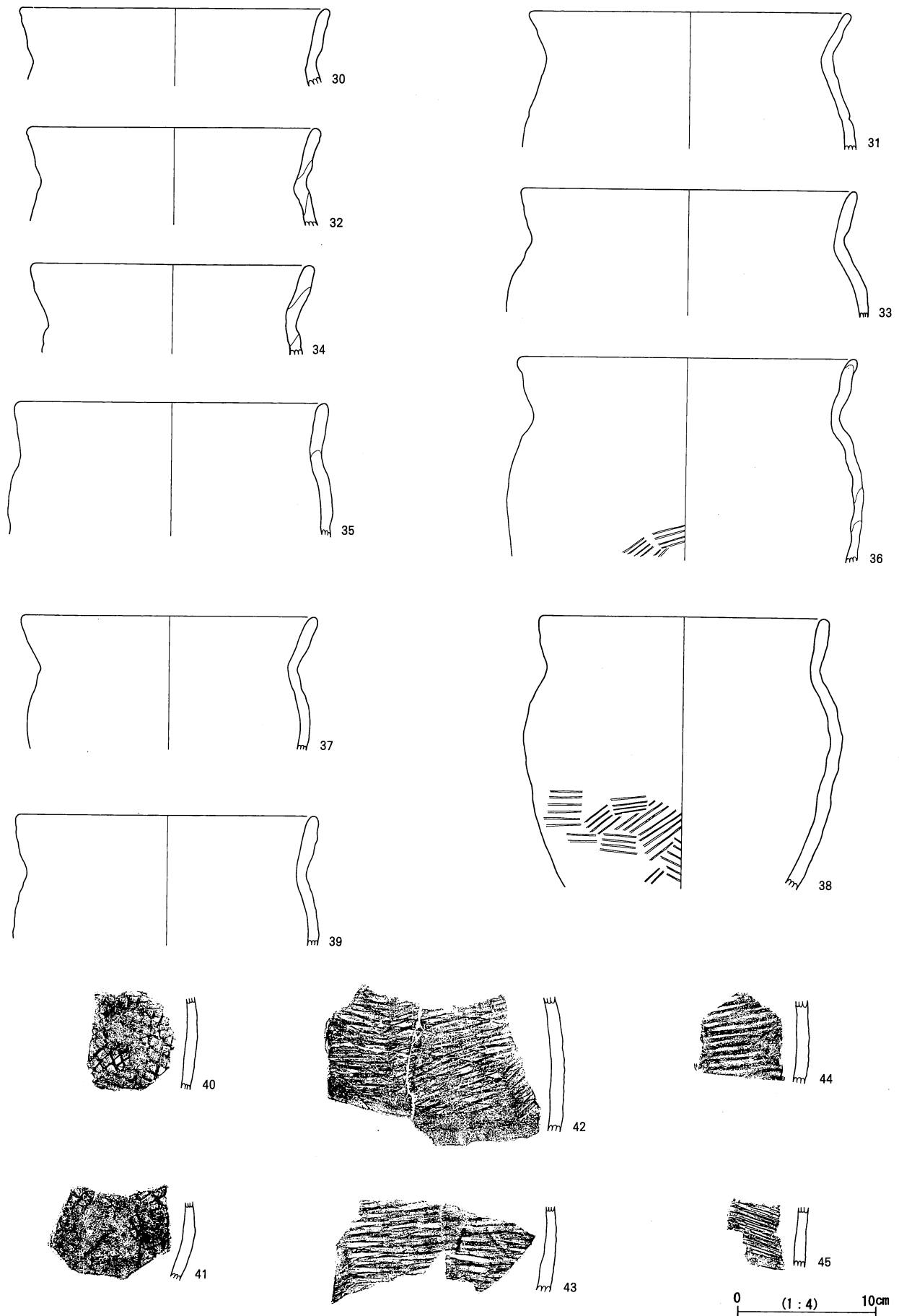

平安時代遺物図 2

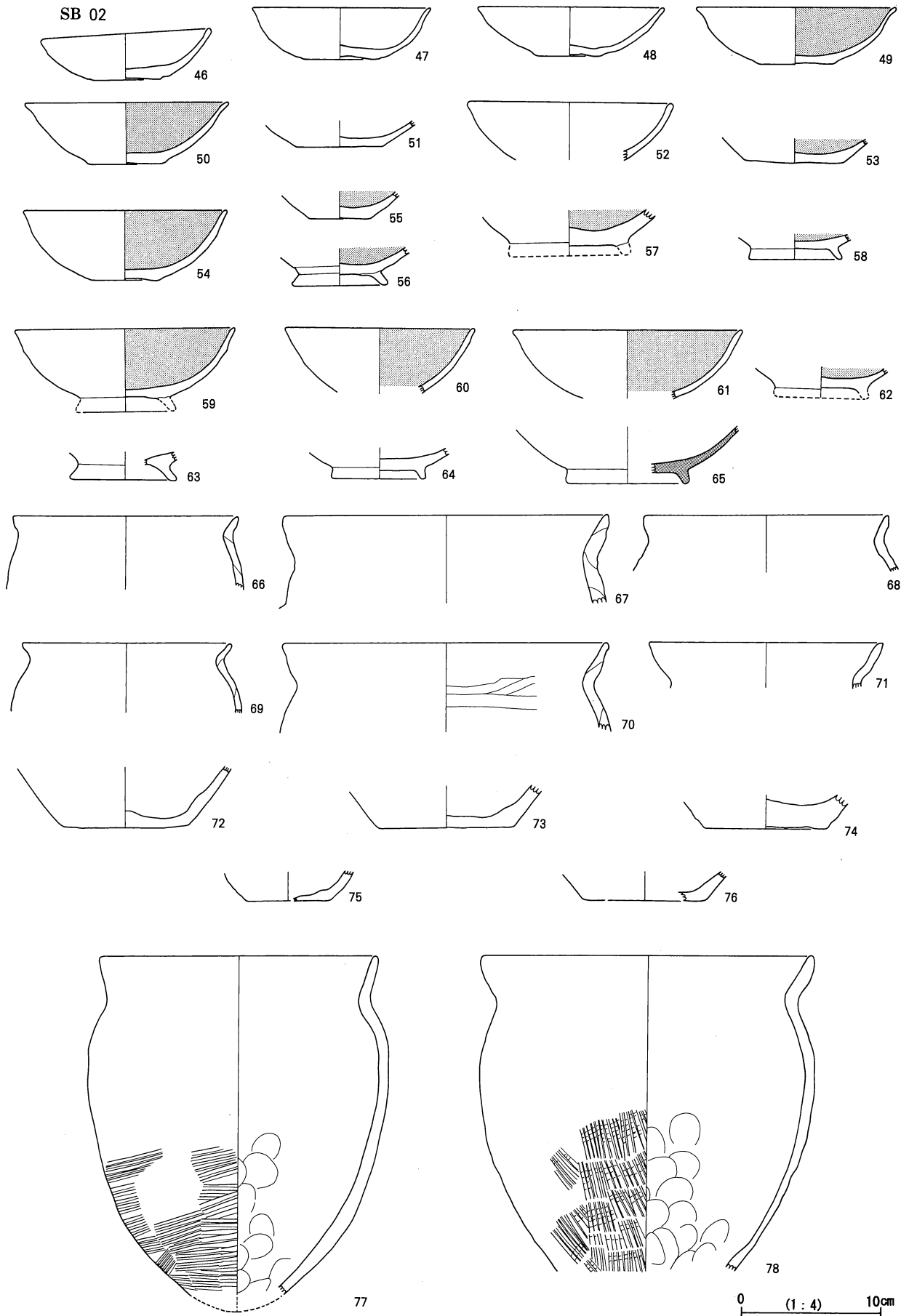

平安時代遺物图 3

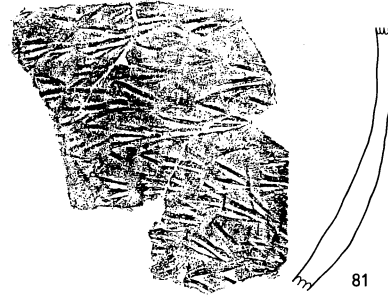
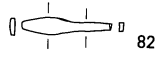
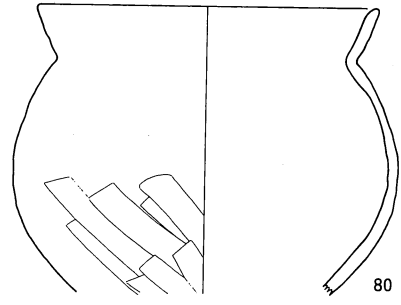
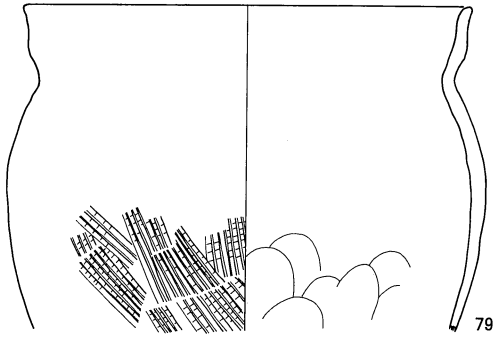

SB 03

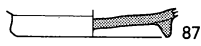
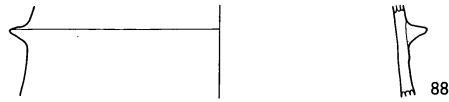
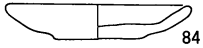
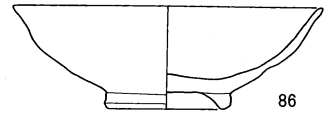
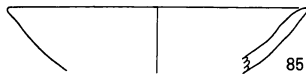
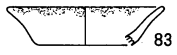

SB 04

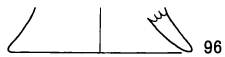
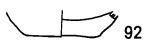
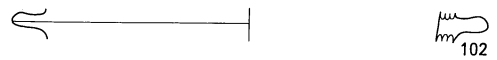
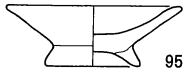
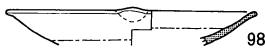
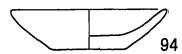
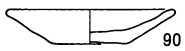
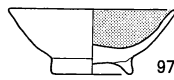
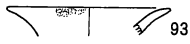
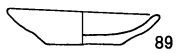

SK 01

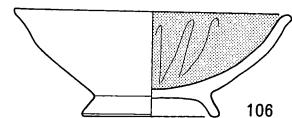
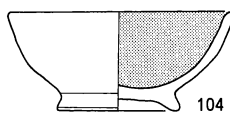
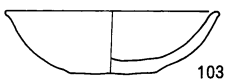

0 (1 : 4) 10cm

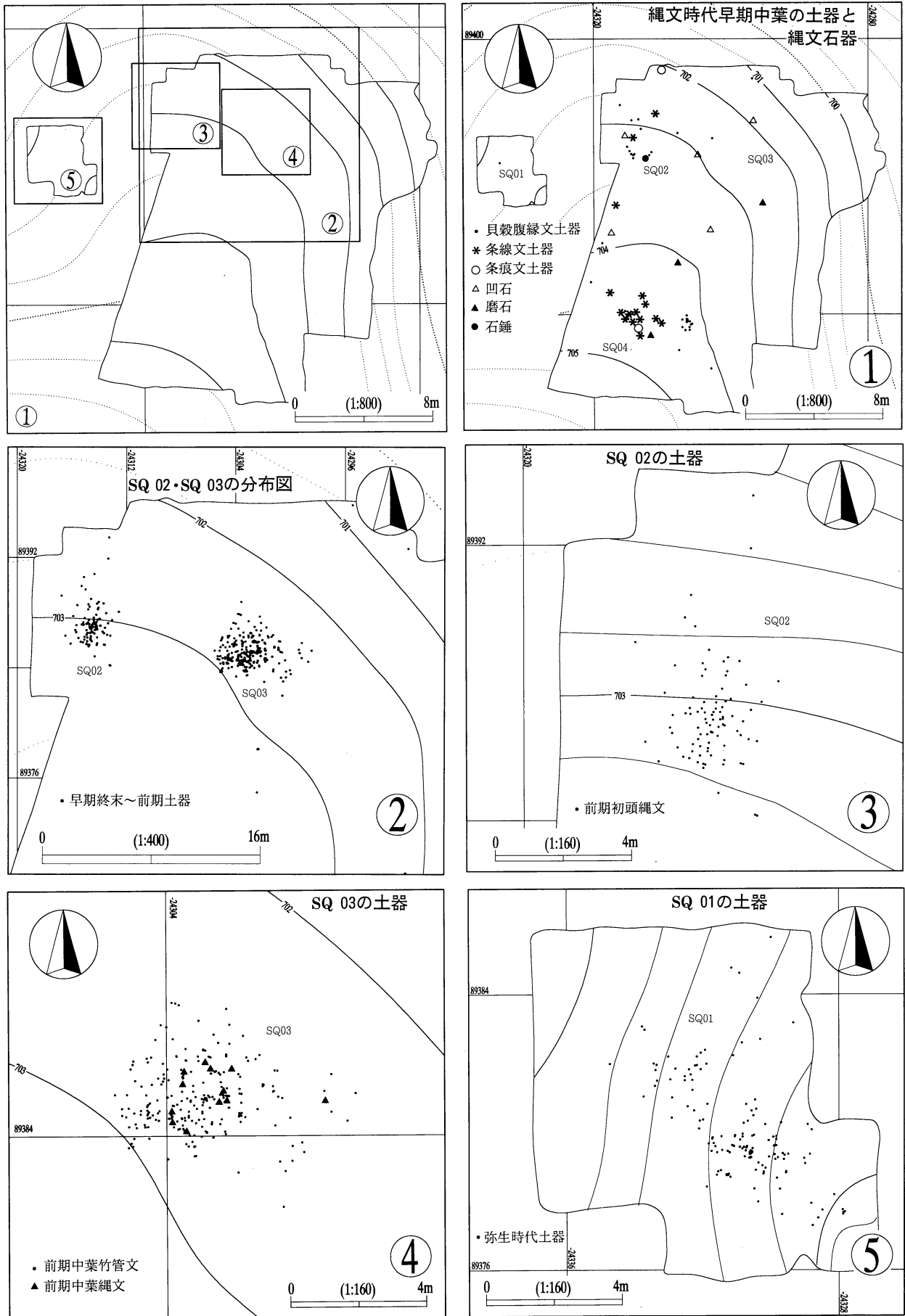

縄文時代・弥生時代遺物分布図

SQ 02

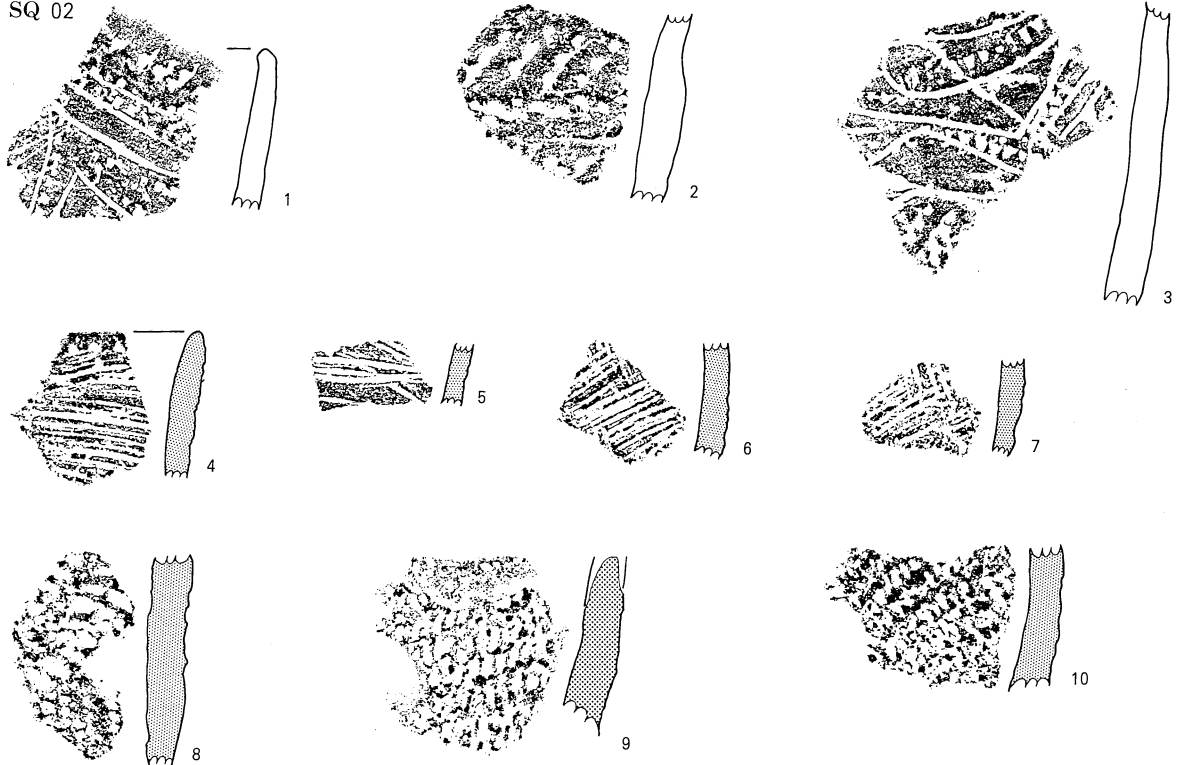

SQ 03

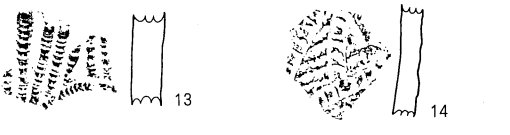

SQ 04

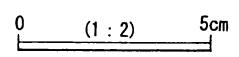
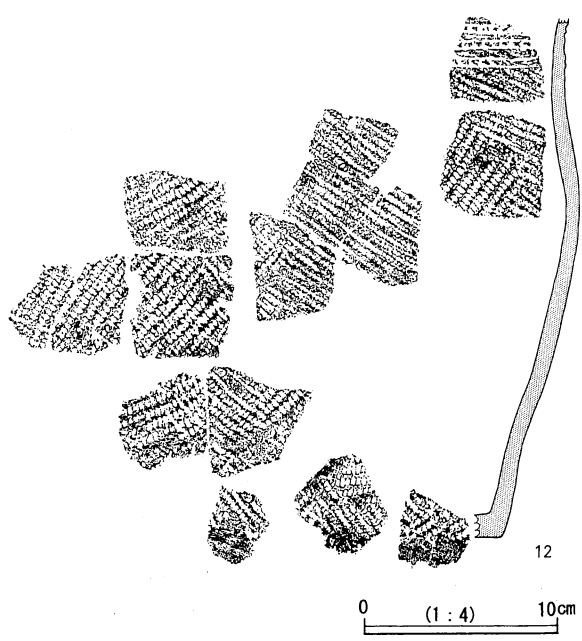
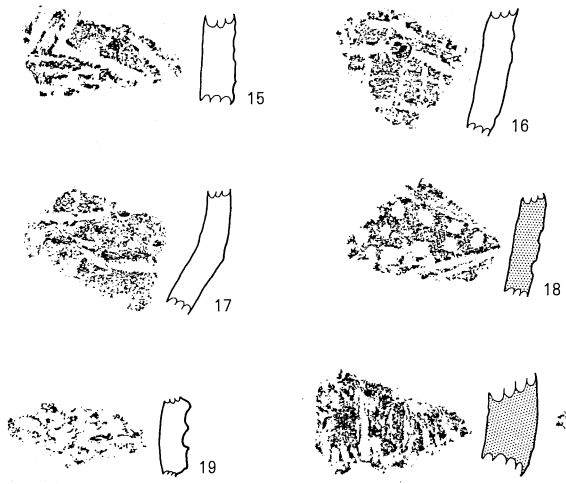

縄文時代遺物図 1

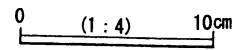
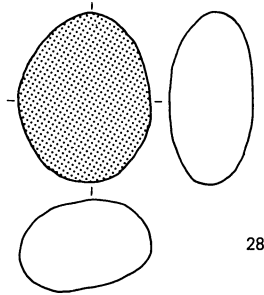
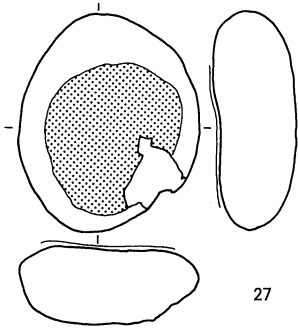
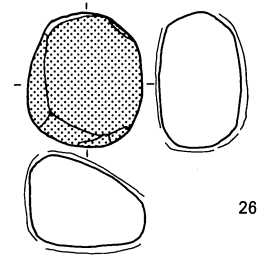
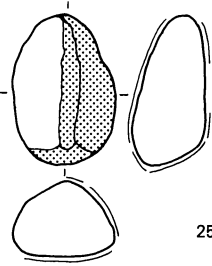
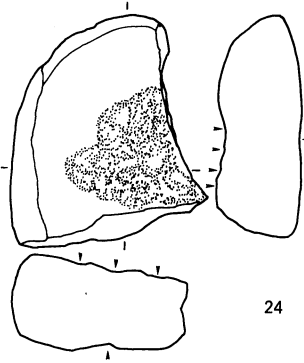
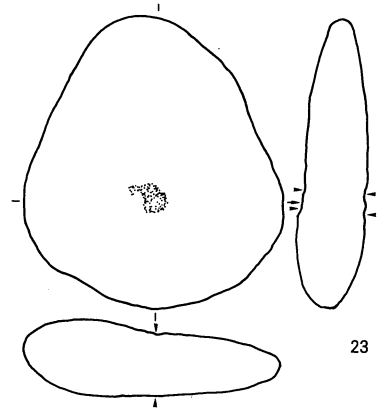
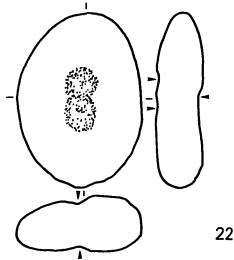
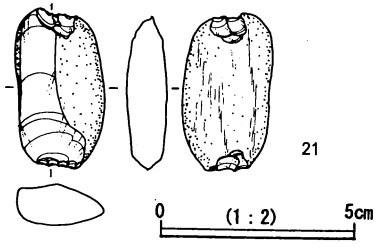

SQ 01

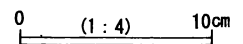
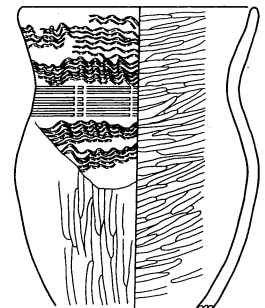
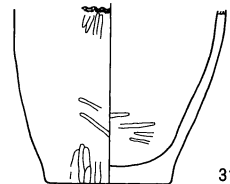
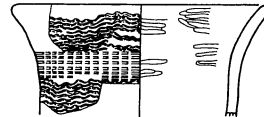
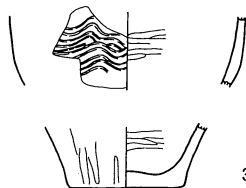
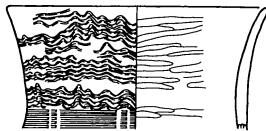
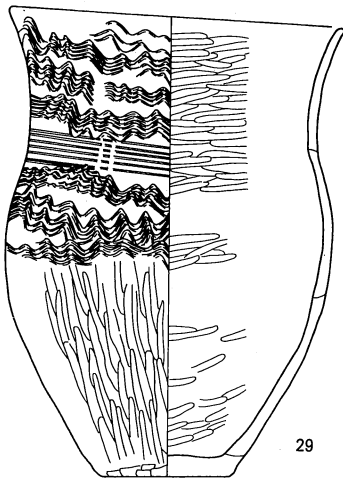

縄文時代遺物図2、弥生時代遺物図

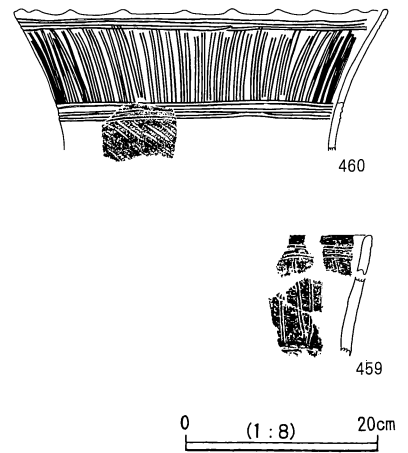
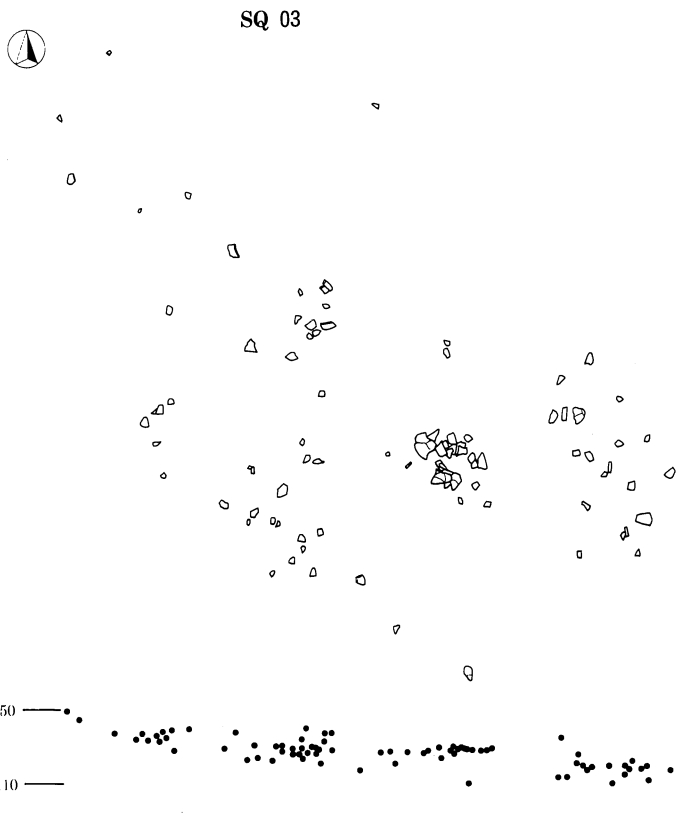
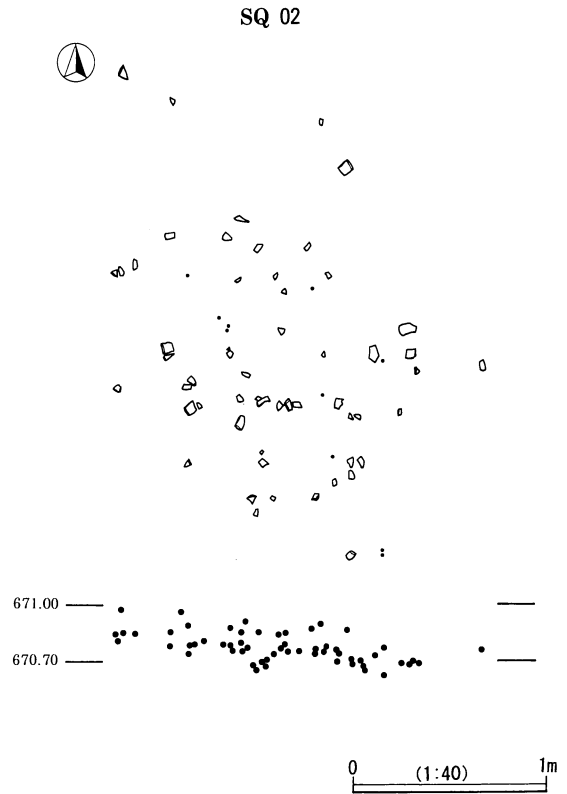
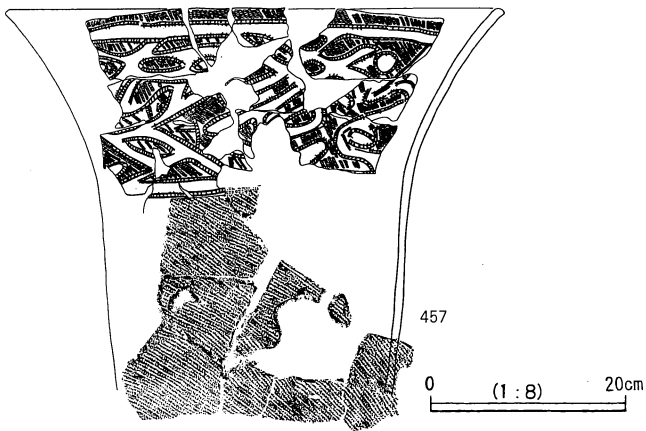
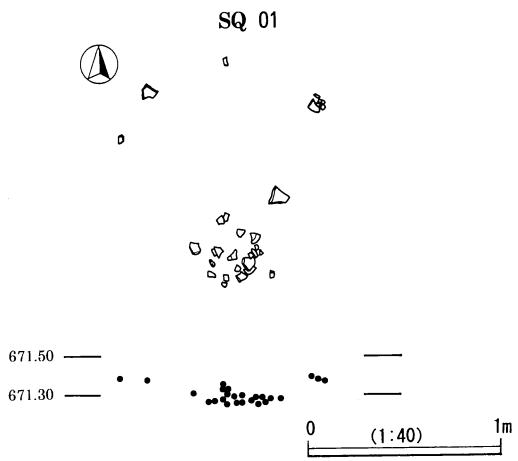

縄文時代遺構図

SH 01



縄文時代集石図 1

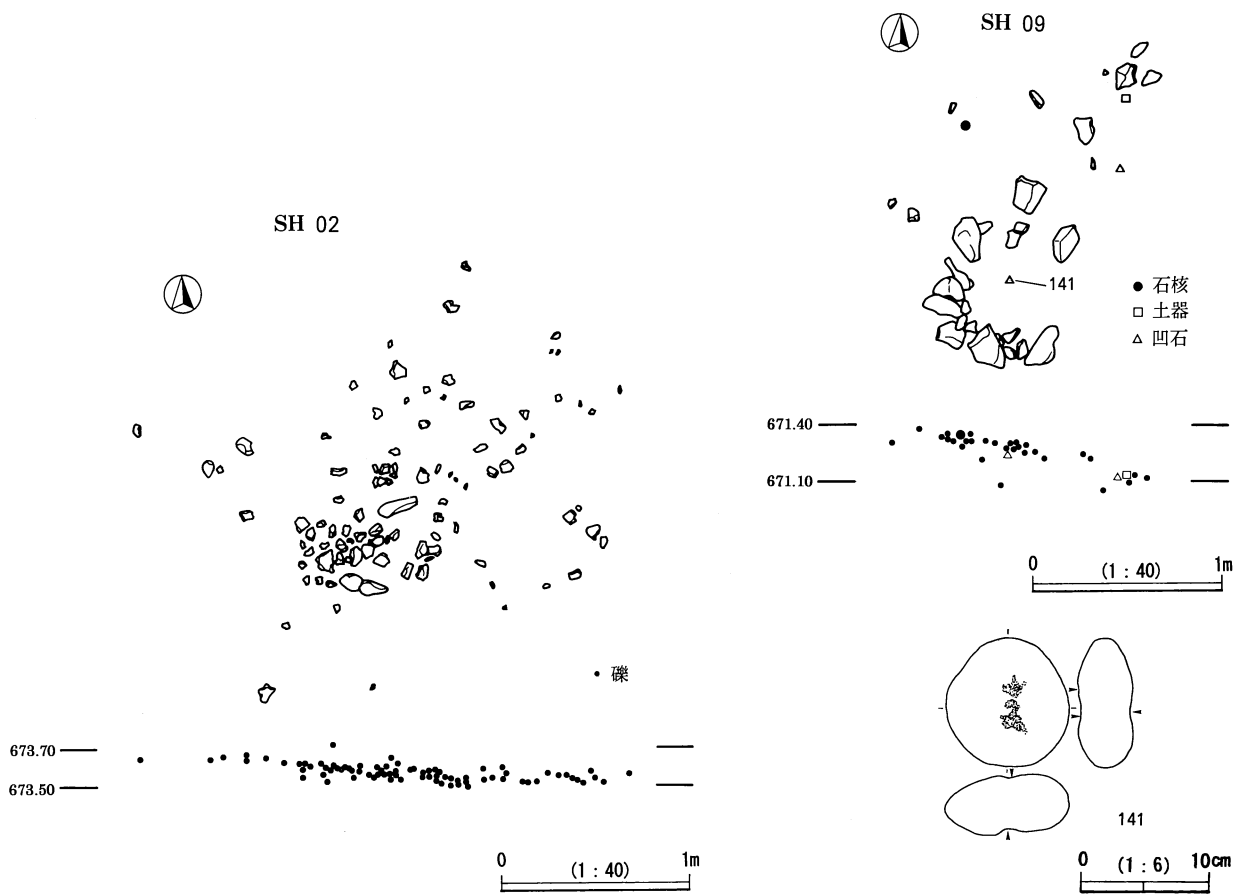
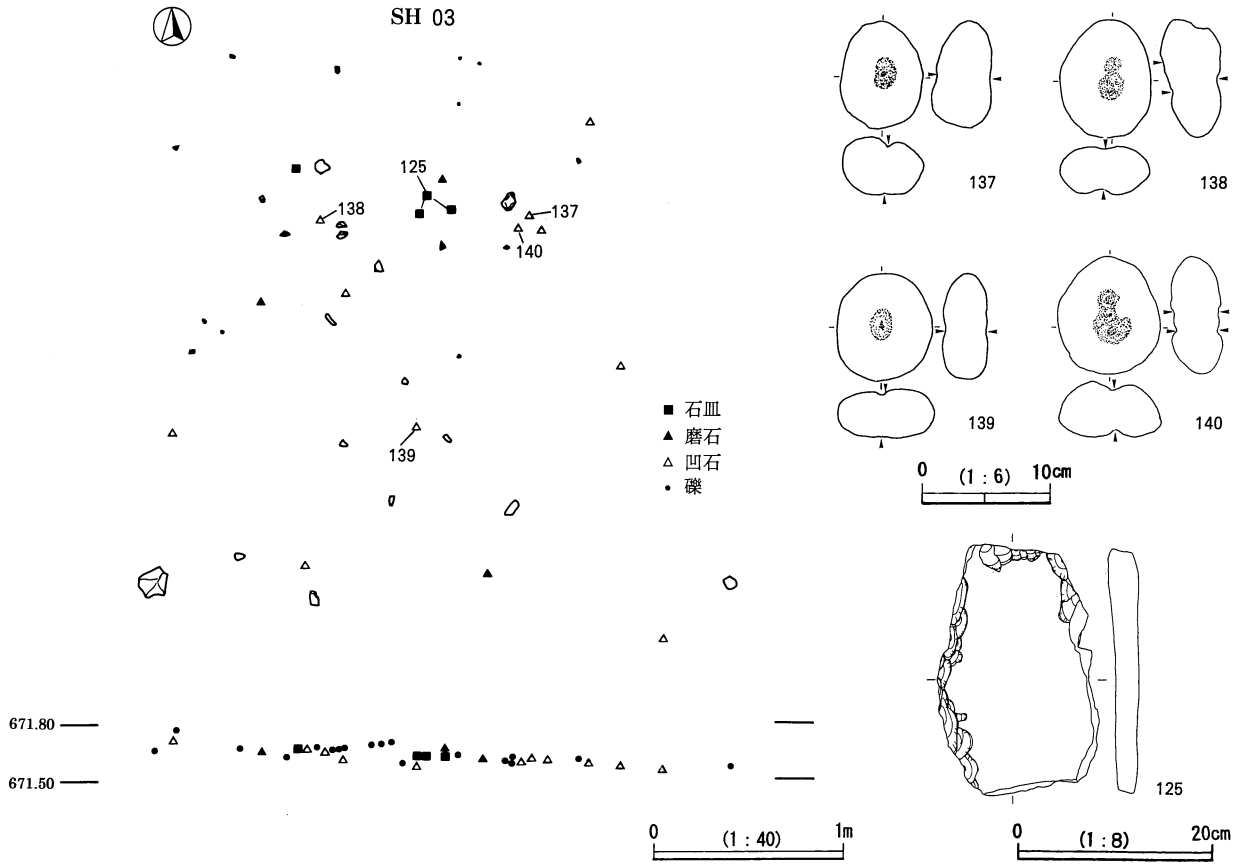

縄文時代集石図 2

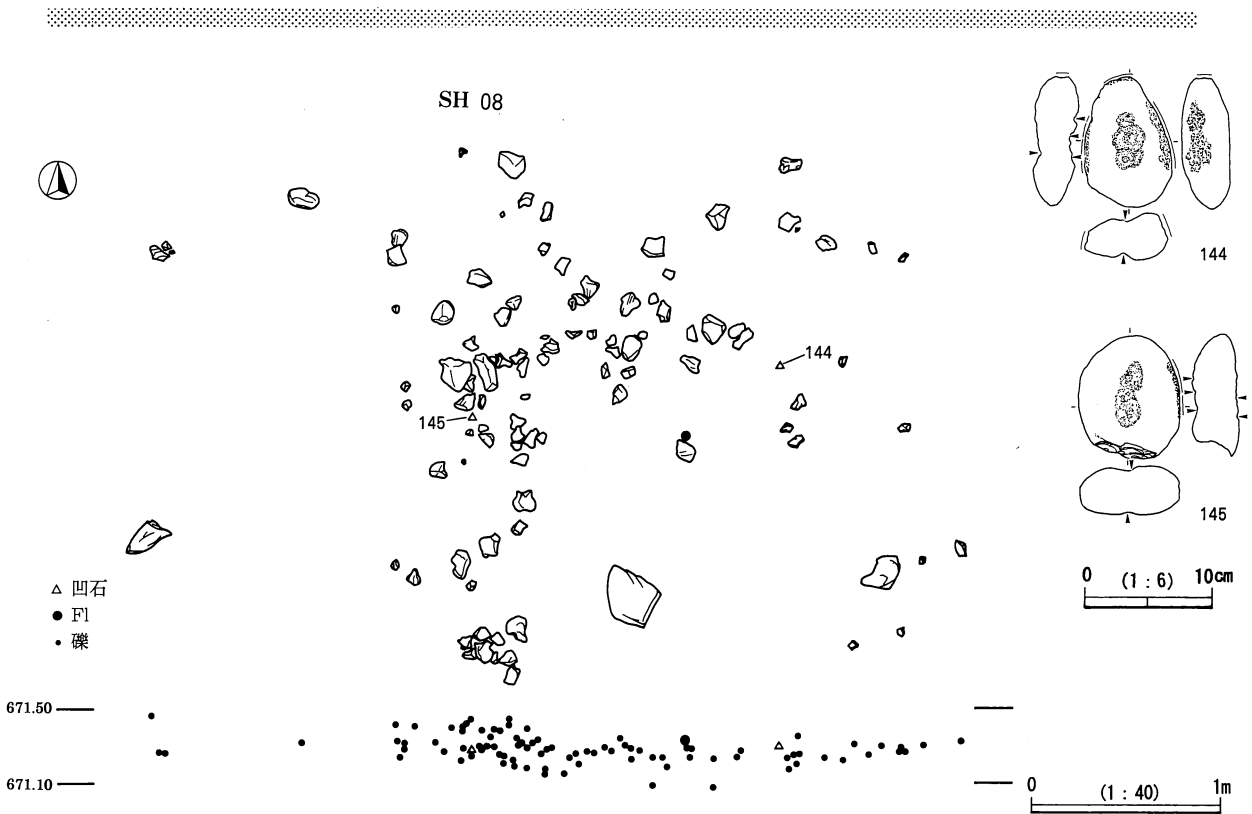
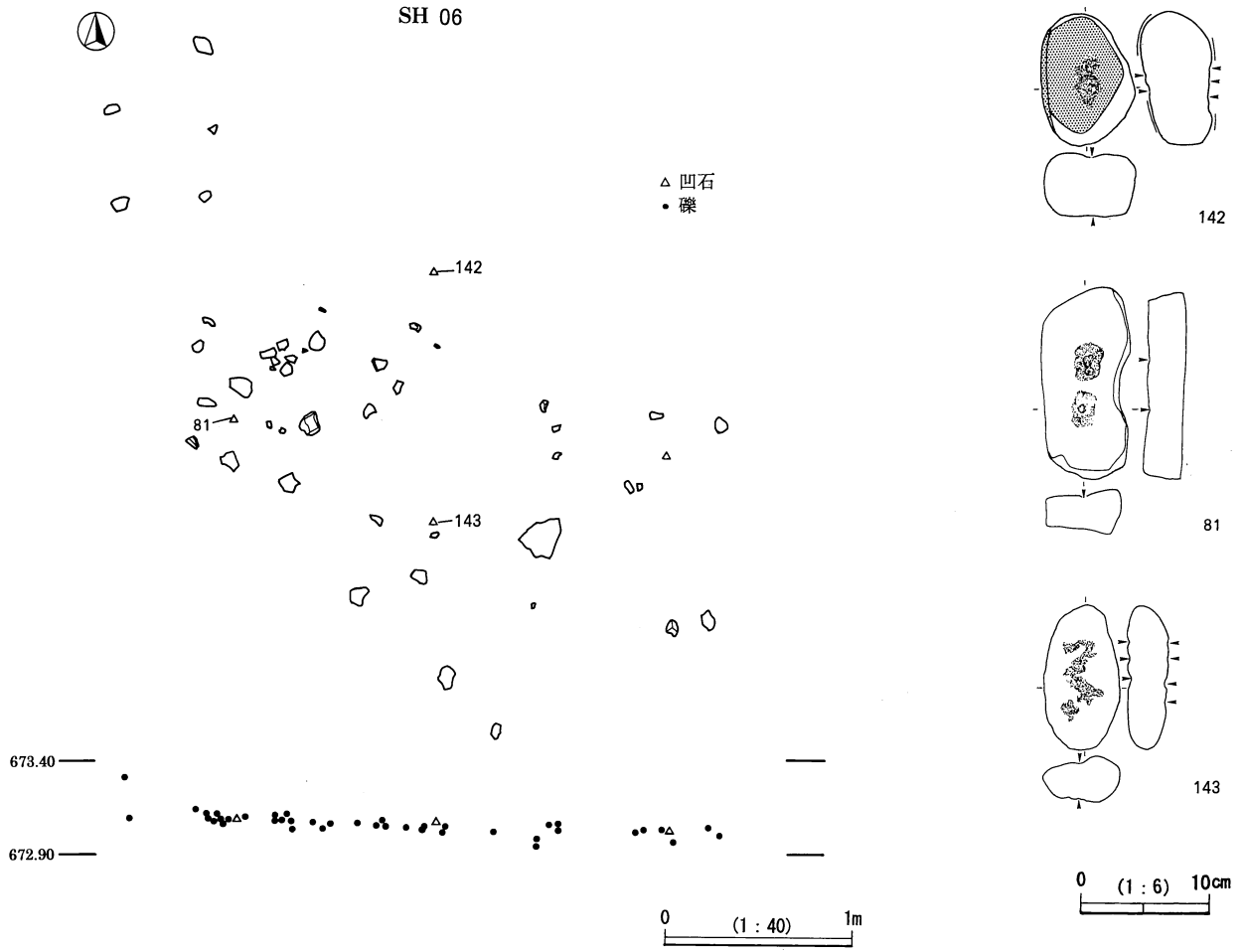

縄文時代集石図 3

SH 07

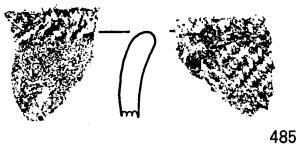
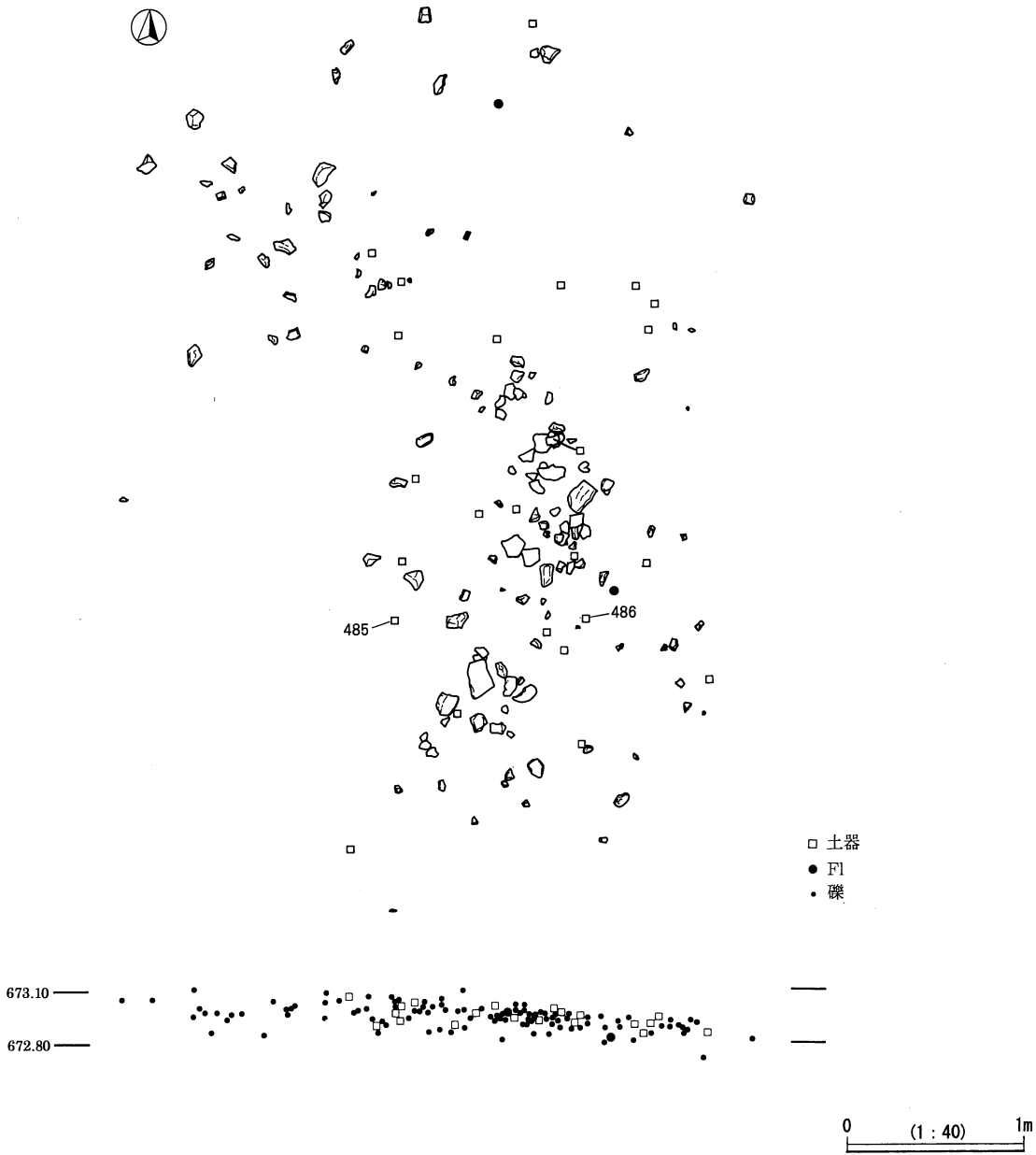

0 (1:2) 5cm

縄文時代集石図 4

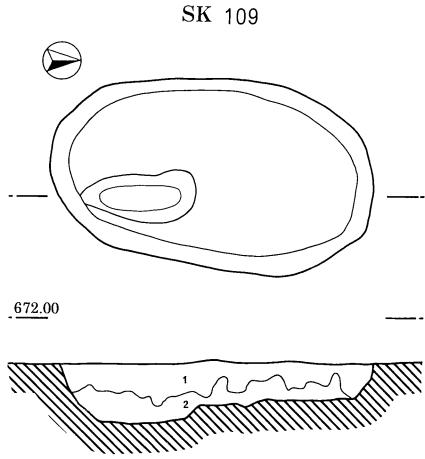

SK109
 1 にぶい赤褐色土 粗 粘性無 II層混入 サラッと
 2 明赤褐色土 粗 粘性無 II層混入 ややローム質

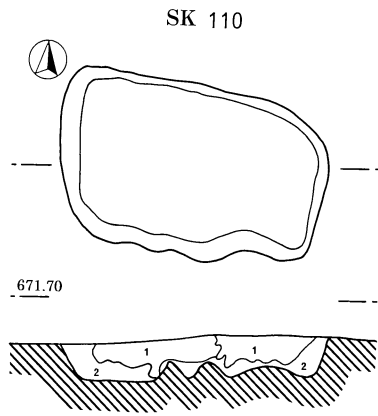

SK110
 1 にぶい褐色土 粗 粘性無 II層混入 赤っぽい覆土 III層土細粒多量含有
 2 明褐色土 粗 粘性無 II層混入 ややローム質

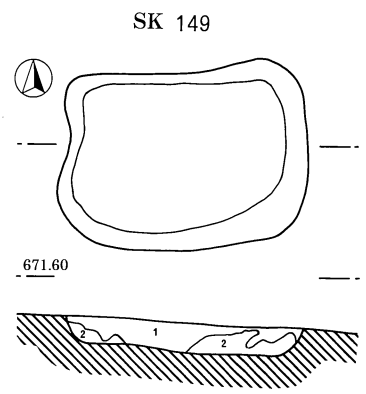

SK149
 1 褐灰色土 粗 粘性無 II層混入 II層埋没土
 2 褐色土 粗 粘性無 II層混入

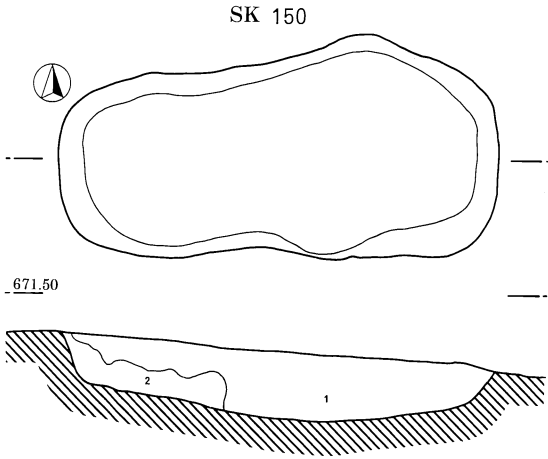

SK150
 1 にぶい赤褐色土 粗 粘性無 サラサラ 焼土っぽい
 2 明褐色土 粗 粘性有 II層混入 ややローム質

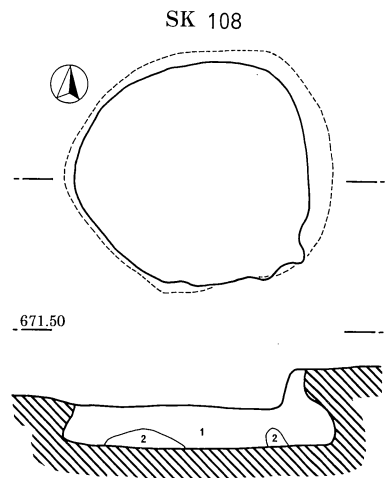

SK108
 1 にぶい褐色土 粗 IV層土 ブロック含有
 2 暗褐色土 粗 1層土の色の濃い部分

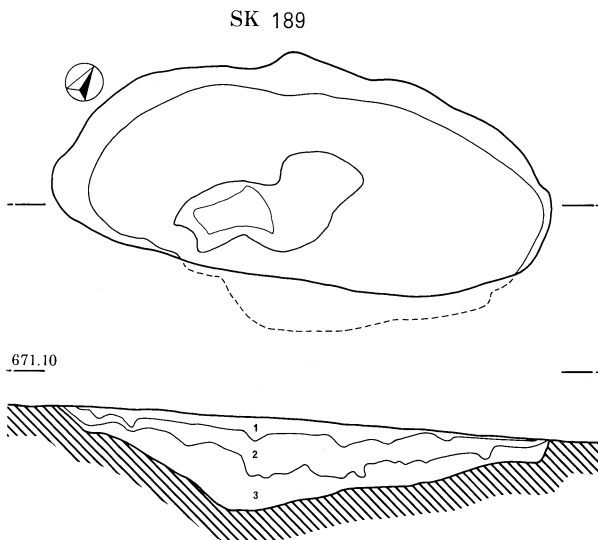

SK189
 1 褐灰色土 粗 粘性無 III層ベース
 2 褐灰色土 粗 粘性無 ポロポロ
 3 黄褐色土 粗 粘性無 ややローム質

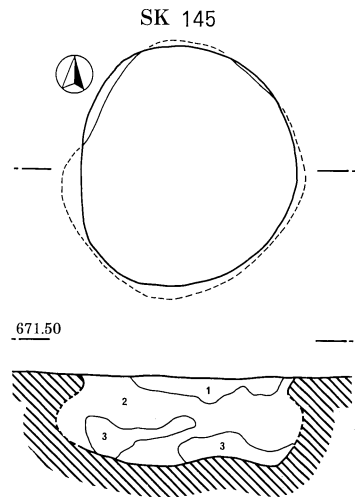

SK145
 1 にぶい褐色土 粗 粘性無 II層混入 ややローム質 焼土っぽい
 2 褐色土 粗 粘性無 II層混入 ややローム質 III層に近似
 3 明褐色土 やや密 粘性無 III層混入

0 (1:40) 1m

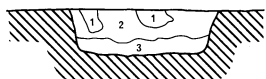
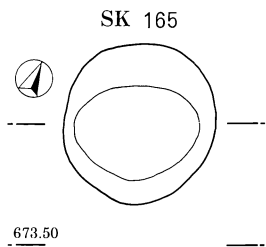

SK165
 1 褐灰色土 粗 粘性無 サラサラ
 2 褐灰色土 粗 粘性無 サラサラ
 3 明黄褐色 粗 粘性有 ローム質に近似

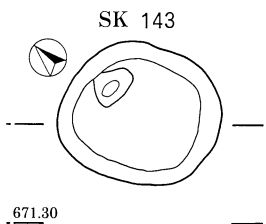

SK143
 1 にぶい褐 粗 粘性無 II層混入 やや
 色土 ローム質 焼土っぽい

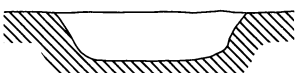
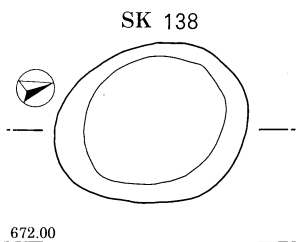

SK138
 1 黄褐色土 粗 粘性有 ローム質 IV層
 の埋没土

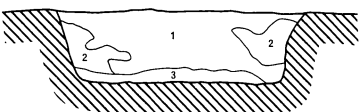
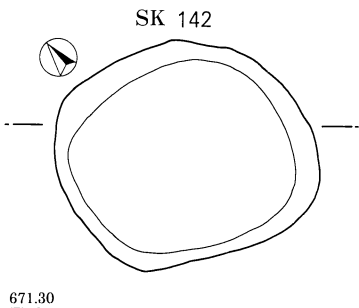

SK142
 1 にぶい黄 粗 粘性無 II層混入 ややロ
 褐色土 ム質 焼土っぽい
 2 褐色土 粗 粘性無 II層混入 ややロ
 ム質 III層に近似
 3 黄褐色土 粗 粘性有 ローム質 IV層の埋
 没土

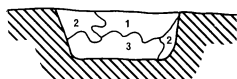
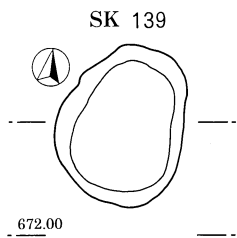

SK139
 1 黒褐色土 粗 粘性無 II層混入 III層ペ
 ースでややローム質
 2 褐色土 粗 粘性無 II層混入 ややロ
 ム質 III層に近似
 3 黄褐色土 粗 粘性有 ローム質 IV層の埋
 没土

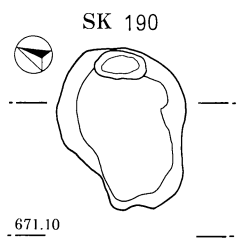

SK190
 1 褐灰色土 粗 粘性無 ポロポロ
 2 黄褐色土 粗 粘性無 ややローム質

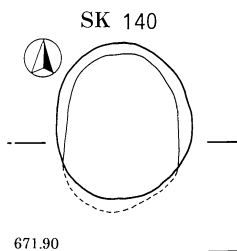

SK140
 1 黒褐色土 粗 粘性無 II層混入 III層ペ
 ースでややローム質
 2 黄褐色土 粗 粘性有 ローム質 IV層の埋
 没土

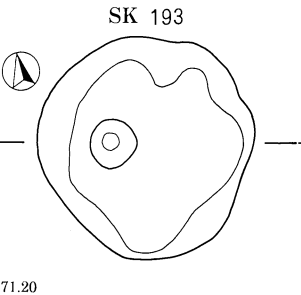

SK193
 1 黒褐色土 粗 粘性無 サラサラ
 2 明黄褐色 粗 粘性無 ややローム質

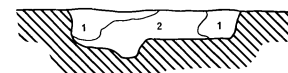
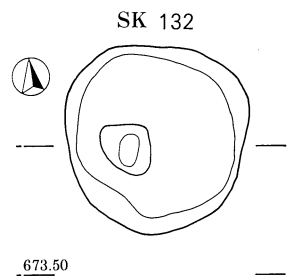

SK132
 1 黒褐色土 粗 粘性無 II層混入 II層埋没
 土
 2 黄褐色土 粗 粘性有 II層混入 ややロ
 ム質

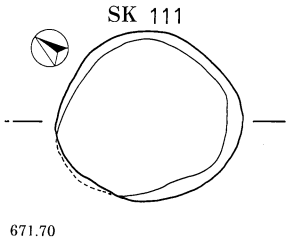

SK111
 1 にぶい褐 粗 粘性無 II層混入 赤っぽい
 色土 覆土 III層土の細粒多量含有

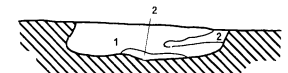
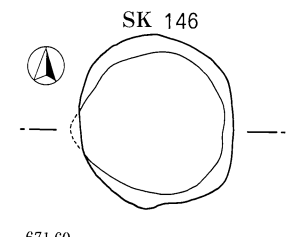

SK146
 1 黒褐色土 粗 粘性無 II層混入 III層ペ
 ースでややローム質
 2 褐色土 粗 粘性無 II層混入 ややロ
 ム質 III層に近似

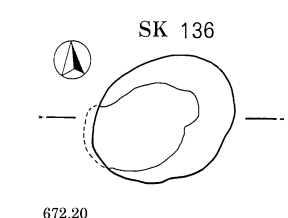

SK136
 1 黒褐色土 粗 粘性無 II層混入 III層ペ
 ースでややローム質
 2 黄褐色土 粗 粘性有 ローム質 IV層の埋
 没土

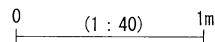

縄文時代土坑図 2

SK 115

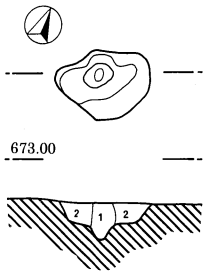

- SK115
- 1 黒褐色土 やや粗 粘性無 I層混入 サラサラ II層の土
 - 2 明黄褐色土 やや粗 粘性有 III層混入 ローム質、IV層の埋没土

SK 147

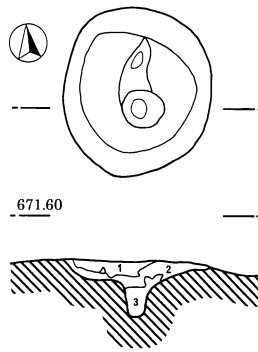

- SK147
- 1 にぶい褐色土 粗 粘性無 II層混入 ややローム質 焼土っぽい
 - 2 明褐色土 やや密 粘性無 III層混入 ポロポロ(IV・V層がブロック状)
 - 3 黄褐色土 粗 粘性有 ローム質 IV層の埋没土

SK 188

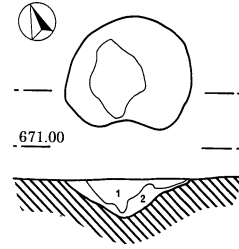

- SK188
- 1 黒褐色土 粗 粘性無 ポロポロ
 - 2 にぶい黄褐色土 粗 粘性無 ややローム質

SK 128

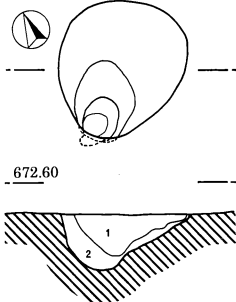

- SK128
- 1 黒色土 やや粗 粘性無 I層混入 I層の埋没土
 - 2 にぶい黄褐色土 やや粗 粘性無 黄褐色ローム混入 ややローム質 III層に近似

SK 170

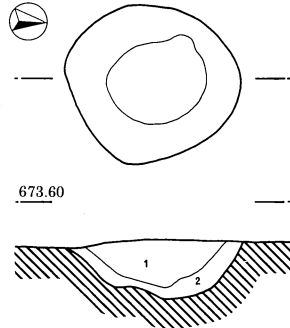

- SK170
- 1 褐灰色土 粗 粘性無 サラサラ
 - 2 黄褐色土 粗 粘性有 ややローム質

SK 122

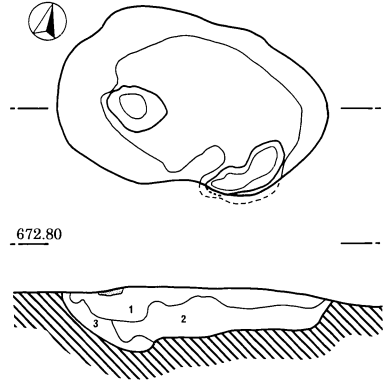

- SK122
- 1 黒色土 やや粗 粘性無 I層の埋没土
 - 2 にぶい黄褐色土 やや粗 粘性無 黄褐色ローム混入 ややローム質 III層に近似
 - 3 明黄褐色土 やや粗 粘性有 III層混入 ローム質 IV層の埋没土

SK 175

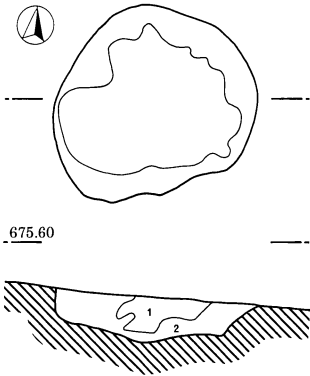

- SK175
- 1 褐灰色土 粗 粘性無 サラサラ
 - 2 黄褐色土 粗 粘性有 ややローム質

SK 131

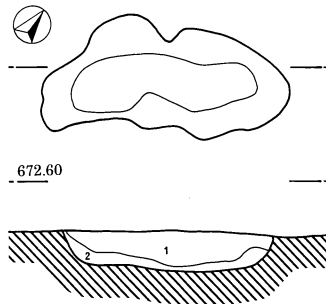

- SK131
- 1 黒色土 やや粗 粘性無 I層混入 I層の埋没土
 - 2 にぶい黄褐色土 やや粗 粘性無 黄褐色ローム混入 ややローム質 III層に近似

SK 172

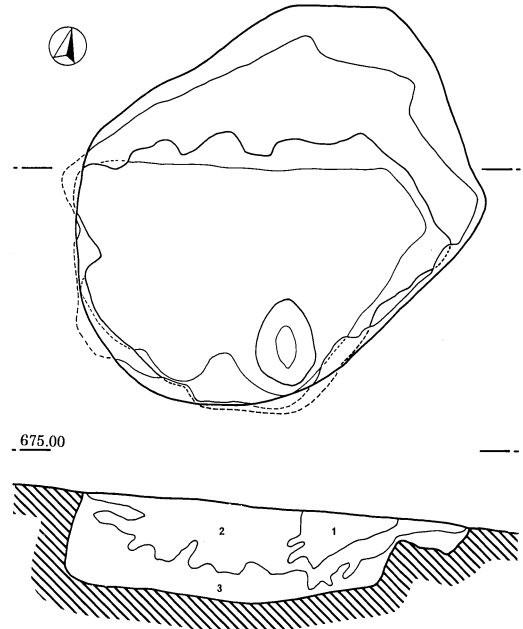

- SK172
- 1 黒褐色土 粗 粘性無 サラサラ
 - 2 褐灰色土 粗 粘性無 サラサラ
 - 3 黄褐色土 粗 粘性有 ややローム質

SK 187

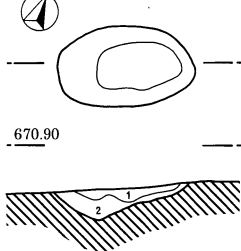

- SK187
- 1 褐灰色土 粗 粘性無 ポロポロ
 - 2 黄褐色土 粗 粘性無 ややローム質

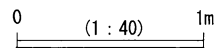

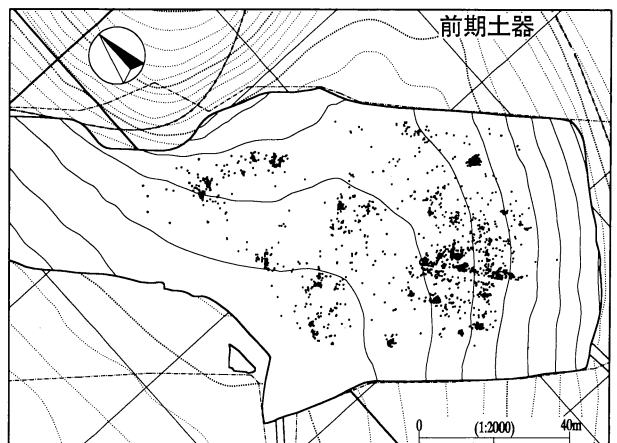
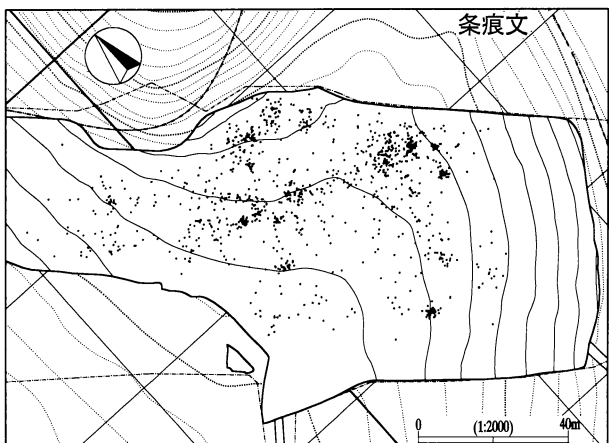
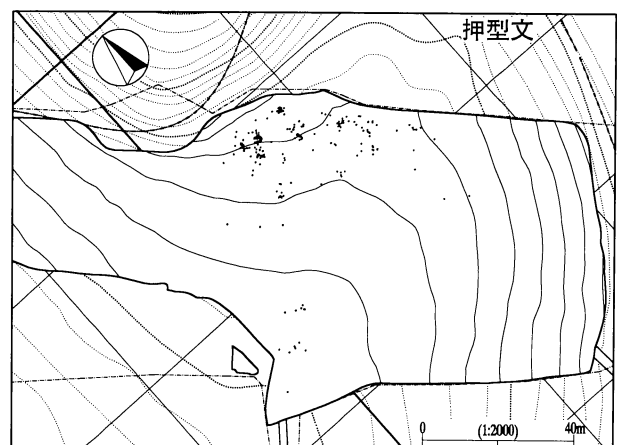
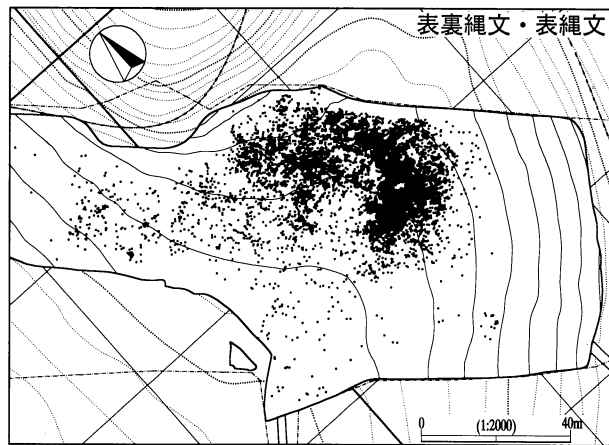
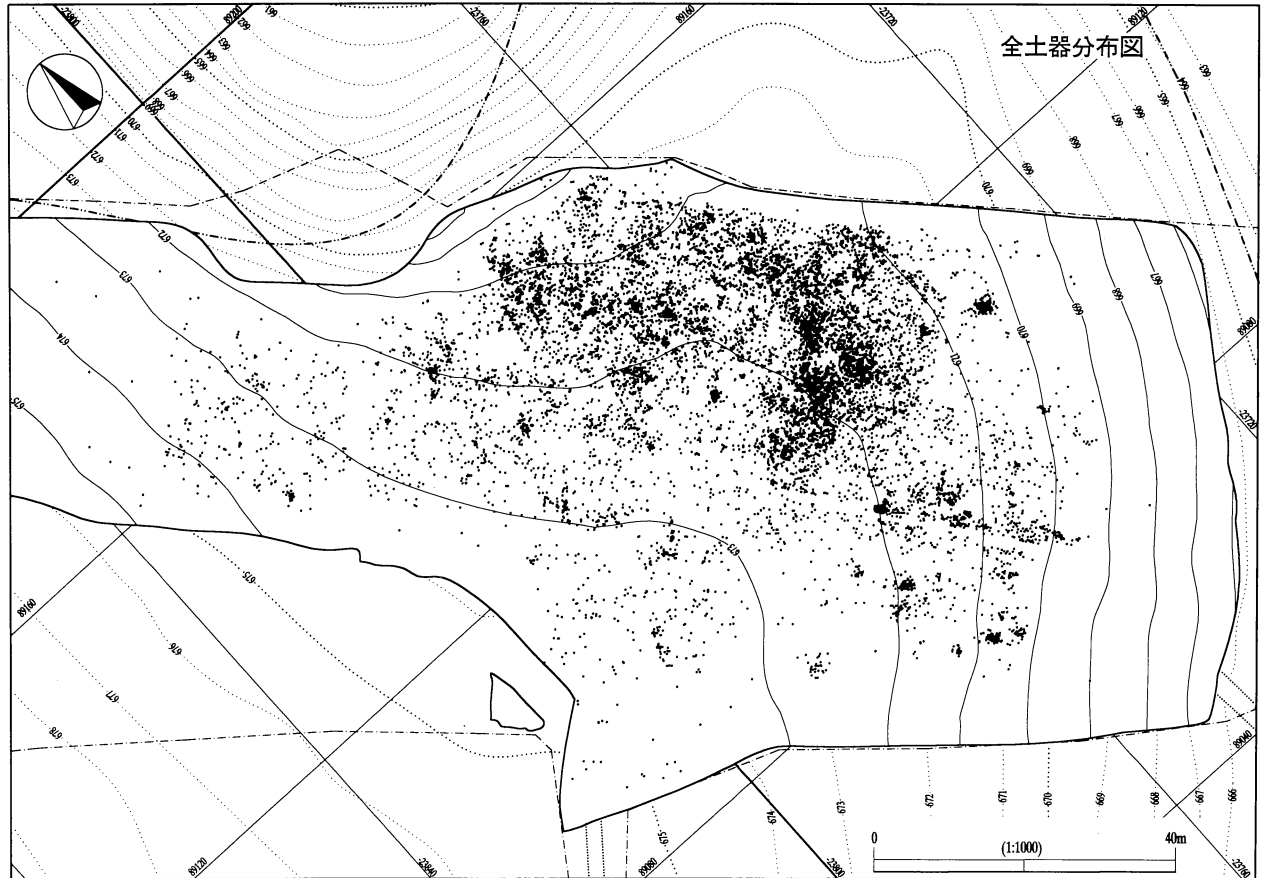

縄文時代土器分布図

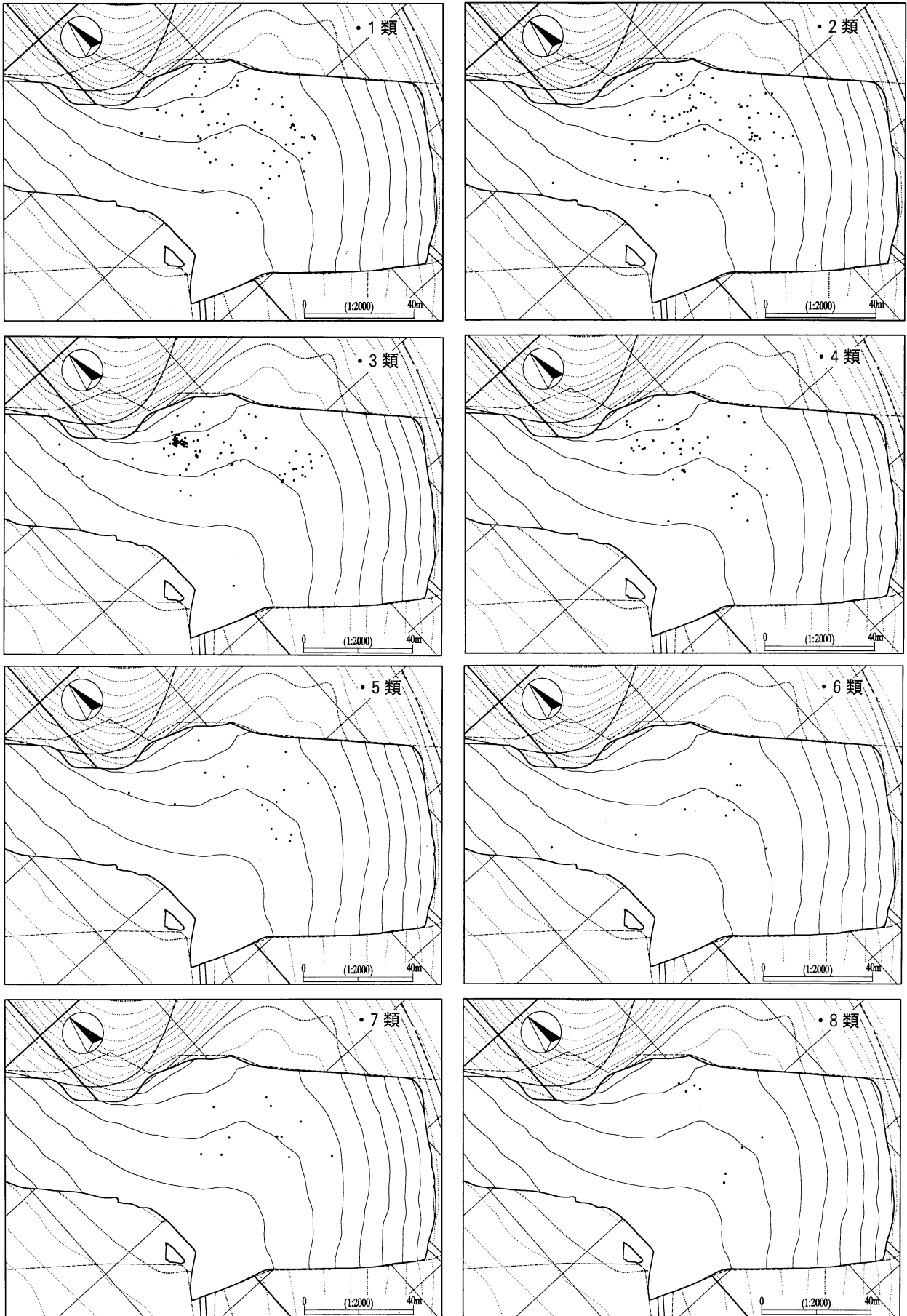

縄文時代表裏縄文土器分類別分布図

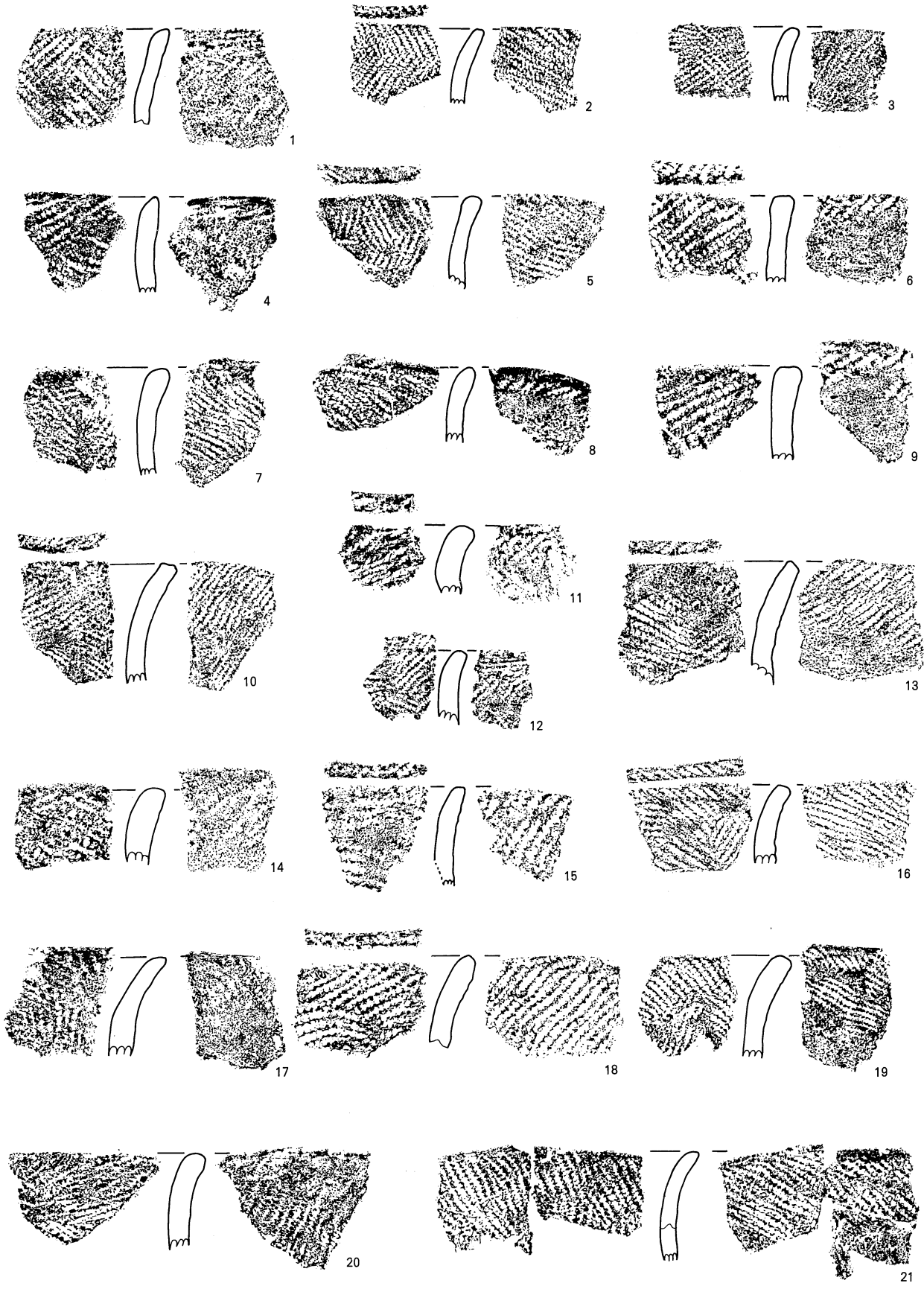

0 (1 : 2) 5cm

縄文時代土器 1

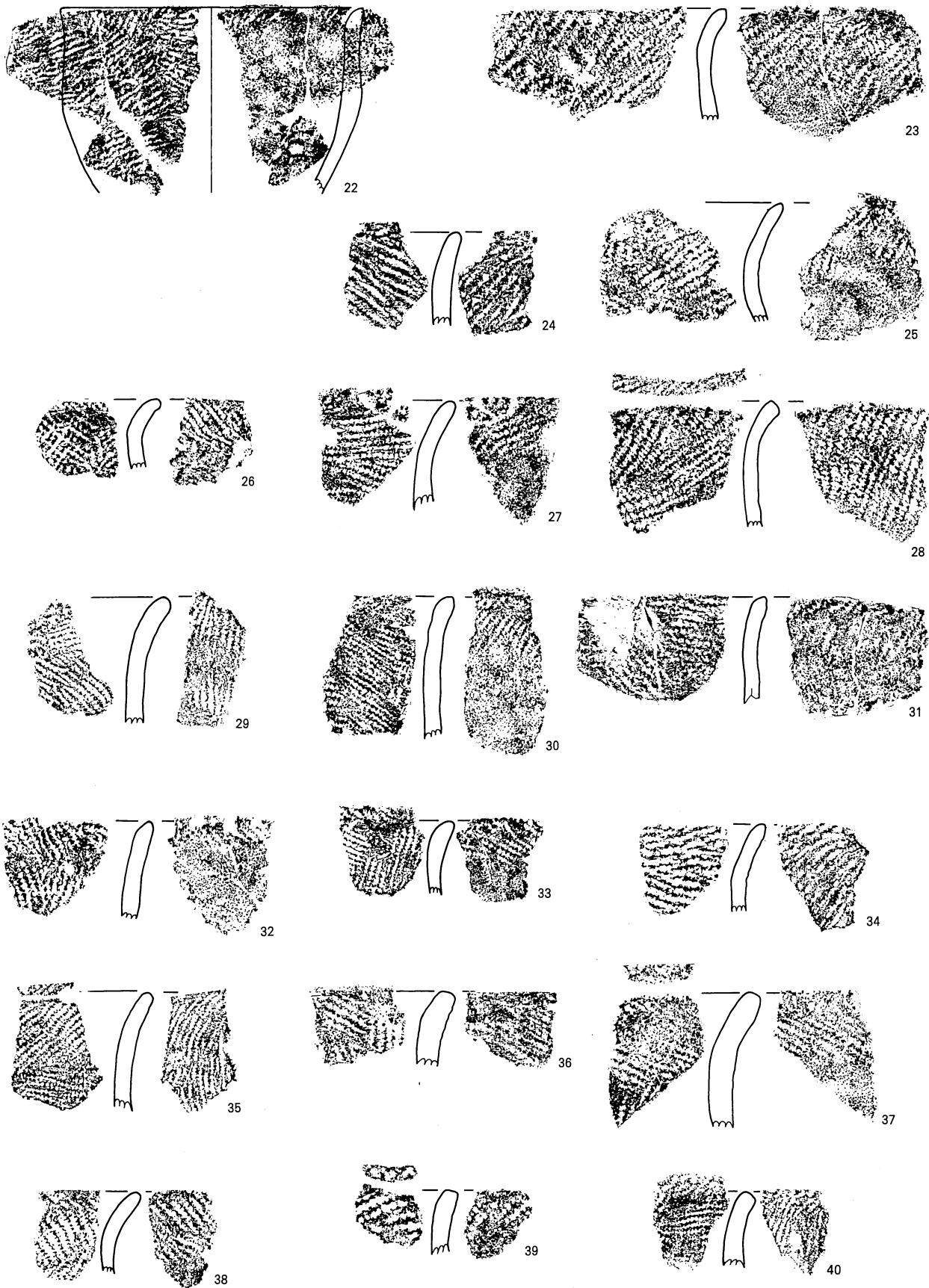

0 (1 : 2) 5cm

縄文時代土器 2

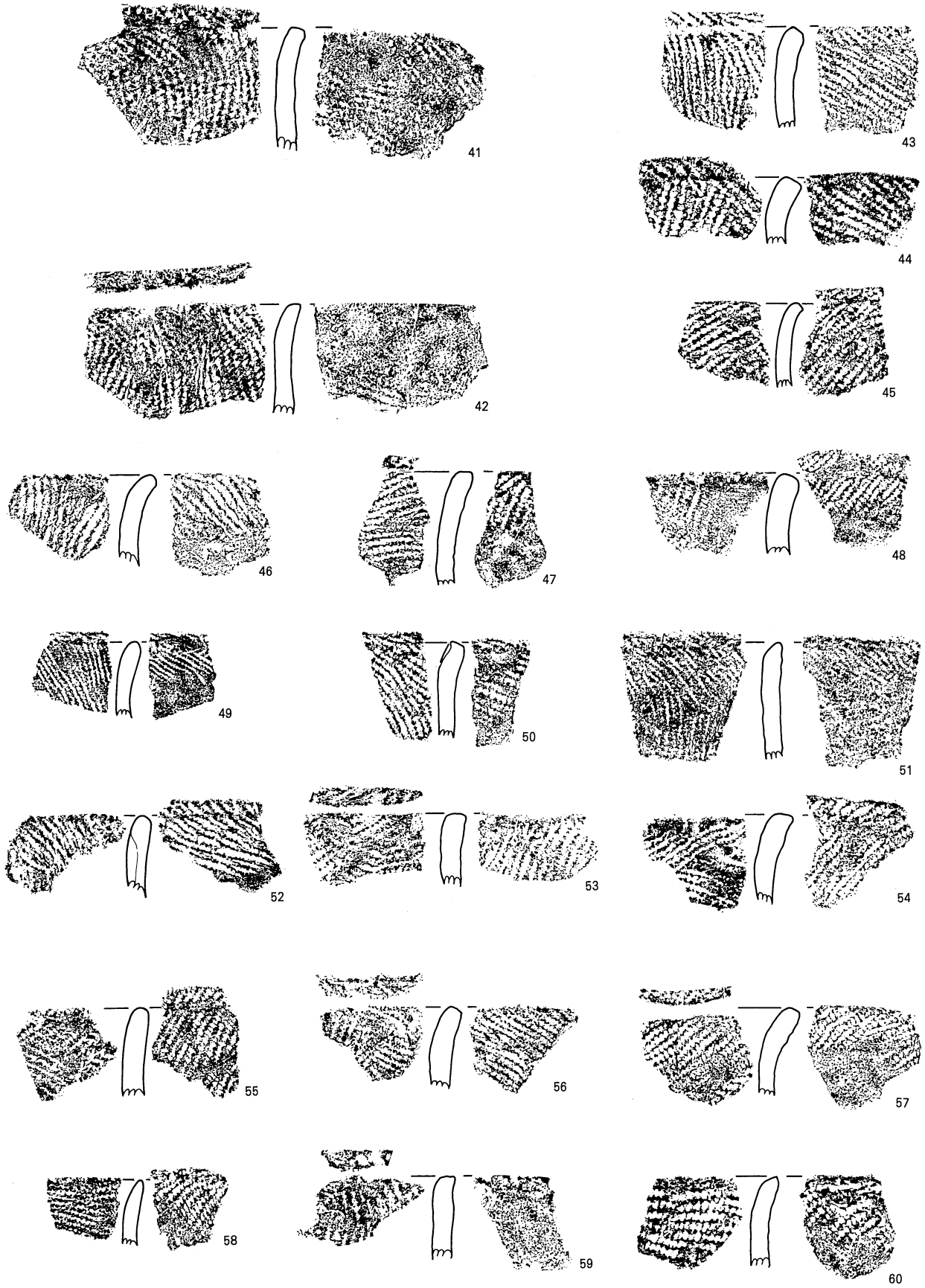

0 (1:2) 5cm

縄文時代土器 3

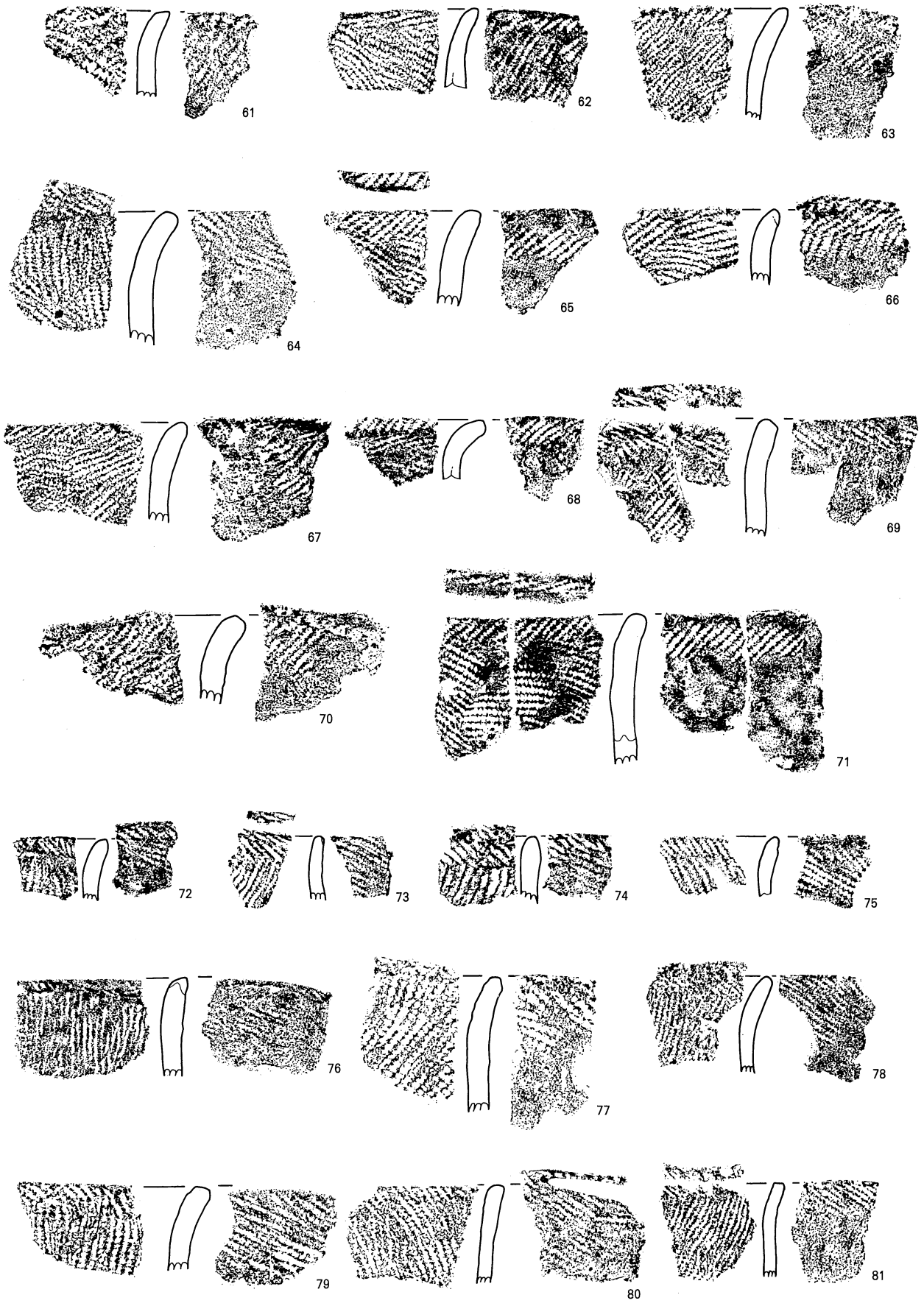

0 (1:2) 5cm

縄文時代土器 4



縄文時代土器 5

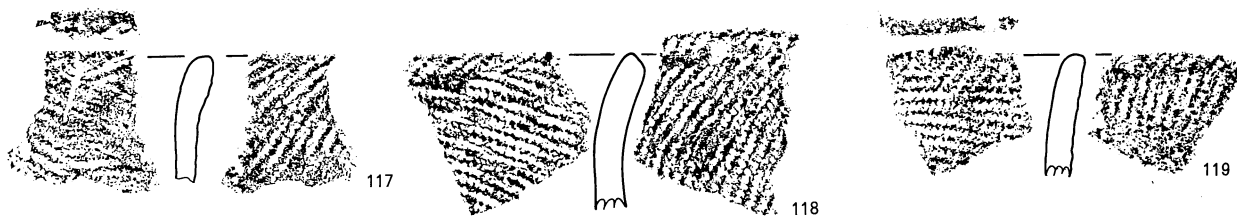
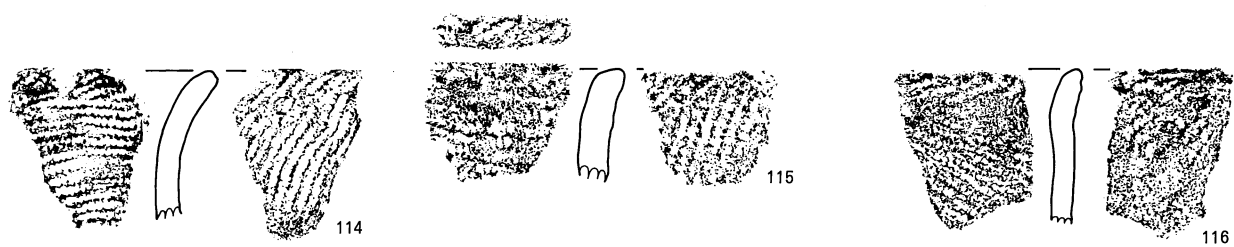
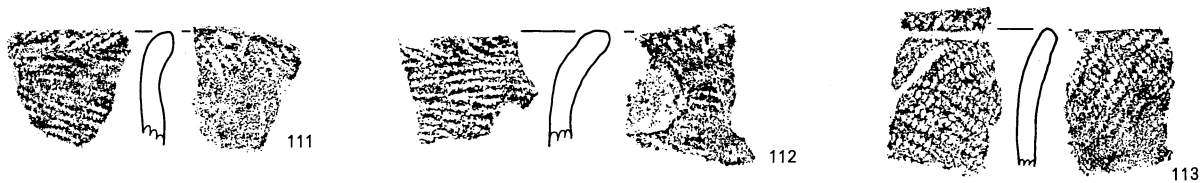
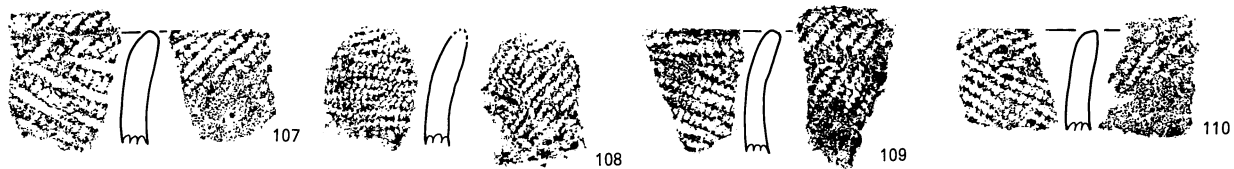

0 (1:2) 5cm

縄文時代土器 6

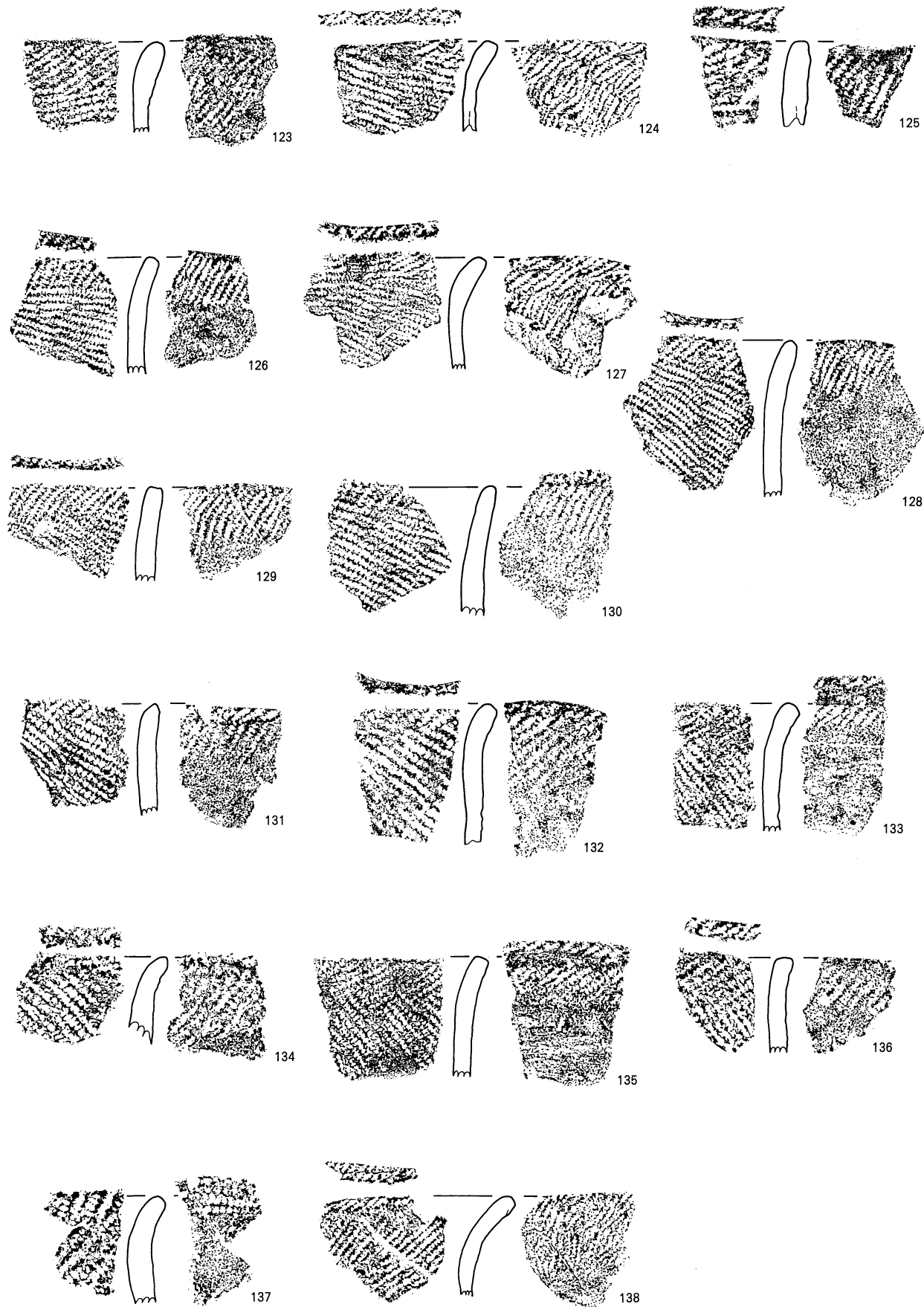

0 (1:2) 5cm

縄文時代土器 7

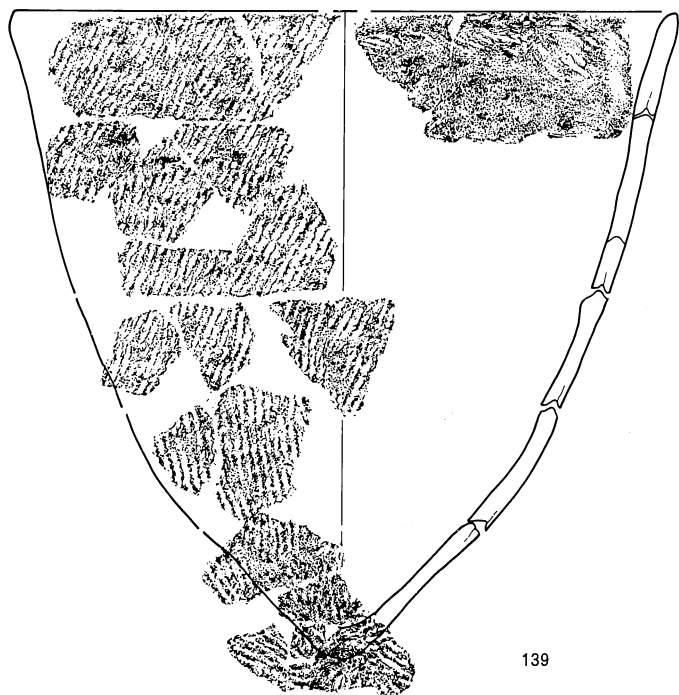

139

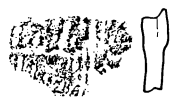

0 (1 : 3) 10cm



140

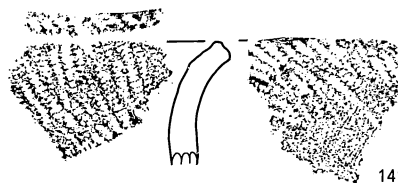

141

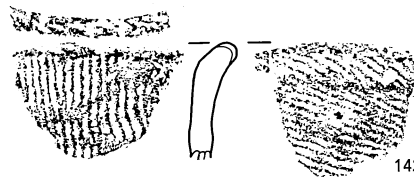

142



143



144



145

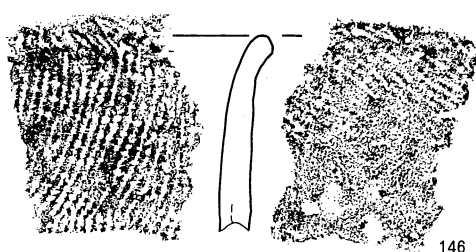

146



147

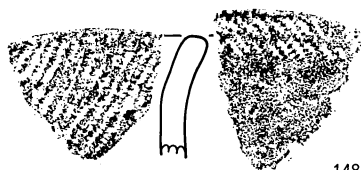

148

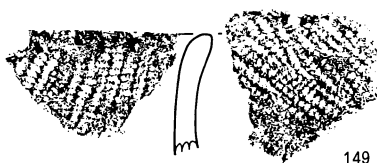

149



150



151

0 (1 : 2) 5cm

縄文時代土器 8

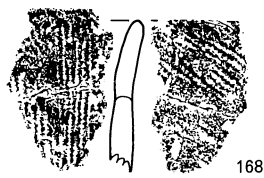
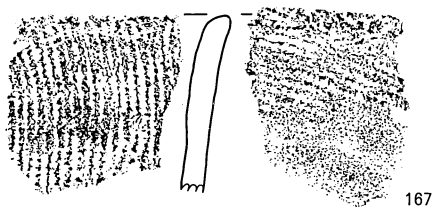
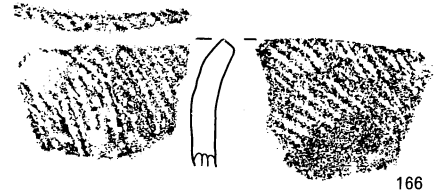
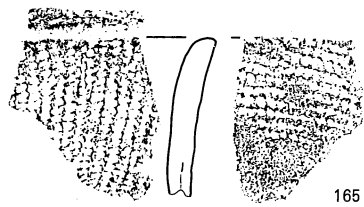
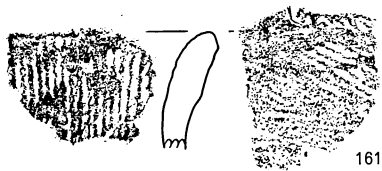
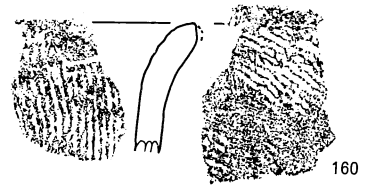
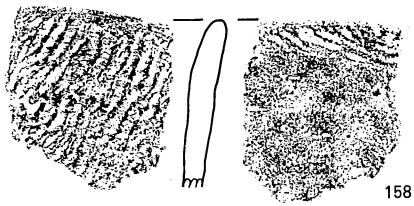
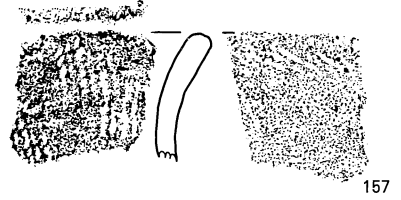
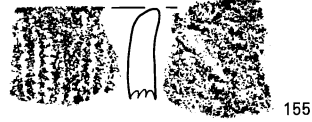
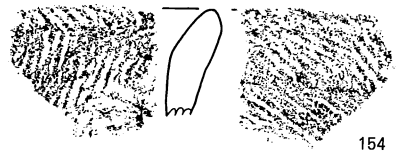

0 (1 : 2) 5cm

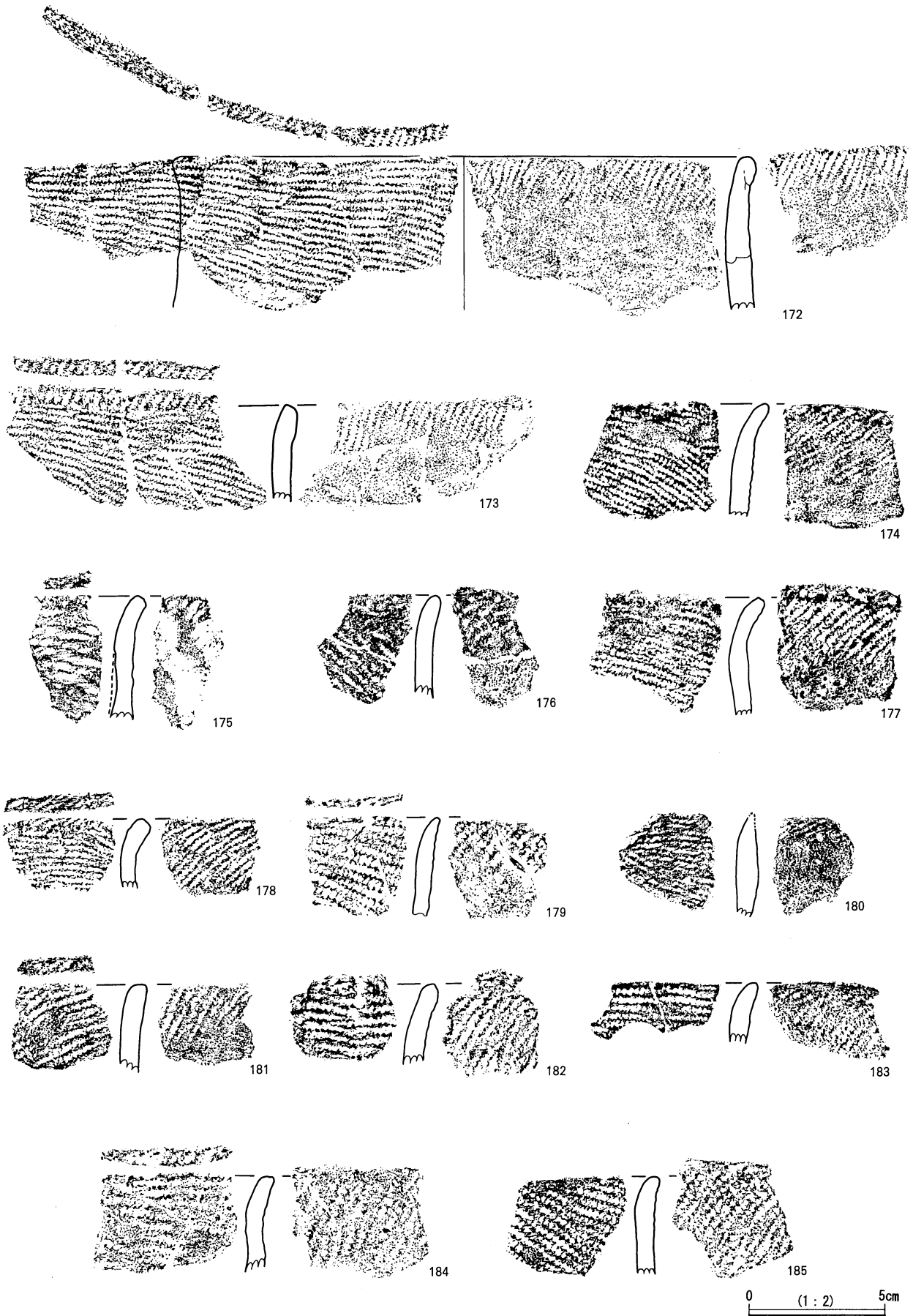

縄文時代土器 10

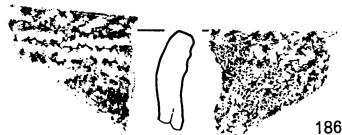

186



187

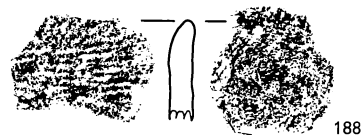

188



189



190



191

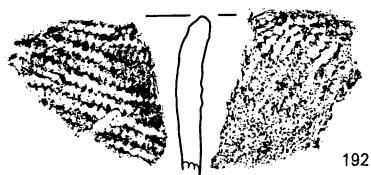

192

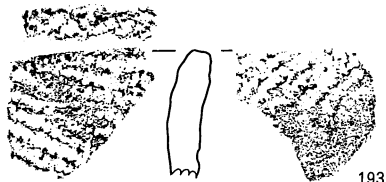

193



194

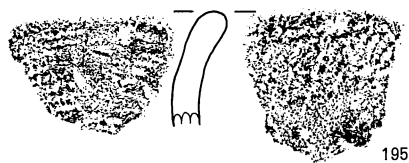

195



196



197

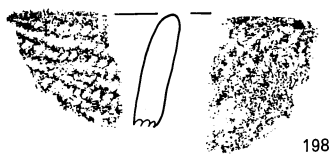

198



199

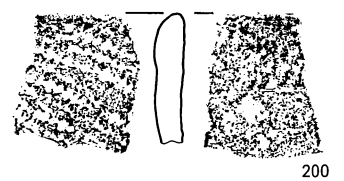

200



201

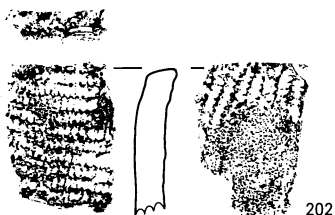

202

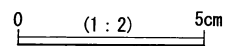

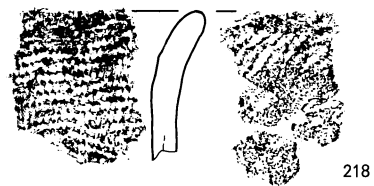
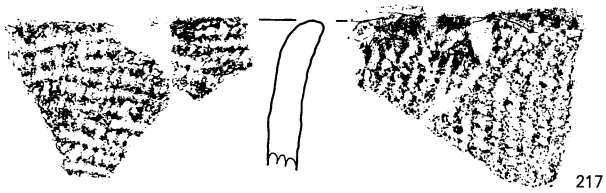
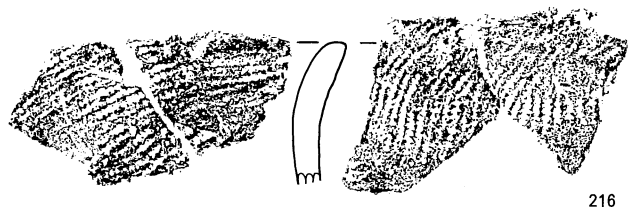
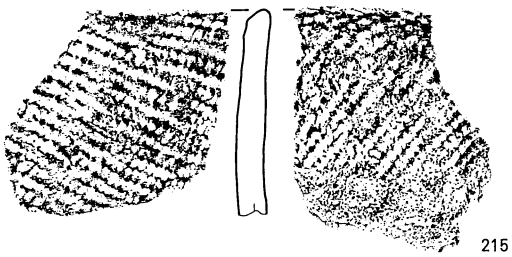
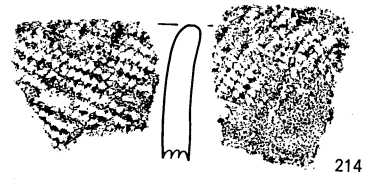
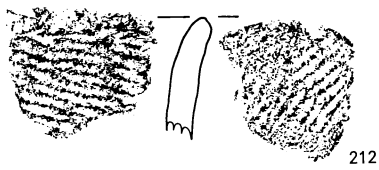
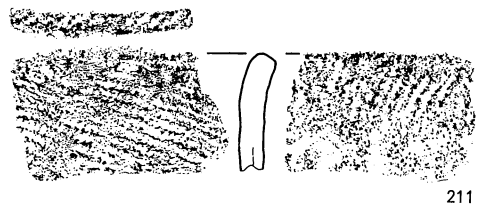
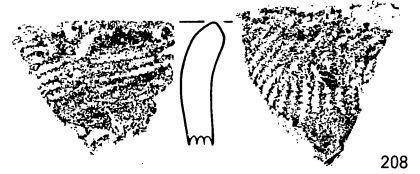
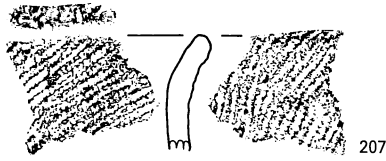
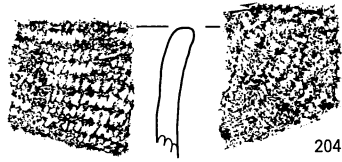

0 (1:2) 5cm

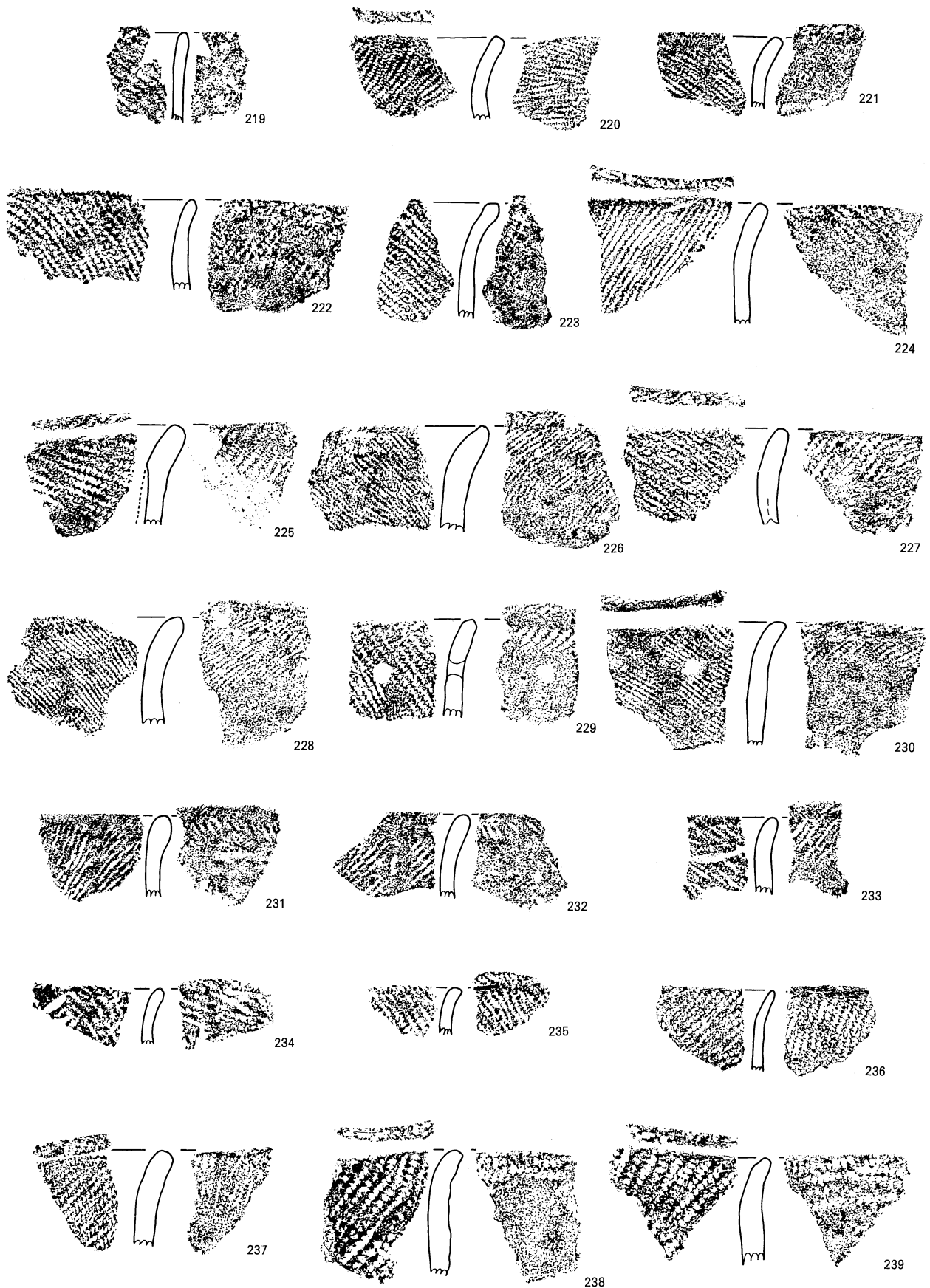

0 (1:2) 5cm



240



241



242

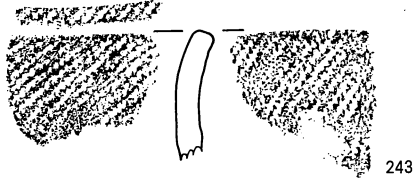

243



244



245

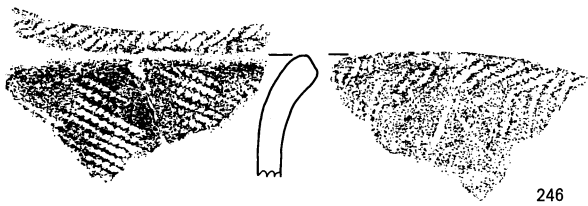

246



247

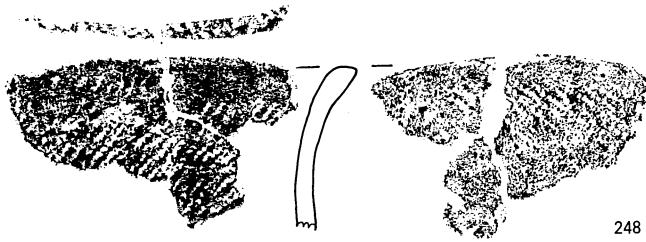

248



249

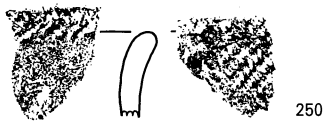

250



251



252

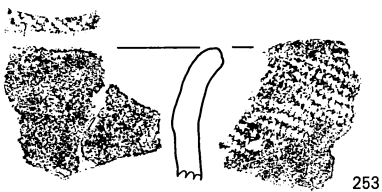

253



254



255

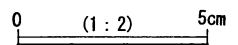

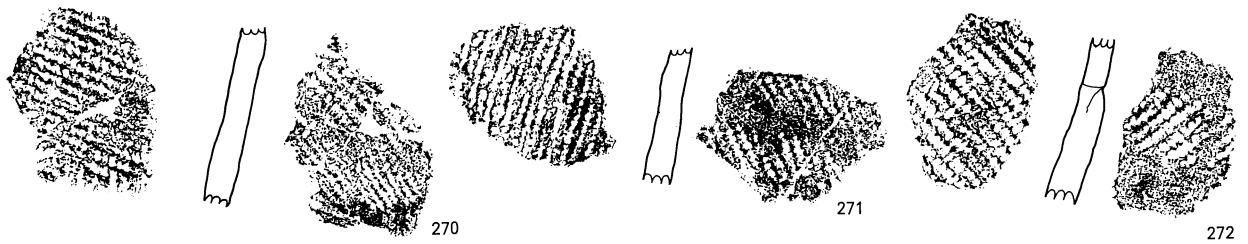
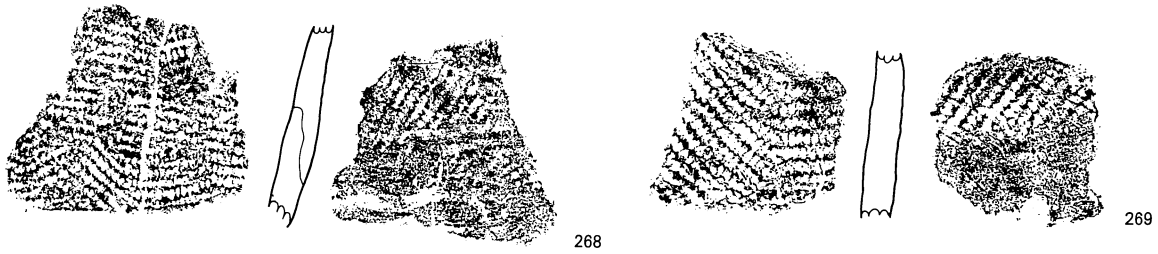
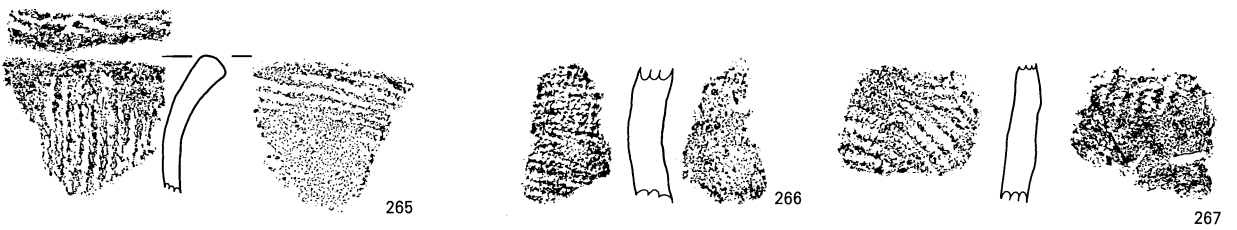
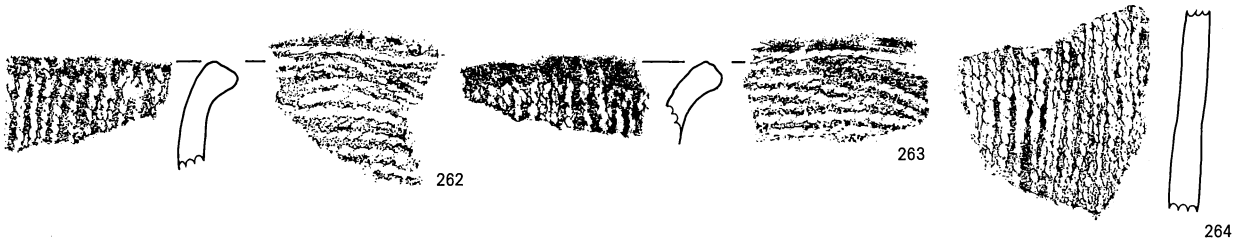
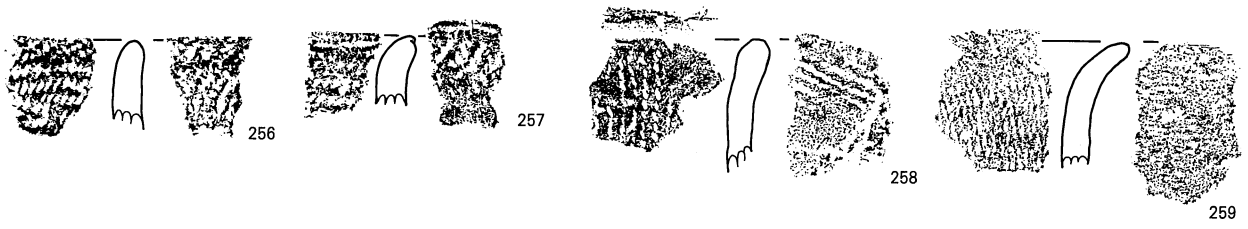

0 (1:2) 5cm

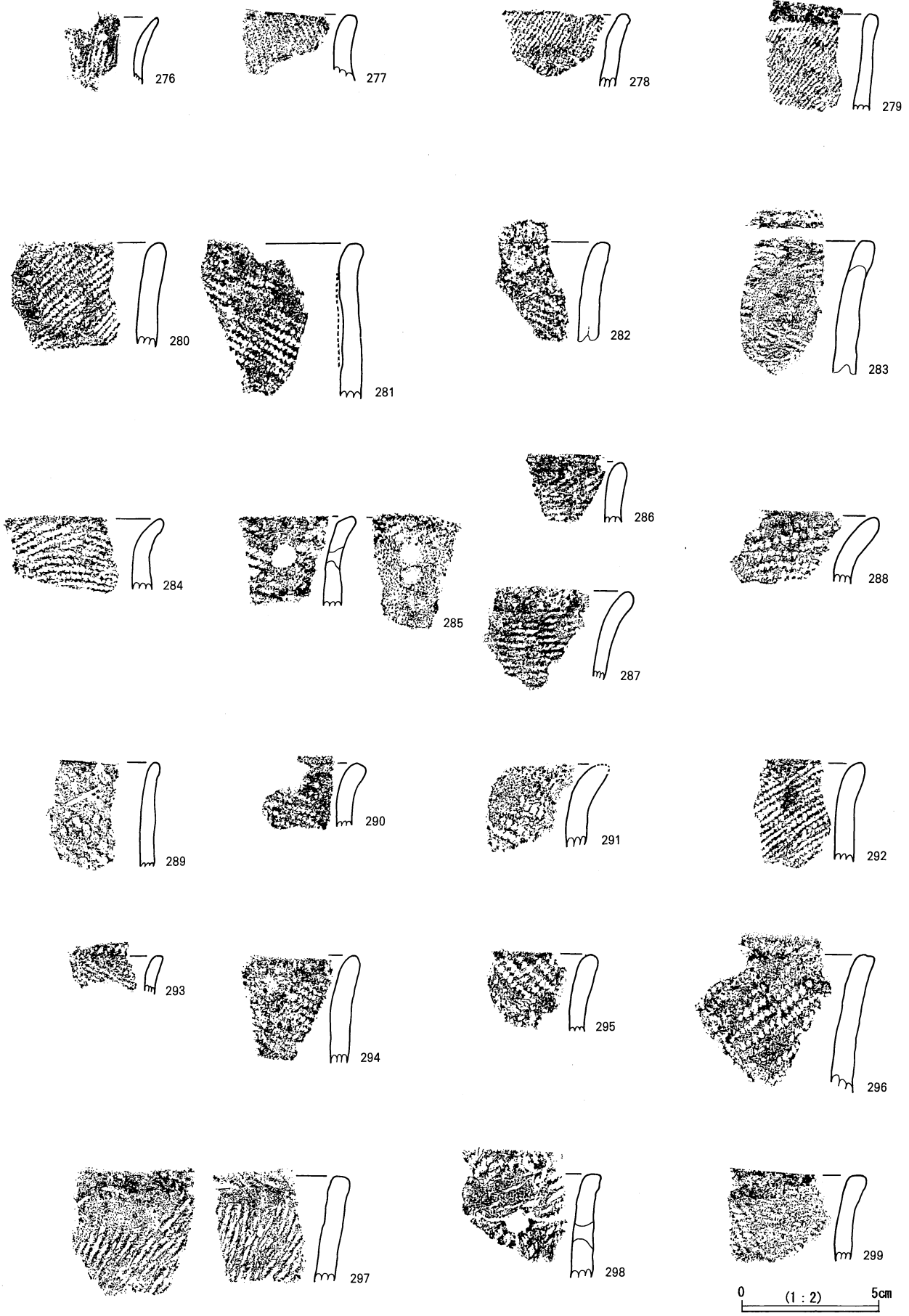

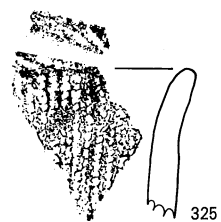
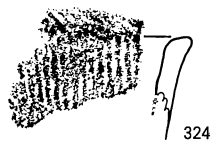
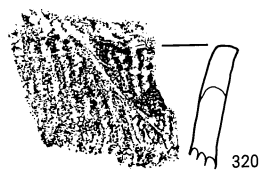
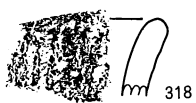
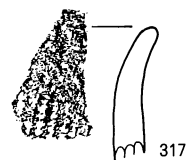
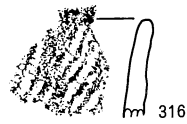
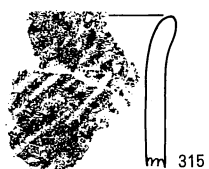
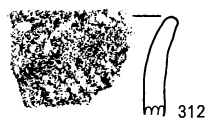
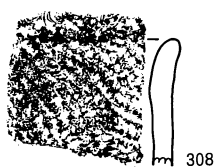
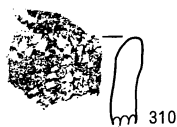
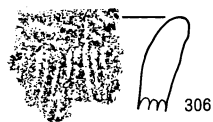
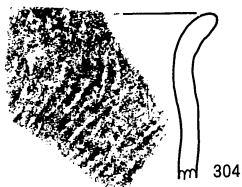
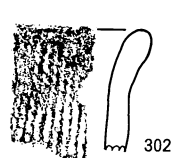

0 (1 : 2) 5cm

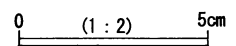
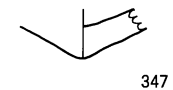
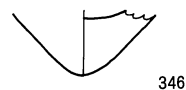
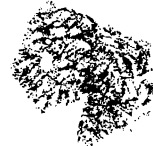
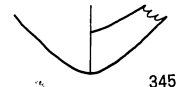
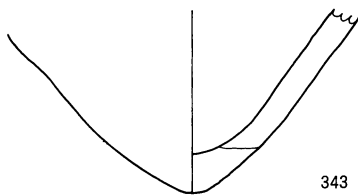
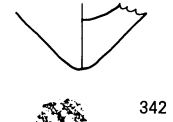
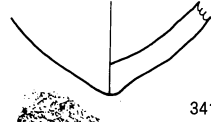
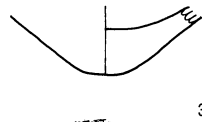
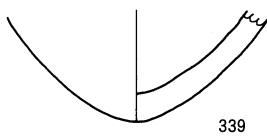
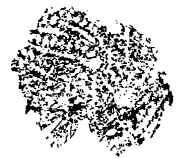
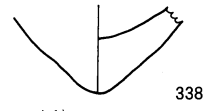
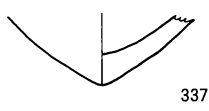
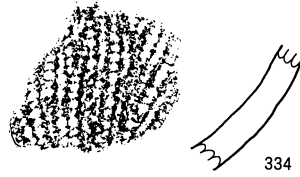

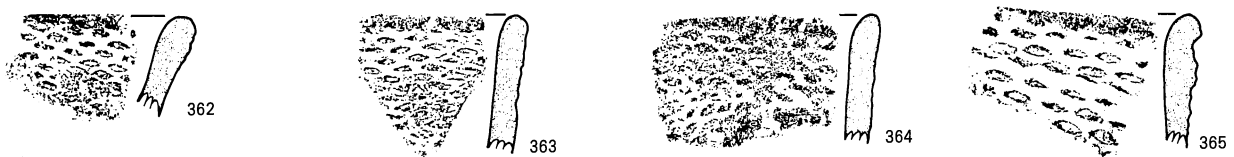
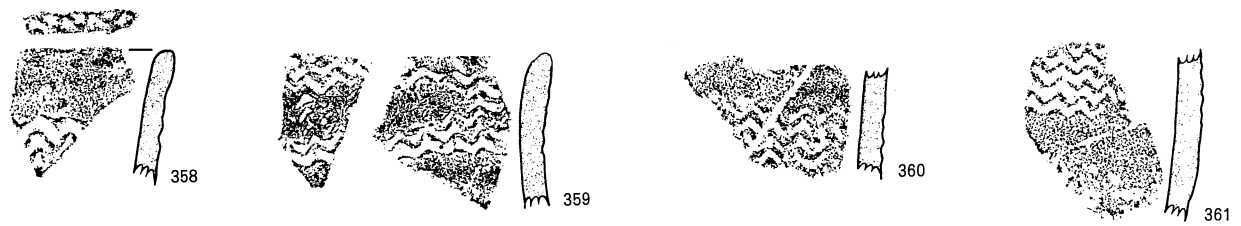
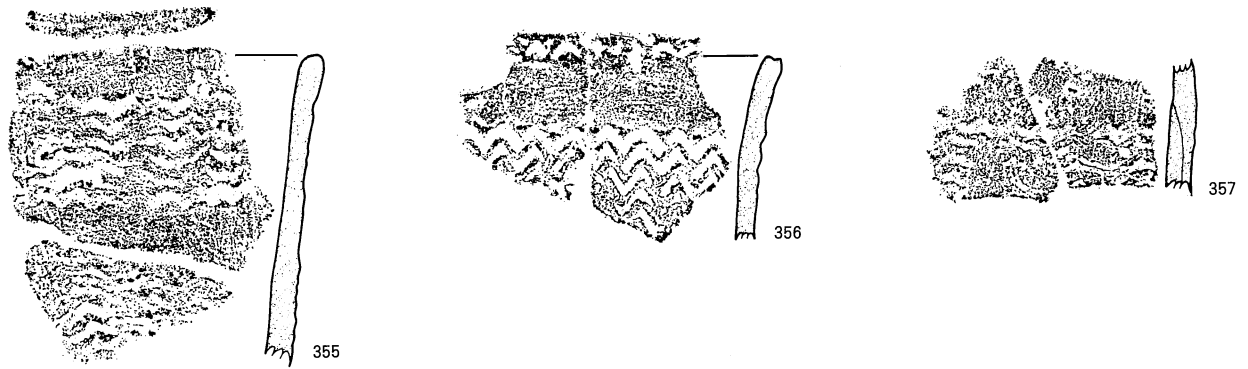
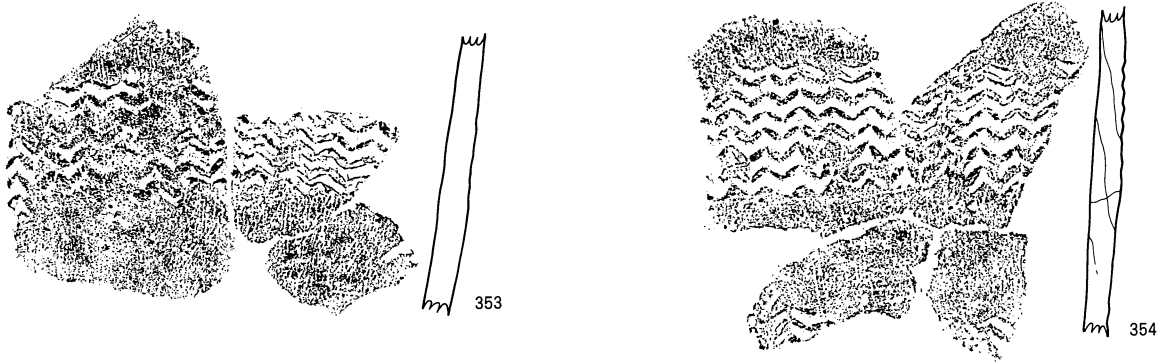
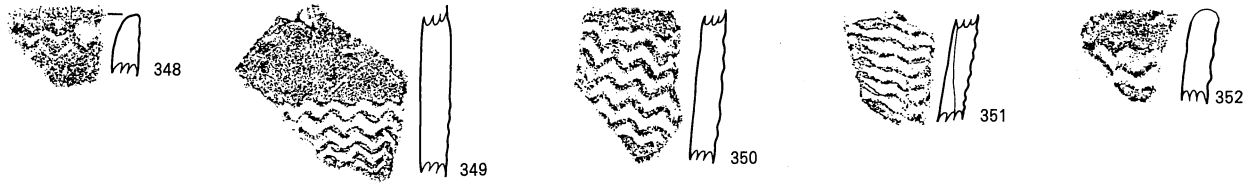

0 (1:2) 5cm

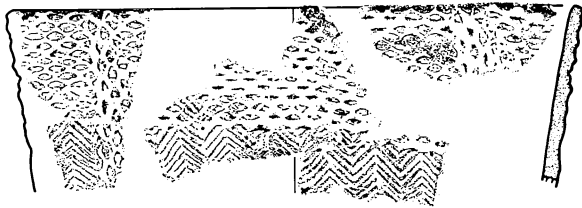
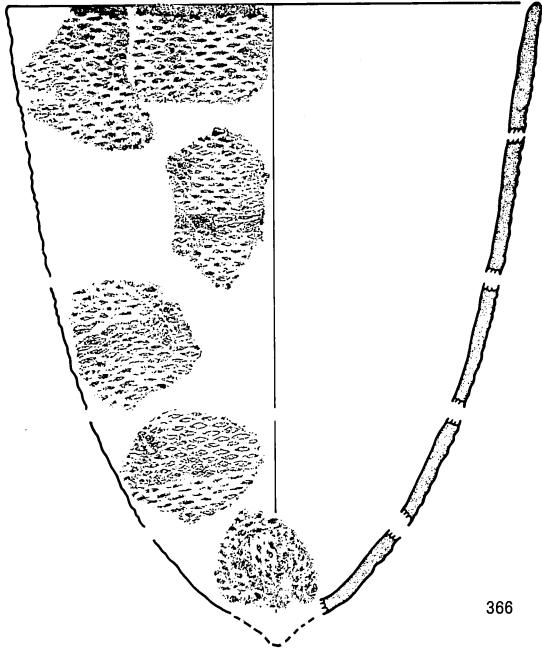

0 (1:3) 10cm

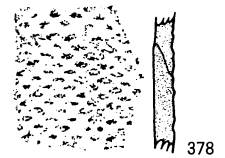
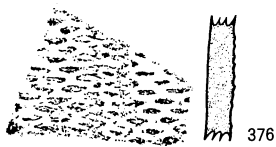
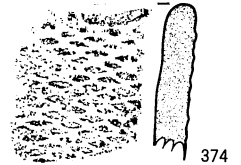
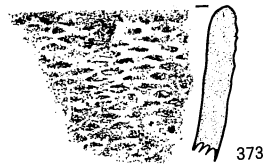
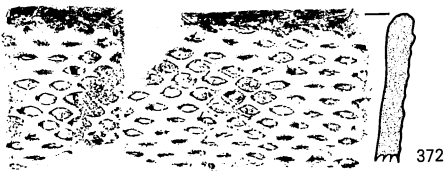
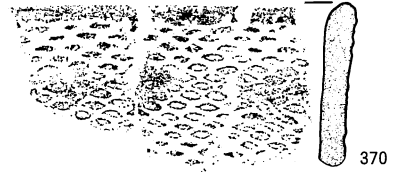
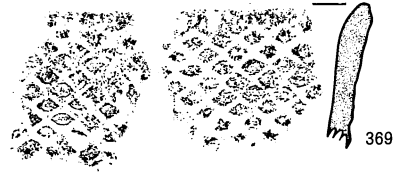

0 (1:2) 5cm

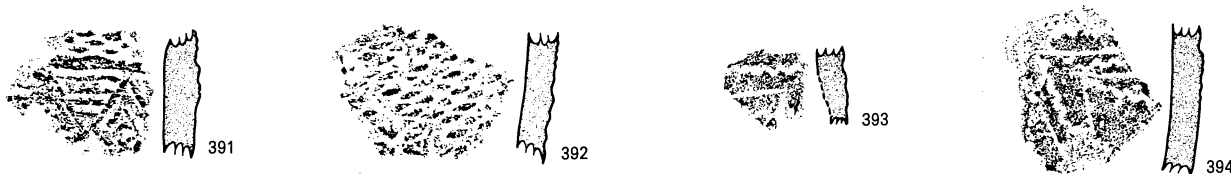
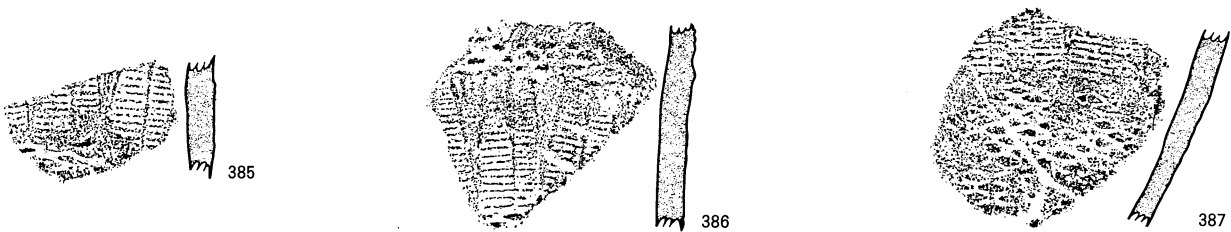
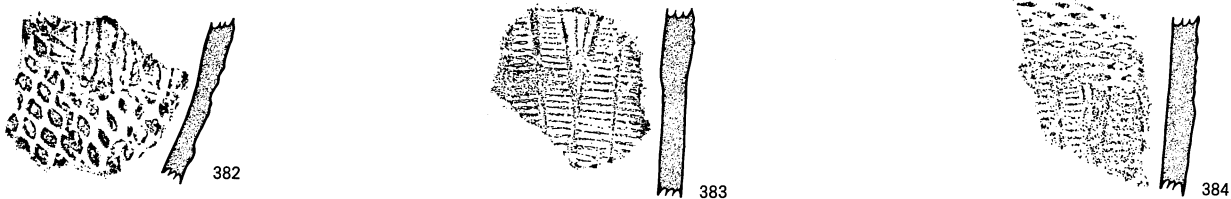
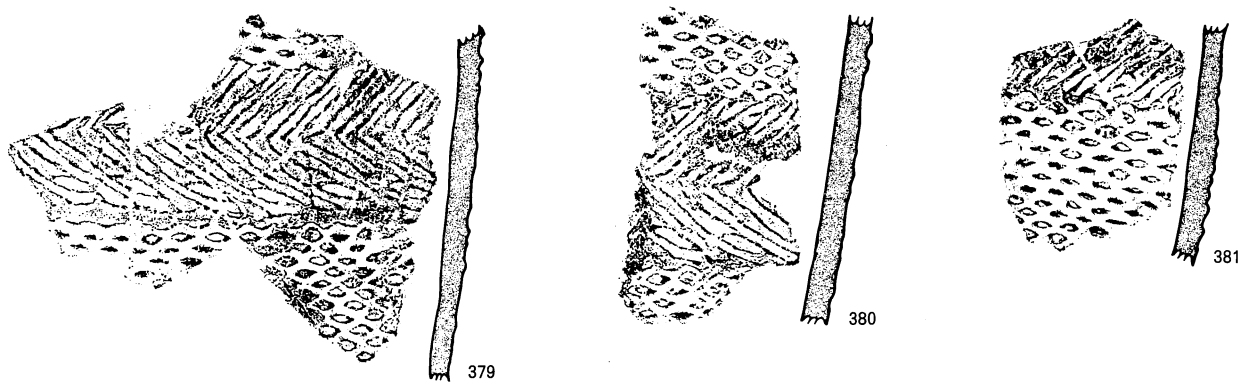

0 (1:2) 5cm



395



396

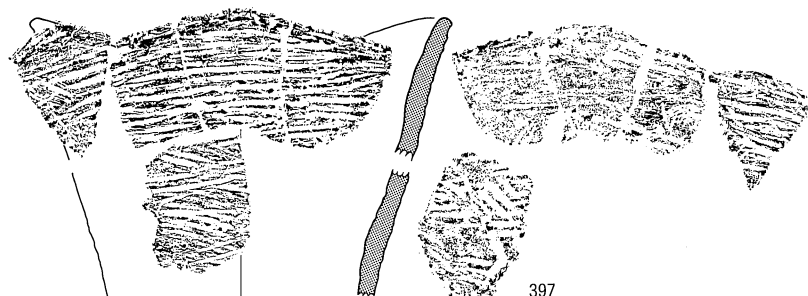

397



400



401



402



403

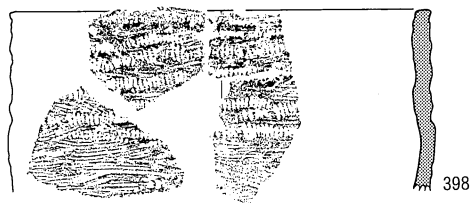

398

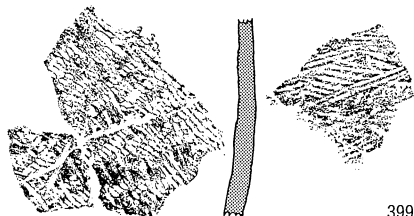

399

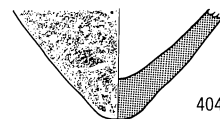

404

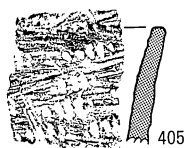
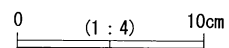

405



406



407

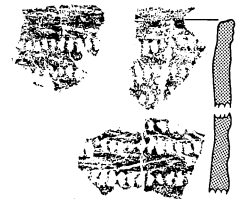

408



409



410

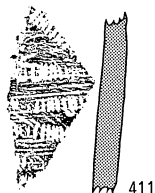

411

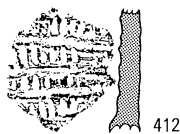

412



413

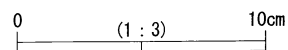

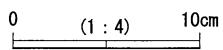
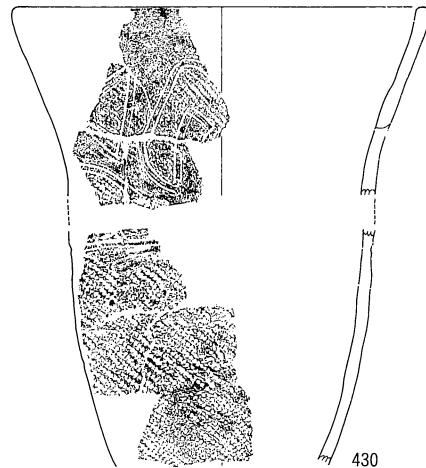
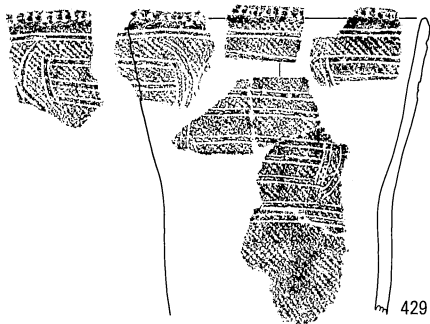
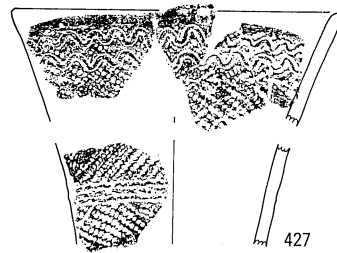
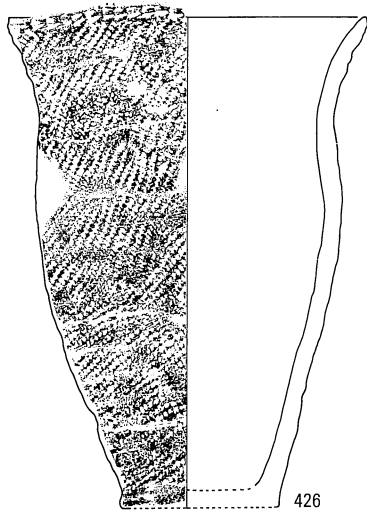
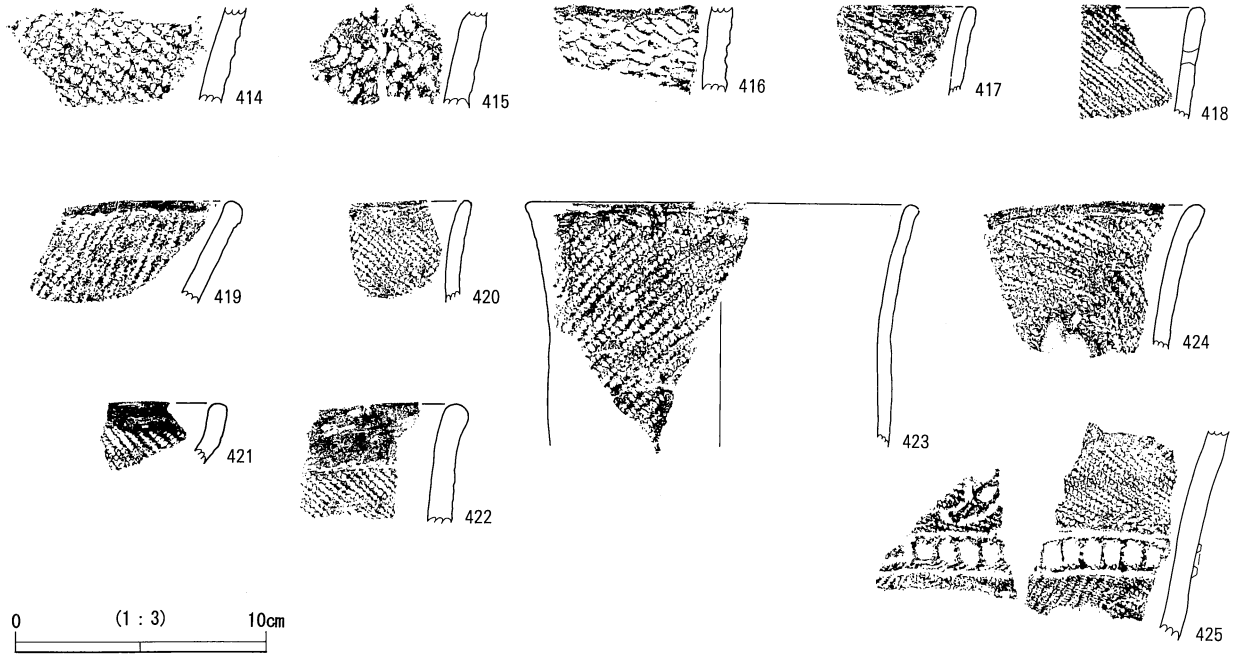

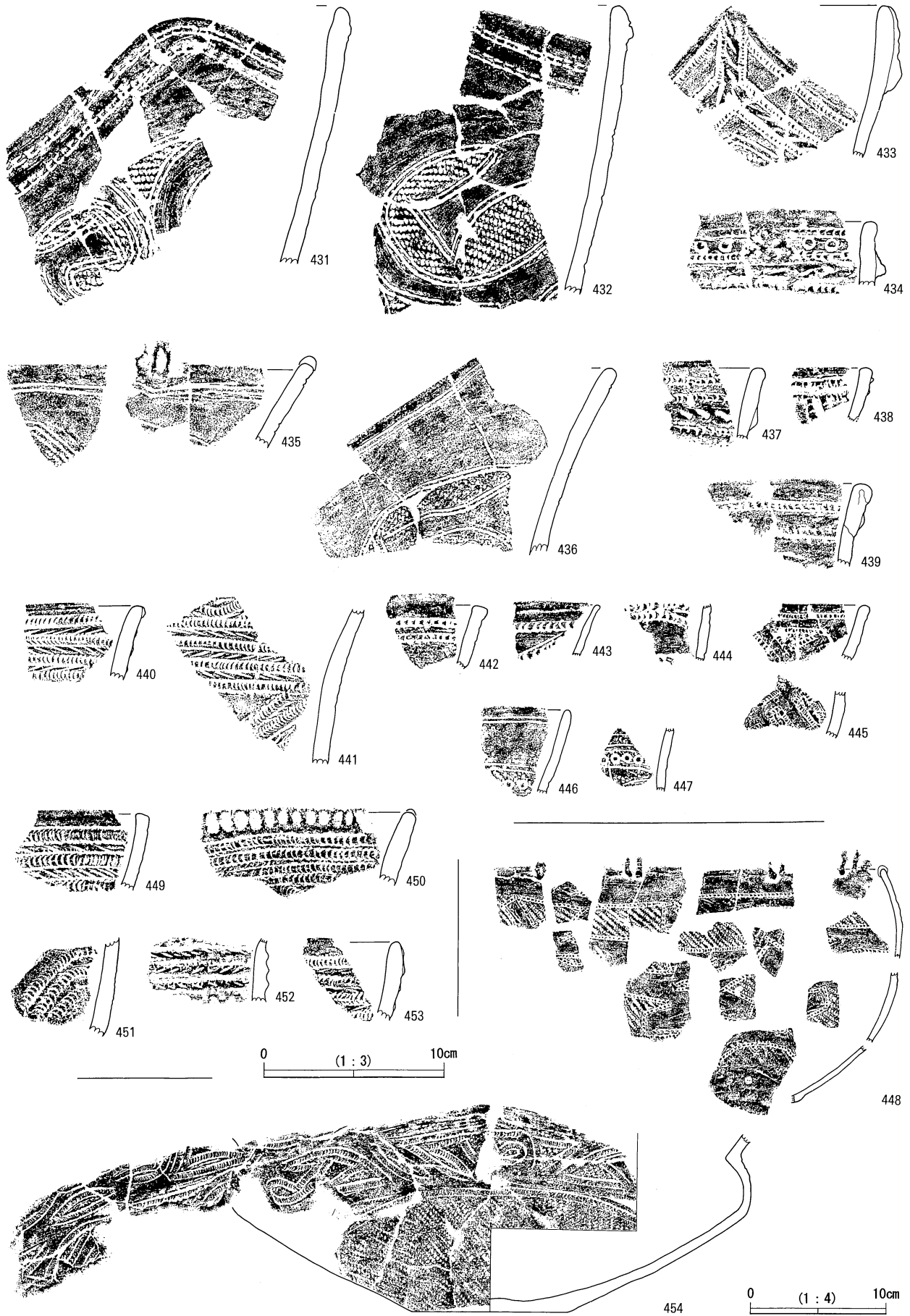

縄文時代土器 24



455

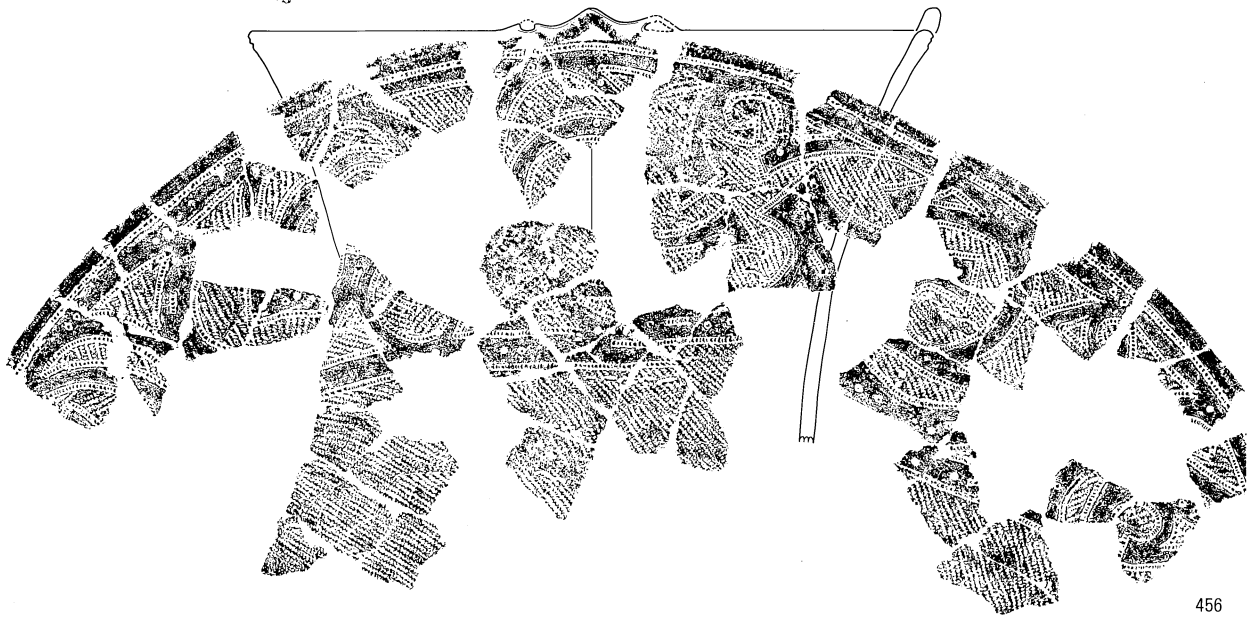

456



457

0 (1 : 4) 10cm

縄文時代土器 25



458

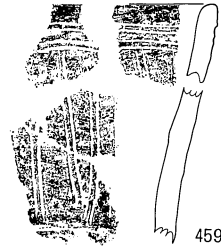

459

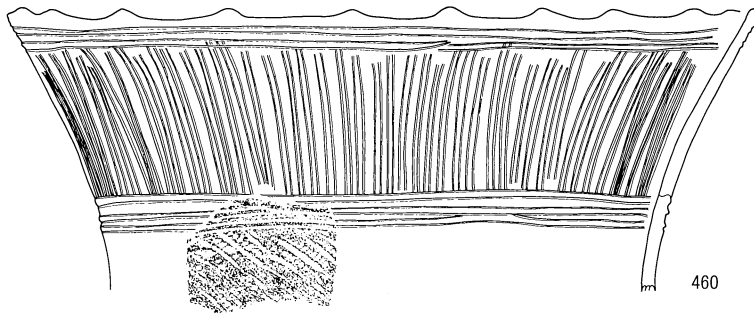

460



461

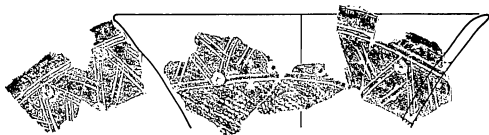

462

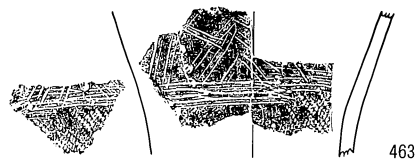

463



0 (1:4) 10cm

縄文時代土器 26

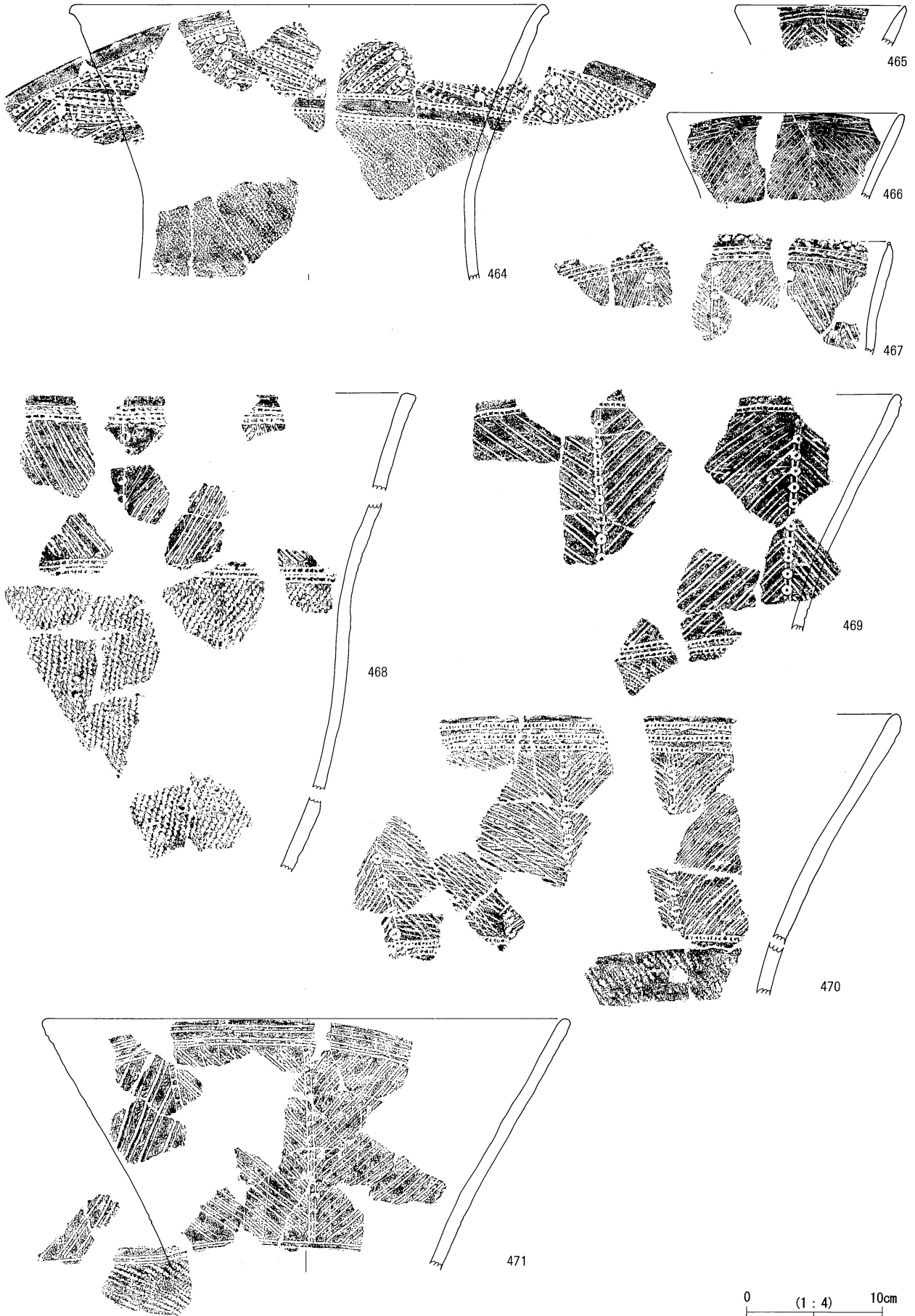

縄文時代土器 27

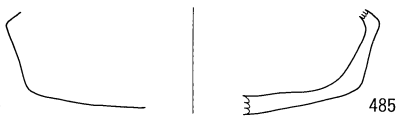
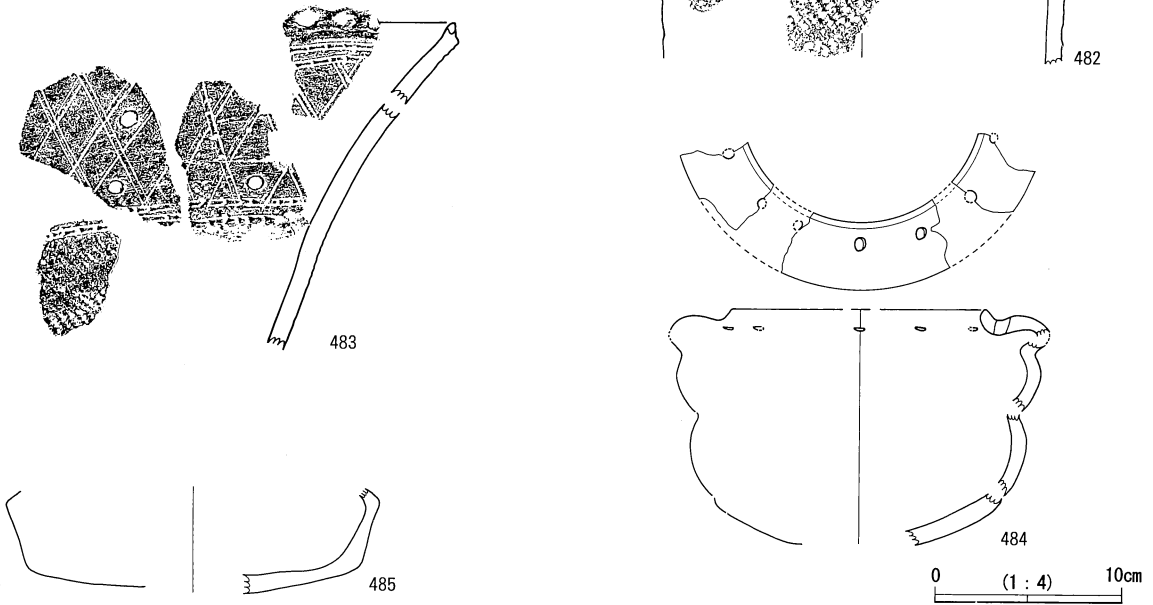
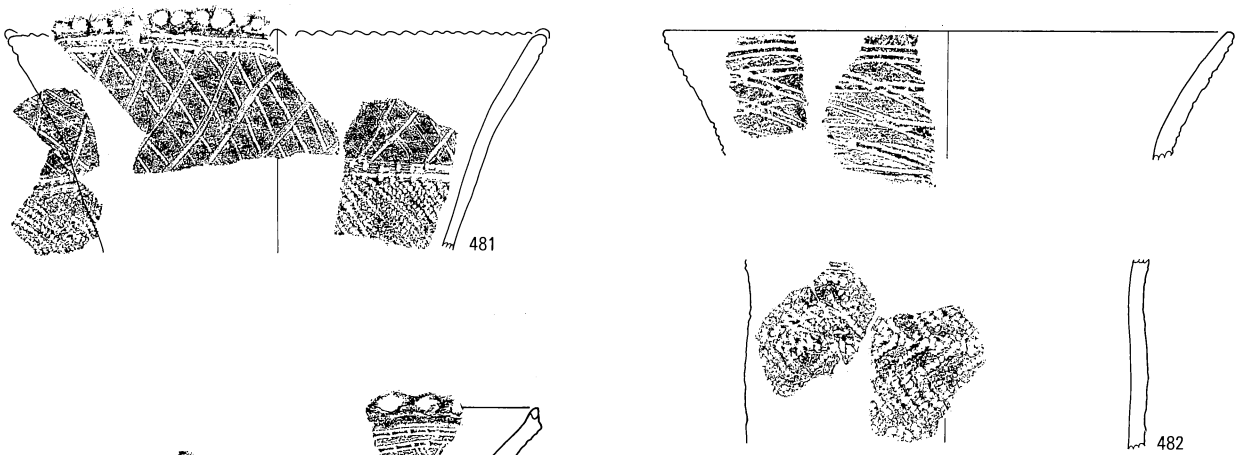
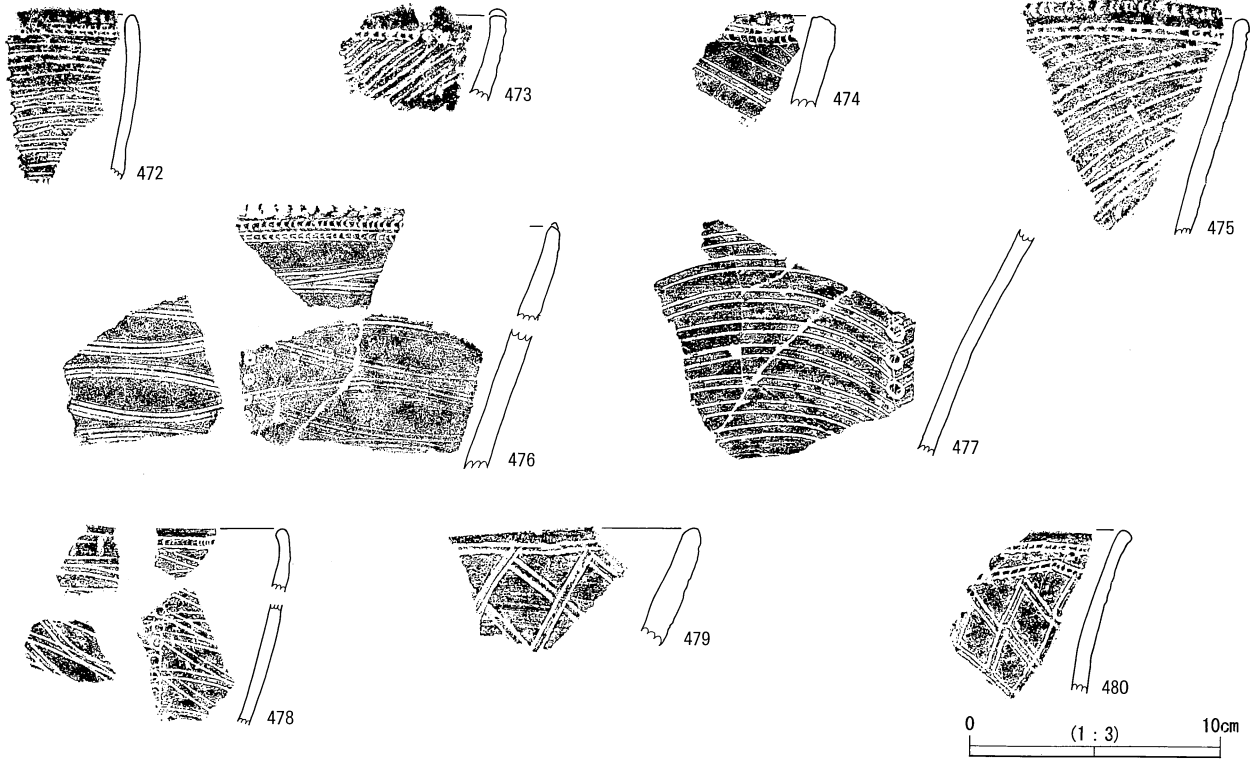

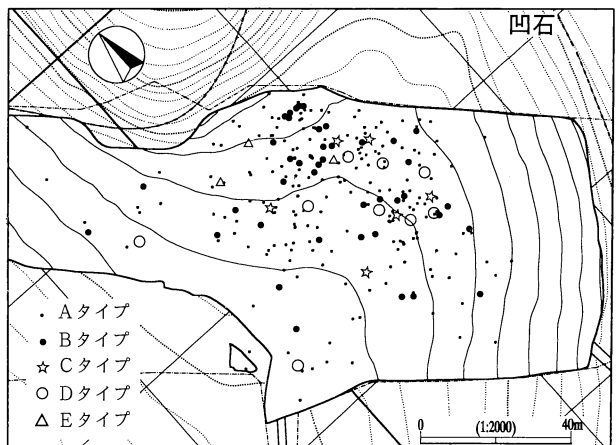
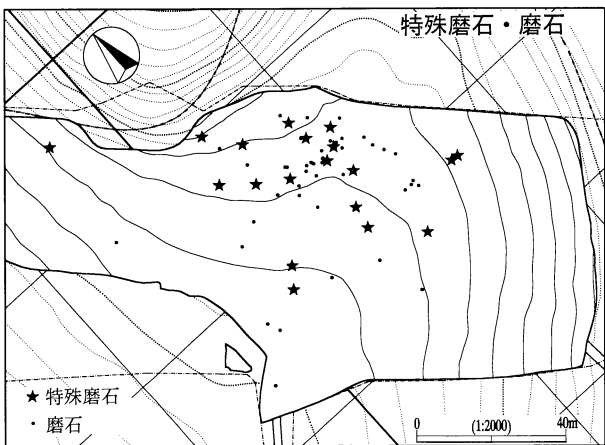
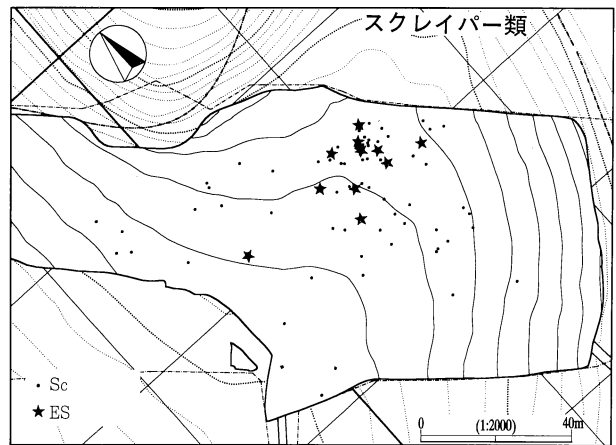
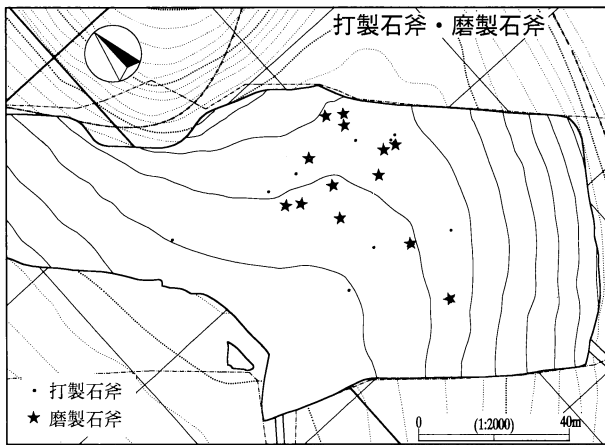
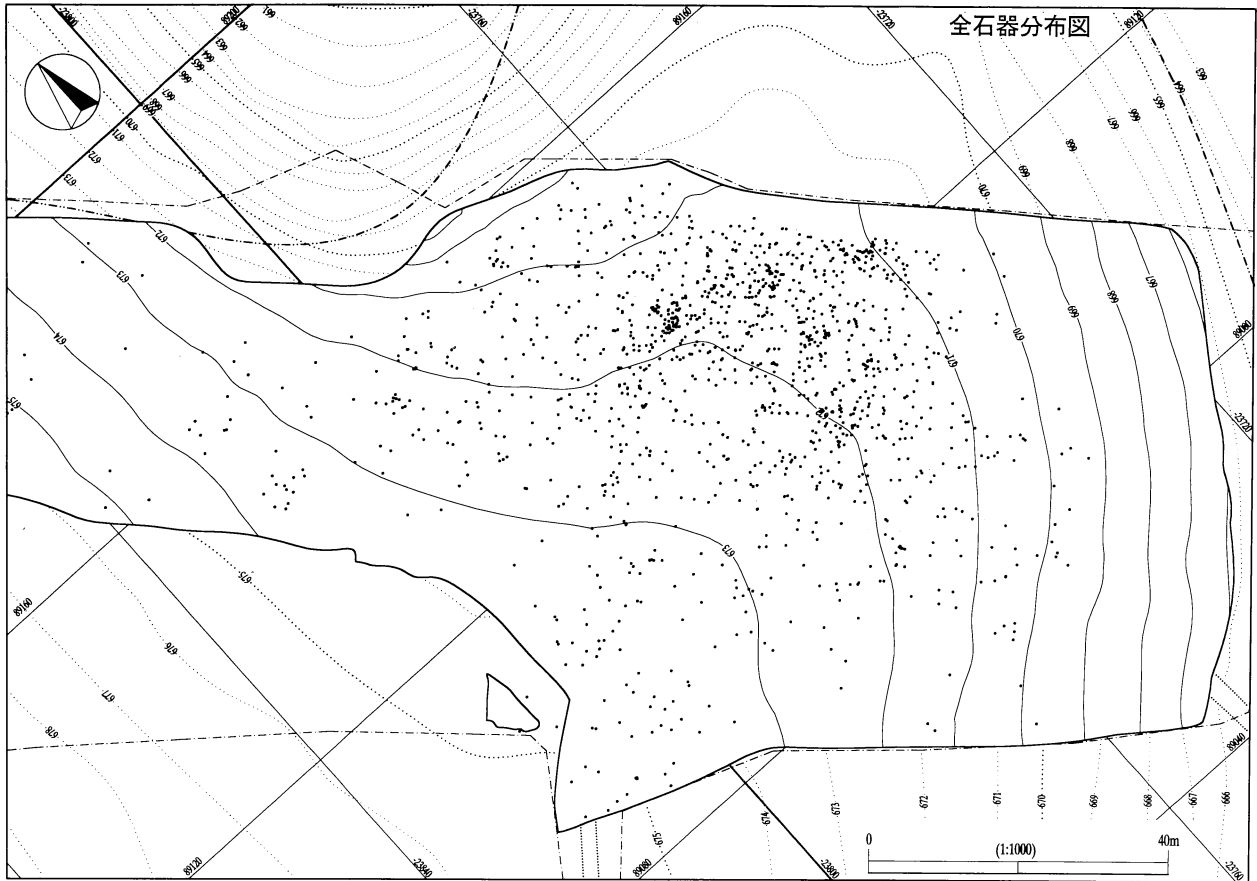

縄文時代石器分布図

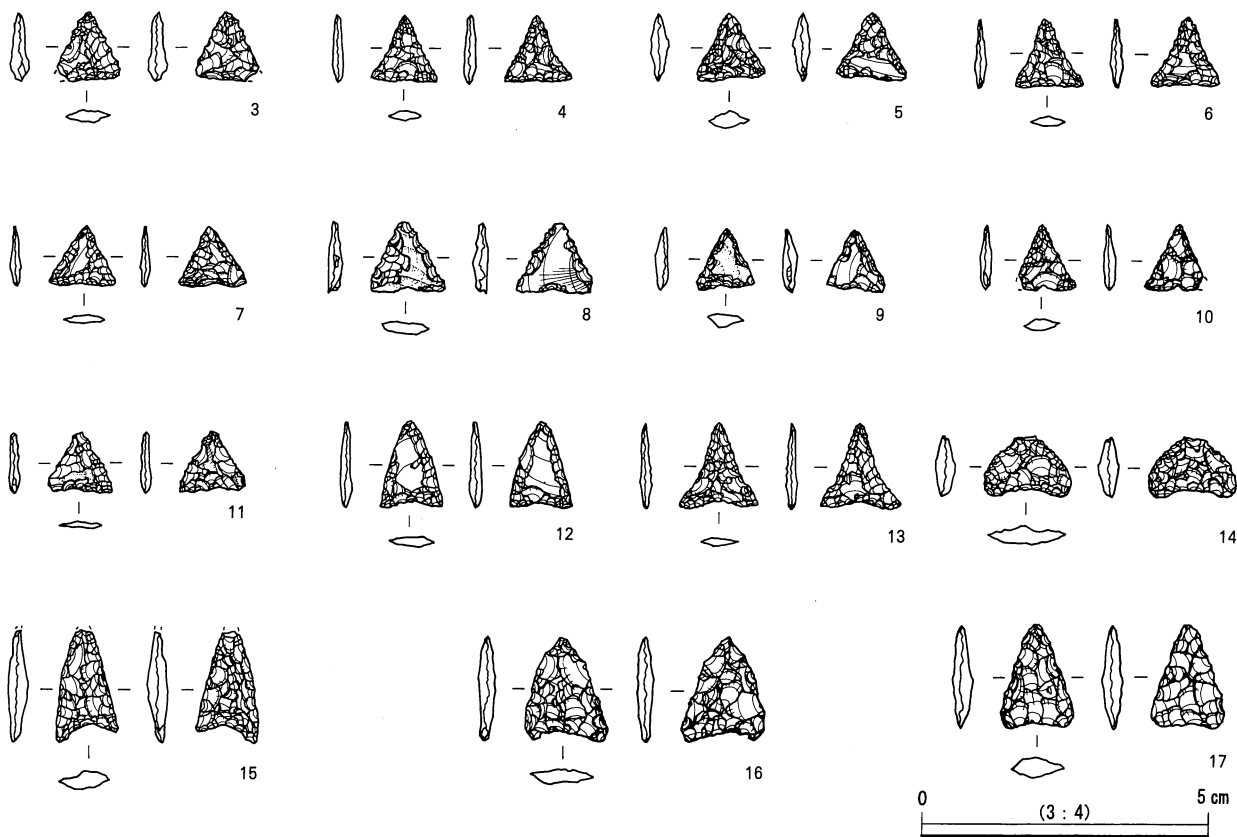
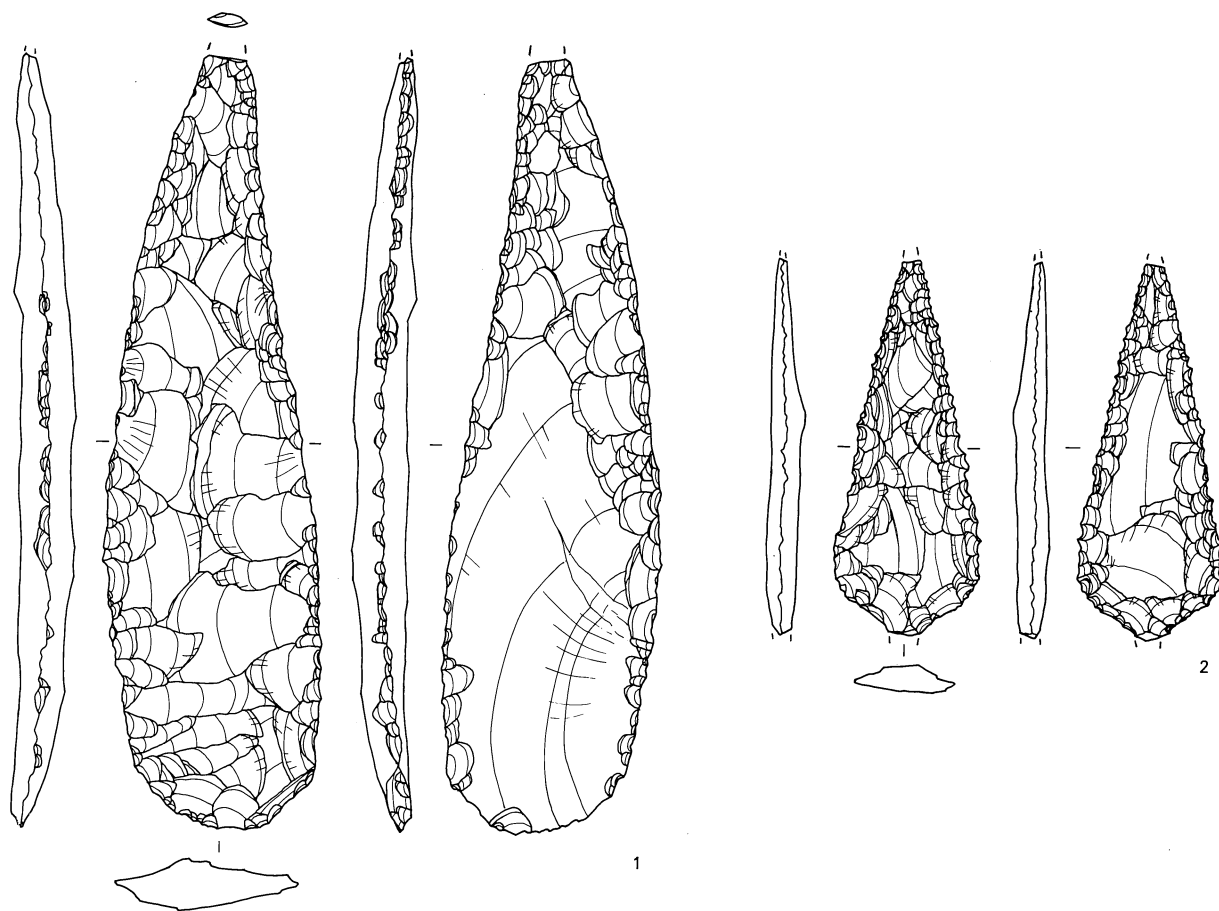

縄文時代石器 1

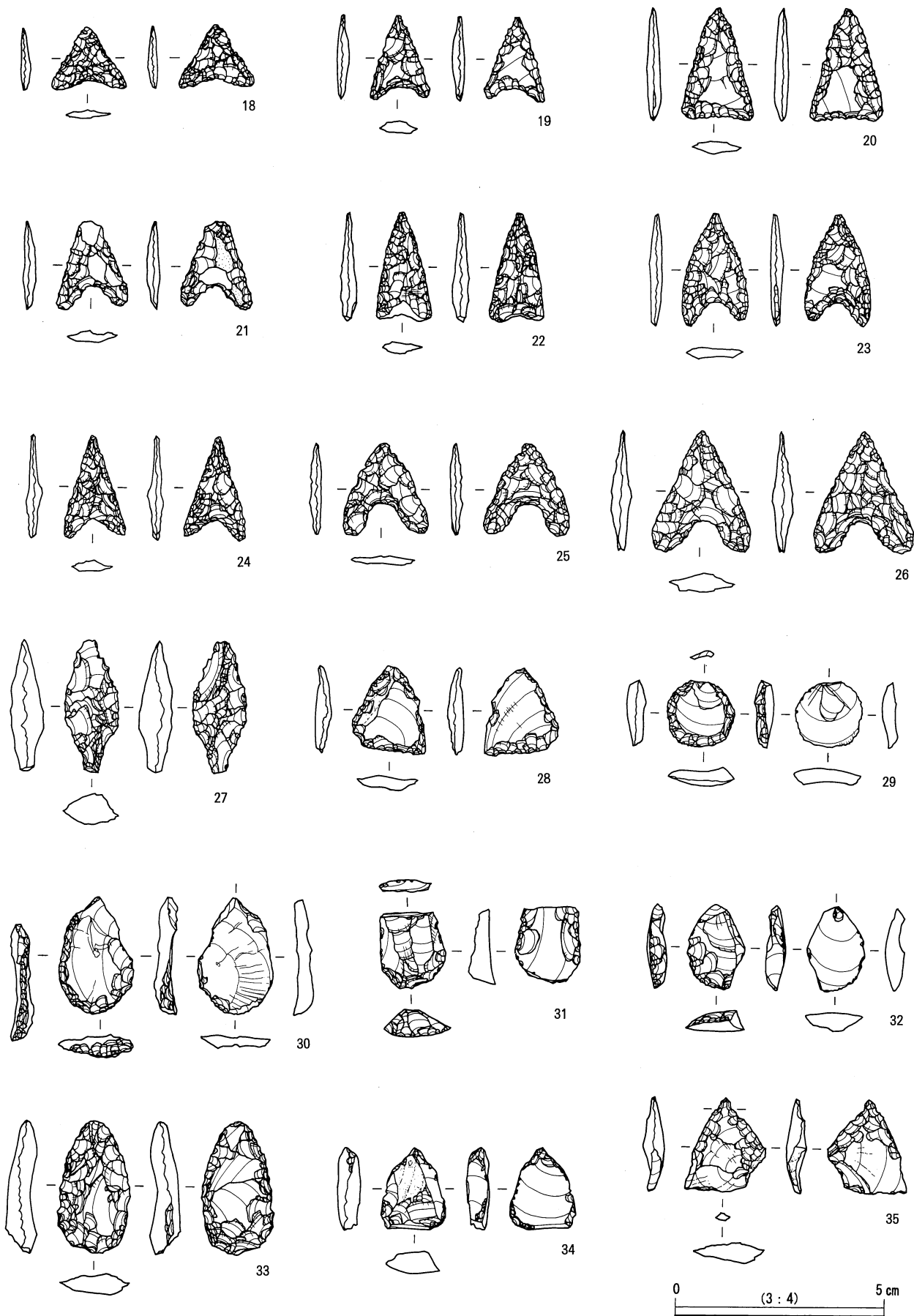

縄文時代石器 2

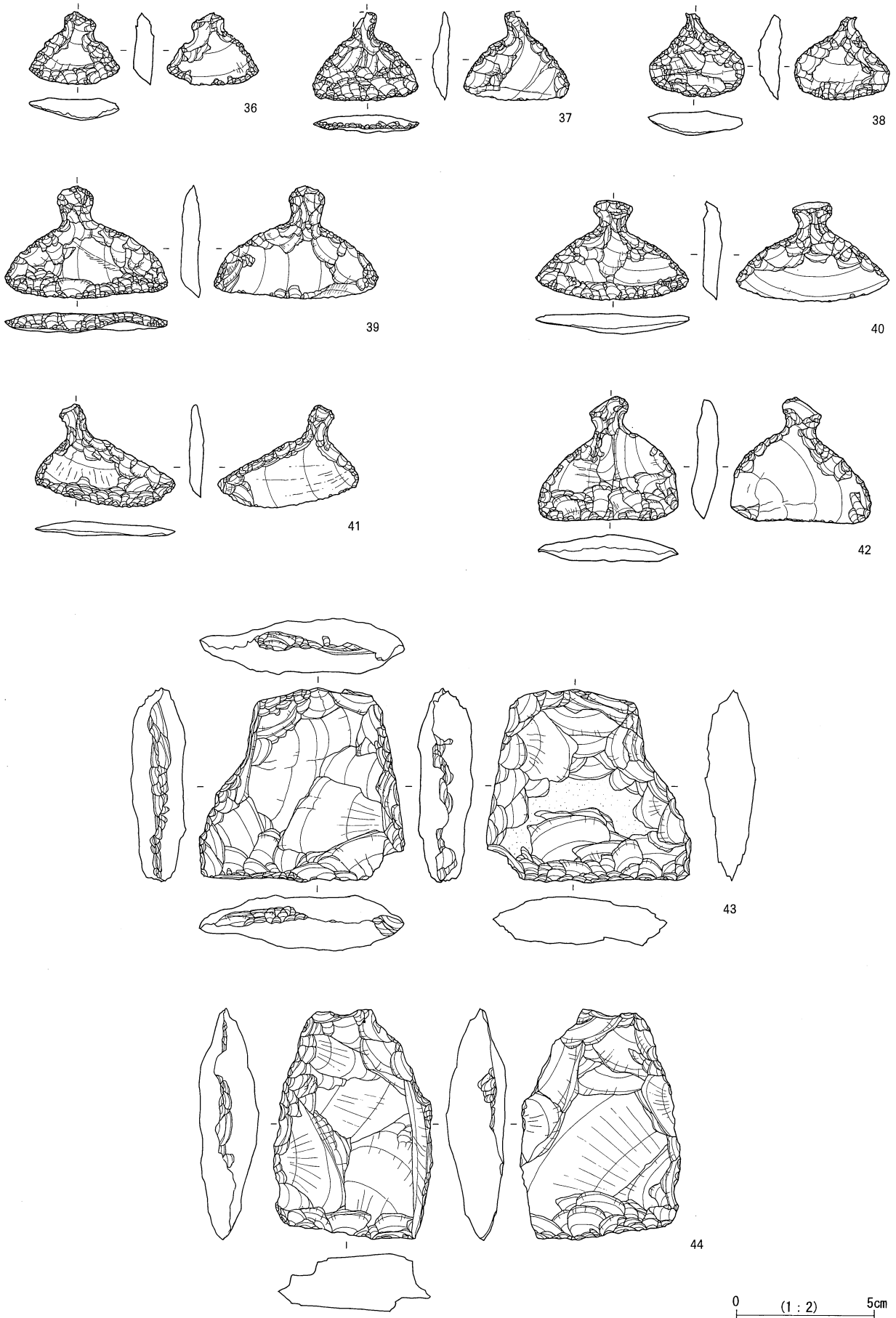

縄文時代石器 3

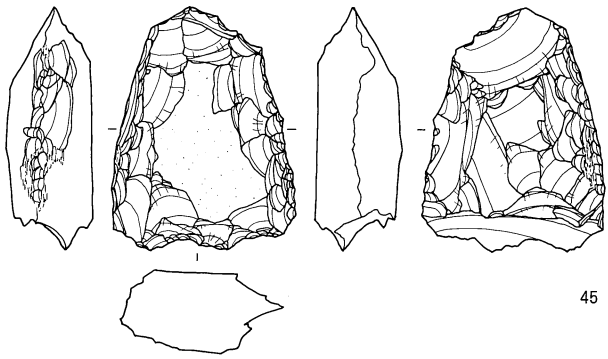

45

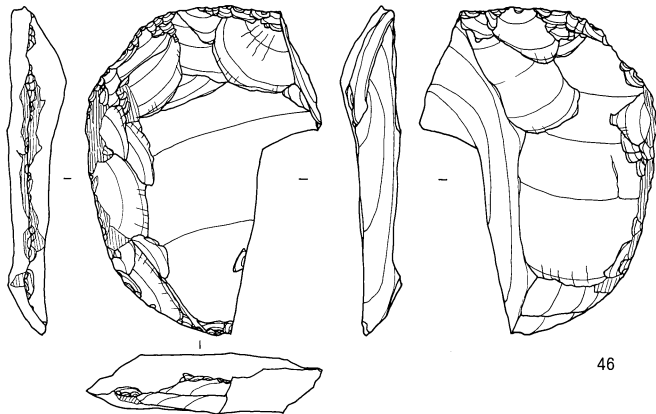

46

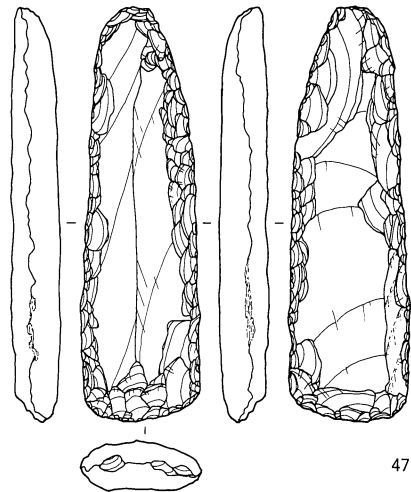

47

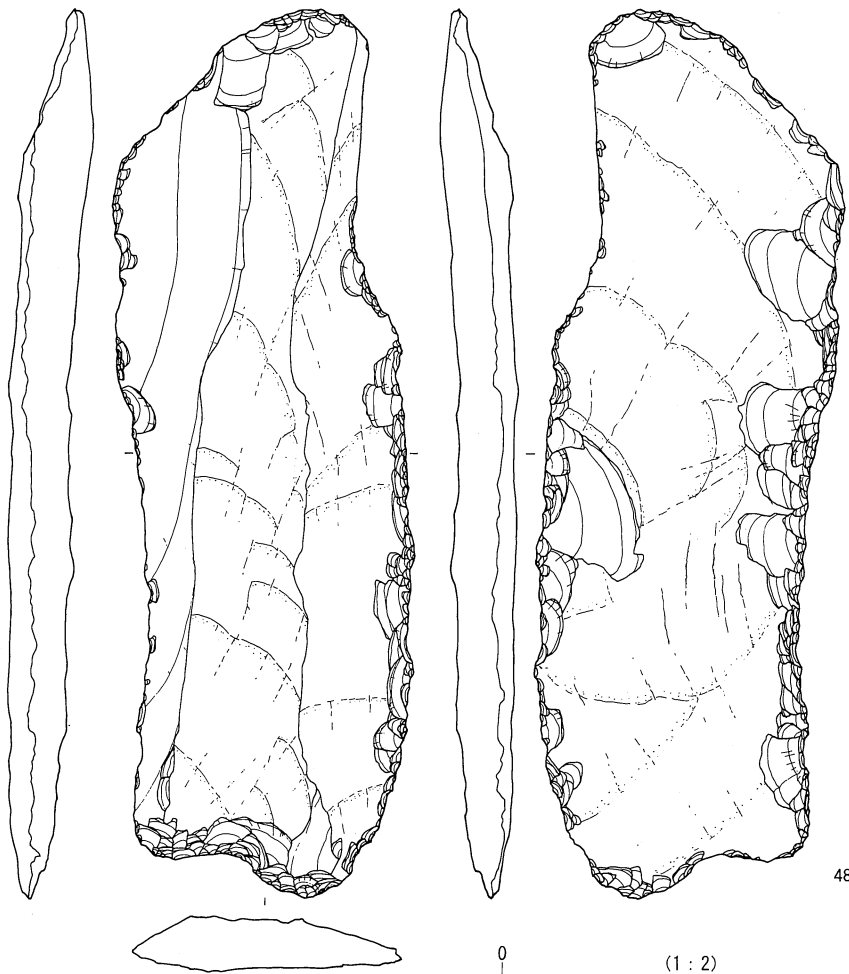

48

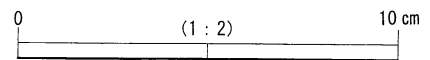

縄文時代石器 4

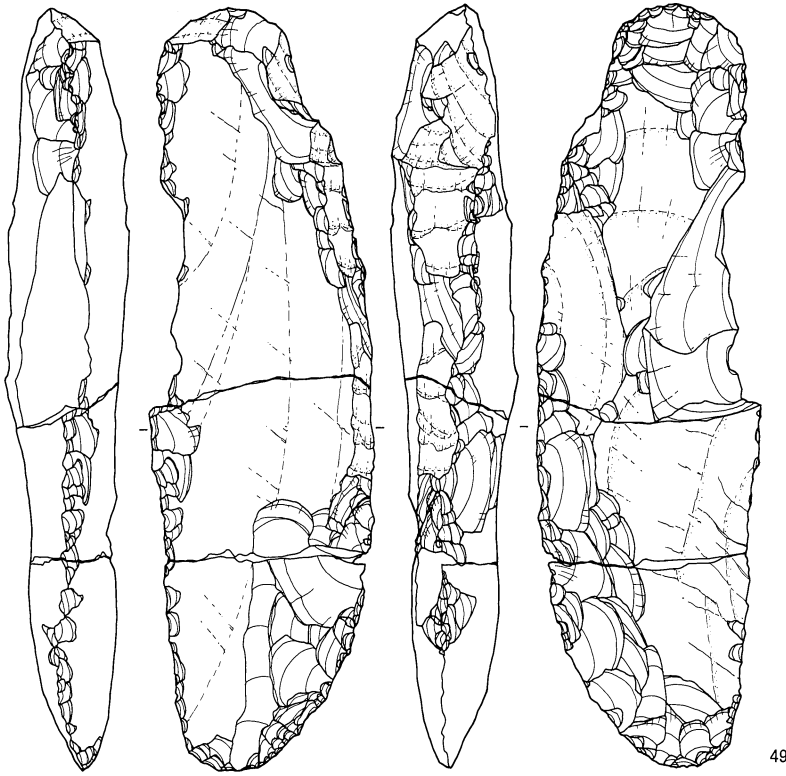

49

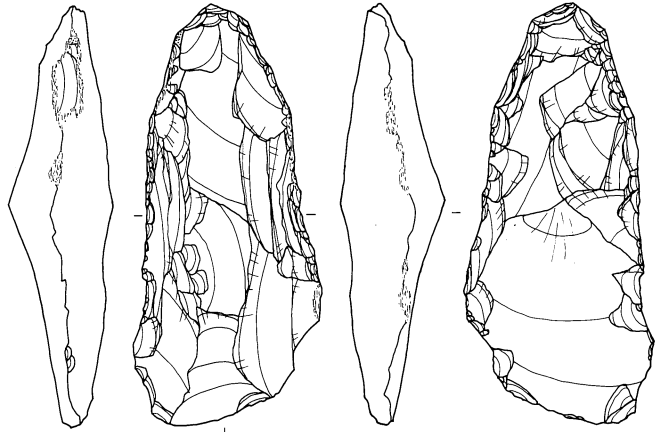

50

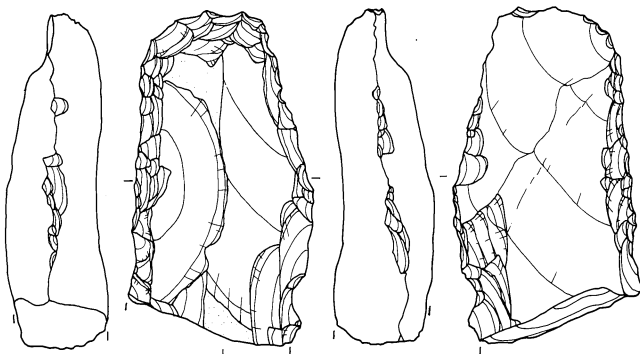

51

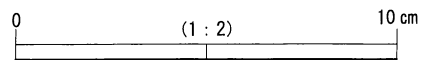

縄文時代石器 5

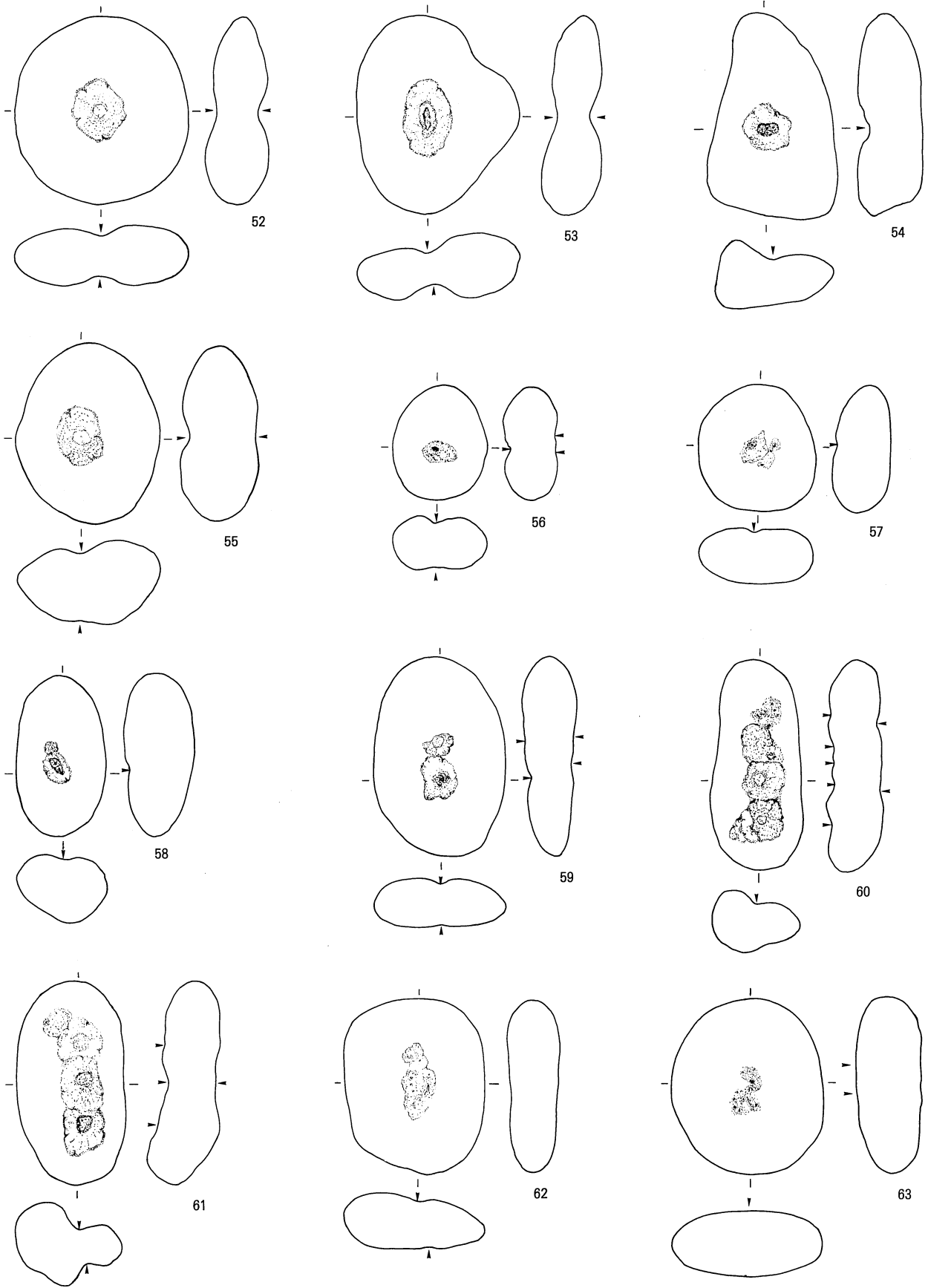

0 (1 : 3) 10cm

縄文時代石器 6

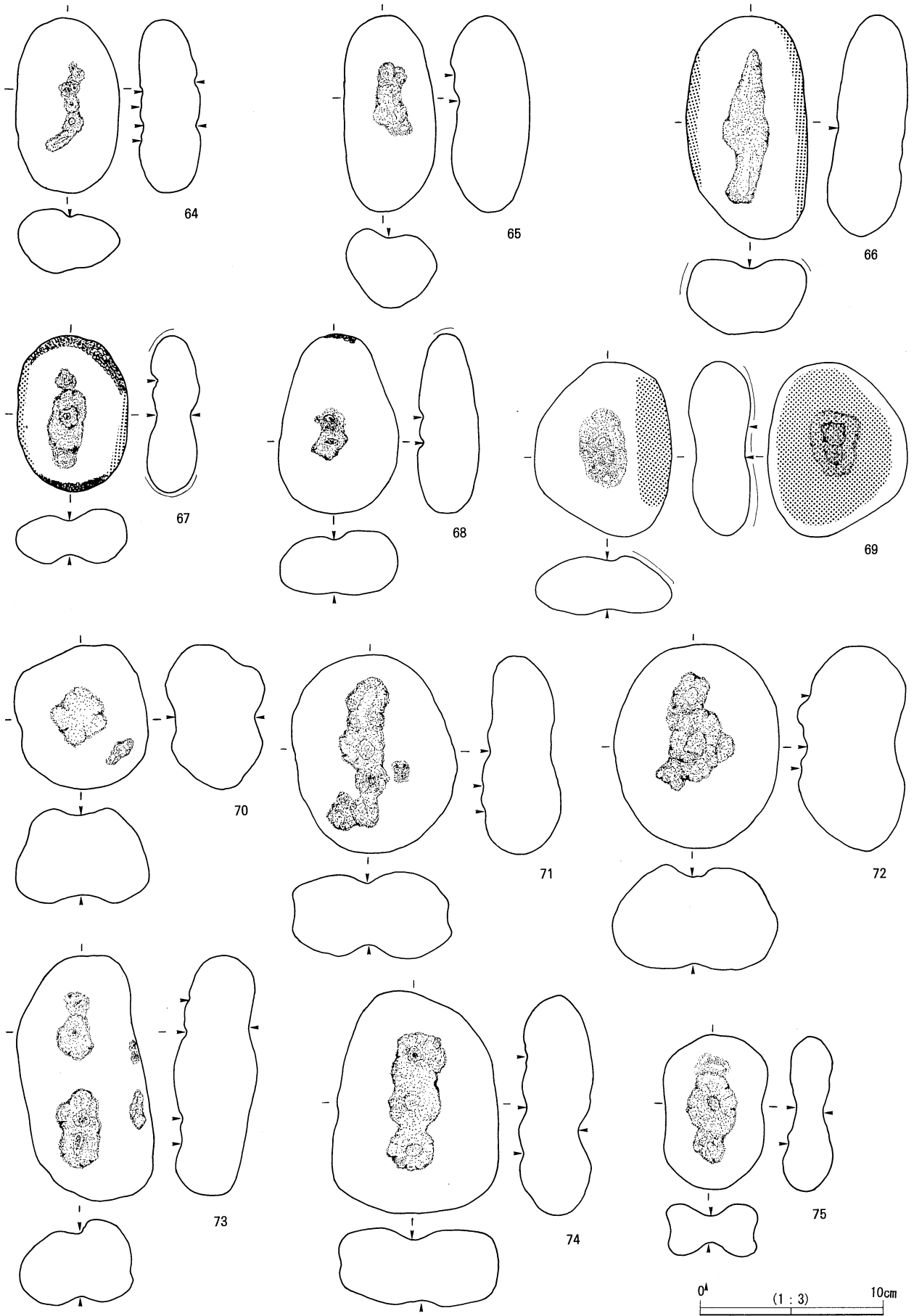

縄文時代石器 7



縄文時代土器 8



縄文時代石器 9

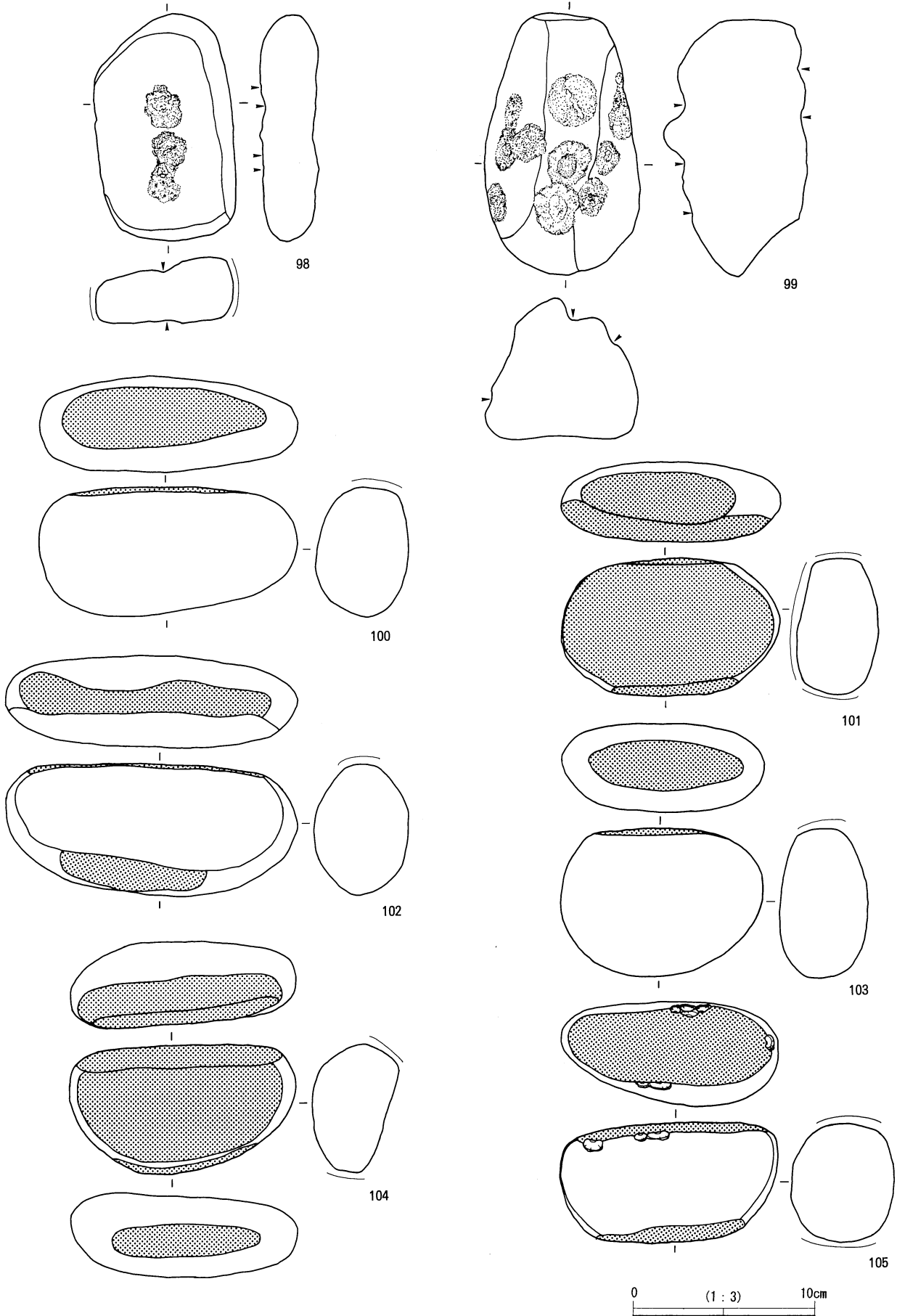

縄文時代石器 10

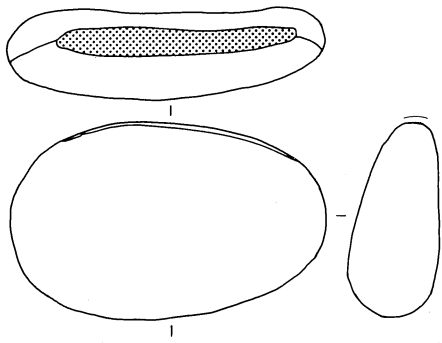

106

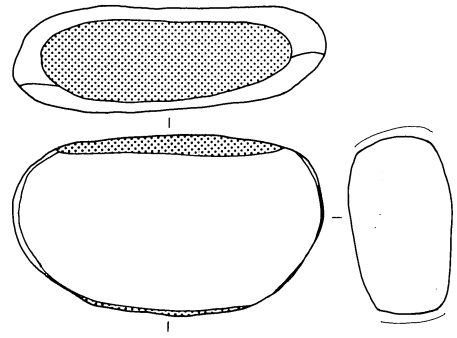

107

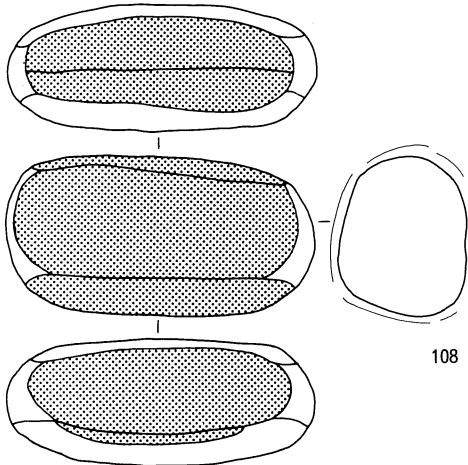

108

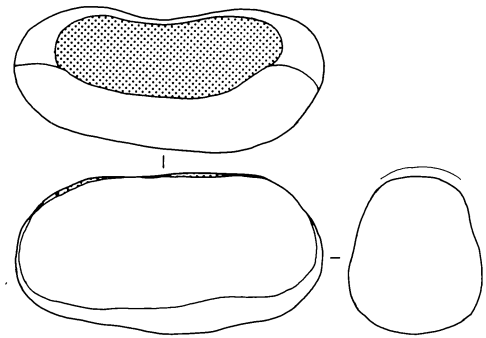

109

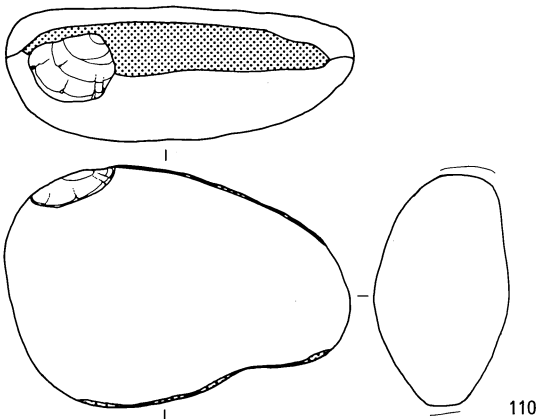

110

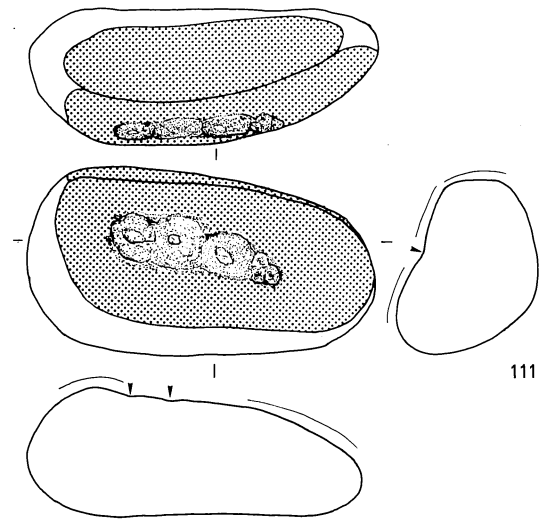

111

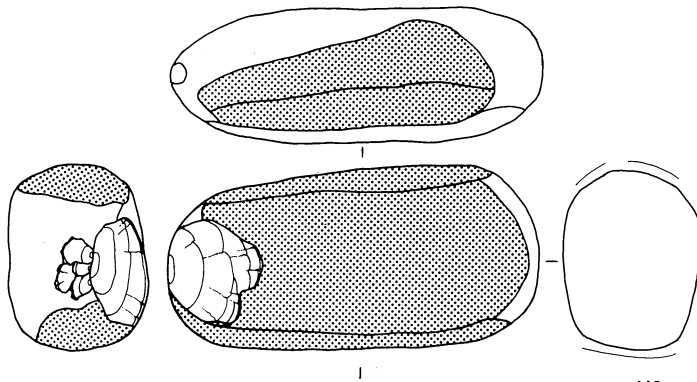

112

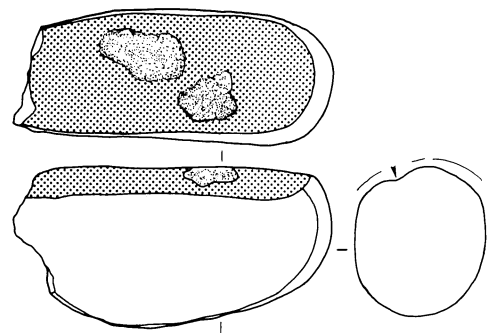

113

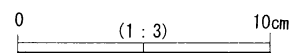

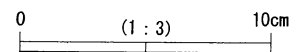
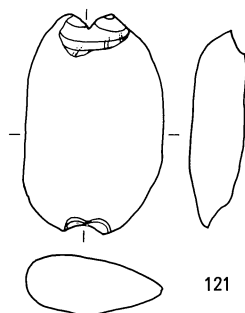
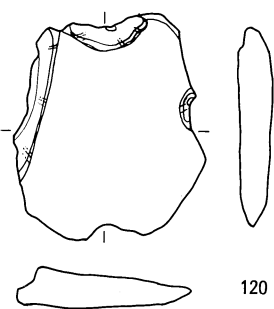
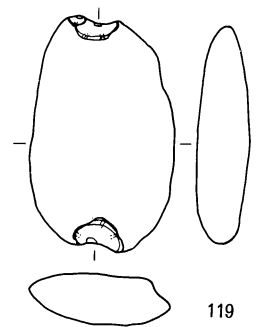
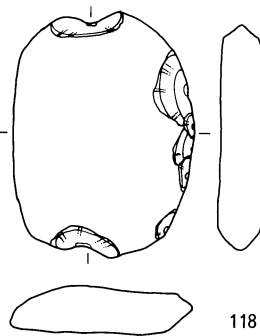
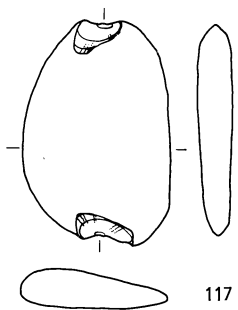
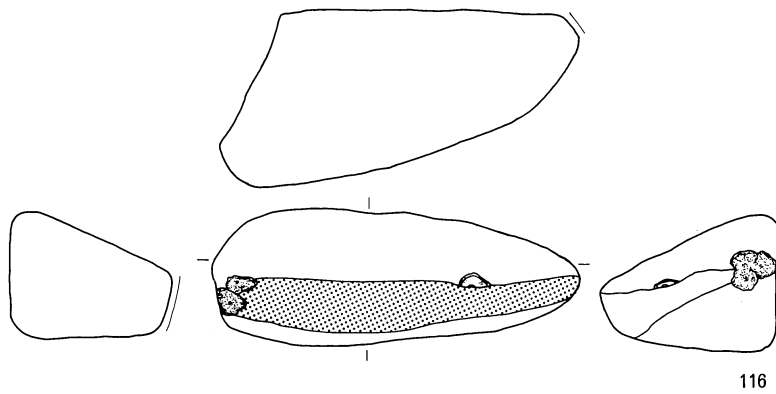
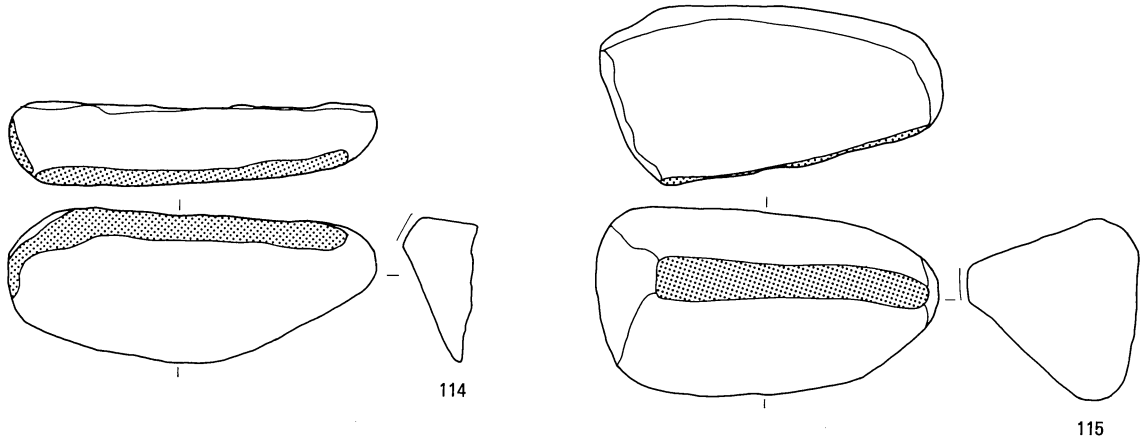

縄文時代石器 12

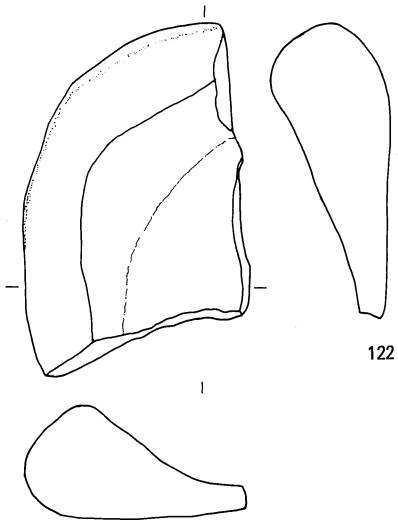

122

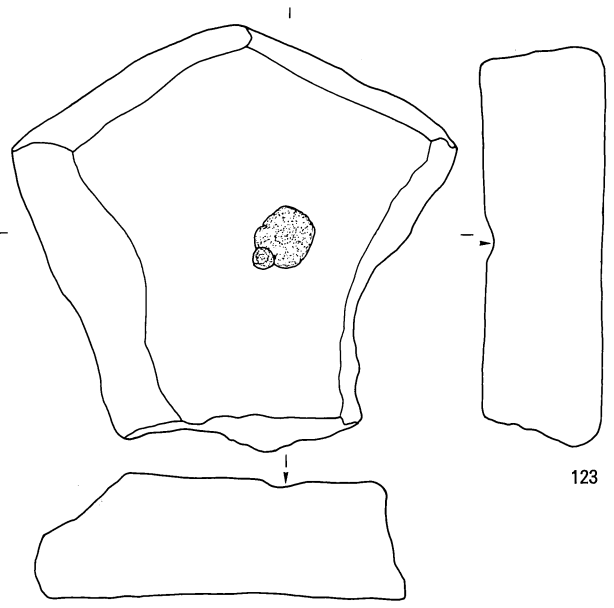

123

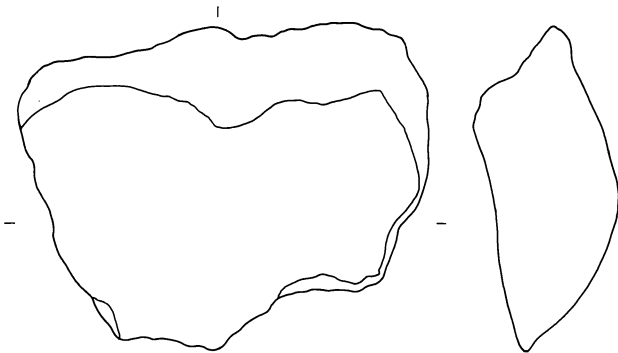

124

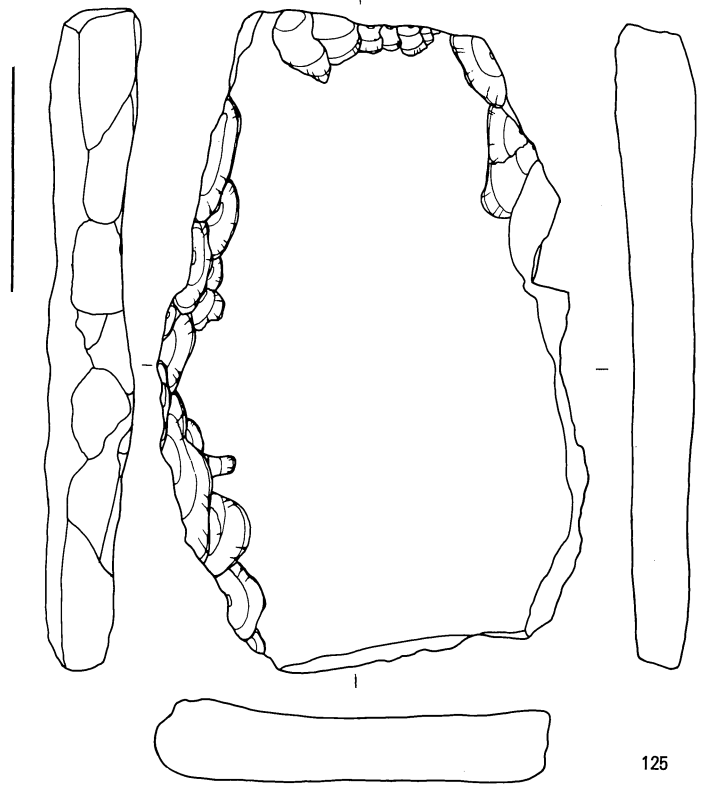
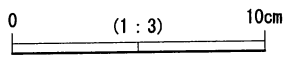
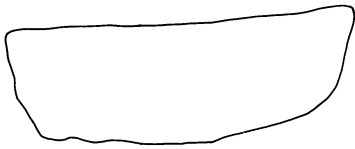

125

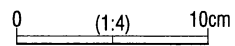

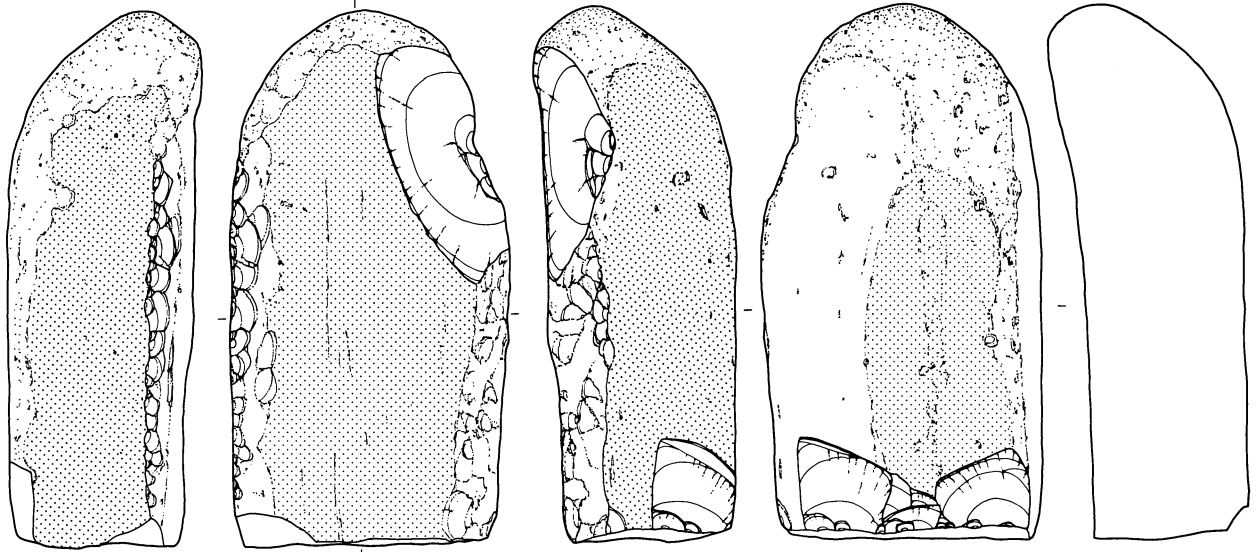

126

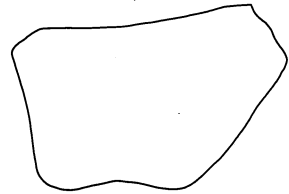
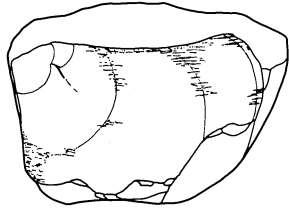

砥石面

0 (1:3) 10cm

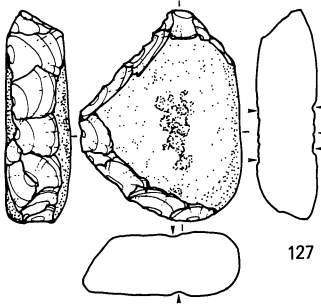

127

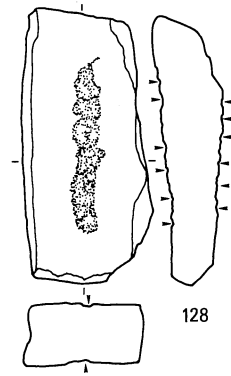

128

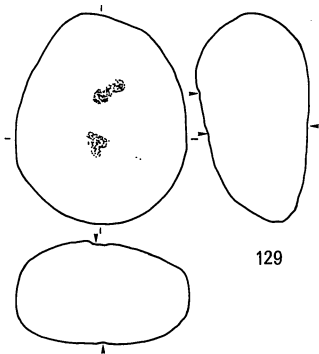

129

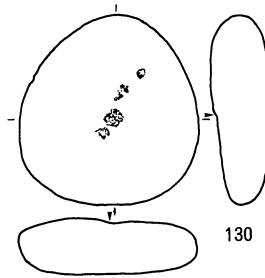

130

0 (1:4) 10cm

縄文時代土坑内出土石器

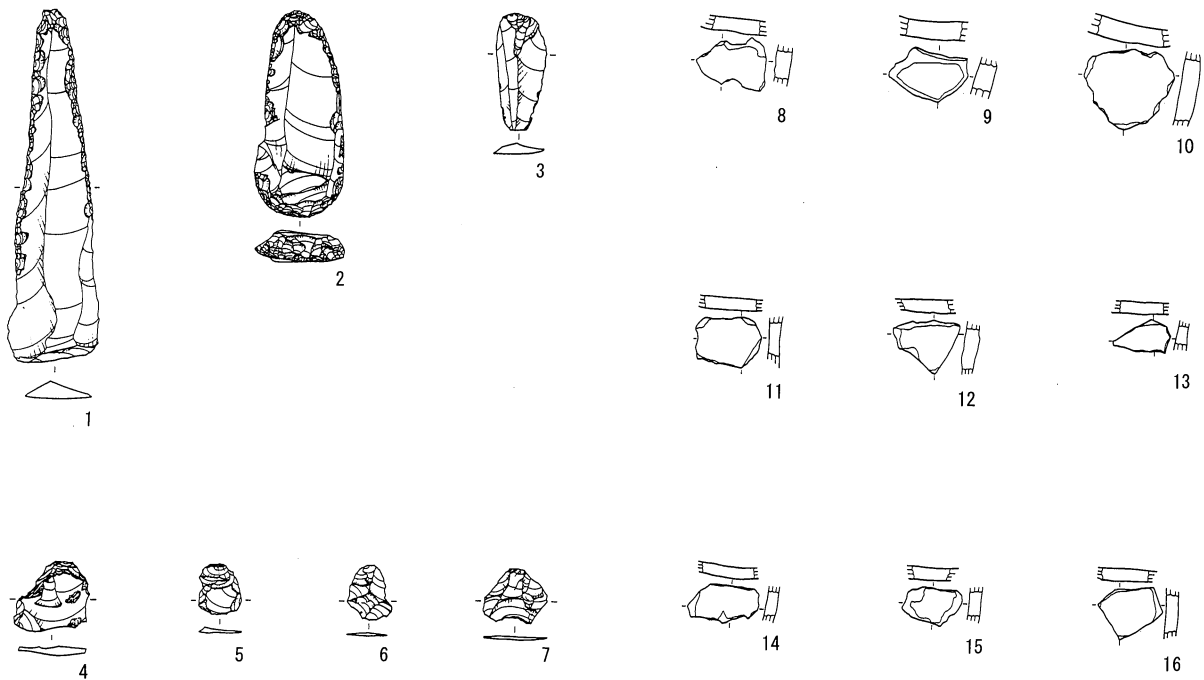
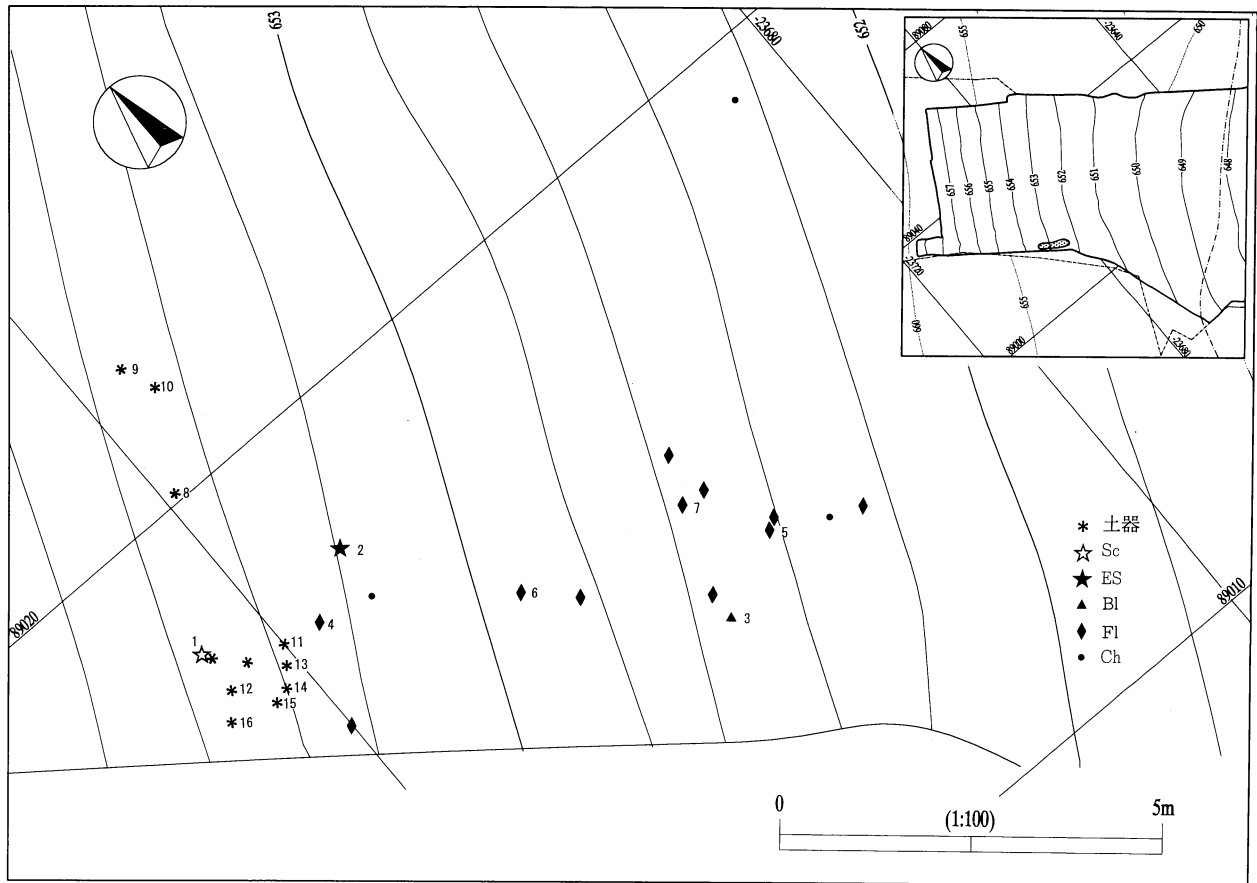

縄文時代草創期石器・無文土器集中部分布図

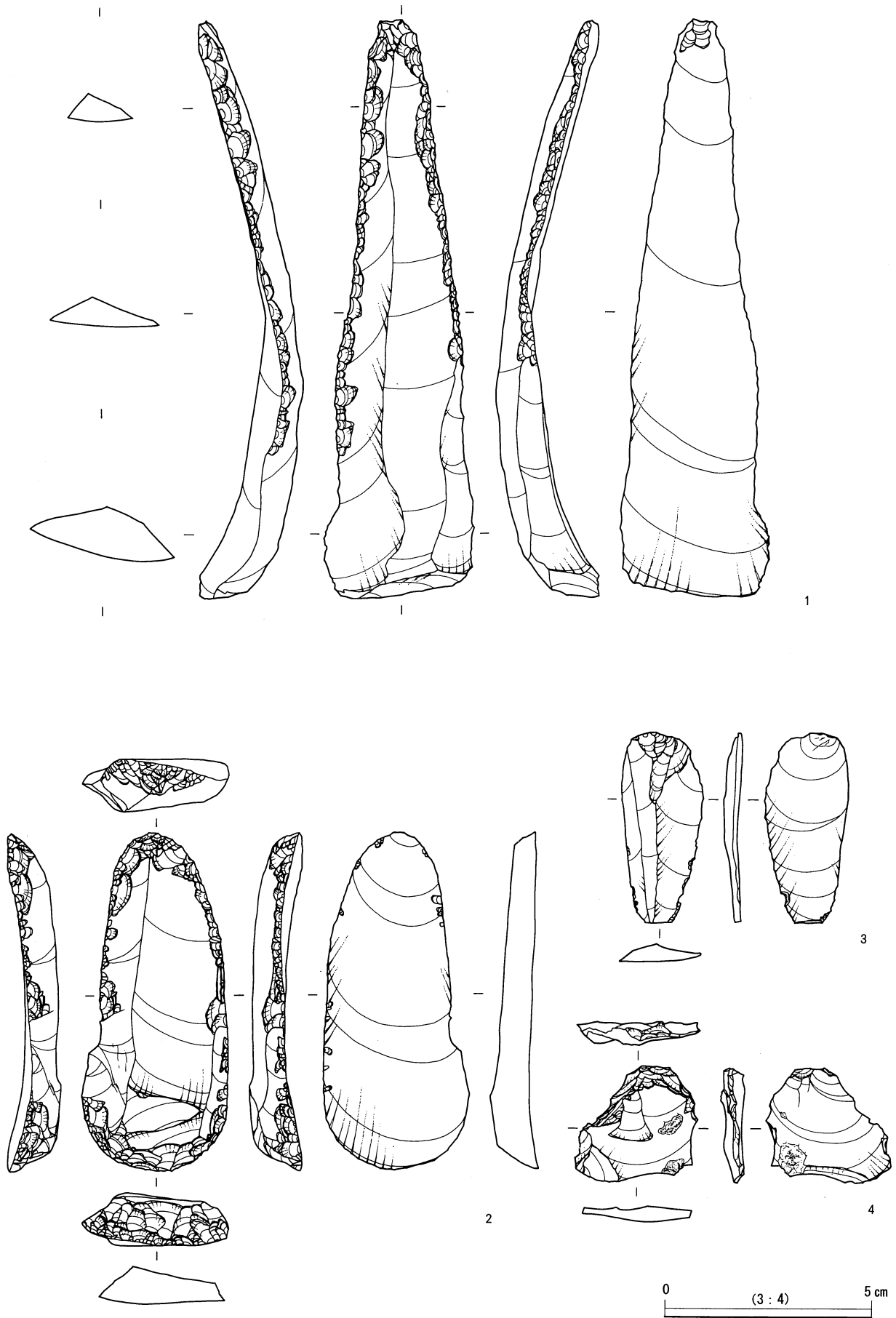

縄文時代草創期集中部出土遺物 1

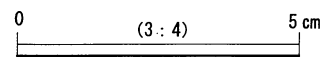
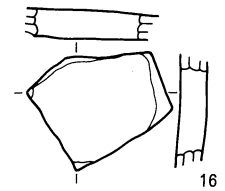
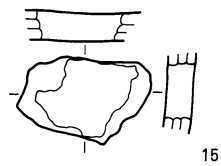
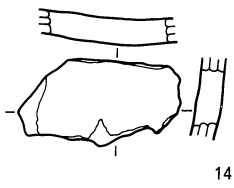
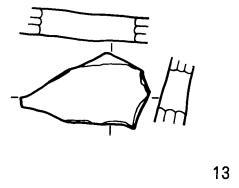
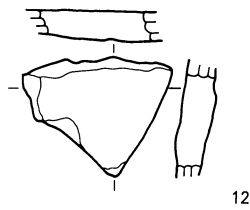
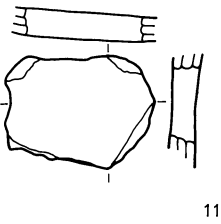
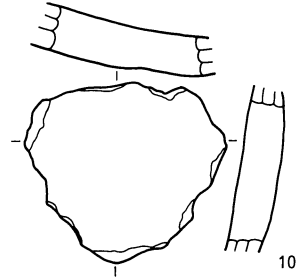
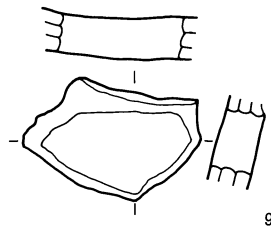
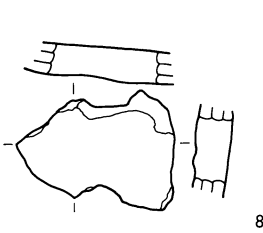
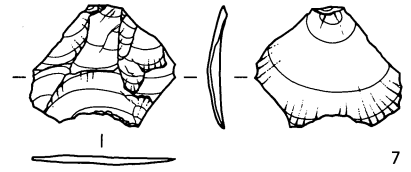
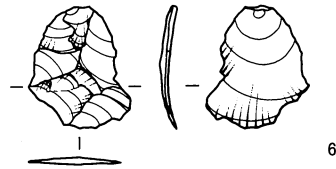
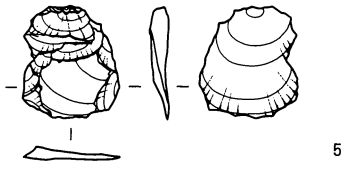

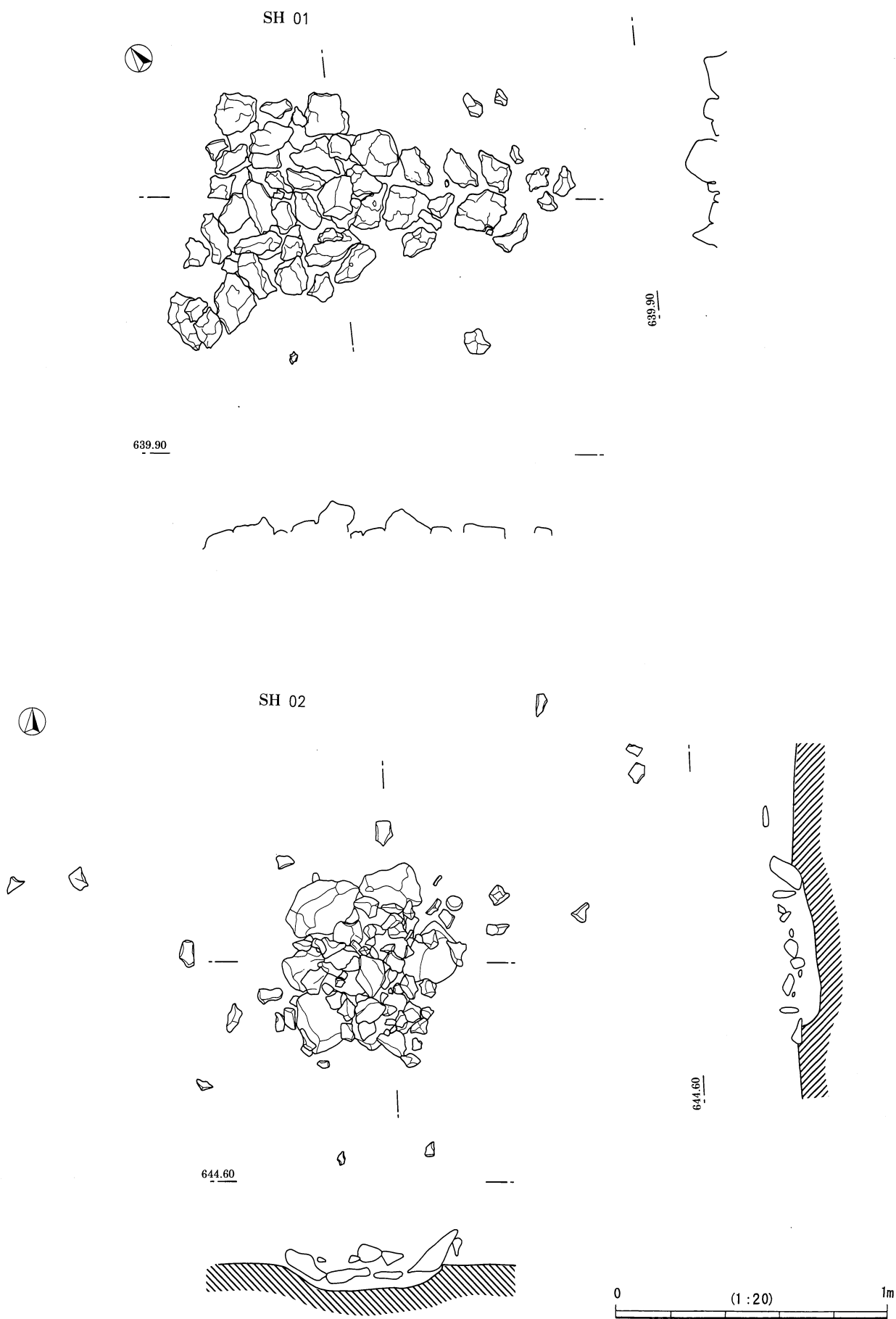

縄文時代集石図

SK 117

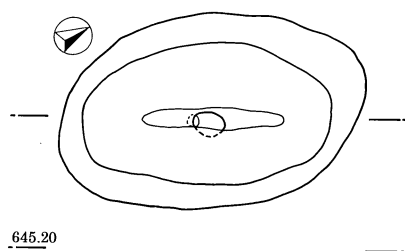

645.20

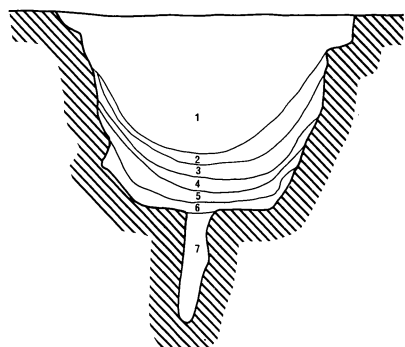

SK117

- 1 黒色土 暗褐色土混合 粗 粘性無 サラサラ
- 2 黒褐色土 黄色ローム混入 粗 粘性無 サラサラ
- 3 黄褐色土 黄色ローム混入 粗 粘性無 サラサラ
- 4 黒褐色土 黄色ローム混入 粗 粘性無 サラサラ
- 5 にぶい黄褐色土 黄色ローム、II層フク土混入 粗 粘性無 サラサラ
- 6 灰黄褐色土 II層フク土混入 やや密 粘性無 ザラザラ
- 7 にぶい黄褐色土 黄色ローム混入 やや密 粘性無 変色有 橙色土

SK 17

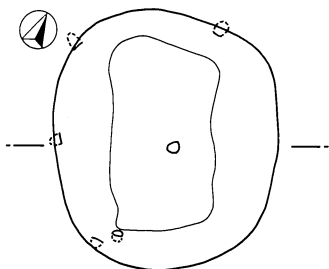

644.20

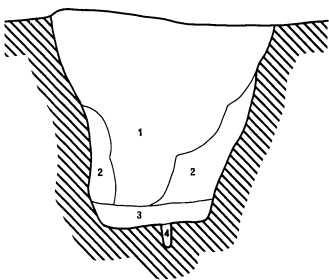

SK17

- 1 黒色シルトとII層がブロック状に混入
- 2 1層に黄褐色水成層ブロック状に混入
- 3 黒色シルトに黄褐色粒混入
- 4 黒色シルトに白色水成層が細いブロック状に混入

SK 118

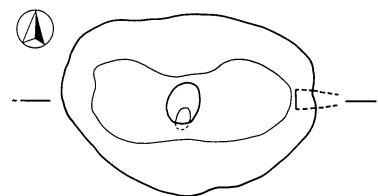

644.80

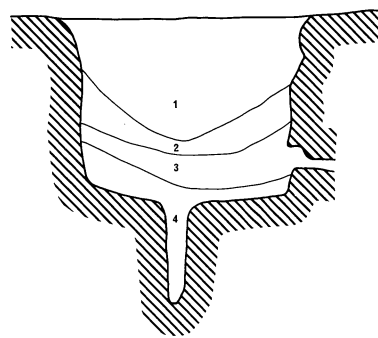

SK118

- 1 黒色土 黄色ローム混入 粗 粘性無 サラサラ
- 2 黒褐色土 黄色ローム混入 粗 粘性無 サラサラ
- 3 黒色土 黄色ローム混入 粗 粘性無 サラサラ
- 4 黒褐色土 黄色ローム混入 やや密 粘性無 ザラザラ

SK 102

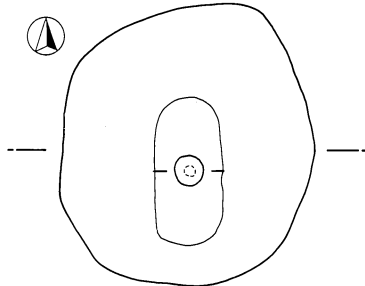

647.00

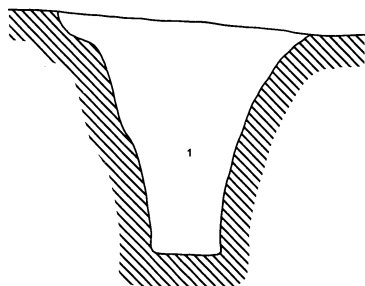

645.70



SK102

- 1 黒褐色土 やや粗 粘性無 III層混入 ややIII層近似 サラサラ
- 2 黒色土 粗 粘性無 黄褐色ローム含有 サラサラ

SK 108

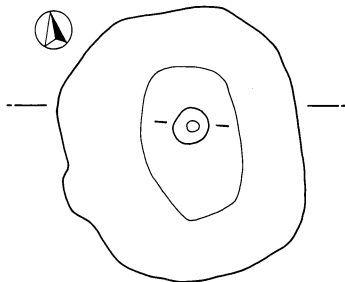

648.60

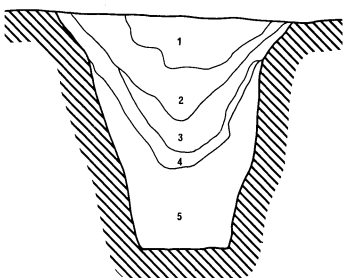

647.40

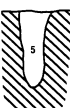

SK108

- 1 黒褐色土 やや粗 粘性無 III層混入 ややIII層に近似 サラサラ
- 2 黒色土 粗 粘性無 黄褐色ローム含有 サラサラ
- 3 黒褐色土 やや粗 粘性無 II層混入 III層
- 4 褐色土 粗 粘性無 黄褐色ローム含有 ややローム層
- 5 黒褐色土 粗 粘性無 II層混入 III層の土

SK 16

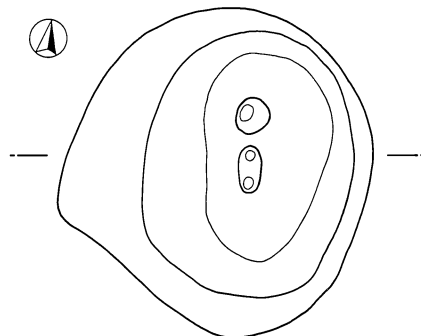

644.40

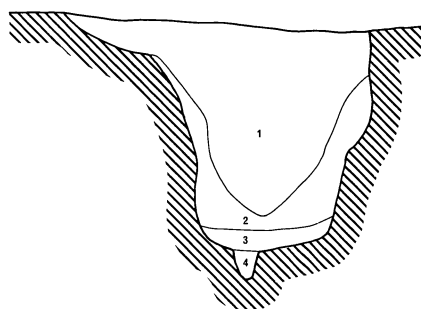

SK16

- 1 黒色シルトとII層がブロック状に混入
- 2 ローム質土に1層の土ブロック状に混入
- 3 1層より水分多い 炭化物混入
- 4 黒色シルトに白色水成層が細いブロック状に混入

0 (1:40) 1m

縄文時代土坑図 1

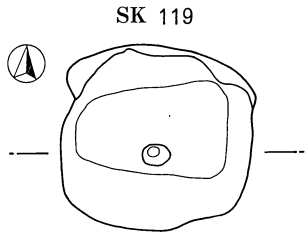

644.80

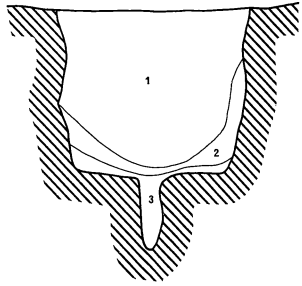

SK119

- 1 黒色土 ローム混入 粗 粘性無 サラサラ
- 2 黒色土 ローム混入 粗 粘性無 サラサラ
- 3 黒褐色土 ローム混入 やや密 粘性無 サラサラ

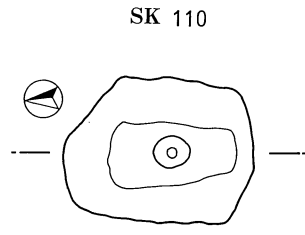

647.40

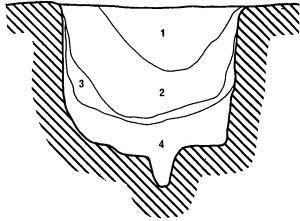

SK110

- 1 黒色土 粗 粘性無 Ⅲ層混入 サラサラ
- 2 黒褐色土 粗 粘性無 Ⅲ層混入 サラサラ
- 3 黒褐色土 粗 粘性無 Ⅲ層混入
- 4 にぶい黄褐色土 粗 粘性無 にぶい黄褐色土混合 ややローム質

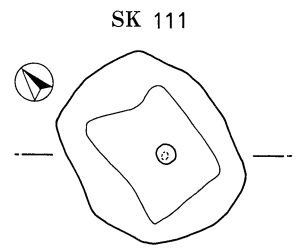

649.00

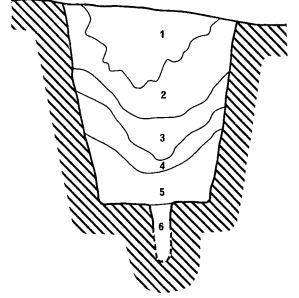

SK111

- 1 黒色土 Ⅲ層混入
- 2 黒褐色土 Ⅲ層混入
- 3 褐灰色土 Ⅲ層混入
- 4 明黄褐色 Ⅱ層混入 土
- 5 黒色土 Ⅲ層混入
- 6 褐色土

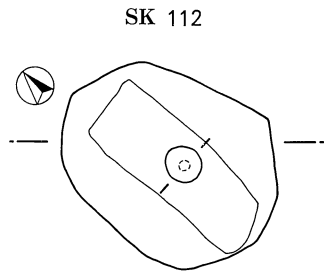

648.40

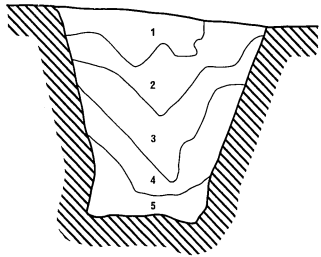

647.30

SK112

- 1 黒色土 粗 粘性無 Ⅲ層混入 サラサラ
- 2 黒褐色土 粗 粘性無 Ⅲ層混入 サラサラ
- 3 黒褐色土 粗 粘性無 Ⅲ層混入
- 4 にぶい黄褐色土 粗 粘性無 にぶい黄褐色混合 ややローム質
- 5 黒褐色土 粗 粘性無 Ⅰ層攪乱

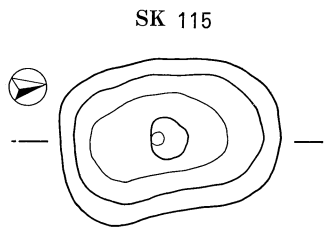

646.00

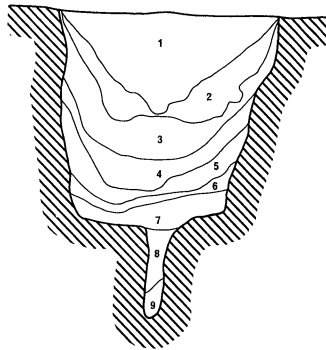

SK115

- 1 黒色土 粗 Ⅲ層混入 ポロポロ
- 2 褐灰色土 粗 Ⅲ層混入 ポロポロ
- 3 黒褐色土 粗 Ⅲ層混入 ポロポロ
- 4 黒褐色土 粗 Ⅲ層混入 ポロポロ
- 5 明黄褐色 やや密 Ⅱ層混入 サラサラ 土
- 6 黒褐色土 やや密 Ⅲ層混入 ポロポロ
- 7 灰黄褐色 密 Ⅲ層混入 粘性有 土
- 8 灰黄褐色 密 Ⅱ層混入 粘性有 土
- 9 にぶい黄褐色 白色に変色 密 粘性有 橙褐色土

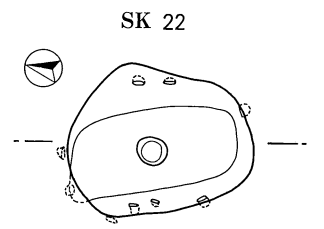

648.10

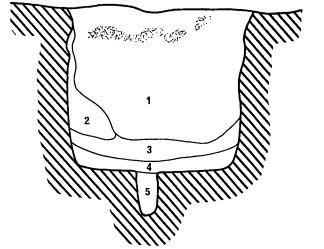

SK22

- 1 黒色土 シルト質土 黄褐色土多量ブロック状に混入
- 2 黒褐色土 黄褐色土との混合 基盤土の黄褐色ローム層の崩落土と黒色火山灰との混合
- 3 黒色土 1層と同類 黄褐色土を均一に混
- 4 黒色土 シルト質土 腐植物、カーボン多
- 5 にぶい黄褐色 粘性やや有 やや粗 4層の土、赤褐色スコリア、他水成層混合

0 (1:40) 1m

縄文時代土坑図 2

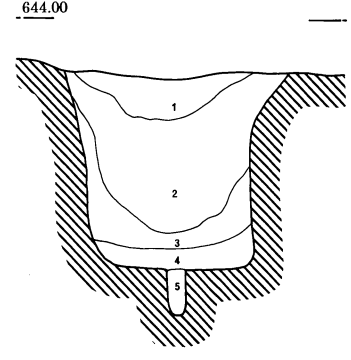
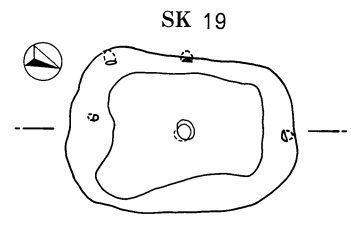
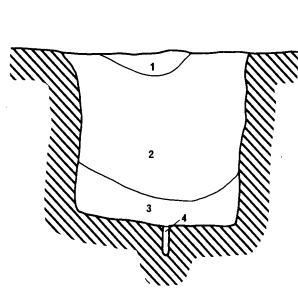
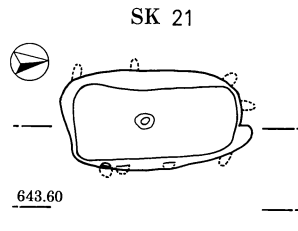
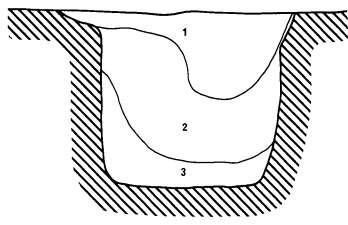
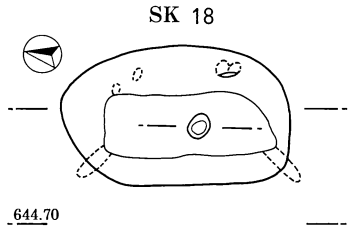

643.90



SK18

- 1 黒色シルトとII層がブロック状に混入
- 2 1層に黄褐色水成層ブロック状に混入
- 3 黒色シルトに黄褐色粒混入
- 4 黒色シルトに白色水成層が細かいブロック状に混入

SK21

- 1 黒色土 カーボン多量含有 黄褐色土微細粒含有 I層土と酷似 シルト質
- 2 黒色土 シルト質 1層より黒色減 質は同類
- 3 黒色土 腐植物、カーボン多量混入 粗
- 4 黒色土 Pit内土層 黄褐色粒含有

SK19

- 1 黒色土 粘性無 粗 黄褐色粒混合
- 2 黒褐色土 粘性無 やや粗 黄褐色粒混合
- 3 黒褐色土 粘性無 やや粗 黄褐色ローム混合
- 4 黒色土 粘性無 粗 3層土 炭化物層
- 5 黒色土 黒色シルトに白色水成層ブロック状混入

SK 120

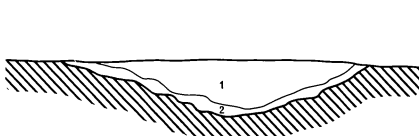
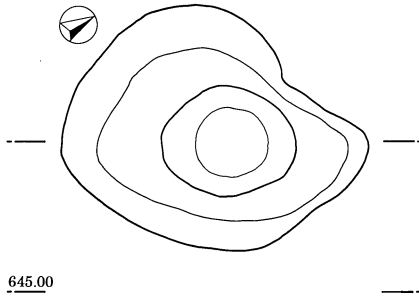

SK120

- 1 黒色土 黄色ローム混入 密 粘性無 ホクホク
- 2 褐灰色土 黄色ローム混入 密 粘性無 サラサラ

SK 20

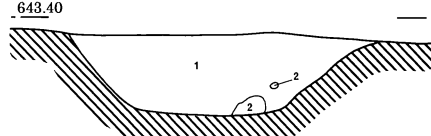
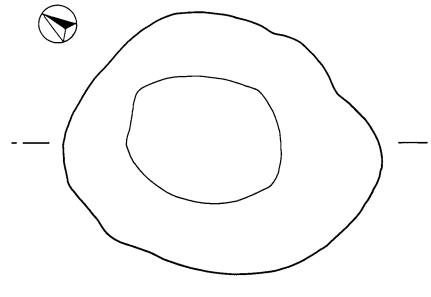

SK20

- 1 黒褐色土 粘性無 やや粗 黄褐色粒混合 シルト質
- 2 明赤褐色土 粘性無 やや密 1層の土混合 焼土

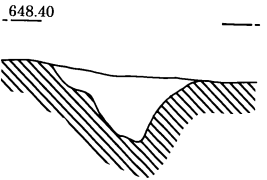
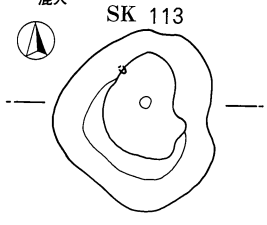

SK113

- 1 黒褐色土 やや粗 粘性無 III層混入 ややIII層に近似 サラサラ

SK 23

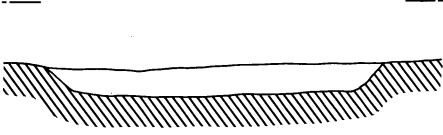
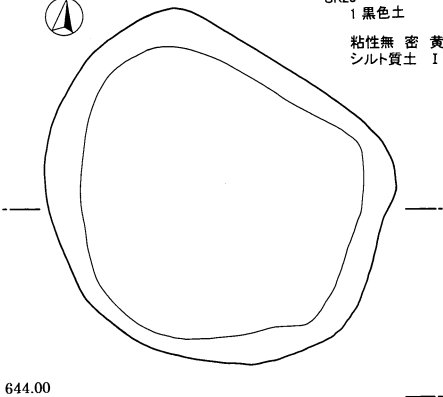

SK23

- 1 黒色土 粘性無 密 黄褐色ローム混合 シルト質土 I層の土と類似

SK 121

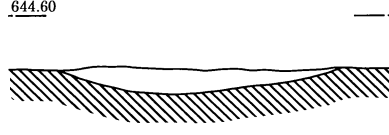
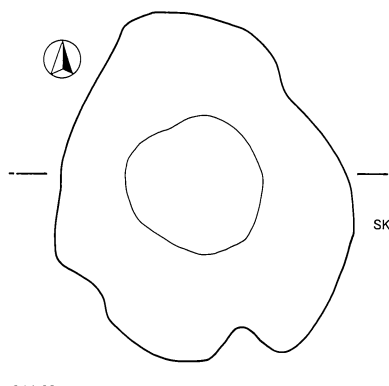

SK103

- 1 黒褐色土 やや粗 粘性無 III層混入 ややIII層に近似 サラサラ
- 2 黒色土 粗 粘性無 黄褐色ローム含有 サラサラ

SK121

- 1 黒色土 IV層土、II層ブロック混入 密 粘性無

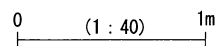

縄文時代土坑図 3

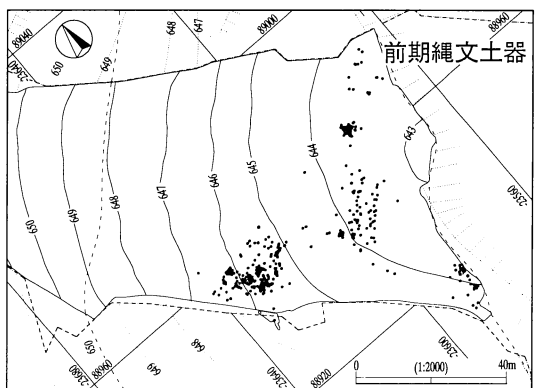
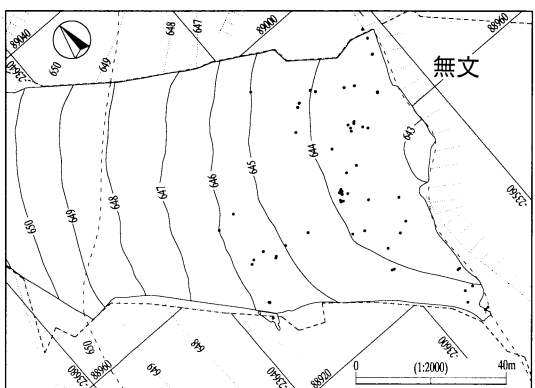
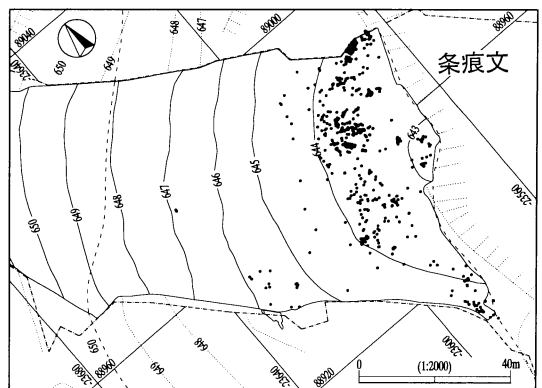
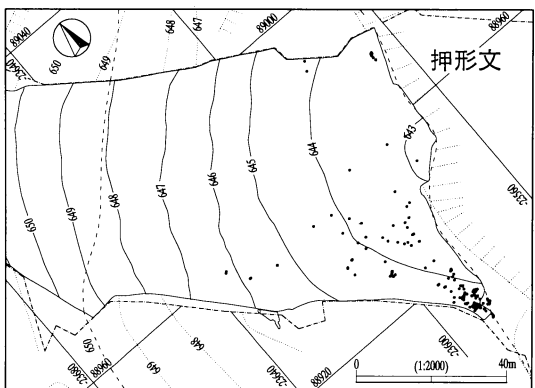
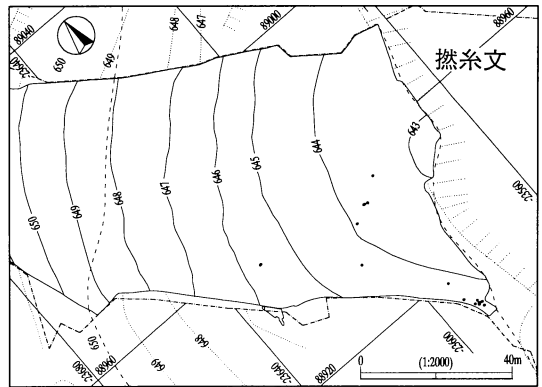
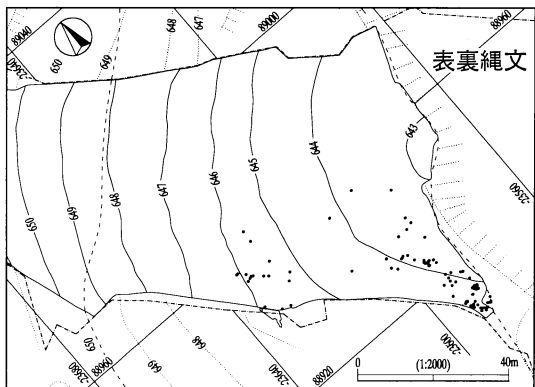
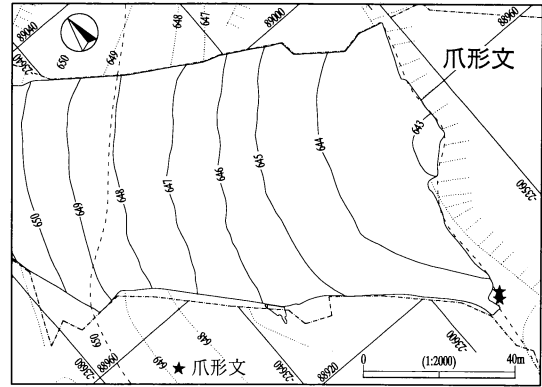
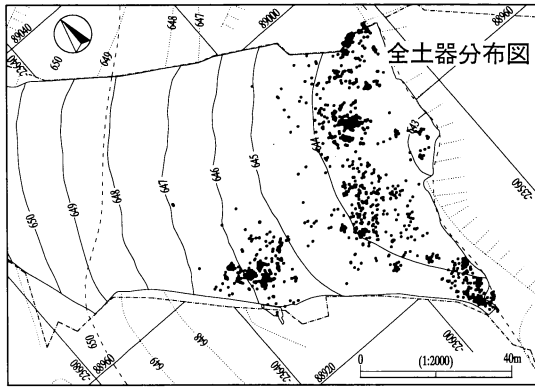

縄文時代土器分布図



縄文時代表裏縄文土器分類別分布図

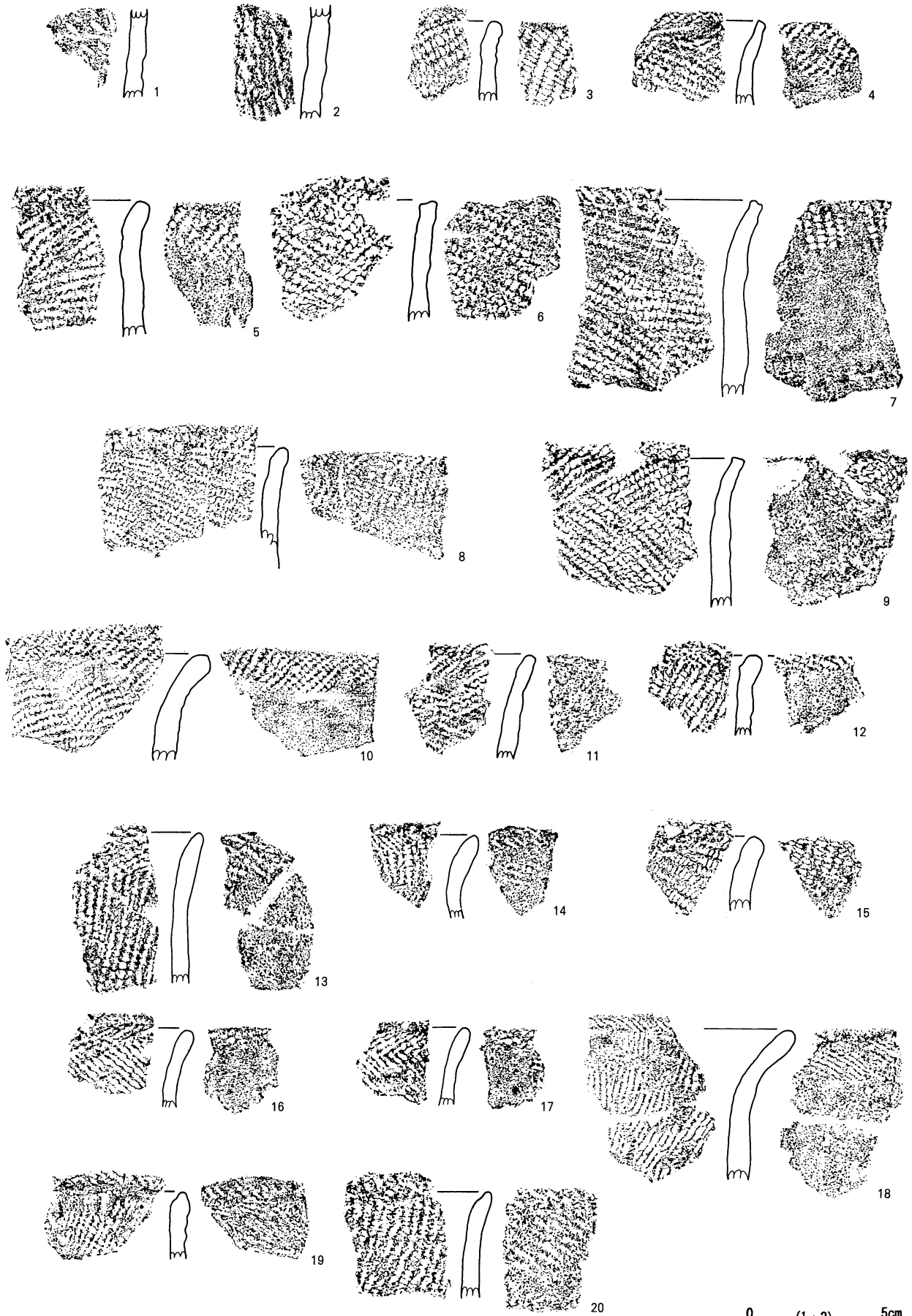

0 (1:2) 5cm

縄文時代土器 1

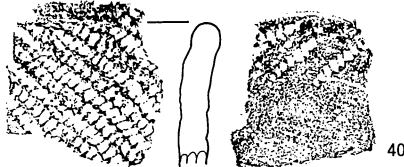
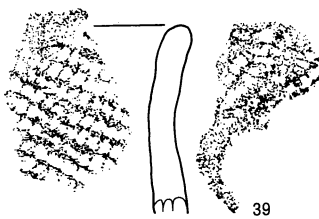
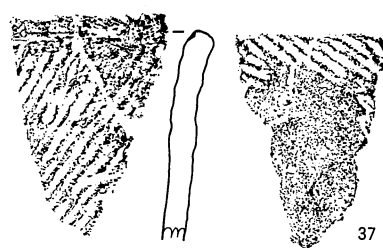
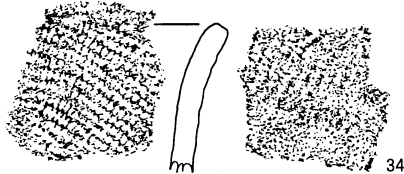
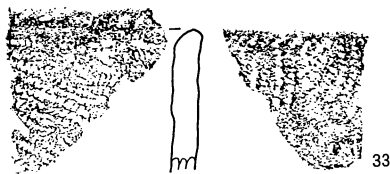
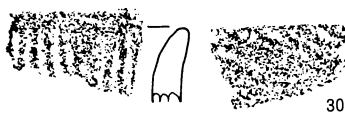
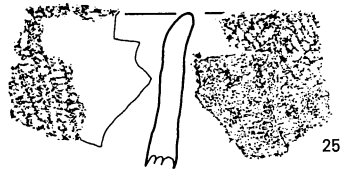

0 (1 : 2) 5cm

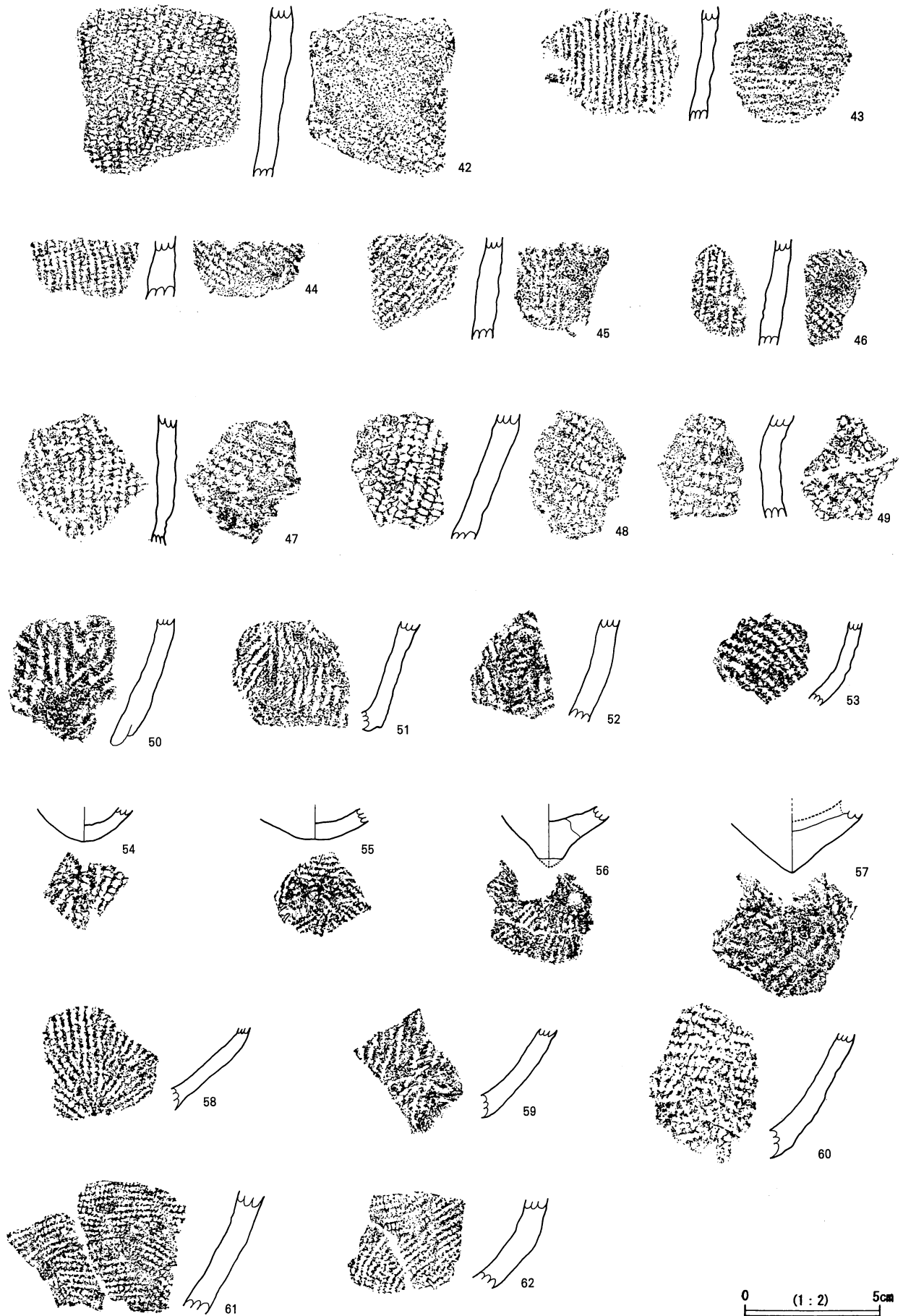

縄文時代土器 3

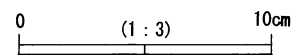
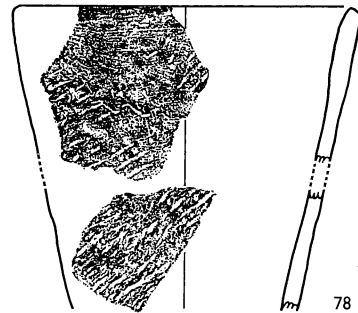
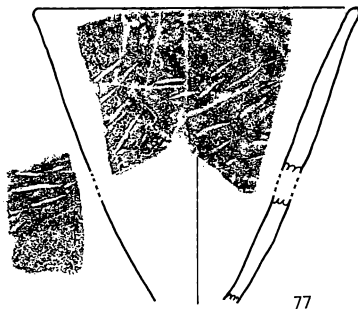
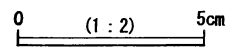
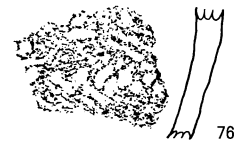
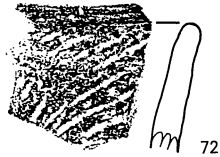
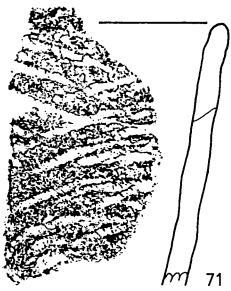
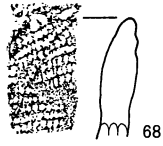
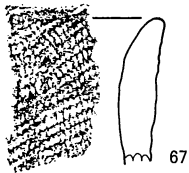
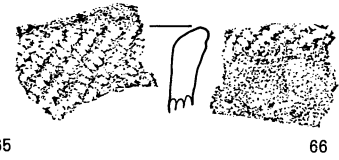

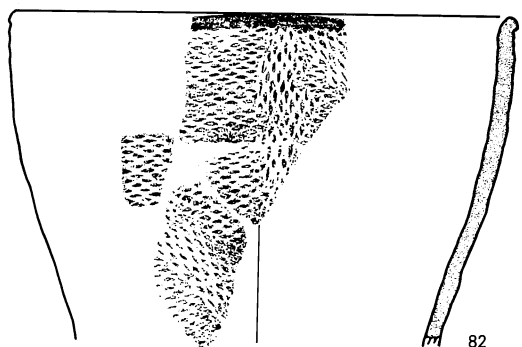
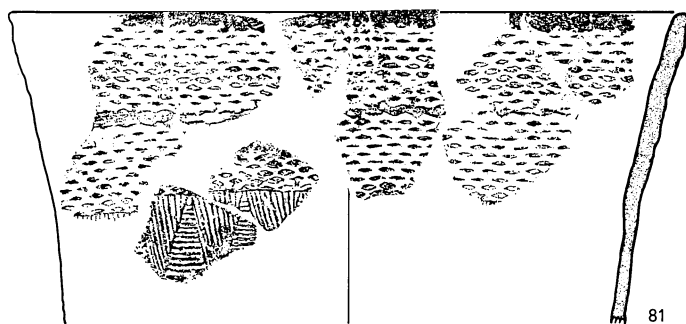
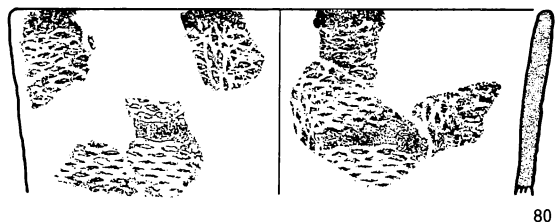
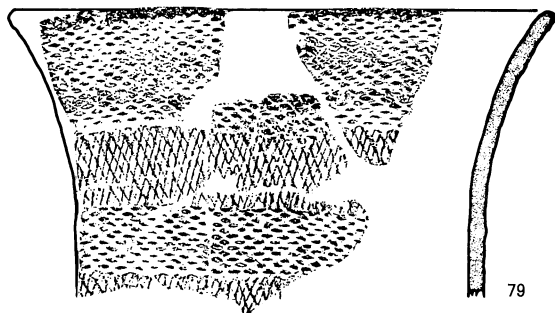

0 (1:3) 10cm

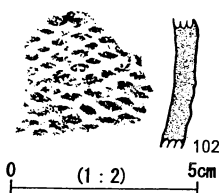
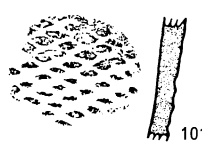
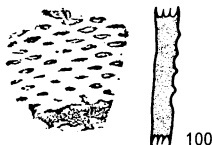
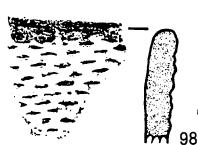
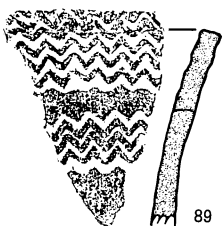
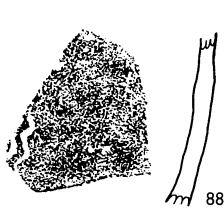
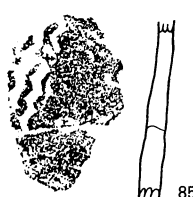
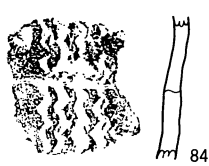
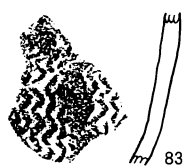

0 (1:2) 5cm

縄文時代土器 5

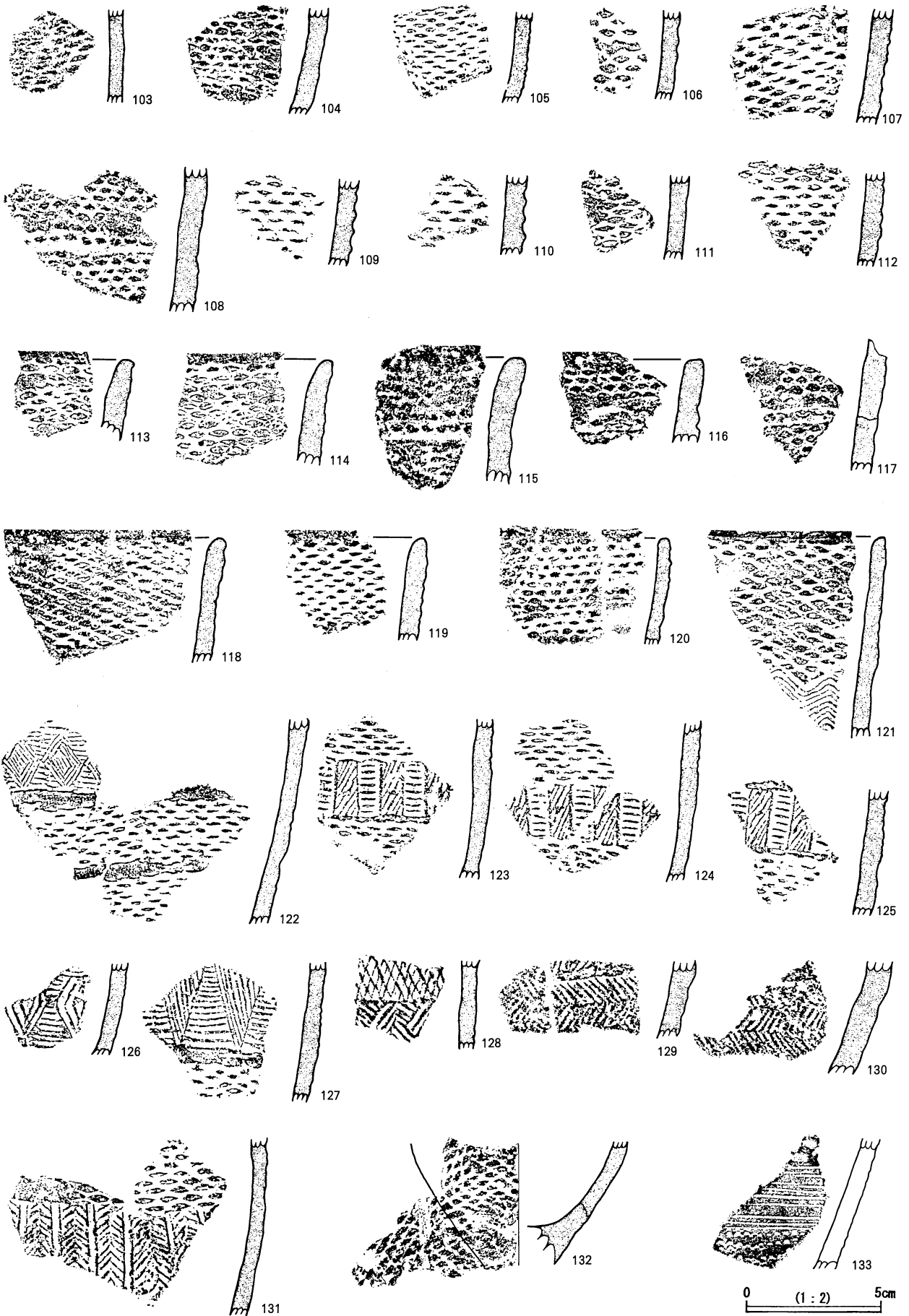

縄文時代土器 6

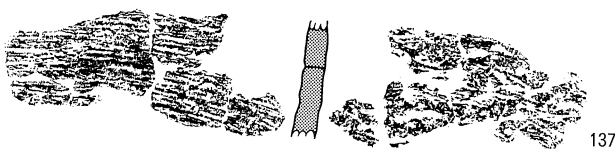
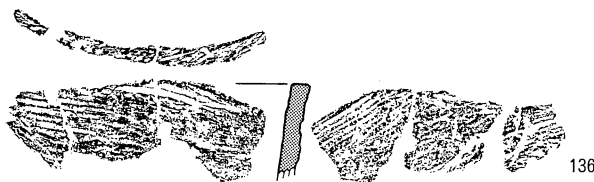
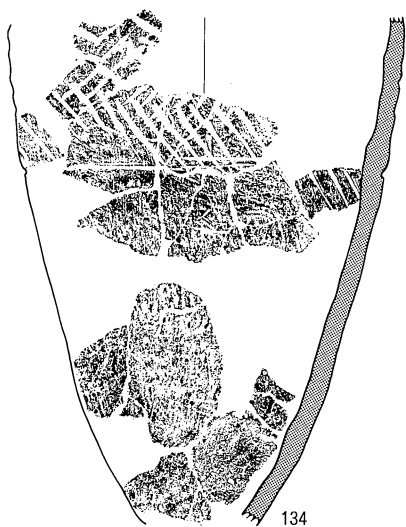

0 (1 : 4) 10cm

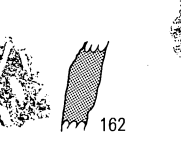
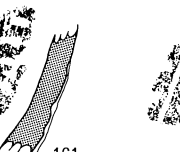
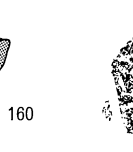
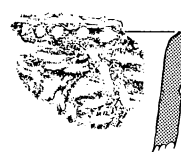
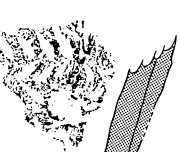
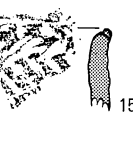
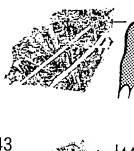
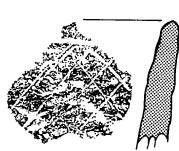
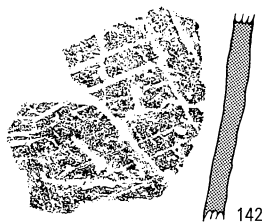
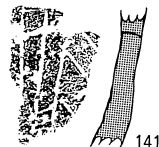
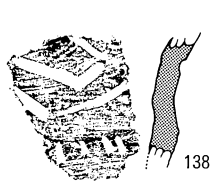

0 (1 : 3) 10cm

縄文時代土器 7

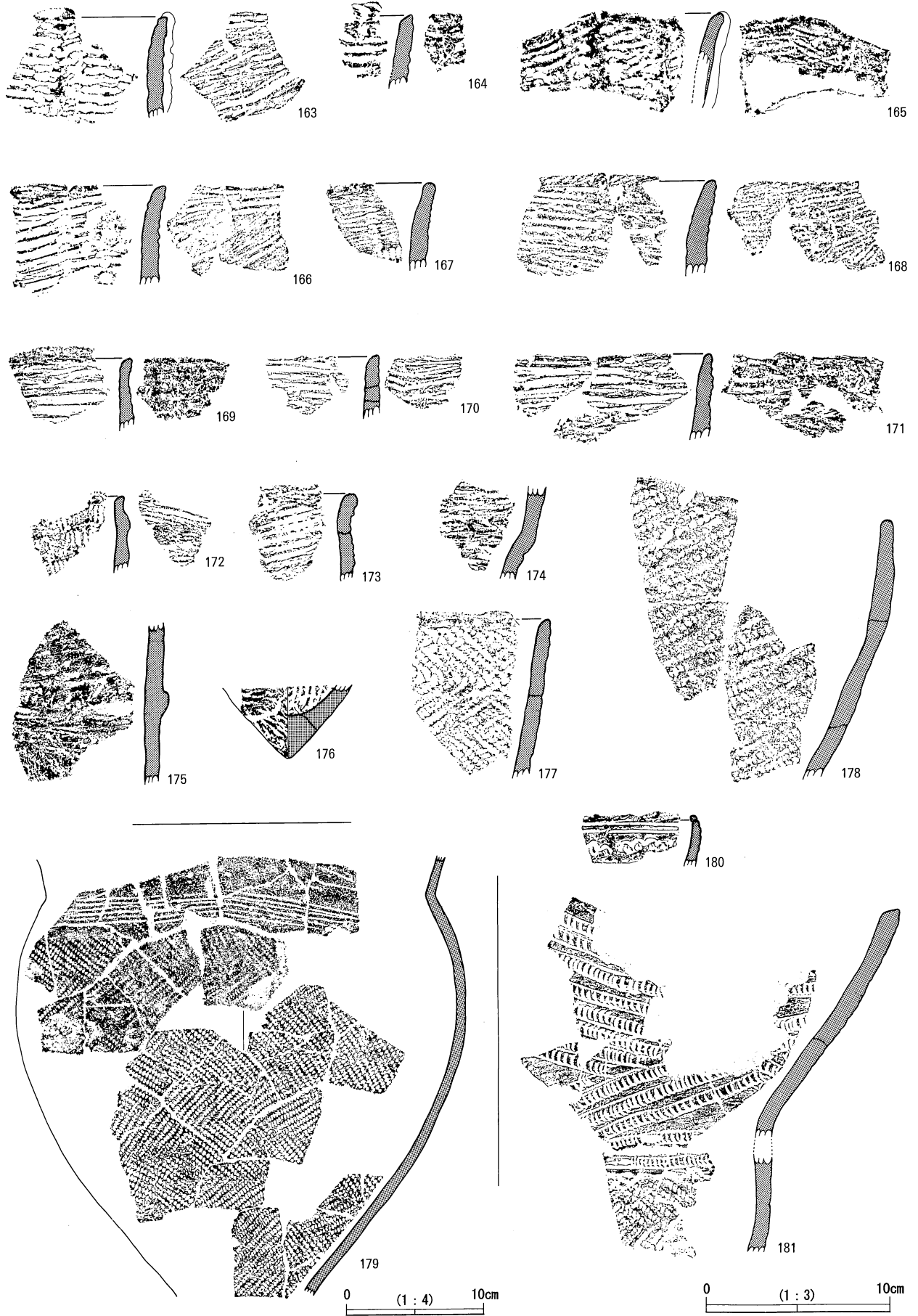

縄文時代土器 8

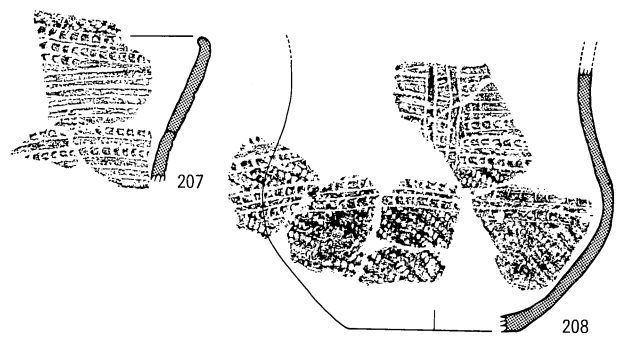
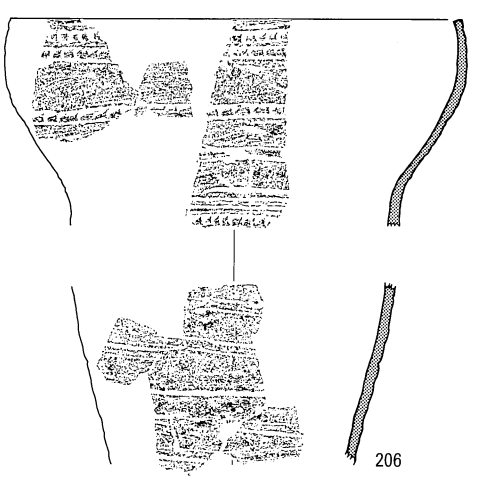
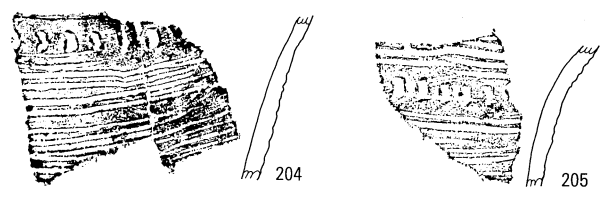
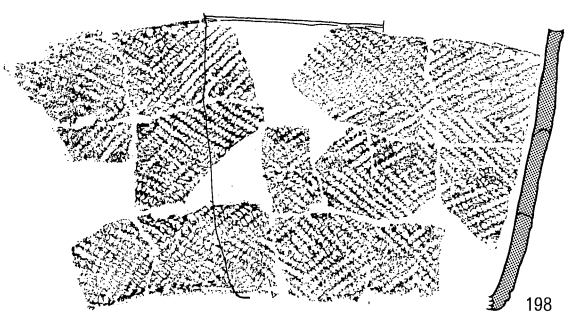
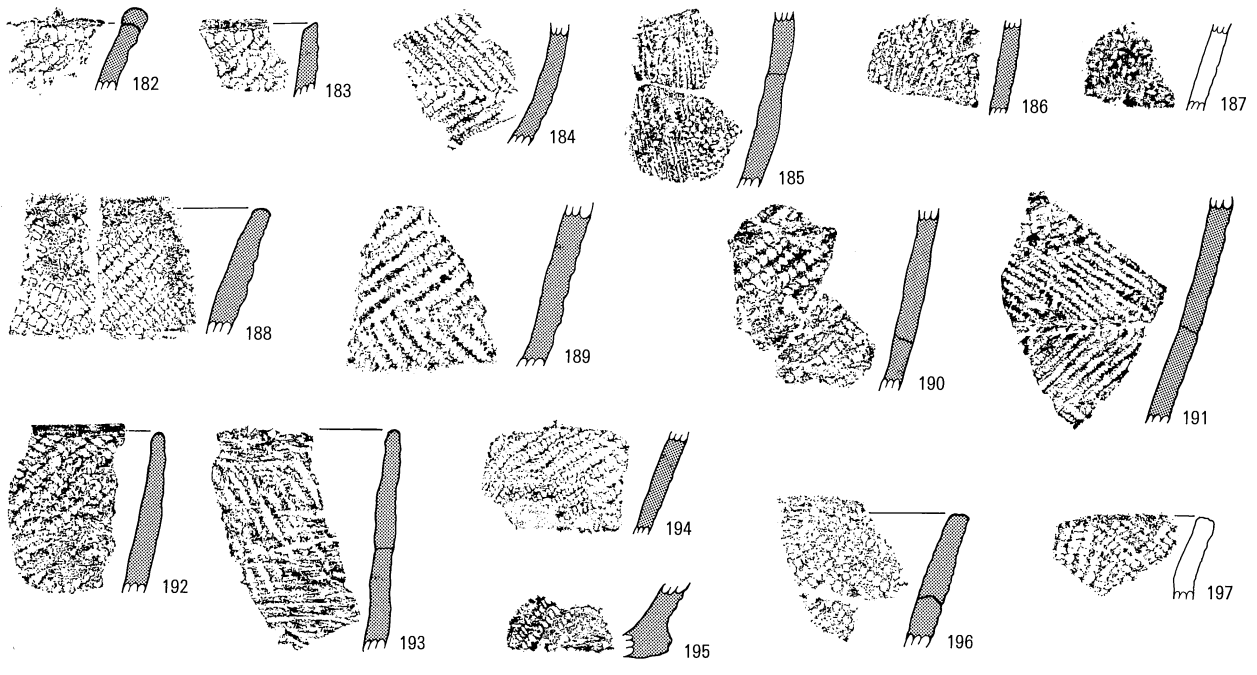

0 (1:4) 10cm

0 (1:3) 10cm

縄文時代土器 9

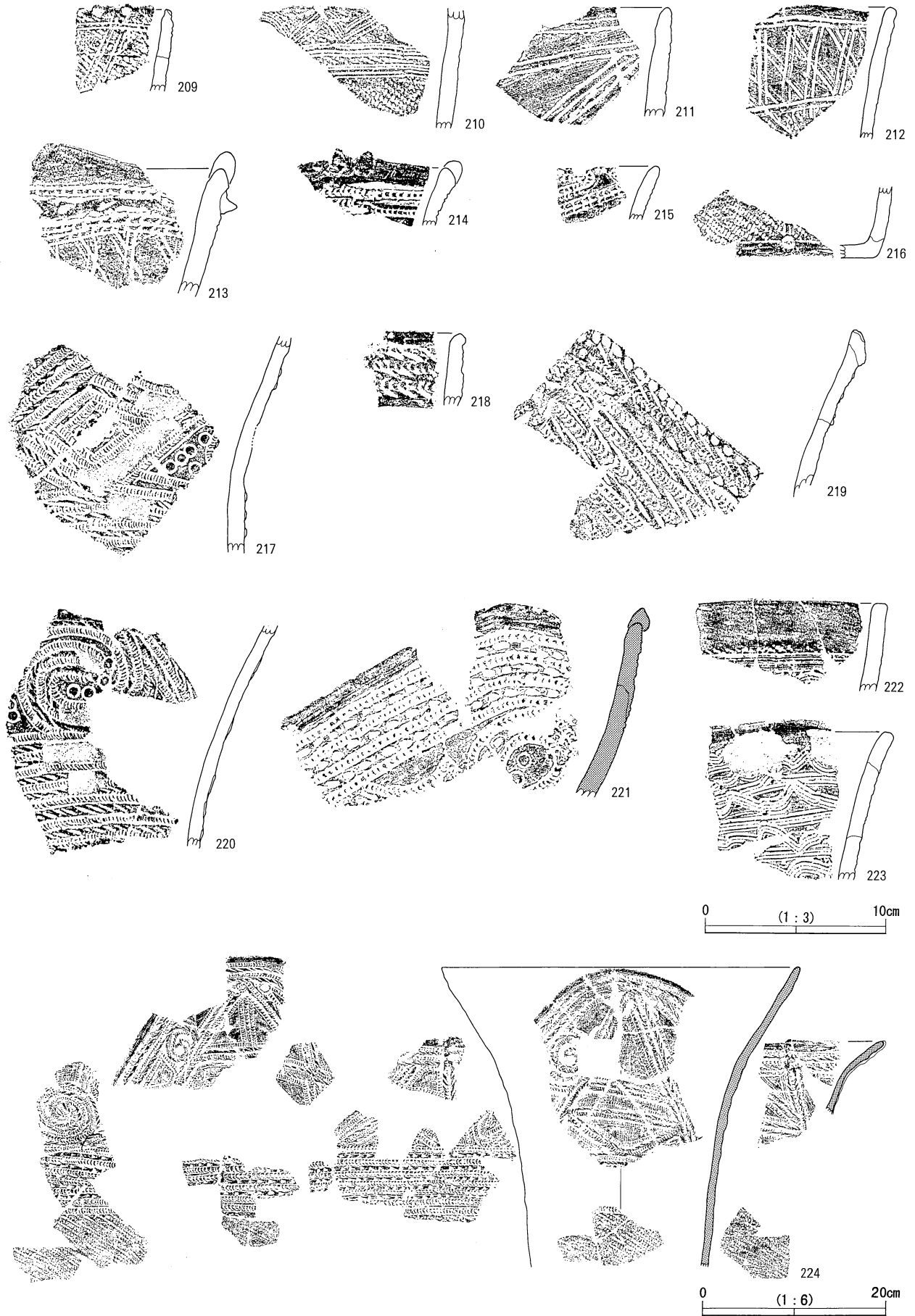

縄文時代土器 10

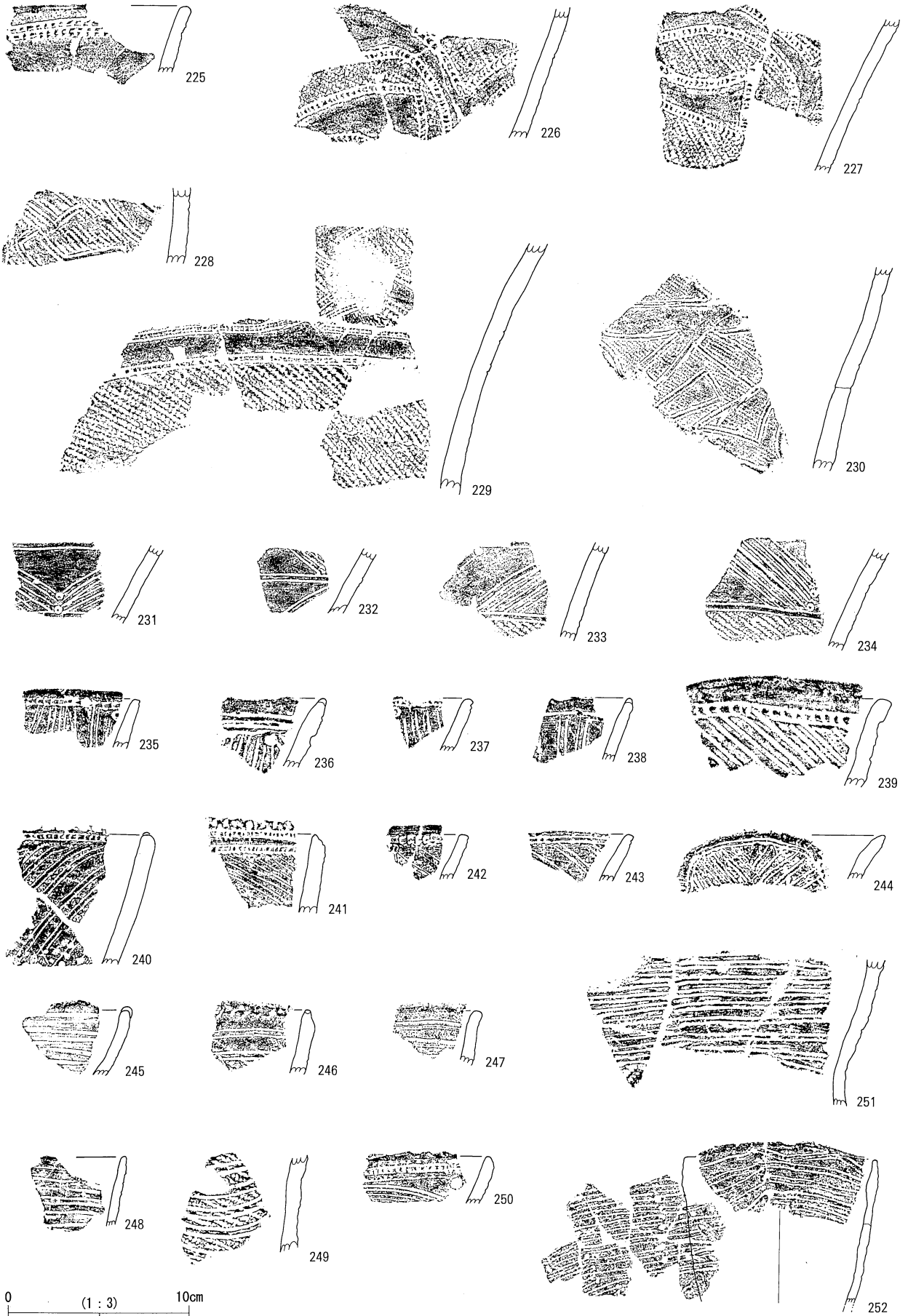

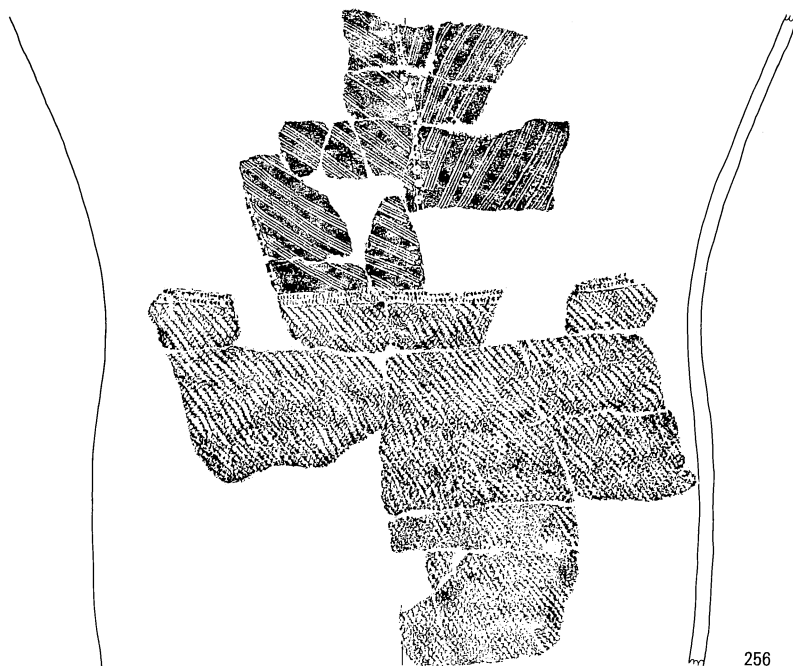
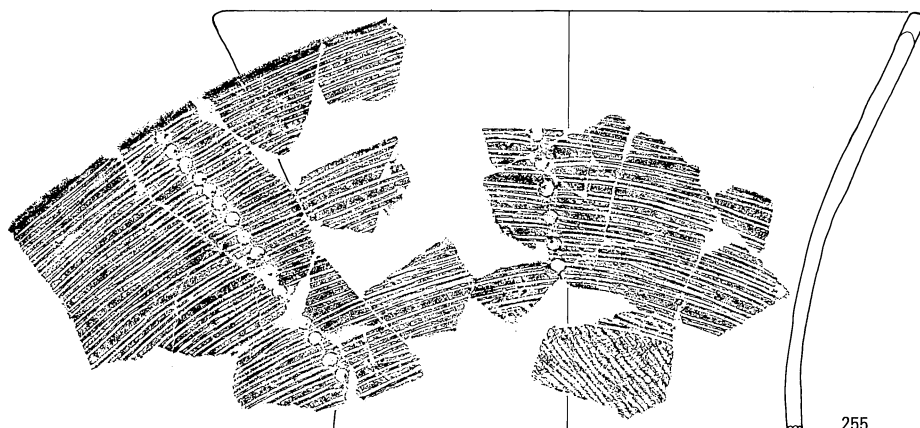
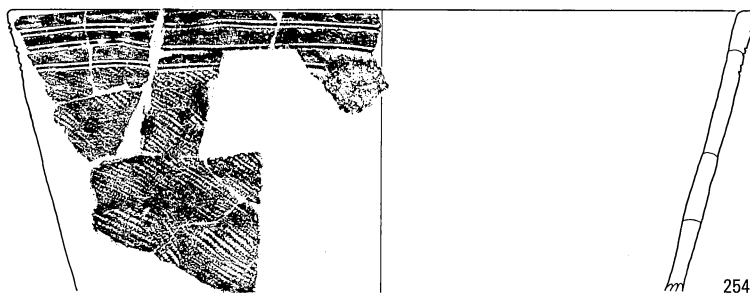
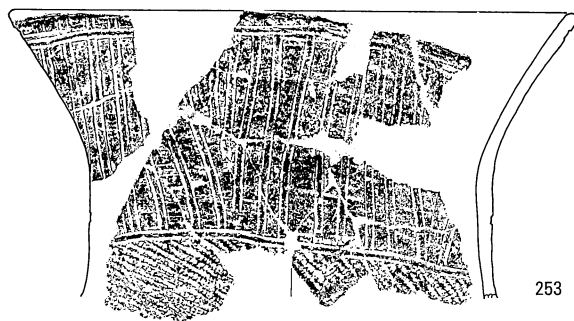

0 (1:4) 10cm

縄文時代土器 12

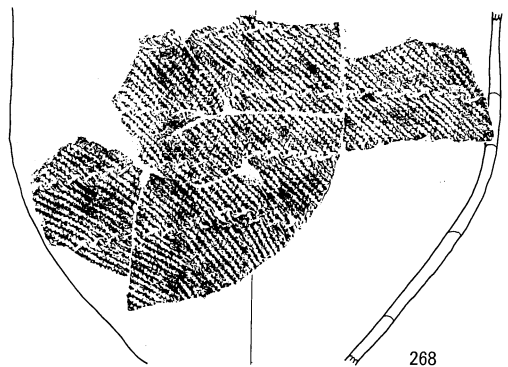
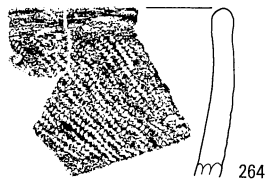
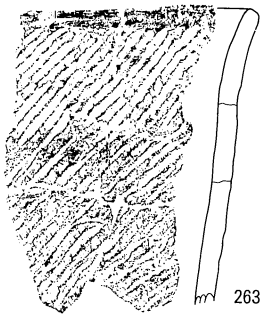
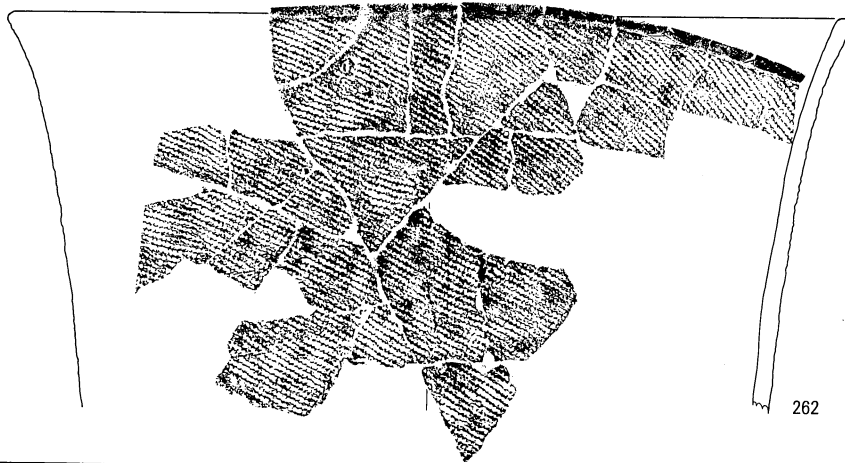
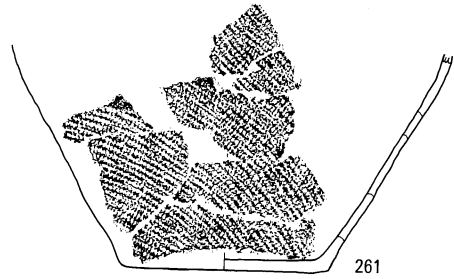
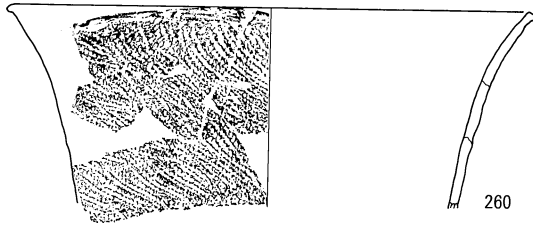
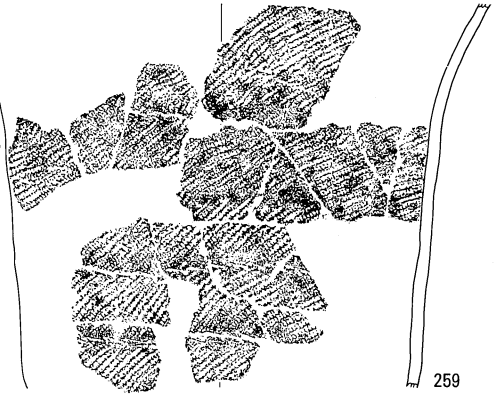
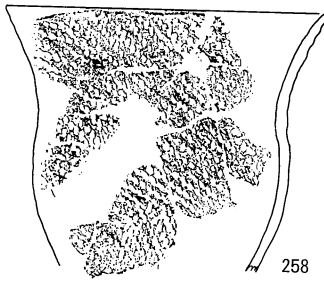
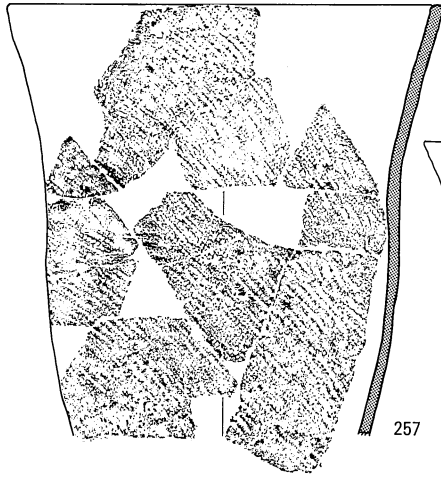

0 (1:3) 10cm

0 (1:4) 10cm

縄文時代土器 13

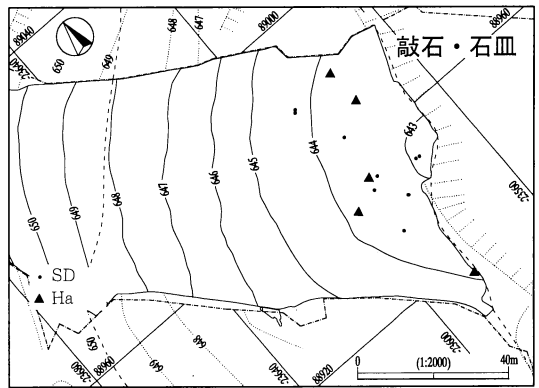
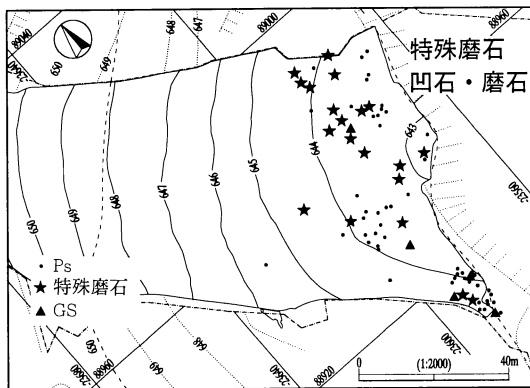
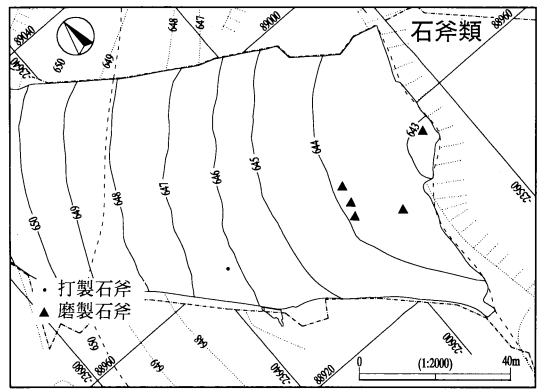
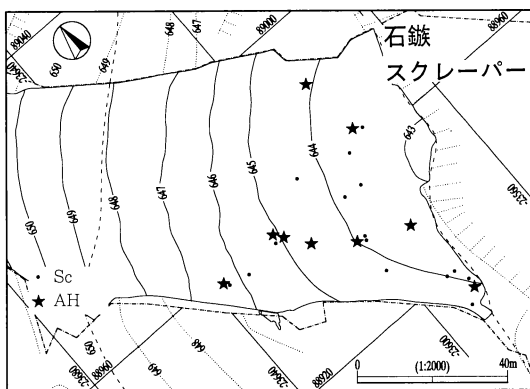
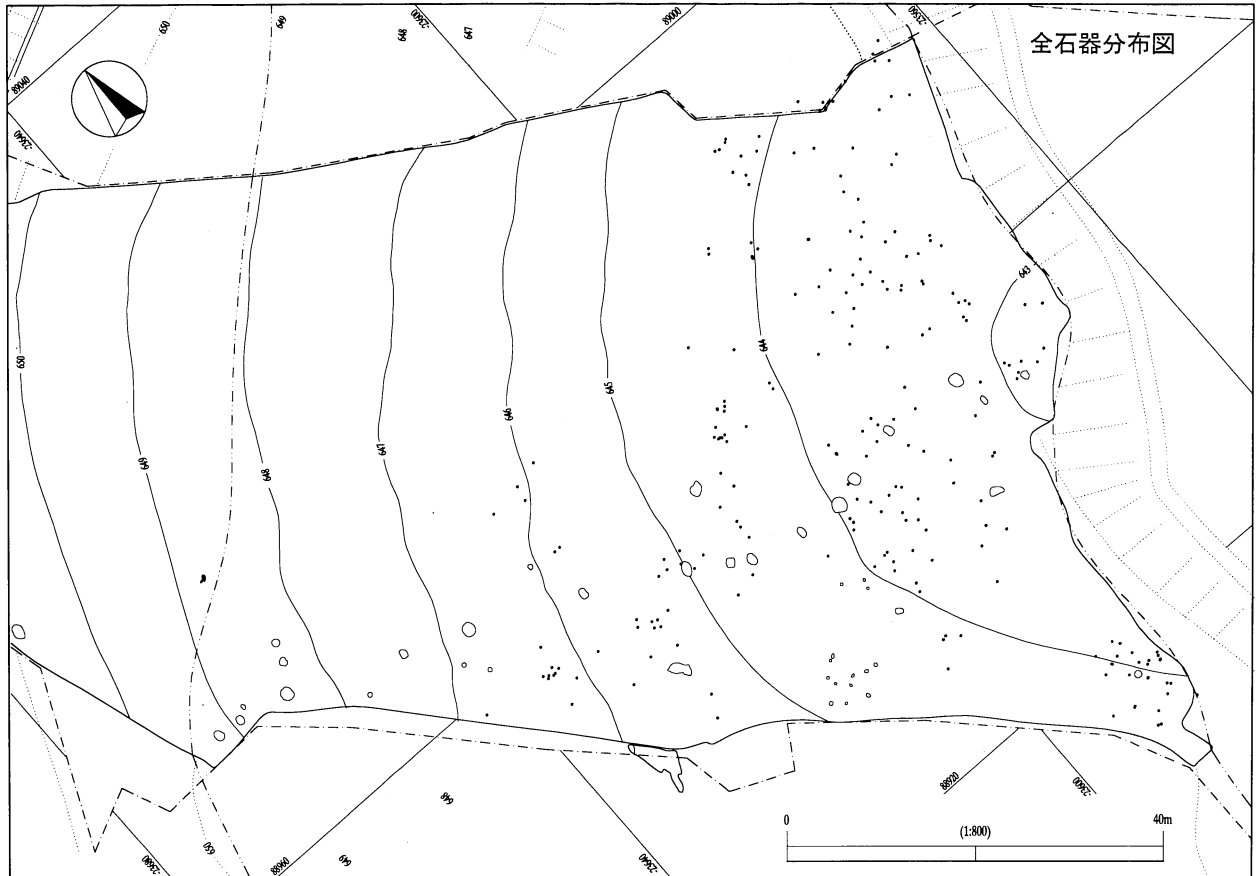

縄文時代石器分布図



縄文時代石器 1

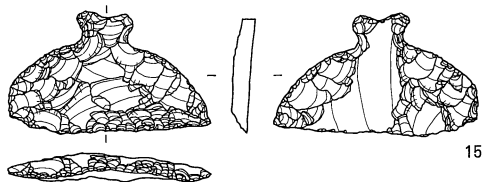

15

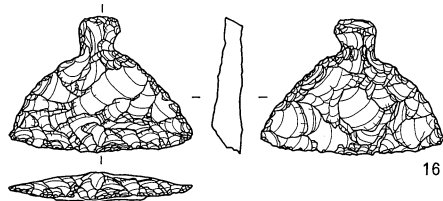

16

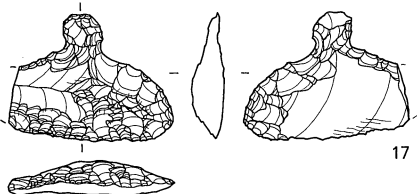

17

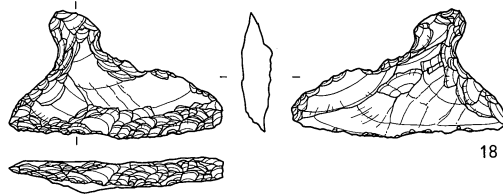

18

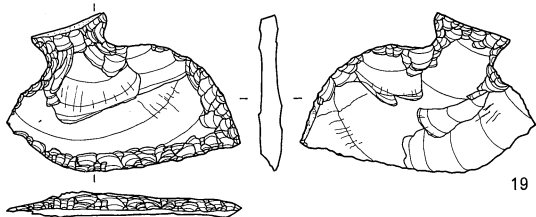

19

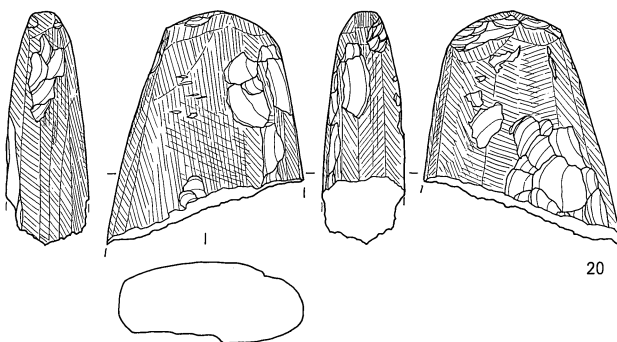

20

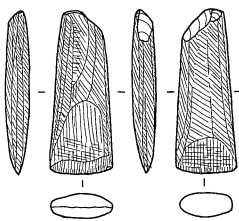

21

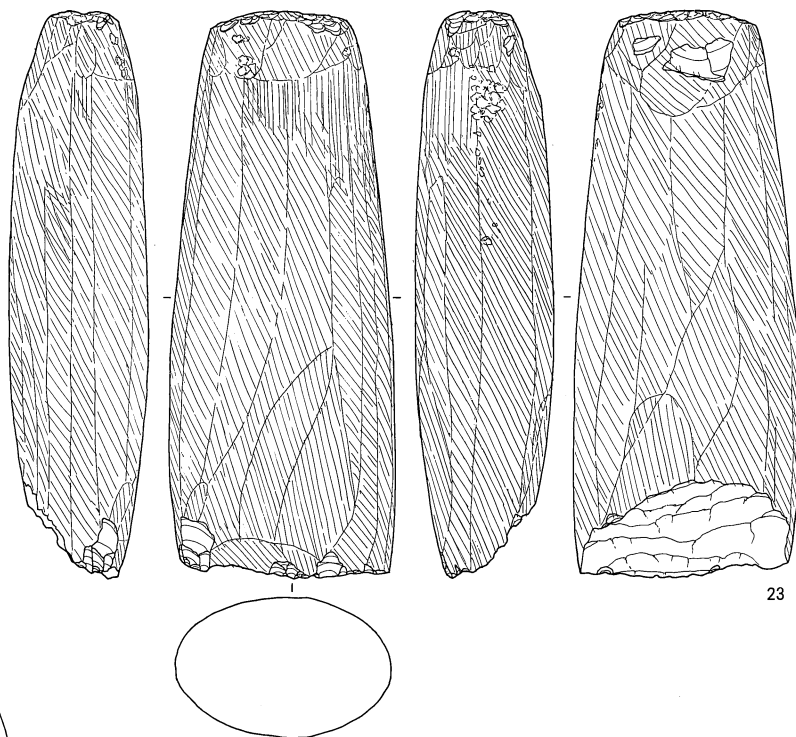

23

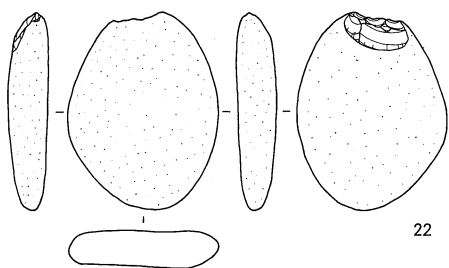

22

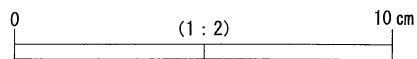

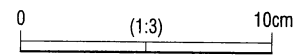
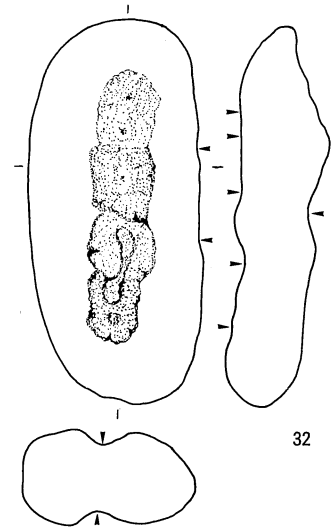
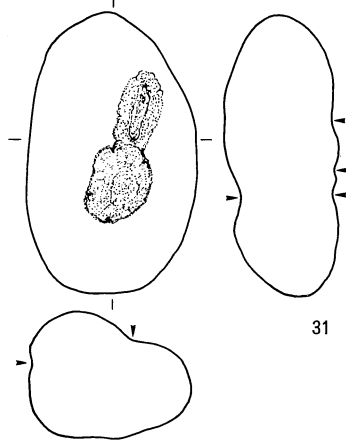
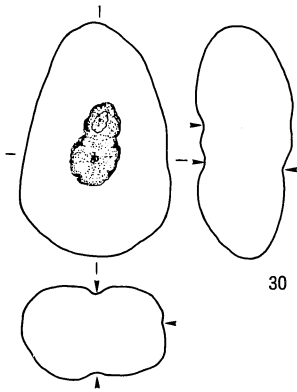
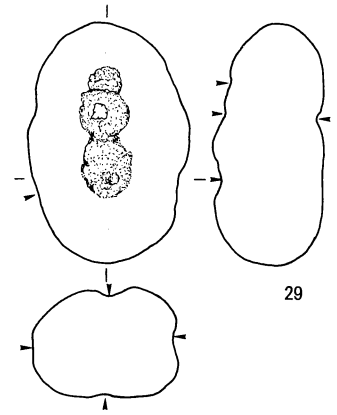
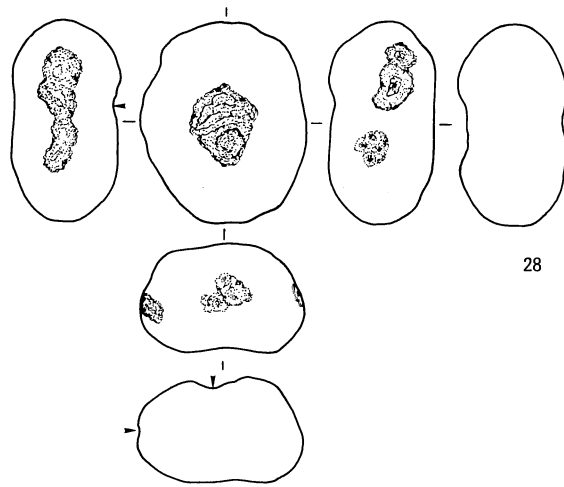
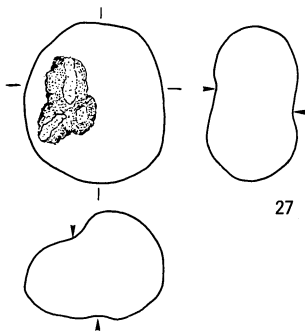
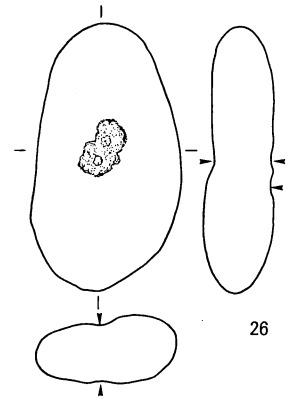
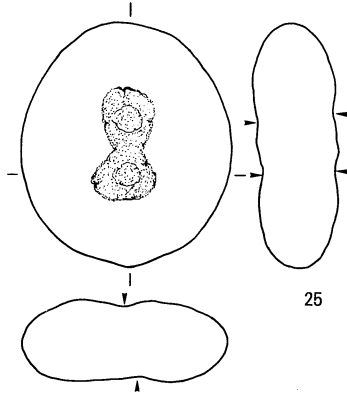
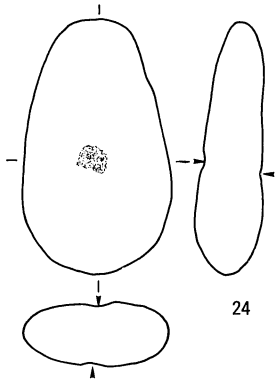

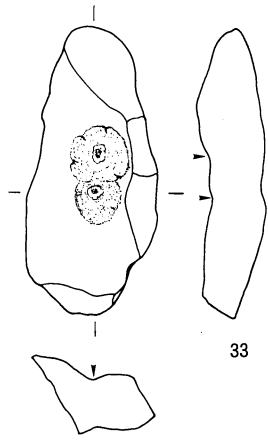

33

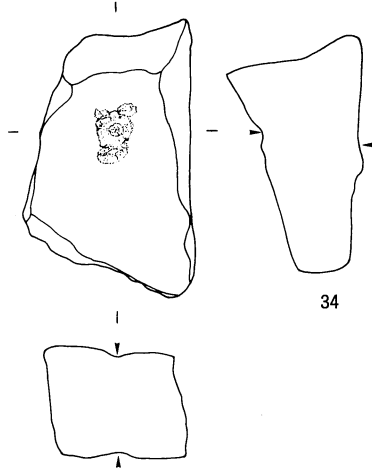

34

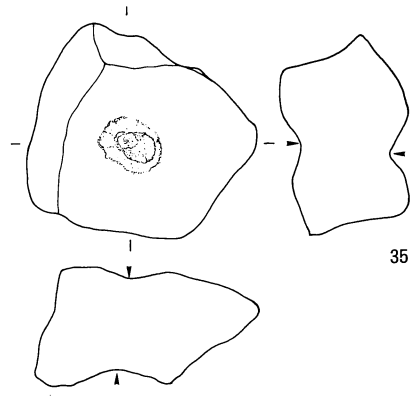

35

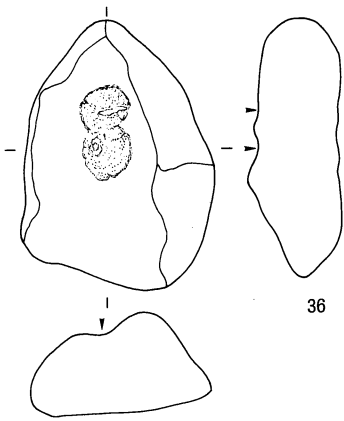

36

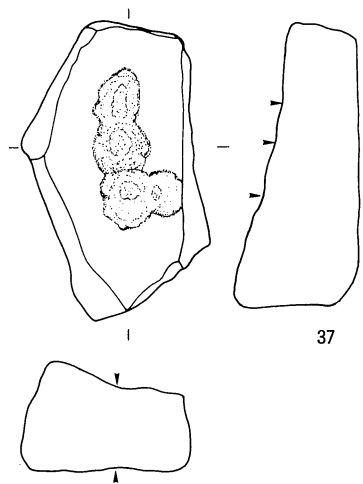

37

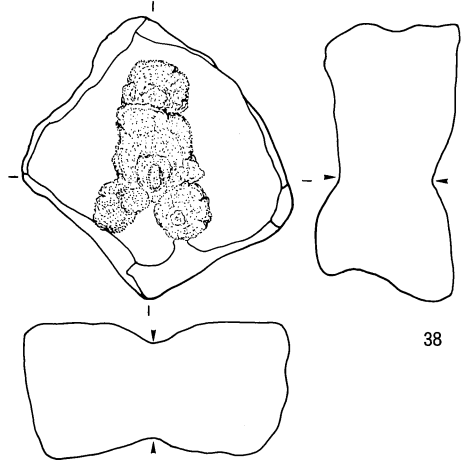

38

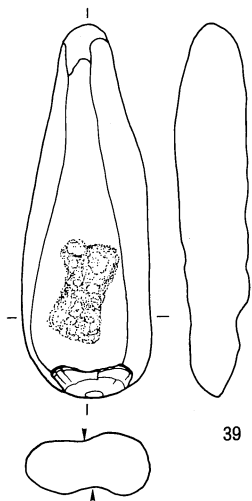

39

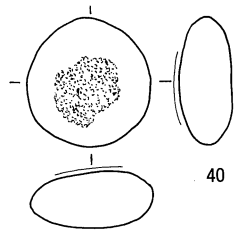

40

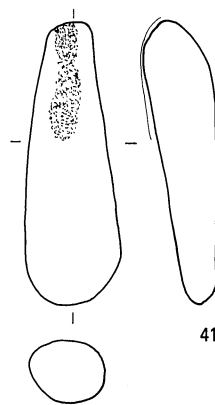

41

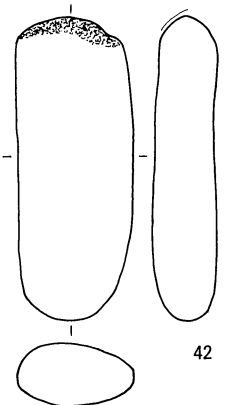

42

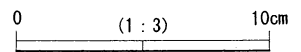

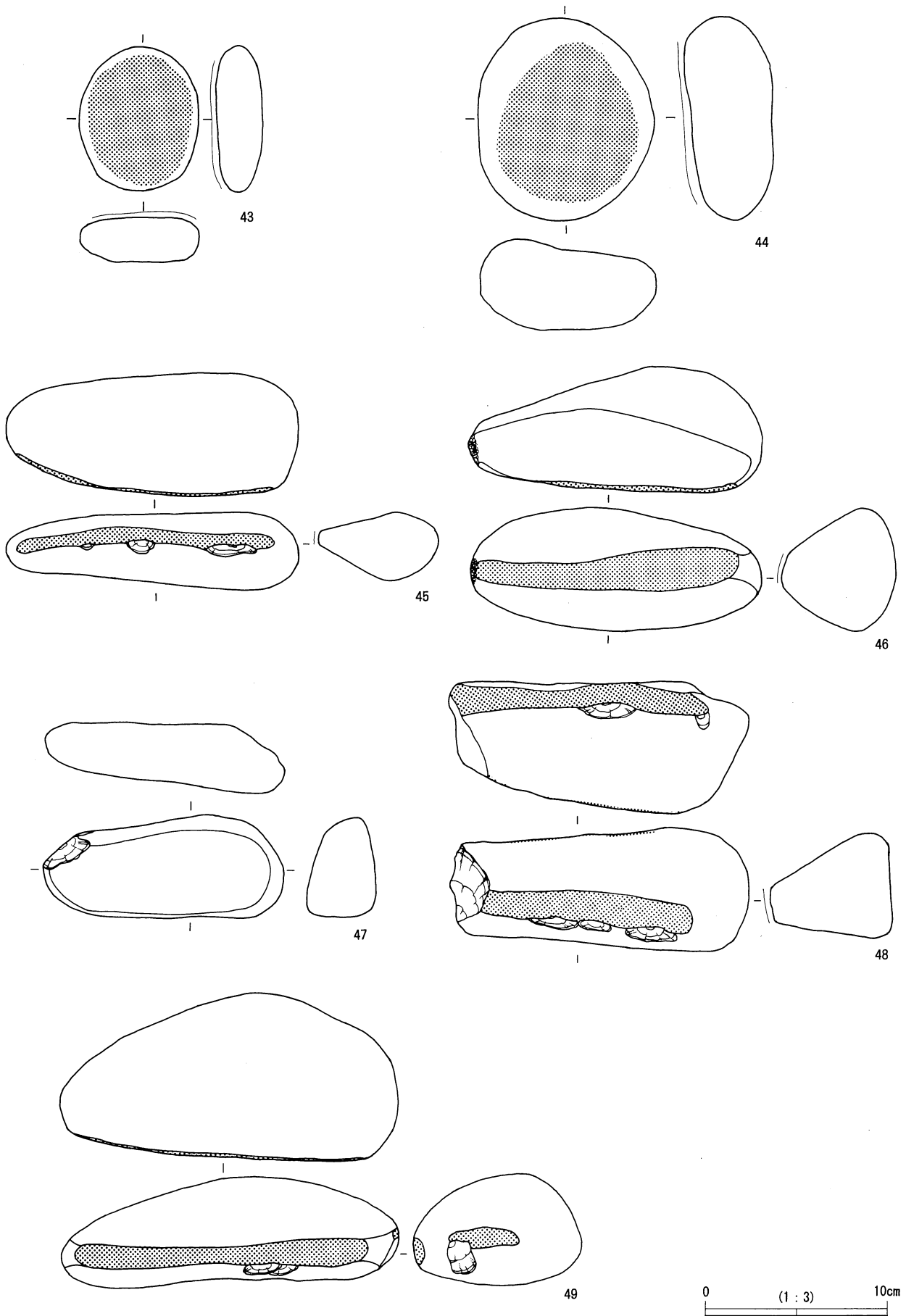

縄文時代石器 5

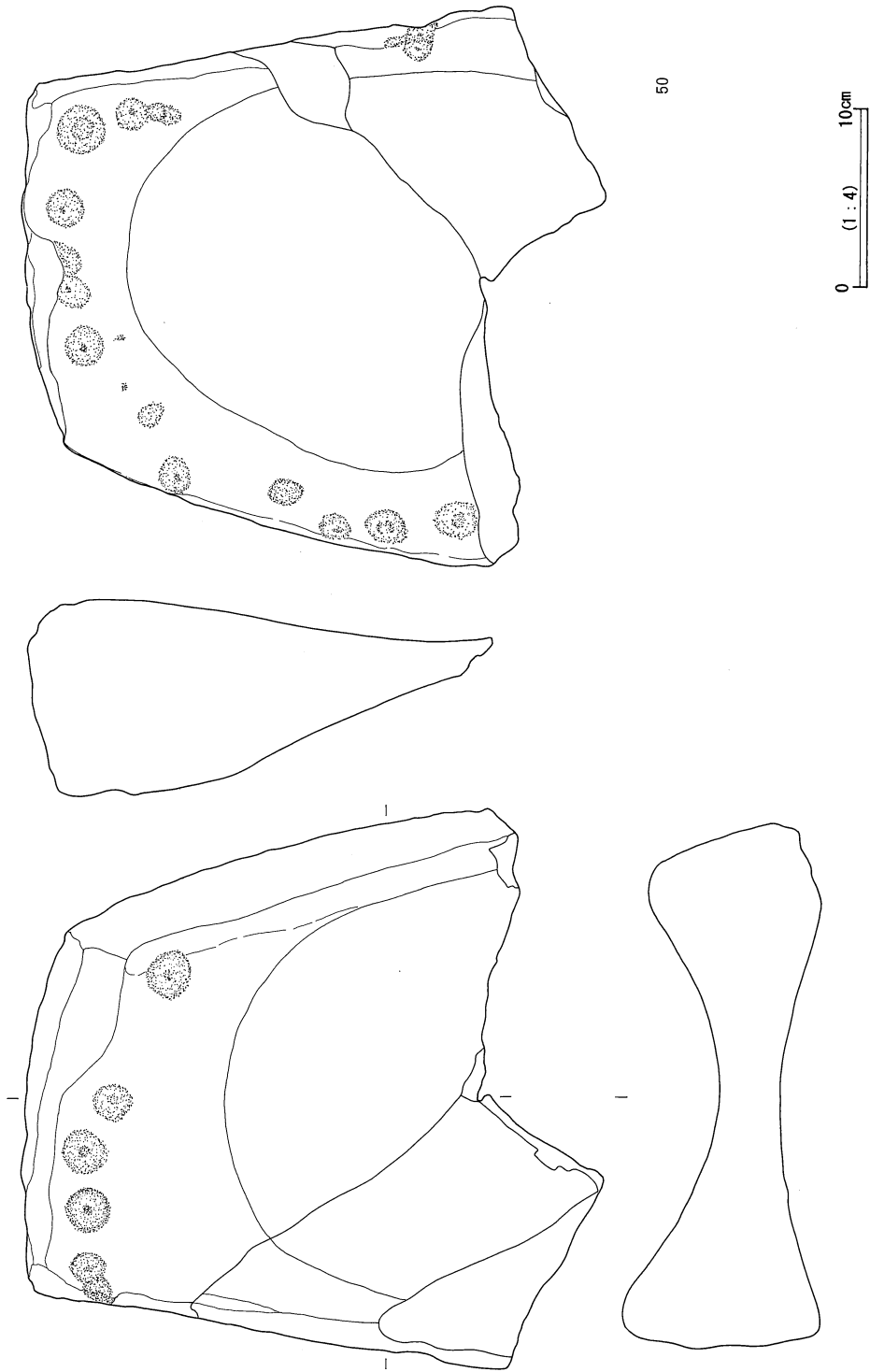

縄文時代石器 6

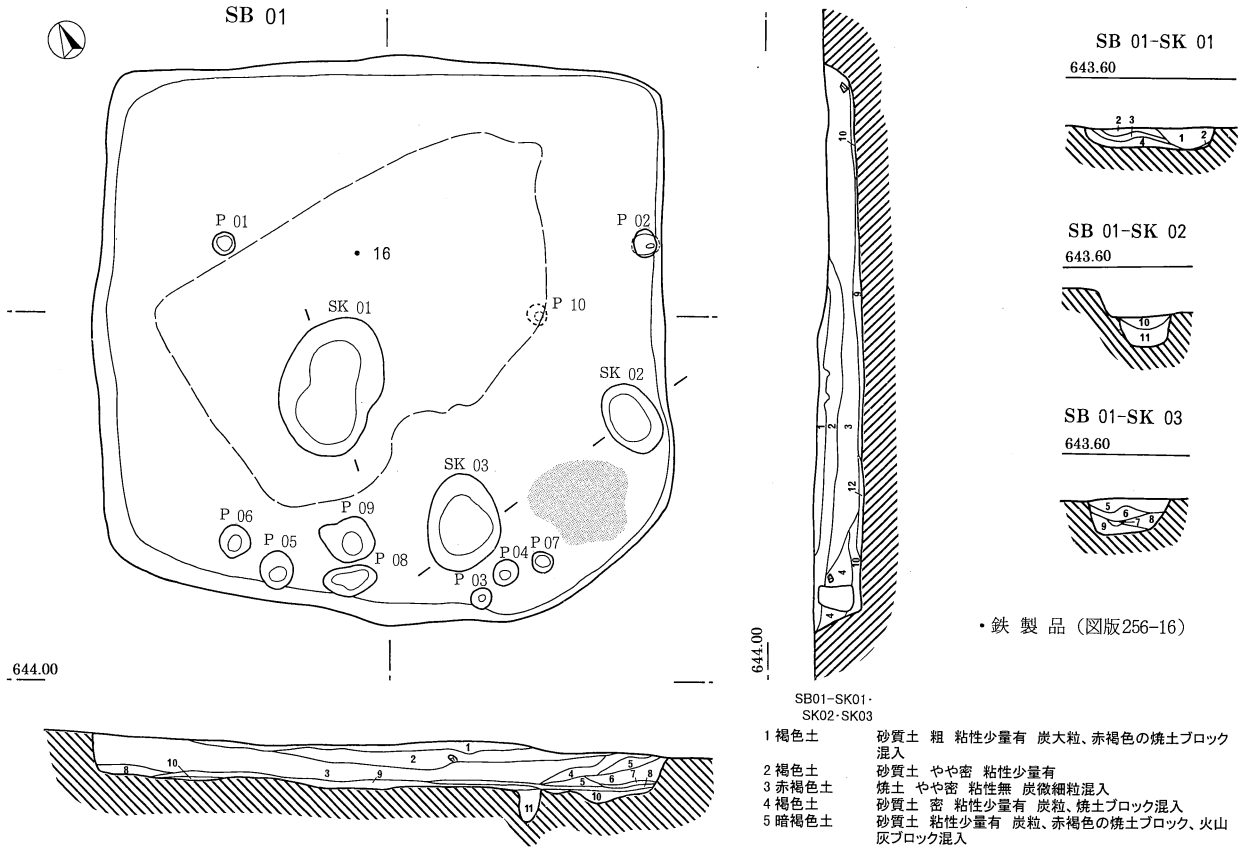

- SB01
- 1 黒色土 やや粗 粘性有 褐色粒混入
 - 2 黒色土 1層より密 褐色粒混入 粘性少量有
 - 3 黒褐色土 粘性少量有 1層より密 褐色細粒と赤褐色焼土含有 焼土塊が部分的混入 上部から土師器片集中出土
 - 4 極暗褐色土 粘性少量有 やや密 焼土粒混入 砂質土
 - 5 明褐色土 粘性少量有 密 焼土、カマドの壁面
 - 6 黒褐色土 粘性少量有 密 焼土粒混入 2層の土に類似 5層下部は赤褐色焼土堆積、その下は褐色の床面
 - 7 明赤褐色土 粘性少量有 密 火床焼土
 - 8 暗褐色土 粘性少量有 砂質土
 - 9 にふい黄褐色土 粘性有 密 焼土粒混入 貼り床
 - 10 暗褐色土 砂質土 粘性少量有 焼土ブロック混入
 - 11 黒褐色土 砂質土 粘性少量有 やや粗
 - 12 暗褐色土 砂質土 粘性少量有 焼土ブロック大粒、炭粒、粘土ブロック混入 貼り床を掘り切り凹にたまっている

- SB01-SK01-SK02-SK03
- 1 褐色土 砂質土 粗 粘性少量有 炭大粒、赤褐色の焼土ブロック混入
 - 2 褐色土 砂質土 やや密 粘性少量有
 - 3 赤褐色土 焼土 やや密 粘性無 炭微細粒混入
 - 4 褐色土 砂質土 密 粘性少量有 炭粒、焼土ブロック混入
 - 5 暗褐色土 砂質土 粘性少量有 炭粒、赤褐色の焼土ブロック、火山灰ブロック混入
 - 6 黒褐色土 砂質土 粘性少量有 赤褐色の焼土ブロック混入
 - 7 黒褐色土 砂質土 やや軟質 粘性有
 - 8 明黄褐色土 火山灰層 軟質 粘性有 Ⅲ層の土
 - 9 暗褐色土 砂質土 粘性有 焼土ブロック、炭大粒混入
 - 10 黒褐色土 砂質土 粘性少量有 赤褐色焼土ブロック、炭混入
 - 11 極暗褐色土 砂質土 粘性少量有 焼土ブロック、炭大粒混入 2層と類似

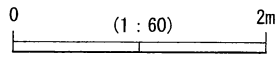

- SB01カマド
- 1 黒褐色土 粘性少量有 やや密 焼土ブロック混入
 - 2 明褐色土 粘性少量有 密 焼土
 - 3 黒褐色土 粘性少量有 密 焼土粒混入 2層の土に類似 5層下部赤褐色焼土堆積
 - 4 明赤褐色土 粘性少量有 密 焼土
 - 5 にふい黄褐色土 密 焼土粒混入
 - 6 暗褐色土 粘性有 焼土ブロック混入

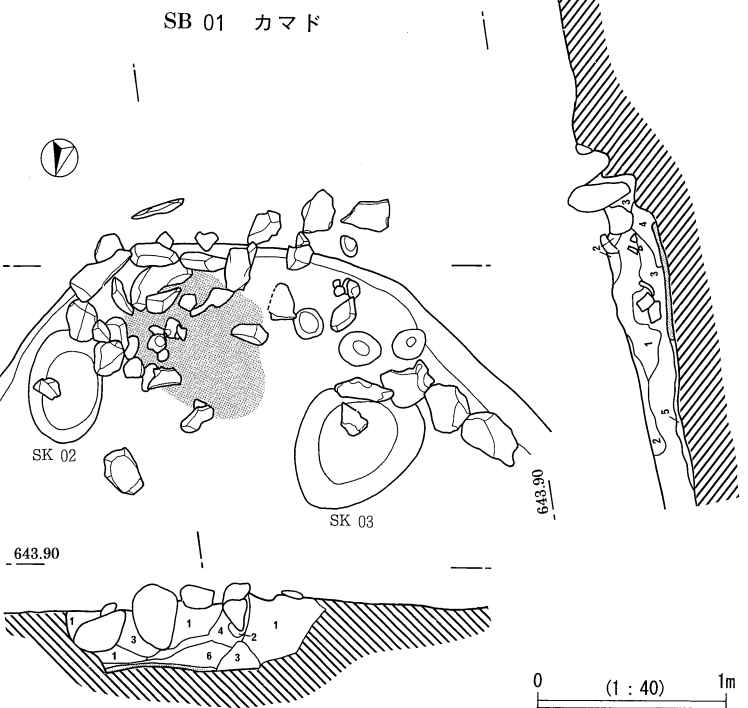

平安時代遺構図 1

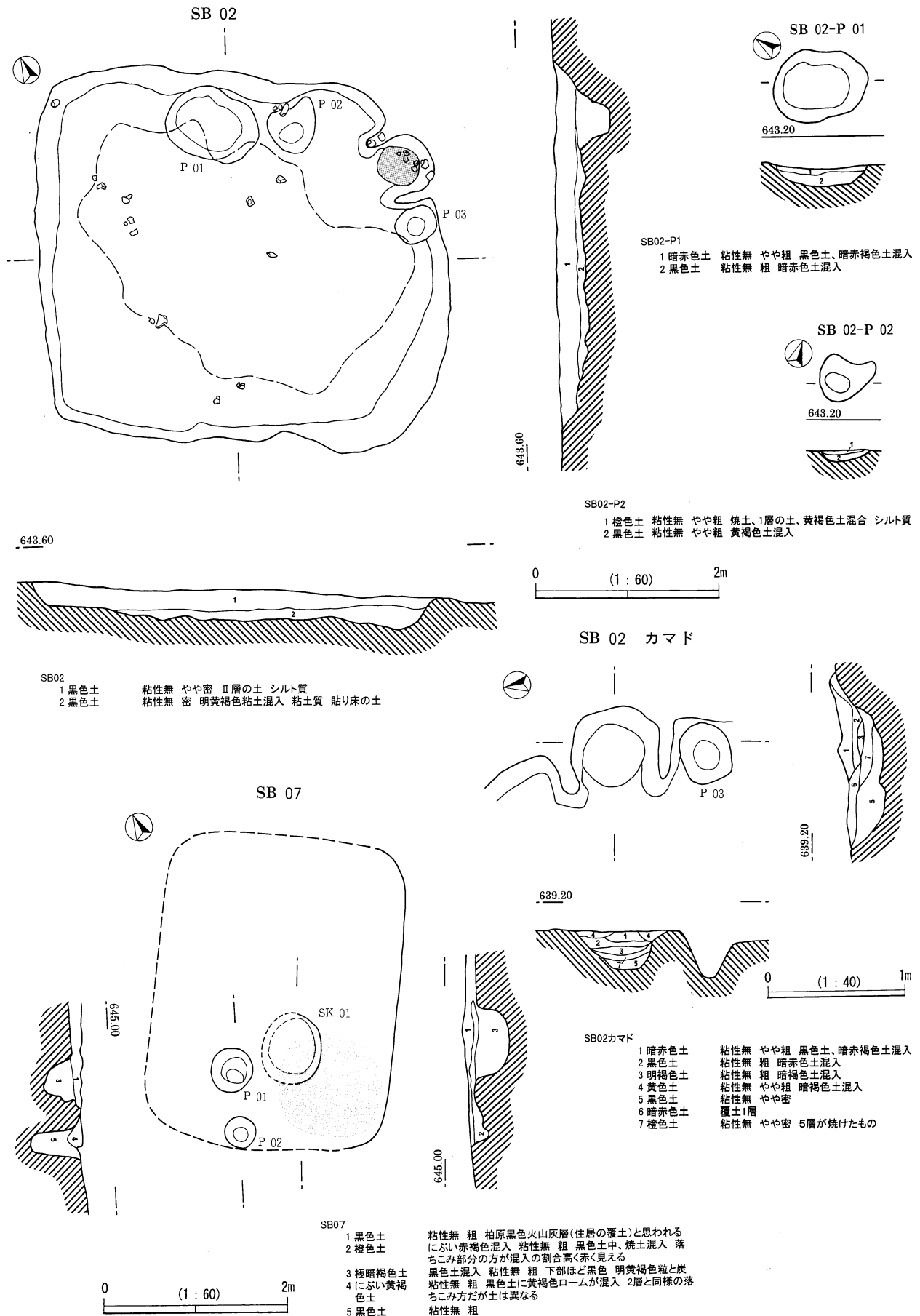

平安時代遺構図 2

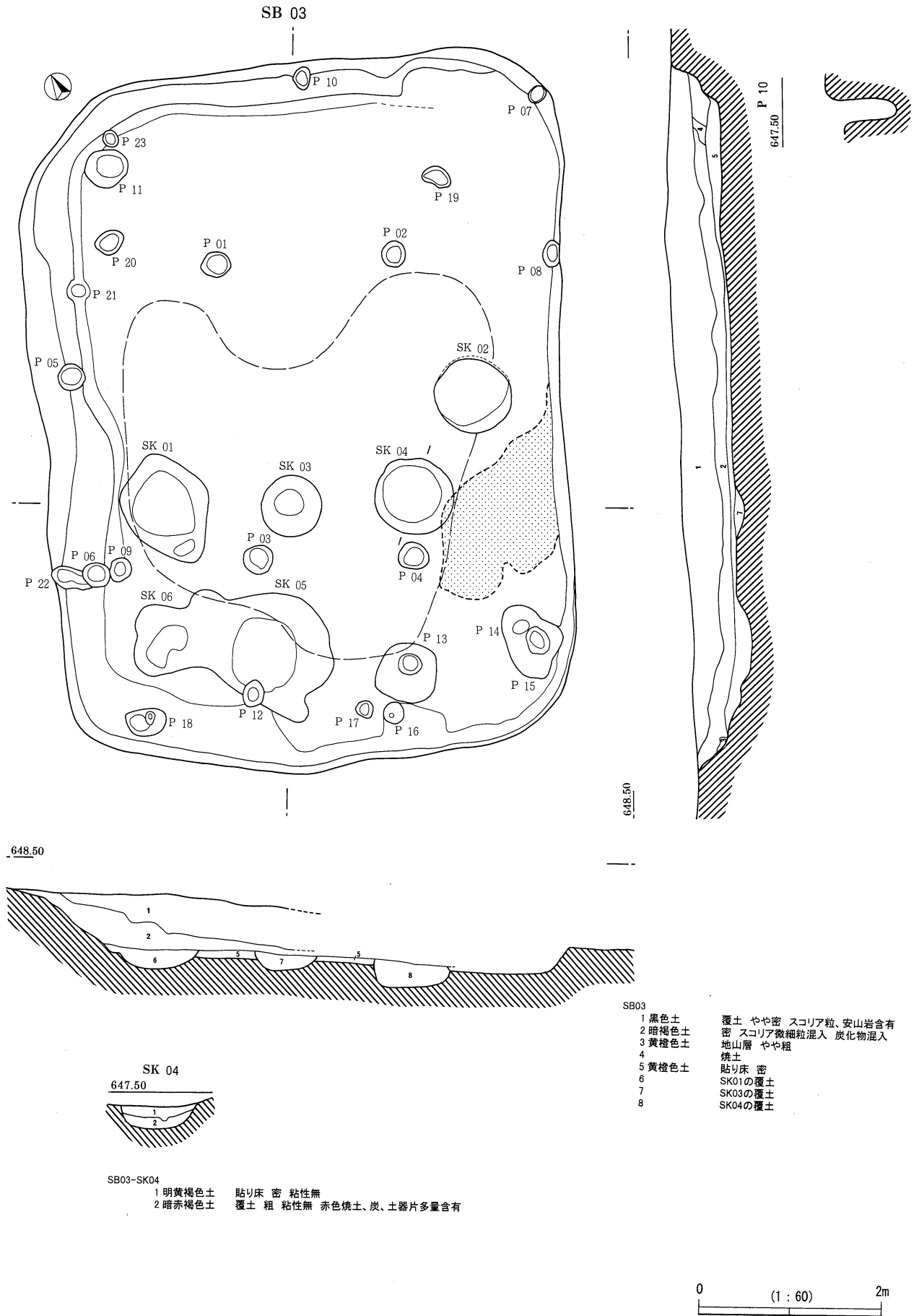

平安時代遺構図 3

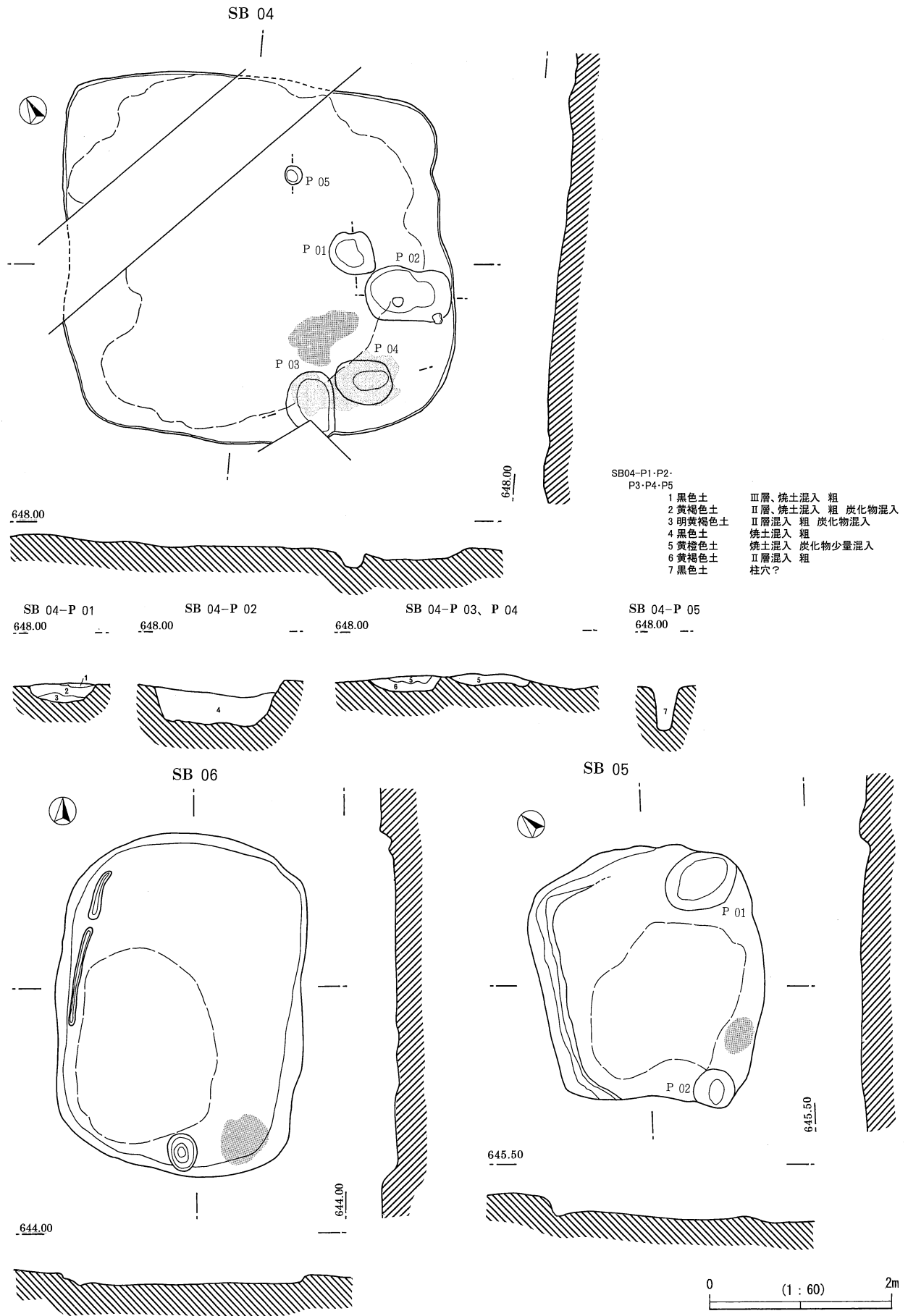

平安時代遺構図 4

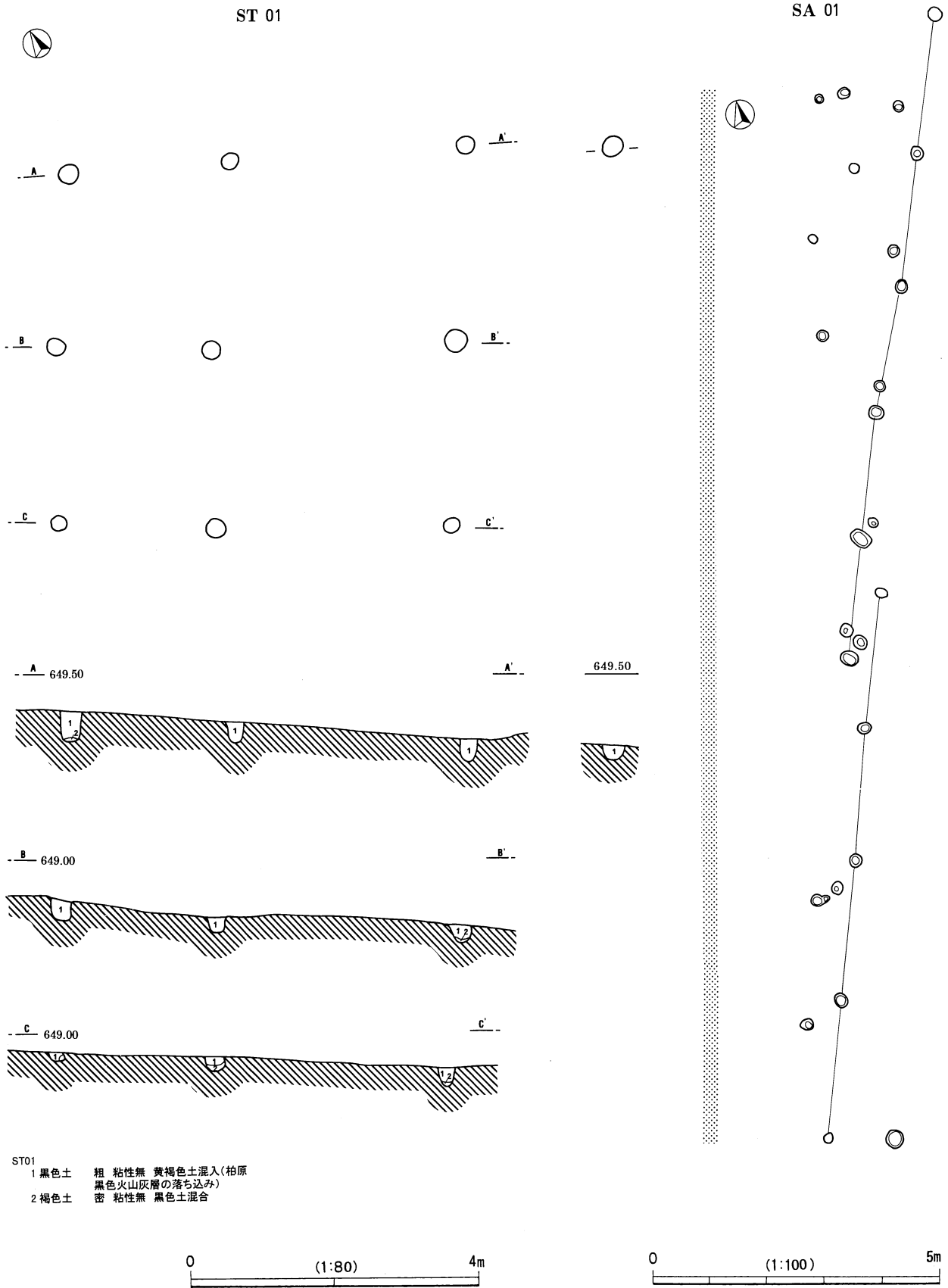

平安時代遺構図 5・近世遺構図

SB 01

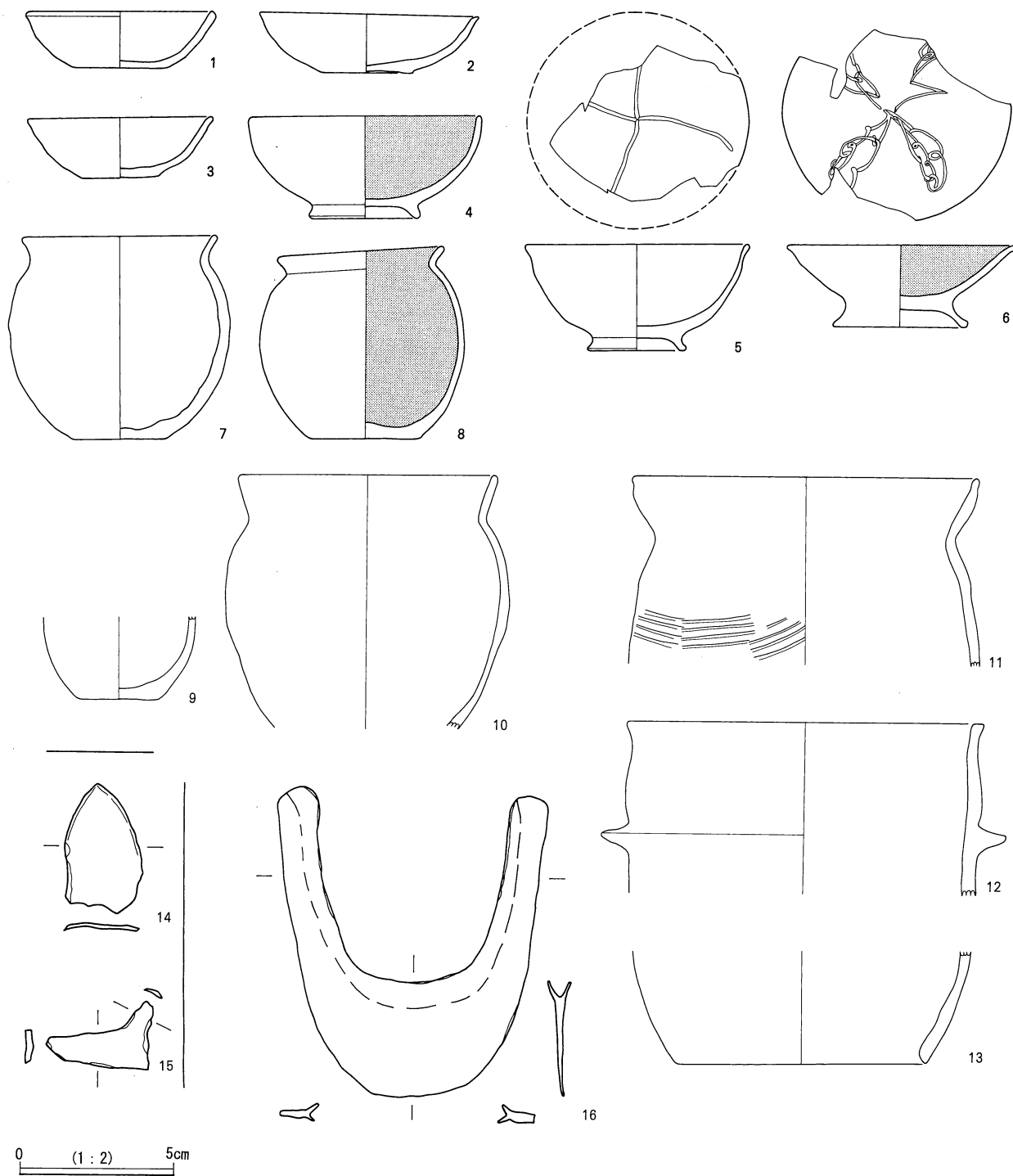

SB 02

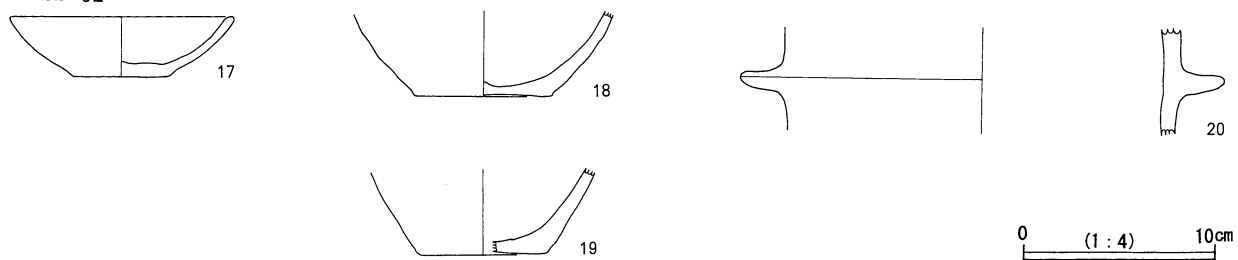

平安時代遺物図 1

SB 03

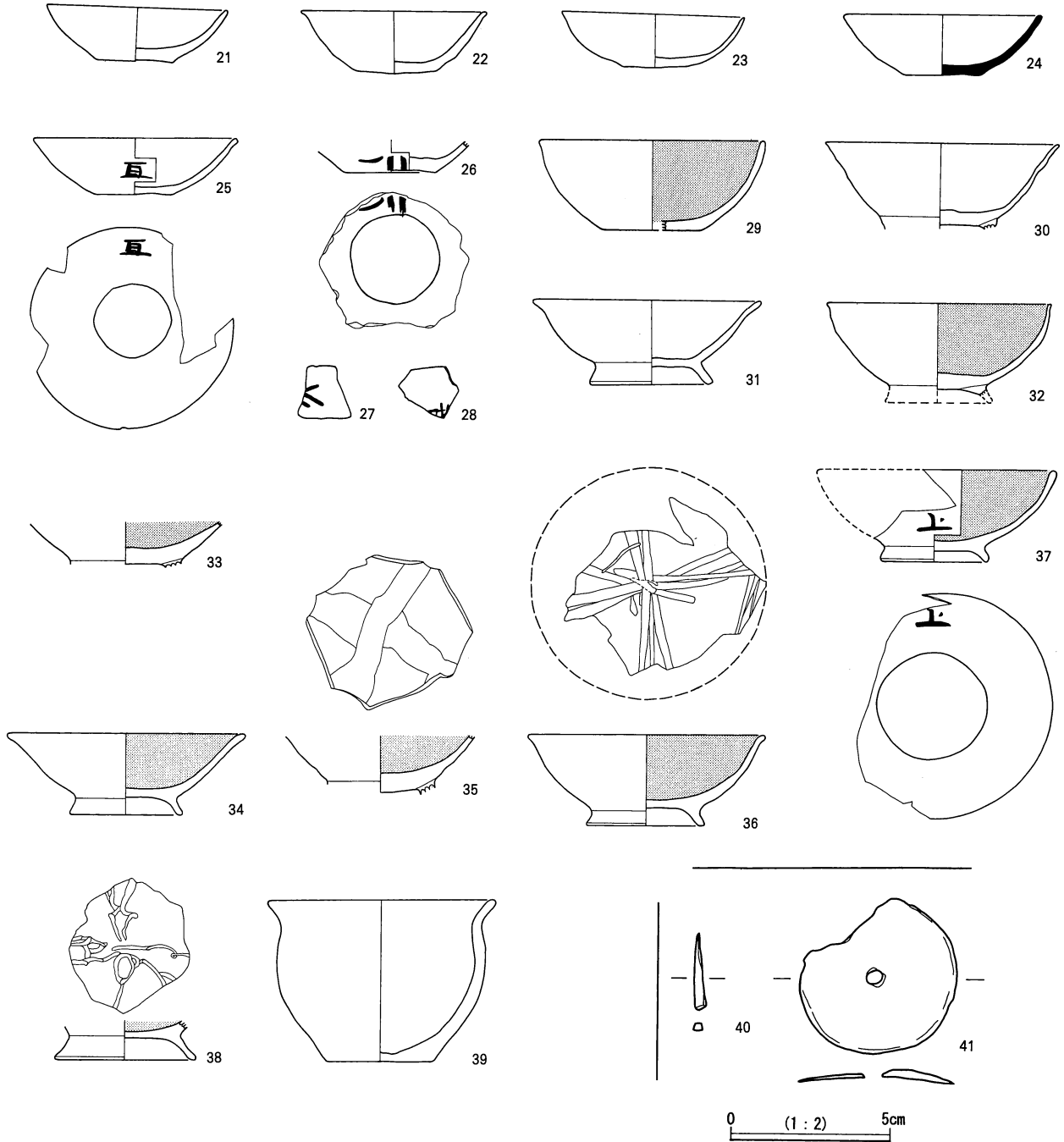

SB 04

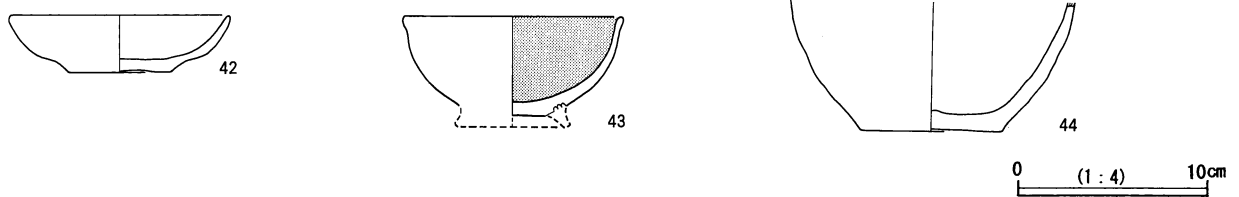

平安時代遺物図 2

SB 05



45



48

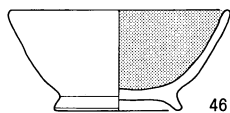

46

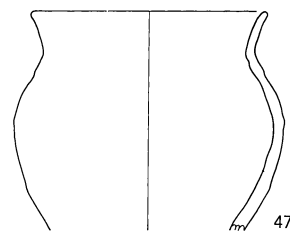

47

SB 06

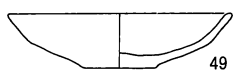

49

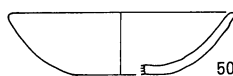

50

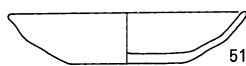

51



52

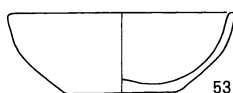

53

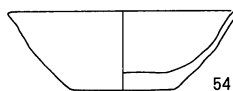

54

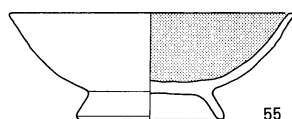

55

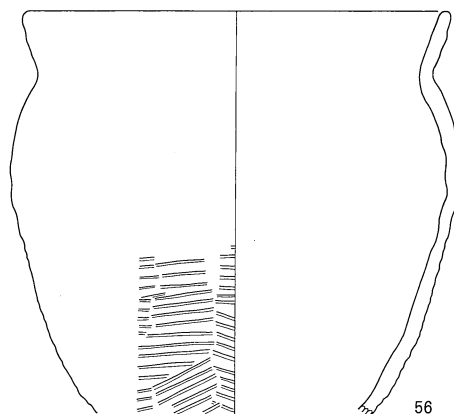

56

SB 07

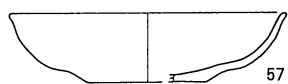

57

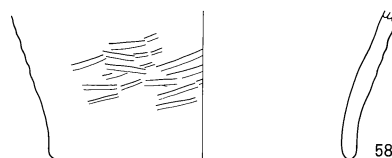

58

遺構外

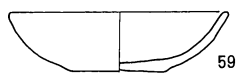

59

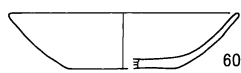

60



61

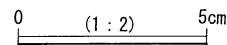
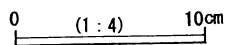

写 真 图 版

左：調查前
右：作業風景

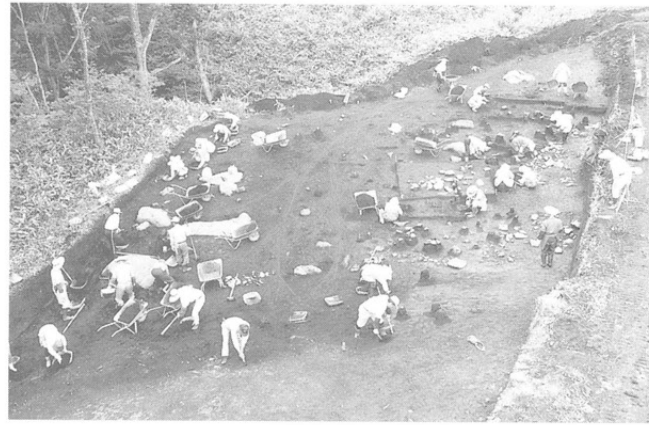

左：SH 01
右：SH 05



左：SH 07
右：SK 18



左：SK 10・09・11
右：SK 06



左：SK 12
右：SK 16





(1 : 3) 早期条痕文



(1 : 3) 前期土器



(1 : 3)

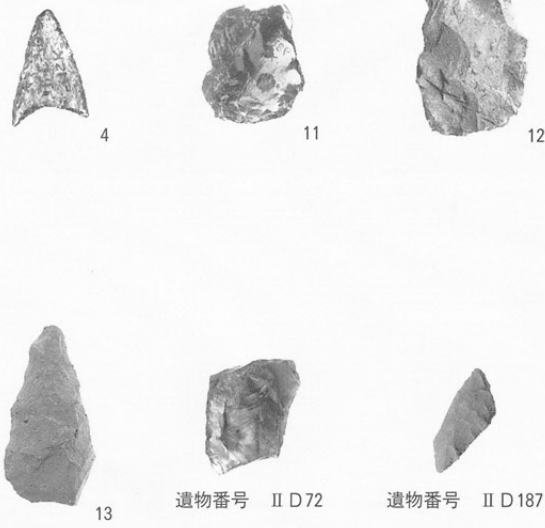

(2 : 3)



(1 : 3)

左：前期土器
右：石器

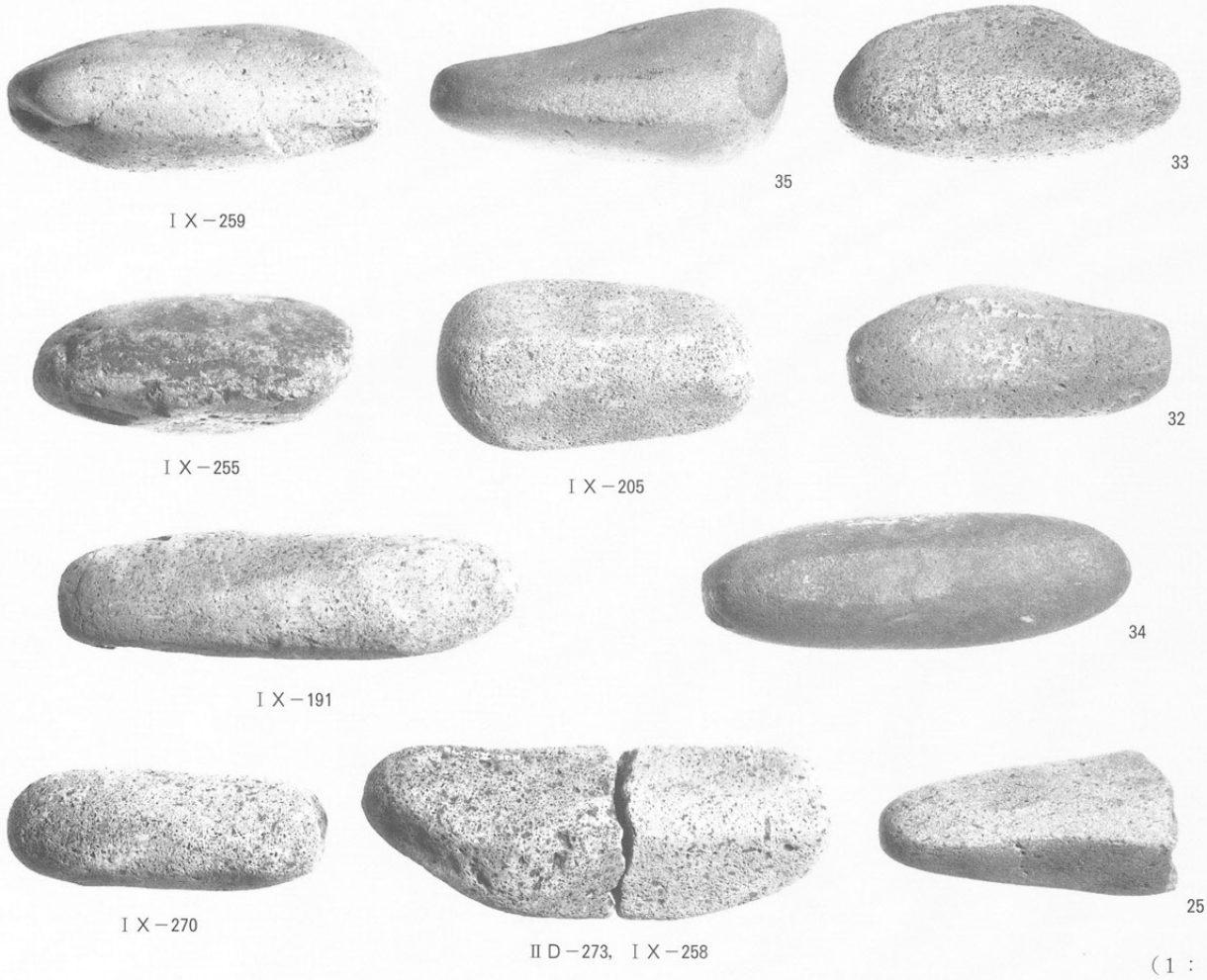

特殊磨石

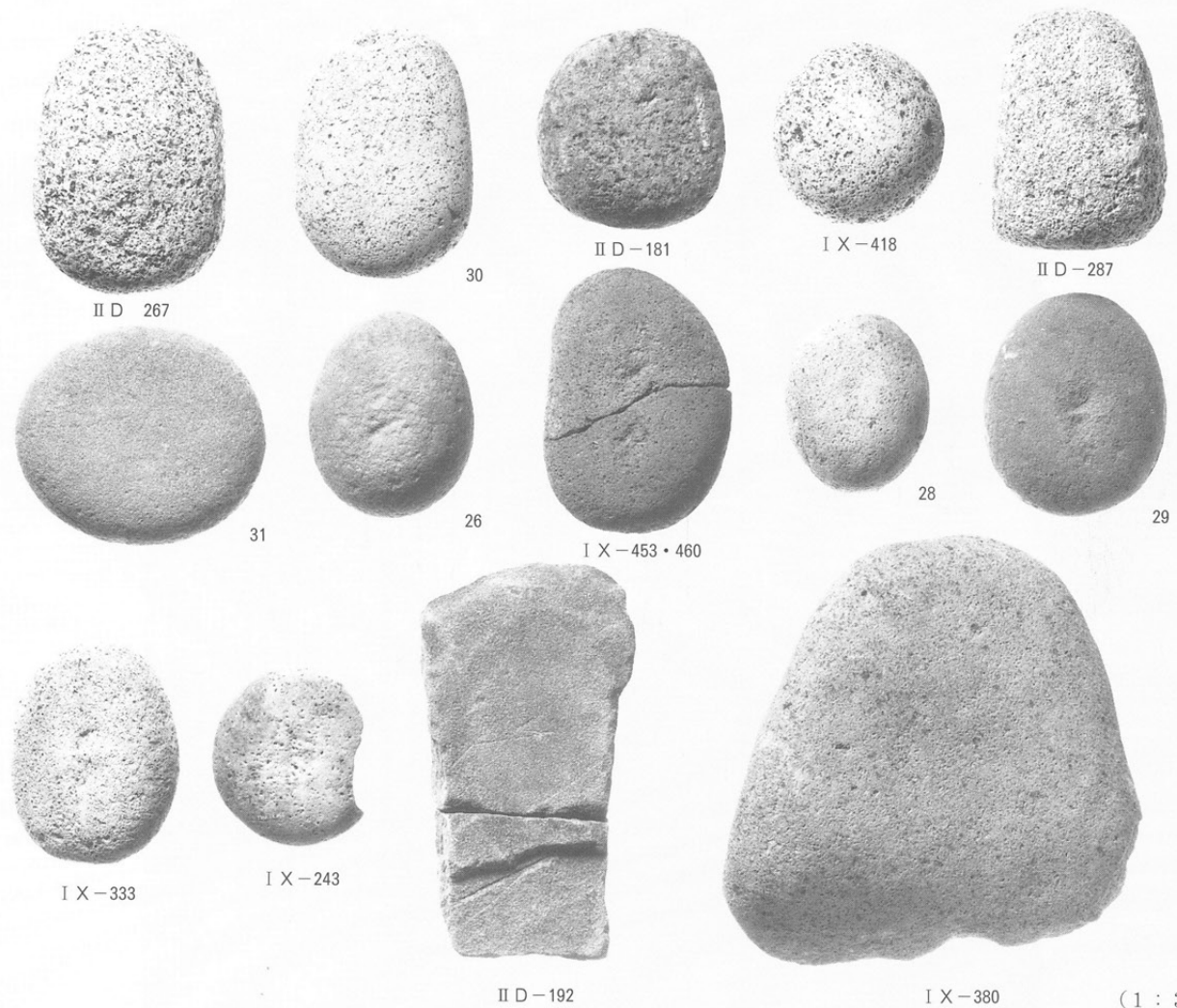

磨石
凹石
石皿



遠景



全景

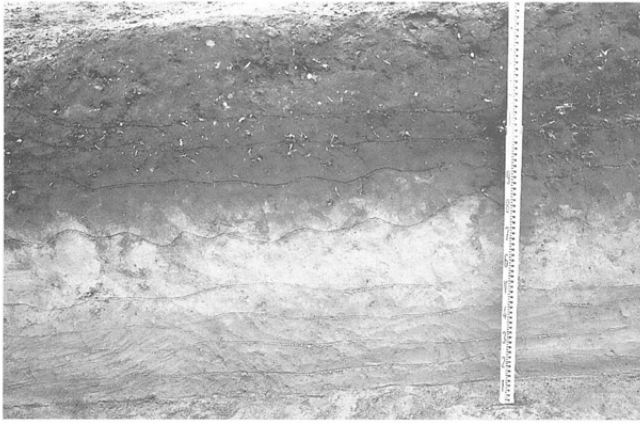

左：ⅢS 基本土層
右：ⅢS 出土狀況

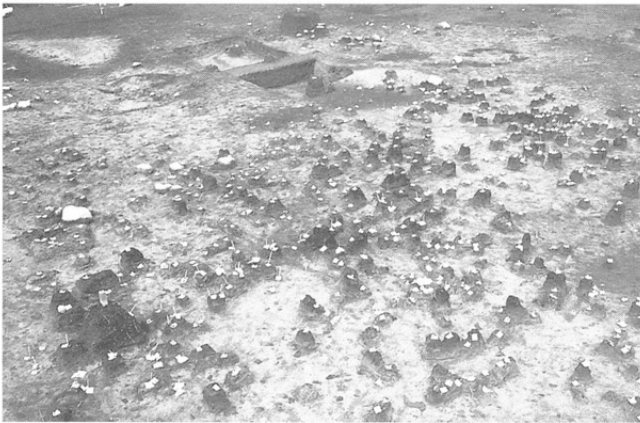
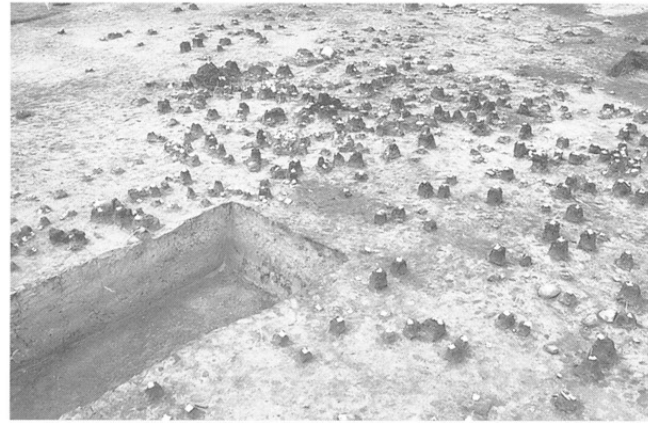

左：ⅢS 出土狀況
右： ”

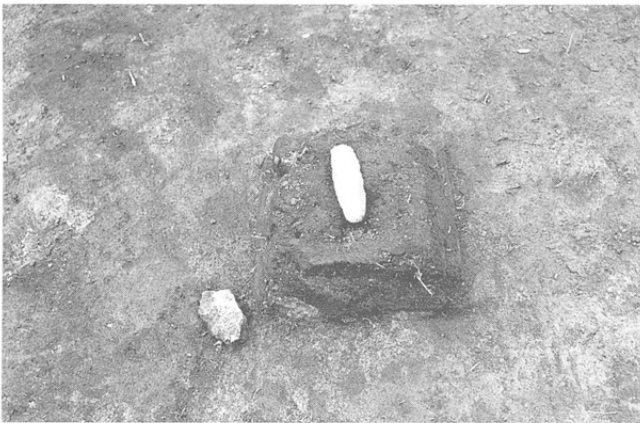

左：石斧
右： ”

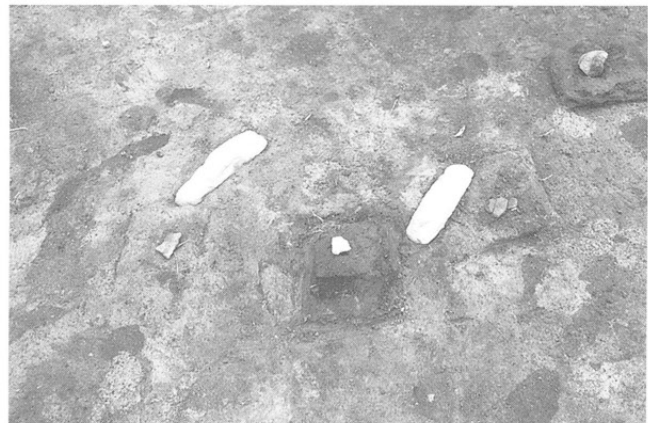

左：出土狀況
右： ”



左：SQ 01
右：SQ 02



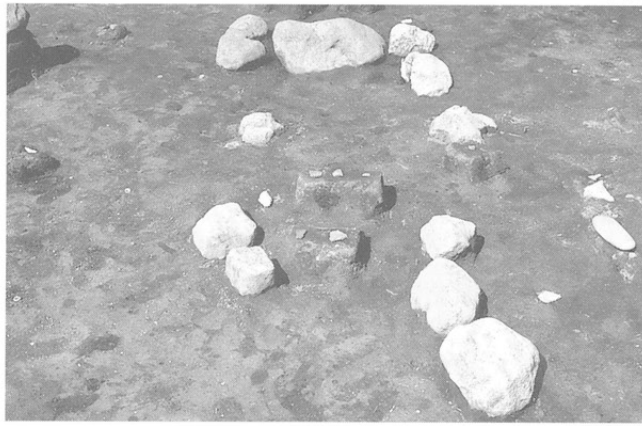

左：遺構外
右：SH 01

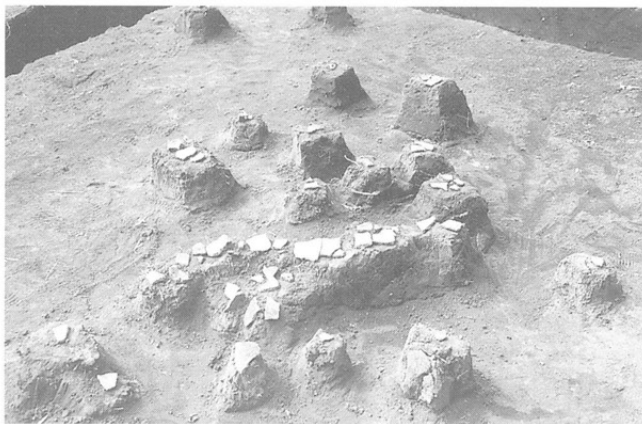

左：SQ 05
右：SQ 04



左：SK 01 石斧
右：SK 01

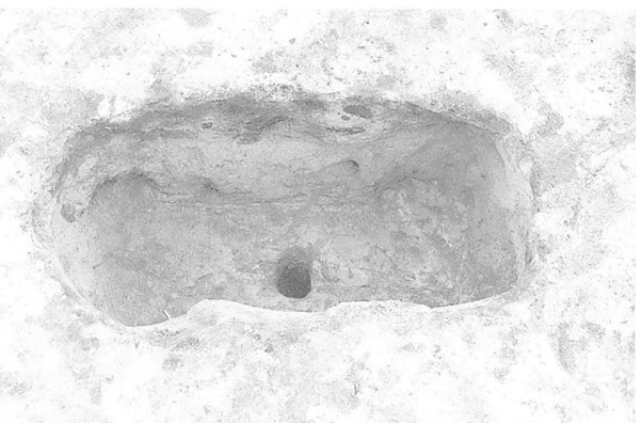

左：SK 08
右：SK 02



左：SK 06
右：SB 01 炭化物
出土狀況





72



79



83



84



86



88



89



94



95

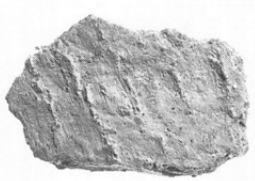

98



99



108



110



114



115

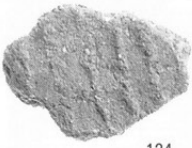

124

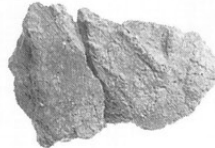

126



140



148



150

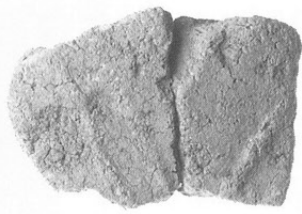

151



161



168

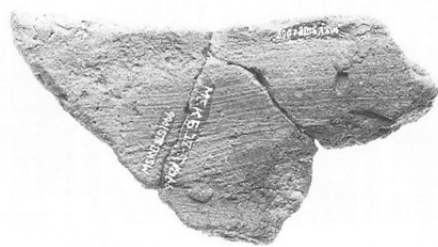

170



175



176



177



早・前期土器

(1 : 2)



197

晚期土器

(1 : 3)

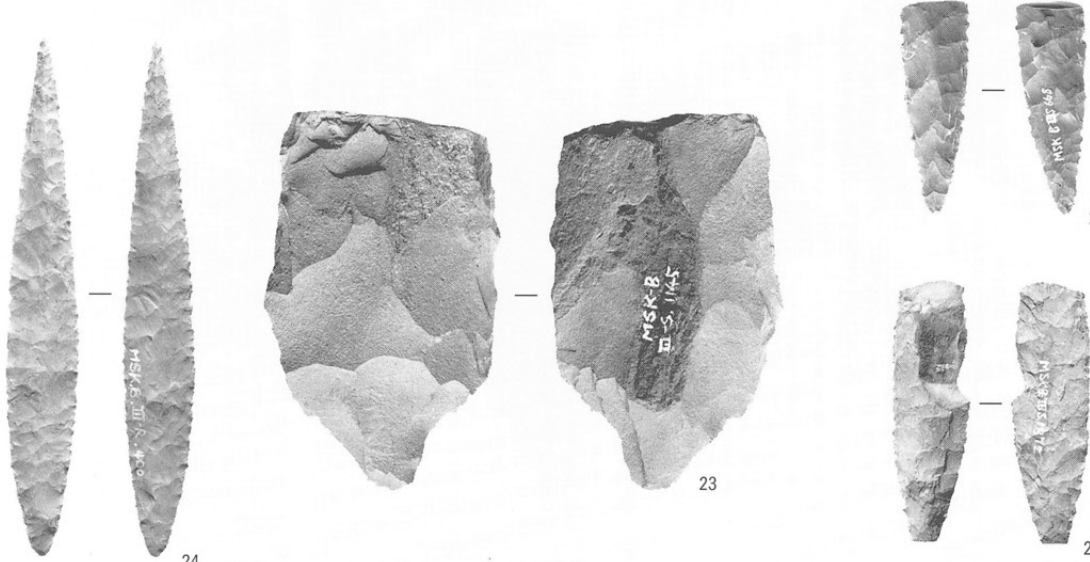
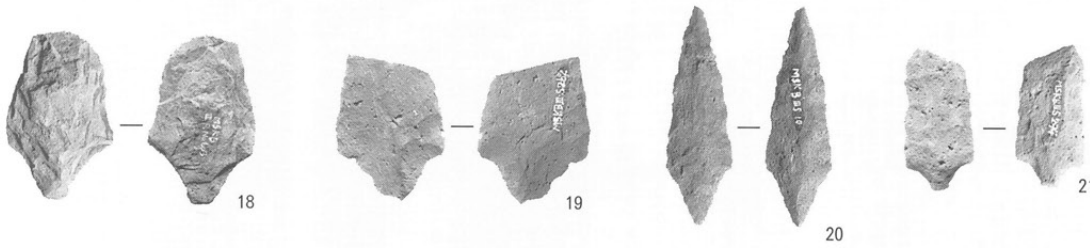
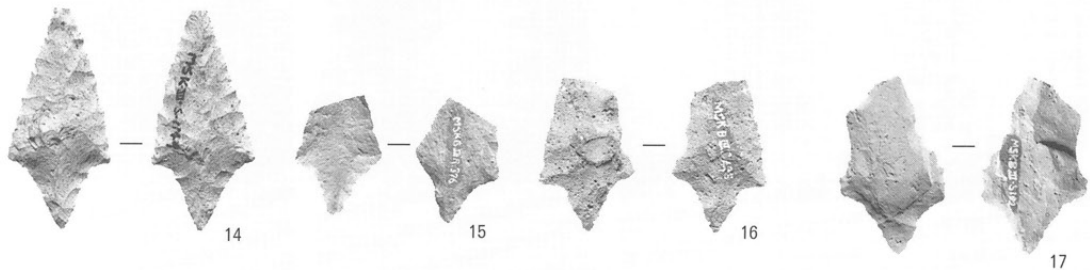
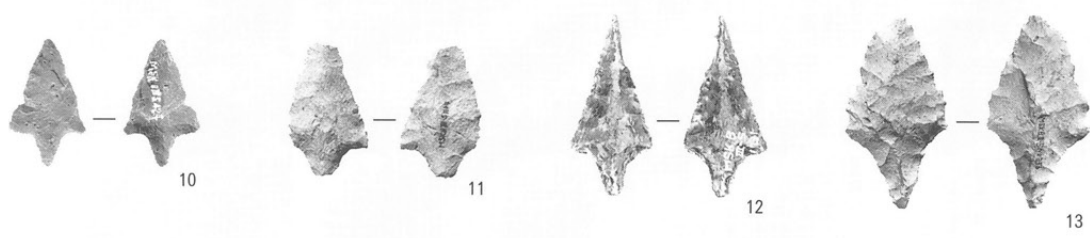
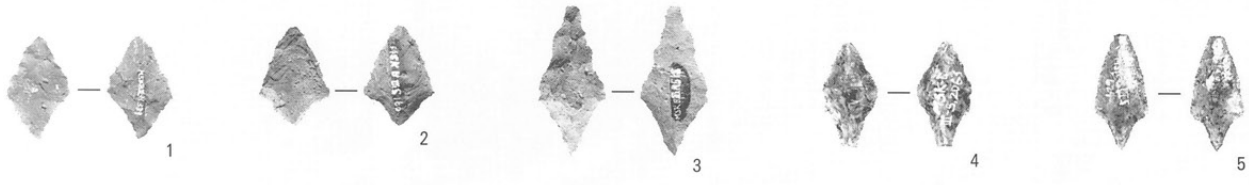

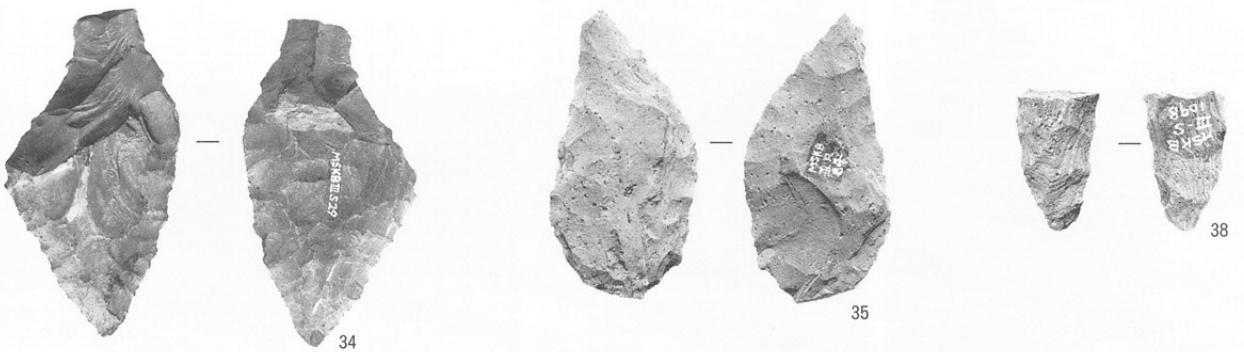
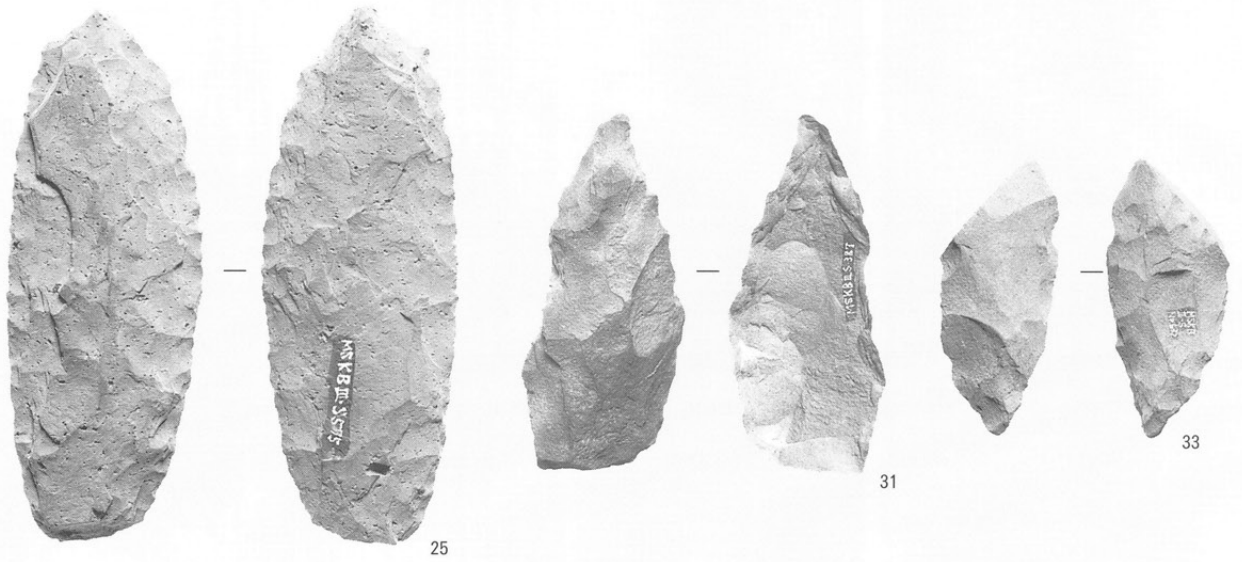

尖頭器
石錐

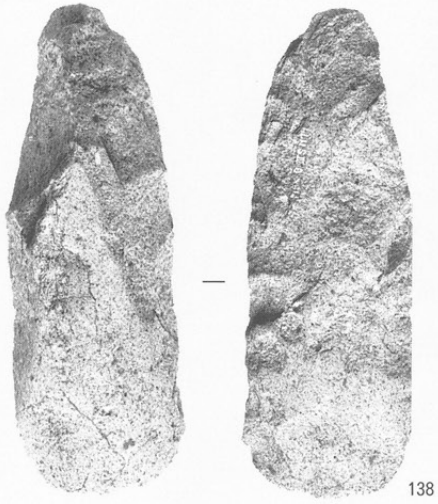

138

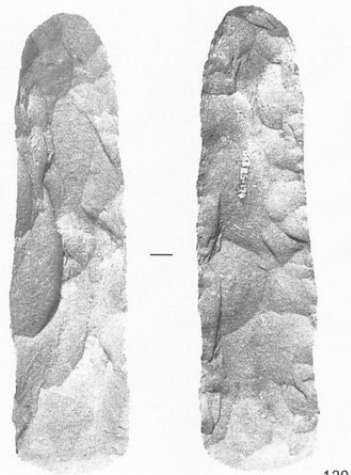

139

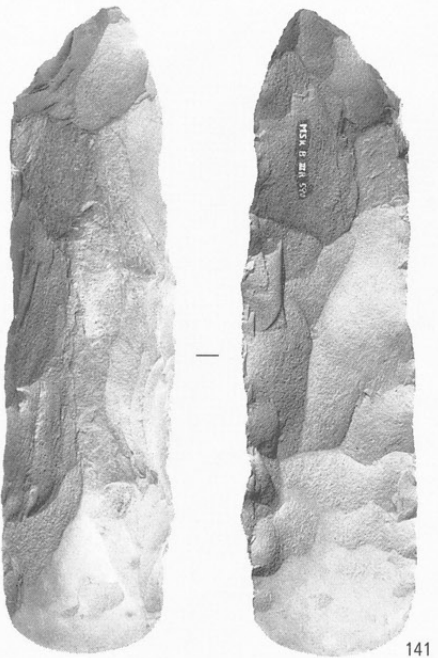

141

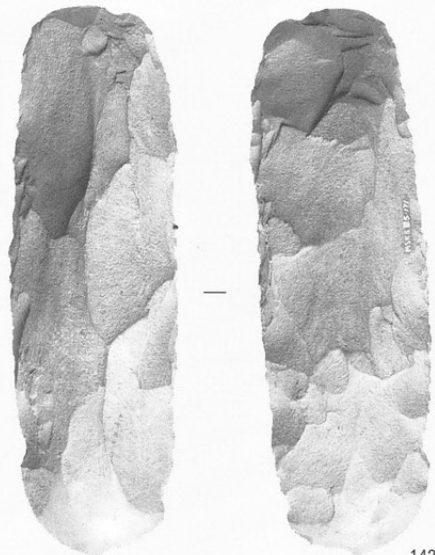

142



145

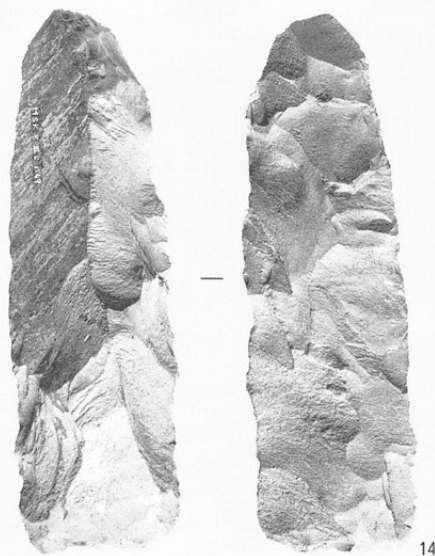

147

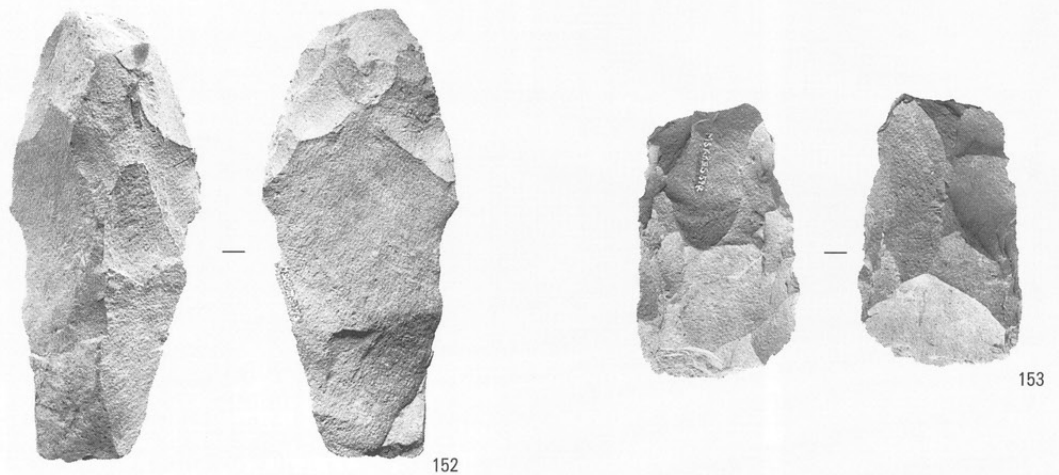
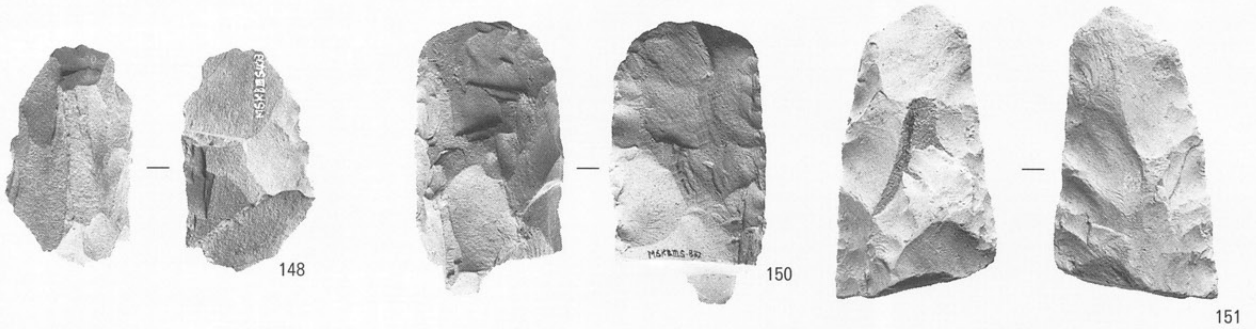
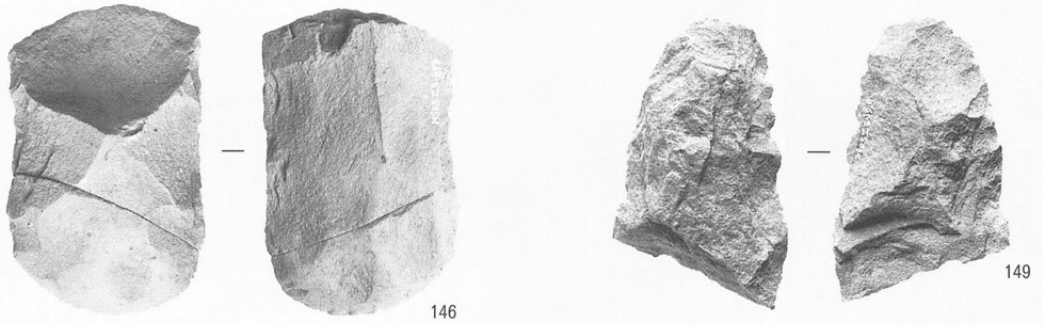
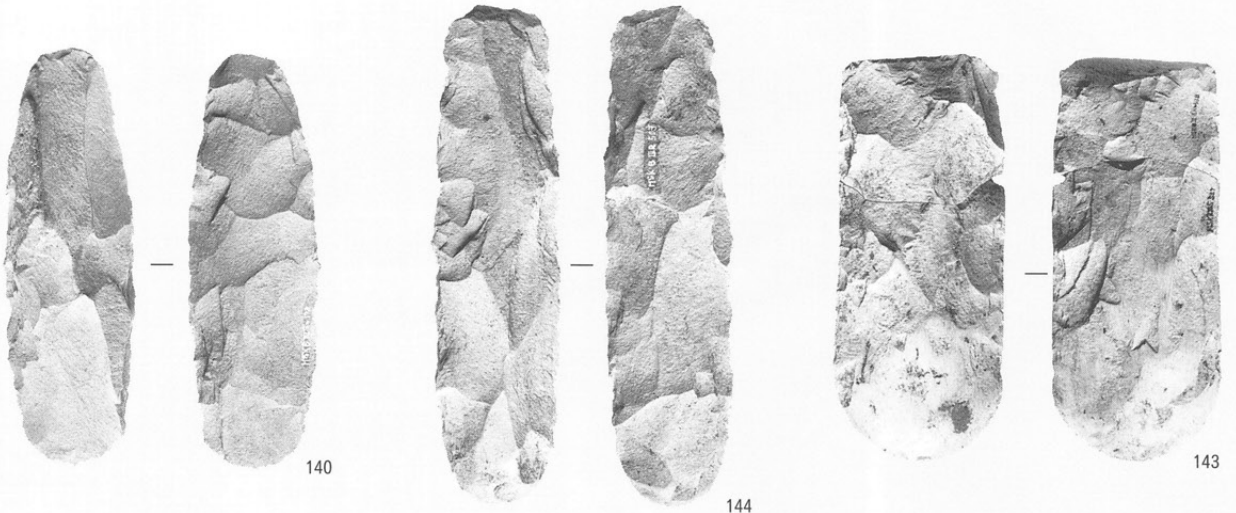



遠景



全景



左：調査前遠景
右： ”



左：調査前風景
右：基本土層



左：SH 11
右：SH 11
中央部分拡大



左：SH 12
右：SH 14

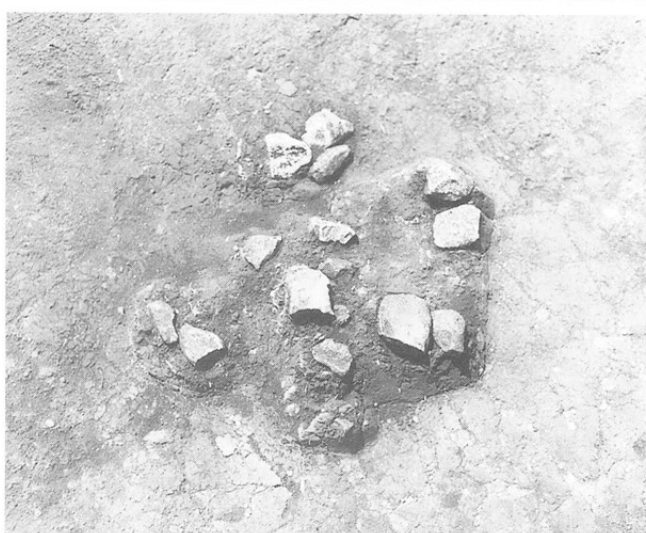

左：SH 15
右：SH 16



左：SH 17
右：SH 18

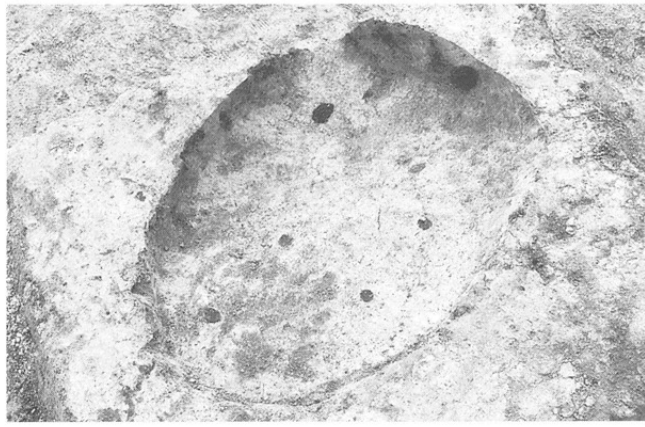
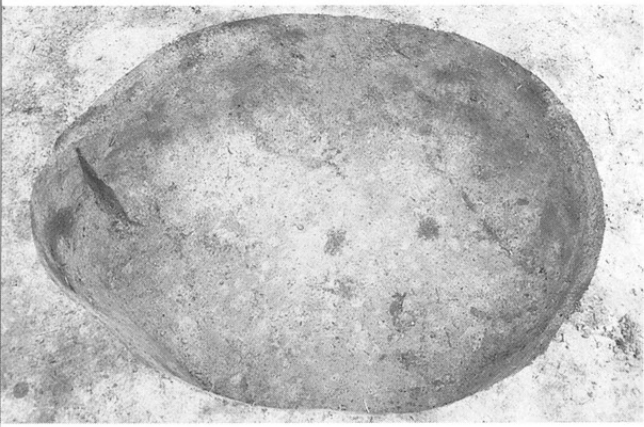

左: SK 04
右: SK 16

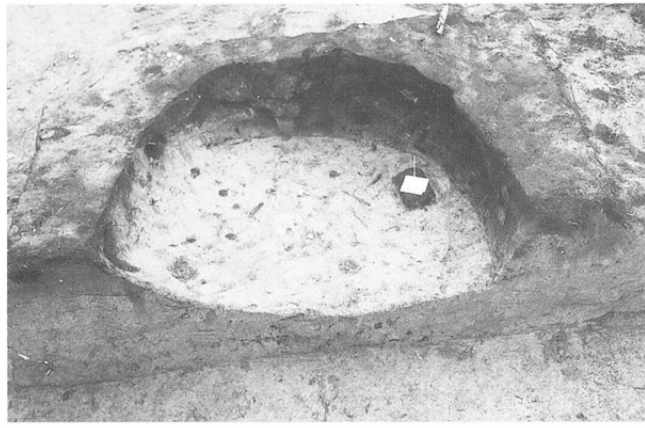

左: SK 20
右: SK 23



左: SK 35
右: SK 44

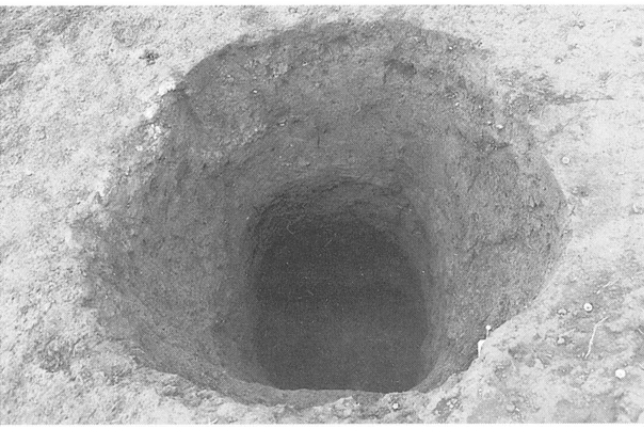

左: SK 36
右: SK 43



左: SK 45
右: SK 38



左：SK 39
右：SK 51

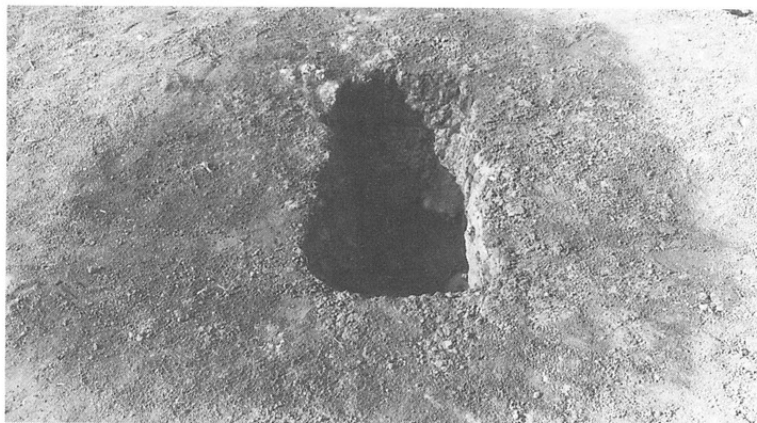

左：SK 27
右：SK 28

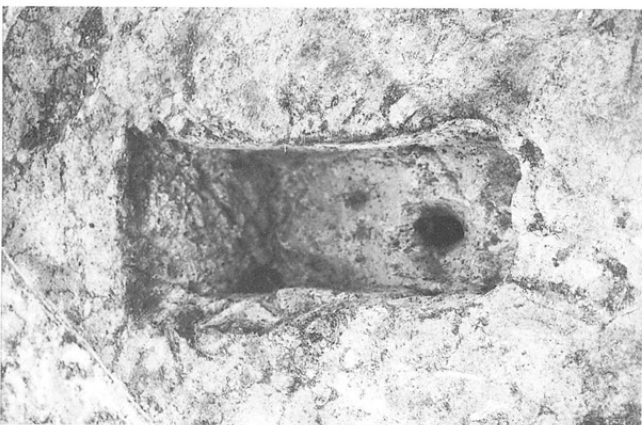

左：SK 30
右：SK 31

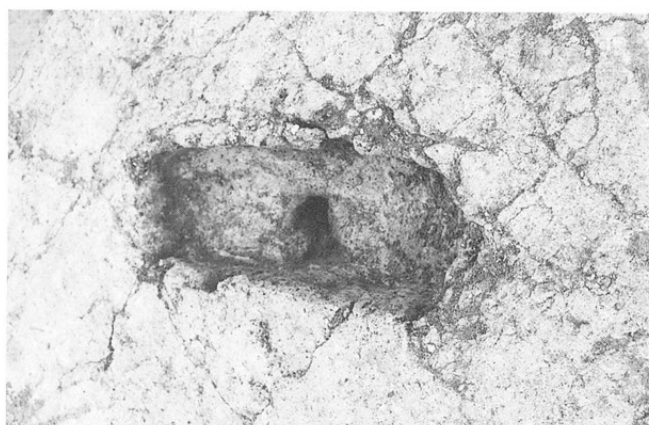

左：SK 32
右：SK 36

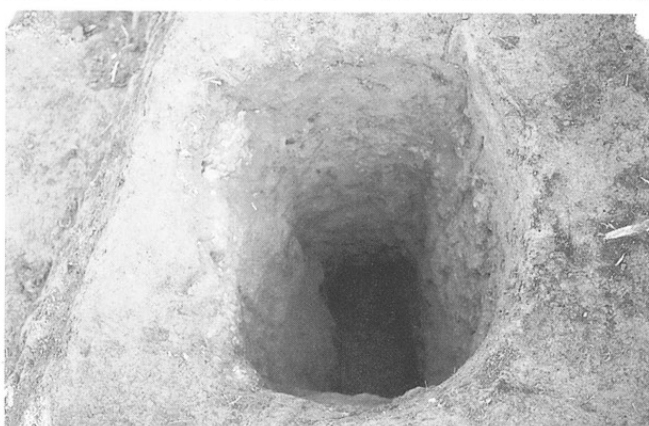

近世
SM 01

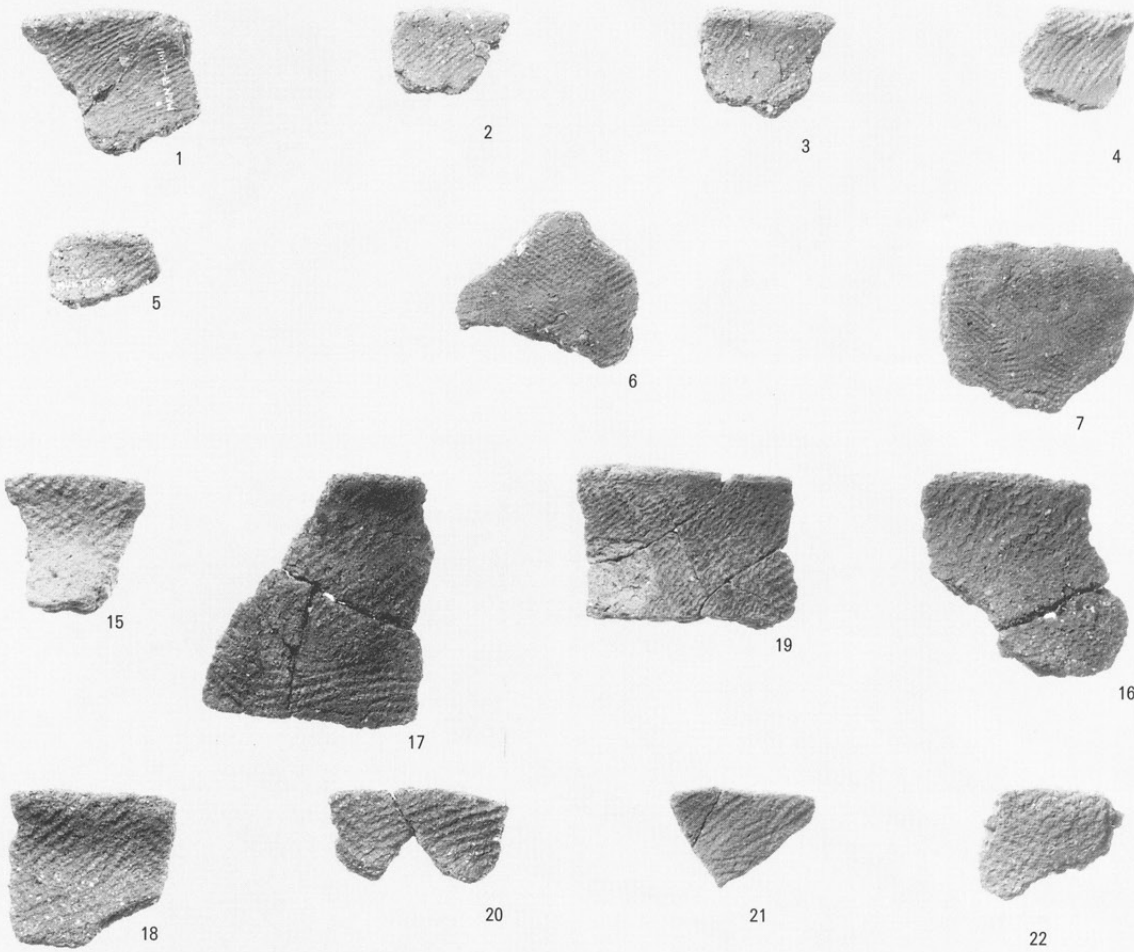

(1 : 2) 表裏縄文
(外 面)

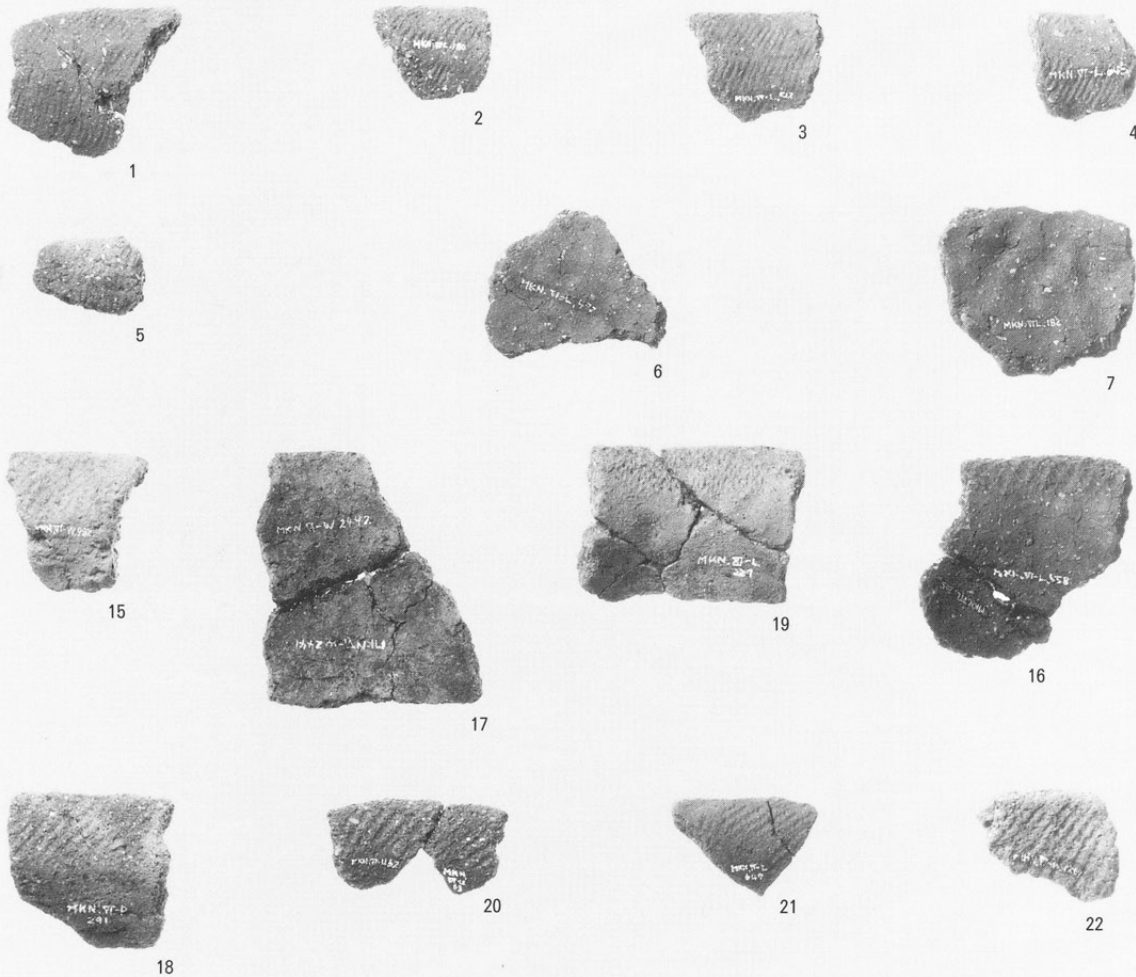

(1 : 2) (内 面)

表裏縄文
(外面)

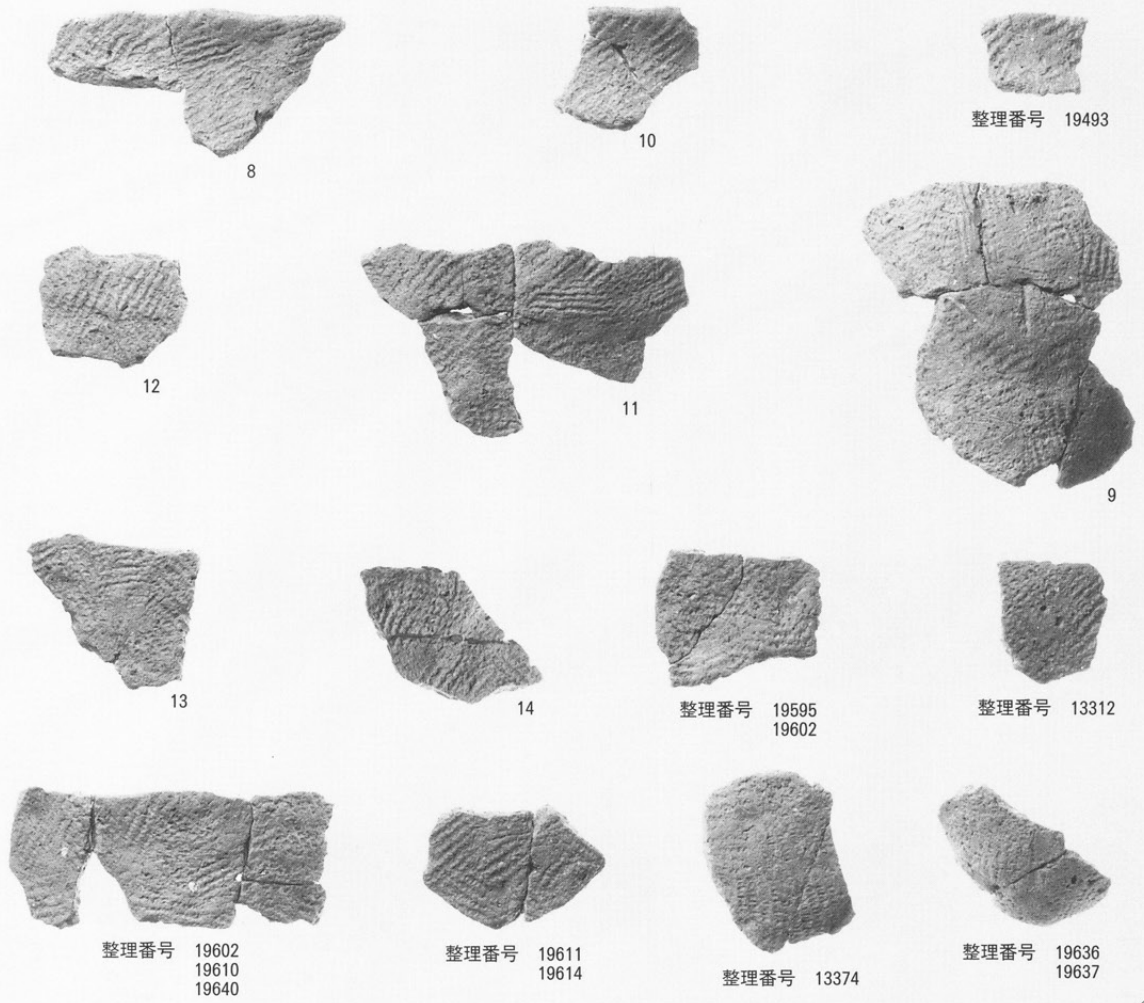

(1 : 2)

(内面)

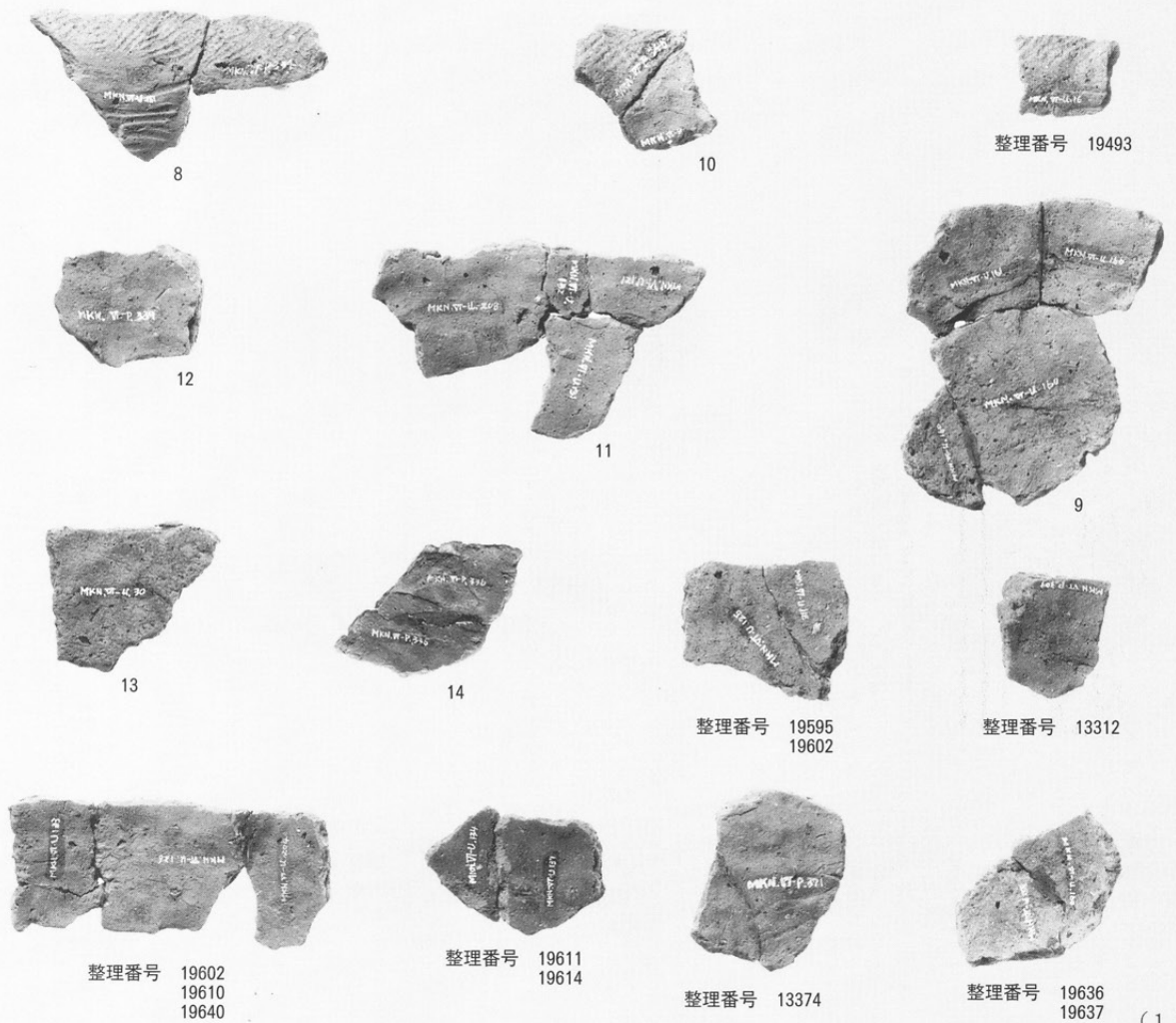

(1 : 2)

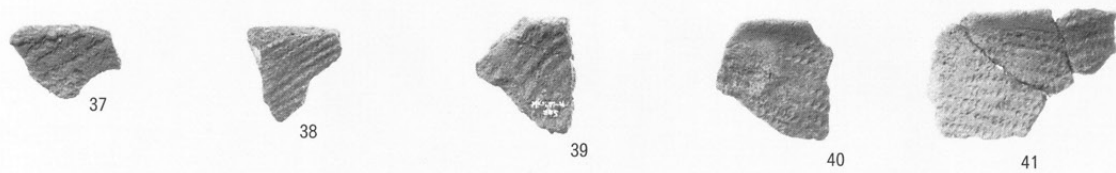
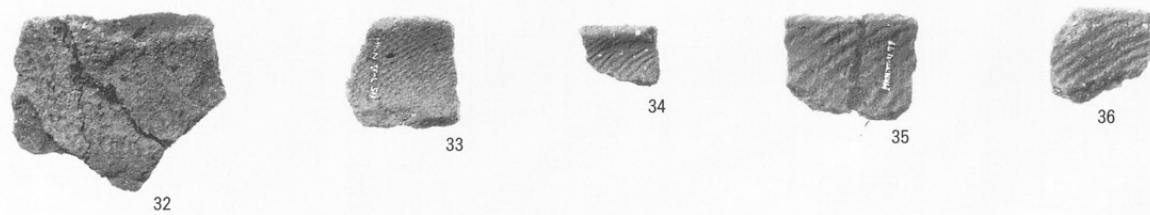
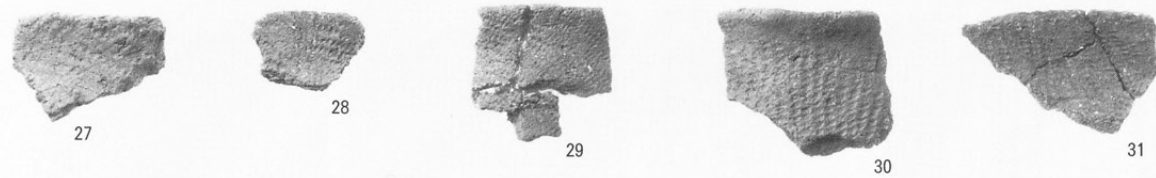

(1 : 2) 表裏縄文 (外 面)

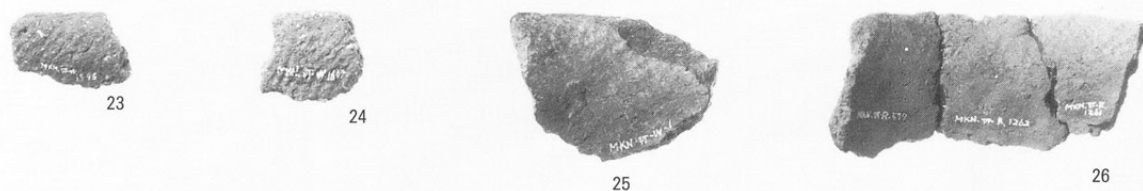

(1 : 2) (内 面)



88



56



57

(1 : 1)



44



47



51

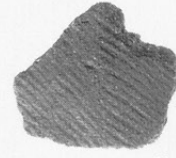

70



62



48



52

整理番号 10922

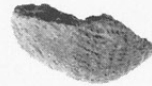

86



87

隆起線文
表縄文

(1 : 2)

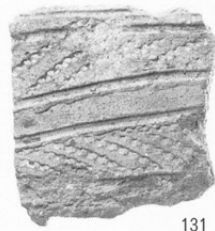

131



132



133



136



139



141



142



145



146



147



150



153



154



157



158



163



165



166



171

貝殻腹縁文

(1 : 2)

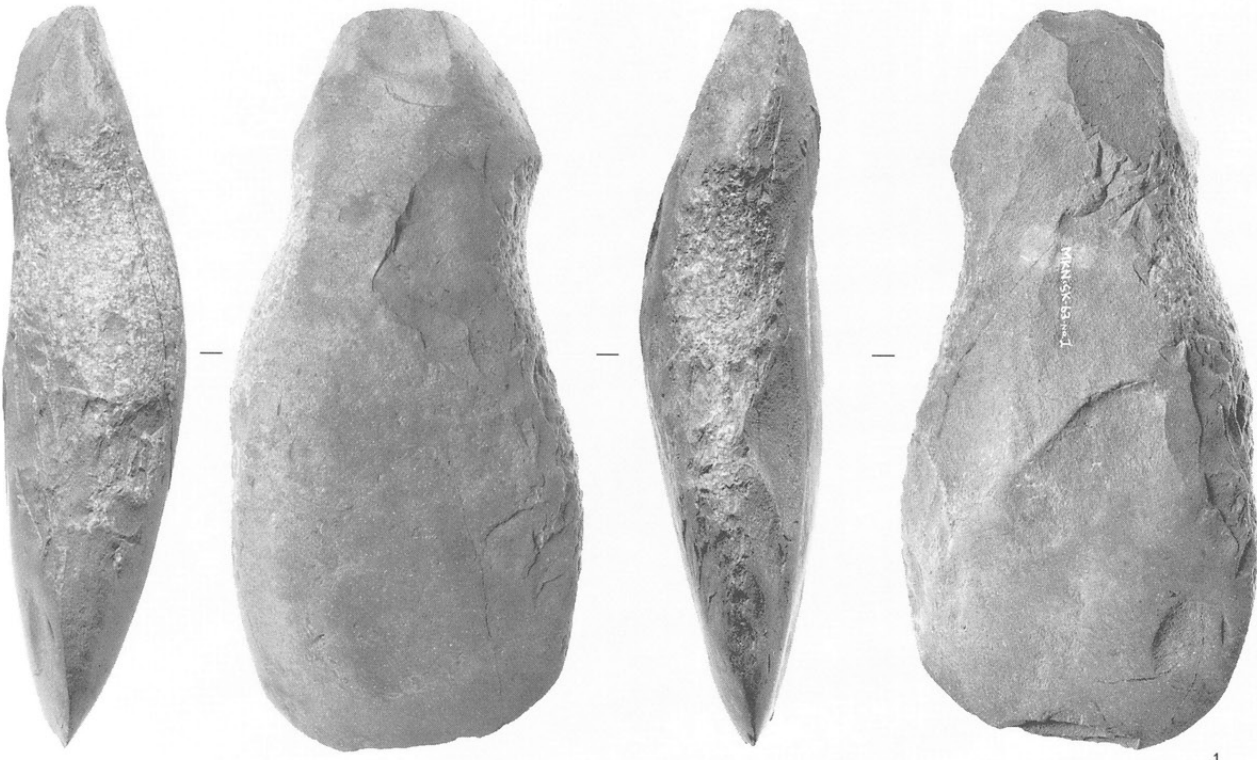

1

(1 : 2) 石斧



29



2



3



4



5



6



7



8



9



10



11



12



13



14



15



16



整理番号
40934



整理番号
13616

(2 : 3) 有茎尖頭器
石鏃



17

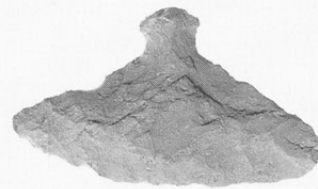

18



19



20



21



整理番号 30460



26



28



25



27



整理番号 11793



22



整理番号 17257



整理番号 12112



24

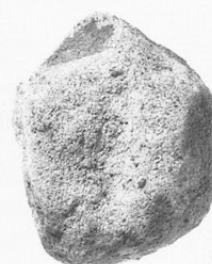

23



遠景



作業風景



左：基本土層
右：空撮



左：SK検出状況
右：SK 2・3・4・
5・29断面



左: SK 03
右: SK 04

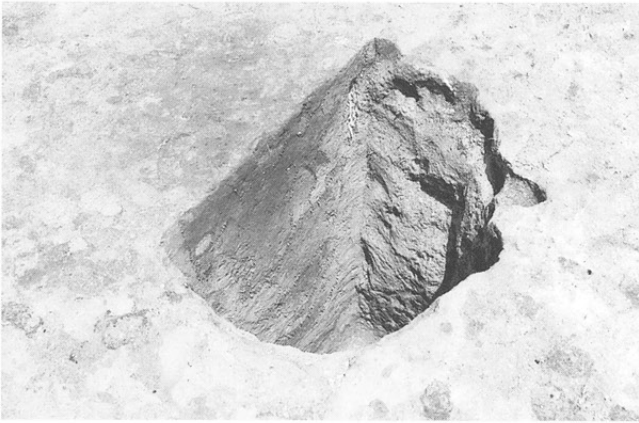
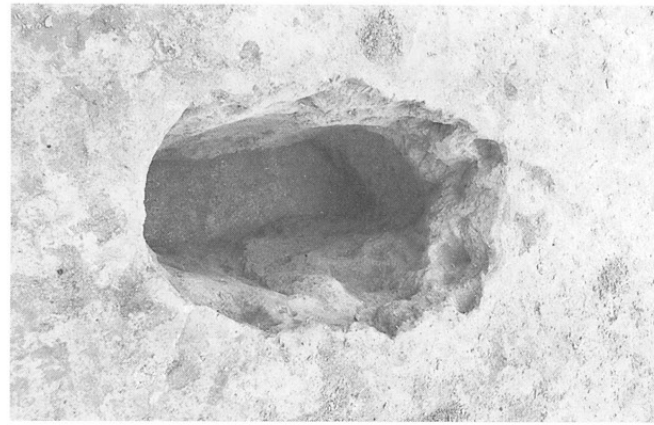

左: SK 05 断面
右: SK 29 断面



左: SK 27 断面
中: SK 29 断面
右: SK 27 断面



左: SK 30



左: SK 31
中: SK 30 断面
右: SK 31 断面



左：SK 17 断面
右：SK 28



左：SK 28 断面
右：SK 10・12・13・
37・38 断面



左：SK 10 断面



左：SK 13

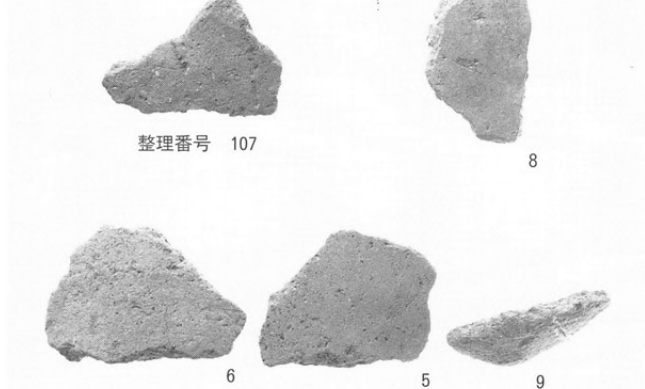

左：SK 34
右：縄文時代土器



左：全 景
右：SQ 01
出土状況

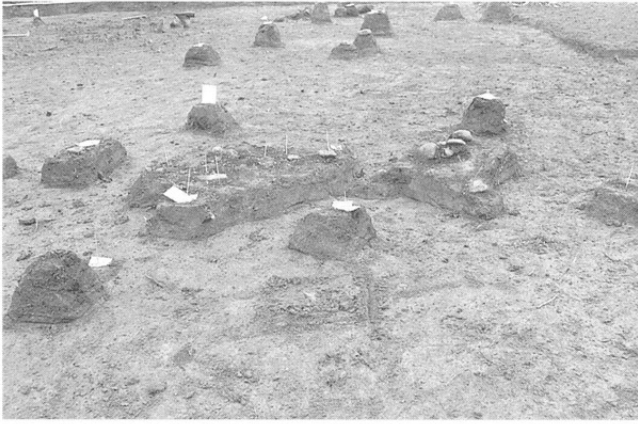

左：SQ 03
出土状況
右：SK 03 断面



左：SK 01
右：SK 02



左：SK 05
右：SK 11

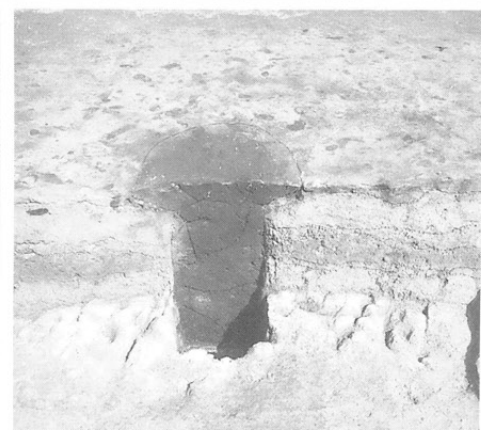
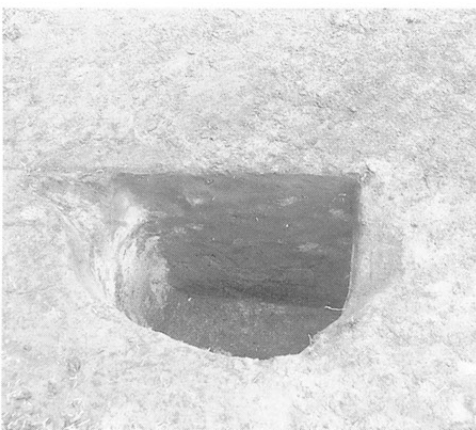

左：SK 11 断面
中：SK 11 逆木痕
右：SK 12 断面

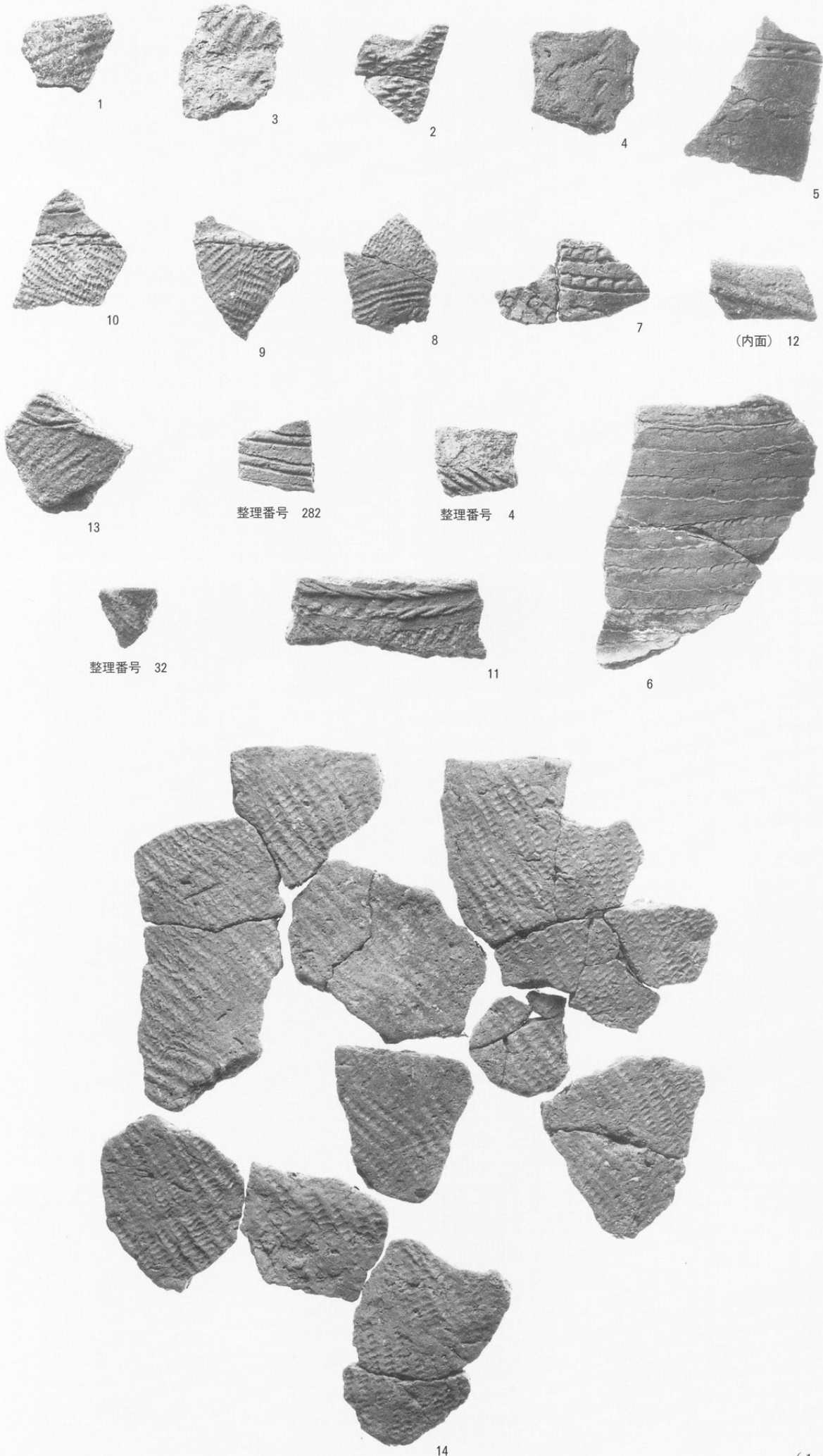



全 景
前方上ノ原遺跡
後方大久保南遺跡

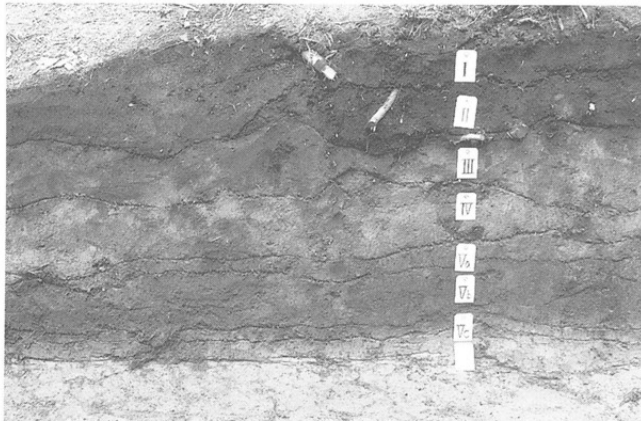

基本土層



左：SK 01
右：SK 01 断面



左：作業風景
右：SK 03
出土状況





遠景



全景



北東より全景

左：東1区調査風景
全景
右：北1区全景

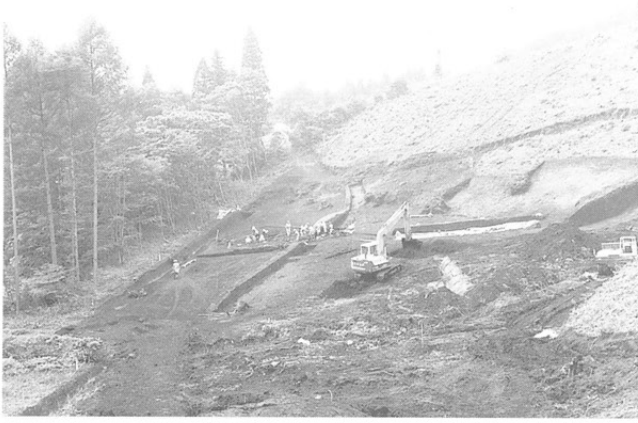

左：3区全景
右：スキー場全景

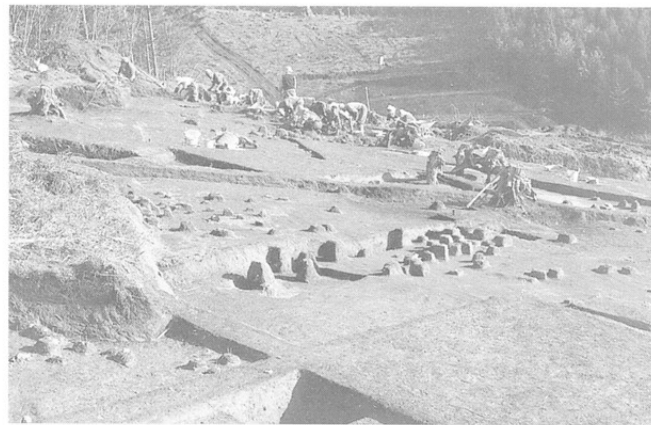

左：VI-C-12
基本土層
中：2区基本土層
右：3区基本土層

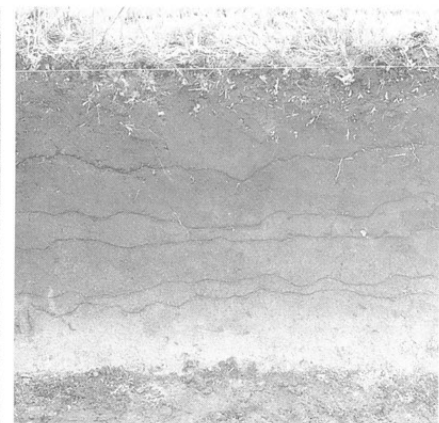
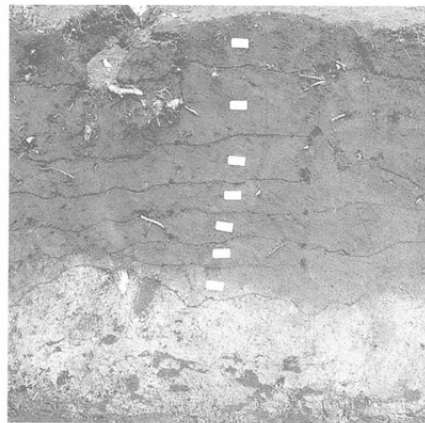
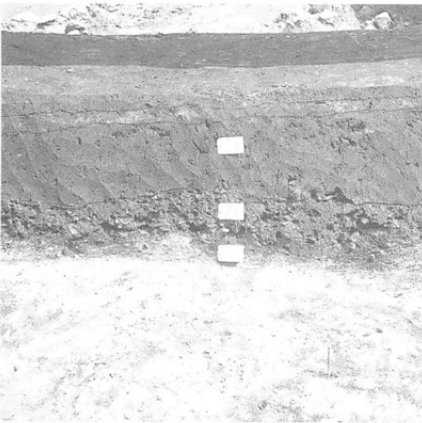

左：2区SB 01
右：2区SB 01
遺物出土状況

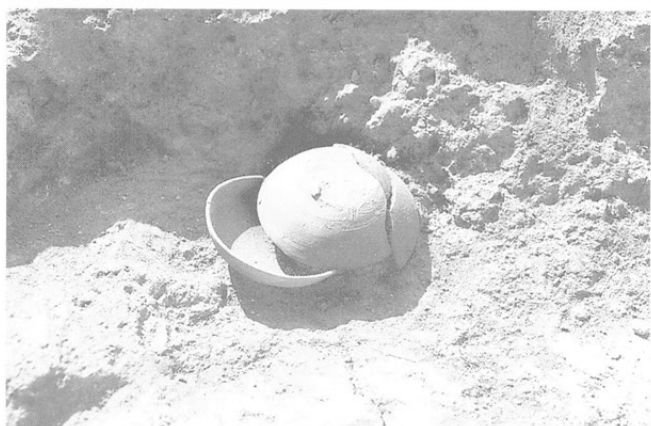

左：2区SB 02
焼土面
右：2区SB 02
P 01



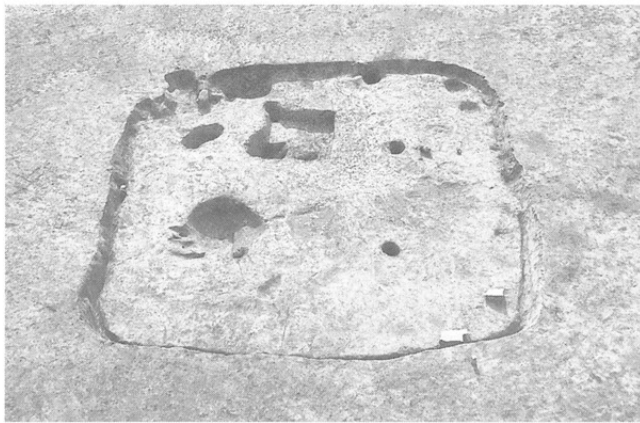

左：2区SB 02
出土状況
右：2区SB 05



左：2区SB 06
右：2区SB 06
カマド出土状況



左：2区SB 07
右：2区SB 07
カマド出土状況



左：1区SB 11
右：1区SB 11
カマド出土状況

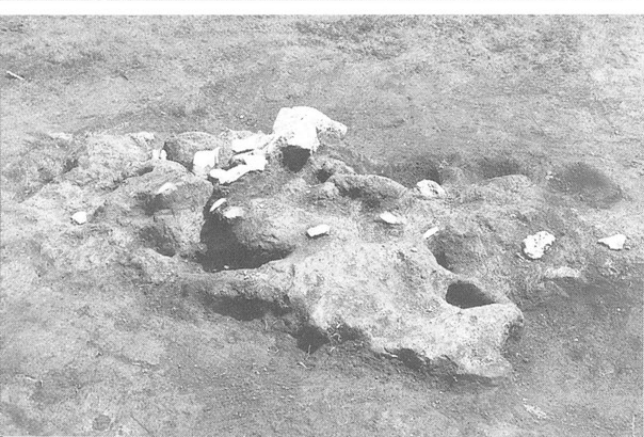

左：1区SB 12
カマド出土状況
右：1区SB 13



左：NR 1
遺物出土状況
右：SH 01



左：SQ 02
右：SQ 01

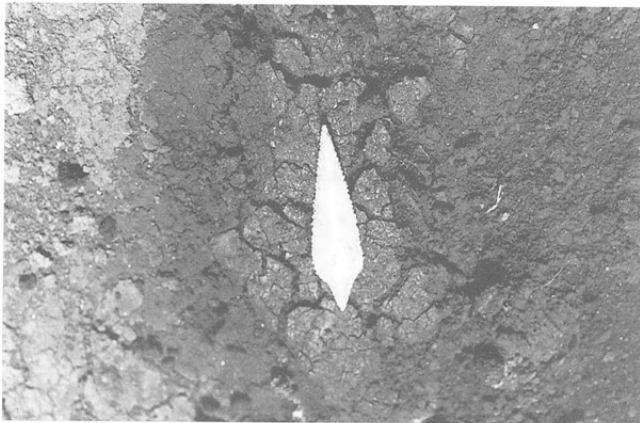

左：有茎石槍
出土状況
右：作業風景
(黒姫山前方)



左：北1区全景
右：2区作業風景



左：2区調査風景
右：2区作業風景

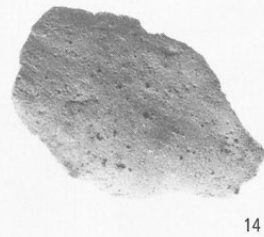
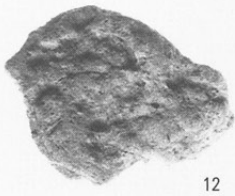
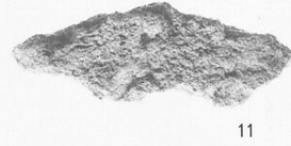
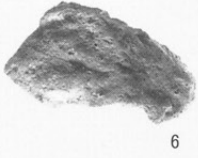
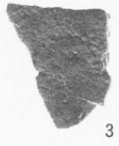

(1 : 1) 無文土器



(1 : 1) 石器

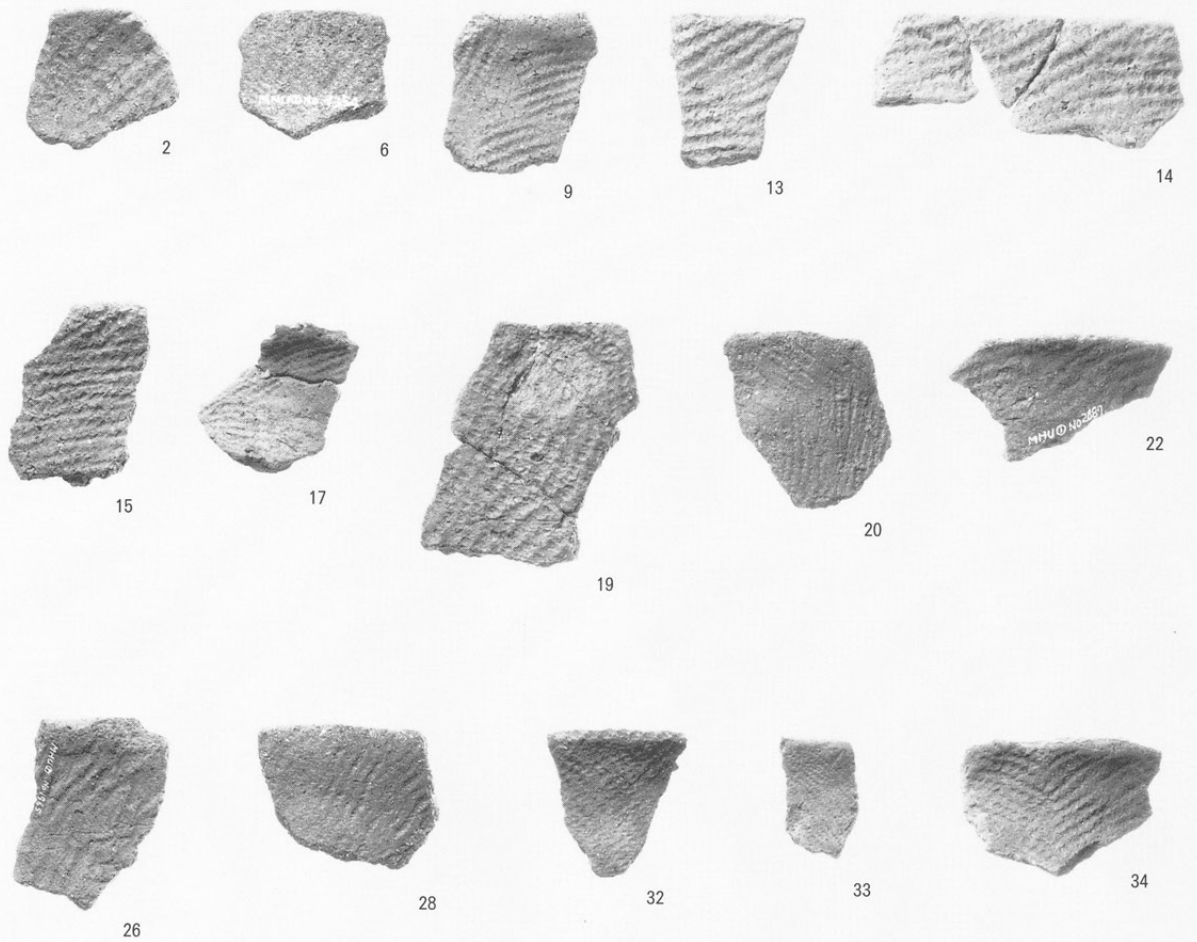

表裏縄文
(外面)

(1 : 2)

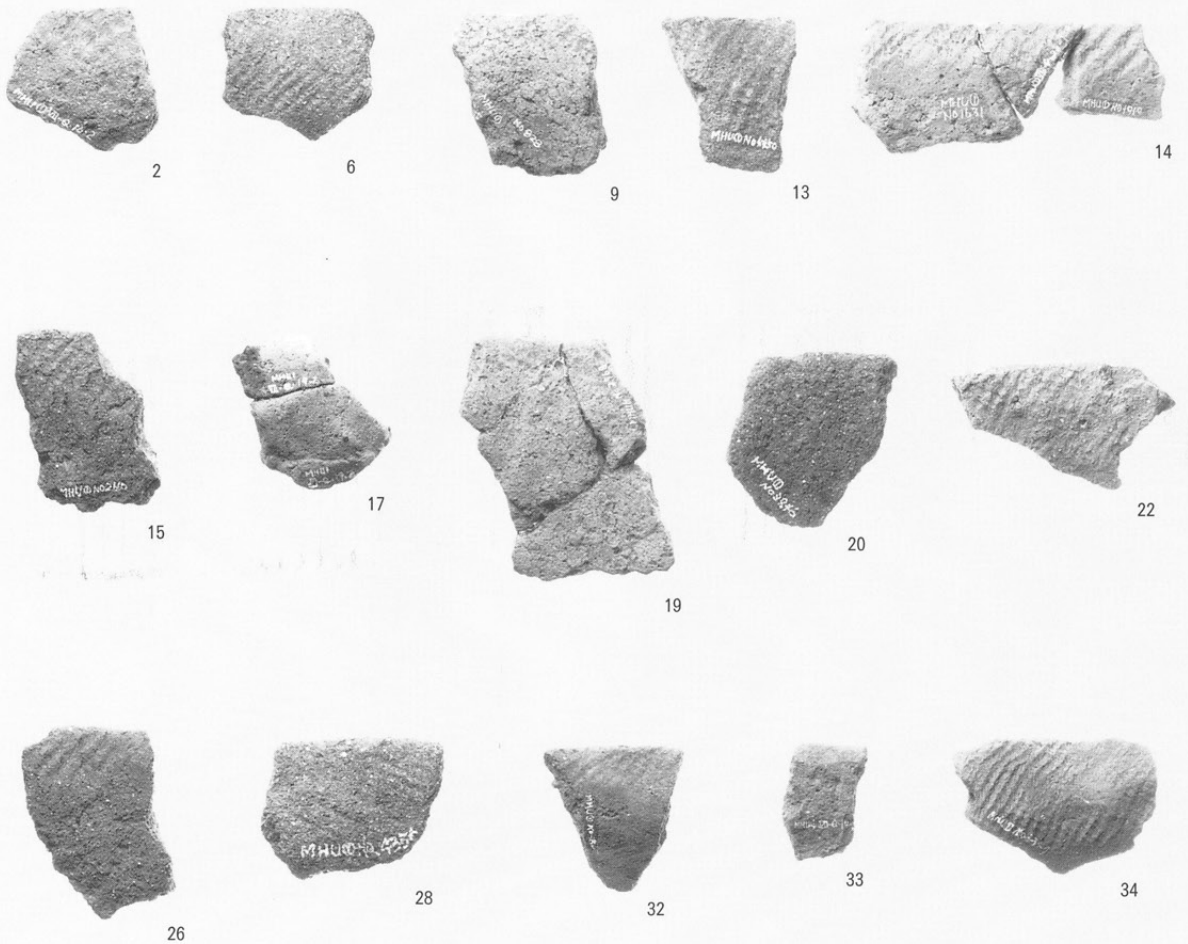

(内面)

(1 : 2)



161



162



40

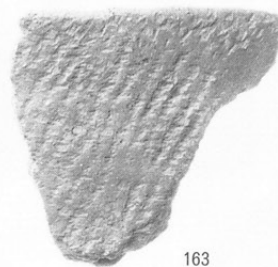

163



41

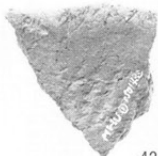

42



44



45



46

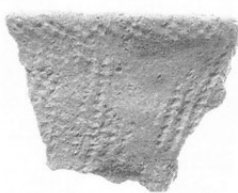

47



49

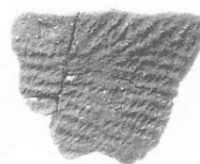

50



51



53



54



55

表裏縄文
(1 : 2) (外 面)



161



162



40



163



41



42



44



45



46



47



49



50



51



53



54



55

(1 : 2) (内 面)

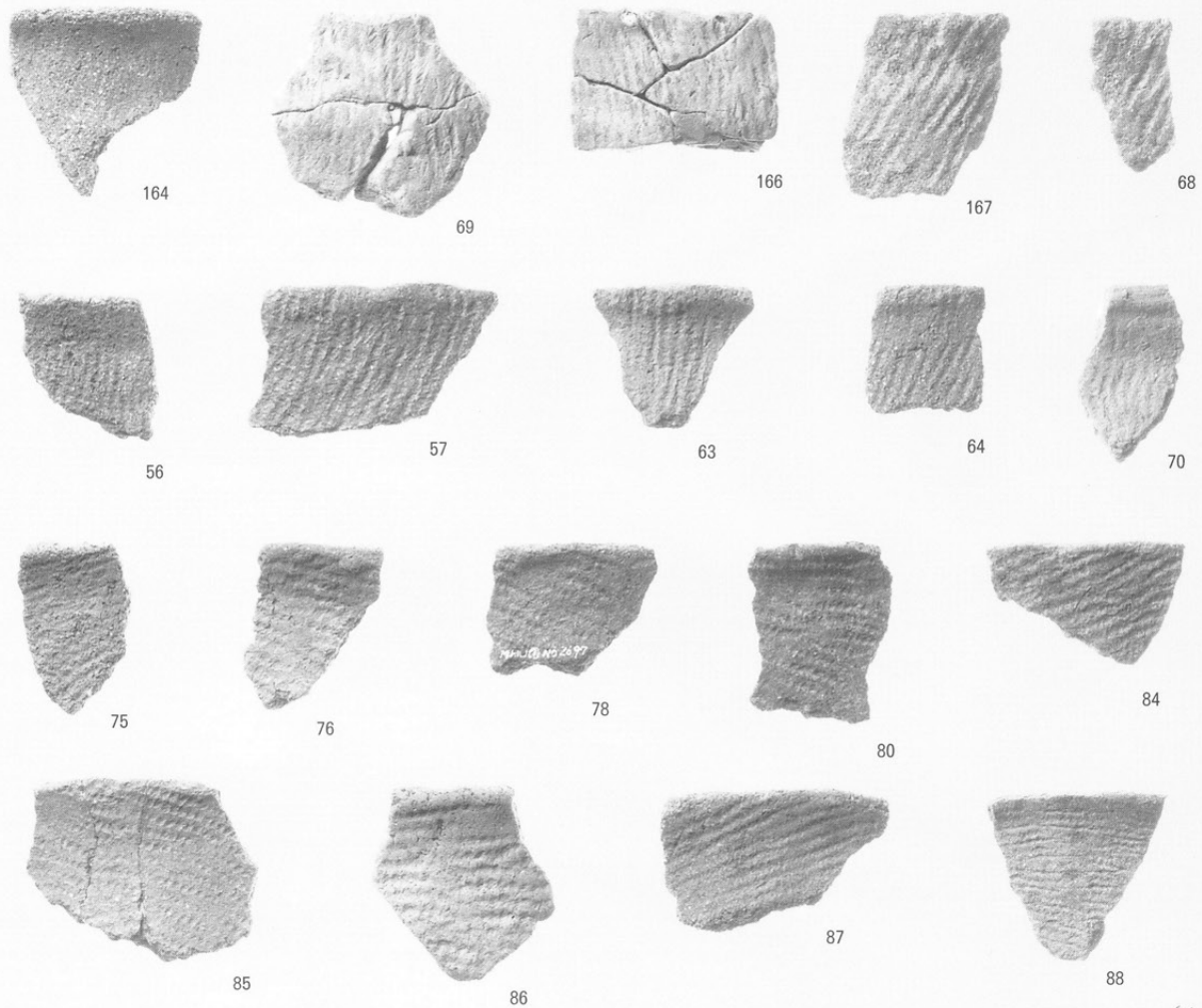

表裏縄文
(外面)

(1 : 2)

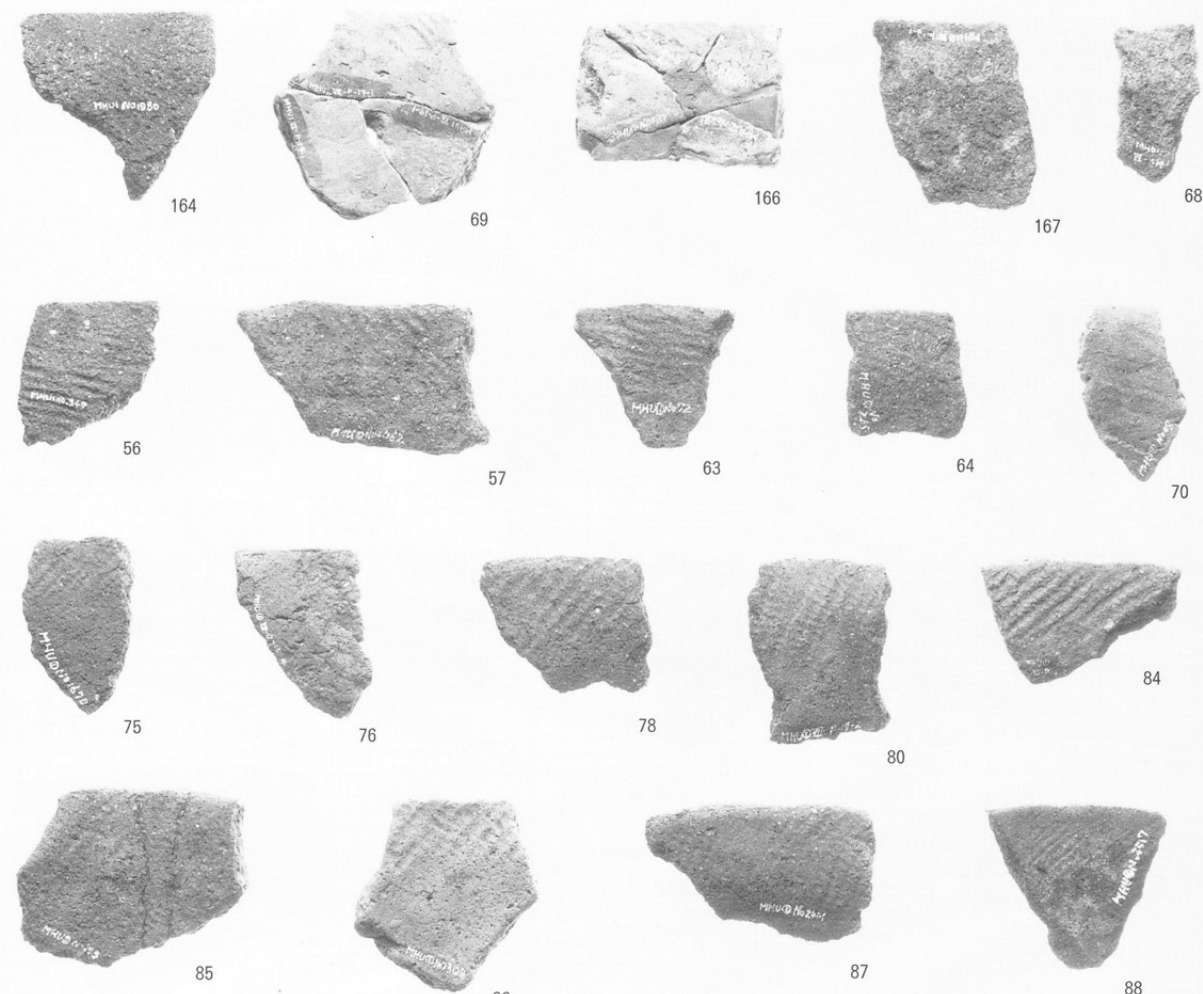

(内面)

(1 : 2)

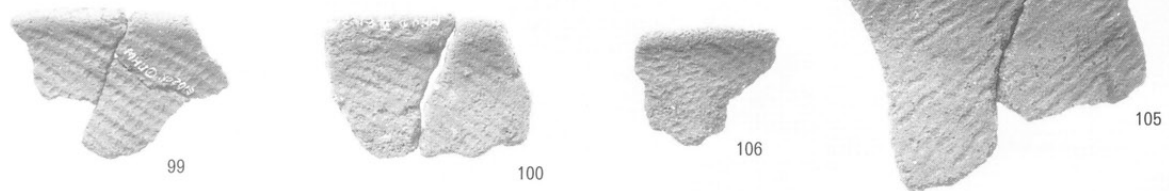
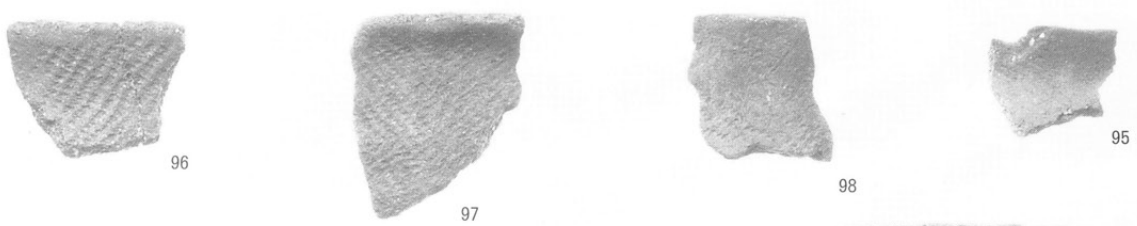
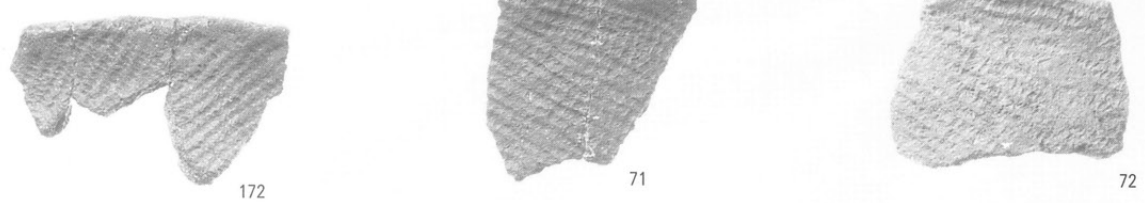
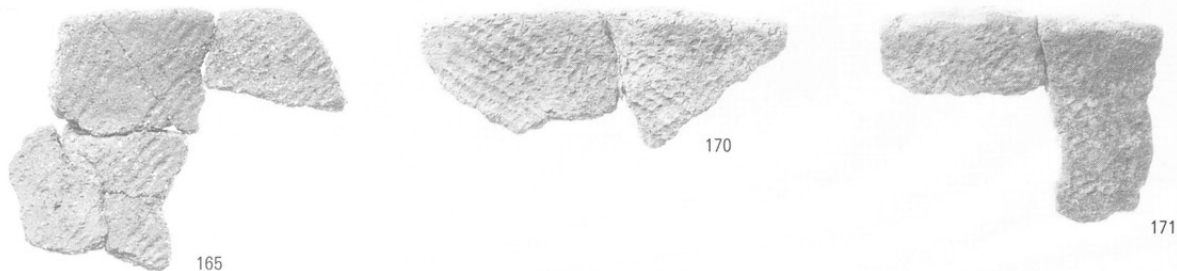

(1 : 2) 表裏縄文 (外面)

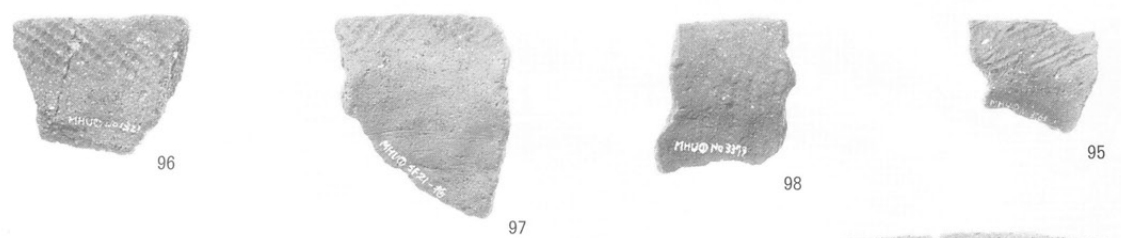
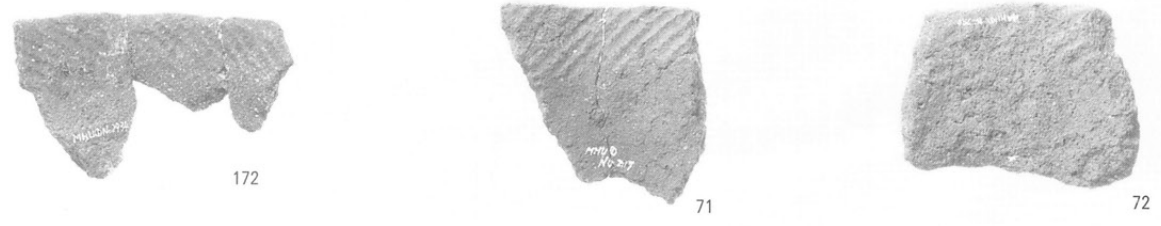
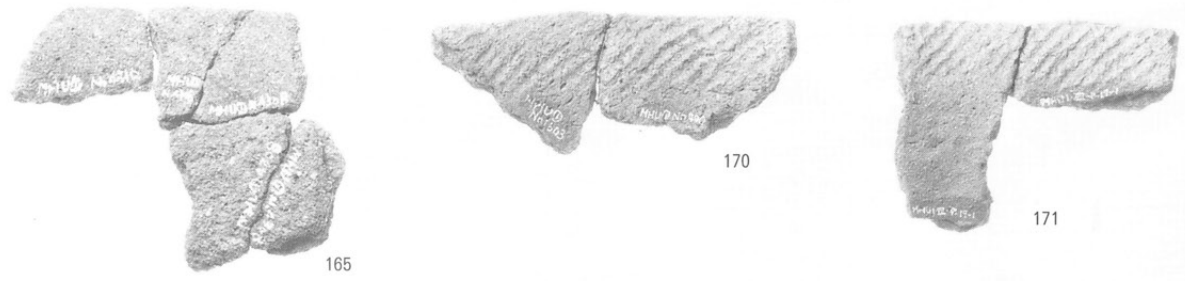

(1 : 2) (内面)

(外 面)

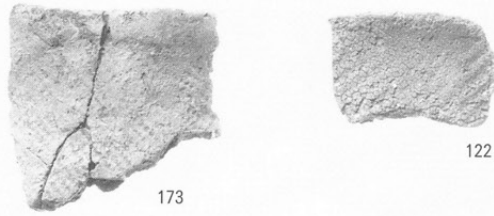

表裏縄文

(1 : 2)

(内 面)

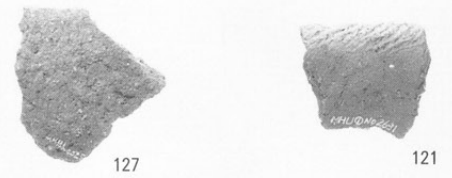
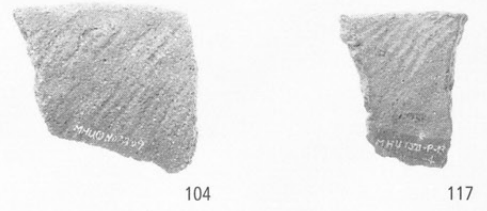
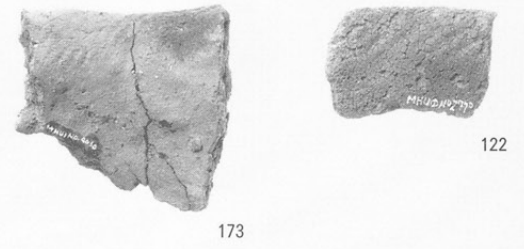

(1 : 2)

(外 面)

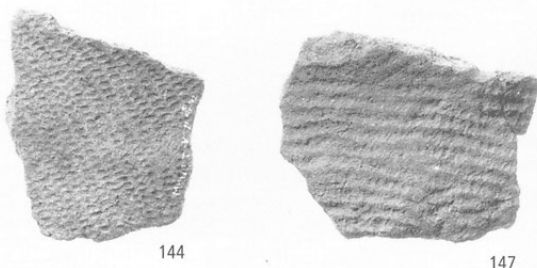
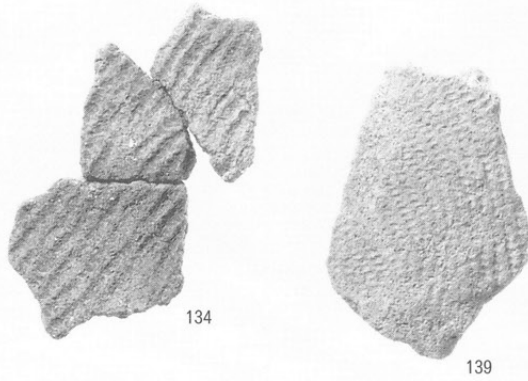
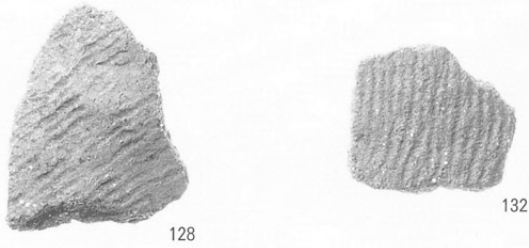

表裏縄文

(1 : 2)

(内 面)



(1 : 2)

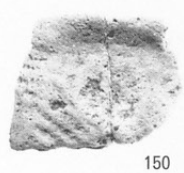

150

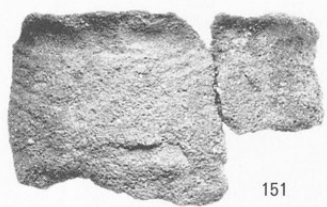

151



152



153



154

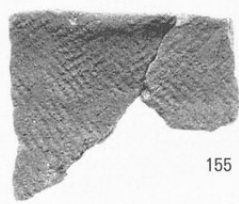

155

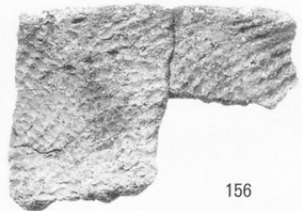

156



157



158



159

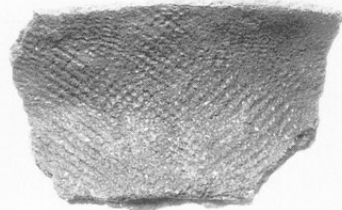

160

(1 : 2)

表裏縄文
(外面)



150

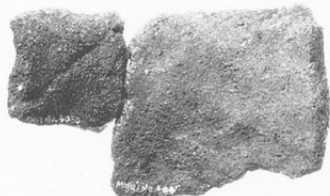

151

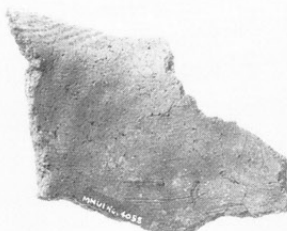

152



153



154



155



156

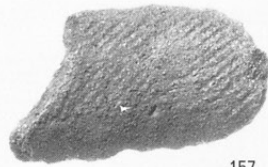

157



158



159

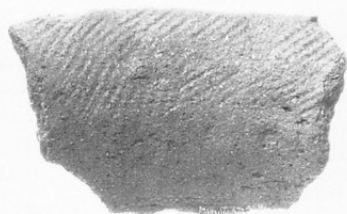

160

(1 : 2)

(内面)

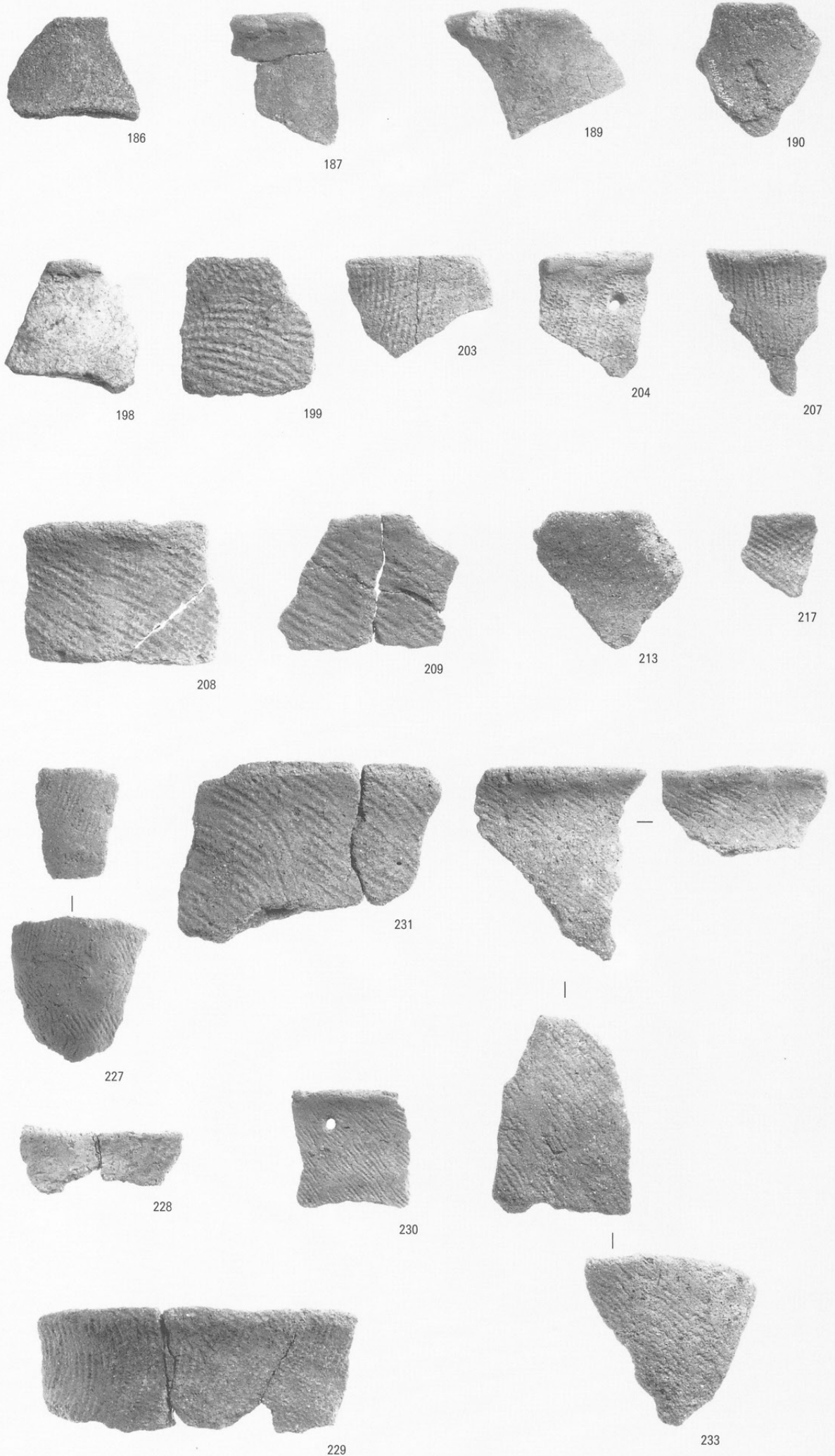

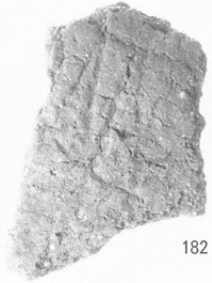

押圧縄文
表裏撚糸文
(1 : 1)

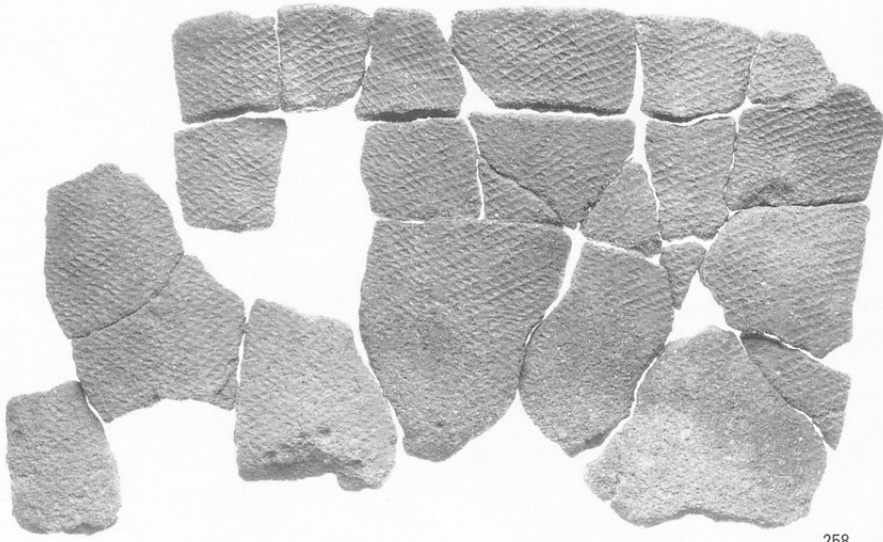

表裏押型文
(外 面)
(1 : 3)

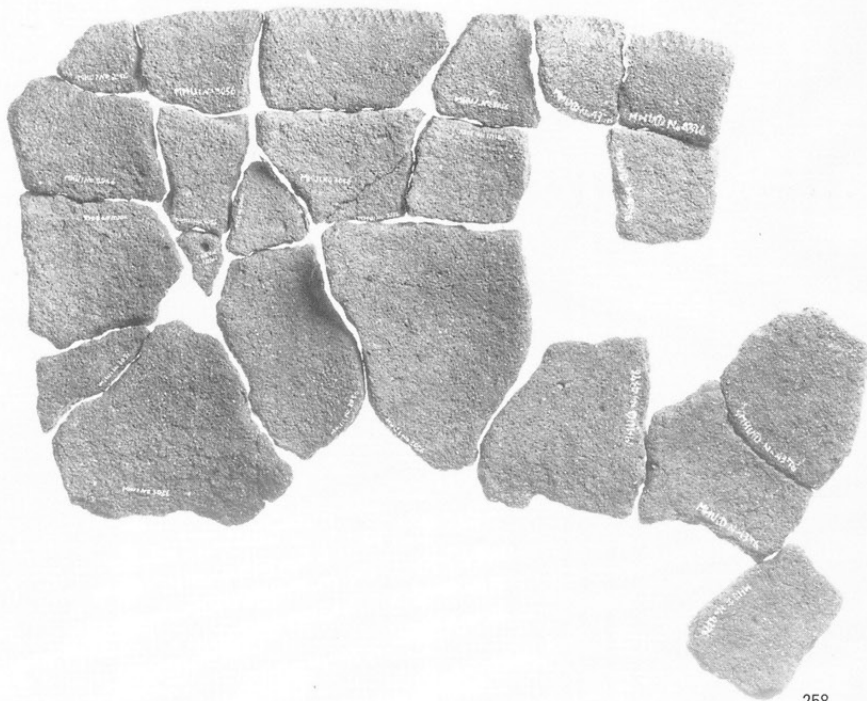

表裏押型文
(内 面)
(1 : 3)



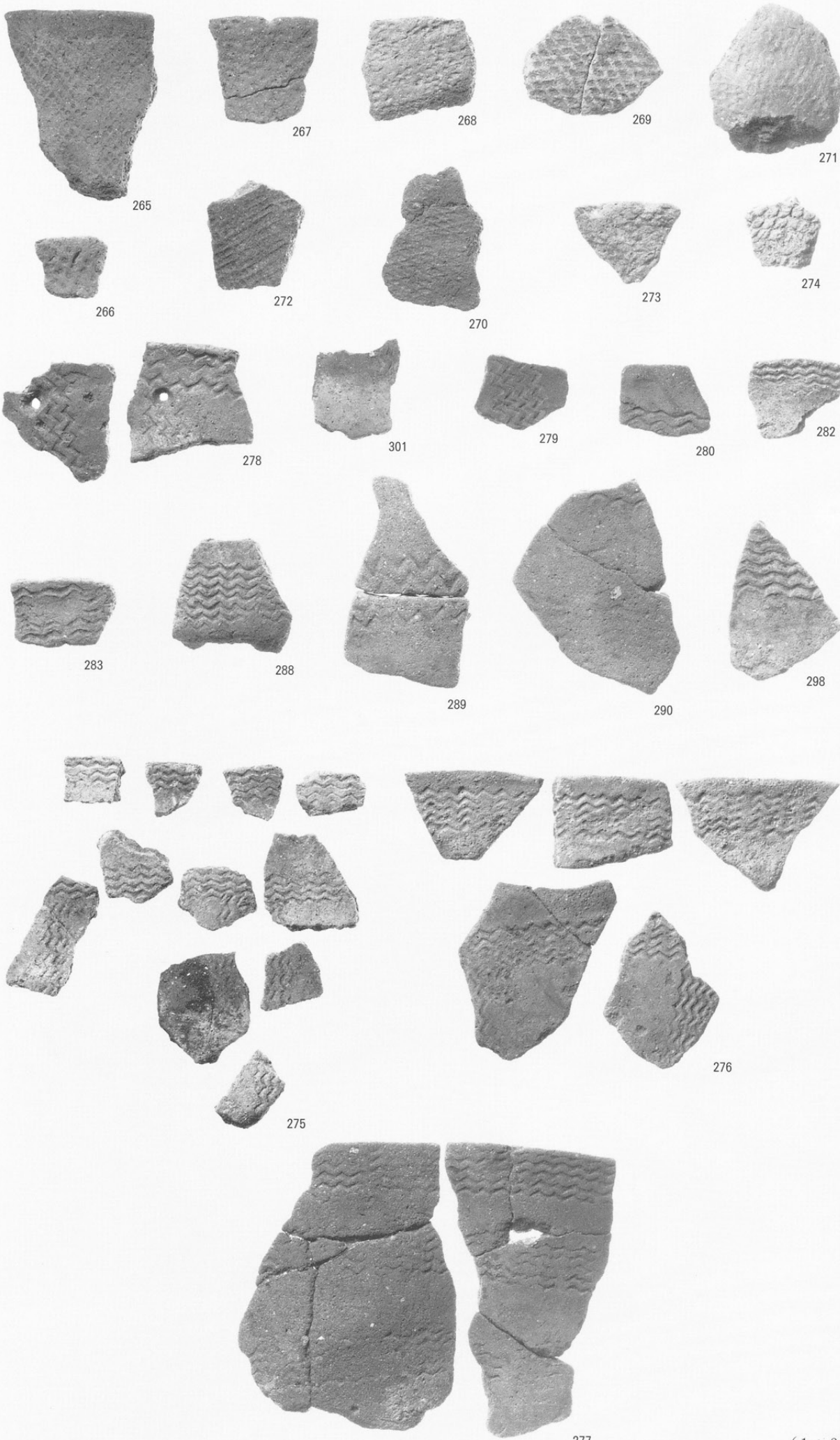

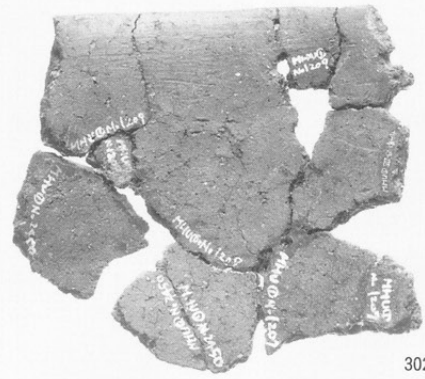
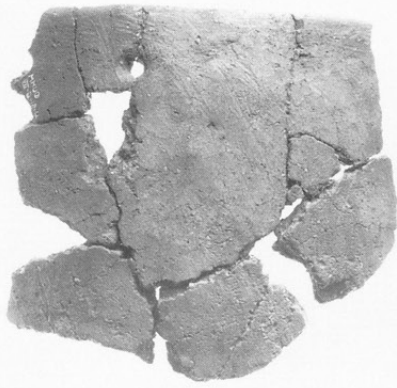

302



304



305



307



308



313



345

(1 : 4)



346

(1 : 4)

左：条痕文
（絡条体压痕文）
右：羽状縄文



347

条痕文
（絡条体压痕文）
(1 : 2)

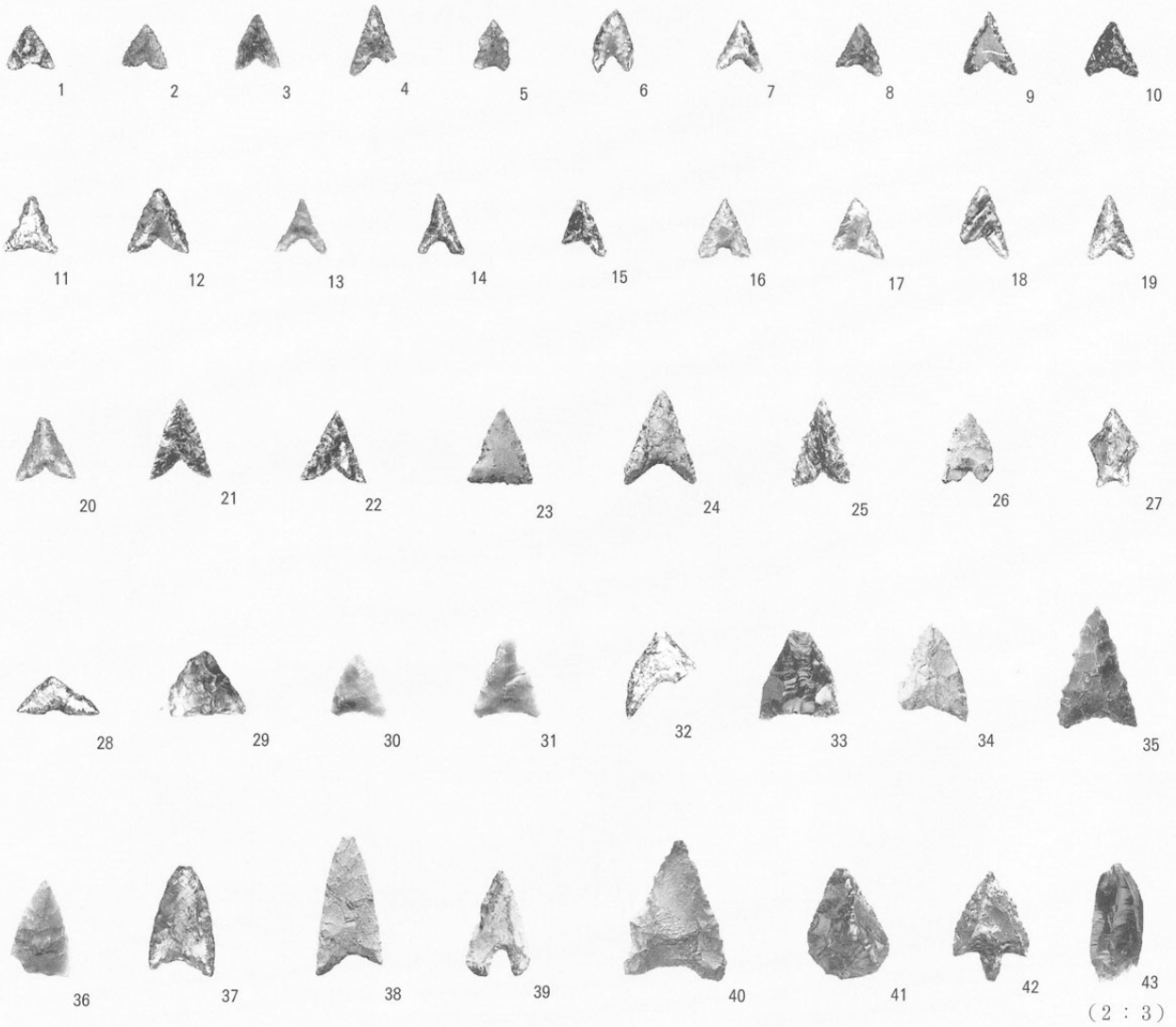

石鏃

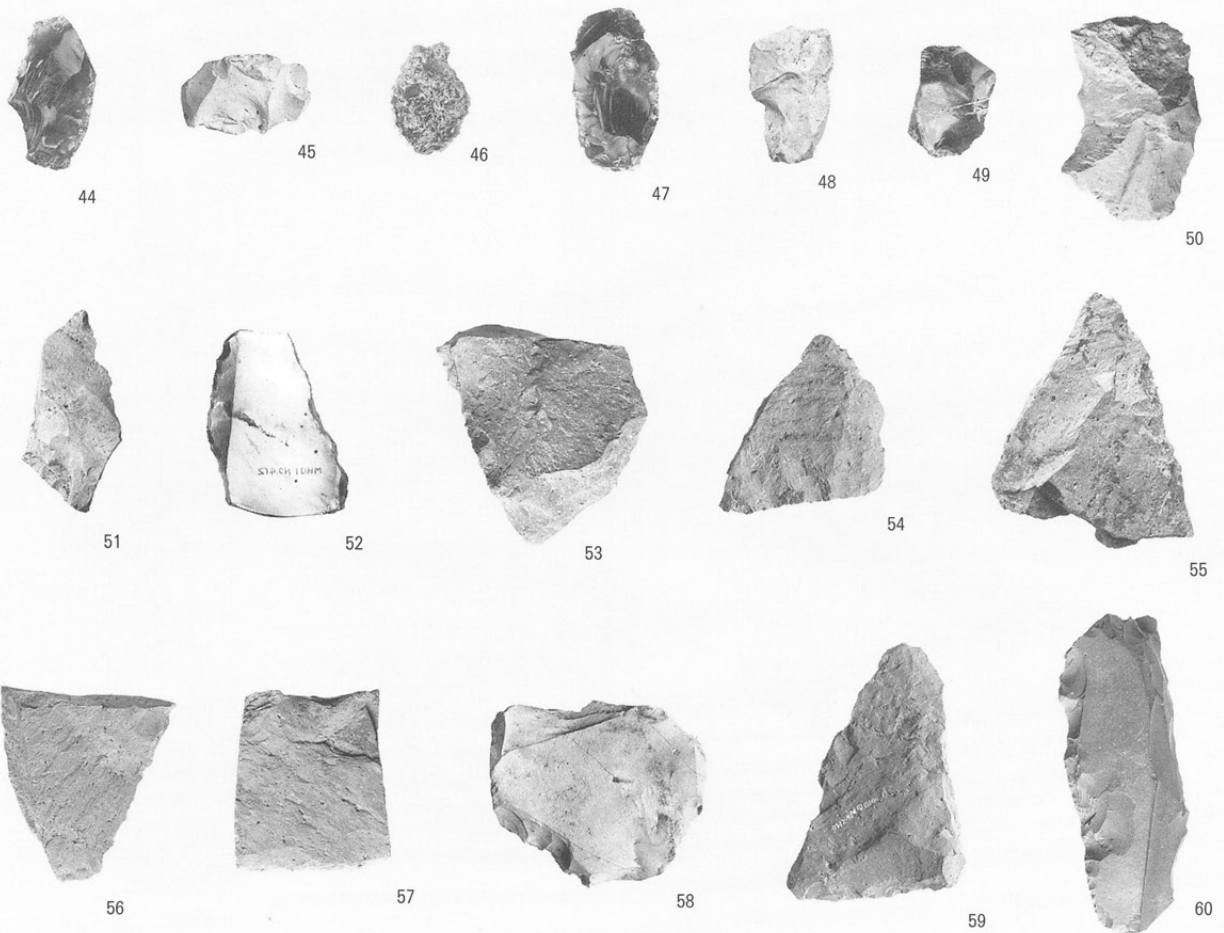

搔器・削器等



62



63



64



65

(1 : 2)

打製石斧
磨製石斧



66

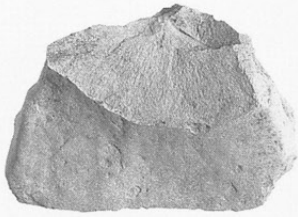

68



69

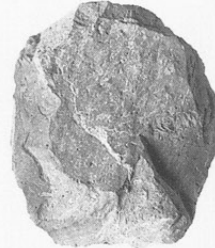

70



71



75

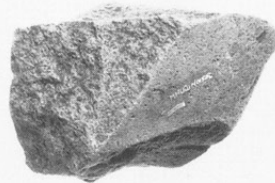

整理番号 13688

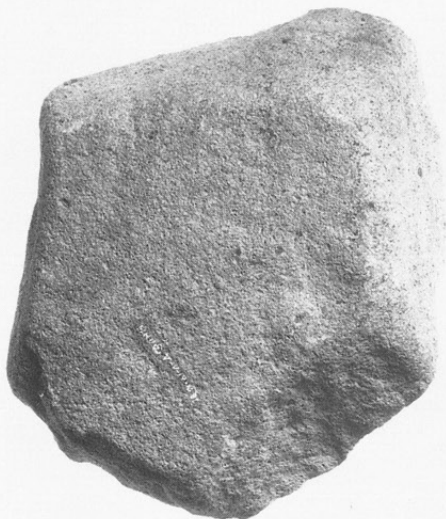

76

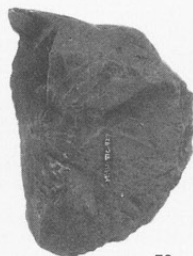

72



74



73

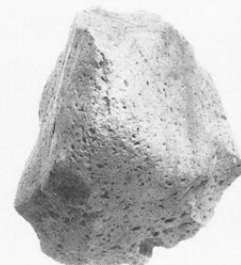

整理番号 6524

(1 : 3)

搔器
打製石器

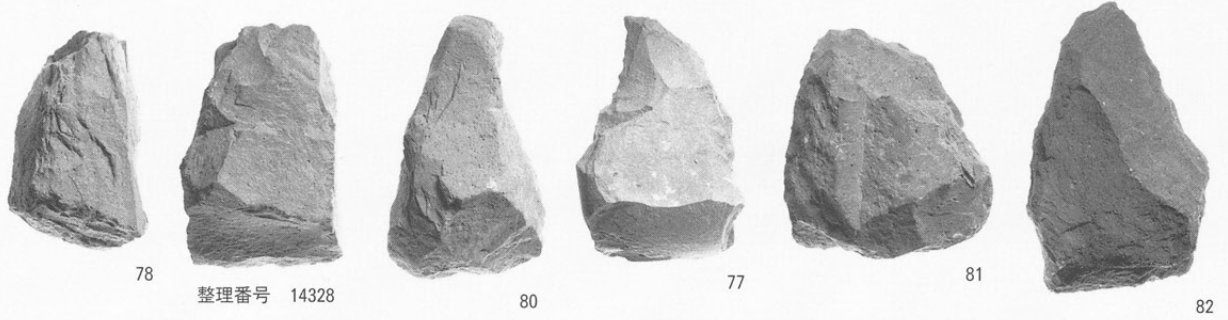

三角錐形石器

(1 : 3)

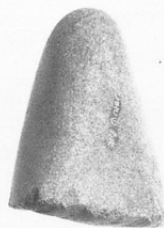
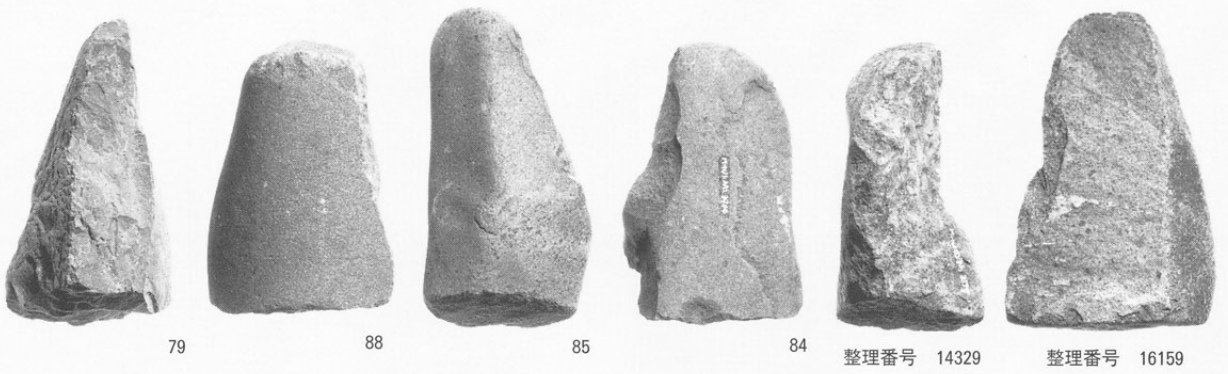

スタンプ形石器

(1 : 3)



97



整理番号 9155



整理番号 9817



整理番号 3184



整理番号 8525



整理番号 3672

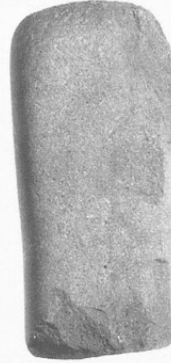

99



整理番号 1882



整理番号 3614



整理番号 9799



整理番号 3625

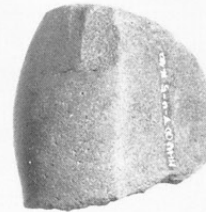

整理番号 4148

(1 : 3) スタンプ形石器



102



整理番号 8941



114



整理番号 2316



整理番号 9909

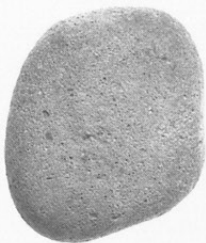

整理番号 2754



整理番号 9132



整理番号 8108



116



整理番号 2134



整理番号 9135



整理番号 8542

(1 : 3) 凹石



115



110



整理番号 14892



整理番号 14161



104



整理番号 14890



118

凹石

(1 : 3)

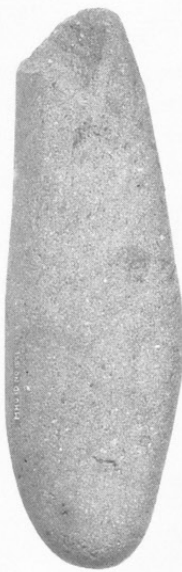

135



整理番号 11590



121



120



整理番号 12818



整理番号 11915



124



整理番号 12061



整理番号 15163



整理番号 13804

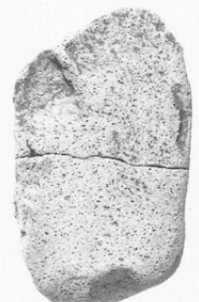

123

敲石・磨石

(1 : 3)

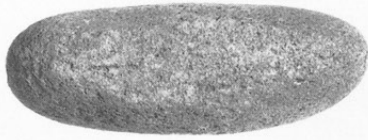

整理番号 9624

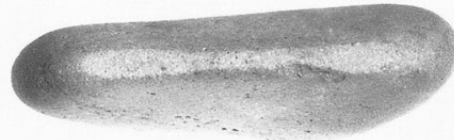

整理番号 9256



整理番号 9191



整理番号 9610

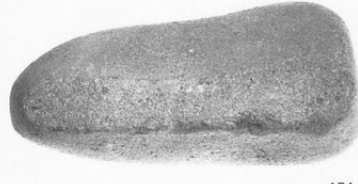

151



整理番号 9621



150



整理番号 8433



整理番号 9738



142

(1 : 3) 特殊磨石



整理番号 9065



整理番号 9737

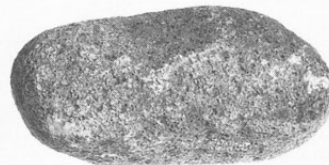

整理番号 15472

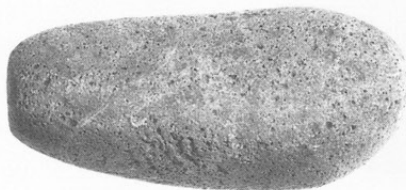

整理番号 9657



整理番号 16196



整理番号 9820



153



整理番号 9351

(1 : 3) 特殊磨石



155



154

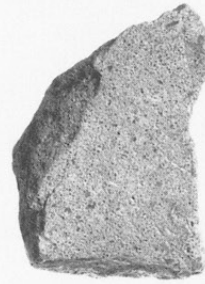

整理番号 15034



整理番号 16174



整理番号 14994
14993



整理番号 12182
12184



156



157

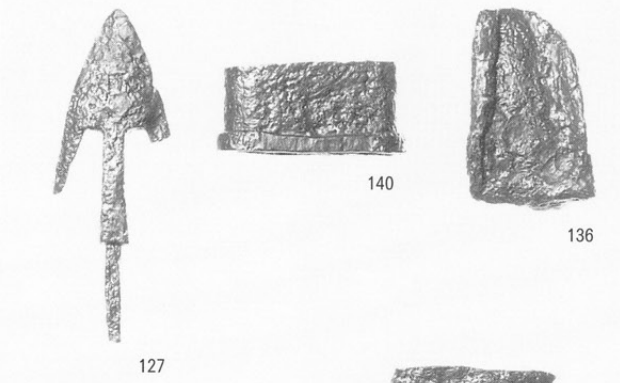
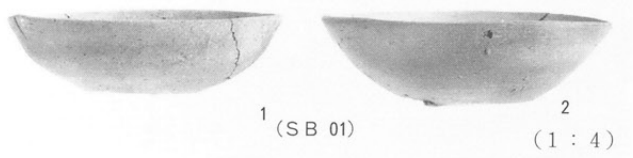

金属器 (1 : 2)



(1 : 4) ST 01

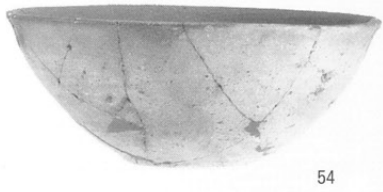
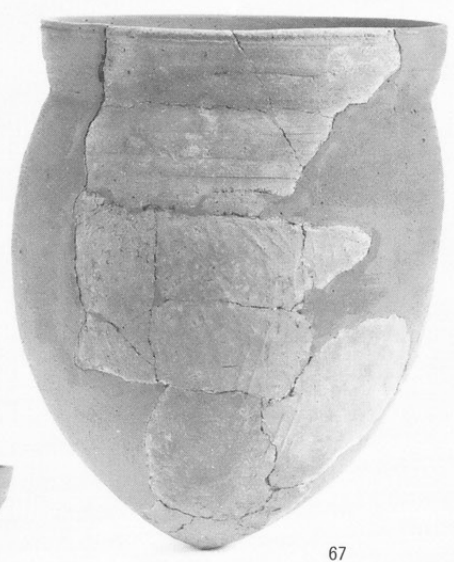

(1 : 4) SB 04



70

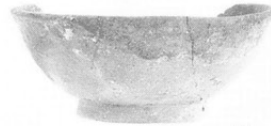

79



77

(1 : 4)



71

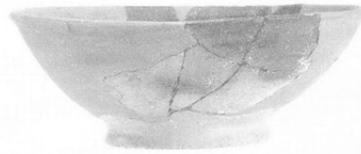

80



72



S B 05



82

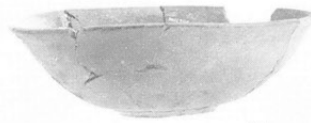

84



85

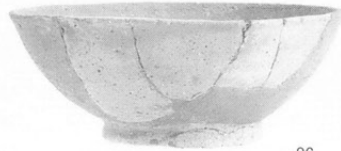

86



89

S B 06

(1 : 4)



92



94



99 (1 : 4)



98

S B 07

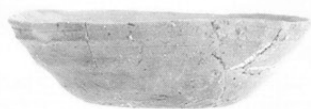

102



108



110

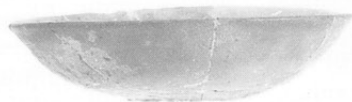

105

S B 11

(1 : 4)



全 景



左：SQ 01
右：SQ 02

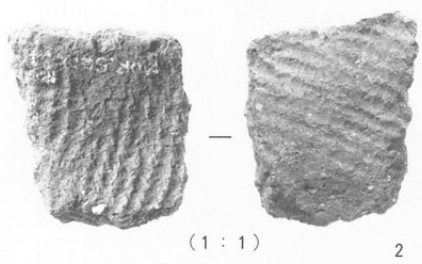

左：表裏縄文土器
右：ループ文土器



左：全 景
 右：住居空撮



1



2

(2 : 3)



3



4



5



8



9

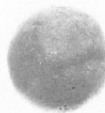

7



I-19



J-16



I-2



J-16



I-2



6



2



7



8



9



10



11



14



15



16



17



23



24



25



28

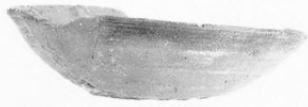

46



48



54

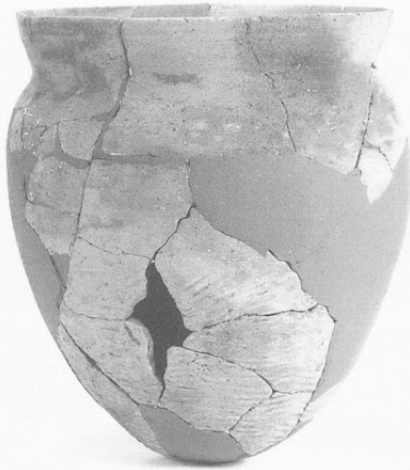

77



78



79



80

SB 02

(1 : 4)

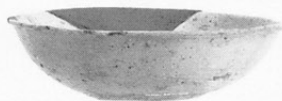

103



104



106

SK 01

(1 : 4)



全 景

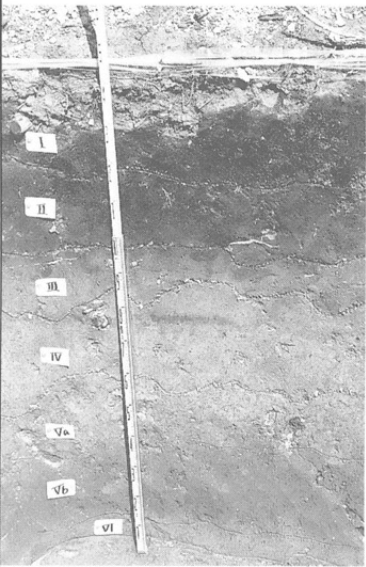

左：基本土層
右：縄文面遺物出土
状況



左：SQ 01
右：SQ 02



左：SQ 03
右：SQ 04

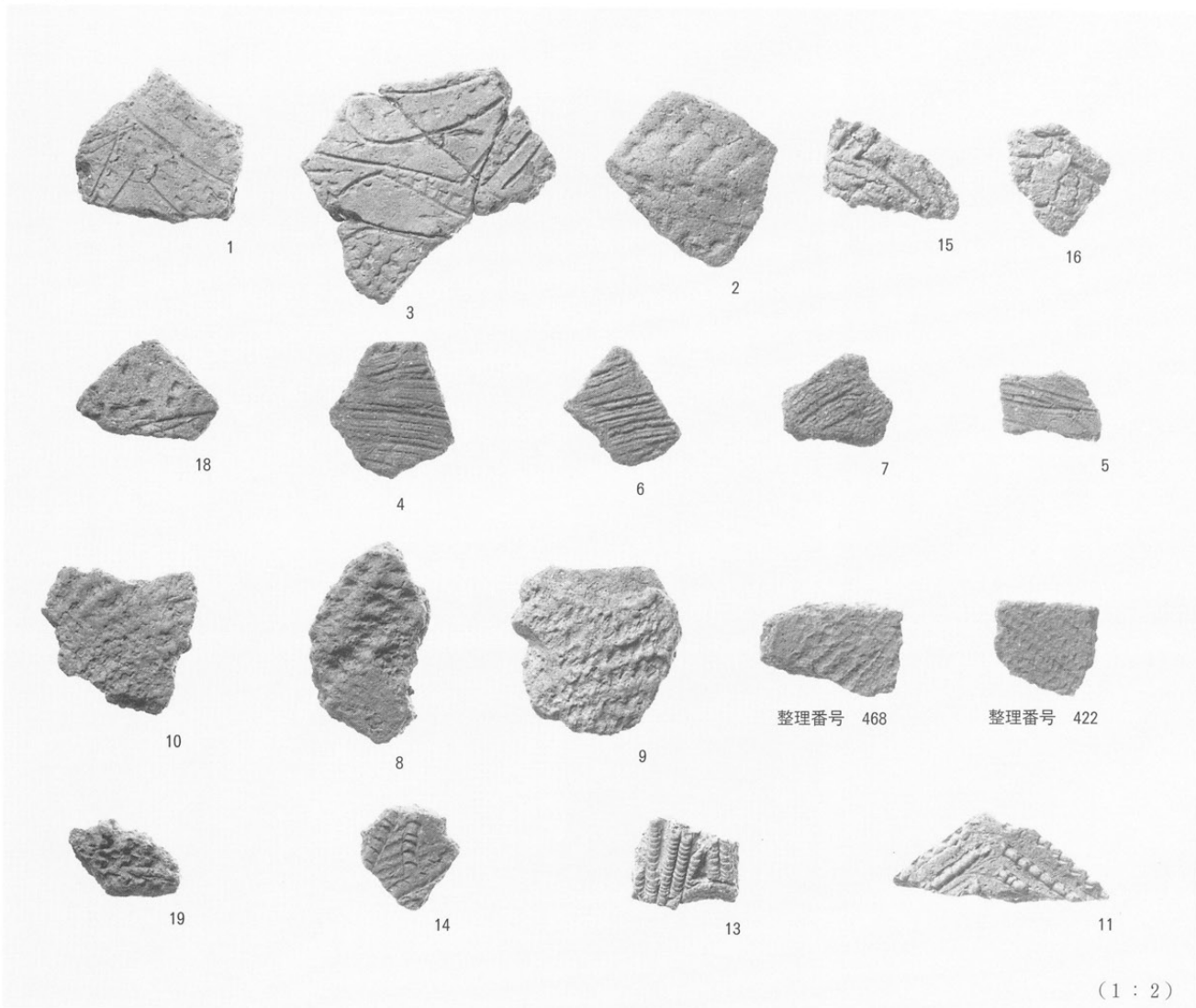

縄文時代土器



左：縄文時代土器
右：弥生時代土器

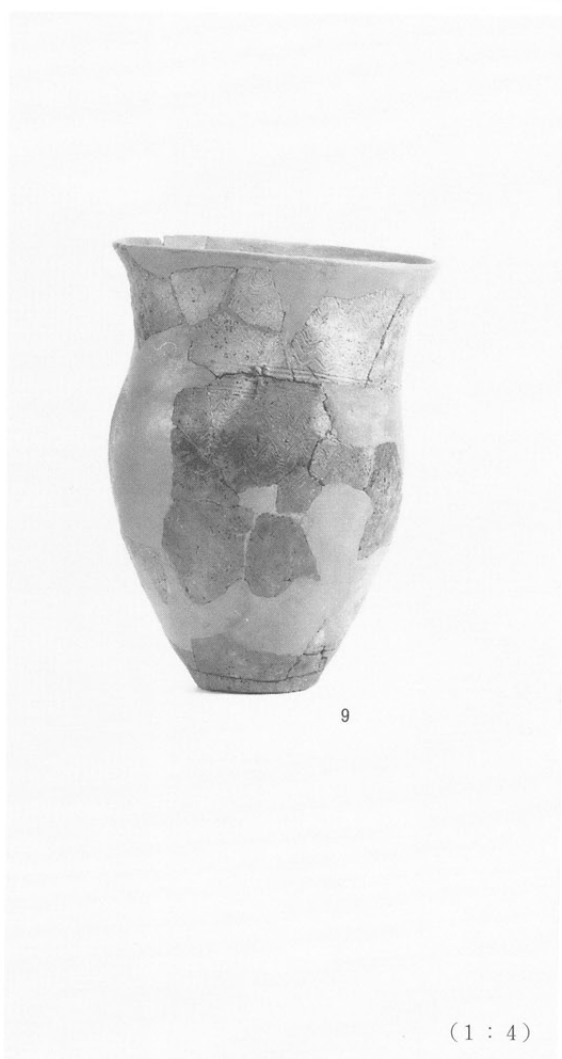



遠景

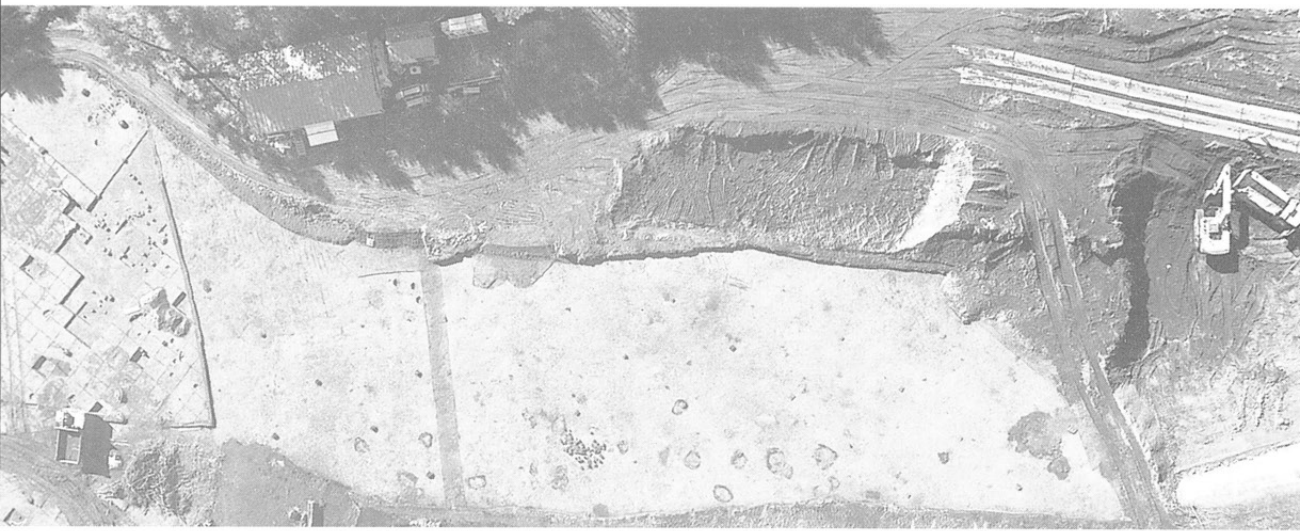

全景

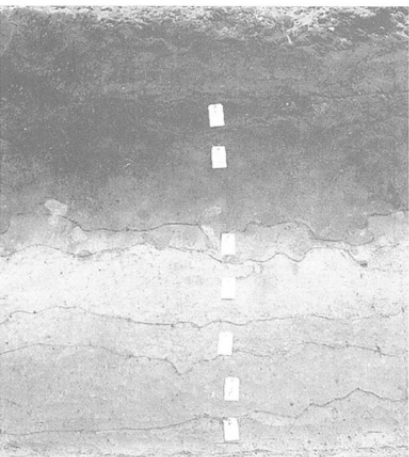

左：基本土層
右：作業風景



作業風景



左：表裏縄文土器
集中部
(I-P-05)

右：表裏縄文土器
出土状況
(I-P-05)



左：表裏縄文土器
出土状況
(I-P-05)

右：石皿出土状況
(I-L-E-04)

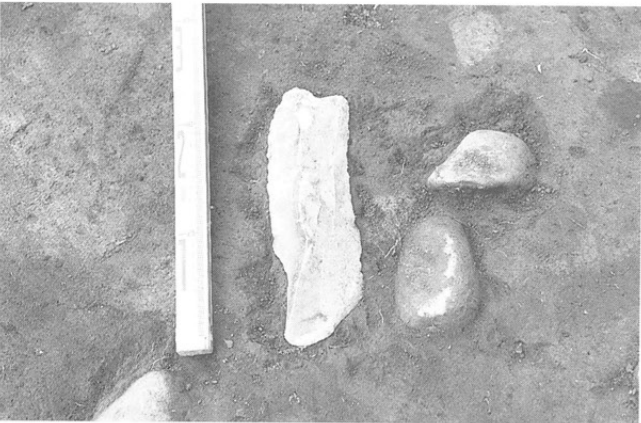

左：削器出土状況
右：尖頭器出土状況
(I-K-23)

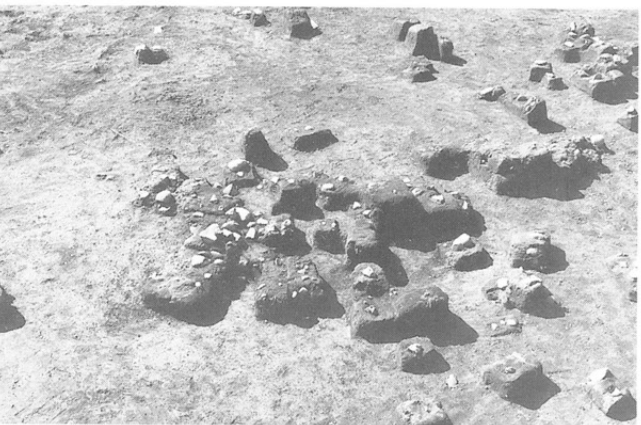

左：SH 01
右：SH 02



左：SK群(I-L-01)
右：SK 108

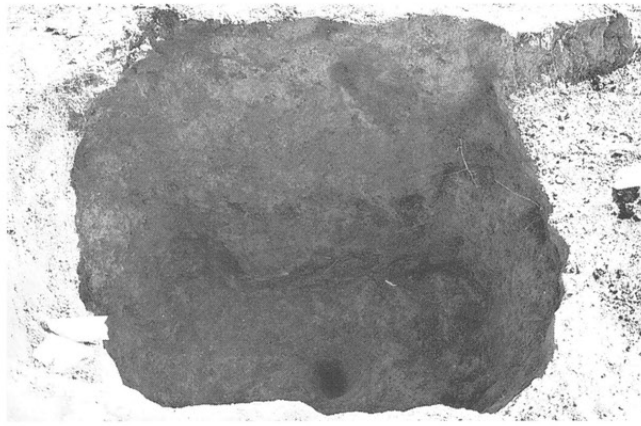
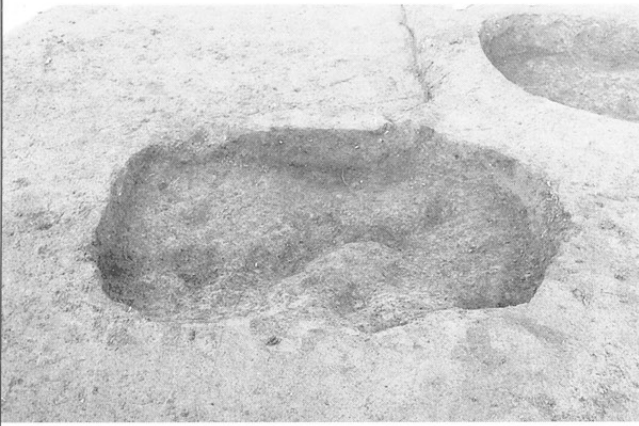

左：SK 110
右：SK 110底面



左：SK 109
右：SK 111



左：SK 122
右：SK 128



左：SK 131
右：SK 142



左：SK 145
右：SK 150

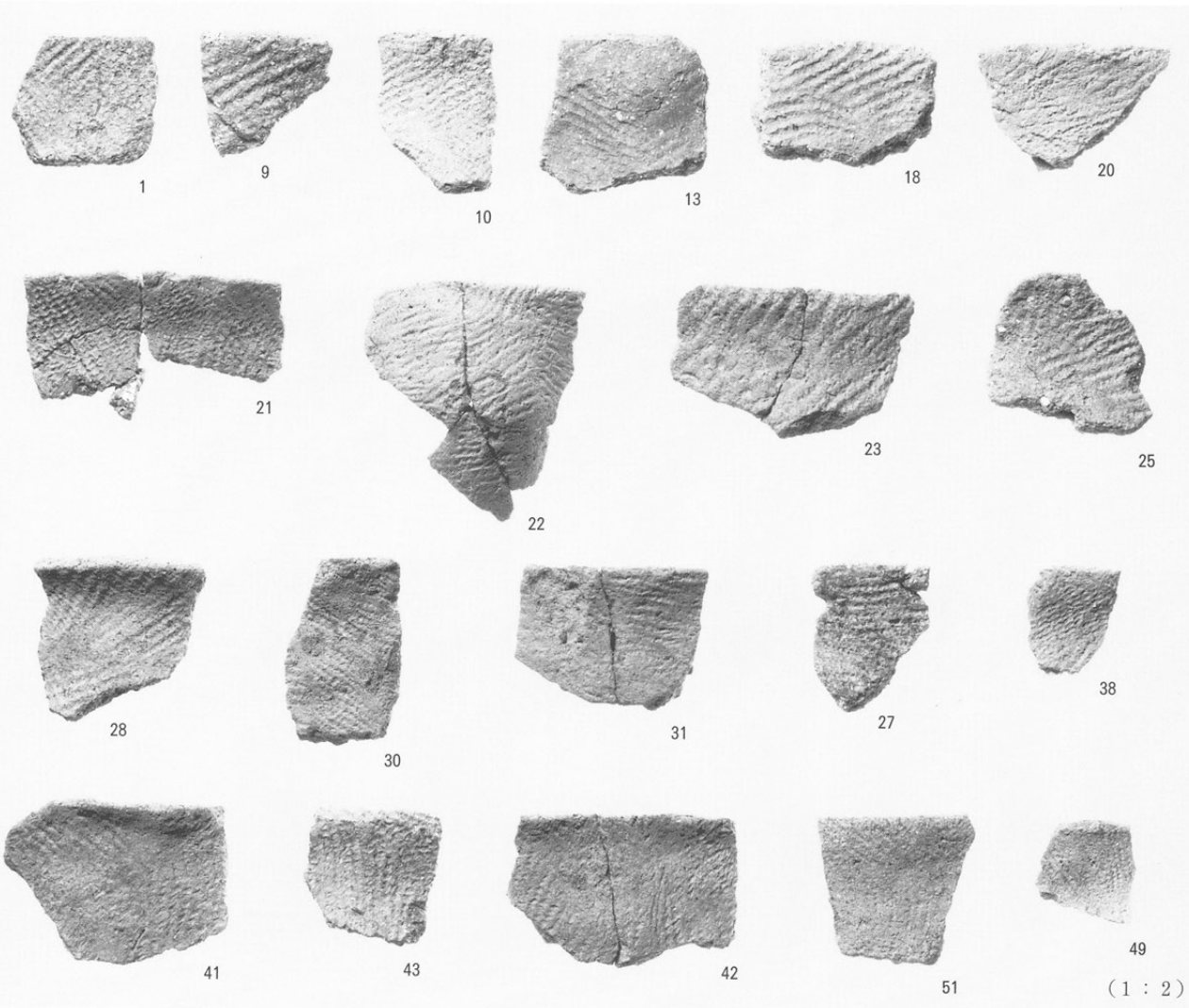

表裏縄文
(外面)

(1 : 2)

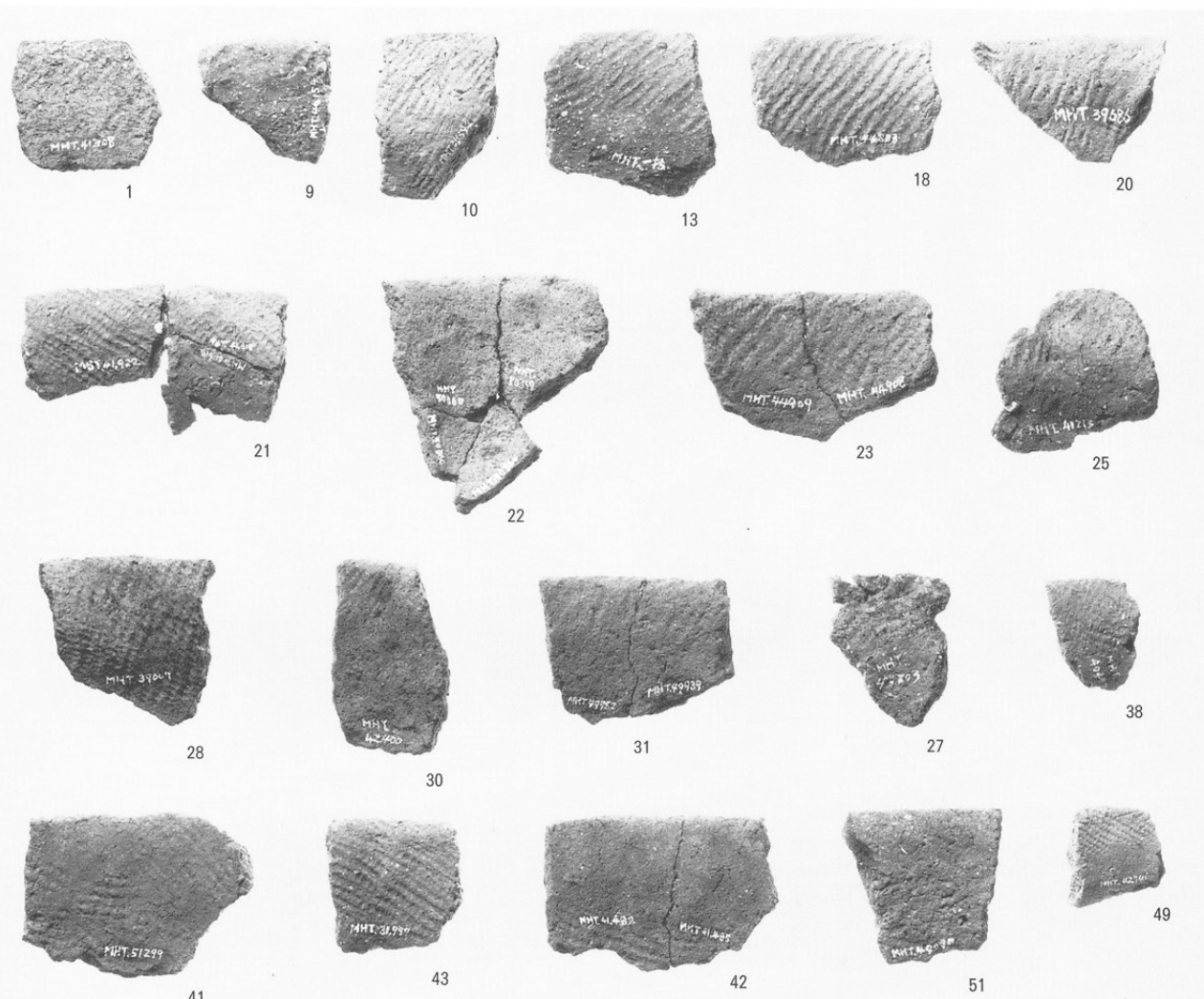

(内面)

(1 : 2)

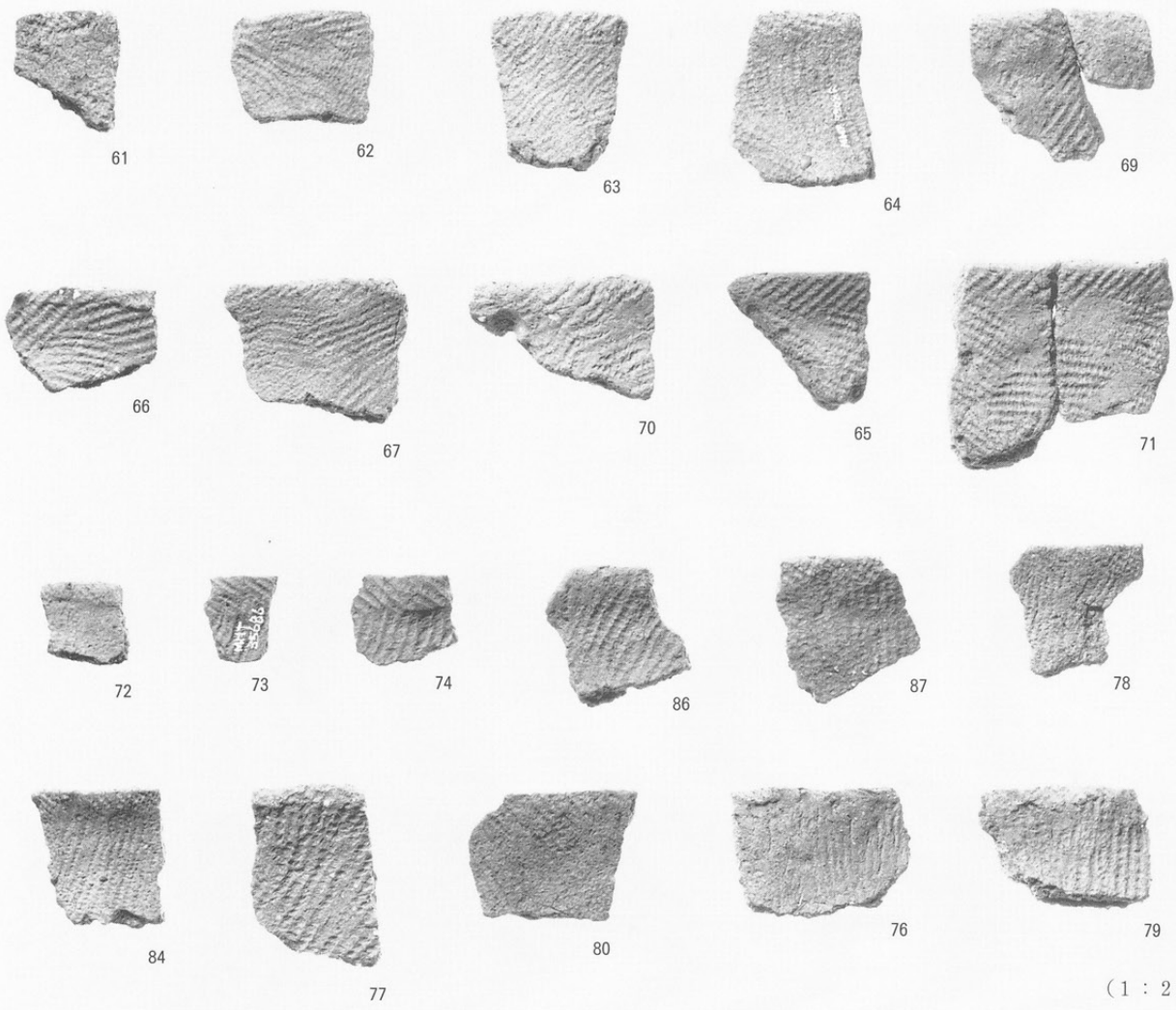

(1 : 2) 表裏縄文
(外 面)

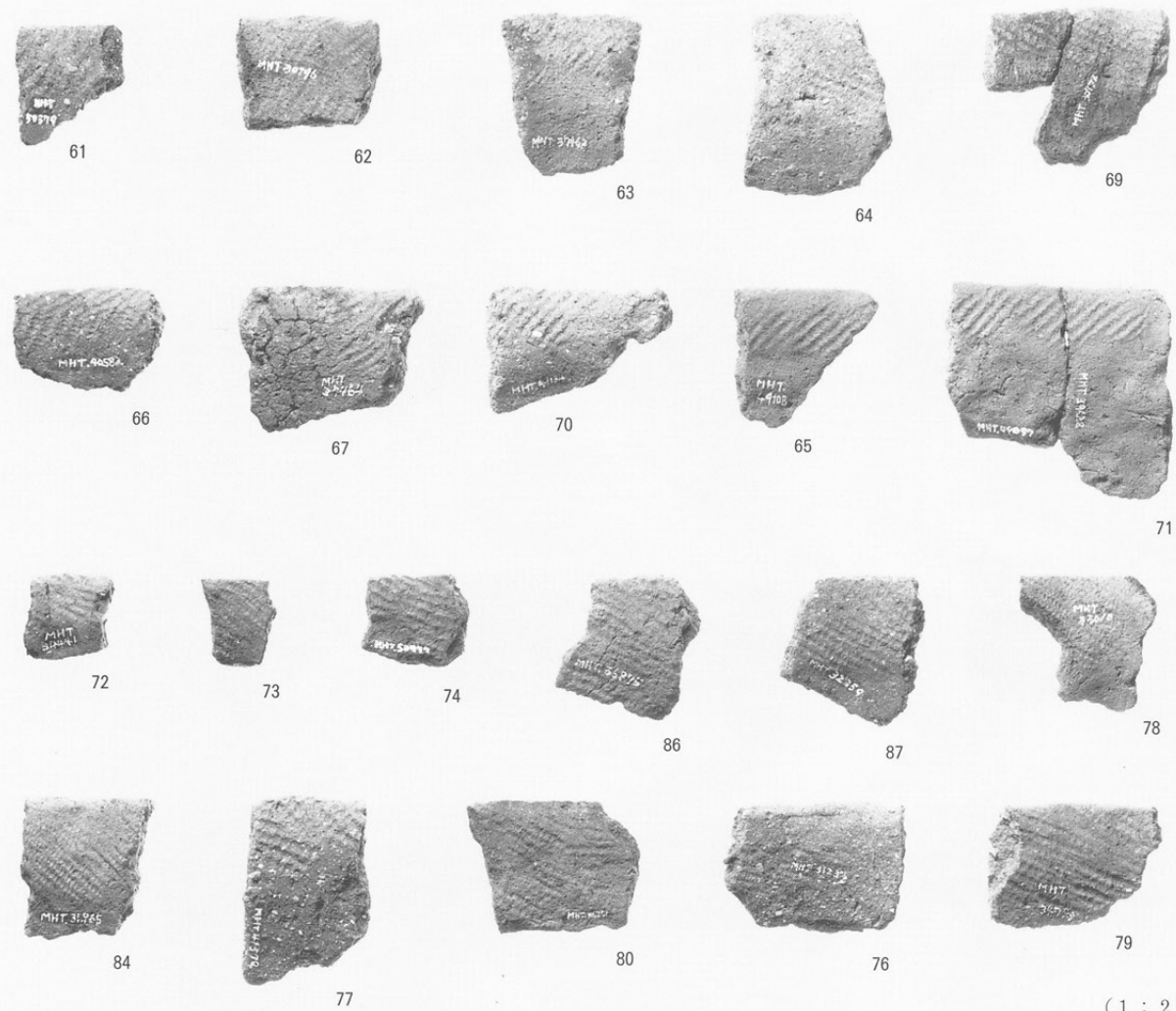

(1 : 2) (内 面)

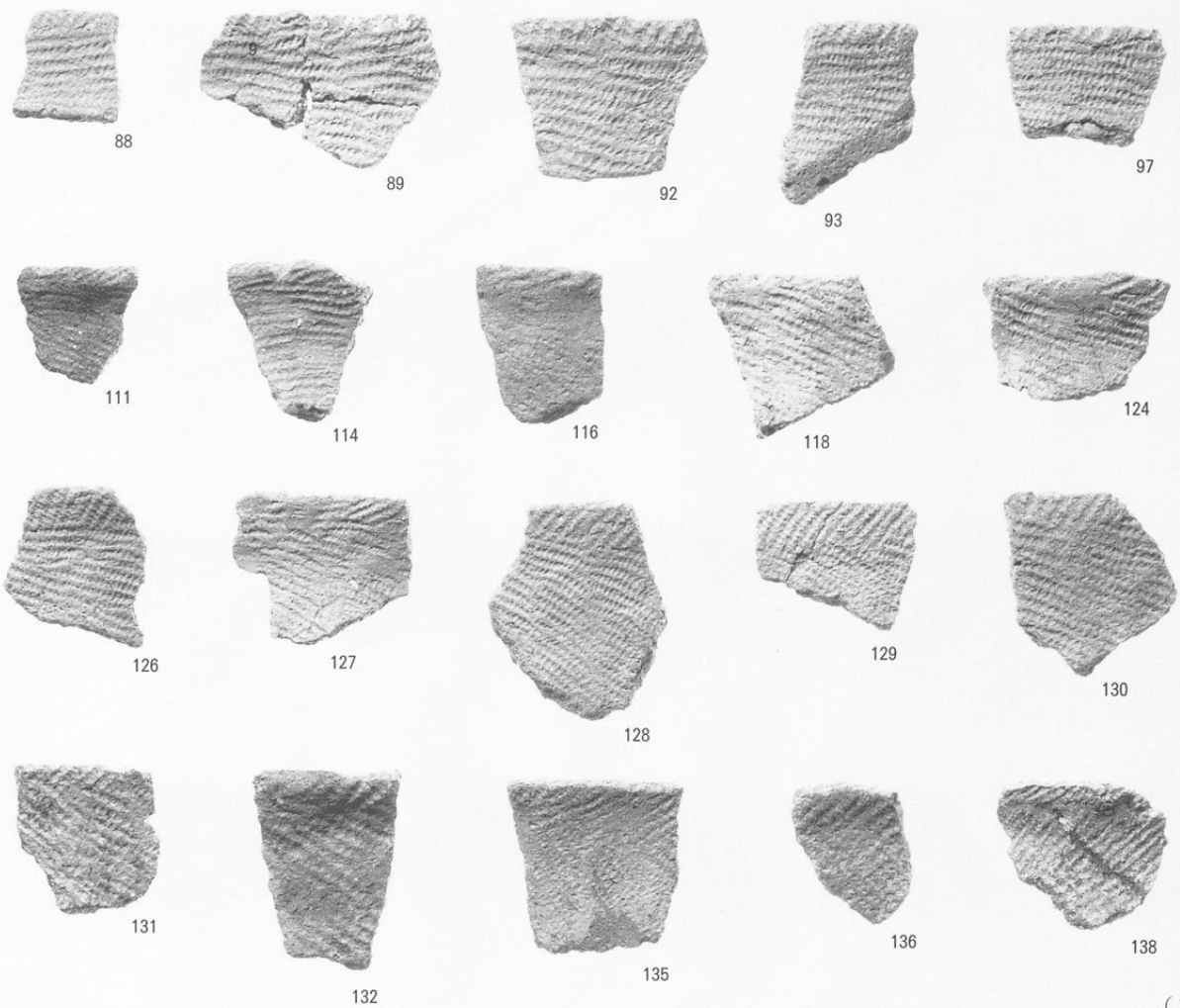

表裏縄文
(外面)

(1 : 2)

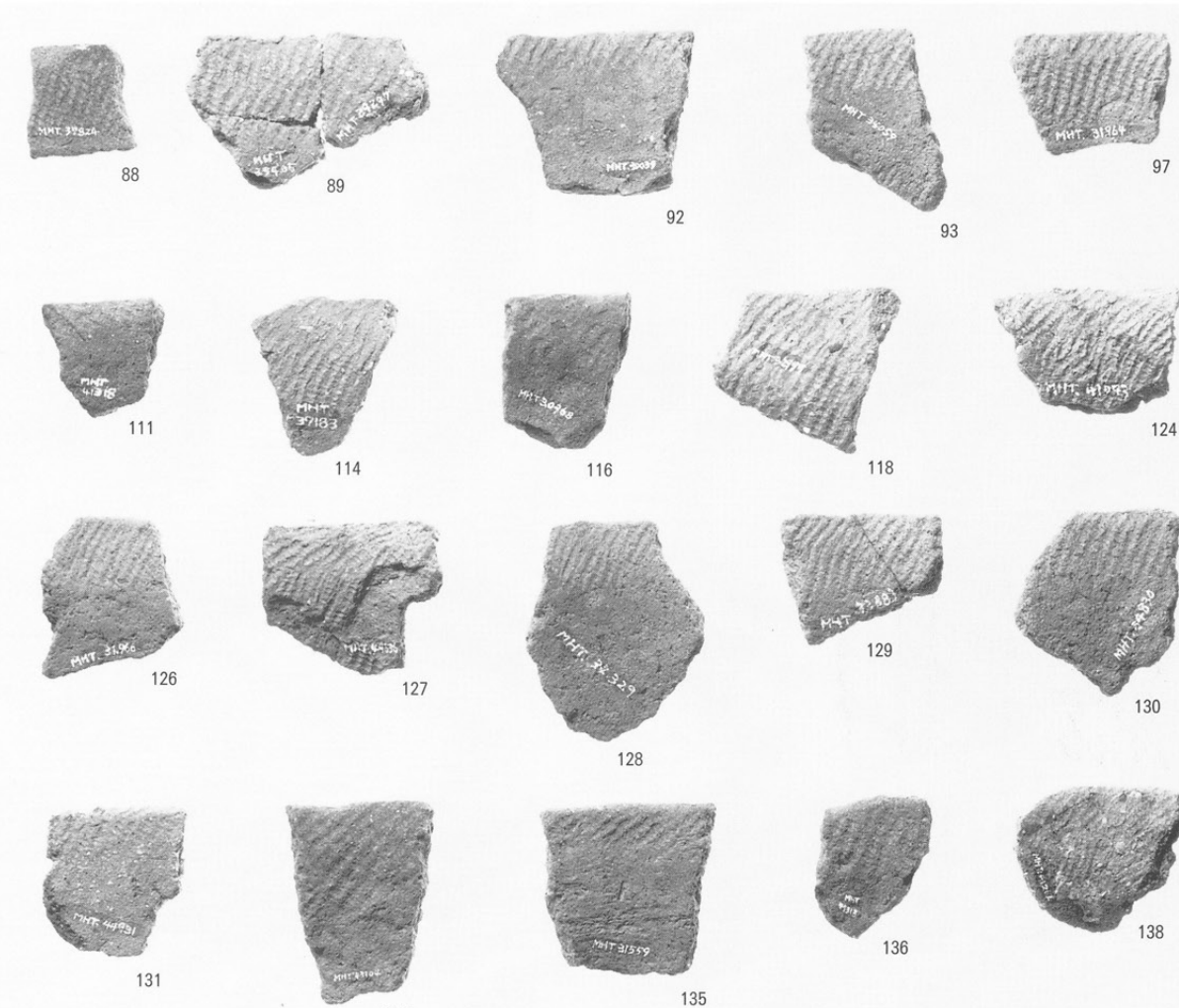

(内面)

(1 : 2)

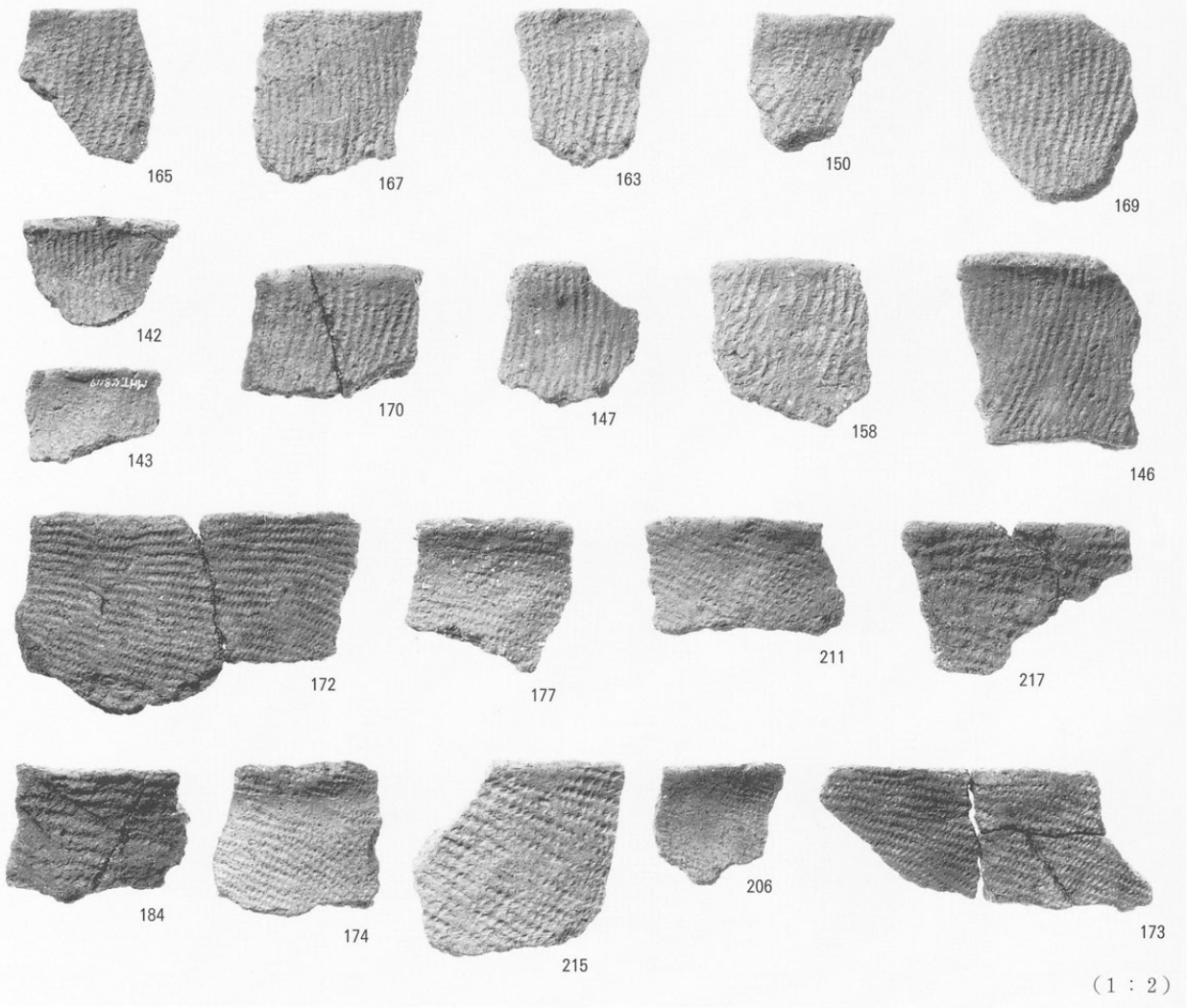

表裏縄文
(外面)

(1 : 2)

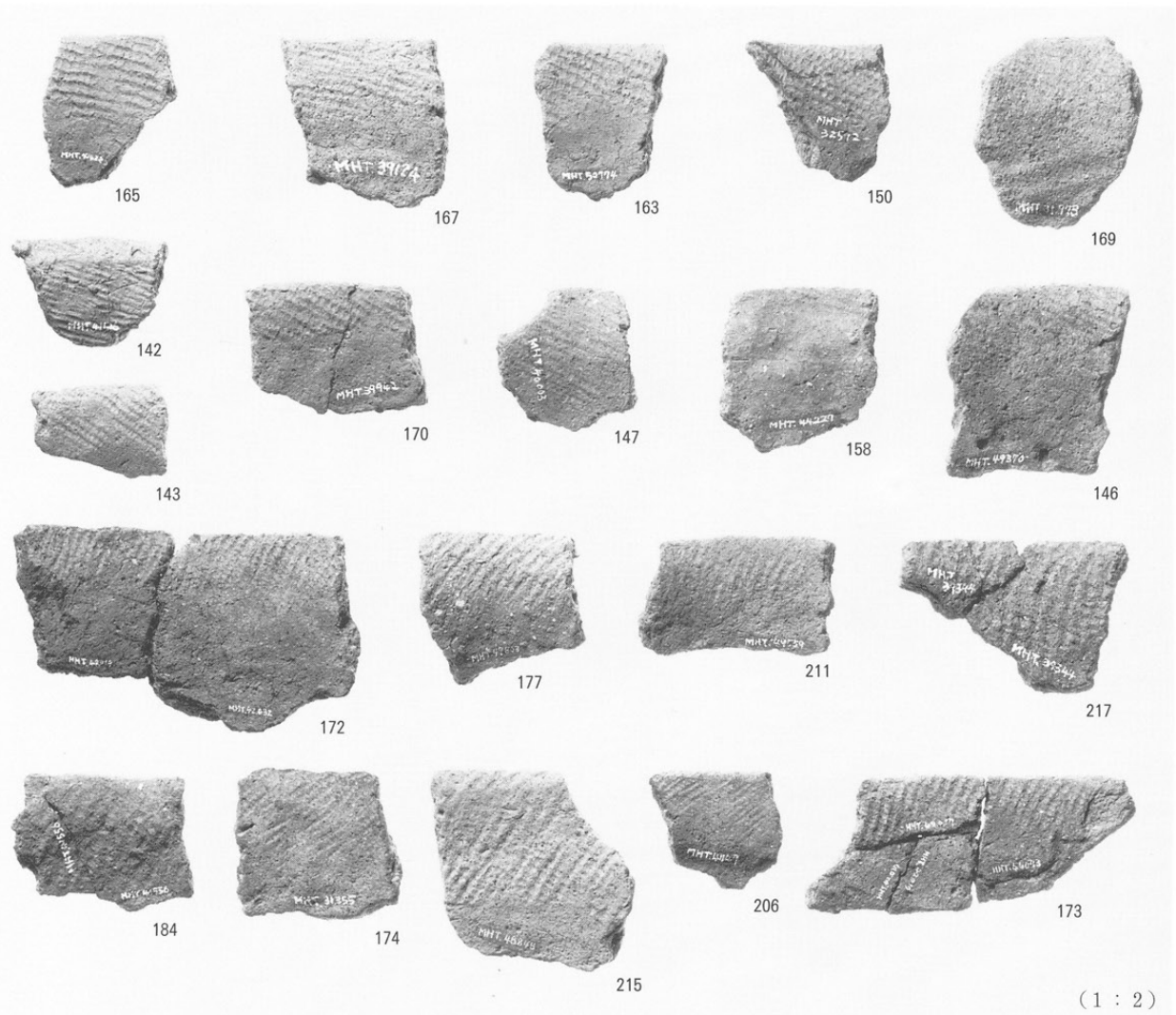

(1 : 2)

(内面)

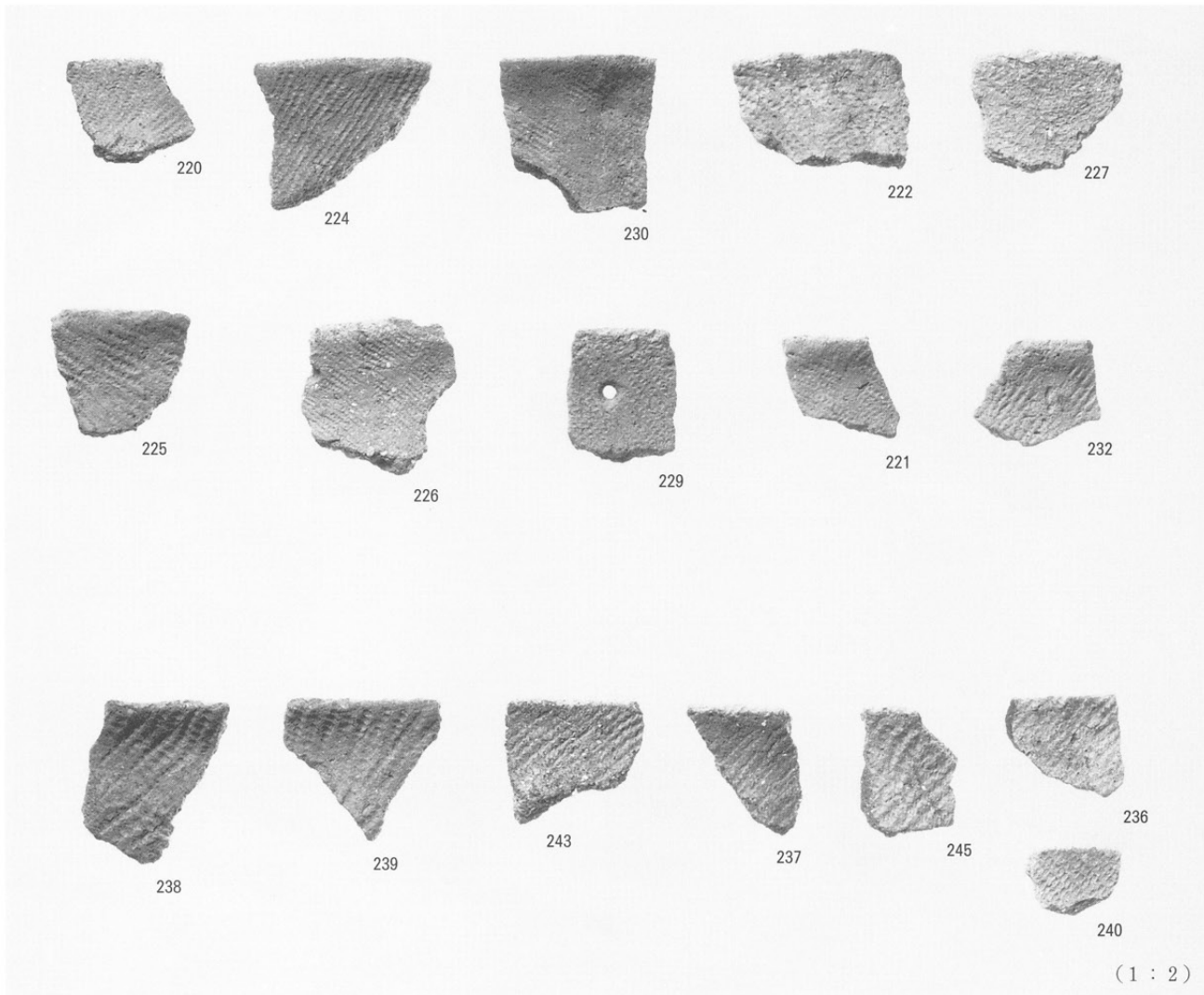

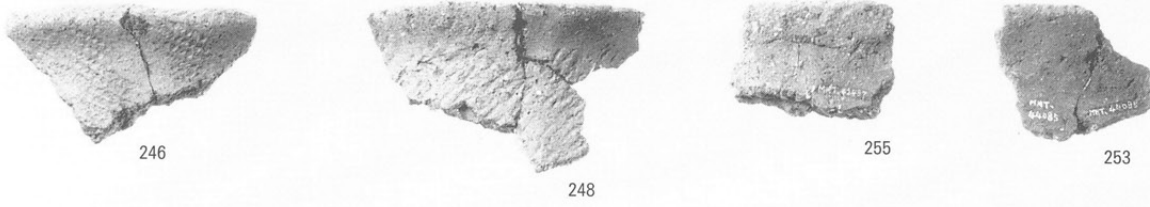

(1 : 2) 表裏縄文
(外面)

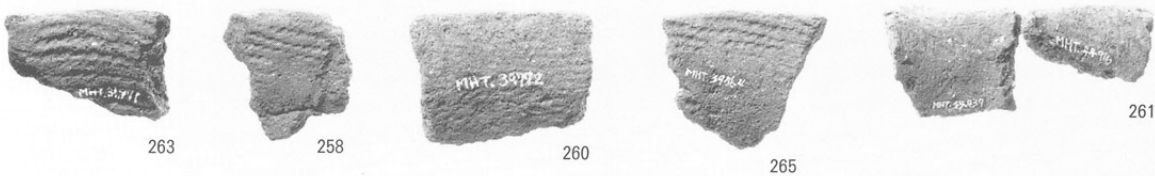

(1 : 2) (内面)



表裏縄文
(外面)

(1 : 2)

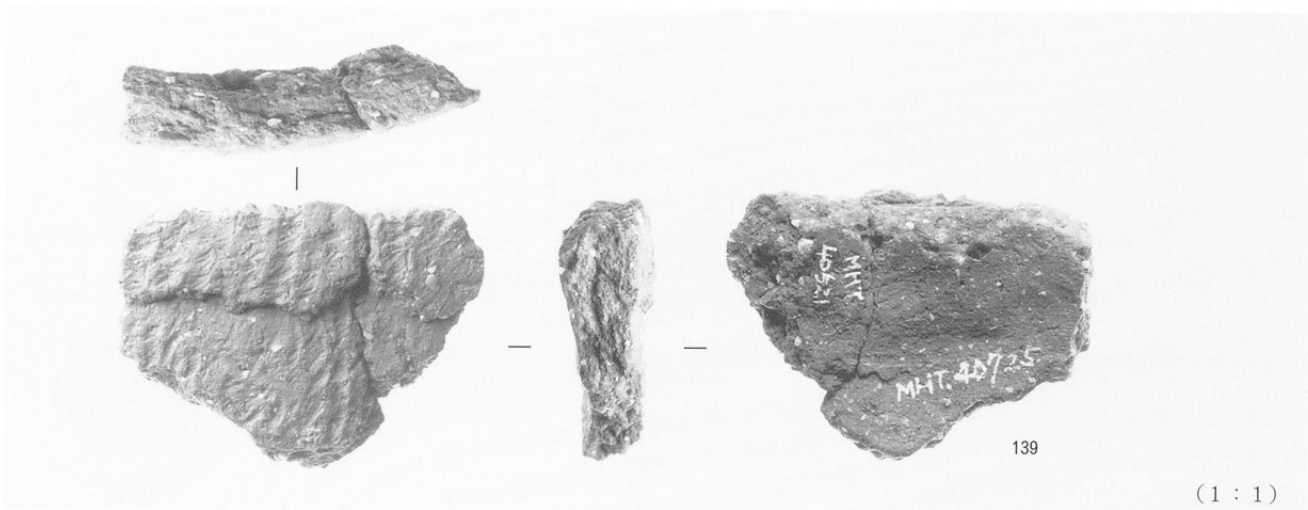

表裏縄文
接合部

(1 : 1)

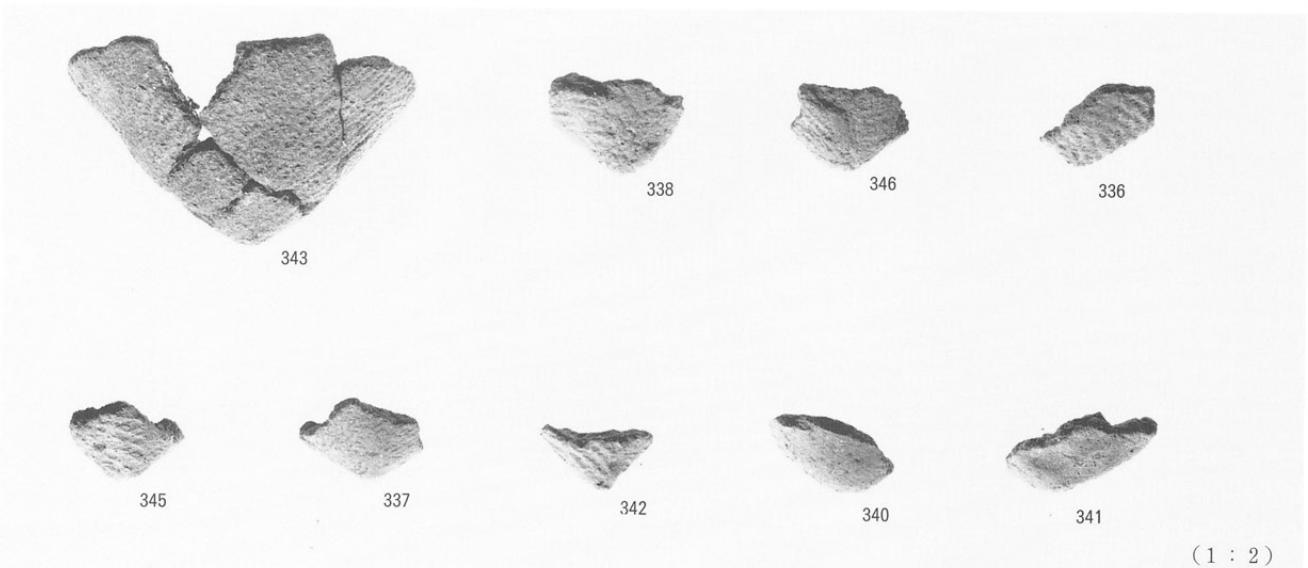

表裏縄文
底部

(1 : 2)

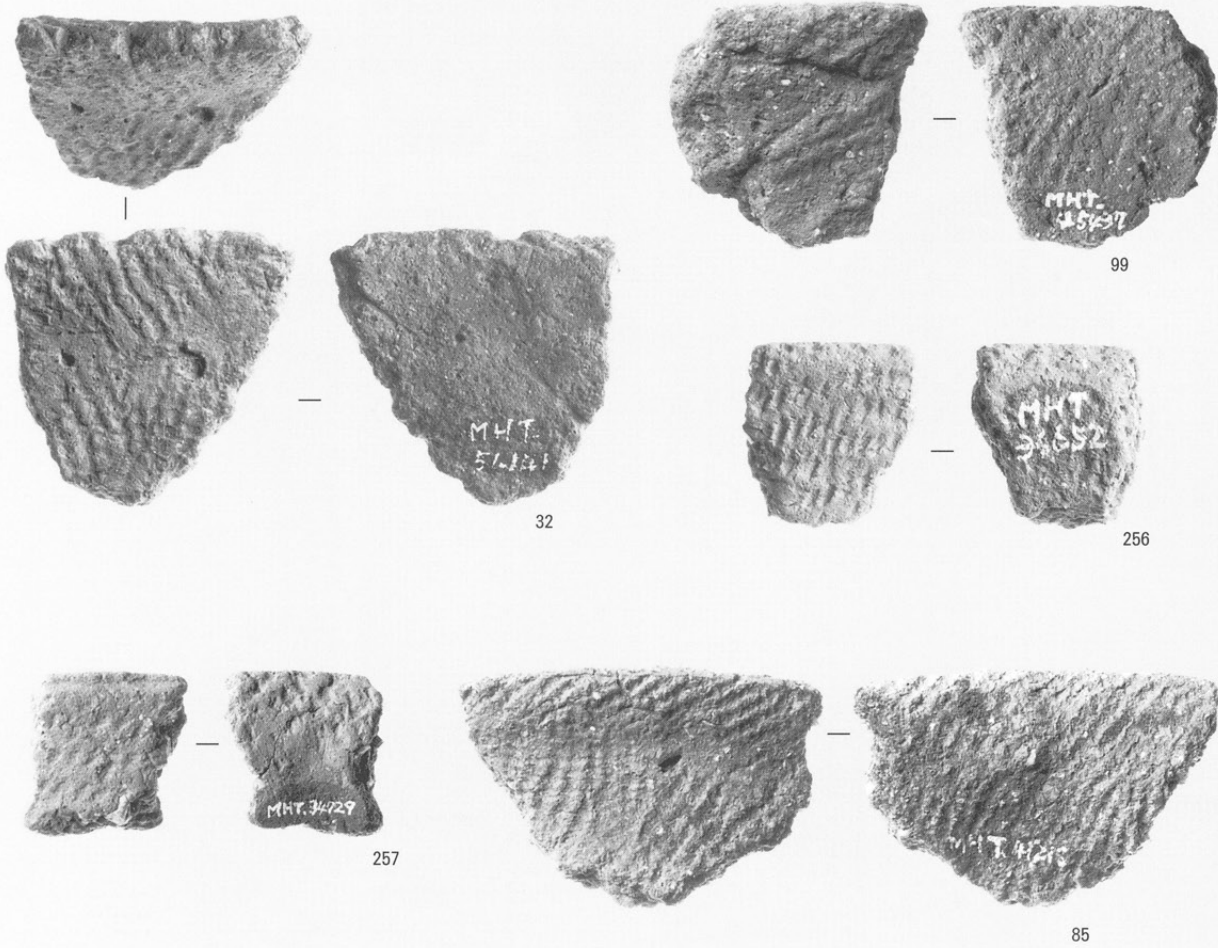

(1 : 1) 表裏縄文

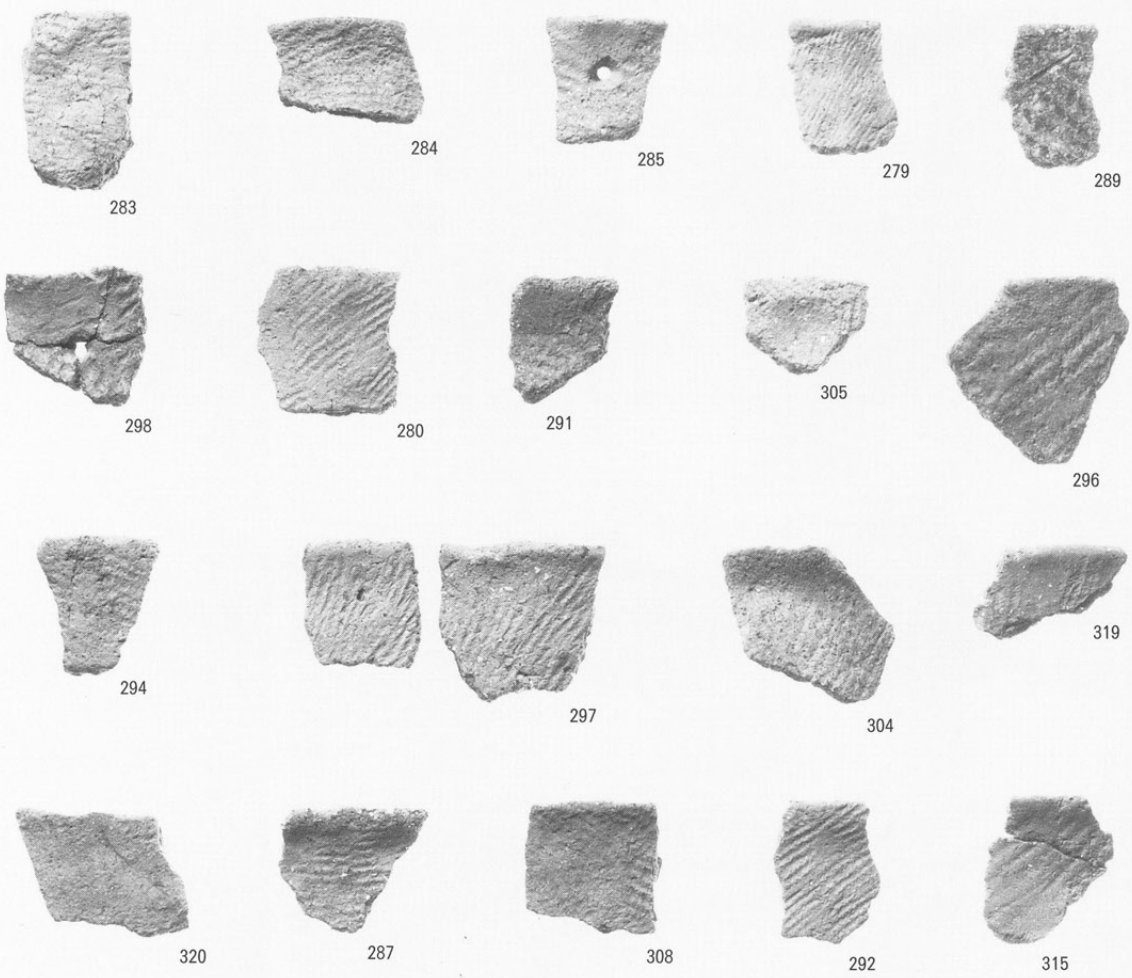

(1 : 2) 表縄文

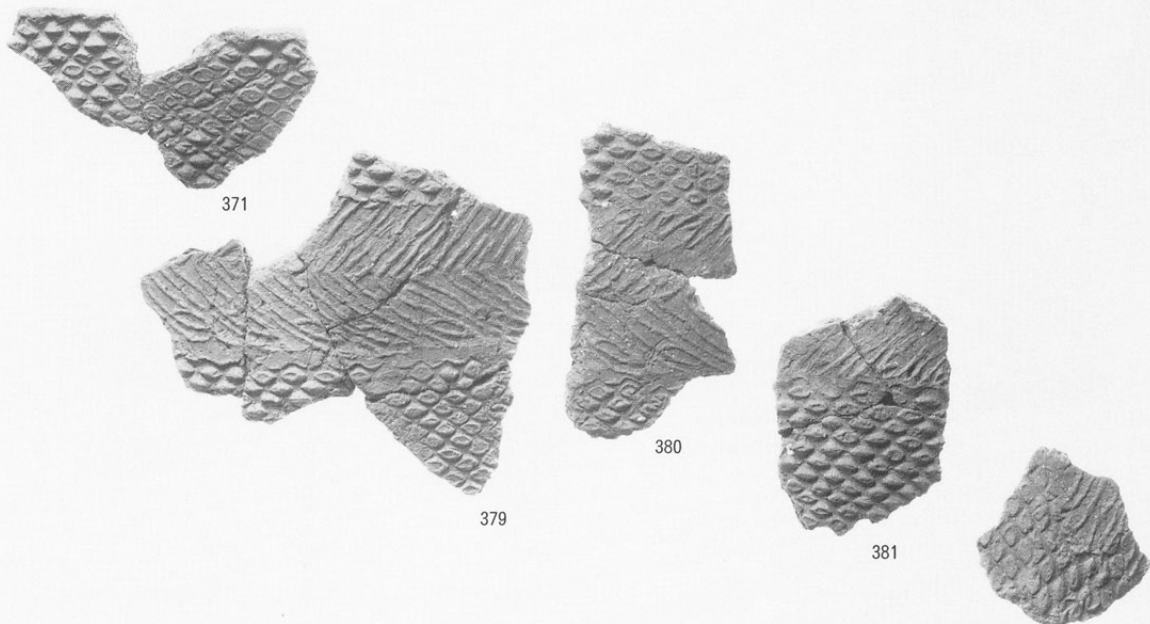
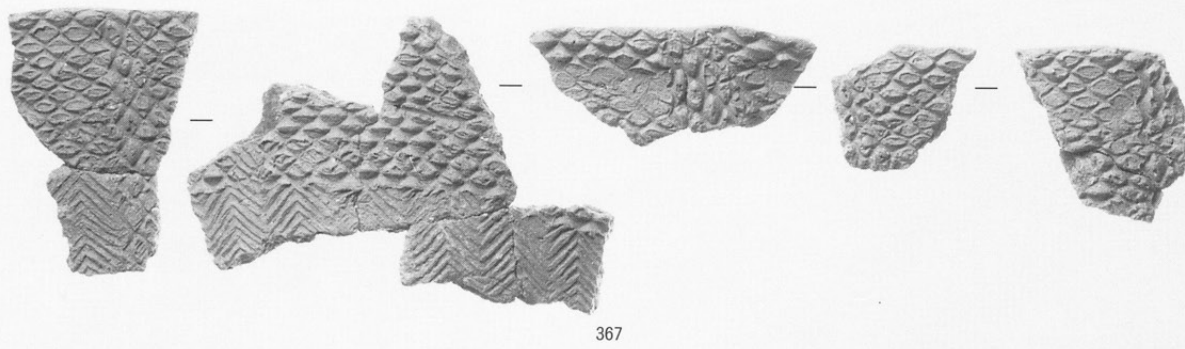
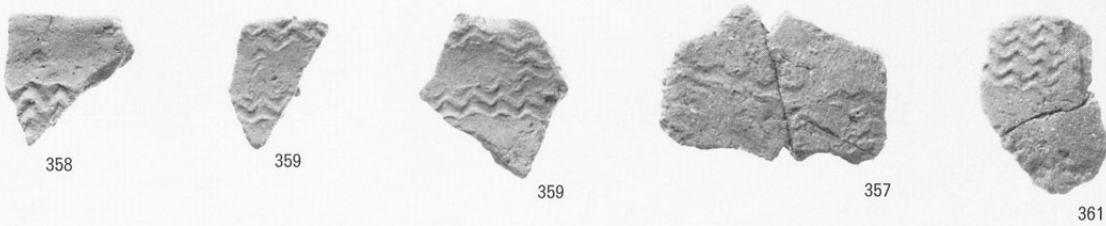
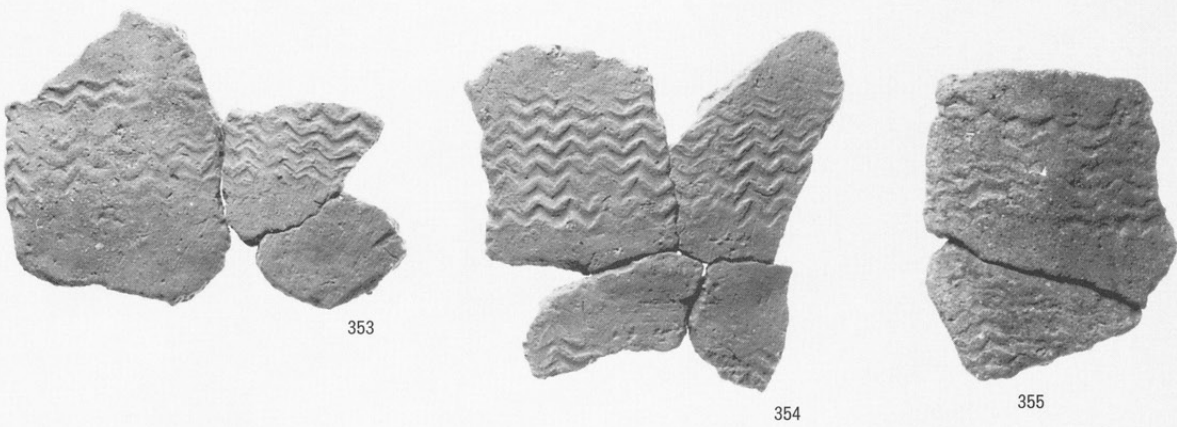
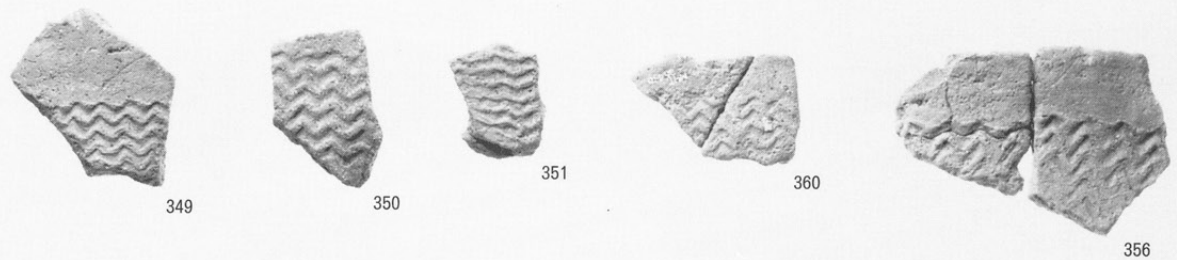



414



415



416



419



423

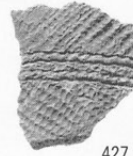

427



420

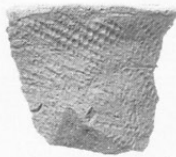

424

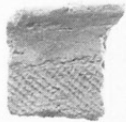

422

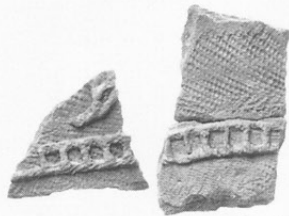

425



429



448



426



443



444



442



445



446



447



460



461

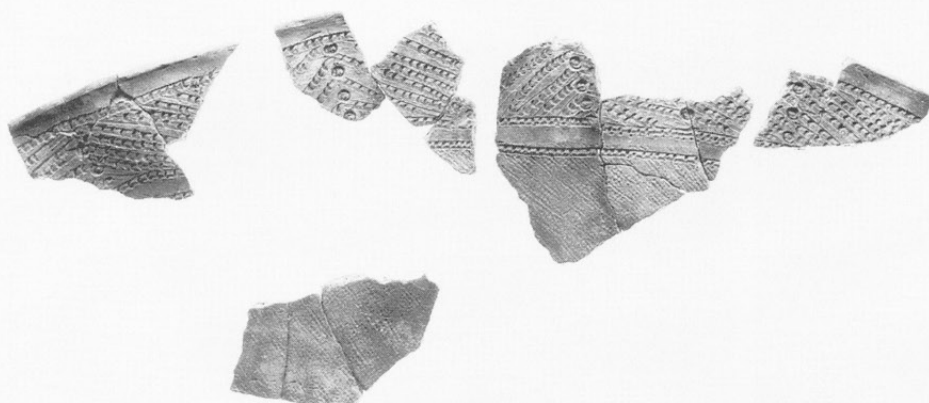

464



454



455



456



457

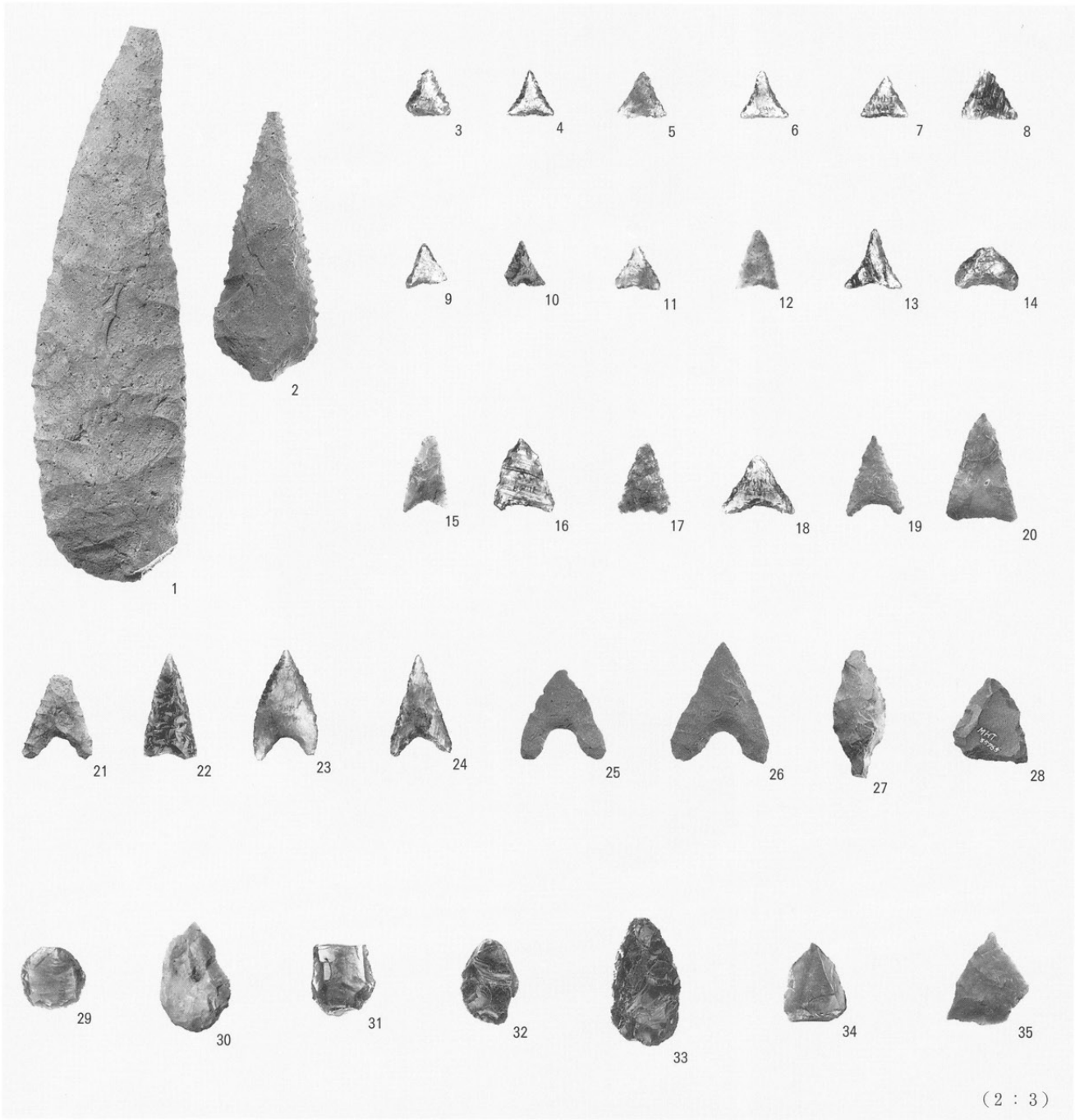

有茎尖頭器・石鏃等

(2 : 3)

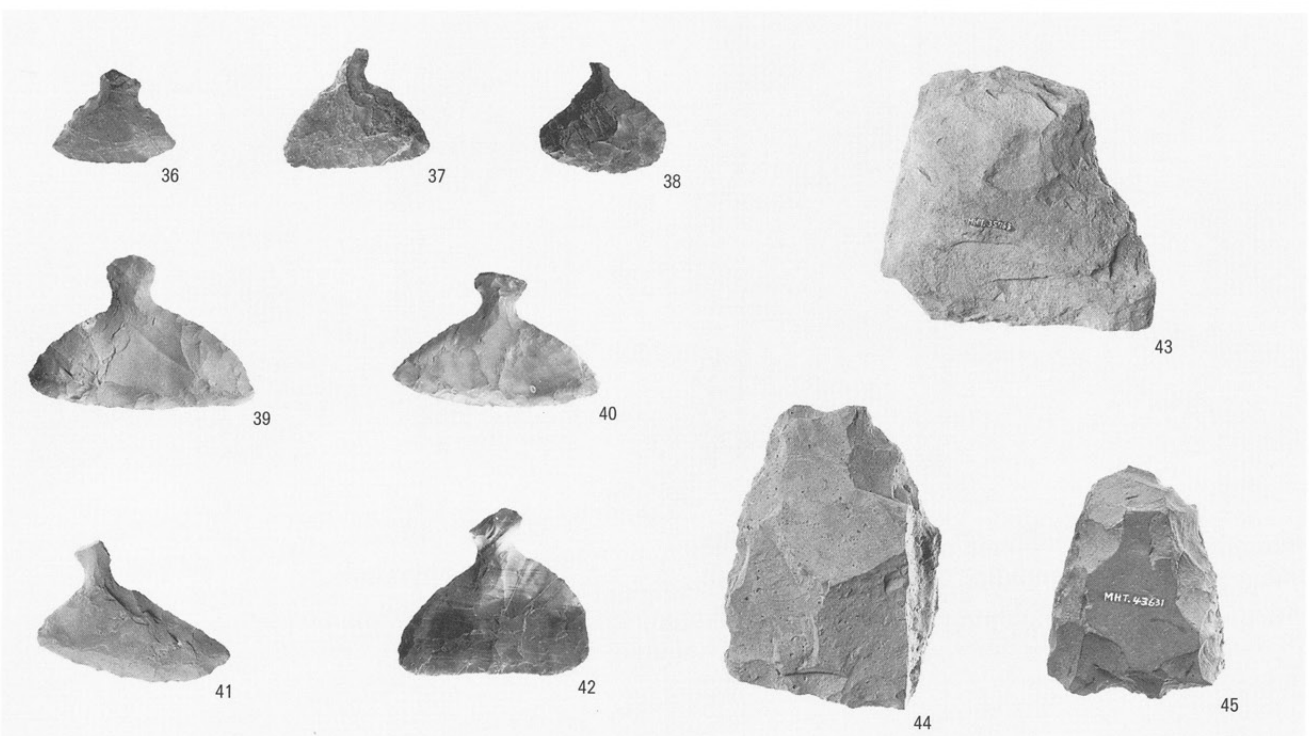

石匙・削器等

(1 : 2)



局部磨製石斧
削器

(1 : 2)

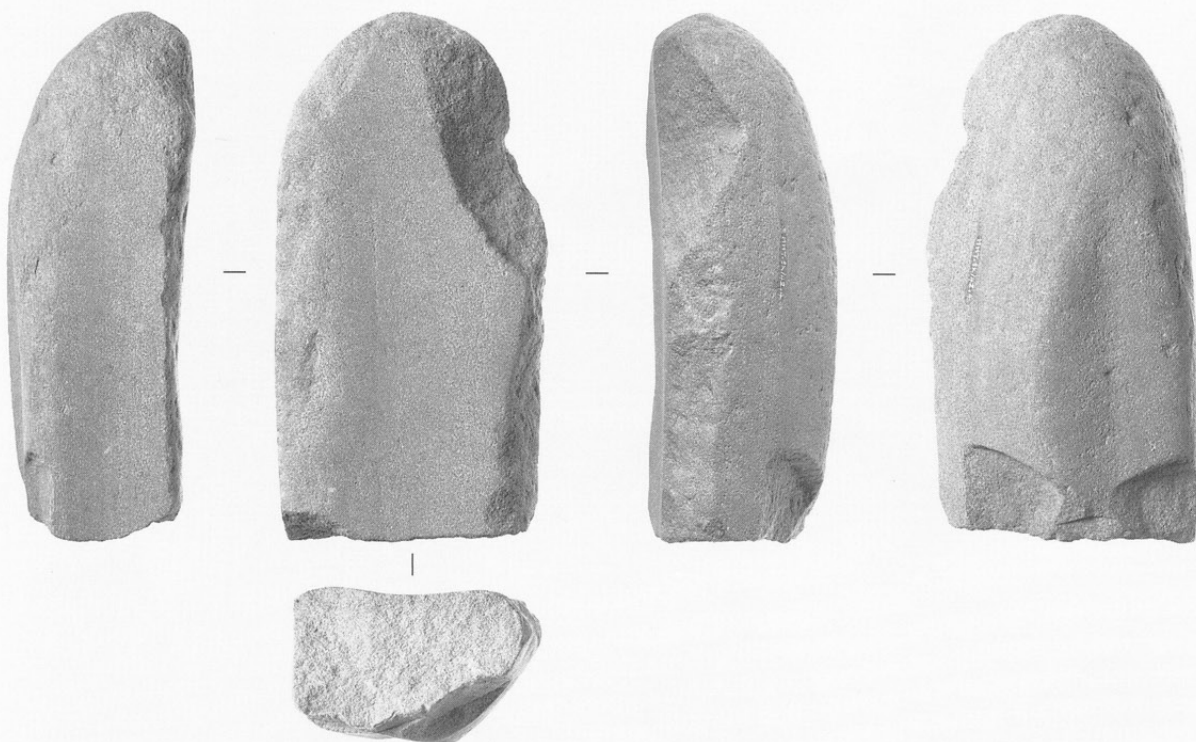

126

土坑内出土
砥石転用スタンプ形
石器

(1 : 3)



114

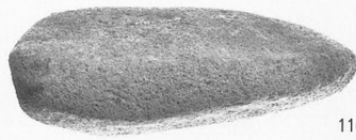

116

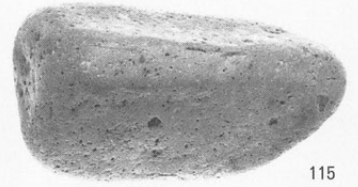

115

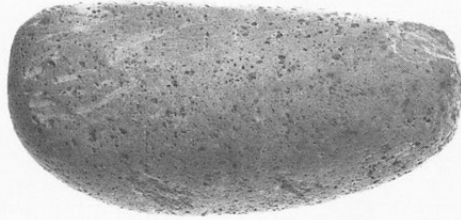

整理番号 42893



104

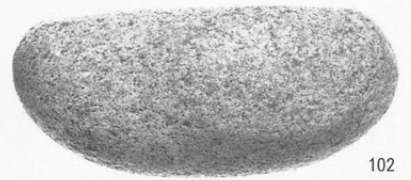

102

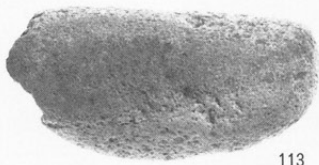

113



109



112

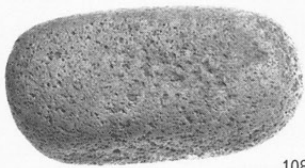

108

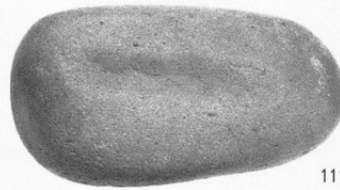

111



110

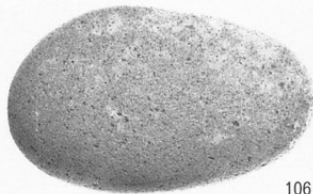

106

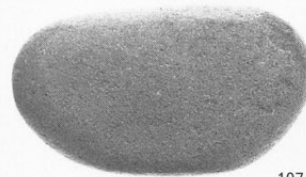

107



100

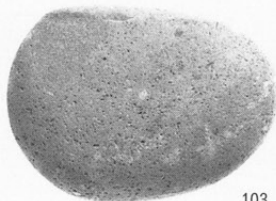

103



105



101

特殊磨石

(1 : 3)



118



117



121



119



120

石錘

(1 : 3)

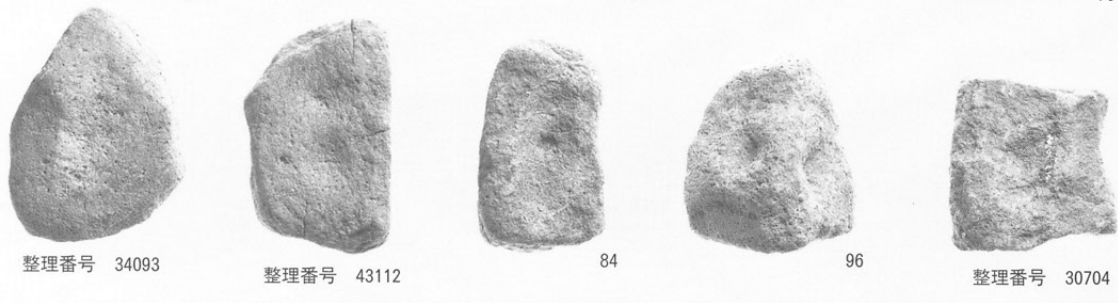
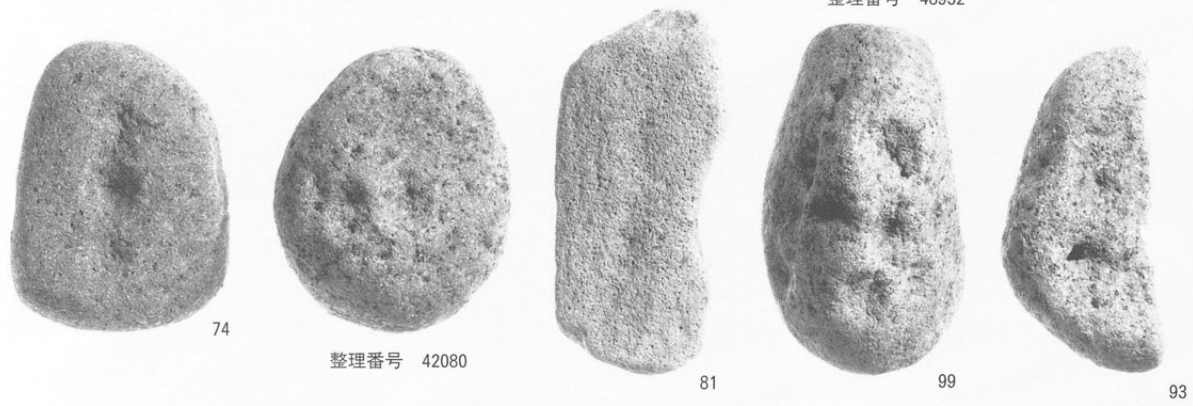

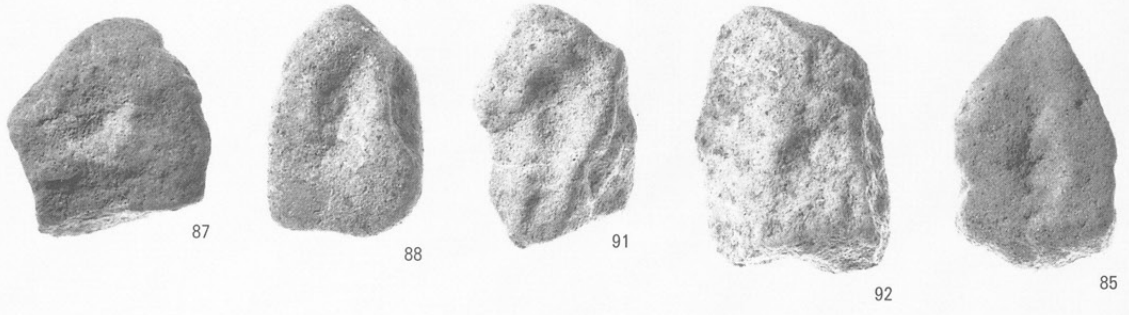

凹石

(1 : 3)

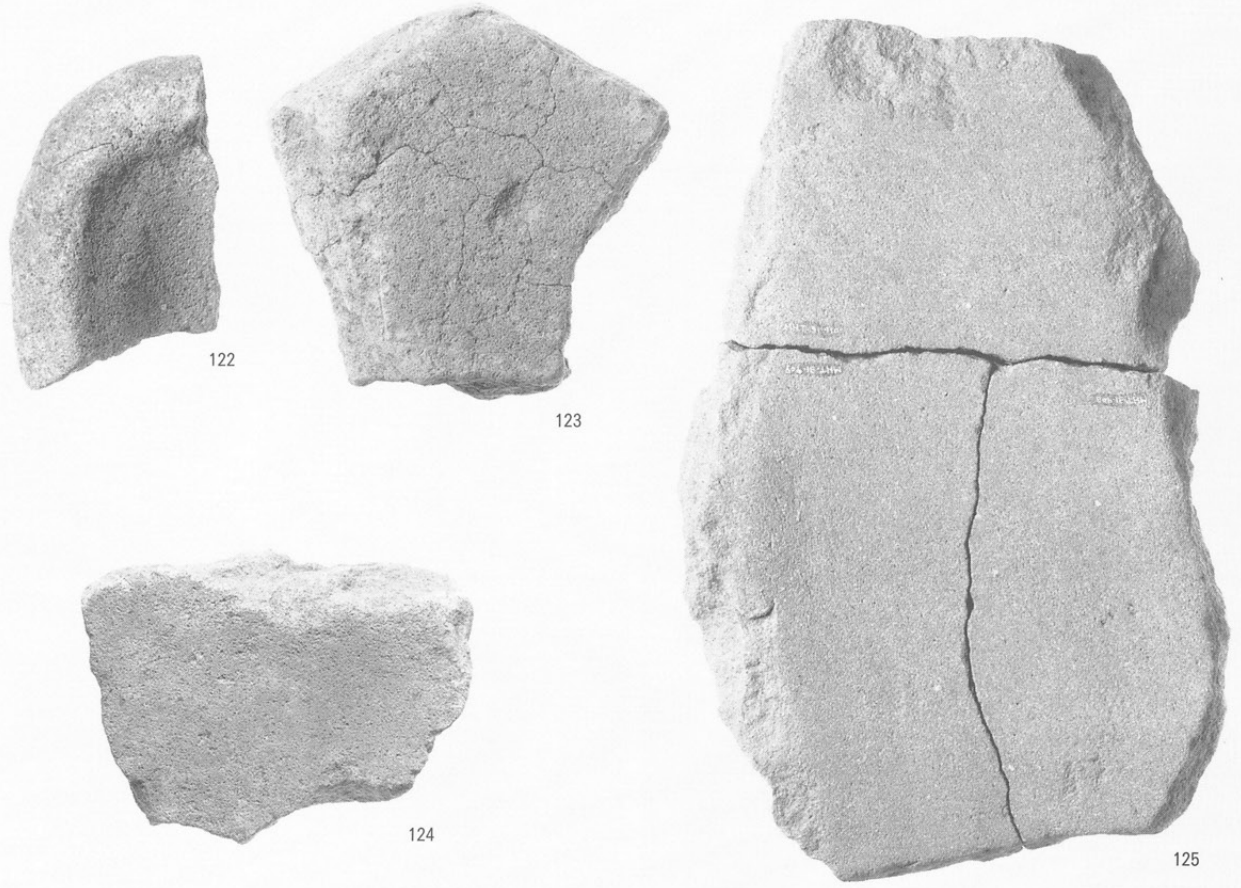

石皿

(1 : 4)

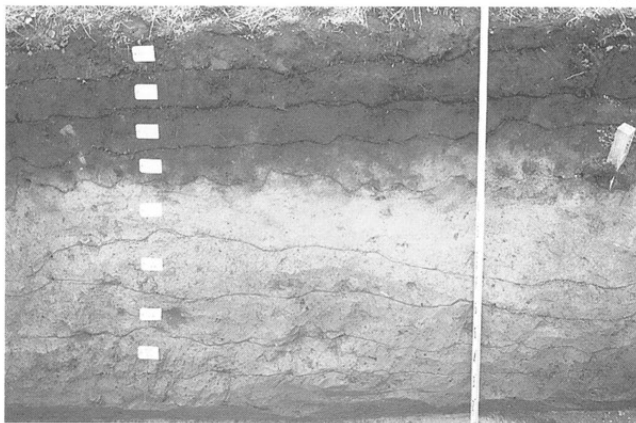
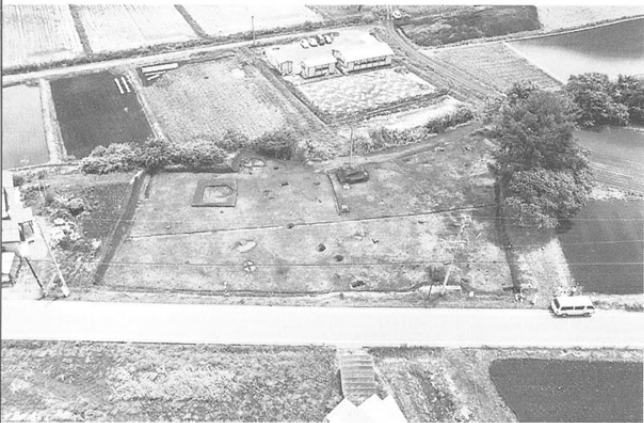

左：全 景
右：基本土層

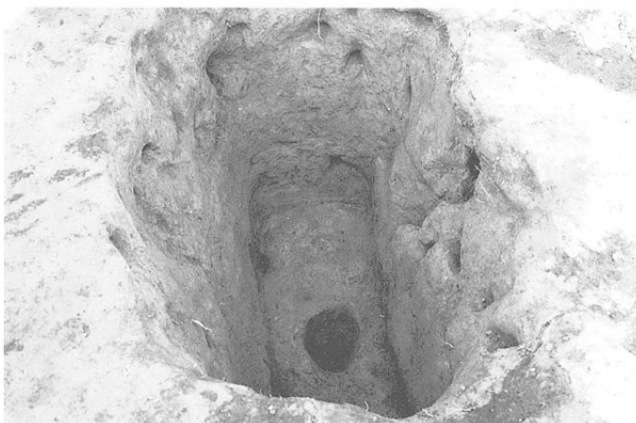

左：SK 19
右：SK 112



左：SK 108
右：SK 22

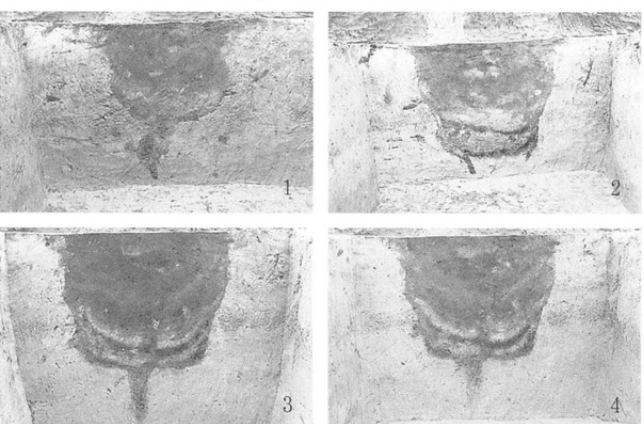

左：SK 117 断面
検出 1～4
右：SK 117 断面
検出 5



左：SK 118 断面
右：SK 115 断面



左: SH 02
右: SH 01

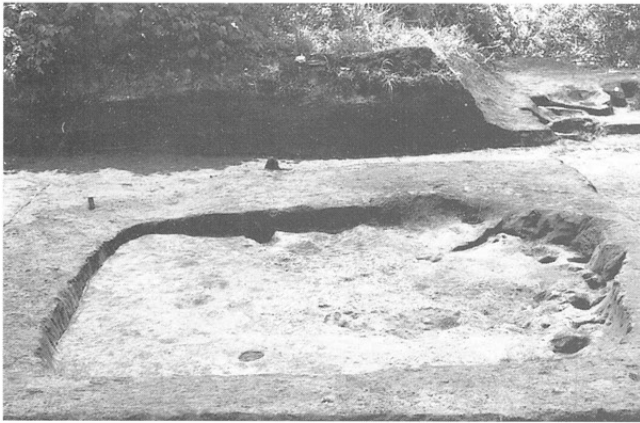

左: SB 01
右: SB 01
床面直上出土
鉄器



左: SB 02
右: SB 02
カマド出土状況



左: SB 03
右: SB 04



左: SB 05
右: SB 06



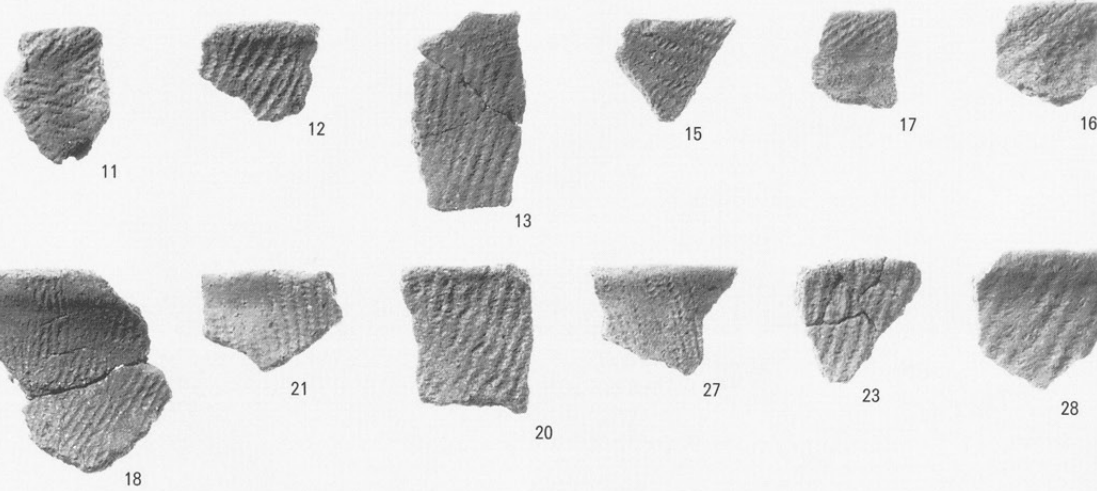
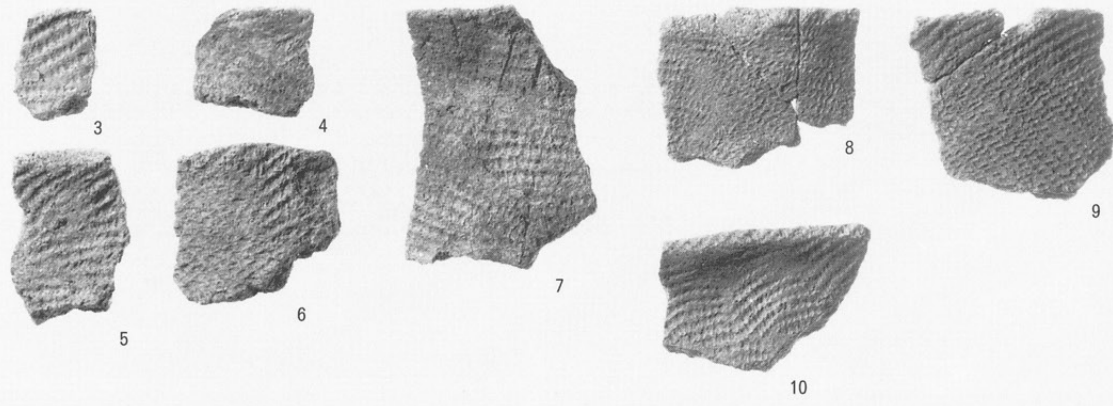

(1 : 2) 表裏縄文
(外 面)

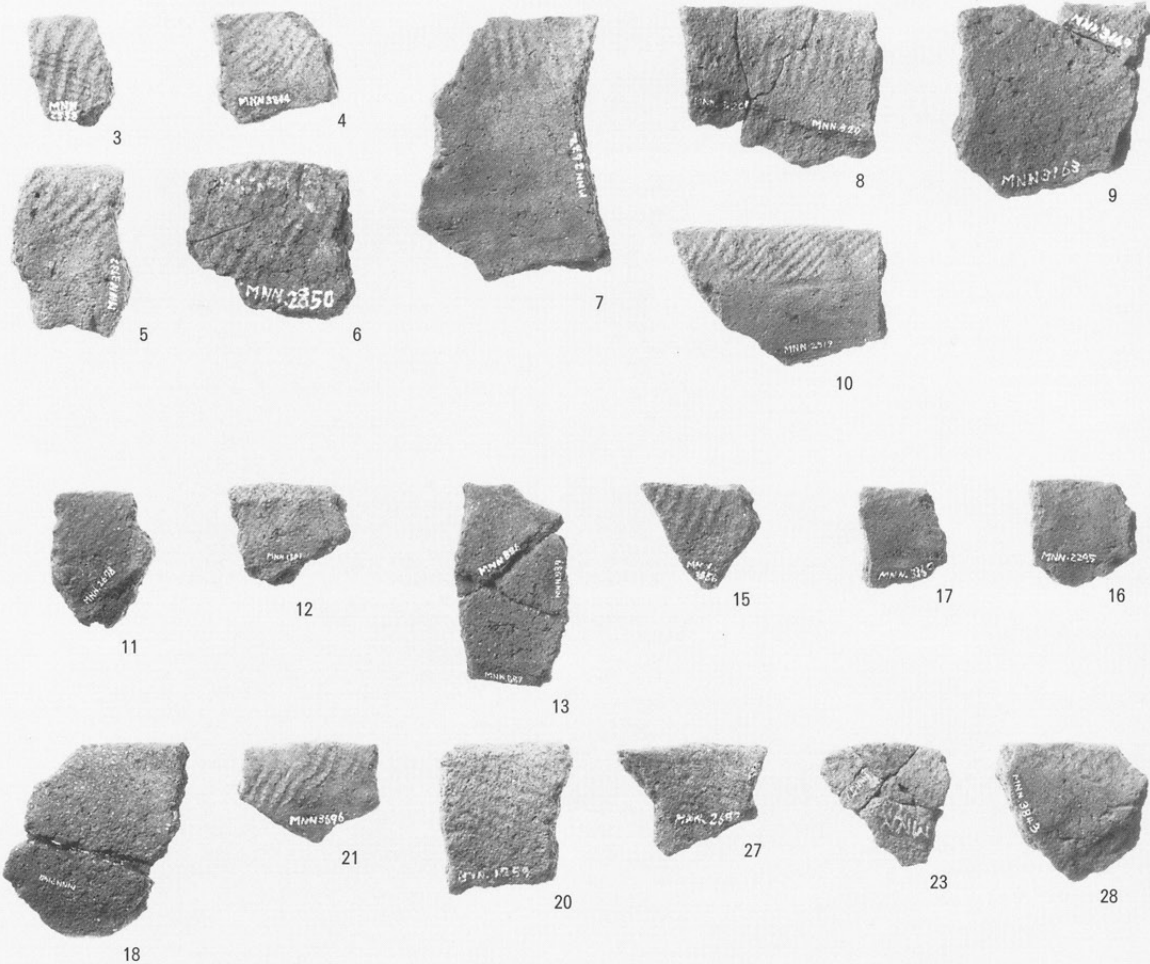

(1 : 2) (内 面)



表裏縄文
(外面)

(1 : 2)

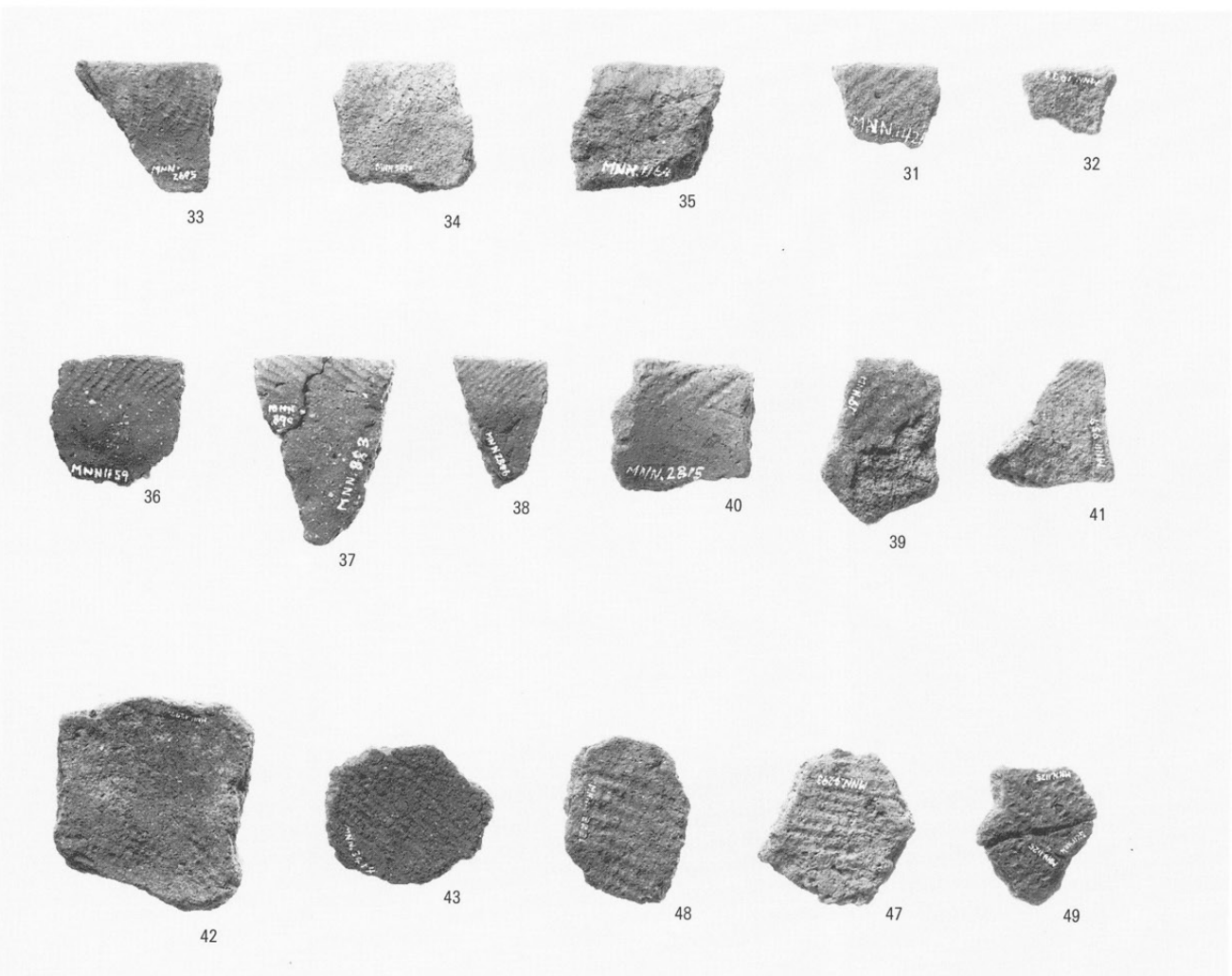

(内面)

(1 : 2)



1



2



76

爪形文(1,2)
縄文結束部(76)



整理番号 3



整理番号 377



整理番号 1132

(1 : 1) 表裏縄文

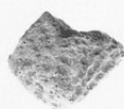

54

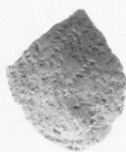

55

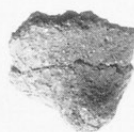

56



60

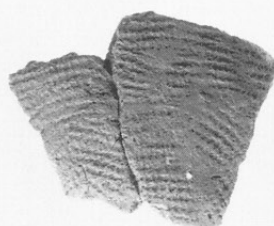

61

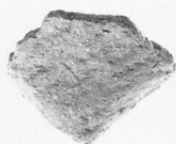

57



58

(1 : 2) 表縄文底部

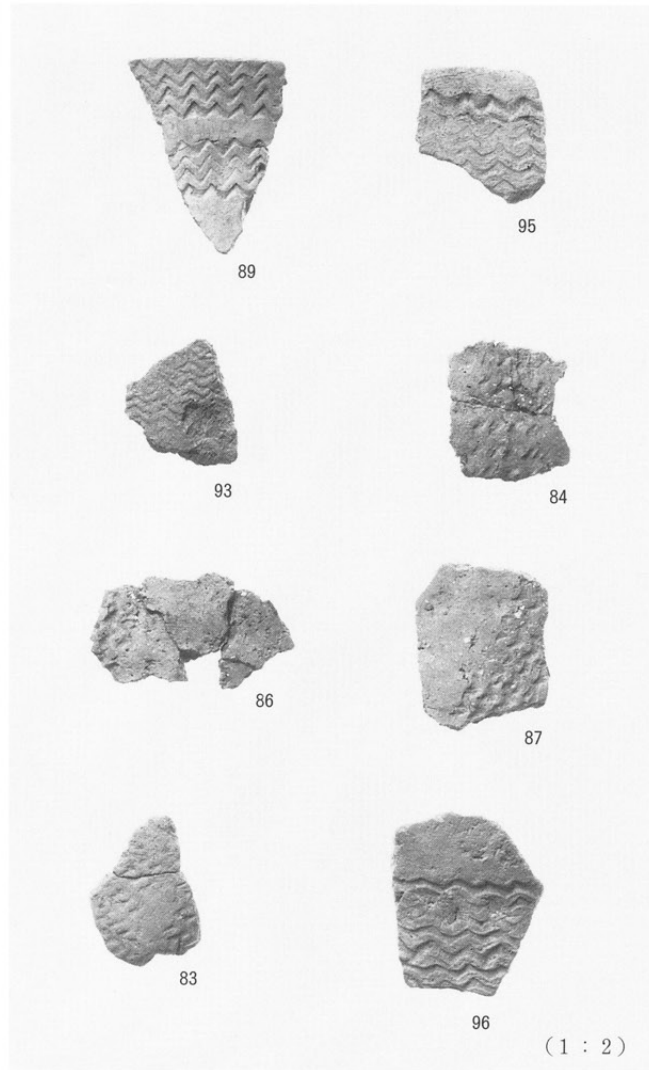
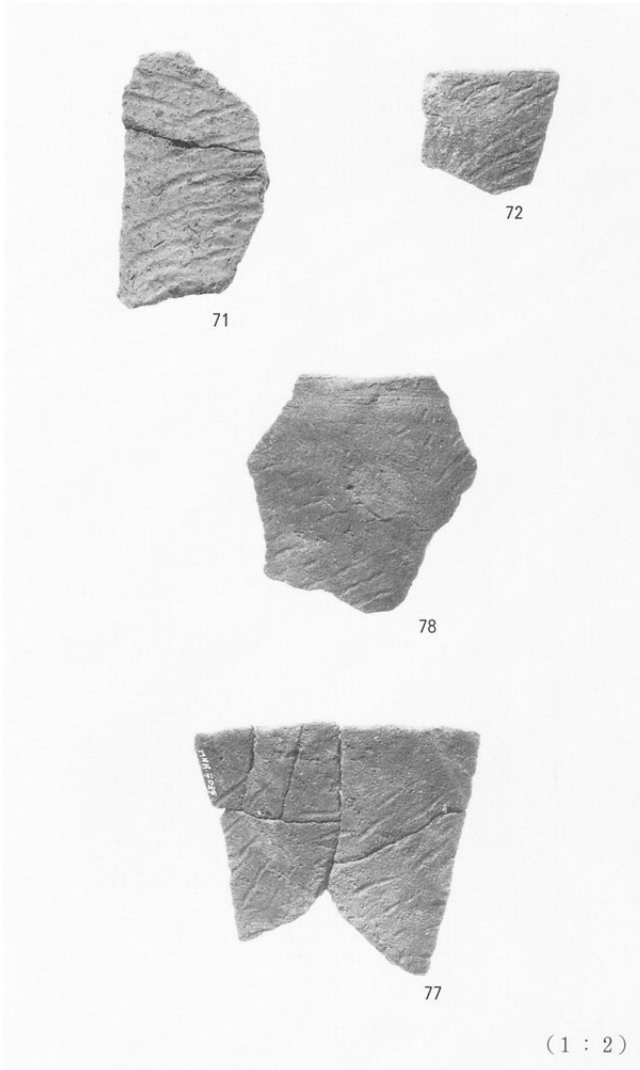

左：表縄文
右：押型文

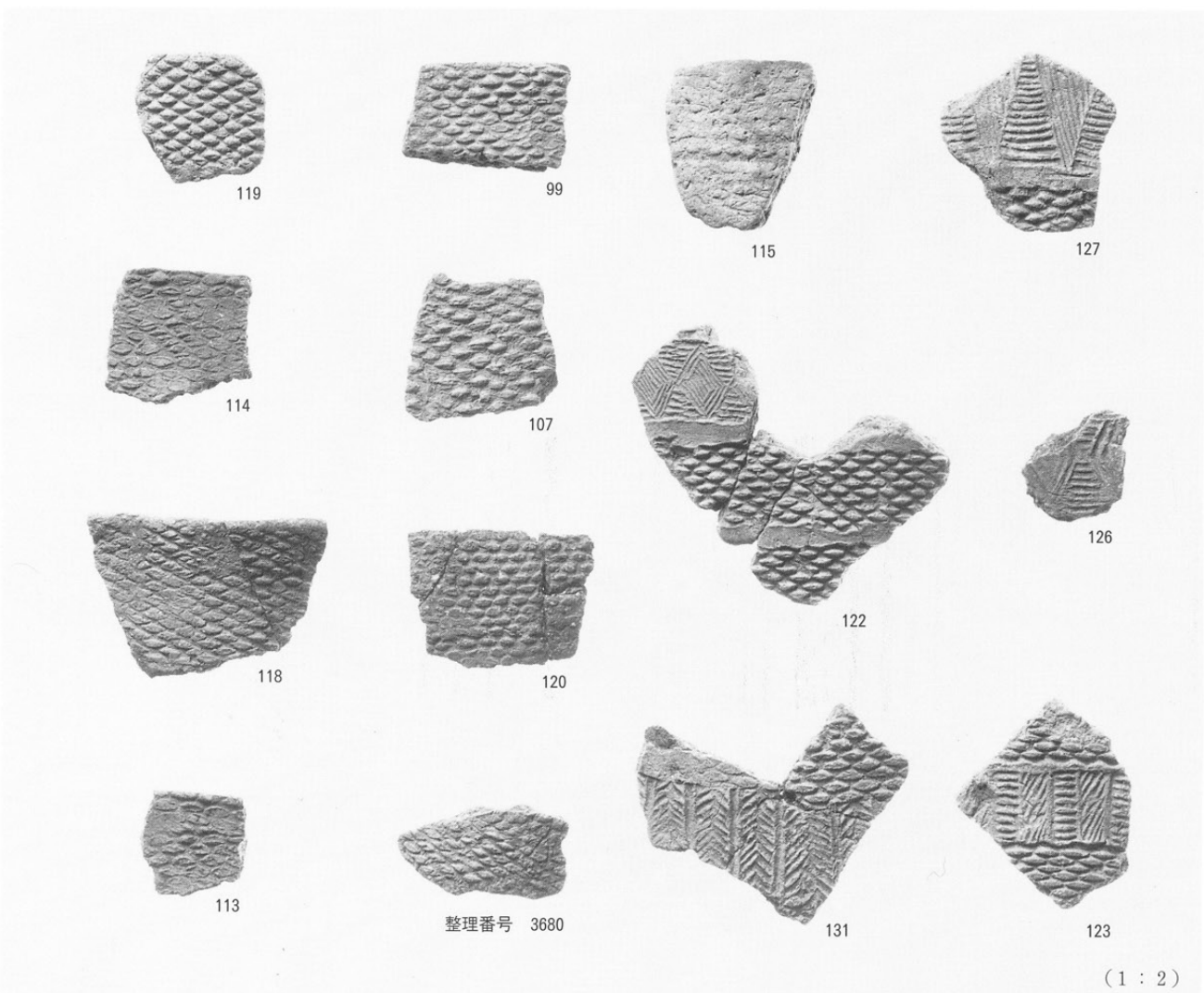

押型文

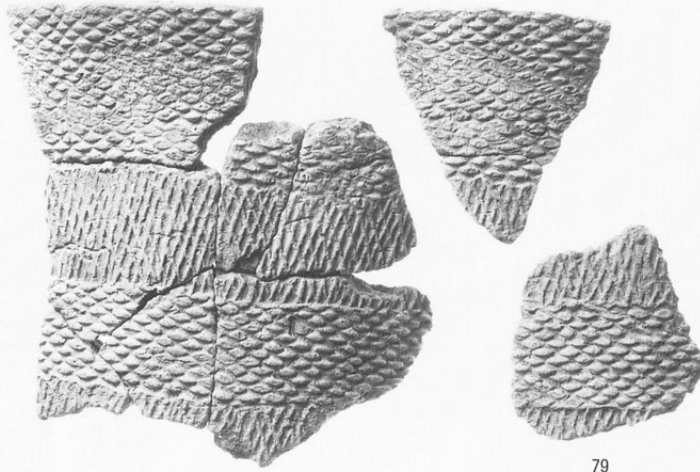

79

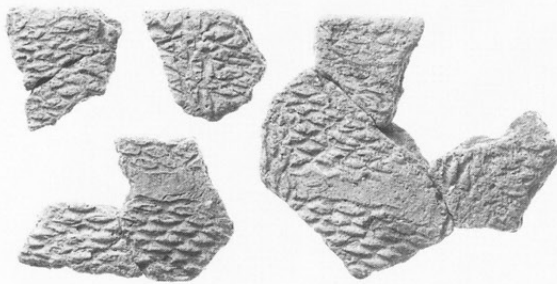

80



128



121



82



129



130



124

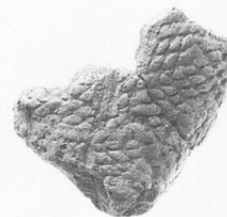

132



81

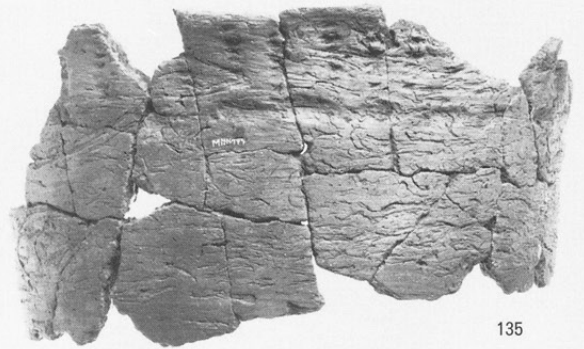

134

135



138

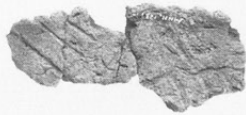

139



140



146



141



144



142



143



147



154



148



158

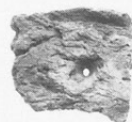

157



151



159



155



149



163



165



175



179

181



258



257



256

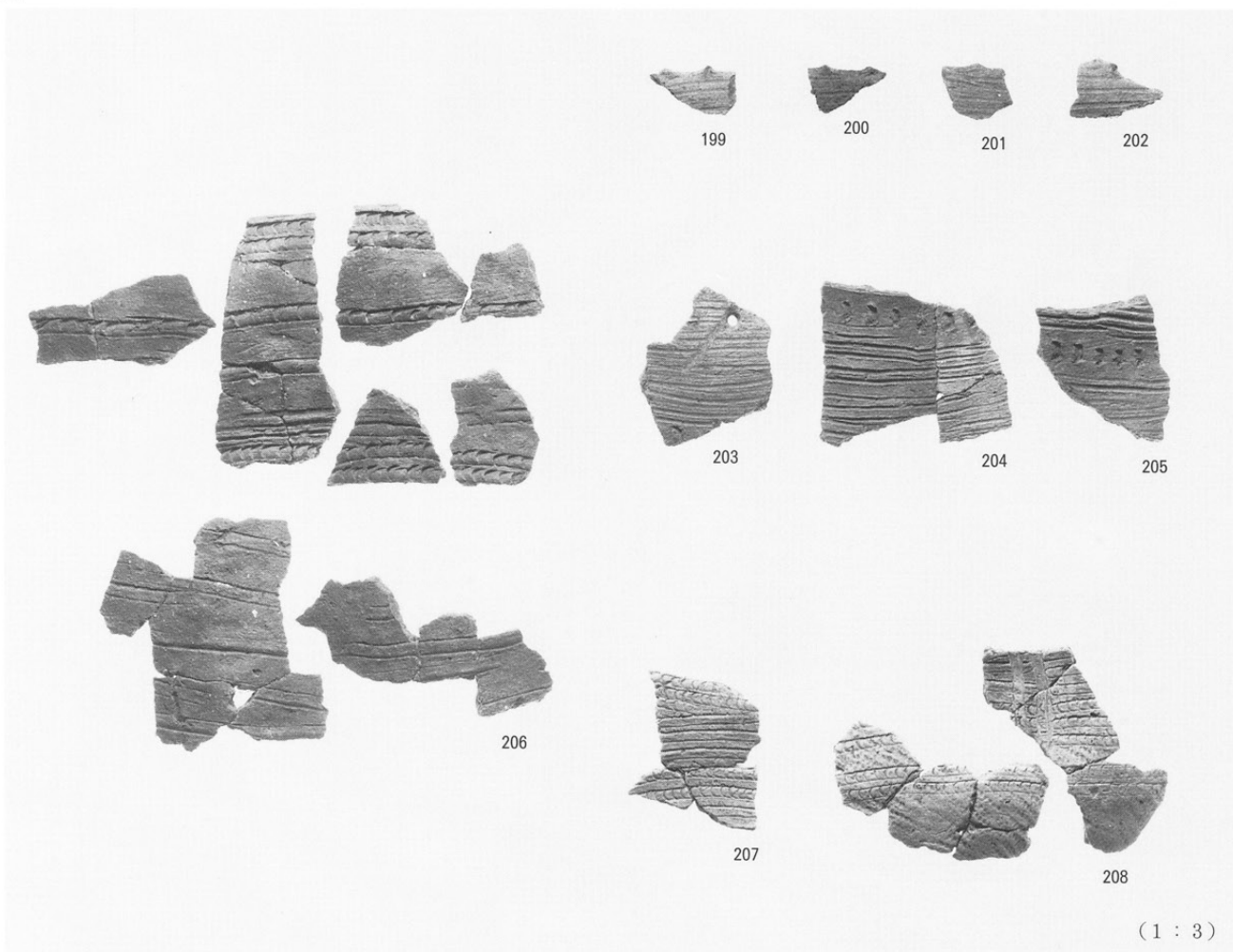

前期土器

(1 : 3)



前期土器

(1 : 4)

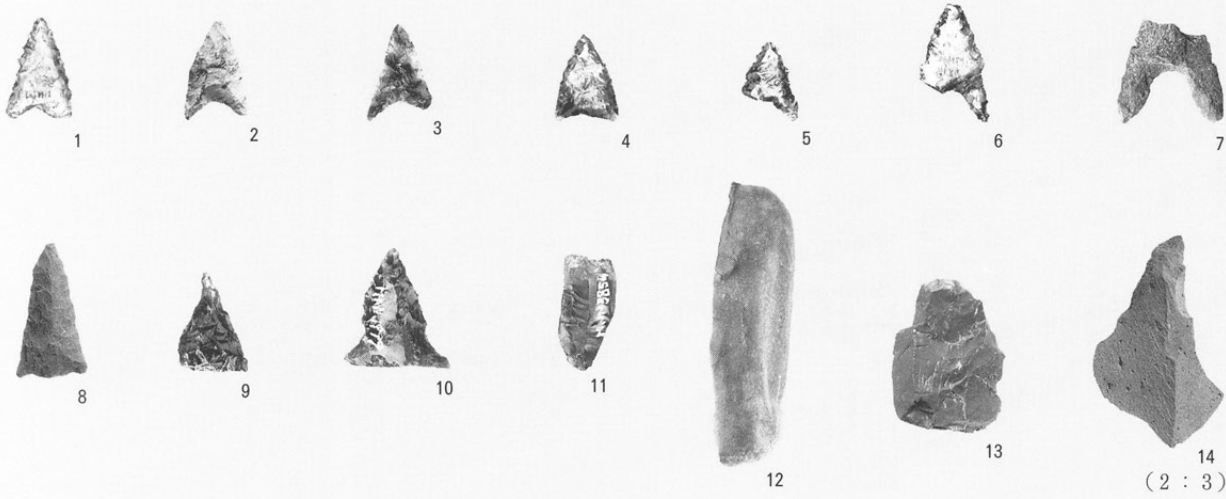

(2 : 3) 石鏃等

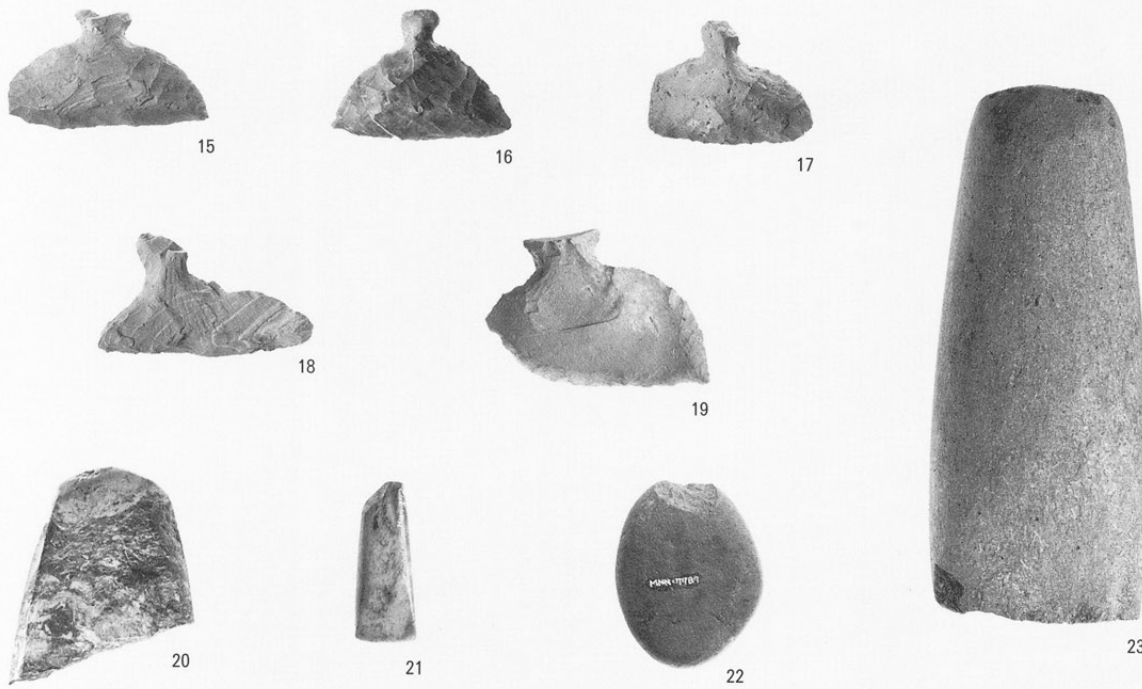

石匙
石錘
磨製石斧
(1 : 2)

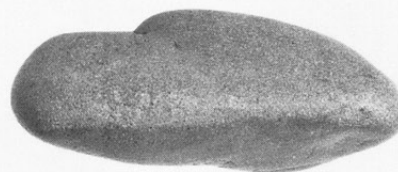
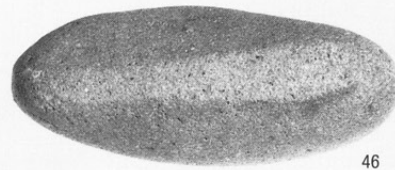

(1 : 3) 特殊磨石

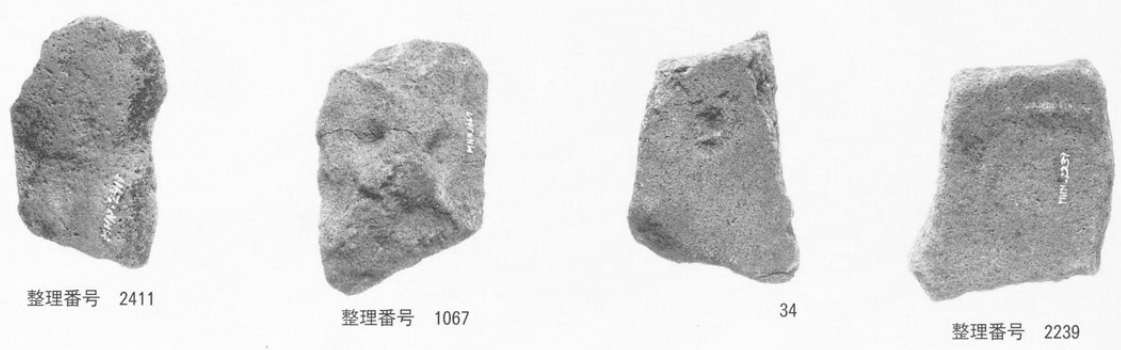
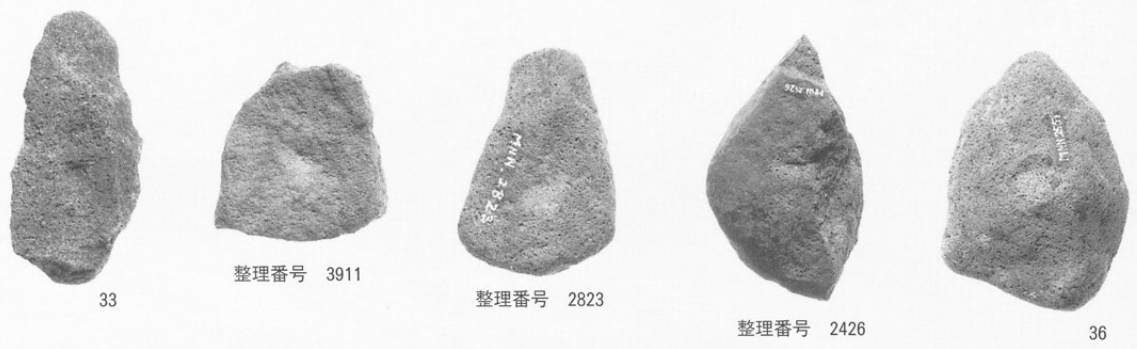
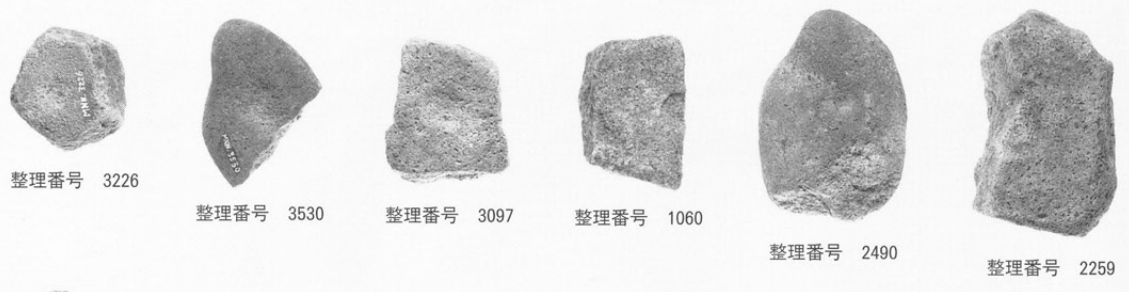



1



2

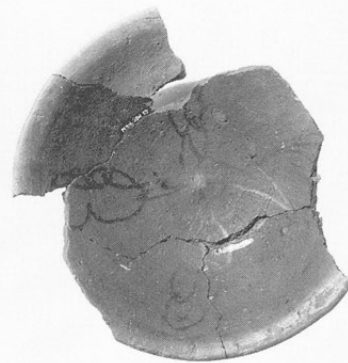

3

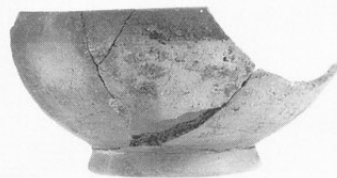

4

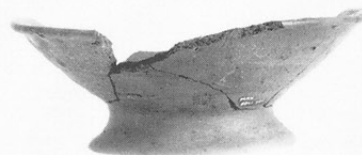

6



7



8



10



14



15

(1 : 2)



16

(1 : 4)

SB 01



21

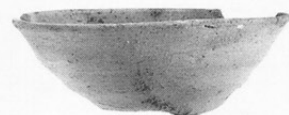

22



23



25



29

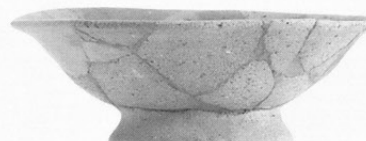

31



32

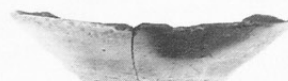

33



34

(1 : 4)

SB 03

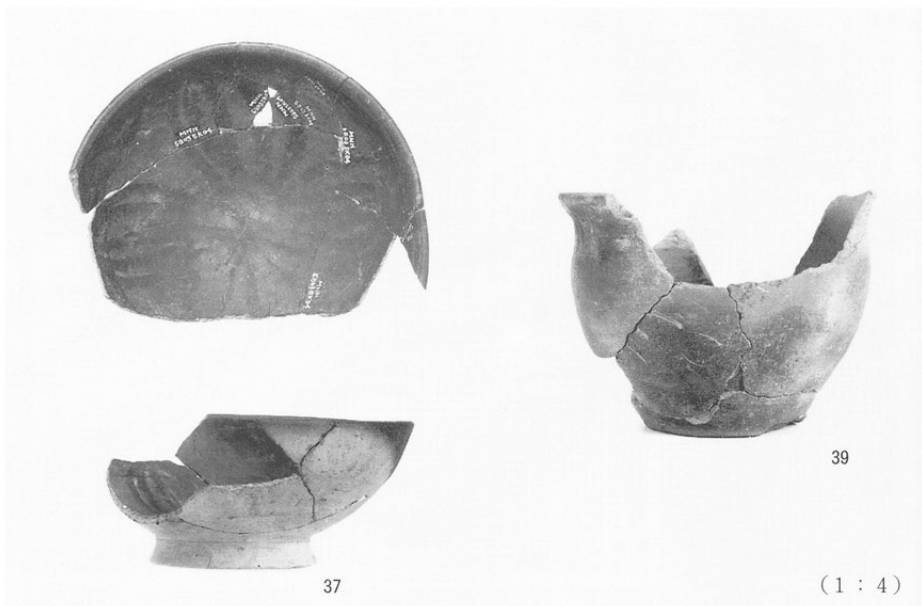

S B 03

37

39

(1 : 4)

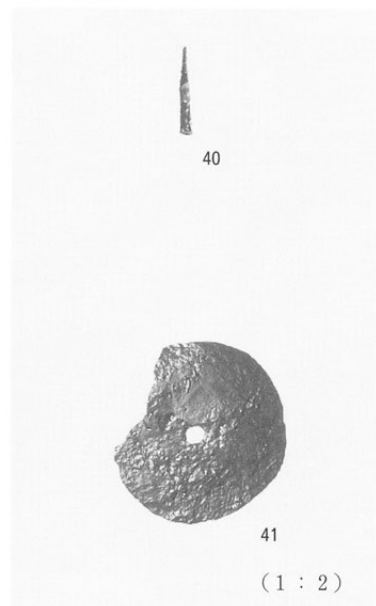

40

41

(1 : 2)



S B 04

42

43

(1 : 4)



S B 05

45

47

(1 : 4)

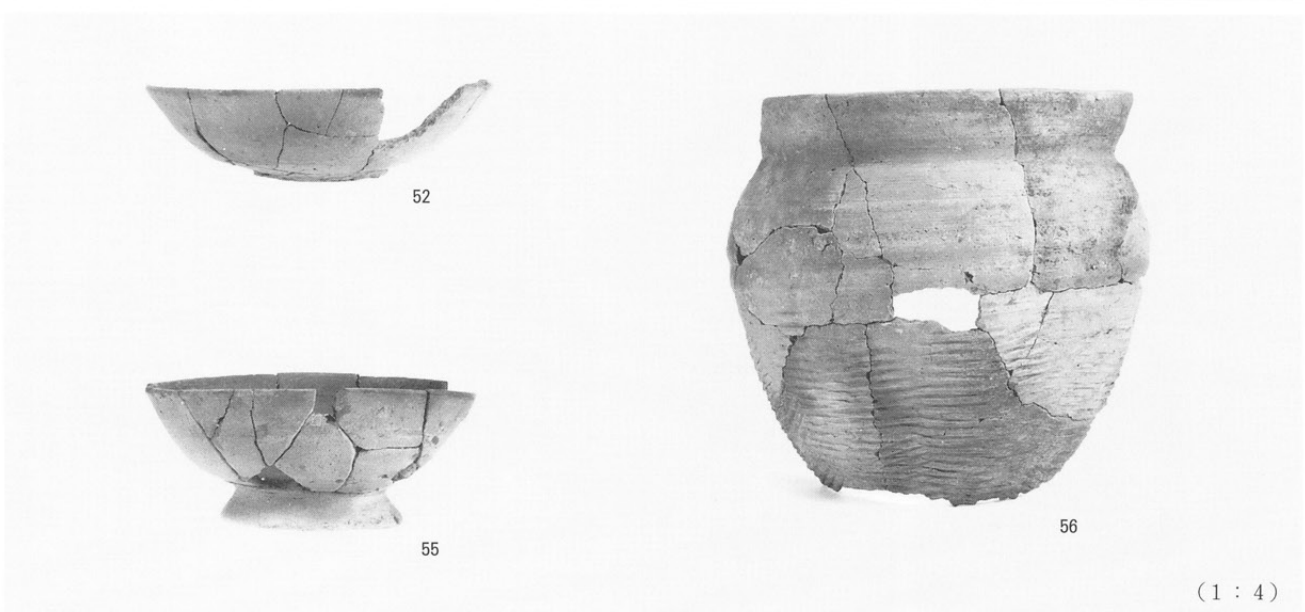

S B 06

52

55

56

(1 : 4)

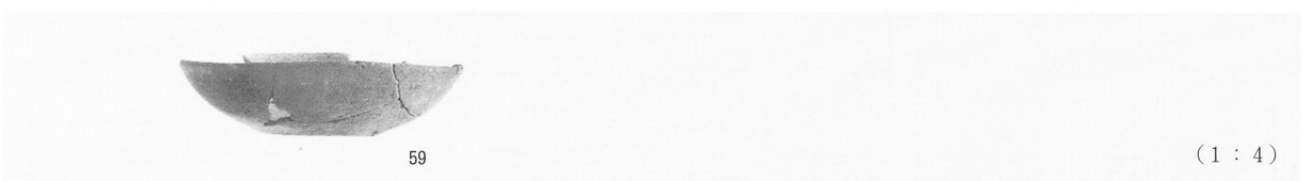

遺構外

59

(1 : 4)



左右：表土はき



左：作業風景
右：基本土層

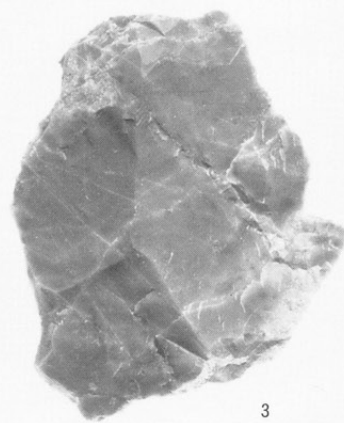

長野県埋蔵文化財センター発掘調査報告書 49

上信越自動車道埋蔵文化財発掘調査報告書 16

—信濃町内 その2—

星光山荘A・星光山荘B・西岡A・貫ノ木・上ノ原・大久保南・東裏・
裏ノ山・針ノ木・大平B・日向林A・日向林B・七ツ栗・普光田遺跡
縄文時代～近世 図版編

発行 平成12年3月31日発行

発行者 日本道路公団

長野県教育委員会

(財)長野県文化振興事業団

長野県埋蔵文化財センター

〒387-0007 長野県更埴市屋代字清水260-6

TEL 026-274-3891 FAX 026-274-3892

印刷 明和印刷株式会社

〒380-0943 長野県長野市安茂里2161-2

TEL 026-226-5311 FAX 026-228-0799

