

# 第VI部 出土遺物図版

1. 土製品：EPL001～EPL177
2. 石製品：SPL001～SPL096
3. 木製品：WPL001～WPL086
4. 骨角製品：BPL001～BPL009
5. 金属製品：MPL001～MPL002
6. ガラス製品：XAPL1

# 第VI部

## 1. 土製品

98Ca 区 検出 I

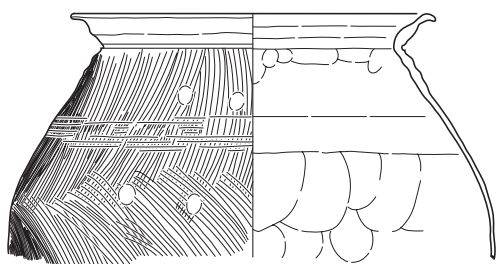

E-98Ca-001

99Aa 区 SB02

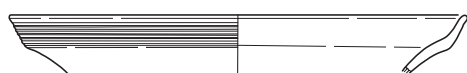

E-99Aa-001

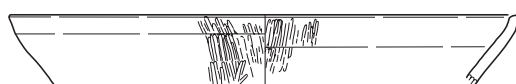

E-99Aa-004

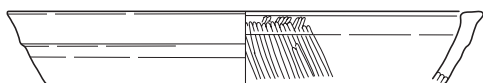

E-99Aa-002

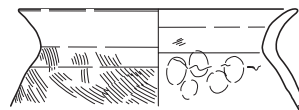

E-99Aa-005



E-99Aa-003

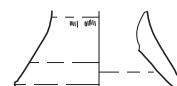

E-99Aa-006

99Aa 区 SB12

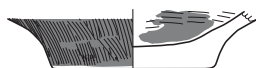

E-99Aa-007

99Aa 区 SB13

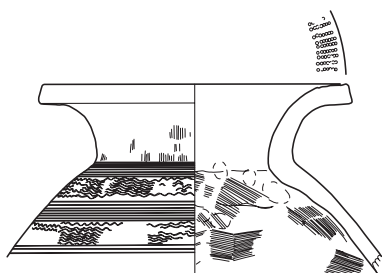

E-99Aa-008

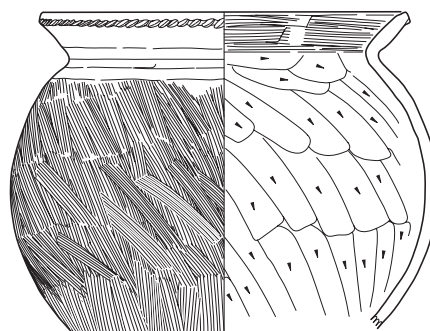

E-99Aa-009

99Aa 区 SB26

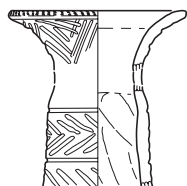

E-99Aa-010

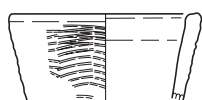

E-99Aa-011



E-99Aa-012

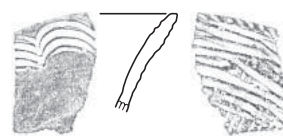

E-99Aa-013



99Aa ☒ SB26

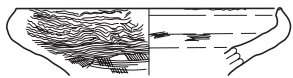

E-99Aa-014

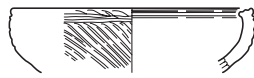

E-99Aa-016

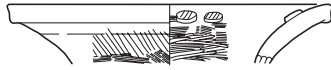
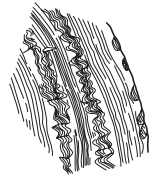

E-99Aa-015

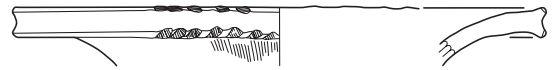

E-99Aa-017

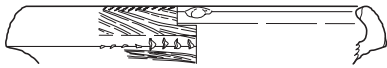

E-99Aa-018



E-99Aa-021

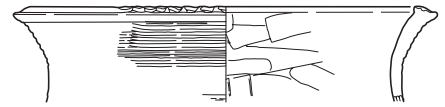

E-99Aa-023



E-99Aa-019

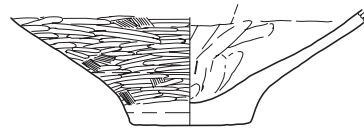

E-99Aa-020



E-99Aa-022

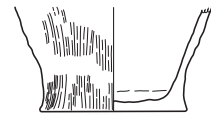

E-99Aa-024

99Aa ☒ SK16

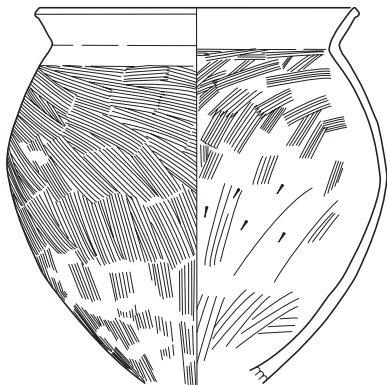

E-99Aa-025

99Aa ☒ SK90

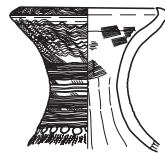

E-99Aa-026

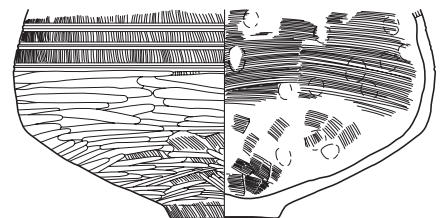

E-99Aa-028

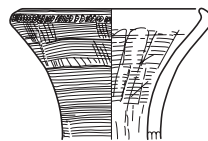

E-99Aa-027

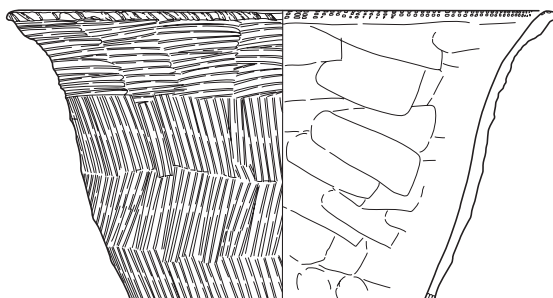

E-99Aa-029

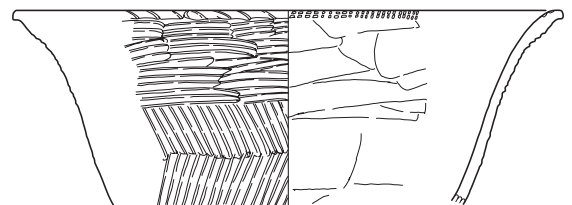

E-99Aa-030

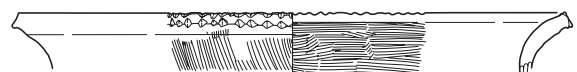

E-99Aa-031



99Aa ☒ SK96

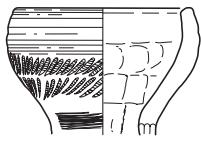

E-99Aa-032

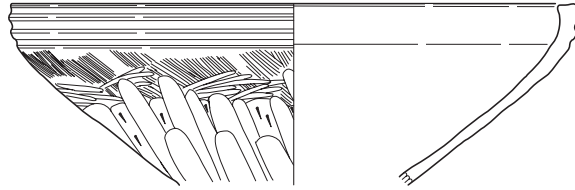

E-99Aa-036

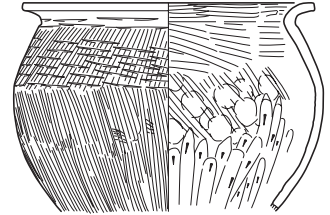

E-99Aa-037

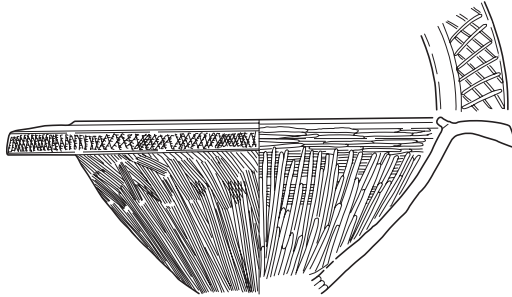

E-99Aa-033

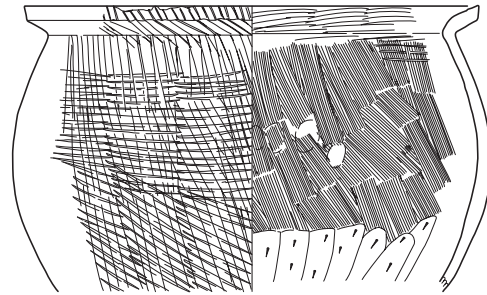

E-99Aa-038

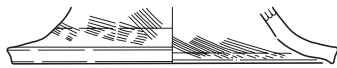

E-99Aa-034

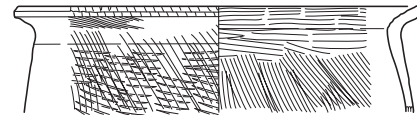

E-99Aa-039

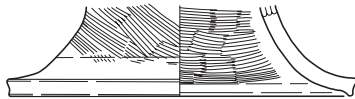

E-99Aa-035

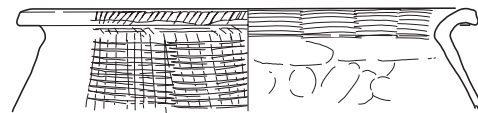

E-99Aa-040

99Aa ☒ SK99

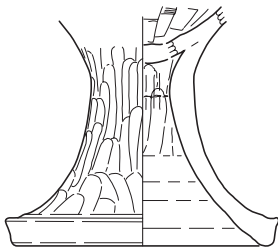

E-99Aa-041

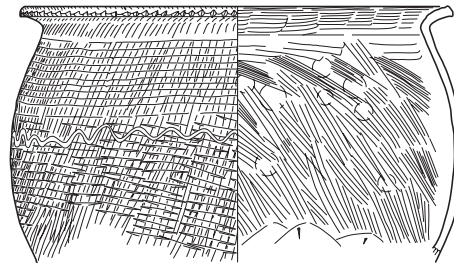

E-99Aa-042

99Aa ☒ SK154

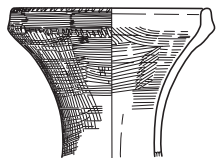

E-99Aa-043

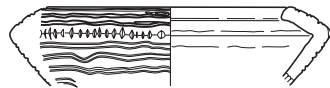

E-99Aa-044



E-99Aa-045

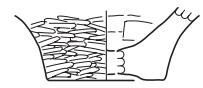

E-99Aa-046

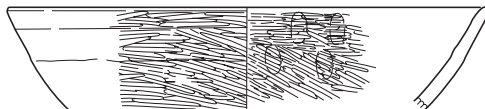

E-99Aa-047



E-99Aa-049



E-99Aa-050



E-99Aa-051

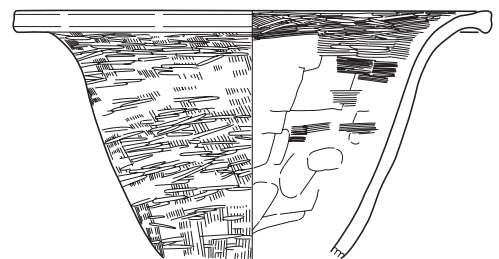

E-99Aa-048



99Aa ☒ SU01

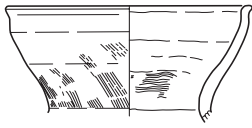

E-99Aa-052

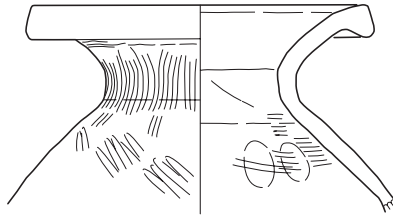

E-99Aa-053

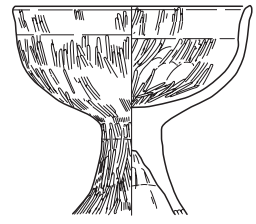

E-99Aa-055

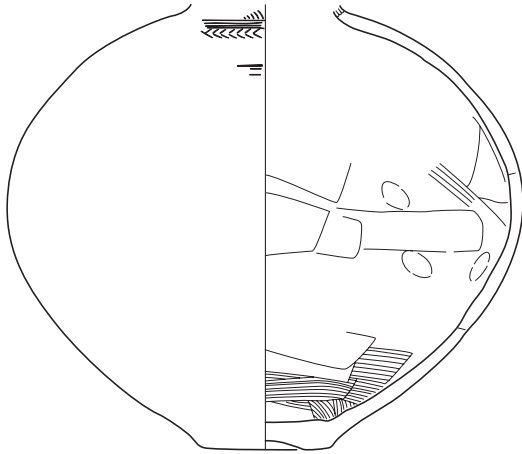

E-99Aa-054

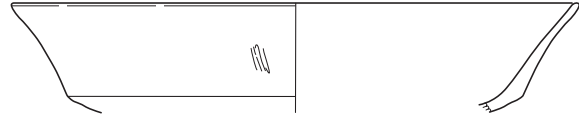

E-99Aa-056

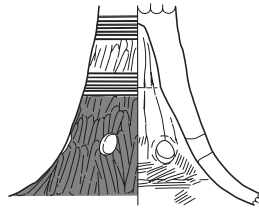

E-99Aa-057

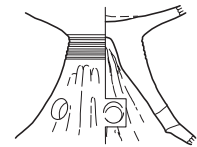

E-99Aa-058

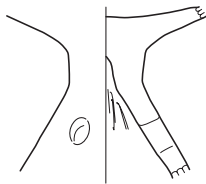

E-99Aa-059

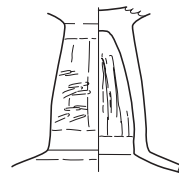

E-99Aa-060

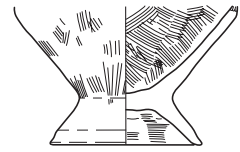

E-99Aa-061

99Aa ☒ SU02

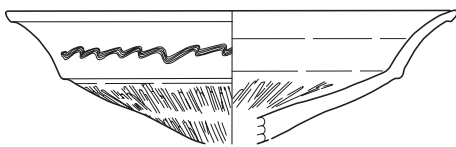

E-99Aa-062

99Aa ☒ SU03

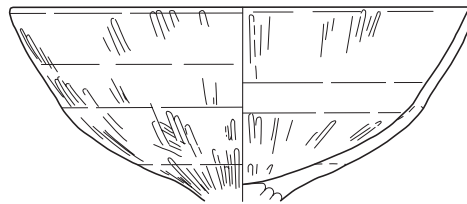

E-99Aa-063

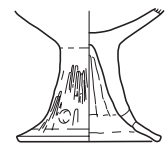

E-99Aa-064

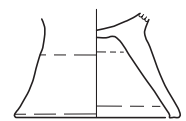

E-99Aa-065

99Ab ☒ SB01

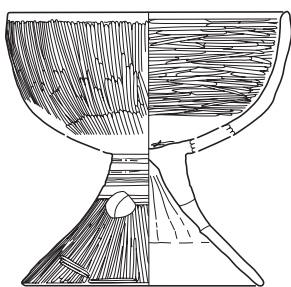

E-99Ab-001

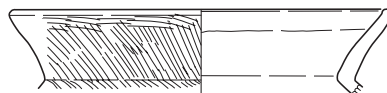

E-99Ab-002

99Ab ☒ SB02



E-99Ab-003



E-99Ab-004



99Ab ☒ SB04

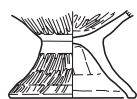

E-99Ab-005



E-99Ab-006

99Ab ☒ SB05

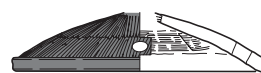

E-99Ab-007

99Ab ☒ SB06

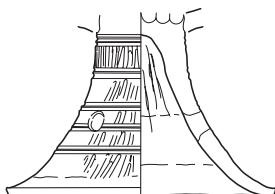

E-99Ab-008

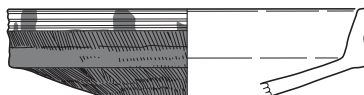

E-99Ab-009



E-99Ab-010

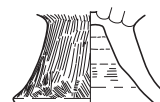

E-99Ab-011

99Ab ☒ SB07

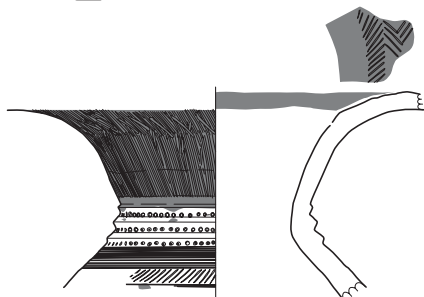

E-99Ab-012

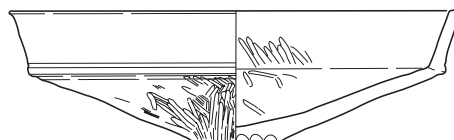

E-99Ab-017

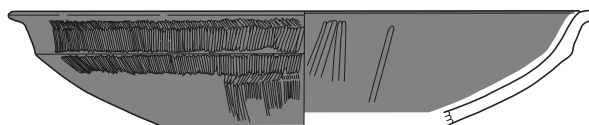

E-99Ab-018



E-99Ab-013



E-99Ab-019



E-99Ab-021

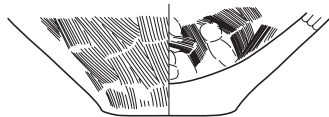

E-99Ab-014



E-99Ab-015

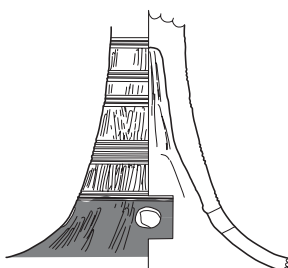

E-99Ab-020

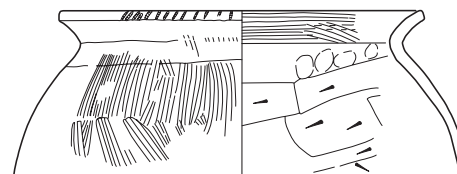

E-99Ab-022

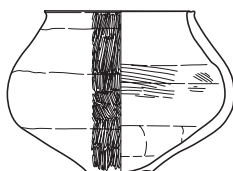

E-99Ab-016

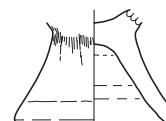

E-99Ab-023



99Ab 区 SB08



E-99Ab-024

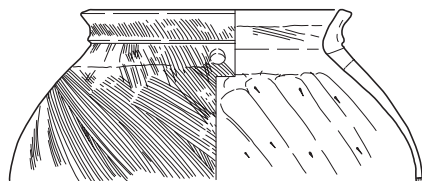

E-99Ab-025

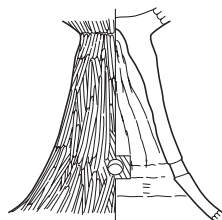

E-99Ab-026



E-99Ab-027

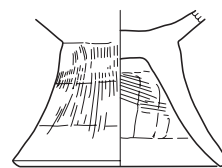

E-99Ab-028



E-99Ab-029

99Ab 区 SB09

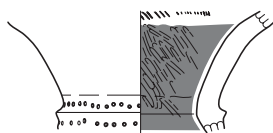

E-99Ab-030

99Ab 区 SB10

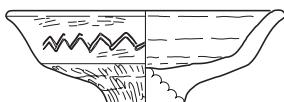

E-99Ab-031



E-99Ab-032

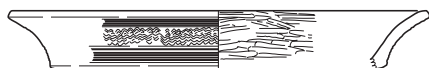

E-99Ab-033

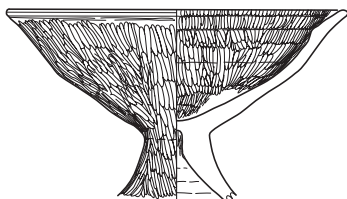

E-99Ab-034

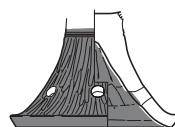

E-99Ab-035

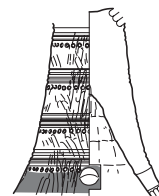

E-99Ab-037

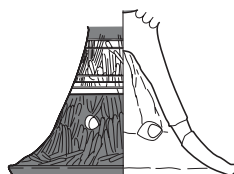

E-99Ab-036

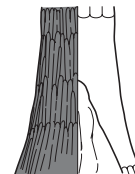

E-99Ab-038



E-99Ab-039

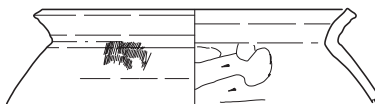

E-99Ab-040

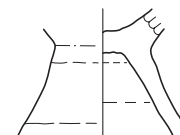

E-99Ab-041

99Ab 区 SB12

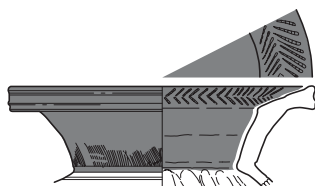

E-99Ab-042

99Ab 区 SB14

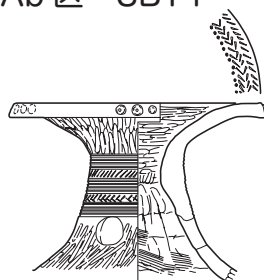

E-99Ab-043





99Ab ☒ SB16

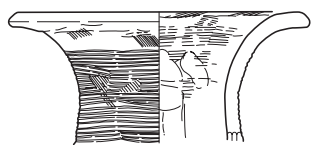

E-99Ab-044

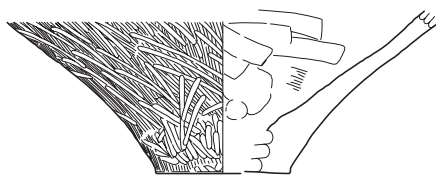

E-99Ab-047

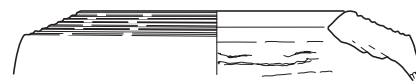

E-99Ab-048

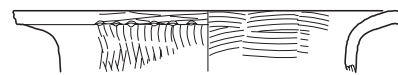

E-99Ab-049



E-99Ab-045



E-99Ab-046



E-99Ab-050

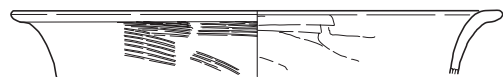

E-99Ab-051

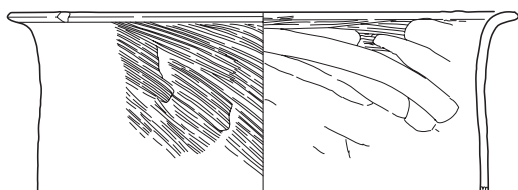

E-99Ab-052

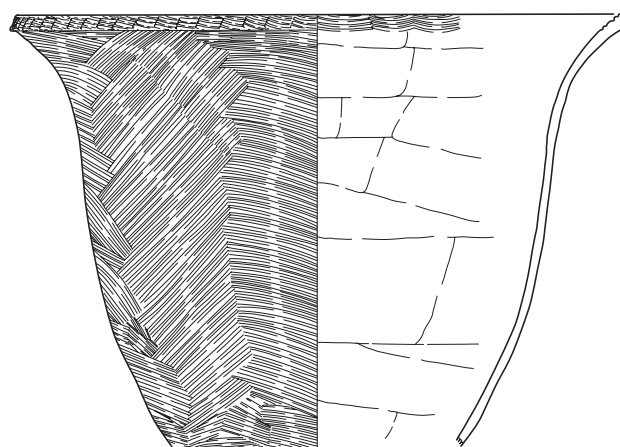

E-99Ab-053

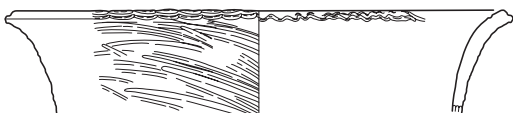

E-99Ab-054

99Ab ☒ SB18

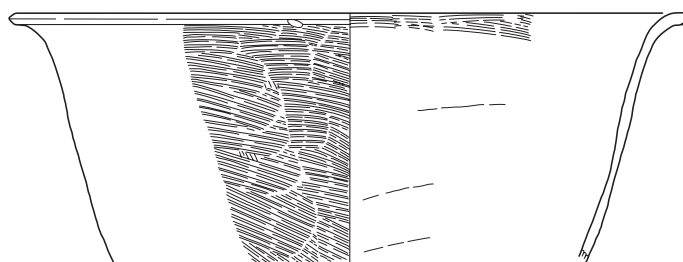

E-99Ab-056



E-99Ab-055

99Ab ☒ SK01

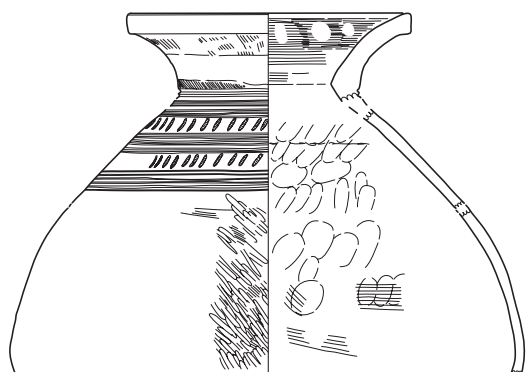

E-99Ab-057

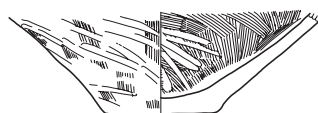

E-99Ab-058



E-99Ab-060

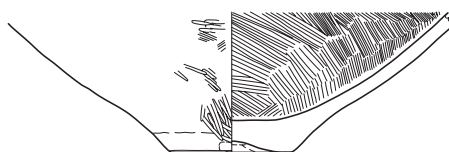

E-99Ab-059



99Ab 区 SK01

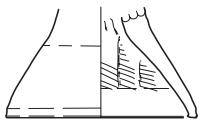

E-99Ab-061



E-99Ab-062

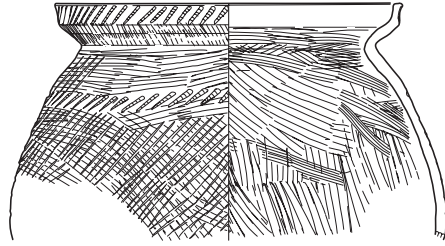

E-99Ab-063

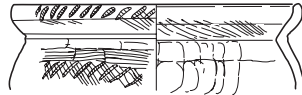

E-99Ab-064

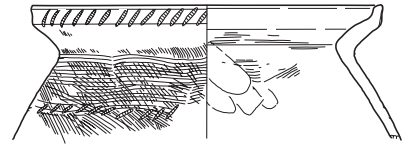

E-99Ab-065

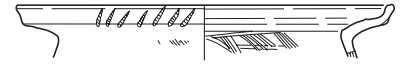

E-99Ab-066



E-99Ab-067

99Ab 区 SK02

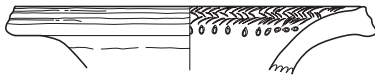

E-99Ab-068

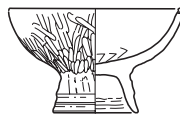

E-99Ab-069

99Ab 区 SK03

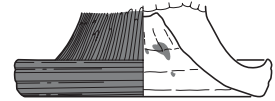

E-99Ab-070

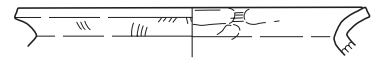

E-99Ab-071

99Ab 区 SK50

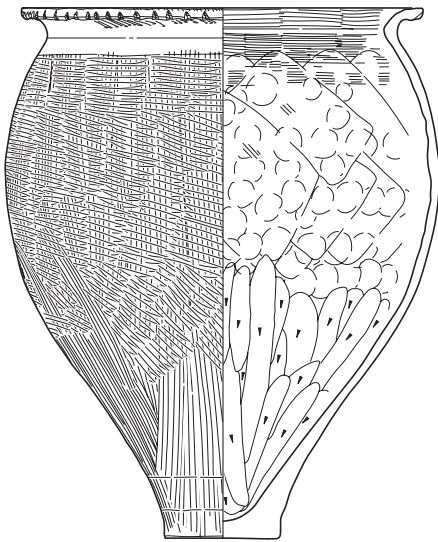

E-99Ab-072

99Ab 区 SK120

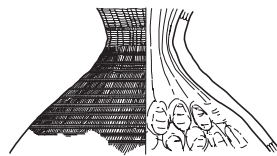

E-99Ab-073



E-99Ab-074

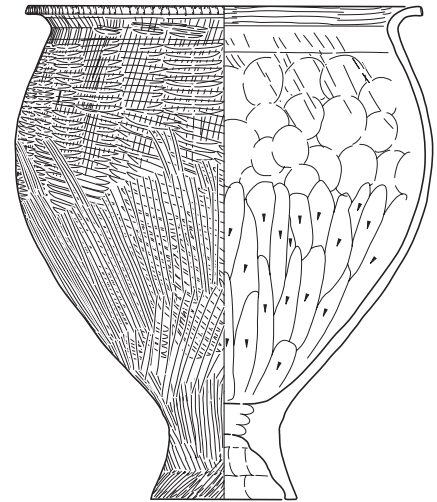

E-99Ab-075

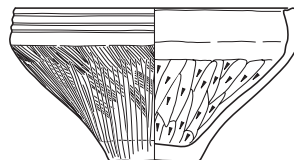

E-99Ab-076



E-99Ab-077



E-99Ab-078

99Ab 区 検 II

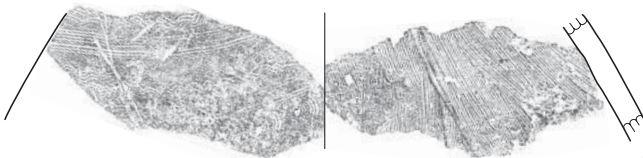

E-99Ab-079



99Ac ☒ SB02

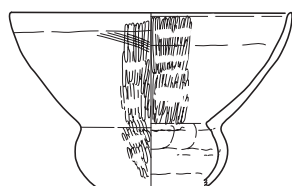

E-99Ac-001

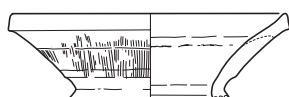

E-99Ac-003



E-99Ac-005

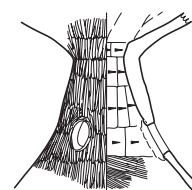

E-99Ac-006

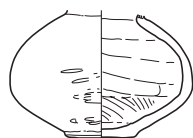

E-99Ac-002



E-99Ac-004

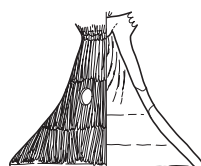

E-99Ac-008

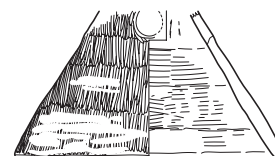

E-99Ac-009

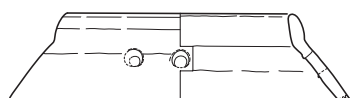

E-99Ac-007

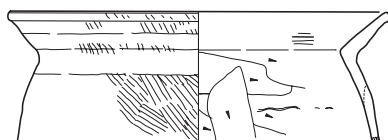

E-99Ac-010

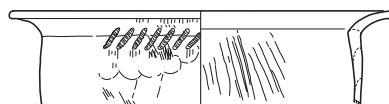

E-99Ac-011



E-99Ac-012

99Ac ☒ SB03



E-99Ac-013

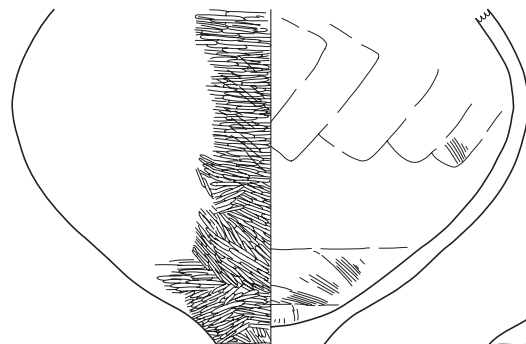

E-99Ac-014

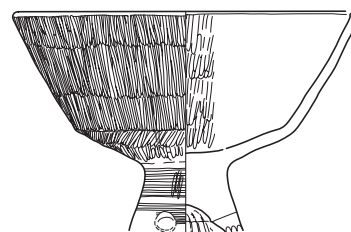

E-99Ac-015



E-99Ac-016



E-99Ac-017

99Ac ☒ SB17

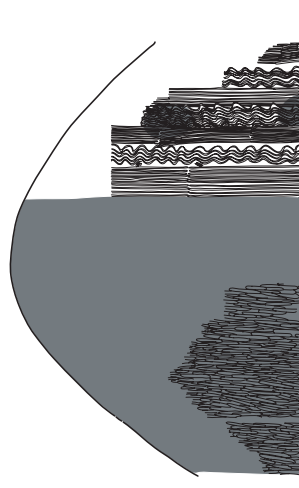

E-99Ac-018

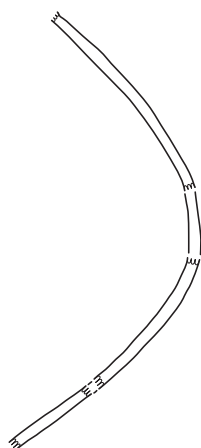

99Ac ☒ SB18

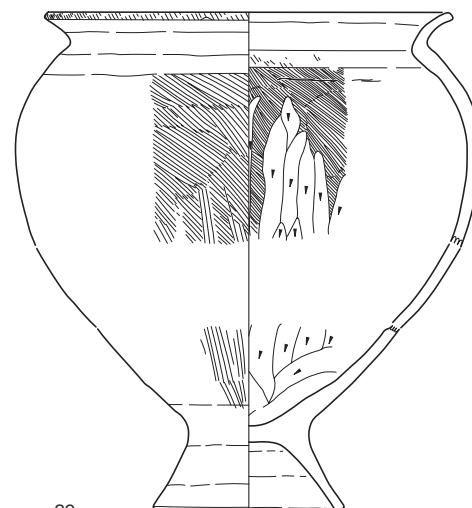

E-99Ac-019

99Ac ☒ SB21

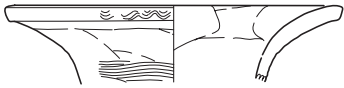

E-99Ac-020

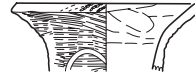

E-99Ac-021

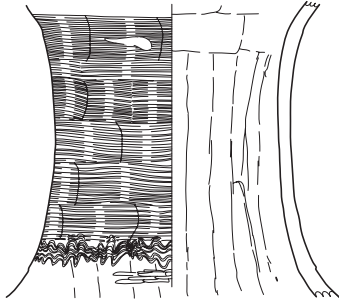

E-99Ac-022

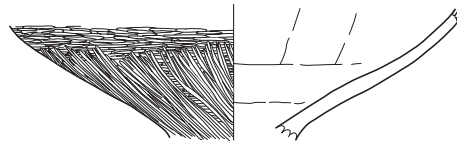

E-99Ac-023

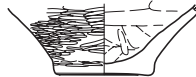

E-99Ac-024

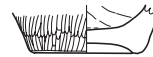

E-99Ac-025

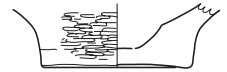

E-99Ac-026

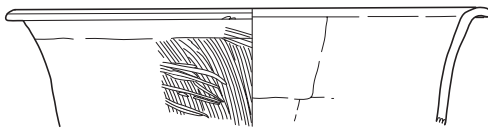

E-99Ac-027

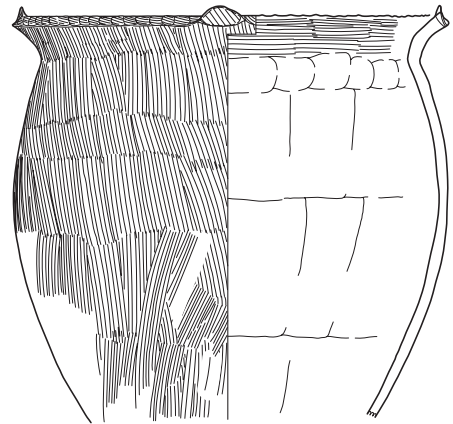

E-99Ac-032

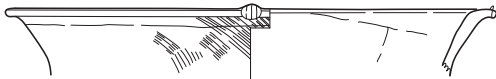

E-99Ac-028

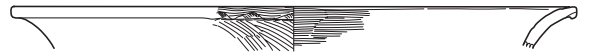

E-99Ac-033

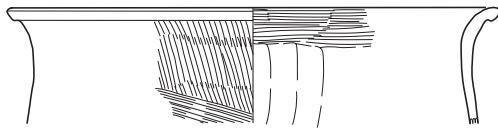

E-99Ac-029

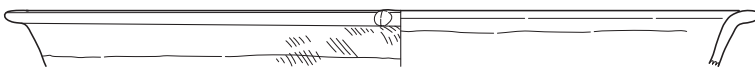

E-99Ac-030

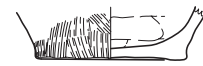

E-99Ac-034

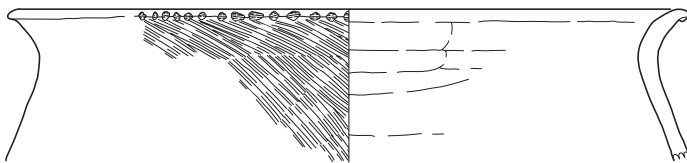

E-99Ac-031

99Ac ☒ SB22

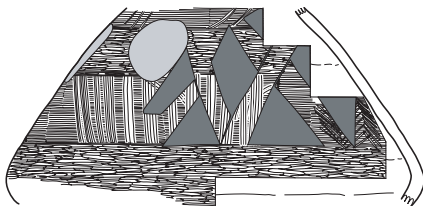

E-99Ac-035

99Ac ☒ SK101

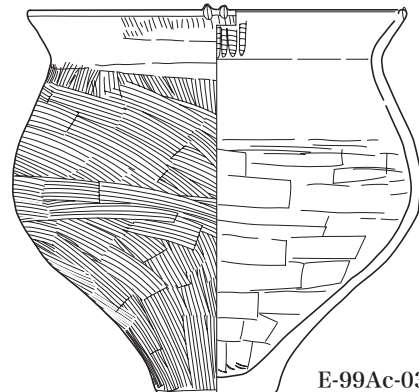

E-99Ac-036



99Ac ☒ SK131

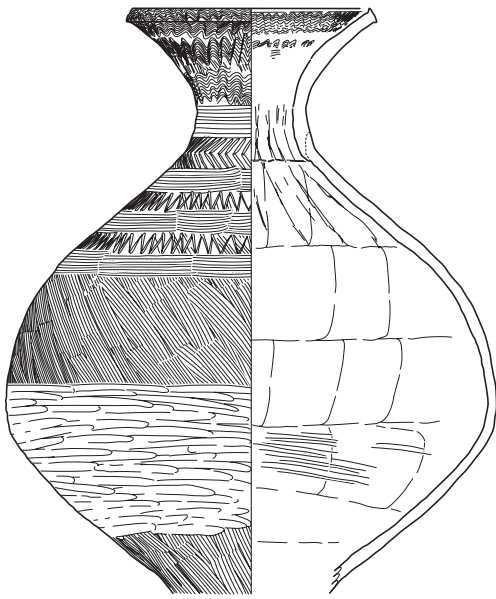

E-99Ac-037

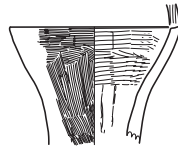

E-99Ac-038

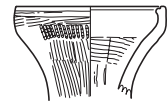

E-99Ac-039

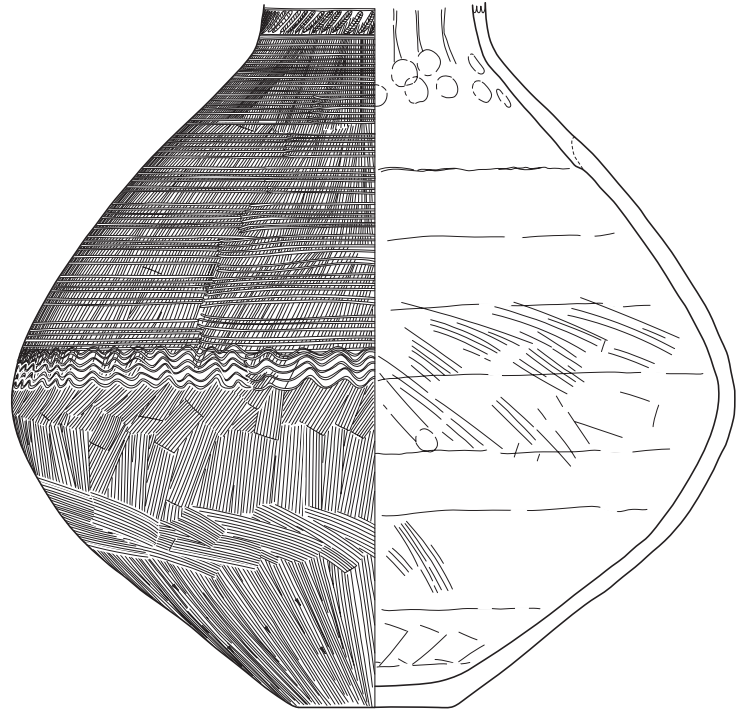

E-99Ac-040

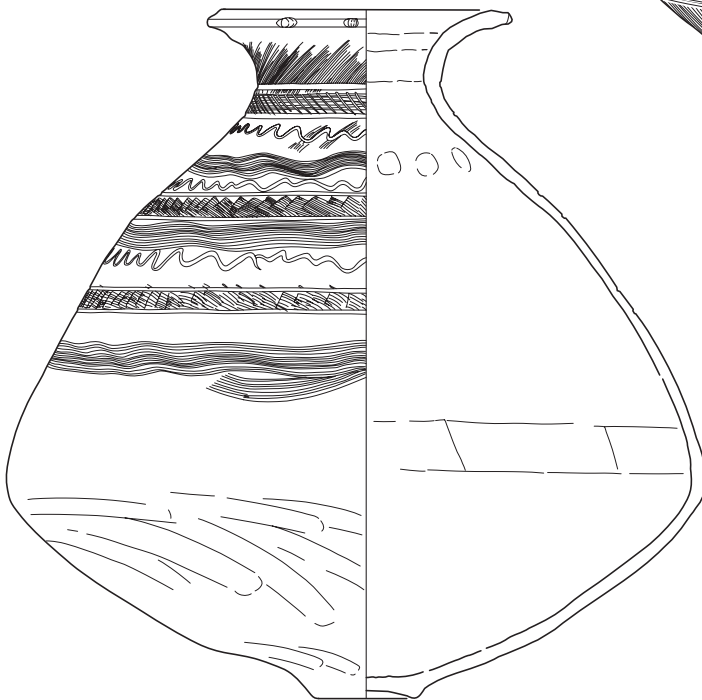

E-99Ac-041

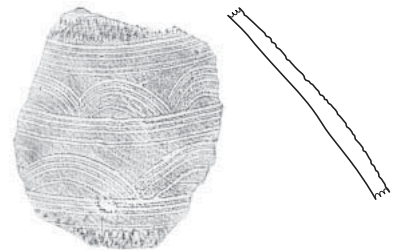

E-99Ac-043



E-99Ac-044



E-99Ac-045



E-99Ac-046



E-99Ac-047

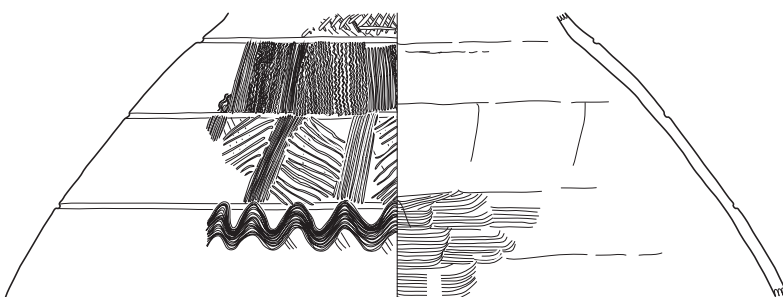

E-99Ac-042



99Ac ☒ SU01

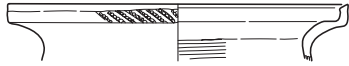

E-99Ac-048

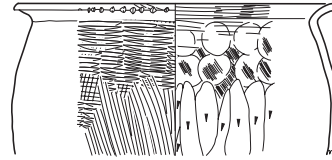

E-99Ac-049

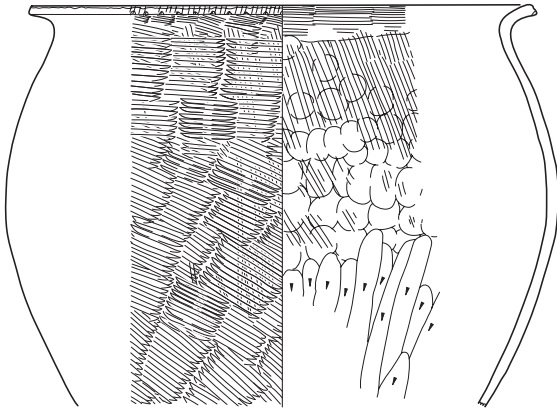

E-99Ac-050

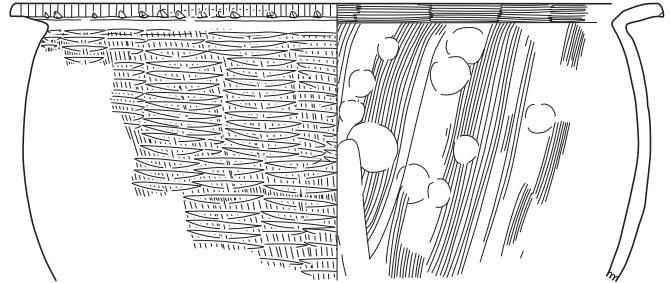

E-99Ac-051

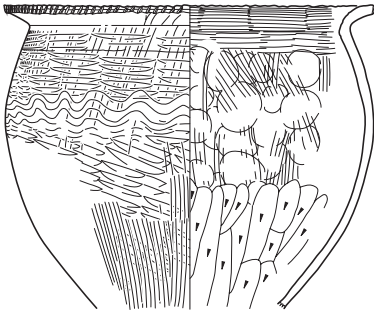

E-99Ac-052

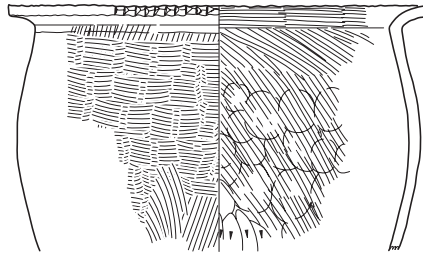

E-99Ac-053

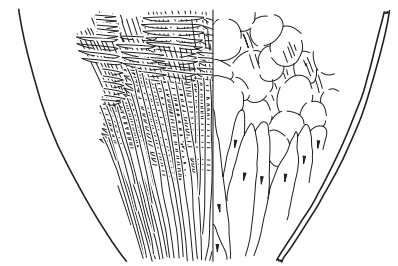

E-99Ac-054

99Ac ☒ SU02

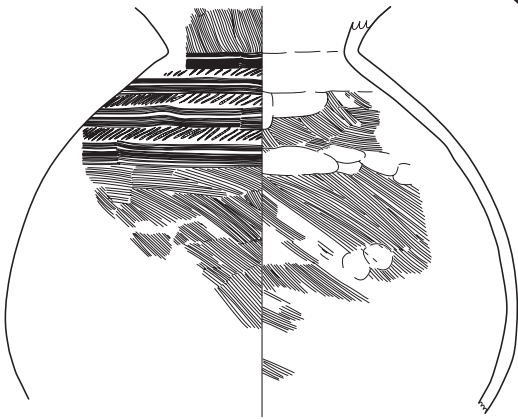

E-99Ac-055

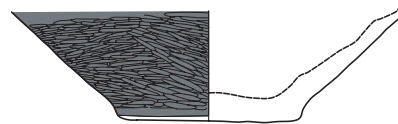

E-99Ac-057

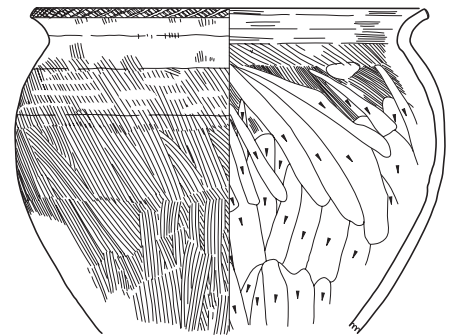

E-99Ac-058

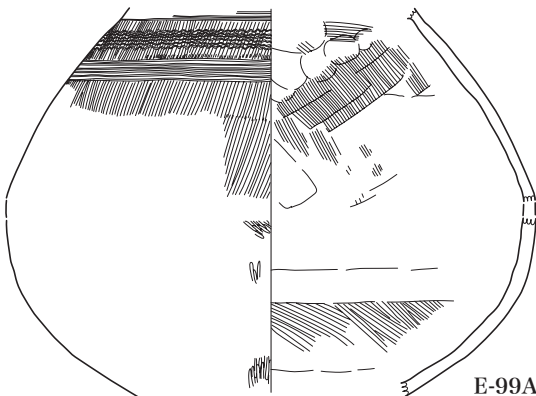

E-99Ac-056

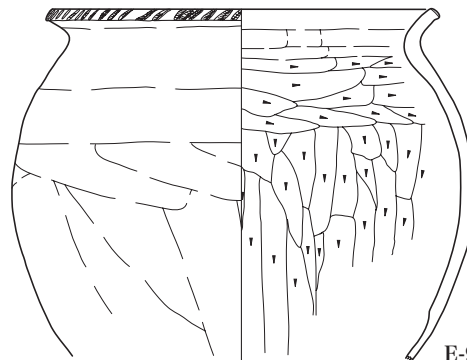

E-99Ac-059



99Ad ☒ SB04

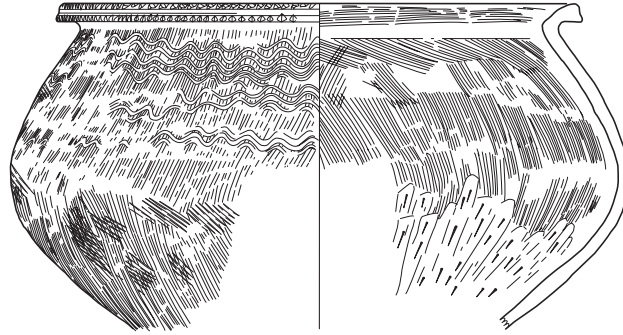

E-99Ad-001

99Ad ☒ SB06

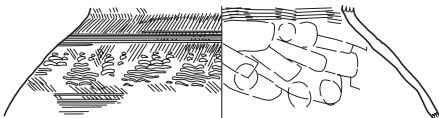

E-99Ad-002



E-99Ad-006

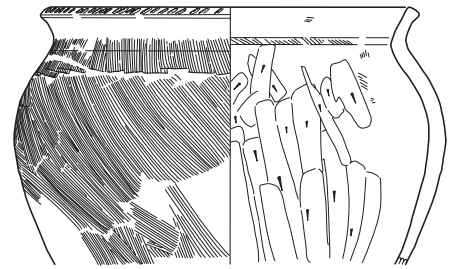

E-99Ad-011

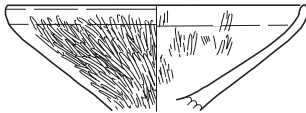

E-99Ad-003

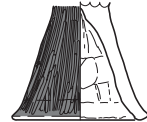

E-99Ad-007

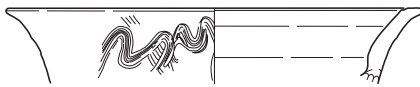

E-99Ad-004

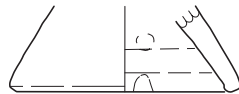

E-99Ad-008

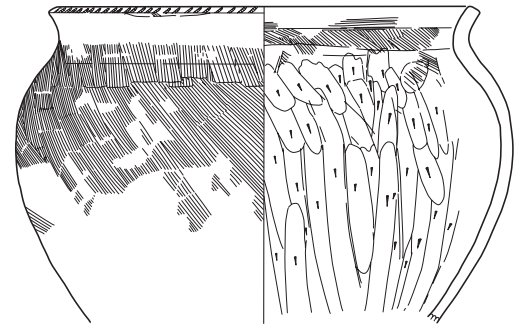

E-99Ad-012

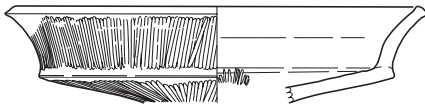

E-99Ad-005

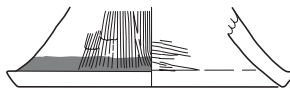

E-99Ad-009

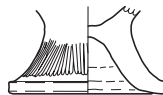

E-99Ad-010

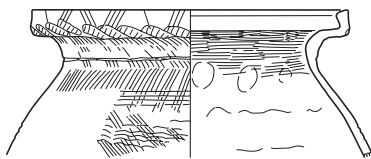

E-99Ad-013

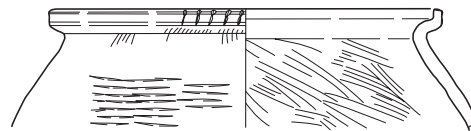

E-99Ad-014

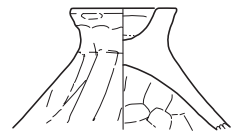

E-99Ad-015

99Ad ☒ SB11

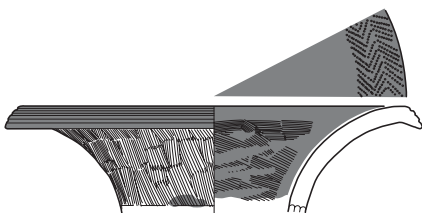

E-99Ad-016

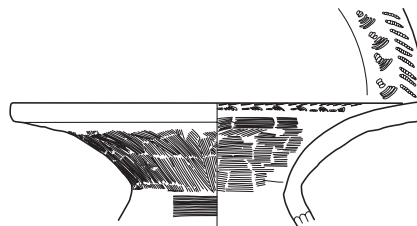

E-99Ad-017



99Ad ☒ SB14

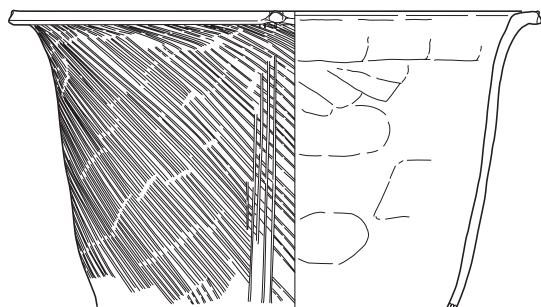

E-99Ad-018

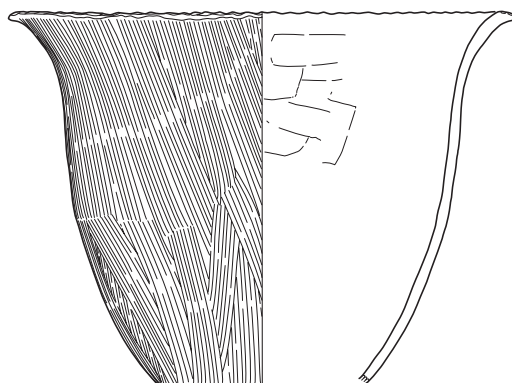

E-99Ad-019

99Ad ☒ SK98

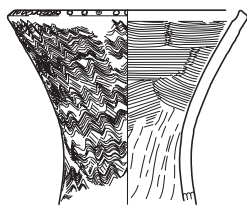

E-99Ad-020

99Ae ☒ SU01

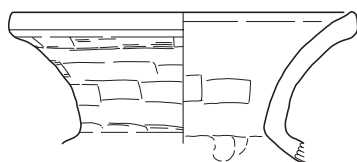

E-99Ae-001

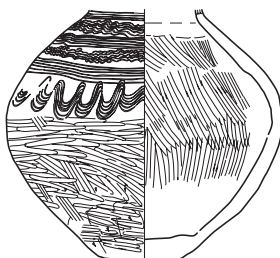

E-99Ae-002

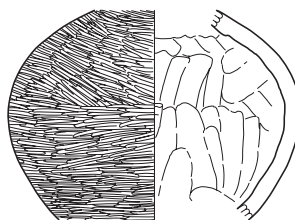

E-99Ae-003



E-99Ae-004

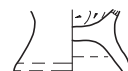

E-99Ae-005

99Ae ☒ SX01

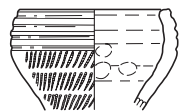

E-99Ae-006

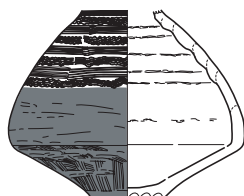

E-99Ae-007

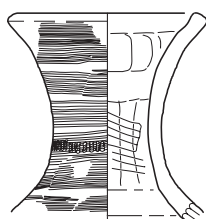

E-99Ae-008

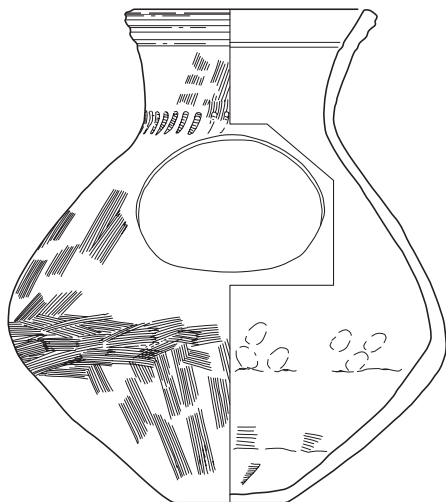

E-99Ae-009

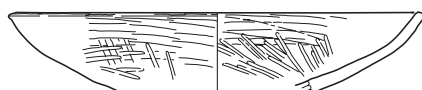

E-99Ae-010



E-99Ae-011

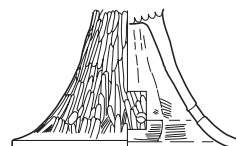

E-99Ae-012



E-99Ae-013

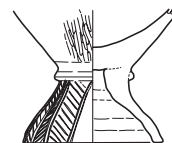

E-99Ae-014





99Ae 区 SX01

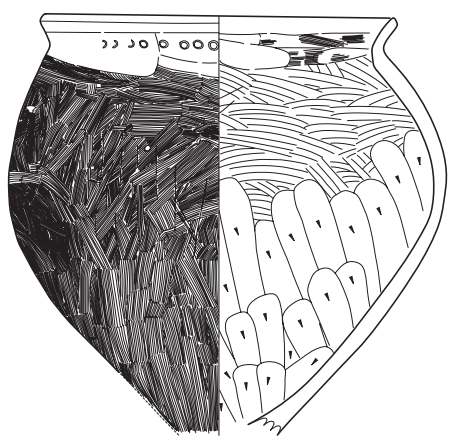

E-99Ae-015



E-99Ae-016



E-99Ae-017

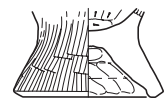

E-99Ae-018

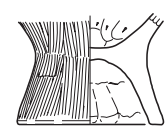

E-99Ae-019

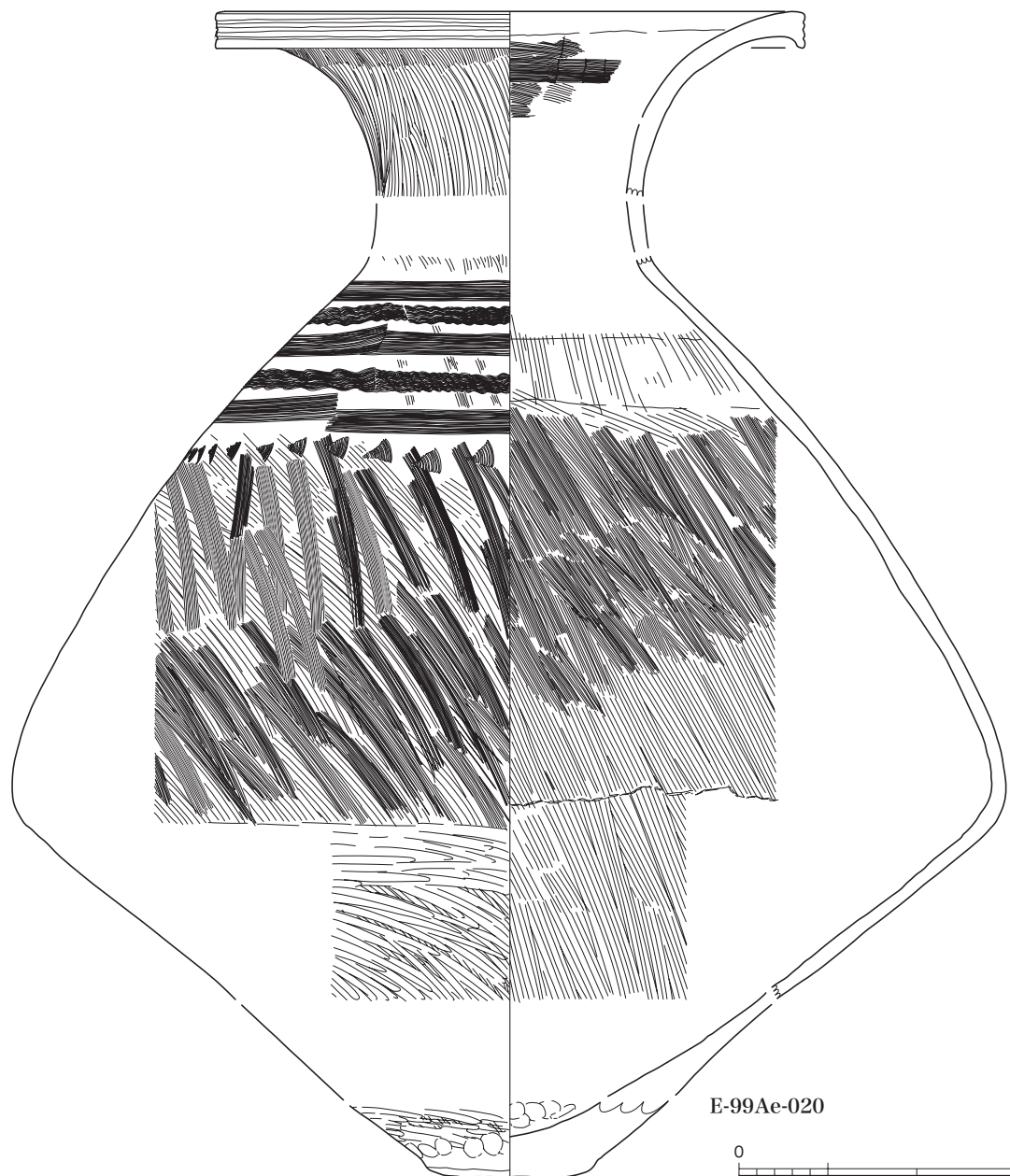

E-99Ae-020



99Ae 区 NR01



E-99Ae-021

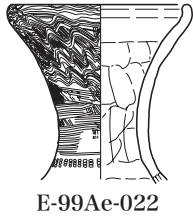

E-99Ae-022

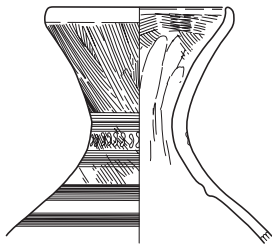

E-99Ae-023

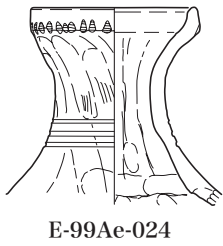

E-99Ae-024

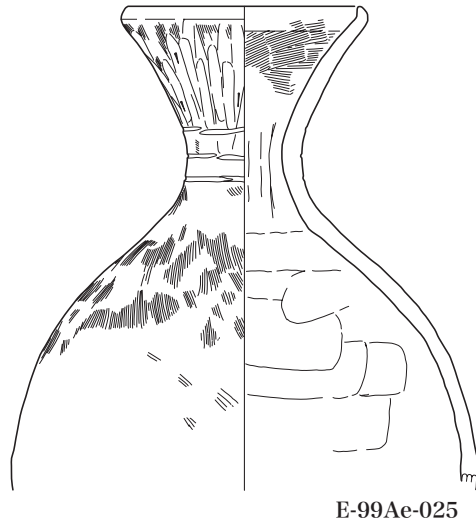

E-99Ae-025



E-99Ae-027

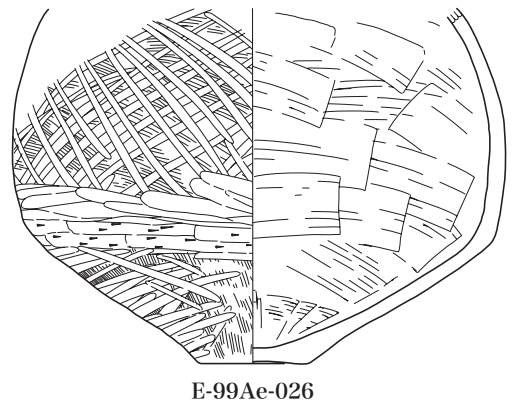

E-99Ae-026

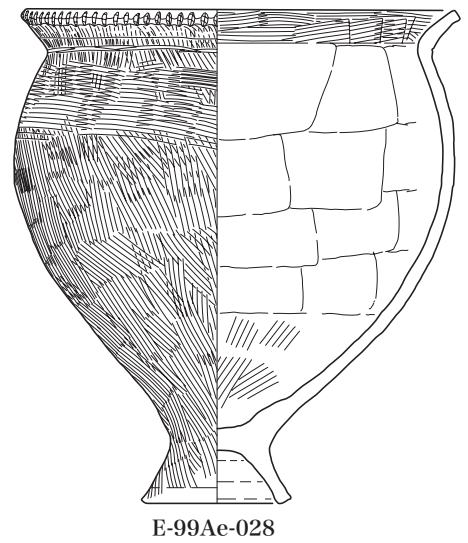

E-99Ae-028

99Ae 区 検I

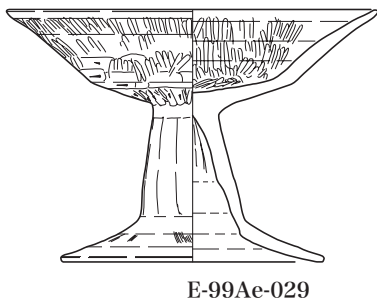

E-99Ae-029

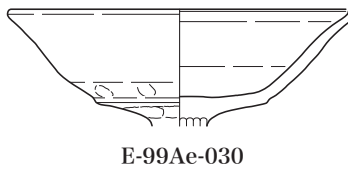

E-99Ae-030

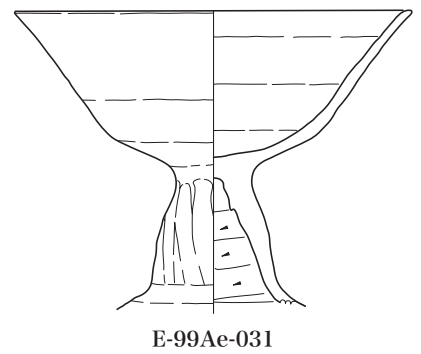

E-99Ae-031

99Ba 区 SB01



E-99Ba-001

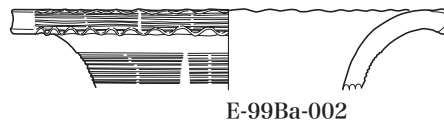

E-99Ba-002

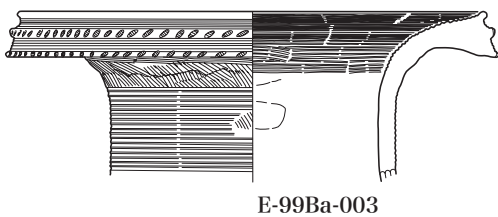

E-99Ba-003



E-99Ba-004

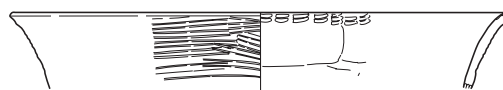

E-99Ba-005



E-99Ba-006

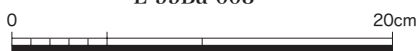

99Ba ☒ SD01

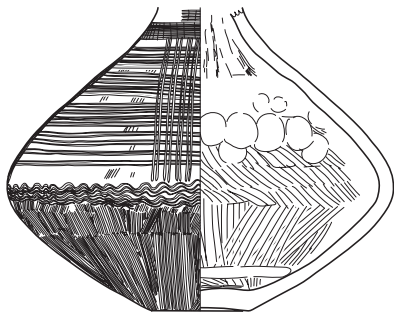

E-99Ba-007

99Ba ☒ SD02

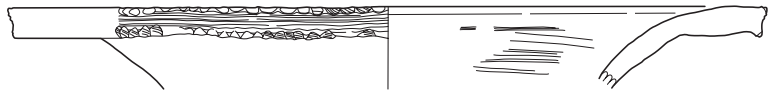

E-99Ba-008

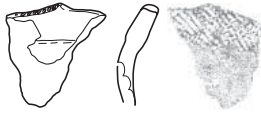

E-99Ba-009

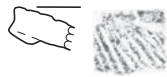

E-99Ba-010

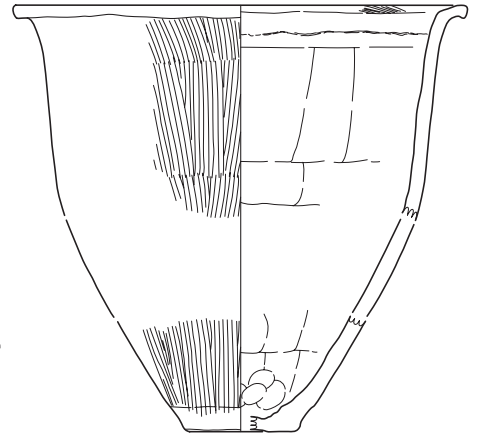

E-99Ba-012

99Ba ☒ SD03

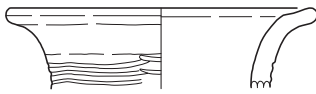

E-99Ba-013



E-99Ba-011

99Ba ☒ SD04



E-99Ba-014

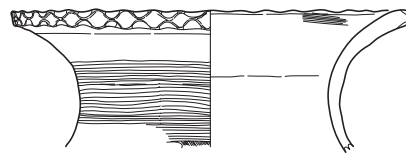

E-99Ba-015

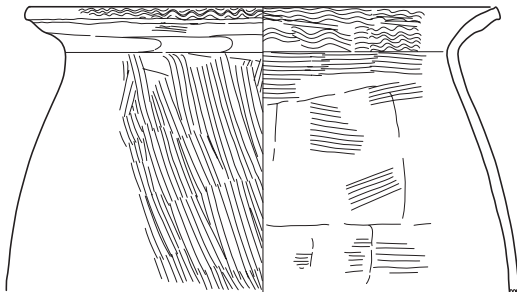

E-99Ba-016

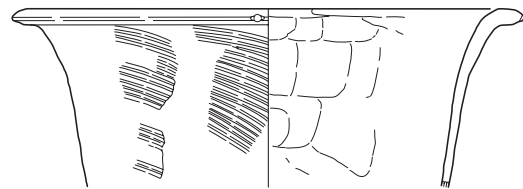

E-99Ba-017

99Ba ☒ SK03

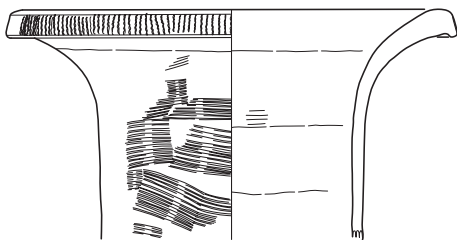

E-99Ba-018

99Ba ☒ SK27

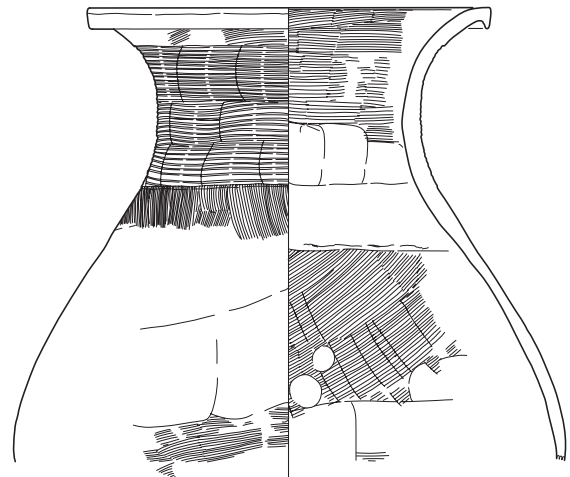

E-99Ba-019



99Bb ☒ NR01

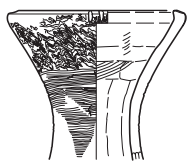

E-99Bb-001

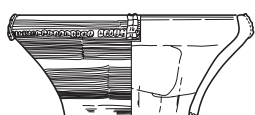

E-99Bb-002

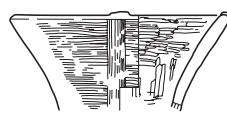

E-99Bb-003

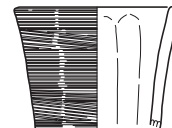

E-99Bb-004

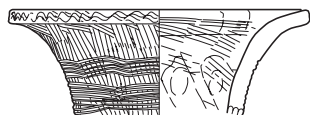

E-99Bb-005

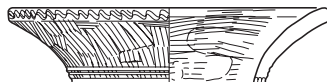

E-99Bb-006

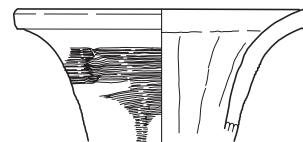

E-99Bb-007

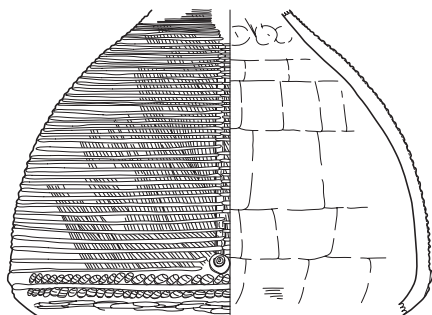

E-99Bb-008

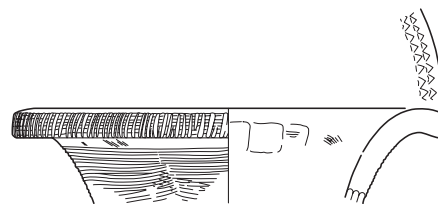

E-99Bb-010

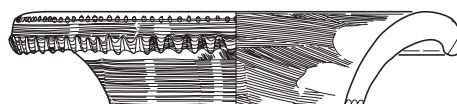

E-99Bb-011

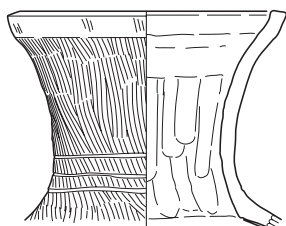

E-99Bb-009

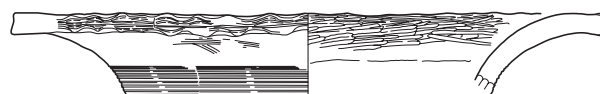

E-99Bb-012

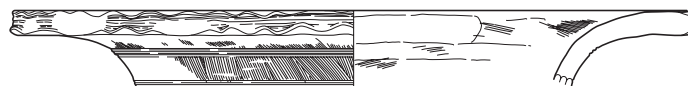

E-99Bb-013

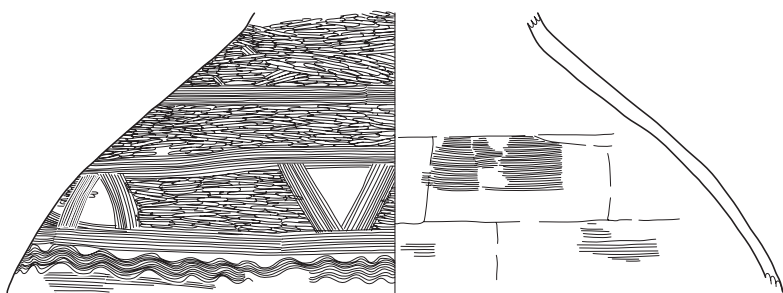

E-99Bb-014

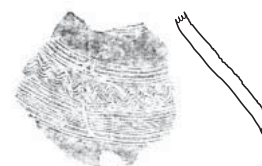

E-99Bb-015



E-99Bb-016

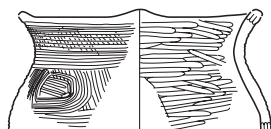

E-99Bb-017



E-99Bb-019

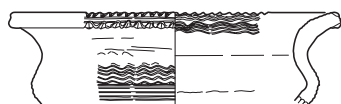

E-99Bb-018



E-99Bb-020



E-99Bb-021



99Bb ☒ NR01



E-99Bb-022



E-99Bb-023

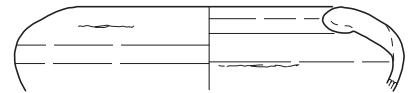

E-99Bb-024

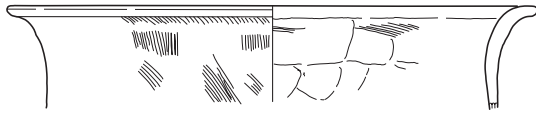

E-99Bb-025



E-99Bb-028



E-99Bb-029

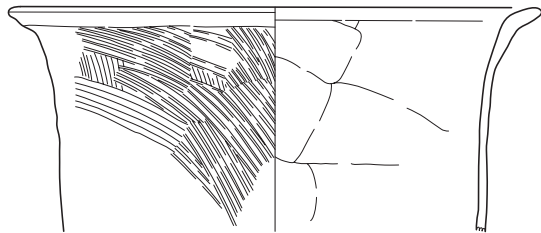

E-99Bb-026

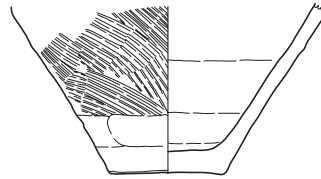

E-99Bb-030

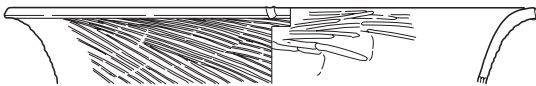

E-99Bb-027

99Ca ☒ SD05

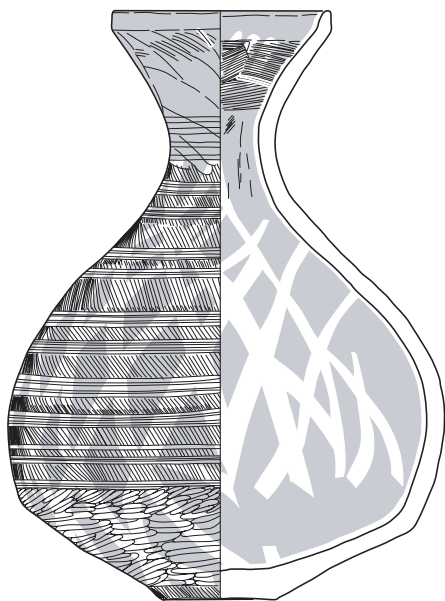

E-99Ca-001

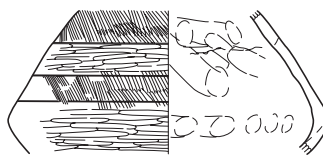

E-99Ca-002

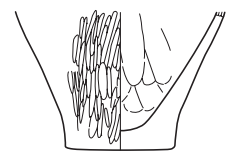

E-99Ca-005



E-99Ca-003

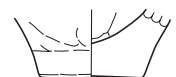

E-99Ca-006

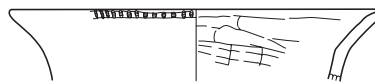

E-99Ca-004

99Ca ☒ SD06

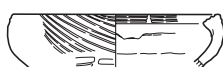

E-99Ca-007

99Ca ☒ SD07

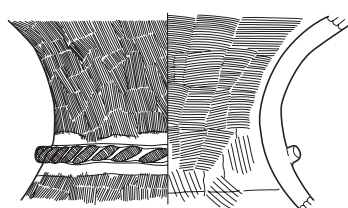

E-99Ca-008



99Ca ☒ SZ01

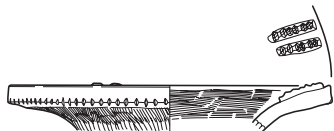

E-99Ca-009

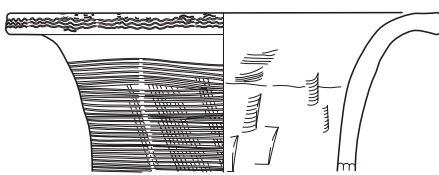

E-99Ca-011

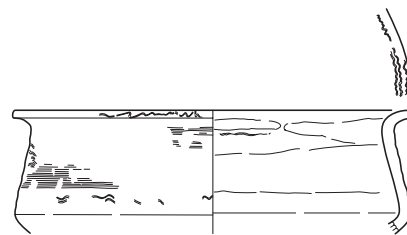

E-99Ca-012

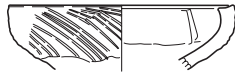

E-99Ca-010

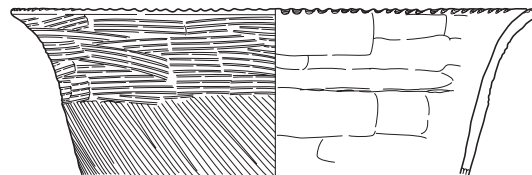

E-99Ca-014

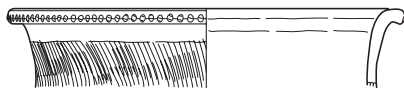

E-99Ca-013

99Ca ☒

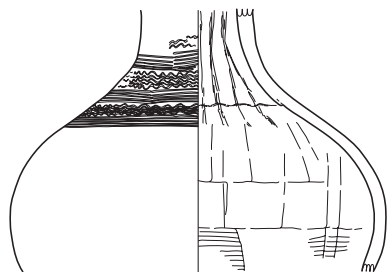

E-99Ca-015

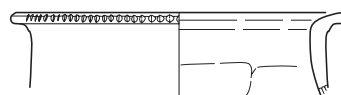

E-99Ca-016

99Cb ☒ SD01



E-99Cb-001

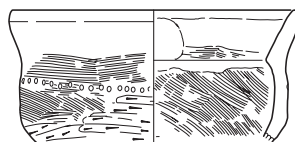

E-99Cb-002

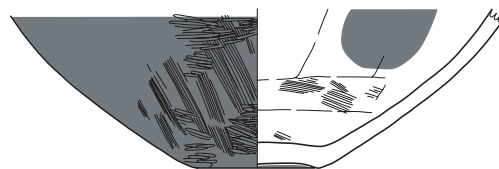

E-99Cb-005



E-99Cb-003

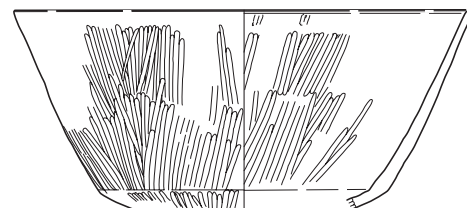

E-99Cb-006

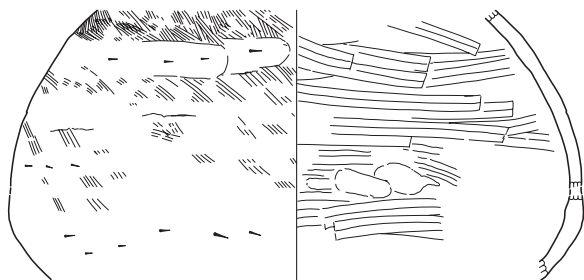

E-99Cb-004

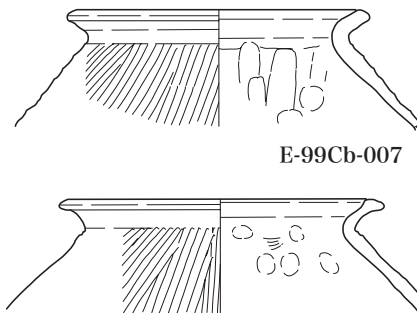

E-99Cb-007



E-99Cb-009



E-99Cb-008



99Cb ☒ SD06

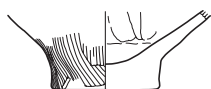

E-99Cb-010

99Cb ☒ SK18

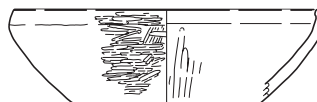

E-99Cb-011

99Cb ☒

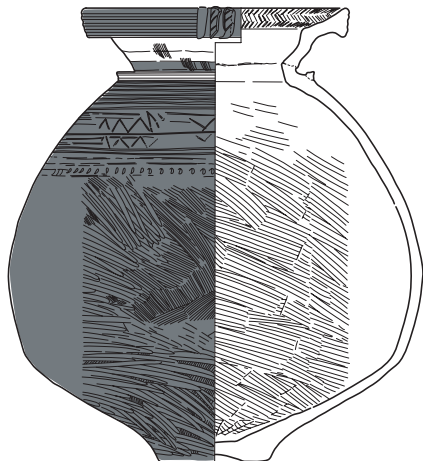

E-99Cb-012

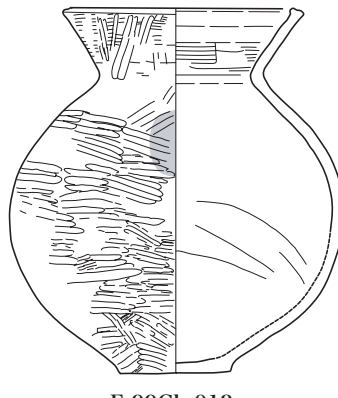

E-99Cb-013

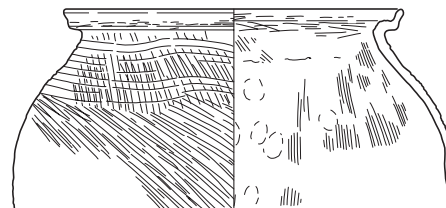

E-99Cb-014

99Cc ☒ SD01

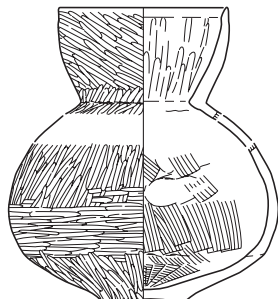

E-99Cc-001

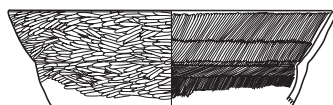

E-99Cc-002

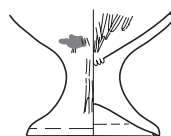

E-99Cc-003

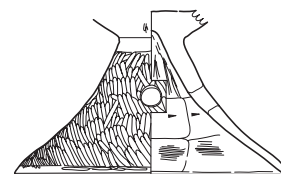

E-99Cc-004

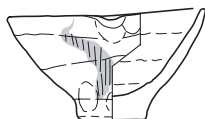

E-99Cc-005

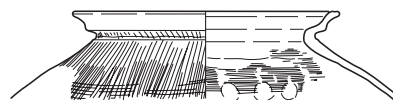

E-99Cc-006

99Cc ☒ SD02

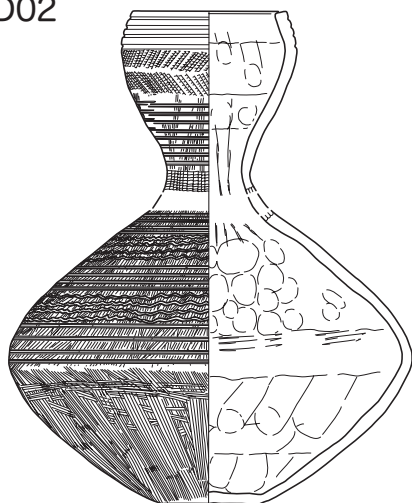

E-99Cc-007

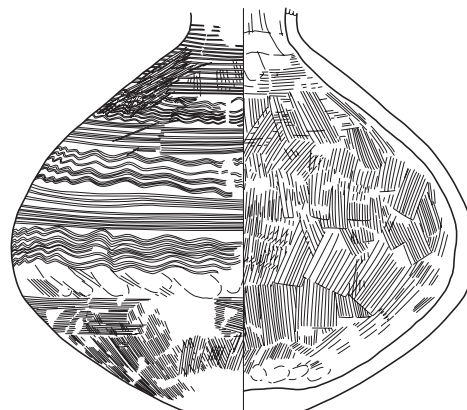

E-99Cc-008



99Cc ☒ SD02

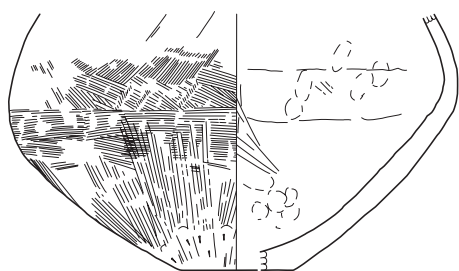

E-99Cc-009

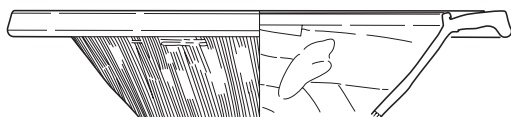

E-99Cc-010



E-99Cc-013

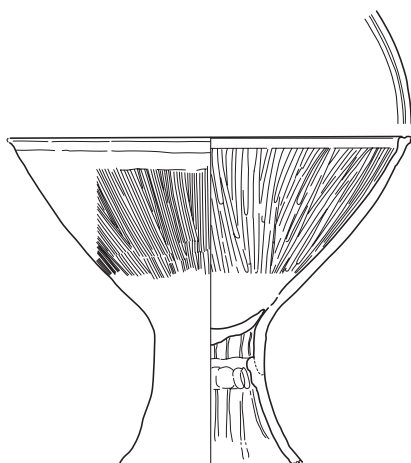

E-99Cc-011

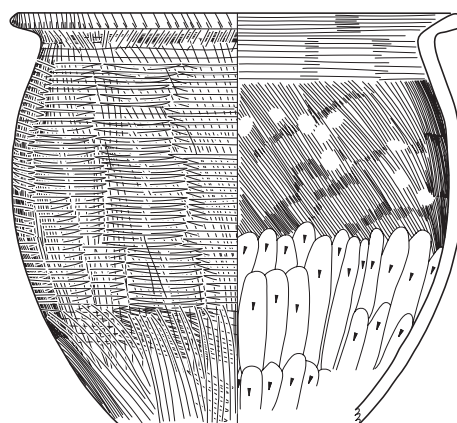

E-99Cc-014

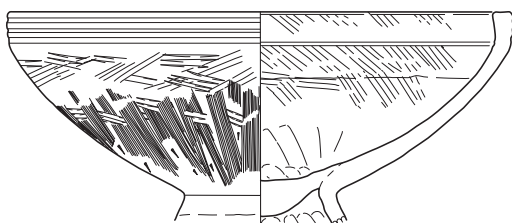

E-99Cc-012

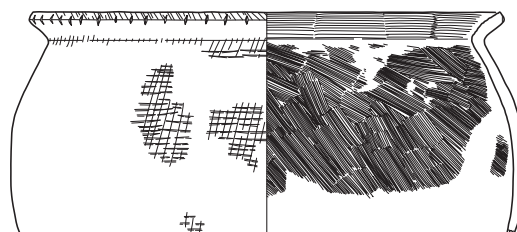

E-99Cc-015

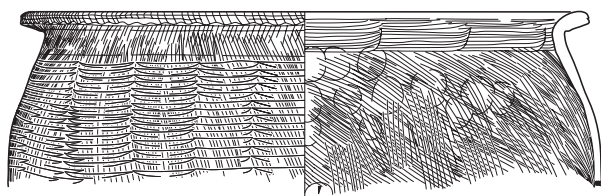

E-99Cc-016

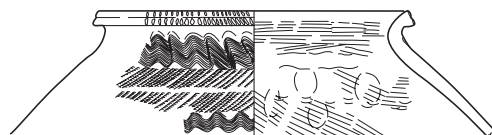

E-99Cc-017

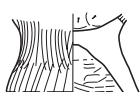

E-99Cc-018

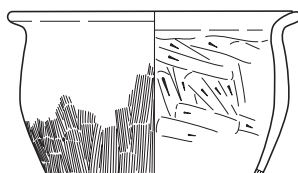

E-99Cc-019

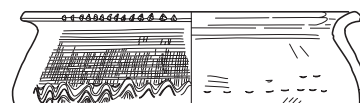

E-99Cc-020





99Cc ☒ SD03

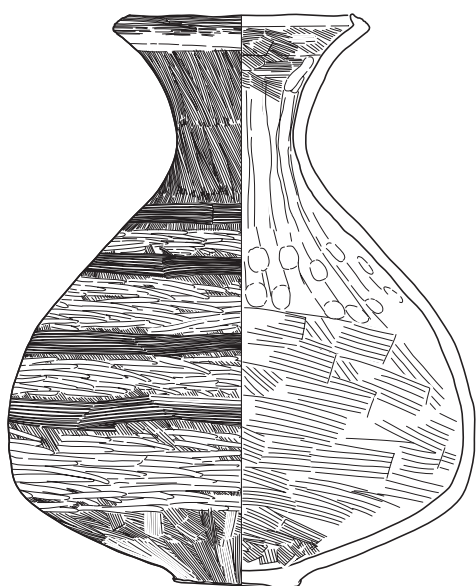

E-99Cc-021

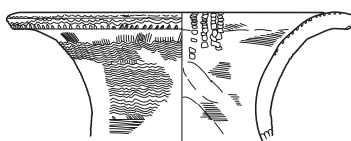

E-99Cc-023

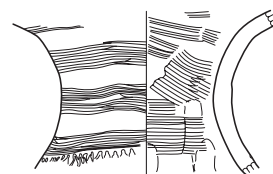

E-99Cc-024

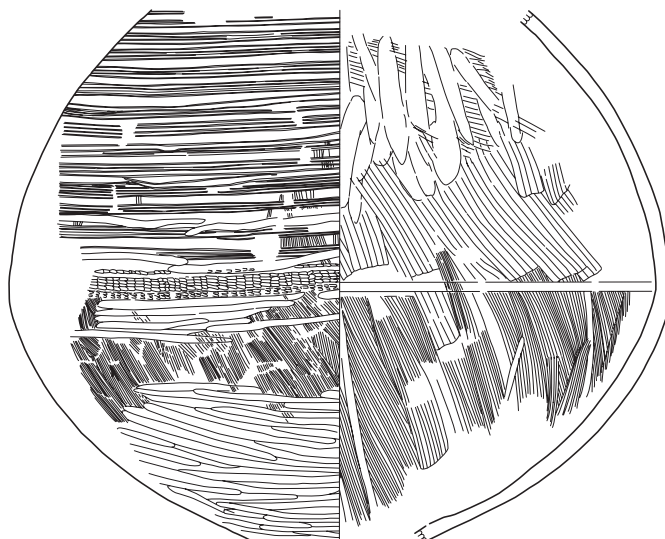

E-99Cc-025

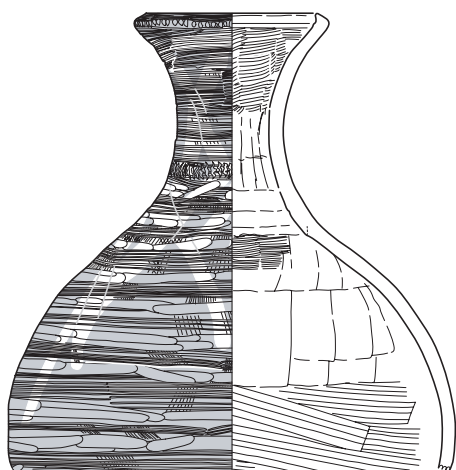

E-99Cc-022

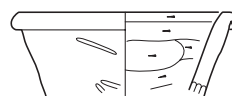

E-99Cc-026

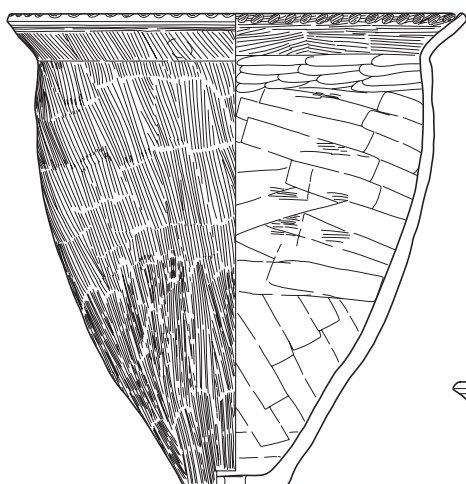

E-99Cc-027

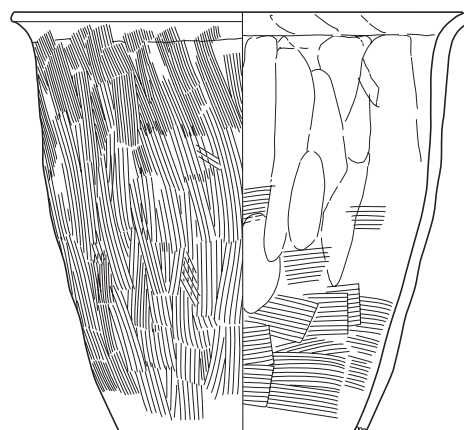

E-99Cc-028

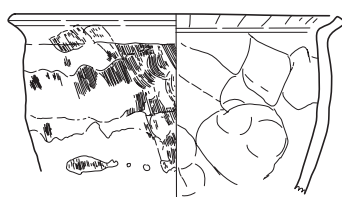

E-99Cc-029

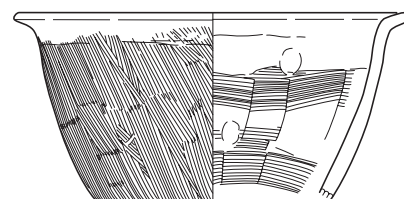

E-99Cc-030



99Cc ☒ SD03

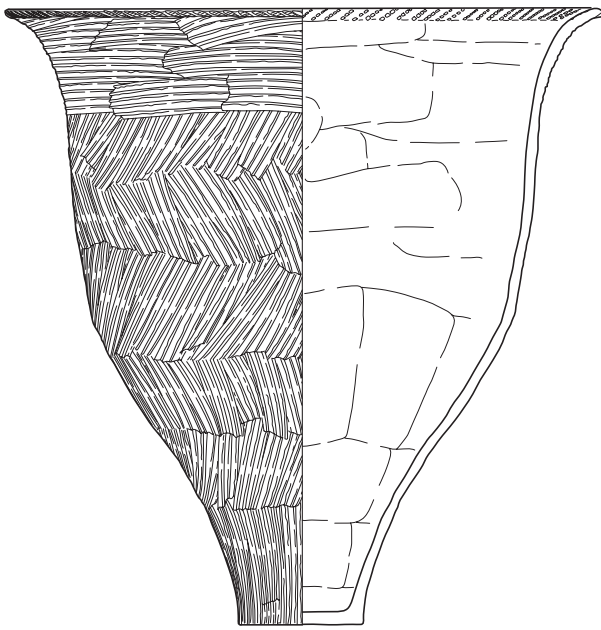

E-99Cc-031

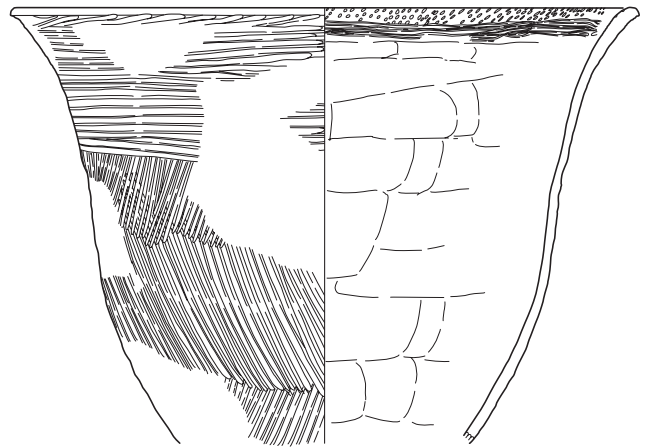

E-99Cc-032

99Cc ☒ SD04

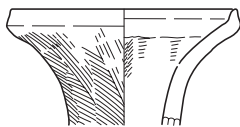

E-99Cc-033

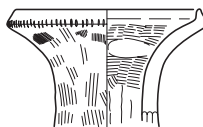

E-99Cc-034



E-99Cc-035

99Cc ☒ SD05

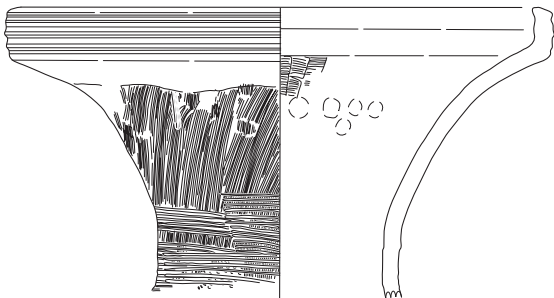

E-99Cc-036

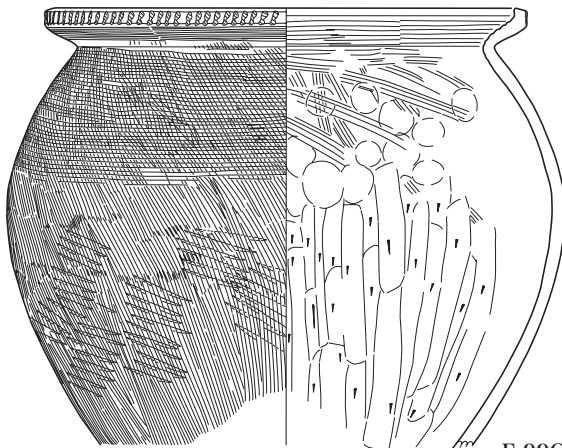

E-99Cc-037

99Cc ☒

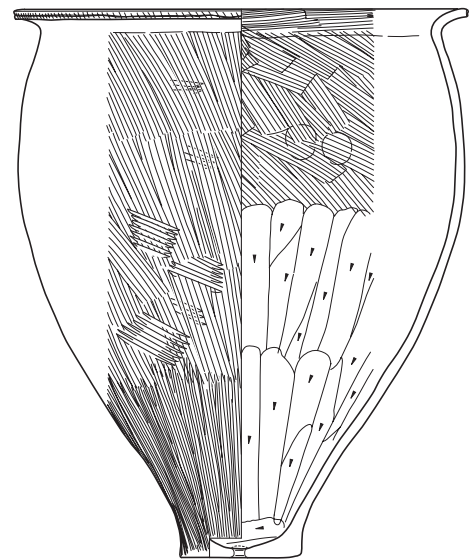

E-99Cc-038



99Cd ☒ SD01

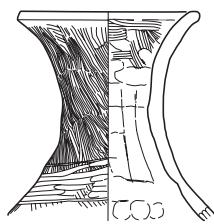

E-99Cd-001



E-99Cd-003

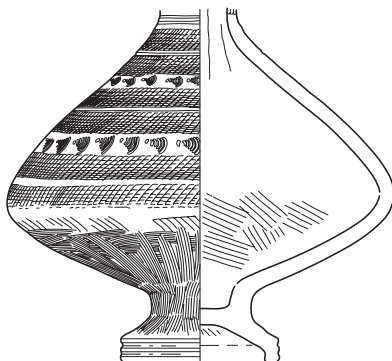

E-99Cd-002

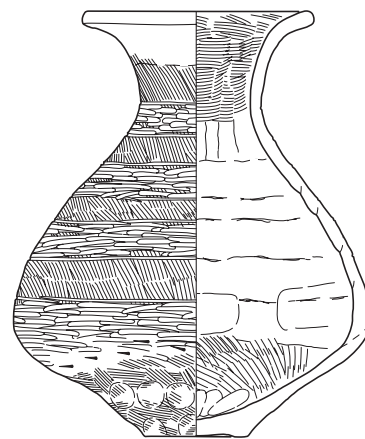

E-99Cd-004

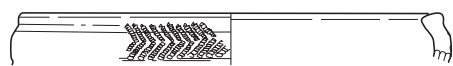

E-99Cd-005



E-99Cd-006

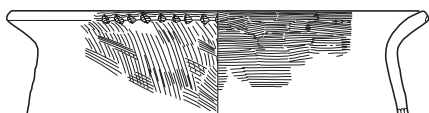

E-99Cd-007



E-99Cd-008

99Cd ☒ SD04

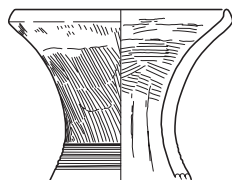

E-99Cd-009

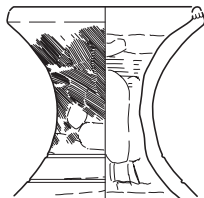

E-99Cd-010

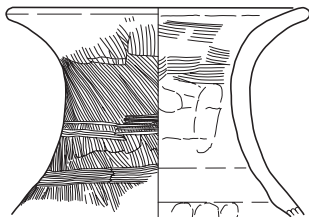

E-99Cd-011

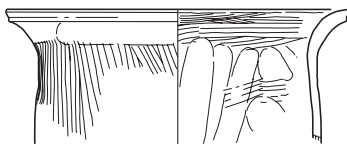

E-99Cd-012

99Cd ☒ SD07

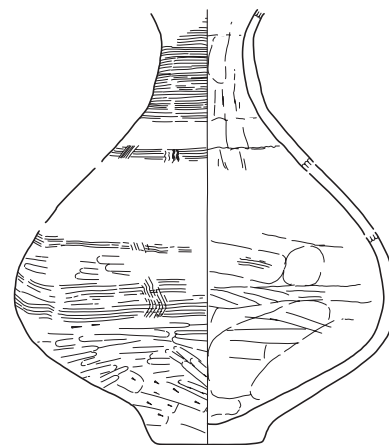

E-99Cd-013

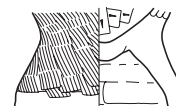

E-99Cd-014

99Cd ☒ SD09

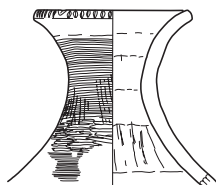

E-99Cd-015



99Cd ☒ SD13

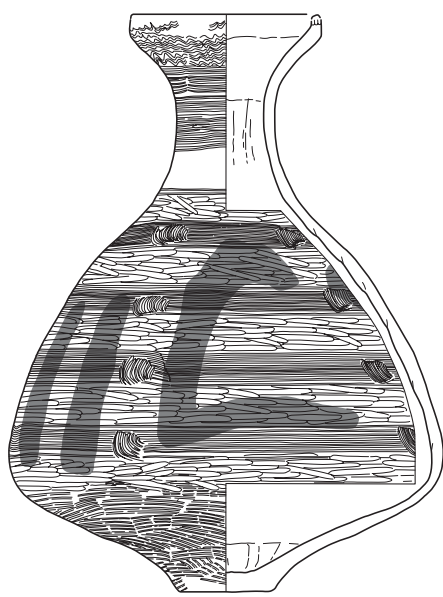

E-99Cd-016

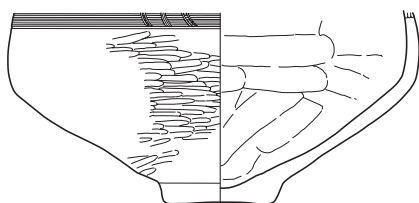

E-99Cd-017

99Cd ☒ SK02



E-99Cd-018

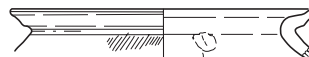

E-99Cd-019

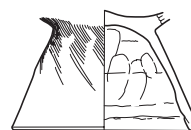

E-99Cd-020

99Ce ☒ SD03

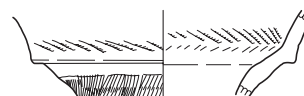

E-99Ce-001

99Ce ☒ SD05

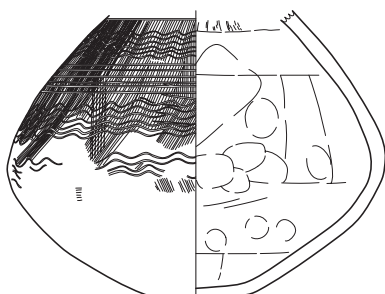

E-99Ce-002

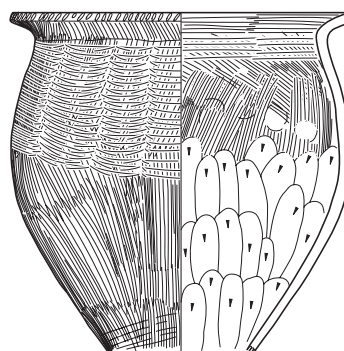

E-99Ce-004

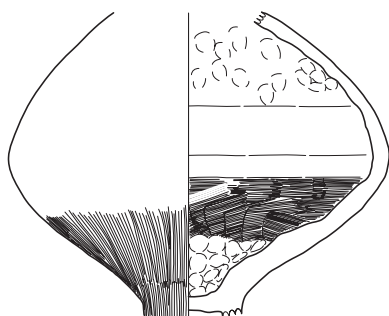

E-99Ce-003



E-99Ce-005

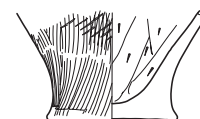

E-99Ce-006



99Ce 区 SD07



E-99Ce-007

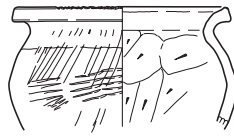

E-99Ce-008

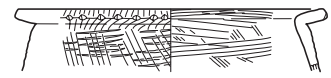

E-99Ce-009

99Ce 区 SD08

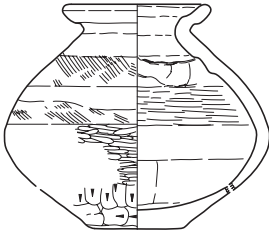

E-99Ce-010

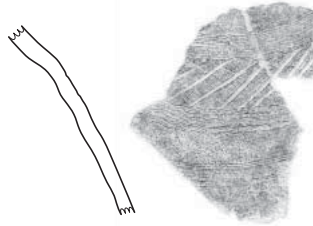

E-99Ce-011

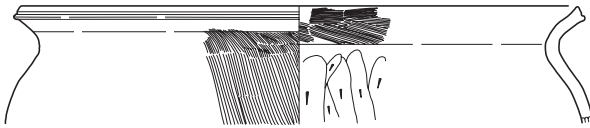

E-99Ce-012

99Ce 区 SK01

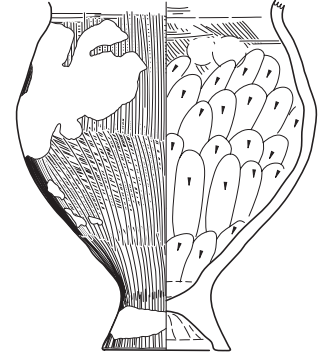

E-99Ce-013

99Ce 区 表土はぎ

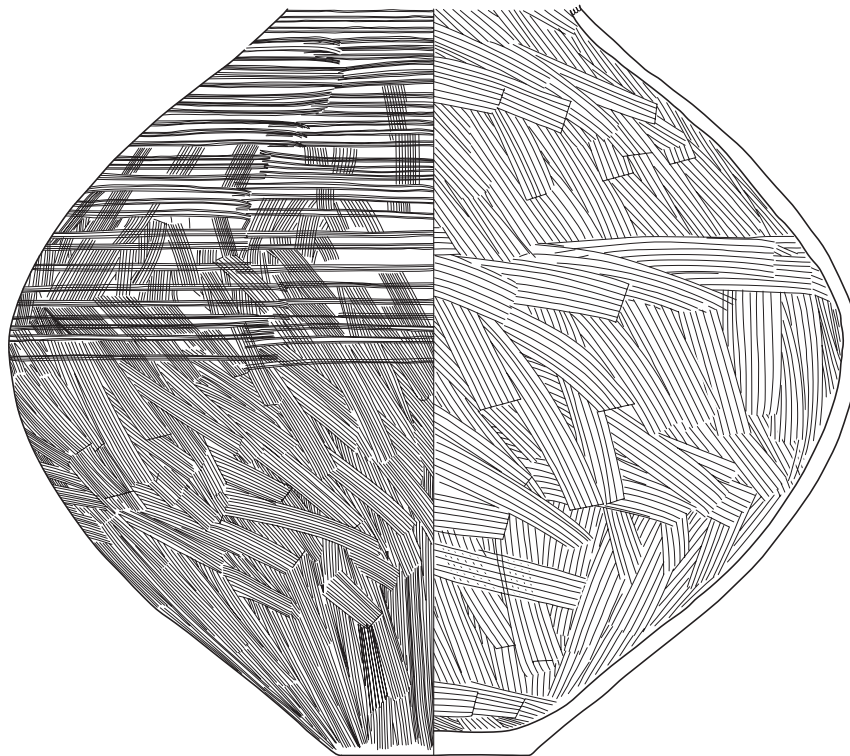

E-99Ce-014

99Cf 区 SD01

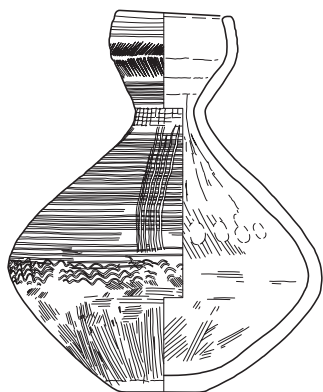

E-99Cf-001

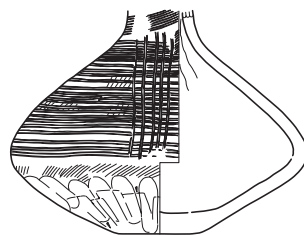

E-99Cf-002

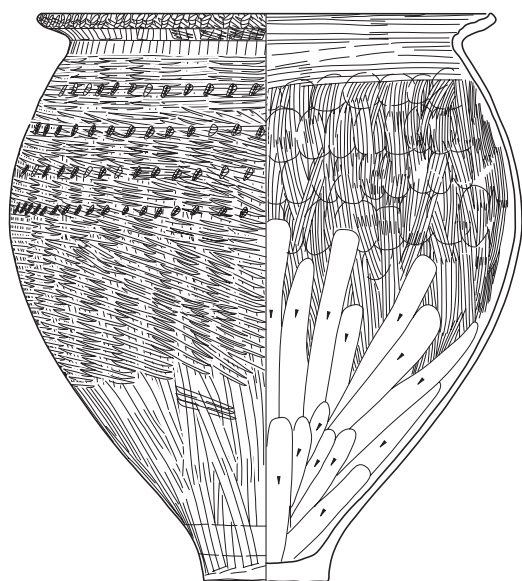

E-99Cf-003

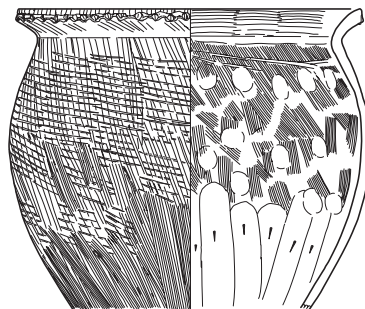

E-99Cf-004

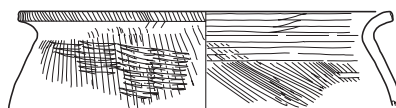

E-99Cf-005

99Cf 区 SD02

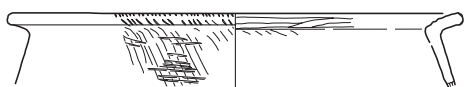

E-99Cf-006

99Cf 区 SK25

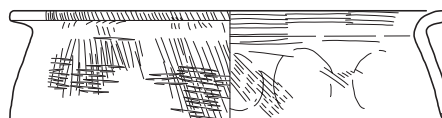

E-99Cf-007

99Cf 区 SZ01



E-99Cf-008

99Cf 区 検II

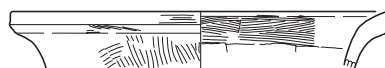

E-99Cf-009

01Aa 区 SB01

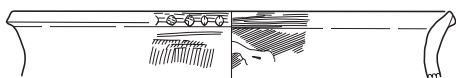

E-01Aa-001

01Aa 区 SD02

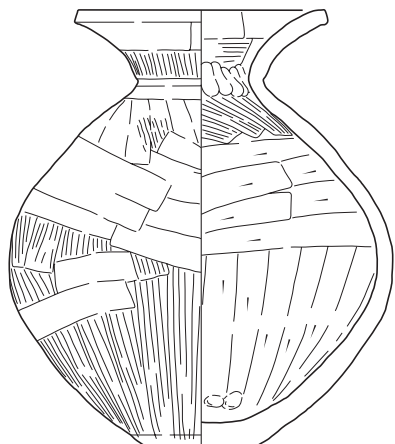

E-01Aa-002

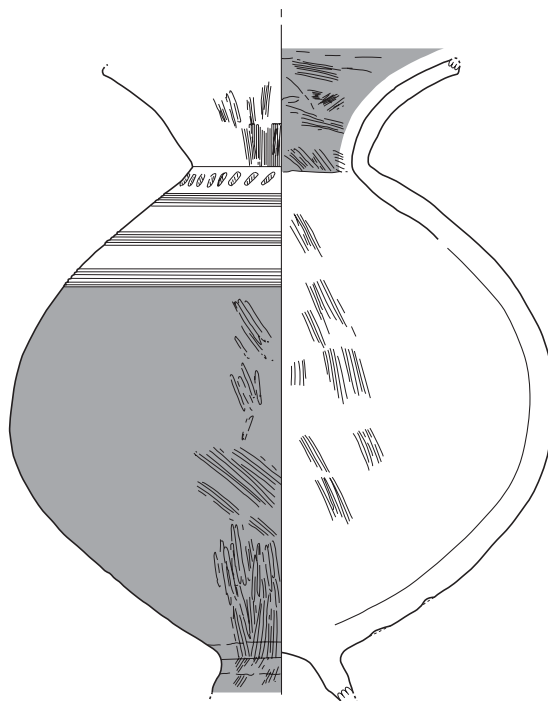

E-01Aa-004

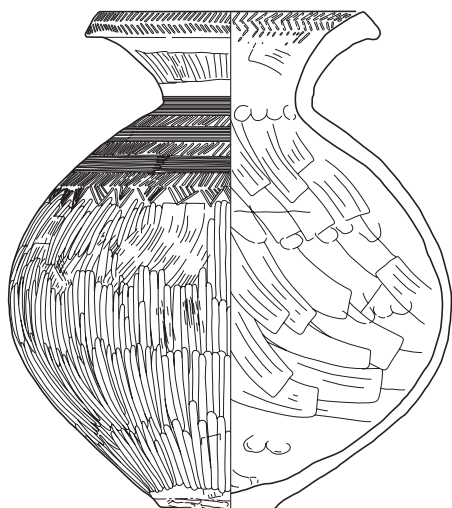

E-01Aa-003

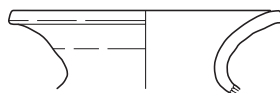

E-01Aa-005

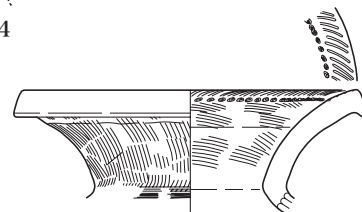

E-01Aa-006

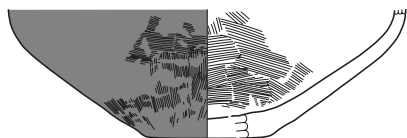

E-01Aa-008

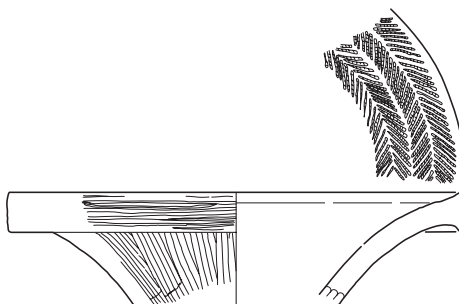

E-01Aa-007



E-01Aa-010

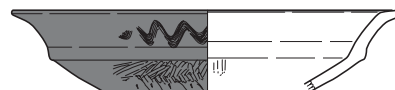

E-01Aa-012

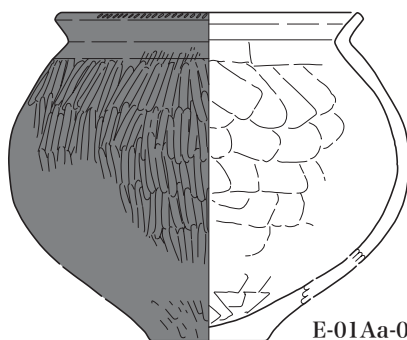

E-01Aa-009

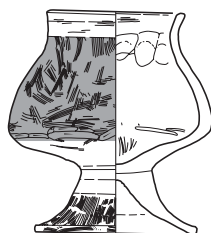

E-01Aa-011

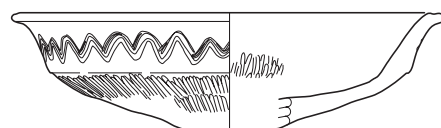

E-01Aa-013



01Aa ☒ SD02

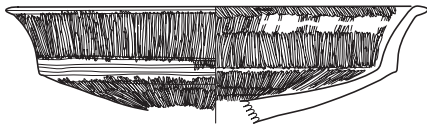

E-01Aa-014



E-01Aa-019

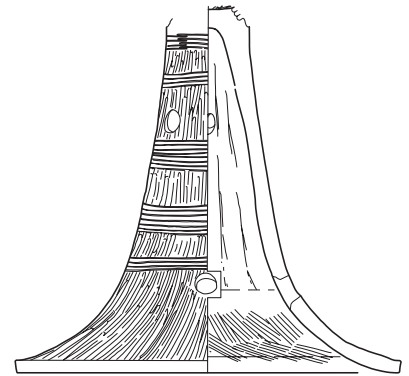

E-01Aa-022



E-01Aa-015

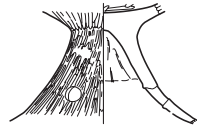

E-01Aa-020

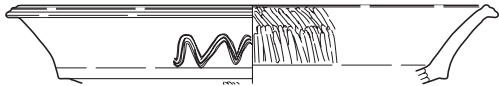

E-01Aa-016

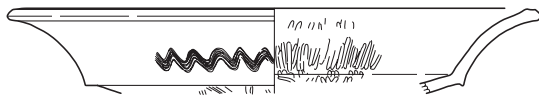

E-01Aa-017

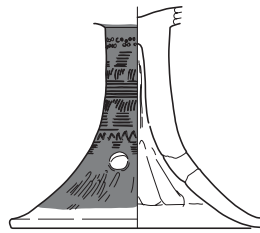

E-01Aa-021

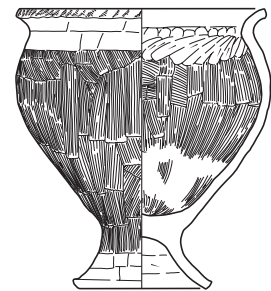

E-01Aa-023

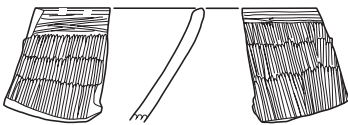

E-01Aa-018

01Aa ☒ SD03

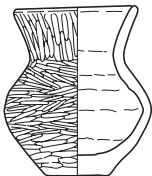

E-01Aa-024

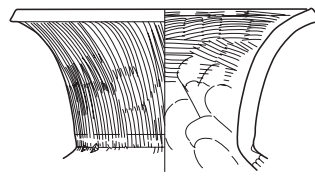

E-01Aa-027

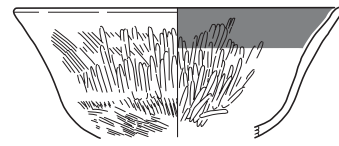

E-01Aa-031

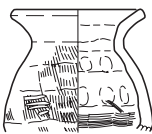

E-01Aa-025

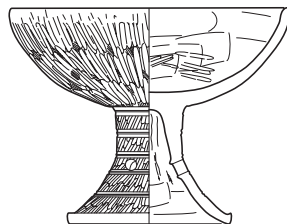

E-01Aa-028



E-01Aa-032

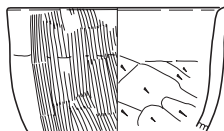

E-01Aa-026

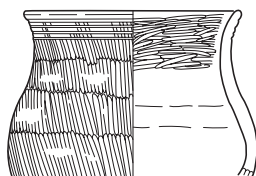

E-01Aa-029

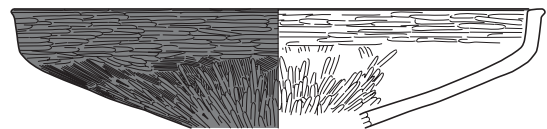

E-01Aa-033



E-01Aa-034



E-01Aa-030





01Aa ☒ SD03

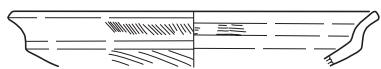

E-01Aa-035

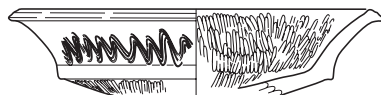

E-01Aa-036

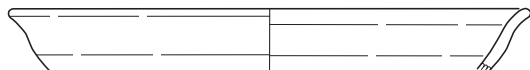

E-01Aa-037

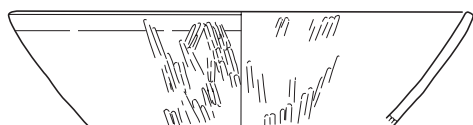

E-01Aa-038

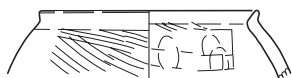

E-01Aa-044

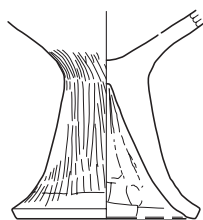

E-01Aa-039

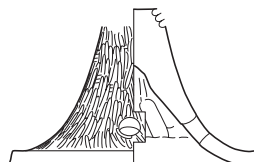

E-01Aa-040

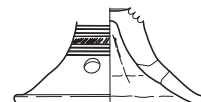

E-01Aa-041

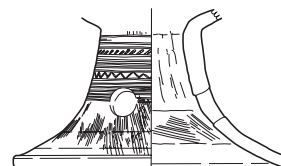

E-01Aa-042



E-01Aa-043

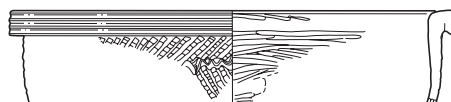

E-01Aa-045

01Aa ☒ SD04

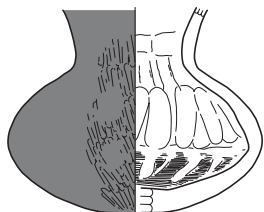

E-01Aa-046

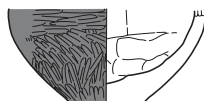

E-01Aa-048



E-01Aa-049

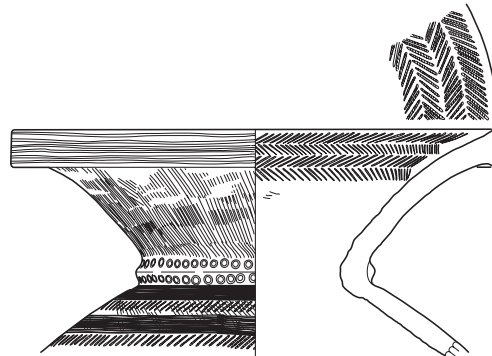

E-01Aa-050

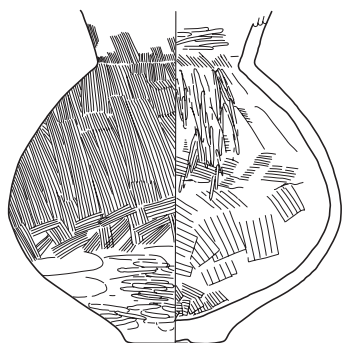

E-01Aa-047

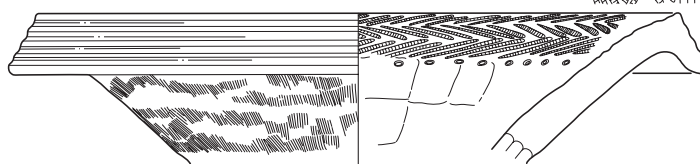

E-01Aa-051



01Aa ☒ SD04

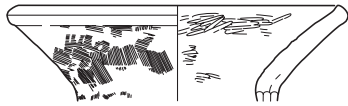

E-01Aa-052

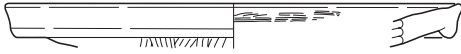

E-01Aa-053

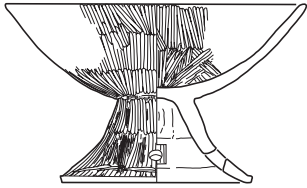

E-01Aa-055

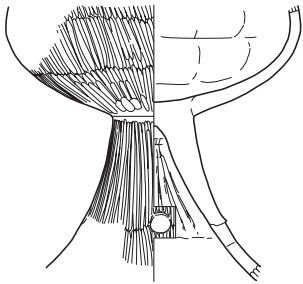

E-01Aa-056



E-01Aa-057

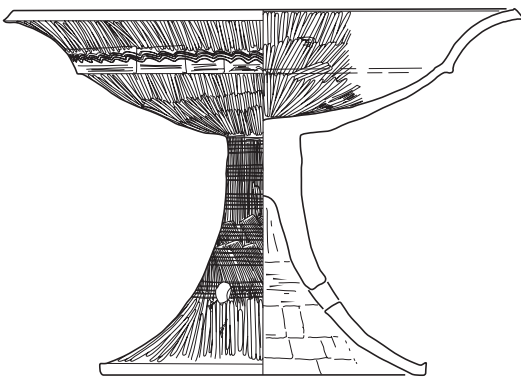

E-01Aa-058

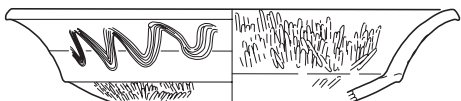

E-01Aa-059

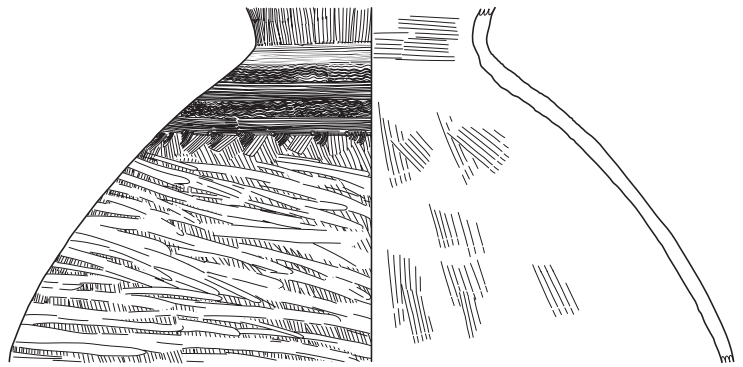

E-01Aa-054

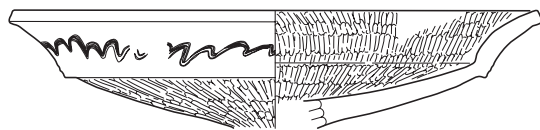

E-01Aa-060

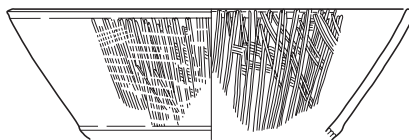

E-01Aa-061

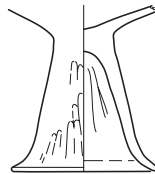

E-01Aa-062

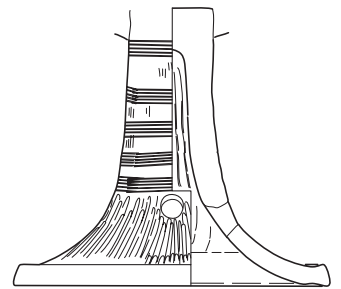

E-01Aa-065

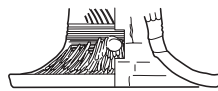

E-01Aa-063

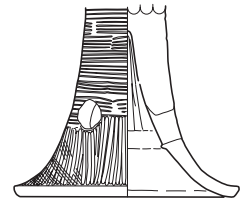

E-01Aa-066

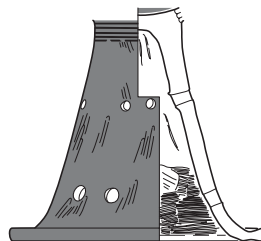

E-01Aa-064

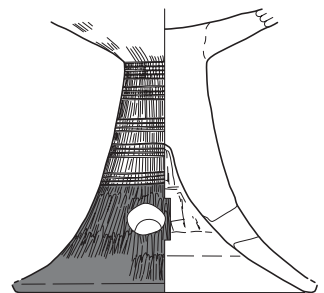

E-01Aa-067



01Aa ☒ SD04

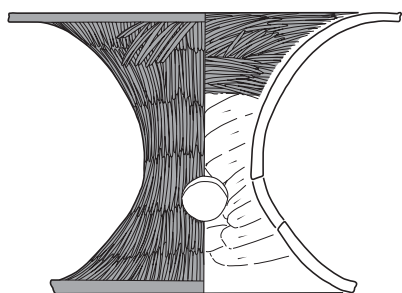

E-01Aa-068



E-01Aa-069

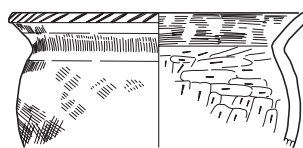

E-01Aa-070

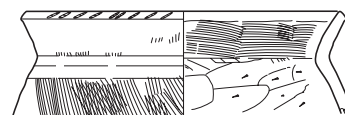

E-01Aa-071

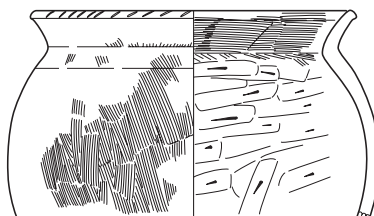

E-01Aa-072

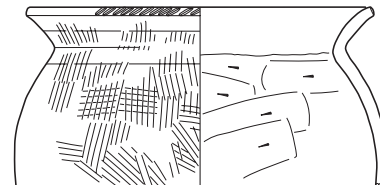

E-01Aa-073

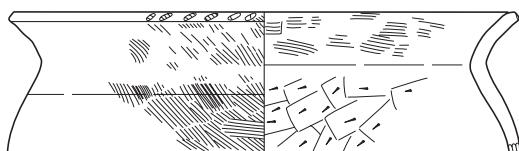

E-01Aa-074

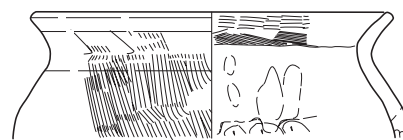

E-01Aa-077

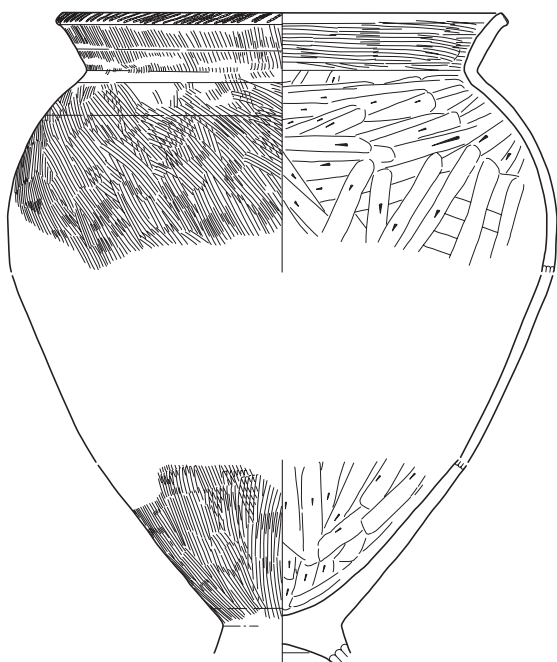

E-01Aa-075

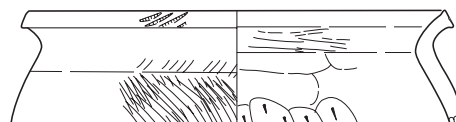

E-01Aa-078

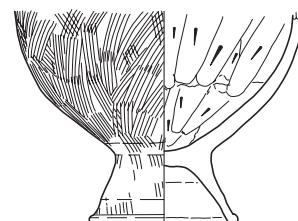

E-01Aa-082



E-01Aa-079

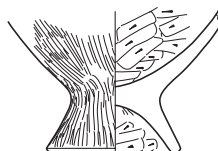

E-01Aa-080

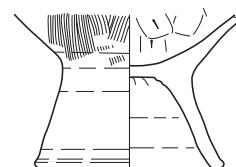

E-01Aa-083

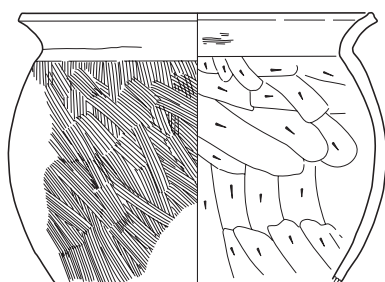

E-01Aa-076

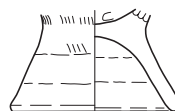

E-01Aa-081



E-01Aa-084



E-01Aa-085



01Aa ☒ SD05

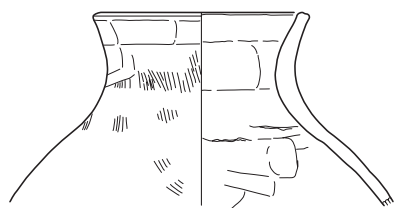

E-01Aa-086

01Aa ☒ SD06

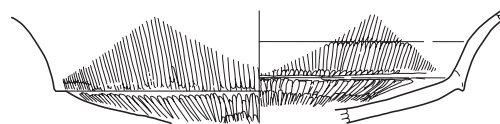

E-01Aa-087

01Aa ☒ SD07



E-01Aa-088

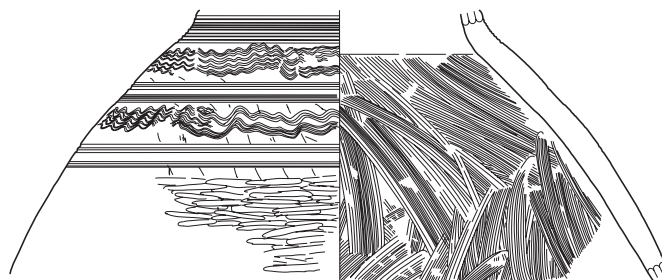

E-01Aa-089

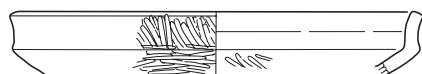

E-01Aa-090

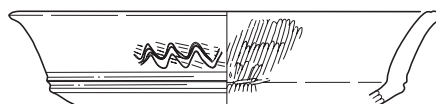

E-01Aa-093

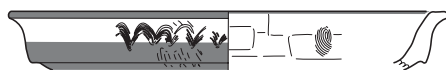

E-01Aa-091

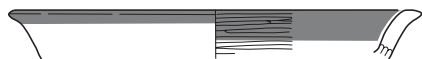

E-01Aa-092

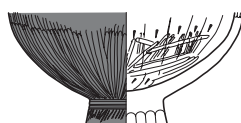

E-01Aa-094

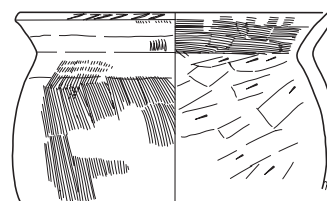

E-01Aa-095

01Aa ☒ SD08

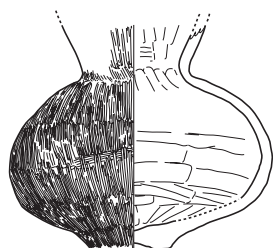

E-01Aa-096

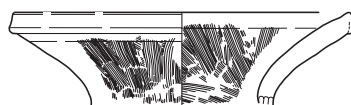

E-01Aa-098

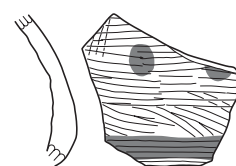

E-01Aa-100

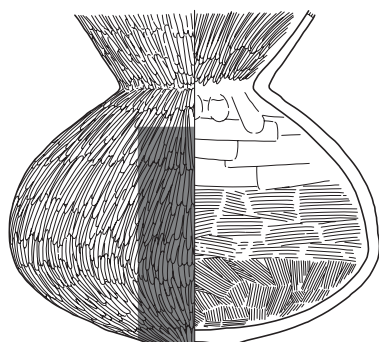

E-01Aa-097



E-01Aa-099



E-01Aa-101



01Aa ☒ SD08

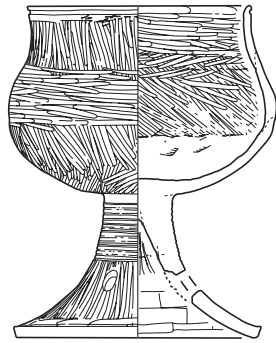

E-01Aa-102



E-01Aa-103

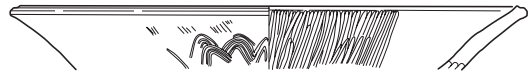

E-01Aa-104

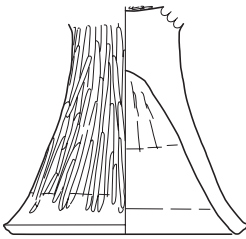
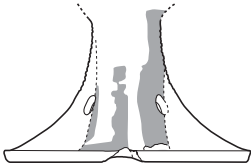

E-01Aa-105

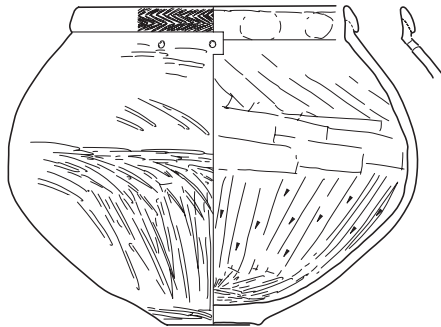

E-01Aa-107

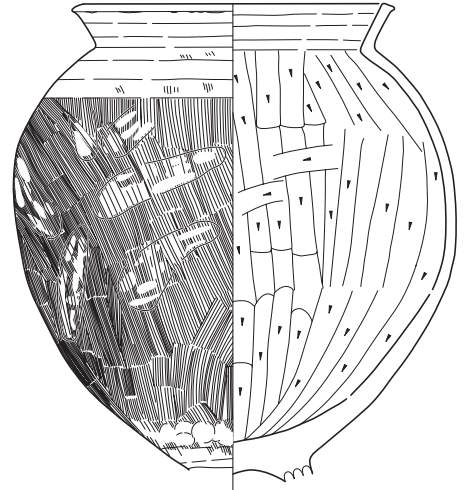

E-01Aa-108

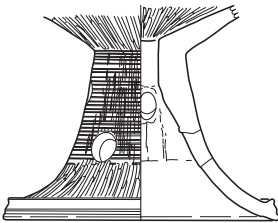

E-01Aa-106

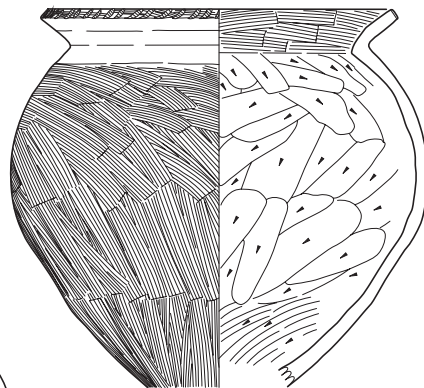

E-01Aa-109

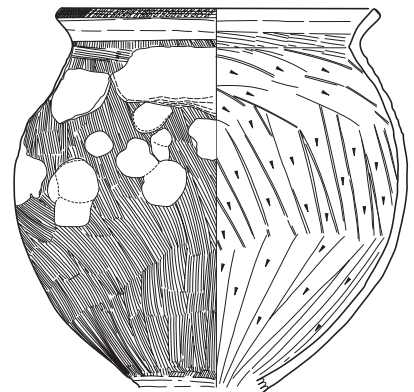

E-01Aa-110

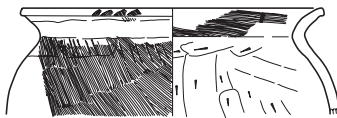

E-01Aa-111

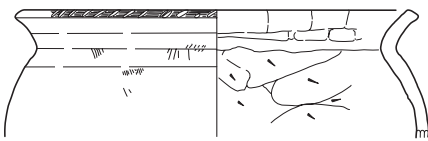

E-01Aa-112

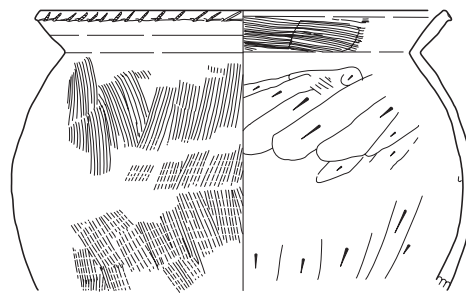

E-01Aa-114

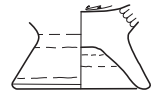

E-01Aa-116

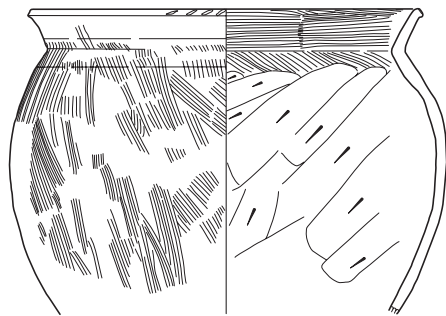

E-01Aa-113

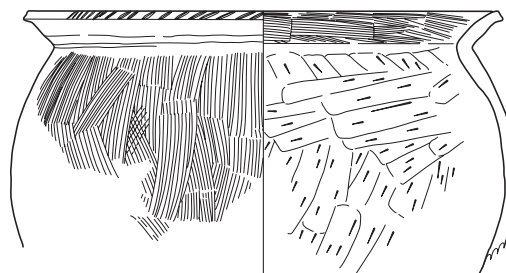

E-01Aa-115

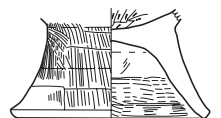

E-01Aa-117



01Aa ☒ SD09

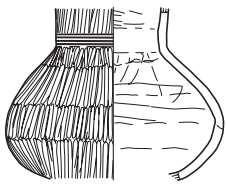

E-01Aa-118

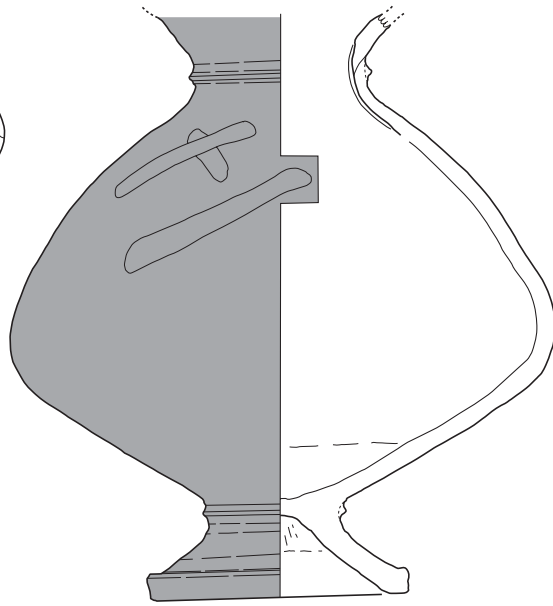

E-01Aa-119

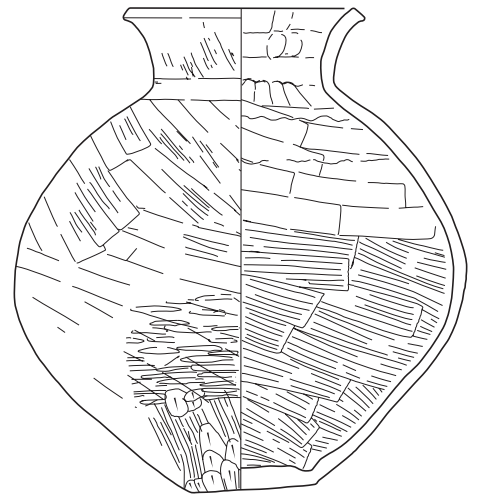

E-01Aa-120

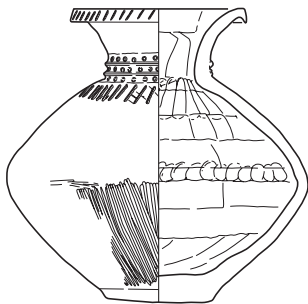

E-01Aa-121

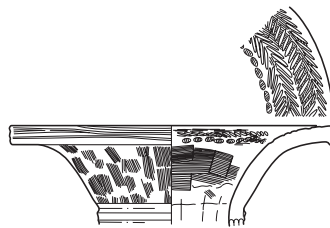

E-01Aa-122

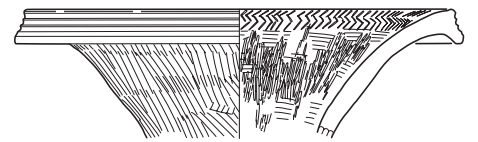

E-01Aa-124



E-01Aa-123



E-01Aa-125

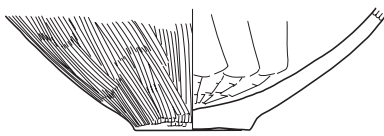

E-01Aa-126



E-01Aa-132

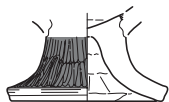

E-01Aa-127

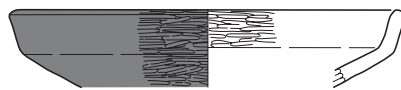

E-01Aa-130

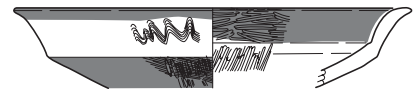

E-01Aa-133

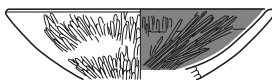

E-01Aa-128

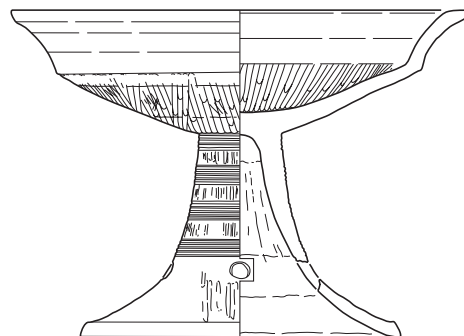

E-01Aa-131

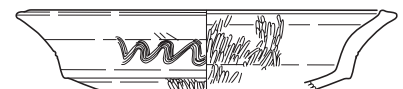

E-01Aa-134

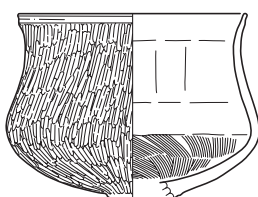

E-01Aa-129



E-01Aa-135



01Aa ☒ SD09

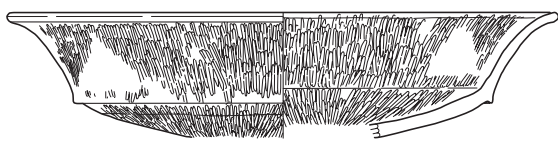

E-01Aa-136

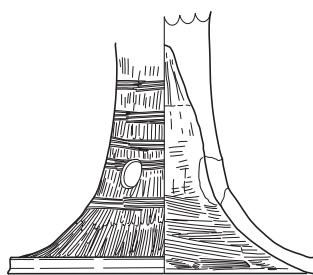

E-01Aa-137

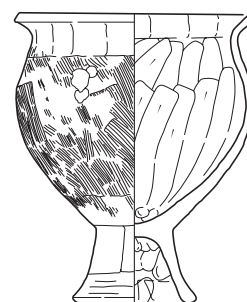

E-01Aa-138

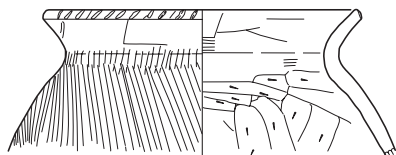

E-01Aa-139

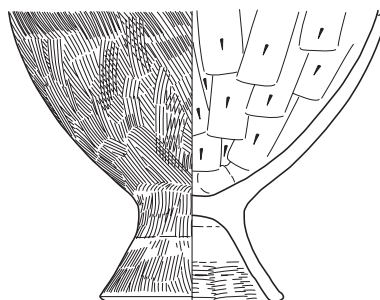

E-01Aa-141

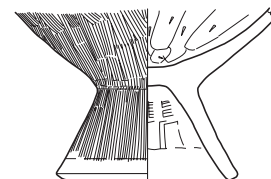

E-01Aa-142

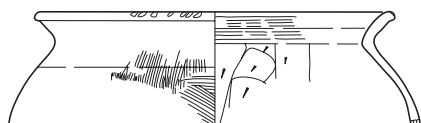

E-01Aa-140

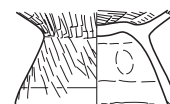

E-01Aa-143

01Aa ☒ SD10

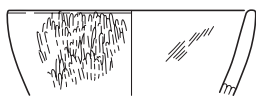

E-01Aa-144

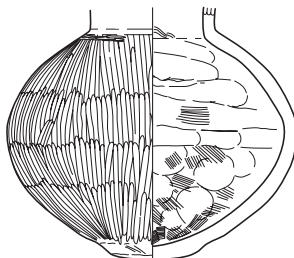

E-01Aa-146

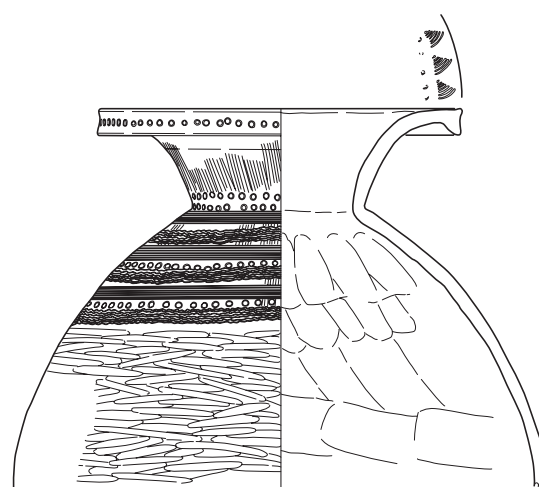

E-01Aa-148

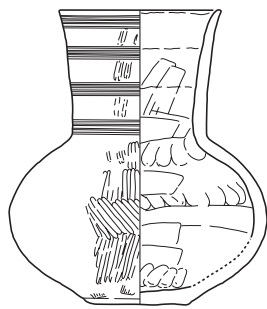

E-01Aa-145

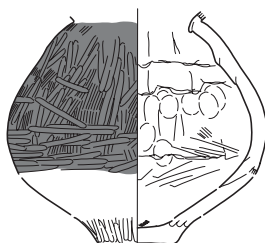

E-01Aa-147



E-01Aa-149

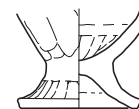

E-01Aa-152



E-01Aa-150

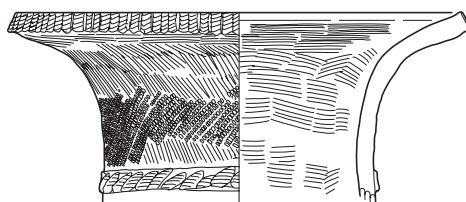

E-01Aa-151

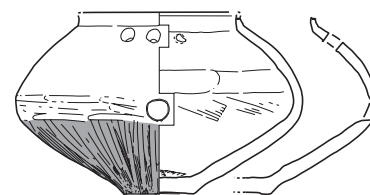

E-01Aa-153



01Aa ☒ SD10

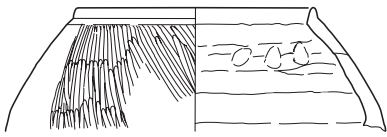

E-01Aa-154

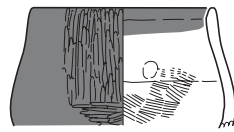

E-01Aa-155



E-01Aa-156

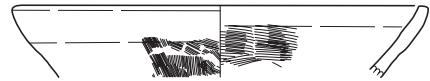

E-01Aa-159

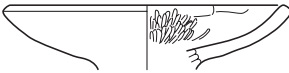

E-01Aa-157



E-01Aa-158

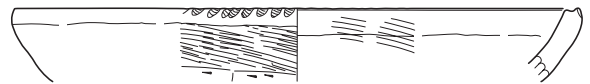

E-01Aa-160

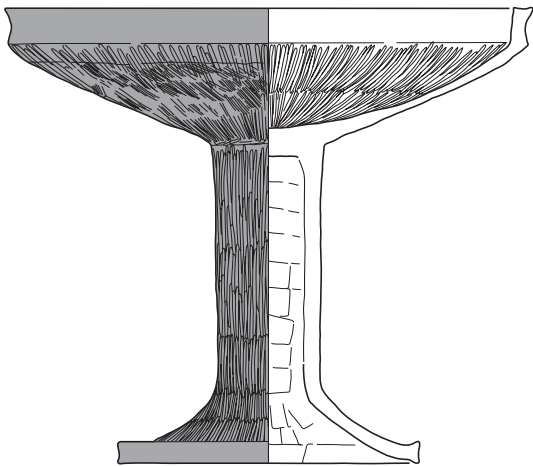

E-01Aa-161

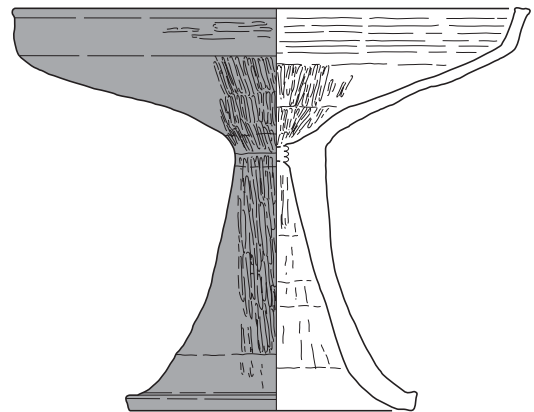

E-01Aa-162

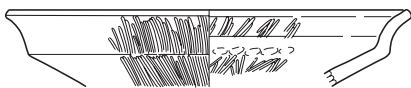

E-01Aa-163

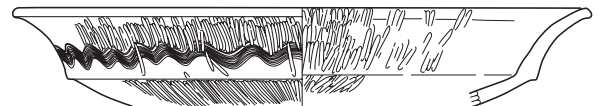

E-01Aa-169



E-01Aa-164

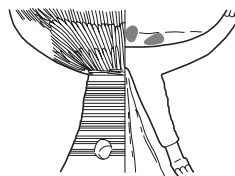

E-01Aa-170

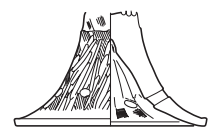

E-01Aa-174

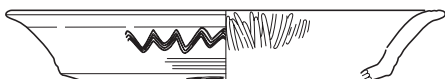

E-01Aa-165



E-01Aa-171

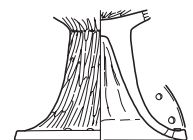

E-01Aa-175

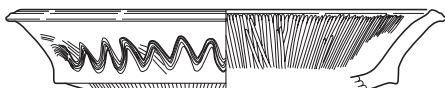

E-01Aa-166



E-01Aa-172

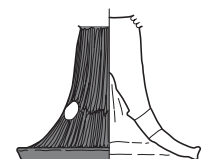

E-01Aa-176

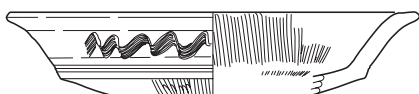

E-01Aa-167

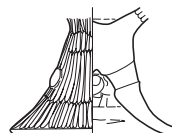

E-01Aa-173

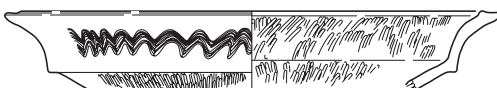

E-01Aa-168





01Aa ☒ SD10

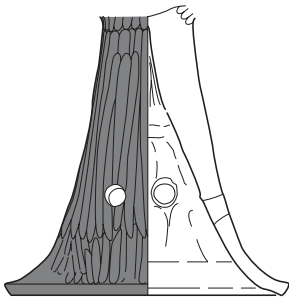

E-01Aa-177

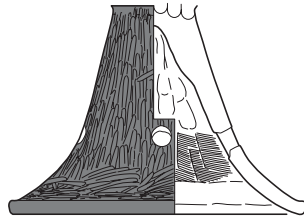

E-01Aa-178

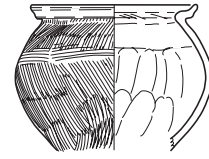

E-01Aa-183

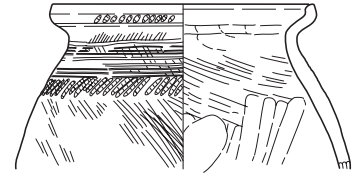

E-01Aa-184

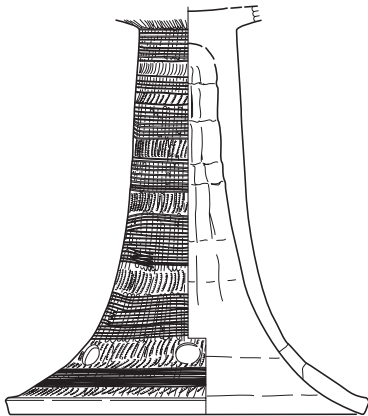

E-01Aa-179



E-01Aa-180

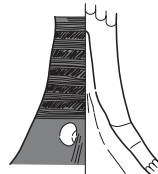

E-01Aa-181

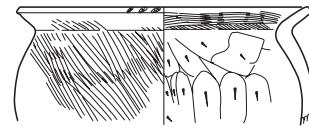

E-01Aa-185

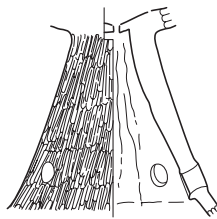

E-01Aa-182

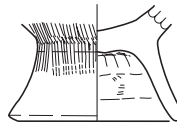

E-01Aa-187

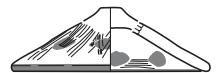

E-01Aa-188

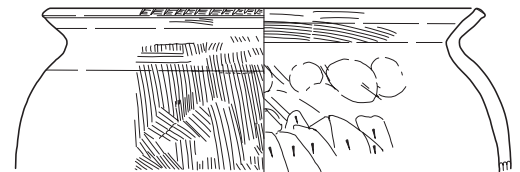

E-01Aa-186

01Aa ☒ SD11

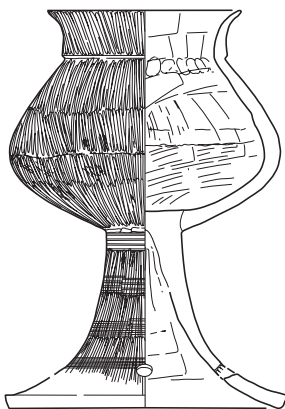

E-01Aa-189

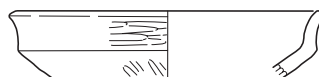

E-01Aa-191

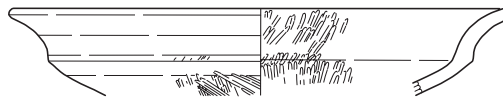

E-01Aa-192

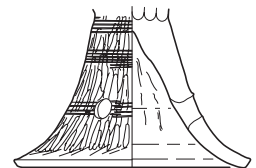

E-01Aa-193

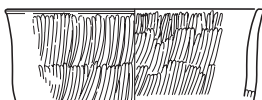

E-01Aa-190

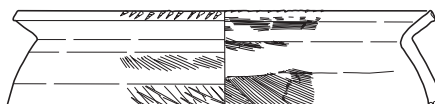

E-01Aa-194

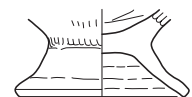

E-01Aa-195

01Aa ☒ SD12

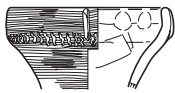

E-01Aa-196

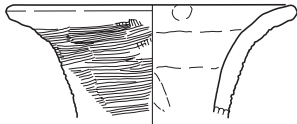

E-01Aa-198

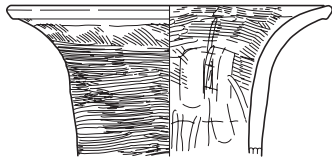

E-01Aa-199

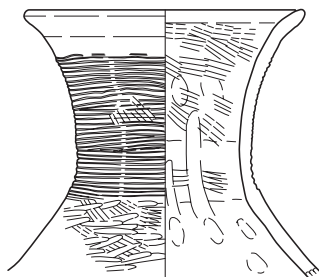

E-01Aa-200

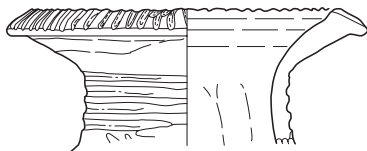

E-01Aa-204

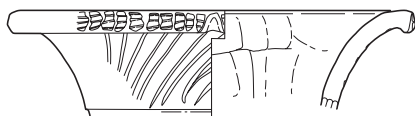

E-01Aa-205



E-01Aa-208

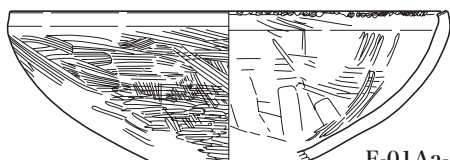

E-01Aa-209

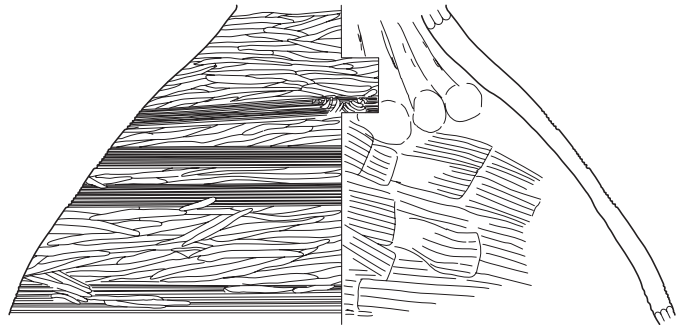

E-01Aa-197



E-01Aa-201

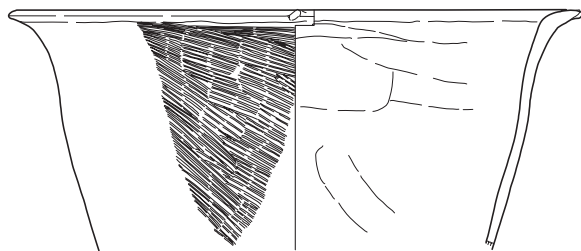

E-01Aa-202



E-01Aa-203

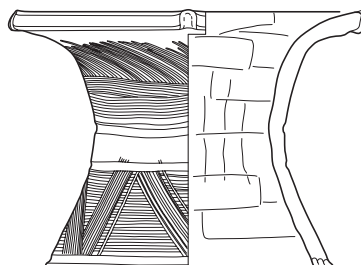

E-01Aa-206

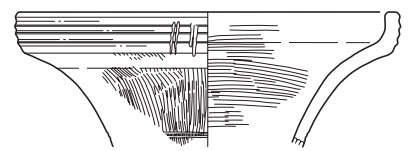

E-01Aa-207

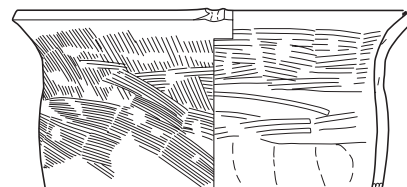

E-01Aa-210

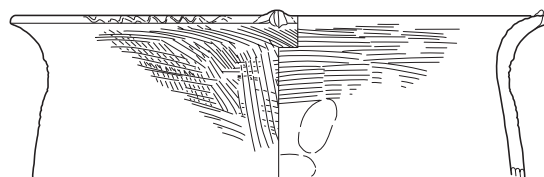

E-01Aa-211



01Aa ☒ SD12

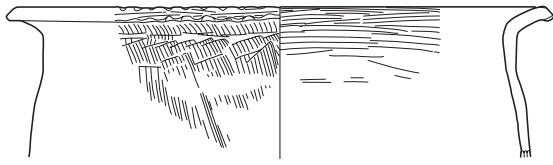

E-01Aa-212

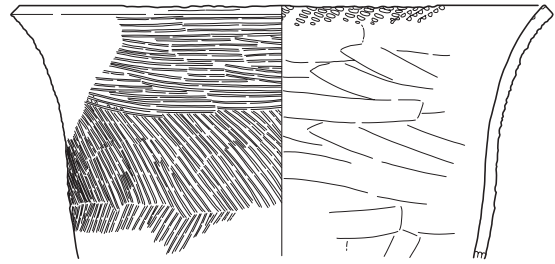

E-01Aa-213

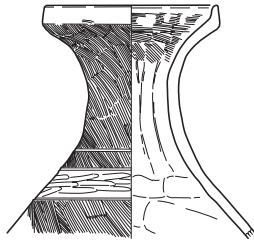

E-01Aa-214

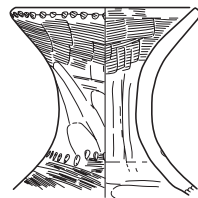

E-01Aa-215

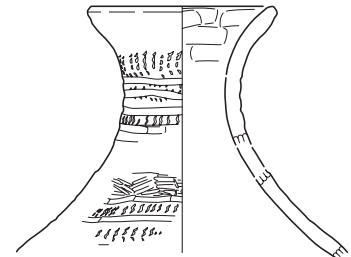

E-01Aa-216



E-01Aa-217

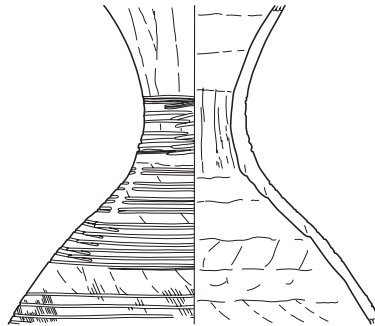

E-01Aa-219

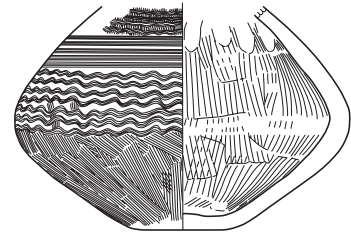

E-01Aa-220

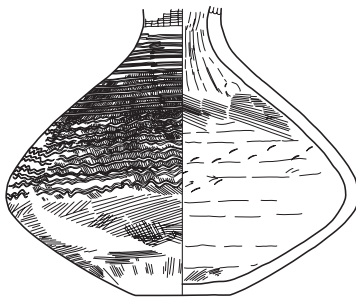

E-01Aa-218

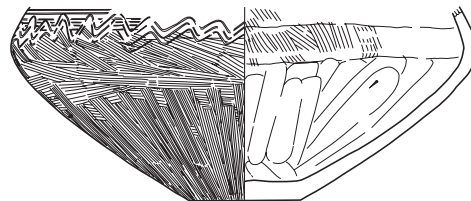

E-01Aa-221

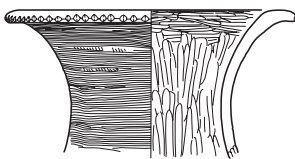

E-01Aa-222

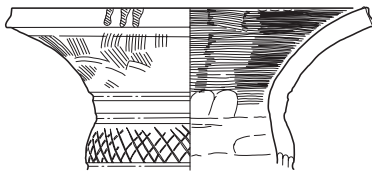

E-01Aa-223

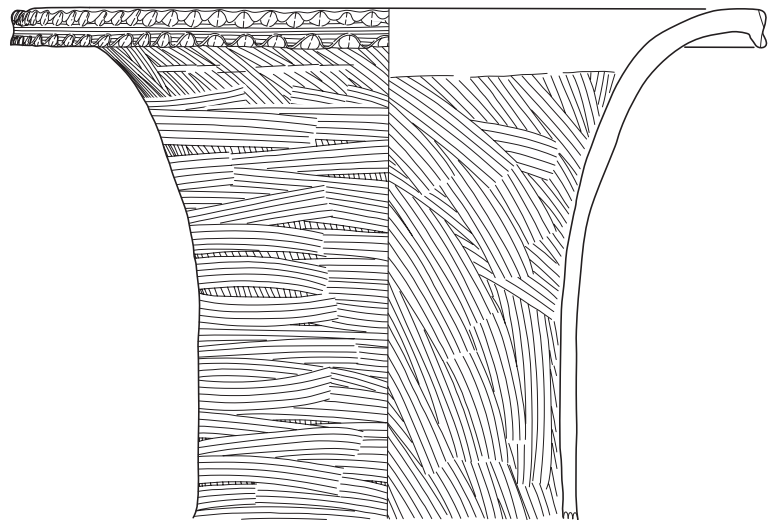

E-01Aa-225



E-01Aa-224



01Aa ☒ SD12

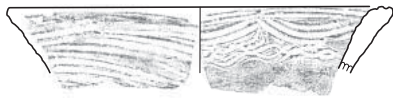

E-01Aa-226

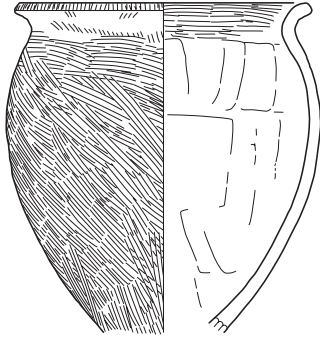

E-01Aa-227

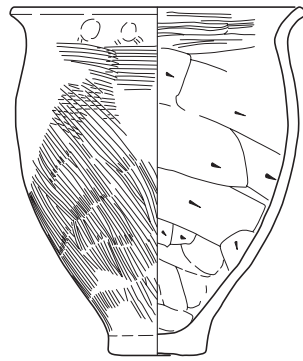

E-01Aa-228

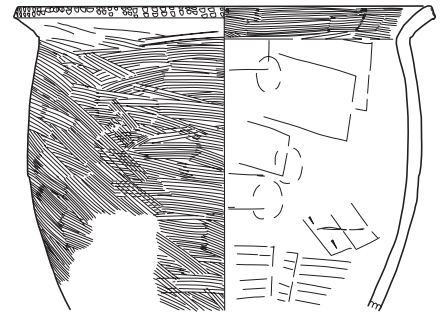

E-01Aa-229

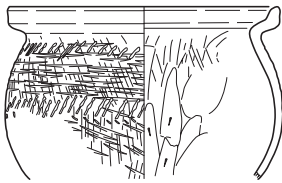

E-01Aa-230

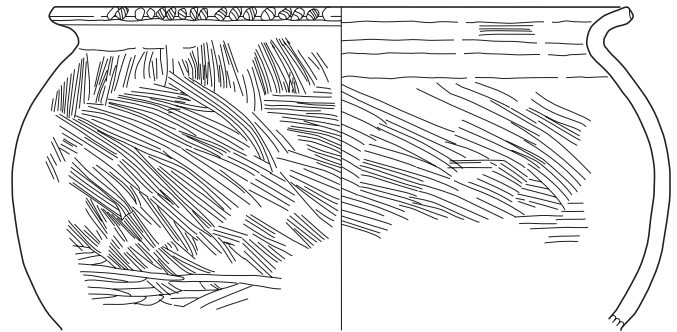

E-01Aa-232

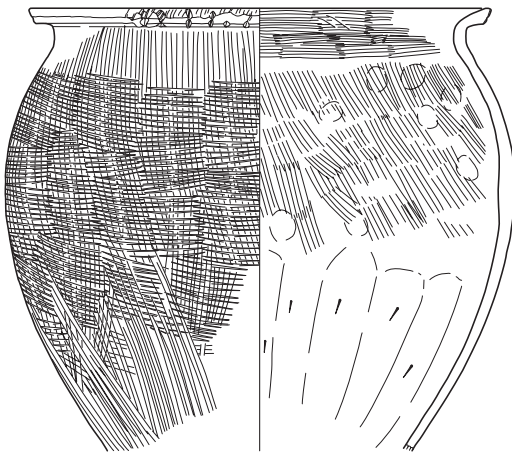

E-01Aa-231

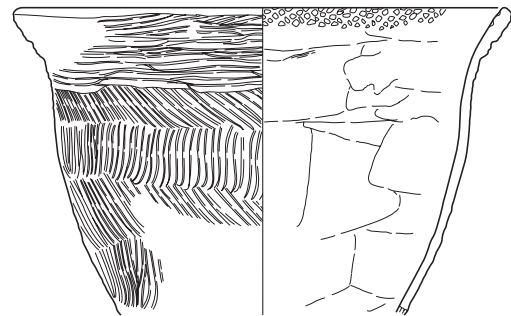

E-01Aa-233

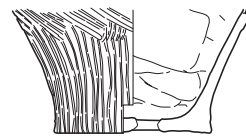

E-01Aa-235

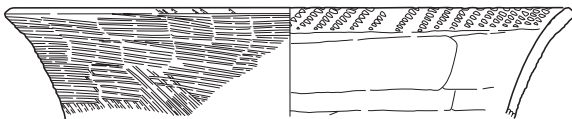

E-01Aa-234

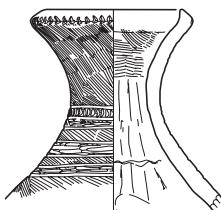

E-01Aa-236

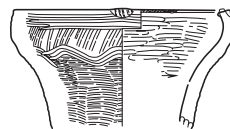

E-01Aa-237

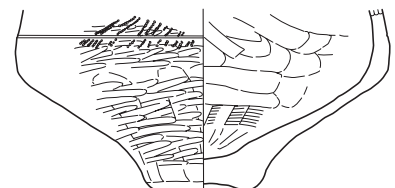

E-01Aa-238



01Aa ☒ SD12

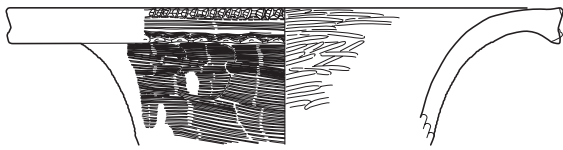

E-01Aa-239

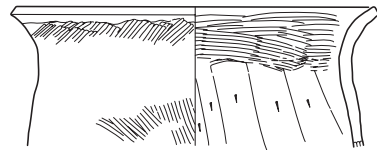

E-01Aa-242

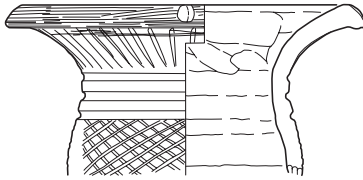

E-01Aa-240

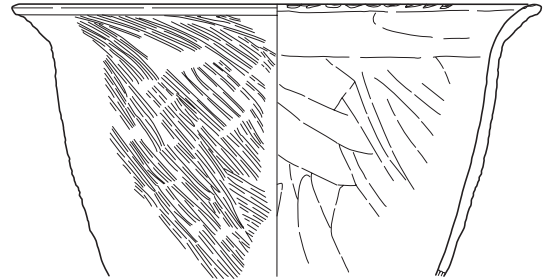

E-01Aa-243

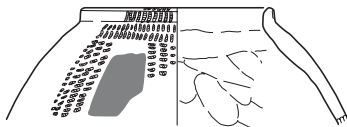

E-01Aa-241

01Aa ☒ SD13

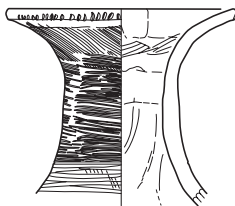

E-01Aa-244

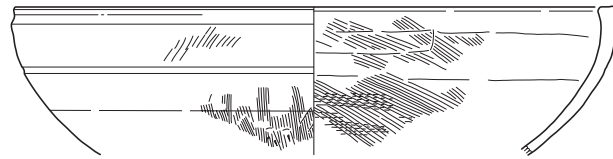

E-01Aa-246



E-01Aa-245



E-01Aa-247

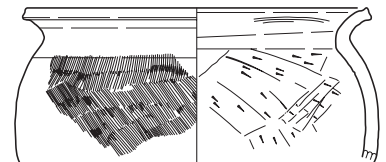

E-01Aa-249

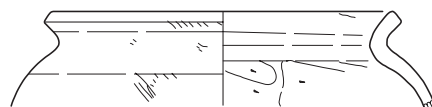

E-01Aa-248

01Aa ☒ SD15

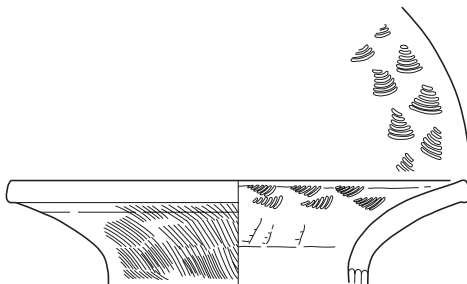

E-01Aa-250

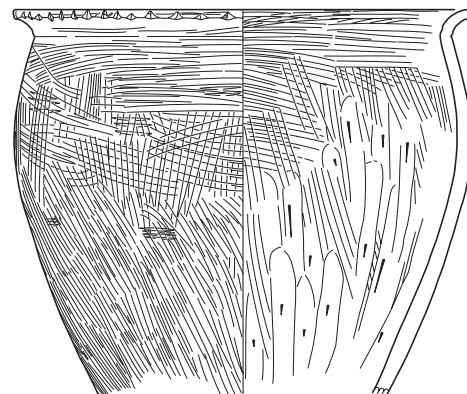

E-01Aa-251



01Aa ☒ SD16

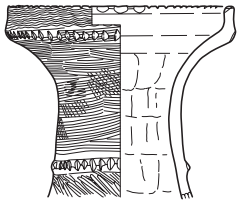

E-01Aa-252

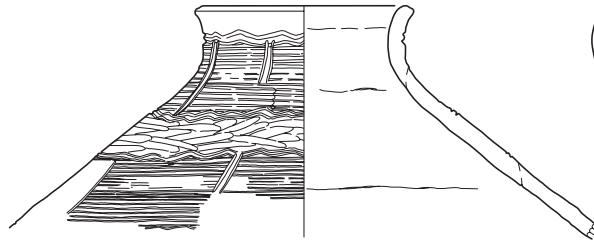

E-01Aa-256

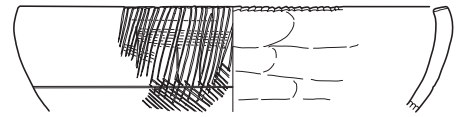

E-01Aa-259



E-01Aa-253

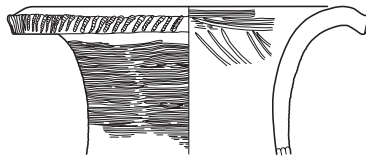

E-01Aa-257

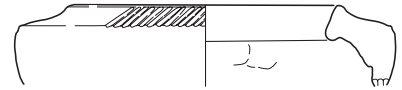

E-01Aa-260

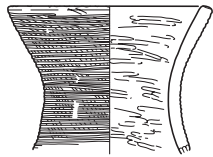

E-01Aa-254

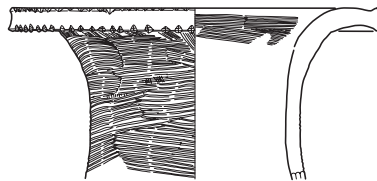

E-01Aa-258

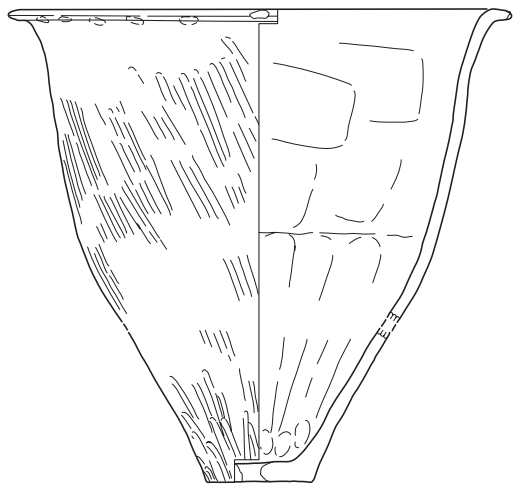

E-01Aa-261

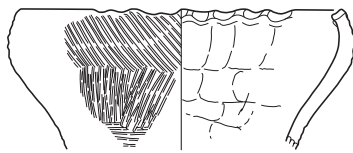

E-01Aa-255

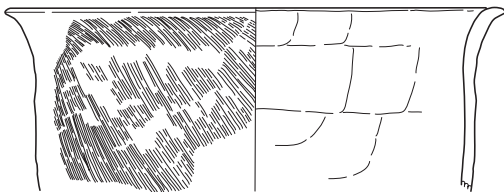

E-01Aa-262

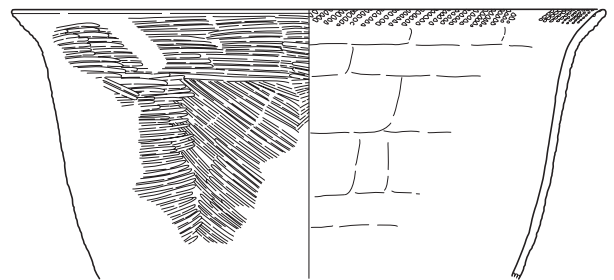

E-01Aa-265

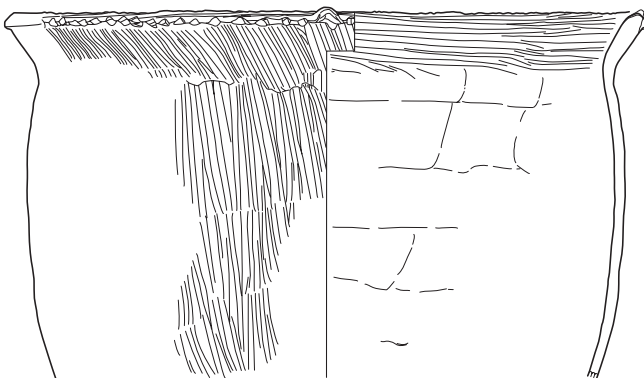

E-01Aa-263

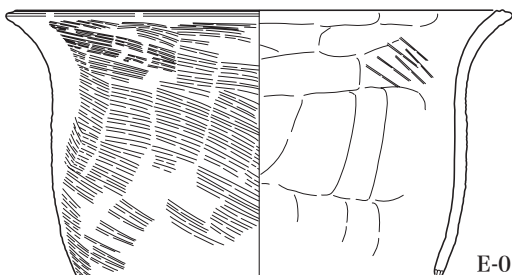

E-01Aa-264

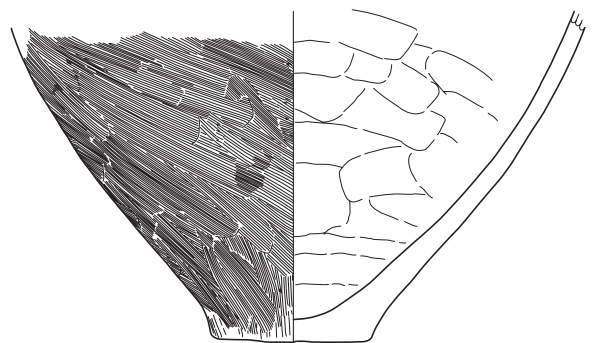

E-01Aa-266



01Aa ☒ SD16



E-01Aa-267

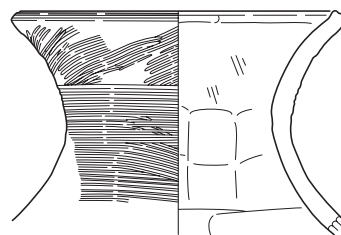

E-01Aa-268

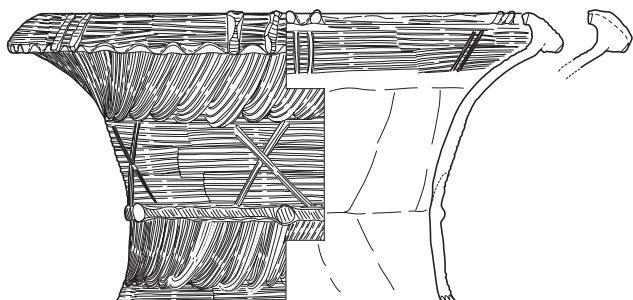

E-01Aa-269

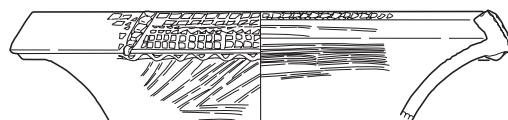

E-01Aa-270

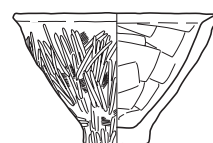

E-01Aa-273

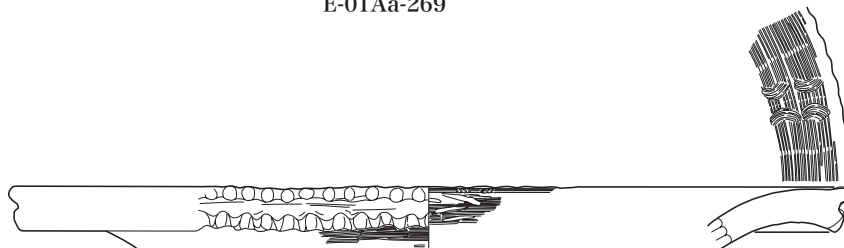

E-01Aa-271

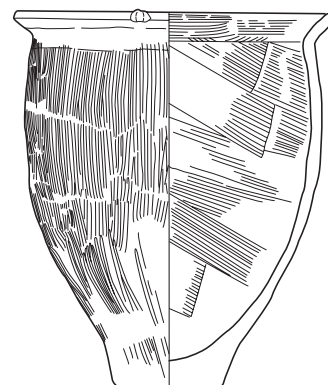

E-01Aa-274

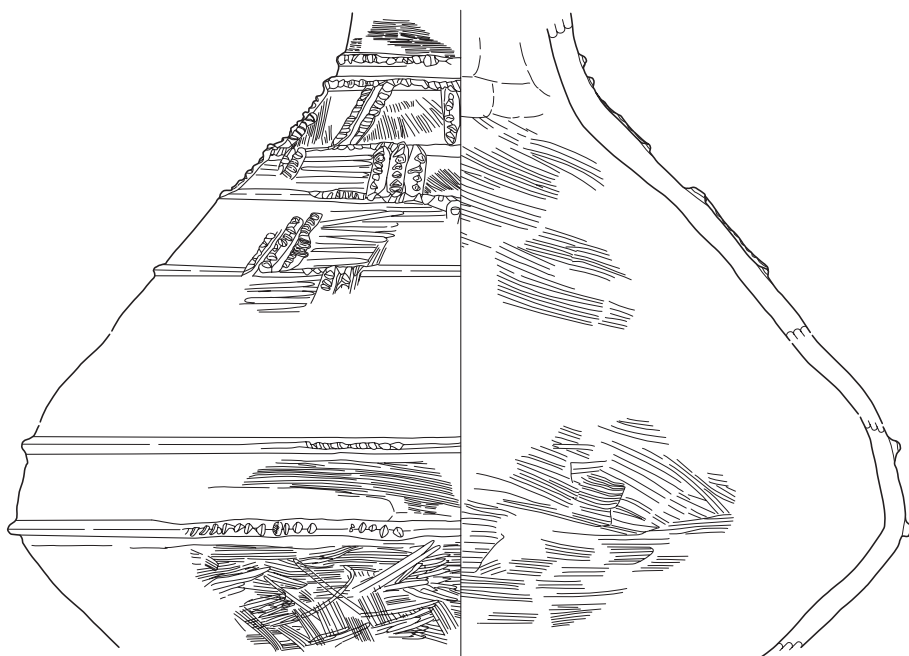

E-01Aa-272

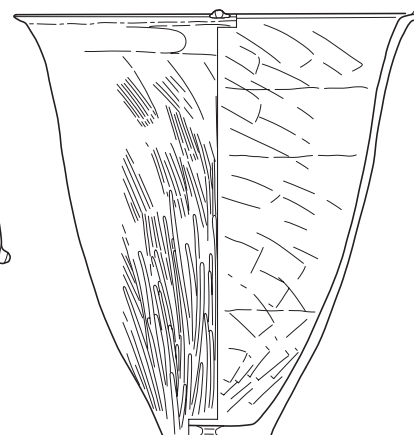

E-01Aa-275

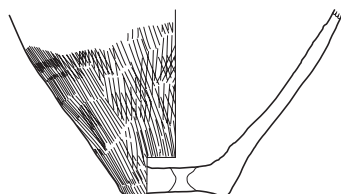

E-01Aa-276

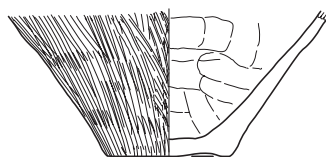

E-01Aa-277



01Aa ☒ SD16

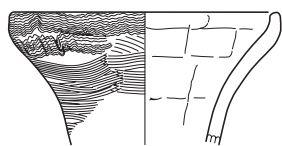

E-01Aa-278

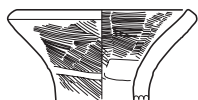

E-01Aa-279

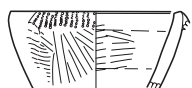

E-01Aa-280

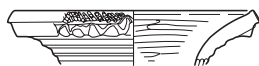

E-01Aa-281

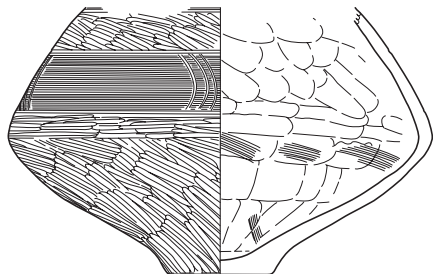

E-01Aa-282

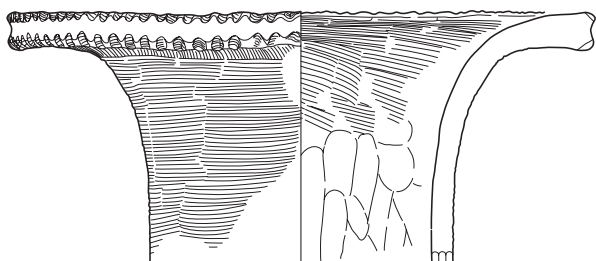

E-01Aa-284

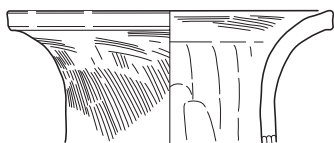

E-01Aa-285

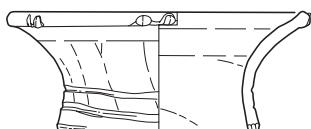

E-01Aa-286



E-01Aa-287

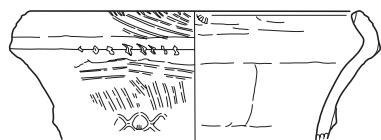

E-01Aa-288

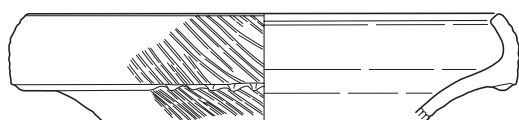

E-01Aa-289

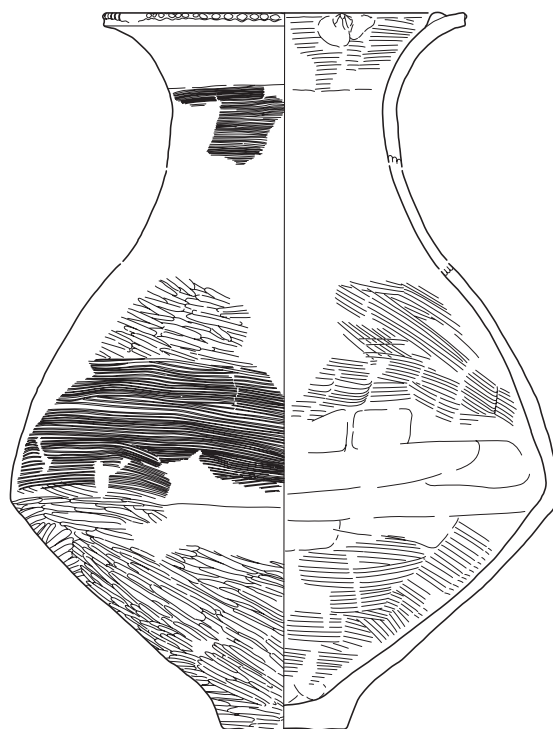

E-01Aa-283

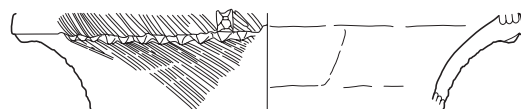

E-01Aa-290

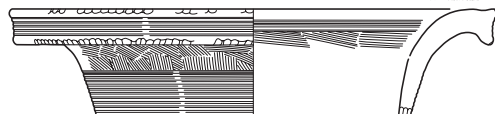
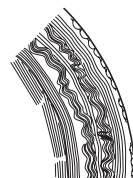

E-01Aa-291

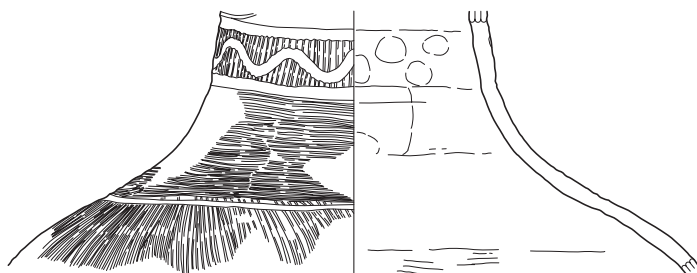

E-01Aa-292





01Aa ☒ SD16

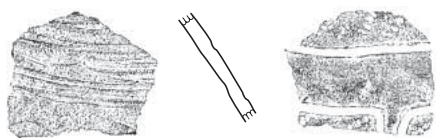

E-01Aa-293



E-01Aa-294

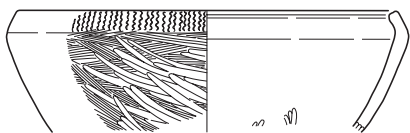

E-01Aa-295

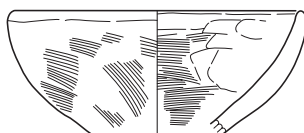

E-01Aa-296

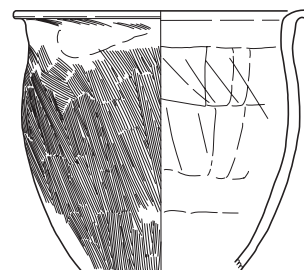

E-01Aa-299

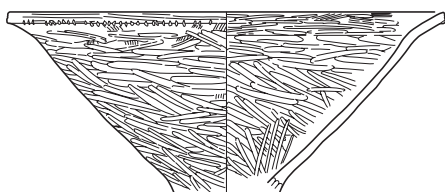

E-01Aa-297

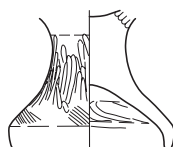

E-01Aa-298

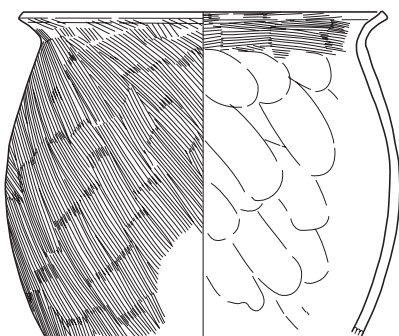

E-01Aa-300

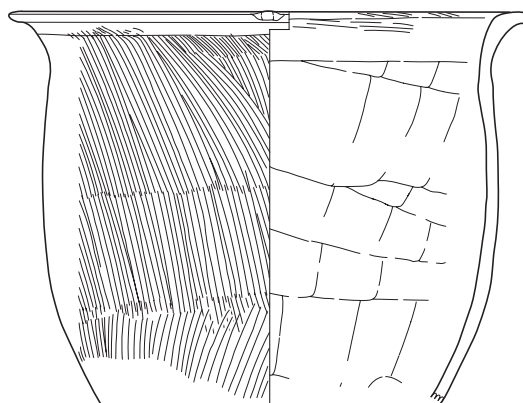

E-01Aa-301

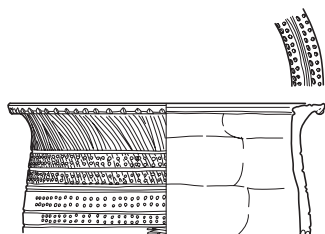

E-01Aa-302

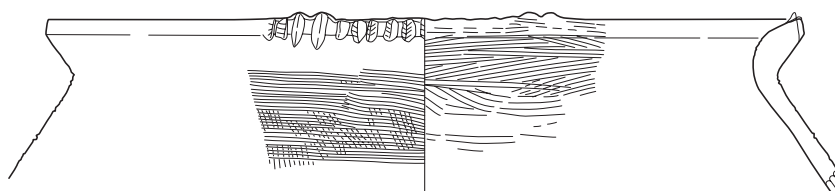

E-01Aa-304

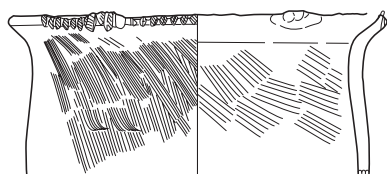

E-01Aa-303

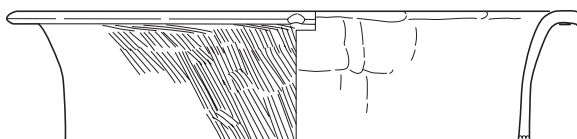

E-01Aa-305

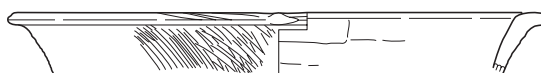

E-01Aa-306



01Aa ☒ SD16

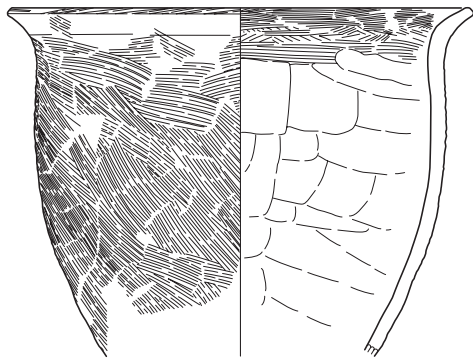

E-01Aa-307

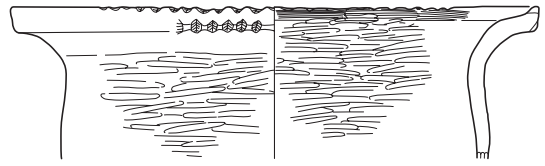

E-01Aa-308

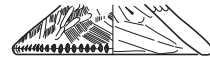

E-01Aa-309

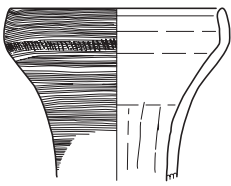

E-01Aa-310

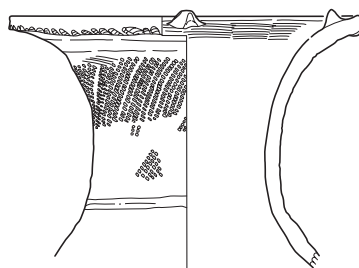

E-01Aa-313

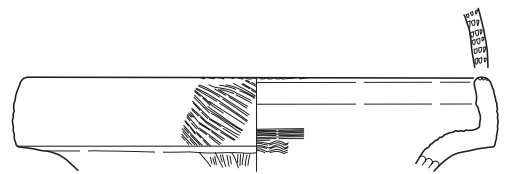

E-01Aa-315

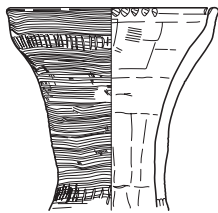

E-01Aa-311

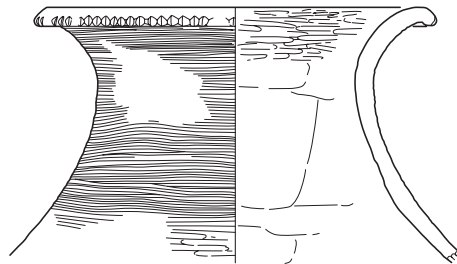

E-01Aa-314

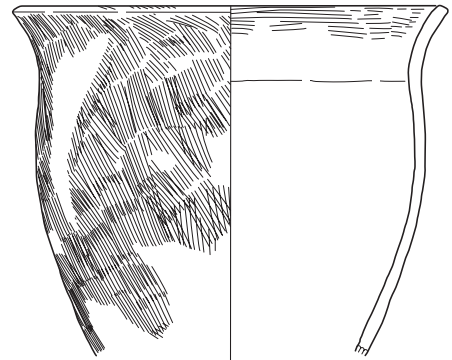

E-01Aa-316

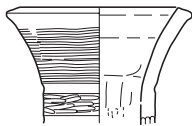

E-01Aa-312

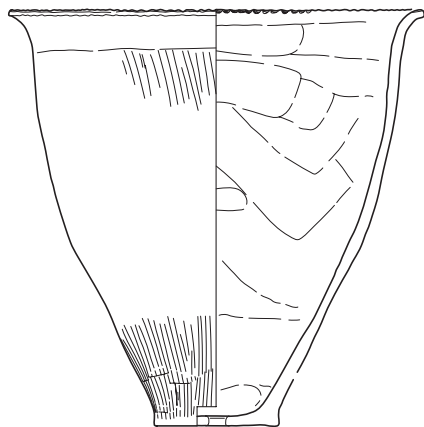

E-01Aa-317

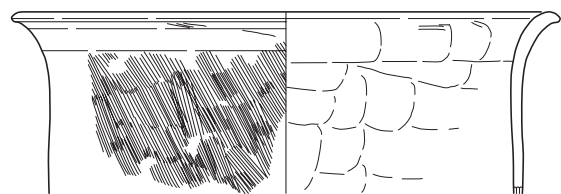

E-01Aa-319

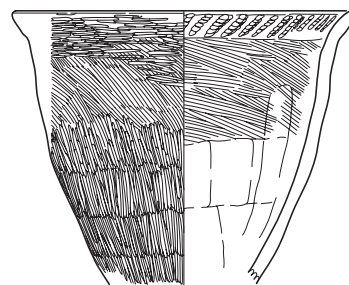

E-01Aa-320

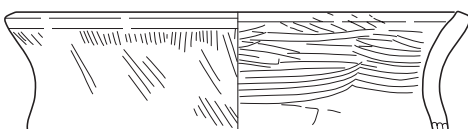

E-01Aa-318



01Aa ☒ SD16

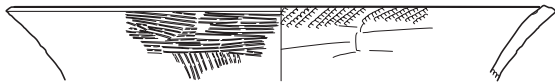

E-01Aa-321

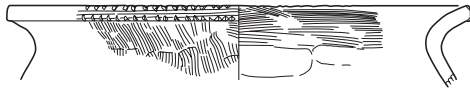

E-01Aa-323

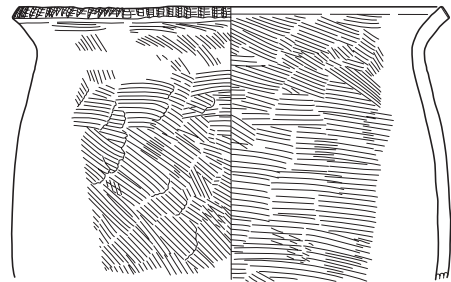

E-01Aa-322

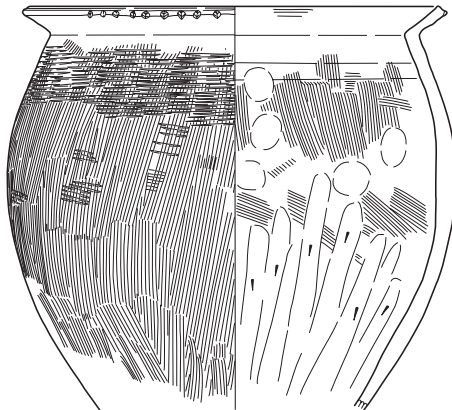

E-01Aa-324

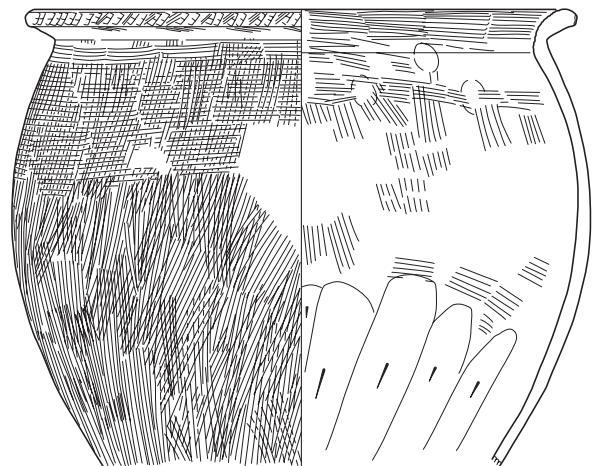

E-01Aa-325

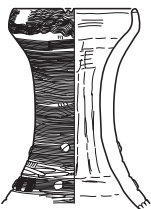

E-01Aa-326

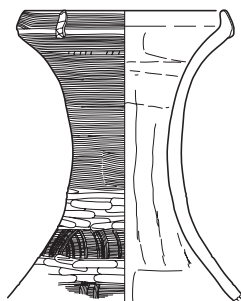

E-01Aa-329

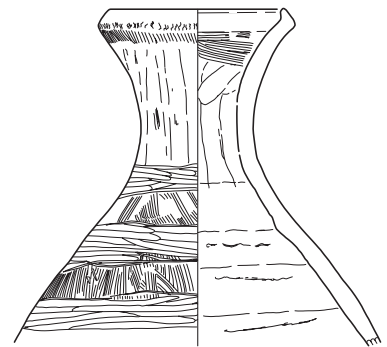

E-01Aa-331

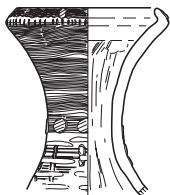

E-01Aa-327

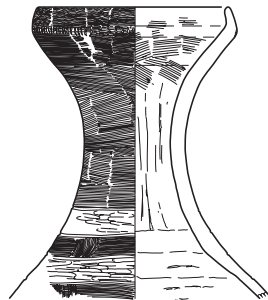

E-01Aa-330

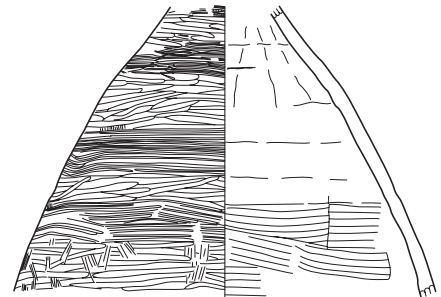

E-01Aa-332

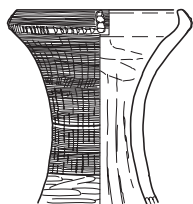

E-01Aa-328



01Aa ☒ SD16

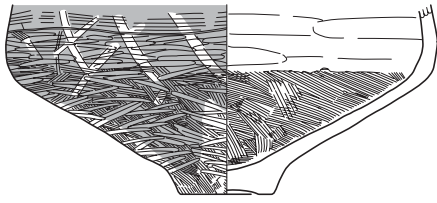

E-01Aa-333

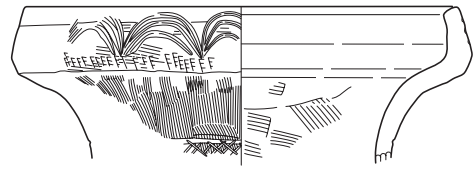

E-01Aa-339

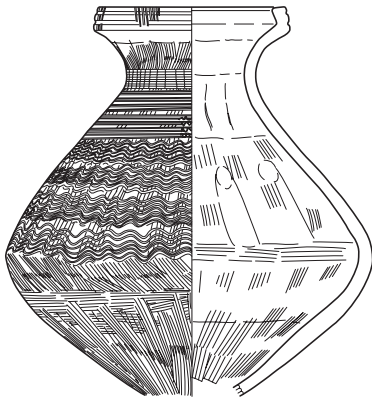

E-01Aa-334

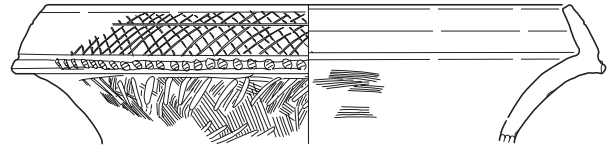

E-01Aa-340

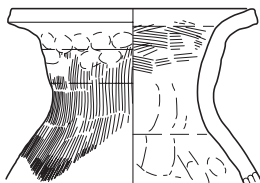

E-01Aa-335

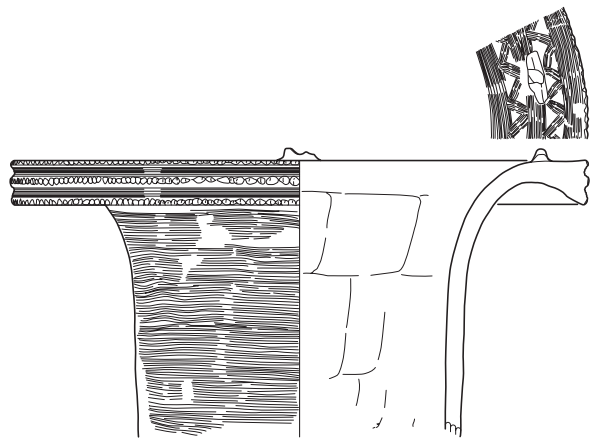

E-01Aa-341

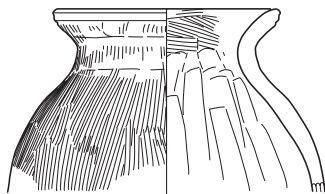

E-01Aa-336

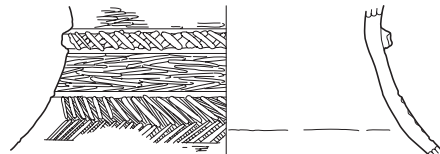

E-01Aa-342

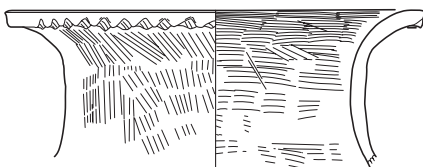

E-01Aa-337

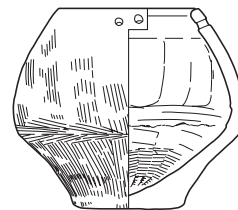

E-01Aa-343

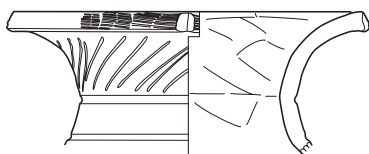
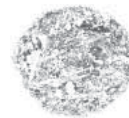

E-01Aa-338



E-01Aa-344



01Aa ☒ SD16

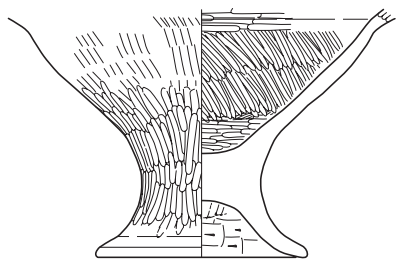

E-01Aa-345

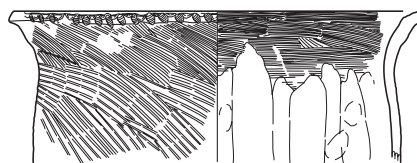

E-01Aa-349

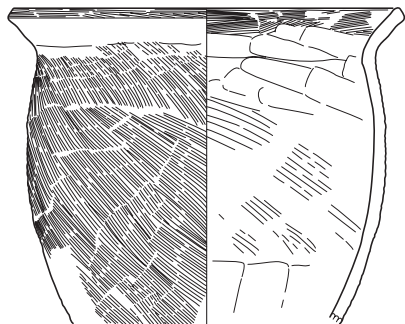

E-01Aa-346

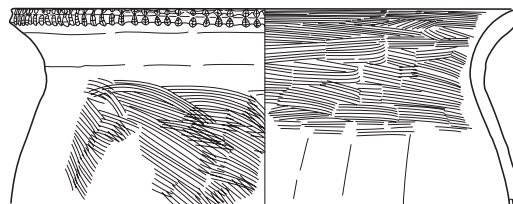

E-01Aa-350

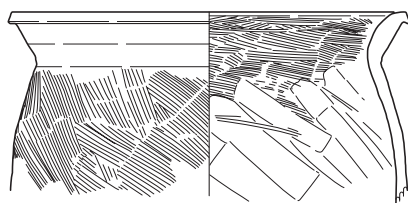

E-01Aa-347

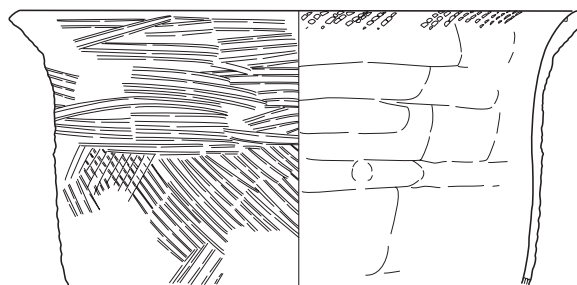

E-01Aa-351

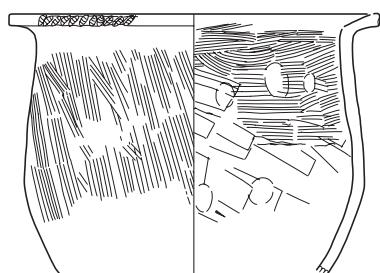

E-01Aa-348

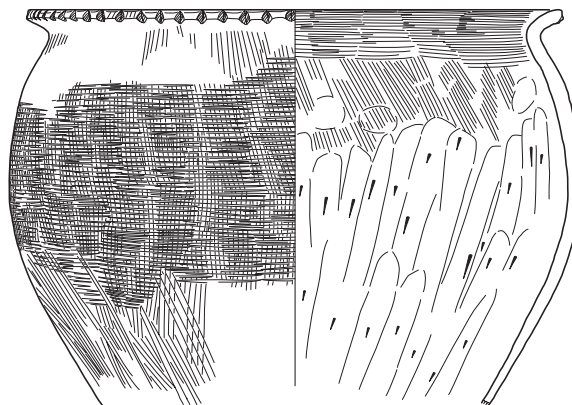

E-01Aa-352



E-01Aa-353

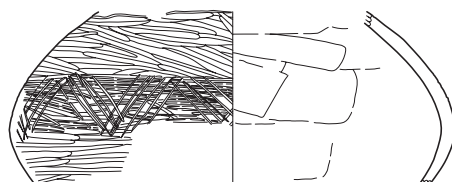

E-01Aa-355

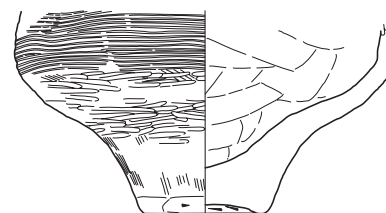

E-01Aa-356

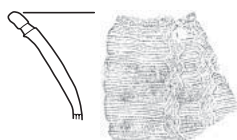

E-01Aa-354



01Aa ☒ SD16

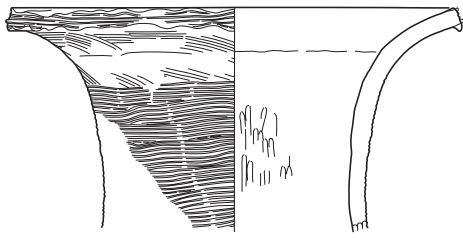

E-01Aa-357

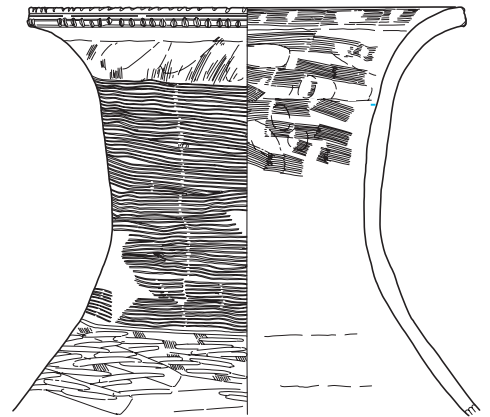

E-01Aa-358

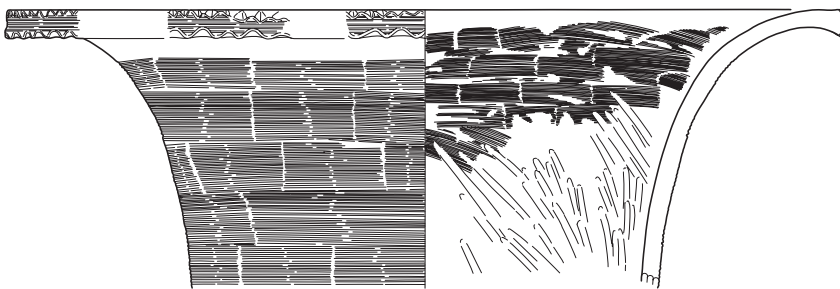

E-01Aa-359

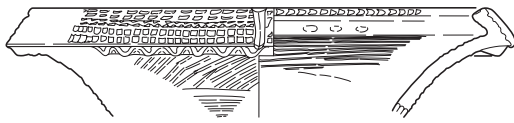

E-01Aa-360

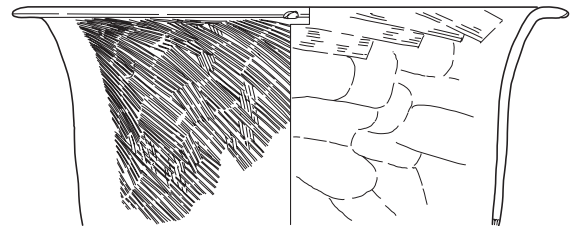

E-01Aa-363

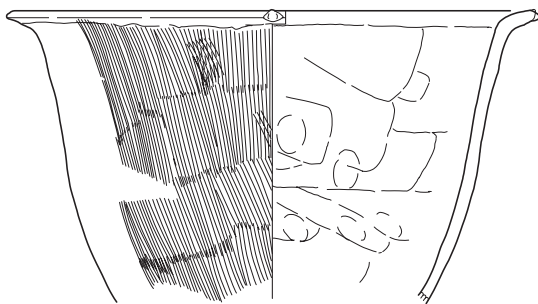

E-01Aa-361

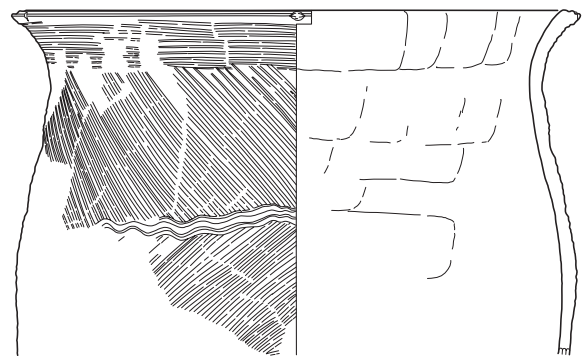

E-01Aa-364

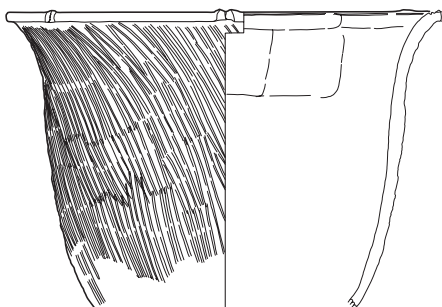

E-01Aa-362

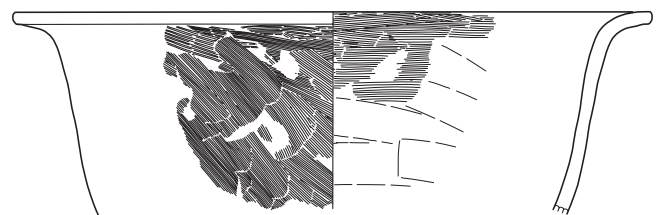

E-01Aa-365



01Aa ☒ SK10

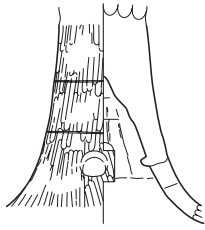

E-01Aa-366

01Aa ☒ SK12

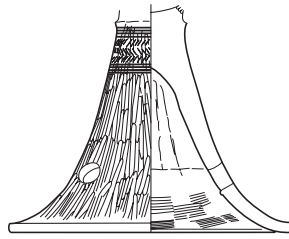

E-01Aa-367

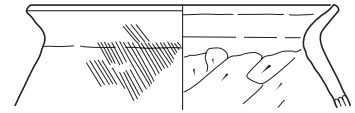

E-01Aa-368

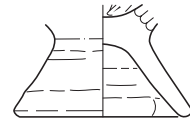

E-01Aa-369

01Aa ☒ SK14

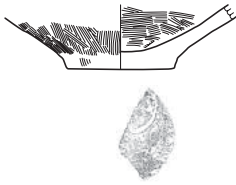

E-01Aa-370

01Aa ☒ SK18



E-01Aa-371



E-01Aa-372

01Aa ☒ SK24

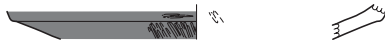

E-01Aa-373

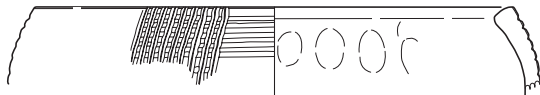

E-01Aa-374

01Aa ☒ SK32

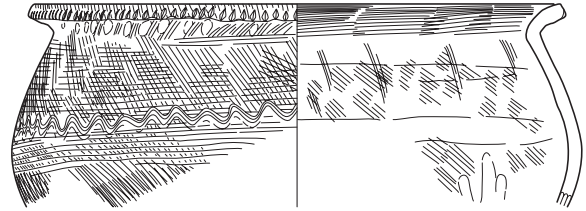

E-01Aa-376

01Aa ☒ SK28



E-01Aa-375

01Aa ☒ SK38



E-01Aa-377

01Aa ☒ SK43



E-01Aa-378

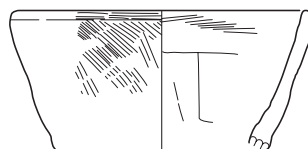

E-01Aa-379

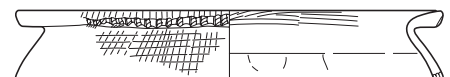

E-01Aa-381

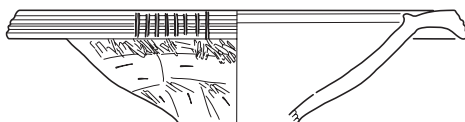

E-01Aa-380

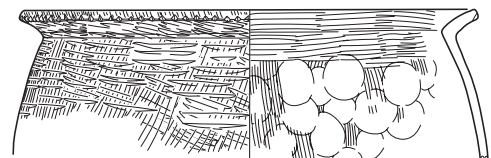

E-01Aa-382



01Aa ☒ SK44

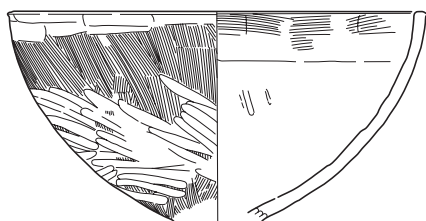

E-01Aa-383

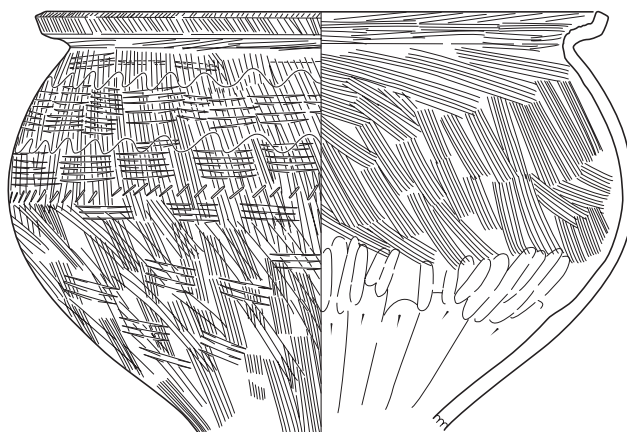

E-01Aa-385

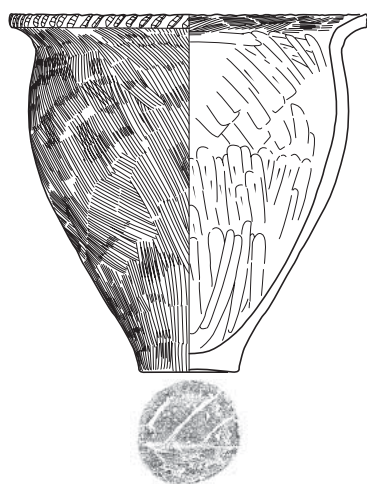

E-01Aa-384

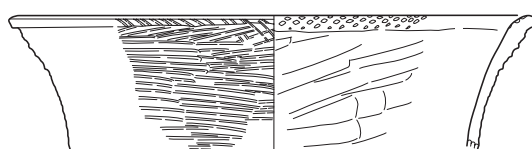

E-01Aa-386



E-01Aa-387

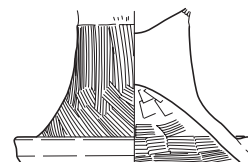

E-01Aa-388

01Aa ☒ SK52

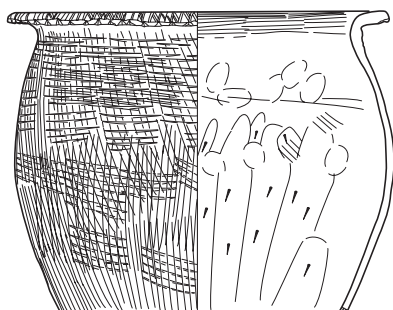

E-01Aa-389

01Aa ☒ SK56



E-01Aa-390

01Aa ☒ SZ01



E-01Aa-391

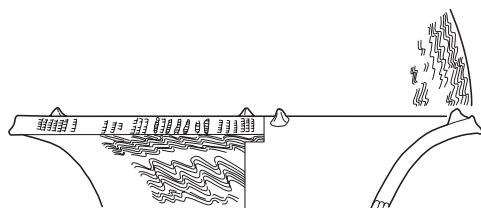

E-01Aa-393

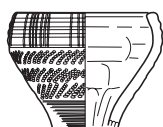

E-01Aa-392

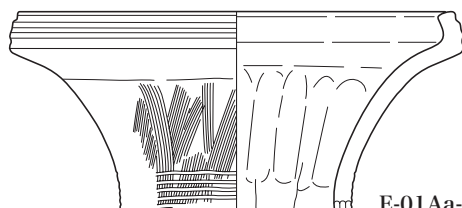

E-01Aa-394

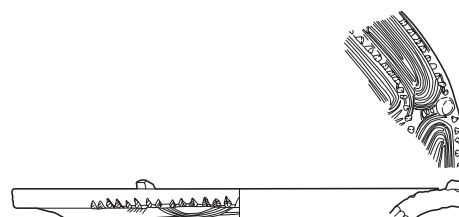

E-01Aa-395





01Aa ☒ SZ01

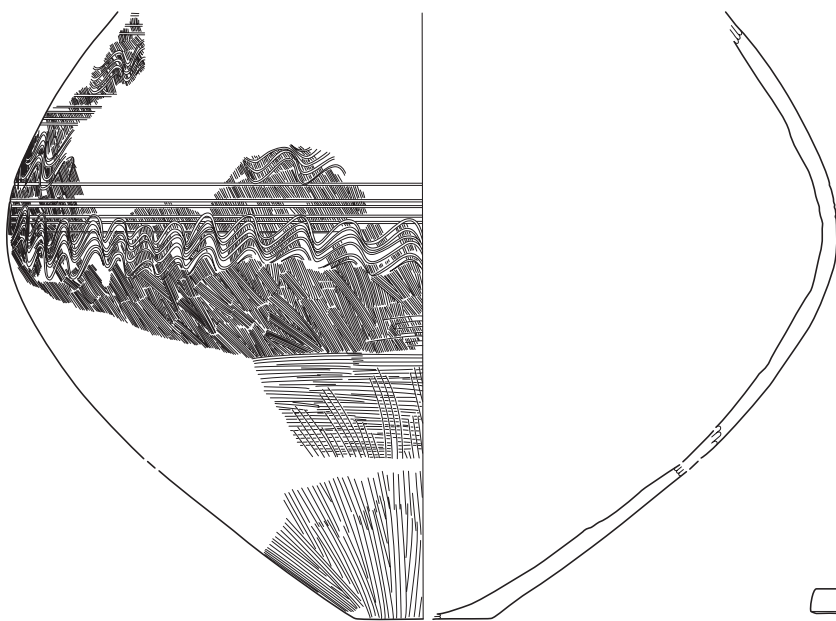

E-01Aa-396

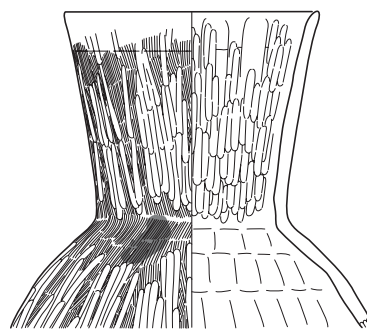

E-01Aa-397

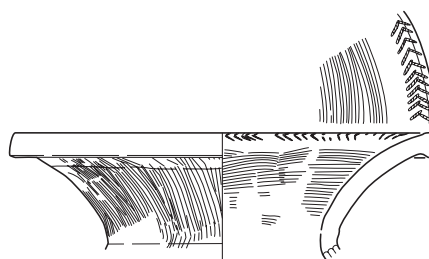

E-01Aa-399



E-01Aa-400

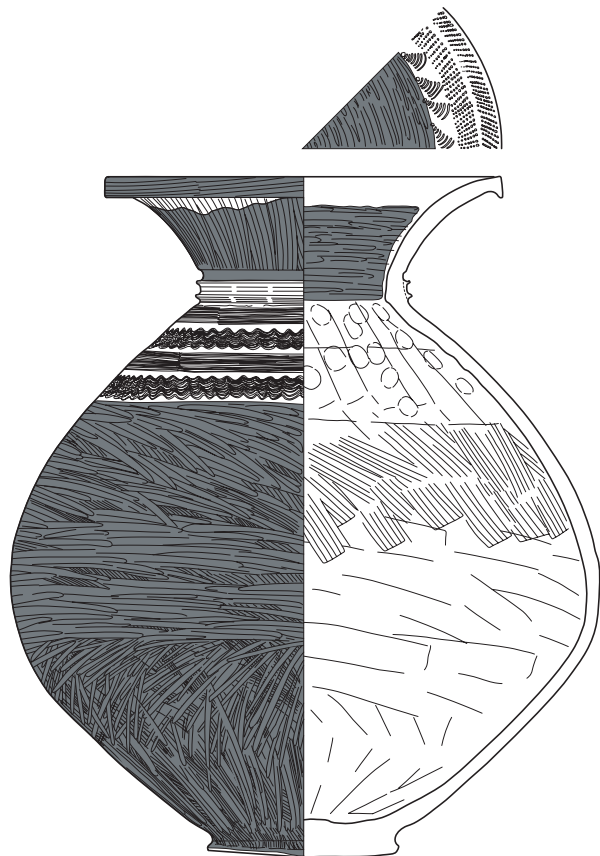

E-01Aa-398

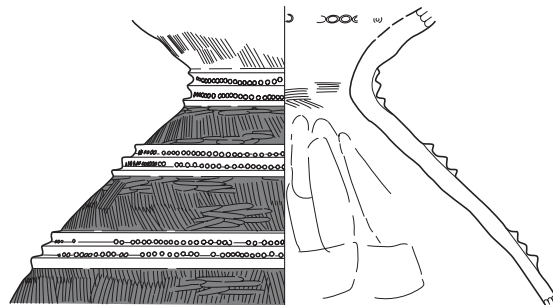

E-01Aa-401

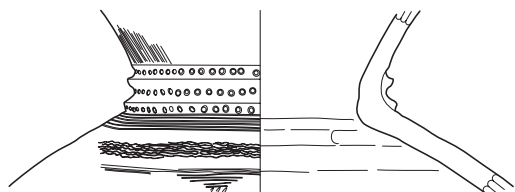

E-01Aa-402

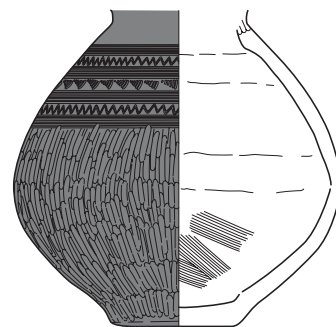

E-01Aa-403



01Aa ☒ SZ01

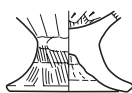

E-01Aa-404

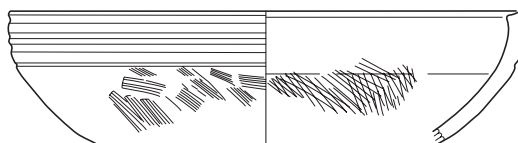

E-01Aa-405

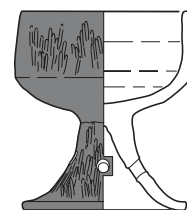

E-01Aa-406

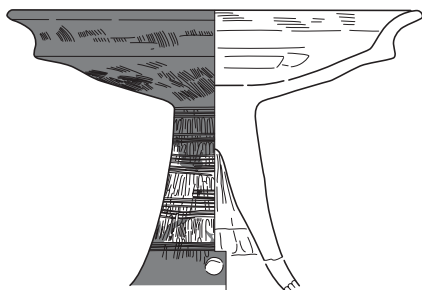

E-01Aa-407

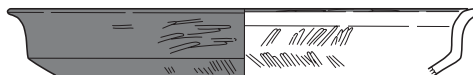

E-01Aa-409

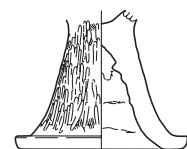

E-01Aa-412

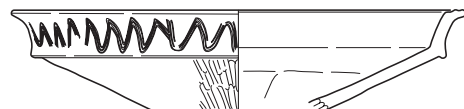

E-01Aa-410

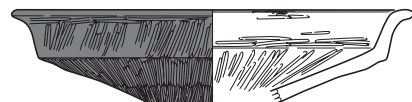

E-01Aa-408

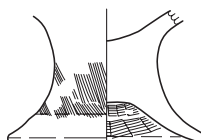

E-01Aa-411

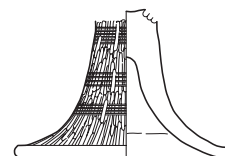

E-01Aa-413



E-01Aa-414

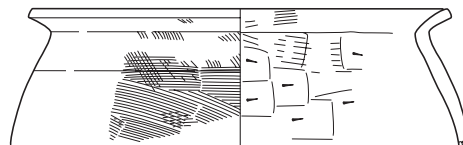

E-01Aa-420

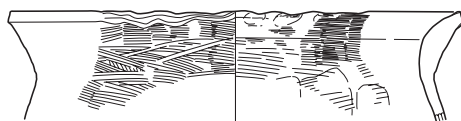

E-01Aa-415

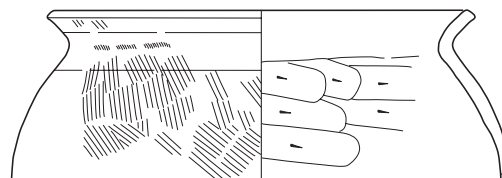

E-01Aa-421

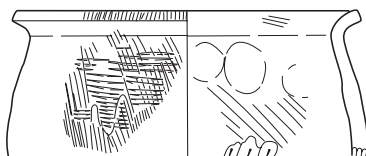

E-01Aa-416

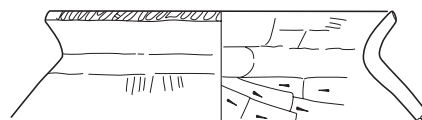

E-01Aa-422

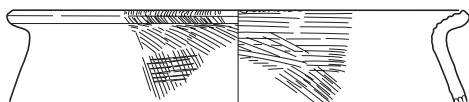

E-01Aa-417



E-01Aa-418

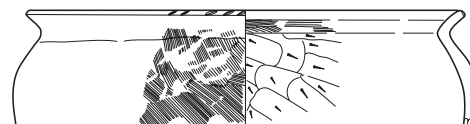

E-01Aa-423

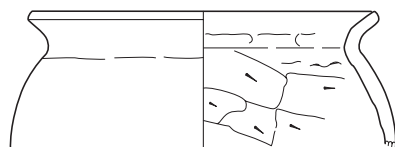

E-01Aa-419

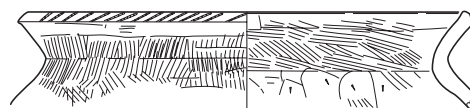

E-01Aa-424



01Aa 区 SZ01

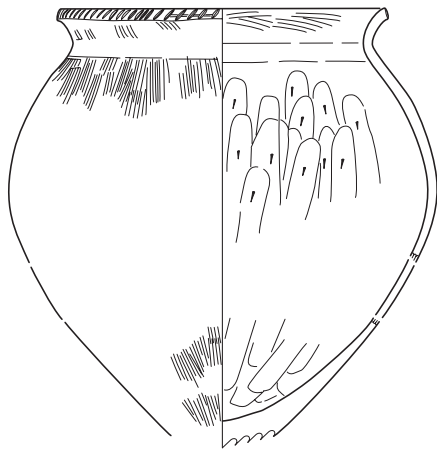

E-01Aa-425

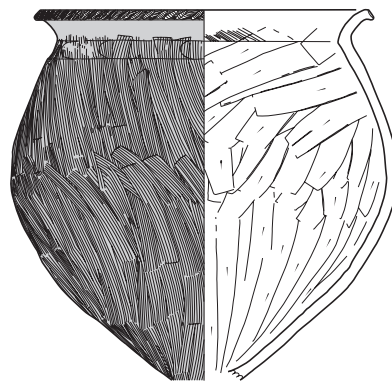

E-01Aa-426



E-01Aa-427



E-01Aa-428

01Aa 区 SZ02

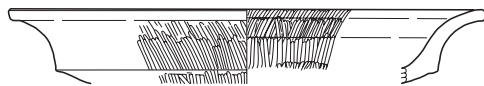

E-01Aa-429

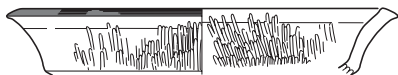

E-01Aa-430

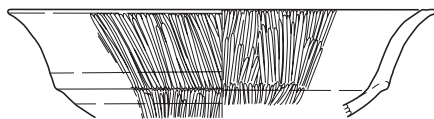

E-01Aa-431

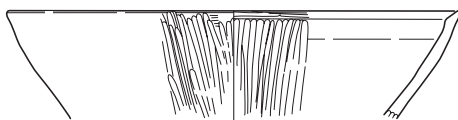

E-01Aa-432



E-01Aa-433

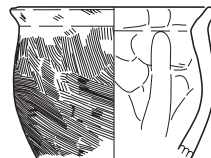

E-01Aa-434

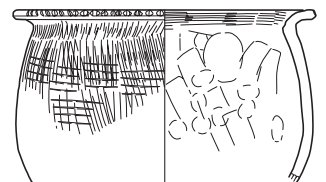

E-01Aa-435

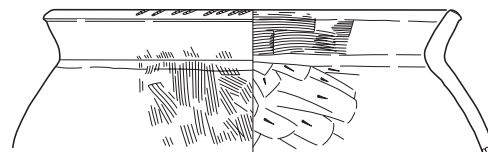

E-01Aa-436



E-01Aa-437



E-01Aa-438

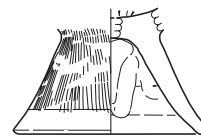

E-01Aa-439

01Aa 区 P48



E-01Aa-440

01Aa 区 P107

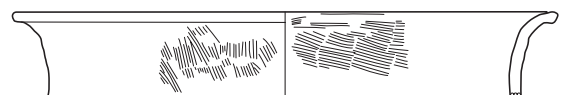

E-01Aa-441

01Aa 区 検II

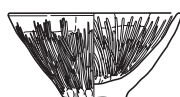

E-01Aa-442



01Ab ☒ SD01

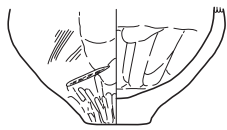

E-01Ab-001



E-01Ab-003

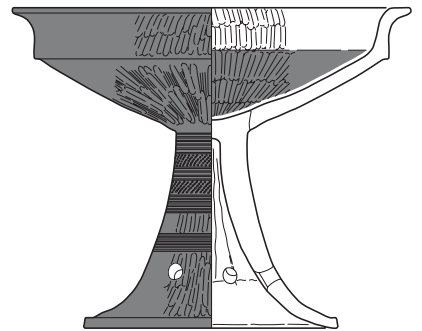

E-01Ab-005

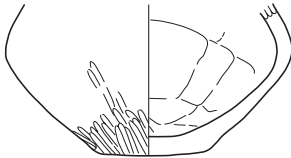

E-01Ab-002

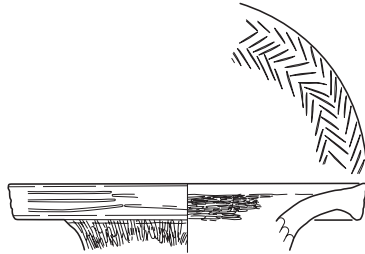

E-01Ab-004

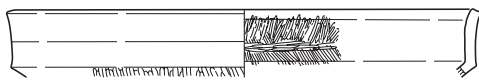

E-01Ab-006

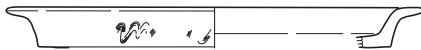

E-01Ab-007

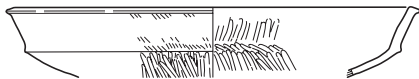

E-01Ab-008

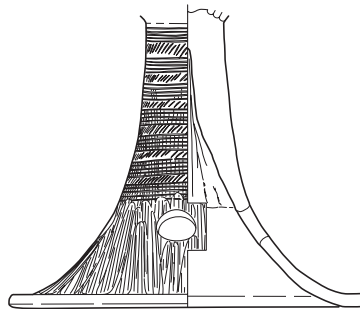

E-01Ab-011

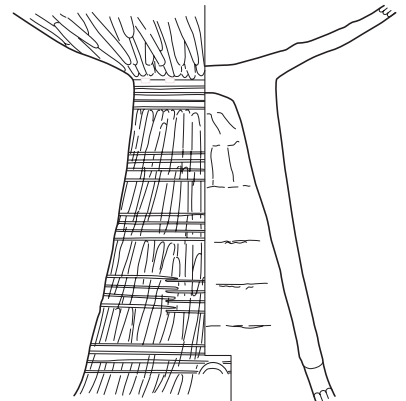

E-01Ab-012

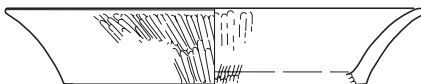

E-01Ab-009

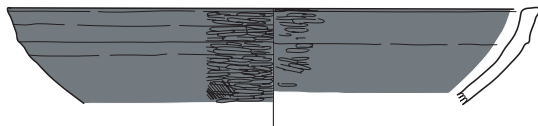

E-01Ab-010

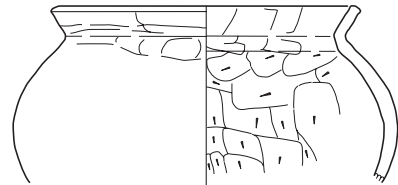

E-01Ab-013

01Ab ☒ SD02

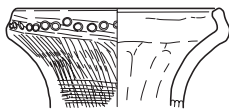

E-01Ab-014

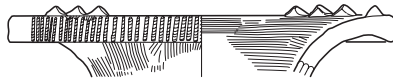

E-01Ab-015

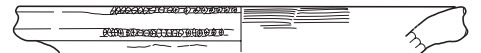

E-01Ab-016

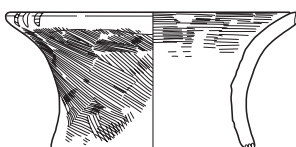

E-01Ab-017

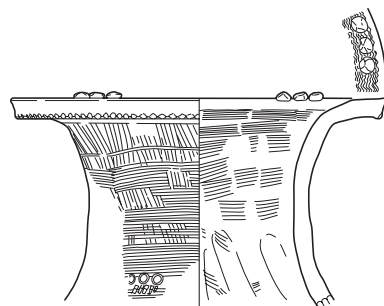

E-01Ab-018

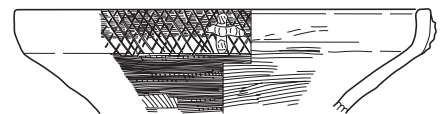

E-01Ab-019



01Ab ☒ SD02

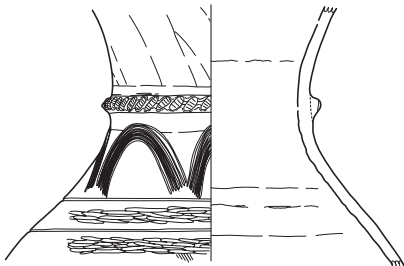

E-01Ab-020

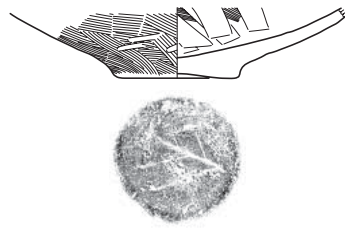

E-01Ab-021

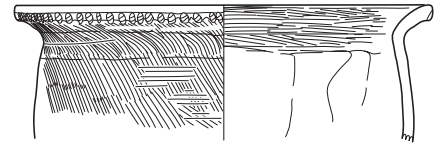

E-01Ab-022

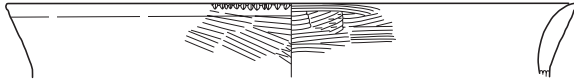

E-01Ab-023

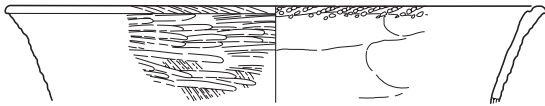
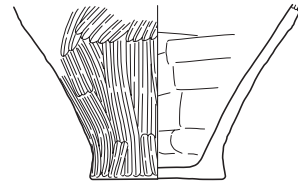

E-01Ab-024



E-01Ab-025

01Ab ☒ SK14

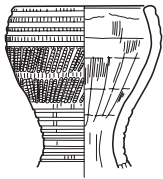

E-01Ab-026

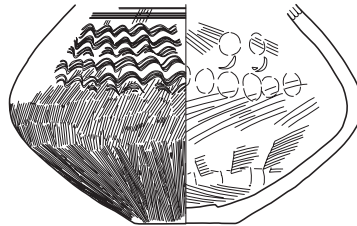

E-01Ab-027

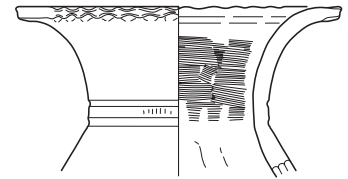

E-01Ab-028

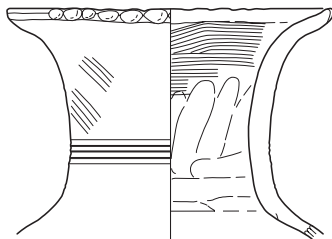

E-01Ab-029

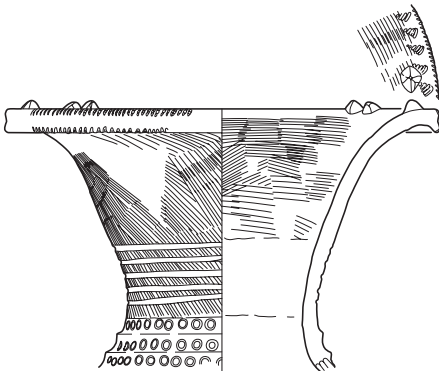

E-01Ab-030

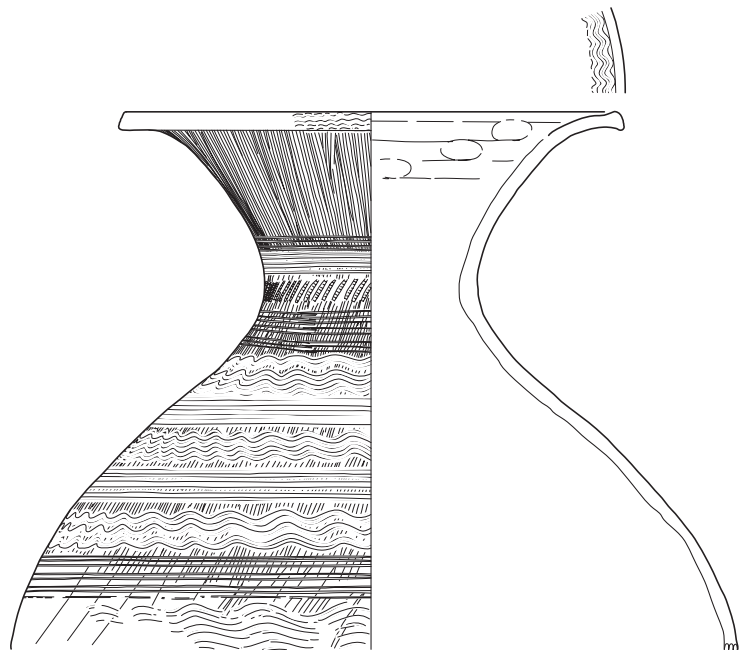

E-01Ab-031

01Ab 区 SK14

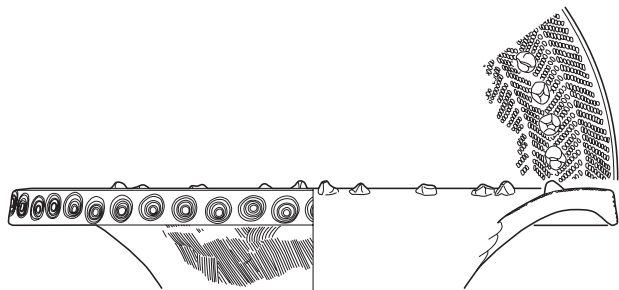

E-01Ab-032

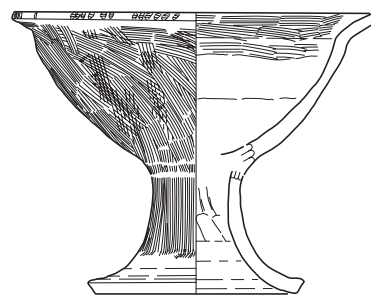

E-01Ab-034

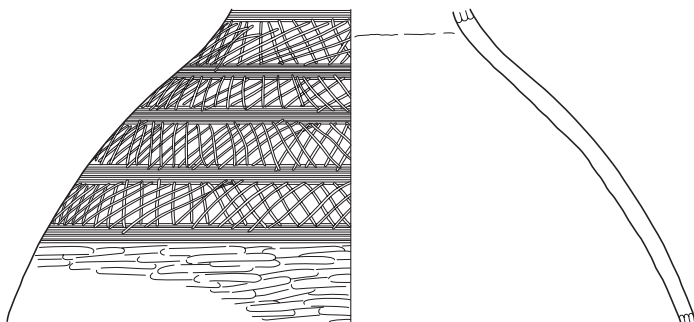

E-01Ab-033

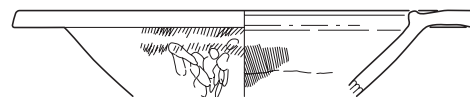

E-01Ab-035

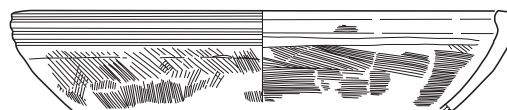

E-01Ab-036

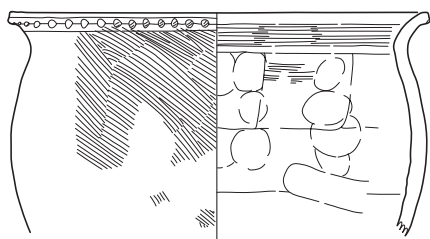

E-01Ab-037

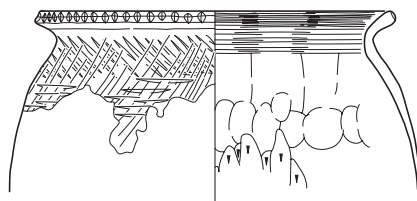

E-01Ab-040

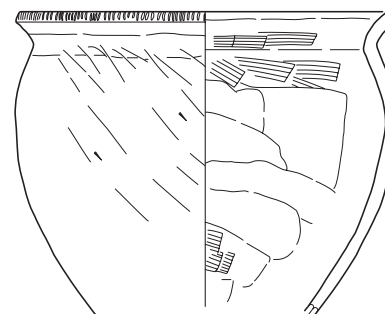

E-01Ab-041

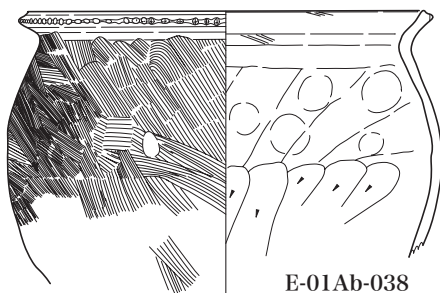

E-01Ab-038

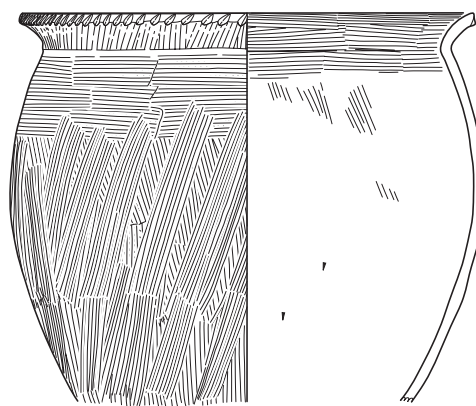

E-01Ab-042

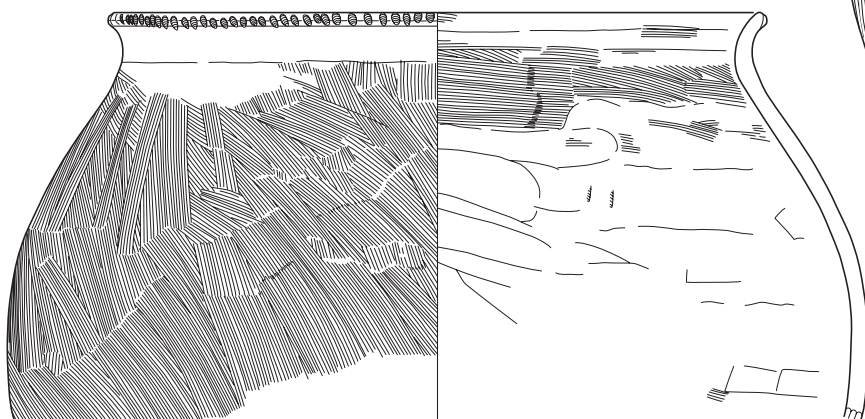

E-01Ab-039



01Ab ☒ SK14

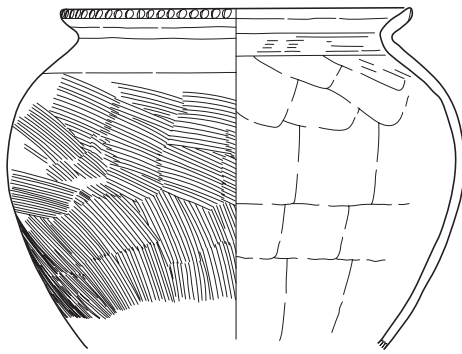

E-01Ab-043

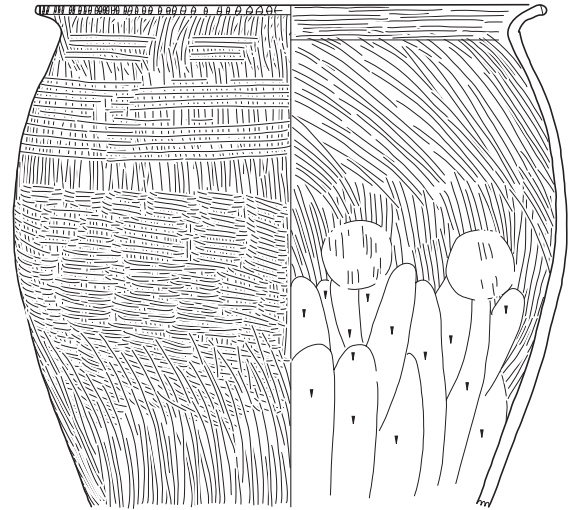

E-01Ab-045

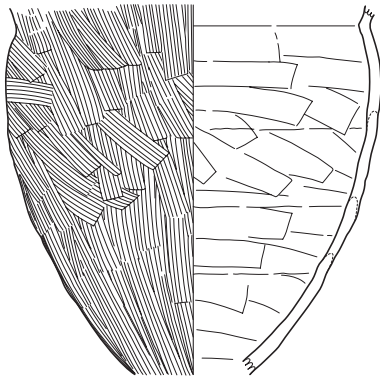

E-01Ab-044

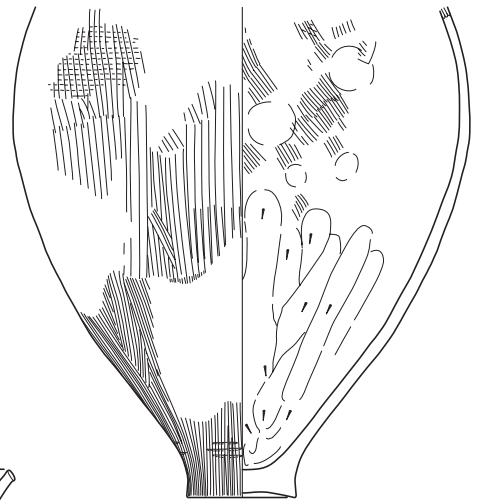

E-01Ab-046

01Ab ☒ SK103

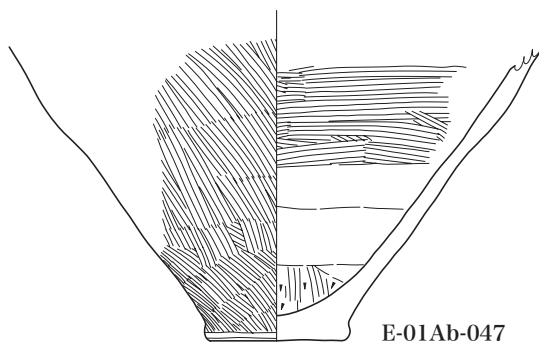
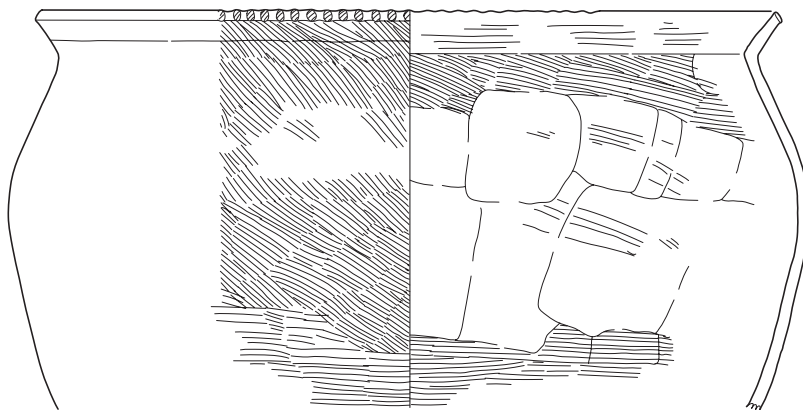

E-01Ab-047



01Ab 区 SX01

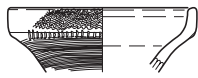

E-01Ab-048

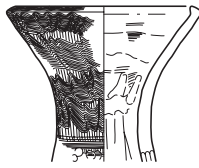

E-01Ab-049

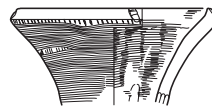

E-01Ab-050

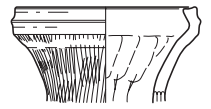

E-01Ab-051

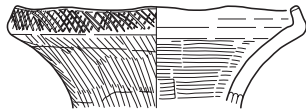

E-01Ab-052

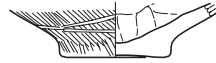

E-01Ab-055

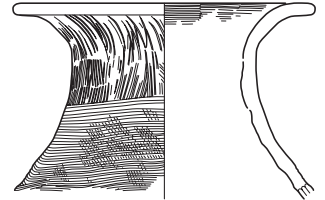

E-01Ab-056

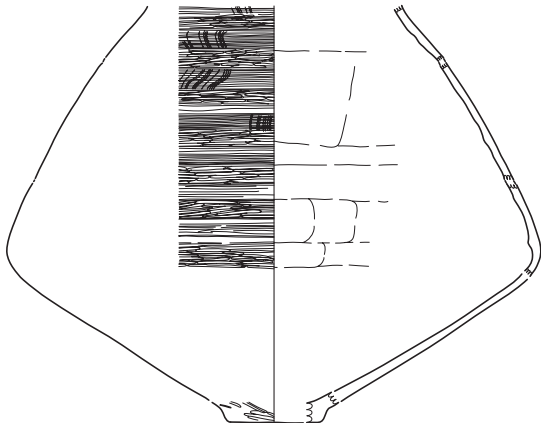

E-01Ab-053

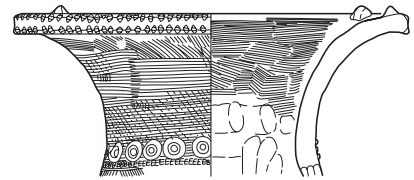

E-01Ab-057

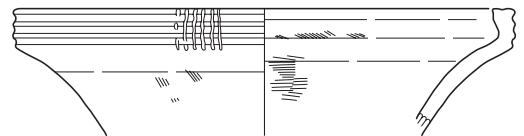

E-01Ab-058

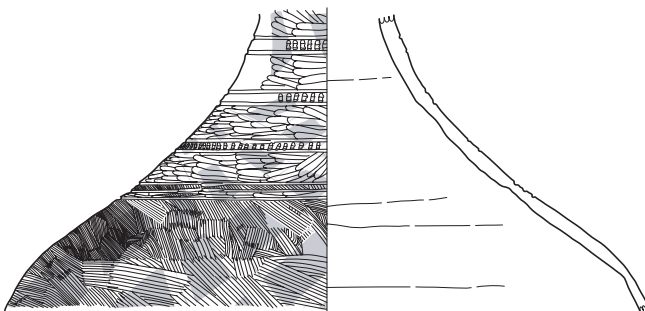

E-01Ab-054

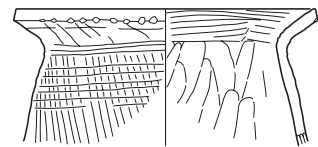

E-01Ab-059

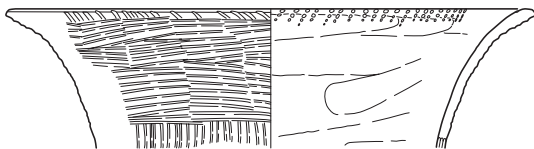

E-01Ab-060

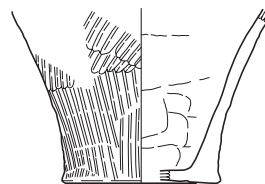

E-01Ab-061



E-01Ab-062

01Ab 区 NR01

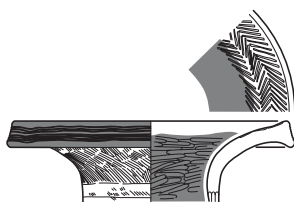

E-01Ab-063





01Ac ☒ SD01

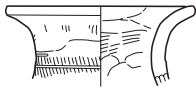

E-01Ac-001

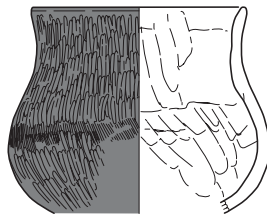

E-01Ac-005

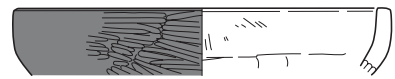

E-01Ac-007

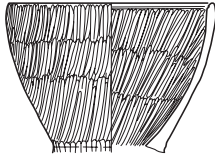

E-01Ac-002



E-01Ac-008

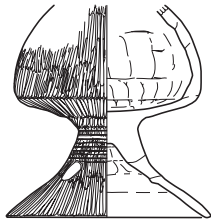

E-01Ac-003

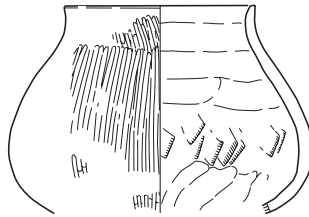

E-01Ac-006

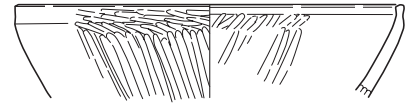

E-01Ac-009

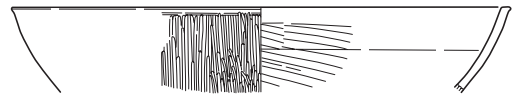

E-01Ac-010

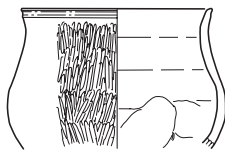

E-01Ac-004

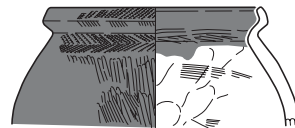

E-01Ac-011

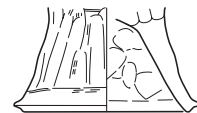

E-01Ac-012

01Ac ☒ SD02

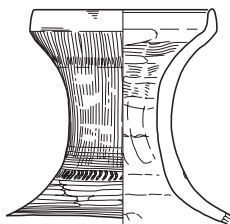

E-01Ac-013

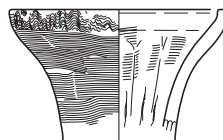

E-01Ac-014

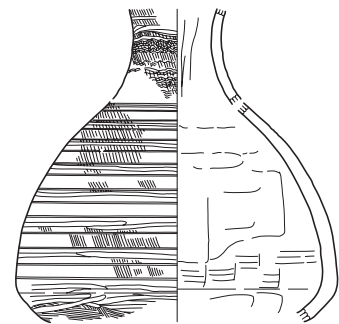

E-01Ac-015

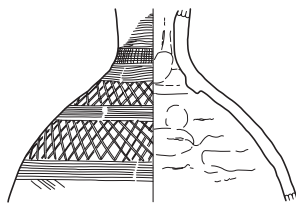

E-01Ac-016

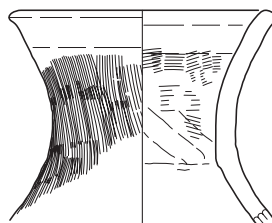

E-01Ac-017

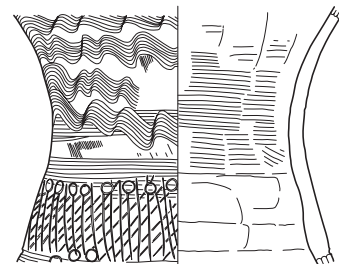

E-01Ac-019

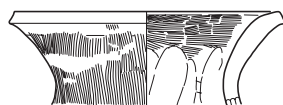

E-01Ac-018



01Ac ☒ SD02

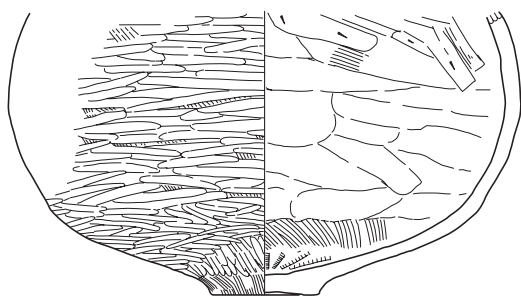

E-01Ac-020



E-01Ac-021

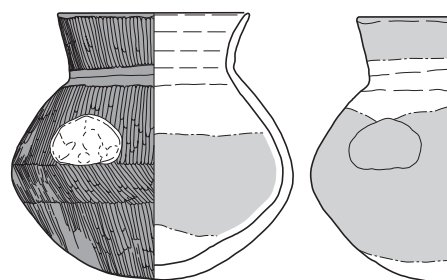

E-01Ac-022



E-01Ac-023

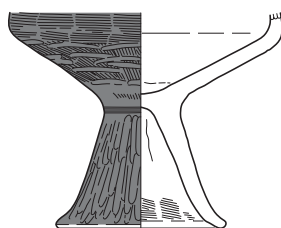

E-01Ac-025

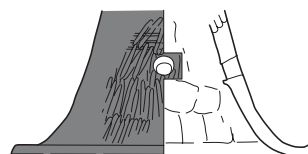

E-01Ac-026

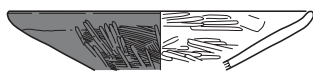

E-01Ac-024



E-01Ac-027

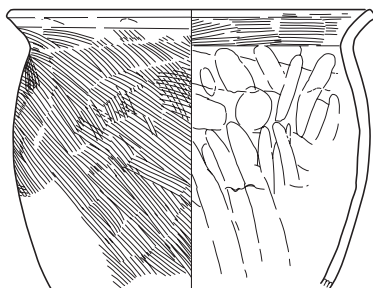

E-01Ac-028



E-01Ac-031

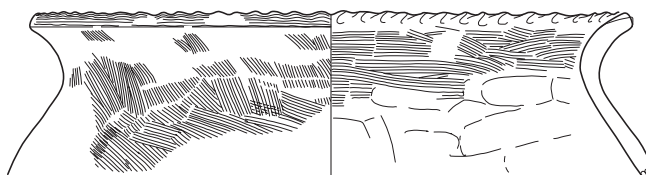

E-01Ac-032

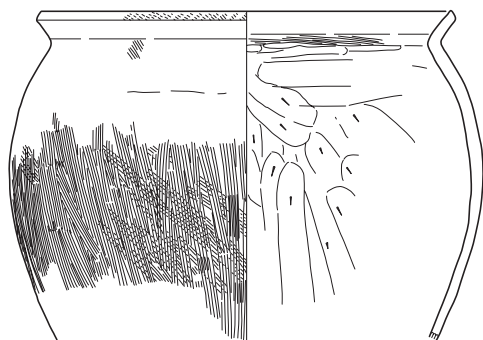

E-01Ac-029

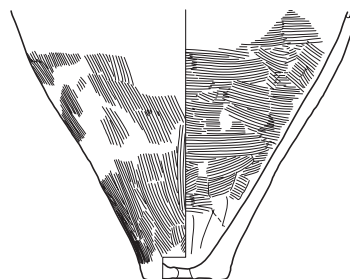

E-01Ac-033

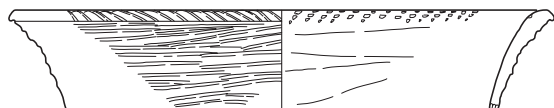

E-01Ac-030

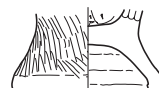

E-01Ac-034



01Ad ☒ SD01

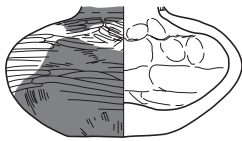

E-01Ad-001

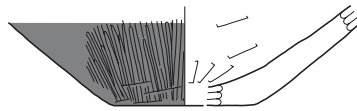

E-01Ad-002

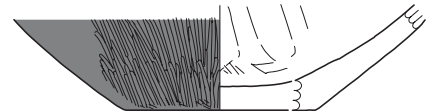

E-01Ad-003

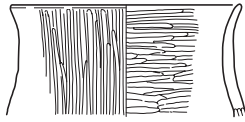

E-01Ad-004

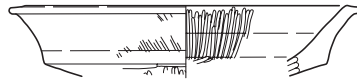

E-01Ad-005



E-01Ad-006

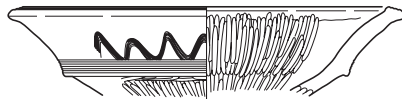

E-01Ad-007

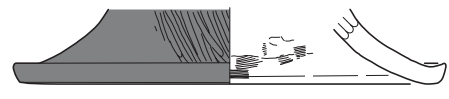

E-01Ad-008

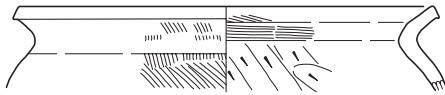

E-01Ad-009

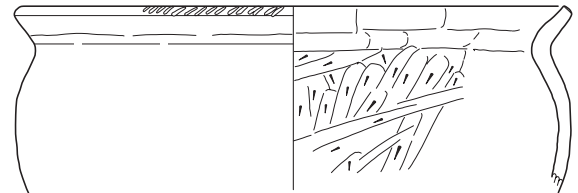

E-01Ad-011

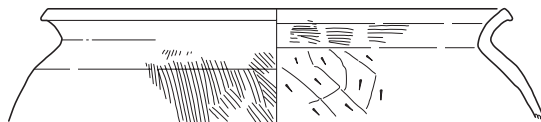

E-01Ad-010

01Ad ☒ SD02

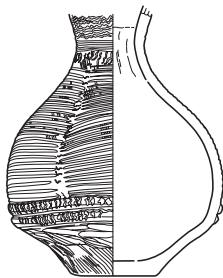

E-01Ad-012

01Ad ☒ SD03

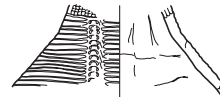

E-01Ad-013

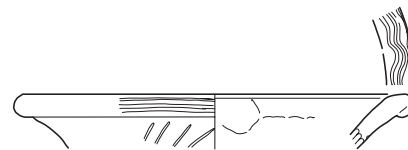

E-01Ad-014

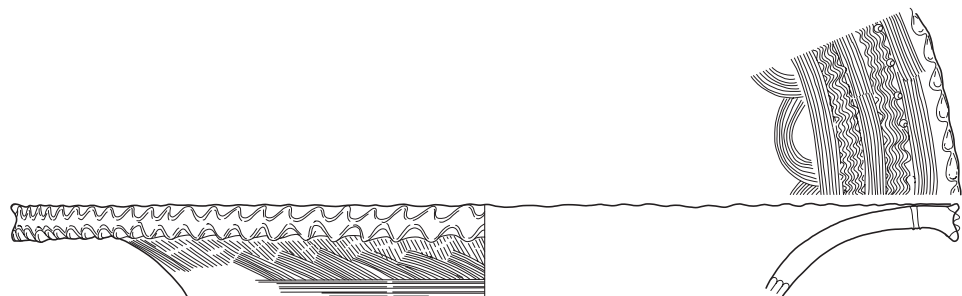

E-01Ad-015



01Ad ☒ SD04

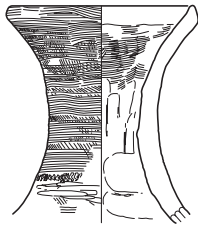

E-01Ad-016



E-01Ad-017

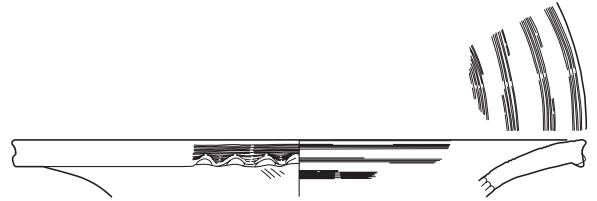

E-01Ad-018

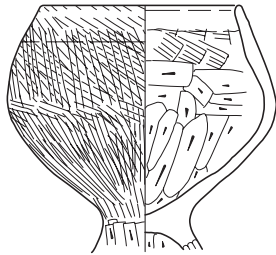

E-01Ad-019

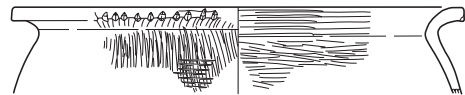

E-01Ad-022

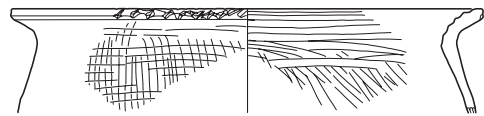

E-01Ad-023

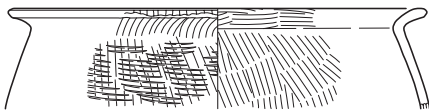

E-01Ad-020

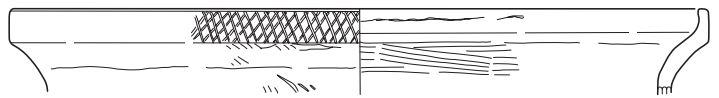

E-01Ad-024

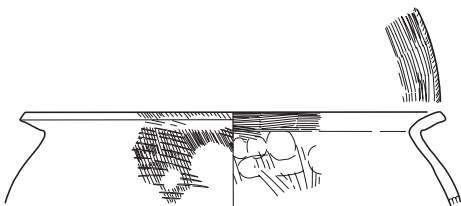

E-01Ad-021

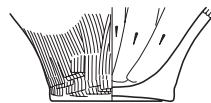

E-01Ad-025

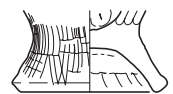

E-01Ad-026

01Ad ☒ SD06

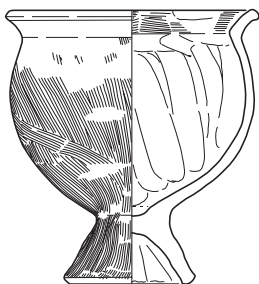

E-01Ad-027

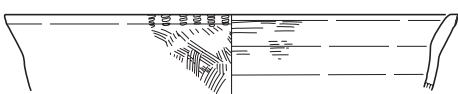

E-01Ad-028

01Ad ☒ SD07

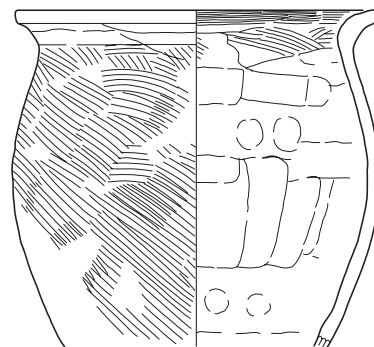

E-01Ad-029



E-01Ad-030

01Ad ☒ SD09

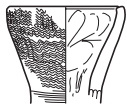

E-01Ad-031

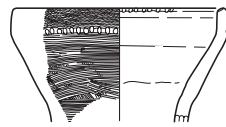

E-01Ad-034

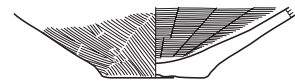

E-01Ad-037

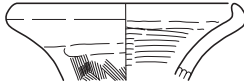

E-01Ad-032

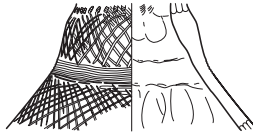

E-01Ad-035

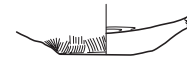

E-01Ad-038

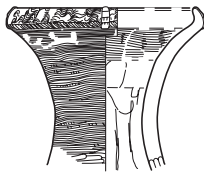

E-01Ad-033

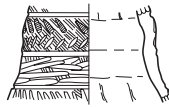

E-01Ad-036

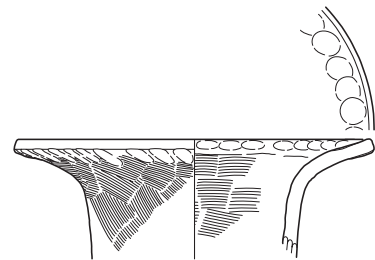

E-01Ad-039

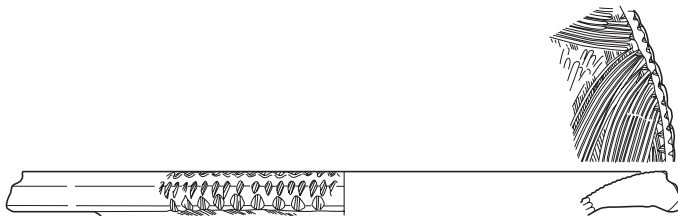

E-01Ad-040

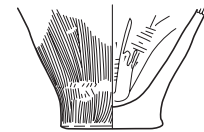

E-01Ad-045

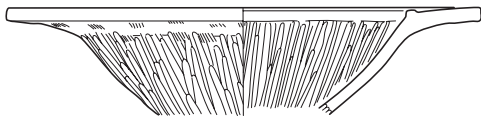

E-01Ad-041

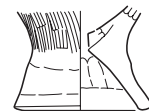

E-01Ad-046

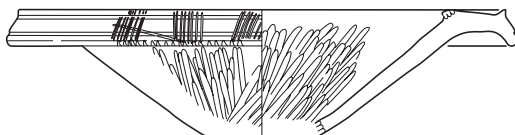

E-01Ad-042



E-01Ad-047

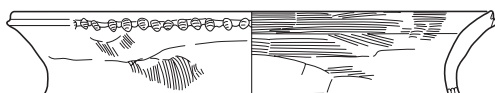

E-01Ad-043

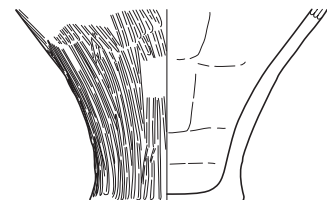

E-01Ad-048

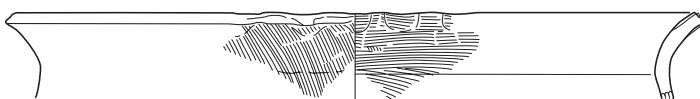

E-01Ad-044



01Ad ☒ SD11

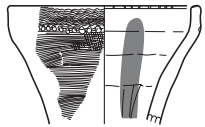

E-01Ad-049

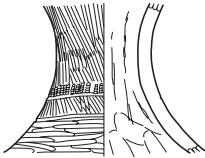

E-01Ad-050

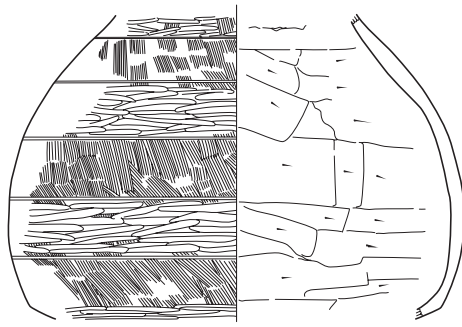

E-01Ad-051

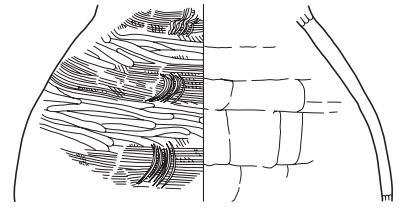

E-01Ad-052

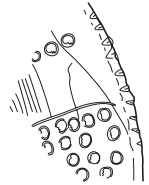

E-01Ad-055

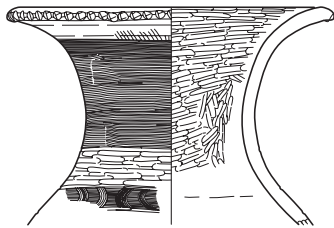

E-01Ad-053

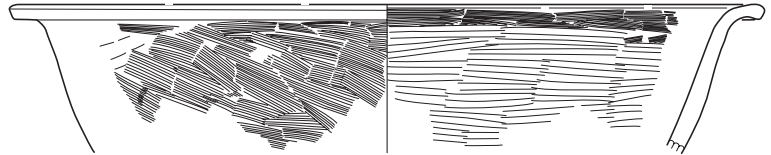

E-01Ad-056

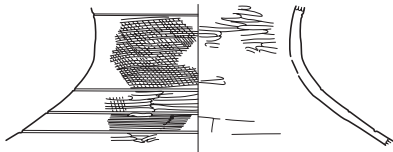

E-01Ad-054



E-01Ad-059

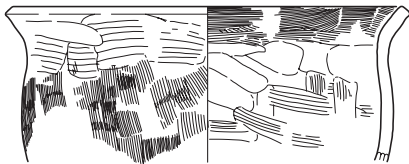

E-01Ad-057

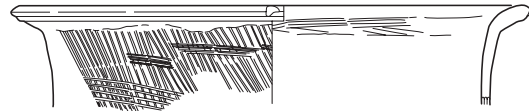

E-01Ad-060

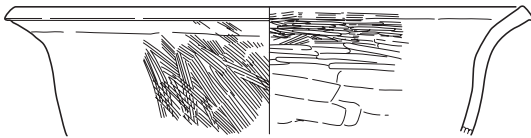

E-01Ad-058

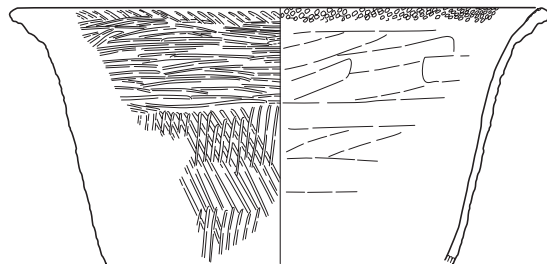

E-01Ad-061

01Ad ☒ SD12

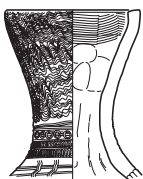

E-01Ad-062

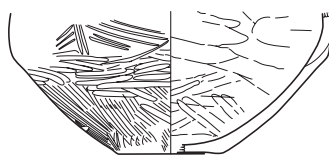

E-01Ad-063

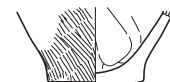

E-01Ad-064



01Ad ☒ SD13

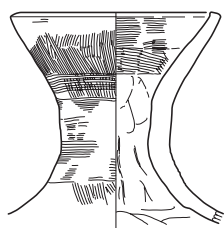

E-01Ad-065

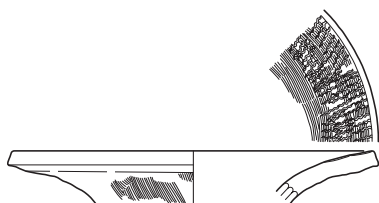

E-01Ad-066

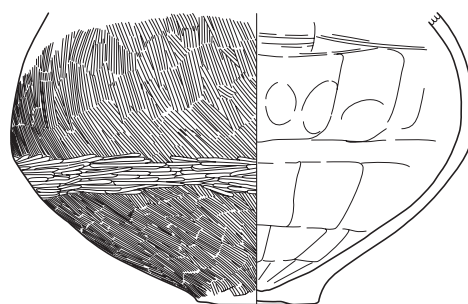

E-01Ad-067

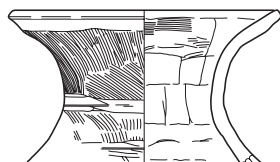

E-01Ad-068



E-01Ad-069

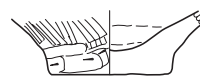

E-01Ad-070

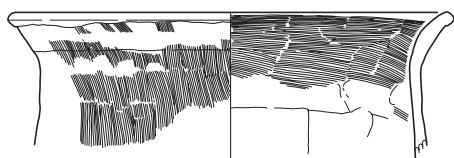

E-01Ad-071

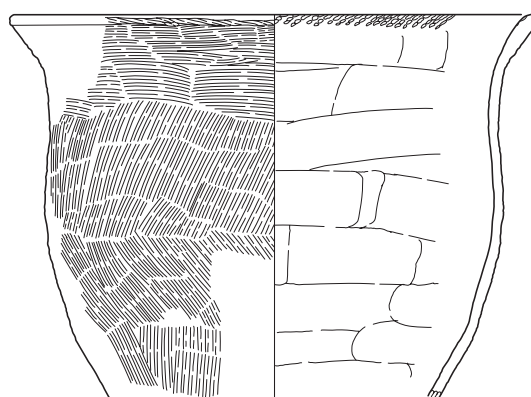

E-01Ad-075

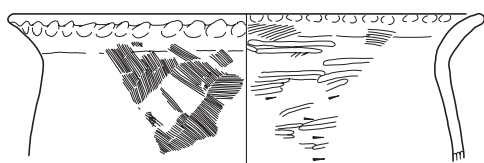

E-01Ad-072

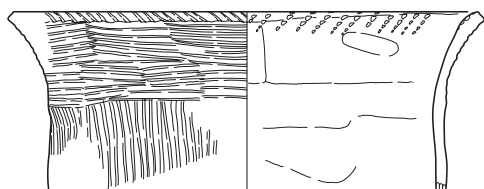

E-01Ad-073



E-01Ad-076

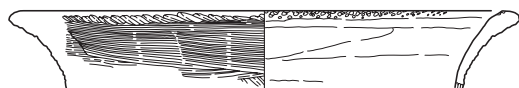

E-01Ad-074



E-01Ad-077

01Ad ☒ SD14



E-01Ad-078



E-01Ad-079

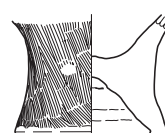

E-01Ad-082



E-01Ad-080

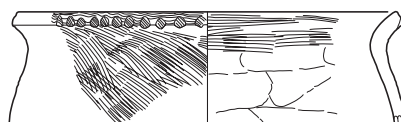

E-01Ad-081



01Ad ☒ SD15

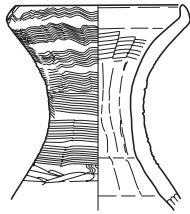

E-01Ad-083

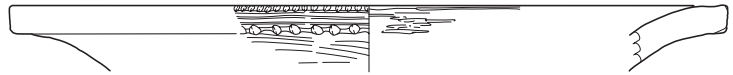

E-01Ad-087

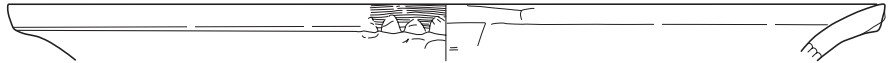

E-01Ad-088



E-01Ad-084

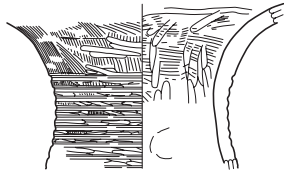

E-01Ad-089

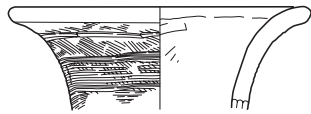

E-01Ad-085

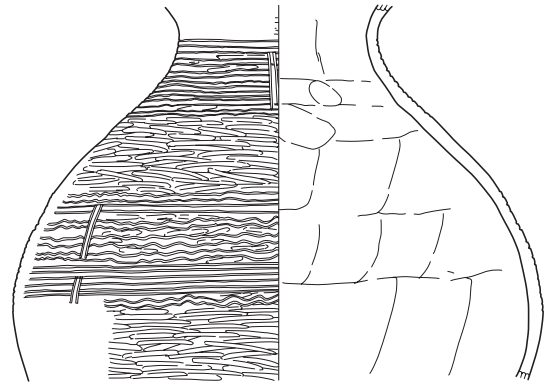

E-01Ad-090



E-01Ad-086

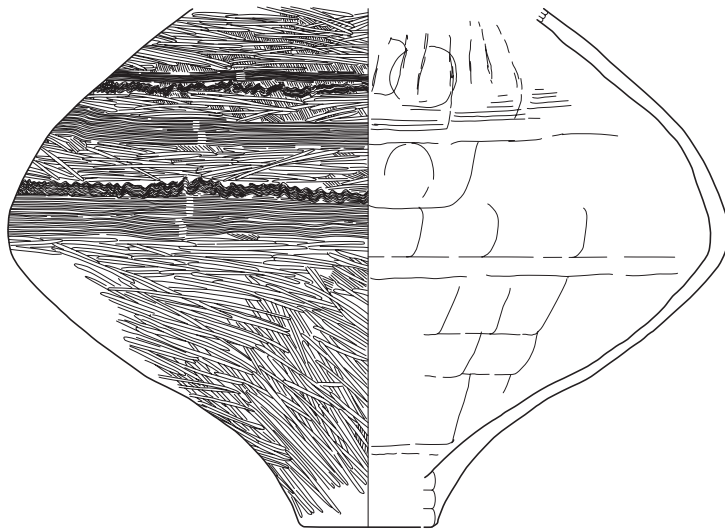

E-01Ad-091



E-01Ad-092



E-01Ad-093

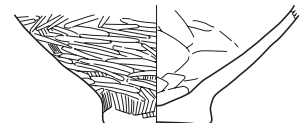

E-01Ad-094

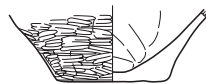
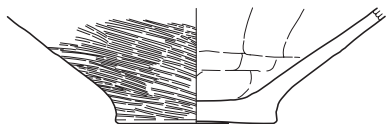

E-01Ad-097

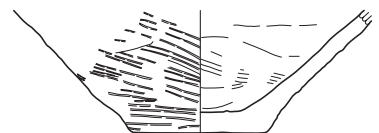

E-01Ad-095



E-01Ad-098

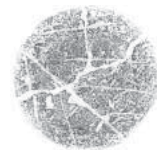

E-01Ad-099



E-01Ad-096





01Ad ☒ SD15



E-01Ad-100



E-01Ad-101

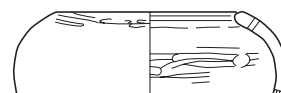

E-01Ad-102

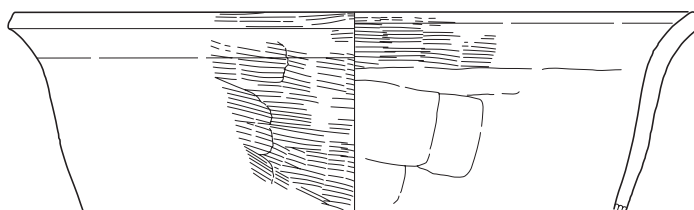

E-01Ad-103

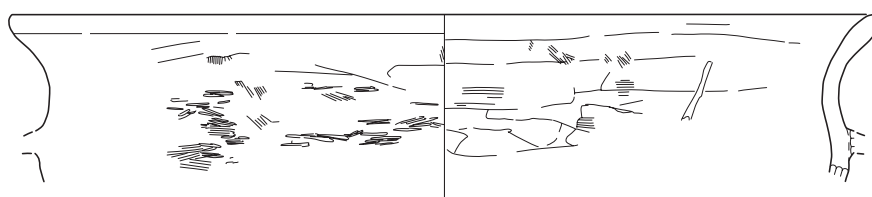

E-01Ad-104

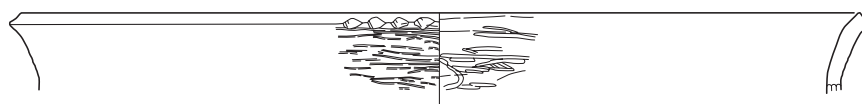

E-01Ad-105

01Ad ☒ SK04

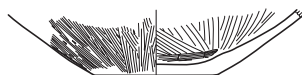

E-01Ad-106



E-01Ad-107

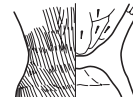

E-01Ad-108

01Ad ☒ SK07



E-01Ad-109

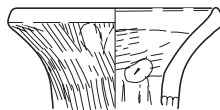

E-01Ad-111

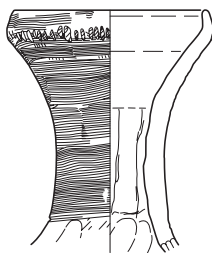

E-01Ad-110



E-01Ad-112



E-01Ad-114

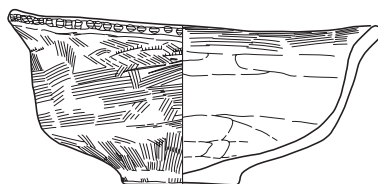

E-01Ad-113



E-01Ad-115



01Ad ☒ SK08

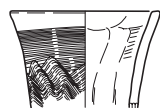

E-01Ad-116

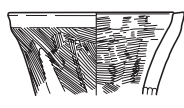

E-01Ad-117

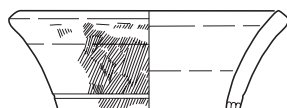

E-01Ad-118

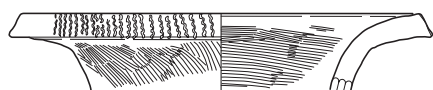

E-01Ad-119



E-01Ad-120



E-01Ad-121

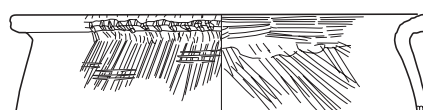

E-01Ad-122

01Ad ☒ SX01

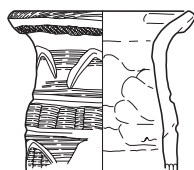

E-01Ad-123



E-01Ad-124

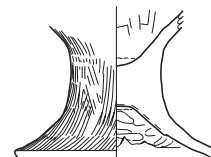

E-01Ad-125

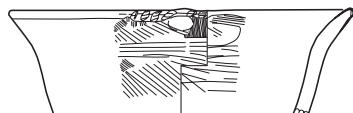

E-01Ad-126

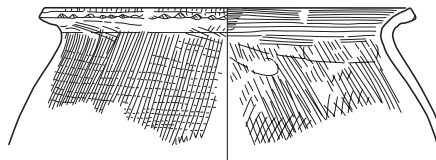

E-01Ad-130

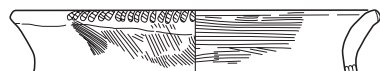

E-01Ad-127

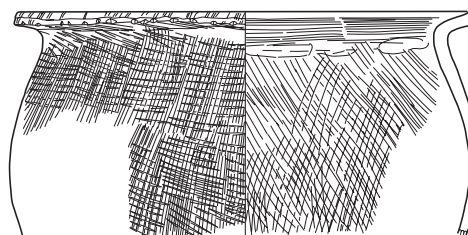

E-01Ad-131

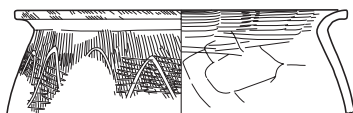

E-01Ad-128



E-01Ad-129

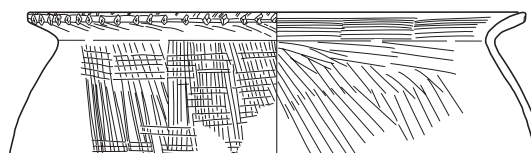

E-01Ad-132



01Ad ☒ SX01



E-01Ad-133

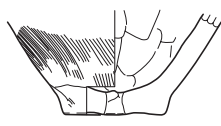

E-01Ad-134



E-01Ad-135



E-01Ad-136

01Ad ☒ NR01

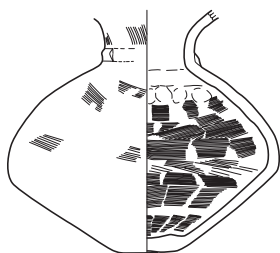

E-01Ad-137

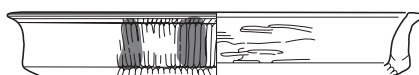

E-01Ad-140

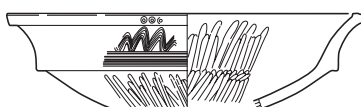

E-01Ad-141



E-01Ad-138

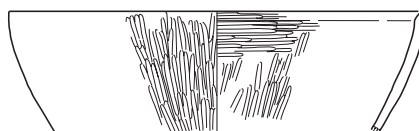

E-01Ad-142

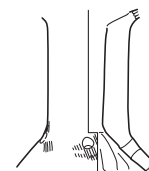

E-01Ad-144

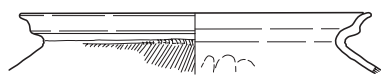

E-01Ad-139

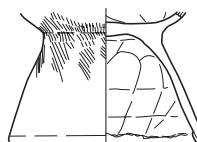

E-01Ad-143

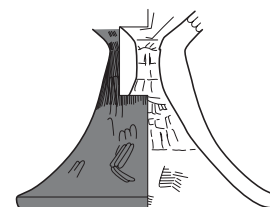

E-01Ad-145

01Ad ☒ NR02

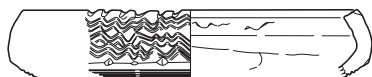

E-01Ad-146



E-01Ad-147

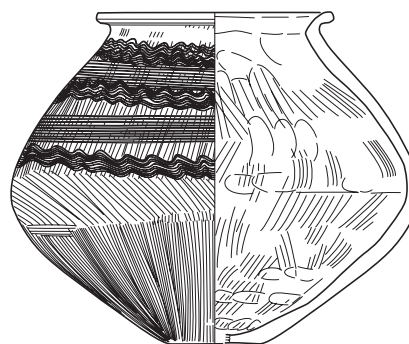

E-01Ad-148



01Ae ☒ SD01

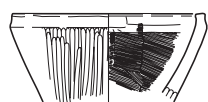

E-01Ae-001



E-01Ae-002

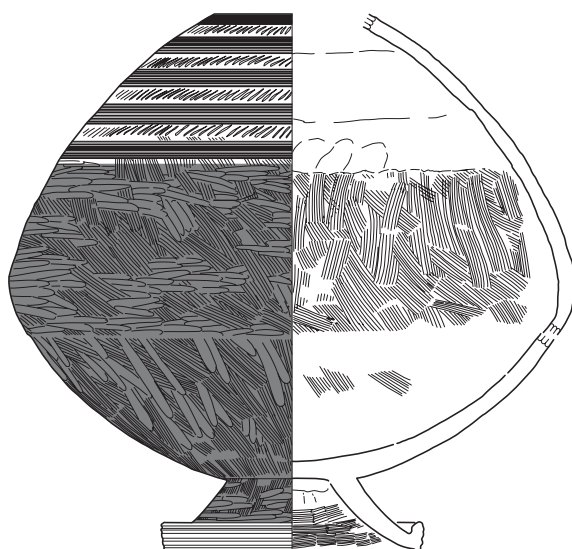

E-01Ae-003

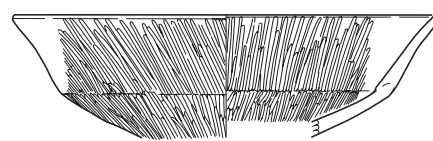

E-01Ae-004

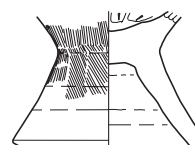

E-01Ae-005

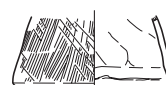

E-01Ae-006

01Ae ☒ SD02

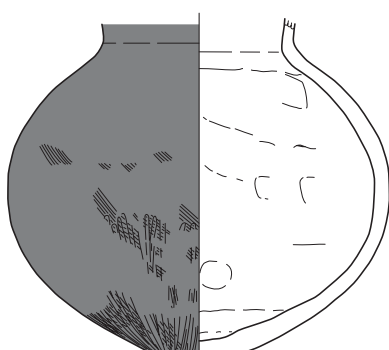

E-01Ae-007

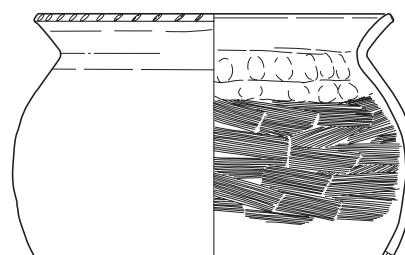

E-01Ae-008

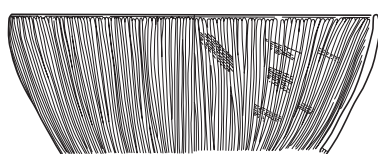

E-01Ae-009

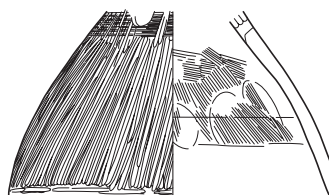

E-01Ae-010



E-01Ae-011

01Ae ☒ SD03

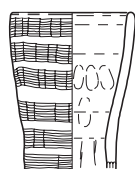

E-01Ae-012

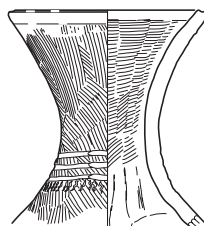

E-01Ae-013

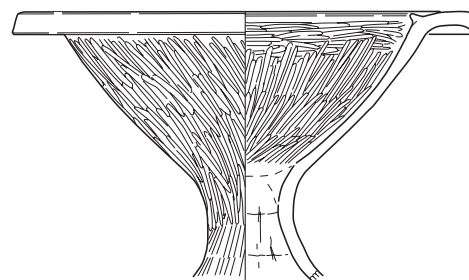

E-01Ae-015

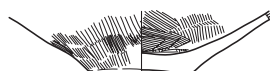

E-01Ae-014



01Ae ☒ SD03

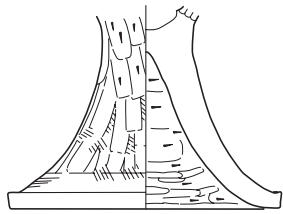

E-01Ae-016

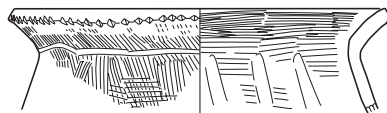

E-01Ae-018

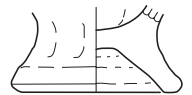

E-01Ae-020

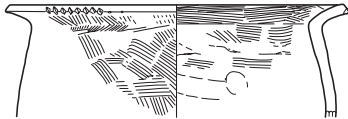

E-01Ae-017

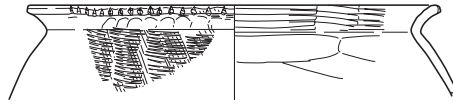

E-01Ae-019



E-01Ae-021

01Ae ☒ SD04

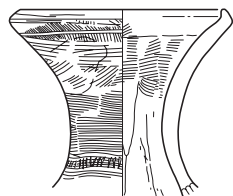

E-01Ae-022

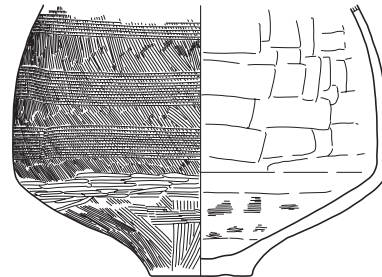

E-01Ae-025

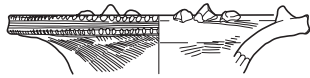

E-01Ae-023

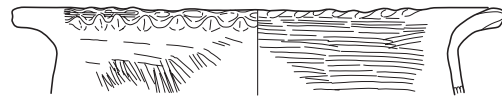

E-01Ae-026



E-01Ae-024



E-01Ae-028

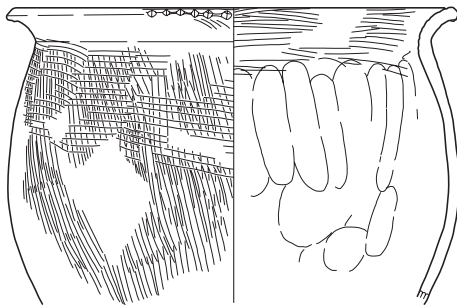

E-01Ae-027

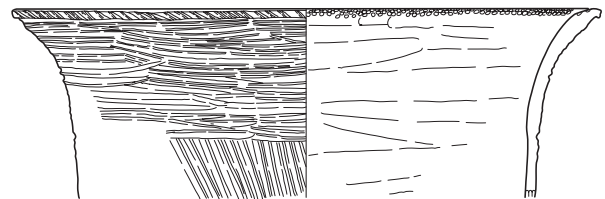

E-01Ae-029

01Ae ☒ SD05



E-01Ae-030

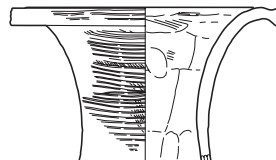

E-01Ae-031



01Ba ☒ SB02

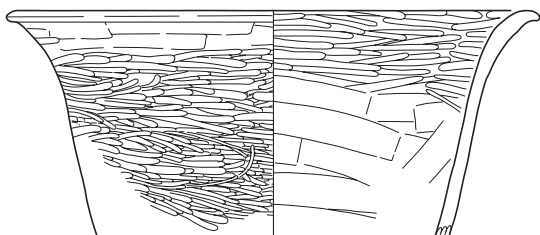

E-01Ba-001

01Ba ☒ SB06

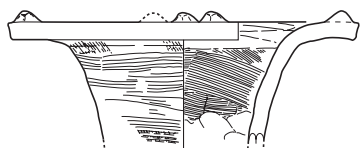

E-01Ba-002

01Ba ☒ SB14

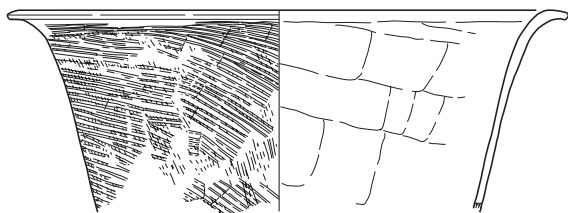

E-01Ba-004

01Ba ☒ SB15

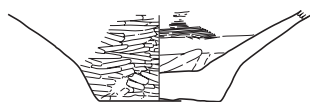

E-01Ba-005

01Ba ☒ SB16



E-01Ba-006

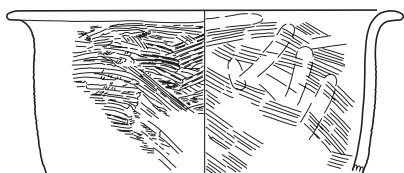

E-01Ba-007

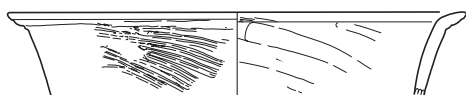

E-01Ba-008

01Ba ☒ SB11



E-01Ba-003

01Ba ☒ SD01

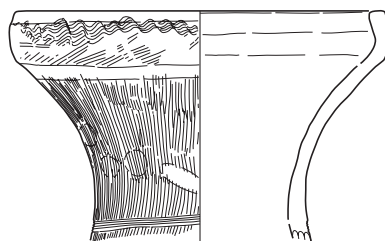

E-01Ba-009

01Ba ☒ SD03

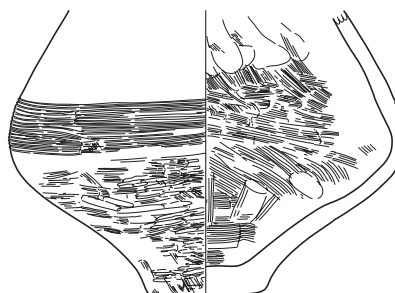

E-01Ba-010



E-01Ba-011

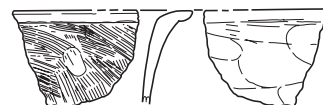

E-01Ba-012



01Ba ☒ SD04

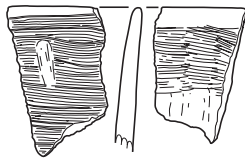

E-01Ba-013

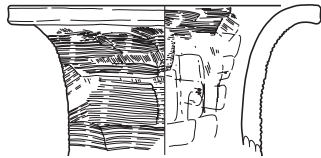

E-01Ba-014

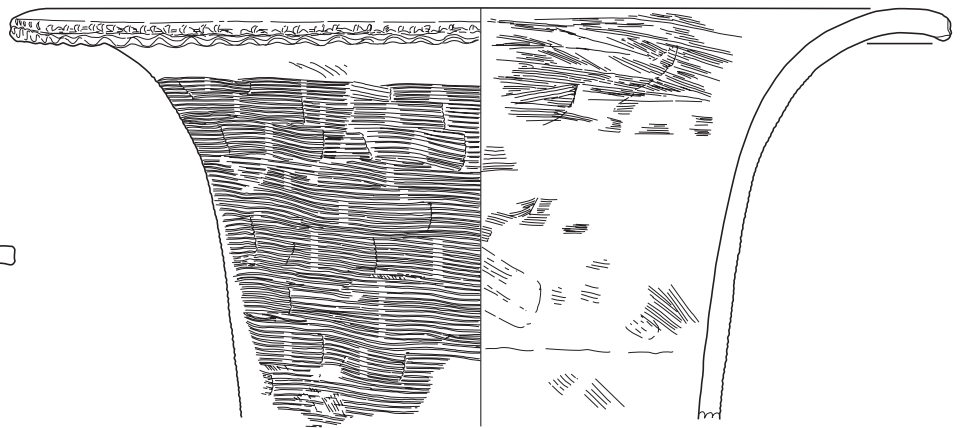

E-01Ba-017

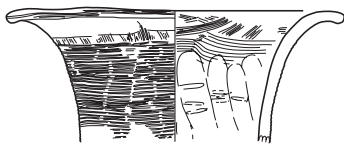

E-01Ba-015

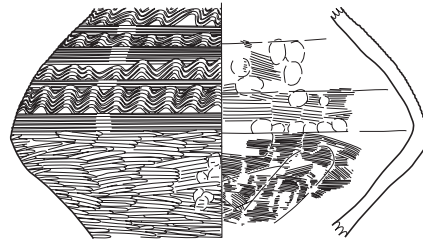

E-01Ba-018

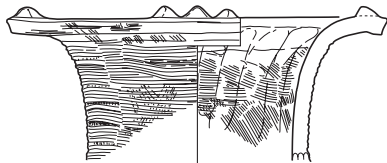

E-01Ba-016

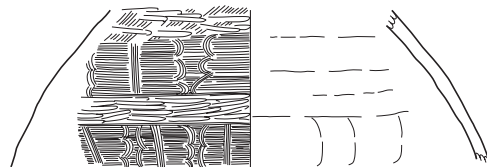

E-01Ba-019

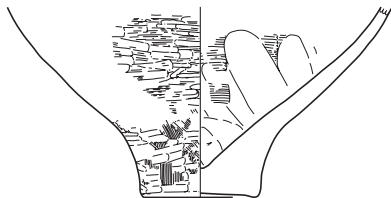

E-01Ba-020



E-01Ba-022

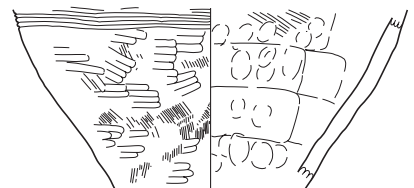

E-01Ba-023

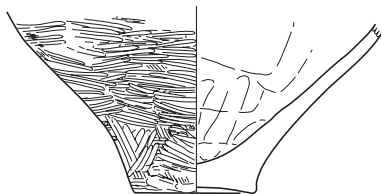

E-01Ba-021



E-01Ba-025

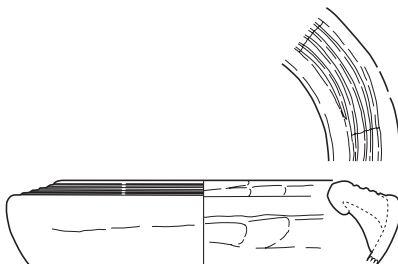

E-01Ba-024

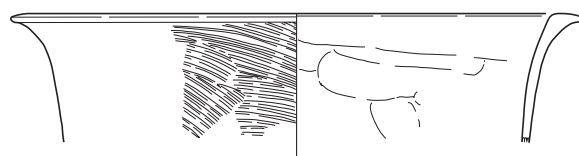

E-01Ba-026



01Ba ☒ SD04

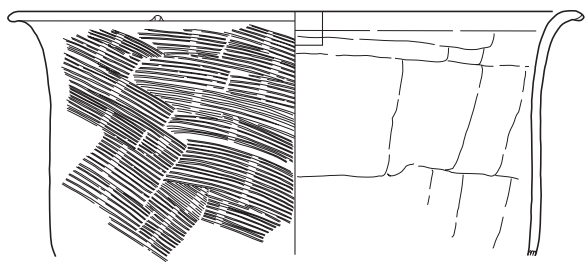

E-01Ba-027

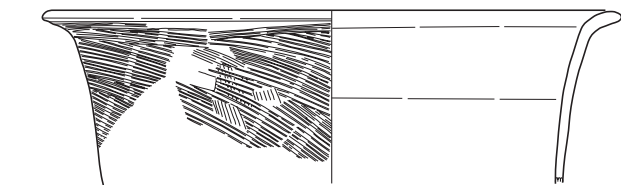

E-01Ba-028

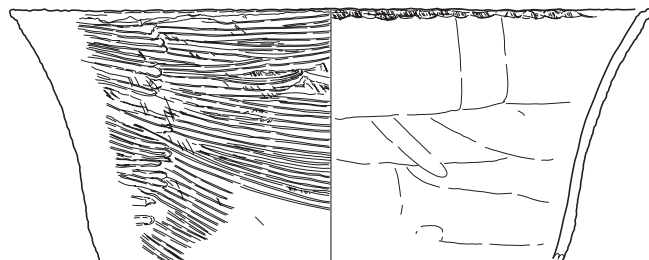

E-01Ba-030

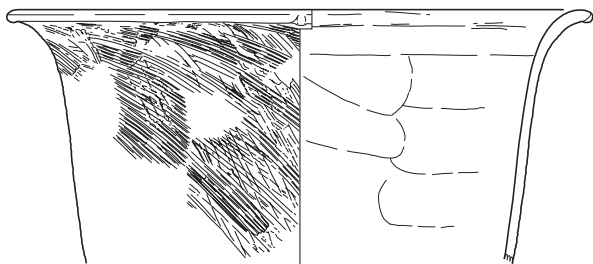

E-01Ba-029

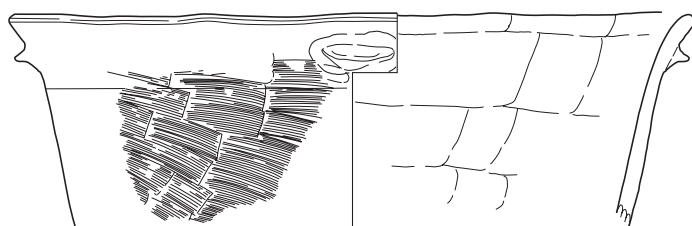

E-01Ba-031

01Bb ☒ SD01

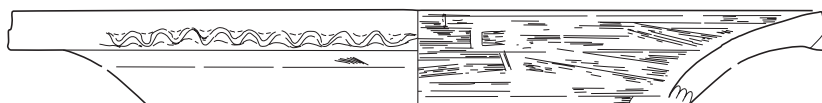

E-01Bb-001

01Bb ☒ SD04

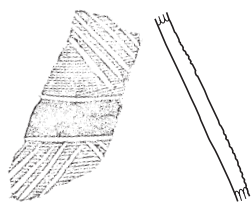

E-01Bb-002

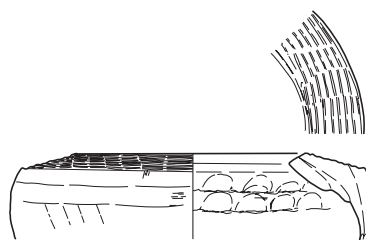

E-01Bb-003

01Bb ☒ SD06



E-01Bb-004



E-01Bb-005

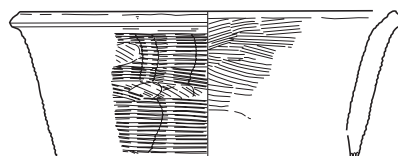

E-01Bb-006



E-01Bb-007





01Bb ☒ SD09

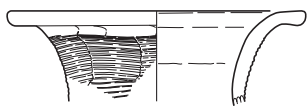

E-01Bb-008

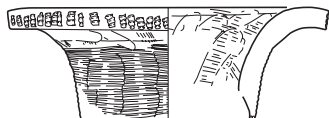

E-01Bb-009

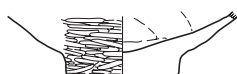

E-01Bb-011

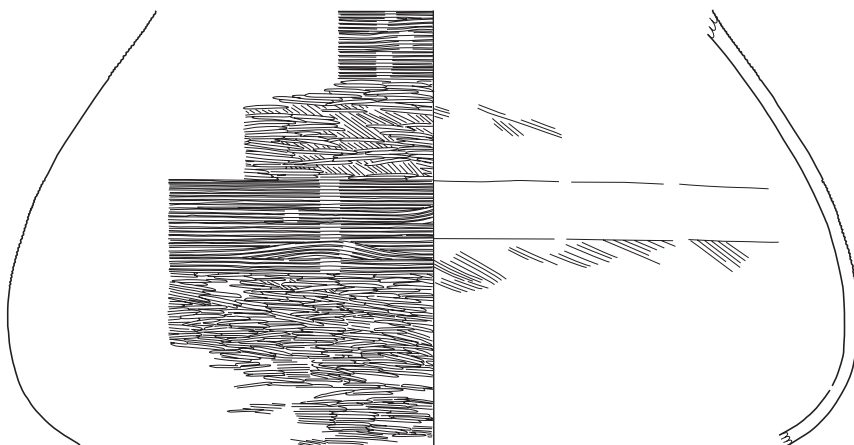

E-01Bb-010

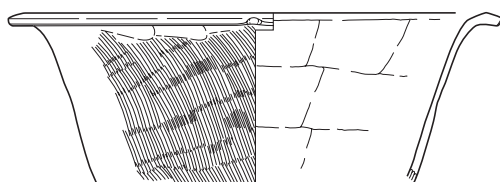

E-01Bb-012



E-01Bb-014

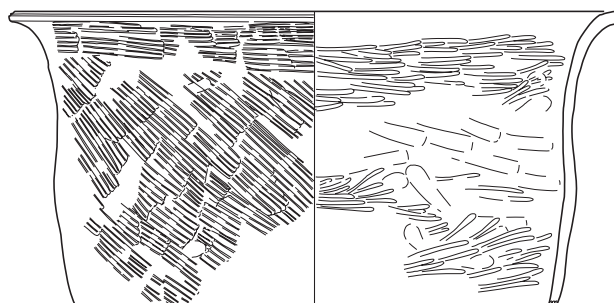

E-01Bb-013

01Bb ☒ SD20

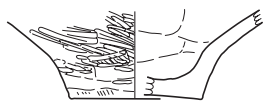

E-01Bb-015



E-01Bb-016

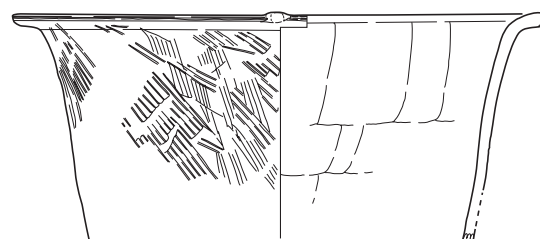

E-01Bb-018

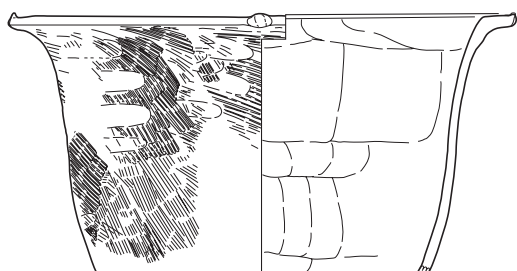

E-01Bb-017

01Bb ☒ SD25

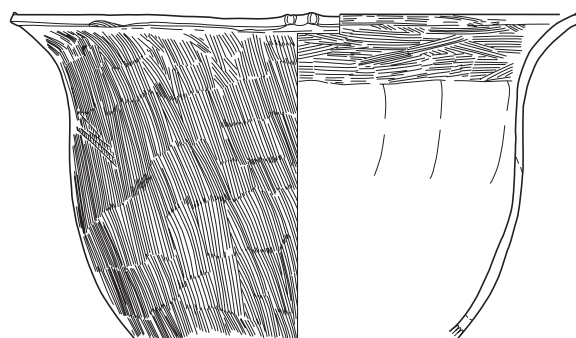

E-01Bb-019



01Bc ☒ SB16

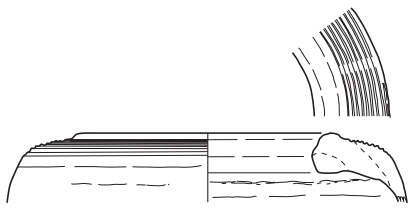

E-01Bc-001

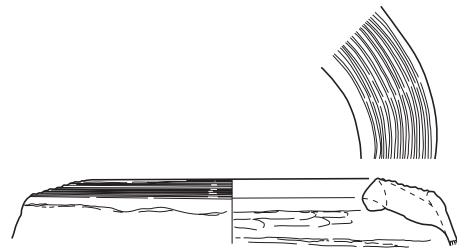

E-01Bc-004



E-01Bc-002

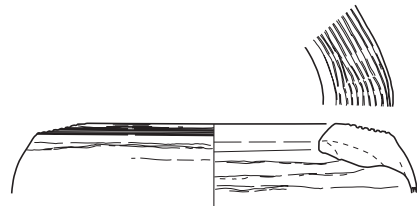

E-01Bc-005

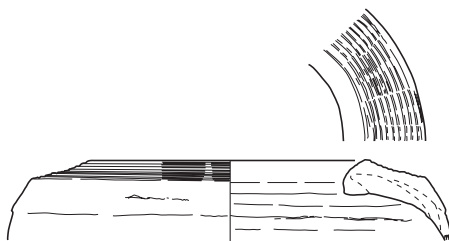

E-01Bc-003

01Bc ☒ SD02

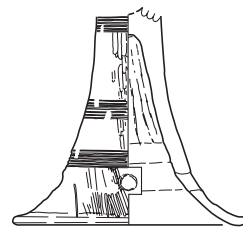

E-01Bc-006

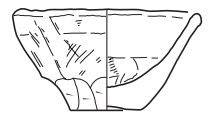

E-01Bc-007

01Bc ☒ SD19



E-01Bc-008

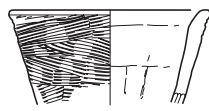

E-01Bc-009

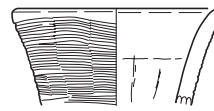

E-01Bc-010

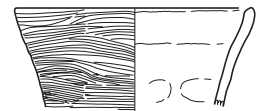

E-01Bc-011

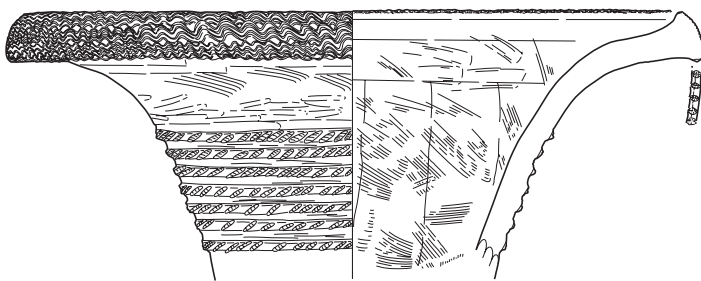

E-01Bc-012

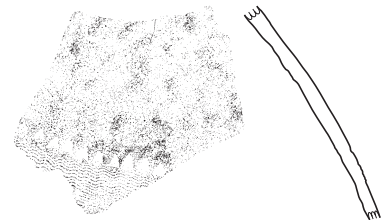

E-01Bc-013

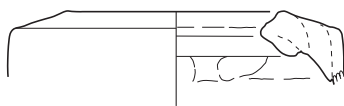

E-01Bc-015

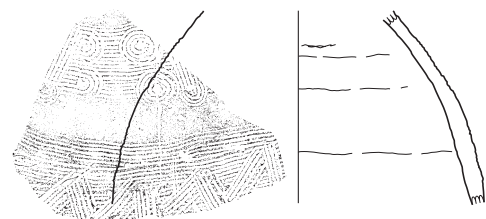

E-01Bc-014



01Bc ☒ SD19

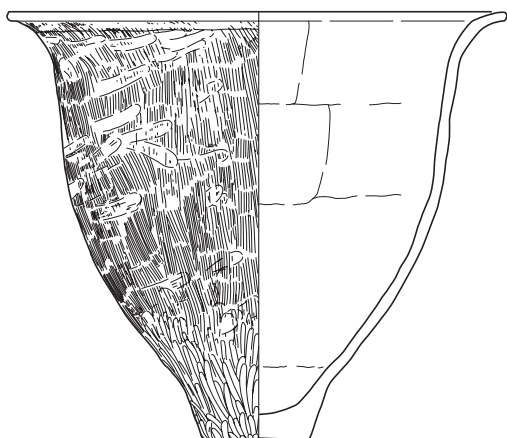

E-01Bc-016

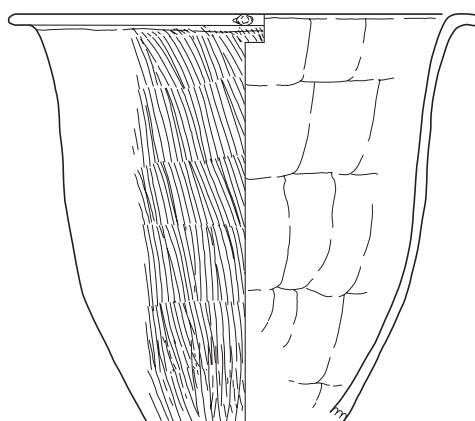

E-01Bc-017

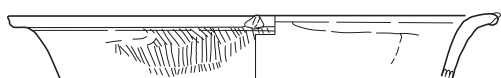

E-01Bc-018

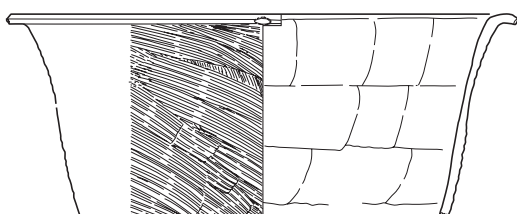

E-01Bc-019

01Bc ☒ SK67

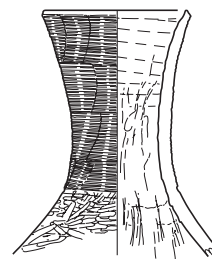

E-01Bc-020

01Bc ☒ SK241

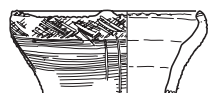

E-01Bc-021

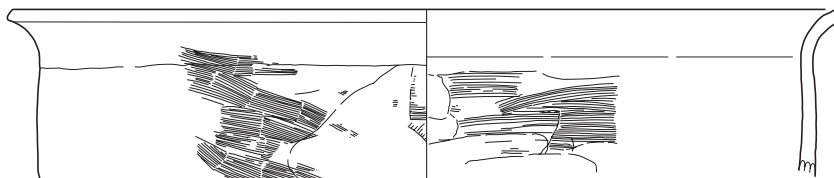

E-01Bc-022

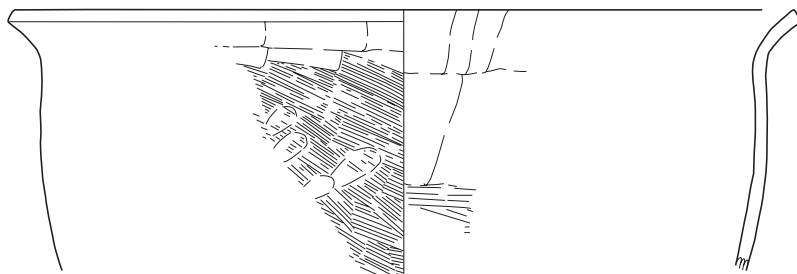

E-01Bc-023

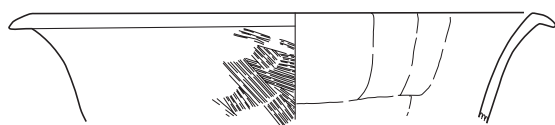

E-01Bc-024

01Bc ☒ SK242

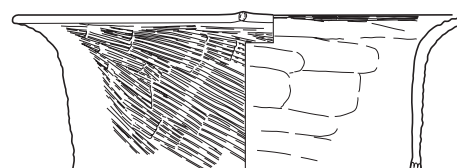

E-01Bc-025



01Bc ☒ SK252

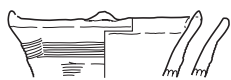

E-01Bc-026

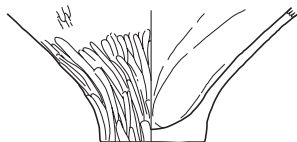

E-01Bc-027

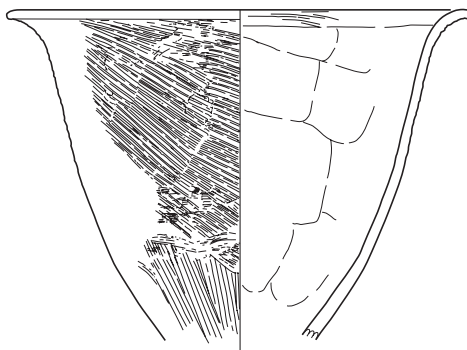

E-01Bc-028

01Bd ☒ SB07

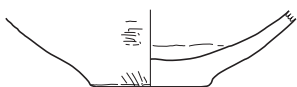

E-01Bd-001

01Bd ☒ SB15

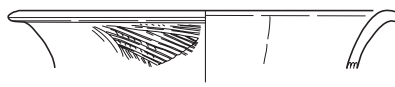

E-01Bd-002

01Bd ☒ SB18

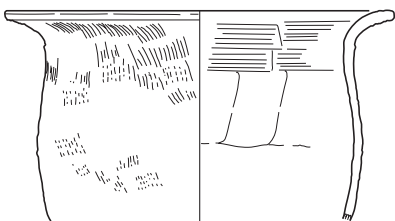

E-01Bd-003

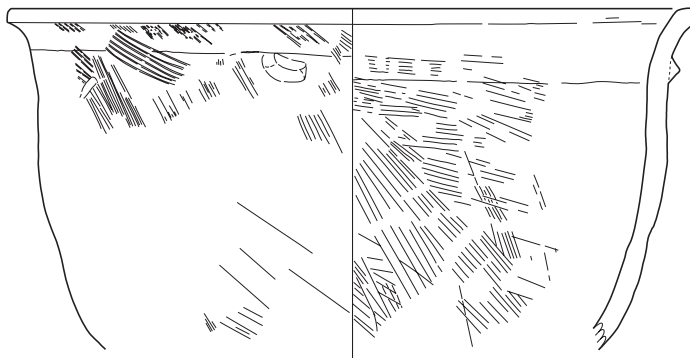

E-01Bd-004

01Bd ☒ SD01

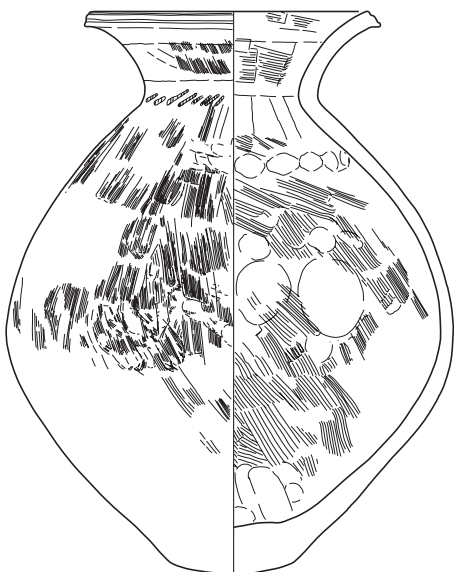

E-01Bd-005

01Bd ☒ SD02



E-01Bd-006

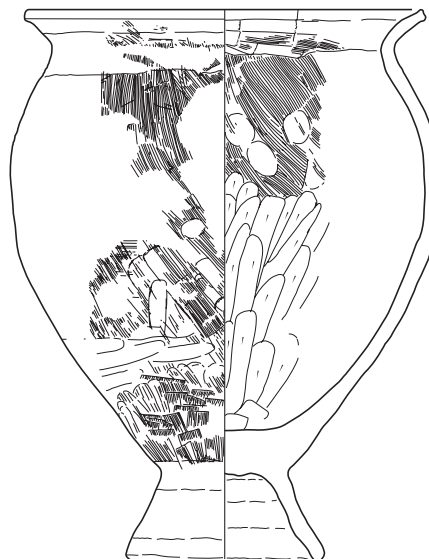

E-01Bd-007



01Bd ☒ SD03

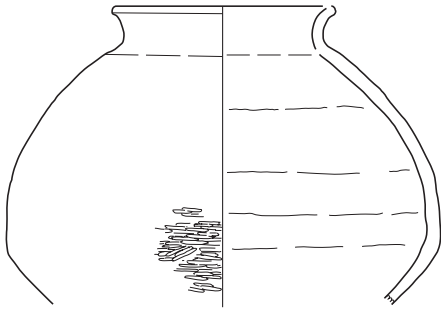

E-01Bd-008

01Bd ☒ SK79

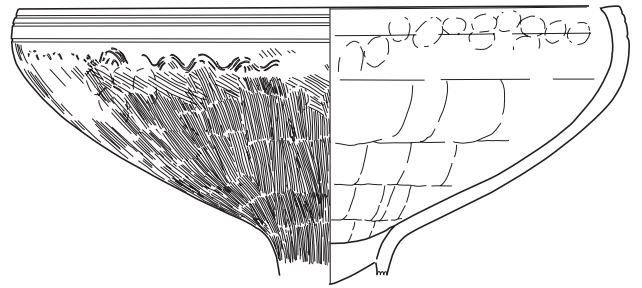

01Bd ☒ SD05

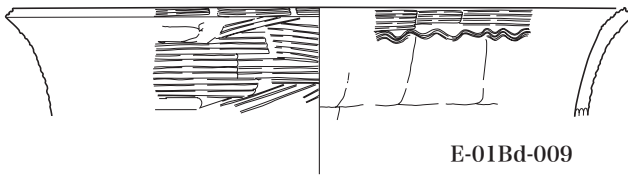

E-01Bd-009

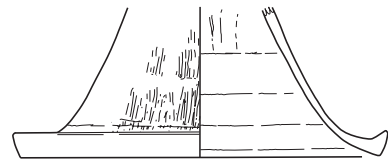

E-01Bd-011

01Bd ☒ SD06

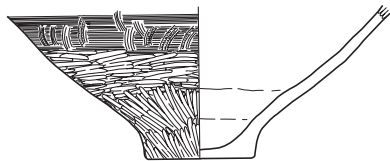

E-01Bd-010

01Bd ☒ SK151

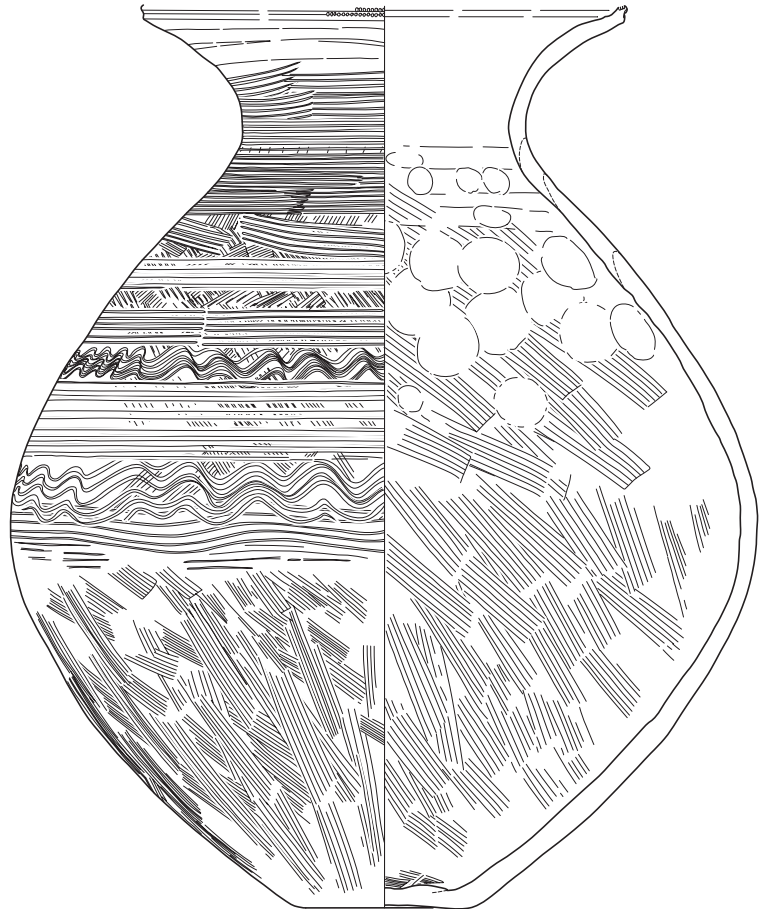

E-01Bd-014

01Bd ☒ SK148

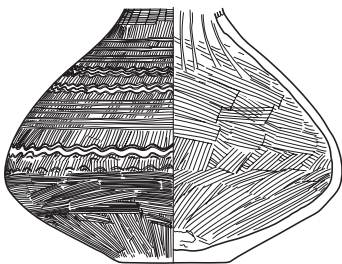

E-01Bd-012

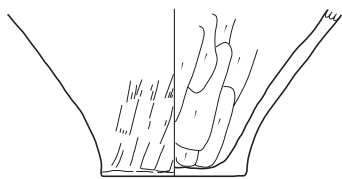

E-01Bd-013



01Ca ☒ SD01

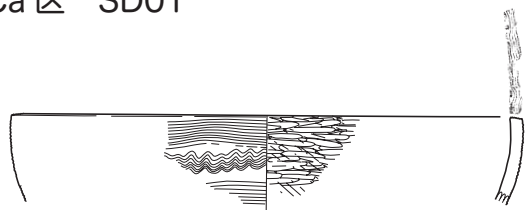

E-01Ca-001

01Cb ☒ SB01

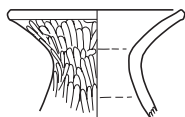

E-01Cb-001

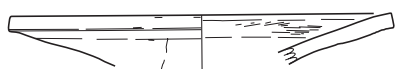

E-01Cb-002

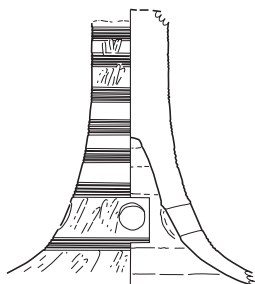

E-01Cb-003



E-01Cb-004

01Cb ☒ SB02

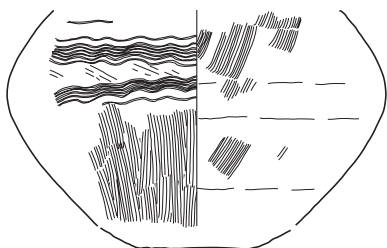

E-01Cb-005

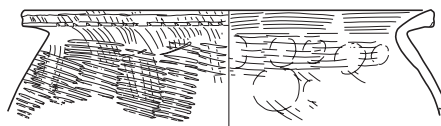

E-01Cb-007

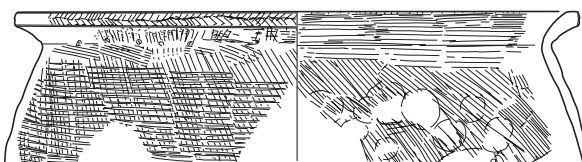

E-01Cb-008

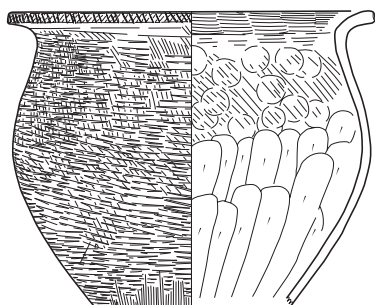

E-01Cb-006

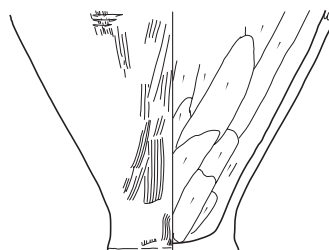

E-01Cb-009

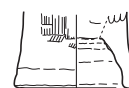

E-01Cb-010

01Cb ☒ SB09

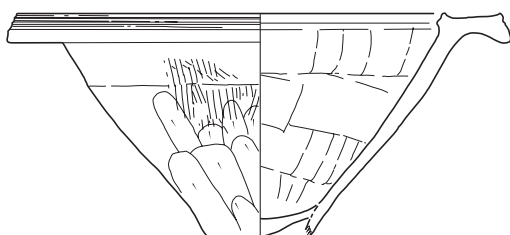

E-01Cb-011

01Cb ☒ SB10

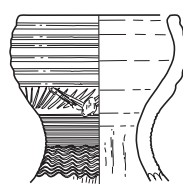

E-01Cb-012



E-01Cb-013



E-01Cb-014



01Cb ☒ SB12

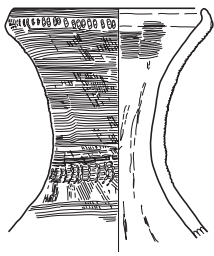

E-01Cb-015

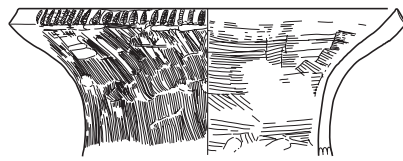

E-01Cb-016

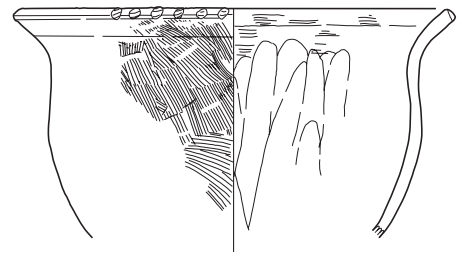

E-01Cb-020

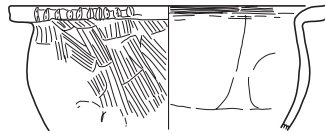

E-01Cb-018

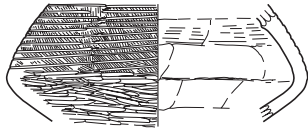

E-01Cb-017

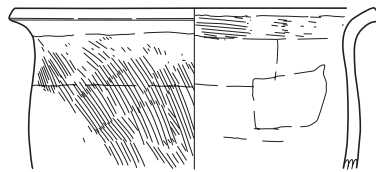

E-01Cb-019

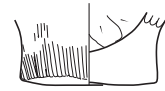

E-01Cb-021

01Cb ☒ SB14

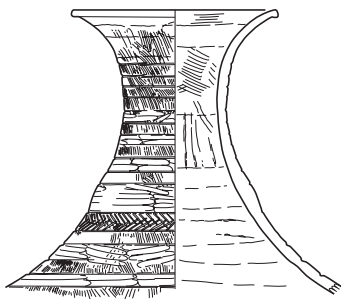

E-01Cb-022

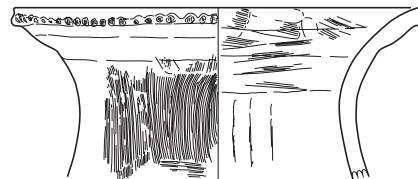

E-01Cb-023

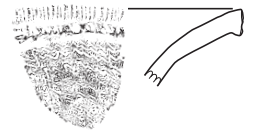

E-01Cb-024

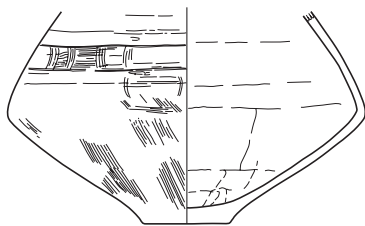

E-01Cb-025

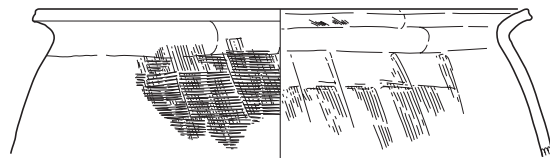

E-01Cb-027

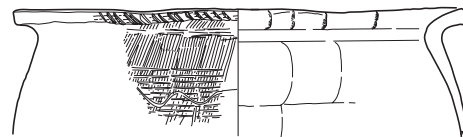

E-01Cb-028

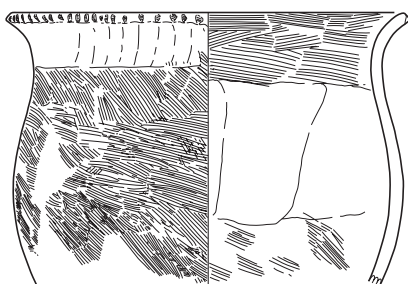

E-01Cb-026

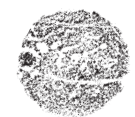
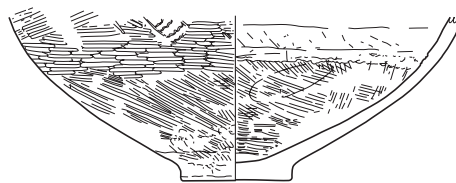

E-01Cb-029



E-01Cb-030



01Cb ☒ SD01

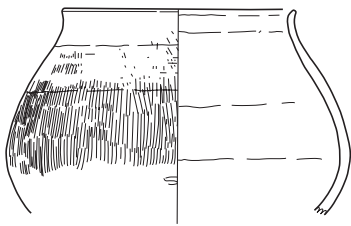

E-01Cb-031

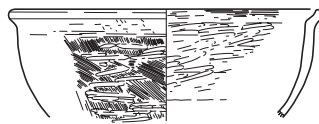

E-01Cb-032

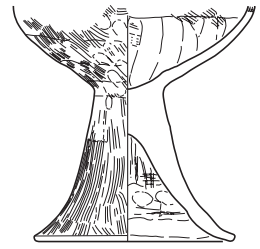

E-01Cb-033

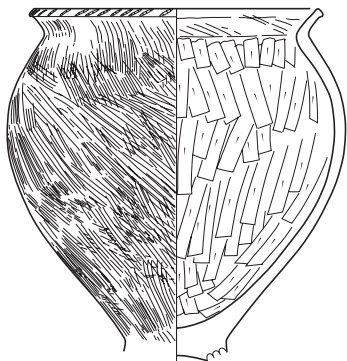

E-01Cb-034

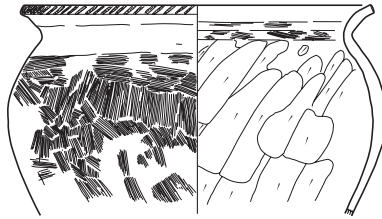

E-01Cb-035

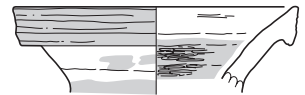

E-01Cb-037

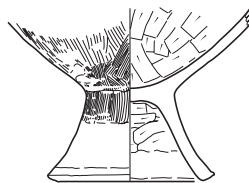

E-01Cb-036



E-01Cb-038



E-01Cb-039

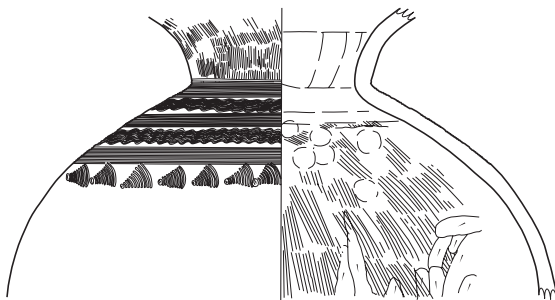

E-01Cb-040

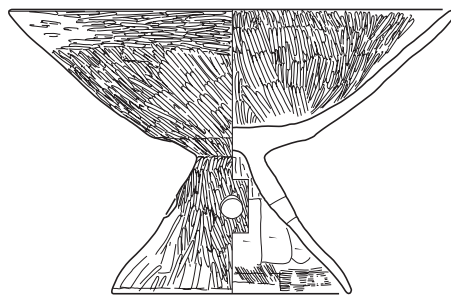

E-01Cb-041

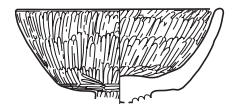

E-01Cb-042

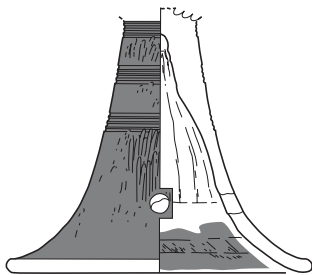

E-01Cb-043

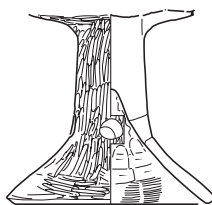

E-01Cb-046

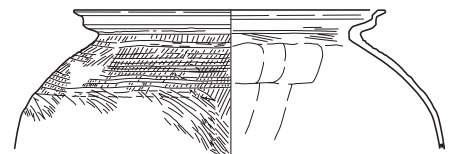

E-01Cb-048

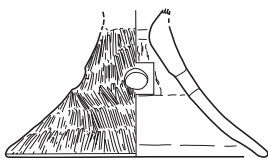

E-01Cb-044

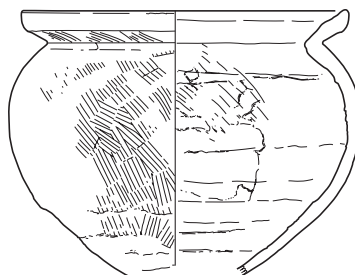

E-01Cb-047

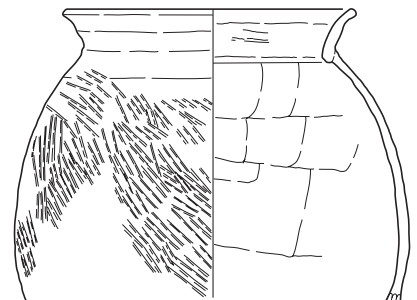

E-01Cb-049

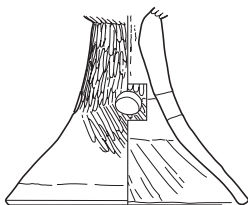

E-01Cb-045





01Cb ☒ SK08

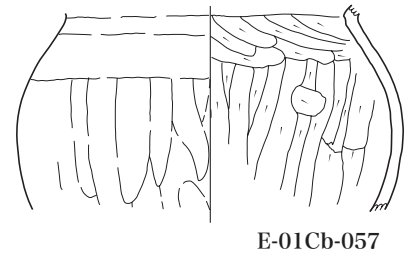
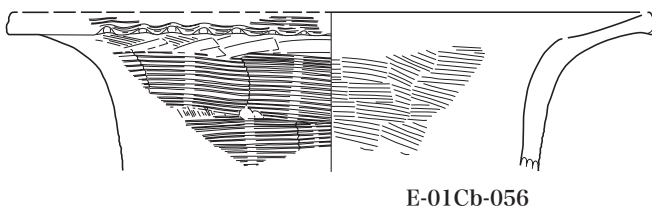
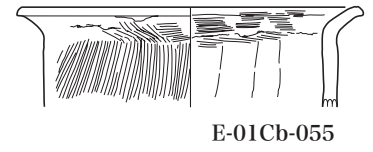
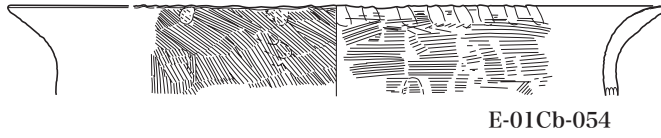
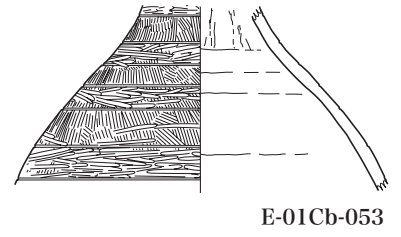
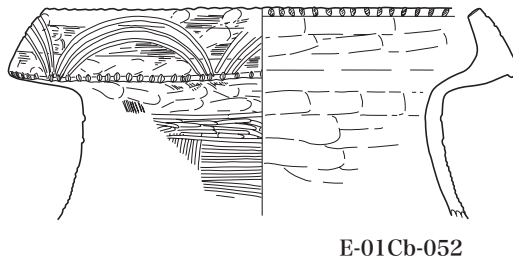
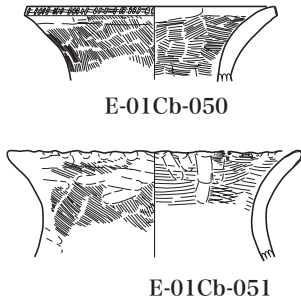

01Cb ☒ SK17

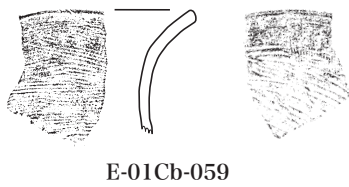
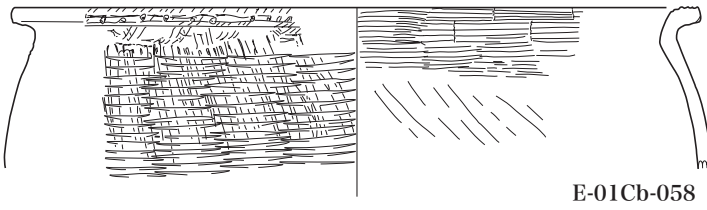

01Cb ☒ SK27

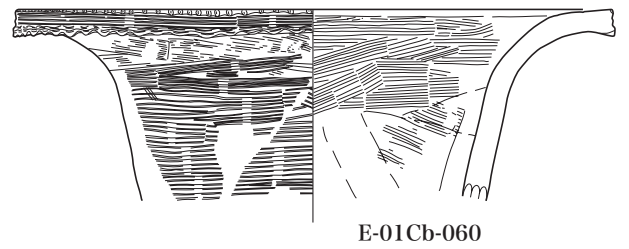

01Cb ☒ SK56

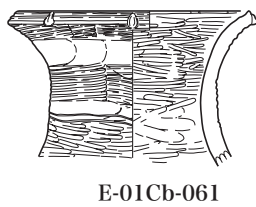

01Cb ☒ SK65

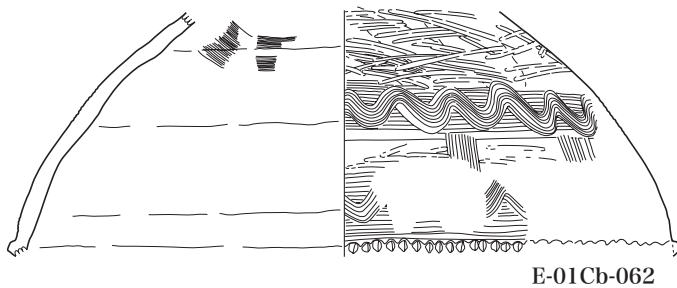
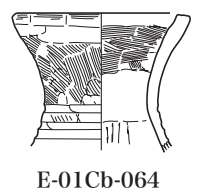
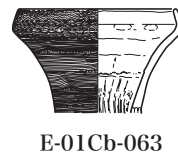

01Cb ☒ SK65

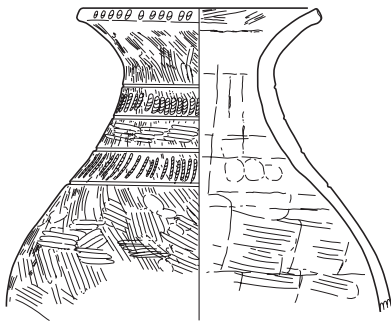

E-01Cb-066

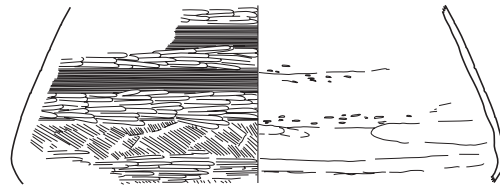

E-01Cb-067



E-01Cb-068

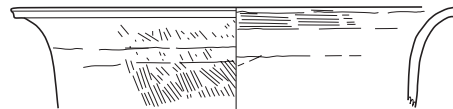

E-01Cb-069

01Cb ☒ SK68

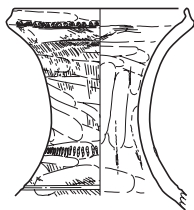

E-01Cb-070

01Cb ☒ SK81

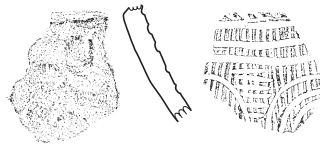

E-01Cb-071

01Cb ☒ SK87

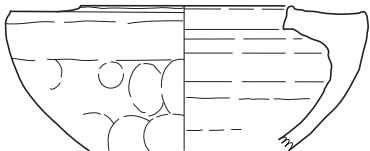

E-01Cb-074

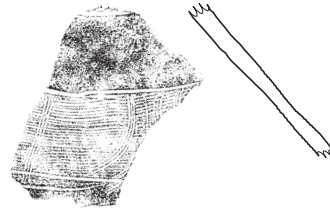

E-01Cb-072

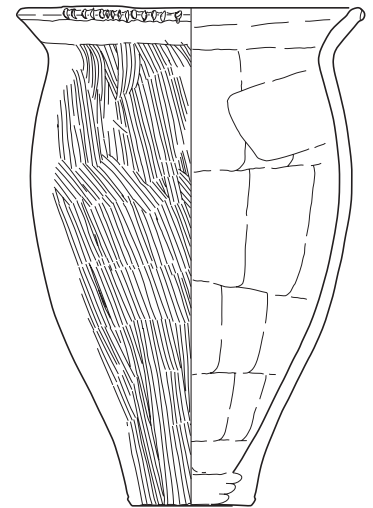

E-01Cb-073

01Cb ☒ SK90

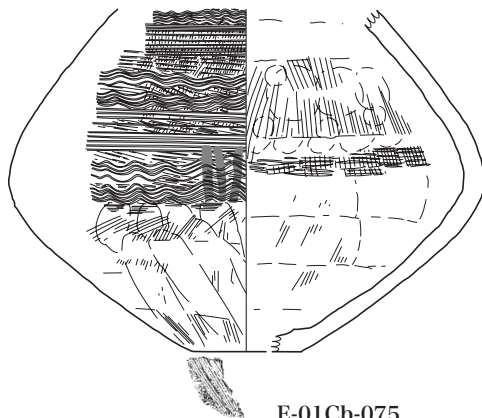

E-01Cb-075

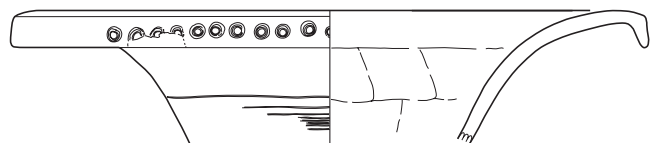

E-01Cb-076

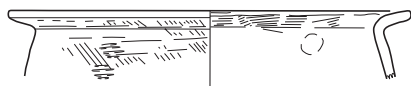

E-01Cb-077



01Da ☒ SB05

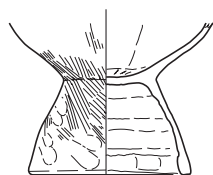

E-01Da-001

01Da ☒ SB26

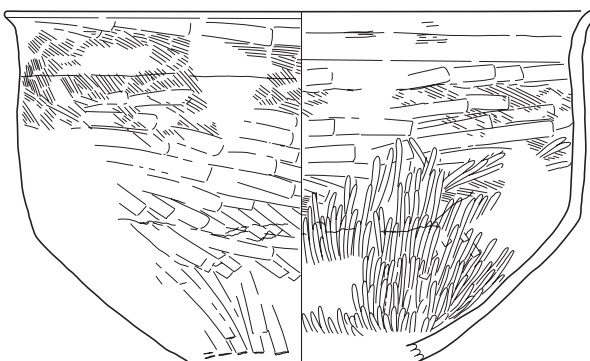

E-01Da-002

01Da ☒ SB34

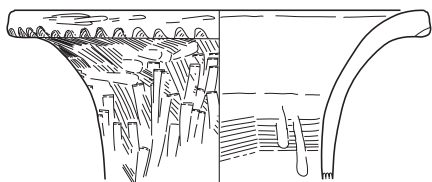

E-01Da-003

01Da ☒ SB57

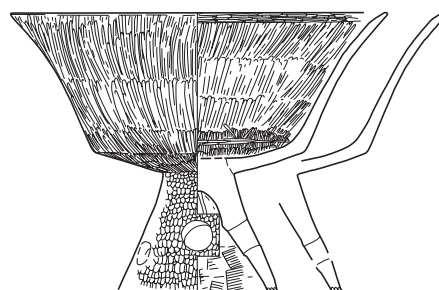

E-01Da-008

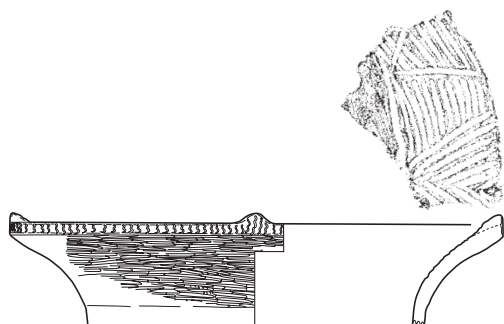

E-01Da-004

01Da ☒ SB76



E-01Da-009



E-01Da-010

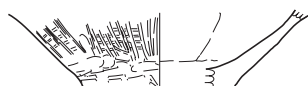

E-01Da-005

01Da ☒ SB78

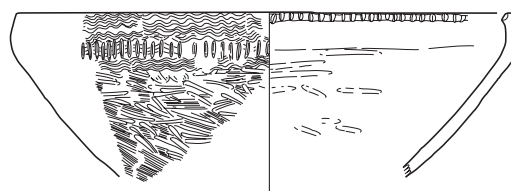

E-01Da-011

01Da ☒ SB43

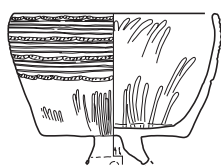

E-01Da-007

01Da ☒ SB84

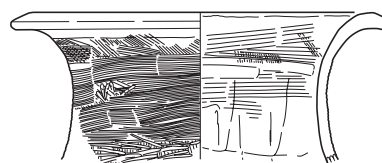

E-01Da-012



01Da ☒ SK16

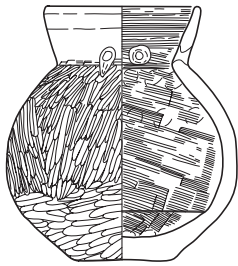

E-01Da-013

01Da ☒ SK76

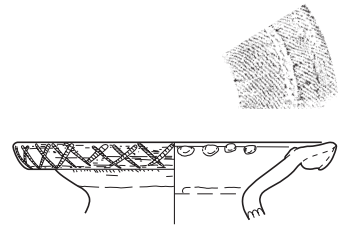

E-01Da-015

01Da ☒ SK72



E-01Da-014

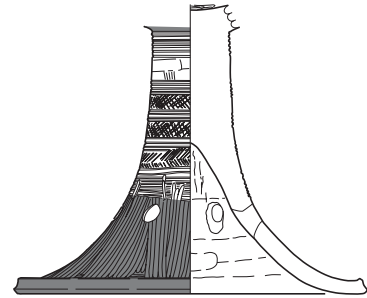

E-01Da-016

01Da ☒ SK257

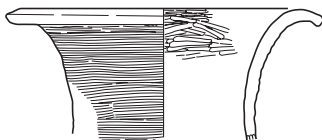

E-01Da-017

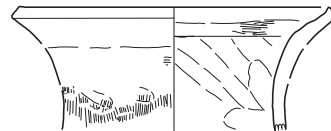

E-01Da-018



E-01Da-019



E-01Da-020

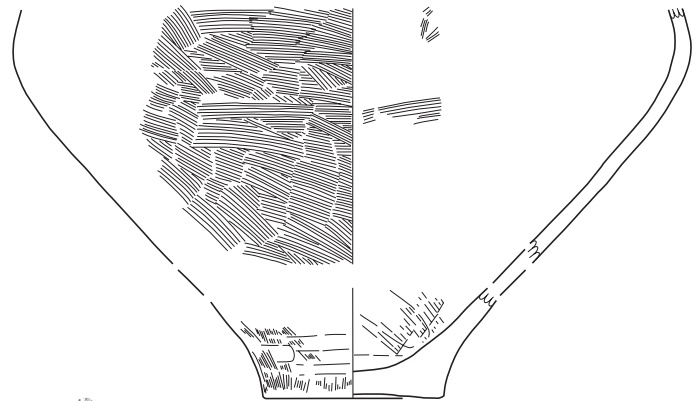

E-01Da-022

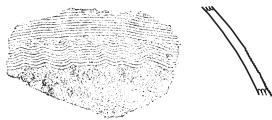

E-01Da-021



E-01Da-023



E-01Da-024

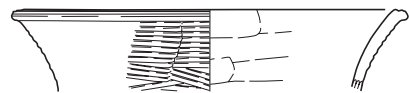

E-01Da-027



E-01Da-025

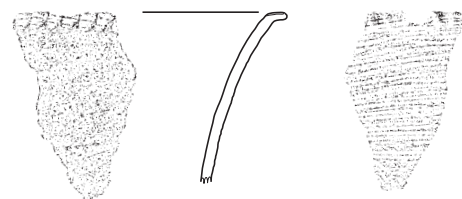

E-01Da-028

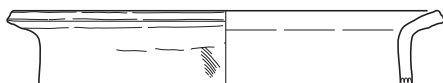

E-01Da-026



01Da 区 SK257

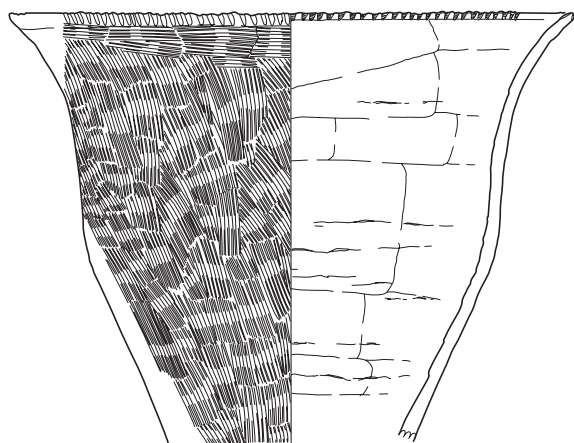

E-01Da-029



E-01Da-030

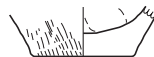

E-01Da-031

01Da 区 検II-4

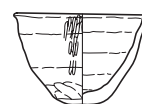

E-01Da-032

01Da 区 南トレンチ



E-01Da-033

01Db 区 SB03

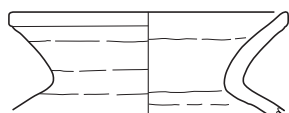

E-01Db-001

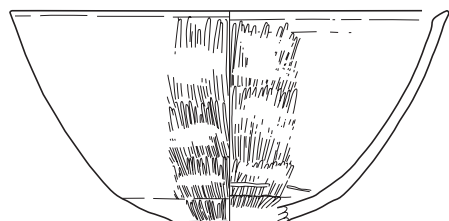

E-01Db-002



E-01Db-003

01Db 区 SB08

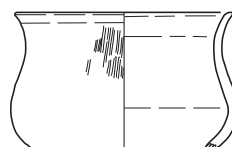

E-01Db-004

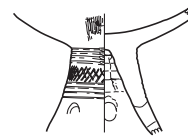

E-01Db-005



E-01Db-006

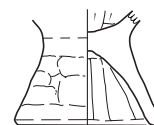

E-01Db-007

01Db 区 SB11

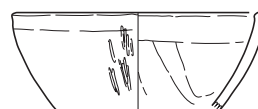

E-01Db-011

01Db 区 SB09



E-01Db-008

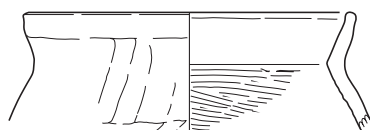

E-01Db-009

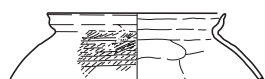

E-01Db-010

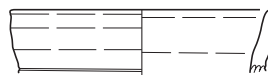

E-01Db-012

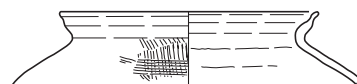

E-01Db-013



E-01Db-014



01Db ☒ SB14

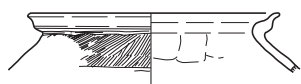

E-01Db-015

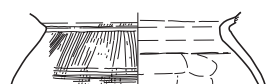

E-01Db-016

01Db ☒ SB55

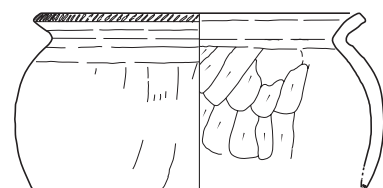

E-01Db-020

01Db ☒ SB17

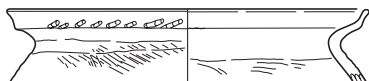

E-01Db-017

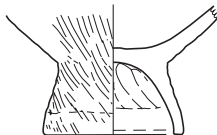

E-01Db-018

01Db ☒ SB84



E-01Db-021

01Db ☒ SB29

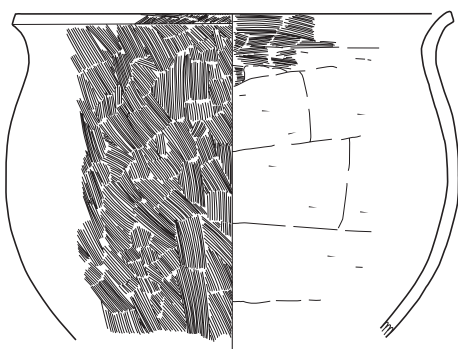

E-01Db-019

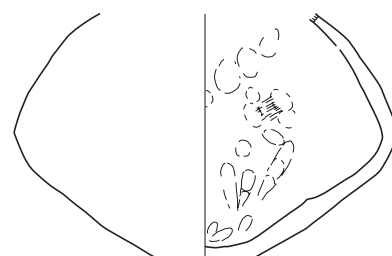

E-01Db-022

01Db ☒ SB85

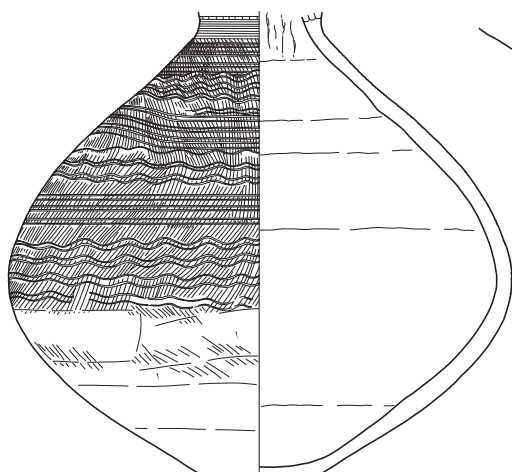

E-01Db-023

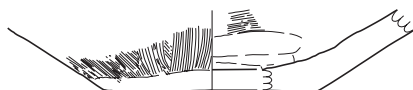

E-01Db-024

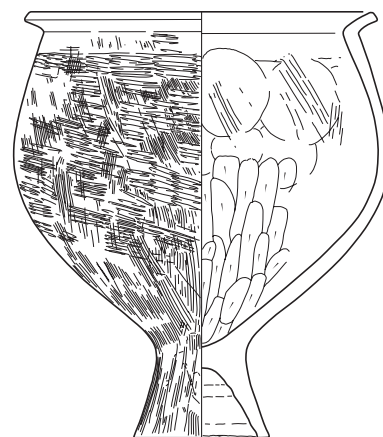

E-01Db-026

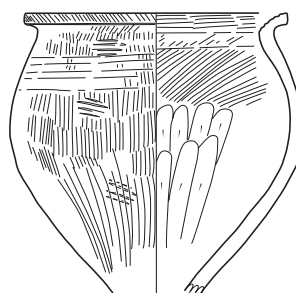

E-01Db-025



E-01Db-029

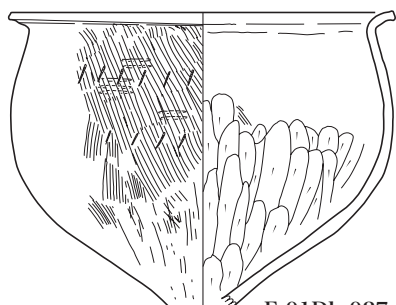

E-01Db-027

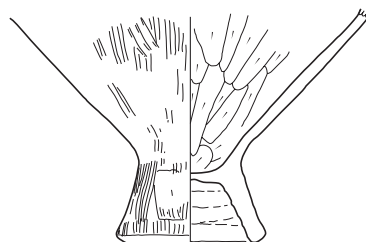

E-01Db-028

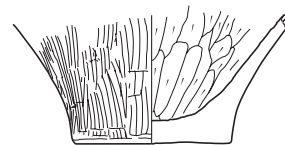

E-01Db-030



01Db ☒ SB86

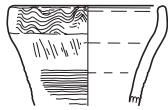

E-01Db-031

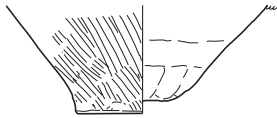

E-01Db-032

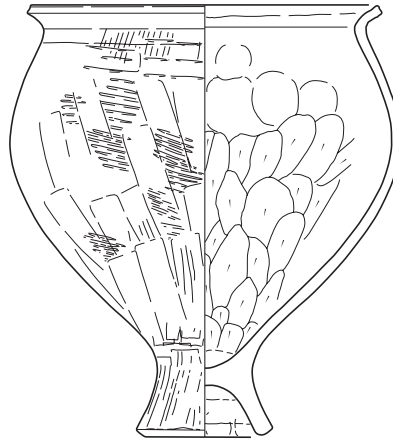

E-01Db-033

01Db ☒ SD01

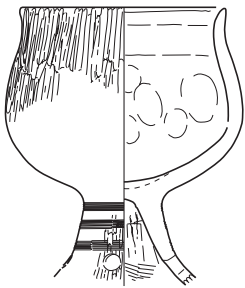

E-01Db-034

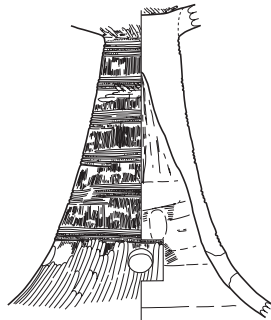

E-01Db-035



E-01Db-038

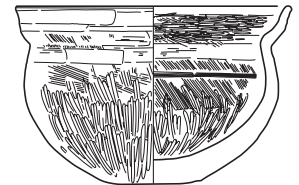

E-01Db-039

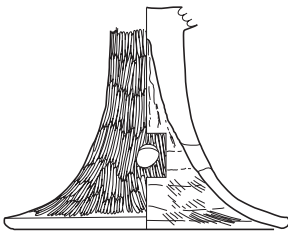

E-01Db-036

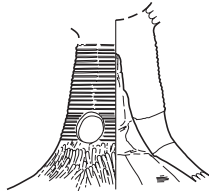

E-01Db-037

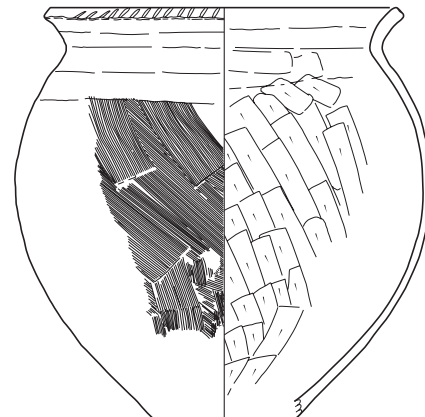

E-01Db-040

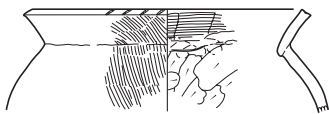

E-01Db-041

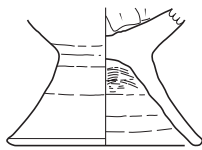

E-01Db-043

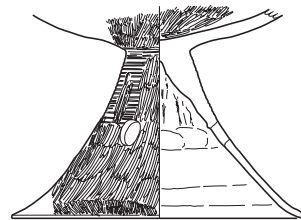

E-01Db-045

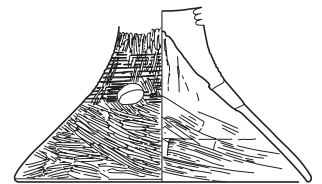

E-01Db-046

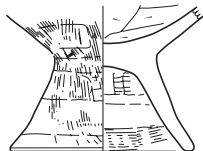

E-01Db-042

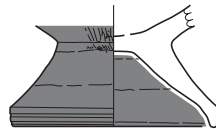

E-01Db-044

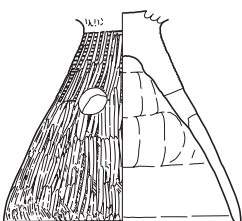

E-01Db-047

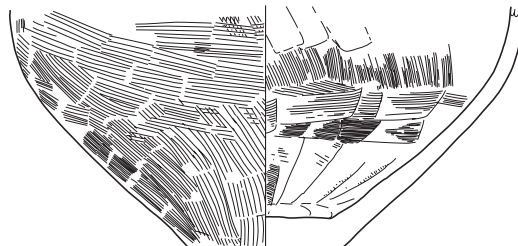

E-01Db-048

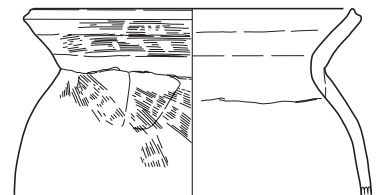

E-01Db-049



01Db ☒ SD01

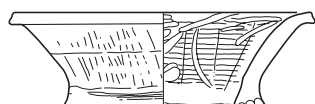

E-01Db-050

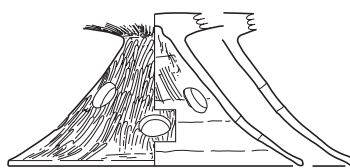

E-01Db-052

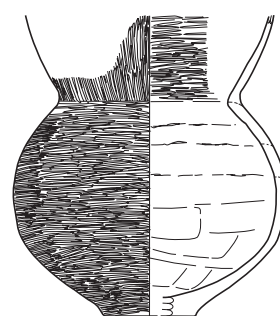

E-01Db-054

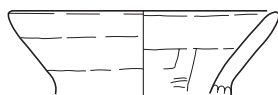

E-01Db-051



E-01Db-053

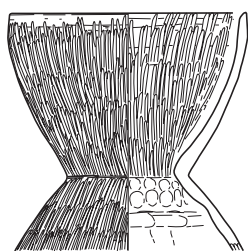

E-01Db-055

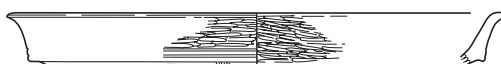

E-01Db-056

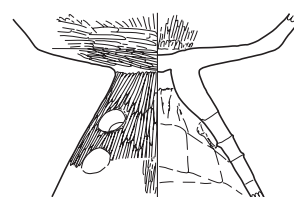

E-01Db-058



E-01Db-057

01Db ☒ SD02

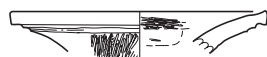

E-01Db-059

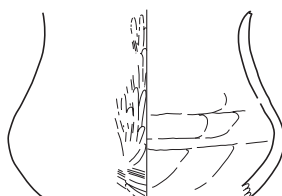

E-01Db-062

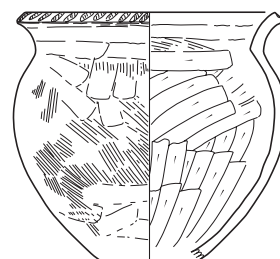

E-01Db-063



E-01Db-060

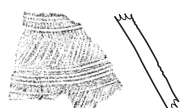

E-01Db-061



E-01Db-064

01Db ☒ SK109

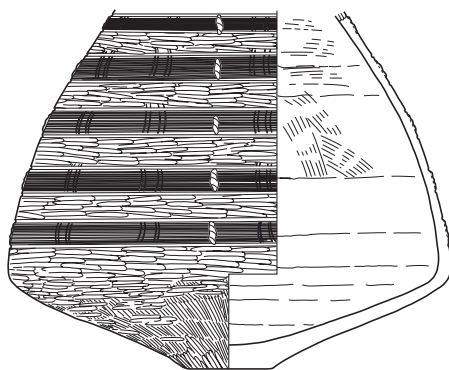

E-01Db-065

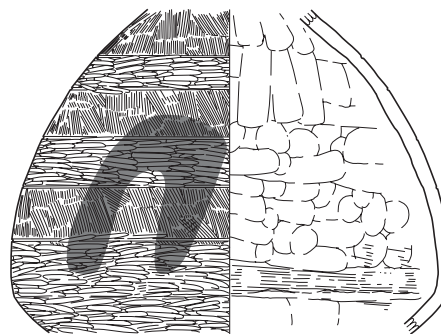

E-01Db-066





01Db 区 SK188

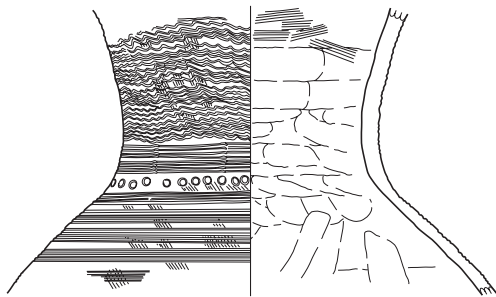

E-01Db-067

01Db 区 SK204

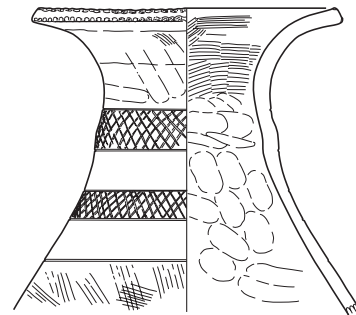

E-01Db-068

01Db 区 SK378

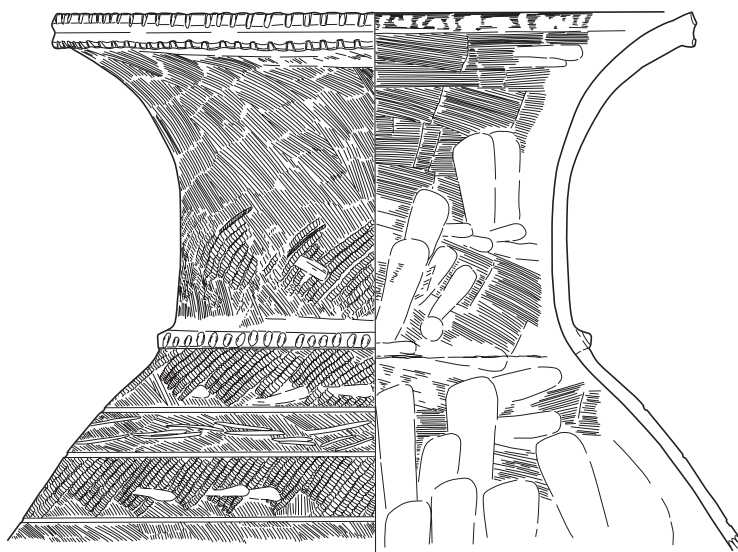

E-01Db-069

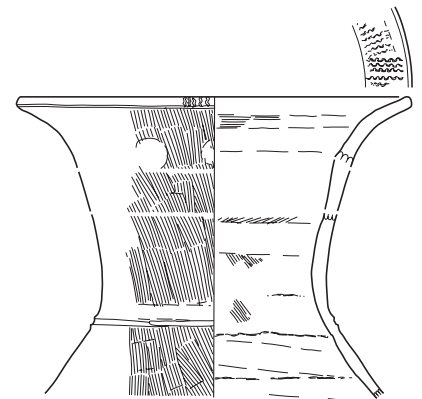

E-01Db-070

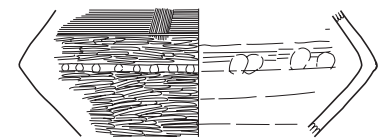

E-01Db-071

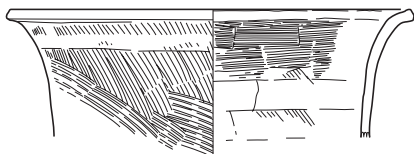

E-01Db-072



E-01Db-073

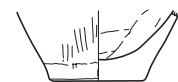

E-01Db-074

01Db 区 SK 北壁ベルト

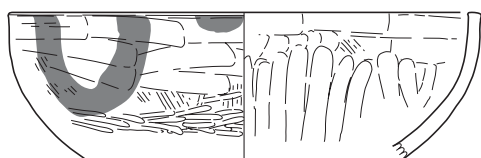

E-01Db-075

01Dc 区 SB03

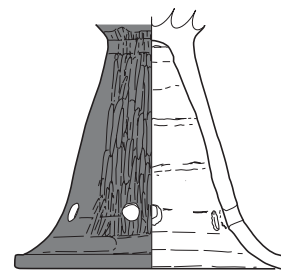

E-01Dc-001



01Dc ☒ SB20

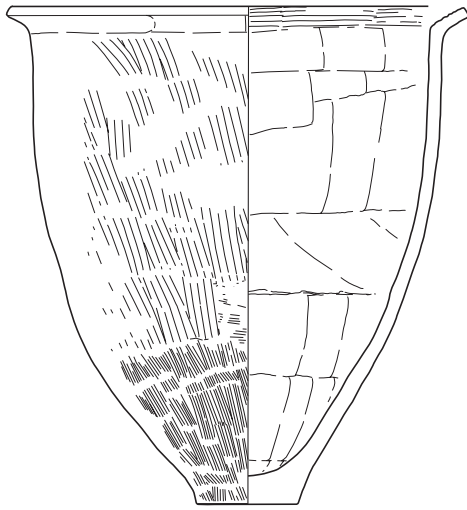

E-01Dc-002

01Dc ☒ SB30

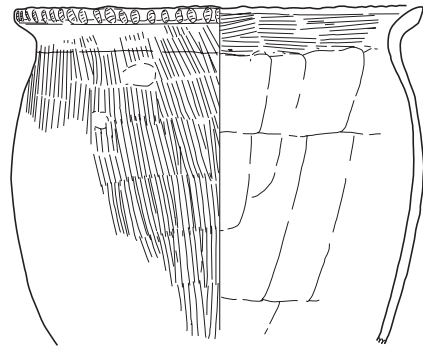

E-01Dc-003



E-01Dc-004

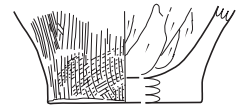

E-01Dc-005

01Dc ☒ SD01



E-01Dc-006

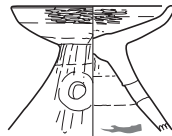

E-01Dc-009

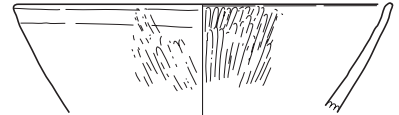

E-01Dc-013

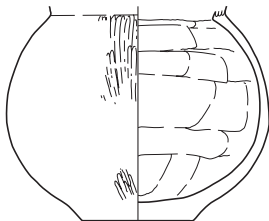

E-01Dc-007

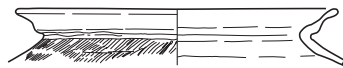

E-01Dc-010



E-01Dc-014

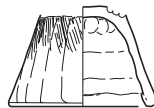

E-01Dc-011

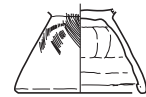

E-01Dc-015

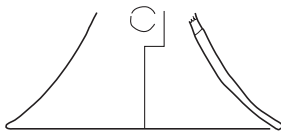

E-01Dc-008

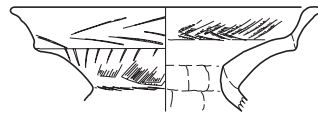

E-01Dc-012

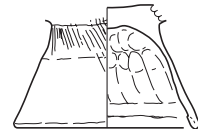

E-01Dc-016

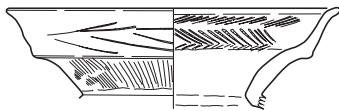

E-01Dc-017

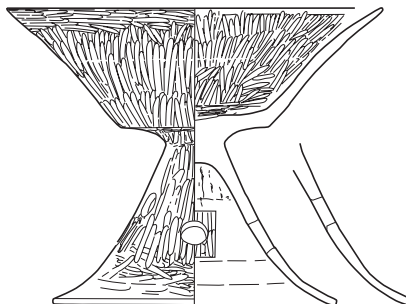

E-01Dc-018

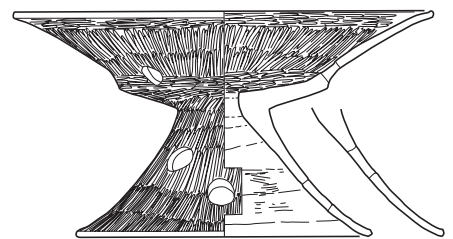

E-01Dc-019



01Dc ☒ SK09

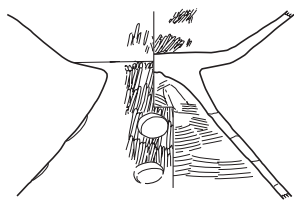

E-01Dc-020

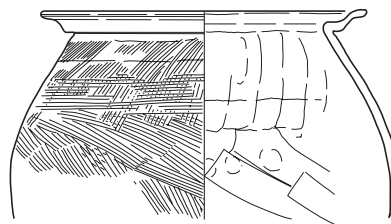

E-01Dc-021

01Dc ☒ SK75

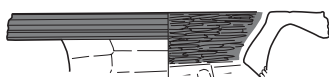

E-01Dc-022

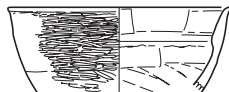

E-01Dc-025

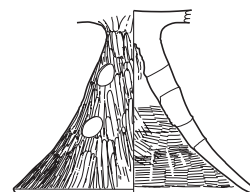

E-01Dc-028

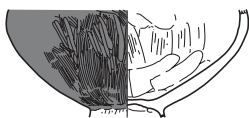

E-01Dc-023



E-01Dc-026

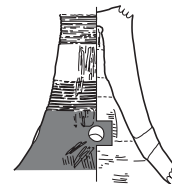

E-01Dc-029



E-01Dc-024

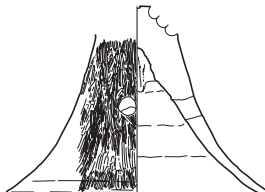

E-01Dc-027

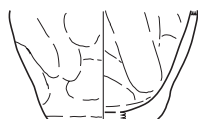

E-01Dc-030

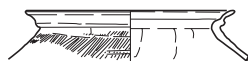

E-01Dc-032

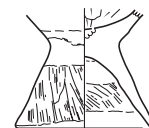

E-01Dc-034

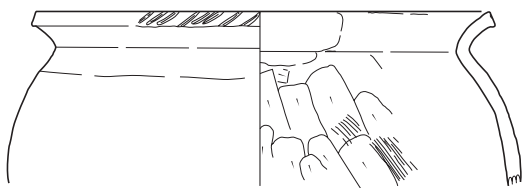

E-01Dc-031

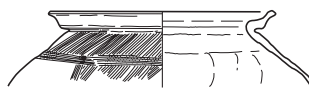

E-01Dc-033

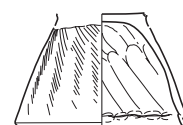

E-01Dc-035

01Dc ☒ SK170

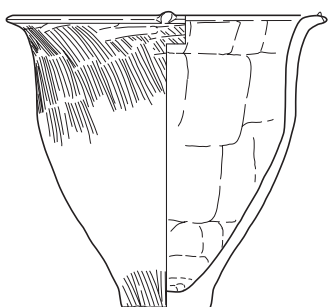

E-01Dc-036



01Dc 区 SK181



E-01Dc-037

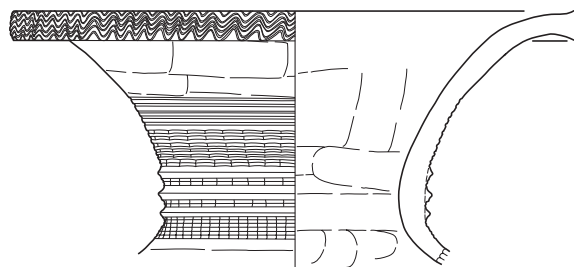
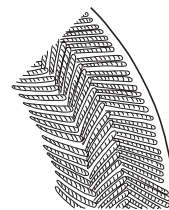

E-01Dc-038

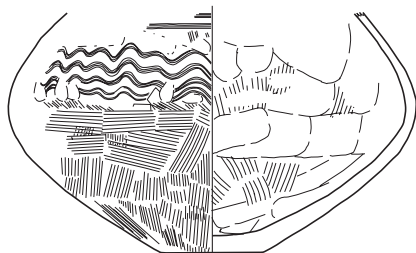

E-01Dc-039

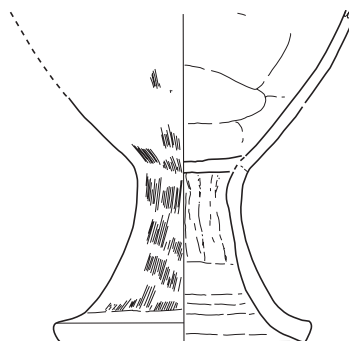

E-01Dc-040

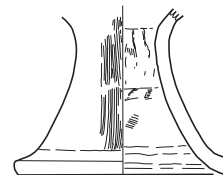

E-01Dc-041

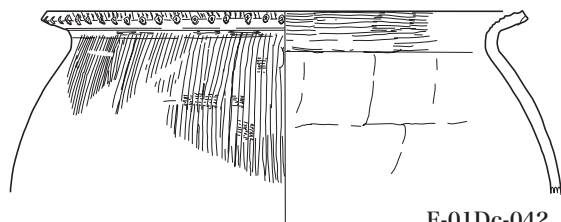

E-01Dc-042

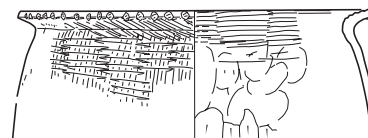

E-01Dc-043

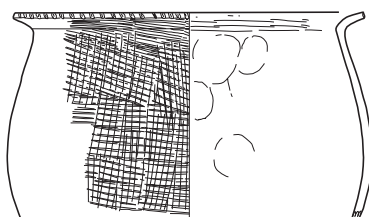

E-01Dc-044

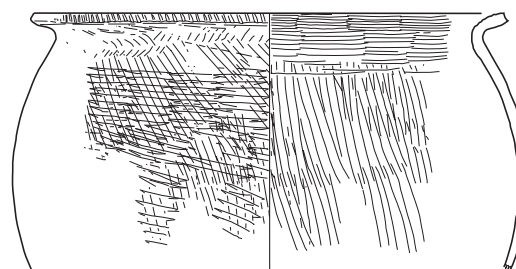

E-01Dc-045

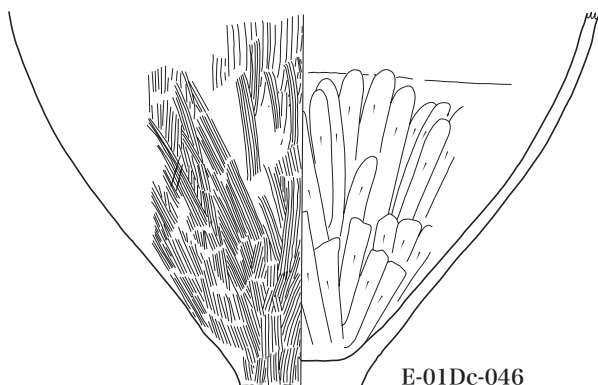

E-01Dc-046

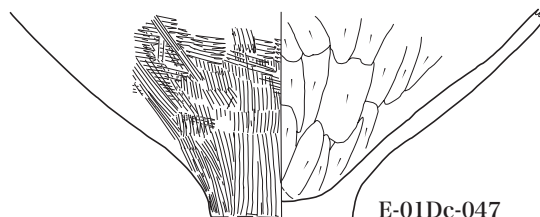

E-01Dc-047



01De ☒ SD01

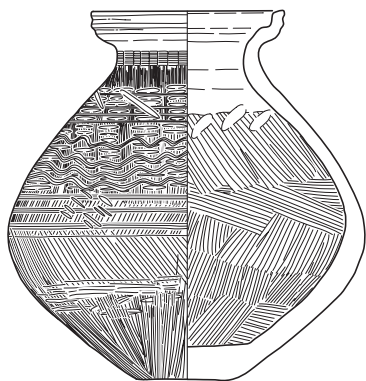

E-01De-001

01Df ☒ SD01

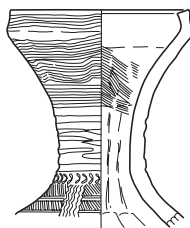

E-01Df-001

01Df ☒ SD03

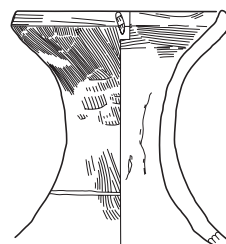

E-01Df-003

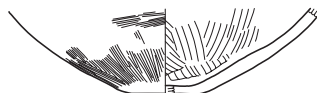

E-01Df-002

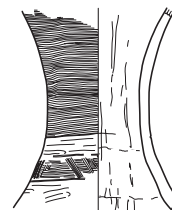

E-01Df-004

01Df ☒ SD04

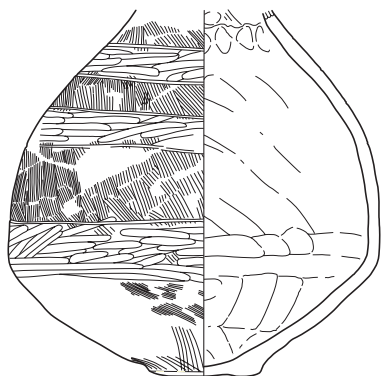

E-01Df-006

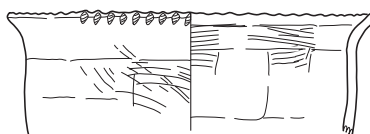

E-01Df-007

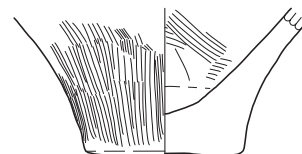

E-01Df-005

01Df ☒ SD05

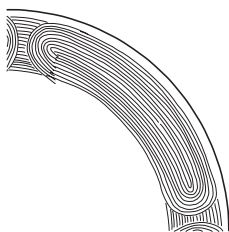

E-01Df-008

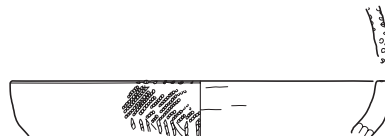

E-01Df-010

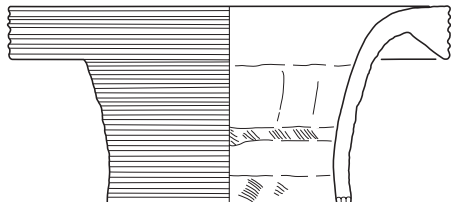

E-01Df-009

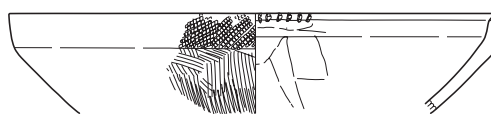

E-01Df-011

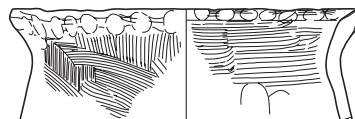

E-01Df-012

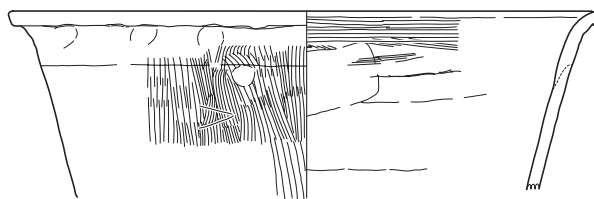

E-01Df-013



01Df ☒ SE01

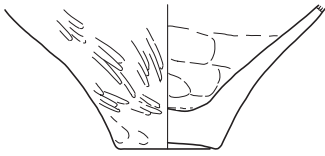

E-01Df-014

01Df ☒ SK02

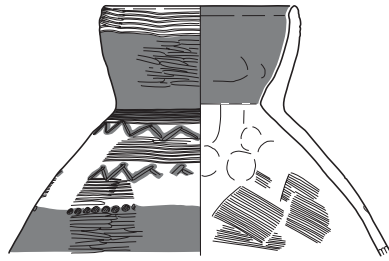

E-01Df-015

01Df ☒ SK04

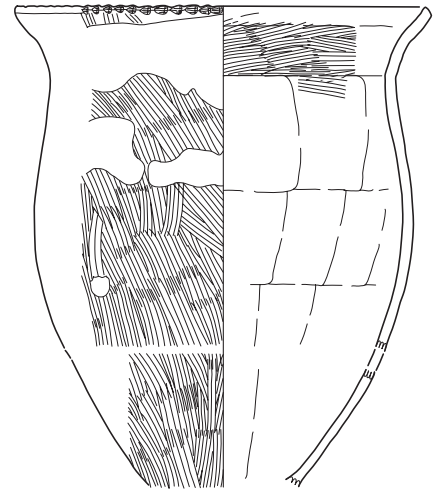

E-01Df-016

01Df ☒ SK06

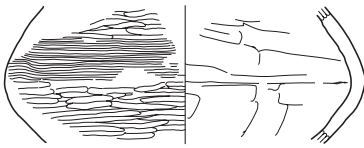

E-01Df-017



E-01Df-018



E-01Df-019

01Df ☒ SK12

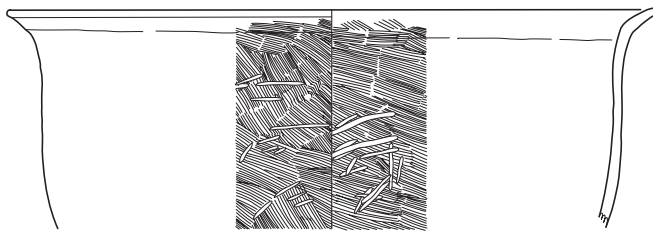

E-01Df-021



E-01Df-022

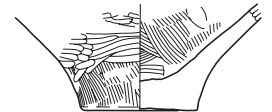

E-01Df-023

01Dg ☒ SD01

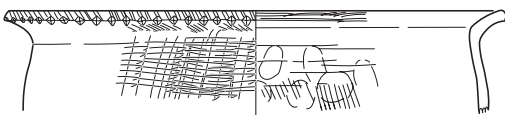

E-01Dg-001

01Dg ☒ SD02

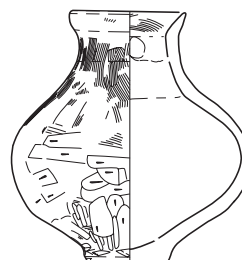

E-01Dg-002

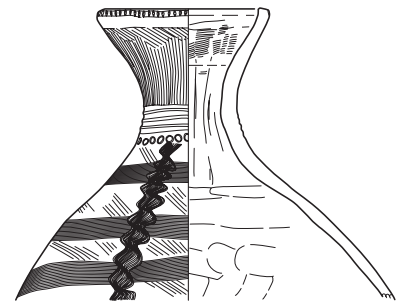

E-01Dg-003

01Dg ☒ SK04

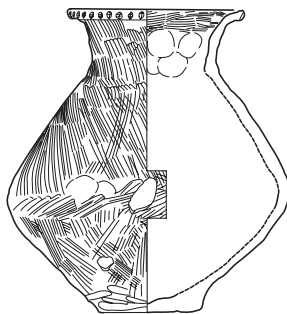

E-01Dg-005

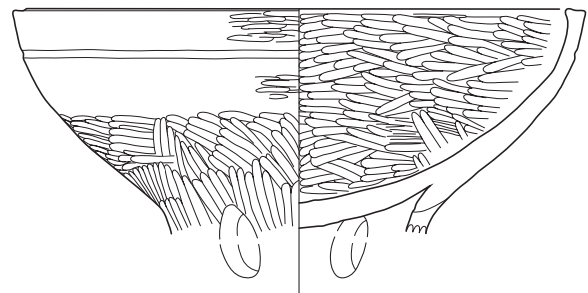

E-01Dg-004



02Ab 区 SD01

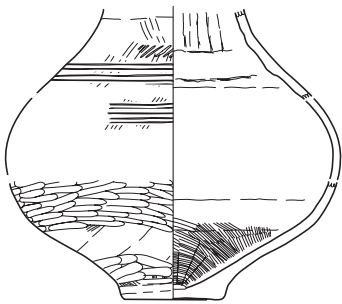

E-02Ab-001

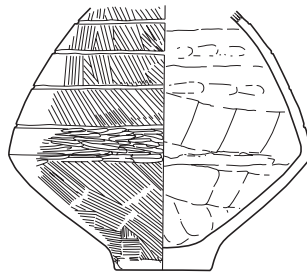

E-02Ab-002

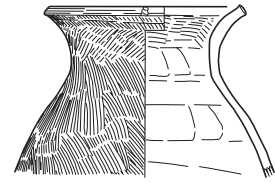

E-02Ab-003

02Ab 区 SD04

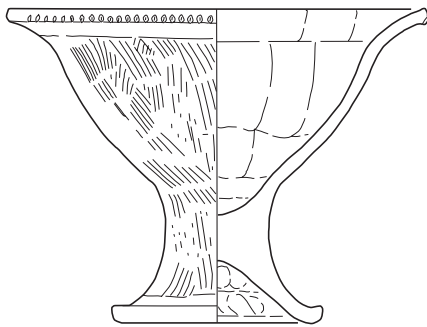

E-02Ab-005

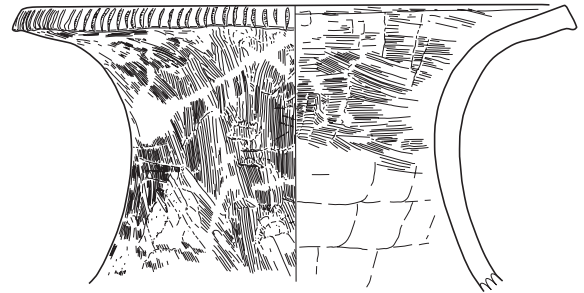

E-02Ab-004

02Ab 区 SK01

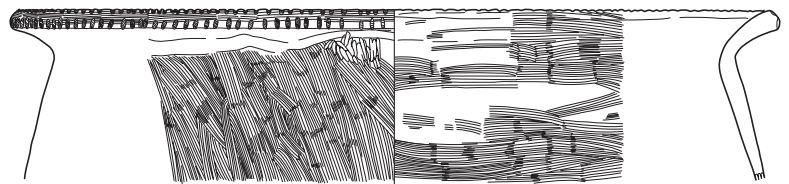

E-02Ab-006

02Ab 区 検出 II

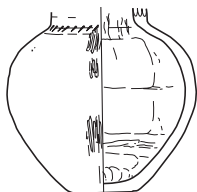

E-02Ab-007

02Ab 区

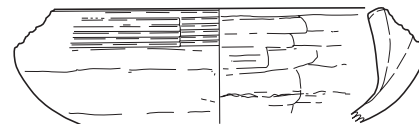

E-02Ab-008

02Ac 区 SD01

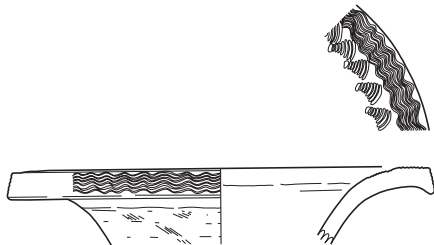

E-02Ac-001

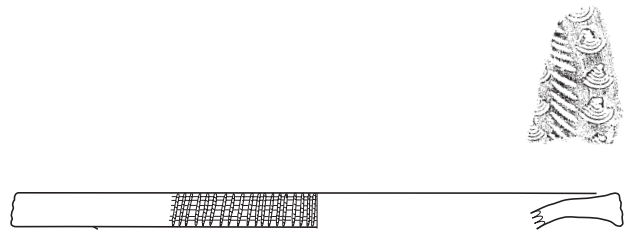

E-02Ac-003

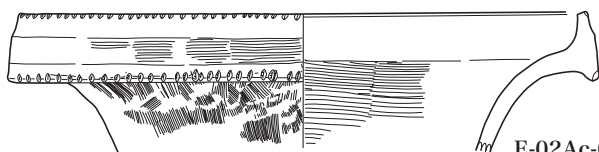

E-02Ac-002



02Ac ☒ SD01

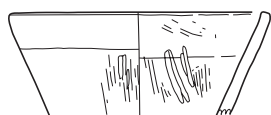

E-02Ac-004

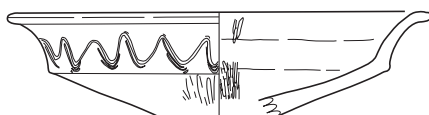

E-02Ac-007

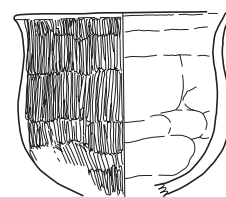

E-02Ac-008

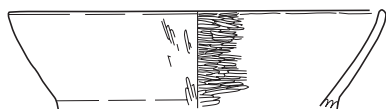

E-02Ac-005

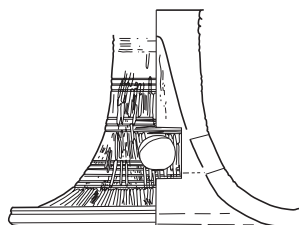

E-02Ac-009

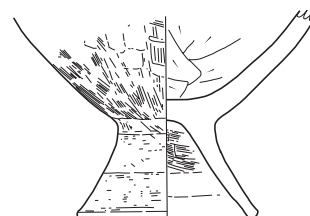

E-02Ac-010

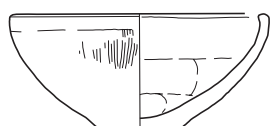

E-02Ac-006

02Ac ☒ SD02

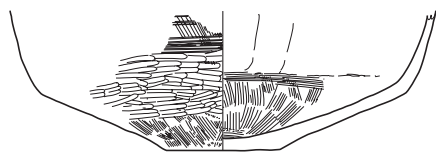

E-02Ac-011

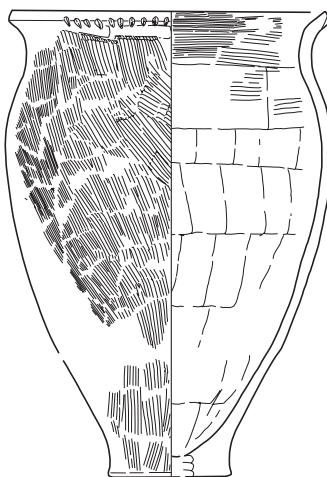

E-02Ac-013

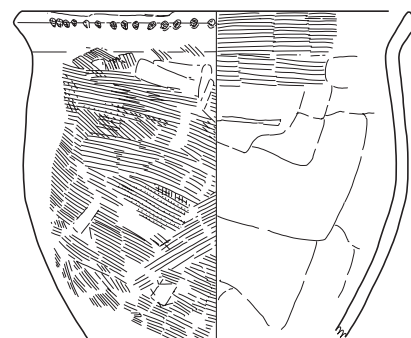

E-02Ac-014

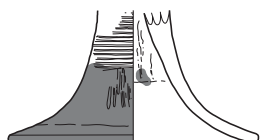

E-02Ac-012

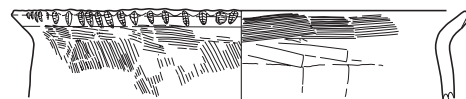

E-02Ac-015

02Ac ☒ SD03



E-02Ac-016

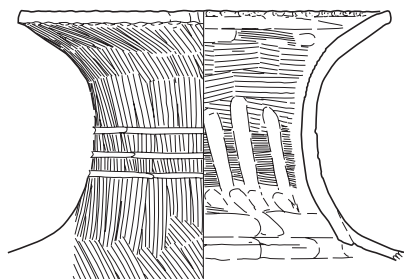

E-02Ac-018

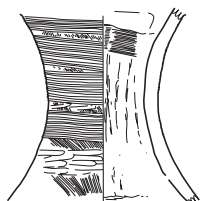

E-02Ac-017

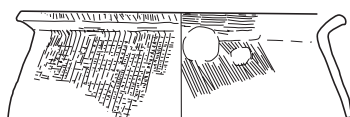

E-02Ac-019

02Ac ☒ SD04



E-02Ac-020





02Ac 区 SD06

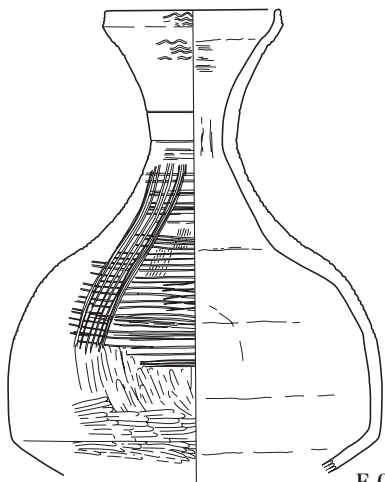

E-02Ac-021

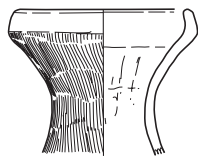

E-02Ac-022

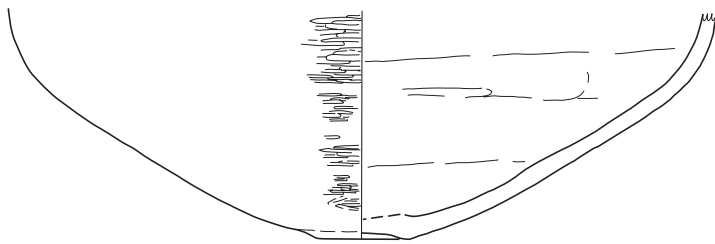

E-02Ac-023

02Ac 区 検出 I

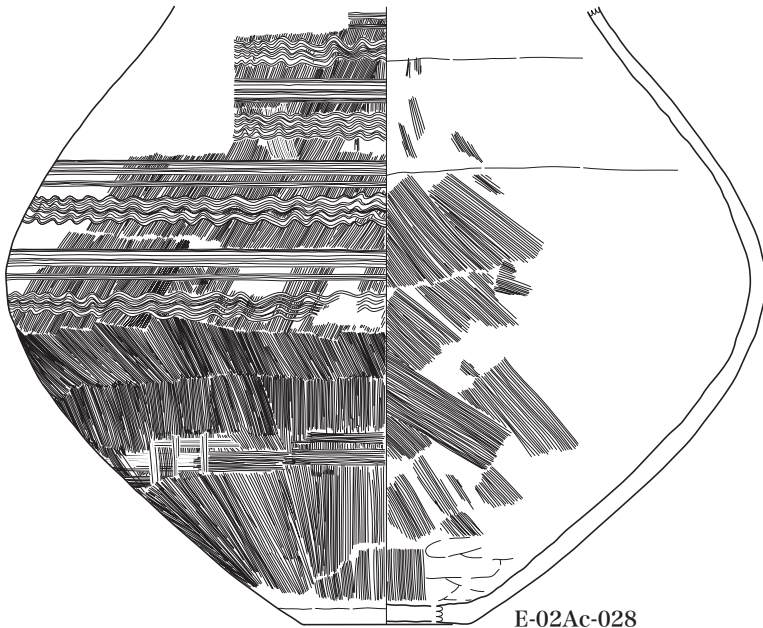

E-02Ac-028

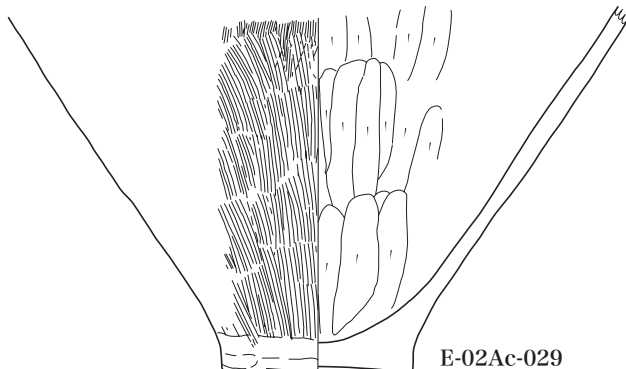

E-02Ac-029

02Ac 区 SK12

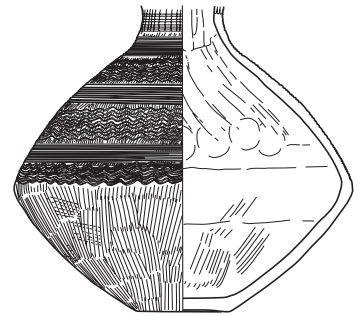

E-02Ac-024

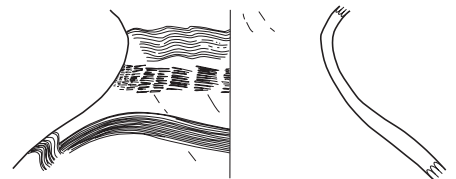

E-02Ac-025

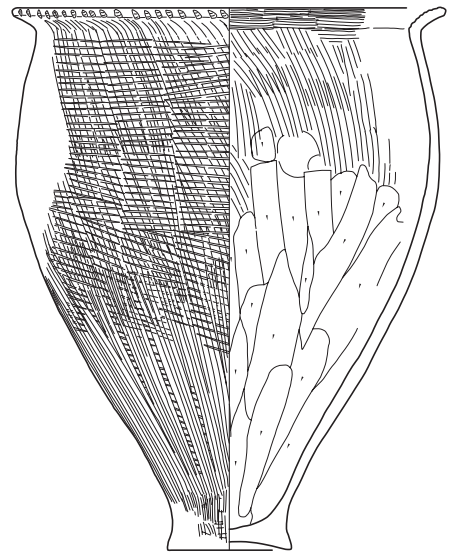

E-02Ac-026

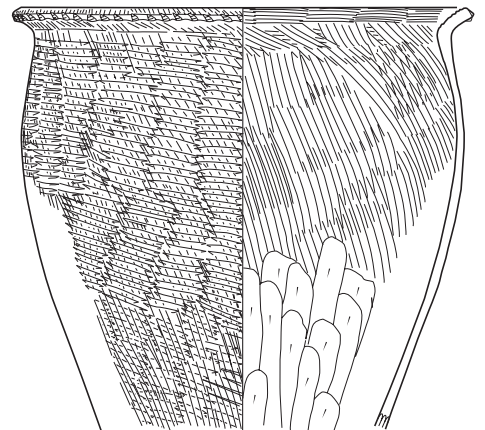

E-02Ac-027



02Ad ☒ SB02

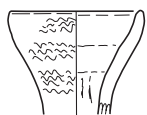

E-02Ad-001

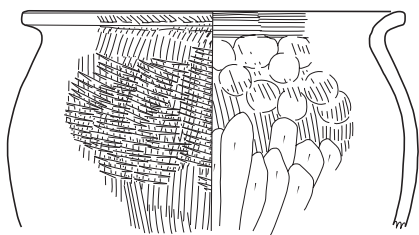

E-02Ad-002

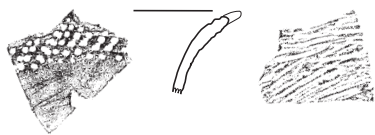

E-02Ad-003

02Ad ☒ SB05

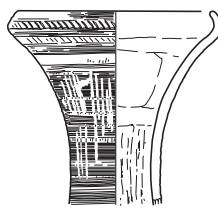

E-02Ad-005

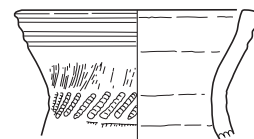

E-02Ad-006

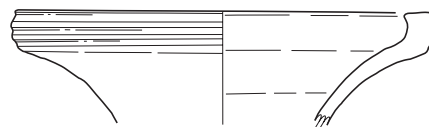

E-02Ad-007

02Ad ☒ SB03

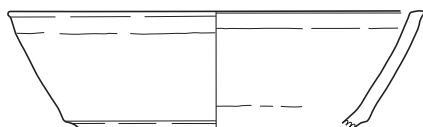

E-02Ad-004

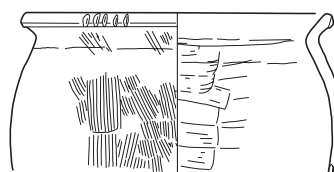

E-02Ad-008

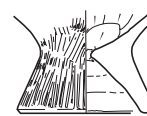

E-02Ad-009

02Ad ☒ SB06

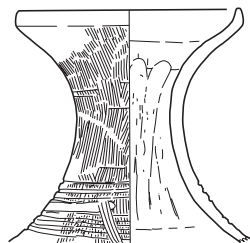

E-02Ad-010

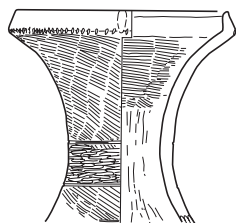

E-02Ad-011

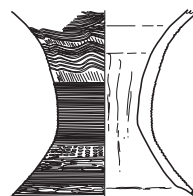

E-02Ad-012

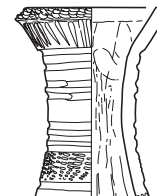

E-02Ad-013



E-02Ad-014

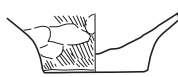

E-02Ad-015



E-02Ad-017

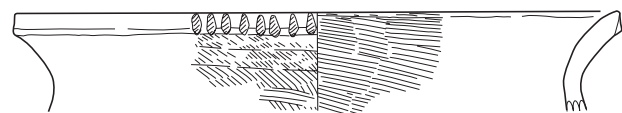

E-02Ad-016

02Ad ☒ SD01

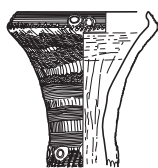

E-02Ad-018

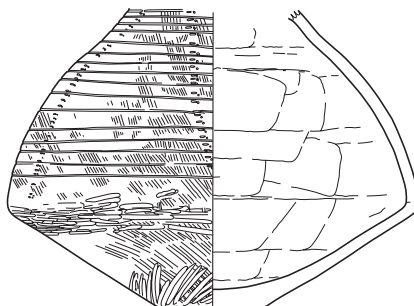

E-02Ad-019

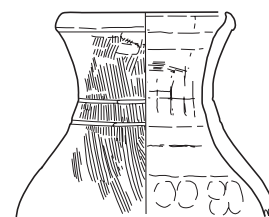

E-02Ad-020



E-02Ad-021



02Ad ☒ SD01



E-02Ad-022

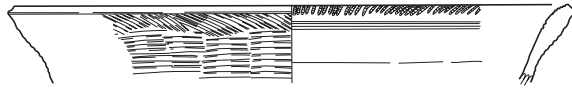

E-02Ad-023

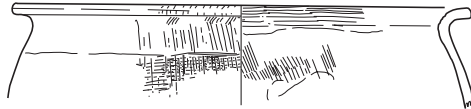

E-02Ad-024

02Ad ☒ SD03

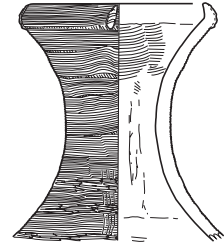

E-02Ad-025

02Ad ☒ SD04

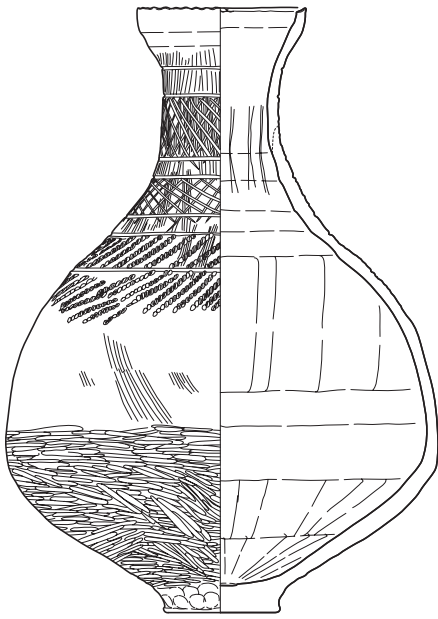

E-02Ad-026

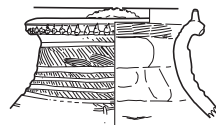

E-02Ad-027

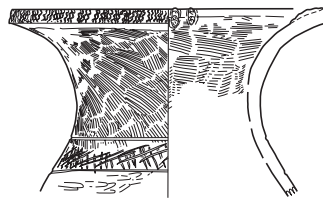

E-02Ad-028

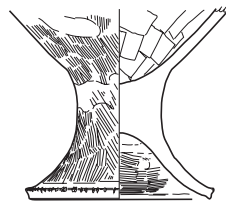

E-02Ad-029

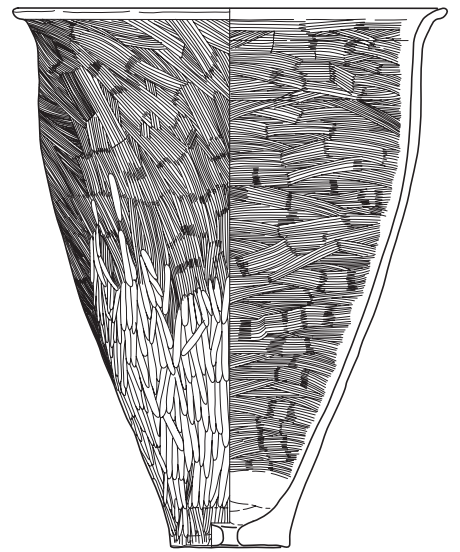

E-02Ad-030

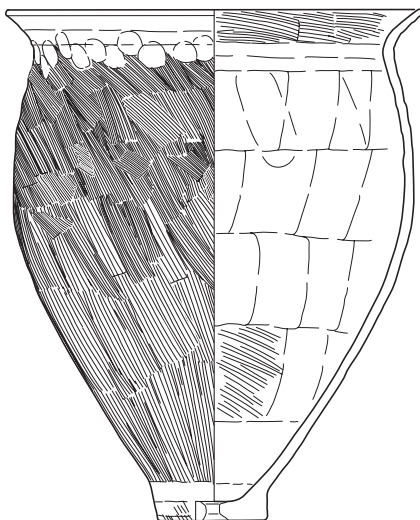

E-02Ad-031

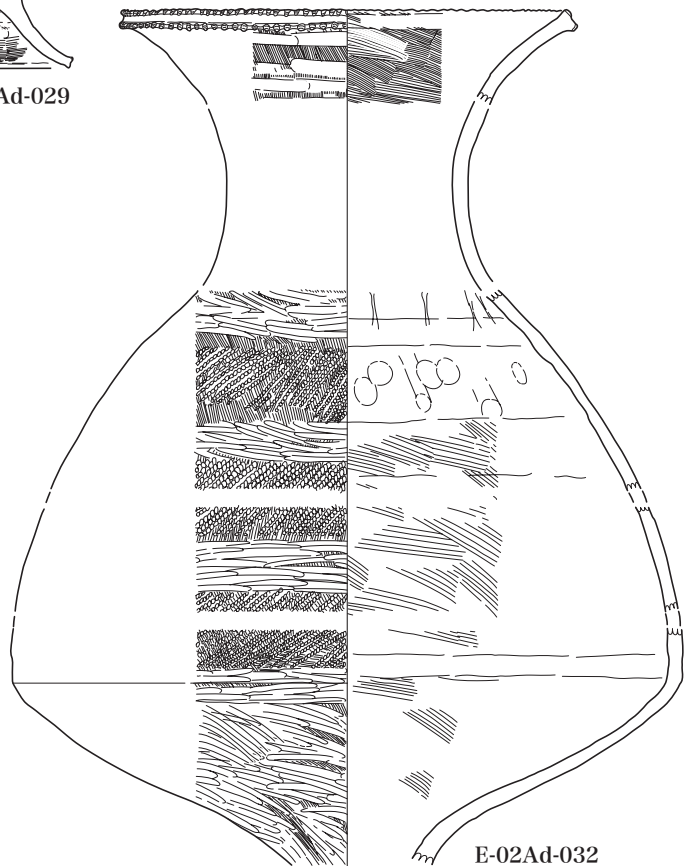

E-02Ad-032



02Ad ☒ SD04

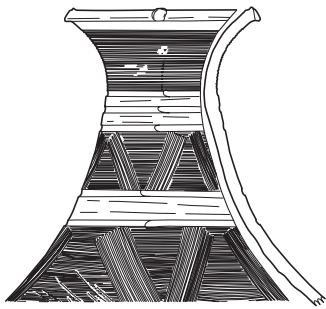

E-02Ad-033

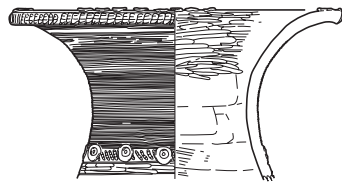

E-02Ad-035

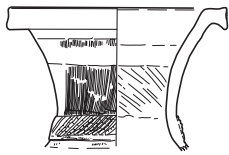

E-02Ad-034

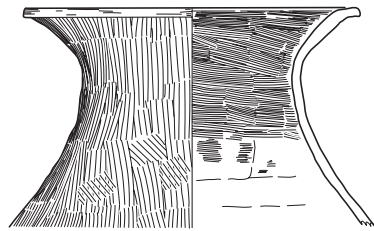

E-02Ad-036



E-02Ad-038

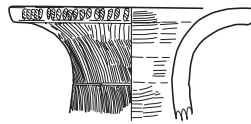

E-02Ad-040

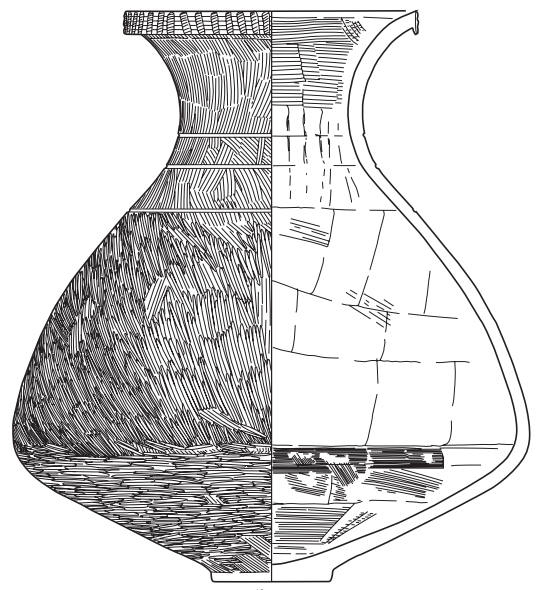

E-02Ad-037

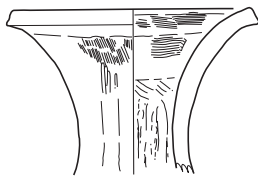

E-02Ad-039

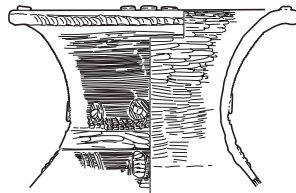

E-02Ad-041



E-02Ad-043

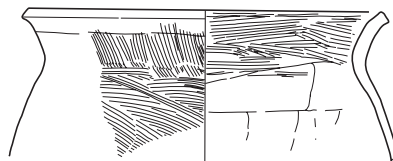

E-02Ad-044

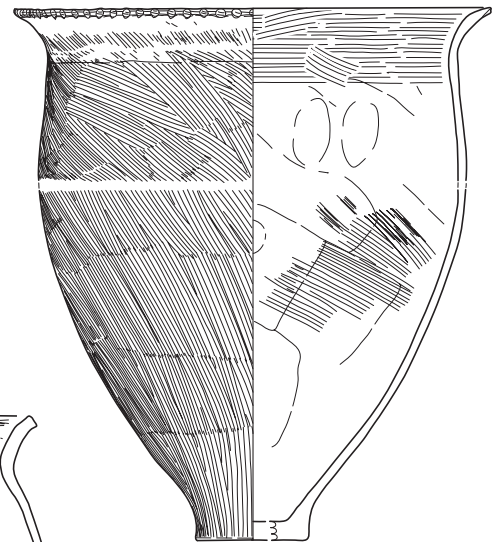

E-02Ad-042

02Ad ☒ SD05

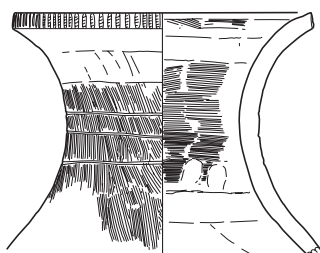

E-02Ad-045

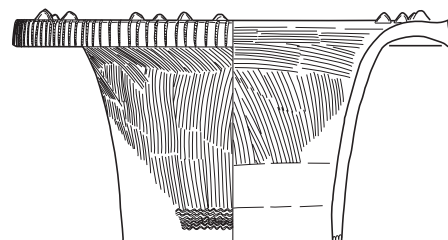

E-02Ad-046



02Ad ☒ SD05

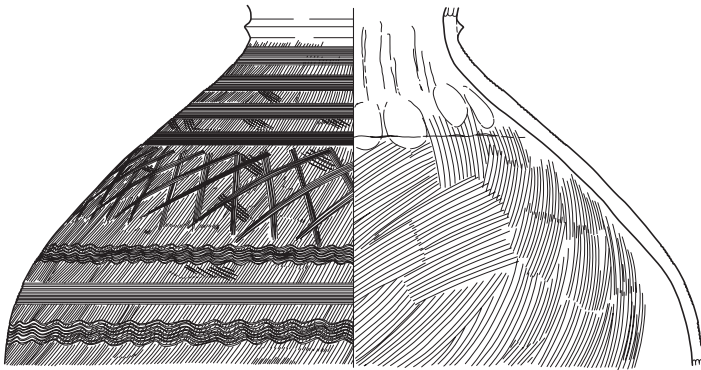

E-02Ad-047

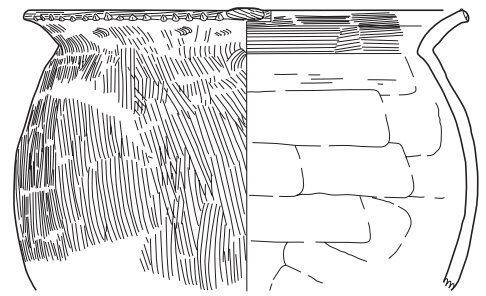

E-02Ad-052

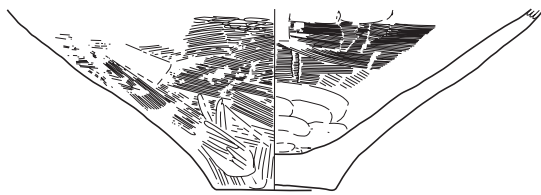

E-02Ad-048

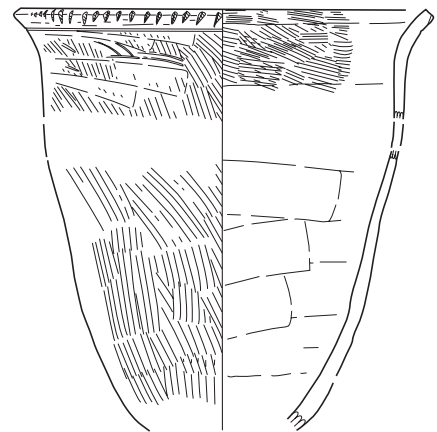

E-02Ad-053

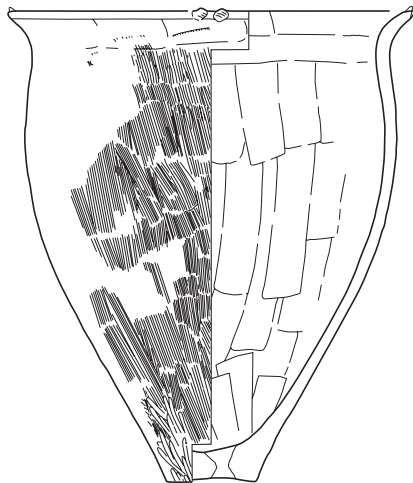

E-02Ad-049



E-02Ad-054

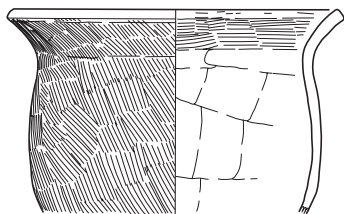

E-02Ad-050

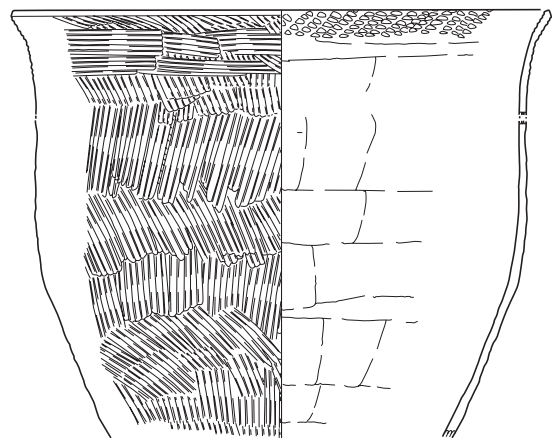

E-02Ad-055

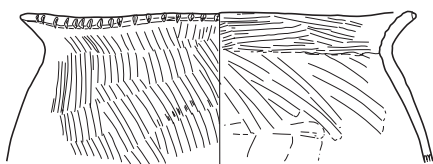

E-02Ad-051



02Ad ☒ SD06

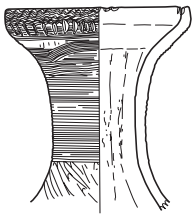

E-02Ad-056

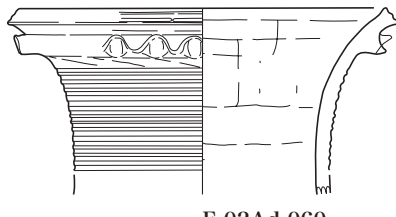

E-02Ad-060

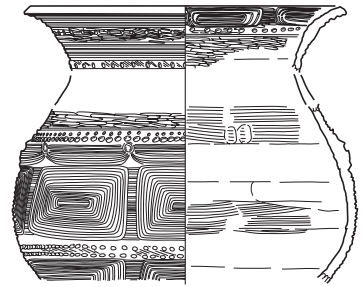

E-02Ad-063



E-02Ad-057

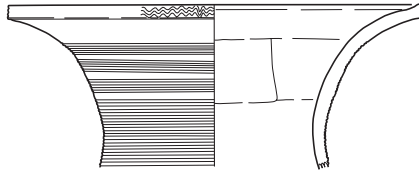

E-02Ad-061

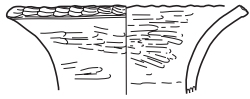

E-02Ad-058

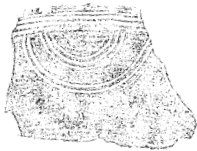

E-02Ad-062

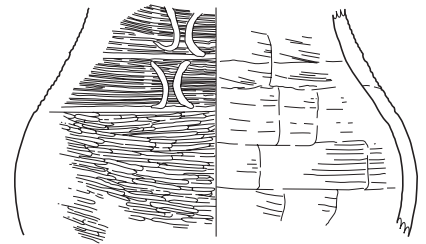

E-02Ad-064



E-02Ad-059

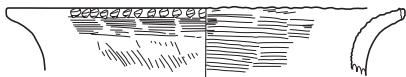

E-02Ad-065



E-02Ad-066

02Ad ☒ SD07



E-02Ad-067

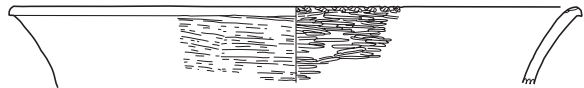

E-02Ad-069



E-02Ad-068

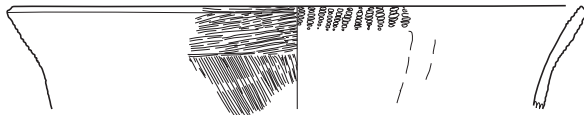

E-02Ad-070

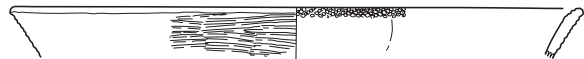

E-02Ad-071

02Ad ☒ SD08

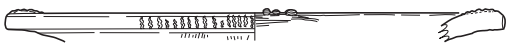

E-02Ad-072

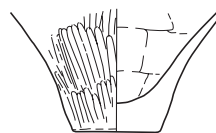

E-02Ad-075

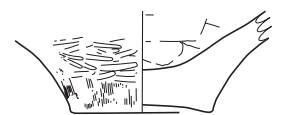

E-02Ad-076

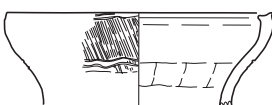

E-02Ad-073

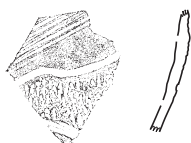

E-02Ad-074

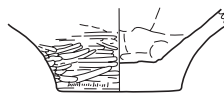

E-02Ad-077

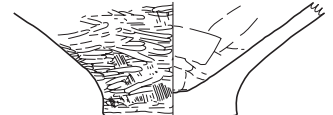

E-02Ad-078



02Ad ☒ SD08

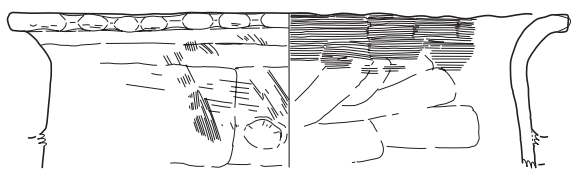

E-02Ad-079

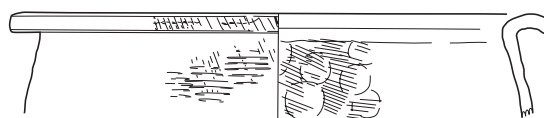

E-02Ad-080

02Ad ☒ SD09

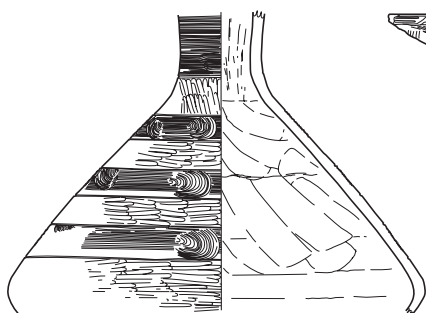

E-02Ad-081



E-02Ad-084

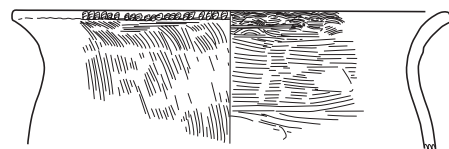

E-02Ad-088

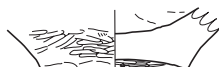

E-02Ad-085

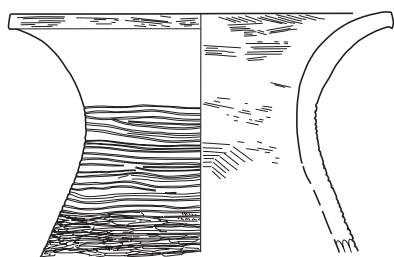

E-02Ad-082



E-02Ad-086

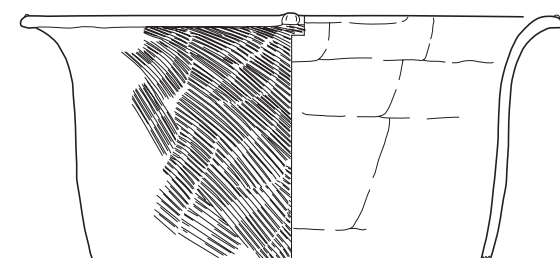

E-02Ad-089

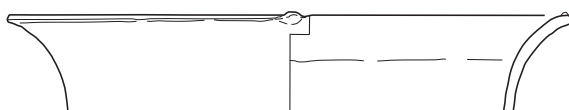

E-02Ad-090

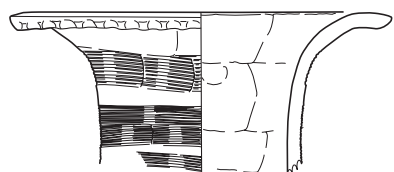

E-02Ad-083

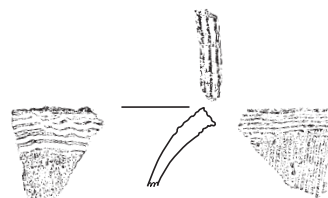

E-02Ad-091

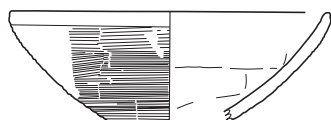

E-02Ad-087

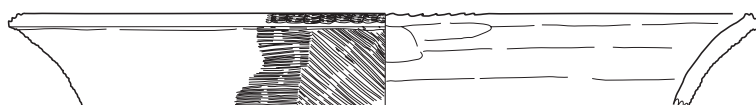

E-02Ad-092

02Ad ☒ SK08

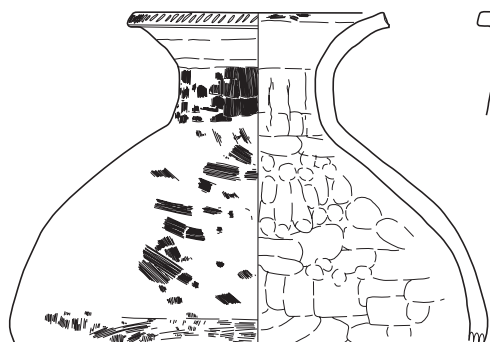

E-02Ad-093

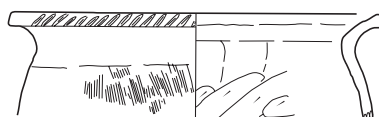

E-02Ad-094

02Ad ☒ SK24



E-02Ad-095



02Ad ☒ NR01

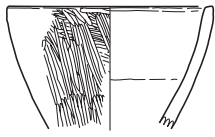

E-02Ad-096

02Ad ☒ NR02

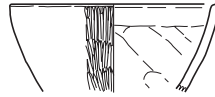

E-02Ad-097

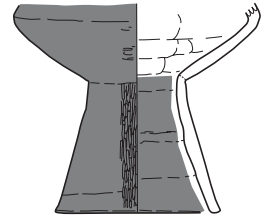

E-02Ad-098

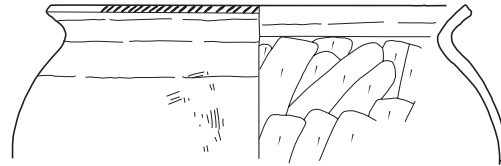

E-02Ad-099

02Ad ☒ NR03

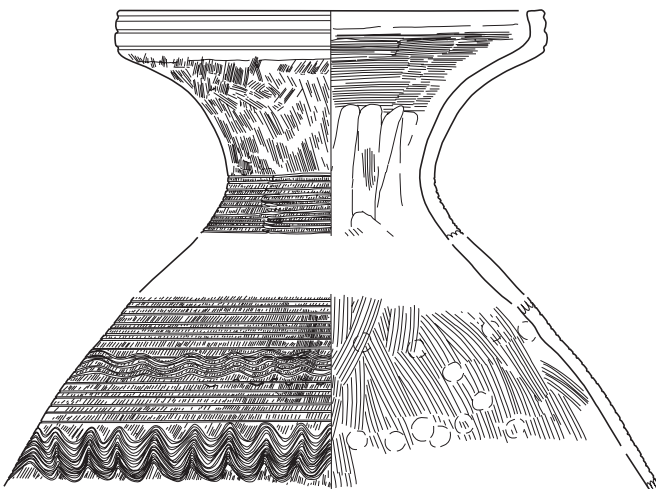

E-02Ad-100

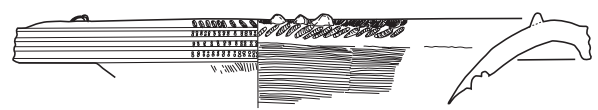

E-02Ad-104

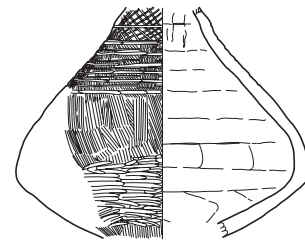

E-02Ad-105

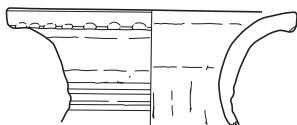

E-02Ad-101

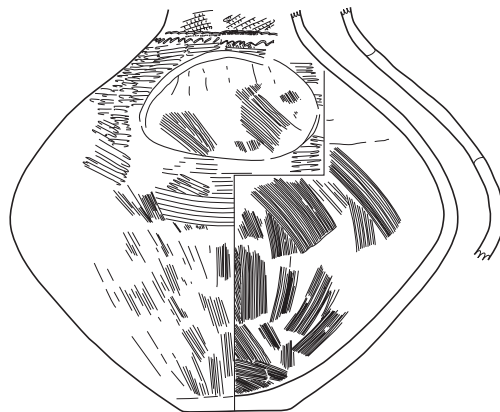

E-02Ad-106

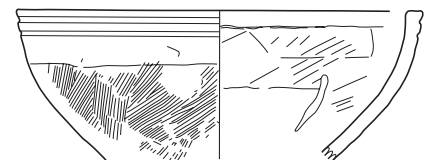

E-02Ad-107

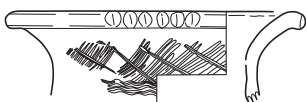

E-02Ad-102

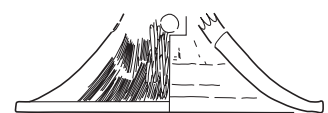

E-02Ad-108

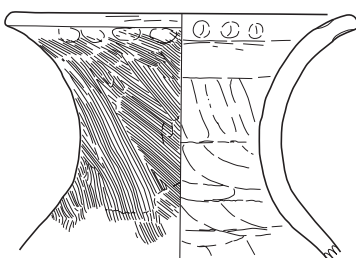

E-02Ad-103

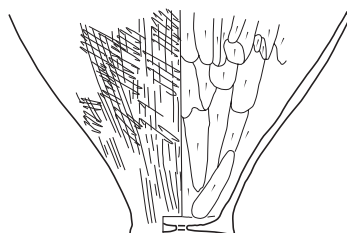

E-02Ad-109

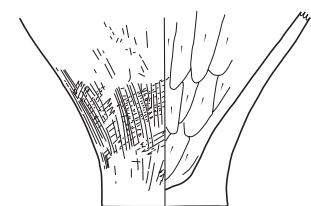

E-02Ad-110





02Ae ☒ SD01

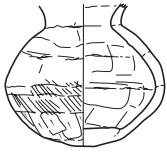

E-02Ae-001

02Af ☒ SD01

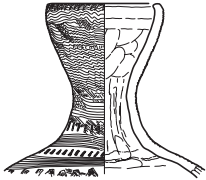

E-02Af-001



E-02Af-002

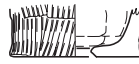

E-02Af-003

02Af ☒ SD02

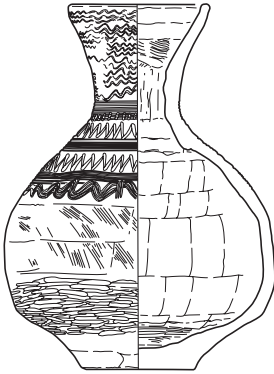

E-02Af-004

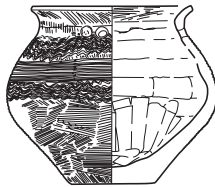

E-02Af-005

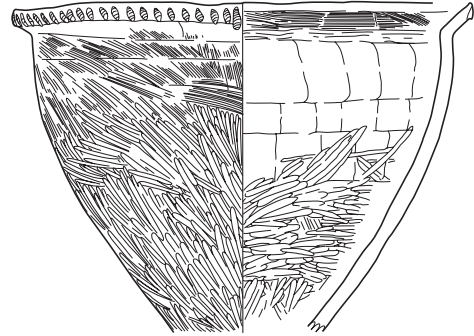

E-02Af-007

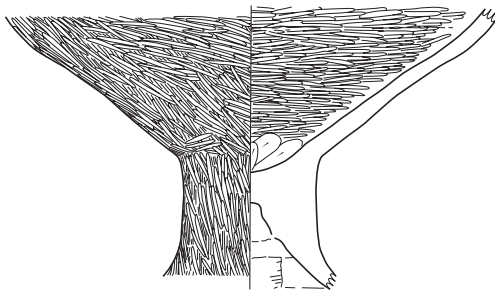

E-02Af-006



E-02Af-008

02Af ☒ SD03

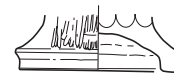

E-02Af-009

02Ag ☒ SD01

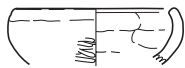

E-02Ag-001

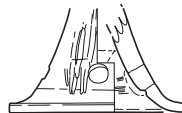

E-02Ag-003

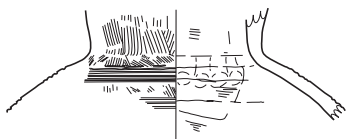

E-02Ag-002

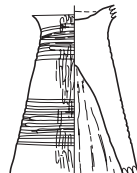

E-02Ag-004

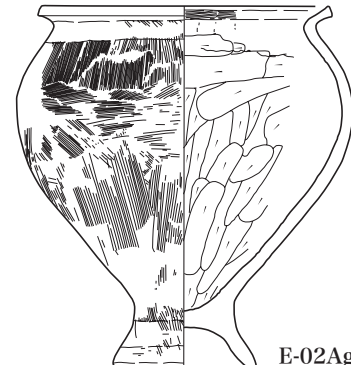

E-02Ag-005



02Ag 区 SD01

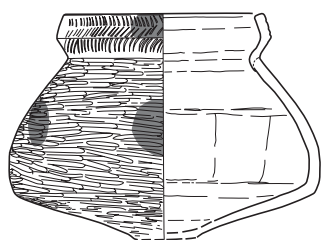

E-02Ag-006

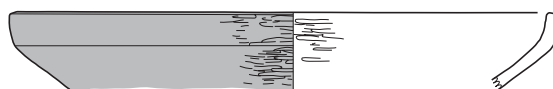

E-02Ag-008

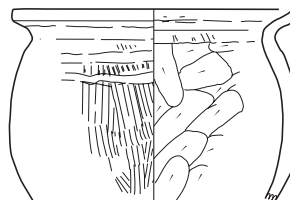

E-02Ag-009

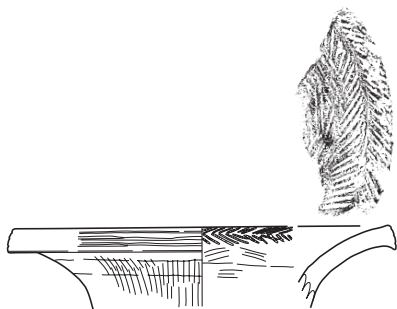

E-02Ag-007



E-02Ag-010

02Ag 区 SD02

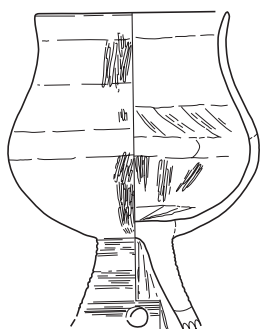

E-02Ag-011

02Ag 区 SK03

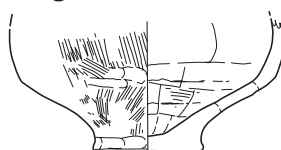

E-02Ag-013

02Ag 区 北トレンチ

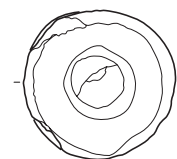

E-02Ag-014



E-02Ag-012

02Ba 区 NR01

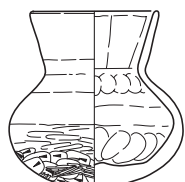

E-02Ba-001

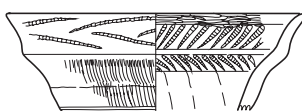

E-02Ba-003

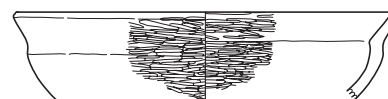

E-02Ba-005

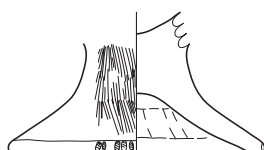

E-02Ba-002

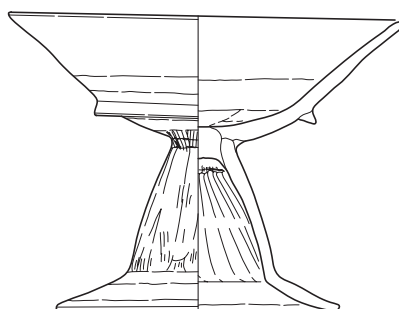

E-02Ba-004

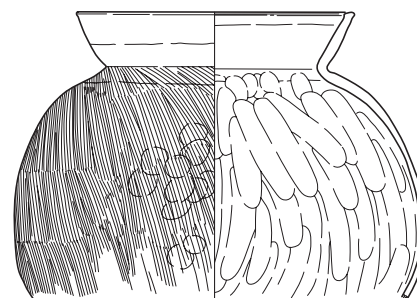

E-02Ba-006



02Bb ☒ SB01

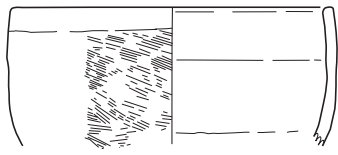

E-02Bb-001

02Bb ☒ SD04

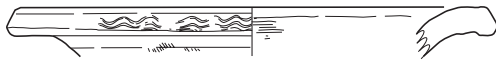

E-02Bb-003



E-02Bb-004

02Bb ☒ SD01

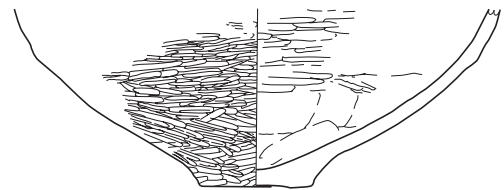
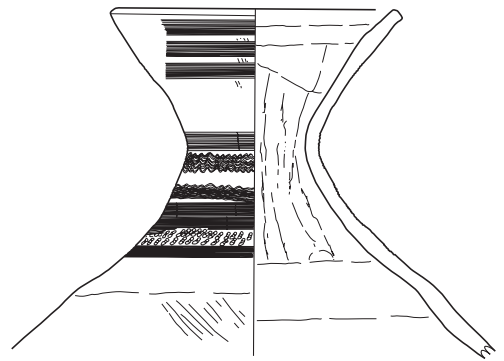

E-02Bb-002

02Bc ☒ SD01

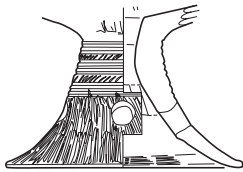

E-02Bc-001

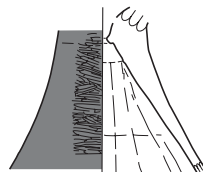

E-02Bc-002

02Bc ☒ SD03

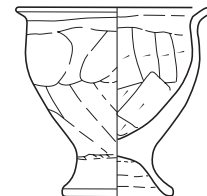

E-02Bc-006

02Bc ☒ SD02



E-02Bc-003

02Bc ☒ SD09



E-02Bc-007

02Bc ☒ SK02

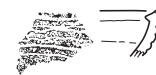

E-02Bc-008

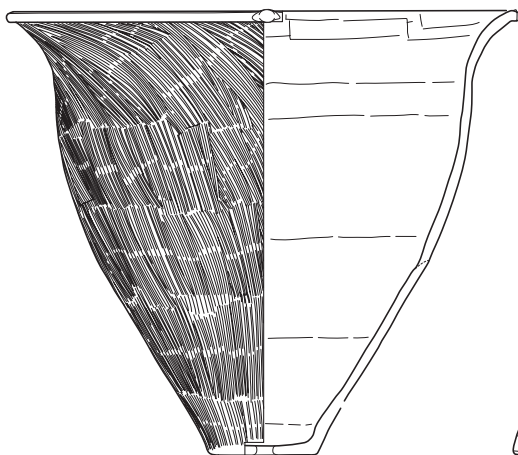

E-02Bc-004



E-02Bc-005



02Bc ☒ SK15

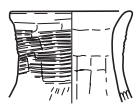

E-02Bc-009

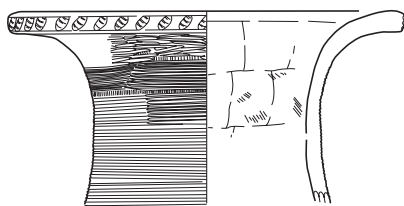

E-02Bc-010

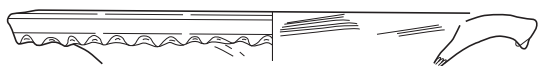

E-02Bc-011

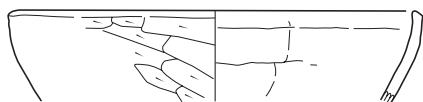

E-02Bc-012

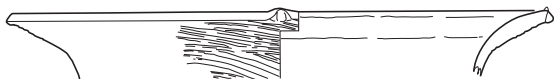

E-02Bc-013

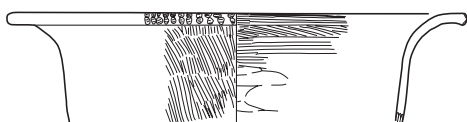

E-02Bc-014

02Bc ☒ SK16

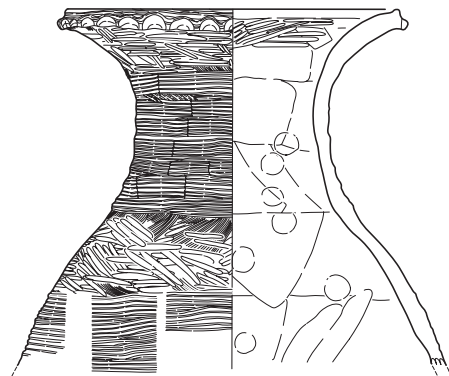

E-02Bc-015

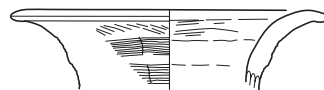

E-02Bc-016

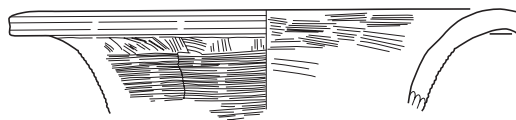

E-02Bc-017

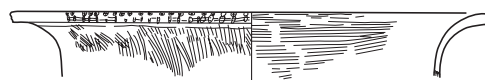

E-02Bc-018

02Bc ☒ SK18

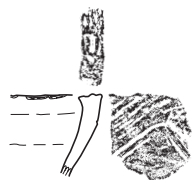

E-02Bc-019

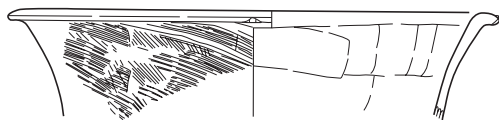

E-02Bc-020

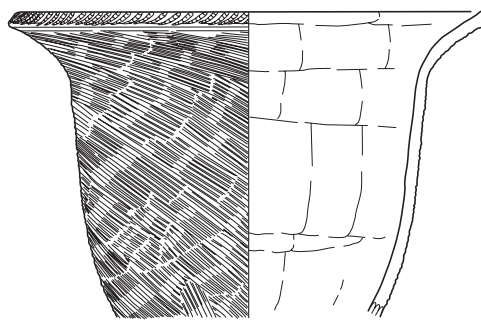

E-02Bc-021

02Bd ☒ SD01



E-02Bd-001



E-02Bd-002

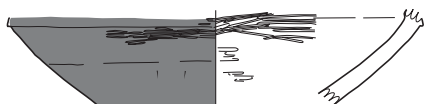

E-02Bd-003

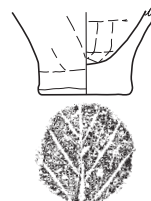

E-02Bd-004



02Bd 区 SD02

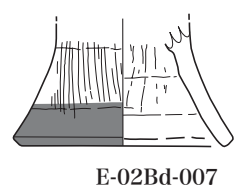
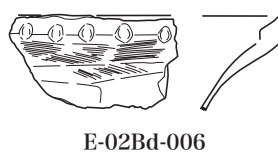
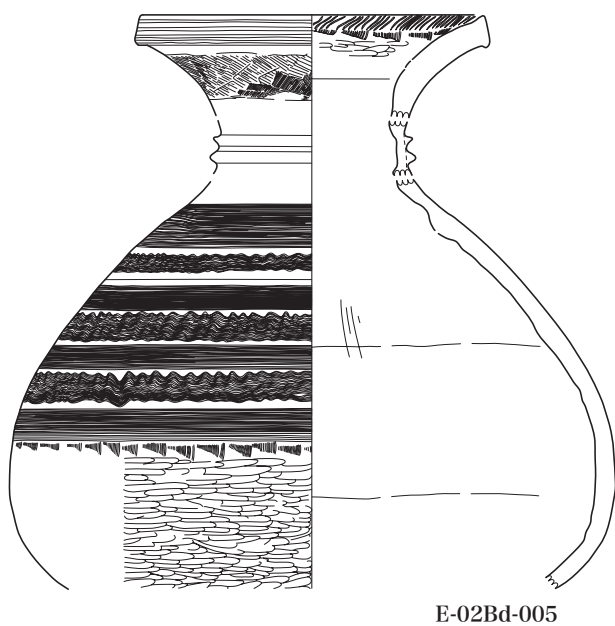

02Bd 区 SD03

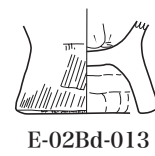
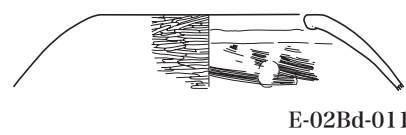
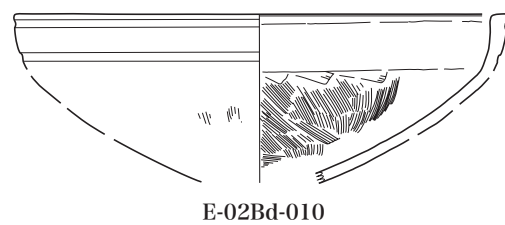
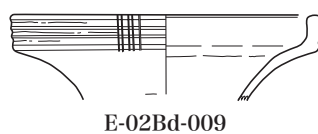
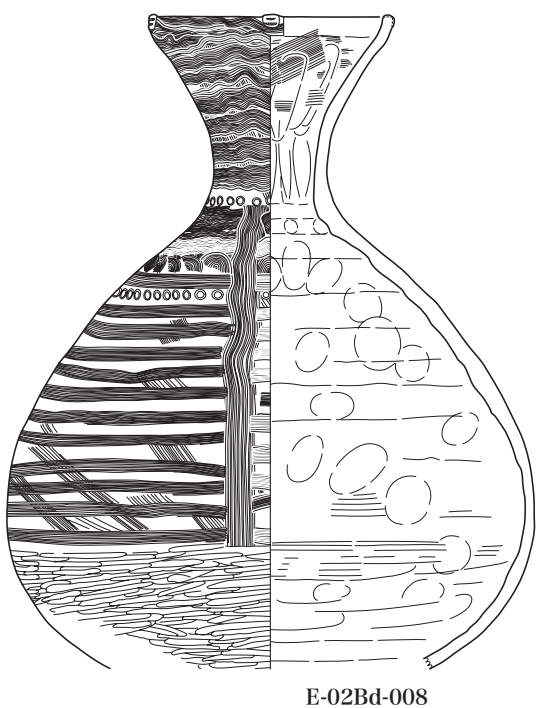

02Bd 区 SD04

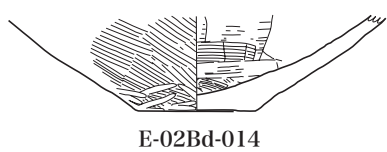

02Be ☒ SD01

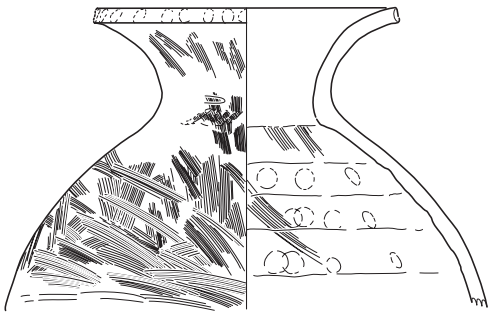

E-02Be-001

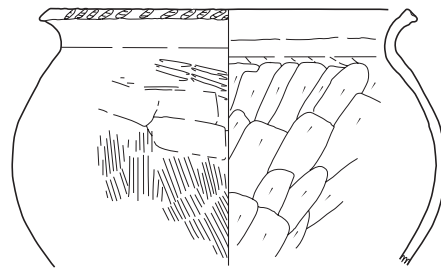

E-02Be-003

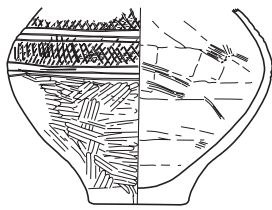

E-02Be-002

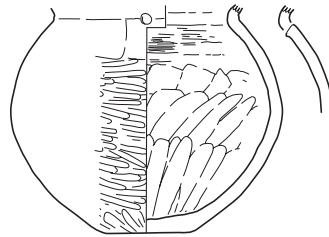

E-02Be-004

02Be ☒ SD02

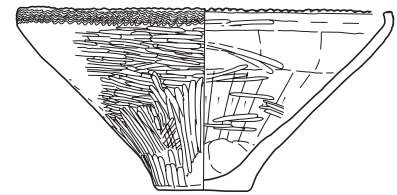

E-02Be-005

02Be ☒ SK05

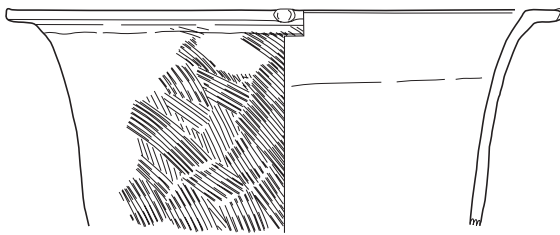

E-02Be-006

02Be ☒ SK06

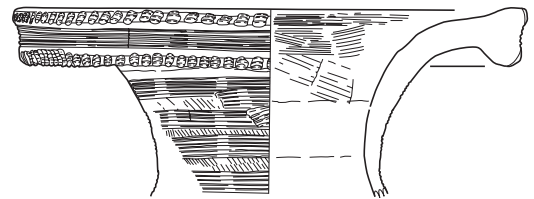

E-02Be-007

02Be ☒ SZ01

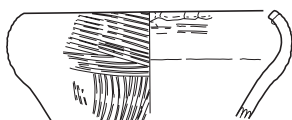

E-02Be-008

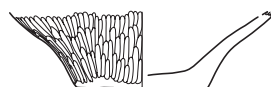

E-02Be-012

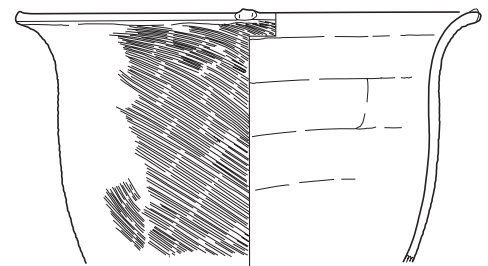

E-02Be-015

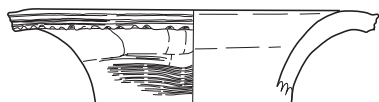

E-02Be-009



E-02Be-013

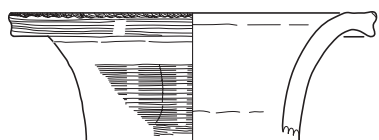

E-02Be-010

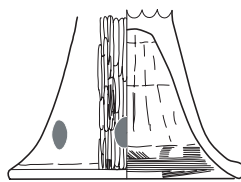

E-02Be-014

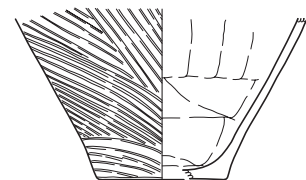

E-02Be-016

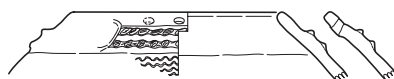

E-02Be-011



02Be 区 検I



E-02Be-017

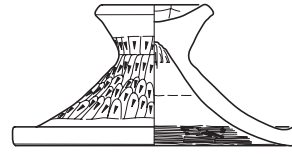

E-02Be-018

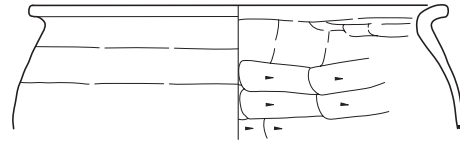

E-02Be-019

02Be 区 T1

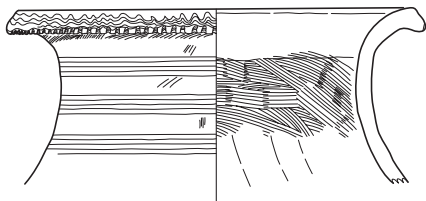

E-02Be-020

02Bg 区 SD01

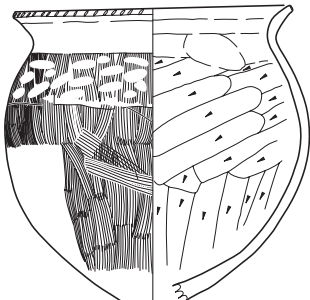

E-02Bg-001

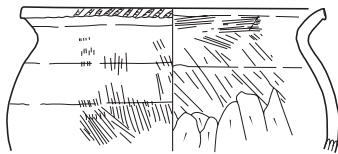

E-02Bg-002

02Bg 区 NR01

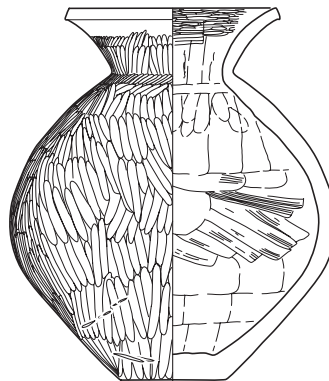

E-02Bg-004

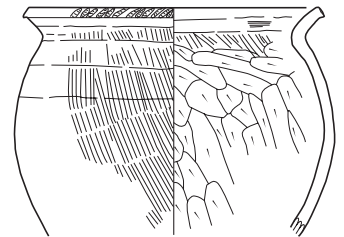

E-02Bg-005



E-02Bg-006

02Bg 区 SK09

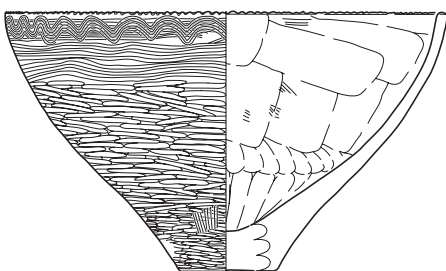

E-02Bg-003

02Bg 区 NR02

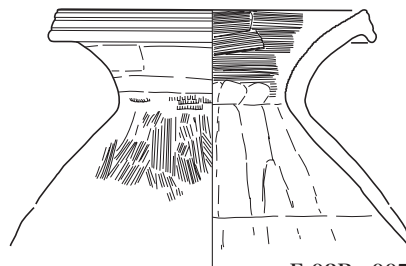

E-02Bg-007

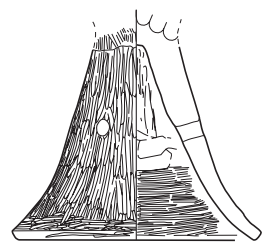

E-02Bg-008



E-02Bg-009



02Bg ☒ NR03 · SX01

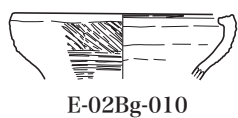

E-02Bg-010



E-02Bg-012



E-02Bg-011

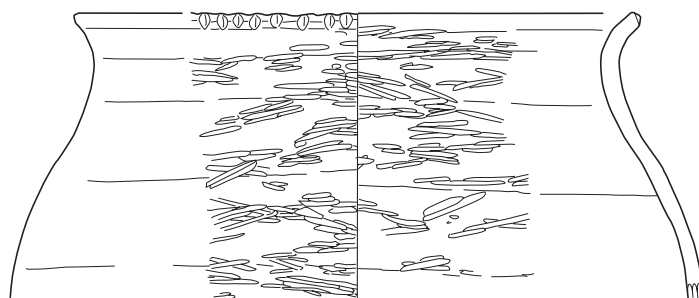

E-02Bg-014

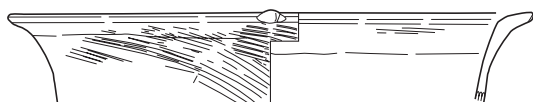

E-02Bg-015

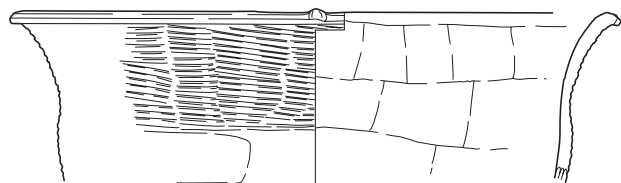

E-02Bg-016



E-02Bg-013

02Bg ☒ NR03



E-02Bg-017

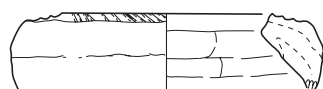

E-02Bg-018

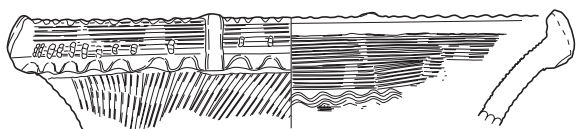

E-02Bg-019

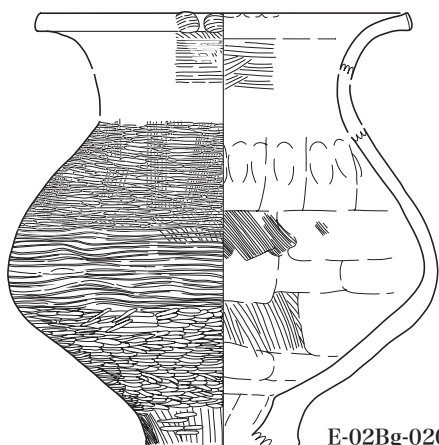

E-02Bg-020

02Bg ☒ NR04

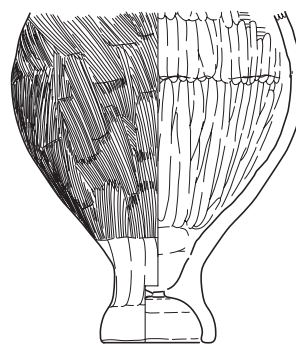

E-02Bg-021

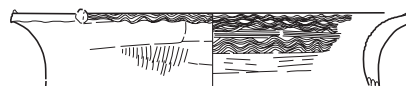

E-02Bg-022

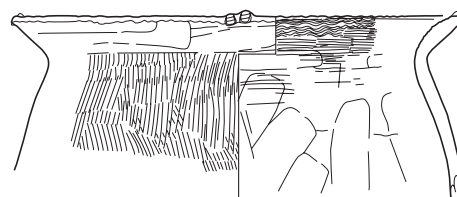

E-02Bg-023





02Bi 区 SD01

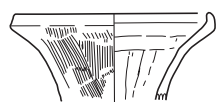

E-02Bi-001

02Bi 区 SD02

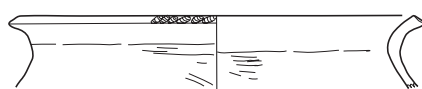

E-02Bi-002

02Bi 区 SD03

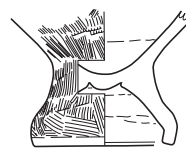

E-02Bi-003

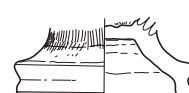

E-02Bi-004

02Bi 区 SD05

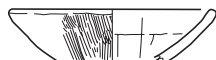
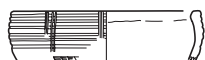

E-02Bi-006

02Bi 区 SD06



E-02Bi-008

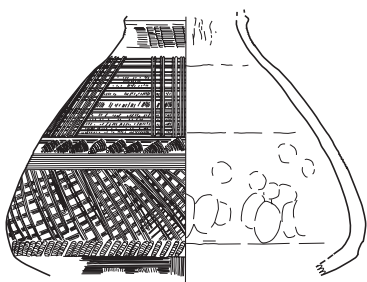

E-02Bi-005

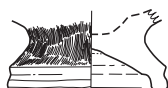

E-02Bi-007

02Bi 区 検II

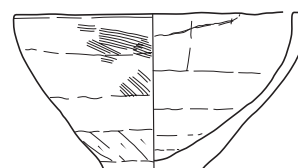

E-02Bi-009

02Bj 区 SD05

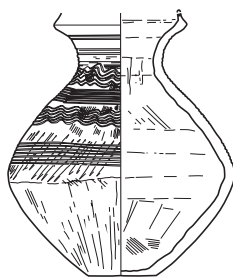

E-02Bj-001



E-02Bj-002

02Cb 区 SB11



E-02Cb-001

02Cb 区 SB15

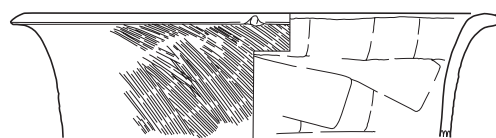

E-02Cb-004

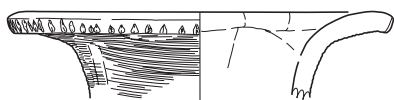

E-02Cb-002

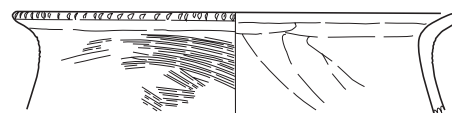

E-02Cb-005

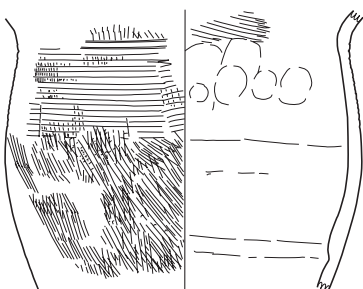

E-02Cb-003

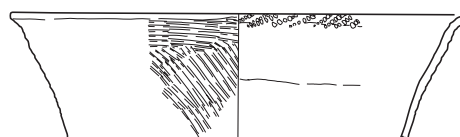

E-02Cb-006



E-02Cb-007



02Cb ☒ NR01

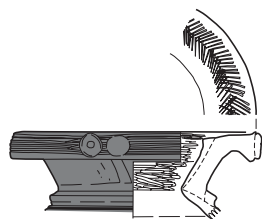

E-02Cb-008

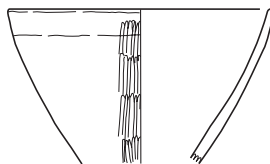

E-02Cb-009

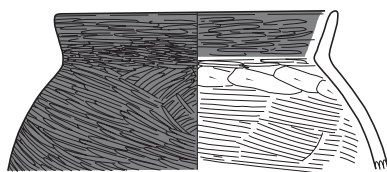

E-02Cb-010

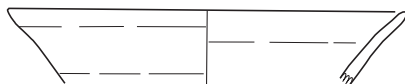

E-02Cb-011



E-02Cb-012

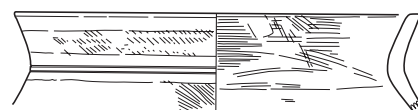

E-02Cb-013

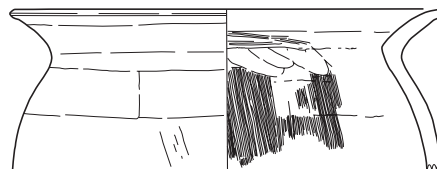

E-02Cb-014

02Cc ☒ SB01

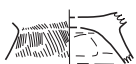

E-02Cc-001

02Cc ☒ SB02

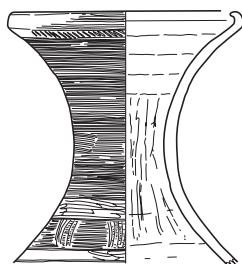

E-02Cc-002

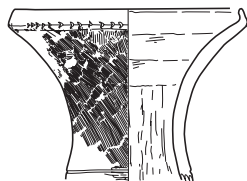

E-02Cc-003

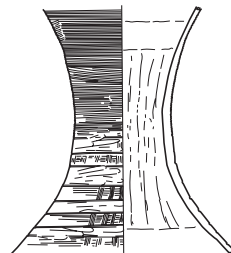

E-02Cc-004

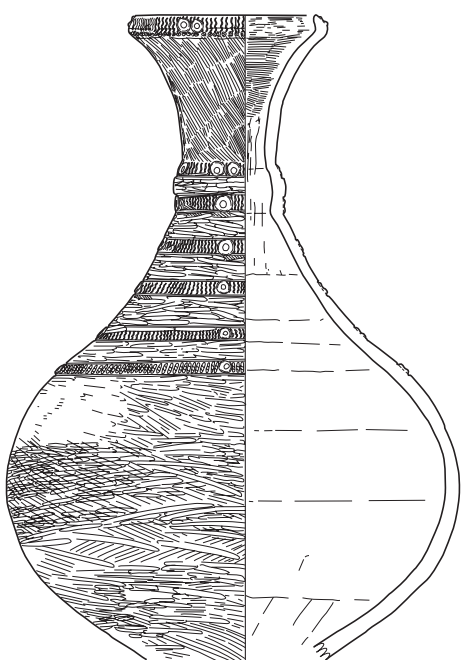

E-02Cc-005

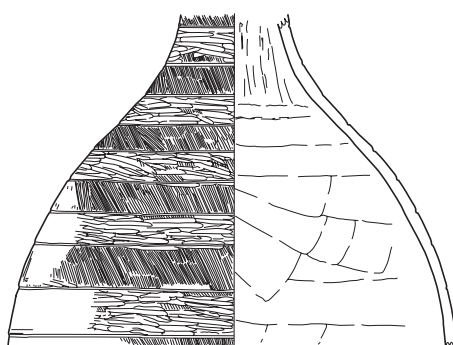

E-02Cc-006

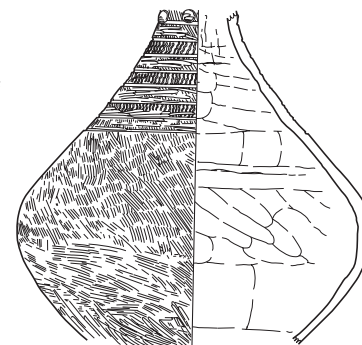

E-02Cc-007

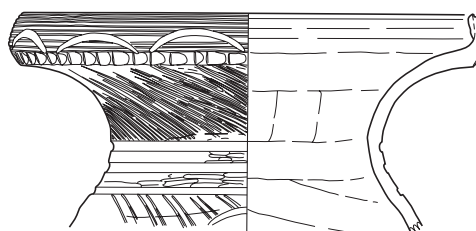

E-02Cc-008



02Cc ☒ SB02

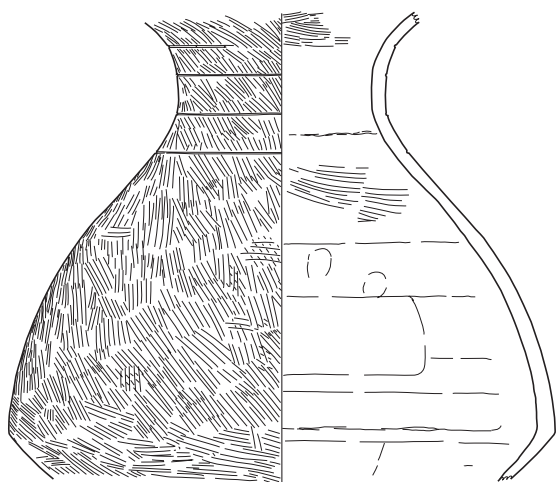

E-02Cc-009

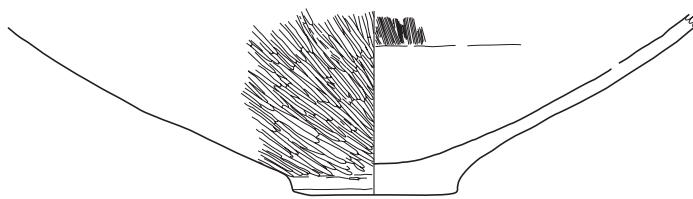

E-02Cc-010

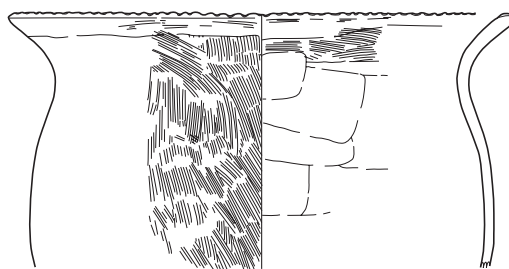

E-02Cc-012

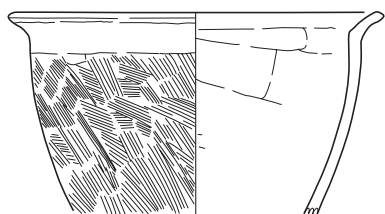

E-02Cc-011

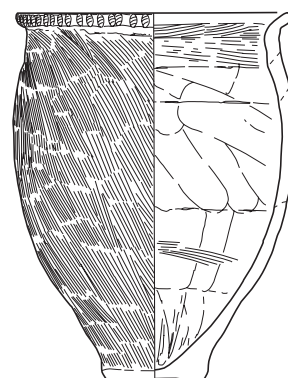

E-02Cc-014

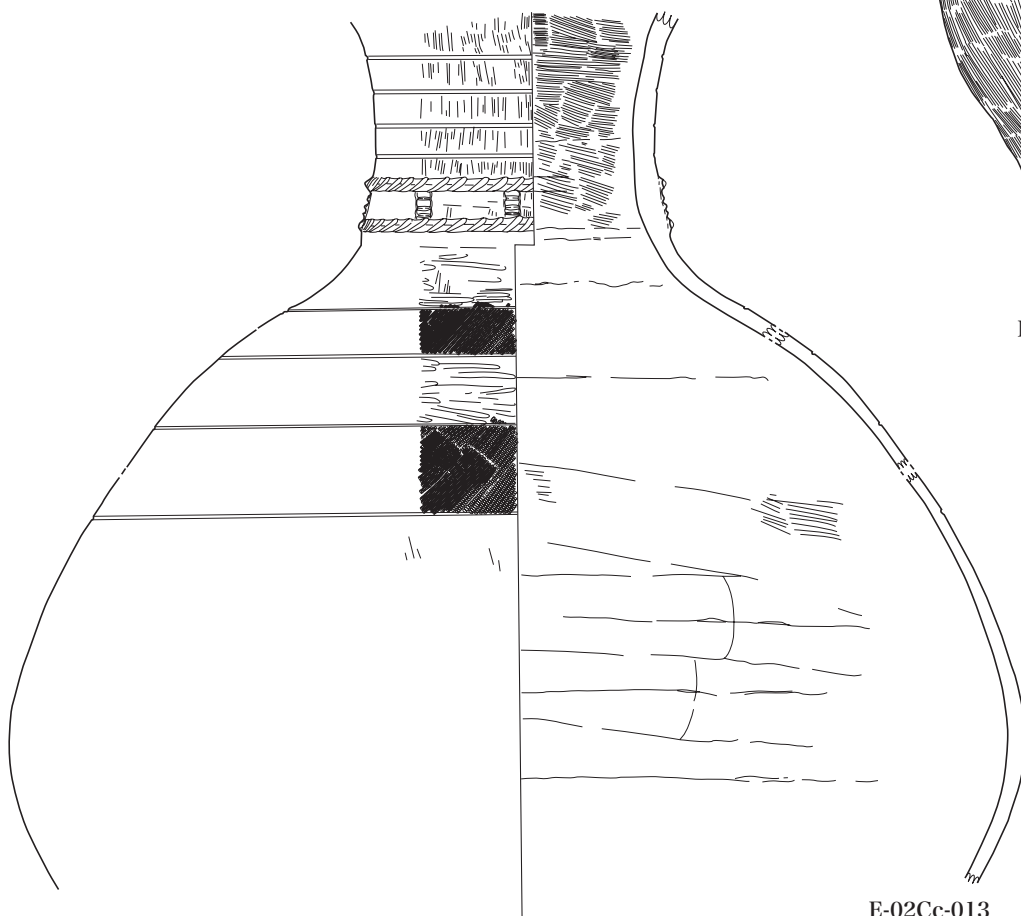

E-02Cc-013



02Cc ☒ SB02

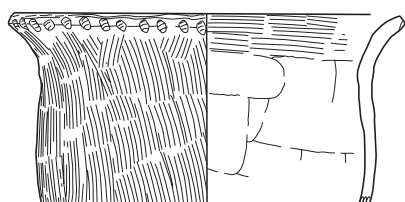

E-02Cc-015

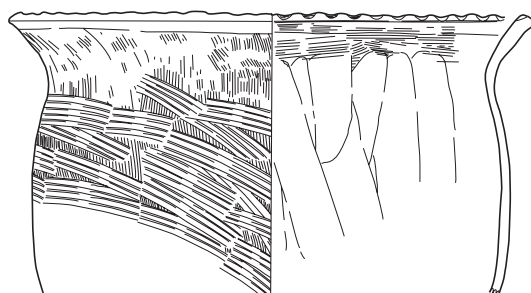

E-02Cc-017

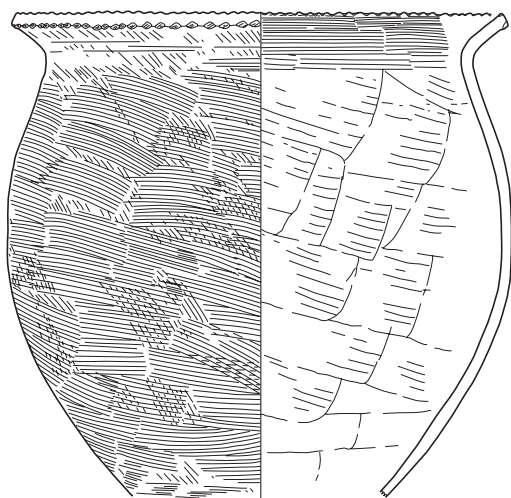

E-02Cc-016

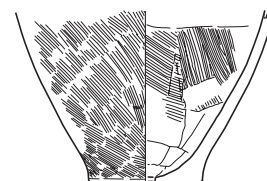

E-02Cc-018



E-02Cc-019

02Cc ☒ SB03

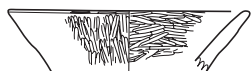

E-02Cc-020

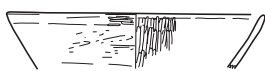

E-02Cc-021

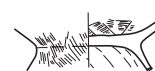

E-02Cc-022

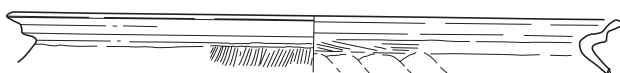

E-02Cc-023

02Cc ☒ SD01

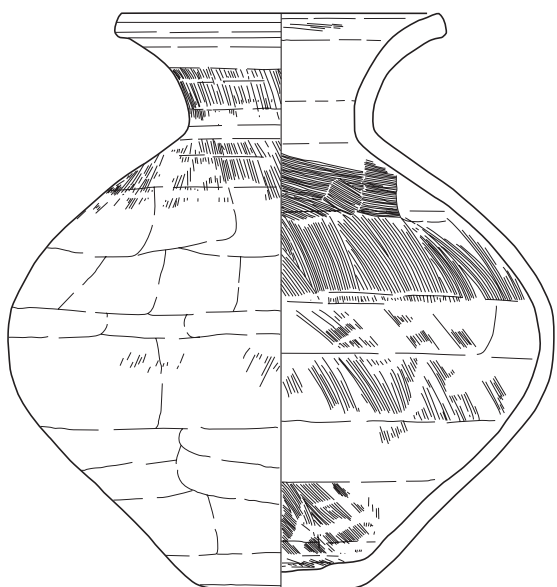

E-02Cc-024

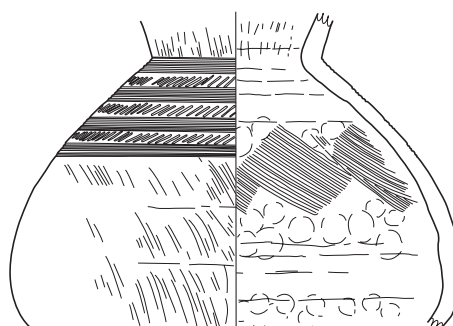

E-02Cc-025

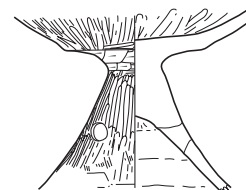

E-02Cc-027

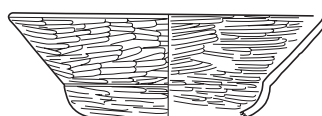

E-02Cc-026



E-02Cc-028



02Cc 区 SD02

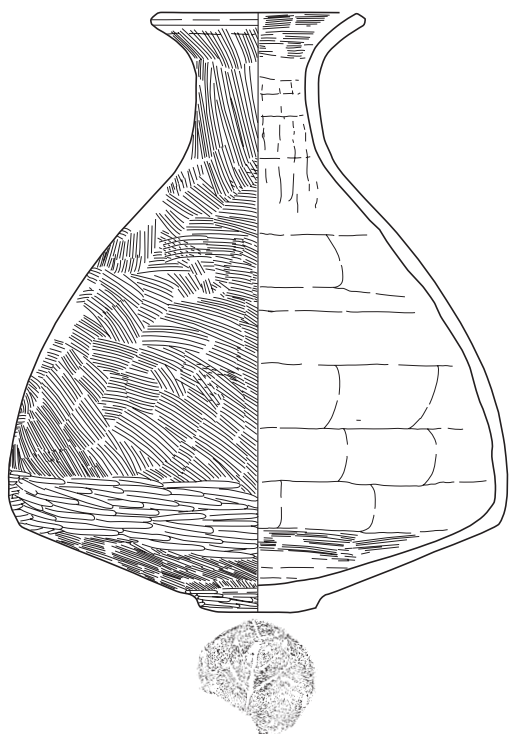

E-02Cc-029

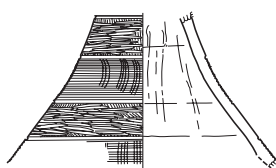

E-02Cc-030

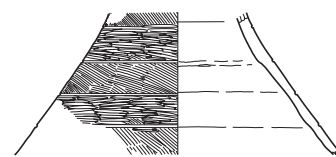

E-02Cc-031

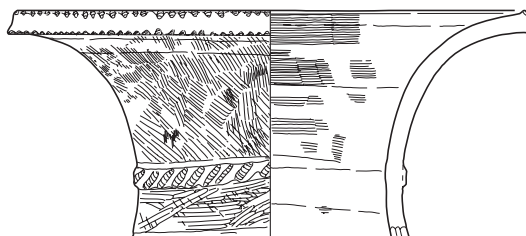

E-02Cc-032



E-02Cc-033

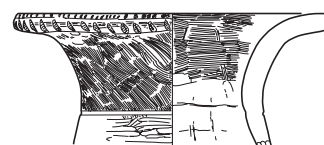

E-02Cc-034

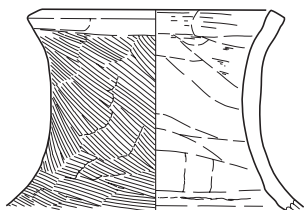

E-02Cc-035

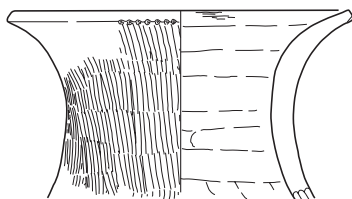

E-02Cc-036

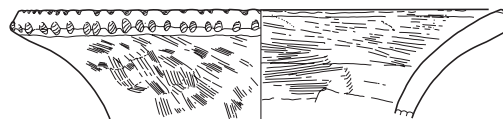

E-02Cc-037

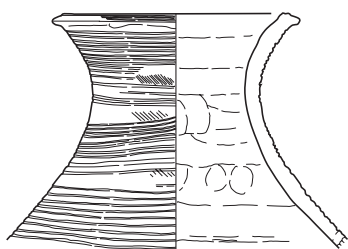

E-02Cc-038

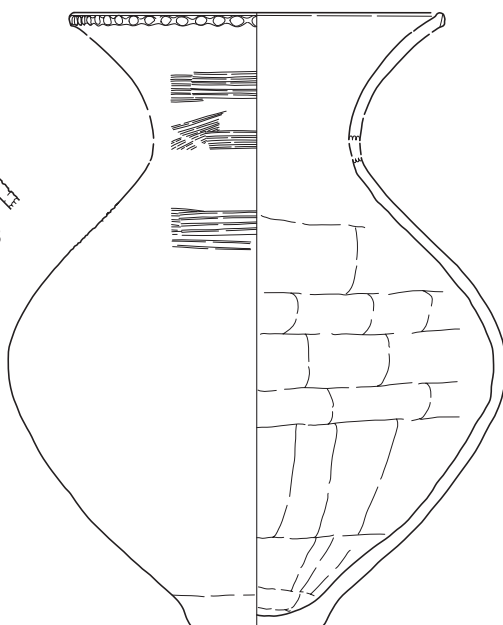

E-02Cc-039

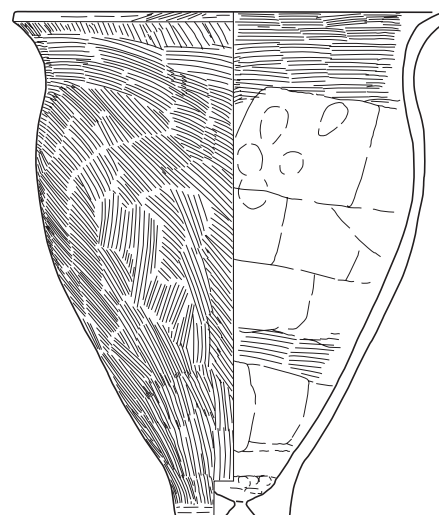

E-02Cc-040



02Cc ☒ SD02

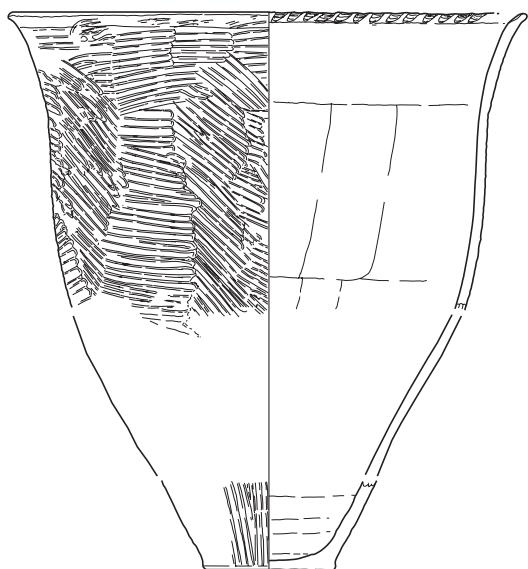

E-02Cc-041

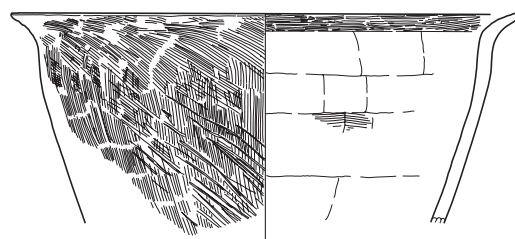

E-02Cc-042

02Cc ☒ SD05

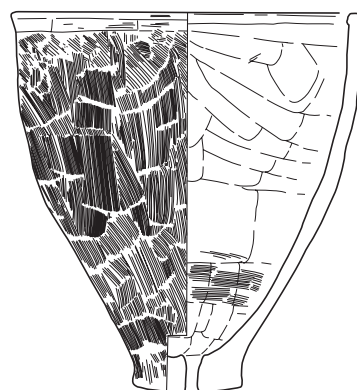

E-02Cc-043

02Cc ☒ SD06

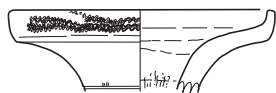

E-02Cc-044

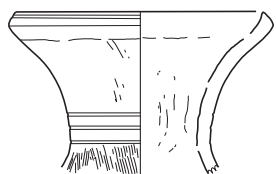

E-02Cc-045

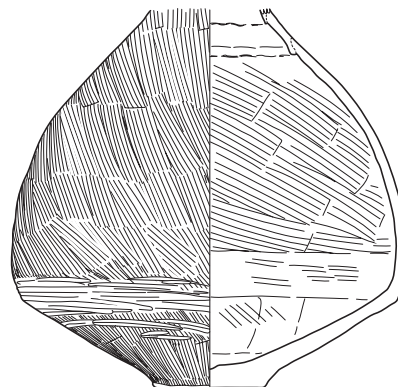

E-02Cc-046

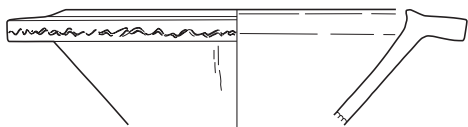

E-02Cc-047

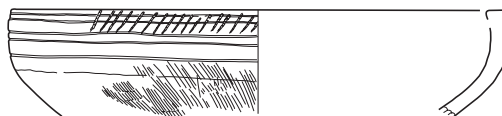

E-02Cc-048

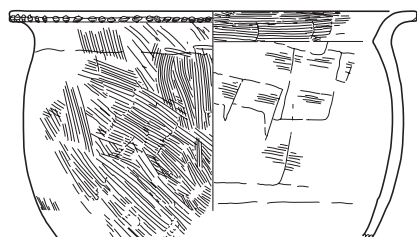

E-02Cc-049

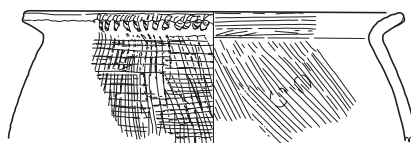

E-02Cc-050



E-02Cc-051



02Cc ☒ SD07

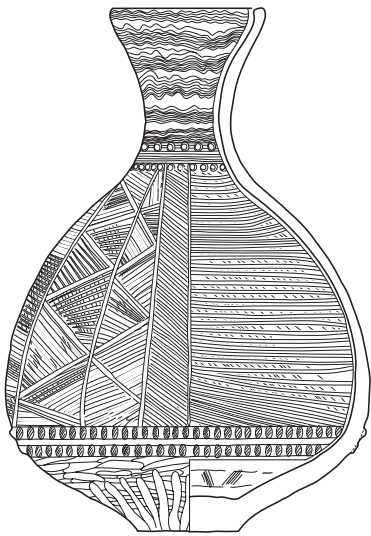

E-02Cc-052

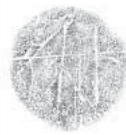
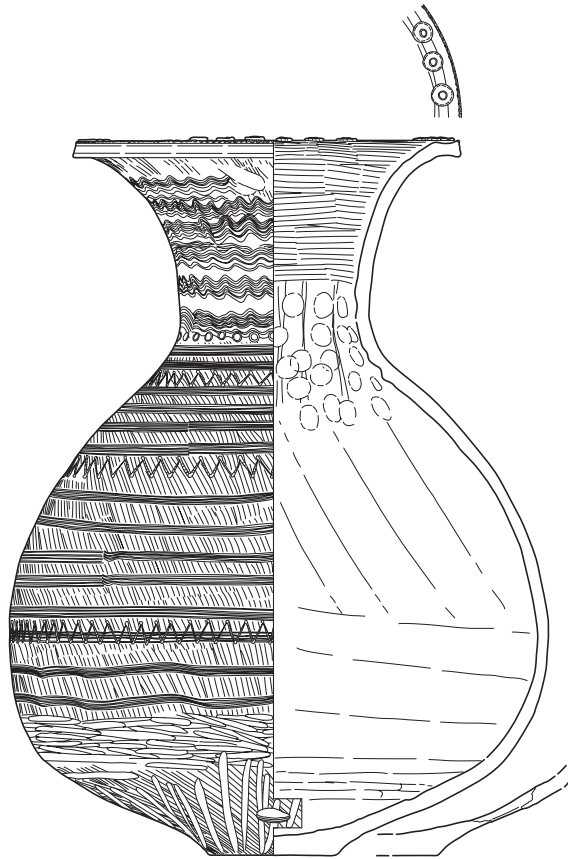

E-02Cc-053

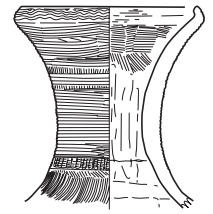

E-02Cc-054

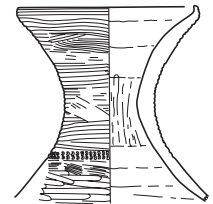

E-02Cc-055



E-02Cc-056



E-02Cc-057

02Cc ☒ SD08

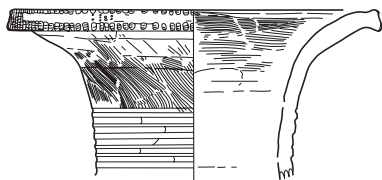

E-02Cc-058

02Cc ☒ SD09

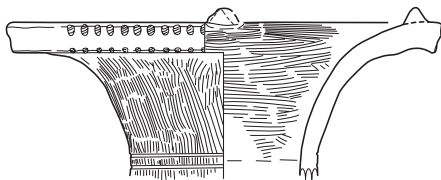

E-02Cc-059

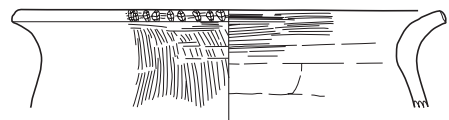

E-02Cc-061

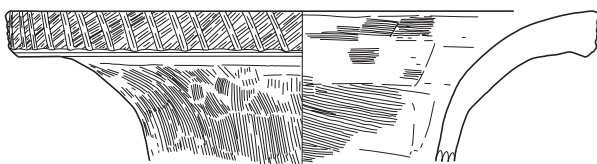

E-02Cc-060

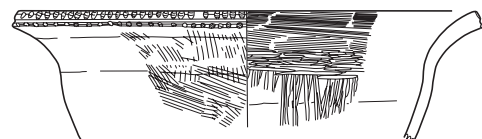

E-02Cc-062



02Cc ☒ SK13

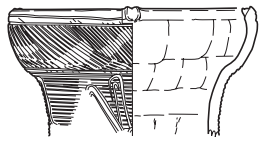

E-02Cc-063

02Cc ☒ SK47

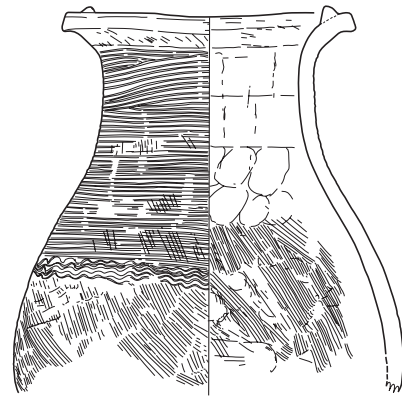

E-02Cc-066

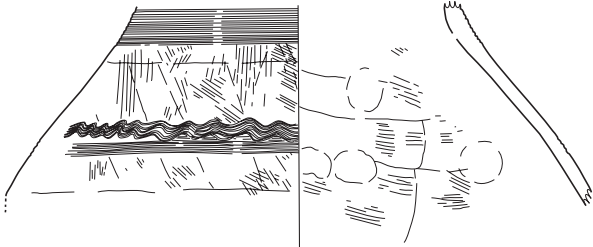

E-02Cc-064

02Cc ☒ SK30

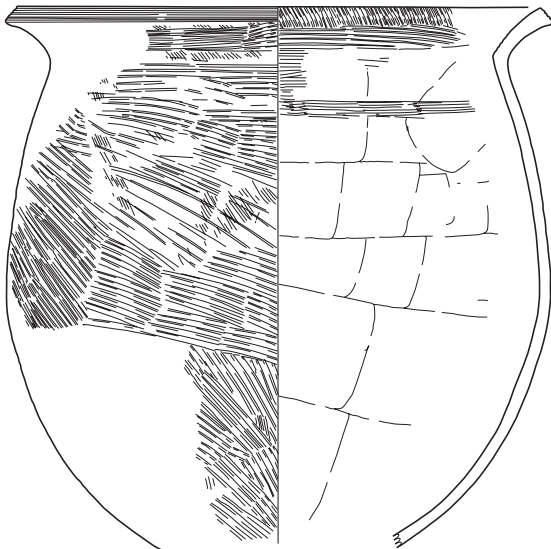

E-02Cc-065

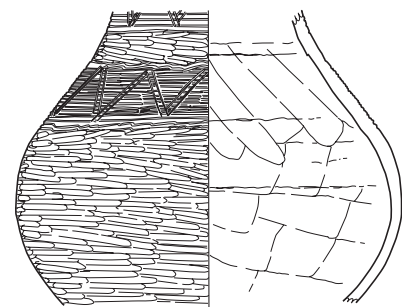

E-02Cc-067

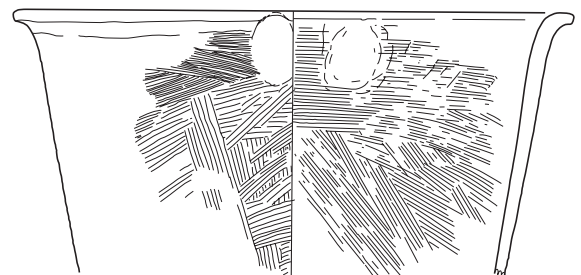

E-02Cc-068

02Cd ☒ SB01



E-02Cd-001

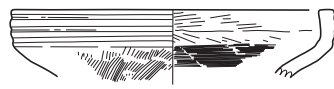

E-02Cd-002

02Cd ☒ SB06

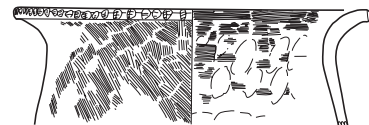

E-02Cd-006

02Cd ☒ SB02

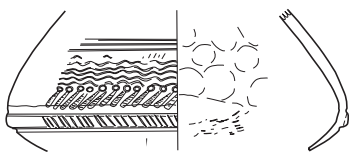

E-02Cd-003

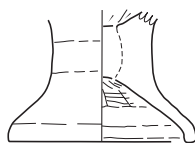

E-02Cd-004



E-02Cd-007

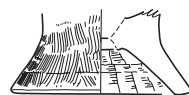

E-02Cd-005





02Cd ☒ SD01

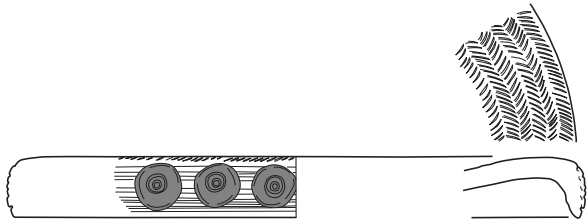

E-02Cd-008

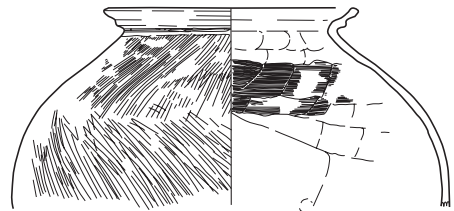

E-02Cd-009

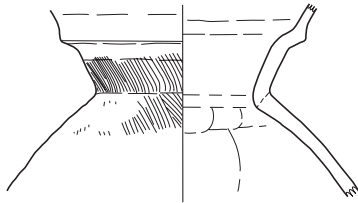

E-02Cd-010

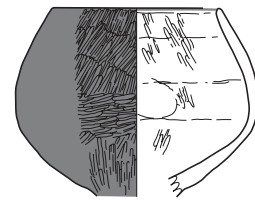

E-02Cd-011

02Cd ☒ SD02

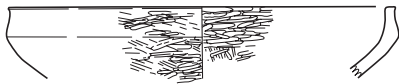

E-02Cd-012

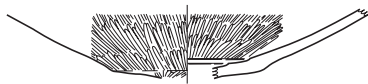

E-02Cd-013

02Cd ☒ SD03



E-02Cd-014

02Cd ☒ SD08

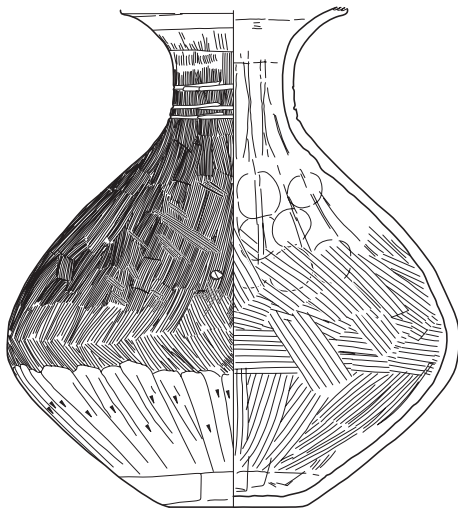

E-02Cd-015

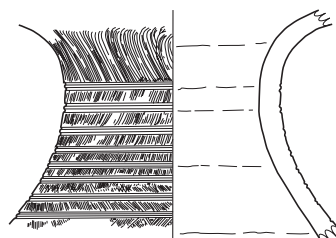

E-02Cd-018

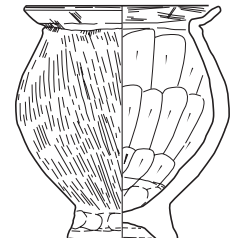

E-02Cd-019

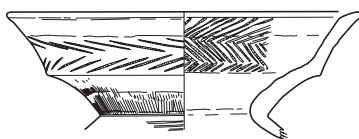

E-02Cd-016

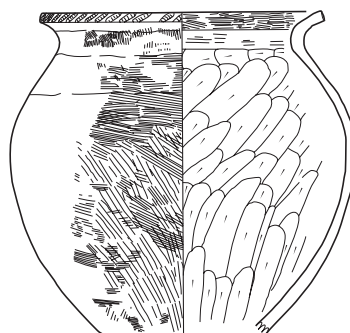

E-02Cd-020

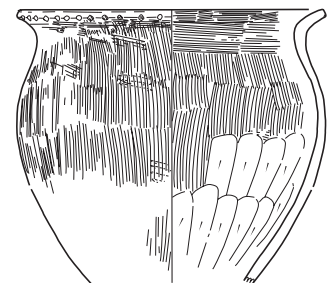

E-02Cd-021

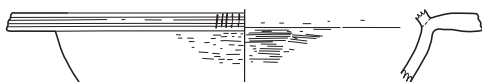

E-02Cd-017

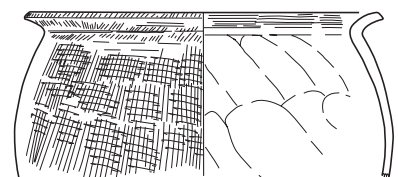

E-02Cd-022



02Cd 区 SD08

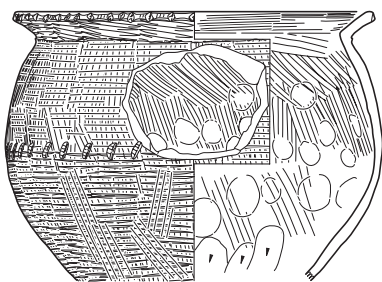

E-02Cd-023

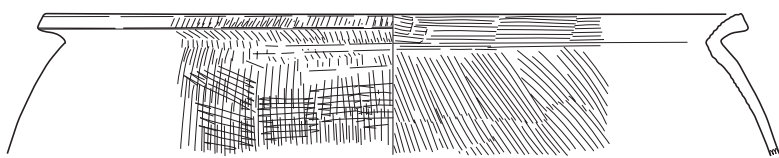

E-02Cd-025

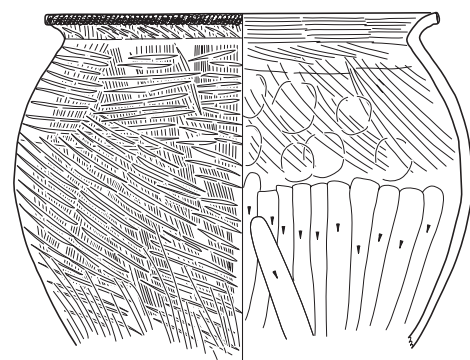

E-02Cd-026

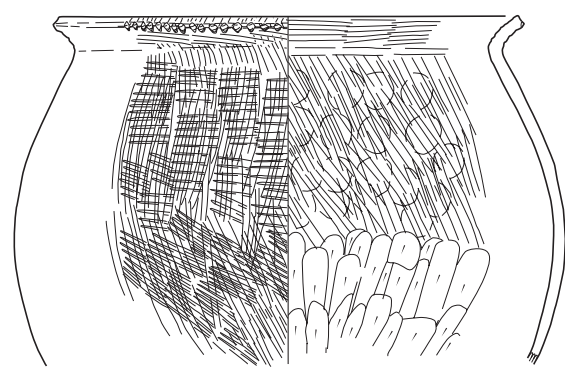

E-02Cd-024

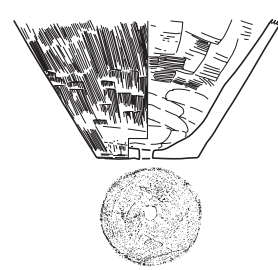

E-02Cd-027

02Cd 区 SK26

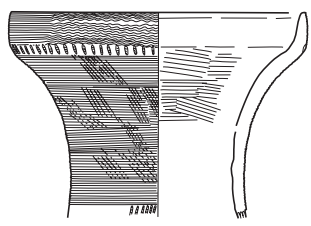

E-02Cd-028



E-02Cd-029

02Cd 区 SK36

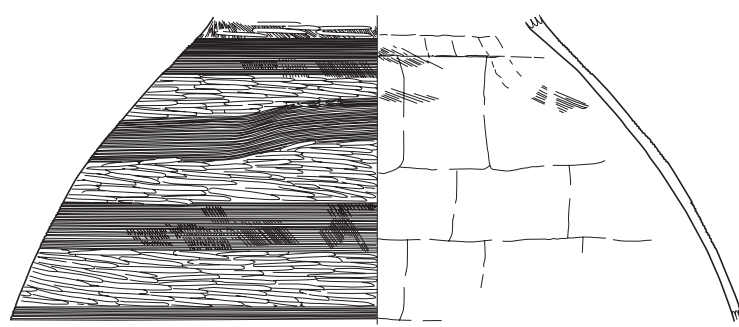

E-02Cd-030

02Cd 区 SK60

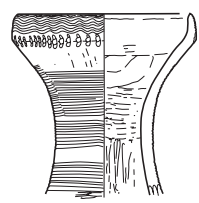

E-02Cd-031

02Cd 区 SK64

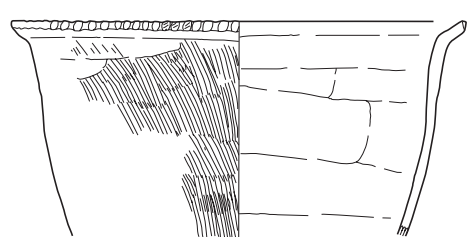

E-02Cd-033

02Cd 区 SK67

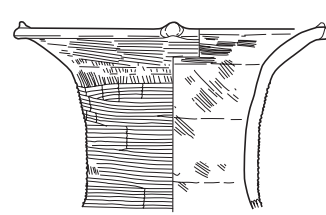

E-02Cd-034

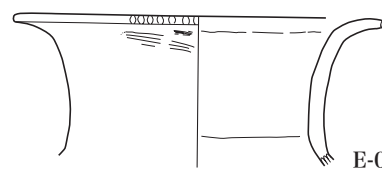

E-02Cd-032



02Cf ☒ SD01

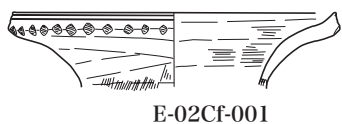

E-02Cf-001

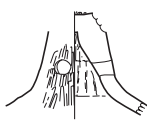

E-02Cf-002

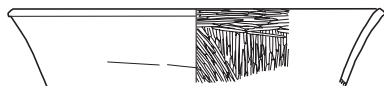

E-02Cf-003



E-02Cf-004

02Cf ☒ SD02

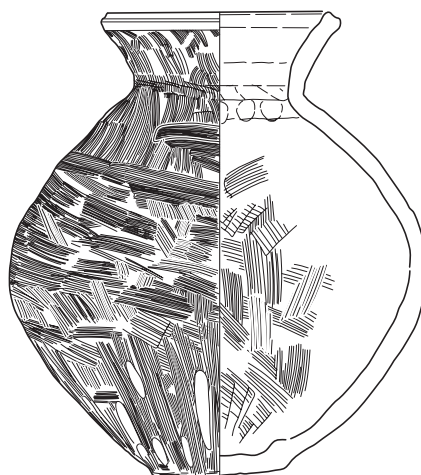

E-02Cf-005

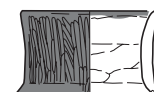

E-02Cf-006

02Cf ☒ SD03

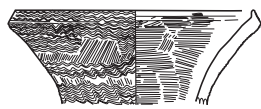

E-02Cf-007

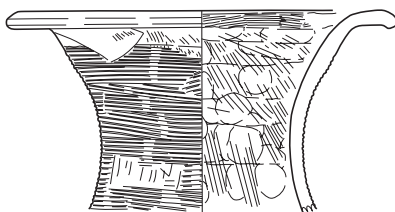

E-02Cf-008

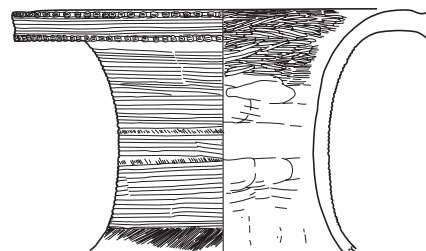

E-02Cf-009

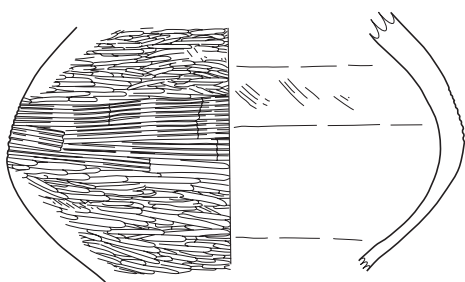

E-02Cf-010

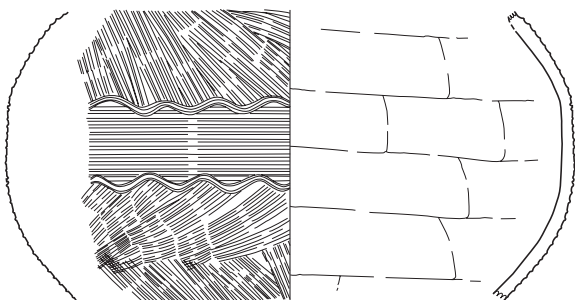

E-02Cf-011

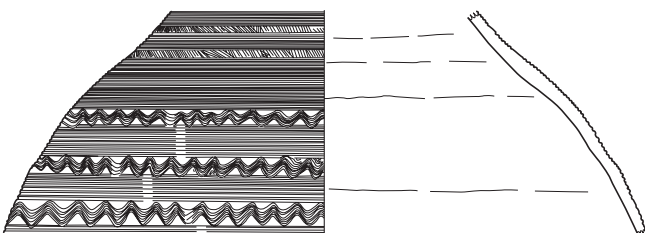

E-02Cf-012

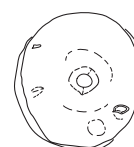
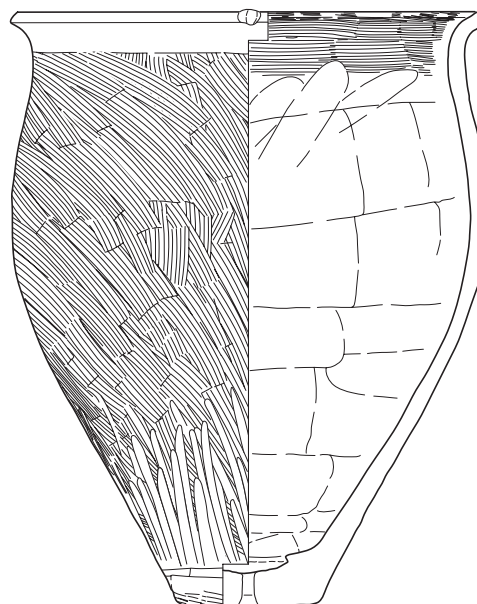

E-02Cf-013



02Cf ☒ SD03

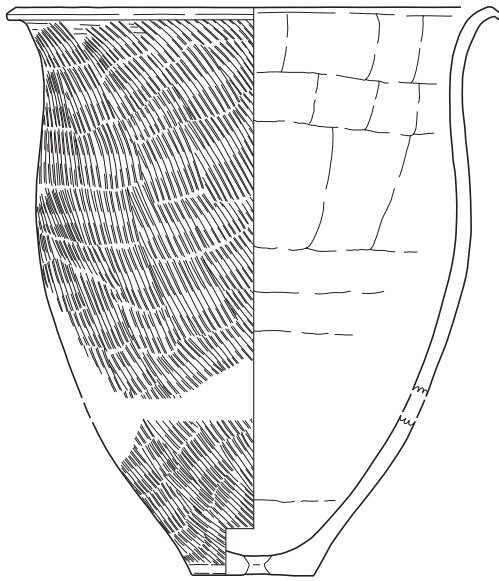

E-02Cf-014

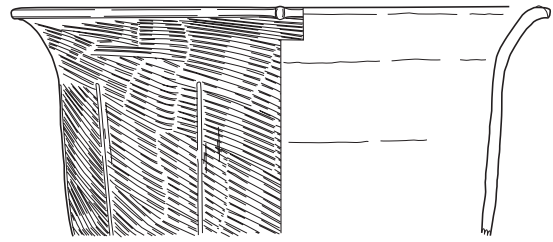

E-02Cf-015

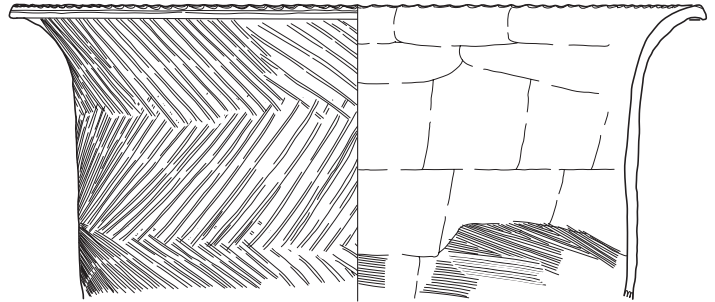

E-02Cf-016

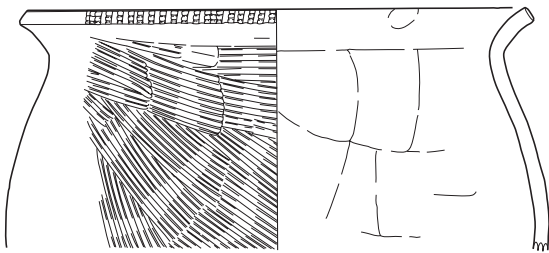

E-02Cf-017

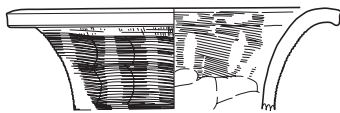

E-02Cf-018

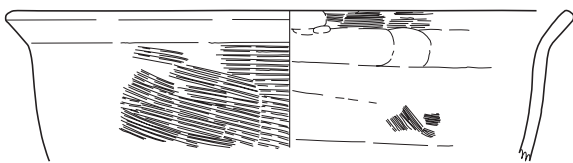

E-02Cf-019

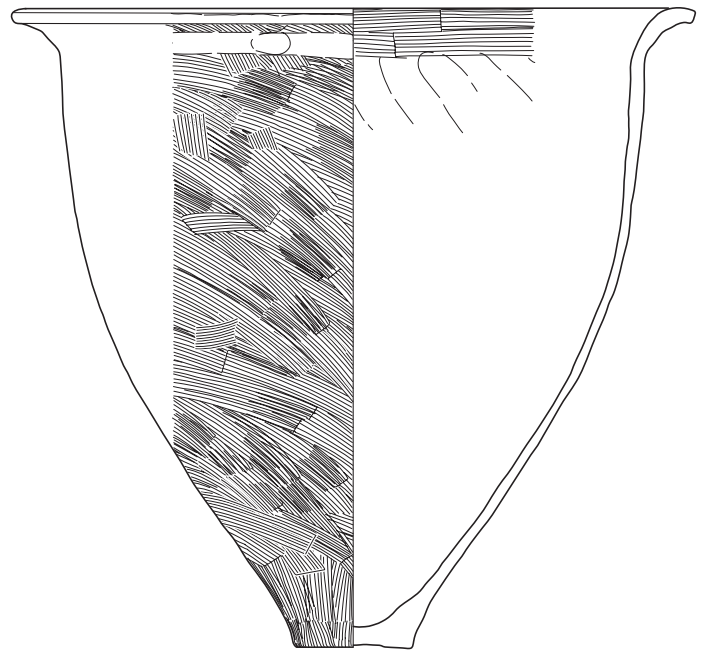

E-02Cf-020

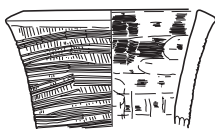

E-02Cf-021

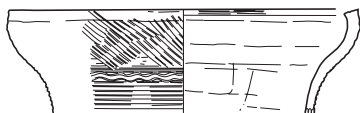

E-02Cf-022

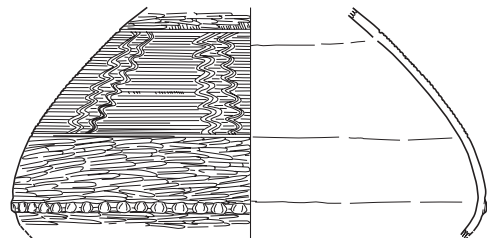

E-02Cf-023

0 20cm

02Cf ☒ SD03

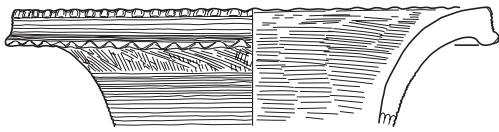

E-02Cf-024

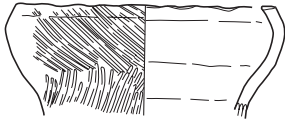

E-02Cf-026



E-02Cf-025

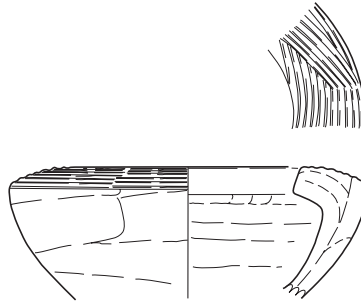

E-02Cf-027

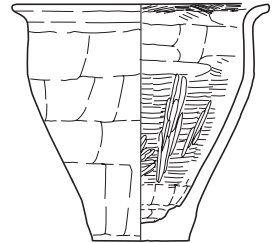

E-02Cf-028

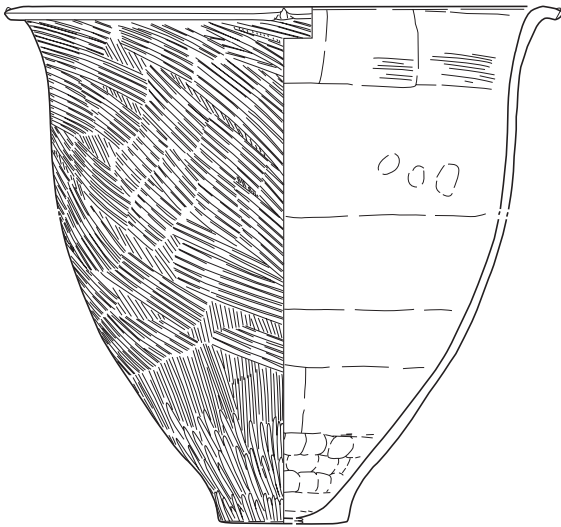

E-02Cf-029

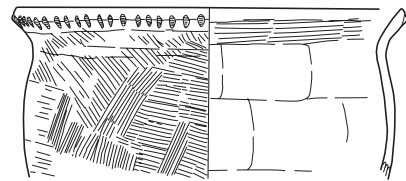

E-02Cf-031

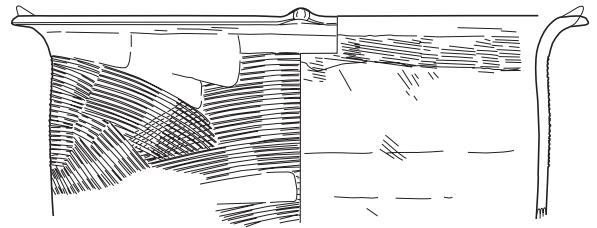

E-02Cf-032

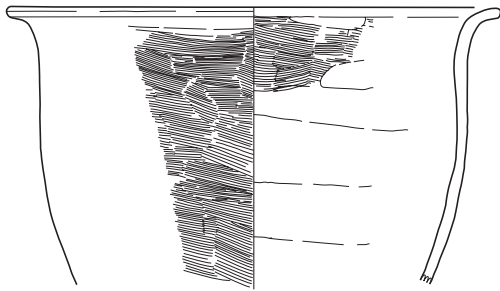

E-02Cf-030

02Cf ☒ SK06

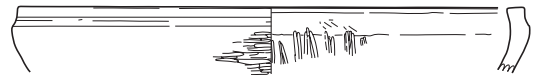

E-02Cf-033

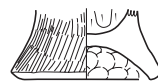

E-02Cf-034



E-02Cf-035

02Cf ☒ SK07

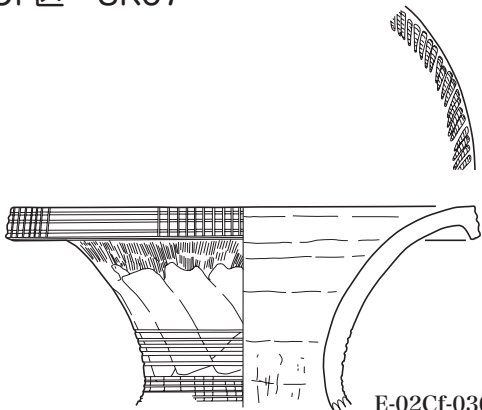

E-02Cf-036

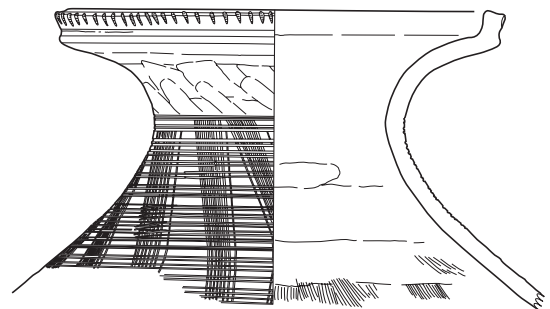

E-02Cf-037



02Cf ☒ SK07

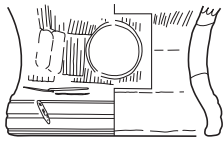

E-02Cf-038

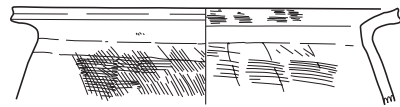

E-02Cf-041

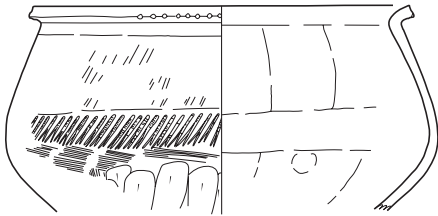

E-02Cf-039

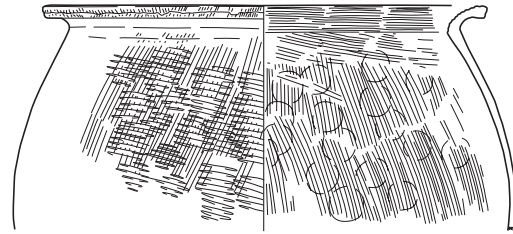

E-02Cf-042

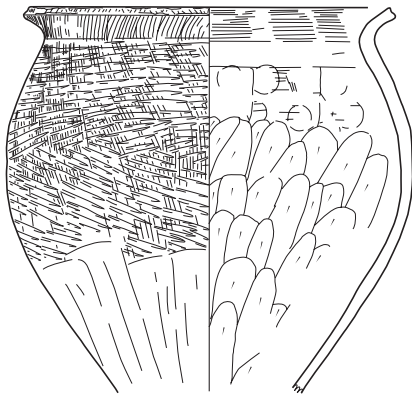

E-02Cf-040

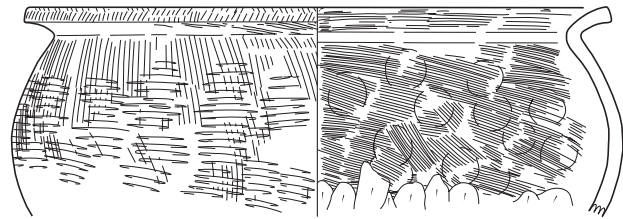

E-02Cf-043

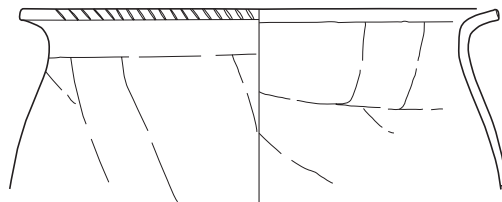

E-02Cf-044

02Cf ☒ SK10

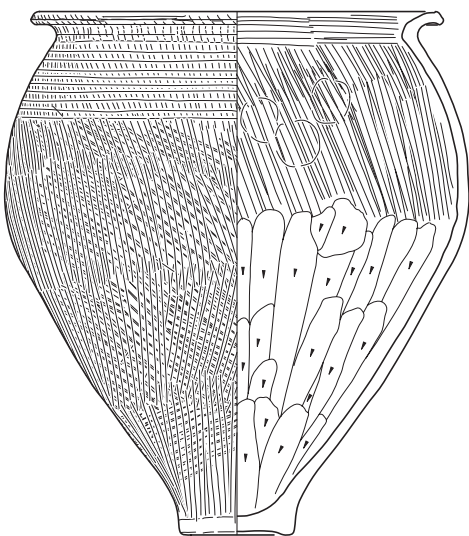

E-02Cf-045

02Cf ☒ SK18

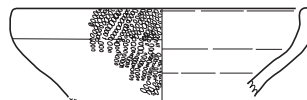

E-02Cf-046



E-02Cf-047

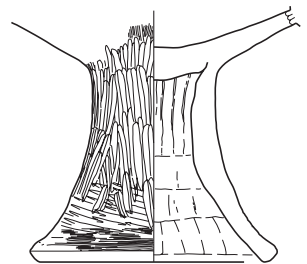

E-02Cf-048

02Cf ☒ SK32

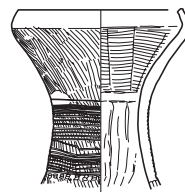

E-02Cf-049



02Cf 区 SK33

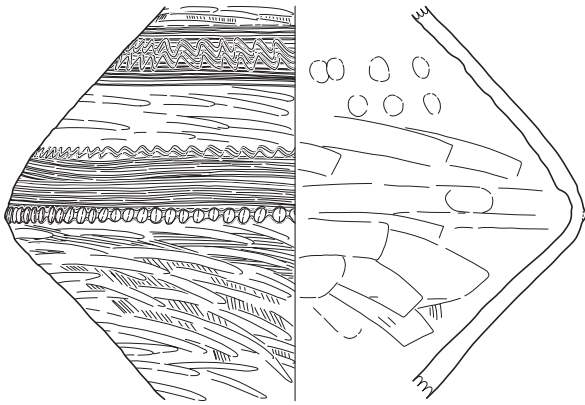

E-02Cf-050

02Cf 区 SK38

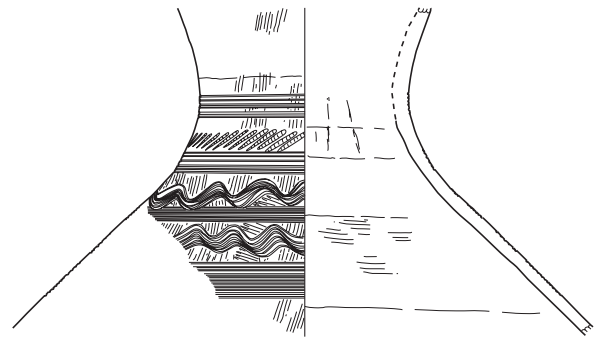

E-02Cf-051

02Cf 区 SK46

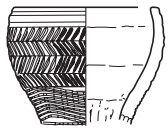

E-02Cf-053

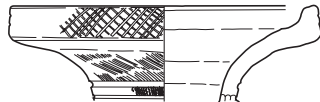

E-02Cf-054

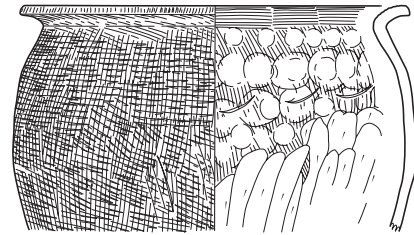

E-02Cf-052

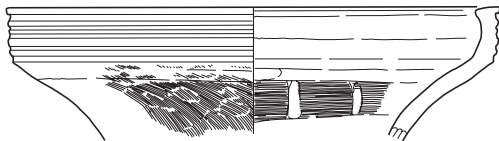

E-02Cf-055

02Cf 区 検 II

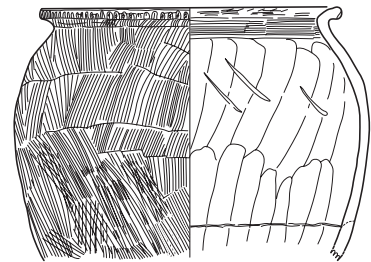

E-02Cf-058



E-02Cf-056

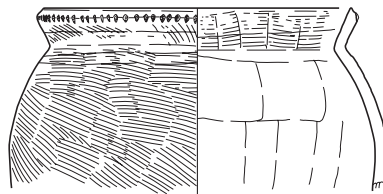

E-02Cf-057

02Cg 区 SD01



E-02Cg-001

02Cg 区 SD02

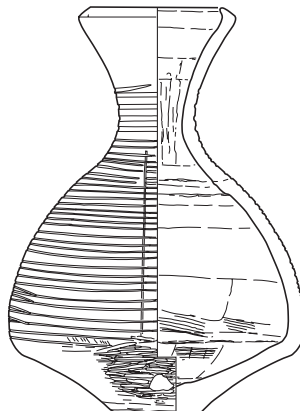

E-02Cg-002

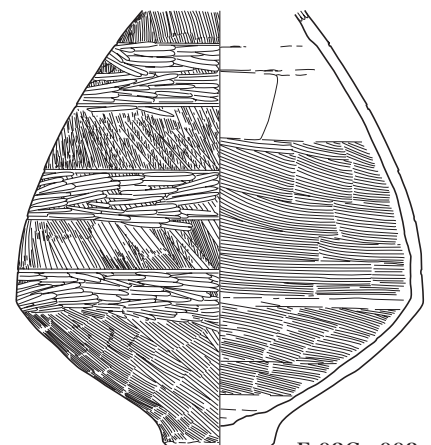

E-02Cg-003



02Cg ☒ SD02

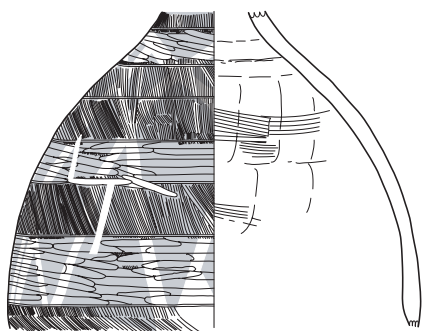

E-02Cg-004

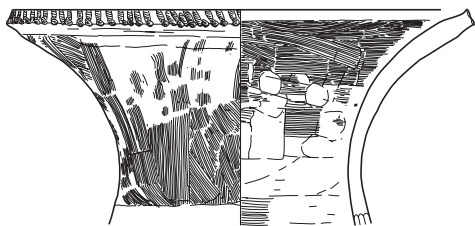

E-02Cg-005

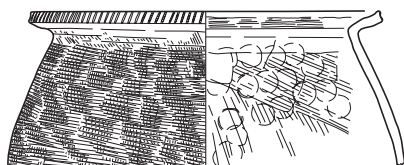

E-02Cg-007

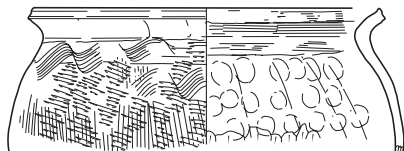

E-02Cg-008

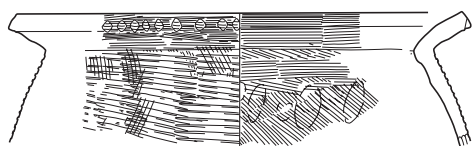

E-02Cg-009

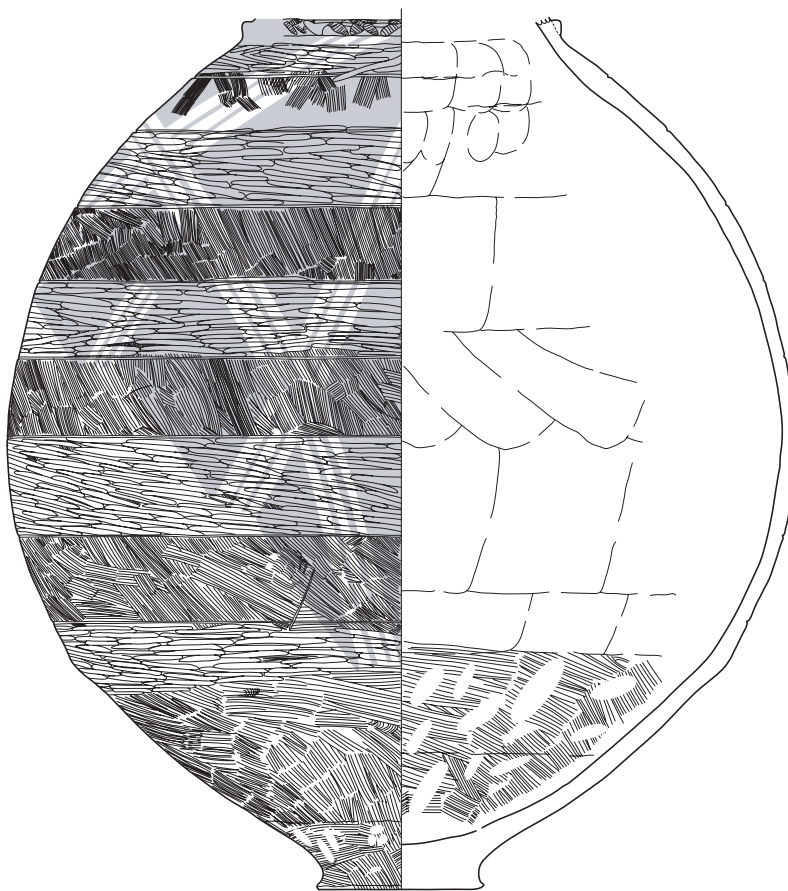

E-02Cg-006

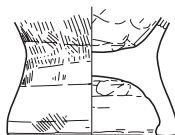

E-02Cg-010



E-02Cg-011



E-02Cg-012

02Cg ☒ SK02

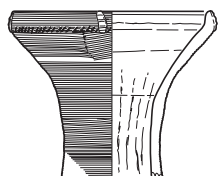

E-02Cg-013



E-02Cg-014

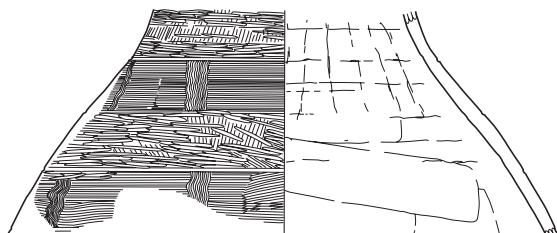

E-02Cg-015

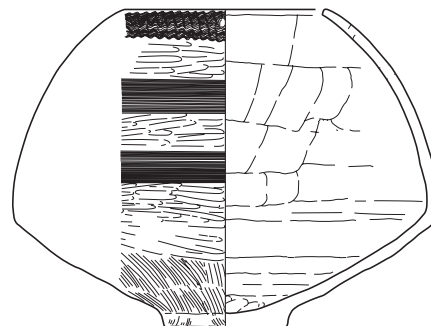

E-02Cg-016

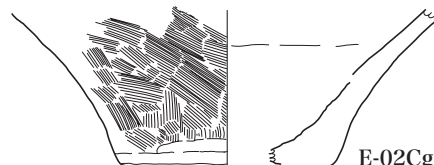

E-02Cg-017





02Da ☒ SK17

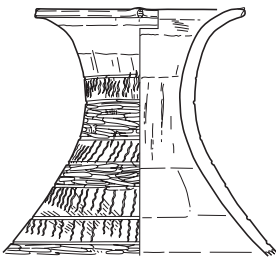

E-02Da-001

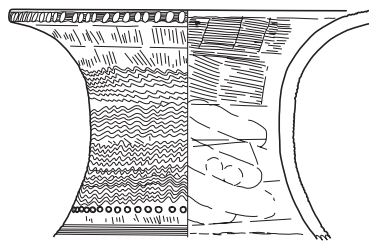

E-02Da-003

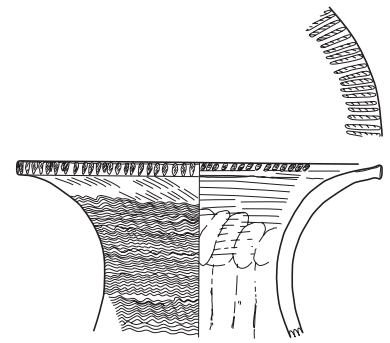

E-02Da-005



E-02Da-002

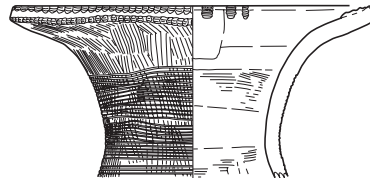

E-02Da-004

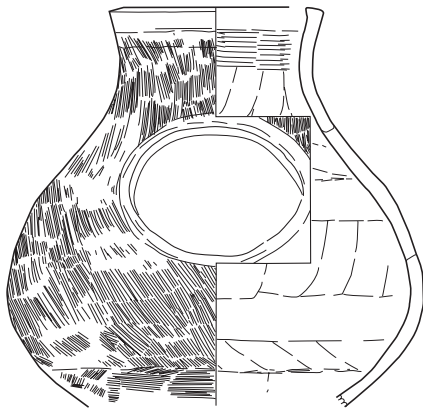

E-02Da-006

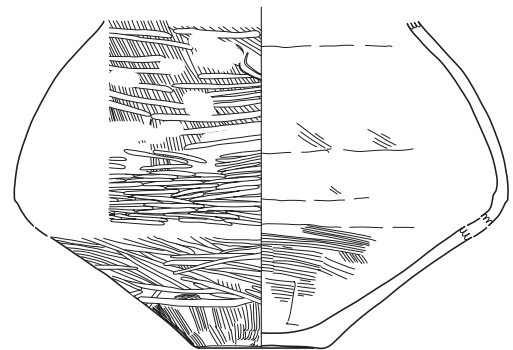

E-02Da-007

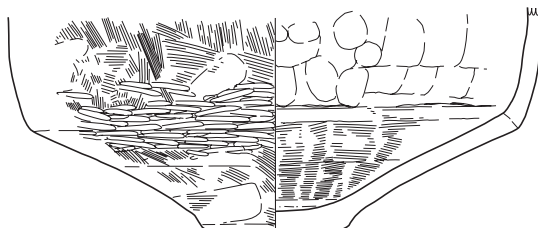

E-02Da-008

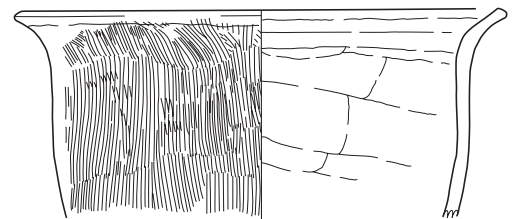

E-02Da-009

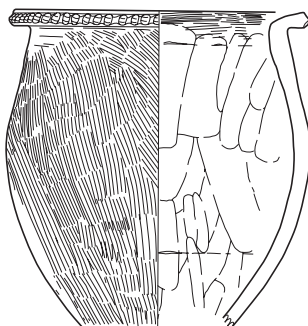

E-02Da-010

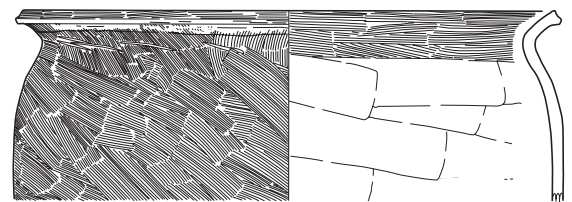

E-02Da-012

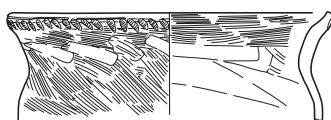

E-02Da-011

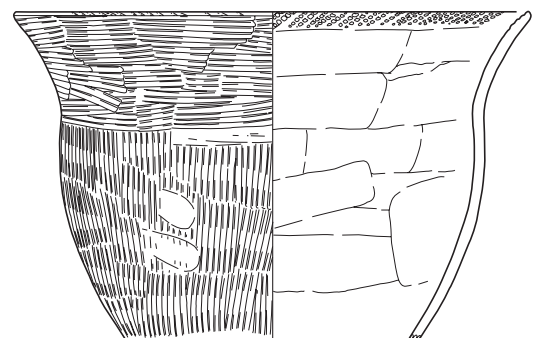

E-02Da-013



02Da ☒ SK17

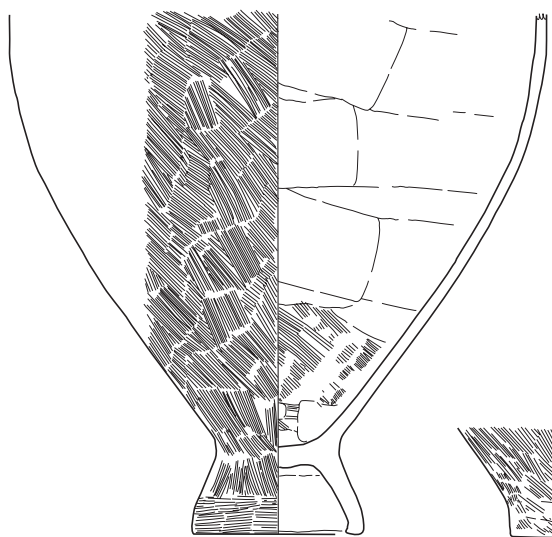

E-02Da-014



E-02Da-015



E-02Da-016

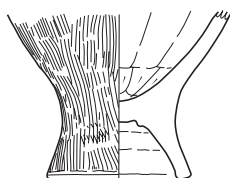

E-02Da-017

02Da ☒ SK18

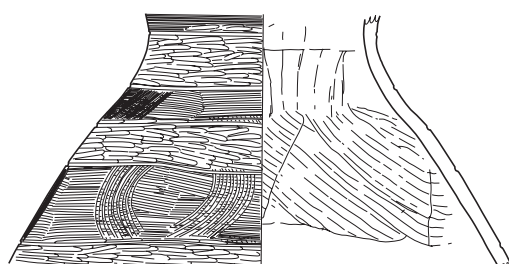

E-02Da-018

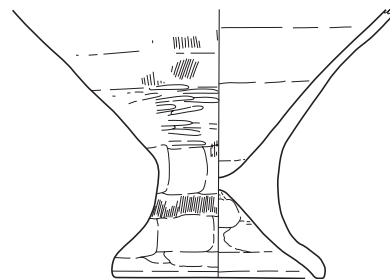

E-02Da-019

02Da ☒ SK22

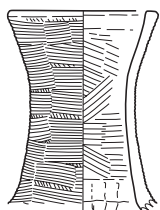

E-02Da-020

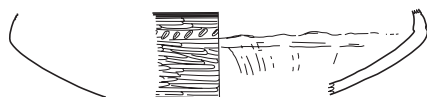

E-02Da-021

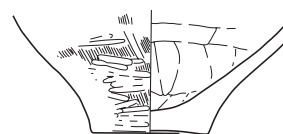

E-02Da-022

02Da ☒ SK23

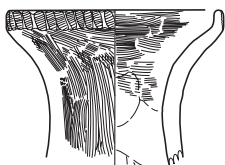

E-02Da-023

02Da ☒ SK29



E-02Da-024

02Da ☒ SK30

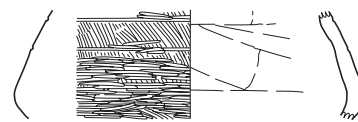

E-02Da-026

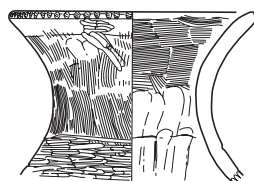

E-02Da-025

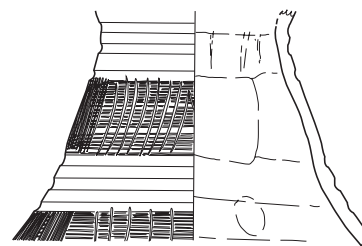

E-02Da-027



02Da 区 SK72

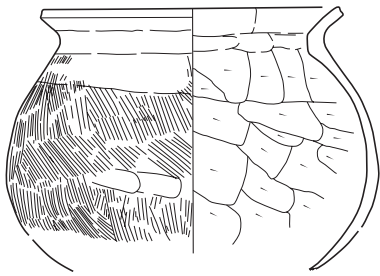

E-02Da-028

02Da 区 SX01

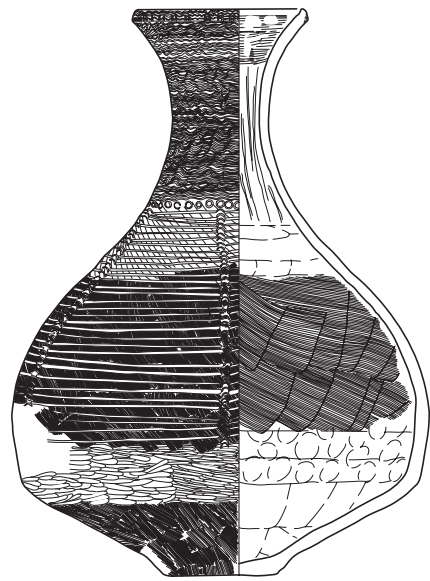

E-02Da-029

02Da 区 検II

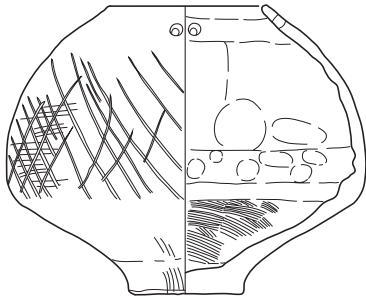

E-02Da-030

02Db 区 SB14

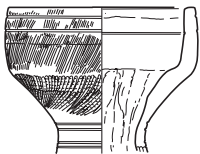

E-02Db-001

02Db 区 SB15

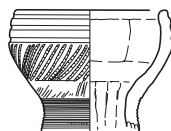

E-02Db-002

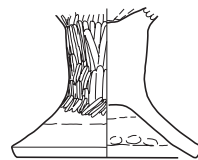

E-02Db-003

02Db 区 SB17

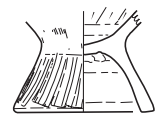

E-02Db-004

02Db 区 SB31

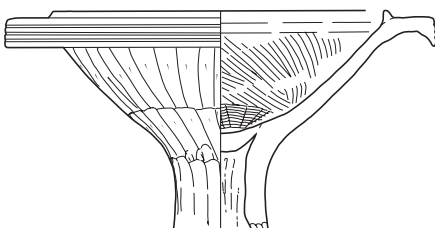

E-02Db-005

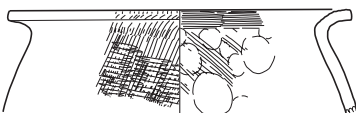

E-02Db-006



E-02Db-007

02Db 区 SB47

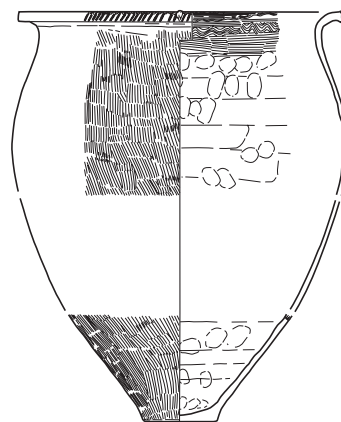

E-02Db-008

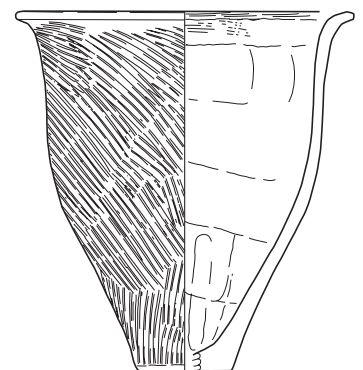

E-02Db-009



02Db ☒ SB48

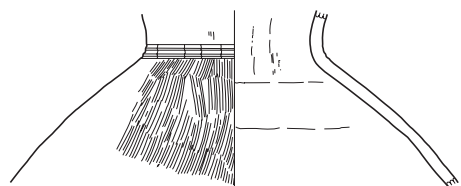

E-02Db-010

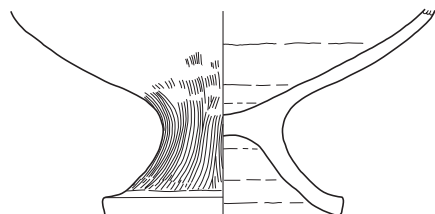

E-02Db-011

02Db ☒ SB51

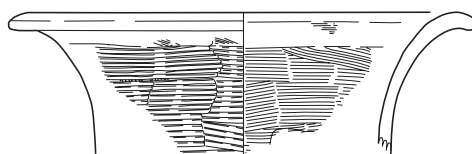

E-02Db-012

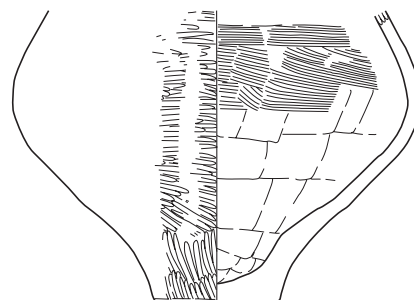

E-02Db-013

02Db ☒ SB61

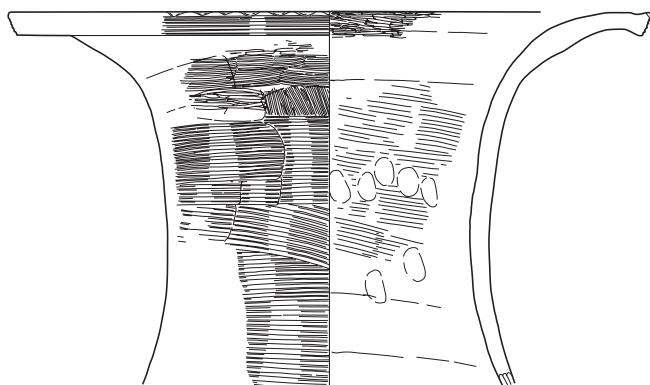

E-02Db-015

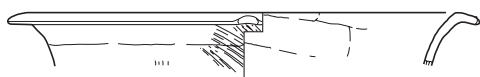

E-02Db-016

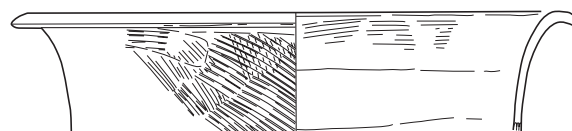

E-02Db-014

02Db ☒ SB66

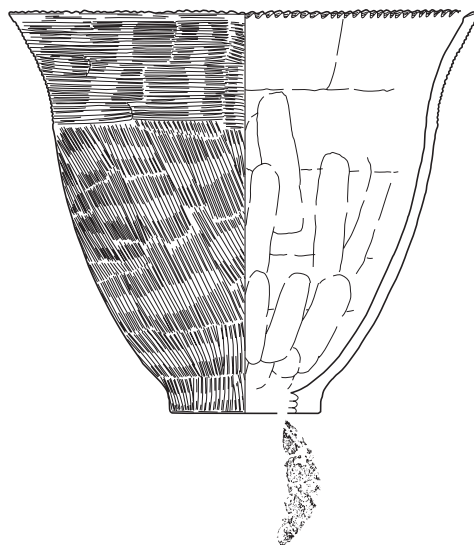

E-02Db-018

02Db ☒ SB63

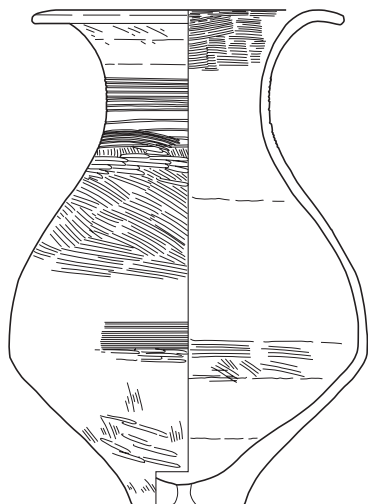

E-02Db-017

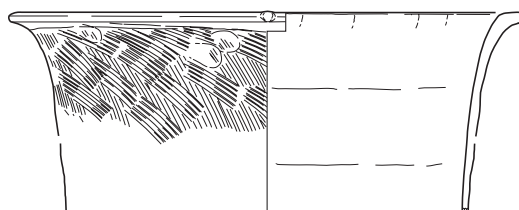

E-02Db-019



02Db ☒ SB67

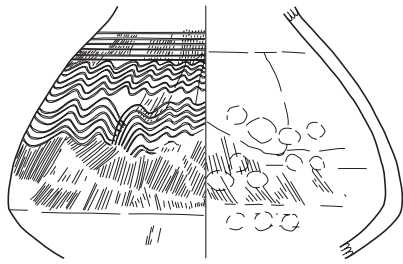

E-02Db-020

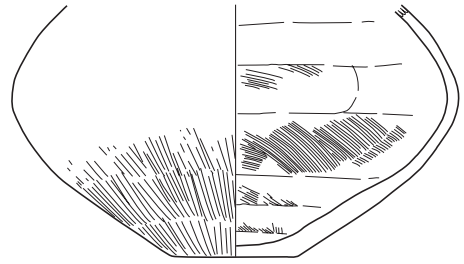

E-02Db-021

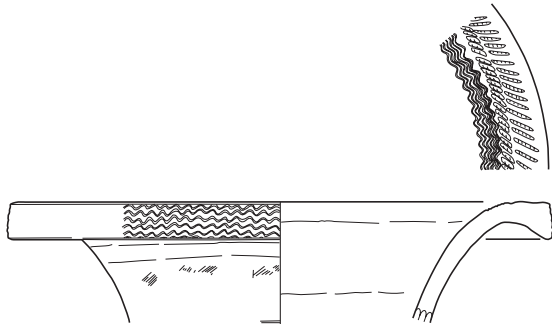

E-02Db-022

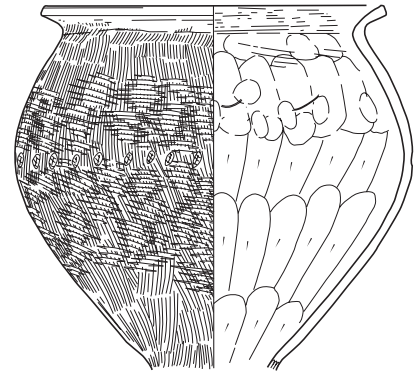

E-02Db-023

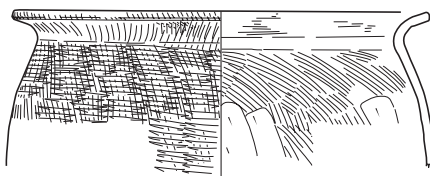

E-02Db-024

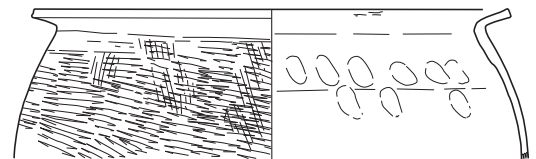

E-02Db-025

02Db ☒ SB68

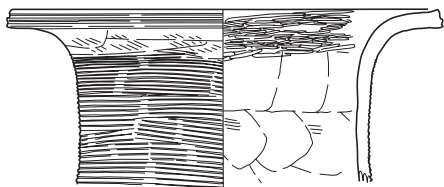

E-02Db-026

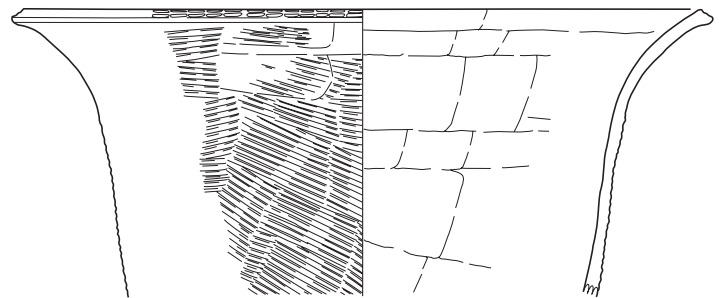

E-02Db-027

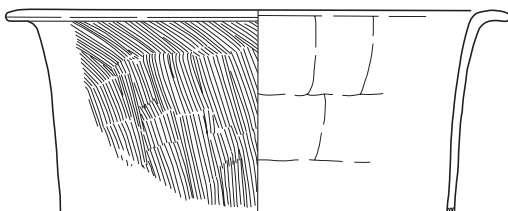

E-02Db-028

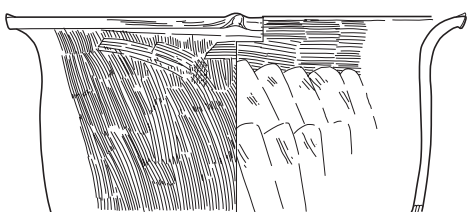

E-02Db-029



02Db ☒ SB72

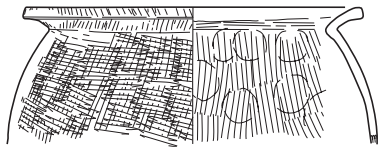

E-02Db-030

02Db ☒ SB77

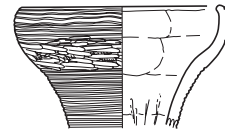

E-02Db-031

02Db ☒ SB79

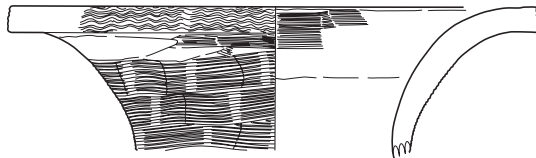

E-02Db-036

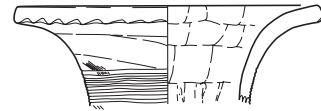

E-02Db-032

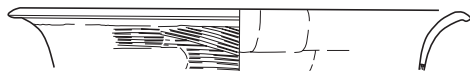

E-02Db-037

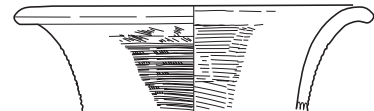

E-02Db-033

02Db ☒ SK49

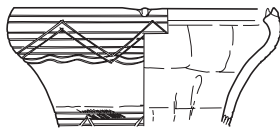

E-02Db-038

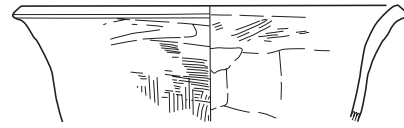

E-02Db-034

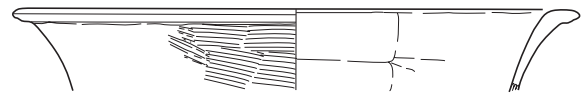

E-02Db-035

02Db ☒ SX01

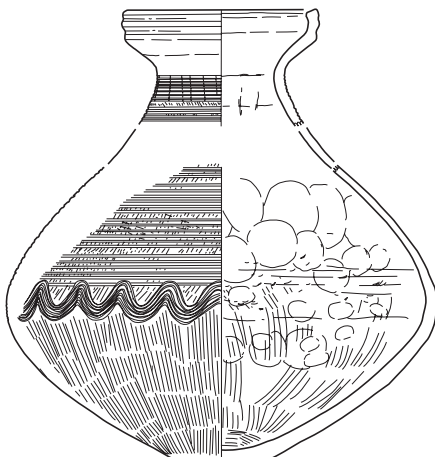

E-02Db-039

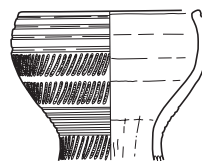

E-02Db-040

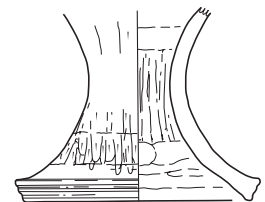

E-02Db-041

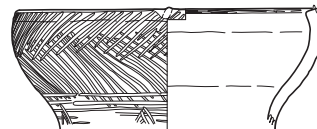

E-02Db-042

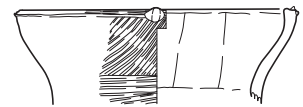

E-02Db-043

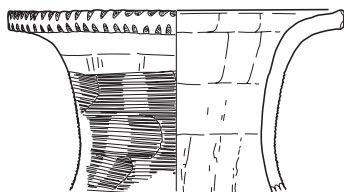

E-02Db-044

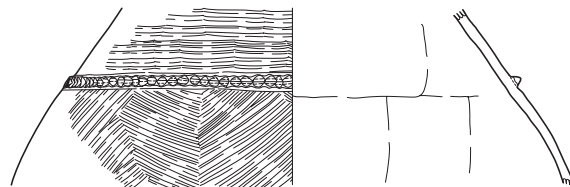

E-02Db-046

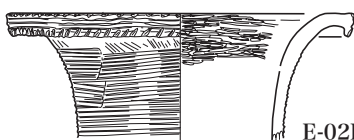

E-02Db-045



E-02Db-047



02Db 区 SX01

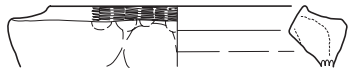

E-02Db-048

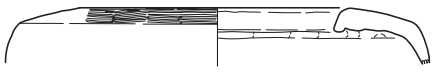

E-02Db-049

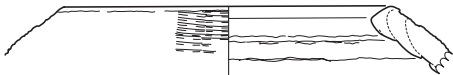

E-02Db-050



E-02Db-051

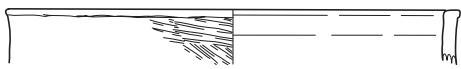

E-02Db-052

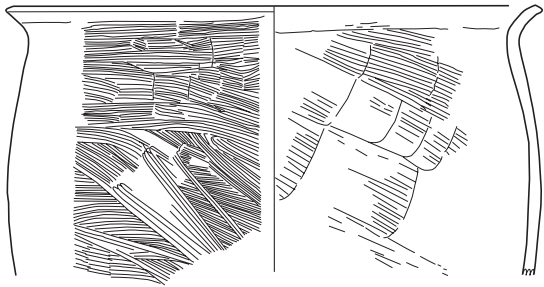

E-02Db-053

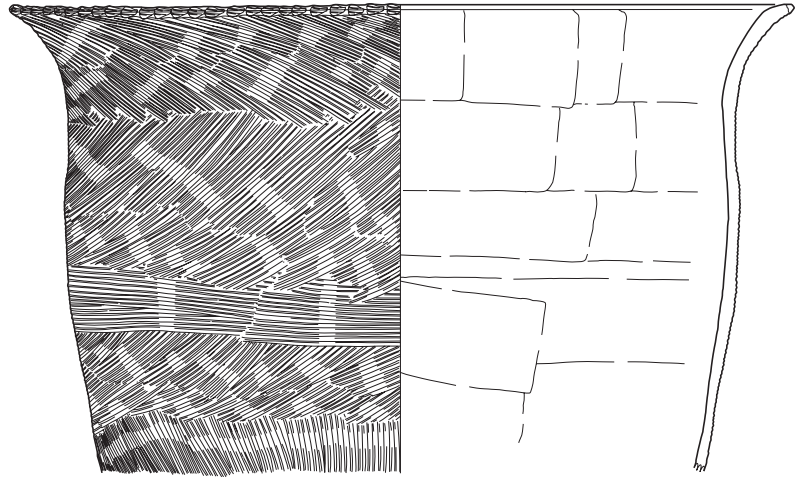

E-02Db-054

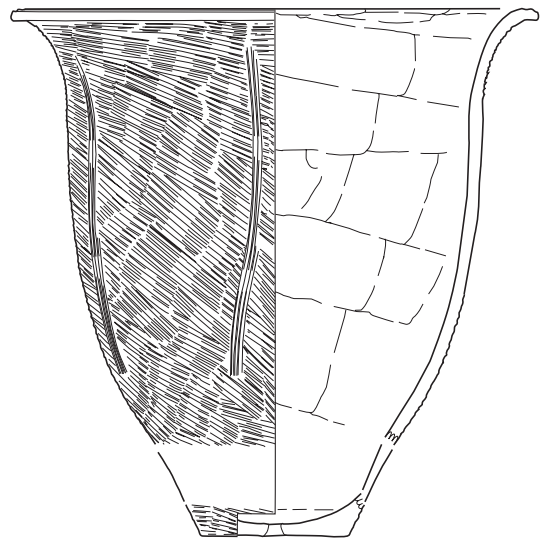

E-02Db-055

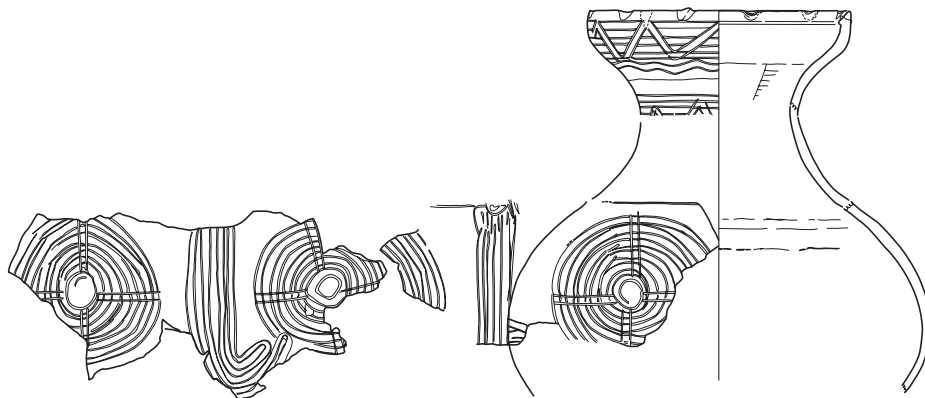

E-02Db-056

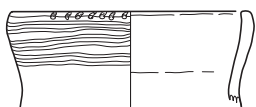

E-02Db-057

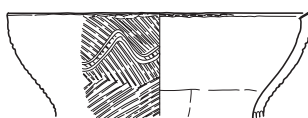

E-02Db-058

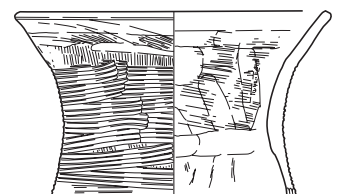

E-02Db-059



02Db ☒ SX01

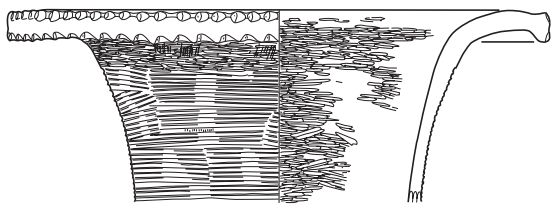

E-02Db-060

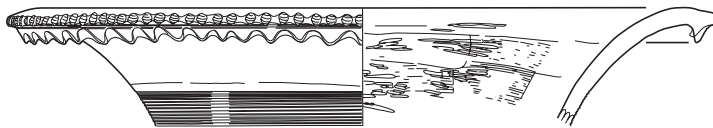

E-02Db-061

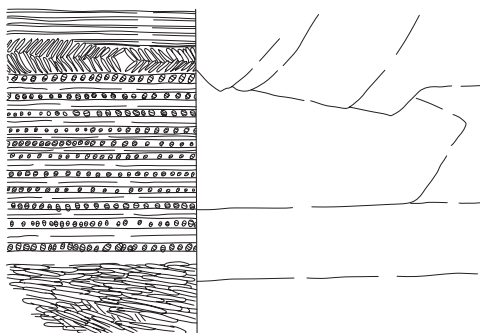

E-02Db-062

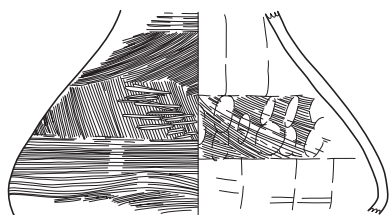

E-02Db-063

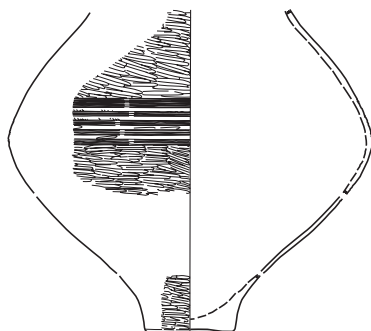

E-02Db-064

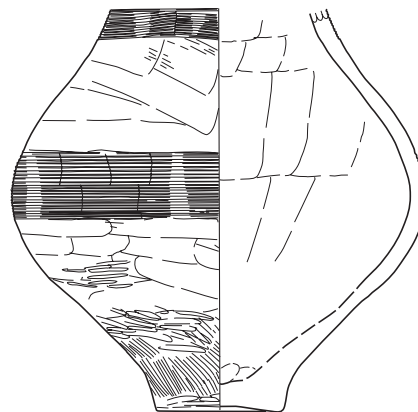

E-02Db-065

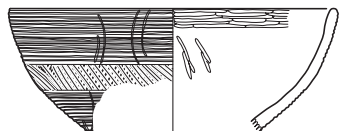

E-02Db-066

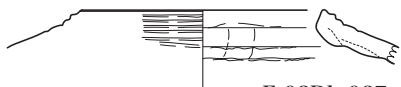

E-02Db-067

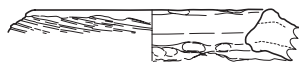

E-02Db-068

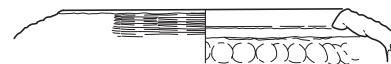

E-02Db-069

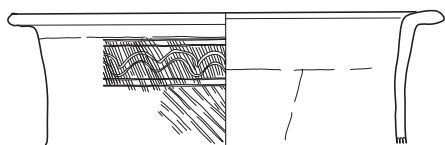

E-02Db-070

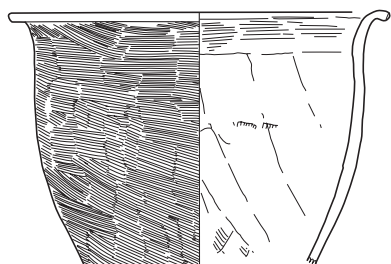

E-02Db-071

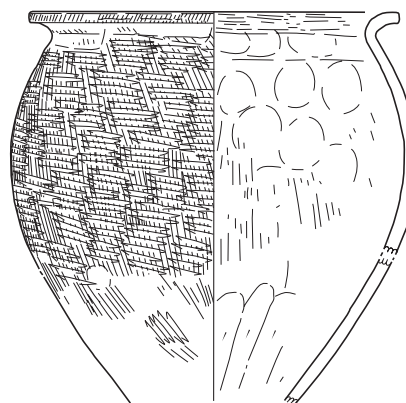

E-02Db-072





02Db区 SX01

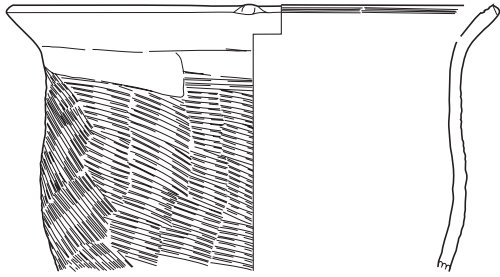

E-02Db-073

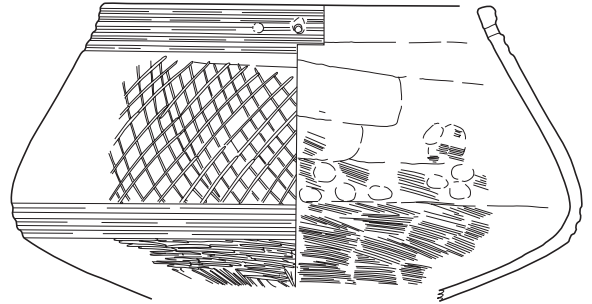

E-02Db-078

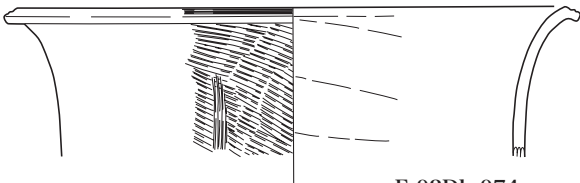

E-02Db-074

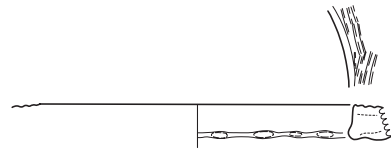

E-02Db-079

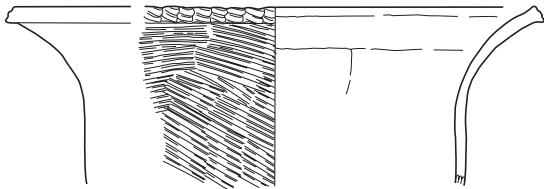

E-02Db-075

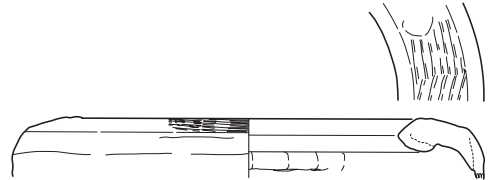

E-02Db-080

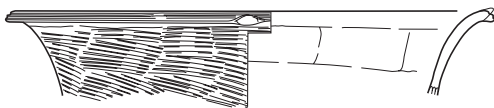

E-02Db-076

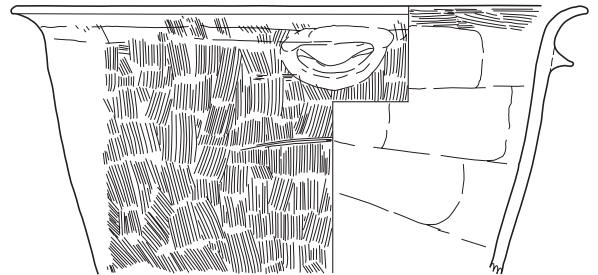

E-02Db-081



E-02Db-077

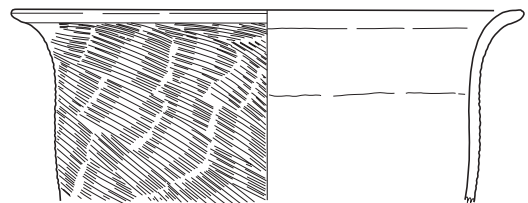

E-02Db-082

02Db区 南トレンチ

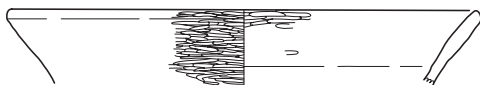

E-02Db-083



02Dc ☒ SB03

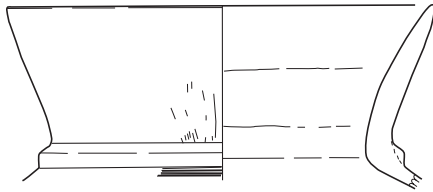

E-02Dc-001

02Dc ☒ SB07

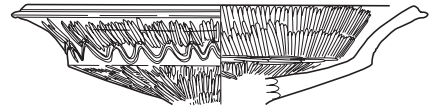

E-02Dc-003

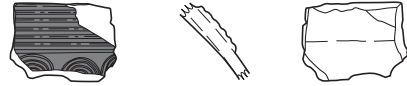

E-02Dc-004

02Dc ☒ SB04

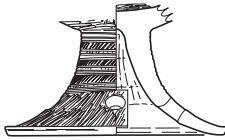

E-02Dc-002

02Dc ☒ SB24

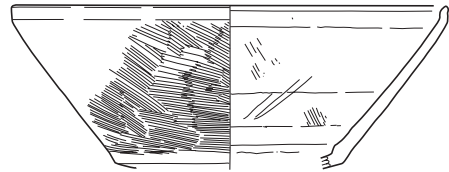

E-02Dc-006

02Dc ☒ SB11

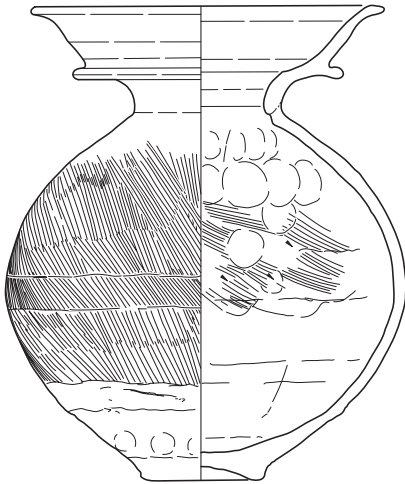

E-02Dc-005

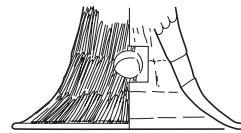

E-02Dc-007

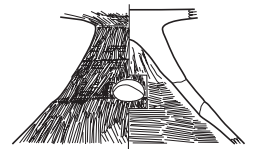

E-02Dc-008

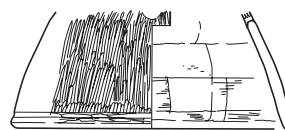

E-02Dc-009

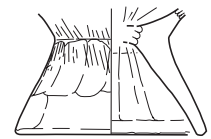

E-02Dc-010

02Dc ☒ SB68

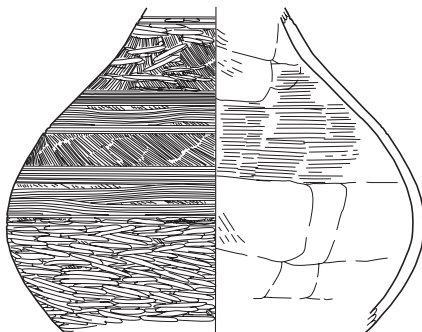

E-02Dc-011

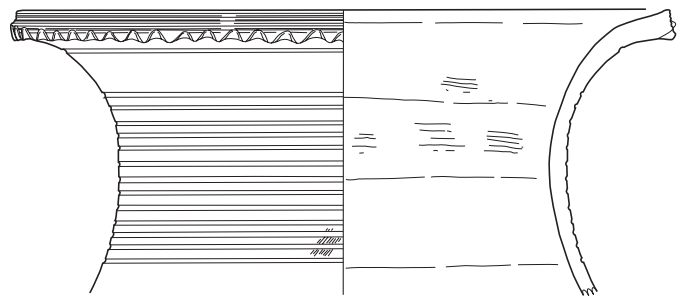

E-02Dc-012

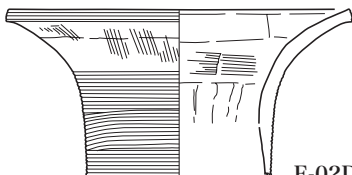

E-02Dc-013

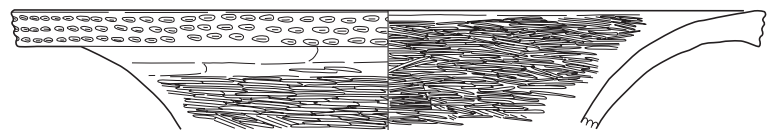

E-02Dc-014



02Dc ☒ SB68

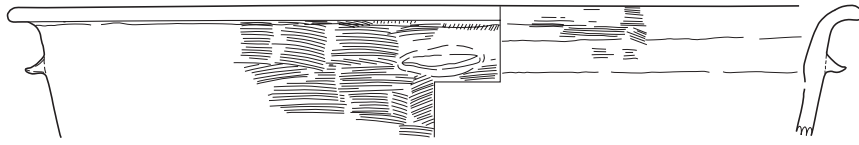

E-02Dc-015

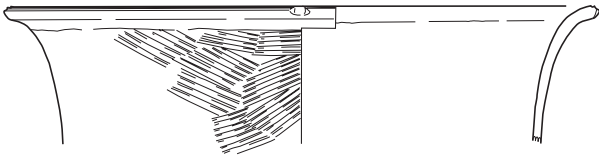

E-02Dc-016

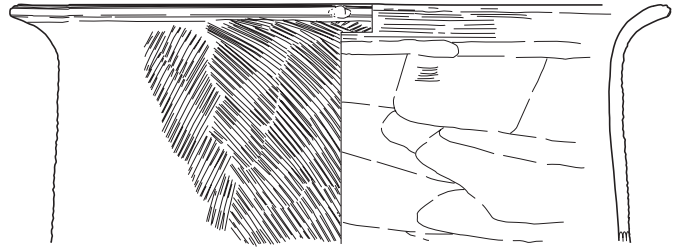

E-02Dc-017

02Dc ☒ SB71



E-02Dc-018

02Dc ☒ SB93

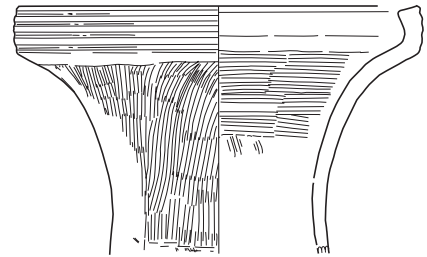

E-02Dc-020

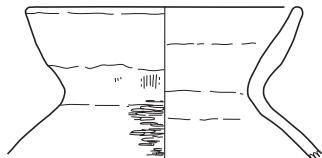

E-02Dc-019

02Dc ☒ SK31

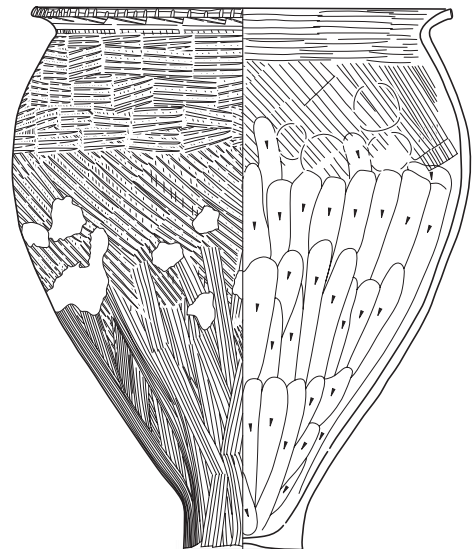

02Dc ☒ SB95

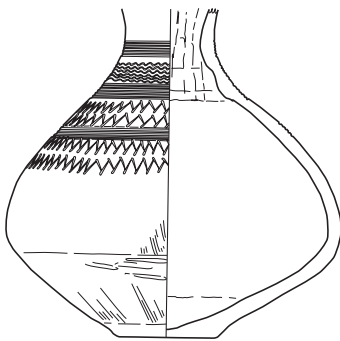

E-02Dc-021

02Dc ☒ SK29

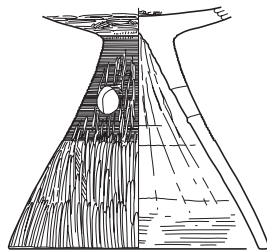

E-02Dc-022



E-02Dc-023



02Dc ☒ SK40

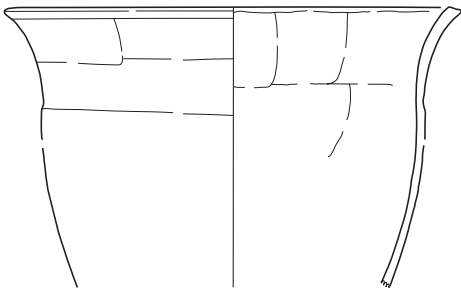

E-02Dc-024

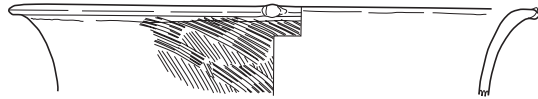

E-02Dc-025

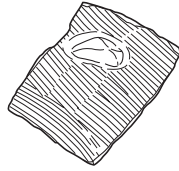

E-02Dc-026

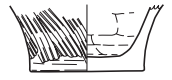
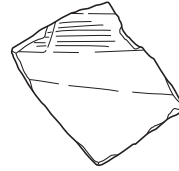

E-02Dc-027

02Dc ☒ SK41

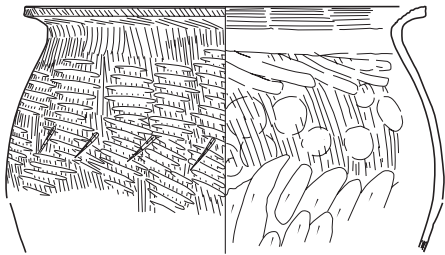

E-02Dc-028

02Dc ☒ SK152

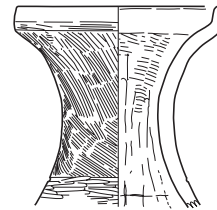

E-02Dc-029

02Dc ☒ SK156

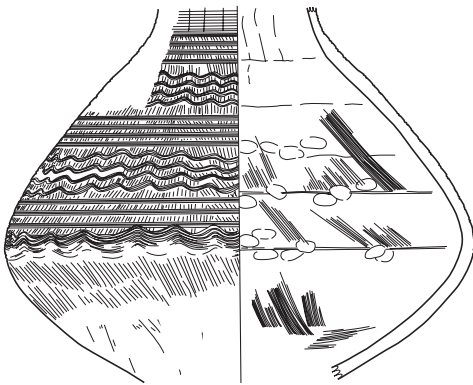

E-02Dc-030

02Dc ☒ SK200

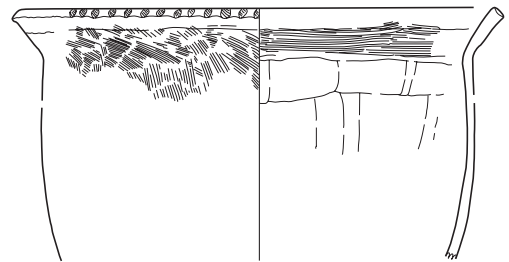

E-02Dc-032



E-02Dc-033

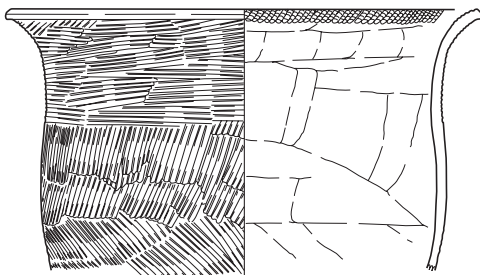

E-02Dc-031

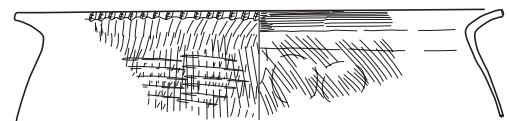

E-02Dc-034



E-02Dc-035

02Dc ☒ SK232

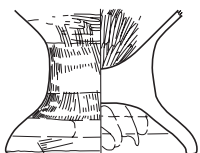

E-02Dc-036

02Dc ☒ SK303

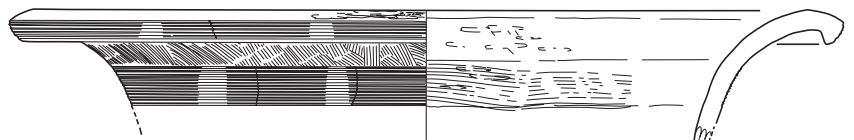

E-02Dc-037



02Dc ☒ SK336

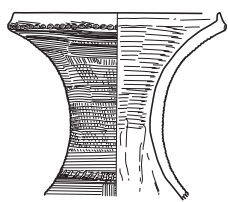

E-02Dc-038

02Dc ☒ SK389

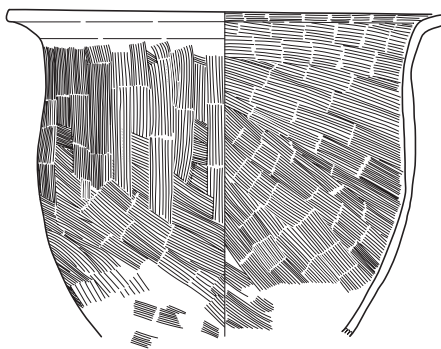

E-02Dc-039

02Dc ☒ SK408

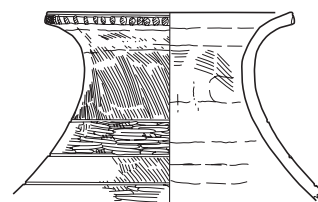

E-02Dc-040

02Dd ☒ SB01

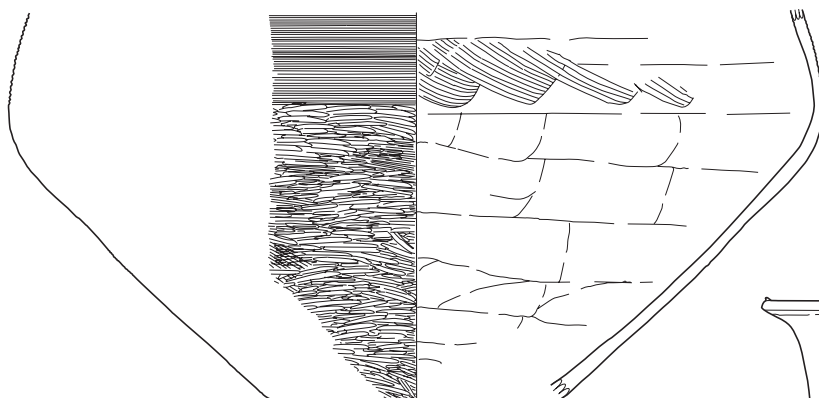
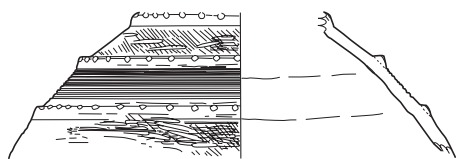

E-02Dd-001

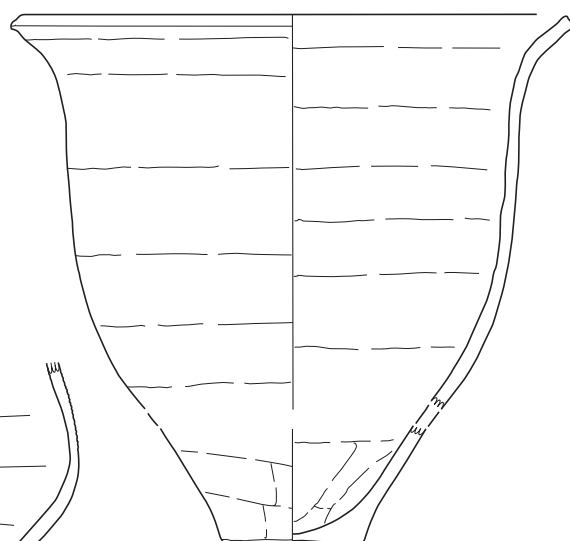

E-02Dd-002

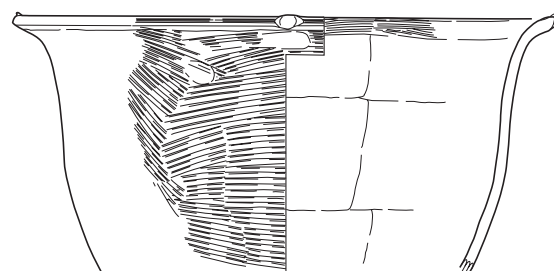

E-02Dd-004

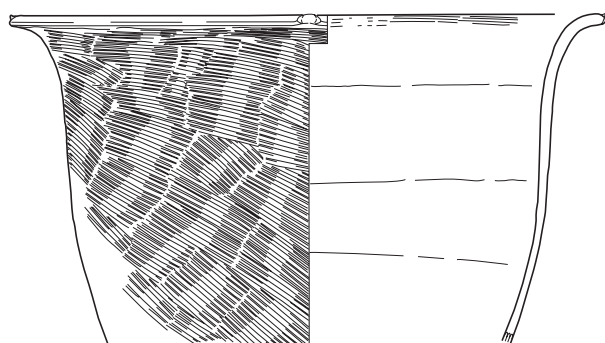

E-02Dd-003

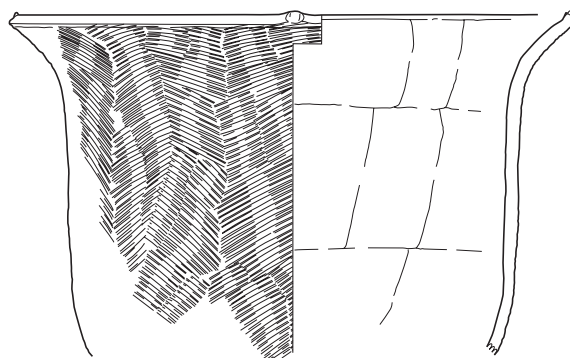

E-02Dd-005



02Dd ☒ SB02

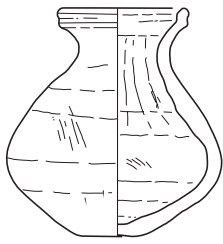

E-02Dd-006

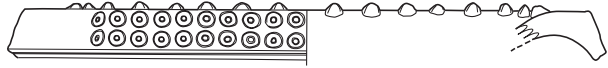
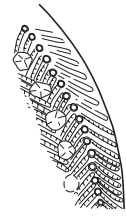

E-02Dd-007

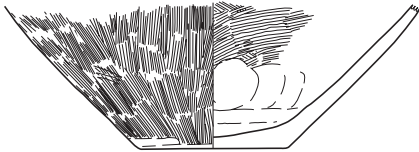

E-02Dd-008

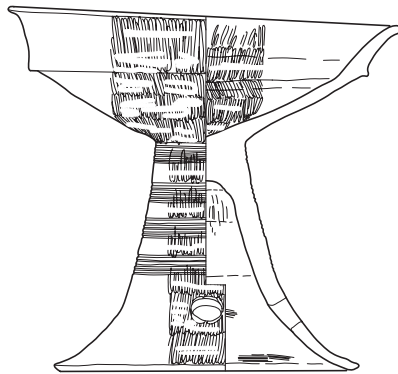

E-02Dd-009

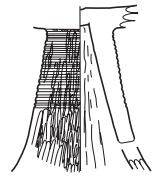

E-02Dd-012

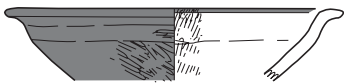

E-02Dd-010

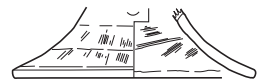

E-02Dd-013

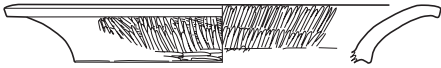

E-02Dd-011

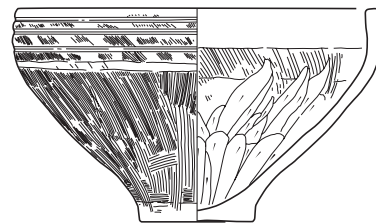

E-02Dd-014

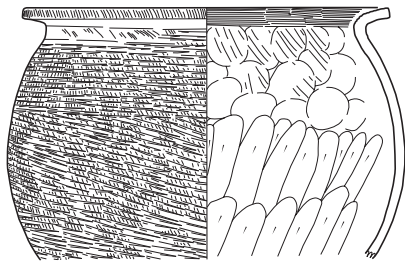

E-02Dd-015

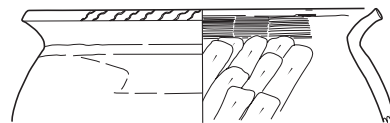

E-02Dd-016

02Dd ☒ SB03



E-02Dd-017

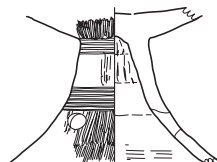

E-02Dd-019



E-02Dd-021

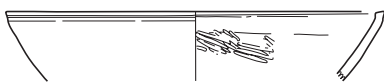

E-02Dd-018

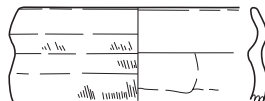

E-02Dd-020

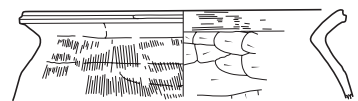

E-02Dd-022



02Dd ☒ SB05

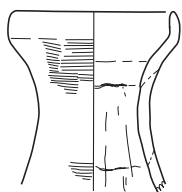

E-02Dd-023

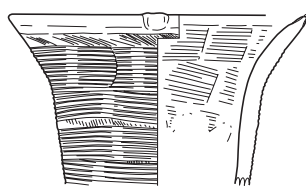

E-02Dd-024

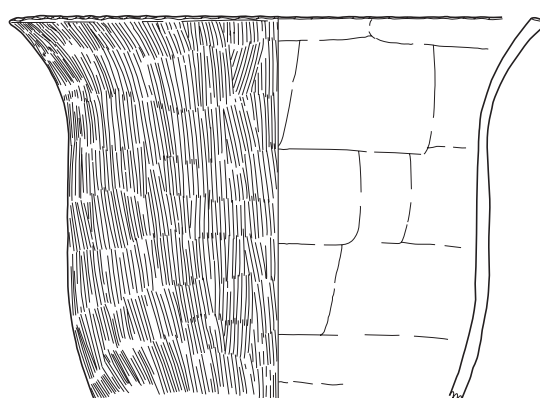

E-02Dd-025

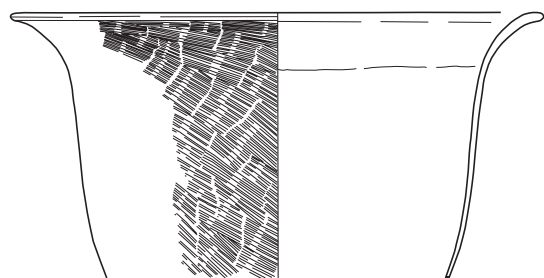

E-02Dd-026

02Dd ☒ SB06

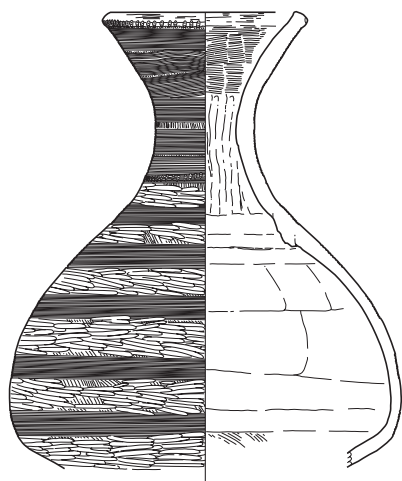

E-02Dd-027

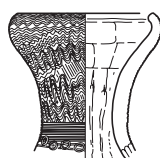

E-02Dd-028

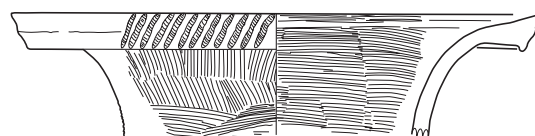

E-02Dd-029

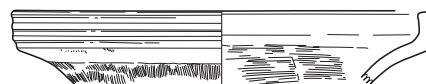

E-02Dd-030

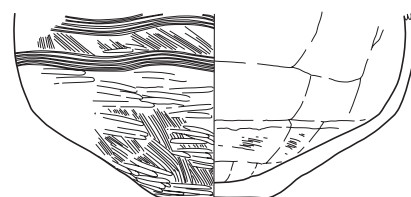

E-02Dd-031



E-02Dd-032

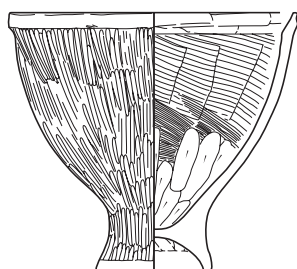

E-02Dd-033

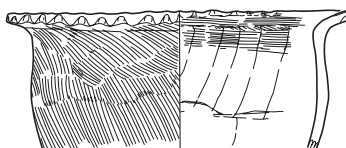

E-02Dd-034

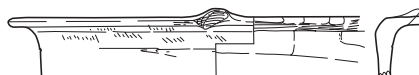

E-02Dd-035



E-02Dd-036



E-02Dd-037



02Dd ☒ SB07

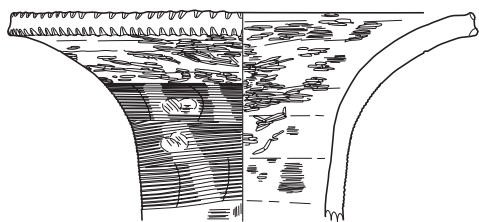

E-02Dd-038

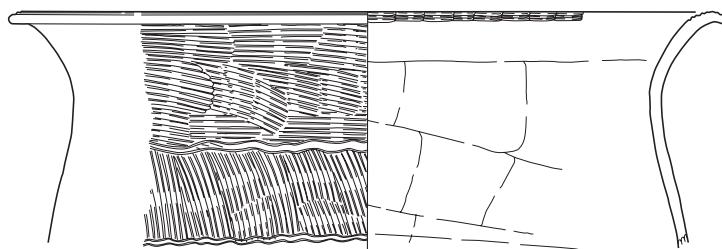

E-02Dd-041

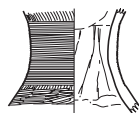

E-02Dd-039

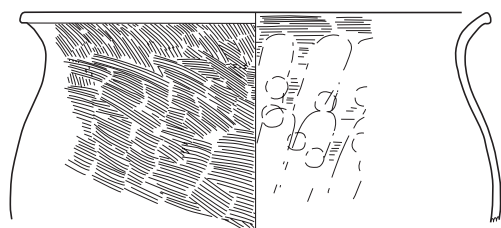

E-02Dd-040

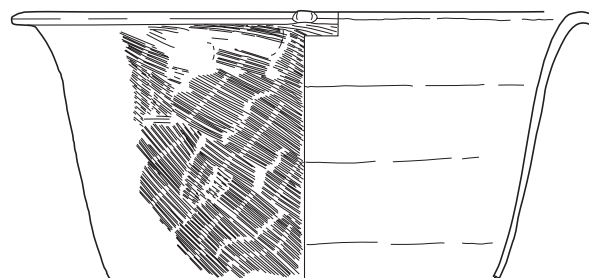

E-02Dd-042

02Dd ☒ SD04



E-02Dd-043



E-02Dd-044

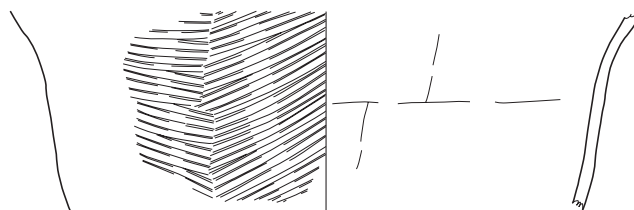

E-02Dd-045

02Dd ☒ SK04

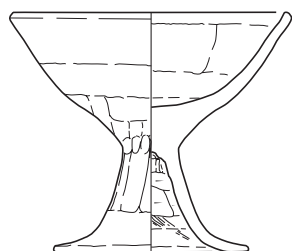

E-02Dd-046

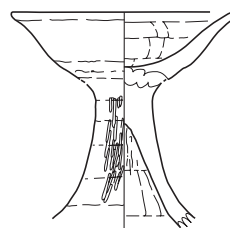

E-02Dd-047





02Dd ☒ SK05

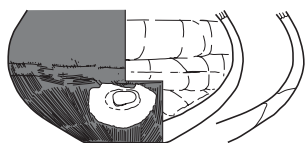

E-02Dd-048

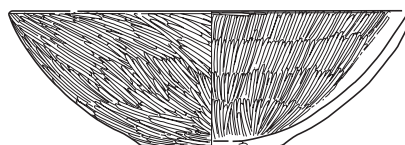

E-02Dd-050

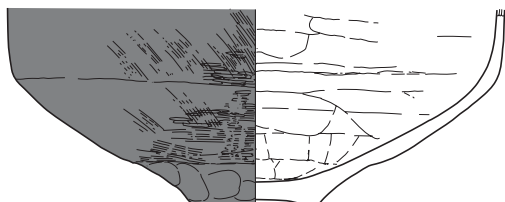

E-02Dd-049

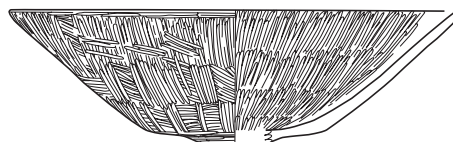

E-02Dd-051

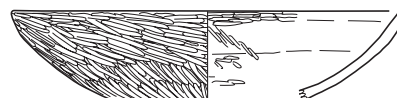

E-02Dd-052

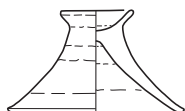

E-02Dd-053

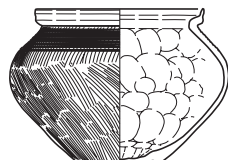

E-02Dd-054

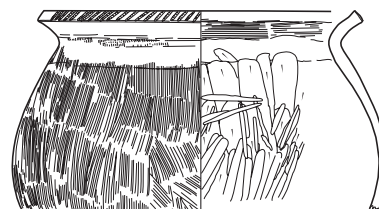

E-02Dd-056

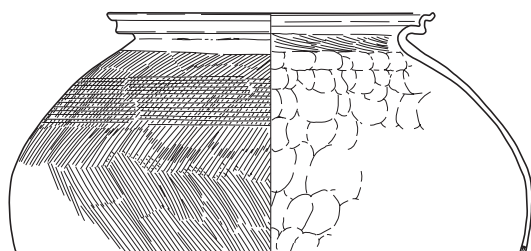

E-02Dd-055

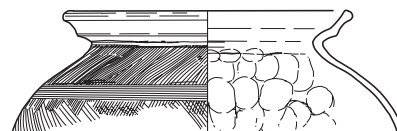

E-02Dd-057

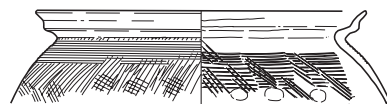

E-02Dd-058

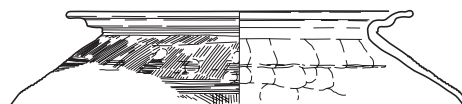

E-02Dd-059

02Dd ☒ SK08



E-02Dd-060

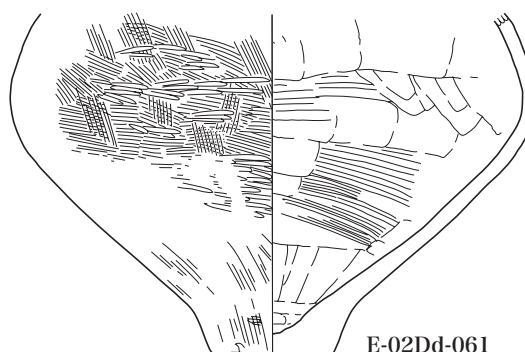

E-02Dd-061



02Dd 区 SK12

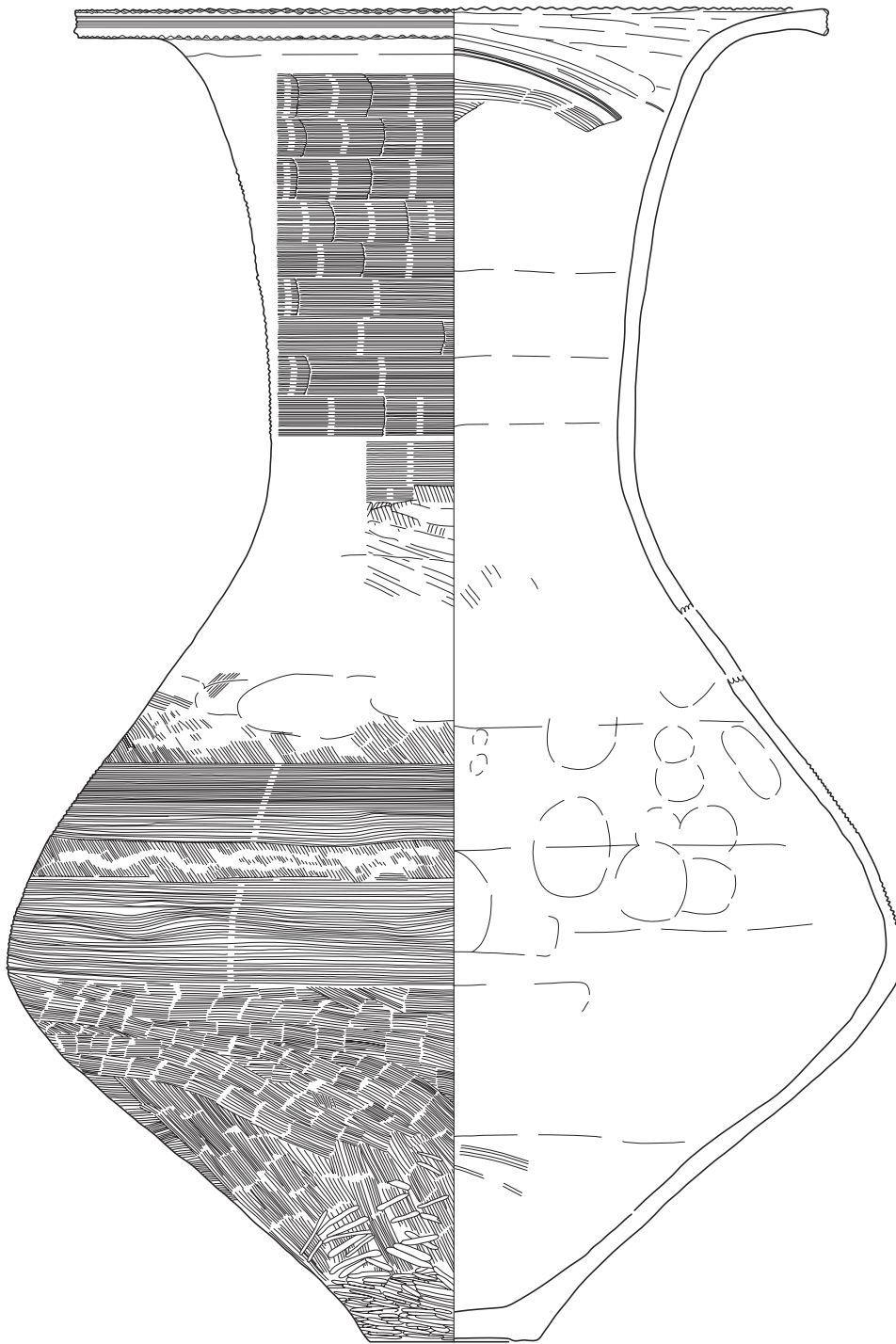

E-02Dd-062

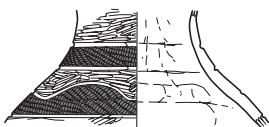

E-02Dd-063

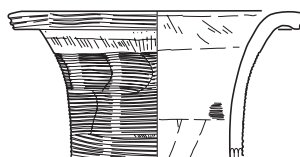

E-02Dd-064



E-02Dd-065



02Dd ☒ SK12

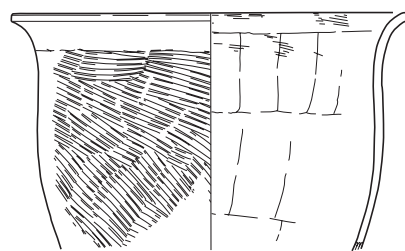
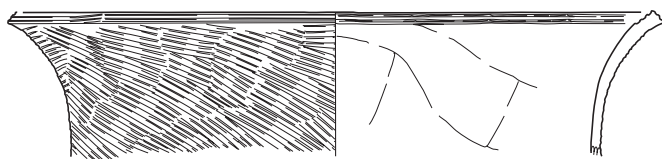

E-02Dd-067

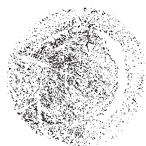
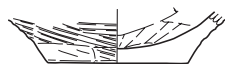

E-02Dd-066

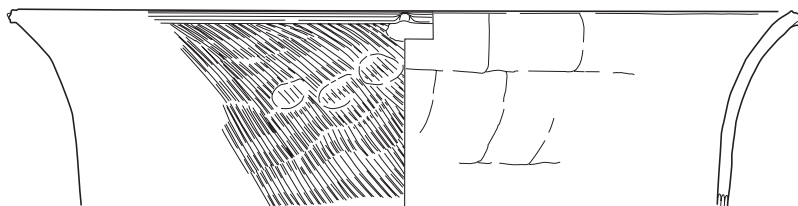

E-02Dd-068

02Dd ☒ SK32

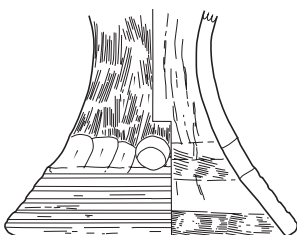

E-02Dd-069

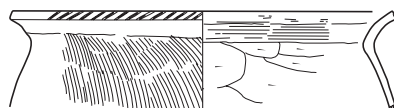

E-02Dd-070

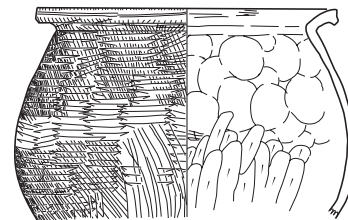

E-02Dd-072

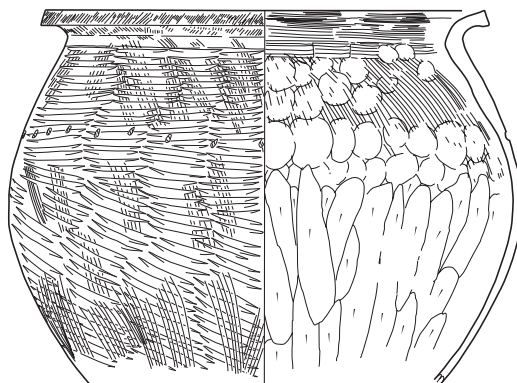

E-02Dd-071

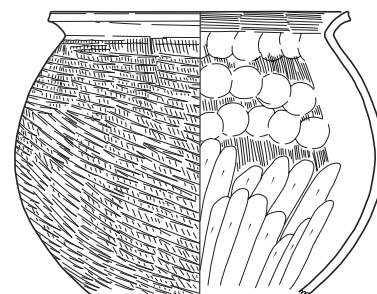

E-02Dd-073

02Dd ☒ SK33

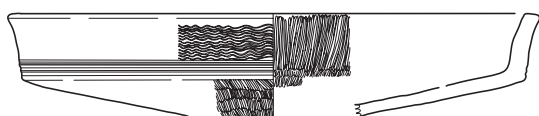

E-02Dd-074



E-02Dd-076

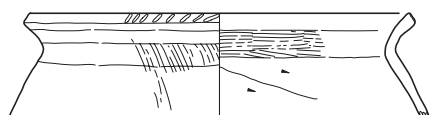

E-02Dd-075

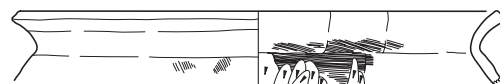

E-02Dd-077



02Dd ☒ SK50

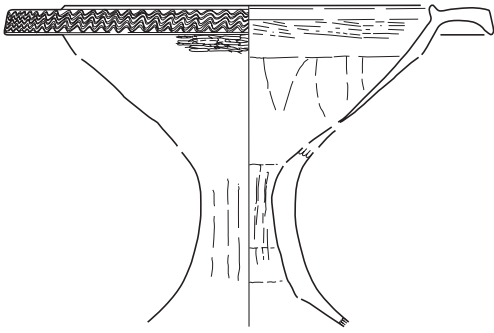

E-02Dd-078

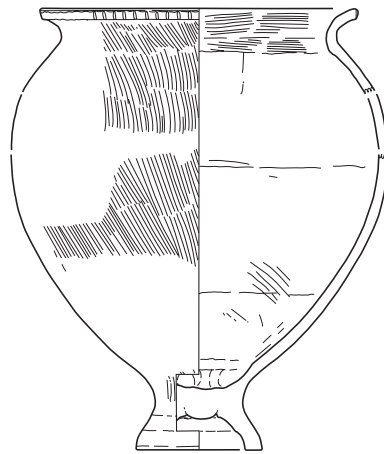

E-02Dd-079

02Dd ☒ SK52

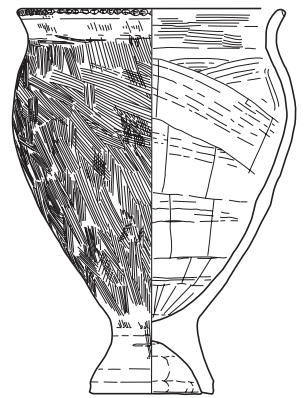

E-02Dd-081

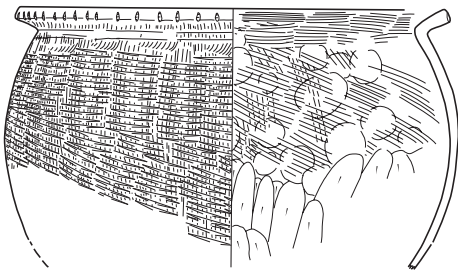

E-02Dd-080

02Dd ☒ SK53

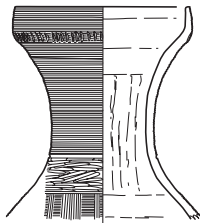

E-02Dd-082

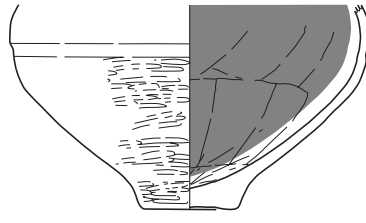

E-02Dd-084

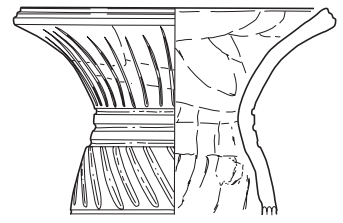

E-02Dd-085

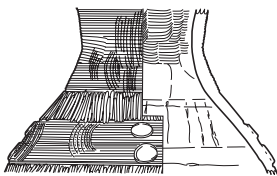

E-02Dd-083

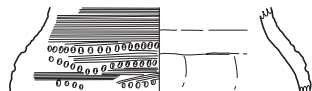

E-02Dd-086

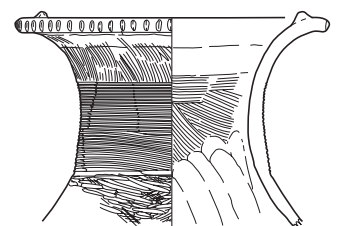

E-02Dd-087

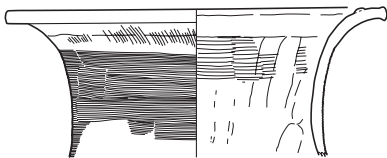

E-02Dd-088

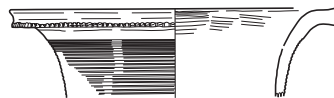

E-02Dd-089

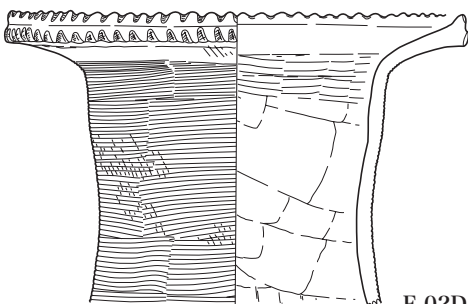

E-02Dd-090

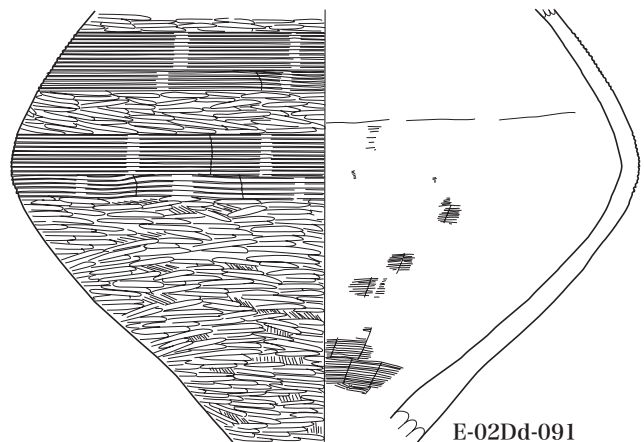

E-02Dd-091



02Dd ☒ SK53

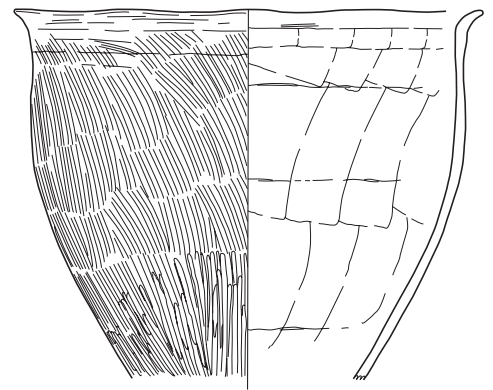
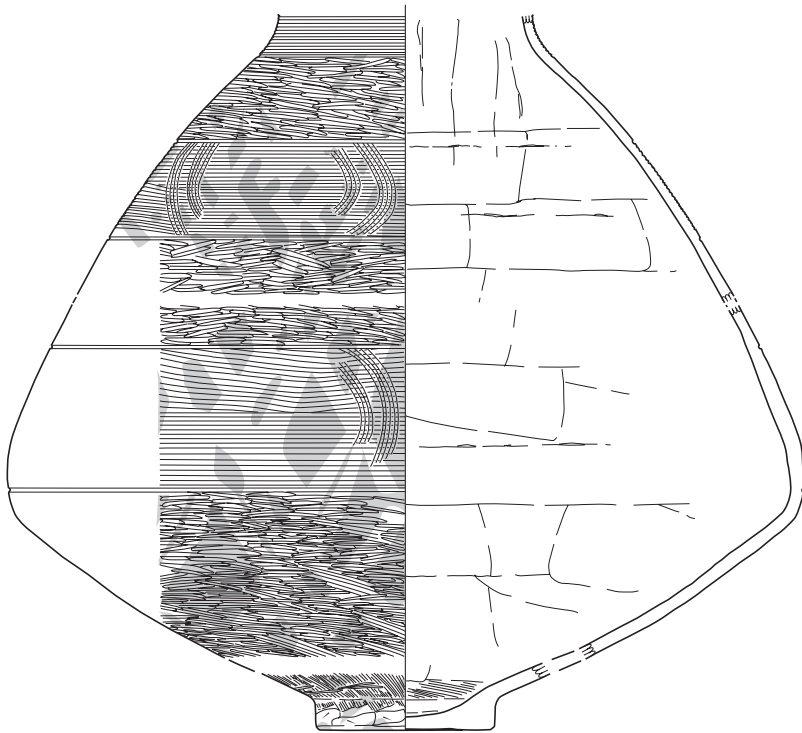

E-02Dd-095

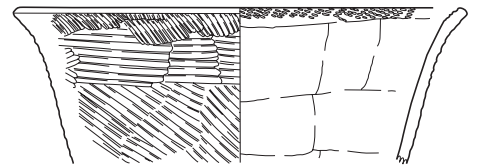

E-02Dd-096



E-02Dd-092

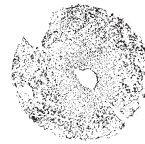

E-02Dd-097

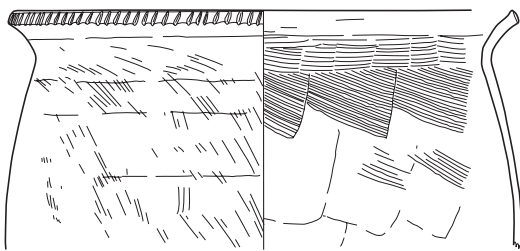

E-02Dd-093

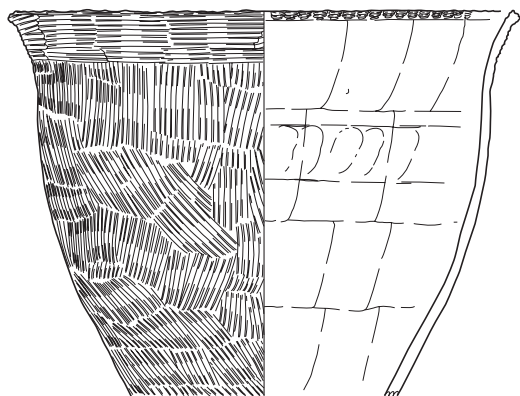

E-02Dd-094

02Dd ☒ SK58

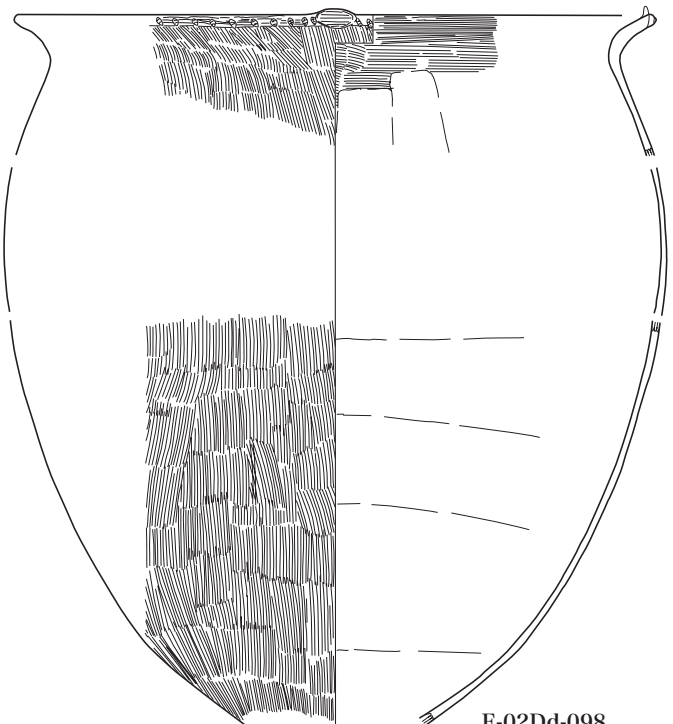

E-02Dd-098



02Dd ☒ SK69

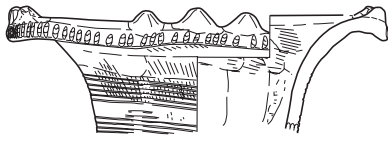

E-02Dd-099

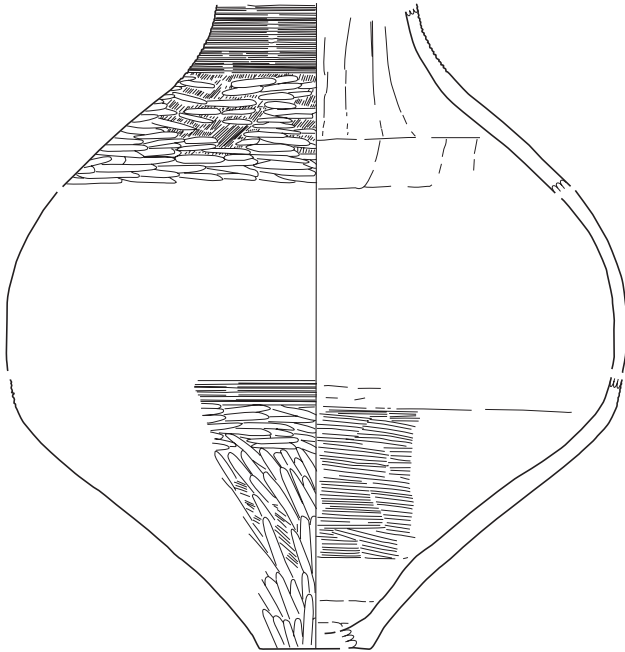

E-02Dd-100

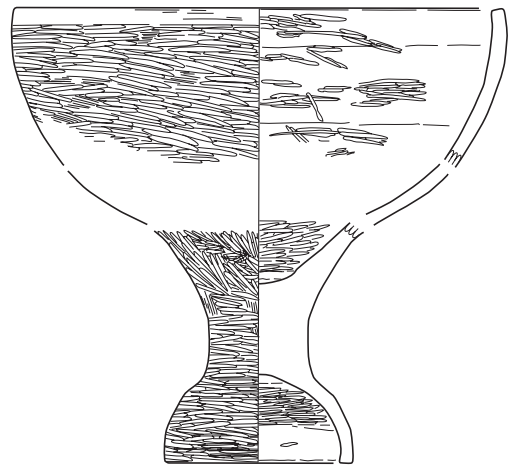

E-02Dd-101

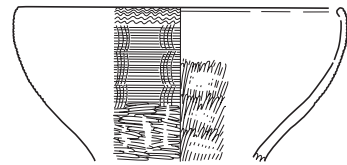

E-02Dd-102



E-02Dd-103

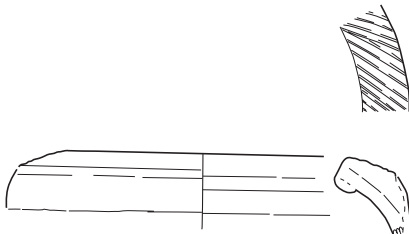

E-02Dd-104

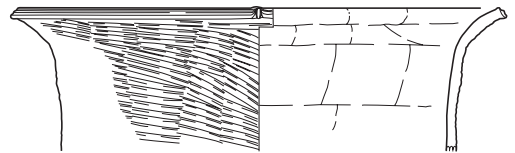

E-02Dd-107

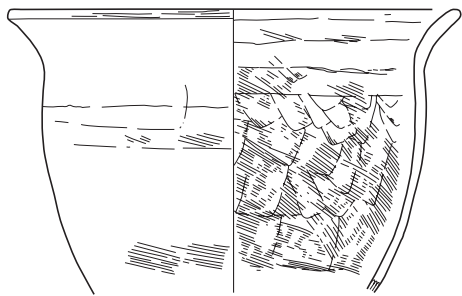

E-02Dd-105

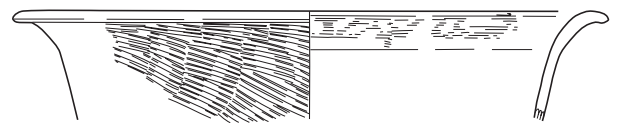

E-02Dd-108

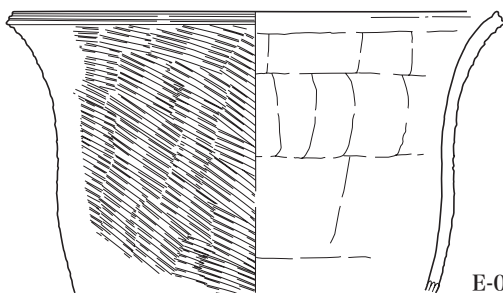

E-02Dd-106

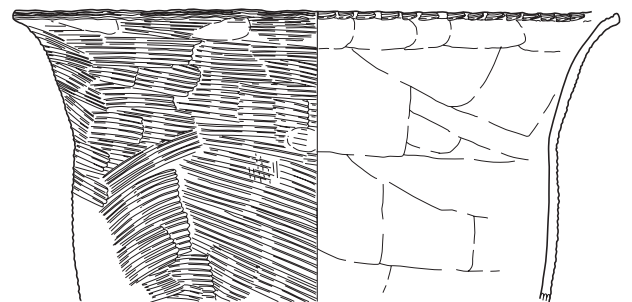

E-02Dd-109



02Dd ☒ SK78

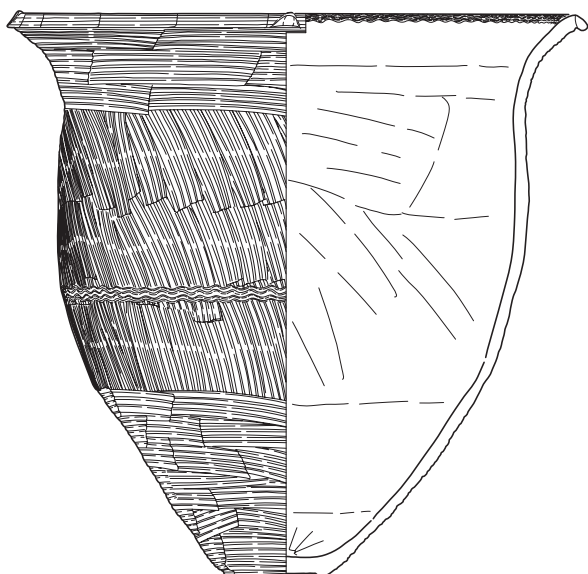

E-02Dd-110

02Dd ☒ SK80

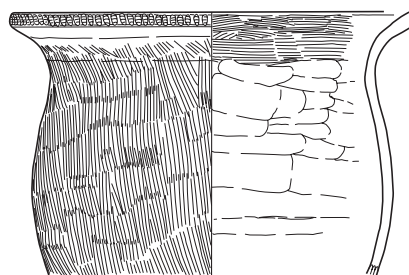

E-02Dd-111

02Dd ☒ SK81

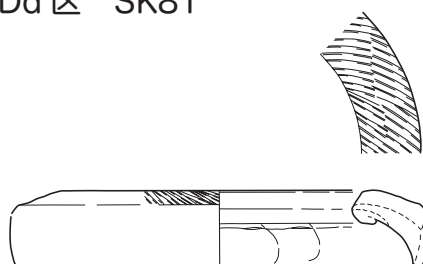

E-02Dd-112

02Dd ☒ SK83

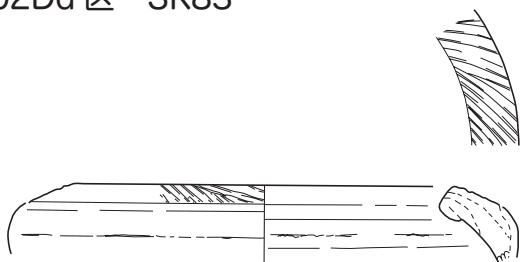

E-02Dd-113

02Dd ☒ SK107

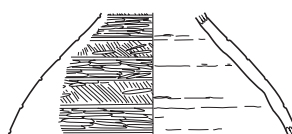

E-02Dd-116



E-02Dd-117

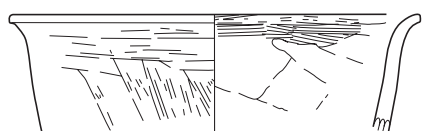

E-02Dd-114

02Dd ☒ SK122

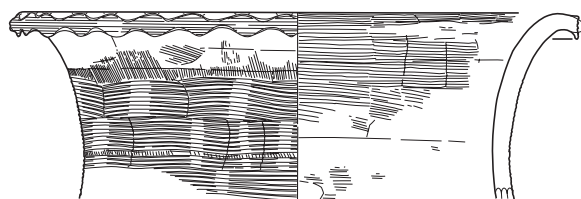

E-02Dd-120

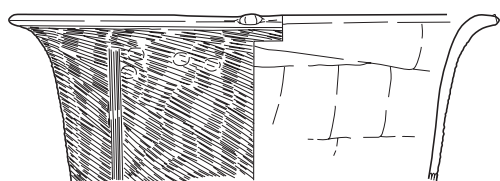

E-02Dd-115

02Dd ☒ SK110

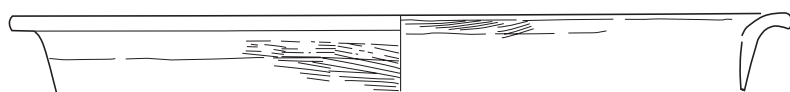

E-02Dd-118



E-02Dd-119

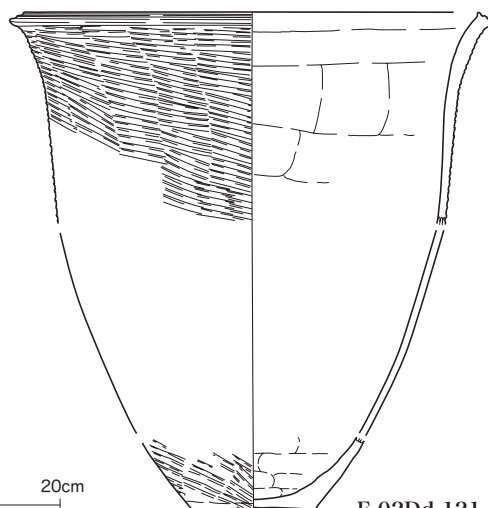

E-02Dd-121



02De ☒ SB01

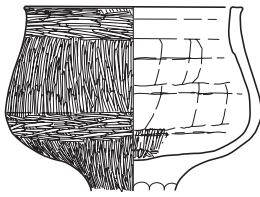

E-02De-001

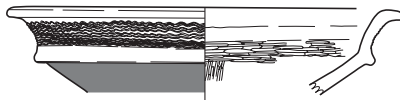

E-02De-003

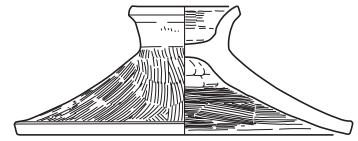

E-02De-006

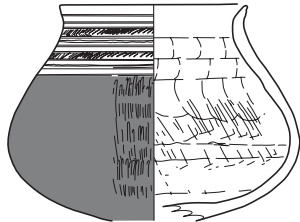

E-02De-002

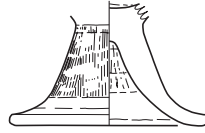

E-02De-004



E-02De-005



E-02De-007

02De ☒ SB02

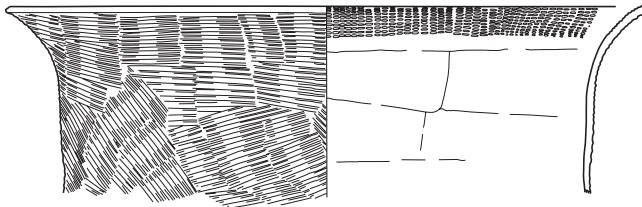

E-02De-008

02De ☒ SD01



E-02De-009

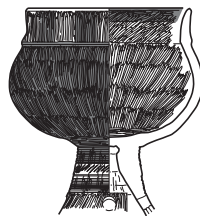

E-02De-011

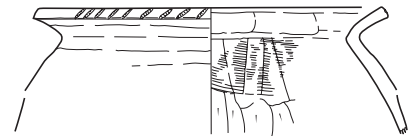

E-02De-013

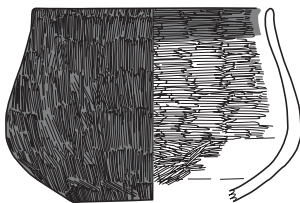

E-02De-010

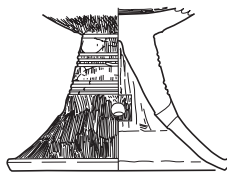

E-02De-012

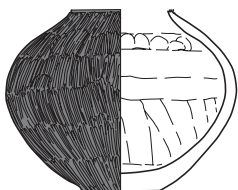

E-02De-014

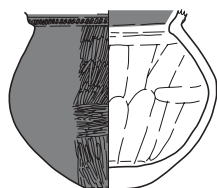

E-02De-015

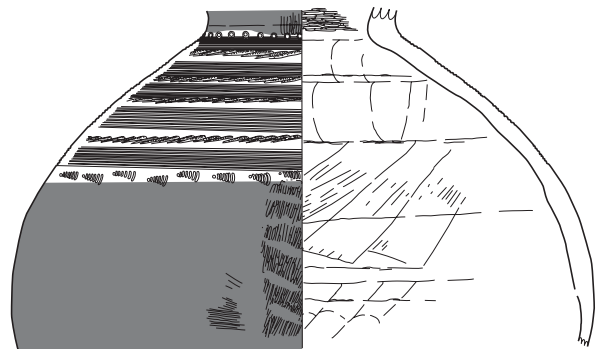

E-02De-016





02De ☒ SD01

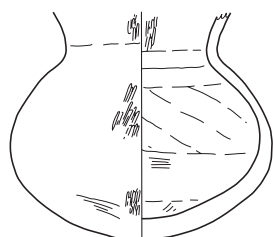

E-02De-017



E-02De-020

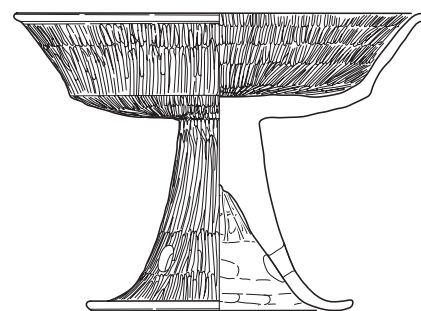

E-02De-023

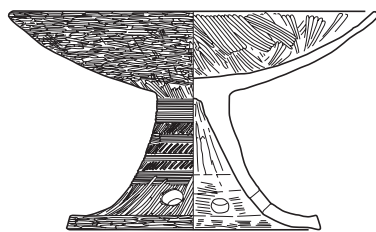

E-02De-018

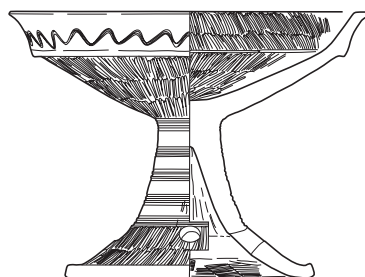

E-02De-021

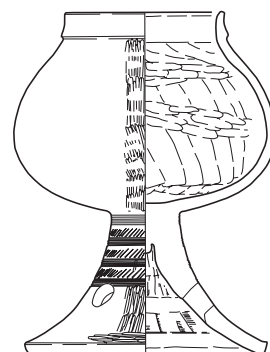

E-02De-024

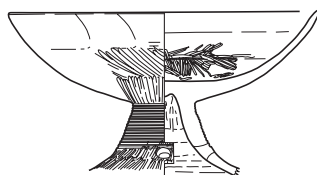

E-02De-019

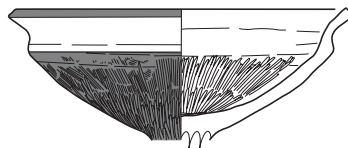

E-02De-022

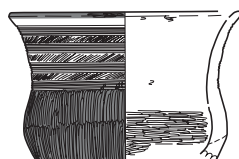

E-02De-025

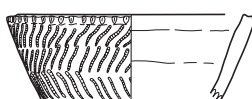

E-02De-027



E-02De-029

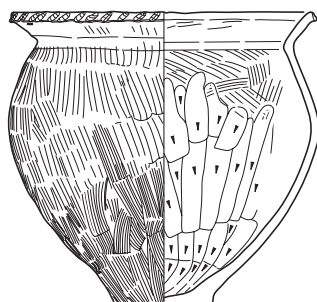

E-02De-026

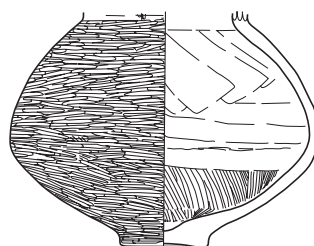

E-02De-028

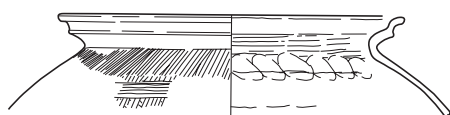

E-02De-030



E-02De-031

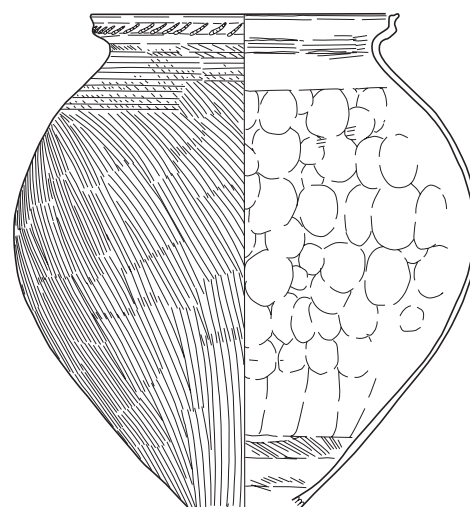

E-02De-032



02De ☒ SK29

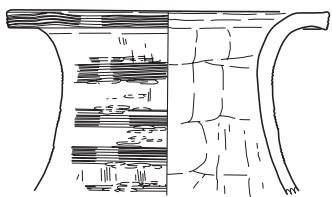

E-02De-033

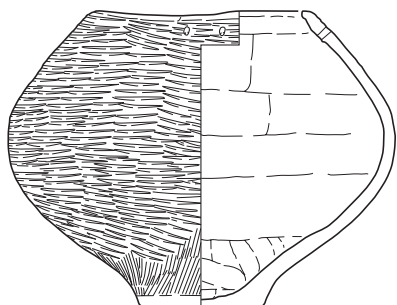

E-02De-034

02De ☒ SK30

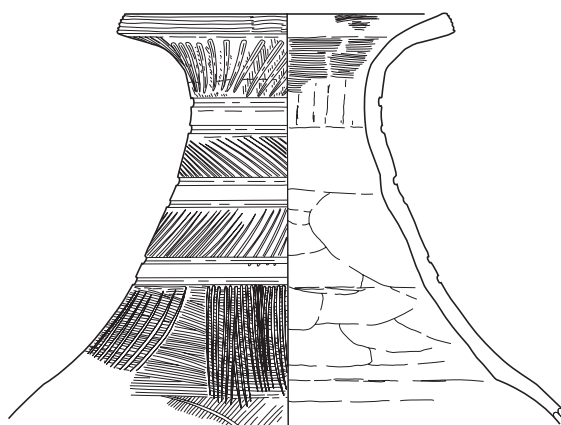

E-02De-035

02De ☒ SK31

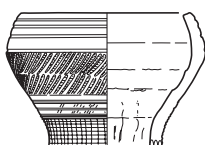

E-02De-036

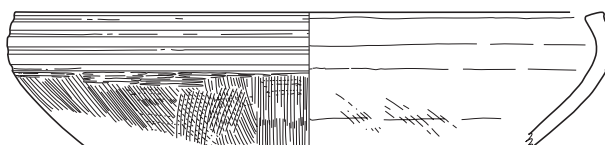

E-02De-037

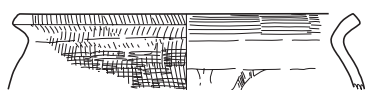

E-02De-038



E-02De-039

02De ☒ SK36

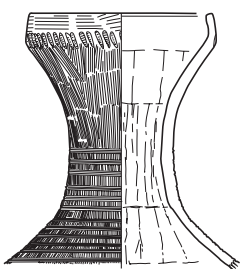

E-02De-040

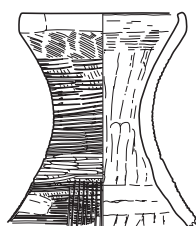

E-02De-041

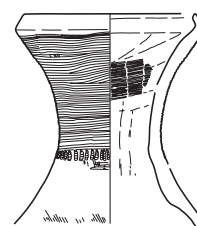

E-02De-042

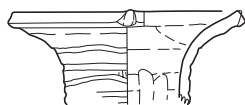

E-02De-043

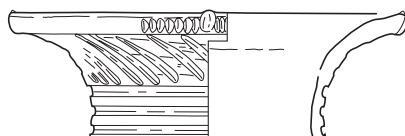

E-02De-044

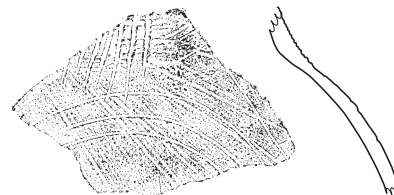

E-02De-046

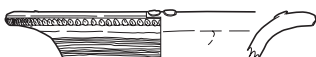

E-02De-045



02De ☒ SK36

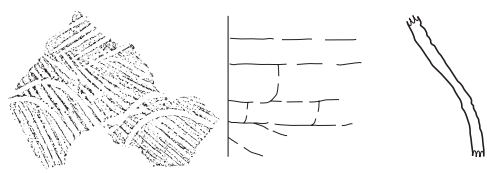

E-02De-047

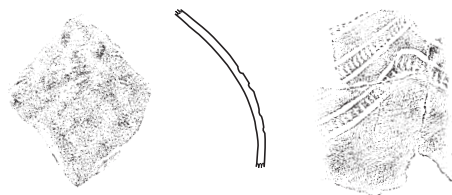

E-02De-048

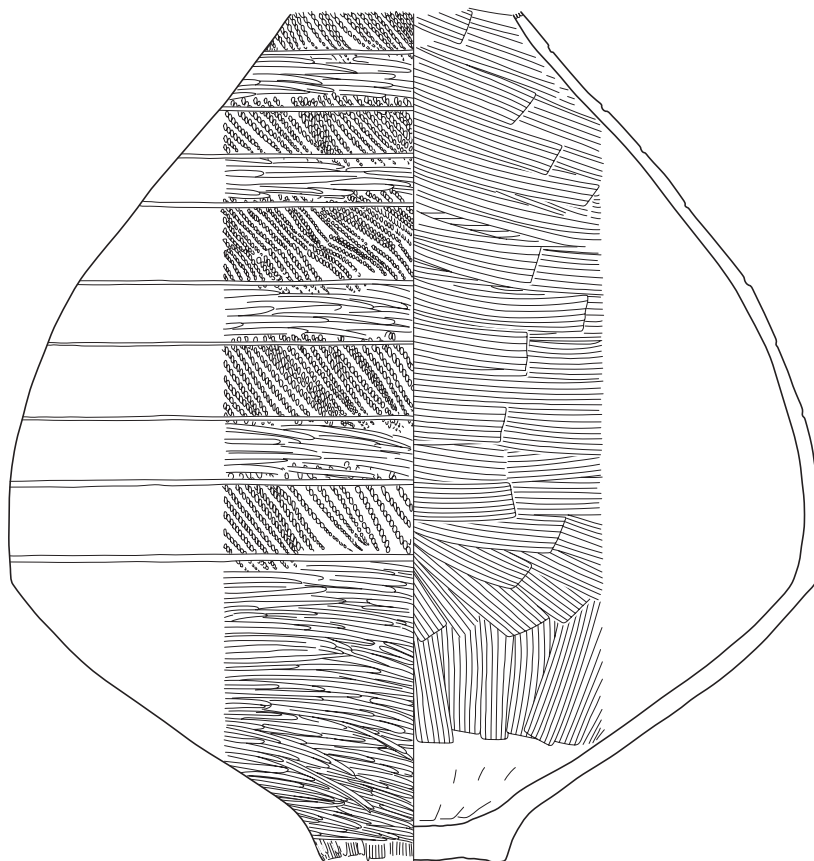

E-02De-049

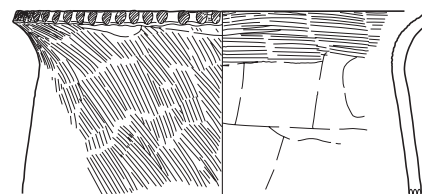

E-02De-051

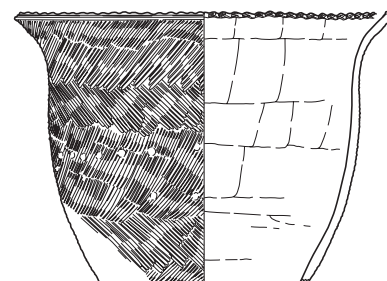

E-02De-052



E-02De-053

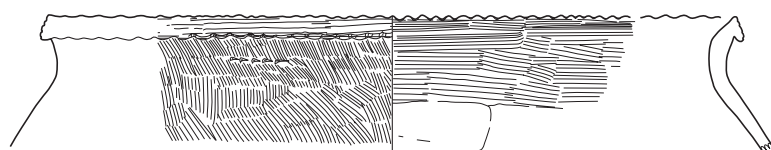

E-02De-050

02De ☒ SK43

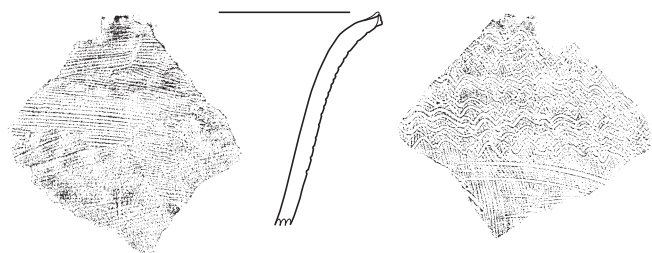

E-02De-054



03Aa ☒ SD03

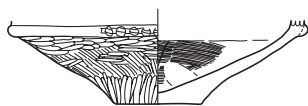

E-03Aa-001



E-03Aa-003

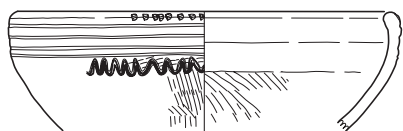

E-03Aa-002

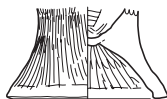

E-03Aa-004

03Aa ☒ SD04

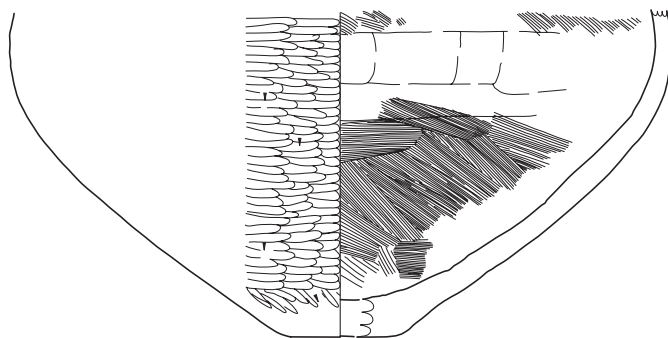

E-03Aa-005

03Ba ☒ SB01

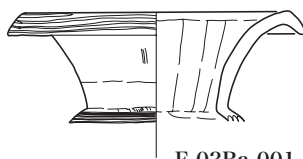

E-03Ba-001

03Ba ☒ SD05



E-03Ba-008

03Ba ☒ SD01

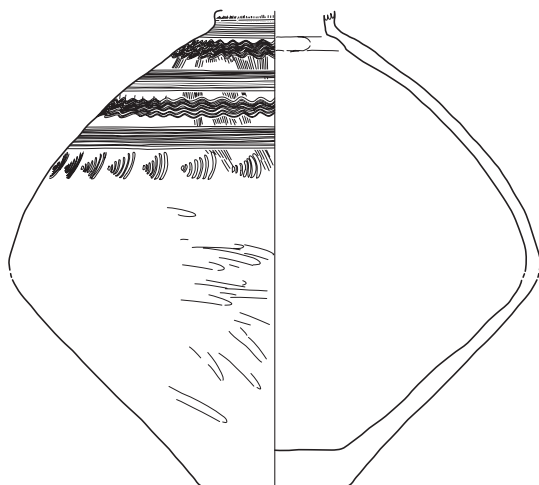

E-03Ba-002

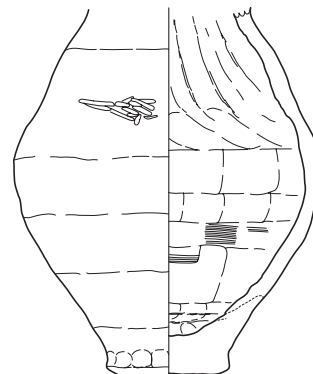

E-03Ba-009

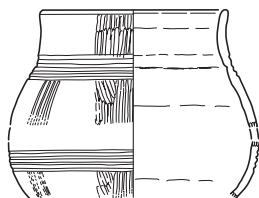

E-03Ba-003

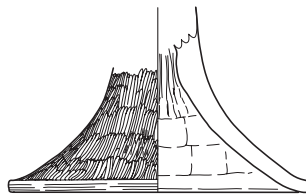

E-03Ba-004



E-03Ba-005

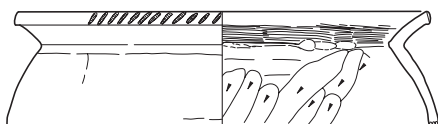

E-03Ba-006

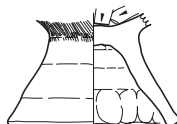

E-03Ba-007

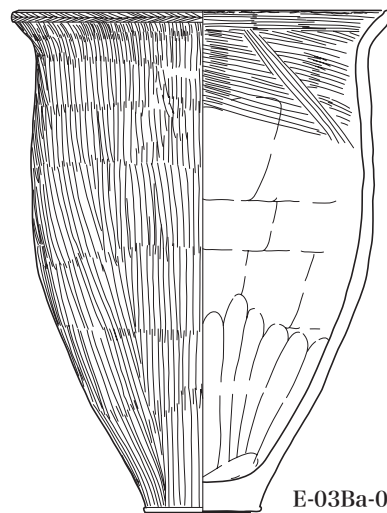

E-03Ba-010



03Ba ☒ SK124

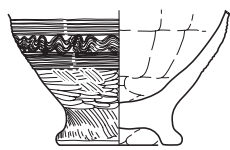

E-03Ba-011

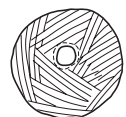
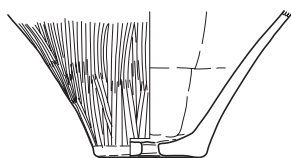

E-03Ba-012

03Ba ☒ SK127

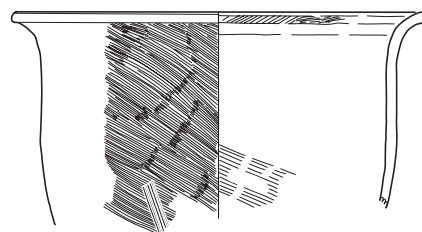

E-03Ba-013

03Ba ☒ SK214

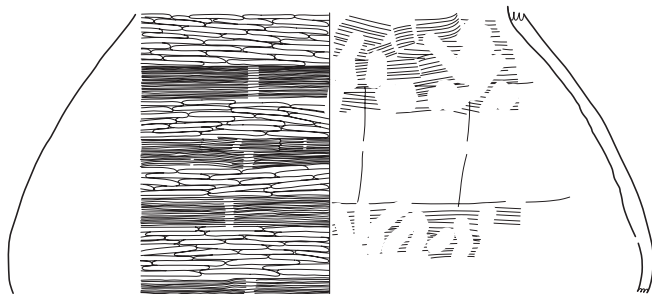

E-03Ba-014

03Ba ☒ SK225

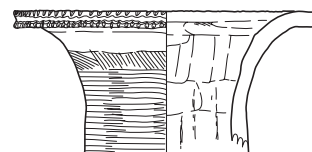

E-03Ba-015

03Ba ☒ ST07

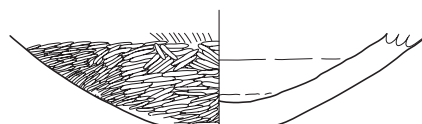

E-03Ba-018

03Ba ☒ ST01

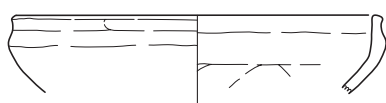

E-03Ba-016

03Ba ☒ ST06



E-03Ba-017

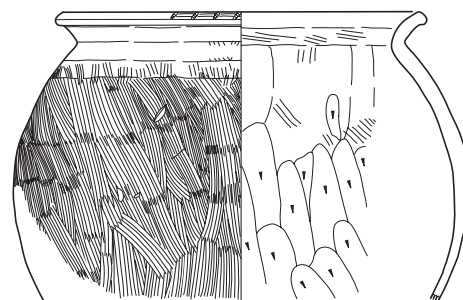

E-03Ba-019

03Bb ☒ SB06

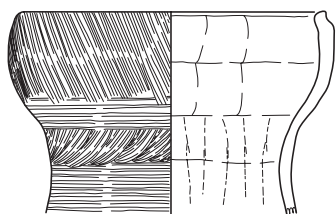

E-03Bb-001

03Bb ☒ SD03

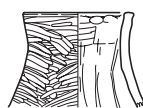

E-03Bb-002

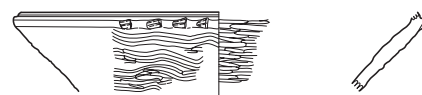

E-03Bb-004

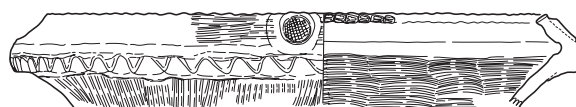

E-03Bb-003

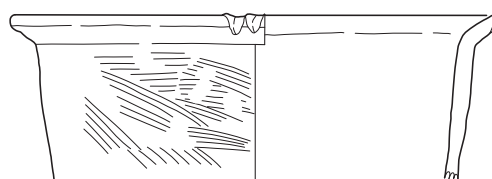

E-03Bb-005



03Bb ☒ SD03

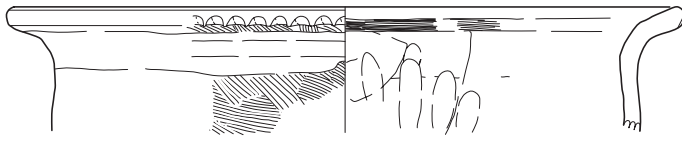

E-03Bb-006

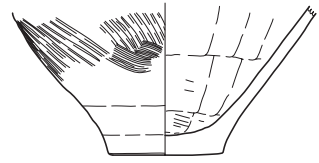

E-03Bb-007

03Bb ☒ SD04

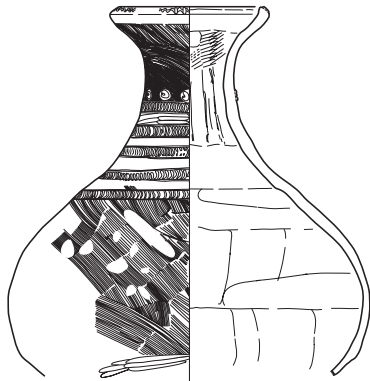

E-03Bb-008

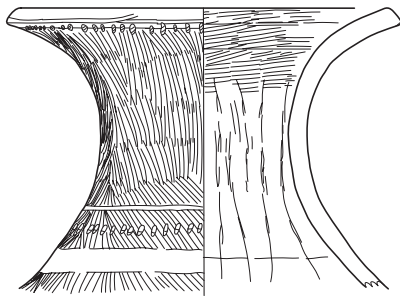

E-03Bb-009

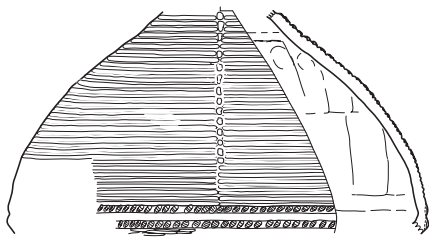

E-03Bb-010



E-03Bb-011

03Bb ☒ SK04

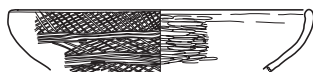

E-03Bb-012

03Bb ☒ SK21

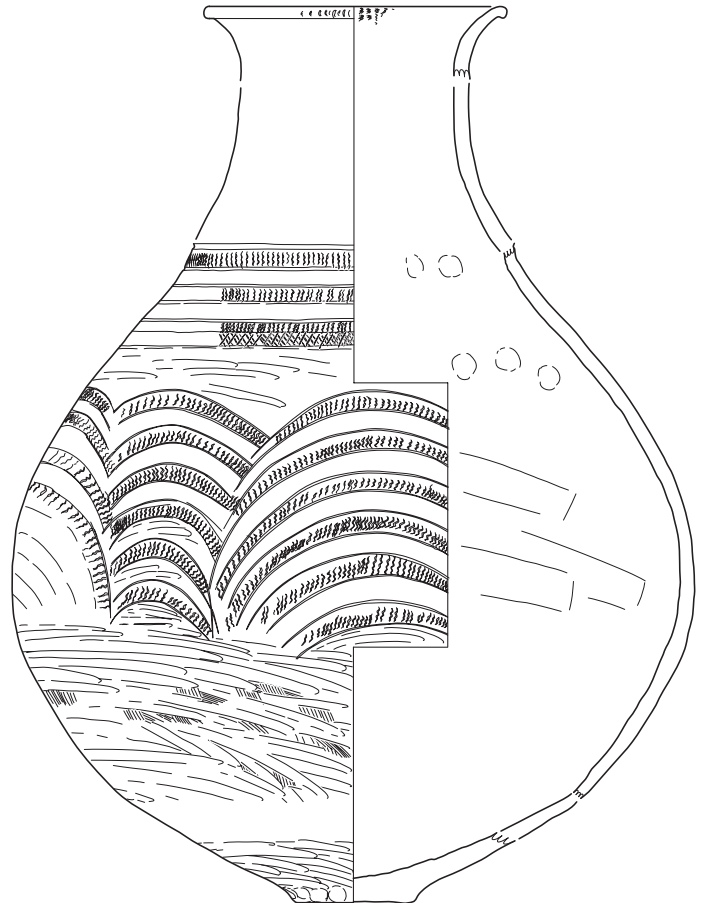

E-03Bb-013

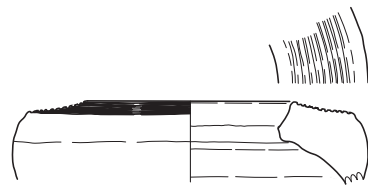

E-03Bb-014

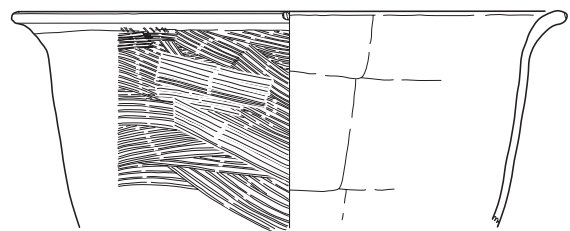

E-03Bb-015



03Bc ☒ SB04

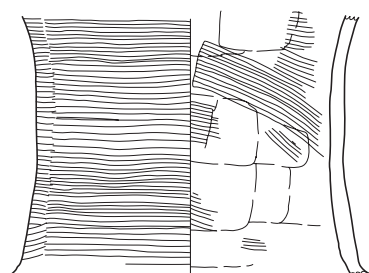

E-03Bc-001

03Bc ☒ SB05

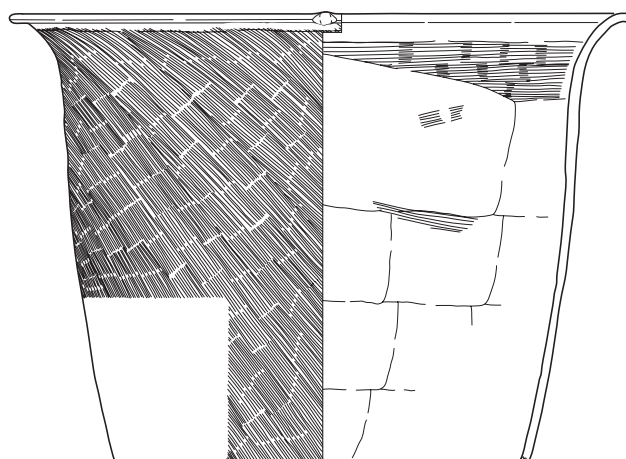

E-03Bc-002

03Bc ☒ SB20

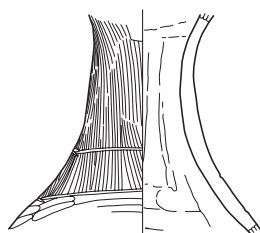

E-03Bc-004

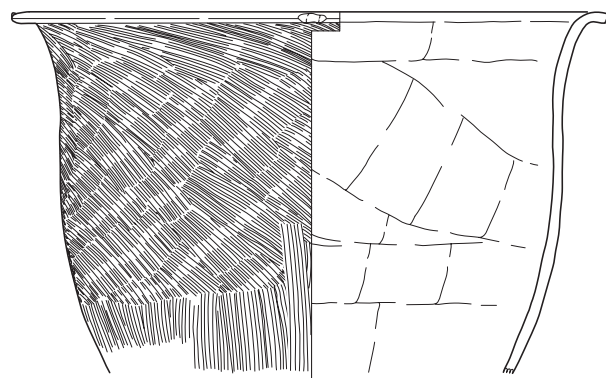

E-03Bc-003

03Bc ☒ SD02



E-03Bc-005

03Bc ☒ SD03

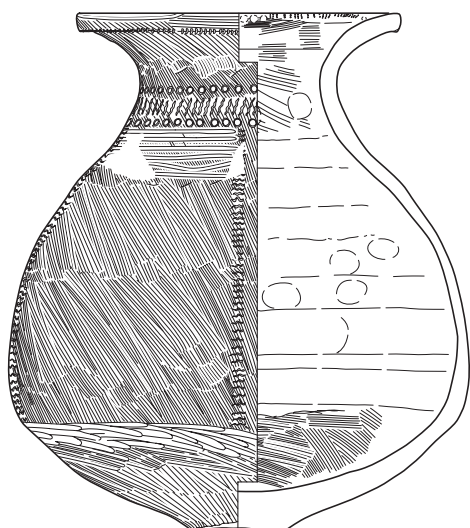

E-03Bc-006

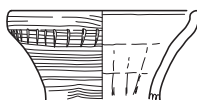

E-03Bc-007



E-03Bc-008

03Bc ☒ SD04

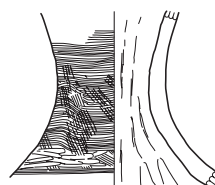

E-03Bc-009

03Bc ☒ SD05

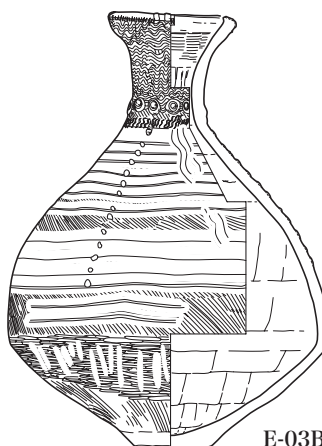

E-03Bc-010

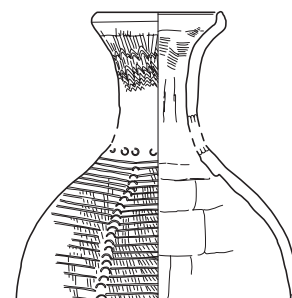

E-03Bc-011



03Bc ☒ SD05

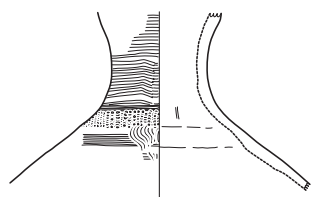

E-03Bc-012

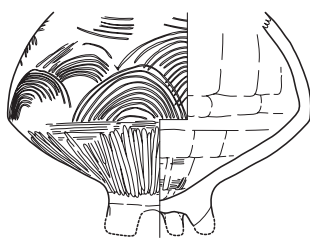

E-03Bc-013

03Bc ☒ SD11

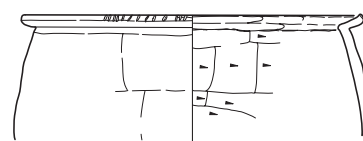

E-03Bc-014

03Bc ☒ SK26

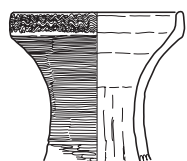

E-03Bc-015



E-03Bc-016

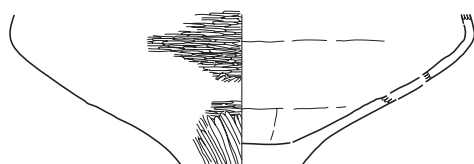

E-03Bc-017

03Bc ☒ SK71



E-03Bc-020

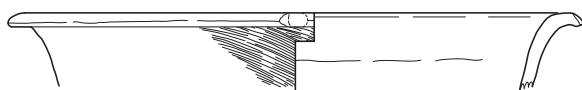

E-03Bc-018

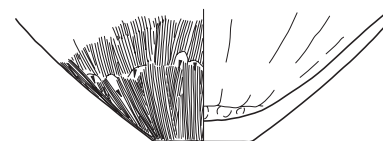

E-03Bc-021

03Bc ☒ SK31

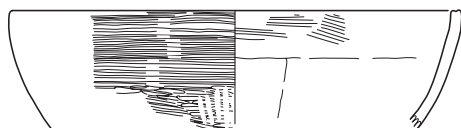

E-03Bc-019



E-03Bc-022

03Bc ☒ SK88



E-03Bc-023

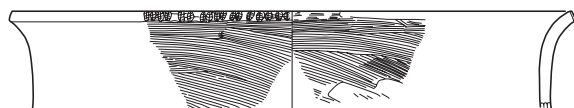

E-03Bc-024



E-03Bc-026

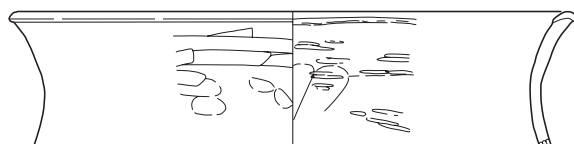

E-03Bc-025





03Bd ☒ SB12

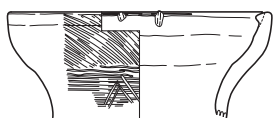

E-03Bd-001

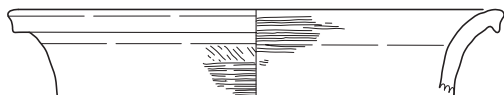

E-03Bd-002

03Bd ☒ SD02

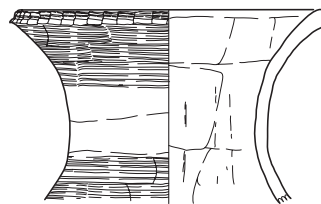

E-03Bd-004

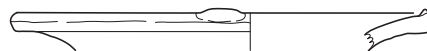

E-03Bd-005

03Bd ☒ SB45

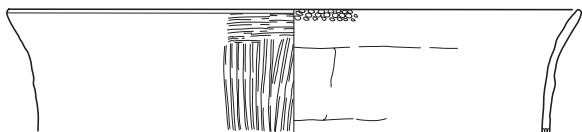

E-03Bd-003

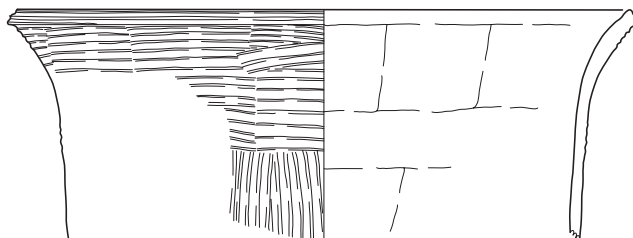

E-03Bd-006

03Bd ☒ SD03

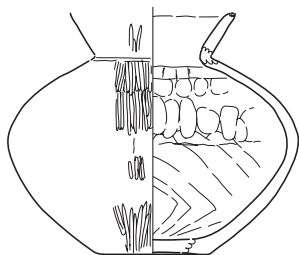

E-03Bd-007

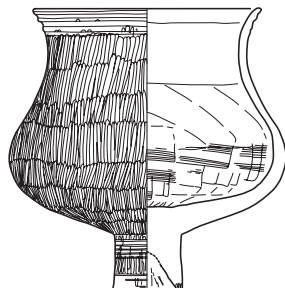

E-03Bd-008

03Bd ☒ SD05

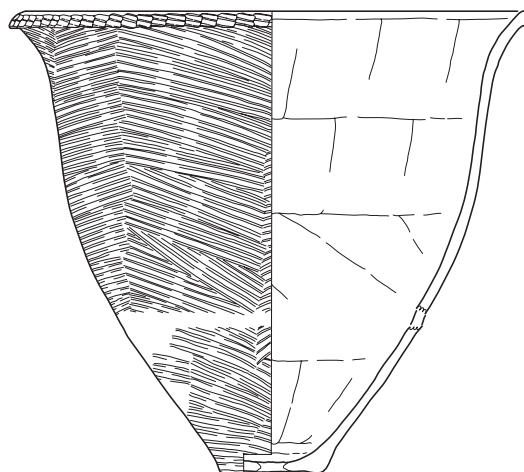

E-03Bd-010

03Bd ☒ SD04

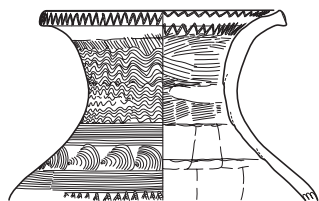

E-03Bd-009

03Bd ☒ SK158

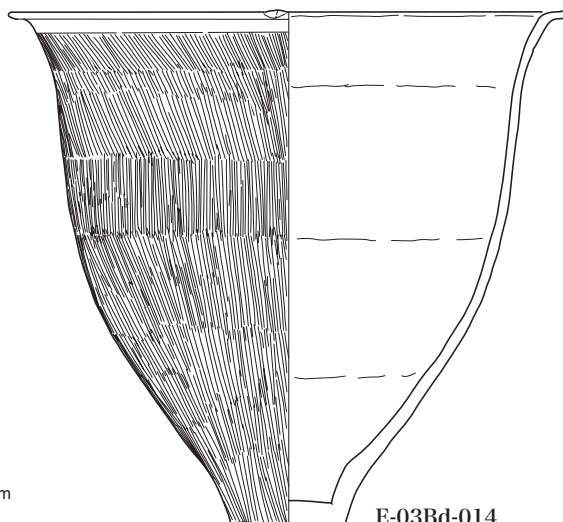

E-03Bd-014

03Bd ☒ SD09



E-03Bd-011

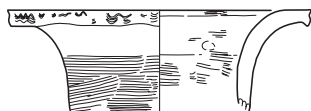

E-03Bd-012

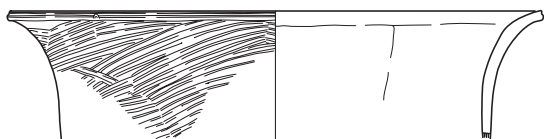

E-03Bd-013



03Ca ☒ NR01

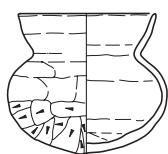

E-03Ca-001

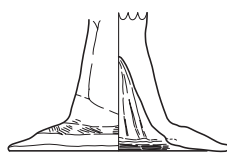

E-03Ca-002



E-03Ca-003

03Ca ☒ NR02



E-03Ca-004

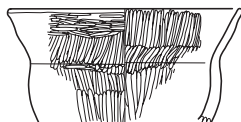

E-03Ca-007

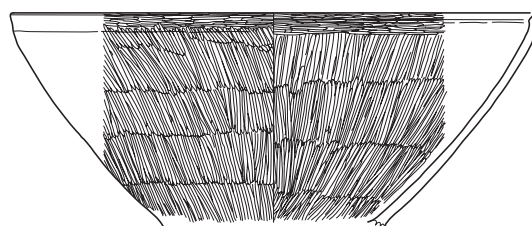

E-03Ca-010

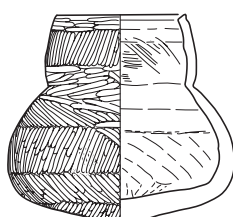

E-03Ca-005

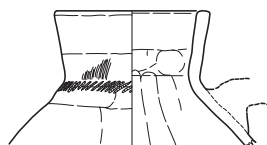

E-03Ca-008

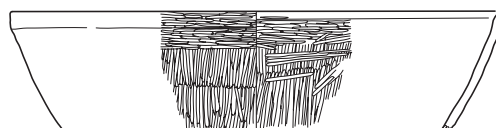

E-03Ca-011

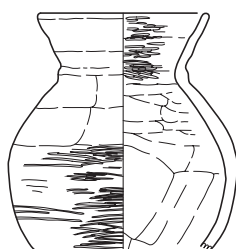

E-03Ca-006



E-03Ca-009

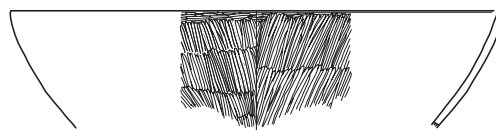

E-03Ca-012

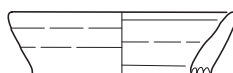

E-03Ca-013

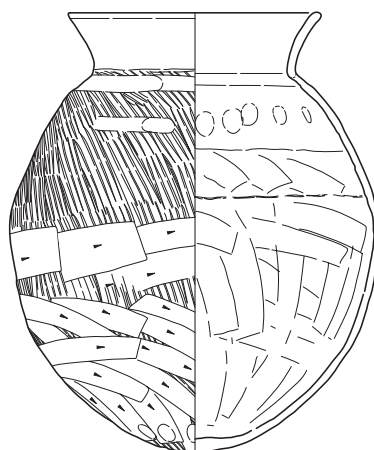

E-03Ca-016

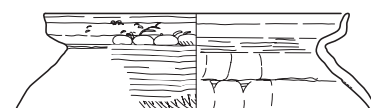

E-03Ca-017



E-03Ca-014

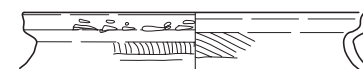

E-03Ca-018

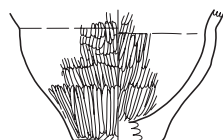

E-03Ca-015

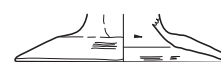

E-03Ca-019

03Cb ☒ SD01



E-03Cb-001



E-03Cb-002

03Da ☒ ST09

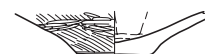

E-03Da-001



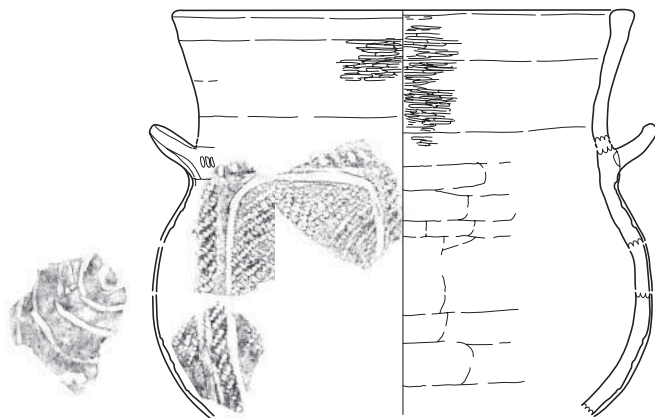

E-02Cg-701



E-03Bc-701



E-03Bc-702

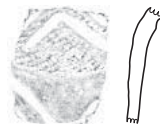

E-99Ac-701



E-02Bb-701

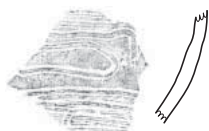

E-02Db-701

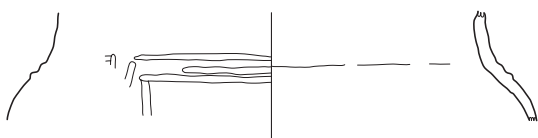

E-02Db-702

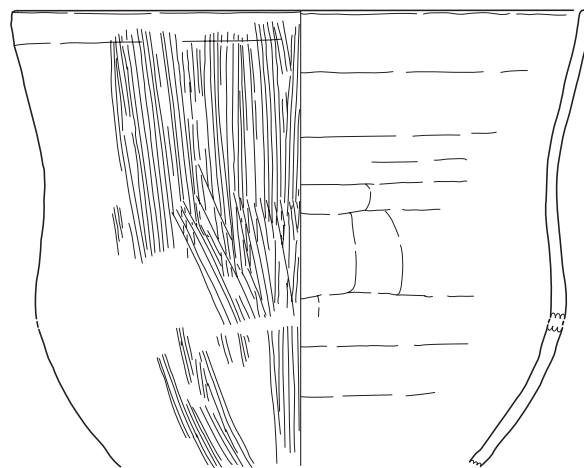

E-03Bd-701



台盤状土製品  
脚台状のもの

中実のもの

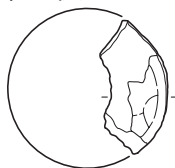

E-01Da-501



E-01Db-501

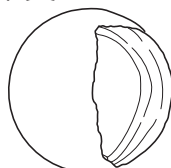

E-02Db-501

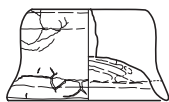

E-99Ab-501

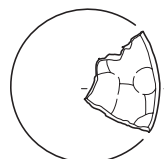

E-99Ac-501

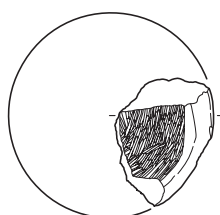

E-01Aa-501

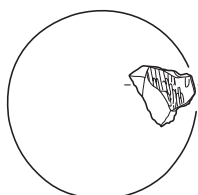

E-01Aa-502

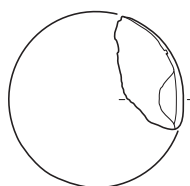

E-01Ab-501

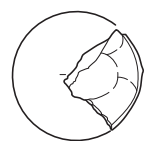
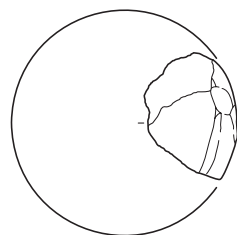

E-01Ad-501

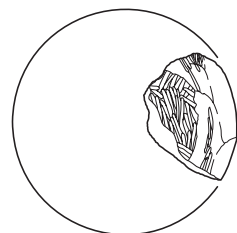

E-01Ab-502

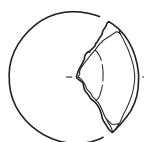

E-01Ad-502



E-01Ad-503

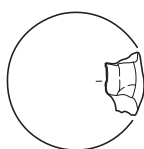

E-01Da-502

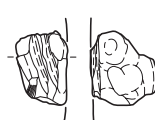

E-01Db-502



E-01Dc-501

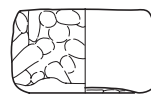

E-01Dc-502

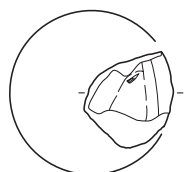

E-02Ac-501

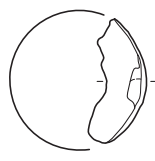

E-02Cc-501

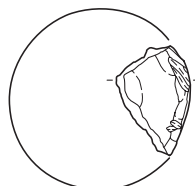

E-02Da-501

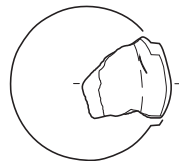

E-02Db-502

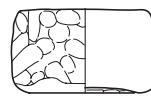
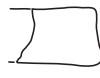

E-02Db-503

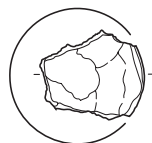

E-02Cg-501



紡錘車

柱状の物

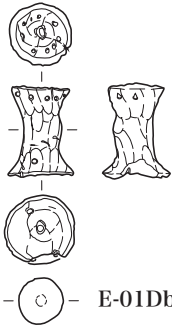

E-01Db-503

縦断面が菱形の物

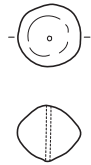

E-02Dd-501

板状の物

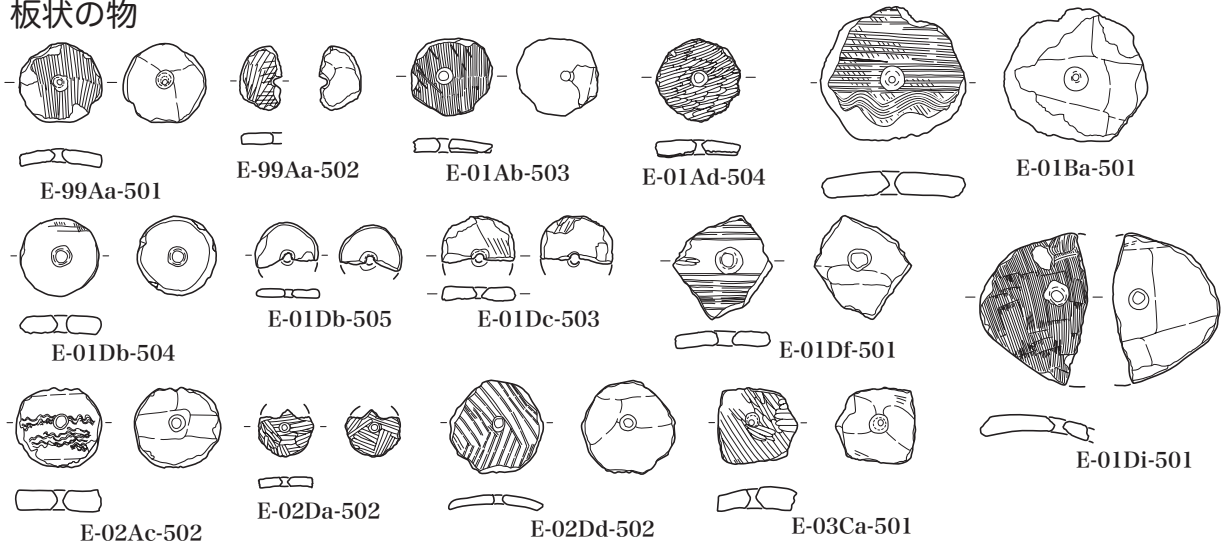

加工円盤

研磨面がある物 (A)

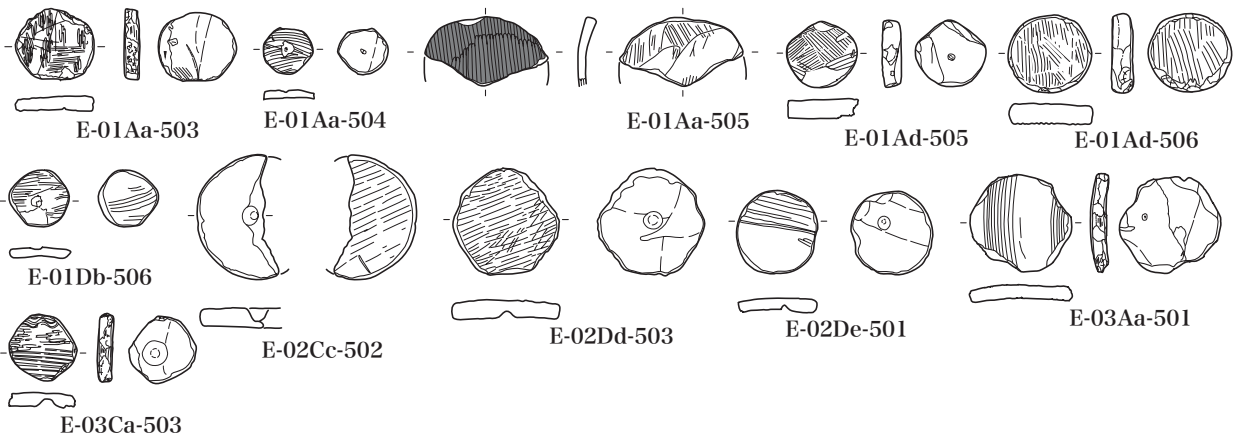

縁辺に研磨面のある可能性がある物 (但し縁辺が多く摩滅している) (B)

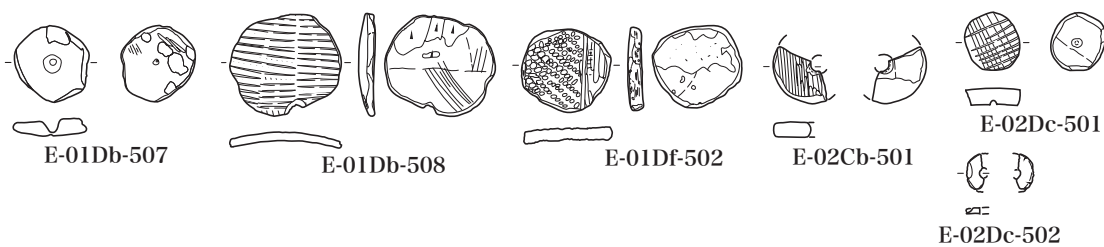

加工円盤

摩滅面が縁辺に複数ある物 (C)

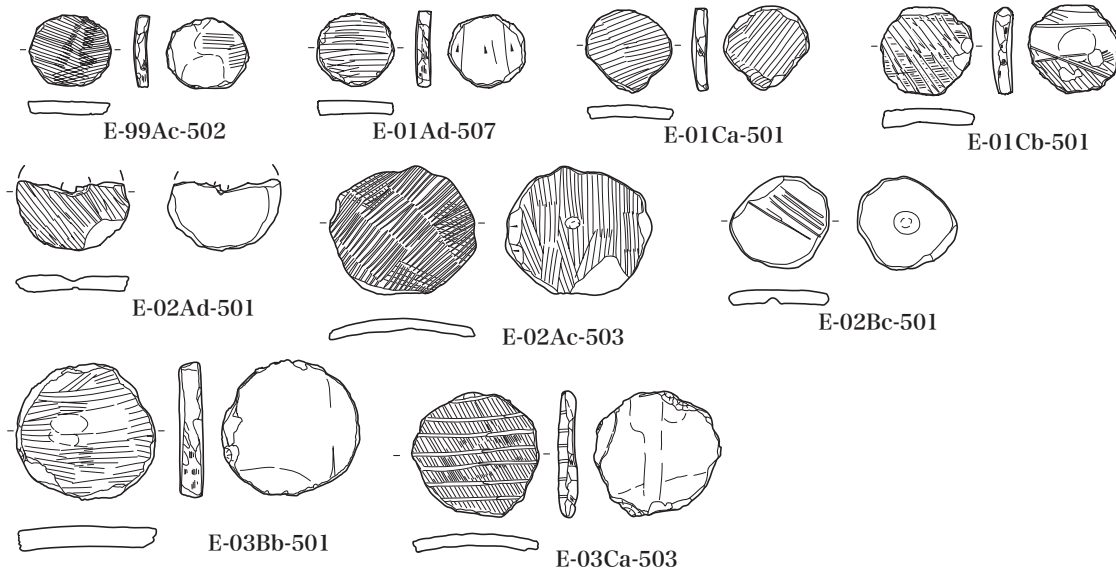

縁辺が破面のみ物 (D)

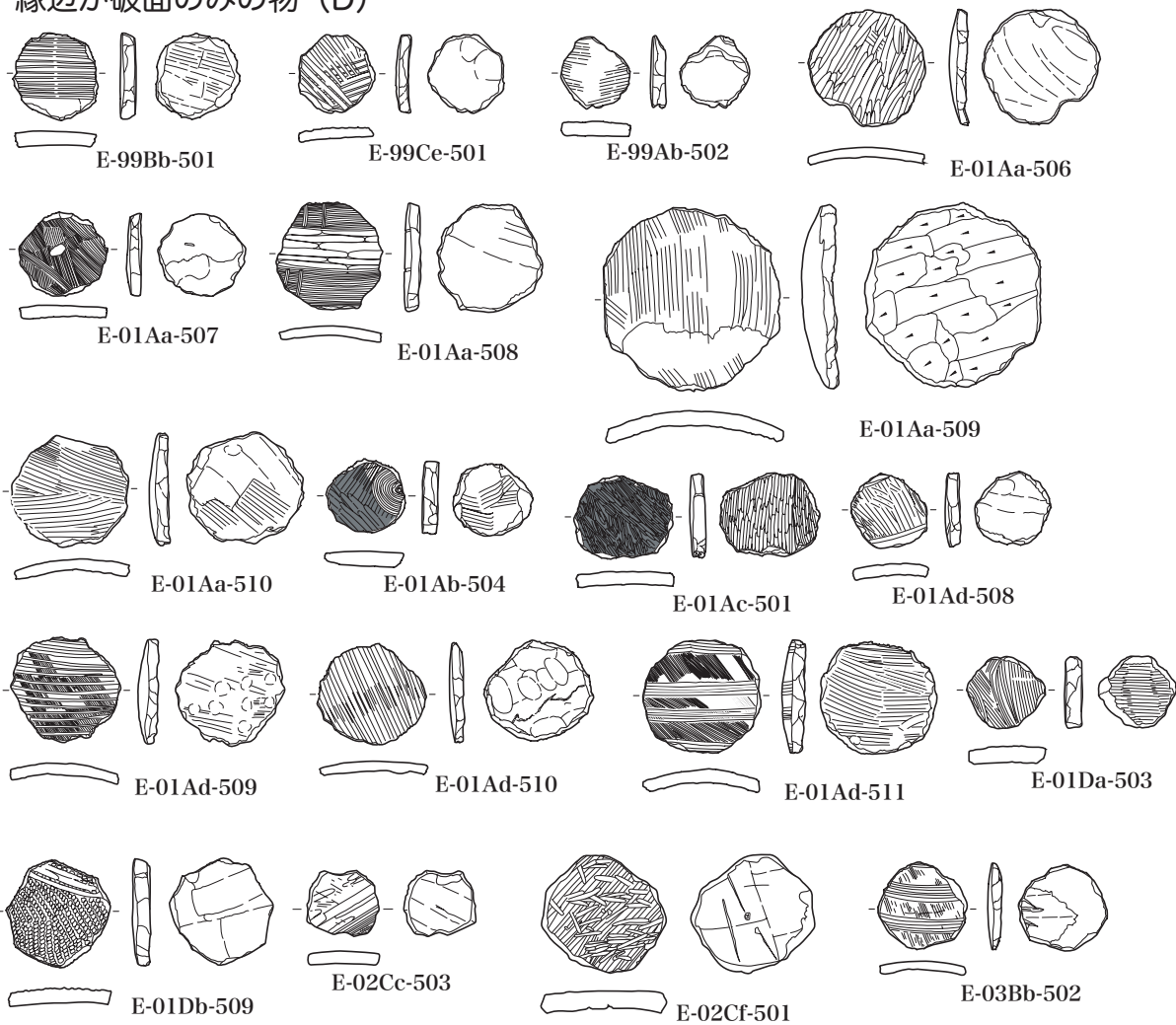

砥土器

研磨条線を持つタイプ / 曲面タイプ

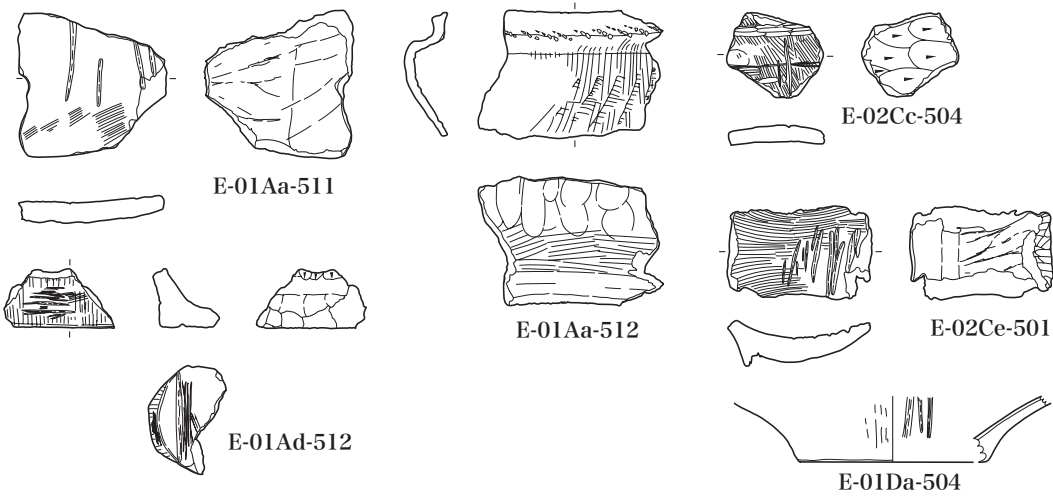

研磨条線を持つタイプ / 平タイプ

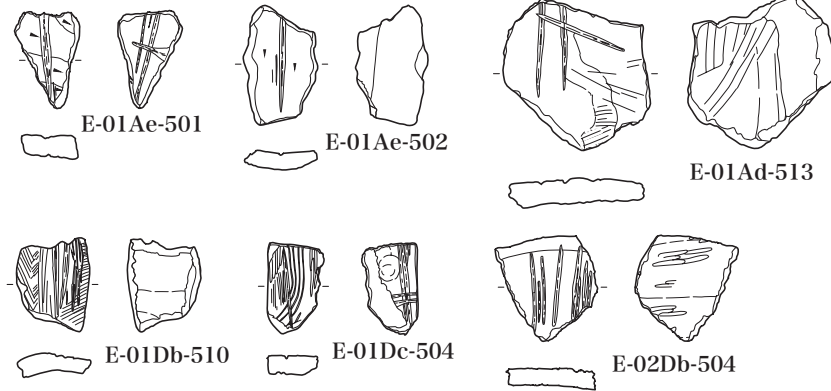

研磨面を持つタイプ



研磨面を持って研磨条線を持つタイプ / 平タイプ

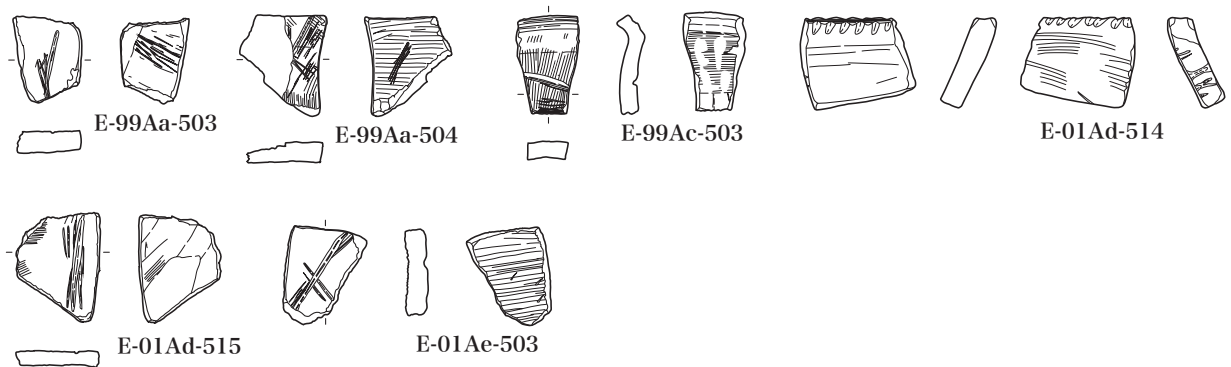

ミニチュア土器

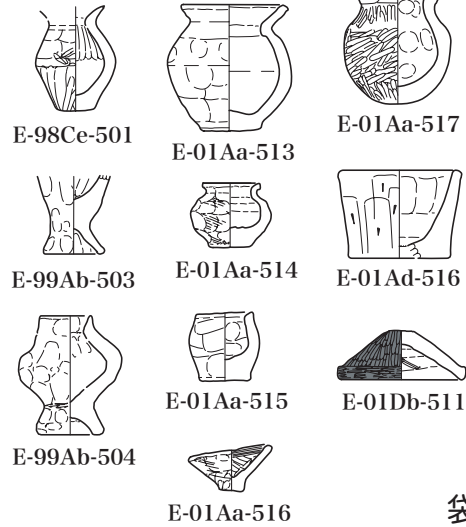

動物形土製品

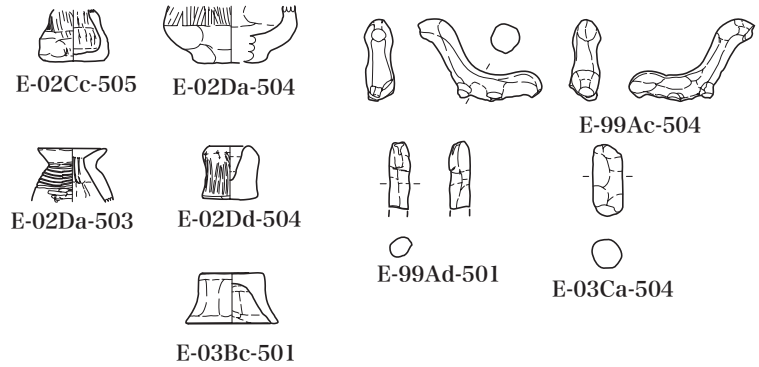

コップ状土器

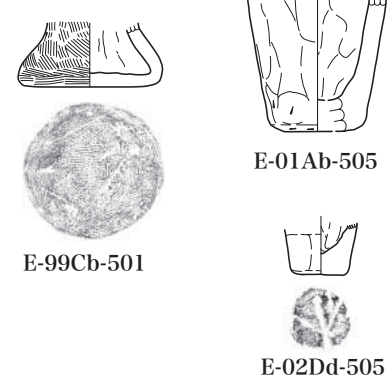

袋形土製品

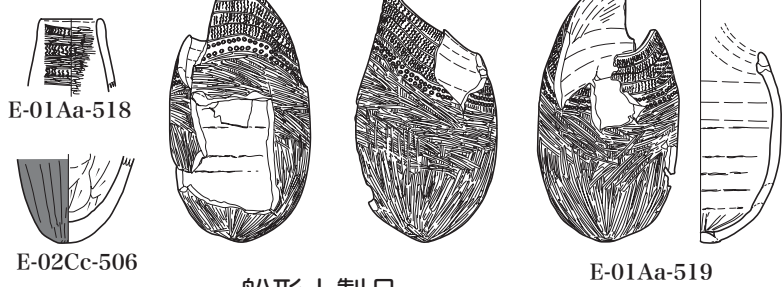

船形土製品



鳥形土製品

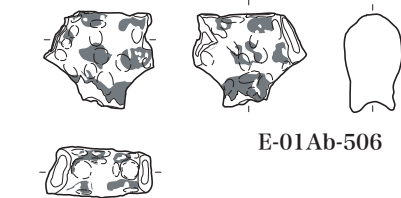

分銅形土製品

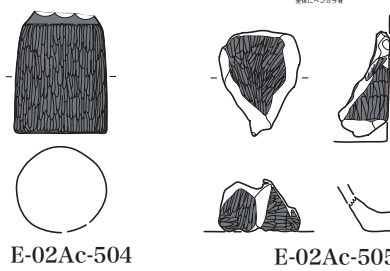

その他・赤彩土製品

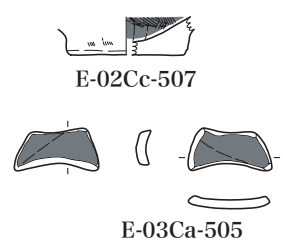

線刻・絵画土器

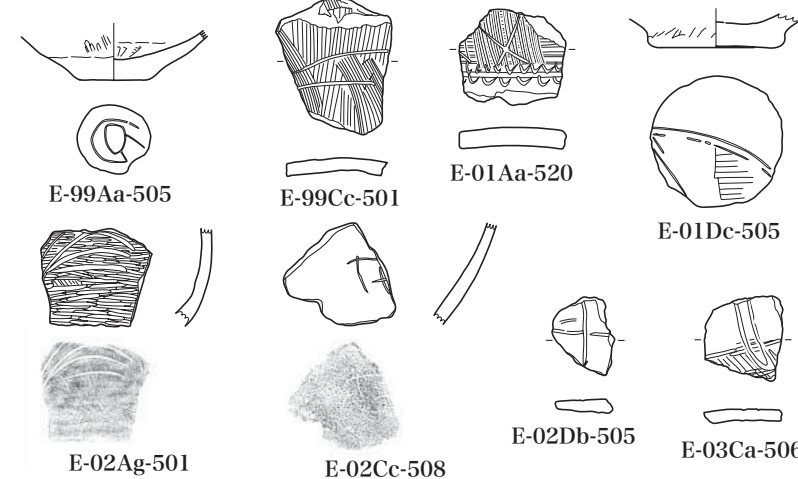

有孔土製品

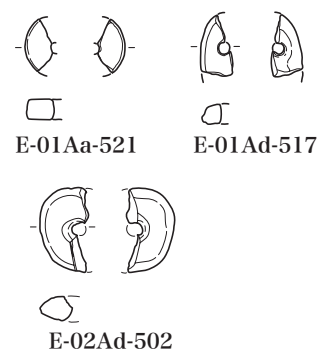



有孔蓋形土器

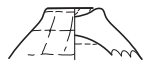

E-99Ac-505

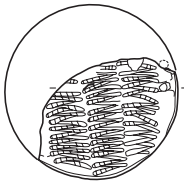

E-99Ae-502



E-01Ac-502



E-02Dd-506

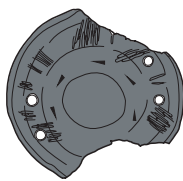
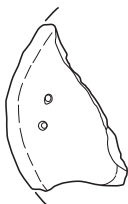

E-01Aa-522



E-01Aa-523



E-01Ab-507

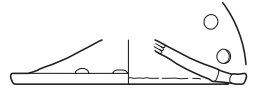

E-01Ab-508



E-99Bb-502

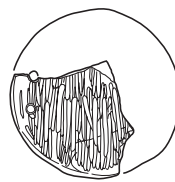

E-02Ac-506

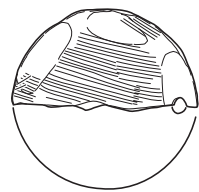
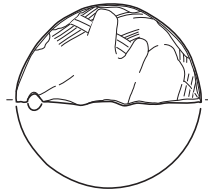

E-02Ba-501

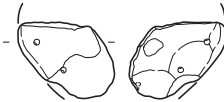

E-03Bc-502

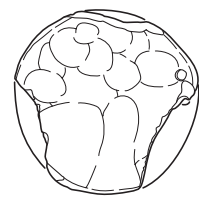
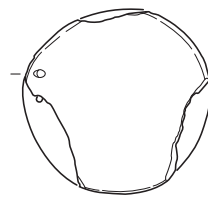

E-03Bd-501

玉形土製品



E-01Ae-504



E-99Ab-505



E-99Ac-506

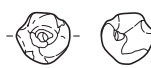

E-01Ca-502



E-02Cc-509



E-02Db-506

錘形土製品

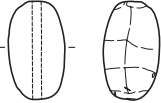

E-01Ad-518

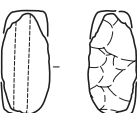

E-01Bc-501

その他・土器

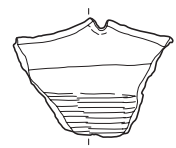

E-01Aa-524



E-01Aa-525

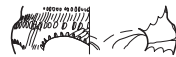
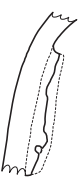

E-01Aa-526



E-02Bg-501



古代以後の陶磁器

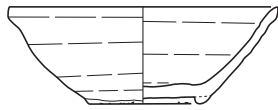

E-99Cb-601

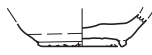

E-01Aa-601



E-01Aa-602

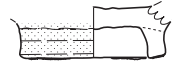

E-01Aa-603

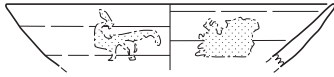

E-01Aa-604



E-01Aa-605

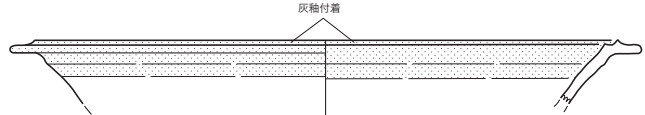

E-01Aa-608

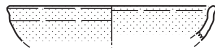

E-01Aa-606

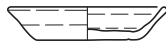

E-01Aa-607



E-01Aa-609

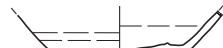

E-01Aa-610



E-01Aa-611

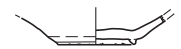

E-01Aa-612

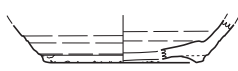

E-01Aa-613

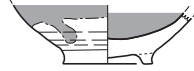

E-01Aa-614

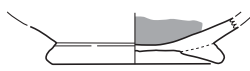

E-01Aa-615

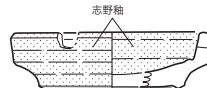

E-01Aa-616

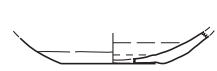

E-01Aa-617



E-01Ba-601



E-01Ca-601

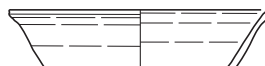

E-01Ca-602

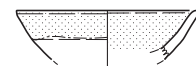

E-01Ca-603

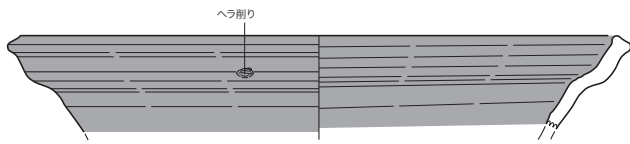

E-01Da-601

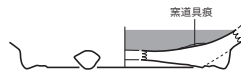

E-01Da-602



E-01Da-603

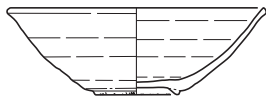

E-01Df-601



E-01Df-602

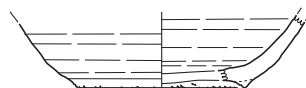

E-01Dh-601



E-01Dh-602



E-01Df-601

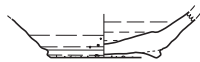

E-02Ac-601



E-02Ac-602

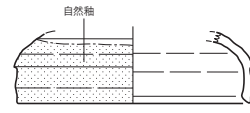

E-02Bb-601

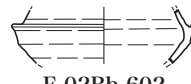

E-02Bb-602

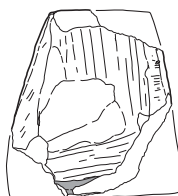
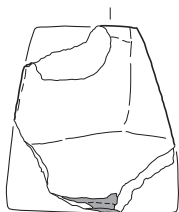

E-02Bh-601

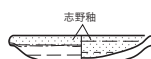

E-02Bj-601



E-02Cb-601

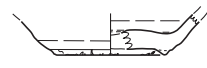

E-02Cb-602

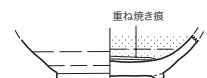

E-02Cg-601



E-02Cb-601



古代以後の陶磁器

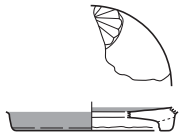

E-02Dc-601



E-02Dc-602



E-02De-601



E-03Ca-601

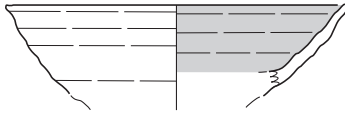

E-03Ca-603

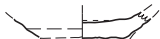

E-03Ca-602

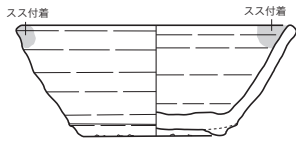

E-03Ca-604

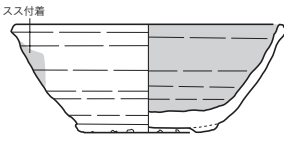

E-03Ca-605

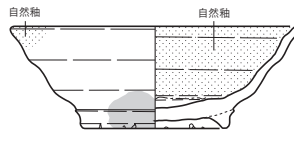

E-03Ca-606

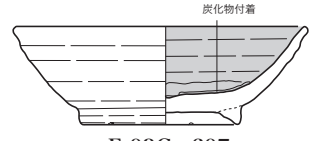

E-03Ca-607

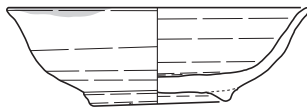

E-03Ca-608

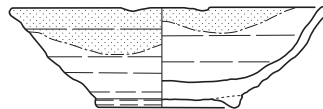

E-03Ca-609

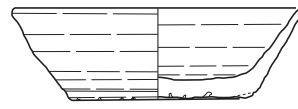

E-03Ca-610

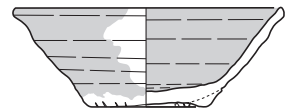

E-03Ca-611

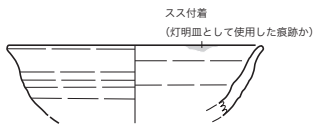

E-03Ca-612

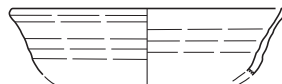

E-03Ca-613

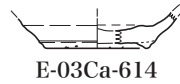

E-03Ca-614

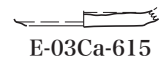

E-03Ca-615

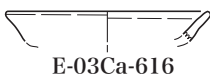

E-03Ca-616

錘形土製品



E-99Cb-602

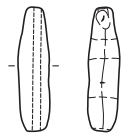

E-03Ca-617

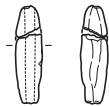

E-03Ca-618

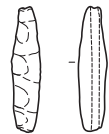

E-03Ca-619

